

A review of fuel cell systems for maritime applications

van Biert, Lindert; Godjevac, M.; Visser, K.; Purushothaman Vellayani, A.

DOI

[10.1016/j.jpowsour.2016.07.007](https://doi.org/10.1016/j.jpowsour.2016.07.007)

Publication date

2016

Document Version

Final published version

Published in

Journal of Power Sources

Citation (APA)

van Biert, L., Godjevac, M., Visser, K., & Purushothaman Vellayani, A. (2016). A review of fuel cell systems for maritime applications. *Journal of Power Sources*, 327, 345-364.
<https://doi.org/10.1016/j.jpowsour.2016.07.007>

Important note

To cite this publication, please use the final published version (if applicable).
Please check the document version above.

Copyright

Other than for strictly personal use, it is not permitted to download, forward or distribute the text or part of it, without the consent of the author(s) and/or copyright holder(s), unless the work is under an open content license such as Creative Commons.

Takedown policy

Please contact us and provide details if you believe this document breaches copyrights.
We will remove access to the work immediately and investigate your claim.



Review article

A review of fuel cell systems for maritime applications

L. van Biert^{a, b, *}, M. Godjevac^a, K. Visser^a, P.V. Aravind^b^a Department of Maritime & Transport Technology, Delft University of Technology, Mekelweg 2, 2628 CD, Delft, The Netherlands^b Department of Process & Energy, Delft University of Technology, Leeghwaterstraat 39, 2628 CB, Delft, The Netherlands

HIGHLIGHTS

- An overview is provided of logistic fuels, fuel processing and fuel cell systems.
- Fuel cell systems are reviewed with regard to maritime power generation requirements.
- The most suitable fuel cell system may depend on a ship's operational requirements.
- Fuel cell application can reduce pollutant emissions from shipping significantly.
- Power density, economics and classification standards need further improvement.

ARTICLE INFO

Article history:

Received 11 March 2016
 Received in revised form
 1 July 2016
 Accepted 2 July 2016
 Available online 27 July 2016

Keywords:

Fuel cells
 Logistic fuels
 Fuel processing
 Ships
 Maritime application
 Emissions

ABSTRACT

Progressing limits on pollutant emissions oblige ship owners to reduce the environmental impact of their operations. Fuel cells may provide a suitable solution, since they are fuel efficient while they emit few hazardous compounds. Various choices can be made with regard to the type of fuel cell system and logistic fuel, and it is unclear which have the best prospects for maritime application. An overview of fuel cell types and fuel processing equipment is presented, and maritime fuel cell application is reviewed with regard to efficiency, gravimetric and volumetric density, dynamic behaviour, environmental impact, safety and economics. It is shown that low temperature fuel cells using liquefied hydrogen provide a compact solution for ships with a refuelling interval up to a tens of hours, but may result in total system sizes up to five times larger than high temperature fuel cells and more energy dense fuels for vessels with longer mission requirements. The expanding infrastructure of liquefied natural gas and development state of natural gas-fuelled fuel cell systems can facilitate the introduction of gaseous fuels and fuel cells on ships. Fuel cell combined cycles, hybridisation with auxiliary electricity storage systems and redundancy improvements are identified as topics for further study.

© 2016 Elsevier B.V. All rights reserved.

1. Introduction

Technology improvements in recent decades have reduced the fuel consumption and environmental impact of ships. However, shipping remains a significant contributor to global emissions of greenhouse gases (GHGs), volatile organic compounds (VOCs), particulate matter (PM), hazardous air pollutants, NO_x and SO_x. It is estimated that shipping activities contribute to 3–5% of global carbon dioxide (CO₂) emissions and over 5% of global SO_x emissions [1]. State of the art propulsion technology in shipping has not kept pace with road transport for various reasons, the most important

being the absence of strict regulations on environmental impact at sea [2,3].

With cost of ownership being the main technology driver, economical but polluting diesel engines and cheap heavy fuels have become default choices for maritime power generation. Recently announced regulations are, however, set to change the common practice in maritime power generation. Although eventually postponed to 2021, the international maritime organization (IMO) recently adopted stringent emission limits in its Tier III regulation, most notably on NO_x and SO_x emissions. For emission control areas (ECAs) these requirements are particularly strict and will be difficult to meet with traditional diesel engines and bunker fuels [4]. Ship owners need to adopt solutions to bring exhaust emissions within these and other future limits.

There are several ways to reduce emission levels from shipping.

* Corresponding author. Department of Maritime & Transport Technology, Delft University of Technology, Mekelweg 2, 2628 CD, Delft, The Netherlands.

E-mail address: l.vanbiert@tudelft.nl (L. van Biert).

These include: engine improvements, such as exhaust gas recirculation, two stage turbocharging, late miller timing, smart combustion chamber design and advanced fuel injection systems [5,6]; exhaust gas aftertreatment, like scrubbers or selective catalytic reduction; and finally the use of different bunker fuels, for example low sulphur diesel or liquefied natural gas (LNG) [7–9]. A combination of these methods will be required, and this is likely to increase size, complexity, fuel consumption and maintenance of maritime power plants [10]. Therefore, clean and efficient alternatives for internal combustion engines are highly desired.

Among the possible alternatives, fuel cells are considered to be one of the most promising future technologies [11]. Fuel cell systems for residential applications have proven their ability to produce electricity with lower heating value (LHV) efficiencies up to 60% using natural gas (NG) [12]. Efficiencies over 70% are projected when they are combined with gas turbines or reciprocating internal combustion engines [13–15].

Fuel cell technology prospects have motivated several studies to assess the potential and applicability of such systems in the maritime environment. In addition, a number of demonstrator systems has been developed and tested on ships. These investigations vary from a feasibility study of various diesel-fuelled fuel cell systems [16], to a commercialised, hydrogen fuelled, air independent propulsion (AIP) system for submarines [17]. Whether fuel cell systems will be applied more general in the maritime environment depends on their ability to meet the requirements of on-board power generation.

Fuel cell systems differ substantially from each other, and it is not clear which system has the best future prospects. An overview of fuel cell systems is provided in this review. Then, various fuel cell systems are evaluated according to important performance criteria for maritime application: fuel consumption, power and energy density, load-following capabilities and environmental impact. Finally, safety and economics are briefly discussed.

2. Fuel cell systems for ships

Electrical power in ships is mainly used for auxiliaries, although there is a tendency towards the use of electricity for propulsion as well. For example in hybrid configurations, and in the *all-electric ship* concept, where advanced electrical propulsion techniques and electrical storage components can be used [18,19].

A vast majority of ships currently uses diesel generators to produce electricity, where chemical energy is converted into electricity via thermal and mechanical energy. In contrast, fuel cells convert chemical energy directly into electrical energy, thus omitting the indirect route via thermal energy in combustion engines. The absence of expansive, high temperature combustion reduces NO_x formation, noise and vibrations, while high efficiencies can still be achieved [20].

Just like batteries, fuel cells are modular in nature and the intrinsic performance of a single cell is not different from a large stack [21]. As a result, power production can be distributed over the ship without a penalty of increased fuel consumption, while electricity transport losses are reduced and redundancy is improved. For this reason, fuel cell systems are successfully applied in back-up power systems and data centers [22]. Furthermore, fuel cell systems have good part load characteristics, since increased mechanical losses affect only the parasitic load of the auxiliary components, such as compressors, while electrochemical losses are reduced [12,23].

The selected fuel cell system and logistic fuel will have a large impact on the suitability for maritime application. Therefore, the implications of fuel cell system choices on overall efficiency, complexity and power density are analysed in this section.

Commonly applied fuel cell types, fuelling options and fuel processing equipment, used to convert various logistic fuels into hydrogen rich gas, are discussed.

2.1. Fuel cell types

A variety of fuel cell types with distinct characteristics has been developed. The low and high temperature polymer electrolyte membrane fuel cell (LT/HT-PEMFC), phosphoric acid fuel cell (PAFC), molten carbonate fuel cell (MCFC) and solid oxide fuel cell (SOFC) will be considered in this review and are briefly introduced. Some relevant characteristics are summarised in Table 1.

The LT-PEMFC has known rapid development in the last decades, and achieved high power densities and good transient performance. Its membrane consist of a proton conducting wetted solid polymer [24]. The necessity of a wet membrane, while the gas-diffusion pores have to remain dry, dictates an operational temperature of 65–85° C and complicates water management [25]. At low temperatures, the use of platina is required to catalyse the electrochemical reaction [26]. Another important disadvantage of the low operational temperature is the limited tolerance to fuel impurities. In particular carbon monoxide (CO) deactivates the catalyst, because of its strong surface adsorption at low temperatures [27,28].

The membrane of the PAFC consists of a silicon carbide matrix saturated with liquid phosphoric acid. The higher operating temperature, 140 to 200° C, reduces the required platinum loading and increases CO tolerance. The low power density and durability issues have so far limited the commercial success of the PAFC. A new membrane operating in the same temperature region has been developed in the past decade in an attempt to overcome these issues. This membrane essentially combines a polymer electrolyte and phosphoric acid membrane, and is therefore known as the high temperature (HT)-PEMFC [29,30].

Platinum can be replaced with cheaper catalysts, such as nickel, in the high temperature fuel cell classes. Furthermore, CO becomes a fuel rather than a contaminant to the fuel cell. Another advantage is the opportunity to use high temperature waste heat and steam, for example in a bottoming cycle or for fuel processing. The MCFC is a relatively mature high temperature fuel cell and operates in a range of 650–700° C. MCFCs are commercially available, but still struggle with high cost, limited life time and low power density [31,32].

The SOFC has been heavily investigated during recent decades, and various classes of SOFCs have been developed over the years, with operating temperatures ranging from 500 to 1000° C. The low temperature classes are mainly applied in stand-alone fuel cell products, with electrical efficiencies up to 60% [12,33], while the high temperature SOFCs are targeted for combined operation with gas turbines, where efficiencies over 70% are projected [13]. Although a promising type, their limited development state, mechanical vulnerability and high cost have so far limited wide-spread adoption of SOFC technology [34].

2.2. Balance of plant components

Auxiliary components are required to generate electrical power with a fuel cell stack. These components are usually referred to as the balance of plant (BoP), and make up a large part of the overall system. A distinction can be made between *hot* and *cold* BoP components in high temperature fuel cell systems and systems with fuel processing equipment. Hot BoP components include, for example, heat exchangers and fuel processors, while power conditioning and system controls are classified as cold parts. Many BoP components consume parasitic power and additional fuel.

Table 1

Overview of commonly applied fuel cell systems, their temperature range, fuel requirements, and the opportunity to reform fuel directly in the fuel cell.

Fuel cell type	Temperature [°C]	Fuel	Poisonous substances	Internal reforming
LT-PEMFC	65–85	H ₂	S, CO >10 ppm [28]	No
HT-PEMFC/PAFC	140–200	H ₂	S, CO >3% [30]	No
MCFC	650–700	H ₂ , CO	S	Yes
SOFC	500–1000	H ₂ , CO	S	Yes

Table 2

Reported electrical efficiencies based on the LHV with air as oxidant. Part load efficiencies can be significantly lower, which is expected to be less detrimental in fuel cell systems due to the possibility of modular switch-off.

	Diesel [%]	NG [%]	H ₂ [%]
Piston engine	35–45 [133,134]	35–47 [139]	
Gas turbine	25–40 [136]	25–40 [136]	
PEMFC	30–40 [39,40,42]	35–45 [138,139]	40–60 [138]
MCFC	29–54 [41,43,44]	40–55 [17,139]	
SOFC	45–55 [16,45]	45–60 [17]	
SOFC combined		>60 [13]	

One class of BoP components is used to supply fuel and oxidant to the stack, and includes pumps, blowers and compressors. Depending on the type of fuel cell, heat exchangers may be present to bring the gas flows to the right temperature, and evaporators are used if liquid fuels are supplied. Gas streams often need filtration and humidification, and the exhaust gasses may contain a significant amount of combustible components, which is usually burned in a catalytic combustor. All gas flows are regulated with control systems and actuators, such as blowers speeds, valves and pressure regulators.

High temperature fuel cells are often equipped with burners to heat the system up during start-up. Although high temperature fuel cells are usually cooled with cathode air, the temperature gradients in low temperature fuel cells are too small to achieve sufficient cooling in this way. Therefore, these systems will usually have a separate cooling system.

Since fuel cells generate DC power with variable voltage and current, power conditioning equipment, such as DC to AC inverters, is used to generate electricity at grid voltage and frequency. Fuel processing equipment is another important part of the BoP with a substantial influence on the overall efficiency, and will be discussed in detail in Section 2.4.

2.3. Logistic fuels

Diesel oil is currently the dominant energy carrier in the maritime industry. Conventional diesel engine-generator sets are entirely accustomed to these fuels, but they can't be used in fuel cells directly. Although direct electrochemical oxidation of various fuels is possible in some fuel cell types, the relatively fast hydrogen oxidation kinetics dominate at practical power densities. This implies that most fuel cells effectively run on hydrogen [35]. Especially low temperature fuel cells oxidise hydrogen exclusively, while some alternative fuels, such as methane and CO, can be converted internally to hydrogen rich gas in high temperature fuel cells [36,37].

Most maritime fuel cell studies consider on-board conversion of diesel to hydrogen, since a diesel infrastructure is readily available and hydrogen is significantly more expensive and considerably less energy dense [16,38–46]. However, the diesel fuel processor increases complexity, cost and size of the fuel cell system. Furthermore, the need to reduce and eventually obviate GHG emissions makes the consideration of alternative logistic fuels indispensable.

Even though the use of fossil fuels is probably still necessary in the near future, renewable alternatives, for example biofuels or so-called *solarfuels*, will become more important on the long term [47–49].

A paradigm shift towards cleaner fossil fuels and renewable fuels is thus foreseen, but their adoption will depend, among others, on their availability, infrastructure, environmental impact, safety, price, regulations and technical suitability. Logistic fuel selection is part of a larger debate and the interested reader is directed to various dedicated reviews [50–52]. However, the technical suitability maritime fuel cell systems is part of the scope of this review, hence some options are briefly discussed in this section. An overview of both gravimetric and volumetric energy densities of these fuels is provided in Fig. 1, showing the energy density of the pure fuel as well as with the storage system included.

2.3.1. Hydrogen

Hydrogen is the most abundant element in the universe, but is rarely found in its pure form [53]. Although hydrogen can be obtained from various sources, such as biomass or electrolysis, it is

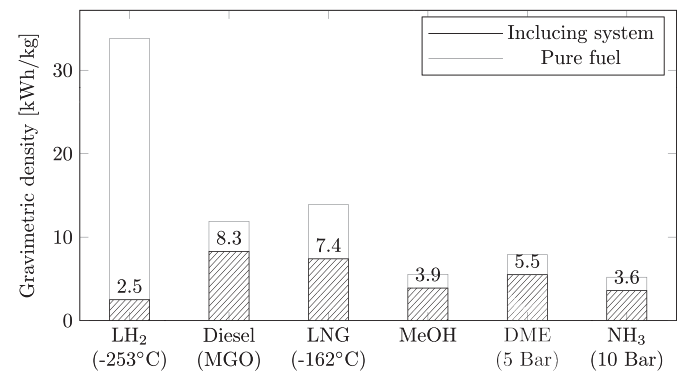

(a) Estimated gravimetric energy densities.

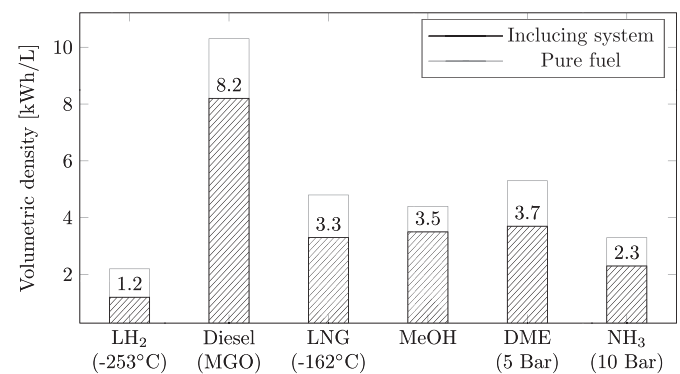

(b) Estimated volumetric energy densities.

Fig. 1. Estimated gravimetric (a) and volumetric (b) energy densities of pure fuels and respective actual densities when the storage system is included. Based on the LHV and [59–61,83,87,91,92].

currently mostly produced from NG [54]. Hydrogen is suitable for fuel cells, as the electrochemical oxidation kinetics are fast, even at low temperatures. Therefore, it can be used without extensive pre-treatment. As a result, pure hydrogen systems can achieve notable overall power densities [55]. Conversion of hydrogen to electricity with fuel cells is usually more efficient than with internal combustion engines [56,57].

The low storage density is the most important drawback of hydrogen as a logistic fuel. Hydrogen is often stored in pressurised vessels at either 350 or 700 Bar for automotive applications. Alternatively, hydrogen can be stored cryogenic at a temperature of -253°C at ambient pressure, or somewhat higher temperatures and elevated pressures, referred to as *cryocompressed* hydrogen (LH_2) [58–61]. The latter is currently the most energy dense physical storage method and, therefore, considered throughout this review. Other options, such as storage in metal hydrides and chemical compounds, are still under investigation [53]. It should be noted that all logistic fuels discussed hereafter can effectively be regarded as hydrogen carriers.

2.3.2. Diesel

Diesel fuels belong to the heavier crude oil distillation fractions. The carbon chains are relatively long, resulting in a viscous and dense fuel, which is usually difficult to process to a hydrogen-rich gas. The high sulphur content is an additional problem, as both the fuel processing equipment and fuel cell have limited sulphur tolerances (see Table 1) [39,40]. Therefore, the sulphur content should be lowered dramatically for fuel cell application. Alternatively, low-sulphur diesel can be synthesised with the Fischer-Tropsch process [62]. These synthetic diesel fuels can originate from fossil feedstocks, usually NG, but also from biogas or CO_2 and renewable electricity, using power to gas and gas to liquid conversion processes [63,64].

Diesel is considered to be an inconvenient fuel for fuel cell systems due to fuel processing complications. Still, it is the most investigated fuel for maritime fuel cell systems, as it is cheap, energy dense, and the infrastructure is fully deployed. Depending on the fuel cell system and type of diesel fuel, various fuel processing steps are required to obtain a feed-gas with sufficient purity. These processing steps will lower both the overall efficiency and power density of the overall system [16]. In this review only low-sulphur marine gas oil (MGO) is considered.

2.3.3. Natural gas

The use of NG for land-based power generation has increased during recent decades, mostly because of the increasing availability and few emission related problems [47]. The composition can vary considerably for various sources, but it usually contains mostly methane, some higher alkanes and small amounts of impurities [65]. Although it is currently produced from fossil feedstocks, it could be produced from biomass or synthesised from CO_2 and renewable hydrogen in the future. Stored at cryogenic conditions, below -162°C at environmental pressure, it is referred to as liquefied natural gas (LNG). Although not yet available everywhere, the LNG infrastructure is expanding [66]. Alternatively NG can be compressed (CNG). The effective volumetric energy density of both LNG and CNG is low compared to diesel fuels.

It should be noted that NG is currently the most important source of both hydrogen and methanol [54,67]. On-board hydrogen production from LNG is probably cheaper, more efficient and more dense than using hydrogen which is produced elsewhere [68,69]. In addition, it can pave the way for the use of future renewable gaseous fuels on-board [70]. Fuel processing is relatively simple, and sulphur is easily removed with adsorbents [71]. It should be noted that many high temperature fuel cell systems are already

designed to use NG, and have demonstrated high electrical efficiencies [12,72].

2.3.4. Methanol

Methanol (MeOH) is another important hydrogen carrier, with the main advantage that it is liquid at ambient temperatures and can, therefore, be used in the conventional liquid fuel infrastructure with minimal adjustments [73]. However, the energy density of the pure fuel is significantly lower than diesel fuels, and it is corrosive towards some metals that are used in the current infrastructure. Although MeOH can be produced from various sources, such as synthetic gas, biomass and hydrogen with CO_2 , most of it is still produced from NG [67,74].

MeOH can be used in the direct methanol fuel cell, but the efficiency of this fuel cell is poor. Alternatively, it can be reformed at moderate temperatures, either in a separate system or integrated in the fuel cell system. Methanol reformers have been successfully integrated within HT-PEMFC systems [75–77]. Few studies have investigated the use MeOH in high temperature fuel cells, as these systems are typically configured to use NG, although direct and indirect utilisation of MeOH in these fuel cells is, at least in principle, possible [36,78,79].

2.3.5. Dimethyl ether

Dimethyl ether (DME) is obtained by MeOH dehydration or directly from synthesis gas [80–82]. It can be stored in liquid form at the relatively low pressures of 5 Bar, similar to liquefied petroleum gas (LPG). Furthermore, the energy density is somewhat higher than MeOH and it is non-toxic. Since it contains no carbon-carbon bonds, it can be used in internal combustion engines without soot formation [83]. The absence of these bonds may lower the susceptibility to coking in fuel cell systems, which is a common problem for fuels with carbon-to-carbon bonds, for example ethanol [84,85].

2.3.6. Ammonia

The logistic fuels discussed so far can be synthesised from renewable electricity and CO_2 . It should be noted that a carbon-neutral fuel is only obtained if the CO_2 required for this synthesis is captured from the atmosphere. However, CO_2 is difficult to extract from the atmosphere, since the concentration is very low. Nitrogen, on the other hand, is available in abundance and can be used as a hydrogen carrier in the form of ammonia [86].

Ammonia is a liquid at a temperature of -33°C and environmental pressure, or under a mild pressure of 10 Bar. Its energy density is somewhat lower than that of MeOH [86,87], and it can be decomposed to hydrogen at temperatures between 300 and 520°C . Since it contains no carbon, it can be used directly in fuel cells without CO poisoning or the risk of coking [88,89]. An important disadvantage of ammonia is its severe toxicity to humans and animals [90].

2.4. Fuel processing

Fuel purity requirements depend on the type of fuel cell, as indicated in Table 1. Low temperature fuel cells, for example, need hydrogen with a relative high purity. More importantly, gases that compete with hydrogen for surface adsorption on the platinum catalyst, most notably CO, inhibit reaction sites and, therefore, affect the cell performance significantly [27]. In contrast, high temperature fuel cells accept fuels of lower quality, can use CO as a fuel [30], and fuel processing can take place directly in the fuel cell [93].

The required fuel processing equipment thus depends on the implemented fuel cell type and logistic fuel, and this has a

significant influence on overall system characteristics, such as efficiency, size, weight, cost and transient behaviour. Commonly applied processing equipment can be subdivided in the following steps:

- Reforming: used to convert carbon hydrates into a hydrogen rich mixture;
- CO clean-up: to lower CO content and maximise hydrogen yield;
- Purification: necessary if hydrogen with a high purity is required;
- Other: includes equipment such as evaporators, burners and desulphurisation (DeS).

This section gives an overview of these fuel processing steps.

2.4.1. Reforming

Reforming is the most widely applied method to convert hydrocarbon fuels into a mixture of hydrogen and CO, commonly referred to as *syngas*. Many fuel cell systems using hydrocarbon fuels are equipped with an external reformer. Light hydrocarbons can be reformed internally if high temperature waste heat is available. In high temperature fuel cell systems waste heat from the electrochemical reaction can be used to reform fuel in indirect internal reforming (IRR) stacks. In direct internal reforming (DIR) fuel cells, hydrocarbons are reformed directly on the anode, using both heat and steam from the electrochemical oxidation of hydrogen.

2.4.1.1. Steam reforming. Steam reforming (SR) is a common reforming method. The endothermic reaction between hydrocarbons and steam produces *syngas* with a high hydrogen content in the following equilibrium reaction:

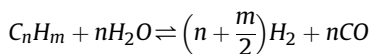

Although the carbon is oxidised in SR, the hydrogen released from the steam maximises overall hydrogen yield. SR takes place at temperatures between 500 and 1000° C in the presence of a catalyst, usually nickel [94,95]. Reforming at higher temperatures is technically feasible [96], but besides improved reaction kinetics there are few advantages. For some fuels near-complete reforming is possible at low temperatures. For example, MeOH can be reformed at temperatures as low as 200° C [75].

Both heat and steam need to be supplied to sustain the reaction, which reduces the overall system efficiency. Anodic recirculation, where a part of the anode tail gas is mixed with the fresh fuel, can be used in high temperature fuel cells to supply heat and steam for reforming and lower the fuel utilisation per anode pass [97–99]. The enhanced system integration improves the overall system efficiency.

DIR at the fuel cell anode results in optimised heat integration, as waste heat is directly used for reforming and less cooling air is required [100]. DIR can be deployed in high temperature fuel cells exclusively, where the SR reaction is promoted by the high temperatures and the formation of steam in the anode. Unfortunately, degradation issues related to carbon deposition, thermal stress and inhomogeneous current distributions, limit the extent of DIR in fuel cells. Therefore, a pre-reformer is still present in the most advanced systems [99,101].

2.4.1.2. Catalytic partial oxidation. The exothermic catalytic partial oxidation (CPOX) process is another reforming method, that is sometimes used because of its simplicity. It relies on the oxidation of carbon, usually with air:

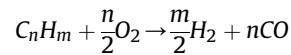

The hydrogen yield is limited compared to SR, since no additional hydrogen is produced from steam, and a part of the hydrogen is inevitably oxidised. Air is usually used as an oxidant, which dilutes the product gas further, since nitrogen is added. This reaction typically takes place between 700 and 900° C, where the hydrogen yield is highest [102].

Although the efficiency is low compared to SR, this reactor is sometimes preferred for its simplicity and compactness, since the use of steam generators, burners and heat exchangers is avoided. This simplification also results in reduced start-up times, which could be advantageous for transport applications [100,103].

2.4.1.3. Autothermal reforming. Autothermal reforming (ATR) essentially combines SR and CPOX. A part of the carbon is oxidised with air, and the heat that is released from this reaction is used for additional SR:

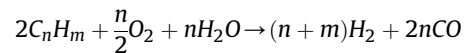

Advantages of ATR are a higher hydrogen yield and a wide temperature window, between 600 and 1000° C, compared to the CPOX reactor [104–106]. Like CPOX, ATR does not require an additional burner to supply heat, although a steam generator is still needed. Perceived advantages over SR are a compact design, lower susceptibility for carbon formation and fast transient behaviour.

2.4.2. CO clean-up

In particular low temperature fuel cells have limited CO tolerance. For these fuel cells the CO content has to be lowered to allowable levels (Table 1). The hydrogen is preferably maximised in the CO clean-up process to enhance fuel cell performance.

2.4.2.1. Water gas shift. The water gas shift (WGS) reaction follows usually after the reforming reaction. The CO produced during reforming reacts further with steam, and forms hydrogen and CO₂:

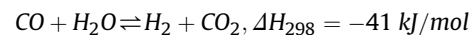

The slightly exothermic WGS reaction is characterised by relatively fast kinetics, and occurs in the SR reactor as well. This equilibrium reaction shifts to the right at low temperatures, where highest hydrogen yields and lowest CO concentrations are obtained [107]. A significant amount of steam is often added to minimise the CO concentration in the product stream.

Syngas is directly used as a fuel in high temperature fuel cells, and the WGS reaction proceeds directly on the anode [108,109]. CO content in the fuel has to be lowered as much as possible for low temperature fuel cells. Therefore, it is common to use two WGS reactors. One operates at a higher temperature (HT-WGS), usually > 350° C, where the kinetics are faster [110], while a second reactor operates a lower temperature (LT-WGS), typically between 150 and 250° C, where the equilibrium concentration of CO is lower [111,112].

2.4.2.2. Preferential oxidation. The allowable CO concentration in low temperature fuel cells is usually lower than obtained in shift reactors. To achieve this, preferential oxidation (PrOX), also known as selective oxidation, can be used as a final clean-up method, where air is supplied to oxidise CO to CO₂:

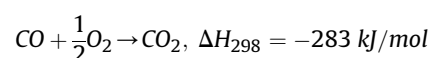

Important advantages of this process are the simplicity and low pressure of the reaction and, hence, relatively low cost and small size [113,114]. An operational temperature in the range of 80–200° C is common, since this reactor is usually placed between a LT-WGS reactor and a PEMFC stack [115]. Waste heat recovery options are limited due to the moderate temperatures. In addition, some hydrogen is inevitably oxidised, lowering the hydrogen concentration in the product gas.

2.4.2.3. Selective methanation. Selective methanation (SMET) can be used as an alternative way to reduce the CO concentration in the fuel, although it is in fact reverse SR of methane:

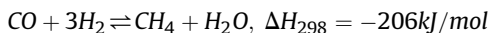

A SMET reactor is typically operated at low pressures, and temperatures ranging from 250 to 350° C, where the equilibrium of the SR reaction of methane reverses [116–118]. Although it reduces the hydrogen content in the product, there are advantages to the SMET process, as it reduces the CO content in the fuel without oxidising a part of it. The catalyst is preferably selective towards the reaction of CO, to minimise the undesired methanation of CO₂.

A high calorific product gas is obtained compared to the ProX reactor, which is particularly beneficial if the tail gas of the fuel cell is further utilised, for example in burners or heat engines [119]. In addition, reactor design and operation is relatively simple, as no air has to be supplied. Waste heat recovery is possible, since the heat produced has a relatively high temperature. Furthermore, it has been reported that a SMET reactor is inherently easier to control [117,120].

2.4.3. Purification

Hydrogen purification is a necessary step for many LT-PEMFC systems using hydrocarbon fuels, due to the sensitivity of this type of fuel cell to contaminants, most noticeable CO.

2.4.3.1. Membrane separation. Membrane separation is a powerful process used to obtain a product gas of relatively high purity. A variety of types exist for hydrogen production. Of these, dense metal and ceramic membranes have the highest selectivity towards hydrogen. Alternatively, porous ceramics and carbon as well as dense polymers can be used, but their selectivity is more limited [121]. Depending on the type of membrane and process conditions, a significant amount of hydrogen remains in the retentate gas and is lost in the process, unless the residual gasses can be burned to supply heat to the reforming reactor [122].

State of the art hydrogen separation membranes are made from palladium-silver alloys and are therefore relatively expensive. They have a high selectivity for hydrogen at temperatures above 250° C. However, the maximum operation temperature is limited to 600° C by the chemical stability of the membrane material. Operation at temperatures up to 900° C is possible with silica based membranes. However, being ceramics, silica based membranes are brittle and susceptible to degradation. Moreover, their selectivity towards hydrogen is usually lower [123].

Membranes can be used as a separate fuel processing step, but also in so-called *membrane reactors*, where hydrogen is separated in the reforming or water gas shift reactor. The removal of hydrogen from the reactor shifts the reaction equilibrium, thus maximising hydrogen yield [124]. The complicated design, close coupling of heat and mass transfer and stability issues of the membrane material are challenging aspects of this reactor type.

2.4.3.2. Pressure swing adsorption. Pressure swing adsorption (PSA) is another commonly used hydrogen purification process. In

PSA, the syngas is fed to a pressure vessel, containing a solid adsorbent. The stronger adsorption of heavier molecules on the adsorbent results in a high purity hydrogen flow at the reactor outlet. The adsorbent is easily regenerated by lowering the pressure. As with membrane separation, the tail gas still contains some of the hydrogen, and 15–30% of the hydrogen is lost in the process if the tail gas cannot be used for other purposes [125,126].

A continuous flow of hydrogen is produced by placing two PSA vessels in parallel, one adsorbing while the other regenerates. Usually a series of PSA units is installed to obtain hydrogen with the required purity [127]. The PSA process is simple, reliable and cost effective. Drawbacks are the relatively large size, elevated pressure and parasitic power consumption of the compressors.

2.4.4. Other

Although fuel processing equipment includes several auxiliary equipment, such as burners and heat exchangers, only desulphurisation is discussed in this section.

2.4.4.1. Desulphurisation. Fossil fuels contain sulphur compounds to a certain extent. Since sulphur deactivates the catalysts used in reformers, shift reactors and fuel cells, DeS is usually required in fuel cell systems using fossil fuels. There are several techniques to do so, ranging from wet scrubbing to hydrodesulphurisation, and at process conditions varying from ambient up to 1200° C and 50 Bar [128,129].

Which desulphurisation process is most suitable depends on the type of fuel and sulphur tolerance levels. When considering the typical scale of fuel cell systems and ship-board applications, conventional industrial processes, like hydrodesulphurisation, are probably too bulky, costly and un-safe [129]. Surface adsorbents are of most interest for fuel cell systems, as they resemble a simple method which is able to reduce the sulphur content to low levels. A drawback of surface adsorbent is the need for either replacement or regeneration.

Hydrogen sulphide can be removed effectively from a gas stream at moderate temperatures between 300 and 550° C [130]. However, this method was found to reduce the sulphur content of diesel fuels insufficiently [39,40]. Alternative adsorbents operating in the range of 20–200° C have been tested for these fuels. Although this method is in principle capable of achieving low sulphur levels, relatively long residence times are required and the sorbent capacity is limited, restricting the suitability of the process to low sulphur fuels [129].

2.5. Fuel cell systems overview

Since the required fuel processing steps are determined by both the selected logistic fuel and fuel purity requirements of the fuel cell type, a choice for a specific combination has important implications on the overall system characteristics. Many of the discussed chemical reactors require specific operation temperatures, pressures levels and heat management. In addition, the chemical composition of the fuel needs to be suitable for the fuel processing equipment. The sulphur content, for example, has to be within tolerable levels, while the oxygen-to-carbon ratio should be sufficiently high to prevent any carbon from depositing.

Fig. 2 gives an overview of the discussed fuel processing steps and fuel cell systems, and indicates their operational temperature as well. The black lines represent the fuel flow direction, starting from either liquid or gaseous fuel, going through various fuel processing steps until the destined fuel cell system is reached. Other solid lines indicate heat flows, steam or oxygen (air). Dashed lines represent additional system integration options, and dotted lines indicate off-gas streams.

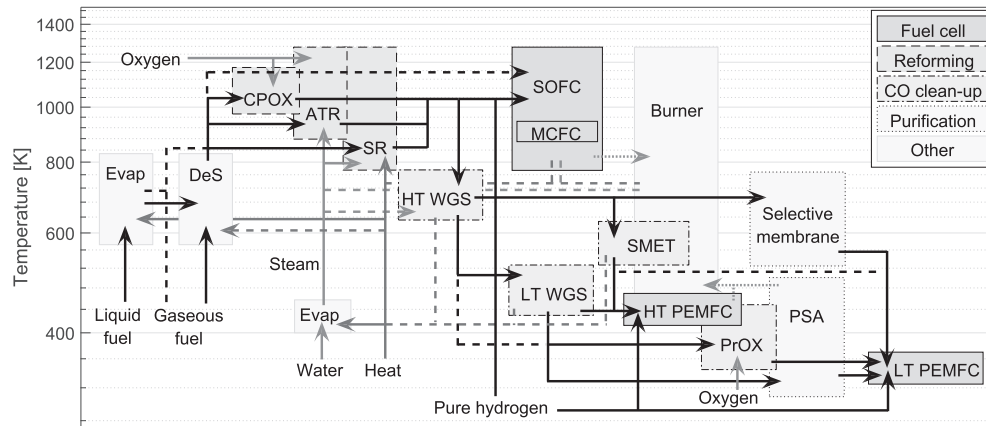

Fig. 2. Overview of on-board fuel processing steps in fuel cell systems, with indication of their operational temperature. The solid black lines indicate the common process flow direction, while the dashed lines are optional. Other solid lines represent flows of heat, steam and oxygen. Off-gas streams are shown as dotted lines.

The fuel processing overview presented in Fig. 2 not only visualises various fuel processing routes, but indicates their operational temperatures as well. Therefore, integration opportunities for fuel processing and fuel cell systems can be quickly identified from this graph. For example, it is clear that high temperature waste heat of MCFC and SOFC systems can be used for reforming, and exhaust gasses from fuel cells and purification processes can be used to generate heat and steam. Both increase the overall system efficiency.

Another observation the reader should take away from this graph, is the complexity of using low temperature fuel cells with non-hydrogen fuels. The overall efficiency is limited by the need to generate high temperature heat and steam for reforming, and losses in CO clean-up and purification equipment. In addition, the large number of processing steps affects the power density and transient response times of the total system. Furthermore, it should be noted that water vapour is generated at the cathode in proton conducting fuel cells and, therefore, more difficult to use for fuel processing. This could imply that purified water has to be produced on-board, reducing the power density and increasing parasitic losses.

3. Maritime power plants

It is assumed that the purpose of an electrical power plant in a transport application is to *supply an amount of electric power for an amount of time*, for either propulsion, auxiliaries or both. The suitability for a particular application depends on specific characteristics of the power plant. Important aspects that determine the suitability of a power plant for maritime application are:

- Electrical efficiency;
- Power and energy density;
- Load transients and system start-up;
- Environmental impact;
- Safety and reliability;
- Economics.

Therefore, this section reviews fuel cell systems and compares them to conventional maritime solutions according to the criteria listed above. However, it should be noted that fuel cell systems have other potential benefits, such as:

- Noise and vibration reductions;
- Reduced infra-red signatures;

- Reduced maintenance;
- Modular and flexible design;
- Improved part load efficiency;
- Water generation.

Although these aspects can be attractive for various vessels, they may be application specific. In addition, the potential benefits are currently uncertain and need further study. Therefore, they are not covered in detail in this review.

3.1. Electrical efficiency

The higher electrical efficiency compared to conventional generators is an important incentive to apply fuel cell technology in ships. The high efficiency is partly a result of the direct conversion of chemical energy into electricity, whereas internal combustion engines convert chemical energy into electricity via thermal and mechanical energy. As fossil fuels may remain an important energy source in the near future, efficiency improvements could result in net GHG emission savings. An overview of the electrical efficiency for various conversion technologies is provided in Table 2.

3.1.1. Conventional maritime power plants

On-board ships, electricity is most commonly produced with diesel generators. Heavy duty generator sets provide power in an efficient and cost effective way. Data provided by manufacturers reveals a peak efficiency of approximately 45% for diesel generator sets on the MW scale. Lean burn, spark ignited gas generator sets in the same power class are reported to achieve efficiencies up to 47% [131,132].

Generator sets are generally not operating in their most efficient operational point. Most ships have a significant overcapacity installed, both for peak loads and redundancy requirements. The mechanical losses are relatively large in part load, since the rotational speed has to be maintained to match grid frequency. Therefore, depending on the generator type and operational point, the practical efficiencies of state-of-the-art heavy duty diesel generators are commonly reported to be in the range of 25–40% [133,134].

Gas turbine generators are sometimes applied in the maritime field. They are especially wide adopted in the aviation industry, since they have higher specific power and require little maintenance compared to reciprocating internal combustion engines [135]. With peak efficiencies in the range of 30–40% for heavy duty maritime gas turbine generators, and subsequently lower practical

efficiencies, they are somewhat less attractive from a fuel consumption perspective [136].

3.1.2. Fuel cell systems

Fuel cells have been considered an alternative for heat engines for decades. Already in the 1970s, the German Navy started developing a PEMFC system for air-independent propulsion of their submarines [17]. Due to the confidentiality of these military programs, studies only appeared in literature from the early nineties. Both the study of Adams [137] and Sattler [17] discuss the possibility to apply fuel cells in naval submarines, for increased AIP, as well as naval surface ships, where noise, vibrations and infra-red signatures can be reduced.

In his early publication, Adams claims that electricity production with fuel cells is up to two times more efficient than generating electricity with diesel generators. Sattler reports efficiencies varying from about 40%, for PEMFCs on reformed hydrocarbons, up to 60% for NG-fuelled SOFC systems. According to a report on civilian maritime fuel cell application, published by Rolls-Royce' Strategic Systems Engineering group [138], fuel cells have to demonstrate significant efficiency improvements to justify the increased cost and lower specific power compared to diesel generators. They see SOFCs as the most promising technology, as a distinct efficiency improvement over existing equipment can be achieved.

Although PEMFCs have demonstrated electrical efficiencies up to 70% on pure hydrogen and oxygen [138], the overall efficiency does not exceed 40% when they are equipped with diesel reformers [39,40,42]. This eliminates an important advantage associated with fuel cell systems, since benefits are restrained to reductions in emitted noise, vibrations and infra-red signatures.

When fuelled with diesel, MCFC systems are expected to achieve higher efficiencies than PEMFCs. Only partial reforming of the fuel is sufficient for MCFC systems, and this can be achieved at lower temperatures. Moreover, high temperature waste heat from the stack can be used for this purpose. A diesel-fuelled MCFC plant is designed in a study by Spccchia et al. [43]. It has an electrical efficiency of only 29%, although an improved system design in a follow-up study achieves an efficiency of 50.6% [44]. A more detailed design of such an MCFC system is discussed by Allen et al. [41] for a U.S. Coast Guard vessel, for which an efficiency of 54% is expected by the author.

SOFC technology is recently getting more attention, as even higher efficiencies are projected. Leites et al. [16] study various diesel-fuelled systems, concluding that an SOFC is preferred over alternative fuel cells, because the BoP can be simplified and it offers inherently higher efficiencies. A diesel-fuelled SOFC system with an efficiency of 55% is designed in a study by Ezgi et al. [45].

As mentioned before, part load characteristics are different in fuel cell systems and peak efficiency is usually achieved at relatively low loads. Still, the efficiency typically reduces for even lower loads, since the parasitic consumption of the BoP becomes relatively large. However, this may be of limited concern if a part of the fuel cell modules can be switched off during low load conditions.

3.1.3. Combined cycles

Electrical efficiencies can be increased when power cycles are combined. The gas turbine with heat recovery steam generators, where the Brayton cycle is equipped with a Rankine bottoming cycle, is a well-known example of a combined cycle power plant. Outstanding efficiencies up to 60% and good part load characteristics are achieved by a combination of these cycles [140]. Waste heat can be recovered from reciprocating internal combustion engines as well, but the electrical efficiency gain is usually less substantial. Although combined electrical efficiencies up to 55% are projected for these systems, the gain is less than five percent point

in most cases, while the system is expensive and complicated [141,142].

High temperature fuel cells can be equipped with bottoming cycles since the hot exhaust gasses from the fuel cell stack still contain thermochemical energy. Un-used fuel is usually burned in a catalytic converter, raising the temperature of the exhaust gasses even further. Integration with gas turbines is particularly advantageous, since it provides good integration with the cathode air flow. Generally, efficiencies up to 70% are projected for cogenerating fuel cell/gas turbine systems [13], although some studies predict even higher efficiencies [14]. SOFC gas turbine hybrids have been studied for maritime application in a system designed by Tse et al. [143], where electricity, heat and cooling is generated for a luxury yacht. Alternative options to use the waste heat of high temperature fuel cells for additional electricity generation are Rankine cycles, Stirling engines and indirect gas turbine coupling [144,145].

Rather than burning the fuel in a catalytic converter, some authors have proposed to burn the remaining fuel in a reciprocating internal combustion engine. Although the cathode air is not used as effectively in this case, the remaining fuel is used efficiently and high combined efficiencies up to 70% may be achieved [15,146,147]. Such a system has a limited degree of coupling compared to a SOFC/gas turbine combined cycle, since close matching of mass and heat flows is not necessary. In a similar fashion, hydrogen rich anode off-gas from high temperature fuel cells can be purified and used in low temperature fuel cells. This enables the use of high temperature electrochemical waste heat for reforming, while a part of the power is provided with low temperature fuel cells [148].

3.1.4. Auxiliary energy storage systems

Alternatives for energy storage in logistic fuels are, for example, batteries, where energy is stored in a chemical compound within the device, supercapacitors, storing electric charge directly, and flywheels, which store momentum in a rotating disc. Round trip efficiencies range from just over 65% for Ni-Cd batteries, to more than 90% for Li-ion batteries, supercapacitors and flywheels [149,150]. Although especially batteries could be a viable options for specific vessels with relative long berth and short sailing times, these systems are expected to be mainly used for auxiliary energy storage, for example during start-up and load transients.

3.2. Power and energy density

The volume and weight of power plants are critical design aspects for any transport applications, since volume and weight are commonly restricted for practical reasons, while a certain amount of power and endurance is required. Depending on the type of application and power plant, designs are typically either volume critical, weight critical, or both. For example, if lead-acid batteries are applied in cars, the allowable weight is likely to restrict the size of the battery [151], and hence the driving range, whereas if hydrogen fuel cells are selected, the volume of the hydrogen tanks is more likely to limit the endurance of the car [53].

3.2.1. Fuel cell systems

The high volumetric energy density compared to batteries is an important motivation to use fuel cells for AIP purposes. As pointed out by Adams [137], this allows submarines to be submerged for longer periods. Although the volumetric power density is low compared to batteries and internal combustion engines, the energy storage density is significantly increased, which allows extended submerged operation. For larger submarines with even longer mission requirements, on-board hydrogen production from MeOH has been demonstrated [152].

Modern ships are commonly volume critical, although specific designs (e.g. high speed vessels) benefit from low weight as well. Like the overall system efficiency, power and energy density of fuel cell systems are determined by the combination of fuel cell type and logistic fuel. Adams [137] compares the weight and volume of typical diesel generator sets to several fuel cell systems equipped with NG reformers, and concludes that fuel cell systems take up more space than diesel generator sets for the same amount of power. However, the opportunity to reduce the volume of the storage tanks due to the reduced fuel consumption is not taken into account.

Projected power densities of fuel cell systems in a Rolls-Royce publication generally exceed those of diesel engines [138]. However, such high power densities have so far not been achieved in practice. Allen et al. [41] give a more realistic density estimation of NG-fuelled fuel cell systems. Still, their density estimations are high compared to those achieved in practice. For example, the estimated densities of a NG-fuelled MCFC system, 37–110 W/kg and 17–36 W/L, are one order of magnitude above the achieved 15 W/kg and 3 W/L in a 330 kW demonstration system [139].

SOFC systems are expected to attain higher power densities than MCFC systems [138,41], while having similar characteristics. Conceptual designs of maritime SOFC systems are discussed in a number of studies, reporting power densities varying from 20 W/kg and 8 W/L to 230 W/kg and 60 W/L [38,45,153]. The highest power densities are obtained with PEMFCs. However, the fuel processing components of PEMFC systems reduce the effective density considerably if they are not operating on pure hydrogen [40].

It should be noted that the discussed gravimetric and volumetric power densities have a rather theoretical value. It is just as important to study how fuel cells can be applied in actual ship designs. A detailed design for a U.S. Coast Guard vessel revealed that, although the MCFC system was heavier than the original diesel generator, removal of exhaust stacks, sound isolation bedplates and a smaller cooling systems resulted in a net weight reduction [41].

As mentioned before, the modularity of fuel cells gives an additional degree of freedom in the layout of the energy system, allowing ship designers to use the available space more effectively. In addition, power density has not yet been an important design objective for all fuel cell systems, as in particular high temperature fuel cell systems have been mainly developed for stationary electricity generation where power density is of limited importance.

3.2.2. Ragone charts

It has become customary in the field of energy storage to compare the differences in power and energy density in so-called *Ragone charts*, where power density is plotted versus energy density [150,154]. This approach is relatively straightforward for appliances that combine storage and conversion in a single device, such as batteries. The solution with the highest density can be identified from the chart if the characteristic timescale of the application is known.

Ragone chart comparison may seem less obvious for systems with separate storage and conversion devices, but there is essentially no difference. However, the power and storage capacity can be scaled individually to a relatively large extend. This implies that the effective power and energy density of the complete solution depends on the power density of the conversion device, the energy density of the storage device, the conversion efficiency, and the timescale of the application.

In this review, both gravimetric and volumetric density of a number of fuel cell systems and logistic fuels are compared. The densities of conventional diesel and gas generator sets, as well as gas turbine generators, are included for reference. For practical reasons, the fuel cell systems considered are a PEMFC, MCFC and an

SOFC, and the fuelling options are limited to those discussed in Section 2.3. However, this analysis can be extended to other fuels and conversion devices, or adapted for new data.

3.2.2.1. Energy density. The energy density is defined as the amount of electrical energy available per unit of either mass or volume. It thus deviates from the energy density of a pure fuel, due to the volume and weight of storage system components, and losses in the conversion process. Therefore, the energy density depends on the fuel properties, storage system and the overall efficiency of the conversion process.

3.2.2.2. Power density. The power density of a conversion process is obtained from specifications of commercial maritime electricity generators [131,132]. A similar approach is used for fuel cell systems, including BoP equipment, although a 50% upper margin is added to account for:

- Their relatively limited development state;
- Their modularity, which may allow more flexible integration into ship designs;
- The possible removal of exhaust stacks, sound isolation bedplates and a smaller cooling system.

An overview of the parameters assumed in this study is given in Appendix A.

3.2.2.3. Effective density. The effective density can be calculated if the timescale of the application is known. This timescale t is defined by the ratio of the effective energy storage density W_{eff} and power density P_{eff} of the complete power plant:

$$\frac{W_{eff}}{P_{eff}} \equiv t \quad (1)$$

The power density of the conversion device P is corrected for the energy density of the fuel storage W and the conversion efficiency η to obtain the effective power density P_{eff} of the power plant:

$$P_{eff} = \frac{P}{\left(1 + t \frac{P}{\eta \cdot W}\right)} \quad (2)$$

The effective energy storage density W_{eff} then follows from Equations (1) and (2):

$$W_{eff} = t \cdot P_{eff} = \frac{t \cdot P}{\left(1 + t \frac{P}{\eta \cdot W}\right)} \quad (3)$$

It can be verified that these equations approach the limits $P_{eff} \approx P$ and $W_{eff} \approx \eta \cdot W$ for $t = 0$ and $t = \infty$ respectively. In some cases fuel processing equipment is included as well, in which case the overall power density and conversion efficiency can be calculated from:

$$P = \left(\frac{1}{P_{fuel\ cell}} + \frac{1}{P_{fuel\ processing}} \right)^{-1} \quad (4)$$

$$\eta = \eta_{fuel\ cell} \cdot \eta_{fuel\ processing} \quad (5)$$

The obtained values for P_{eff} and W_{eff} can be plotted against each other in a Ragone chart to compare the densities of various power plants. Due to the uncertainty and spread in the data, two lines are plotted for each system in this study. The solid lines indicate the

projected maximum density that can be achieved, while the dotted lines correspond to the minimal density expected by the author.

3.2.4. Gravimetric density

In Fig. 3a various maritime power plants are compared in a gravimetric Ragone chart. It is clear that the Brayton turbine generator offers the highest density potential for most timescales. A higher fuel efficiency only starts to pay off when hundreds of hours independent operation is required. From a gravimetric perspective, diesel-fuelled SOFCs and LNG-fuelled MCFCs seem to perform comparable, and the same holds for Diesel generators and LNG-fired Otto generators. Cryogenic hydrogen and PEMFCs could provide an interesting alternative up to several dozens of hours.

Fuel cell systems with various logistic fuels are compared in Fig. 3b. PEMFCs offer a dense solution up to about 12 h, after which the higher energy density of ammonia and MeOH starts to pay off. Although the storage tank decreases the effective storage density of LNG considerably, NG-fuelled fuel cell systems are still expected to offer the highest gravimetric density for sailing times over several dozens of hours, partly due to the high efficiency of NG-fuelled

SOFC systems. DME is inherently easier to store, hence less weight is allocated to the storage system. However, this is insufficient to compensate for the lower energy density of the pure fuel.

From the Ragone chart it is concluded that MGO- and LNG-fuelled systems have comparable effective gravimetric energy densities. The gravimetric power density of systems using LNG is expected to be higher than those on MGO and DME. The gravimetric density of LNG-fuelled systems is expected to increase even further when SOFC combined cycles become available. Hydrogen could be a good alternative if the refuelling interval is limited to tens of hours, while MeOH seems more interesting for the region between 15 and 100 h.

3.2.5. Volumetric density

The volumetric Ragone chart for various maritime power plants, shown in Fig. 4a, reveals that the considered fuels are significantly more different from a volumetric perspective. MGO can be stored more dense than the considered alternatives, thus diesel-fuelled systems are superior from a volumetric perspective. However, PEMFCs with hydrogen stored under cryogenic conditions can still

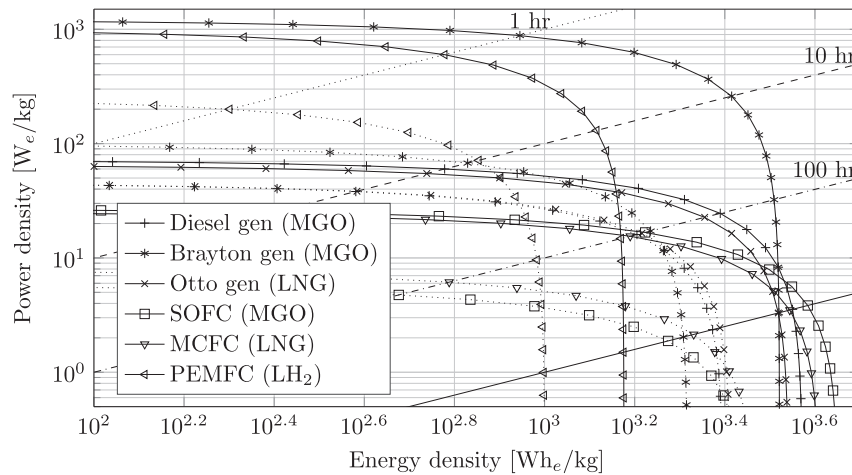

(a) Gravimetric density of various maritime power plants.

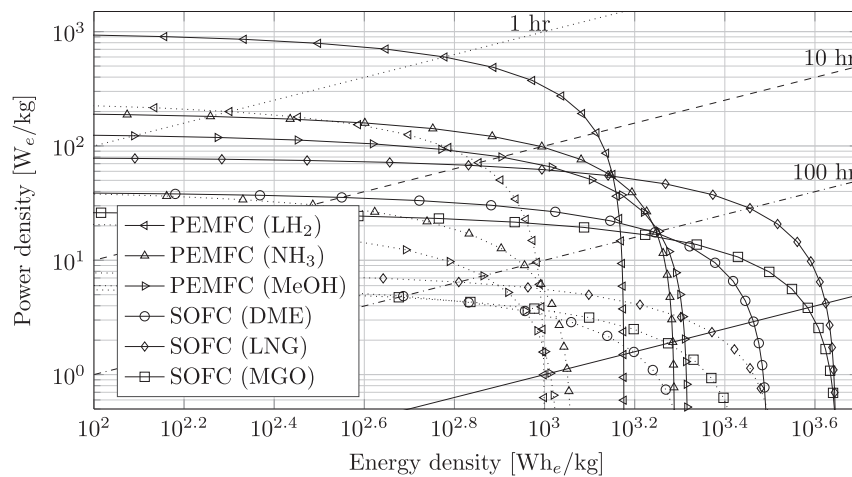

(b) Gravimetric density of fuel cell systems with various logistic fuels.

Fig. 3. Gravimetric Ragone charts for various maritime power plants (a) and fuel cell systems with several logistic fuels (b). The solid and dashed lines represent the expected maximum and minimum densities respectively. The density of conventional generators is based on manufacturer data. For the fuel cell systems there is more uncertainty due to the limited development state. An overview of the data used can be found in Appendix A.

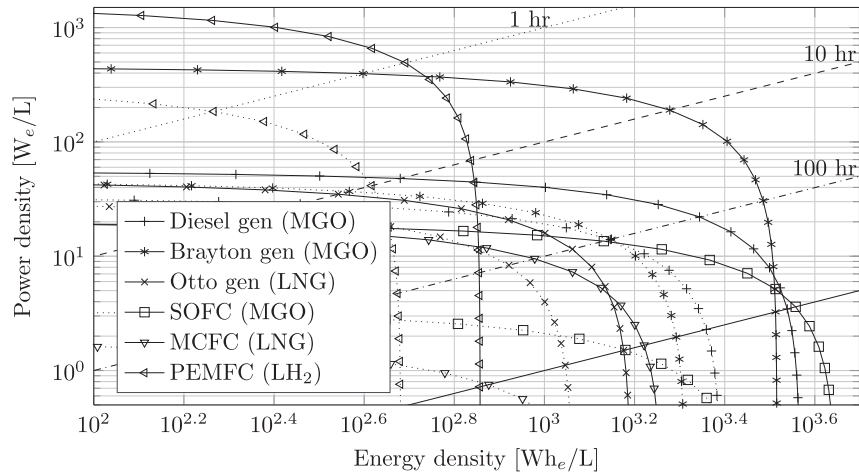

(a) Volumetric density of various maritime power plants.

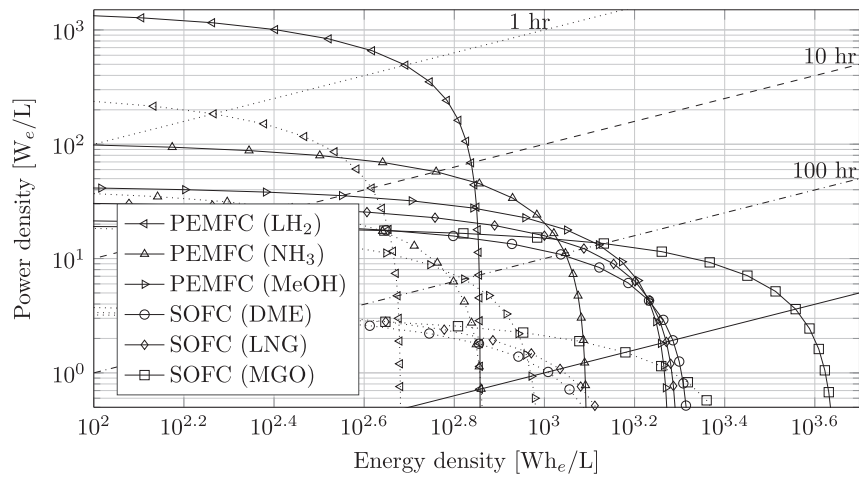

(b) Volumetric density of fuel cell systems with various logistic fuels.

Fig. 4. A volumetric equivalent of Fig. 3 for various maritime power plants (a) and fuel cell systems with several logistic fuels (b). The solid and dashed lines represent the expected maximum and minimum densities respectively.

prove an interesting alternative for diesel generators up to 15 h of independent operation.

Differences in volumetric energy density dominate Fig. 4b as well, where various fuelling options for fuel cell systems are plotted. The diesel-fuelled SOFC system is expected to achieve a reasonable power density, and probably offers the most dense solution for timescales over 100 h. From a volumetric energy density perspective, this seems to be the best choice for vessels with long mission requirements, such as cargo carriers and offshore ships. Fuel cell systems fuelled with LNG, MeOH or DME are very comparable from a volumetric energy density perspective, but they are significantly less energy dense than diesel-fuelled systems.

Liquefied hydrogen and ammonia are expected to offer the most compact overall system for sailing times up to dozens of hours. However, for longer mission requirements the limited volumetric storage density of liquefied hydrogen results in relatively large system volumes. For a 100 h refuelling interval the hydrogen-fuelled PEMFC system is expected to be 1.5 to 2 times larger than the alternatives. For 1000 h independent operation, not uncommon for some types of vessels, the high volume of liquefied hydrogen storage tanks results in total system volumes about 1.75 times

larger compared to ammonia, to roughly 2.5 times larger than LNG, MeOH or DME and up to 5 times larger compared to MGO-fuelled SOFC systems.

In contrast to the gravimetric density, it appears to be difficult to achieve the volumetric densities of diesel engine-generator sets with fuel cell systems and unconventional fuels. However, the volumetric density of diesel engine-generators is expected to decrease in the future due to emission requirements, which forces ship owners to install auxiliary equipment that will inevitably lower the efficiency and power density of the overall system. In addition, the difference seems acceptable for applications with sailing times up to several hundreds of hours, corresponding to a sailing time of a couple of days. The introduction of SOFC combined cycles can decrease the gap between conventional engine-generator sets and SOFC systems.

3.3. Load transients and system start-up

Depending on the type of vessel and operational profile, electrical power demand on ships is usually subjected to significant changes over various timescales. Furthermore, system start-up

times should be reasonable and at least comparable to the conventional electricity generators. Since electrification of on-board power distribution is anyway required if fuel cell technology is adopted, hybridisation with auxiliary electricity storage components can be used to meet these requirements if fuel cell systems alone are unable to do so.

3.3.1. Fuel cell systems

The type of fuel cell and logistic fuel determine many system characteristics, and this is not different for dynamic behaviour. For example, PEMFC systems fuelled with hydrogen accept significant load steps in seconds, but the transient performance is probably dominated by the fuel processing equipment if they are running on NG [138]. The inclusion of a hydrogen buffer could, at least partially, overcome this issue.

Even if a fuel cell system is capable of meeting the demanded load transient or delivering peak power for a short amount of time, this could result in an increased rate of degradation [155]. Therefore, even LT-PEMFCs, which have good transient response capabilities, are often combined with supercapacitors. An additional advantage is the opportunity to decrease the required size of the fuel cell stack, which results in weight and cost savings [156].

High temperature fuel cells are known to have long start-up times and to allow only slow load changes, since the high temperature requires heating of a large thermal mass. The allowable temperature gradients in SOFCs are limited by the brittle ceramics they are made of. Metal-supported SOFCs are reported to be more robust and to enable fast thermal cycling [157]. Still, high temperature fuel cell systems have a notable BoP, and the increased thermal mass and interdependency of individual components limits their transient capabilities.

Hybridisation with gas turbines, characterised by relatively rapid start-up and load-following, seems promising to address the limitations of high temperature fuel cell systems. However, since the fuel cell and gas turbine are closely coupled in such systems, the transient behaviour of the slowest component may restrict the overall system dynamics. For example, fast transients in turbomachinery may induce unacceptable operational conditions on the SOFC stack [158].

In general, the number of system components and the total thermal mass seem to be good indicators for system start-up and load response times. Simplification of the BoP and fuel processing equipment could be an effective method to enhance the transient performance. Unfortunately, this may result in an increased fuel consumption. CPOX reactors, for example, can achieve short start-up and load response times, but the overall system efficiency compared to SR is low [159].

3.3.2. Auxiliary electricity storage

Storage components with good transient capabilities can be used to compensate for the limited dynamics of fuel cell systems. Batteries, supercapacitors and flywheels could be suitable for this purpose, as the power-to-energy ratio of these components is relatively high, which allows them to discharge in seconds to minutes [160].

From a power density perspective, batteries are best applied to supply power for minutes and up to hours [149]. However, their specific power and number of charge cycles is limited. Therefore, they appear to be most suitable to cover loads during cold start-ups of the fuel cell system and large transients [161].

The specific energy storage capacity of supercapacitors is limited compared to batteries, but their power density is high, allowing them to charge and discharge in seconds [149]. In addition, they can take many charge and discharge cycles without a significant loss in capacity and power [162]. These characteristics make

supercapacitors more suitable for peak-shaving.

Flywheels are placed between batteries and supercapacitors in terms of power and energy density. Conventional flywheels are made from steel and have limited density, but are relatively mature. Advanced composite flywheels outperform these, but their development state is more limited. Although round-trip efficiencies of flywheels are usually somewhat lower than of batteries and supercapacitors, they are expected to offer cost savings [163].

A part of the energy is lost in any auxiliary electricity storage equipment, and this should not exceed the power gained by the slow prime power conversion device. Preferably, the losses in the auxiliary storage equipment are small compared to the efficiency gain in the fuel cell system. In addition, the inclusion of auxiliary electricity storage equipment lowers the overall power density of the power plant. Careful scaling of the storage device will be necessary to maximise the reduction in fuel consumption and capital cost, and maximise the power density of the system.

3.4. Environmental impact

The potential reduction of local emissions during operation is an important incentive to apply fuel cell systems in ships, since these are typically subject of environmental regulations. For example, Ludvigsen et al. [139] discuss the possibility to eliminate local hazardous emissions completely and reduce local GHG emissions significantly. No SO_x, low NO_x and 40% reduced CO₂ emissions were demonstrated with a 20 kW MeOH-fuelled maritime SOFC system in the METHAPU project [153].

Fig. 5 shows typical local emission levels for engine-generator sets and high temperature fuel cell systems, fuelled with either MGO or LNG. Engine data is obtained from Bengtsson et al. [8], and fuel cell system data from Altmann et al. [164]. Gas engines have significantly lower emissions of NO_x and PM compared to diesel engines, but fuel slip results in much higher emissions of VOCs, mostly methane, and CO. Fuel cell systems have virtually zero emissions of NO_x, PM, VOCs and CO, and the higher electrical efficiency results in reduced CO₂ emissions.

Although Fig. 5 illustrates the potential of fuel cells to reduce local emissions during their operational life, it represents only a part of the environmental impact over a complete life cycle. Next to the impact during the operational life, the complete environmental burden from maritime electricity generators is determined by contributions from:

- Manufacturing;
- Maintenance;
- Decommissioning;
- Fuel supply.

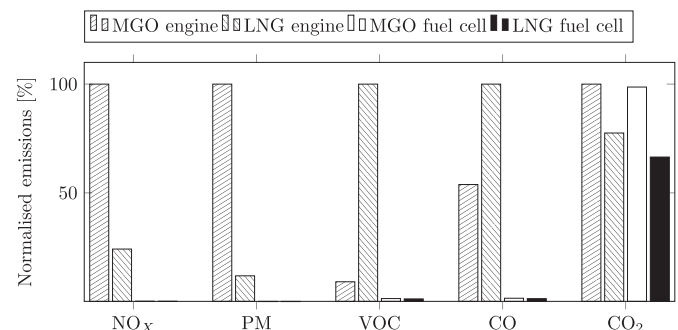

Fig. 5. Normalised local tank-to-electricity emissions of NO_x, PM, VOC, CO and CO₂ for various maritime power plants. Original data (g/kWh_e) extracted from Refs. [8,164].

Manufacturing, maintenance and decommissioning stages may be important since the energy intensive production processes and limited lifetimes of fuel cell systems can result in a net increase in environmental impact [165]. Fuel supply considerations account for the production, processing and transportation of fuels. For example, although Fig. 5 shows reduced tank-to-electricity CO₂ emissions for LNG compared to MGO, it has been argued that methane emissions associated with its production and distribution may in some cases result in a net increase in GHG impact [166,167].

In contrast to the manufacturing, maintenance and decommissioning stages, fuel supply considerations are only partly fuel cell specific. Stringent fuel quality requirements may impose additional fuel processing, and the supplied fuel may influence the performance of the fuel cell system. Other aspects of fuel supply, such as origin and transport, are similar for fuel cell systems and combustion engines and are, therefore, out of the scope of this review. However, it should be noted that these aspects have an important contribution to the environmental impact of maritime electricity generation.

Three life cycle assessments have been carried out for maritime fuel cell systems. Two of them assume continued use of diesel fuels for the traditional engine-generator sets, while renewables are considered only for the fuel cell system [164,79]. However, a complete life cycle assessment should evaluate the use of renewable fuels in conventional generators as well. Pehnt [168] shows, for example, that using renewable hydrogen in an internal combustion engine may still result in lower GHG emissions compared to a fuel cell based drivetrain over a complete life cycle, although others argue differently [169].

Altmann et al. [164] analyse the life cycle performance of diesel engines, fuelled with heavy fuel oils, as well as high temperature fuel cells using low sulphur diesel fuels or LNG and low temperature PEMFCs on hydrogen from various sources. Emissions of hazardous pollutants are found to be much lower for fuel cell systems. Although different fuelling options are considered for the investigated systems, various hydrogen origins are analysed for the PEMFC system, showing that reduced GHG emissions are only achieved if the hydrogen is produced from a renewable source.

In a study by Strazza et al. [79] a traditional diesel-generator set is compared to a maritime SOFC system. Rather than frequent stack replacement, maintenance after every 6000 operating hours is assumed to be sufficient. Similar to the study of Altmann et al. [164], several fuelling options are analysed for the SOFC system, while only diesel fuel is considered for the internal combustion engine. The results show that the environmental impact of SOFC operation and manufacturing is low compared to the fuel extraction and refining phase.

Alkaner et al. [46] compare a conventional diesel-generator to a diesel-fuelled MCFC system. They conclude that the net environmental impact of the MCFC system is lower, mainly due to reduced emissions during its operational life. However, the manufacturing phase of the MCFC is responsible for a significantly higher environmental impact than that of the diesel-generator. This is partly due to necessary stack replacement every 5 years. Maintenance requirements for the diesel generator are neglected in this study.

Similar assessments have been carried out for non-maritime applications. An SOFC auxiliary power unit fuelled with diesel is compared to electricity generation with an idling truck diesel engine in a study by Baratto et al. [170]. Clear advantages in environmental impact for the fuel cell unit are reported, partly because idling diesel engines operate far from their optimal operational conditions. Although this comparison is not representative for heavy duty diesel-generator sets, it demonstrates the potential to reduce the environmental impact of ships in low load conditions. Fuel cell generators can offer an alternative for so-called *cold*

ironing, where ships are connected to the land-based electricity grid during berth. Pratt et al. [171] analysed a conceptual barge-mounted hydrogen fuelled PEMFC system for cold ironing purposes, concluding that such a system could be both technically and commercially feasible.

General aspects of life cycle assessments of fuel cell systems are discussed by Pehnt [168]. A detailed analysis of both low and high temperature fuel cells is presented, for mobile applications as well as stationary power generation, and several important uncertainties are pointed out. For example, fuel cell production methods vary and are still likely to change, and the possibility of recycling is often unknown. The study concludes that high temperature fuel cell systems have clear environmental benefits over conventional generators during a complete life cycle, due to fuel savings and emission reductions during their operational life. Low temperature fuel cells have this potential if renewable hydrogen is available, for example generated via electrolysis.

3.5. Safety and availability

Like every power plant for maritime applications, fuel cell systems will have to comply with classification standards. These regulations usually differ from land-based systems, and make sure that a vessel can be operated safely and reliably. For example, single point failures should be avoided, since complete loss of power due to an emergency shut down is not desirable [172]. It is expected that a redundant fuel cell system design, equipped with adequate ventilation, fire suppression, monitoring and control systems, will meet all classification requirements [38].

Fuel cell systems have few mechanical parts and tend to degrade rather than fail, which results in a high availability [138]. This is further enhanced by the modularity of fuel cell systems, which allows clean, silent and reliable distributed electricity production next to large consumers. This increases the redundancy of the electricity grid, and is one of the reasons some companies have, although yet modest, commercial success applying fuel cell systems in data centers and backup power generation for telecom systems [22,173].

Next to the fuel cell system itself, classification rules on logistic fuels are of particular importance. Fuels that are either harmful, hazardous or have a flash points below 60° C, will need special precautions before their use on-board will be allowed. Some fuels, such as ammonia and MeOH, are toxic to humans and animals, while other alternatives, such as hydrogen and DME have the advantage that they are non-toxic, non-mutagenic and non-carcinogenic [83,90,138]. It should be noted that conventional diesel oils are toxic as well [174].

Volatile, low flashpoint fuels, such as hydrogen and NG, impose the risk of explosions in closed spaces. These fuels will have to comply with the two-barrier-principle for gas supply, which is either achieved by double-walled piping, ventilation ducts or gas tight enclosures [172]. This may be necessary as well for outlet piping, as these can still contain traces of hydrogen and CO. These issues are addressed by the recently approved International Code of Safety for Ships using Gases or other Low-flashpoint Fuels (IGF Code), although this code initially focusses on LNG and its applicability is restricted to vessels under the International Convention for the Safety of Life at Sea (SOLAS) [175].

There is some awareness of these issues among fuel cell developers and classification societies, which is reflected in two recent publications. In particular the publication by Vogler et al. [172] addresses several issues regarding gas safety, such as venting, explosion protection and high pressure storage. Ludvigsen et al. [139] shortly discusses two different class notations for maritime fuel cell systems, *FC-SAFETY* and *FC-POWER*, both developed by

DNV. However, current standards by classification bodies are based on limited experience with a small number of systems. Communication between system designers and classification societies should result in safe, yet not overly stringent rules for future fuel cell applications [38]. In addition, the possibility to improve the redundancy and reliability of the electricity grid should be studied further.

3.6. Economics

The development of naval fuel cell systems commenced by the 1970s, and the first demonstration projects of the technology followed in the next two decades. Still, fuel cell systems have no substantial market share, and high costs are often mentioned as the main reason [176]. PAFCs and MCFCs currently have the most advanced development state, and so far several MWs have been installed for stationary power. Despite this, capital investment cost is reported to be over 5000 \$/kW for both system types [177]. The HT-PEMFC, is anticipated to be more efficient and less expensive than the PAFC, although both fuel cell types still struggle with a limited lifetime [178,29].

Fuel cell systems in their current development state are significantly more expensive than conventional generators, but many companies see potential to reduce the cost of fuel cell technology. Especially the LT-PEMFCs for the automotive sector have seen major price cuts in recent years. Although stack prices at the current production volume, 500 to 1000 mid-sized fuel cell vehicles per year, are typically still >1000\$/kW, projected production costs for automotive LT-PEMFC stacks vary from 280 \$/kW at an annual production volume of 20,000 units to 50 \$/kW for 500,000 units [179,180]. A price level of 50 \$/kW would put them in direct competition with diesel generators, although lifetime issues and the high cost of the BoP, in particular if hydrocarbon fuels are used, still remain important issues [181].

Although the expected price level of high temperature fuel cell systems is higher, the reduced consumption of hydrocarbon fuels might provide a decent return on investment for these systems. The need for expensive platinum is omitted in high temperature fuel cells, but their active layers rely on rare earth oxides. Although these are far cheaper than platinum, a substantially larger amount is needed. In addition, the high operational temperature limits the material choices for other stack components, the specific power is usually lower and manufacturing costs are relatively high [182,183].

Lee et al. [184] conclude from a study of stand-alone NG-fuelled SOFC systems that, in order to make such systems economically viable, there is a need to bring down the capital costs of the stack and the inverter, even if this would result in a lower system efficiency. The limited lifetime of the stack has an important effect on the results. Most studies assume a system life cycle of 20–30 years, whereas stack lifetime is currently 2–3 years [185]. Although some manufacturers aspire lifetimes in the range of 5–7 years, this is still an ambitious target for most suppliers [186].

Although fuel cell systems already provide an economically attractive choice in specific business cases, such as material handling and back-up power, it is often stated that they will be economically attractive for a wider range of applications if a substantial market volume is attained. However, a recent study of domestic fuel cell systems by Staffel et al. [181] shows that full market penetration may be required to achieve target prices at the current learning rates. This would imply that the fuel cell market will depend on government support programs for several decades, which leads to the conclusion that incremental learning should not be the only route to cost reduction.

While several car manufacturers are scaling up their LT-PEMFC production volume, researchers have taken SOFCs back to the

laboratory to develop more cost effective fuel cell concepts before scaling up. Although it is difficult to estimate just how effective these efforts will be, some promising results have been published. Researchers in the SECA program claim that stack production costs of 175 \$/kW can be achieved with current technology [21]. In general, estimates of mass produced SOFC stack production cost vary from 150 to 1500 \$/kW [187]. This would be a competitive price level, provided that the cost of the BoP is lowered accordingly.

4. Experience in maritime fuel cell application

4.1. Maritime fuel cell research projects

Several research projects have been carried out during the last two decades, varying from naval programs to industrial projects. The most noticeable projects are briefly discussed in this section. An overview of the projects discussed is given in Table 3.

4.1.1. Class 212 submarines

The first preliminary studies of PEMFC based AIP systems for submarines started in the 1970s. This resulted in the development of such a system in the early 1980s, and finally the production of the *Class 212 submarines* by Howaldtswerke-Deutsche Werft (HDW) in 1998 [17]. The Siemens fuel cell system consists of two 120 kW PEMFC modules, hydrogen is stored in metal hydrides, and liquid oxygen is carried in a vacuum-insulated tank. Over thirty submarines with a fuel cell AIP system have been commissioned so far.

4.1.2. SSFC

The *ship service fuel cell* (SSFC) project started in 1997 and aimed to develop diesel-fuelled fuel cell systems for naval ships and other vessels. The goals were to reduce fuel consumption, noise, thermal signatures, maintenance cost and emissions. In addition, the distribution of generators throughout the ship should enhance survivability. Conceptual designs for a 2.5 MW MCFC and PEMFC system were developed, and demonstrators of 0.5 MW were tested. High complexity, long start-up times and prices were pointed out as the most important issues [41,42,138].

4.1.3. DESIRE

The *diesel reforming with fuel cell* (DESIRE) project commenced in 2001 and developed a 25 kW technology demonstrator of a diesel fuel processor for PEMFCs, to be used for naval application. A small fuel cell system was successfully connected to the fuel processor. Promising results were presented, but problems with sulphur removal, load transients and robustness were identified [40].

4.1.4. FCSHIP

In the *fuel cell technology for ships* (FCSHIP) project a large consortium of European partners cooperated in providing a road-map for future research and development on waterborne fuel cell application. Operational and safety requirements were investigated, and conceptual designs were developed. Finally, the life cycle impact of a marinised MCFC system was assessed and compared to a conventional diesel engine-generator set [46].

4.1.5. FellowSHIP

A 330 kW LNG-fuelled MCFC was installed on-board of the offshore supply vessel 'Viking Lady' in the *fuel cells for low emissions ships* (FellowSHIP) project. The fuel cell system was operated successfully for 18,500 h, and demonstrated a net electrical efficiency of ~44.4% with no detectable NO_x, SO_x and PM emissions [139,189].

Table 3

An overview of the most noticeable maritime fuel cell application research projects.

Program	Period	Fuel cell type	Logistic fuel	Application	Project lead	References
Class 212	1980–1998	PEMFC	Hydrogen	Submarine AIP	Howaldtswerke-Deutsche Werft	[17,188]
SSFC	1997–2003	MCFC/PEMFC	Diesel	Naval ship	Office of naval research	[41,42,138]
DESIRE	2001–2004	PEMFC	Diesel	Naval ship	Energy research centre Nld	[40]
FCSHIP	2002–2004	MCFC	Diesel		Norwegian Shipowners' Ass.	[46]
FellowSHIP	2003–2013	MCFC	LNG	Offshore supply	DNV research and innovation	[139,189]
FELICITAS	2005–2008	SOFC/GT	Diesel, LPG, CNG	Mega yacht	Frauenhofer institute	[143]
MC-WAP	2005–2011	MCFC	Diesel	RoPax, RoRo	CETENA	[43,44]
ZEMSHIP	2006–2010	PEMFC	Hydrogen	Passenger	ATG Alster Touristik GmbH	[190,172]
METHAPU	2006–2009	SOFC	MeOH	Car carrier	Wärtsilä corporation	[191,79]
Nemo H ₂	2008–2011	PEMFC	Hydrogen	Passenger	Fuel Cell Boat BV	[188,172]
SchIBZ	2009–2016	SOFC	Diesel	Multipurpose	ThyssenKrupp marine systems	[16,192,193]
PaXell	2009–2016	HT-PEMFC	MeOH	Cruise ship	Meyer Werft	[192,193]

4.1.6. FELICITAS

The *fuel cell power trains and clustering in heavy-duty transport* (FELICITAS) project studied multiple heavy duty power trains, among which a SOFC auxiliary power unit for a mega yacht. Various marinisation aspects of SOFC technology were investigated, as well as hybridisation with flywheels. Furthermore, coupling of the SOFC systems with a gas turbine and the heating ventilation and air-conditioning system was examined [143].

4.1.7. MC-WAP

The objective of the 2005 *molten-carbonate fuel cells for waterborne application* (MC-WAP) project was to develop and test a 0.5 MW MCFC auxiliary power generators for on-board testing on RoPax, RoRo and cruise vessels. Eventually tests were performed on an existing MCFC research plant and various conceptual designs were developed [43,44].

4.1.8. ZEMSHIP

The passenger vessel *FCS Alsterwasser* was equipped with a hydrogen-fuelled PEMFC system in the *zero emission ship* (ZEMSHIP) project, and was operated successfully for two seasons. The vessel was heavily damaged in a fire during a test run, caused by overheating of the lead-acid batteries. Since the fuel cell system and the hydrogen storage were not damaged, the incident proved the suitability of the applied hydrogen safety concept [172].

4.1.9. METHAPU

In the *methanol auxiliary power unit* (METHAPU) project a 20 kW SOFC demonstrator was marinised and tested on-board of the car carrier 'Undine'. Additional objectives of the project were to facilitate the introduction of international regulations on MeOH as a marine fuel, and to assess the environmental impact of such applications [191,79].

4.1.10. Nemo H₂

Fuel Cell Boat BV has developed the passenger vessel *Nemo H₂* for canal cruises in Amsterdam. It is propelled with a 60–70 kW PEMFC system, hybridised with a 55 kW lead acid battery pack [188]. The vessel was delivered in 2011, but has not entered active service as of now due to the absence of a permanent hydrogen fuelling station.

4.1.11. SchIBZ

The *ship-integrated fuel cell* (SchIBZ) project started in 2009 and is still ongoing. The target of the project is to install and evaluate a 0.5 MW diesel-reformer integrated SOFC system on the vessel 'MS Forester'. Design calculations showed that LHV efficiency up to 55% can be obtained. So far, a 27 kW system demonstrated an electrical efficiency over 50% on low sulphur diesel for more than 1000 h.

Tests with a 50 kW system at sea are planned for 2016 [16,192,193].

4.1.12. Pa-X-ell

The Pa-X-ell project is part of the same program as the SchIBZ project. The Pa-X-ell project focusses on the integration and safety aspects of MeOH-fuelled HT-PEMFC systems in cruise ships. Investigations include the placement of fuel cells in different fire zones, safe supply of low-flashpoint fuels, and thermal and electrical integration of fuel cells. A 120 kW fuel cell container has been developed for long term trials [192,193].

4.2. Lessons learned

The first noticeable projects focussed on using fuel cell systems with conventional diesel as a logistic fuel. This proved to be problematic due to the sulphur susceptibility of catalysts in both reformers and fuel cells. The use of diesel fuels in LT-PEMFCs was shown to be inefficient compared to diesel engine-generator sets. Although diesel-fuelled MCFC systems were expected to achieve significantly higher efficiencies, this was never successfully demonstrated on-board.

More recently, the focus shifted towards the use of LNG and MeOH as logistic fuels. The METHAPU and especially the FellowSHIP project managed to test systems on-board for significant periods, demonstrating high electrical efficiencies and low emissions. The Pa-X-ell project seems to take MeOH-fuelled systems to the next level, aiming to demonstrate a significant amount of distributed power generation on a cruise vessel. The SchIBZ project seems on track to show robust and highly efficient electricity generation from low-sulphur or synthetic diesel fuels with an SOFC system.

There has been significant progress during recent decades in the development of fuel cell systems. However, some specific maritime requirements have hardly been addressed. For example, LNG-fuelled SOFC systems have never been demonstrated on vessels, although this seems to be an obvious choice given recent developments in NG-fuelled stationary SOFC systems. More specifically, SOFCs combined with reciprocating engines, as proposed by several authors [15,146,147], may offer a near-future solution to reduce fuel consumption and specific emissions considerably compared to conventional generators. In addition, hybridisation with auxiliary energy storage components to improve transient capabilities, which is well developed in automotive applications, should be addressed.

5. Summary

This review provided a resume of fuel cell types, logistic fuels and fuel processing equipment, to provide insight into the implications of choices for fuel cell types and logistic fuels on the overall

fuel cell system characterises. This supported an analysis of the suitability of these systems for electrical power generating on-board ships, for which electrical efficiency, gravimetric and volumetric density, system dynamics, environmental impact, safety and economics were discussed. Finally an overview of research projects on maritime fuel cell application was presented.

Low temperature fuel cells can achieve high electrical efficiencies if hydrogen is available as a logistic fuel. However, the efficiency is significantly reduced if hydrocarbon fuels are used, mostly due to the need to reform and clean these fuels, and subsequent parasitic losses. As a result, heavy duty internal combustion engine-generators are probably more efficient. High temperature fuel cells provide better integration with the fuel processing equipment, and have higher tolerances for impurities in the fuel. Especially when combined with gas turbines or reciprocating engines, these fuel cell systems can attain higher electrical efficiencies than conventional generators.

Competitive power densities have already been demonstrated by some fuel cell car developers with hydrogen-fuelled LT-PEMFCs, as this is an important development objective for automotive application. The power density achieved by high temperature fuel cell systems is lower, which is partly due to the increased BoP and heat insulation. However, a Ragone chart comparison showed that fuel savings by high temperature fuel cell systems and the higher energy density of hydrocarbon fuels result in a more compact system when operation over several dozens of hours is required. The total volume of a LT-PEMFC plant with cryogenic hydrogen storage is shown to be 1.5 to 5 times larger than alternative options for vessels with refuelling intervals over 100 h.

Load transient capabilities of fuel cell systems have a similar dependence on the fuel cell type and fuel processing requirements. In general, systems with a large BoP and thermal mass have longer start-up times and limited load-following capabilities. Therefore, hybridisation with auxiliary electricity storage components, such as batteries, supercapacitors or flywheels will be required in many cases to meet maritime power requirements.

Various assessments have shown that fuel cell systems can achieve a lower environmental life cycle impact than diesel engine-generators sets, mainly due to reduced local emissions during their operational life time. However, the manufacturing stage has a relatively large impact, and the environmental gains depend on the life time of the stacks and recyclability of stack materials. High temperature fuel cells have a clear potential to reduce greenhouse gas emissions over their life cycle due to the high efficiencies that can be achieved, even if fossil fuels are used. Their low temperature counterparts have this potential if renewable hydrogen is available.

Some classification standards have been developed for maritime fuel cell systems, but currently they do not provide a general approach for safety assessment of all fuel cell systems, and can be overly stringent. In particular storage and handling of volatile, low flash point fuels needs careful consideration. On the other hand, the high availability and the opportunity to distribute power generation over the vessel can improve the redundancy of electricity generation. This should be further studied for future classification standards.

It is expected that fuel cell systems will remain relatively expensive in the near future. However, significant cost reductions have been demonstrated lately, and novel concepts have shown the potential to reduce investment costs even further. It is expected that price levels can be achieved where reductions in fuel consumption, emissions, noise and vibrations would justify the higher a higher capital cost.

6. Concluding remarks

Fuel cell systems provide an efficient way to generate electricity on-board from a variety of logistic fuels, with few hazardous emissions. Liquefied hydrogen-fuelled LT-PEMFC systems provide a power dense solution for ships with mission requirements up to a dozen hours. However, for sailing times over 100 h the limited hydrogen storage density is expected to result in 1.5–5 times larger total system volumes compared to alternative systems with more energy dense logistic fuels.

High temperature fuel cell systems can achieve high overall system efficiencies using various hydrocarbon fuels, especially when equipped with bottoming cycles. Such systems can attain relatively low emission levels and reasonable density for ships with mission requirements of several days. For vessels that require longer independent operation, ship owners may face a trade-off between smaller fuel tanks using a dense logistic fuel, such as diesel, and fuel savings using a less energy dense gaseous fuel, for example NG.

Several challenges will have to be addressed before fuel cell systems are able to meet all maritime power requirements and can compete with state-of-the-art maritime solutions. The following topics are identified as most interesting for immediate further study:

- The increasing availability of LNG and the rapid development of NG-fuelled fuel cell systems justifies maritime demonstration of such systems;
- Fuel cell combined cycles have the potential to attain an even lower fuel consumption. Combining SOFCs with reciprocating engine generator sets seems particularly interesting for near-future maritime application;
- Hybridisation with auxiliary electricity storage components, capable of following the demanded load transients, requires further development;
- Classification standards on opportunities to increase the redundancy of power supply with distributed electricity generation should be investigated.

Currently available fuel cell systems are significantly more expensive than conventional generators, but it is expected that system prices can be reduced to levels where the higher investment cost is justified by the advantages. These benefits stand out for vessels which operate in ECA zones, since exhaust gas cleaning is avoided entirely. LNG fuelling is already being adopted for these ships to meet stringent emission requirements.

Although environmental benefits from LNG as a logistic fuel are debatable from a total life cycle perspective, NG-fuelled fuel cell systems have a relatively advanced development state, and the application of SOFC combined cycles can further improve the well-to-wave efficiency. In addition, most alternatives, such as hydrogen, MeOH and DME, are currently produced from a fossil feedstock, and NG can be produced from renewable sources as well.

The authors envision that the developing LNG infrastructure and development state of NG-fuelled fuel cell systems can facilitate the introduction of gaseous fuels and fuel cell systems on ships. Therefore, the development of a maritime LNG-fuelled SOFC-reciprocating engine combined system will be taken up in the recently commenced Dutch national GasDrive project.

A. Data for Ragone charts

Table A.4

Gravimetric and volumetric power density and efficiency ranges for heat engine generators, fuel cells and fuel processing equipment, based on literature and commercially available systems. For fuel cell systems, a 50% upper margin is added to account for their limited development state, their modularity, the possible removal of exhaust stacks and sound isolation bedplates, and a smaller cooling system.

	Gravimetric Density [W/kg]	Volumetric Density [W/L]	LHV Efficiency [%]
Heat engines			
Diesel genset	45–71.5	32.5–55	30–45
Gas genset	45–65	30–45	35–47
Gas turbine genset	100–1200	45–450	25–40
Fuel cell systems			
PEMFC (H ₂)	250–1000	300–1550	40–60
MCFC (NG/syngas)	7.75–25	1.75–20	40–55
SOFC (NG/syngas)	8–80	4–32	45–60
Fuel processing			
Ammonia cracker	50–250	50–115	80–90
MeOH SR	25–120	22–45	70–90
DME SR	30–150	40–75	85–95
Diesel SR	20–40	20–50	75–90

References

- [1] A. Miola, B. Ciuffo, E. Giovine, M. Marra, "Regulating Air Emissions from Ships," the State of the Art on Methodologies, Technologies and Policy Options, 2010, pp. 978–992. Joint Research Centre Reference Report, Luxembourg, EUR24602EN, ISBN.
- [2] V. Eyring, H. Köhler, A. Lauer, B. Lemper, Emissions from international shipping: 2. impact of future technologies on scenarios until 2050, *J. Geophys. Res. Atmos.* 110 (D17) (2005), 1984–2012.
- [3] D. Gerard, L.B. Lave, Implementing technology-forcing policies: the 1970 clean air act amendments and the introduction of advanced automotive emissions controls in the United States, *Technol. Forecast. Soc. Change* 72 (7) (2005) 761–778.
- [4] S. Brynolf, M. Magnusson, E. Fridell, K. Andersson, Compliance possibilities for the future ECA regulations through the use of abatement technologies or change of fuels, *Transp. Res. Part D Transp. Environ.* 28 (2014) 6–18.
- [5] F. Millo, M.G. Bernardi, D. Delneri, Computational Analysis of Internal and External EGR Strategies Combined with Miller Cycle Concept for a Two Stage Turbocharged Medium Speed Marine Diesel Engine, 2011. Tech. Rep., SAE Technical Paper.
- [6] T. Tow, D. Pierpont, R.D. Reitz, Reducing Particulate and NOx Emissions by Using Multiple Injections in a Heavy Duty DI Diesel Engine, 1994. Tech. Rep., SAE Technical Paper.
- [7] F. Burel, R. Taccani, N. Zuliani, Improving sustainability of maritime transport through utilization of liquefied natural gas (LNG) for propulsion, *Energy* 57 (2013) 412–420.
- [8] S. Bengtsson, K. Andersson, E. Fridell, A comparative life cycle assessment of marine fuels liquefied natural gas and three other fossil fuels, *Proc. Inst. Mech. Eng. Part M J. Eng. Marit. Environ.* 225 (2) (2011) 97–110.
- [9] C. Christen, D. Brand, IMO tier 3: gas and dual fuel engines as a clean and efficient solution, *CIMAC* 187 (2013).
- [10] A. Azzara, D. Rutherford, H. Wang, Feasibility of IMO Annex VI Tier III Implementation Using Selective Catalytic Reduction, 2014.
- [11] A.B. Stambouli, E. Traversa, Fuel cells, an alternative to standard sources of energy, *Renew. Sustain. Energy Rev.* 6 (3) (2002) 295–304.
- [12] R. Payne, J. Love, M. Kah, Generating electricity at 60% electrical efficiency from 1–2 kWe SOFC products, *ECS Trans.* 25 (2) (2009) 231–239.
- [13] A. Massardo, F. Lubelli, Internal reforming solid oxide fuel cell-gas turbine combined cycles (IRSOFC-GT): part ACell model and cycle thermodynamic analysis, in: *International Gas Turbine and Aeroengine Congress and Exhibition*, ASME, 1998.
- [14] H. Patel, T. Woudstra, P. Aravind, Thermodynamic analysis of solid oxide fuel cell gas turbine systems operating with various biofuels, *Fuel Cells* 12 (6) (2012) 1115–1128.
- [15] GE developing hybrid SOFC-gas engine for distributed generation, *Fuel Cells Bull.* 2013 (10) (2013) 5.
- [16] K. Leites, A. Bauschulte, M. Dragon, S. Krummrich, P. Nehter, SCHIBZ-design of different diesel based fuel cell systems for seagoing vessels and their evaluation, *ECS Trans.* 42 (1) (2012) 49–58.
- [17] G. Sattler, Fuel cells going on-board, *J. power sources* 86 (1) (2000) 61–67.
- [18] T.J. McCoy, Trends in ship electric propulsion, in: *Power Engineering Society Summer Meeting, 2002 IEEE*, vol. 1, IEEE, 2002, pp. 343–346.
- [19] J. Langston, S. Suryanarayanan, M. Steurer, M. Andrus, S. Woodruff, P. Ribeiro, "Experiences with the simulation of a notional all-electric ship integrated power system on a large-scale high-speed electromagnetic transient simulator, in: *Power Engineering Society General Meeting, 2006. IEEE*, IEEE, 2006, p. 5.
- [20] S. Singhal, Advances in solid oxide fuel cell technology, *Solid State Ionics* 135 (1) (2000) 305–313.
- [21] E.D. Wachsman, K.T. Lee, Lowering the temperature of solid oxide fuel cells, *Science* 334 (6058) (2011) 935–939.
- [22] A.C. Riekstin, S. James, A. Kansal, J. Liu, E. Peterson, No more electrical infrastructure: towards fuel cell powered data centers, *ACM SIGOPS Oper. Syst. Rev.* 48 (1) (2014) 39–43.
- [23] B. Thorstensen, A parametric study of fuel cell system efficiency under full and part load operation, *J. power sources* 92 (1) (2001) 9–16.
- [24] Y. Wang, K.S. Chen, J. Mishler, S.C. Cho, X.C. Adroher, A review of polymer electrolyte membrane fuel cells: technology, applications, and needs on fundamental research, *Appl. Energy* 88 (4) (2011) 981–1007.
- [25] W. Dai, H. Wang, X.-Z. Yuan, J.J. Martin, D. Yang, J. Qiao, J. Ma, A review on water balance in the membrane electrode assembly of proton exchange membrane fuel cells, *Int. J. Hydrogen Energy* 34 (23) (2009) 9461–9478.
- [26] M. Çögenli, S. Mukerjee, A.B. Yurtcan, Membrane electrode assembly with ultra low platinum loading for cathode electrode of PEM fuel cell by using sputter deposition, *Fuel Cells* 15 (2) (2015) 288–297.
- [27] J. Baschuk, X. Li, Carbon monoxide poisoning of proton exchange membrane fuel cells, *Int. J. Energy Res.* 25 (8) (2001) 695–713.
- [28] X. Cheng, Z. Shi, N. Glass, L. Zhang, J. Zhang, D. Song, Z.-S. Liu, H. Wang, J. Shen, A review of PEM hydrogen fuel cell contamination: impacts, mechanisms, and mitigation, *J. Power Sources* 165 (2) (2007) 739–756.
- [29] J.O. Jensen, Q. Li, C. Pan, N.J. Bjerrum, H.C. Rudbeck, T. Steenberg, D. Stolten, T. Grube, "Ongoing Efforts Addressing Degradation of High Temperature PEMFC," Report Nr. Schriften des Forschungszentrums Jülich/Energy & Environment, 2010.
- [30] J. Zhang, Z. Xie, J. Zhang, Y. Tang, C. Song, T. Navessin, Z. Shi, D. Song, H. Wang, D.P. Wilkinson, et al., High temperature PEM fuel cells, *J. Power Sources* 160 (2) (2006) 872–891.
- [31] J. Huijismans, G. Kraaij, R. Makkus, G. Rietveld, E. Sitters, H.T.J. Reijers, An analysis of endurance issues for MCFC, *J. Power Sources* 86 (1) (2000) 117–121.
- [32] A. Kulkarni, S. Giddey, Materials issues and recent developments in molten carbonate fuel cells, *J. Solid State Electrochem.* 16 (10) (2012) 3123–3146.
- [33] R.T. Leah, A. Bone, A. Selcuk, D. Corcoran, M. Lankin, Z. Dehaney-Steven, M. Selby, P. Whalen, Development of highly robust, volume-manufacturable metal-supported SOFCs for operation below 600C, *ECS Trans.* 35 (1) (2011) 351–367.
- [34] S. Pellegrino, A. Lanzini, P. Leone, Techno-economic and policy requirements for the market-entry of the fuel cell micro-chp system in the residential sector, *Appl. Energy* 143 (2015) 370–382.
- [35] R.J. Kee, H. Zhu, D.G. Goodwin, Solid-oxide fuel cells with hydrocarbon fuels, *Proc. Combust. Inst.* 30 (2) (2005) 2379–2404.
- [36] N. Laosiripojana, S. Assabumrungrat, Catalytic steam reforming of methane, methanol, and ethanol over Ni/YSZ: the possible use of these fuels in internal reforming SOFC, *J. Power Sources* 163 (2) (2007) 943–951.
- [37] P. Aguiar, C. Adjiman, N.P. Brandon, Anode-supported intermediate temperature direct internal reforming solid oxide fuel cell. i: model-based steady-state performance, *J. Power Sources* 138 (1) (2004) 120–136.
- [38] L. Cohen, A. Tate, N. Weinhold, Investigation into the Implications of Fuel Cell Shipboard Integration into the T-agos 19 Class, 2012 tech. rep., DTIC Document.
- [39] M. Kicuklies, Fuel cell power for maritime applications, *Fuel Cells Bull.* 9 (2005) 12–15.
- [40] S. Krummrich, B. Tuinstra, G. Kraaij, J. Roes, H. Olgun, Diesel fuel processing for fuel cells, *J. Power Sources* 160 (1) (2006) 500–504.
- [41] S. Allen, E. Ashby, D. Gore, J. Woerner, M. Cervi, Marine applications of fuel cells: a multi-agency research program, *Nav. Eng. J.* 110 (1) (1998) 93–106.
- [42] R. Privette, T. Flynn, M. Perna, R. Holland, S. Rahmani, C. Wood-burn, S. Scoles, R. Watson, 2.5 MW PEM Fuel Cell System for Navy Ship Service Power, 2002.
- [43] S. Specchia, G. Saracco, V. Specchia, Modeling of an APU system based on MCFC, *Int. J. Hydrogen Energy* 33 (13) (2008) 3393–3401.
- [44] S. Bensaïd, S. Specchia, F. Federici, G. Saracco, V. Specchia, MCFC-based

- marine APU: comparison between conventional ATR and cracking coupled with SR integrated inside the stack pressurized vessel, *Int. J. Hydrogen Energy* 34 (4) (2009) 2026–2042.
- [45] C. Ezgi, M.T. Çoban, Ö. Selvi, Design and thermodynamic analysis of an SOFC system for naval surface ship application, *J. Fuel Cell Sci. Technol.* 10 (3) (2013) 031006.
- [46] S. Alkaner, P. Zhou, A comparative study on life cycle analysis of molten carbon fuel cells and diesel engines for marine application, *J. Power Sources* 158 (1) (2006) 188–199.
- [47] S. Lee, J.G. Speight, S.K. Loyalka, *Handbook of Alternative Fuel Technologies*, CRC Press, 2014.
- [48] H.B. Gray, Powering the planet with solar fuel, *Nat. Chem.* 1 (1) (2009), 7–7.
- [49] S. Dahl, I. Chorkendorff, Solar-fuel generation: towards practical implementation, *Nat. Mater.* 11 (2) (2012) 100–101.
- [50] H. Goyal, D. Seal, R. Saxena, Bio-fuels from thermochemical conversion of renewable resources: a review, *Renew. Sustain. Energy Rev.* 12 (2) (2008) 504–517.
- [51] S.C. Roy, O.K. Varghese, M. Paulose, C.A. Grimes, Toward solar fuels: photocatalytic conversion of carbon dioxide to hydrocarbons, *ACS Nano* 4 (3) (2010) 1259–1278.
- [52] J. Newman, P.G. Hoertz, C.A. Bonino, J.A. Trainham, Review: an economic perspective on liquid solar fuels, *J. Electrochem. Soc.* 159 (10) (2012) A1722–A1729.
- [53] L. Schlapbach, A. Züttel, Hydrogen-storage materials for mobile applications, *Nature* 414 (6861) (2001) 353–358.
- [54] J.A. Turner, Sustainable hydrogen production, *Science* 305 (5686) (2004) 972–974.
- [55] T. Taner, Alternative energy of the future: a technical note of PEM fuel cell water management, *J. Fundam. Renew. Energy Appl.* 5 (163) (2015) 2.
- [56] P.P. Edwards, V.L. Kuznetsov, W.I. David, N.P. Brandon, Hydrogen and fuel cells: towards a sustainable energy future, *Energy Policy* 36 (12) (2008) 4356–4362.
- [57] C. White, R. Steeper, A. Lutz, The hydrogen-fueled internal combustion engine: a technical review, *Int. J. Hydrogen Energy* 31 (10) (2006) 1292–1305.
- [58] K. Hirose, M. Hirscher, *Handbook of Hydrogen Storage: New Materials for Future Energy Storage*, John Wiley & Sons, 2010.
- [59] R. Ahluwalia, T. Hua, J.-K. Peng, S. Lasher, K. McKenney, J. Sinha, M. Gardiner, Technical assessment of cryo-compressed hydrogen storage tank systems for automotive applications, *Int. J. Hydrogen Energy* 35 (9) (2010) 4171–4184.
- [60] S.M. Aceves, F. Espinosa-Loza, E. Ledesma-Orozco, T.O. Ross, A.H. Weisberg, T.C. Brunner, O. Kircher, High-density automotive hydrogen storage with cryogenic capable pressure vessels, *Int. J. Hydrogen Energy* 35 (3) (2010) 1219–1226.
- [61] D. Durbin, C. Malardier-Jugroot, Review of hydrogen storage techniques for on board vehicle applications, *Int. J. Hydrogen Energy* 38 (34) (2013) 14595–14617.
- [62] Y.H. Kim, K.-W. Jun, H. Joo, C. Han, I.K. Song, A simulation study on gas-to-liquid (natural gas to Fischer–Tropsch synthetic fuel) process optimization, *Chem. Eng. J.* 155 (1) (2009) 427–432.
- [63] G. Cinti, A. Baldinelli, A. Di Michele, U. Desideri, Integration of solid oxide electrolyzer and Fischer–Tropsch: a sustainable pathway for synthetic fuel, *Appl. Energy* 162 (2016) 308–320.
- [64] Y. Xiang, J. Zhou, B. Lin, X. Xue, X. Tian, Z. Luo, Exergetic evaluation of renewable light olefins production from biomass via synthetic methanol, *Appl. Energy* 157 (2015) 499–507.
- [65] B. Guo, A. Ghalambor, *Natural Gas Engineering Handbook*, Elsevier, 2014.
- [66] Y.M. Kurlle, S. Wang, Q. Xu, Simulation study on boil-off gas minimization and recovery strategies at LNG exporting terminals, *Appl. Energy* 156 (2015) 628–641.
- [67] É.S. Van-Dal, C. Bouallou, Design and simulation of a methanol production plant from CO₂ hydrogenation, *J. Clean. Prod.* 57 (2013) 38–45.
- [68] S.K. Das, K.K. Gadde, Computational fluid dynamics modeling of a catalytic flat plate fuel reformer for on-board hydrogen generation, *J. Fuel Cell Sci. Technol.* 10 (6) (2013) 061005.
- [69] Y. Bang, S.J. Han, J. Yoo, J.H. Choi, K.H. Kang, J.H. Song, J.G. Seo, J.C. Jung, I.K. Song, Hydrogen production by steam reforming of liquefied natural gas (LNG) over trimethylbenzene-assisted ordered mesoporous nickel–alumina catalyst, *Int. J. Hydrogen Energy* 38 (21) (2013) 8751–8758.
- [70] S. Brynolf, E. Fridell, K. Andersson, Environmental assessment of marine fuels: liquefied natural gas, liquefied biogas, methanol and bio-methanol, *J. Clean. Prod.* 74 (2014) 86–95.
- [71] X. Peng, D. Cao, Computational screening of porous carbons, zeolites, and metal organic frameworks for desulfurization and decarburization of biogas, natural gas, and flue gas, *AIChE J.* 59 (8) (2013) 2928–2942.
- [72] A. Buonomano, F. Calise, M.D. d’Accadia, A. Palombo, M. Vicidomini, Hybrid solid oxide fuel cells–gas turbine systems for combined heat and power: a review, *Appl. Energy* 156 (2015) 32–85.
- [73] I. Ridjan, *Integrated Electrofuels and Renewable Energy Systems*, PhD thesis, Videnbasen for Aalborg Universitet/VBN, Aalborg Universitet/Aalborg University, Det Teknisk-Naturvidenskabelige Fakultet/The Faculty of Engineering and Science, 2015.
- [74] E. Alberico, M. Nielsen, Towards a methanol economy based on homogeneous catalysis: methanol to H₂ and CO₂ to methanol, *Chem. Commun.* 51 (31) (2015) 6714–6725.
- [75] C. Pan, R. He, Q. Li, J.O. Jensen, N.J. Bjerrum, H.A. Hjulmand, A.B. Jensen, Integration of high temperature PEM fuel cells with a methanol reformer, *J. Power Sources* 145 (2) (2005) 392–398.
- [76] S.J. Andreasen, S.K. Kær, S. Sahlin, Control and experimental characterization of a methanol reformer for a 350 W high temperature polymer electrolyte membrane fuel cell system, *Int. J. Hydrogen Energy* 38 (3) (2013) 1676–1684.
- [77] G.C. Bandlamudi, M. Steffen, T. Meijer, A. Heinzel, Internal reforming methanol fuel cell development, in: *Meeting Abstracts*, vol. 3, The Electrochemical Society, 2015, 644–644.
- [78] B. Hu, M. Keane, K. Patil, M.K. Mahapatra, U. Pasaogullari, P. Singh, Direct methanol utilization in intermediate temperature liquid-tin anode solid oxide fuel cells, *Appl. Energy* 134 (2014) 342–348.
- [79] C. Strazza, A. Del Borghi, P. Costamagna, A. Traverso, M. Santin, Comparative LCA of methanol-fuelled SOFCs as auxiliary power systems on-board ships, *Appl. Energy* 87 (5) (2010) 1670–1678.
- [80] M. Xu, J.H. Lunsford, D.W. Goodman, A. Bhattacharyya, Synthesis of dimethyl ether (DME) from methanol over solid-acid catalysts, *Appl. Catal. A General* 149 (2) (1997) 289–301.
- [81] R. Vakili, E. Pourazadi, P. Setoodeh, R. Eslamloueyan, M. Rahimpour, Direct dimethyl ether (DME) synthesis through a thermally coupled heat exchanger reactor, *Appl. Energy* 88 (4) (2011) 1211–1223.
- [82] H.-J. Chen, C.-W. Fan, C.-S. Yu, Analysis, synthesis, and design of a one-step dimethyl ether production via a thermodynamic approach, *Appl. Energy* 101 (2013) 449–456.
- [83] T.A. Semelsberger, R.L. Borup, H.L. Greene, Dimethyl ether (DME) as an alternative fuel, *J. Power Sources* 156 (2) (2006) 497–511.
- [84] E.P. Murray, S.J. Harris, H. Jen, Solid oxide fuel cells utilizing dimethyl ether fuel, *J. Electrochem. Soc.* 149 (9) (2002) A1127–A1131.
- [85] S. Freni, N. Mondello, S. Cavallaro, G. Cacciola, V. Parmon, V. Sobyani, Hydrogen production by steam reforming of ethanol: a two step process, *React. Kinet. Catal. Lett.* 71 (1) (2000) 143–152.
- [86] C. Zamfirescu, I. Dincer, Using ammonia as a sustainable fuel, *J. Power Sources* 185 (1) (2008) 459–465.
- [87] R. Metkemeijer, P. Achard, Comparison of ammonia and methanol applied indirectly in a hydrogen fuel cell, *Int. J. Hydrogen Energy* 19 (6) (1994) 535–542.
- [88] T. Hejze, J. Besenhard, K. Kordes, M. Cifrain, R. Aronsson, Current status of combined systems using alkaline fuel cells and ammonia as a hydrogen carrier, *J. Power Sources* 176 (2) (2008) 490–493.
- [89] A. Klerke, C.H. Christensen, J.K. Nørskov, T. Vegge, Ammonia for hydrogen storage: challenges and opportunities, *J. Mater. Chem.* 18 (20) (2008) 2304–2310.
- [90] R. Lan, J.T. Irvine, S. Tao, Ammonia and related chemicals as potential indirect hydrogen storage materials, *Int. J. Hydrogen Energy* 37 (2) (2012) 1482–1494.
- [91] M. Klell, Storage of Hydrogen in the Pure Form, in: *Handbook of Hydrogen Storage: New Materials for Future Energy Storage*, 2010, p. 1.
- [92] D. Stapersma, H. Klein Woud, *Design of Propulsion and Electric Power Generation Systems*, IMarEST, London (United Kingdom), 2002.
- [93] K. Ahmed, K. Föger, Approach to equilibrium of the water–gas shift reaction on a ni/zirconia anode under solid oxide fuel-cell conditions, *J. Power Sources* 103 (1) (2001) 150–153.
- [94] J. Xu, G.F. Froment, Methane steam reforming, methanation and water–gas shift: I. intrinsic kinetics, *AIChE J.* 35 (1) (1989) 88–96.
- [95] M. Mitchell, P.J. Kenis, et al., Ceramic microreactors for on-site hydrogen production from high temperature steam reforming of propane, *Lab a Chip* 6 (10) (2006) 1328–1337.
- [96] I.-K. Sung, I. Christian, M. Mitchell, D. Kim, P. Kenis, Tailored macroporous sio₂ and sic structures for high-temperature fuel reforming, *Adv. Funct. Mater.* 15 (8) (2005) 1336–1342.
- [97] C.O. Colpan, I. Dincer, F. Hamdullahpur, Thermodynamic modeling of direct internal reforming solid oxide fuel cells operating with syngas, *Int. J. Hydrogen Energy* 32 (7) (2007) 787–795.
- [98] Y. Yi, A.D. Rao, J. Brouwer, G.S. Samuelsen, Fuel flexibility study of an integrated 25kW SOFC reformer system, *J. Power Sources* 144 (1) (2005) 67–76.
- [99] R. Peters, E. Riensche, P. Cremer, Pre-reforming of natural gas in solid oxide fuel-cell systems, *J. Power Sources* 86 (1) (2000) 432–441.
- [100] R. Peters, R. Dahl, U. Klüttgen, C. Palm, D. Stolten, Internal reforming of methane in solid oxide fuel cell systems, *J. Power Sources* 106 (1) (2002) 238–244.
- [101] J. Meusinger, E. Riensche, U. Stimming, Reforming of natural gas in solid oxide fuel cell systems, *J. Power Sources* 71 (1) (1998) 315–320.
- [102] D. Dissanayake, M.P. Rosynek, K.C. Kharas, J.H. Lunsford, Partial oxidation of methane to carbon monoxide and hydrogen over a Ni/Al₂O₃ catalyst, *J. Catal.* 132 (1) (1991) 117–127.
- [103] A. Lindermeier, S. Kah, S. Kavurucu, M. Mühlner, On-board diesel fuel processing for an SOFC–APU technical challenges for catalysis and reactor design, *Appl. Catal. B Environ.* 70 (1) (2007) 488–497.
- [104] F. Yagi, A. Nagumo, Y. Wada, M. Shimura, S. Asaoka, and S. Wakamatsu, "Process for preparing synthesis gas by autothermal reforming," Jan. 22 2002. US Patent 6,340,437.
- [105] A. Ersoz, H. Olgun, S. Ozdogan, C. Gungor, F. Akgun, M. Tiris, Autothermal reforming as a hydrocarbon fuel processing option for PEM fuel cell, *J. Power Sources* 118 (1) (2003) 384–392.
- [106] B. Lindström, J. Karlsson, P. Ekdunge, L. De Verdier, B. Häggendal, J. Dawody,

- M. Nilsson, L.J. Pettersson, Diesel fuel reformer for automotive fuel cell applications, *Int. J. Hydrogen Energy* 34 (8) (2009) 3367–3381.
- [107] D.S. Newsome, The water-gas shift reaction, *Catal. Rev. Sci. Eng.* 21 (2) (1980) 275–318.
- [108] R. Suwanwarangkul, E. Croiset, E. Entchev, S. Charojrochkul, M. Pritzker, M. Fowler, P. Douglas, S. Chewathanakup, H. Mahaudom, Experimental and modeling study of solid oxide fuel cell operating with syngas fuel, *J. Power Sources* 161 (1) (2006) 308–322.
- [109] O. Costa-Nunes, R.J. Gorte, J.M. Vohs, Comparison of the performance of Cu–CeO₂–YSZ and Ni–YSZ composite SOFC anodes with H₂, CO, and syngas, *J. Power Sources* 141 (2) (2005) 241–249.
- [110] C. Wheeler, A. Jhalani, E. Klein, S. Tummala, L. Schmidt, The water–gas-shift reaction at short contact times, *J. Catal.* 223 (1) (2004) 191–199.
- [111] A.F. Ghenciu, Review of fuel processing catalysts for hydrogen production in PEM fuel cell systems, *Curr. Opin. solid state Mater. Sci.* 6 (5) (2002) 389–399.
- [112] D.J. Moon, K. Sreekumar, S.D. Lee, B.G. Lee, H.S. Kim, Studies on gasoline fuel processor system for fuel-cell powered vehicles application, *Appl. Catal. A General* 215 (1) (2001) 1–9.
- [113] M. Echigo, T. Tabata, Development of novel Ru catalyst of preferential CO oxidation for residential polymer electrolyte fuel cell systems, *Catal. today* 90 (3) (2004) 269–275.
- [114] A. Manasilp, E. Gulari, Selective CO oxidation over Pt/alumina catalysts for fuel cell applications, *Appl. Catal. B Environ.* 37 (1) (2002) 17–25.
- [115] I. Son, M. Shamsuzzoha, A. Lane, Promotion of Pt/ γ -Al₂O₃ by new pretreatment for low-temperature preferential oxidation of CO in H₂ for PEM fuel cells, *J. Catal.* 210 (2) (2002) 460–465.
- [116] R.A. Dagle, Y. Wang, G.-G. Xia, J.J. Strohm, J. Holladay, D.R. Palo, Selective CO methanation catalysts for fuel processing applications, *Appl. Catal. A General* 326 (2) (2007) 213–218.
- [117] C. Galletti, S. Specchia, G. Saracco, V. Specchia, CO-selective methanation over Ru– γ -Al₂O₃ catalysts in H₂-rich gas for PEM FC applications, *Chem. Eng. Sci.* 65 (1) (2010) 590–596.
- [118] C. Galletti, S. Specchia, V. Specchia, CO selective methanation in H₂-rich gas for fuel cell application: microchannel reactor performance with Ru-based catalysts, *Chem. Eng. J.* 167 (2) (2011) 616–621.
- [119] G. Ercolino, M.A. Ashraf, V. Specchia, S. Specchia, Performance evaluation and comparison of fuel processors integrated with PEM fuel cell based on steam or autothermal reforming and on CO preferential oxidation or selective methanation, *Appl. Energy* 143 (2015) 138–153.
- [120] P. Djinović, C. Galletti, S. Specchia, V. Specchia, Ru-based catalysts for CO selective methanation reaction in H₂-rich gases, *Catal. Today* 164 (1) (2011) 282–287.
- [121] N.W. Ockwig, T.M. Nenoff, Membranes for hydrogen separation, *Chem. Rev.* 107 (10) (2007) 4078–4110.
- [122] Y.-M. Lin, M.-H. Rei, Study on the hydrogen production from methanol steam reforming in supported palladium membrane reactor, *Catal. Today* 67 (1) (2001) 77–84.
- [123] G. Lu, J.D. da Costa, M. Duke, S. Giessler, R. Socolow, R. Williams, T. Kreutz, Inorganic membranes for hydrogen production and purification: a critical review and perspective, *J. Colloid Interface Sci.* 314 (2) (2007) 589–603.
- [124] S. Uemiyama, N. Sato, H. Ando, T. Matsuda, E. Kikuchi, Steam reforming of methane in a hydrogen-permeable membrane reactor, *Appl. Catal.* 67 (1) (1990) 223–230.
- [125] J. Yang, C.-H. Lee, J.-W. Chang, Separation of hydrogen mixtures by a two-bed pressure swing adsorption process using zeolite 5A, *Ind. Eng. Chem. Res.* 36 (7) (1997) 2789–2798.
- [126] S.-I. Yang, D.-Y. Choi, S.-C. Jang, S.-H. Kim, D.-K. Choi, Hydrogen separation by multi-bed pressure swing adsorption of synthesis gas, *Adsorption* 14 (4–5) (2008) 583–590.
- [127] S. Sircar, T. Golden, Purification of hydrogen by pressure swing adsorption, *Sep. Sci. Technol.* 35 (5) (2000) 667–687.
- [128] P.R. Westmoreland, D.P. Harrison, Evaluation of candidate solids for high-temperature desulfurization of low-Btu gases, *Environ. Sci. Technol.* 10 (7) (1976) 659–661.
- [129] O. van Rheinberg, K. Lucka, H. Köhne, T. Schade, J.T. Andersson, Selective removal of sulphur in liquid fuels for fuel cell applications, *Fuel* 87 (13) (2008) 2988–2996.
- [130] I.I. Novochinskii, C. Song, X. Ma, X. Liu, L. Shore, J. Lampert, R.J. Farrauto, Low-temperature H₂S removal from steam-containing gas mixtures with ZnO for fuel cell application. 1. ZnO particles and extrudates, *Energy & Fuels* 18 (2) (2004) 576–583.
- [131] “Diesel and Gas Engines Generator Sets and Propulsion systems.” Brochure, 2016.
- [132] “Wärtsilä Engines & Generating sets.” Brochure, 2016.
- [133] A.K. Adnanes, Maritime Electrical Installations and Diesel Electric Propulsion, ABB, 2003.
- [134] P. Yadav, R. Kumar, S. Panda, C. Chang, An improved harmony search algorithm for optimal scheduling of the diesel generators in oil rig platforms, *Energy Convers. Manag.* 52 (2) (2011) 893–902.
- [135] P.P. Walsh, P. Fletcher, Gas turbine Performance, John Wiley & Sons, 2004.
- [136] D. Woodyard, Pounder’s Marine Diesel Engines and Gas Turbines, Butterworth-Heinemann, 2009.
- [137] V. Adams, Possible fuel cell applications for ships and submarines, *J. power sources* 29 (1) (1990) 181–192.
- [138] C. Bourne, T. Nietsch, D. Griffiths, J. Morley, Application of Fuel Cells in Surface Ships, Harwell Laboratory, Energy Technology Support Unit, Fuel Cells Programme, 2001.
- [139] K.B. Ludvigsen, E. Ovrum, Fuel Cells for Ships, DNV Research and Innovation, 2012. Position Paper, no. 13.
- [140] R. Kehlhofer, B. Rukes, F. Hannemann, F. Stirnimann, Combined-cycle Gas & Steam Turbine Power Plants, Pennwell Books, 2009.
- [141] C. Sprouse, C. Depcik, Review of organic rankine cycles for internal combustion engine exhaust waste heat recovery, *Appl. Therm. Eng.* 51 (1) (2013) 711–722.
- [142] G. Shu, Y. Liang, H. Wei, H. Tian, J. Zhao, L. Liu, A review of waste heat recovery on two-stroke ic engine aboard ships, *Renew. Sustain. Energy Rev.* 19 (2013) 385–401.
- [143] L.K.C. Tse, S. Wilkins, N. McGlashan, B. Urban, R. Martinez-Botas, Solid oxide fuel cell/gas turbine trigeneration system for marine applications, *J. Power Sources* 196 (6) (2011) 3149–3162.
- [144] M. Rokni, Thermodynamic analysis of an integrated solid oxide fuel cell cycle with a rankine cycle, *Energy Convers. Manag.* 51 (12) (2010) 2724–2732.
- [145] M. Rokni, Thermodynamic analysis of SOFC (solid oxide fuel cell)–Stirling hybrid plants using alternative fuels, *Energy* 61 (2013) 87–97.
- [146] S.H. Park, Y.D. Lee, K.Y. Ahn, Performance analysis of an SOFC/HCCI engine hybrid system: system simulation and thermo-economic comparison, *Int. J. Hydrogen Energy* 39 (4) (2014) 1799–1810.
- [147] A. Chaudhari, R. Stobart, Investigation of optimum operating range for a solid oxide fuel cell-ic engine hybrid system, in: *Electric and Hybrid Vehicles, 2006. ICEHV’06. IEEE Conference on*, IEEE, 2006, pp. 1–6.
- [148] A. Fernandes, T. Woudstra, A. van Wijk, L. Verhoef, P. Aravind, Fuel cell electric vehicle as a power plant and sofc as a natural gas reformer: an exergy analysis of different system designs, *Appl. Energy* 173 (2016) 13–28.
- [149] H. Chen, T.N. Cong, W. Yang, C. Tan, Y. Li, Y. Ding, Progress in electrical energy storage system: a critical review, *Prog. Nat. Sci.* 19 (3) (2009) 291–312.
- [150] P.J. Hall, E.J. Bain, Energy-storage technologies and electricity generation, *Energy policy* 36 (12) (2008) 4352–4355.
- [151] B.C. Chan, The state of the art of electric, hybrid, and fuel cell vehicles, *Proc. IEEE* 95 (4) (2007) 704–718.
- [152] S. Krummrich, J. Llabrés, Methanol reformer—the next milestone for fuel cell powered submarines, *Int. J. Hydrogen Energy* 40 (15) (2015) 5482–5486.
- [153] M.C. Díaz-de Baldasano, F.J. Mateos, L.R. Núñez-Rivas, T.J. Leo, Conceptual design of offshore platform supply vessel based on hybrid diesel generator-fuel cell power plant, *Appl. Energy* 116 (2014) 91–100.
- [154] Y. Gogotsi, P. Simon, True performance metrics in electrochemical energy storage, *Sci. Mag.* 334 (2011) 917–918.
- [155] R.S. Gemmen, Analysis for the effect of inverter ripple current on fuel cell operating condition, *J. Fluids Eng.* 125 (3) (2003) 576–585.
- [156] P. Thounthong, V. Chankag, P. Sethakul, B. Davat, M. Hinaje, Comparative study of fuel-cell vehicle hybridization with battery or supercapacitor storage device, *Veh. Technol. IEEE Trans.* 58 (8) (2009) 3892–3904.
- [157] M.C. Tucker, Progress in metal-supported solid oxide fuel cells: a review, *J. Power Sources* 195 (15) (2010) 4570–4582.
- [158] D. McLarty, Y. Kuniba, J. Brouwer, S. Samuelsen, Experimental and theoretical evidence for control requirements in solid oxide fuel cell gas turbine hybrid systems, *J. Power Sources* 209 (2012) 195–203.
- [159] V. Liso, A.C. Olesen, M.P. Nielsen, S.K. Kær, Performance comparison between partial oxidation and methane steam reforming processes for solid oxide fuel cell (SOFC) micro combined heat and power (CHP) system, *Energy* 36 (7) (2011) 4216–4226.
- [160] P. Thounthong, S. Rael, B. Davat, Energy management of fuel cell/battery/supercapacitor hybrid power source for vehicle applications, *J. Power Sources* 193 (1) (2009) 376–385.
- [161] K. Rajashekara, J. MacBain, M.J. Grieve, et al., Evaluation of SOFC hybrid systems for automotive propulsion applications, in: *Industry Applications Conference, 2006. 41st IAS Annual Meeting. Conference Record of the 2006 IEEE*, vol. 3, IEEE, 2006, pp. 1593–1597.
- [162] A.F. Burke, Batteries and ultracapacitors for electric, hybrid, and fuel cell vehicles, *Proc. IEEE* 95 (4) (2007) 806–820.
- [163] R.T. Doucette, M.D. McCulloch, A comparison of high-speed flywheels, batteries, and ultracapacitors on the bases of cost and fuel economy as the energy storage system in a fuel cell based hybrid electric vehicle, *J. Power Sources* 196 (3) (2011) 1163–1170.
- [164] M. Altmann, W. Weindorf, M. Weinberger, “Life Cycle Analysis Results of Fuel Cell Ships,” *EU Project Contract*, No. G3RD-CT, 2004, 2002–00823.
- [165] A. Simons, C. Bauer, A life-cycle perspective on automotive fuel cells, *Appl. Energy* 157 (2015) 884–896.
- [166] R.W. Howarth, A bridge to nowhere: methane emissions and the greenhouse gas footprint of natural gas, *Energy Sci. Eng.* 2 (2) (2014) 47–60.
- [167] E. Stephenson, A. Doukas, K. Shaw, Greenwashing gas: might a transition fuel label legitimize carbon-intensive natural gas development? *Energy Policy* 46 (2012) 452–459.
- [168] M. Peht, Life-cycle analysis of fuel cell system components, *Handb. Fuel Cells* 4 (Part 13) (2003) 1293–1317.
- [169] S. Basu, Future directions of fuel cell science and technology, in: *Recent Trends in Fuel Cell Science and Technology*, Springer, 2007, pp. 356–365.
- [170] F. Baratto, U.M. Diwekar, Life cycle assessment of fuel cell-based apus, *J. Power Sources* 139 (1) (2005) 188–196.
- [171] J.W. Pratt, A.P. Harris, Vessel Cold-ironing Using a Barge Mounted Pem Fuel

- Cell: Project Scoping and Feasibility, Sandia National Laboratories, 2013. Report SAND2013-0501, available at: <http://energy.gov/eere/fuelcells/downloads/vessel-cold-ironing-using-barge-mounted-pem-fuel-cell-project-scoping-and>.
- [172] F. Vogler and G. Würsig, "Fuel Cells in Maritime Applications Challenges, Chances and Experiences,".
- [173] Y. Zhan, Y. Guo, J. Zhu, H. Wang, Intelligent uninterruptible power supply system with back-up fuel cell/battery hybrid power source, *J. Power Sources* 179 (2) (2008) 745–753.
- [174] J.M. Neff, S. Ostazeski, W. Gardiner, I. Stejskal, Effects of weathering on the toxicity of three offshore australian crude oils and a diesel fuel to marine animals, *Environ. Toxicol. Chem.* 19 (7) (2000) 1809–1821.
- [175] T. Krilić, News from imo, *Trans. Marit. Sci.* 4 (01) (2015) 54–57.
- [176] J. Garche, L. Jörissen, Applications of fuel cell technology: status and perspectives, *Electrochem. Soc. Interface* 24 (2) (2015) 39–43. The Electrochemical Society.
- [177] L. Chick, M. Weimar, G. Whyatt, M. Powell, The case for natural gas fueled solid oxide fuel cell power systems for distributed generation, *Fuel Cells* 15 (1) (2015) 49–60.
- [178] Y. Oono, A. Sounai, M. Hori, Influence of the phosphoric acid-doping level in a polybenzimidazole membrane on the cell performance of high-temperature proton exchange membrane fuel cells, *J. Power Sources* 189 (2) (2009) 943–949.
- [179] H. Chen, P. Pei, M. Song, Lifetime prediction and the economic lifetime of proton exchange membrane fuel cells, *Appl. Energy* 142 (2015) 154–163.
- [180] D.L. Greene, G. Duleep, Status and Prospects of the Global Automotive Fuel Cell Industry and Plans for Deployment of Fuel Cell Vehicles and Hydrogen Refueling Infrastructure, Oak Ridge National Laboratory, 2013.
- [181] I. Staffell, R. Green, The cost of domestic fuel cell micro-chp systems, *Int. J. hydrogen energy* 38 (2) (2013) 1088–1102.
- [182] N. Brandon, A. Blake, D. Corcoran, D. Cumming, A. Duckett, K. El-Koury, D. Haigh, C. Kidd, R. Leah, G. Lewis, et al., Development of metal supported solid oxide fuel cells for operation at 500–600 c, *J. Fuel Cell Sci. Technol.* 1 (1) (2004) 61–65.
- [183] J. Otomo, J. Oishi, T. Mitsumori, H. Iwasaki, K. Yamada, Evaluation of cost reduction potential for 1 kW class SOFC stack production: implications for SOFC technology scenario, *Int. J. Hydrogen Energy* 38 (33) (2013) 14337–14347.
- [184] Y.D. Lee, K.Y. Ahn, T. Morosuk, G. Tsatsaronis, Exergetic and exergoeconomic evaluation of a solid-oxide fuel-cell-based combined heat and power generation system, *Energy Convers. Manag.* 85 (2014) 154–164.
- [185] J. Thijssen, Solid Oxide Fuel Cells and Critical Materials: a Review of Implications, US Department of Energy, National Energy Technology Laboratory, 2011.
- [186] H.R. Ellamla, I. Staffell, P. Bujlo, B.G. Pollet, S. Pasupathi, Current status of fuel cell based combined heat and power systems for residential sector, *J. Power Sources* 293 (2015) 312–328.
- [187] J. Thijssen, The Impact of Scale-up and Production Volume on SOFC Manufacturing Cost, US Department of Energy, National Energy Technology Laboratory, Morgantown, WV, 2007.
- [188] V.P. McConnell, Now, voyager? the increasing marine use of fuel cells, *Fuel Cells Bull.* 5 (2010) 12–17.
- [189] Fuel cell system on fellowship supply vessel is hybridised, *Fuel Cells Bull.* 4 (2012) 3–4.
- [190] J. Schneider, S. Dirk, D. Stolten, T. Grube, Zemship, in: 18th World Hydrogen Energy Conference, 2010, pp. 16–21.
- [191] METHAPU prototypes methanol SOFC for ships, *Fuel Cells Bull.* 5 (2008) 4–5.
- [192] Sunfire 50 kW SOFC for ship-integrated fuel cell project in Germany, *Fuel Cells Bull.* 11 (2015) 3–4.
- [193] e4ships brennstoffzellen im maritimen einsatz." <http://www.e4ships.de>. Accessed: 2015-05-29.