



Delft University of Technology

Smart & Adaptive Why? How? What?

Teuffel, P.M.

Publication date
2009

Document Version
Final published version

Citation (APA)
Teuffel, P. M. (2009). *Smart & Adaptive: Why? How? What?* Delft University of Technology.

Important note

To cite this publication, please use the final published version (if applicable).
Please check the document version above.

Copyright

Other than for strictly personal use, it is not permitted to download, forward or distribute the text or part of it, without the consent of the author(s) and/or copyright holder(s), unless the work is under an open content license such as Creative Commons.

Takedown policy

Please contact us and provide details if you believe this document breaches copyrights.
We will remove access to the work immediately and investigate your claim.

*This work is downloaded from Delft University of Technology.
For technical reasons the number of authors shown on this cover page is limited to a maximum of 10.*



Prof. Dr.-Ing. Patrick Teuffel

Smart & Adaptive Why?How?What?

Inaugural speech 25th November 2009

Faculty of Architecture

Smart & Adaptive Why?How?What?

Intreerede Prof. Dr.-Ing. Patrick Teuffel

**Uitgesproken op 25 november 2009
ter gelegenheid van de aanvaarding van het ambt van
hoogleraar Architectural Engineering
aan de Faculteit Bouwkunde van de Technische Universiteit Delft**

Inaugural speech of Prof. Dr.-Ing. Patrick Teuffel

**Delivered on the 25th November 2009
at the occasion of his acceptance of the position of
full professor of Architectural Engineering
at the Faculty of Architecture of the Delft University of Technology**

*Mijnheer de Rector Magnificus,
Leden van het College van Bestuur,
Collegae Hoogleraren en andere leden van de universitaire gemeenschap,
Zeer gewaardeerde toehoorders,
Dames en heren,
Ladies and Gentlemen,*

I'm pleased to start this afternoon session with one of the two inaugural speeches. Thijs Asselbergs and I started together approximately one year ago and when we started to think about the inauguration it was clear that we will do the lectures together in order to reflect the situation that we run this chair together. After one year I can say, at least from my point of view, that it was a fruitful idea to have an architect and an engineer at the Architectural Engineering Chair. I structured this lecture into three chapters:

Why should we build smart & adaptive?
How should we build smart & adaptive?
What should we build smart & adaptive?

Why should we build Smart & Adaptive?

The first chapter shall answer two questions – first: why smart and adaptive in general at all? And second: why smart and adaptive at an Architectural Engineering chair in specific? To answer the first – the general – question, I want to illustrate the position of buildings in the context of society and the environment. Here I will show that the interface between architecture, society and environment is a highly active and dynamic process and therefore buildings should not be static. To answer the second one, the specific relation to Architectural Engineering, I will show the interdisciplinary character of the design and form finding process in Architectural Engineering. The role of the Architectural Engineer is the integration and co-ordination of these disciplines.

Let me start with a quote by the Swiss architect Luigi Snozzi about the relation between architecture and the environment. He says:

“Every architectural intervention represents destruction,
therefore we should destroy intelligently.”

I fully disagree - if we understand architectural interventions as destruction, then I will quit our profession. I don't think that we should minimize destruction, we should maximise the benefit, we should not see architecture and other technical interventions in such a negative way in relation to the environment – no one would consider a birds nest as a destruction of the environment, so why should a "human's nest" be considered in that way ? But why do many people see these architectural, technical or infrastructural measures as "destruction"?

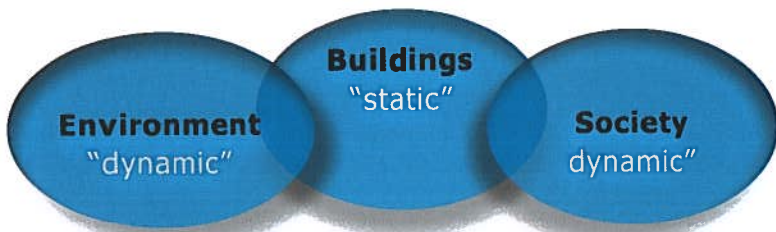

Fig.1: Architecture as a symbiotic link between environment and society

From my point of view architecture is a link between society and environment and it should be seen in a positive way, as a kind of symbiotic connection between environment and society and not as a boundary. But if we do so it is very important to look at the dynamic behaviour of the environment and society – both systems are not static, they change their properties, their behaviour and their requirement on a permanent basis. In that sense static buildings are really destruction, or at least a handicap for the environment and society. In order to play the role of collaborative links architecture, buildings and infrastructure need to be able to adapt to these changing conditions.

In the current situation architecture as a monument has a long tradition and buildings are conceived as static objects. The architectural configuration is fixed during the design process and only little attention is attracted to possible changing conditions or future changes. However, this approach is inflexible and on the long term unsustainable.

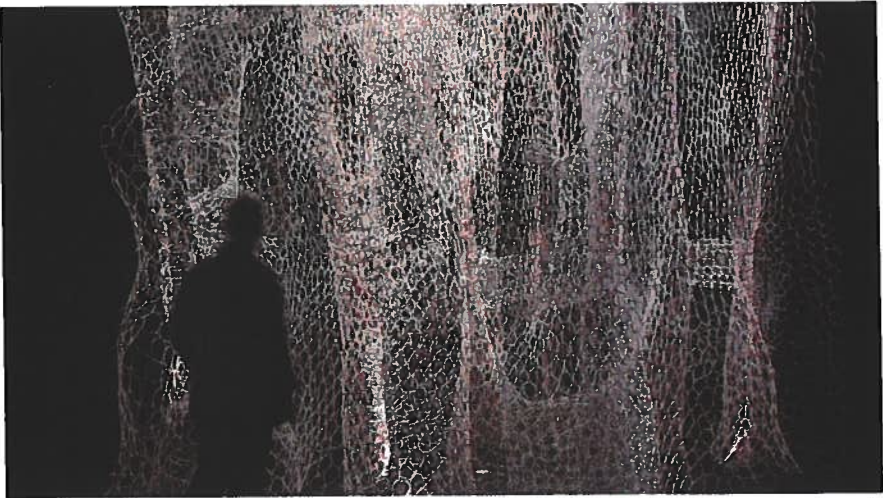

*Fig.2: Monumental architecture
(Pyramids of Cheops, Khafre and Micerino-Golden Age_ Fourth Dynasty)*

So why don't we create space, when we need it? Why does it not disappear, when we don't need it? One possibility to approach this is the use of mobile, flexible and lightweight systems and a lot of work has been done in that field, by pioneers, such as Buckminster Fuller or Frei Otto. This can create the basis for adaptive or responsive buildings. Fuller and Otto developed visionary concepts, but today we have the knowledge to understand adaptive processes and we have the materials and tools to turn this into reality.

But what is the right balance between monumental and ephemeral – between permanent and adaptive? Of course not everything will be adaptive; there will be still elements, which are static and permanent. It depends on the specific purpose, which the design has to fulfil.

The design process involves various methods to develop the shape, the topology, the materials and the degree of adaptiveness of a building. Obviously this depends on the type of building, the boundary conditions and a lot of other aspects, such as technical, ecological, social or economic concerns. In that context it is important to point out that thinking out of the box is absolutely necessary, when exploring new fields.



©2008 Sabin+Jones LabStudio, UPenn"Project Branching Morphogenesis"

Branching Morphogenesis explores fundamental processes in living systems and their potential application in architecture. The project investigates part-to-whole relationships revealed during the generation of branched structures formed in real-time by interacting lung endothelial cells placed within a 3D matrix environment. The installation materializes five slices in time that capture the force network exerted by interacting vascular cells upon their matrix environment. The time lapses manifest as five vertical, interconnected layers made from over 75,000 cable zip ties. Gallery visitors are invited to walk around and in-between the layers, and immerse themselves within an organic and newly created "Datascape" fusing dynamic cellular change with the body and human occupation, all through the constraints of a ready-made.

Branching Morphogenesis is currently on display at the Futurelab within Ars Electronica, Linz Austria-European Cultural Capital 2009. On view through October 2010.

Design team
 Jenny E. Sabin, Andrew Lucia
Science Team
 Peter Lloyd Jones, Jones Lab Members
Design Critic
 Annette Fierro

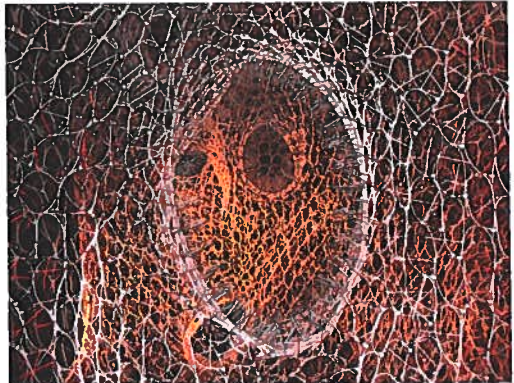

Fig.3: *Ephemeral architecture*

One major concern in architecture is obviously to fulfil the requirements of the user, but these needs are not constant. They can change within a day, due to different situations of a specific user, they can change over weeks, due to different functions taking place within the building, or they can change over years, because new users have different requirements than the initial ones.

I think sustainable architecture should be able to deal with these circumstances and be able to adapt to this. On the other side also environmental impacts can be something very dynamic – in general all environmental aspects change over time as well. The only constant is gravity.



© BAWI AG 04/2008 - 10065324 Gina Light visionary model
 BAWI Group Press Club: www.press.club.baawi.com

Fig.4: Design and Formfinding Process: Gina Light visionary model

One impact which can play an important role is the wind, which is by nature nothing static but something dynamic. In terms of structural engineering wind is a threat, but in terms of climate design it can be beneficial and can be used for ventilation and cooling if directed in a specific way. But also any other building physics influence, such as light, noise or moisture, or structural implications, such as earthquakes or live loads, vary over time.

The diagram in figure 5 gives an overview about smart and adaptive systems in the context of Building Technology and Architectural Engineering.

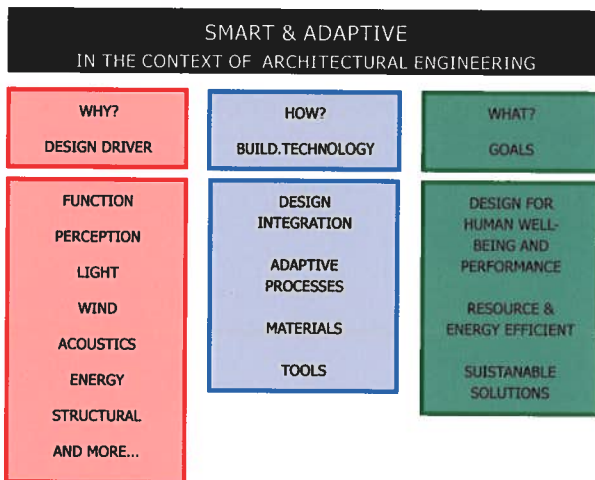

Fig.5 : Smart and adaptive in the context of Architectural Engineering

One can see a long list of design drivers, which are all variant and thus requiring systems which can response to that. Within Building Technology our role is the design integration of many aspects.

Within this lecture I want to focus on three core areas, which are crucial for the composition of smart and adaptive building systems. It is about the understanding of adaptive processes, about new applications of well known materials or about application of new materials. Further on the consideration of new design tools, mainly based on computational methods, is a key aspect.

The goal is to establish building systems, which are for the benefit of the user and also providing positive impact to the environment.

Let me conclude the why-answer with another quote:

“When one talks about adaptation, one talks about accepting the reality of these impacts and putting in place technological and policy measures by which we’re able to manage the problem. That’s absolutely essential.”

This is not my formulation; this is the one from Nobel Prize winner Doctor Pachauri. I hope with this I can clarify why we should aim for smart and adaptive solutions and I think if you take all these different topics together it creates an appealing foundation for the future activities of the Architectural Engineering chair.

How can we build Smart and Adaptive?

After explaining why we should build smart and adaptive, now I want to answer the question how we can achieve this. Architectural Engineering is about making architecture, so we need to understand how we can make use of fundamental sciences and convert theory and knowledge into applications in architecture and engineering.

As mentioned before I think there are three core areas relevant in order to bring the idea of adaptation into technical reality. First we need to understand the process of adaptation; this can be done by looking at natural and biological systems, for instance.

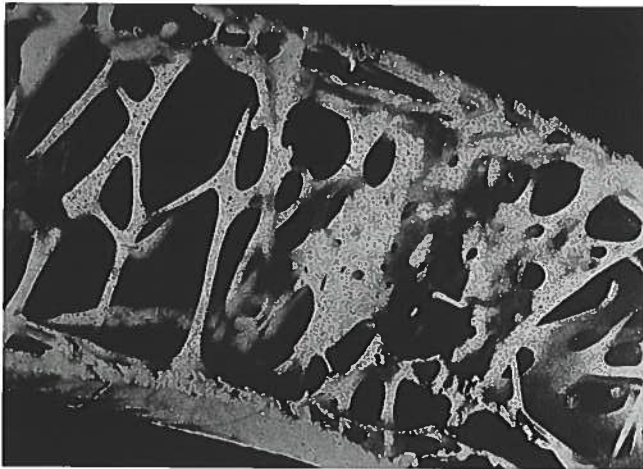

Fig.6: Adaptation

Second, I think it is quite clear that we need new materials, which are able to change their properties in order to compose adaptive systems: actually my colleague Thijs Asselbergs already asked for this kind of material twenty years ago and he also gave it a name: Zappi. And third, not only the materials are very important – it is also about the tools we use to design, to model, to simulate, to analyse and to evaluate any project.

If we want to understand how adaptive systems work I think it is worth to look at biological systems – in contrast to technical systems it is self-evident for biological systems to be adaptive and responsive to its environment. They evolved and are optimised over millions of years and they are in a constant state of change. In general the adaptation takes place at three temporal levels: in real-time within seconds, as growing process over months or years, and finally as evolution over several generations of any specie

Another aspect is very import if you look at nature: in biological systems separation between different disciplines does not exist: the integration of function, load carrying system and any others aspects is a matter of course – I think this is also important when we think and work in interdisciplinary design teams.

If we now study different systems in nature we will realise that they have one thing in common: to be adaptive three main components are required. There are nerves or sensors, which are the components that measure any variation of different physical or chemical values. There is some kind of control system or even brain that steers the whole process. And finally there are muscles or actuators, which are able to carry out a specific reaction in order to fulfil certain performance criteria.

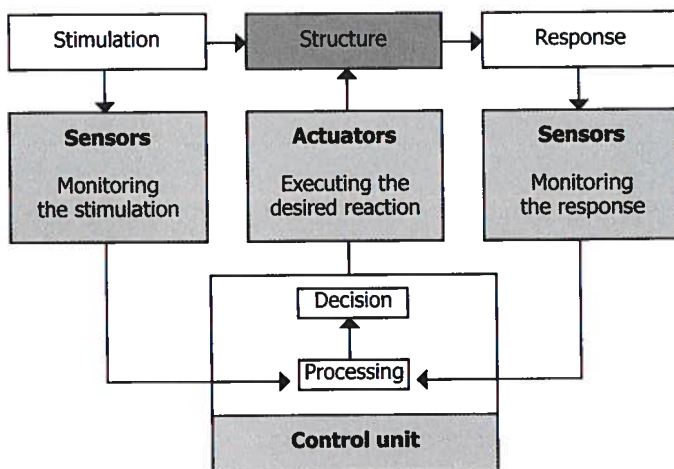

Fig.7: Theoretical framework of any adaptive system

Ideally this is a closed-loop control system, where not only the external stimuli are monitored, but also the manipulated behaviour of the system is observed continuously. This diagram can be seen as the theoretical framework of any adaptive system, but how can this be implemented into technical reality and get materialised?

Therefore the second focus is on materials: In recent years new materials played a major role in architectural practice and research: for example the enhancement of traditional materials, such as textiles – today their spectrum spans from natural fibres to high-performance yarn. Furthermore **smart materials**, which are able to alter their properties in a specific manner, can be applied in order to optimise the mechanical or thermal response of a structure or building – I'll come back to this later on. Finally nanotechnology can offer new possibilities, which enables to create tailor-made materials with properties for specific needs or functions.



Fig.8: Adaptive system: Exhibition pavilion "Corpform" (© Frank Vinken)

A huge variety of smart materials exists, but actually it is not really clearly defined what they are exactly : they can be metals, polymers, ceramics or other materials - it can be a material which modifies shape, colour, light transmission or its phase state.

For instance shape memory alloys belong to the group of smart materials. They are able to change their geometry as a result of temperature changes and they possess an interesting characteristic: they can remember their original shape and can transform at a specific transition temperature. Possible applications in buildings could be the shape reconfiguration of wall elements in order to allow various partitioning, lighting or ventilation conditions, without any requirement of mechanical joints, which will lead to much more resilient building components.

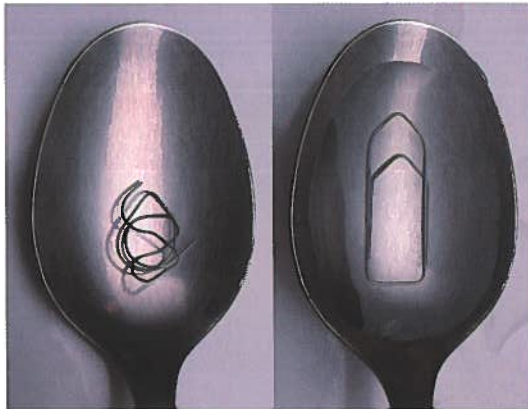

Fig.9: *Shape memory alloys: nitinol paperclip* (© klangspiel.ch)

Other interesting materials are piezo-electrical ceramics or polymers, these are materials which can change their geometry by an electrical field or which can generate an electrical field, when they are mechanically stressed.

From an architectural point of view phase change materials are very interesting and promising. They have the ability to store and to release heat energy. When the temperature of these materials increases they absorb energy, but at a specific temperature, where the phase change takes place, they are able to absorb more heat at an almost constant temperature. When the ambient temperature decreases the phase change is reverted and heat energy is

released. This can be beneficial to control the thermal response of buildings by storing the energy during the hot day and to release it and to heat the building during the cold night time.

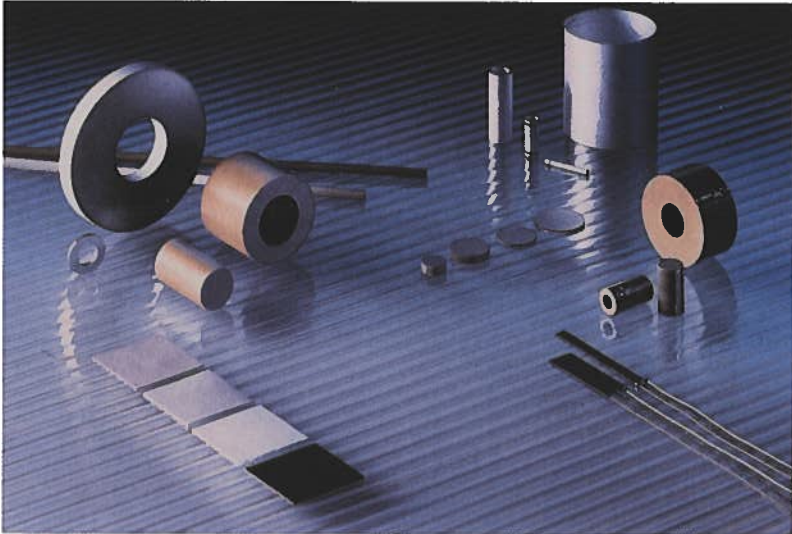

Fig.10: Piezoceramic materials (© PI Physikinstrumente)

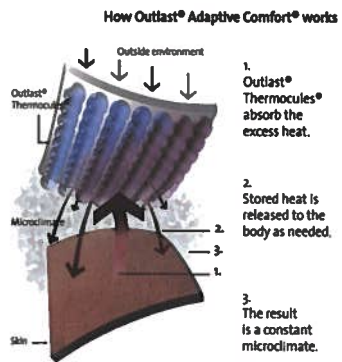
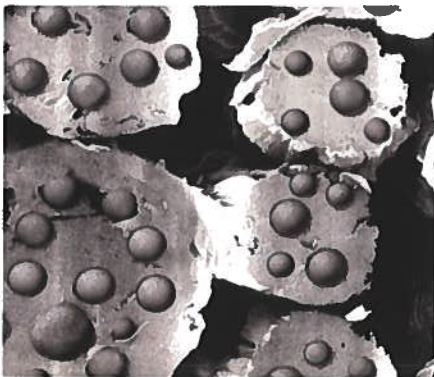

Fig.11: Microscopic view of embedded PCM capsules and principle function (PCM) (© Outlast Europe)

Why don't we use textile materials more often for buildings? They can combine elegance with high technical performance. In particular in combination with smart materials they are important, because they are geometrical flexible and lot of possibilities exist to integrate other materials to create specific functions. Depending on the manufacturing process, such as weaving, knitting or felting, various functional materials can be integrated into a compound with great geometrical flexibility.



Fig.12: "Fashioningtech" and elegance (© Theresa Lusser "Project Dis-appear")

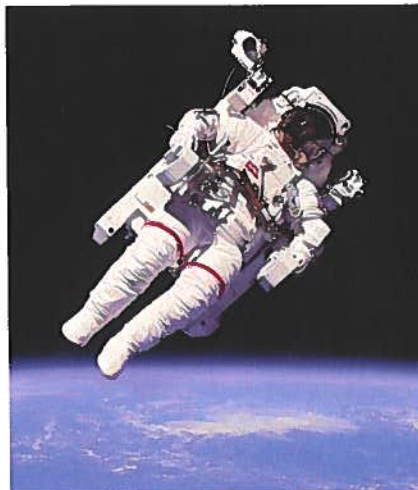
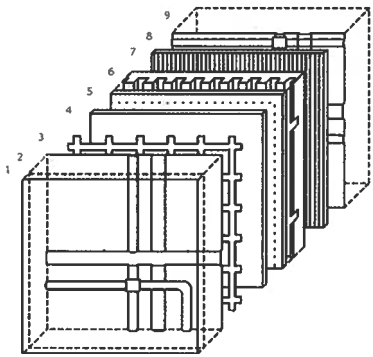

Fig.13: high technical performance: spacewalk (© NASA)

Apart from smart materials recent developments in nanotechnology enable new ideas: already in the 80s Mike Davies announced the polyvalent wall and predicted for the 21st century the shift to a solid state world – instead of having lot of mechanical devices the properties of materials can be altered due to electronic or molecular proceedings. This means that the adaptability of the systems lays in the material and not in mechanical components any more, such as shutters, hinges, bearings and so on and therefore the durability of building components can be increased.



- 1. silica skin and deposition substrate
- 2. sensor and control logic layer, external
- 3. photoelectric grid
- 4. thermal sheet radiator/selective absorber
- 5. electro-reflective deposition
- 6. micro-pore gas flow layers
- 7. electro-reflective deposition
- 8. sensor and control logic layer, internal
- 9. silica deposition substrate and inner skin

Fig.14: Polyvalent wall (© Mike Davis)

With great interest I attended the inaugural speech of Professor Urs Stauer two weeks ago at this location. He talked about the manufacturing of systems at micro- and nano-level and of course today these developments are far away from possible large scale applications, which would be necessary in our field. But maybe sometime we can realise buildings not by putting one stone on the other, but by putting one atom to the other in the far future?

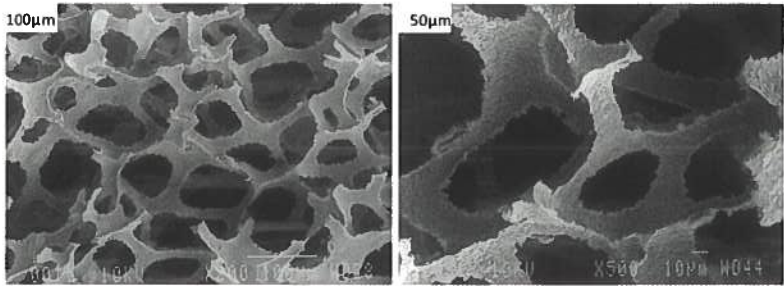

Fig.15: Nanoparticles (Factors affecting the microstructure of a fine ceramic foam; © H.X. Peng, Z. Fan, J.R.G. Evans)

But it is not only about materials – the simulation of these new systems is crucial to its success as well. If we want to realise new ideas with new materials, we need the right tools to predict the behaviour of them. In general in architecture we don't have the possibility to test prototypes and the sums, which are invested in buildings, are huge – so there is no trial and error possible. It has to work at first go. But I'm sure, that rapid advances in information technology will provide these tools for the computer-aided design and manufacturing process.

What should we build Smart & Adaptive?

Finally I want to show what kinds of applications are thinkable in the near and far future in the area of building technology. I will show several examples of ongoing projects with different kinds of interaction between user, architecture and the environment.

One of our interests is the [interaction between the user and the building](#) and the subsequent question how the way the building is designed and constructed has impact to the well-being and the performance of the user. Currently one of our PhD students, Charlotte Lelieveld, is studying interactive architecture, and one focus is on the application of smart materials, in her case shape memory alloys and polymers.

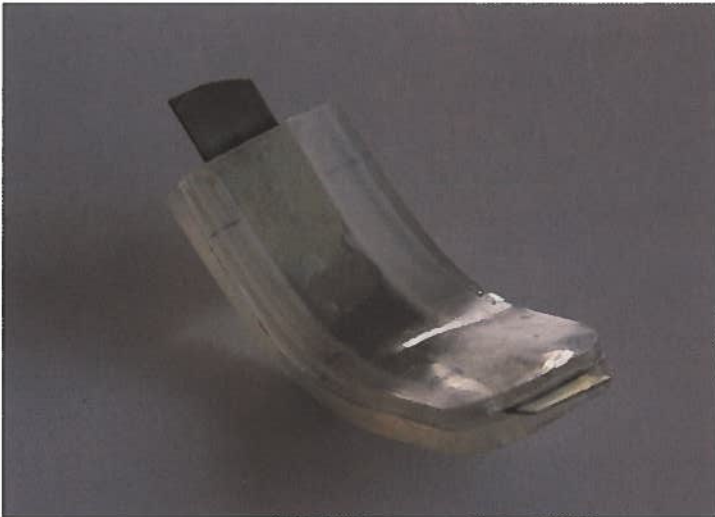
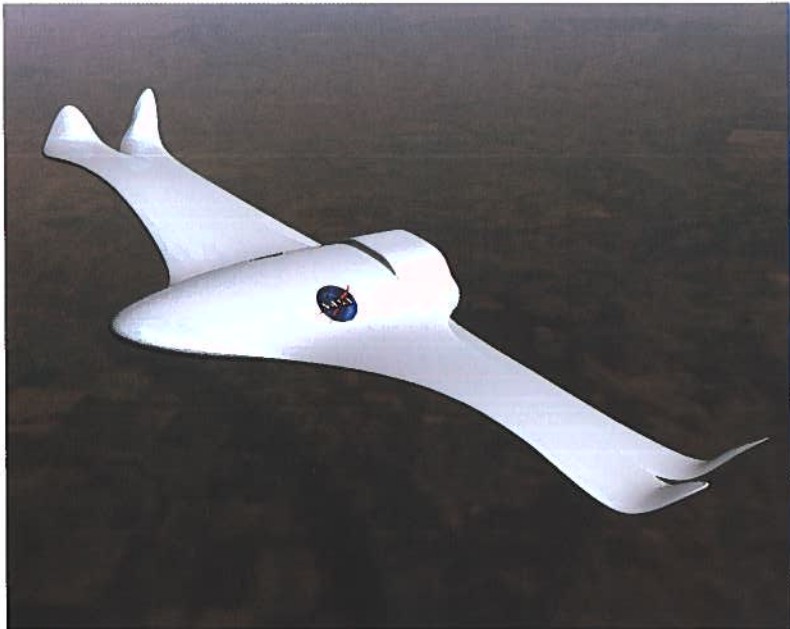

Fig.16: *Smart composite component* (© PhD researcher Charlotte Lelieveld)

Another focus is on the psychological consequences if a building interacts with the user. In that context we also work with the Centre for Socio-technical systems design at Leeds Business School to better understand the relation between interactive architecture and human behaviour.

Another area of our research is the development of shape morphing system. This idea is interesting in relation to the wind and building interaction, because

the shape of a building strongly influences the way the building responds to any wind impact. In order to understand the relation between wind and technical objects we also look at other disciplines, such as aerospace engineering.



NASA Dryden Flight Research Center Photo Collection

<http://www.dfrc.nasa.gov/gallery/photo/index.html>

NASA Photo: ED01-0348-1 Date: 2001 Photo by: NASA

An artist's rendering of the 21st Century Aerospace Vehicle, sometimes nicknamed the Morphing Airplane, shows advanced concepts NASA envisions for an aircraft of the future.

Fig. 17: Morphing system (©NASA)

In other engineering disciplines the understanding of aerodynamics seems to be much further developed than in architecture, but actually car industry or aerospace engineers have one major advantage, which simplifies their life: they have a dominant wind direction, which influences the shape of the object they design. In architecture this is not the case and one has to question if and how a building can react to this. This is not only related to structural engineering, but is relevant for the impact buildings have in an urban context as well. From my background I'm a structural engineer – so there is always the interest for wide-span or high-rise structures. In a recent project we had the opportunity to study the feasibility of an extreme high-rise building, a 1080m high tower. For a project like that the wind forces are the key design driver, in order to develop an optimised and efficient structural system. The interesting

point here is the situation, that the wind does not only change its direction in general, but the wind direction is also a function of the height: our proposed solution is a shape morphing building skin, which can have optimal shape at every level of the building in order to minimise the drag forces and any potential wind induced vibrations of the building. Obviously this is nothing, which can go on site tomorrow, but I think we can take some academic freedom to explore these kinds of ideas for the day after tomorrow.

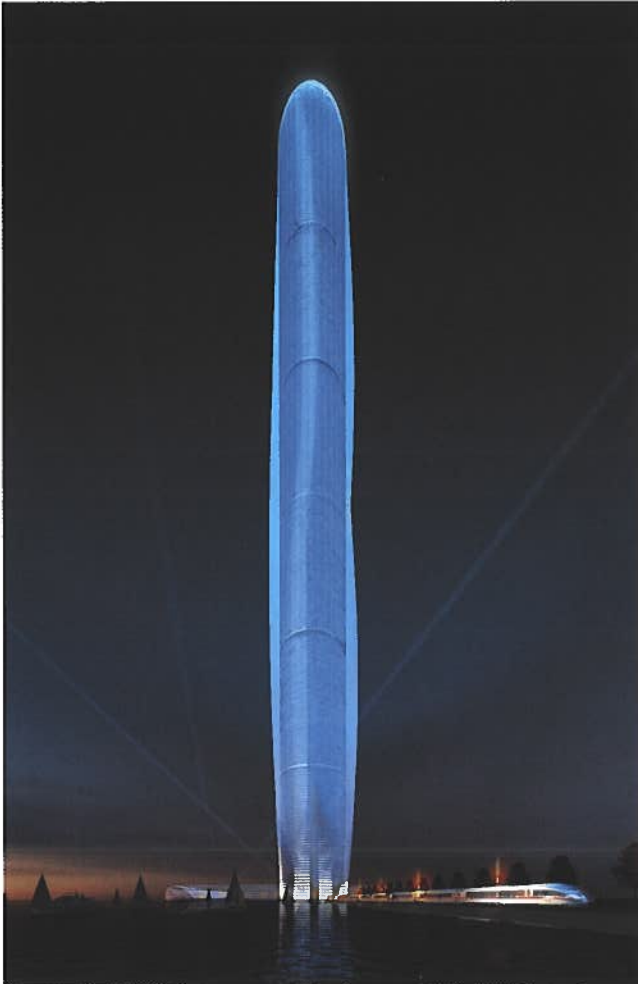

Fig.18: *Bionic architecture: Evolo Tower*
(© Braun Associates Architekten, Eng. Teuffel Engineering Consultants)

Further on I want to put the idea of adaptation into the context of **energy and climate design**. Figure 19 shows a smart, textile skin which is able to control the inner climate with the use of phase change materials.

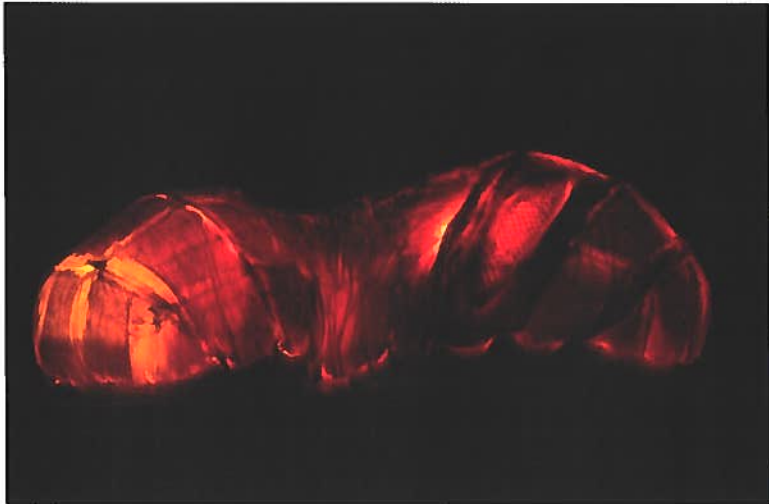

Fig.19: Climate control (© M. Holzbach, ILEK)

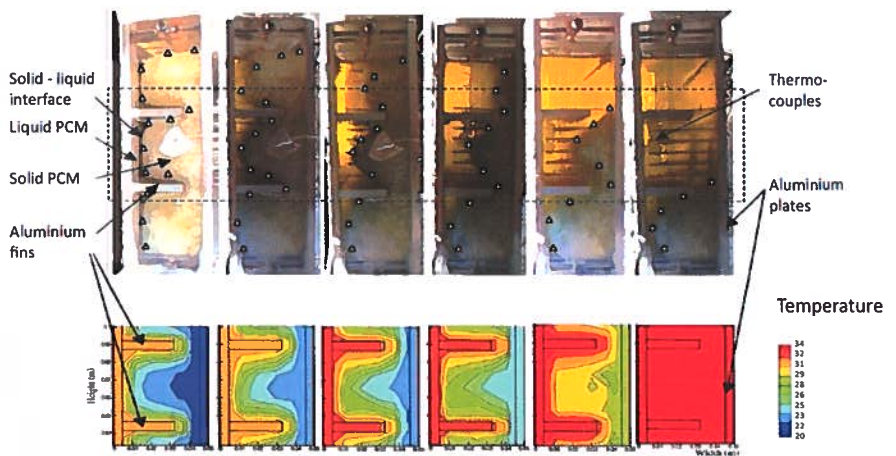

Fig.20: Interaction between PV and PCM (© Hwang)

I think I don't have to stress the importance of energy efficiency and sustainability for this audience, and I think it is clear that this issue, which started 30 or 40 years ago by some eco-hippies, today, arrived in society, including the political and economic system. However, the outcome of the UN climate change conference in Copenhagen in December seems not to be too promising at the moment, so I think it is crucial not only to rely on politics or idealists – sustainability can only be successful if it works as a business model.

This is why we seek contact to industry, which is interested to develop new products and to enter new markets. In the context of energy one interesting material family are phase change materials, as briefly mentioned before (see figure 20). Of course I don't see the Architectural Engineer as a material scientist, but a thorough understanding of these developments can create new opportunities.

Further on we can challenge material scientists with specific functional requirement to meet our needs. Of course just the simple use of phase change materials in walls or ceilings is not a new idea any more, but we try to explore what consequences it can have, when we forget about traditional compositions of houses. We are interested if new materials will lead to entirely new architectural concepts?

L'Institut du Monde Arabe by Jean Nouvel from the 80s – is something, which you all will know. I like it a lot and think it is a great idea and concept to have this semi-transparent wall, but with all the moveable mechanical elements, it is just not durable over a long time. Just imagine you can have a material which is able to generate the performance of this wall without any moveable mechanical elements – I'm convinced that this will lead to some fresh ideas in architecture.

Of course the control of light is not only a matter of energy gain, but also of comfort of the user in the building, which needs consideration and what is studied by Florian Heinzlmann, one of our PhD students.

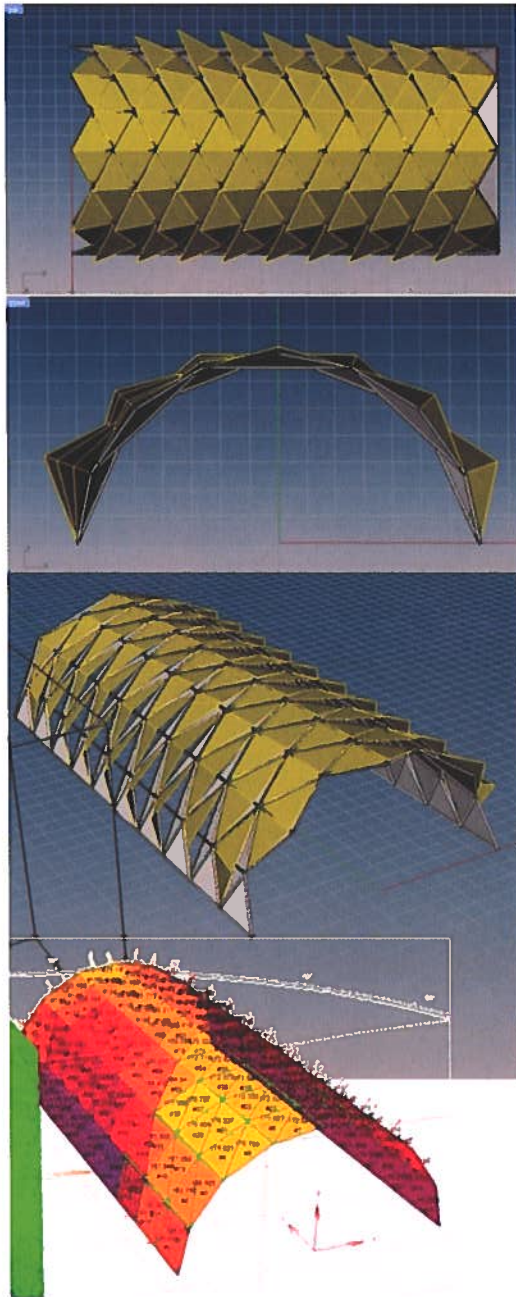

Fig.21: Adaptive daylight simulation (© PhD researcher Florian Heinzlmann)

Similar to all the more building physics related aspects of environmental influences, also structural loadings vary a lot. As mentioned before wind is something dynamic, but also live loads, such as people or traffic on a bridge, or earthquakes are nothing static ([structural control](#)).

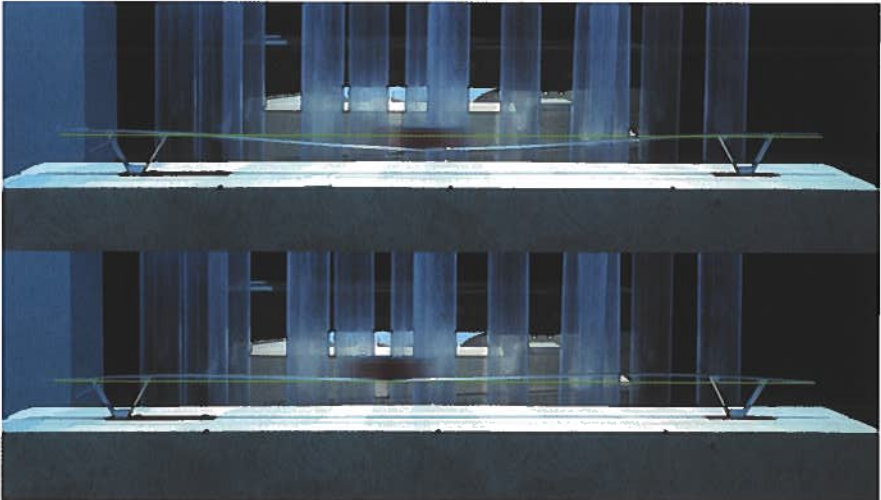

Fig.22: *Structural control* (© ILEK)

Figure 22 shows the idea to have a zero-deflection structure, instead of using a lot of mass and material to create stiffness, energy is used to create a virtual infinite stiff system – this is just not possible with a conventional structure. Possible applications could be bridges for high-speed trains, which are very sensitive to deformations. Nowadays adaptive stiffness or damping devices are used in automobile industry, so why not use them to increase the structural performance of wide-span bridges or high-rise towers?

The last specific area of possible applications of smart materials, which I want to mention, is the topic of [energy harvesting](#). Of course photovoltaic systems are wide spread in the meantime, but there are other ways to gain energy as well. It is also possible to gain energy using so called energy harvesting systems: This means, that some devices use the energy, which is around us in the form of vibrations, air movements or ambient temperature, and convert this into useable electrical energy. Small-scale products show the principle

feasibility of this idea: for example the integration of piezo-electric materials into sports equipment is used to generate power and to control these devices. Today everybody is talking about low-energy or even zero-energy houses – I think we should aim for energy producing houses.

Currently we are working on a competition: the Smart Material House at IBA, the Internationale Bauausstellung in Hamburg – the goal of the competition is to study the possible utilisation of various smart materials in order to increase the overall performance of the building. In that project we, as the researchers of the university, work together with Architectuurcentrale Thijs Asselbergs and we try to combine many ideas, which I described before, to maximise the performance for different conditions. We were selected for the second round and hopefully we can make it to the third and final round next spring in order to realise this project. Currently we are starting to negotiate with potential investors to develop this together and to get this project funded.



Fig.23: IBA House: application of smart materials

Why? How? What?

After explanation of the “why”, the “how” and the “what” I want to continue with the conclusion and the future plans. Yesterday evening I reflected upon the preparation of this presentation and I realised that I have only very few images relating to adaptation and architecture, many of the slides are about materials, natural systems or other engineering disciplines. First I was concerned about that, but then I realised that this is actually quite good, because it seems that there is a lot work to be done in the future!

During the last couple of months I had the opportunity to talk to many other researchers at our faculty and apparently there is already quite some work going on related to adaptive systems at different other chairs. So I want to take the chance to bundle these interests and expertise from various fields, such as building envelopes, climate design, design informatics and interactive architecture. With these topics we will establish a research team covering these fields in close relation to the ongoing Building Technology research programs, namely Green Building Innovation and Computation and Performance. You can find more information about this initiative on the internet at www.adaptivebuildingsystems.com and at the university website.

The development of these ideas requires a much more integrative approach than the traditional brick-and-mortar philosophy which is still wide spread in the construction industry – this is one of the things, which we want to overcome with this initiative.

The focus of my lecture was mainly about research issues, which is also the distinction between Thijs Asselbergs’ role and me, but of course we are also working on links between researchers and PhD students with our educational programs, especially the Architectural Engineering Master track, with its research and design studios in it. So I hope we can stimulate the curiosity and imagination of students and young researchers to ask the right questions and to bring things forward.

Finally I want to conclude my position about smart and adaptive buildings and how to deal with sometimes rough conditions. The only constant in our life and in our environment is the status of change and variation, so I want to propose buildings, which are not static obstacles, but which are part of the adaptive processes in nature and around us. This is only possible if we understand these processes and if we are able to make use of new materials and new tools.

Further on the design and development of adaptive systems requires naturally the integration of architectural, structural and building services, which makes it a logical background for any activity at the Chair of Architectural Engineering. The goal of my proposal is to develop new concepts with a holistic and sustainable approach and this can be achieved by the consequent introduction of adaptive building systems.

I'm convinced that these developments will result in new concepts for architecture and engineering. The development of adaptive systems and the consideration of design, technical or economic concerns is one important goal, but the question how this evolution influences the design process and finally the appearance of buildings is not answered yet, but we will find out. It is clear and exciting that these findings will affect the relation between humans, buildings and the environment, when architecture becomes alive.

Finally I want to thank all the persons who made this appointment possible: Professor Mick Eekhout as the head of the vacancy commission, Professor Sevil Sariyildiz as the former head of Building Technology department, Professor Wytze Patijn as the Dean of this Faculty and last but not least the College van Bestuur.

Thank you for your attention. Ik heb gezegd.

Faculty of Architecture

Julianalaan 134

2628 BL Delft

tel: +31-15-2784094