

**Institutional form versus function in a common property context
The credibility thesis tested through an agent-based model**

Ghorbani, Amineh; Ho, Peter; Bravo, Giangiacomo

DOI

[10.1016/j.landusepol.2020.105237](https://doi.org/10.1016/j.landusepol.2020.105237)

Publication date

2021

Document Version

Final published version

Published in

Land Use Policy

Citation (APA)

Ghorbani, A., Ho, P., & Bravo, G. (2021). Institutional form versus function in a common property context: The credibility thesis tested through an agent-based model. *Land Use Policy*, 102, Article 105237. <https://doi.org/10.1016/j.landusepol.2020.105237>

Important note

To cite this publication, please use the final published version (if applicable). Please check the document version above.

Copyright

Other than for strictly personal use, it is not permitted to download, forward or distribute the text or part of it, without the consent of the author(s) and/or copyright holder(s), unless the work is under an open content license such as Creative Commons.

Takedown policy

Please contact us and provide details if you believe this document breaches copyrights. We will remove access to the work immediately and investigate your claim.

Green Open Access added to TU Delft Institutional Repository

'You share, we take care!' - Taverne project

<https://www.openaccess.nl/en/you-share-we-take-care>

Otherwise as indicated in the copyright section: the publisher is the copyright holder of this work and the author uses the Dutch legislation to make this work public.

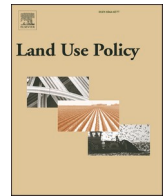

Institutional form versus function in a common property context: The credibility thesis tested through an agent-based model

Amineh Ghorbani^a, Peter Ho^{b,c,*}, Giangiacomo Bravo^d

^a Delft University of Technology, Faculty of Technology, Policy and Management, Delft, the Netherlands

^b Zhejiang University, School of Public Affairs, Zijingang Campus, Hangzhou, 310058, China

^c Department of International Development, London School of Economics, Houghton Street, London, WC2A 2AE, UK

^d Linnaeus University, Department of Social Studies Faculty of Social Science, Sweden

ARTICLE INFO

Keywords:

Credibility thesis
Institutional function
Endogeneity and emergence
Common property
Common pool resource
Agent-based modeling (ABM)
Socio-ecological systems (SES)

ABSTRACT

A key debate in the study on land, housing and natural resources revolves around the notion that general institutional forms (such as private, common, public, and likewise formal property rights) lead to a certain institutional performance (as may be expressed in terms of prices, transaction costs or sustainability). However, a modest, yet, growing stream in institutional analysis aims to move away from 'merely describing the characteristics' of institutions (i.e., form variables) to 'performance or quality measures' (i.e., function variables). Following this line of argument, the credibility thesis as put forward in this journal (Ho, 2014) postulates that the form of institutions is unrelated to their performance, and institutions are unintentional outcomes rather than designed artefacts. The primary goal of this research is to ascertain whether this dual prediction could be observed in a simulation model that is driven by agent behaviour and interaction, resulting in emerging institutions. We devise an empirically verified agent-based model within a classical thought experiment on a common property resource to validate the thesis' predictions. First, our model confirms that different forms of institutions can have a similar performance. Second, we ascertain that successful institutions in difficult management situations can emerge (rather than being designed) that are beneficial for the sustainability of the common resource and the appropriators of that resource.

1. Introduction

Acceptance of computer modeling and experimentation has spread slowly at best in economics in large part because agent-based models often seem foreign to the neoclassical core of economics, as that core is understood today (Leijonhufvud, 2006).

Within the thinking about institutions and property rights, often conceptualized as "the rules of the game" (North, 1990: 3), one of the more controversial premises is the one on form versus performance. In effect, the prediction is that predefined institutional forms – such as private, common, public, or likewise formal and informal property rights – would lead to a certain performance which can be expressed in terms of higher investments, lower transaction costs or less ecological

degradation. This paper is rooted in an opposite paradigm, and questions whether general institutional forms impact on performance.

The paper's disquisition on private, common, public and likewise formal and informal property rights is not arbitrary, but follows from the fact that these are the institutional forms that have generally, and most forcefully, been proposed to lead to a certain performance, positive or negative (e.g. Hardin, 1968; Demsetz, 1967; Olson, 1965).¹ For instance, when picturing a resource or a socio-ecological system – be it grassland, forest, or wetland – the argument is that privatization through land titling or nationalization by establishing state-governed nature reserves – are imperative to safeguard the resource's efficient allocation and sustainability. A manifestation of the premise on institutional form is reflected in the following:

* Corresponding author at: Zhejiang University, School of Public Affairs, Zijingang Campus, Hangzhou, 310058, China.

E-mail address: peter_ho@zju.edu.cn (P. Ho).

¹ This is a simplified rendering of a more complicated debate. Here the scholars used to identify the position in the debate are associated with a specific work that has gained most traction academically. However, a person's position is often more nuanced or may change over time. For instance, although mostly identified with the position of privatization (and his critique of common property) Hardin's concern was actually overpopulation, while Olson not necessarily argued for nationalization, but more that organizations need some form of coercion to make individuals act towards a common goal or interest.

“[T]he problem of overexploitation or overharvesting is a result of the resource’s being under public rather than private ownership (...). Wherever we have *public ownership* we find overuse, waste, and extinction; but *private ownership* results in sustained-yield use and preservation” (Smith, 1981: 444; italics added).

One might ask why the premise on form warrants our attention. There are various compelling reasons.

For one, its argument is easily understood and straightforward. It seems commonplace to assume that the form of a given set of rules affects the behavior of social actors and economic agents.² Two, the premise’s argument is consistently studied over different sectors and disciplines, including – but not limited to – studies on land (e.g. Sjaastad and Cousins, 2009), natural resources (Bergstén et al., 2018), housing (De Soto, 2000), labor markets (Santos, 2009), financial institutions (Fries and Taci, 2005), and intellectual property rights (Kim et al., 2012). A final reason why the premise is important is because of its persistency. Regardless whether we examine studies of the 1950s (Gordon, 1954), those from over four decades later (Micelli et al., 2000: 387), or those of today (Haas and Jones, 2017), it can be ascertained that a relation between form (in this case: private ownership) and performance (value, market efficiency, or sustainability) is assumed.

At the same time, the premise on institutional form has incited significant controversy due to its difficulties of validation. Some studies have found evidence that form and performance are negatively (cor) related (e.g. Jones, 2017; Monkkonen, 2012). Other studies demonstrated positive relation (Lawry et al., 2017), and yet again, there are studies that fail to establish an unambiguous relation (Choplin and Dessie, 2017; Sitko et al., 2014). Scholars have tried to deal with the paradox by including more countries, more variables, and more levels of data aggregation. However, as Freeman and Carchedi (1995: 129) duly noted, the endeavor to establish a relation between institutional form and performance is “unlikely to be settled by additional studies using aggregate data and making cross-country comparisons.”

It appears as if something fundamental is missing in the debates over, and the empirical validation on institutions: the way how they operate. Having said this, a modest but steadily rising group of scholars has been calling for a reappraisal of the role of function in the study of institutions. Close to twenty years ago, Aron (2000: 128) put forward the position that we should move away from institutional analyses in which we “merely describe the characteristics or attributes” of institutions (i.e., form variables) when, instead, it is the “performance or quality measures” (i.e., function variables) that are plausibly more important. Over the years, this position has been increasingly echoed by others, such as Chang (2007: 20), Agrawal et al. (2014: 277), and Davy (2018: 855).

In the context above, the credibility thesis (Ho, 2014) was put forward in this journal, and later elaborated (Ho, 2017), postulating that institutional Form follows from Function, in effect, the position that predicting the performance of institutions in relation to whether they are private, public or common is irrelevant, as any institutional form may function or dysfunction depending on space and time. Described by Davy (2018: 855) as a “rallying call of function presides over form”, the inclusion of function in institutional analysis has since been applied in different sectors, ranging from ecological conservation (Fan et al., 2019; Zhao and Rokpelnis, 2016), climate policy (Rogge and Dütschke, 2018), urbanization and informal settlements (Wu et al., 2018; Zeuthen, 2018; Oranje et al., 2020; Celhay and Gil, 2020), water management and

irrigation (Gomes and Hermans, 2018; Mollinga, 2016), banks and notaries (Marois and Güngen, 2016; Monkkonen, 2016), artisanal mining and property rights (Nesru et al., 2019; Fold et al., 2018; Mengistu and Dijk, 2018), and labor institutions (Miyamura, 2016). These studies have validated the thesis in qualitative and quantitative ways, thereby covering a variety of regions, ranging from Asia, Latin America, Africa and Europe.

Yet, perhaps something is still missing. While most research on form and performance is modeled through regression, such mathematical simulation might not be particularly suited for a thesis that postulates that form (as dependent variable) is *unrelated* to performance (as independent variable). In effect, the credibility thesis would actually, and counterintuitively, be validated if *no* correlation was found. A key reason for this is that the thesis discards causality in lieu of endogeneity. Put differently, a major reason why institutional form is difficult to link to performance indicators, such as GDP, assets values and investments, is because institutions arise from and *interact* with the innumerable bargaining, choices and conflicts between economic agents and social actors. *Ergo*, they emerge through autonomous momentum albeit driven by human behaviour. Or, as Scottish philosopher Ferguson succinctly formulated: “the result of human action, but not the execution of any human design” (1782: 205).³ It is this paradigm shift from causality to endogeneity that requires a different approach to modeling in the social sciences as ascertained by various researchers (Farmer and Foley, 2009; Janssen and Ostrom, 2006; Bonabeau, 2002).

The primary aim of this article is to ascertain whether the predictions of the credibility thesis could be observed in a model based on endogeneity – i.e. interaction – rather than the causality between agents and rules. For this purpose, we devised an Agent-Based Model⁴ (hereafter: ABM) within a classical thought experiment on institutional emergence and change. The experiment boils down to the simulation: if agents are individually equipped with basic needs and exploit a certain resource, what institutions (or institutional forms) would surface and endure after repeated resource consumption amongst the agents?

Apart from this introductory part, the article is divided into four sections each of which contains one of the following: i) a review of the theory of credibility with particular reference to notions of divergence and emergence; ii) the description of the agent-based model and its underlying principles and assumptions; iii) the presentation of the data resulting from the modeling; and lastly, iv) a concluding section examining the wider ramifications of the model’s results for our understanding of the form and function of institutions.

2. Two debates and predictions: a review

The study of institutions features a double-sided debate that has divided scholars, although not always openly or consciously, here rendered as: 1) “convergence versus divergence”; and 2) “design versus emergence”. These two debates encompass fundamental assumptions – and perhaps, personal beliefs – about the ordering of the human world and the rules to govern it. In the paragraphs to follow, we will see that each of the *starting* positions in the two debates leads to a contradiction that in turn spawns the formulation of an *opposing* position.

The first debate of convergence versus divergence touches on the question whether institutions tend to evolve towards commonly shared forms. For example, convergence is assumed when stating that “[i]n a given economic and technological environment, certain trajectories are

² For instance, in this line of argument, when a set of rules is not formalized, that is, written down and endorsed by an authority, there would be allegedly a greater likelihood of these being abused. Following the same logic, a set of rules that assigns a good to a more anonymous collective entity instead of to an individual, will more likely lead to the squandering of that good. In effect, a person would care less about the state of a plot of green, when that is designated as a public park instead of as one’s own garden. See also the critique by Ostrom (1990) on this kind of reasoning.

³ The precise reference is Part III, Section 2, page 205.

⁴ An agent-based model (hereafter: ABM) is a computational model that can be employed to simulate the actions and interactions of autonomous agents. These can be conceptualized as individual as well as collective entities. The model allows one to observe how concurrent operations and interactions of multiple agents at a micro-level lead to the appearance of more complex phenomena at a higher level of aggregation.

more probable than others: it is clear that, in the course of history, numerous patterns of social organization have been tried and discarded, while other patterns eventually *became dominant*" (Inglehart, 1997: 17, emphasis added). The contradiction that spawned the opposing side is: when digging into the nitty gritty of institutions (by generating elaborate classifications or taxonomies), why is it so difficult to confirm convergence? (see e.g. Radice, 2000). It is the reason why scholars, such as Eisenstadt (1998:42) maintain that:

"[T]he institutional responses to the problems arising out of growing structural differentiation (...) that emerge in different societies at seemingly *similar stages* of differentiation may *vary considerably* across societies" (emphasis added).

The second debate represents the scholarly schism whether institutions can be exogenously designed: created and enforced as intended (Hodgson, 2004).⁵ For instance, the assumption of exogenous design is reflected in the statement that a "country that is *able* to revise the rules of the game in the direction of strengthening the property rights (...) is likely to experience a lasting increase in its productive capacity" (Rodrik, 2004: 1, emphasis added).

The contradiction that vexes the assumption of exogenous design is: why would actors go to such length in devising the enormously complicated, contradictory, and inefficient institutions that we witness all around us, when they could have been designed in a rational, logical manner? Differently phrased, why is it virtually impossible to design and enforce the "right" institutions to govern our societies and economies?⁶

In trying to answer this question, an opposing standpoint is tabled: endogenous emergence. In this view, institutions emerge spontaneously, although driven by human action and intentions. Its main underpinnings are aptly reflected in the – classically worded – passage by the founder of the Austrian School of Economics:

"How can it be that institutions which serve the common welfare and are extremely significant for its development come into being without a common will directed toward establishing them?" (Menger, 1883: 146).

Within the two debates sketched above, the credibility thesis makes a dual prediction on the institutions witnessed around us:

- Form follows from Function, i.e. the emergence of diverging institutional forms that may all function for a group of actors (or resource users);
- Unintended Intentionality, i.e. *non-optimal* institutions may emerge that would not have emerged if actors would have been aware (or, intentional) of their choices and consequences.

We aim to explore these two predictions with the help of an agent-based model in the next sections.

3. Methodology: the agent-based model explained

Having described the theoretical and empirical ramifications of the credibility thesis, we will now turn to the description of our agent-based model.

3.1. Agent-based modelling

Agent-based modelling is a well-established computer simulation approach which is commonly used to study complex adaptive systems

⁵ The introduction to Hodgson, 2004 book contains a comprehensive description of this debate, which he alternatively described as "agency versus structure".

⁶ See also Aoki's (2007: 2) observation on this matter.

(Epstein, 2006). In agent-based modelling, the system under study is viewed as a collection of heterogeneous agents representing actors (e.g. buyers and sellers), and their actions and interactions in a given environment. Agent-based models can be viewed as virtual experimental labs to explore complex social systems (Holland, 1992) or/and to compare policy scenarios (Lempert, 2002). More recently, agent-based modelling is also being used to further study and evaluate theoretical and empirical findings, e.g. (Bravo, 2011; A. Ghorbani et al., 2017; Poteete et al., 2010). This is done by considering system dynamics complementary to static snapshots of systems, and adding the time dimension to findings from empirical observations that usually have a limited time horizon (Janssen and Ostrom, 2006; Railsback and Grimm, 2012; Squazzoni, 2012)

Additionally, the main benefits of ABM over other modelling approaches for studying theoretical findings are:

- 1 Inherent methodological interactionism: a system simulated with the ABM approach is inherently based on individuals and their interactions in a given structure (Seth, 2008)(Grosz and Kraus, 1996) (Gräbner, 2016).
- 2 Possibility to model instincts, habits (of thought) and (collective) action: agents can have incomplete information and make irrational decisions based on their individual observations, instincts and habits, making the simulation system closer to reality (Gräbner, 2016).
- 3 Possibility to model the social structure of a social system (i.e., norms and institutions): by modelling formal and informal institutions, the agents in the simulation are influenced by the social structure of the system, and can in turn affect that social structure (Diesing, 1971; Ghorbani et al., 2013).

In this article, we further explore and evaluate the credibility thesis with the help of an ABM.

3.2. Model description

The model is an extended version of the SONICOM model presented in (Ghorbani et al., 2017). The model was initially developed for studying endogenous institutional emergence patterns in common-pool resource (CPR) settings and for analysing whether they indeed prevent the tragedy of the commons (Ghorbani and Bravo, 2016). It was further extended (by adding monitoring and sanctioning) and the model was extensively validated using an extensive dataset and by comparing the outcomes of the model with main-stream theoretical and empirical findings (Ghorbani et al., 2017). In this paper, we extend SONICOM by studying whether the outcomes of the model are in line with the postulates of the credibility thesis.

3.2.1. Model overview

The model is an abstract representation of a common-pool resource setting. In this setting, the agents benefit from a shared resource which is at first under a free access regime but later regulated endogenously by the appropriators themselves. The agents (i.e. the appropriators) define their own behavioural strategies; i.e., how much they would appropriate from the resource and under what condition. They either do this by copying their successful neighbours or by innovating (coming up with new strategies). The agents define the institutional rules of the system through a voting mechanism. The institutional mechanism that is decided upon includes *one* institutional rule, the monitoring intensity and the level of fine. Based on their cheating propensity, the agents may disobey the institutional rule if they see that they would benefit more by following their own behavioural strategy rather than the institution in place. If a certain proportion of the population is unsatisfied with the existing institutional rule, they repeat the voting process.

Overtime, the model shows realistic patterns, observable in real world CPR or socio-ecological systems, of resource dynamics, agent well-being dynamics, and institutional change. For example, an

emergent pattern from the simulation shows that an abundant resource leads to open-access regime where agents appropriate large quantities of the resource frequently. On the contrary, when the system is faced with resource scarcity, the agents take small quantities and less frequently. These seemingly trivial patterns are extremely valuable, as they are not rules put in the system but are outcomes of bottom-up individual dynamics based on their own survival needs. The agents do not have any learning behaviour whatsoever, no intention of saving the resource, and no empathy for other agents. As such, it is interesting to see how the finding of this model can be compared with the postulates of the credibility thesis.

3.2.2. Model details

The model consists of three main components: agents, resource, institution.

3.2.2.1. Resource. There is only one shared resource in the system. This resource starts with an initial amount (K) and grows with a specific rate (r) at each simulation step

In the function below, the resource growth follow a logistic function, as it is common, for instance, in fishery-like situations. However, it can be replaced by any kind of resource growth function in the model. ΔR of the resource R , at time t is given by:

$$\Delta R = rR \left(1 - \frac{R}{K} \right)$$

where: K is the carrying capacity and r is the reproduction rate (Perman et al., 2003).

3.2.2.2. Agents. The agents have two parameters that distinguish them from other agents: energy level and behavioural strategy. Each unit of resource is equivalent to the unit of agent energy.

The behavioural strategy of the agent is constructed by the agent herself, by combining an action (how much she would appropriate) and a condition (when she would appropriate). In the simulation, there is a list of actions and a list of conditions for the agents to randomly choose from. In each time step of the simulation, the agents may also look at other agents in their neighbourhood (those they are connected to in a social network) and copy the behaviour (i.e. action + condition) of the agent with the highest energy. During the initial phase of the simulation, the agents follow their behavioural strategies to appropriate from the resource, and may also change their strategy if they are not satisfied with their current strategy (i.e. they have lost energy compared to the previous round). This dynamic continues until the institutional emergence time (see Fig. 1).

3.2.2.3. Institution. After running the simulation for a period of time,⁷ the agents enter an institutional establishment phase where they vote on an institutional rule that they must all comply with. This institutional rule which is referred to as the institution from here onwards has, in fact, the same structure as a behavioural strategy; i.e., an action part, and a condition part. In the voting phase, the behavioural strategy that is most common among the agents is selected as the institution (Fig. 2).

The agents have to comply with the selected institution from this point onwards, otherwise they risk the probability of being fined. In addition to the strategy, each agent can vote on the frequency of monitoring and the amount of fine in case of cheating. Therefore, these parts of the institution are also selected based on their popularity among the agents.

Since the strategy of the agents is not prescribed and is formed during the simulation, we can claim that the institution that is selected is also

⁷ The time point is determined by the researcher and not inherent to the model itself.

non-prescribed and relatively “emergent” (i.e., random combination of action, condition, fine amount and monitoring intensity).

During the simulation, the agents continuously update their behavioural strategy even if they are following the institution. In other words, when the agents start following the institution instead of their own behavioural strategy, they evaluate their current performance (their level of energy) to the situation where they would follow their own strategy instead of the institution. If the institution is less beneficial for them, they may cheat based on their level of cheating propensity and social influence (Listing 1). They perform this comparison in every time step “or tick”.

```

if (random-float 1 <
  (individual-cheating-propensity * (1 - social-influence)
  +
  (count link-neighbors with [cheated = true] / count
  link-neighbours) * social-influence))

set agent cheat

```

Listing 1: Decision to Cheat

If a certain number of agents are ‘not satisfied’ with the current institution; i.e., if they are losing energy every tick, they enter the institutional voting phase again to select a new institution. While carefully avoiding anthropomorphism – as the agents lack consciousness or emotion – an unintended or ‘non-optimal’ outcome may be defined as one in which more energy can be taken from the agents than is being given to them (i.e. the average agent energy is less than zero).⁸ Fig. 3, shows the dynamics of the agent-based model.

3.2.3. Simulation setup

The model is implemented in Netlogo (Wilensky, 1999). We ran 1000 repetitions of the model with random parameter setup. Each run lasted for 30,000 time steps (or ticks). The parameter setup of the simulation is illustrated in Table 1.⁹

3.3. Theoretical and empirical validity

The model explained above has been theoretically and empirically validated (Bravo, 2011; Ghorbani et al., 2017). For the former validation, the general patterns of outcome as well as the outcome variables and their correlation with input parameters were compared to the general theoretical findings, mainly proposed by Ostrom and her colleagues. Examples of theoretical findings that the emergent outcomes of the model confirmed are:

- With resource scarcity (low initial amount, and low growth rate), the presence of institutions is crucial to sustain the system.
- Monitoring enforcement is strong in situations where there is resource scarcity.
- The long enduring institutions have low monitoring enforcement.

The outcomes of the model have also been compared to a dataset of emerging institutions (fishery and irrigation). The comparison between the correlations among the variables in the dataset and correlation between the variables in the simulation showed many similarities. An example of similar correlations is: Rule compliance has a negative correlation with the state of the resource, meaning that with resource

⁸ Note that satisfaction is something different than non-optimality, as the former is something that the agent measures (inherent to the model), while the latter is something that the modeler interprets and understands as such (and is thus external to the model).

⁹ Note that the values of these parameters have been calibrated with sensitivity analysis.

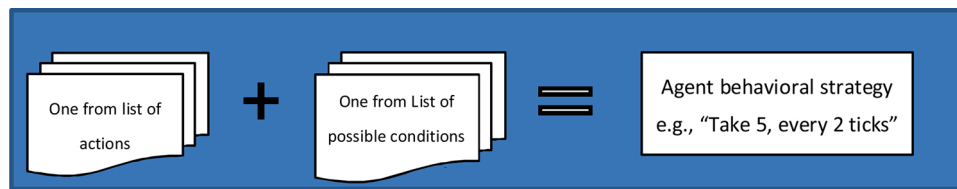

Fig. 1. Composing the behavioural strategy per agent.

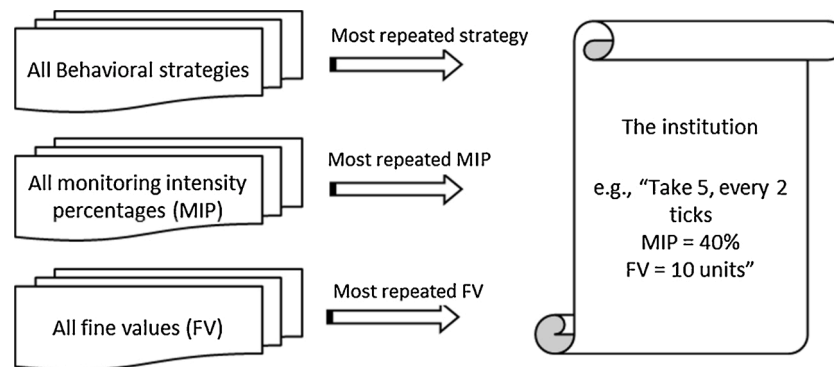

Fig. 2. Defining an institution.

scarcity, compliance with institutions is higher.

4. Results: the credibility thesis in the model

The following indicators were selected for the measurement of institutional performance: the average institutional lifespan across the whole simulation; the average agent energy; the average resource status left at the end of the simulation; and the outcome.

The institutional lifespan clearly shows a bimodal distribution with two peaks on extremely long-lasting institutions and rapidly changing ones respectively (Fig. 4A). The density of the average energy of agents peaks slightly above zero, even if a long left tail is present (Fig. 4B).¹⁰ Finally, the resource density shows an intermediate behaviour, with a higher peak corresponding to a sustainable management condition and a lower one where the resource is almost fully depleted (Fig. 4C).

The institutional lifespan is clearly, although not perfectly, linked to the average energy that institutions are able to grant to the agents (Pearson's $r = 0.67, p < 0.001$). Fig. 5 shows that, although institutions that are not able to guarantee sufficient energy to agents almost always have very short lifespans, the opposite is not necessarily true (which outcome might point to unintended intentionality, i.e. 'non-optimal' institutions emerge that would not otherwise have emerged if agents would have been intentional about them, i.e. avoiding a situation leading to self-destruction). The correlation indeed falls to non-significant levels ($r = 0.04, p = 0.145$) if we only consider cases where the average energy of agents is positive.

We define the outcome as "sustainable" if the average agent energy is larger than zero and at least half of the initial resource is left at the end of the simulation (which corresponds to the maximum sustainable yield given the logistic growth function used in the model).¹¹ As a whole, of the 2000 runs, 1476 runs ended up in an unsustainable state, while 524

in a sustainable one. To this outcome, corresponds a strong difference in the institutional lifespans ($11,719 \pm 341$ vs. $24,661 \pm 315$ time steps, respectively). Thus, in effect, close to three quarters of the total runs result in an unsustainable situation, although the sustainable outcomes also feature a more than double lifespan of the institutions.

As this outcome also depends on the resource characteristics, we define an "easy management" situation when both the carrying capacity and the regeneration rate of the resource were above the median values, while all other cases are labelled as "difficult management".¹² Overall, 527 runs are considered easy management situations, 1473 difficult. The two cases lead to differences in the institutional lifespans ($13,558 \pm 343$ vs. $19,447 \pm 523$ ticks, respectively), although not as large as the ones for the outcome case. Note that an easy management condition is not necessarily linked to a sustainable outcome. About two thirds of the runs under an easy management condition actually produced an unsustainable outcome, while approximately one quarter of the ones under difficult conditions led to a sustainable situation (Table 2).

4.1. Form follows from function

Looking at the cases that led to sustainable outcomes, with a specific focus on the ones that had to cope with difficult management conditions (bottom-left panel in Fig. 6), shows a certain variability in the aim and condition rules of these successful institutions. Except the handful of cases that ended up with giving some or taking no energy, which correspond to short-lasting institutions at the very end of the simulation, most other institutions were set up with rule combination prescribing to take either little energy (4–10 units) in each time step per round or, somewhat more frequently, to take 14–18 energy units every 2–3 time steps or whenever the agent energy is below zero. Note also that the variability of institutions seems to be larger for unsustainable outcomes,

¹⁰ The energy of the agent is relative as it represents loss and gain. In other words, energy below zero does not imply that the agent is dead but has received more loss than gain.

¹¹ Through sensitivity analysis meaningful patterns were explored, resulting in the outcome that institutions were no longer stable when less than half of the resource was available. In this sense, the definition of sustainability is an emergent result of the model.

¹² In the case of land or natural resource use, the carrying capacity under "easy" management would be defined as the middle value of the maximum population size of a biological species (crops, cattle, or humans) that can be sustained on a given plot, given the food, habitat, water, and other physical conditions present. The regeneration rate under "easy" management would be defined as the middle value of the regrowth by a population of animals, plant, or humans of the part that has been lost or destroyed.

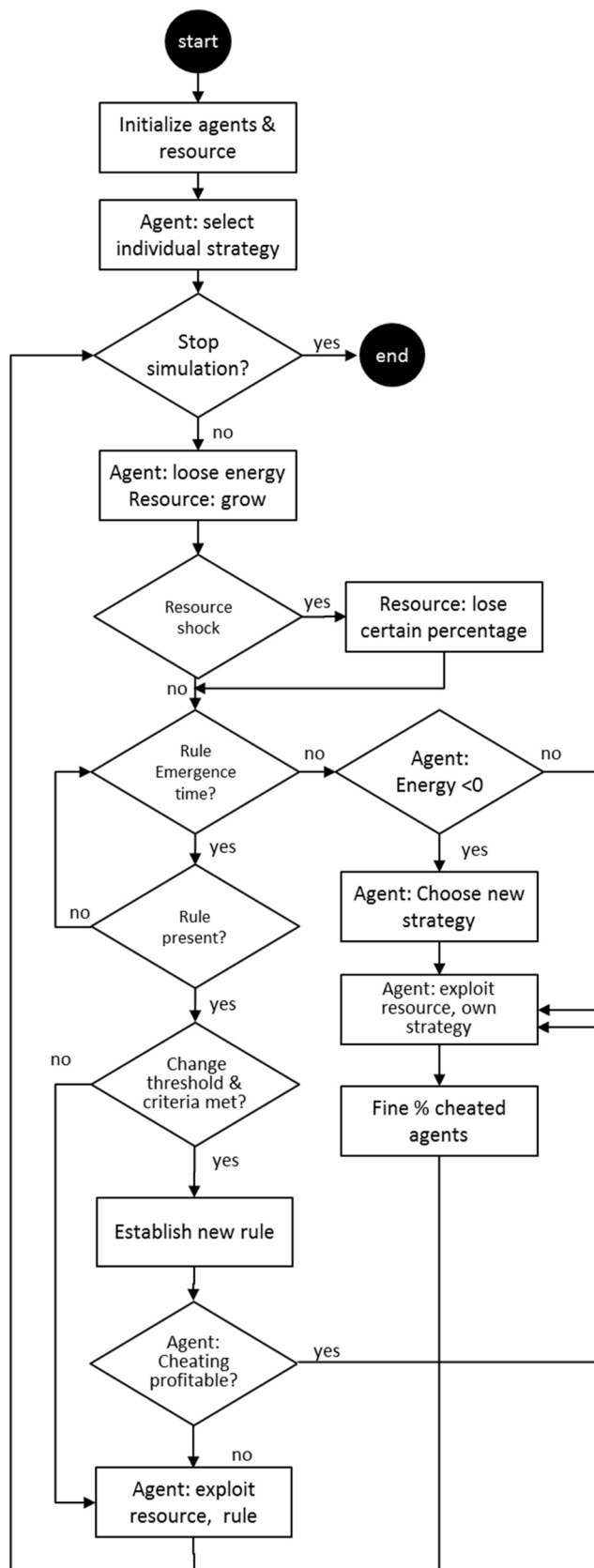

Fig. 3. Flow chart of the model.

Table 1 parameter setup.

Parameter	Values	Description
Actions	consume [1 < n < 16], [-5]	Action list
Conditions	(ticks mod 10) = 0, (ticks mod 5) = 0, (ticks mod 4) = 0, (ticks mod 3) = 0, (ticks mod 2) = 0, energy <= 0, (ticks mod 20)	Condition list
Social influence	0.9 – 1	agents may be influenced by their neighbours when making decision to cheat
Individual cheating propensity	0.1 – 0.35	Agents have different opinions about cheating
Max fine	20	The value of fine is between 0 and 20
Monitoring cost weight	50–60	The cost of monitoring is distributed equally among agents
Carrying capacity (K)	10000–20000	The initial amount of the resource
Growth rate (r)	0.25 – 0.35	The growth rate of the resource
Number of agents	100	
Energy consumption	1	The amount of energy consumed by each agent per tick
(personal) Innovation rate	0.01 – 0.2	The probability of agents choosing their own new strategy instead of copying neighbours
Threshold for institutional change	0 – 0.75	The percentage of the unsatisfied agents for changing the institution
Institutional emergence time	50 – 100	The intervals for meetings to vote for potentially new institution (in case of dissatisfaction)
Number of links	1 – 4	In the network
Type of network	Random	
Number of iterations	1000	

which is not surprising as, given the model structure, where a failure to provide agents with a sufficient amount of energy leads to more frequent institutional change.

We further analysed the diversity of the institutions in the sustainable case by grouping all institutions in five different clusters. In addition to the Aim and Condition, already considered above, we also consider in the cluster analysis the proportion of monitoring activities and the fine to cheaters. Being Aim and Condition categorical variables, we used the Glower algorithm (Gower, 1971) to compute the distances among cases. To achieve a more robust grouping with categorical data, we used a PAM (partitioning around medoids) algorithm (Reynolds et al., 2006) to build the clusters. The optimal number of clusters was identified by maximising the silhouette value of the cluster configuration (Rousseeuw, 1987). Table 3 shows the resulting typical institution in each cluster.

To check whether the institutional design affects its performance, the clusters were included in three regression models having as dependent variables the institutional lifespan, the energy of agents and the resource status respectively. The carrying capacity *K* and regeneration rate *r* were included as covariates. The model estimates show only limited differences among clusters, and these are mainly related to the energy outcome (Table 4). It is also worth noting that, at least for this group of successful cases, the institutional longevity seems to be only weakly

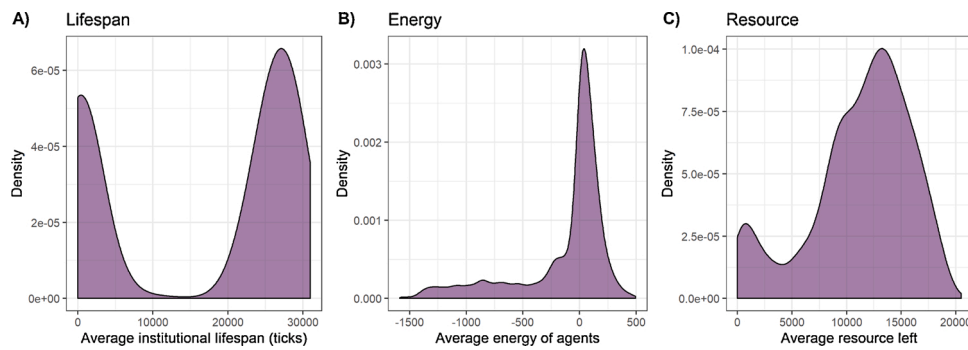

Fig. 4. A–C: Density of average (A) institutional lifespan, (B) agent energy and (C) resource status in 2000 simulation runs.

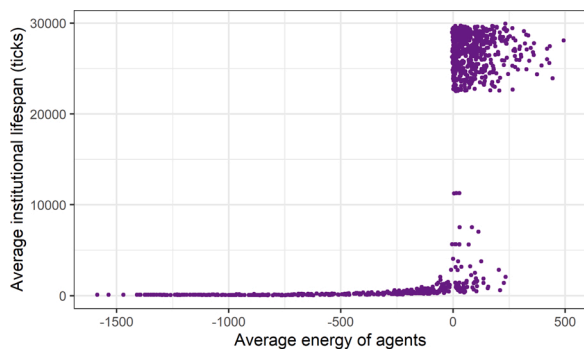

Fig. 5. Average energy of agents and institutional lifespan in 2000 simulation runs.

Table 2
Number of simulation runs with sustainable and unsustainable outcomes by management condition.

	Sustainable outcome	Unsustainable outcome
Easy management	168	359
Difficult management	356	1117

related to both the resource characteristics and the specific institutional form.¹³

Therefore, we can conclude that in-line with the credibility thesis, the form of the institution, does not have a significant influence on the success (or performance) of that institution. In other words, there are diverse institutions that can lead to sustainable outcomes even in difficult resource management situations.

4.2. Unintended intentionality

The second postulate of the credibility thesis states that non-optimal institutions may emerge that would not have emerged if actors would have been intentional about the final outcomes of their decisions (Ho, 2017: 52, 61–80). Although Fig. 4 shows that, in a limited number of cases, institutions with little logic from the point of view of the agents — that is, asking them to give energy — do emerge,¹⁴ the fact that only the

¹³ However, the picture changes if we consider the whole set of simulation runs. In this case, both the resource characteristics and the clusters dummies become significant predictors of the institutional lifespan.

¹⁴ Here we do not consider the hypothetical situation in which agents could give energy to gain something better at the end of the simulation (a sustainable outcome), which would not necessarily be illogical or non-optimal. What occurs in the model is that non-optimal institutions that are only taking energy from the agent rather than giving, do not last long and are unsustainable.

final institution was recorded in the data does not allow to carefully check their performance and longevity. To do so, we ran further 100 + 100 simulations, recording the relevant variables each time the institution changed (after a warm-up period of 7500 time steps). The institutional setting and performance indicators of a total of 10,107 institutions were recorded.

The outcome of the new simulations confirms that, although non-optimal institutions do sometimes emerge (all possible combinations of Condition and Aim are now covered by at least one case), they do not last long. On the other hand, enduring institutions show a clear pattern, with a focus either on periodically taking enough resource or on taking smaller amounts in almost every tick (Fig. 7).

Within these limits, differences among institutions may emerge. A cluster analysis similar to the one done above led to the selection of 6 clusters showing a certain amount of diversity, although within clear boundaries (Table 5).

As above, we regressed the different clusters against the institutional lifespan, the energy of agents and the amount of resource (Table 6). The different clusters do have significant differences in performance, showing that not always agents were able to select the best institutions given their situation.

5. Conclusion: credibility thesis’ predictions and future research

The primary aim of this article is to use an agent-based model to ascertain whether some of the predictions of the credibility thesis could be validated in a computational simulation. The model is an abstract representation of a common pool resource setting: agents are individually equipped with basic needs and exploit a certain resource. In this regard, it may also have wider relevance for socio-ecological systems (SES) in general. An institutional form emerges and changes after repeated decision-making amongst the agents. With this model we explored: 1) whether different forms of institutions can have similar outcomes; and 2) whether institutions are unintentional outcomes rather than designed artefacts.

The prediction that form follows from function (and not vice versa) appears to be supported by the model under certain constraints. More specifically, there is a given variation or divergence of institutional forms, which seems unrelated to the resource characteristics and the performance of the institution in general. Thus, contrary to institutional convergence, the model ascertains that different institutions can emerge and endure as long as they satisfy the basic reason (or function) why they were built in the first place. Within this boundary, they are relatively free to develop different forms. This finding is similar, for instance, to studies on cultural evolution showing that functional features of canoes in Polynesia (subjected to physical constraints) do not significantly vary across time and space, while symbolically designed ones (which do not alter the canoes’ performance) are more free to change and present substantial variation (Rogers and Ehrlich, 2008).

The second prediction of unintended intentionality is – within certain limits – also validated, as during the majority of the runs

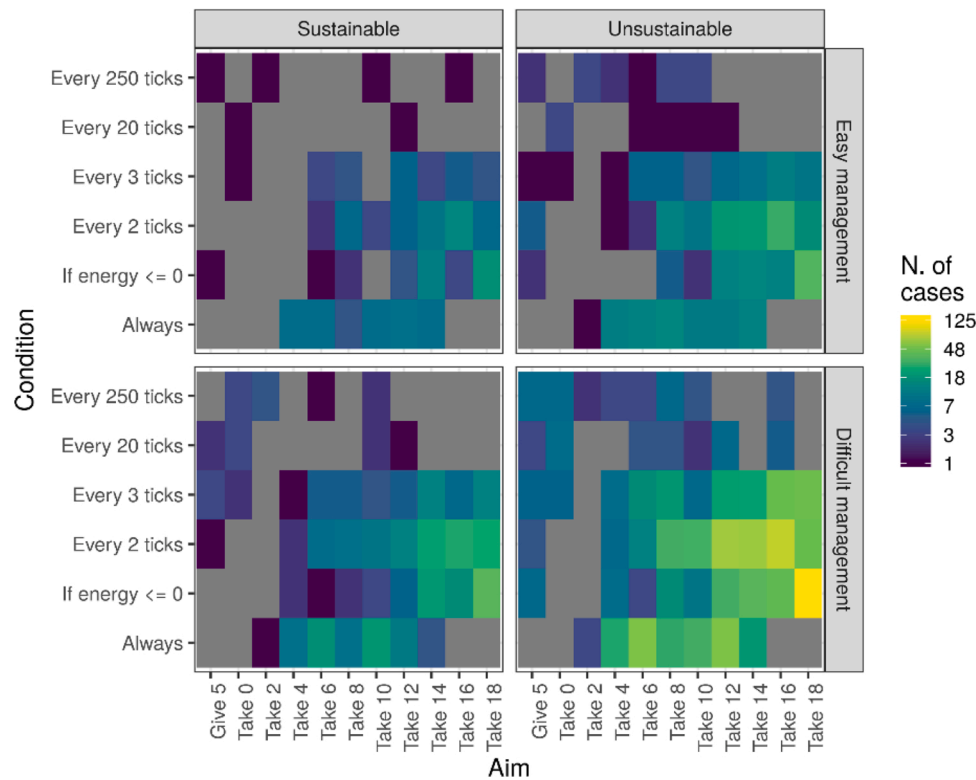

Fig. 6. Final institution: number of cases of for each combination of condition and aim that led to sustainable and unsustainable outcome under easy and difficult management conditions. The color scale is logarithmic (base 2), with grey patches corresponding to no cases.

Table 3
Modal institution in each cluster.

Cluster	Aim	Condition	Monitoring (%)	Fine
1	Take 16	Every 2 ticks	7	5
2	Take 14	Every 3 ticks	6	15
3	Take 10	Always	5	8
4	Take 18	If energy <= 0	5	9
5	Take 14	Every 2 ticks	4	15

Table 4
OLS model estimate for the performance of each cluster. The first cluster is used as reference. Standard error are in brackets. Significance symbols: $p < 0.05$; $p < 0.01$; $p < 0.001$.

	Lifespan	Energy	Resource
Cluster 2	381.468 (1081.293)	4.536 (12.253)	-50.864 (185.264)
Cluster 3	-28.674 (966.177)	28.074 (10.949)	-107.847 (165.540)
Cluster 4	1343.502 (952.977)	2.144 (10.799)	140.243 (163.279)
Cluster 5	1195.843 (1027.028)	24.532 (11.638)	155.744 (175.966)
K	-0.152 (0.113)	0.006 (0.001)	0.890 (0.019)
R-	5668.613 (10998.800)	66.317 (124.640)	4332.124 (1884.485)
Constant	24270.550 (3851.297)	-46.695 (43.643)	-1831.359 (659.864)
N	524	524	524
R^2	0.015	0.068	0.805
F(7516)	1.103	5.394	304.435

$p < .05$; $p < .01$; $p < .001$.

‘illogical’, non-optimal institutions (i.e. that asked agents to give energy) emerged, although not lasting long. At this point, it needs emphasis that our model was designed in such way to allow for institutions to emerge from agent behavior rather than being designed as parameters exogenous to the model. Since our agents were, technically speaking, not intentional about their choices, we aimed to explore whether these unintended institutions could also be successful in sustainable terms.

We defined the sustainability of a system as “the average agent energy being larger than zero and at least half of the initial resource being left at the end of the simulation” and looked into difficult CPR management situations. Thus, for instance, if one imagines a forest or a plot of arable land, this implies that only half of the trees or fertile top soil remains, while the forest and land users still have (financial, material, or human) resources left. Having said this, what is sustainable in an empirical setting depends on the resource and can vary per case. Thus, setting 50 % of the initial resource left as sustainable would be arbitrary. Yet, the resource in our model is based on a logistic growth function, which means that the maximum growth occurs at 50 % of the carrying capacity. This is consistent with the definition of “maximum sustainable yields” (or MSY, the maximum crop that can be removed from a population of animals or plants without adverse effects) in environmental economics and in bio-economic models (Perman et al., 2003).

From the simulations, there were non-optimal institutions that were sustainable although their differences remained within clear limits in the sense that they were rapidly ruled-out. At the same time, three quarters of the simulations (1476 out of 2000 runs) resulted in an unsustainable situation, which again, could indicate an unintended outcome assuming that the agents would at least strive for their own survival.

This study’s outcomes may have relevance for the research on institutions and property rights, with particular reference to their

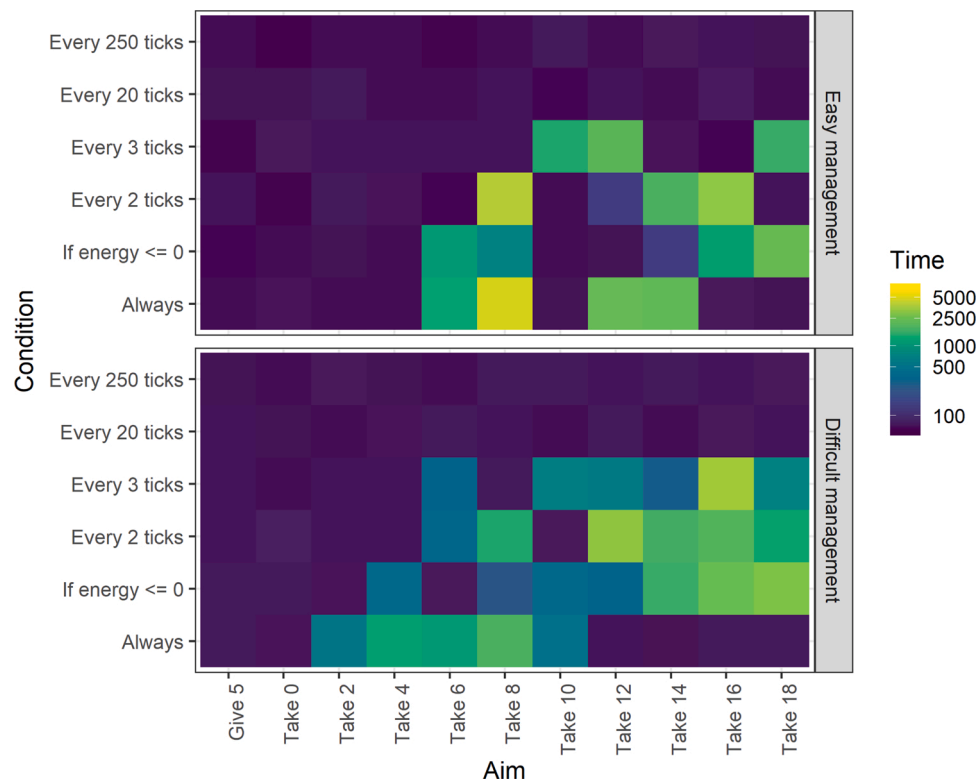

Fig. 7. Institutional lifespan for each combination of condition and aim under easy and difficult management conditions. The color scale is logarithmic (base 2).

Table 5

Modal institution in each cluster taking into account all institutions that emerged in 200 simulation runs.

Cluster	Aim	Condition	Monitoring (%)	Fine
1	Take 14	Every 2 ticks	45	11
2	Take 14	Every 250 ticks	50	11
3	Take 4	If energy < = 0	49	10
4	Take 16	Every 3 ticks	51	10
5	Take 18	Always	47	11
6	Take 12	Every 20 ticks	50	11

performance, at various levels. One, to our knowledge, this is the first time that a model based on endogeneity has confirmed a phenomenon that has been observed empirically: *different* institutions may perform *equally*.¹⁵ For instance, while some research has found that *formal* land ownership may lead to economic efficiency (Lawry et al., 2017; Galiani and Scharrodsky, 2010), other research has established that *informal* land ownership can have the same efficiency effects (Oranje et al., 2020; Fold et al., 2018; Sitko et al., 2014; Monkkonen, 2012; Sjaastad and Cousins, 2009).

Having said this, the credibility thesis' postulate on function over form holds a dual implication. Not only would different institutions perform identically, but the opposite is equally true: *identical* institutions can perform *differently*. This phenomenon, too, has been empirically observed, for example, Easthope et al. (2020), ascertained that the same property right (in their case, strata rights) performed differently around the world. In a similar vein, Zheng and Ho (2020), demonstrate that the continental European, civil law notion of "absolute" ownership can

¹⁵ It may count to a lesser extent for unintentional intentionality. Although there is research that establishes the unintentional outcomes of human action (e.g. Fawcett, 2013; Hale, 2013) of which the work by Pressman and Wildavsky (1984) is perhaps the most classical, the bulk of these studies is not specifically framed through the lens of institutions and property rights.

Table 6

OLS model estimate for the performance of each cluster taking into account all institutions that emerged in 200 simulation rounds. The first cluster is used as reference. Standard error are in brackets. Significance symbols: p < 0.05; p < 0.01; p < 0.001.

	Lifespan	Energy	Resource
Cluster 2	-948.888 (114.825)	-171.635 (14.935)	-1513.913 (143.640)
Cluster 3	-661.085 (108.030)	-161.586 (14.051)	-1364.970 (135.140)
Cluster 4	-663.799 (111.928)	-222.625 (14.558)	-1775.177 (140.016)
Cluster 5	-86.716 (109.610)	-40.808 (14.256)	-185.756 (137.117)
Cluster 6	-828.849 (112.601)	-150.502 (14.645)	-1124.275 (140.859)
K	0.126 (0.012)	0.028 (0.002)	0.383 (0.015)
R	2781.083 (1080.448)	-518.232 (140.528)	-2354.961 (1351.589)
Constant	-1546.921 (387.592)	-997.943 (50.412)	387.596 (484.859)
N	10,107	10,107	10,107
R ²	0.025	0.086	0.094
F(8,10098)	32.363	118.411	131.550

p < .05; p < .01; p < .001.

function completely differently in the Chinese context. At this point, there is a clear area for future agent-based modeling, which could test whether the second implication can be witnessed in a simulation as well.

Another interesting level at which the model may have made a useful contribution to the study of institutional function is by demonstrating a viable and useful alternative for the existing studies that aim to (cor) relate form and performance variables. In contrast to regression models that test whether any causal relations exist between, for instance, private, common, public, or likewise formal and informal property rights on the one hand, vis-à-vis higher GDP, lower transaction costs, or

sustainability, on the other hand, we can now simulate how institutions' performance results from an (unintentional) emergent process shaped by actors' multitudinous interactions.

The model presented in this paper still contains rather simplified agents, without any form of learning behaviour or elaborate decision-making. Although it is already valuable to see results emerging from this model, future research should also examine the consequences of having more "intelligent" agents. What this necessitates, however, is a closer coupling between empirical data and simulation through the development of data-driven or empirically grounded agent-based models. This, in turn, would require a careful calibration of the agents' and resources' attributes, heterogeneity and/or decision-making rules through data derived from methods, such as surveys, in-depth interviews, and participatory observation (Rounsevell et al., 2012).¹⁶ In the context of all of the above, it is hoped that this paper could be the start for a new methodological perspective on the study of property rights and institutions.

Declaration of Competing Interest

The authors report no declarations of interest.

CRediT authorship contribution statement

Amineh Ghorbani: Conceptualization, Data curation, Formal analysis, Investigation, Methodology, Software, Validation, Visualization, Writing - original draft, Writing - review & editing. **Peter Ho:** Conceptualization, Formal analysis, Funding acquisition, Investigation, Methodology, Resources, Supervision, Validation, Visualization, Writing - original draft, Writing - review & editing. **Giangiaco Bravo:** Conceptualization, Data curation, Formal analysis, Methodology, Resources, Software, Validation, Visualization, Writing - review & editing.

Acknowledgments

The authors would like to express their heartfelt thanks to the three anonymous reviewers of this journal, as well as the participants of the double panel on Institutional Credibility and Function at the EAEPE annual conference, Manchester, November 3-5, 2016 (see: www.recoland.eu). Their comments were instrumental in the conceptualization and design of this paper. This research has been supported by the National Natural Science Foundation of China, project number 71573231 and the European Research Council, RECOLAND GA282690.

References

- Agrawal, A., Wollenberg, L., Persha, L., 2014. Governing mitigation in Agriculture-Forest Landscapes. *Glob. Environ. Change* 29, 270–326.
- Aron, Janine, 2000. Growth and institutions: a review of the evidence. *World Bank Res. Obs.* 15 (1), 99–135.
- Bergstén, Sabina, Stjernström, Olof, Pettersson, Örjan, 2018. Experiences and emotions among private forest owners versus public interests: why ownership matters. *Land Use Policy* 79, 801–811.
- Bonabeau, Eric, 2002. "Agent-based Modeling: Methods and Techniques for Simulating Human Systems", 99/3. *Proceedings of the National Academy of Sciences (PNAS)*, pp. 7280–7287.

¹⁶ For instance, survey research established that in the 1990s and 2000s, Chinese farmers supported insecure tenure, through which land lease rights were periodically reallocated to ensure that anyone had sufficient land to live off in time of adversities (Kung and Liu, 1997; Quanguo Nongcun Guding Guanchadian Bangongshi, 1998; Yang et al., 2008; Ho, 2014; Kong et al., 2014). Thus, insecure land tenure functioned as a form of social security. By mining the data from these studies, one could derive at specific agents' attributes (e.g. older agents are more inclined to insecure tenure than younger ones) and the constraints that they are facing (e.g. absence of alternative employment or sufficient social insurance). These data could subsequently be fed into an ABM to assess whether the simulation matches that what was observed empirically.

- Bravo, G., 2011. Agents' beliefs and the evolution of institutions for common-pool resource management. *Ration. Soc.* 23 (1), 117–152.
- Celhay, Pablo, Gil, Diego, 2020. The function and credibility of urban slums: unexpected evidence on informal settlements and affordable housing in Chile. *Cities* 2020, 97. <https://doi.org/10.1016/j.cities.2020.102605>.
- Chang, Ha-Joon, 2007. *Institutional Change and Economic Development*. United Nations University Press, Tokyo, New York, Paris.
- Choplin, Armelle, Dessie, Elizabeth, 2017. Titling the desert: Land formalization and tenure (in)security in Nouakchott (Mauritania). *Habitat Int.* 64 (June), 49–58.
- Davy, Benjamin, 2018. After form. The credibility thesis meets property theory. *Land Use Policy* 79 (12), 854–862.
- De Soto, Hernando, 2000. *The Mystery of Capital: Why Capitalism Triumphs in the West and Fails Everywhere Else*. Basic Books, New York.
- Demsetz, Harold, 1967. Toward a theory of property rights, the American economic review. In: *Papers and Proceedings of the Seventy-Ninth Annual Meeting of the American Economic Association*, Vol. 57, pp. 347–359. No. 2.
- Diesing, P., 1971. *Patterns of Discovery in the Social Sciences*. Routledge, London.
- Easthope, Hazel, Nouwelant, Ryanvanden, Thompson, Sian, 2020. Apartment ownership around the world: focusing on credible outcomes rather than ideal systems. *Cities* 97 (February). <https://doi.org/10.1016/j.cities.2019.102463>, pp. 102463.
- Eisenstadt, Samuel N., 1998. Comparative studies and sociological theory: autobiographical notes. *Am. Sociol.* 29, 38–58.
- Epstein, J.M., 2006. *Generative Social Science: Studies in Agent-based Computational Modeling*. Princeton Univ Pr.
- Fan, Shengyue, Yang, Jinfei, Liu, Wenwen, Wang, He, 2019. Institutional credibility measurement based on structure of transaction costs: a case study of ongnuid banner in the Inner Mongolia autonomous Region. *Ecol. Econ.* 159, 212–225.
- Farmer, J., Doynne, Foley, Duncan, 2009. The economy needs agent-based modeling. *Nature* 460 (6), 685–686.
- Fawcett, Louise, 2013. The Iraq war ten years on: assessing the fallout. *Int. Aff.* 89 (2), 325–343.
- Fold, N., Allotey, A.N., Kalvig, P., Moeller-Jensen, L., 2018. Grounding institutions through informal practice: credibility in artisanal mining of aggregates, Ghana. *Land Use Policy* 79, 922–931.
- Freeman, Alan, Carchedi, Guglielmo (Eds.), 1995. *Marx and Non-Equilibrium Economics*. Edward Elgar Publishing Limited, Aldershot.
- Fries, Steven, Taci, Anita, 2005. Cost efficiency of banks in transition: evidence from 289 banks in 15 post-communist countries. *J. Bank. Financ.* 29 (1), 55–81.
- Galiani, Sebastián, Scharfrodsky, Ernesto, 2010. Property rights for the poor: effects of land titling. *J. Public Econ.* 94 (9-10), 700–729.
- Ghorbani, A., Bravo, G., 2016. Managing the commons: a simple model of the emergence of institutions through collective action. *Int. J. Commons* 10 (1), 200–219.
- Ghorbani, A., Bots, P., Dignum, V., Dijkema, G., 2013. MAIA: a framework for developing agent-based social simulations. *J. Artif. Soc. Soc. Simul.* 16 (2), 9.
- Ghorbani, A., Bravo, G., Frey, U., Theesfeld, I., 2017. Self-organization in the commons: an empirically-tested model. *Environ. Model. Softw.* 96, 30–45.
- Gomes, Sharlene L., Hermans, Leon M., 2018. Institutional function and urbanization in Bangladesh: how peri-urban communities respond to changing environments. *Land Use Policy* 932–941.
- Gordon, H.Scott, 1954. The economic theory of a common-property resource: the fishery. *J. Polit. Econ.* 62, 124–142.
- Gower, J.C., 1971. A general coefficient of similarity and some of its properties. *Biometrics* 27 (4), 857–871.
- Gräbner, C., 2016. Agent-based computational models—a formal heuristic for institutional pattern modelling? *J. Inst. Econ.* 12 (1), 241–261.
- Grosz, B.J., Kraus, S., 1996. Collaborative plans for complex group action. *Artif. Intell.* 86 (2), 269–357.
- Haas, Astrid R.N., Jones, Patricia, 2017. The importance of property rights for successful urbanisation in developing countries. *Int. Growth Centre Policy Brief* 43609 (January 5), 1–8.
- Hale, Henry E., 2013. Regime change cascades: what we have learned from the 1848 revolutions to the 2011 Arab uprisings. *Annu. Rev. Political Sci.* (16), 331–353.
- Hardin, G., 1968. The tragedy of the commons. *Science* 162, 1243–1247.
- Ho, Peter, 2014. The 'Credibility thesis' and its application to property rights: (In)secure land tenure and social welfare in China. *Land Use Policy* 40, 13–27.
- Ho, Peter, 2017. *Unmaking China's Development: The Function and Credibility of Institutions*. Cambridge University Press, Cambridge.
- Hodgson, Geoffrey, 2004. *The Evolution of Institutional Economics: Agency, Structure and Darwinism in American Institutionalism*. Routledge, London.
- Holland, J.H., 1992. Complex adaptive systems. *Daedalus* 121 (1), 17–30.
- Janssen, M.A., Ostrom, E., 2006. Adoption of a new regulation for the governance of common-pool resources by a heterogeneous population. In: Baland, J.-M., Bardhan, P., Bowles, S. (Eds.), *Inequality, Cooperation and Environmental Sustainability*. Princeton University Press, Princeton, pp. 60–96.
- Jones, Paul, 2017. Formalizing the informal: understanding the position of informal settlements and slums in sustainable urbanization policies and strategies in Bandung, Indonesia. *Sustainability* 9 (8), 1436–1463.
- Kim, Yee Kyoung, Lee, Keun, Park, Kineung, 2012. Appropriate intellectual property protection and economic growth in countries at different levels of development. *Res. Policy* 41 (2), 358–375.
- Kong, Tao, Unger, Jonathan, Liu, Pengling, 2014. "Nongcun chengbaodi tiaozheng de shizheng yanjiu – Tongguo cunmin xiaozu shuju de fenxi" (empirical research on readjustments of rural contract land: an analysis based on villagers' group data). *Nongye Jingji Wenti* 11, 87–97.

- Kung, James Kai-sing, Liu, Shouying, 1997. 'Farmers' preferences regarding ownership and land tenure in Post-Mao China: unexpected evidence from eight counties. *China J.* 38 (July), 33–63.
- Lawry, Steven, Samii, Cyrus, Hall, Ruth, Leopold, Aaron, Hornby, Donna, Mtero, Farai, 2017. The impact of land property rights interventions on investment and agricultural productivity in developing countries: a systematic review. *J. Dev. Eff.* 9 (1), 61–81.
- Leijonhufvud, Axel, 2006. Agent-based macro. In: Tesfatsion, Leigh, Judd, Kenneth L. (Eds.), *Handbook of Computational Economics*, Volume 2. Elsevier, Amsterdam, pp. 1626–1637.
- Marois, Thomas, Güngen, Ali R.ıza, 2016. Credibility and class in the evolution of public banks: the case of Turkey. *J. Peasant Stud.* 43 (6), 1285–1309.
- Mengistu, Frew, van Dijk, MeinePieter, 2018. Credibility of institutions in Addis Ababa (Ethiopia), effects of government policies on real estate developers. *Land Use Policy* 79 (12), 913–921.
- Micelli, Thomas J., Sirmans, C.F., Turnbull, Geoffrey K., 2000. The dynamic effects of land title systems. *J. Urban Econ.* (47), 370–389.
- Miyamura, Satoshi, 2016. Rethinking labour market institutions in Indian industry: forms, functions and socio-historical contexts. *J. Peasant Stud.* 43 (6), 1262–1284.
- Mollinga, Peter P., 2016. Secure rights and non-credibility: the paradoxical dynamics of canal irrigation in India. *J. Peasant Stud.* 43 (6), 1310–1331.
- Monkkonen, Paavo, 2012. The demand for land regularisation: theory and evidence from Tijuana, Mexico. *Urban Stud.* 49 (February 2), 271–288.
- Monkkonen, P., 2016. Are civil-law notaries rent-seeking monopolists or essential market intermediaries? Endogenous development of a property rights institution in Mexico. *J. Peasant Stud.* 43 (6), 1224–1248.
- North, Douglass, 1990. *Institutions, Institutional Change and Economic Performance*. Cambridge University Press, Cambridge.
- Olson, Mancur, 1965. *The Logic of Collective Action: Public Goods and the Theory of Groups*. Harvard University Press, Cambridge MA.
- Oranje, Mark, van Huyssteen, Elsona, Maritz, Johan, 2020. Rapid urbanisation to non-metropolitan urban South Africa: a call for accrediting credible 'informal' life-enhancing responses and institutions. *Cities* 96. <https://doi.org/10.1016/j.cities.2019.102487>, p. 102487.
- Ostrom, Elinor, 1990. *Governing the Commons: The Evolution of Institutions for Collective Action*. Cambridge University Press, Cambridge.
- Perman, R., Ma, Y., McGilvray, J., Common, M., 2003. *Natural Resource and Environmental Economics*. Pearson, London.
- Poteete, A.R., Janssen, M.A., Ostrom, E., 2010. *Working Together: Collective Action, the Commons, and Multiple Methods in Practice*. Princeton University Press.
- Pressman, Jeffrey L., Wildavsky, Aaron, 1984. *Implementation: How Great Expectations in Washington Are Dashed in Oakland*, 3rd edition. University of California Press, Oakland.
- Quanguo Nongcun Guding Guanchadian Bangongshi, 1998. *Dangqian Nongcun Tudi Chengbao Jingying Guanli de Xianzhuang ji Wenti* (The Present Situation and Problems facing the Management and Administration of Rural Land Lease). Zhongguo Nongcun Guancha (5), 56–57.
- Radice, Hugo, 2000. Globalization and national capitalisms: theorizing convergence and differentiation. *Rev. Int. Political Econ.* 7 (4), 719–742.
- Railsback, S.F., Grimm, V., 2012. *Agent-Based and Individual-Based Modeling: A Practical Introduction*. Princeton University Press, Princeton.
- Reynolds, A.P., Richards, G., de la Iglesia, B., Rayward-Smith, V.J., 2006. Clustering rules: a comparison of partitioning and hierarchical clustering algorithms. *J. Math. Model. Algorithms* 5 (4), 475–504.
- Rodrik, Dani, 2004. Getting institutions right. CESifo DICE Report (April 2), 1–13.
- Rogers, D.S., Ehrlich, P.R., 2008. Natural selection and cultural rates of change. *Proc. Natl. Acad. Sci. U. S. A.* 105 (9), 3416–3420.
- Rogge, Karoline S., Dütschke, Elisabeth, 2018. What makes them believe in the low-carbon energy transition? Exploring corporate perceptions of the credibility of climate policy mixes. *Environ. Sci. Policy* 87, 74–84.
- Rounsevell, M.D.A., Robinson, D.T., Murray-Rust, D., 2012. From actors to agents in socio-ecological systems models. *Philos. Trans. Biol. Sci.* 367, 259–269. <https://doi.org/10.1098/rstb.2011.0187>.
- Rousseeuw, P.J., 1987. Silhouettes: a graphical aid to the interpretation and validation of cluster analysis. *J. Comput. Appl. Math.* 20, 53–65.
- Santos, Alvaro, 2009. Labor flexibility, legal reform, and economic development. *J. Int. Law* 50, 43–106.
- Seth, A., 2008. Measuring emergence via nonlinear Granger causality. *Artif. Life* 11, 545.
- Sitko, Nicholas J., Chamberlin, Jordan, Hichaambwa, Munguzwe, 2014. Does smallholder land titling facilitate agricultural growth? An analysis of the determinants and effects of smallholder land titling in Zambia. *World Dev.* 64 (December), 791–802.
- Sjaastad, Espen, Cousins, Ben, 2009. Formalisation of land rights in the South: an overview. *Land Use Policy* 26 (January 1), 1–9.
- Smith, R.J., 1981. Resolving the tragedy of the commons by creating private property rights in wildlife. *Cato J.* 1 (2), 439–468.
- Squazzoni, F., 2012. *Agent-Based Computational Sociology*. John Wiley & Sons, Chichester.
- Wilensky, U., 1999. NetLogo. Retrieved from. <http://ccl.northwestern.edu/netlogo/>.
- Wu, Jiayu, Song, Yan, Lin, Jian, He, Qingsong, 2018. Tackling the uncertainty of spatial regulations in China: an institutional analysis of the "multi-plan combination". *Habitat Int.* 78, 1–12.
- Yang, Xuecheng, Ruibao, Zhao, Shuming, Yue, 2008. "Nongcun tudi guanxi sikao – jiyu 1995–2008 nian sancu Shandong nonghu diaocha" (Thoughts on the Relations of Rural Land – based on the 3rd Rural Household Survey of Shandong from 1995–2008). *Guanli Shijie* 7 (July), 53–61.
- Zeuthen, Jesper Willaig, 2018. Urban development for whom? Changing credibilities and forms of urbanization in Chengdu, China. *Land Use Policy* 79, 942–951.
- Zhao, Heng, Rokpelnis, Karlis, 2016. Local perceptions of grassland degradation in China: a socio-anthropological reading of endogenous knowledge and institutional credibility. *J. Peasant Stud.* 43 (6), 1206–1223.
- Zheng, Ying, Ho, Peter, 2020. Unpacking the paradox of "insecure" housing rights in China: urban residents' perceptions on institutional credibility. *Cities* 97 (February). <https://doi.org/10.1016/j.cities.2019.102485>, p. 102485.