

A Partition-Enabled Multi-Mode Band Approach to Arterial Traffic Signal Optimization

Ma, Wanjing; Zou, Li; An, Kun; Gartner, Nathan H.; Wang, Meng

DOI

[10.1109/TITS.2018.2815520](https://doi.org/10.1109/TITS.2018.2815520)

Publication date

2018

Document Version

Accepted author manuscript

Published in

IEEE Transactions on Intelligent Transportation Systems

Citation (APA)

Ma, W., Zou, L., An, K., Gartner, N. H., & Wang, M. (2018). A Partition-Enabled Multi-Mode Band Approach to Arterial Traffic Signal Optimization. *IEEE Transactions on Intelligent Transportation Systems*, 20(2019)(1), 313-322. <https://doi.org/10.1109/TITS.2018.2815520>

Important note

To cite this publication, please use the final published version (if applicable). Please check the document version above.

Copyright

Other than for strictly personal use, it is not permitted to download, forward or distribute the text or part of it, without the consent of the author(s) and/or copyright holder(s), unless the work is under an open content license such as Creative Commons.

Takedown policy

Please contact us and provide details if you believe this document breaches copyrights. We will remove access to the work immediately and investigate your claim.

A Partition-Enabled Multi-Mode Band Approach to Arterial Traffic Signal Optimization

Wanjing Ma¹, Li Zou, Kun An, Nathan H. Gartner, and Meng Wang

Abstract—Arterial traffic signal coordination makes traffic flow more efficient and safer. This paper presents a partition-enabled multi-mode band (PM-BAND) model that is designed to solve the signal coordination problem for arterials with multiple modes, i.e., passenger cars and transit vehicles. The proposed method permits the progression bands to be broken if necessary and optimizes system partition and signal coordination in one unified framework. The impacts of traffic demand of passenger cars and transit vehicles as well as the geometry characteristics of the arterials are taken into account. Signal timings and waiting time of transit vehicles at stations are optimized simultaneously. The PM-BAND model is formulated as a mixed-integer linear program, which can be solved by the standard branch-and-bound technique. Numerical example results have demonstrated that the PM-BAND model can significantly reduce the average number of stops and delay compared with the other models, i.e., MAXBAND and MULTIBAND. Moreover, the progression bands generated by the PM-BAND model have a higher reliability and effectiveness.

Index Terms—Arterial signal coordination, progression band, system partition, transit vehicles.

I. INTRODUCTION

TRAFFIC signals are used to assure safety and mobility. The performance of one isolated intersection is determined by its own signal timings, but also nearby signals. Traffic signal coordination is one of the most important strategies for urban traffic signal control. A well-timed coordinated system permits continuous movement with minimum number of stops and delays, which reduces fuel consumption and improves air quality. Potential benefits that may be observed are smoother traffic flows, more uniform vehicle speeds, and fewer accidents.

Manuscript received March 26, 2017; revised October 8, 2017 and January 11, 2018; accepted February 24, 2018. This work was supported in part by the National Natural Science Foundation of China under Grant 51722809, in part by the National Key Research and Development Program of China under Grant 2016YFE0206800, in part by the Fok Ying-Tong Education Foundation under Grant 151076, and in part by the Humanity and Social Science Youth Foundation of Ministry of Education of China under Grant 16YJCZH070. The Associate Editor for this paper was W. Fan. (*Corresponding author: Wanjing Ma.*)

W. Ma and L. Zou are with the Key Laboratory of Road and Traffic Engineering, Ministry of Education, Tongji University, Shanghai 201804, China (e-mail: mawanjing@tongji.edu.cn; 1532515@tongji.edu.cn).

K. An is with the Department of Civil Engineering, Monash University, Clayton, VIC 3800, Australia (e-mail: kun.an@monash.edu).

N. H. Gartner is with the Department of Civil and Environmental Engineering, University of Massachusetts Lowell, Lowell, MA 01854 USA (e-mail: nathan_gartner@uml.edu).

M. Wang is with the Department of Transport and Planning, Delft University of Technology, Delft 2628, The Netherlands (e-mail: m.wang@tudelft.nl).

Color versions of one or more of the figures in this paper are available online at <http://ieeexplore.ieee.org>.

Digital Object Identifier 10.1109/TITS.2018.2815520

Research on traffic signal coordination can generally be divided into two categories: bandwidth-oriented methods and disutility-oriented methods. Examples of bandwidth-oriented methods include MAXBAND [1], MULTIBAND [2], and PASSER II [3]. Such methods provide a progression band for vehicles on the main street and focus on maximizing the bandwidth. Traffic signals tend to group vehicles into a platoon. Under this circumstance, continuous movement of vehicle platoons through successive traffic lights can be maintained. Disutility-oriented methods are meant to seek minimum delay, stops, or other measures of disutility through different combinations of signal timing parameters. Examples of offline disutility-oriented methods include TRANSYT-7F [4] and SIGOP-III [5], adaptive systems include SCOOT [6] and UTOPIA/SPOT [7]. Many engineers prefer bandwidth-oriented methods for the relatively lesser input requirements, operational robustness, and convenient visualization of coordination quality. In addition, bandwidth-oriented methods operate better when the main street flow is predominantly through traffic and the volume turning onto the main street is low [2]. This paper also concentrates on bandwidth-oriented methods, and focuses on offline arterial problem which is the foundation of adaptive network problem.

Morgan and Little [8] first computerized the setting of arterial signals for maximal bandwidth. Little *et al.* [1] developed the classical MAXBAND model. The model uses mixed-integer linear programming method for optimization. It can determine a global optimal solution and calculates cycle time, offsets, progression speeds, and order of left turn phases to maximize the weighted combination of the bandwidths in both directions along the artery. Later, Chang *et al.* [9] extended the application of this model to networks and developed the MAXBAND-86 model. To ensure that the signal coordination plan suitably matches the actual traffic demand, Gartner *et al.* [2] developed the MULTIBAND model, which provides the capability to adapt the progression scheme to the specific traffic flow pattern on each link of the artery. Then, Gartner and Stamatiadis [10] extended the MULTIBAND model to grid networks. A few other methods, which are improvements of the bandwidth-oriented methods, are also available. Tsay and Lin [11] have considered queuing vehicles in detail as well as Lin and Ku [12]. Their models provided an exclusive time for vehicles queuing on a major-street approach to completely discharge and leave the intersection. Zhang *et al.* [13] proposed an asymmetrical multi-band model to an improved utilization of the available green times and to provide additional opportunities for vehicular progression. To contend with spillback on commuting arterials,

Yang *et al.* [14] presented three multi-path progression models using path-flow data.

Bandwidth-oriented methods are designed to maximize bandwidth in both directions. However, adequate bandwidth may not be able to be obtained in all cases. In the case where there are an excessive number of intersections or the green split of certain intersections is significantly short, the maximum bandwidth may not be adequate or a feasible solution may not even be available. Besides, the consideration of transit vehicles may increase the difficulty of achieving an adequate bandwidth for passenger cars. In light of these problems, this study proposed a Partition-enabled Multi-mode band (PM-BAND) model, which is designed to solve the signal coordination problem for an arterial with multiple modes, i.e., transit vehicles and passenger cars.

The remainder of this paper is organized as follows. In section II, detailed explanation of the problems is first presented. In section III, the notations adopted in this paper are described. The proposed PM-BAND model is formulated in section IV. The performance of the proposed model is evaluated in section V through extensive numerical and simulation analysis. Conclusions are provided toward the end of the paper.

II. PROBLEM DEFINITION

When adequate bandwidth cannot be obtained, the most common approach is to divide the entire signalized arterial into several subsystems before signal optimization—a technique called system partition [15]. In other words, the progression band is permitted to be discontinued at certain road links. Then, we need to consider the location of the breakpoint and the time at which the progression band is to be partitioned.

The first task is to identify the locations where the arterial is to be partitioned. Tian and Urbanik [16] proposed a method of dividing a major system into several subsystems. Then, the bandwidth is optimized for each subsystem and offsets between subsystems are adjusted. The partition is based on the spacing between intersections as well as traffic flow characteristics, such as volume and queue conditions. Fan and Tian [17] discussed three partition indexes—coupling index (CI), strength of attraction (SA), and coordinatability factor (CF). In selecting of a link for the breakpoint location, one would like to choose a link with lower degree of saturation and more pronounced platoon dispersion. This can be calculated by the indexes mentioned above. However, the breakpoint location has a high influence on the bandwidth solution. The separation of system partition and signal optimization may result in a non-optimal solution. Therefore, this necessitates the formulation of a method that is an integration of system partition and signal optimization.

The second task is to identify when partition is to be conducted. Prior to partition, the adequate bandwidth has to be determined. Fig. 1 illustrates two choices of bandwidth results. Fig. 1 (a) has a narrow progression band through all the intersections while Fig. 1 (b) has a wider band with a breakpoint. With the premise that the vehicles can maintain a specified speed, Fig. 1 (a) is chosen when the traffic demand is low, for example, at night. When the volume is substantially high and the vehicles are likely to drop out of a narrow

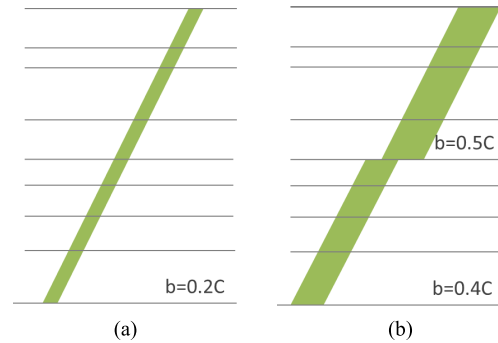

Fig. 1. Two choices. (a) Narrow band with no partition. (b) Wide band after being partitioned.

progression band, for example, during morning rush hours, Fig. 1 (b) is chosen.

Moreover, a further consideration of transit vehicles is necessary. Transit signal priority strategies in a large number of literatures are based on one isolated intersection [18], [19] rather than coordinated signals in the whole artery. The delay of a bus may be reduced due to signal priority at an upstream intersection. However, it may wait longer time at downstream intersections, and the signal priority is not effective for the whole bus travel. Therefore, coordination in the whole artery is necessary [20], [21]. Traffic signal coordination for transit is the provision of an extra progression band for transit based on the knowledge of the transit routes and ridership patterns [22], [23]. Usually, the bandwidths of transit vehicles and passenger cars are balanced by weight index. However, signal control coordination for transit vehicles may be ineffective because of the transit travel time fluctuations caused by interactions with general traffic and dwell-time variability. In the case of bus rapid transit (BRT) systems and modern tram systems, the exclusive lanes render the system highly reliable. The transit progression band can be effectively utilized by these transit vehicles, and a substantially narrow progression band could suffice for a single transit vehicle. This paper focuses on such transit vehicles driving on the exclusive lanes with reliable travel time.

PM-BAND model is dedicated to solving these problems. In summary, it permits the progression bands to be broken if necessary, and it optimizes system partition and signal coordination in one unified framework. The impacts of traffic demand of passenger cars and transit vehicles as well as the geometry characteristics of arterials are taken into account. Signal timings and waiting time of transit vehicles at stations are optimized simultaneously.

III. GENERAL NOTATIONS

PM-BAND is modeled on a two-way arterial with n signalized intersections. As illustrated in Fig. 2, the two travel directions along the artery are referred to be inbound and outbound. The outbound approaching arm j is numbered as 1, the other arms are then numbered consecutively in an anticlockwise direction. The straight-going movement k is numbered as 1. Left-turn movement and right-turn movement are numbered as 2 and 3, respectively. The symbols are defined in Table I and some are presented in Fig. 3. To linearize the

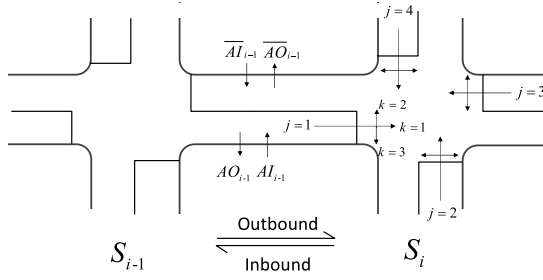

Fig. 2. Numbering rules for each traffic movement.

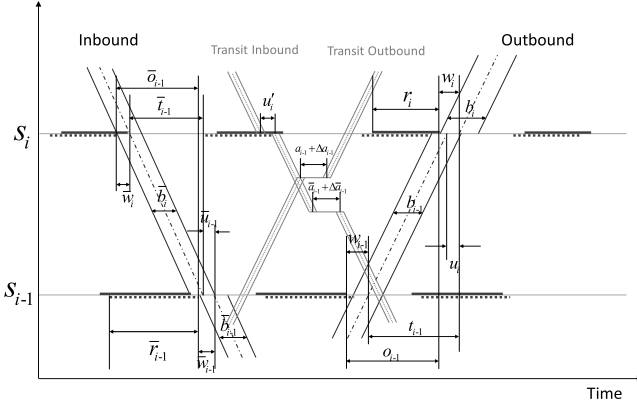

Fig. 3. Time-space diagram for PM-BAND.

model, a large number of the time variables are in units of cycle time.

For progression bands of passenger cars, we introduce the variables u_i and p_i to depict the location of breakpoint. These variables achieved the integration of system partition and signal timings coordination. On the other hand, we introduce variables x_i for the consideration of traffic demand. In the MULTIBAND model, each directional road section has an individually weighted bandwidth. A higher volume road links are more likely to obtain higher bandwidth. However, the bandwidth may still not be adequate for the actual demand, or the bandwidth could be so high that it is not fully utilized. In the PM-BAND, x_i denotes the necessary bandwidth, which is calculated based on traffic volumes and flow capacities. The necessary bandwidth is the minimum proportion of cycle length, which ensures that all the platooning passenger cars can pass through the section. Furthermore, the PM-BAND model provides each signal bandwidth b_i with at least x_i to ensure that the bandwidth is adequate to accommodate actual volume.

For transit vehicles, the progression bands have fixed bandwidth b' for a single vehicle rather than a platoon. Progression bands of passenger cars are partitioned at signals, while bands of transit vehicles are partitioned first at stations to avoid unnecessary stops at signals. Signal timings and waiting time of transit vehicles at stations are optimized simultaneously. The waiting time at each station includes normal dwell time a_i and extra waiting time Δa_i . Progression bands of transit vehicles can also be partitioned at signals to ensure there is always a feasible solution.

TABLE I
NOTATIONS OF KEY MODEL PARAMETERS AND VARIABLES

Symbol	Illustration
S_i	i th signal, $i = 1, 2, \dots, n$;
r_i (\bar{r}_i)	Outbound (inbound) red time at S_i (cycles);
C_1, C_2	Lower and upper limits on cycle length (s);
z	The inverse of cycle time (cycles/s);
d_i (\bar{d}_i)	Distance between S_i and S_{i+1} outbound or ? inbound (m);
L_i (\bar{L}_i)	Time allocated for outbound (inbound) left turn green at S_i (cycles);
O_i	Offset between S_i and S_{i+1} (cycles);
b_i (\bar{b}_i)	Outbound (inbound) passenger cars' bandwidth of the downstream link of S_i (cycles);
w_i (\bar{w}_i)	Time from right side of red at S_i to centerline of outbound (inbound) passenger cars' green band (cycles);
t_i (\bar{t}_i)	Passenger cars' travel time from S_i to S_{i+1} outbound (S_{i+1} to S_i inbound) (cycles);
e_i, f_i (\bar{e}_i, \bar{f}_i)	Lower and upper limits on outbound (inbound) speed of passenger cars (m/s);
g_i, h_i (\bar{g}_i, \bar{h}_i)	Lower and upper limits on change in outbound (inbound) speed of passenger cars (m/s);
p_i (\bar{p}_i)	A binary variable indicating the upstream link of S_i is the breakpoint of passenger cars' progression bands (1—partitioned, 0—unpartitioned);
u_i (\bar{u}_i)	Centerline of outbound (inbound) progression bands of passenger cars shifted time at S_i (cycles);
x_i (\bar{x}_i)	Necessary bandwidth of the downstream link of S_i outbound progression band of passenger cars (inbound) (cycles);
Q_{ij}	Traffic volume of j th approaching arm at S_i (1000veh/h);
γ_{ijk}	The ratio of k th movement volume to Q_{ij} ;
AI_i (\bar{AI}_i)	The ratio of traffic volume turn into the outbound (inbound) artery from the access between S_i and S_{i+1} ;
AO_i (\bar{AO}_i)	The ratio of traffic volume from the outbound (inbound) traffic turn out to the access between S_i and S_{i+1} ;
q_i^* (\bar{q}_i^*)	Outbound (inbound) straight-going volume at the adjacent upstream intersection of S_i among straight-going volume at S_i (1000veh/h);
ζ_i ($\bar{\zeta}_i$)	Correction factor for outbound (inbound) bandwidth of the downstream link of S_i ;
b' (\bar{b}')	Transit vehicles' bandwidth outbound (inbound) (cycles);
b'_{min}	Lower limits on transit vehicles' bandwidth (s);
w'_i (\bar{w}'_i)	Time from right side of red at S_i to centerline of outbound (inbound) transit vehicles' green band (cycles);
t'_i (\bar{t}'_i)	Transit vehicles' travel time from S_i to S_{i+1} outbound (S_{i+1} to S_i inbound) (cycles);
θ_i ($\bar{\theta}_i$)	A binary parameter indicating the existence of a transit vehicles station between S_i to S_{i+1} outbound (inbound) (1—exist, 0—does not exist);
a_i (\bar{a}_i)	Dwell-time for transit vehicles at the station between S_i to S_{i+1} outbound (inbound) (s);
Δa_i ($\bar{\Delta a}_i$)	Extra waiting time at station between S_i to S_{i+1} outbound (inbound) (cycles);
Δa_{max}	Upper limit on extra waiting time at station (cycles);
e'_i, f'_i (\bar{e}'_i, \bar{f}'_i)	Lower and upper limits on outbound (inbound) speed of transit vehicles (m/s);
g'_i, h'_i (\bar{g}'_i, \bar{h}'_i)	Lower and upper limits on change in outbound (inbound) speed of transit vehicles (m/s);
p'_i (\bar{p}'_i)	A binary variable indicating the upstream link of S_i is the breakpoint of transit vehicles' progression bands (1—partitioned, 0—unpartitioned);
u'_i (\bar{u}'_i)	Centerline of outbound (inbound) progression bands of transit vehicles shifted time at S_i (cycles).

IV. MODEL FORMULATION

A. Assumptions

- All the vehicles are willing to travel at a given speed along the artery.
- Waiting time of transit vehicles at stations, including normal dwell-time and extra waiting time, can be rigidly

controlled with current available connected vehicle technologies.

B. Objective Function

The objective function consists of six parts: maximizing the number of nonstop passenger cars, maximizing the weighted bandwidth of passenger cars, minimizing the platoon waiting time of passenger cars, minimizing the number of stops of transit vehicles, maximizing the bandwidth of transit vehicles, and minimizing the extra waiting time of transit vehicles at stations and delay caused by red light. The smaller the value of K_4 , K_5 , and K_6 relative to K_1 , K_2 , and K_3 , the greater the impact of passenger cars on transit. The formula is as follows:

$$\begin{aligned} & \text{Max} K_1 \sum_i [\zeta_i q_i^* (1 - p_i) + \bar{\zeta}_i \bar{q}_i^* (1 - \bar{p}_i)] \\ & + K_2 \sum_i [q_i^* b_i + \bar{q}_i^* \bar{b}_i] - K_3 \sum_i [q_i^* u_i + \bar{q}_i^* \bar{u}_i] \\ & - K_4 \sum_i (p_i' + \bar{p}_i') + K_5 b' - K_6 \sum_i (\Delta a_i + \Delta \bar{a}_i + u_i' + \bar{u}_i'), \\ & K_1 \gg K_2 \gg K_3, K_4 \gg K_5 \gg K_6. \quad (1) \end{aligned}$$

K_1 is the weight of number of nonstop passenger cars, which is the primary objective. K_2 is the weight of bandwidth, which is required in the constraints to be greater than the necessary bandwidth. We make it as large as possible to make the model more robust. K_3 is the weight of platoon waiting time when there is a breakpoint. This is equivalent to the coordination between subsystems. Following paragraphs explain the highest priority objective of passenger cars: maximizing the number of nonstop passenger cars.

First, the part of traffic, which is the object of signal coordination, has to be identified. As shown in Fig. 4, $Q_{i1}\gamma_{i11}$, the straight-going traffic volume along artery at S_i in the outbound direction, consists of two parts. The part q_i^* is a straight-going traffic volume along artery at S_{i-1} . The other is traffic volume turning into the artery from S_{i-1} or access between S_{i-1} and S_i . Signal coordination is mainly in order to let q_i^* , rather than the entire $Q_{i1}\gamma_{i11}$, goes through the intersection without stopping. To simplify the problem, the model assumes the turning flow, i.e. the volume in $Q_{i1}\gamma_{i11}$ except q_i^* , can drain into main platoon spontaneously after S_i . q_i^* (\bar{q}_i^*) is calculated as follows:

$$\left. \begin{aligned} Q_{i1} &= (Q_{i-1,1}\gamma_{i-1,1,1} + Q_{i-1,2}\gamma_{i-1,2,3} + Q_{i-1,4}\gamma_{i-1,4,2}) \\ &\quad \times (1 - A O_{i-1} + A I_{i-1}), i = 2, \dots, n. \\ Q_{i3} &= (Q_{i+1,3}\gamma_{i+1,3,1} + Q_{i+1,2}\gamma_{i+1,2,2} + Q_{i+1,4}\gamma_{i+1,4,3}) \\ &\quad \times (1 - A O_i + A I_i), i = 1, \dots, n - 1. \end{aligned} \right\} (2)$$

$$\left. \begin{aligned} q_i^* &= Q_{i-1,1}\gamma_{i-1,1,1}\gamma_{i11} (1 - A O_{i-1}), i = 2, \dots, n. \\ \bar{q}_i^* &= Q_{i+1,3}\gamma_{i+1,3,1}\gamma_{i31} (1 - A O_i), i = 1, \dots, n - 1. \\ q_1^* &= Q_{11}, \bar{q}_n^* = Q_{n3}. \end{aligned} \right\} (3)$$

If the outbound progression band is not partitioned at the upstream link of S_i , then $p_i = 0$, and traffic volume q_i^* passes through S_i without stopping. Therefore, the number of non-stopping passenger cars at S_i is $q_i^*(1 - p_i)$. On the contrary, if the progression band is partitioned, then the entire q_i^* will stop at S_i . Correction factor ζ_i ($\bar{\zeta}_i$) is to correct the effect of platoon dispersion caused by turning traffic and long travel distance.

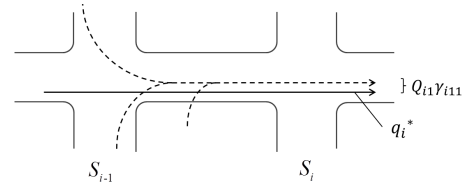

Fig. 4. Traffic volume composition.

C. Constraints

The constraints of the PM-BAND model are categorized into three: passenger cars constraints, transit vehicles constraints, and their mutual constraints.

1) *Passenger Cars Constraints*: Constraints (4)–(9) of the PM-BAND model are similar to those of the MAXBAND model. Constraint (4) is related to the position of progression bands that use only the available green time.

$$\left. \begin{aligned} b_i/2 &\leq w_i \leq 1 - r_i - b_i/2 \\ \bar{b}_i/2 &\leq \bar{w}_i \leq 1 - \bar{r}_i - \bar{b}_i/2 \end{aligned} \right\}, \quad i = 1, \dots, n. \quad (4)$$

$$b_i \geq 0, \bar{b}_i \geq 0, \quad i = 1, \dots, n. \quad (5)$$

Constraints (6) and (7) are limitations of the road link speed and the changes in speed, respectively. Constraint (8) ensures that the speeds of outbound and inbound traffic are the same between two adjacent intersections. When conditions permit, this constraint may be rendered unnecessary.

$$\left. \begin{aligned} (d_i/f_i)z &\leq t_i \leq (d_i/e_i)z \\ (\bar{d}_i/\bar{f}_i)z &\leq \bar{t}_i \leq (\bar{d}_i/\bar{e}_i)z \end{aligned} \right\}, \quad i = 1, \dots, n - 1. \quad (6)$$

$$\left. \begin{aligned} (d_i/h_i)z &\leq (d_i/d_{i+1})t_{i+1} - t_i \leq (d_i/g_i)z \\ (\bar{d}_i/\bar{h}_i)z &\leq (\bar{d}_i/\bar{d}_{i+1})\bar{t}_{i+1} - \bar{t}_i \leq (\bar{d}_i/\bar{g}_i)z \end{aligned} \right\}, \quad i = 1, \dots, n - 2. \quad (7)$$

$$\bar{d}_i \bar{t}_i = d_i t_i, \quad i = 1, \dots, n - 1. \quad (8)$$

Constraints (9) are the signal timing restraints of every two adjacent intersections. It should be noted that, for this proposed partition-enabled band, we add variables u_i unlike the MAXBAND model.

$$\begin{aligned} & (w_i - \bar{w}_i) - (w_{i+1} - \bar{w}_{i+1}) + (t_i + \bar{t}_i) + (u_{i+1} + \bar{u}_i) \\ & + \delta_i L_i - \bar{\delta}_i \bar{L}_i - \delta_{i+1} L_{i+1} + \bar{\delta}_{i+1} \bar{L}_{i+1} \\ & = -(r_i - \bar{r}_i) + (r_{i+1} - \bar{r}_{i+1}) + m1_i, i = 1, \dots, n - 1; \end{aligned} \quad (9)$$

$m1_i$ integer; $\delta_i, \bar{\delta}_i$ zero/one variable.

Constraints (10)–(11) are related to decision variables u_i and p_i . u_i is the centerline of outbound shifted time at intersection S_i , i.e., the platoon waiting time when the progression band is partitioned. If $u_i > 0$, the progression band is partitioned at the upstream link of S_i and $p_i = 1$. Otherwise, $u_i = 0$, then $p_i = 0$. If the outbound progression band is not partitioned at the upstream link of S_{i+1} , then $p_{i+1} = 0$ and according to the constraint (11) $b_{i+1} = b_i$. This implies that the upstream link and downstream link of S_{i+1} have the same bandwidth. On the contrary, if the progression band is partitioned, then the upstream link and downstream link of S_{i+1} may have different

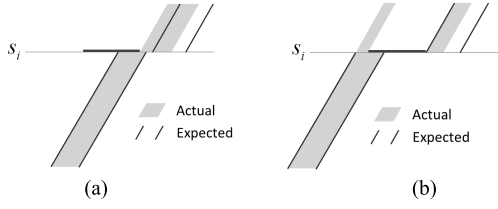

Fig. 5. Progression bands of two situations that should be avoided. (a) Situation A. (b) Situation B.

bandwidths.

$$\left. \begin{aligned} \varepsilon p_i &\leq u_i \leq p_i \\ \varepsilon \bar{p}_i &\leq \bar{u}_i \leq \bar{p}_i \end{aligned} \right\}, \quad i = 1, \dots, n. \quad (10)$$

$$\left. \begin{aligned} -\varepsilon p_{i+1} &\leq b_{i+1} - b_i \leq \varepsilon p_{i+1} \\ -\varepsilon \bar{p}_i &\leq \bar{b}_{i+1} - \bar{b}_i \leq \varepsilon \bar{p}_i \end{aligned} \right\}, \quad i = 1, \dots, n-1. \quad (11)$$

p_i, \bar{p}_i zero/one variables; ε is a very small positive number, and ε is a large positive number.

Constraints (12) and (13) are to ensure the effectiveness of the progression band, i.e., the actual utilization of the progression bands by the platoon. As Fig. 5 illustrates, in situation A, the platoon would leave S_i exactly when the traffic light is green while the solution band begins after a period of time. If the progression band is partitioned at the upstream link of S_i , then $p_i = 1$ and $w_i = 0.5b_i$ according to constraints (4) and (12). This implies that the progression band would begin exactly when the traffic light is green. In situation B, progression band is partitioned at S_i , while a few passenger cars do not leave S_i in the new started progression band. Constraint (13) requires that the first passenger car in the platoon arrive at S_i during red time when there is a breakpoint.

$$\left. \begin{aligned} w_i &\leq b_i/2 + 1 - p_i \\ \bar{w}_i &\leq \bar{b}_i/2 + 1 - \bar{p}_i \end{aligned} \right\}, \quad i = 1, \dots, n. \quad (12)$$

$$\left. \begin{aligned} w_{i+1} + r_{i+1} - u_{i+1} &\geq b_i/2 \\ \bar{w}_i + \bar{r}_i - \bar{u}_i &\geq \bar{b}_{i+1}/2 \end{aligned} \right\}, \quad i = 1, \dots, n-1. \quad (13)$$

As mentioned above, the PM-BAND model provides each signal bandwidth b_i with a bandwidth equal to or more than the necessary bandwidth x_i in order to ensure that it is adequate to satisfy the actual volume, the formulation is given by (14).

$$\left. \begin{aligned} b_i &\geq x_i \\ \bar{b}_i &\geq \bar{x}_i \end{aligned} \right\}, \quad i = 1, \dots, n. \quad (14)$$

2) *Transit Vehicles Constraints*: Constraints (15)–(24) are related to transit vehicles.

Constraint (15) requires that the transit vehicles' bandwidth is higher than the lower limit b'_{min} . b'_{min} is determined by the permitted fluctuations in transit travel time. Constraint (16) ensures that the bandwidths of the outbound and inbound transit vehicles are equal. In most cases, the difference in this value of the transit vehicles moving in either direction is insignificant.

$$b' \geq b'_{min}z. \quad (15)$$

$$b' = \bar{b}'. \quad (16)$$

Constraint (17) is related to the position of transit vehicles progression bands. Constraints (18) are the signal timing restraints of every two adjacent intersections.

$$\left. \begin{aligned} b'/2 &\leq w'_i \leq 1 - r_i - b'/2 \\ \bar{b}'/2 &\leq \bar{w}'_i \leq 1 - \bar{r}_i - \bar{b}'/2 \end{aligned} \right\}, \quad i = 1, \dots, n. \quad (17)$$

$$\begin{aligned} (w'_i - \bar{w}'_i) - (w'_{i+1} - \bar{w}'_{i+1}) + (t'_i + \bar{t}'_i) + (u'_{i+1} - \bar{u}'_i) \\ + \delta_i L_i - \bar{\delta}_i \bar{L}_i - \delta_{i+1} L_{i+1} + \bar{\delta}_{i+1} \bar{L}_{i+1} \\ = -(r_i - \bar{r}_i) + (r_{i+1} - \bar{r}_{i+1}) + m2_i, \quad i = 1, \dots, n-1. \end{aligned} \quad (18)$$

$m2_i$ integer.

Constraints (19) and (20) are limitations of the transit vehicles link speed and the changes in speed, respectively. It should be noted that the travel time t'_i of transit vehicles includes dwell-time a_i and extra waiting time Δa_i at stations. Variables Δa_i transfer the extra waiting time from signals to stations and thus reduce the number of stops. The extra waiting time should not be excessively large, and therefore, there is an upper limit Δa_{max} as provided by constraint (21). If there is no transit station between S_i and S_{i+1} in the outbound direction, i.e., $\theta_i = 0$, then, there is no extra waiting time and $\Delta a_i = 0$.

$$\left. \begin{aligned} (d_i/f'_i)z &\leq t'_i - \theta_i a_i z - \Delta a_i \leq (d_i/e'_i)z \\ (\bar{d}_i/\bar{f}'_i)z &\leq \bar{t}'_i - \bar{\theta}_i \bar{a}_i z - \Delta \bar{a}_i \leq (\bar{d}_i/\bar{e}'_i)z \end{aligned} \right\}, \quad i = 1, \dots, n-1. \quad (19)$$

$$\left. \begin{aligned} (d_i/h'_i)z &\leq (d_i/d_{i+1})(t'_{i+1} - \theta_{i+1} a_{i+1} z - \Delta a_{i+1}) \\ &\quad - (t'_i - \theta_i a_i z - \Delta a_i) \leq (d_i/g'_i)z \\ (\bar{d}_i/\bar{h}'_i)z &\leq (\bar{d}_i/\bar{d}_{i+1})(\bar{t}'_{i+1} - \bar{\theta}_{i+1} \bar{a}_{i+1} z - \Delta \bar{a}_{i+1}) \\ &\quad - (\bar{t}'_i - \bar{\theta}_i \bar{a}_i z - \Delta \bar{a}_i) \leq (\bar{d}_i/\bar{g}'_i)z \end{aligned} \right\}, \quad i = 1, \dots, n-2. \quad (20)$$

$$\left. \begin{aligned} 0 &\leq \Delta a_i \leq \theta_i \Delta a_{max} \\ 0 &\leq \Delta \bar{a}_i \leq \bar{\theta}_i \Delta a_{max} \end{aligned} \right\}, \quad i = 1, \dots, n-1. \quad (21)$$

Because the waiting time at stations of transit vehicles can be rigidly controlled, we usually partition the progression bands at stations to transfer delay at intersections to stations and avoid unnecessary stops. However, if there is no feasible solution when only partition at stations, it also need to be partitioned at signals. Similar to the constraints for passenger cars, constraints (22)–(24) are for the partition of transit vehicles progression bands at signals.

$$\left. \begin{aligned} \varepsilon p'_i &\leq u'_i \leq p'_i \\ \varepsilon \bar{p}'_i &\leq \bar{u}'_i \leq \bar{p}'_i \end{aligned} \right\}, \quad i = 1, \dots, n; \quad p'_i, \bar{p}'_i \text{ zero/one variable.} \quad (22)$$

$$\left. \begin{aligned} w'_i &\leq b'/2 + 1 - p'_i \\ \bar{w}'_i &\leq \bar{b}'/2 + 1 - \bar{p}'_i \end{aligned} \right\}, \quad i = 1, \dots, n. \quad (23)$$

$$\left. \begin{aligned} w'_{i+1} + r_{i+1} - u'_{i+1} &\geq b'/2 \\ \bar{w}'_i + \bar{r}_i - \bar{u}'_i &\geq \bar{b}'/2 \end{aligned} \right\}, \quad i = 1, \dots, n-1. \quad (24)$$

3) *Mutual Constraints*: Constraint (25) is a limitation on cycle length. O_i is the offset between S_i and S_{i+1} . Constraints (26)–(27) ensure that the passenger cars progression bands and transit vehicle progression bands have identical

offsets.

$$1/C_2 \leq z \leq 1/C_1. \quad (25)$$

$$O_i = w_i + t_i - w_{i+1} + u_{i+1}, i = 1, \dots, n-1. \quad (26)$$

$$\begin{aligned} & w_i + t_i - w_{i+1} + u_{i+1} \\ & = w'_i + t'_i - w'_{i+1} - m3_i, i = 1, \dots, n-1; m3_i \text{ integer.} \end{aligned} \quad (27)$$

D. Solution

The PM-BAND model is formulated as a mixed-integer linear programming and is solved by the standard branch-and-bound technique. Many software, such as LINGO and CPLEX, has the default solver to solve MILP problem, usually branch-and-bound. And a customized design is not necessarily required. In addition to the optimization variables including cycle length, offsets, progression speeds, and order of left turn phases (as in MAXBAND or MULTIBAND model), the PM-BAND model can also determine a global optimal solution and calculate location of breakpoints, platoon waiting time when partitioned, and extra waiting time at stations of transit vehicles. Although the PM-BAND substantially increases the number of variables and constraints compared with the MAXBAND or MULTIBAND, this causes no computational difficulty with present computers.

V. NUMERICAL EXAMPLE

A. Site Description

Huaide road (Fig. 6), an artery with eight two-way lanes including two BRT exclusive lanes, is in the Changzhou, China. We selected a 5.2 km segment with 16 signalized intersections as the coordination objects (Some approaches of specific intersections adopt protected left-turn phase). BRT line 2 passes this artery and there are seven BRT stations in each direction. The distance between every two adjacent intersections and red time are shown in Table II. And we listed q_i^* and \bar{q}_i^* in Table II which are calculated by the input traffic demand variables.

B. PM-BAND Model Results

According to field road conditions, the values of the parameters are as follows: $C_1 = 90$ s, $C_2 = 110$ s; $e_i(\bar{e}_i) = 11.5$ m/s, $f_i(\bar{f}_i) = 13.5$ m/s, $g_i(\bar{g}_i) = -\infty$, $h_i(\bar{h}_i) = +\infty$; $e'_i(\bar{e}'_i) = 11.5$ m/s, $f'_i(\bar{f}'_i) = 13.5$ m/s, $g'_i(\bar{g}'_i) = -\infty$, $h'_i(\bar{h}'_i) = +\infty$; $a_i(\bar{a}_i) = 18$ s, $\Delta a_i(\Delta \bar{a}_i) = 0$; $b'_{min} = 8$ s. $h_i(\bar{h}_i) = +\infty$; $a_i(\bar{a}_i) = 18$ s, $\Delta a_i(\Delta \bar{a}_i) = 0$; $b'_{min} = 8$ s.

The results of signal coordination in the PM-BAND model considering both passenger cars and transit vehicles are illustrated as Fig. 7, and those considering passenger cars only in Fig. 8. In Fig. 7, both outbound and inbound passenger cars progression band is partitioned into four parts. The optimal cycle length is 101 s. Passenger cars progression band speed is 11.5 m/s, and transit vehicles progression band speed is 12 m/s without extra waiting time at any stations or signals. The bus frequency is not higher than one vehicle per cycle, so every progression band is served for only one transit vehicle. In Fig. 8, outbound progression band is partitioned into three parts and the inbound one into two parts. The

TABLE II
BASIC DATA OF HUAIDE ROAD

	$d_i(\bar{d}_i)$	$r_i(\bar{r}_i)$	q_i^*	\bar{q}_i^*
S1	253	0.51	0.800	0.786
S2	441	0.49	0.525	0.927
S3	218	0.27	0.525	1.106
S4	345	0.56	0.609	0.753
S5	463	0.72	0.383	0.829
S6	208	0.28	0.436	1.115
S7	521	0.49	0.601	1.115
S8	312	0.28	0.601	1.023
S9	343	0.57	0.559	0.845
S10	279	0.48	0.522	0.611
S11	391	0.57	0.769	0.545
S12	492	0.27	0.782	0.428
S13	502	0.56	0.418	0.317
S14	236	0.61	0.326	0.675
S15	221	0.27	0.706	0.690
S16		0.70	0.836	0.690



Fig. 6. Huaide road in Chinese city Changzhou.

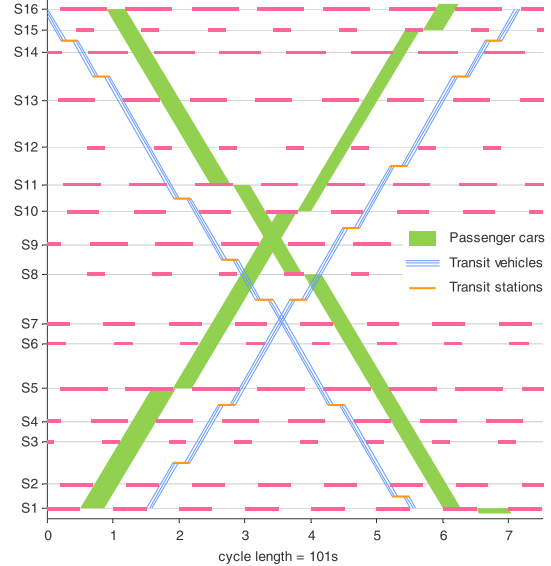

Fig. 7. Time-space diagram of PM-BAND result considering both passenger cars and transit vehicles.

optimal cycle length is 110 s. Passenger cars progression band speed is 13.5 m/s.

When considering both passenger cars and transit vehicles, results showed more number of partitioned subsystems for progression band of passenger cars in Fig. 7. This, in turn, it demonstrates that the partition technique is necessary when solving multi-mode progression band problem with multiple signals. Furthermore, the breakpoint location for passenger cars progression band is very different between Fig. 7 and

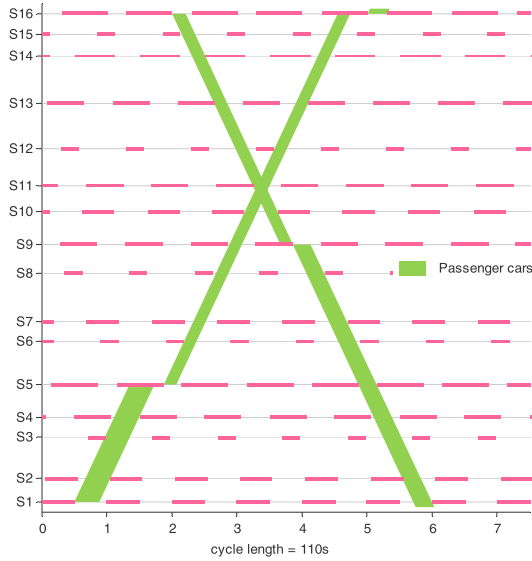

Fig. 8. Time-space diagram of PM-BAND result considering only passenger cars.

Fig. 8. This proves that using the same partition standard in different situations is not appropriate and that it is necessary to integrate system partition and signal timings coordination.

LINGO is used to generate the optimal signal coordination plans using PM-BAND model. A desk computer is used. It has an Intel i-5 CPU, 4 GB RAM and runs a 64-bit Windows 7 operating system. For this MILP model, it is able to obtain the optimal solution in less than two minutes.

C. Performance Evaluation

To evaluate the performance of the PM-BAND model, we compared it with the basic MAXBAND model, basic MULTIBAND model, partitioned MAXBAND model, and partitioned MULTIBAND model. As the first step in both partitioned MAXBAND model and MULTIBAND model, use partition technique to divide the entire signalized arterial into several subsystems. Then, use basic MAXBAND and MULTIBAND model to optimize bandwidth for each subsystem. Finally, adjust offsets between subsystems. According to coupling index (CI) [17], we have partition results: S1-S5/S6-S7/S8-S12/S13/S14-S16.

Each signal setting scheme was simulated using VISSIM, a program which performs a microscopic simulation of traffic flow in a signalized network. The traffic demand is shown in Table II, and simulation network is as Fig. 6. The simulation duration is one hour. We extracted all the trajectory points in the artery of each vehicle, and then calculate four indexes, i.e. average number of stops, average delay, band coverage, and drop-out rate, to assess the performance of each model. The calculation methods of average number of stops and delay are as follows:

$$\text{Average Number of Stops} = \sum_m \text{Stop}_m / \sum_m TD_m \quad (28)$$

$$\text{Average Delay} = \sum_m \text{Delay}_m / \sum_m TD_m \quad (29)$$

Stop_m is the number of stops in the artery of vehicle m , and Delay_m is total delay in the artery of vehicle m . Vehicles have different routes and different travel distance. TD_m represents

the travel distance in the artery of vehicle m and the unit is kilometer. The other two indexes (band coverage and drop-out rate) are elaborated later.

1) *Results of Considering Passenger Cars and Transit Vehicles:* Arterial signal optimization results of the partitioned MAXBAND model and the partitioned MULTIBAND model when considering both passenger cars and transit vehicles are illustrated on the time-space diagram as Fig. 9. Simulation results are summarized in Table III. As the results show, the basic MAXBAND model and the basic MULTIBAND model yielded no feasible solution. The PM-BAND model has the fewest average number of stops and least average delay compared with the partitioned MAXBAND model and the partitioned MULTIBAND model. Compared to the PM-BAND model, the average number of stops the partitioned MULTIBAND model by 9%.

2) *Results of Considering Only Passenger Cars:* In the most practical situations, only passenger cars, rather than both passenger cars and transit vehicles, need to be taken into account. Therefore, we also evaluated the PM-BAND model taking only passenger cars into consideration.

Arterial signal optimization results of the four compared models without taking into consideration transit vehicles are illustrated on the time-space diagram as Fig. 10, and VISSIM simulation results are summarized in Table IV. For both MAXBAND and MULTIBAND models, the application of partition technique here reduced average number of stops and delay. Moreover, PM-BAND performs better than any of the four compared models. Compared to PM-BAND model, the average number of stops of basic MAXBAND model, basic MULTIBAND model, partitioned MAXBAND model, and partitioned MULTIBAND model is higher by 42%, 15%, 20%, and 13%, respectively.

3) *Two New Proposed Performance Indexes:* We proposed two performance indexes—band coverage and drop-out rate, which are presented in Table III and Table IV. These two indexes are used to evaluate the effectiveness and reliability of passenger cars progression band. Band coverage is the proportion of trajectory points covered by progression bands among all the trajectory points in the artery. Usually the wider the bandwidth, the greater the value of band coverage is and more effective progression bands are. Drop-out rate is the proportion of vehicles that drop out from the progression bands among all the vehicles that enter the progression bands. The smaller the value of drop-out rate is, the more smoothly vehicles follow the progression bands and more reliable progression bands are.

We extracted trajectory points of all the passenger cars traveling in the artery from the VISSIM simulation road network. Then, the two performance indexes were calculated, i.e., band coverage and drop-out rate. The calculation results are listed in Table III and Table IV. When considering passenger cars and transit vehicles, band coverage in basic MAXBAND and MULTIBAND models is very low while it is significantly improved in partitioned MAXBAND and MULTIBAND models. Partition technique produces the improved results in this case. Moreover, under all conditions, both band coverage and drop-out rate of the PM-BAND perform better than those in other models. The drop-out rate of PM-BAND model is

TABLE III
VISSIM SIMULATION RESULTS OF CONSIDERING BOTH
PASSENGER CARS AND TRANSIT VEHICLES

	Average number of stops	Average delay (s/veh/km)	Band coverage	Drop-out rate
PM-BAND	1.14	49.09	65.01%	20.62%
Basic MAXBAND	*	*	*	*
Partitioned MAXBAND	1.31(+15%)	52.67(+6%)	42.11%	53.17%
Basic MULTIBAND	*	*	*	*
Partitioned MULTIBAND	1.24(+9%)	51.18(+3%)	20.72%	52.05%

* no feasible solution

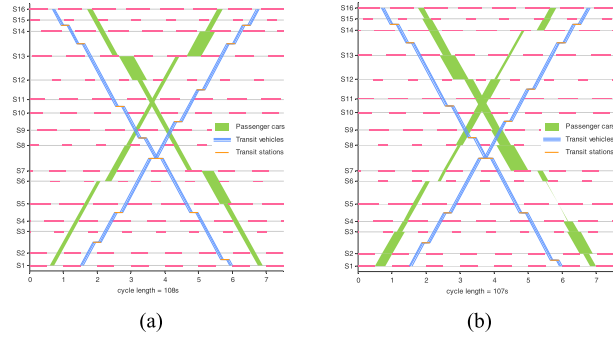

Fig. 9. Results of time-space diagram considering both passenger cars and transit vehicles. (a) Partitioned MAXBAND. (b) Partitioned MULTIBAND.

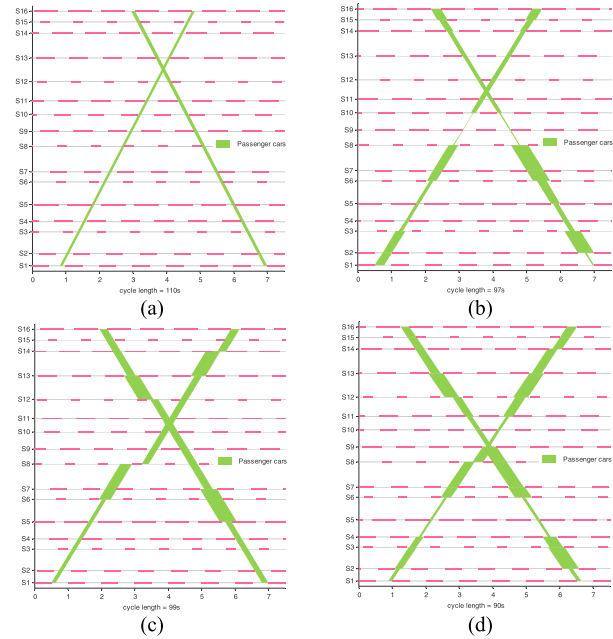

Fig. 10. Results of time-space diagram considering only passenger cars and transit vehicles. (a) Basic MAXBAND. (b) Basic MULTIBAND. (c) Partitioned MAXBAND. (d) Partitioned MULTIBAND.

20.62% when considering both passenger cars and transit vehicles and is only 12.88% when considering passenger cars only. This demonstrates that the solving progression bands of PM-BAND model have a high reliability, and once the passenger cars enter the progression band, they can conveniently follow the progression band until they leave the artery.

TABLE IV
VISSIM SIMULATION RESULTS OF CONSIDERING
ONLY PASSENGER CARS

	Average number of stops	Average delay (s/veh/km)	Band coverage	Drop-out rate
PM-BAND	0.93	35.02	61.96%	12.88%
Basic MAXBAND	1.32(+42%)	51.38(+47%)	20.07%	43.78%
Partitioned MAXBAND	1.12(+20%)	44.99(+28%)	55.09%	42.39%
Basic MULTIBAND	1.07(+15%)	42.38(+21%)	14.55%	49.90%
Partitioned MULTIBAND	1.05(+13%)	39.87(+14%)	52.30%	50.40%

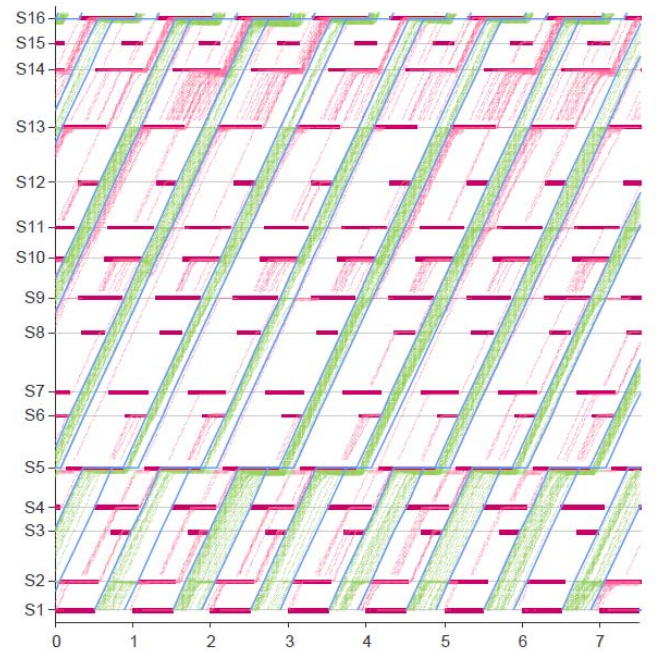

Fig. 11. PM-BAND model—outbound trajectory points.

To visually demonstrate the meaning of the proposed two performance indexes—band coverage and drop-out rate, we draw trajectory points on the time-space diagram. Because of the limitation set by this manuscript's page size, only the results of the outbound direction based on PM-BAND, basic MAXBAND, and partitioned MULTIBAND models, which only considers passenger cars, are showed in Fig. 11, Fig. 12 and Fig. 13, respectively. The boundary of progression bands are colored blue, the trajectory points inside progression bands are colored green, and the trajectory points outside progression bands are colored red. Furthermore, band coverage is the proportion of green trajectory points among all trajectory points.

In the PM-BAND model, as shown in Fig. 11, most of the trajectory points are inside progression bands, and once the passenger cars enter a progression band, they can conveniently follow the progression band until they leave the artery. In basic MAXBAND model, as shown in Fig. 12, the progression band is too narrow to adapt to actual traffic demand. The

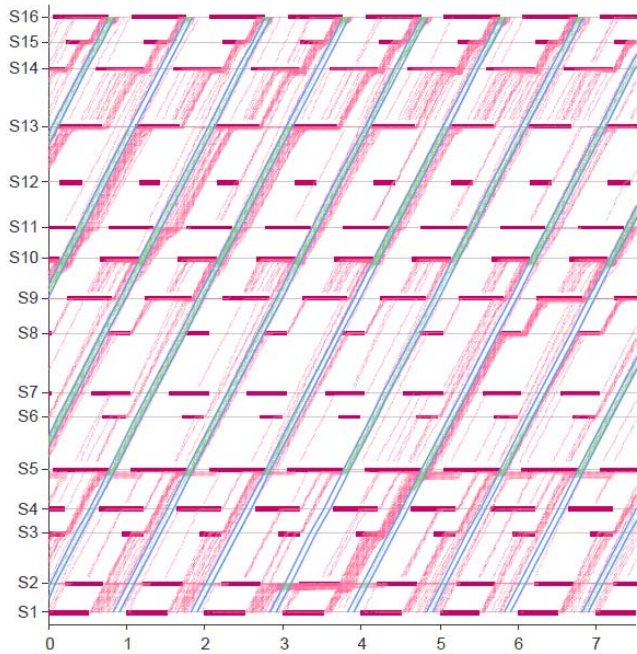

Fig. 12. Basic MAXBAND model—outbound trajectory points.

trajectory points of only a small number of vehicles are inside progression bands. Moreover, the passenger cars inside the progression bands have a high tendency to drop out from the progression bands. As shown in Fig. 13, the partitioned MULTIBAND model provides different bandwidths to each road link. However, the platoon cannot contract and expand in tandem with the different bandwidths. Thus, the bandwidth of a few road links cannot be fully utilized by passenger cars, and a few others are too small to adapt traffic volume.

4) *Sensitivity Analysis*: The sensitivity analysis is to assess the performance of PM-BAND model under different traffic demand scenarios. We compare the PM-BAND with the Partitioned MULTIBAND model, which perform the best in the four compared models. Based on the volume in Table II, five traffic scenarios are added, which are 0.2, 0.5, 0.8, 1.2 and 1.5 times of the volume respectively (corresponding to the different values of the parameters μ). When $\mu = 1.5$, some intersections just reach the saturation state. Simulation results are shown in Table V. The values outside the brackets are the results of the PM-BAND, and the values in the brackets are the changes in the PM-BAND relative to the Partitioned MULTIBAND model.

The results show that the performance of the PM-BAND is far better than the Partitioned MULTIBAND in low demand. However, when the demand is high, due to the random fluctuations of the volume, some cycles are oversaturated, which will greatly increase stops and delay. Hence, when the demand is high, the performance of the PM-BAND is slightly worse than the Partitioned MULTIBAND, while the indicator Drop-out rate of the PM-BAND always perform very well.

VI. CONCLUSIONS AND DISCUSSIONS

A partition-enabled multi-mode band (PM-BAND) model for arterial traffic signal coordination has been presented in

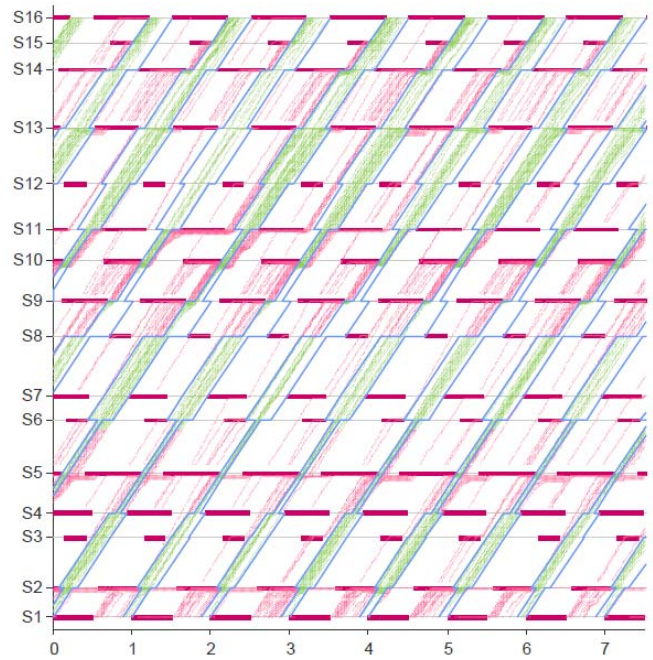

Fig. 13. Partitioned MULTIBAND model—outbound trajectory points.

TABLE V
VISSIM SIMULATION RESULTS OF PM-BAND MODEL COMPARED WITH PARTITIONED MULTIBAND MODEL

	Average number of stops	Average delay (s/veh/km)	Band coverage	Drop-out rate
$\mu=0.2$	0.77(-25%)	21.34(-37%)	55.89%(+19%)	11.54%(-75%)
$\mu=0.5$	0.81(-17%)	27.02(-24%)	46.13%(-10%)	9.24%(-79%)
$\mu=0.8$	0.90(-11%)	28.75(-22%)	61.38%(+14%)	15.39%(-66%)
$\mu=1$	0.93(-11%)	35.02(-12%)	61.96%(+19%)	12.88%(-74%)
$\mu=1.2$	1.14(-2%)	43.92(-1%)	66.44%(+26%)	20.49%(-56%)
$\mu=1.5$	1.78(+5%)	71.4(+3%)	58.06%(+29%)	28.3%(-44%)

this paper. The model solves the problem through the partition approach when it is difficult to achieve realistic progression bands. The PM-BAND model is formulated as a mixed-integer linear program and can be solved using the standard branch-and-bound technique. The main improvements of PM-BAND model are as follows:

- System partition and signal coordination of two traffic modes, i.e., passenger cars and transit vehicles, have been considered in one unified framework.
- The model adapts better to the field traffic demand.
- Signal timings and waiting time of transit vehicles at stations are optimized simultaneously.

Numerical analyses are conducted to evaluate the performance of the proposed PM-BAND model by comparing it to the basic MAXBAND, basic MULTIBAND, partitioned MAXBAND, and partitioned MULTIBAND models. VISSIM simulation results demonstrated that PM-BAND model can significantly reduce average number of stops and delay when compared with the other models. Furthermore, we proposed two performance indexes: band coverage and drop-out rate to evaluate the effectiveness and reliability of progression bands. The results

demonstrate that calculating progression bands by the PM-BAND model have high reliability and vehicles can effectively utilize the progression bands.

The PM-BAND model focused on offline control problem in the artery. The fluctuations of traffic demand have an adverse effect on controller. Therefore, when there is an obvious fluctuation in traffic demand, a reactive strategy would be preferred. Moreover, this model is built under under-saturated traffic, no feasible solution might be provided when under over-saturated traffic. The extension of the proposed model to actuated control is expected. Other concerns such as over-saturated conditions can also be included.

REFERENCES

- [1] J. D. C. Little, M. D. Kelson, and N. H. Gartner, "MAXBAND: A program for setting signals on arteries and triangular networks," *Transp. Res. Rec.*, vol. 795, pp. 40–46, 1981.
- [2] N. H. Gartner, S. F. Assman, F. Lasaga, and D. L. Hou, "A multi-band approach to arterial traffic signal optimization," *Transp. Res. B, Methodol.*, vol. 25, no. 1, pp. 55–74, 1991.
- [3] C. J. Messer, R. H. Whitson, C. L. Dudek, and E. J. Romano, "A variable sequence multiphase progression optimization program," *Highway Res. Rec.*, vol. 445, pp. 24–33, 1973.
- [4] C. E. Wallace, K. G. Courage, D. P. Reaves, G. W. Schoene, and G. W. Euler, "TRANSYT-7F user's manual," Fed. Highway Admin., Washington, DC, USA, Tech. Rep., 1984.
- [5] E. B. Lieberman, J. Lai, and R. E. Ellington, "SIGOP-III user's manual," Fed. Highway Admin., Washington, DC, USA, Tech. Rep., 1983.
- [6] P. B. Hunt, D. I. Robertson, R. D. Bretherton, and M. C. Royle, "The SCOOT on-line traffic signal optimisation technique," *Traffic Eng. Control*, vol. 23, no. 4, pp. 190–192, 1982.
- [7] V. Mauro and C. Di Taranto, "UTOPIA," in *Control, Computers, Communications in Transportation*. New York, NY, USA: Pergamon Press, 1990, pp. 245–252.
- [8] J. T. Morgan and J. D. C. Little, "Synchronizing traffic signals for maximal bandwidth," *Oper. Res.*, vol. 12, no. 6, pp. 896–912, 1964.
- [9] E. C.-P. Chang, S. L. Cohen, C. Liu, N. A. Chaudhary, and C. Messer, "MAXBAND-86: Program for optimizing left-turn phase sequence in multiarterial closed networks," *Transp. Res. Rec.*, vol. 1181, pp. 61–67, 1988.
- [10] N. H. Gartner and C. Stamatidis, "Arterial-based control of traffic flow in urban grid networks," *Math. Comput. Model.*, vol. 35, nos. 5–6, pp. 657–671, 2002.
- [11] H.-S. Tsay and L.-T. Lin, "New algorithm for solving the maximum progression bandwidth," *Transp. Res. Rec.*, vol. 1194, pp. 15–31, 1988.
- [12] L.-T. Lin, L.-W. Tung, and H.-C. Ku, "Synchronized signal control model for maximizing progression along an arterial," *J. Transp. Eng.*, vol. 136, no. 8, pp. 727–735, 2010.
- [13] C. Zhang, Y. Xie, N. H. Gartner, C. Stamatidis, and T. Arsava, "AM-band: An asymmetrical multi-band model for arterial traffic signal coordination," *Transp. Res. C, Emerg. Technol.*, vol. 58, pp. 515–531, Sep. 2015.
- [14] X. Yang, Y. Cheng, and G.-L. Chang, "A multi-path progression model for synchronization of arterial traffic signals," *Transp. Res. C, Emerg. Technol.*, vol. 53, pp. 93–111, Apr. 2015.
- [15] *Synchro Studio 7 User Guide*, Trafficware, Sugar Land, TX, USA, 2006.
- [16] Z. Tian and T. Urbanik, "System partition technique to improve signal coordination and traffic progression," *J. Transp. Eng.*, vol. 133, no. 2, pp. 119–128, 2007.
- [17] W. Fan and Z. Tian, "Arterial signal timing and coordination: Sensitivity analyses and partition techniques," in *Proc. 7th Int. Conf. Traffic Transp. Stud.*, 2010, pp. 338–350.
- [18] Q. He, K. L. Head, and J. Ding, "Multi-modal traffic signal control with priority, signal actuation and coordination," *Transp. Res. C, Emerg. Technol.*, vol. 46, pp. 65–82, Sep. 2014.
- [19] W. Ma, K. L. Head, and Y. Feng, "Integrated optimization of transit priority operation at isolated intersections: A person-capacity-based approach," *Transp. Res. C, Emerg. Technol.*, vol. 40, pp. 49–62, Mar. 2014.
- [20] J. Hu, B. B. Park, and Y.-J. Lee, "Coordinated transit signal priority supporting transit progression under connected vehicle technology," *Transp. Res. C, Emerg. Technol.*, vol. 55, pp. 393–408, Jun. 2015.
- [21] E. Christofa, K. Ampountolas, and A. Skabardonis, "Arterial traffic signal optimization: A person-based approach," *Transp. Res. C, Emerg. Technol.*, vol. 66, pp. 27–47, May 2016.
- [22] Y. Jeong and Y. Kim, "Tram passive signal priority strategy based on the MAXBAND model," *KSCE J. Civil Eng.*, vol. 18, no. 5, pp. 1518–1527, 2014.
- [23] G. Dai, H. Wang, and W. Wang, "Signal optimization and coordination for bus progression based on MAXBAND," *KSCE J. Civil Eng.*, vol. 20, no. 2, pp. 890–898, 2016.



Wanjing Ma received the B.S. degree in civil engineering from Chang'an University, China, in 2001, and the M.S. and Ph.D. degrees in transportation engineering from Tongji University, China, in 2004 and 2007, respectively.

He is currently a Professor and the Associate Dean with the College of Transportation Engineering, Tongji University. His research interests include traffic operation and control, connected vehicles, and shared mobility.



Li Zou received the B.S. degree in transportation engineering from Tongji University, Shanghai, China, in 2015. She is currently pursuing the M.S. degree in traffic information engineering and control. Her research interests include traffic signal coordination and bus priority control.



Kun An received the B.S. degree in transport engineering from Tongji University, Shanghai, China, and the Ph.D. degree in civil engineering from The Hong Kong University of Science and Technology, Hong Kong.

She is currently a Lecturer with the Department of Civil Engineering, Monash University. Her research interests include reliable transit network design with stochastic demand, logistics management, supply chain network design, and traffic operation and control.



Nathan H. Gartner received the B.S. and M.S. degrees in engineering and the Sc.D. degree in transportation engineering and operations research from Israel Institute of Technology, Israel.

He is currently a Professor Emeritus with the Department of Civil and Environmental Engineering, University of Massachusetts Lowell, Lowell, MA, USA. He was a Visiting Professor with Università di Napoli, Italy; Universities of Kyoto, Nagoya and Tokyo, (Japan); Institut National de Recherche sur les Transports et leur Sécurité (INRETS), France; German Air and Space Center (DLR), Germany; and Tongji University, China. His research interests include intelligent transportation systems, traffic control strategies, optimization and simulation methods, and project evaluation methods.



Meng Wang received the M.Sc. degree in transportation engineering from Research Institute of Highway, China, and the Ph.D. degree in transport and planning from Delft University of Technology, The Netherlands, in 2006 and 2014, respectively. From 2014 to 2015, he was a Post-Doctoral Researcher with the Department of BioMechanical Engineering, Delft University of Technology.

Since 2015, he has been an Assistant Professor with the Department of Transport and Planning, Delft University of Technology. His main research interests include driving behavior modeling, traffic flow, and control approaches for cooperative driving systems.