



Delft University of Technology

## Weaving Textile-form Interfaces

### A Material-Driven Design Journey

Buso, Alice; McQuillan, Holly; Voorwinden, Milou; Karana, Elvin

#### DOI

[10.1145/3563657.3596086](https://doi.org/10.1145/3563657.3596086)

#### Publication date

2023

#### Document Version

Final published version

#### Published in

DIS '23: Proceedings of the 2023 ACM Designing Interactive Systems Conference

#### Citation (APA)

Buso, A., McQuillan, H., Voorwinden, M., & Karana, E. (2023). Weaving Textile-form Interfaces: A Material-Driven Design Journey. In *DIS '23: Proceedings of the 2023 ACM Designing Interactive Systems Conference* Association for Computing Machinery (ACM). <https://doi.org/10.1145/3563657.3596086>

#### Important note

To cite this publication, please use the final published version (if applicable). Please check the document version above.

#### Copyright

Other than for strictly personal use, it is not permitted to download, forward or distribute the text or part of it, without the consent of the author(s) and/or copyright holder(s), unless the work is under an open content license such as Creative Commons.

#### Takedown policy

Please contact us and provide details if you believe this document breaches copyrights. We will remove access to the work immediately and investigate your claim.

***Green Open Access added to TU Delft Institutional Repository***

***'You share, we take care!' - Taverne project***

**<https://www.openaccess.nl/en/you-share-we-take-care>**

Otherwise as indicated in the copyright section: the publisher is the copyright holder of this work and the author uses the Dutch legislation to make this work public.



# Weaving Textile-form Interfaces: A Material-Driven Design Journey

## Alice Buso

Industrial Design Engineering, TU Delft  
Delft, the Netherlands  
a.buso@tudelft.nl

## Holly McQuillan

Industrial Design Engineering, TU Delft  
Delft, the Netherlands  
h.l.mcquillan@tudelft.nl

## Milou Voorwinden

Industrial Design Engineering, TU Delft  
Delft, the Netherlands  
m.voorwinden@tudelft.nl

## Elvin Karana

Industrial Design Engineering, TU Delft  
Delft, the Netherlands  
CARADT, Avans University of Applied Sciences  
Breda, the Netherlands  
e.karana@tudelft.nl

## ABSTRACT

A woven textile-form is a form that is constructed simultaneously as the textile is woven. Interfaces designed with this approach hold undisclosed potential for rich interactions. However, the design of woven textile-form interfaces requires specialised tacit knowledge, which is limited even in craft and practice spaces; and it is therefore inaccessible to HCI designers. To bridge this gap, we present the material-driven journey of a multidisciplinary team to design a woven textile-form interface using various techniques such as paper models and diagrams to design for multi-layer weaving. Replacing traditional yarns with conductive yarn, we achieved woven textile-forms with electronic sensing capabilities. By outlining our process, the pictorial highlights the challenges and opportunities of textile-form thinking for HCI designers. Additionally, its printed version serves as a 'paper prototyping tool' for designers to gain hands-on experience developing textile-form interfaces.

## Authors Keywords

• Textile-form Interfaces; weaving; HCI textiles; Material-Driven Design; design tools; prototyping.

## CSS Concepts

• Human-centered computing~Human computer interaction (HCI)

Permission to make digital or hard copies of part or all of this work for personal or classroom use is granted without fee provided that copies are not made or distributed for profit or commercial advantage and that copies bear this notice and the full citation on the first page. Copyrights for third-party components of this work must be honored. For all other uses, contact the Owner/Author.

DIS '23, July 10–14, 2023, Pittsburgh, PA, USA  
© 2023 Copyright is held by the owner/author(s).  
ACM ISBN 978-1-4503-9893-0/23/07.  
<https://doi.org/10.1145/3563657.3596086>



## **INTRODUCTION**

Weaving, one of the most common textile production methods, has been of particular interest for HCI because it allows in a relatively simple manner to create textile interfaces by integrating sensors (e.g., [20, 56]) or actuators (e.g., [27, 28]) towards intuitive and seamless interactions in our everyday life [44]. In particular, the possibility of multi-layer weaving, i.e. weaving simultaneously multiple layers of fabric on top of each other, has appealed to artists (e.g., [37, 38]), and scholars who developed electronic wiring and circuits [9, 18, 33, 50, 52] by integrating conductive yarn, for instance, in a hand puppet [45]. In the textile design domain, McQuillan's work on woven textile-forms [30], produced at the same time as the textile is woven, set the ground for weaving entire garments or textile artefacts. Recently, McQuillan & Karana [31] emphasized the under-explored potential of textile-forms for interaction because of the deep textile knowledge required and the lack of accessibility to tools and design workflows. In this emerging field for HCI, existing accounts have not fully addressed the practical expertise that novice designers need to approach the design of woven interfaces, presuming a certain understanding of textile production processes and terminology. As pointed out by Pouta & Mikkonen [46], limited studies considered the lack of documentation and detailed instructions to ease of reproduction of HCI textiles [8, 9, 50]. Moreover, the specialised knowledge required to design woven textile-form interfaces, which requires the combined understanding of textile thinking, weave theory, form thinking and interaction, remains largely inaccessible.

To fill this gap, we present a material-driven design journey of a multidisciplinary team focused on understanding the material at hand by tinkering and sharing activities [24], to design woven textile-form interfaces. This pictorial is a first guide in bridging the 2D and 3D representations of woven textile-forms and the actual weaving process. Furthermore, through the printed version of this pictorial, we provide the reader with a paper prototyping tool that can be cut and assembled to understand the basic principles of textile-forms for textile-form interfaces.

## **WOVEN TEXTILE-FORMS IN HCI**

McQuillan [30] defined textile-forms as those cases in which textile and form are simultaneously created, e.g., through knitting, weaving, or other textile production methods. McQuillan & Karana [31] positioned woven textile-forms in HCI, revealing their advantages in reducing textile waste in both the design and the use time of textile artefacts. The authors also mentioned the potential of woven textile-forms in relation to embedding responsive technologies in textiles, augmenting the already existing textiles' interaction potential.

However, the potential of woven textile-forms in HCI remains undisclosed because it calls for recognising textiles as complex multi-scale material systems across fibre, yarn, structure, and form. Limited studies dived deep into weave structures, tuning elements and material characteristics to fabricate woven textile interfaces (e.g., [10, 16, 20, 46]). The majority of the work to date has focused on employing textiles as substrates for other technologies [54] or as two-dimensional surfaces [56] or as fabric to be manipulated [21].

Textile-form thinking applied to woven textiles requires simultaneously applying knowledge both on weaving techniques (such as multi-layer weaving) and structures and on 3D-form building techniques deriving from pattern cutting. This holistic approach presents an obstacle, especially for HCI designers unfamiliar with using or developing textiles, that can only be overcome through knowledge sharing and collaboration between designers and researchers with different expertise.

## **KNOWLEDGE SHARING IN HCI TEXTILES**

The flourishing of new technologies and production methods for HCI textiles is made possible by interdisciplinary approaches across interaction and textile design [2, 7]. Traditional crafting techniques and the open-ended experimentation typical of craft spaces [35] allowed the exploration of textiles with shape-changing and colour-changing capabilities [9, 34], interactive fabric displays [12, 14], garments [51], environments [40], and educational tools [22]. Speculative [43] and critical [15, 47] approaches questioned the role of computation and digital technologies when intertwined with hand-crafted textiles. A recent strand of literature across digital craftsmanship and design research practice has addressed creative ways of sharing research insights in HCI textiles through reports on sample making [15], pictorials [8, 48], multi-layered pdfs [47], and other tutorial media such as stitch samplers [22], craft tools [41, 42] and prototyping toolkits [23, 29, 55]. Scholars highlighted how an understanding of textile thinking, methods, and techniques [9] and their consistent documentation [46] is needed to broaden the participation of non-textile designers in the design of interactive textiles.

Improving the accessibility to weaving has been a recent object of study in HCI by educating novice weavers on the complexity of Jacquard weaving [36] or by offering new weaving workflows for novice users through computational design tools [6, 32], a low-cost loom [1] and the open-source weaving software AdaCAD [13]. Even though many books have been published on weaving, these mostly target hand-weaving and craft techniques and are often too advanced for novice weavers. Additionally, the tacit knowledge behind operating a loom or programming weave structures cannot be divulged through figures printed on books. It can only be gained through first-person experiences. To fill this gap, Devendorf et al. [8] guided the reader to understand the process of drafting woven structures (also known as bindings) with the novel pictorial format of an instructional booklet.

In line with these approaches, we see an urgent need for practical tools to effectively share weaving and textile-form knowledge, specifically oriented towards HCI, across different types of expertise. We were inspired by the pictorial's potential, in its printed form, to serve as a hands-on tutorial medium. Therefore, with this work, we aim to share the knowledge required to design, prototype, and program a woven textile interface developed from a textile-form. The material-driven design journey of the team serves as an example of the workflow designers could apply to design woven textile-form interfaces, making use of the tools explained throughout the pictorial.

Our target readers are HCI researchers interested in designing textile-form interfaces with a basic understanding of jacquard weaving. For novice readers, we recommend referring to prior literature in textiles [19] and HCI: Devendorf & Di Lauro [9] and Devendorf et al. [8] to learn about basic weaving terminology, drafting and operating a loom; to Pouta & Mikkonen [46] for an overview of multi-layer weaving.

## OUR APPROACH

This pictorial outlines our journey to design a woven textile-form interface characterised by a material-driven approach. Instead of considering materials as passive and with fixed applications or expressions, the Material Driven Design (MDD) [24] helps designers consider materials open to change in design and use time [26]. As demonstrated in several studies (e.g., [3, 17, 25, 57]), by applying an MDD approach, designers play an active role in revealing material potentials by immersing themselves in material tinkering [39, 49], reflecting, and sharing activities. Textiles are commonly understood as “materials” (which is why they are often ‘used’ as a substrate). However, we encourage the reader to approach textiles as a system of materials, of which each element and their relations can be understood through tinkering and other techniques motivated by the MDD approach (e.g., technical and experiential characterisation studies).

The value of hands-on material exploration is well-known in textile design, but it is more typically found in craft and artistic approaches (e.g., [5]). Therefore, more knowledge is needed on how a material-driven approach could be applied to the design of textile-form interfaces. In the following section, we invite the reader to walk through an in-depth visual report of our material-driven design and making process for a particular woven textile-form interface, Deployable Textile-form Interface.

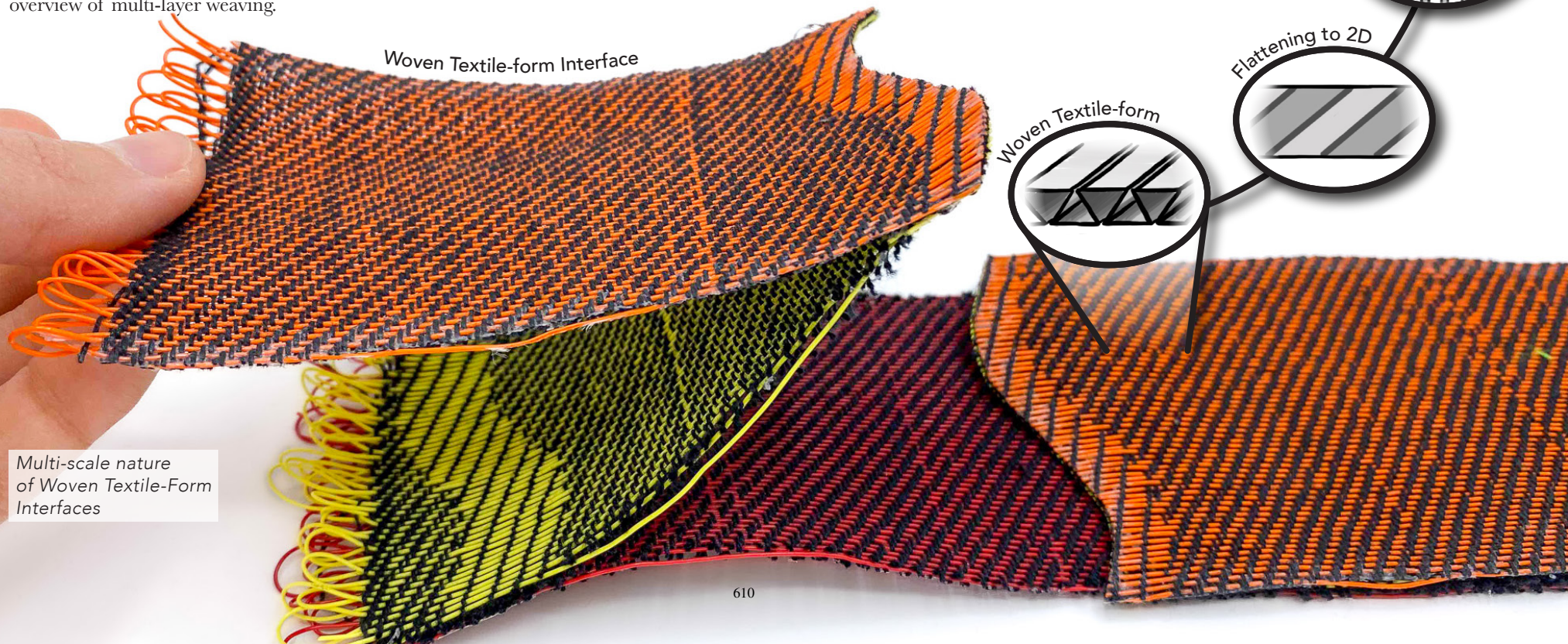

## DESIGN JOURNEY

This section describes the design journey undertaken by a multidisciplinary team consisting of an interaction designer, a jacquard designer and a textile and fashion designer in the design of the Deployable Textile-form Interface. Throughout the design and making process, we took notes of the different phases and insights through photo and video recording, reflective writing of notes and sharing sessions within the research team. Then, we mapped the tools and activities of our journey (see diagram to the right), building on the textile-form design process framework by Walters [53]. The map helps us situate the main elements of our material-driven journey by acknowledging textiles as complex material systems across scales and as three-dimensional structures [30]. At the macro-scale, the textile-form emerges from the distribution of multi-layer woven structures, flattened to allow the weaving process. At the micro-scale, the textile-form emerges from the material properties of fibre and yarn and their interlacement in weave structures, i.e., bindings. The textile form, i.e., the 3D expression of the textile in space and time, can be represented via 2D flattened visualisations.

Among the tools used in our design journey, common 2D visualisation tools in the weaving community (i.e., weave repeats, weave drafts and yarn paths) have been addressed in HCI [8, 9]. On top of these common tools, in our design process, we used 2D and 3D visualisations to move across the macro-scale and the micro-scale of the woven textile-form. In some cases, for example, we felt that a 3D render was more useful to understand the expected outcome of the weaving process, especially to check the merging or splitting of multiple layers of textiles. In other cases, we used in-depth section views of the yarn path to discuss the most suitable bindings.

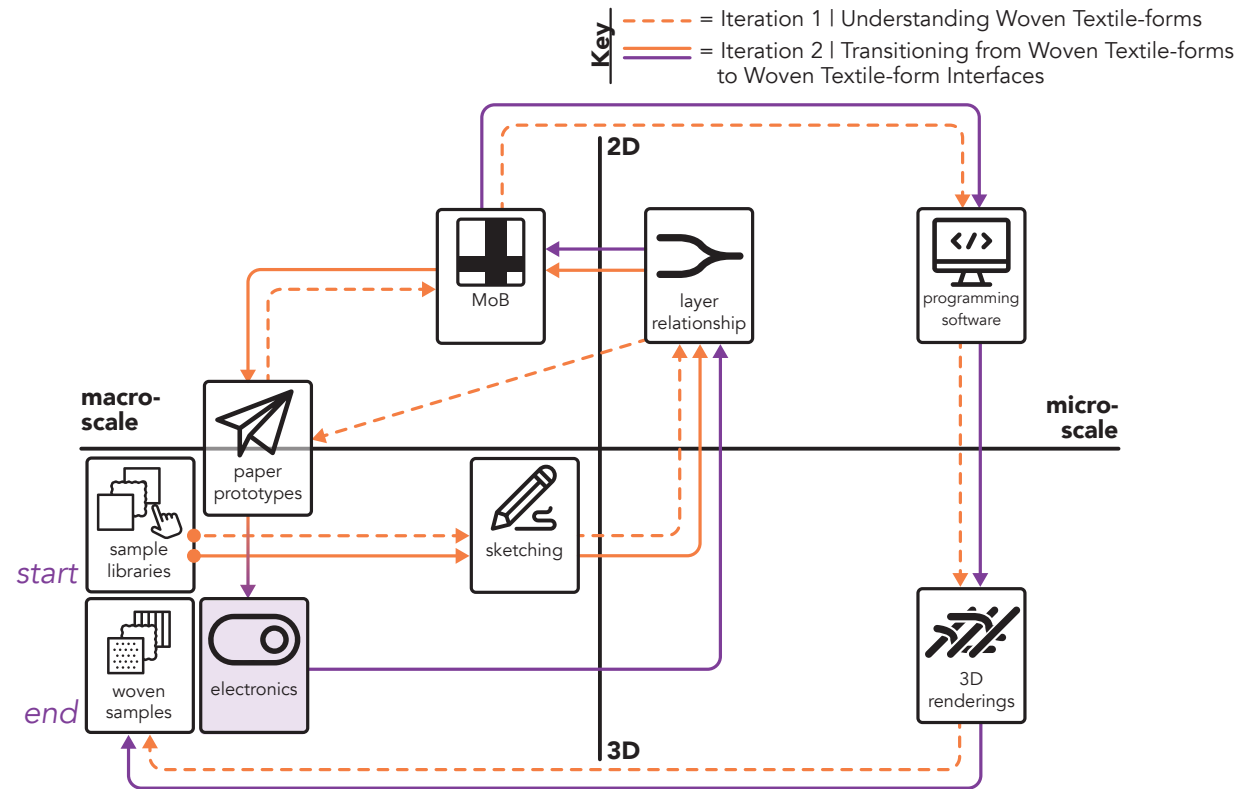

*Design journey developed over multiple iterations*

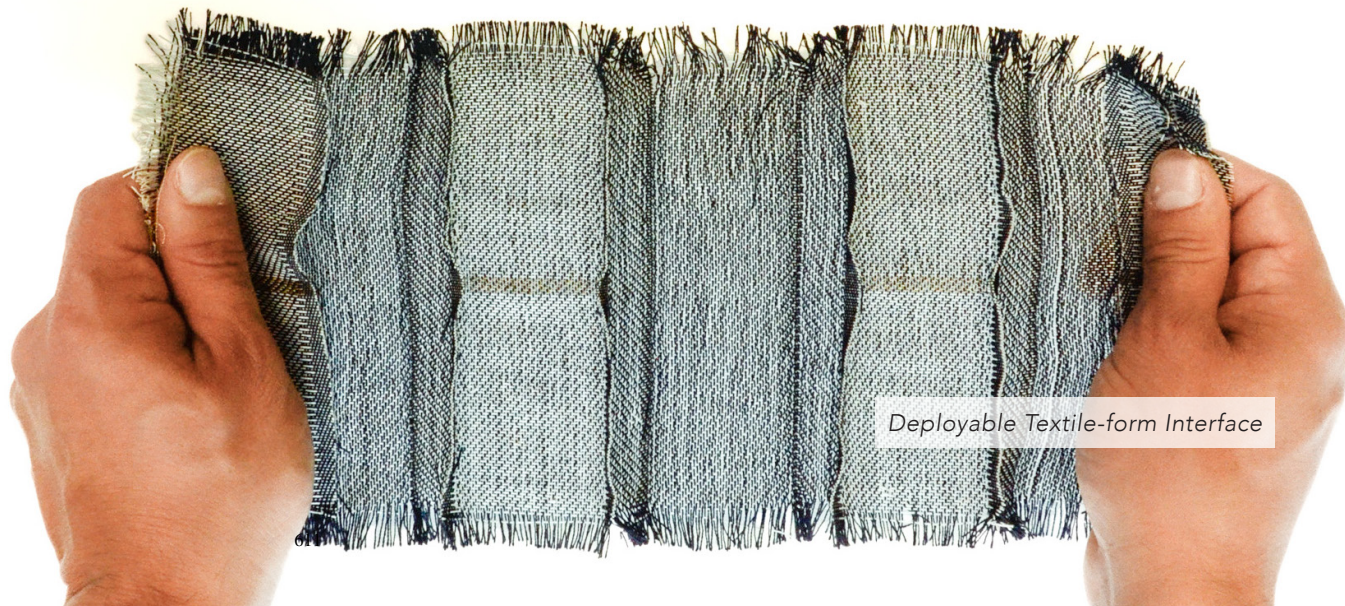

*Deployable Textile-form Interface*



Two recurring questions guided our process:

- 1) How to develop a textile interface from woven textile-forms?
- 2) What are the main challenges for novice designers who want to start making textile-form interfaces?

Because our iterative material-driven design process did not follow a linear path, in the next sections, we present activities and tools as an overview of techniques used, not according to a specific chronological order.

Our design journey started with a series of inspiration sessions within our team. We explored samples of woven textile-forms, taking notes through sketches to interrogate the overall form of the samples. To experience different ways of unfolding the 2D flattened forms into 3D textile-forms, we played with samples and discussed their design among the team.



## Sample libraries

We focused on the existing woven textile-form samples from the personal libraries of textile and jacquard designers. The discussions mainly revolved around which elements were varied in samples fabricated with the same technique. For example, in some woven textile-form samples, stiff yarns would allow the form to expand when stretched and quickly return to its initial state when released. In others, softer yarns would not allow this springy effect, but the textile ‘pleats’ would collapse. Even when the bindings and structures were kept constant, the choice of yarn influenced the whole behaviour and expression of the textile-form.

The samples helped the interaction designer (1st author) understand how the three flat woven layers of the deployable form (one of the explored textile-form samples) can become three-dimensional and the interrelationship between materials, weave structure, and form.



Deployable textile-form from the jacquard designer's library



## Sketching

We used sketching as a note-taking, analytical and communication tool. The sketches included three-dimensional visualisations of flattened and released textile-forms and illustrations such as cross sections with various levels of detail. The cross-sections were particularly useful in understanding the insertion of the conductive yarn to create a connection/disconnection point.

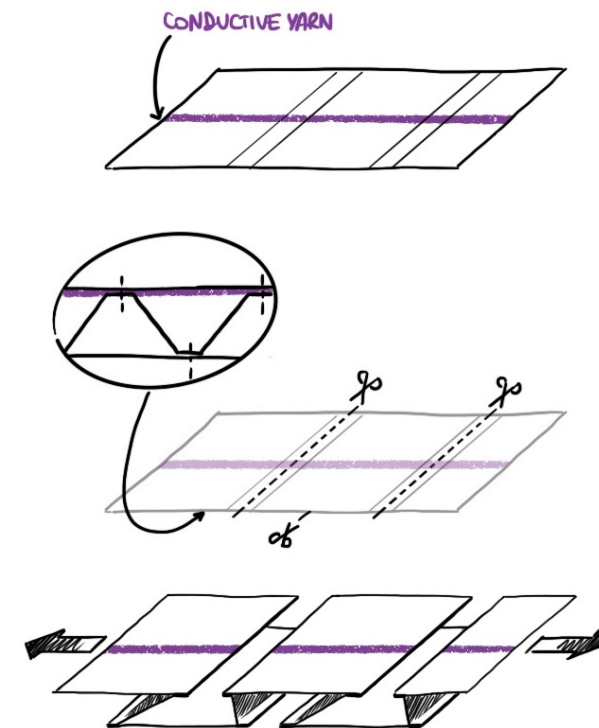

Initial sketches of the Deployable Interface. The purple stripe represents the conductive yarn



## Map of Bindings

Extending on the concept of “artwork” from weaving, the Map of Bindings (MoB), introduced by McQuillan [30], represents the flattened three-dimensional form into a two-dimensional plan for the zones of each weave structure/binding. In the deployable interface, the MoB consists of three different colours, each representing a unique type of binding with a different layer relation. For representation purposes, the MoB below is turned 90° counterclockwise.



## Layer relationship

The layer relationship is drawn as a cross-section of the warp yarns. Our notation system indicates different warp yarns with numbers (1, 2, 3, ...) and different weft yarns with capital letters (A, B, C, ...). For example, layer 1A is obtained by weaving warp yarns 1 with weft yarns A. In combination with MoB, the layer relationship describes the connection and separation of the different layers obtained by the interlacement of sets of warp and weft yarns. We indicate with the symbol / the separation between layers. When two or more layers are not separated by the symbol /, the layers are merged in a compound weave. We indicate with discontinued lines the cutting lines to perform cuts across specific layers after weaving, in order to release the textile form.

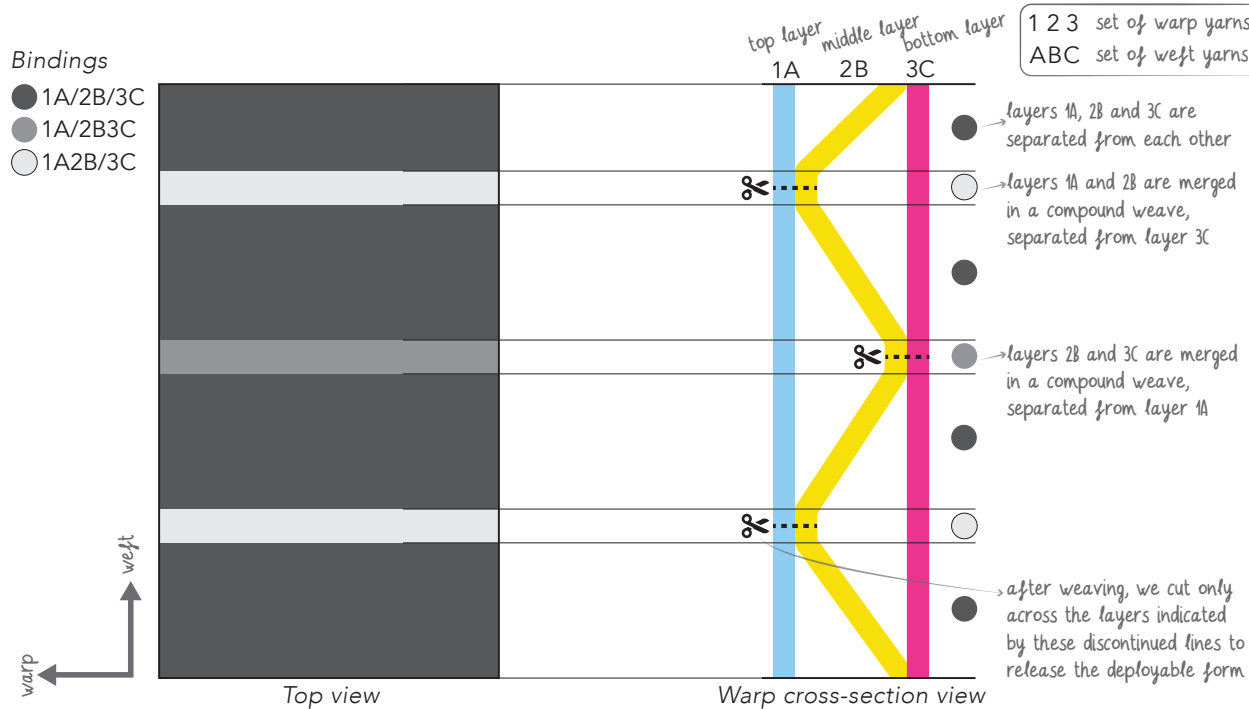

## Programming software

Once the main aspects of the design, i.e., layers, placements, conductive yarn, were clear we started to program the textiles on the open source software AdaCAD [13]. Given that the logic of AdaCAD resembles that of parametric modelling softwares typical of product and interaction design spaces (e.g., Rhinoceros Grasshopper), the interaction designer (1st author) could easily become independent in programming the samples. Programming the textile-form consists of 3 main steps: 1) create the MoB and upload on AdaCAD; 2) assign the bindings (the operation ‘layer notation’ [11] can be useful to directly translate the layer relationship into AdaCAD); 3) assign the drafts of each layer notation to their corresponding colour (‘technical colour’) via the operation ‘image map’; 4) export the card (i.e., the file read by the loom software).

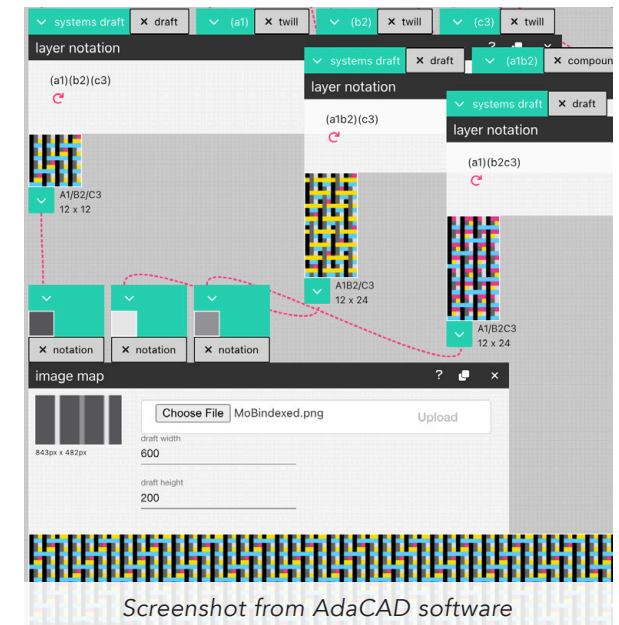



## 3D renderings

Once the textile-form interface was programmed, NedGraphics software allowed us to create realistic 3D visualisations of sections of the textile that could be observed from diverse angles. By assigning different colours to different weft yarns on NedGraphics, we could verify the correct definition of the bindings in the sections where the layers split or merge. Checking 3D renderings before starting to weave samples minimised the potential mistakes that could happen on the loom, for example, avoiding errors in the programming of the compound structure.

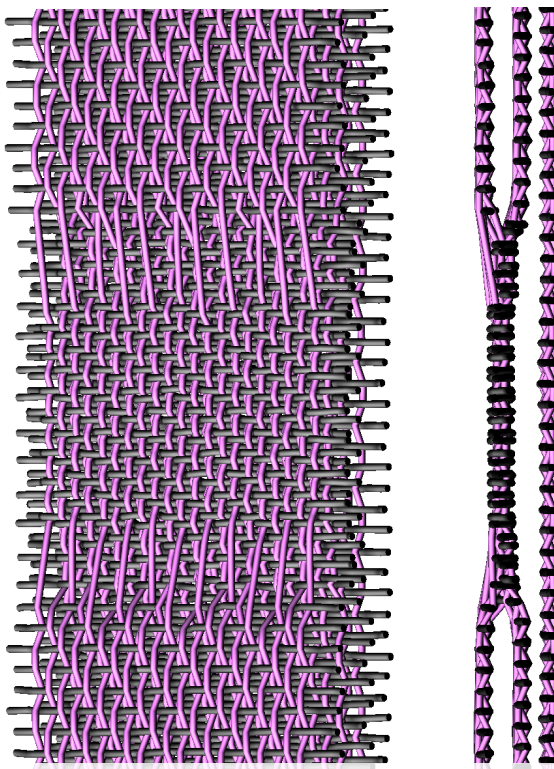

3D-rendered angled view (left) and side view (right)

## Electronics

In this work, we used conductive yarn as a strategy to activate the Deployable Interface. From time to time, prototyping simple electronic switches and sensors helped verify the working principle envisioned through the textile-form. At the beginning of the journey, alligator clamps, conductive fabric, and old textile samples were sufficient to simulate the connection/disconnection or the overlapping of two layers of woven textile. After weaving some initial samples, we connected the Deployable Interface to an Arduino UNO and turned the interface into a contact switch (see schematic below): pulling the opening of the interface causes an interruption in the circuit that triggers the GUI to turn on.

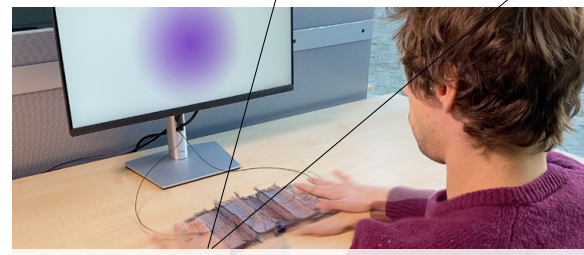
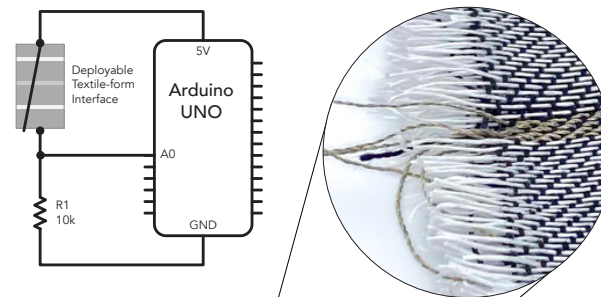

Deployable Interface connected to the GUI

## Paper prototypes

Paper prototypes are often used to '3D sketch' the expected final textile-form. For the interaction designer (1st author), the paper prototyping helped materialise the textile-form structures previously only visualised through MoB and layer relationships. For the Deployable Interface, paper prototypes were also used to verify that the scale of the sample was big enough to support the interaction and to test the working principle of the switch, by taping conductive yarn on it and connecting it to the Arduino board.

In the next pages, we will guide the reader through the steps of building the paper prototype of the Deployable Interface as an attempt to bridge between the 2D and 3D representations of woven textile-forms and the weaving process. When assembled, the paper prototype matches the MoB and layer relationship diagrams on p.6. The same technique of paper prototyping could be applied to other textile-forms.

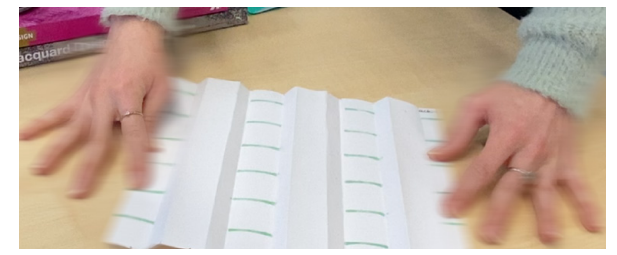

Interaction with an early-stage paper prototype

# BUILD YOUR PAPER PROTOTYPE

On the next page you can find the model to build a paper prototype of the Deployable Textile-form Interface. We recommend you print this document two-sided, flipped along the short edge and with the setting 'Fit'. Remove the next page from the pictorial and follow the instructions below to assemble the paper prototype. You will need a pair of scissors and tape.

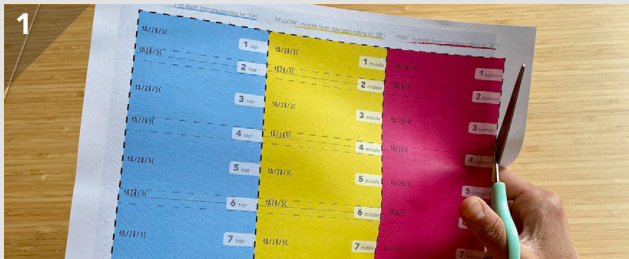

Cut the drawings on p.9 along **cutting lines 1** (see the legenda at the bottom left corner) to obtain 3 rectangles. These blue, yellow, and pink rectangles correspond to layer 1A (top), layer 2B (middle) and layer 3C (bottom) respectively of the *layer relationship diagram* on p.6. For the entire duration of the assembly, you will always keep the blue layer on top, the yellow one in the middle, and the pink one at the bottom.



Cut the layers along **cutting lines 2**. In this phase, keeping the sections separated per color might help.

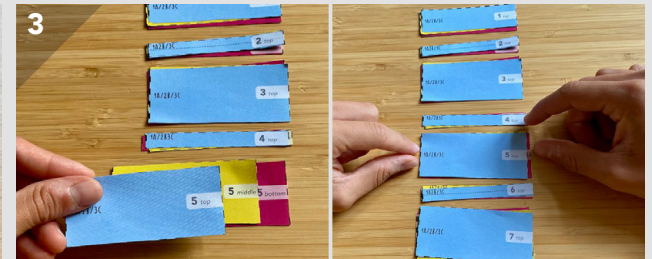

Overlap the sections with the same numbers following the layer order: blue on top, yellow in the middle, and pink at the bottom. Then, arrange the overlapped sections in their initial sequence, following the numbers **1-7** from top to bottom.

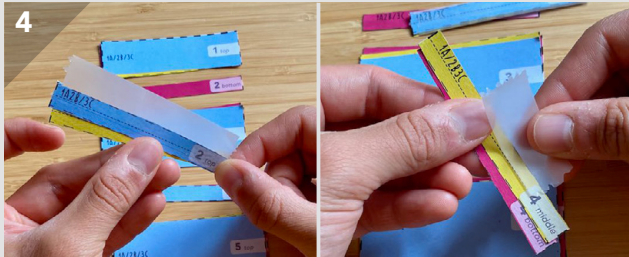

For each section, look at the notation (ex: **1A/2B3C**) and proceed to tape together the layers that will be woven together (in this case, layers yellow and pink). If you are not sure, the annotations of the *layer relationship diagram* on p.6 will help you. Use tape to stick the sections together. After taping, put the sections back in their initial layout.

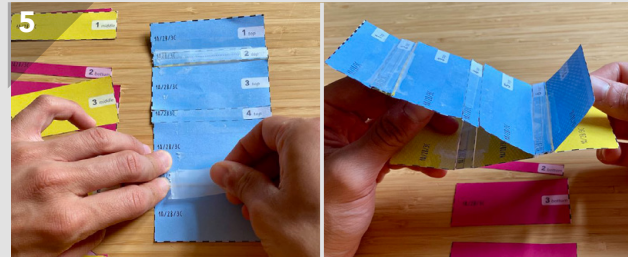

Now, you can tape the different layers back together, making sure that each colour continues throughout the entire length of the prototype. If necessary, you can flip the sections to access and tape.

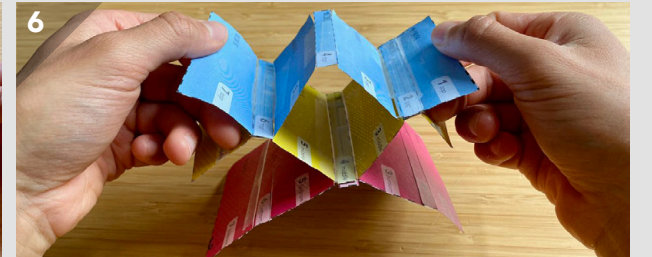

You should have ended up with the initial layout, with the blue layer on top, the yellow one in the middle, and the pink one at the bottom. This time, in some sections, the layers merge together and split up. You can check how this resembles the *layer relationship diagram* on p.6.

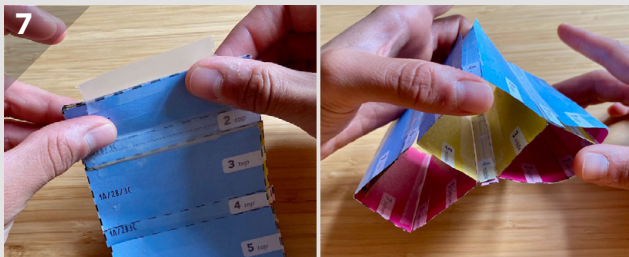

Tape the top and bottom extremities of the prototype.

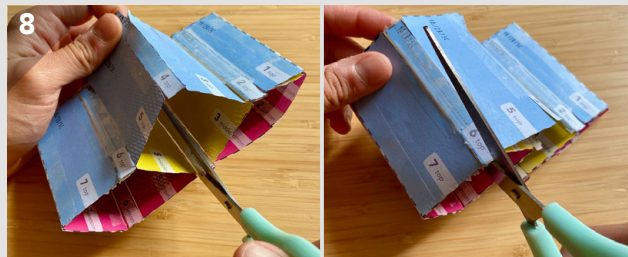

Now cut along **cutting lines 3**. Be careful: only cut across the layers where the dash line is drawn. If the dash line is missing, do not cut! This is a crucial step. If two pieces are taped together and you can see the cutting line of the top piece, cut through both.

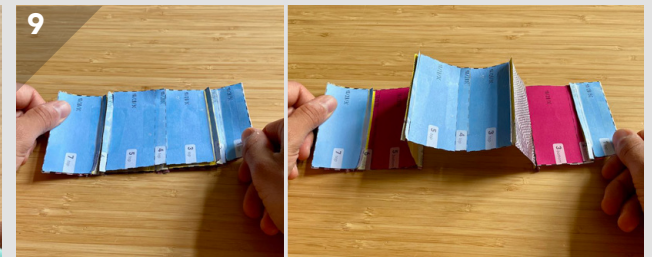

You can now stretch the prototype by pulling to the sides, therefore releasing the deployable shape. Congratulations! You have now created the paper prototype of the Deployable Textile-form Interface.

BLUE - top layer (corresponding to '1A')

YELLOW - middle layer (corresponding to '2B')

PINK - bottom layer (corresponding to '3C')

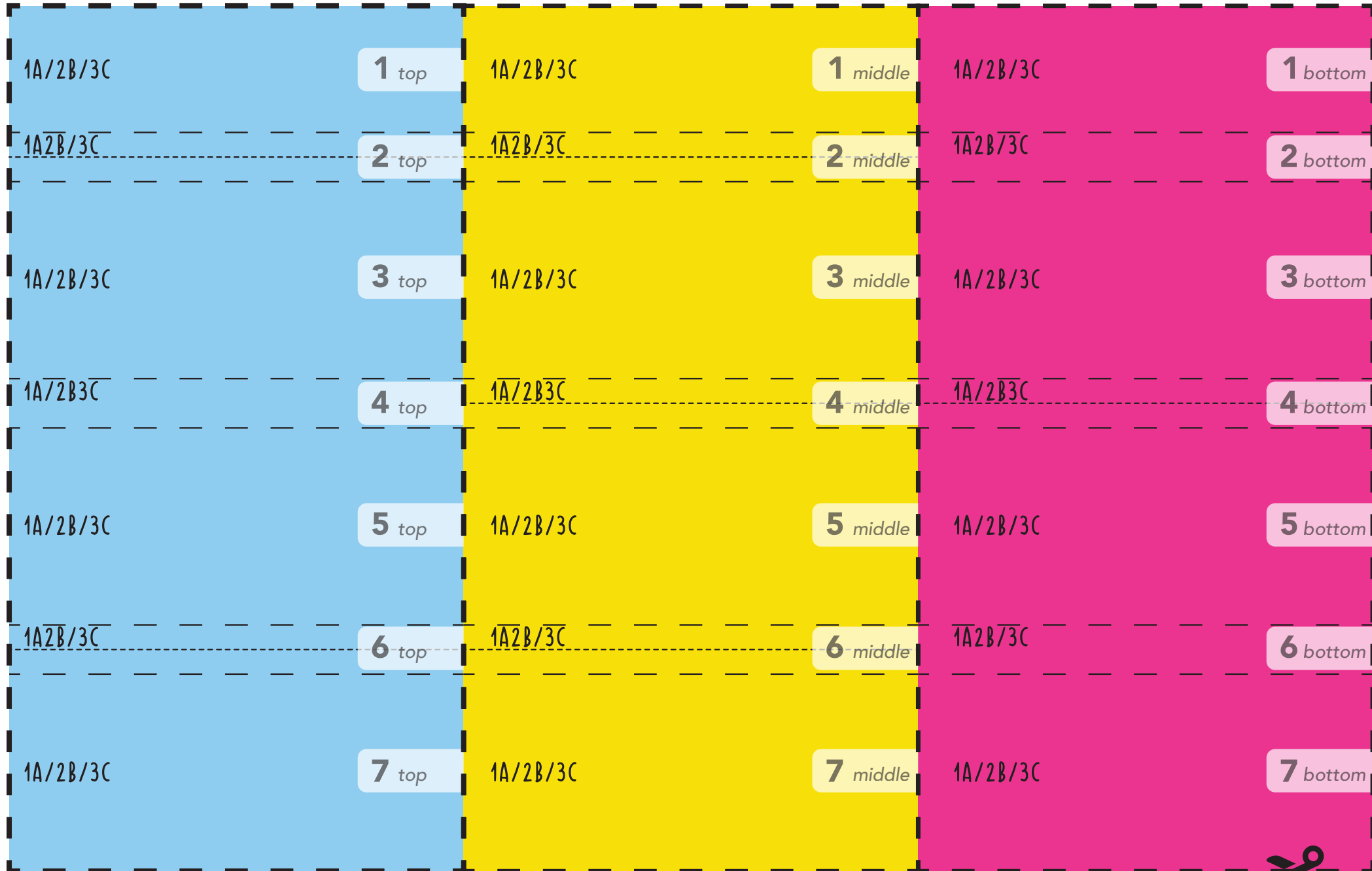

**LEGEND**  
— — — — Cutting lines 1  
- - - - Cutting lines 2  
..... Cutting lines 3 after assembly

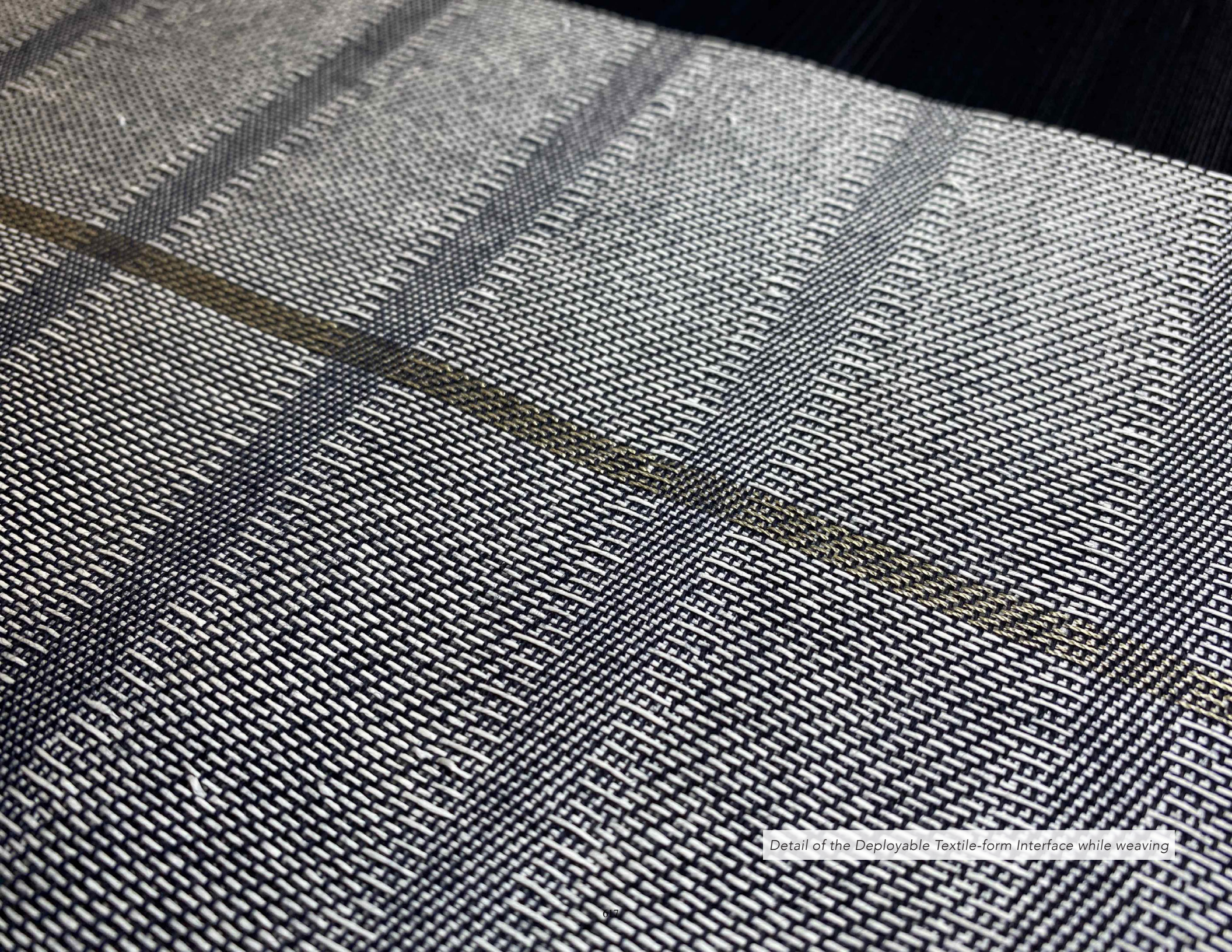

*Detail of the Deployable Textile-form Interface while weaving*

The paper prototype serves for multiple purposes. When annotating the layers notation directly on the prototype, it can be used to extract and understand the MoB and layer relationship; this way, these three-dimensional and two-dimensional tools can simultaneously inform the programming of the textile to produce the card. Alternatively, also more experienced textile designers could benefit from the paper prototype. It can be a generative tool to develop novel textile-forms and translate them into interfaces. Thanks to their three-dimensionality and scale, paper prototypes help to explore interaction possibilities that could not emerge otherwise, for example through drafting.

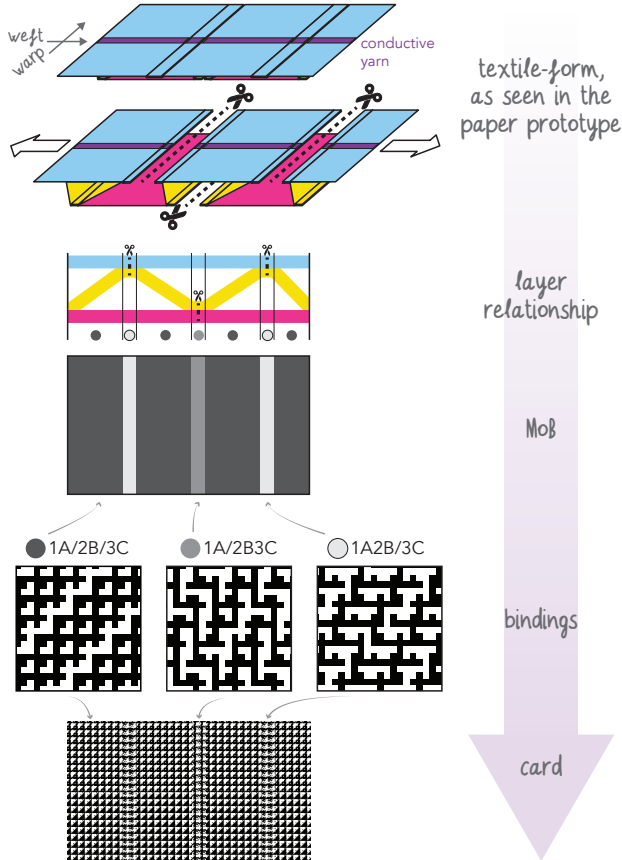

## Woven samples

We wove several samples and some functional prototypes of the Deployable Textile-form Interface, embedding conductive yarn. Sampling over several iterations allowed us to tinker with different materials for the weft, such as TPU-coated yarns and paper yarns, looking for a material that would provide the feeling of 'textileness' [4] while being stiff enough to provide the springy behaviour to the interface. The paper yarn sample can be easily stretched to open the switch. When released, the textile goes back to its original state but it still requires the user to interact in order to successfully close the circuit with their hands.



Sample with TPU-coated yarn: too stiff

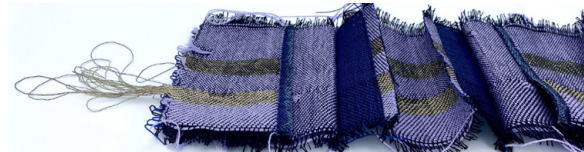

Sample with wool yarn: too soft

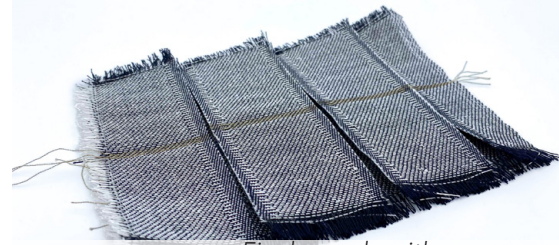

Final sample with paper yarn: good balance of stiffness and softness



All samples were woven on a TC2 digital jacquard loom with black cotton warp (Venne Cotton Ne16/2 M 28/2; warp density 36epc). The conductive yarn used is Shieldex Statex 235/36 dtex 2-ply HC+B x2.

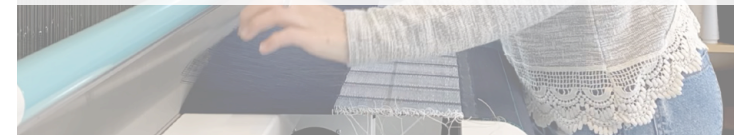



## FINAL REFLECTIONS

In this pictorial, we described the material-driven design journey of a multidisciplinary team in the design of a woven textile-form interface, the Deployable Textile-form Interface. We discussed in a non-chronological and non-prescriptive way the main activities and tools involved in our process through understanding woven textile forms and transitioning to woven textile-form interfaces. The printed version of this pictorial offers a cut-and-assemble paper prototype to share the specialised knowledge to understand woven textile forms and their potential for novel interactions. We faced a couple of challenges along the way, which we briefly touch upon below.



### “How do you call this?”

“How do you call this?” was a recurrent question among the designers of our team. The use of a common vocabulary has been one of the main challenges. In textile design, a wide variety of terms exist to define the same concept depending on the discipline and even country (our team is composed of researchers from diverse parts of the world). The need for a common vocabulary became even more prominent when working in a multidisciplinary team. For example, the MoB is commonly known in textile design as ‘artwork’; in fashion and form-making, it is closely related to ‘pattern’ and specification. The need for common ground was partly filled by developing the notation system to describe the layer relationship and to guide while assigning the bindings on the programming software. While we believe this system could benefit other designers in their weaving practice, we call for other researchers to share their own methods and techniques that could support the development of a common vocabulary of woven textiles in HCI.

### Future tools for HCI textiles

The tools used and described in this study are relevant for novice and expert designers of woven textile-form interfaces. Even though the combination of different techniques has been shown as an example process, it could be generalized in a material-driven design methodology to support to the design of any textile-form. Yet, the current tools present some limitations. In some cases, the layer relationships and paper prototypes cannot precisely replicate all types of weave structures (e.g., a compound weave that expands three-dimensionally due to the presence of shrinking yarn). In other cases, a more zoomed-in view of the cross-section displaying the warp yarns could be a more effective method than layer relationships. For these reasons, future research is needed on how the tools are perceived by novice designers and students of textile courses and which changes might be required to satisfy their needs.

To conclude, we share the first author’s perspective on this design journey, who learned to weave through this study.

### From the first author’s perspective

*“As an interaction designer that approached weaving to make textile interfaces, I was so surprised by the steep learning curve. Despite my experience with material-driven explorations and making, I underestimated the barriers I would encounter to access the right expertise and equipment. I started by researching literature on weaving. Of course, books on weaving theory exist, but they target craftspeople. They address waving on hand or table looms, and they focus on weaving mostly flat textiles to produce ‘aesthetically pleasing’ patterns. Even then, the knowledge was scattered around many different books: for example, one would cover the process of drafting and others double-weaving. By collaborating with the other designers in the team (textile and jacquard designers), I could access a whole new level of weaving knowledge: that kind of tacit knowledge that is not written in books, and that does not leave the realm of art academies. Including (at least basic principles of) textile design in the curricula of technical design education would benefit apprentice and novice designers in the HCI community that, like me, might want to approach weaving from a non-textile background.*

*Interestingly, I gained some of the most fundamental principles and complex mechanisms of weave structures not in books, not through sampling woven textile interfaces, but when trying to solve mistakes in my woven samples. For example, activities of loom preparation (warping the loom) and maintenance (like fixing warp tension issues) gave me some ‘mental space’ to take distance from the making itself, and to reflect on the reasons and consequences of those issues, helping me to fully understand the delicate interplay between the different elements of textile systems. Hence, I suggest acknowledging these tasks not as secondary or optional but as formative in a learning and design journey towards weaving textile interfaces.*

*Looking back at this journey, my choice of learning such complicated processes rather than delegating the weaving tasks to the other expert designers of the team gave me the ability to combine familiar interaction principles (what is an interface, how it would work via conductive materials) with woven textile-forms. Only through this deep understanding of weaving, I could uncover the interaction potential of woven textile-forms that would not have emerged by looking at them as an outsider. I was able to effectively communicate with the other designers using a shared vocabulary and to anticipate the consequences of my design choices on the final woven textile outcome.”*

## REFERENCES

- [1] Albaugh, L., McCann, J., Yao, L. and Hudson, S. E. 2021. Enabling Personal Computational Handweaving with a Low-Cost Jacquard Loom. Proceedings of the 2021 CHI Conference on Human Factors in Computing Systems. (Yokohama, Japan, 2021). <https://doi.org/10.1145/3411764.3445750>
- [2] Andersen, K., Goveia, B., Tomico, O., Toeters, M., Mackey, A. and Nachtigall, T. Year. Digital Craftsmanship in the Wearable Senses Lab New York, New York, USA, Year). 257-260. <http://dl.acm.org/citation.cfm?doid=3341163.3346943>
- [3] Barati, B., Giaccardi, E. and Karana, E. 2018. The Making of Performativity in Designing [with] Smart Material Composites New York, New York, USA, 2018). 1-11. <http://dl.acm.org/citation.cfm?doid=3173574.3173579>
- [4] Buso, A., McQuillan, H., Jansen, K. and Karana, E. 2022. The unfolding of textileness in animated textiles: An exploration of woven textile-forms. DRS 2022 (Bilbao, Spain, 2022) <https://doi.org/10.21606/drs.2022.612>
- [5] Chen, L.-L., Djajadiningrat, T., Feijs, L., Hu, J., Kyffin, S., Rampino, L., Rodriguez, E. and Steffen, D. Year. Design and semantics of form and movement. DeSForM 2015 Aesthetics of interaction: Dynamic, Multisensory, Wise. (Milan, Italy, 2015) [https://re.public.polimi.it/bitstream/11311/973605/1/DeSForM\\_2015.pdf](https://re.public.polimi.it/bitstream/11311/973605/1/DeSForM_2015.pdf)
- [6] Deshpande, H., Takahashi, H. and Kim, J. 2021. EscapeLoom: Fabricating New Affordances for Hand Weaving Proceedings of the 2021 CHI Conference on Human Factors in Computing Systems. (Yokohama, Japan, 2021). <https://doi.org/10.1145/3411764.3445600>
- [7] Devendorf, L., Arquilla, K., Wirtanen, S., Anderson, A. and Frost, S. 2020. Craftspeople as Technical Collaborators: Lessons Learned through an Experimental Weaving Residency. Proceedings of the 2020 CHI Conference on Human Factors in Computing Systems. (Honolulu, HI, USA, 2020). 1-13. <https://doi.org/10.1145/3313831.3376820>
- [8] Devendorf, L., De Koninck, S. and Sandry, E. 2022. An Introduction to Weave Structure for HCI: A How-to and Reflection on Modes of Exchange. DIS '22. (Virtual Event, Australia, 2022) <https://doi.org/10.1145/3532106.3534567>
- [9] Devendorf, L. and Di Lauro, C. 2019. Adapting Double Weaving and Yarn Plying Techniques for Smart Textiles Applications. Proceedings of the Thirteenth International Conference on Tangible, Embedded, and Embodied Interaction. (Tempe, Arizona, USA, 2019). 77-85. <https://doi.org/10.1145/3294109.3295625>
- [10] Devendorf, L., Lo, J., Howell, N., Lee, J. L., Gong, N.-W., Karagozler, M. E., Fukuhara, S., Poupirev, I., Paulos, E. and Ryokai, K. 2016. "I don't Want to Wear a Screen" New York, NY, USA, 2016). 6028-6039. <https://dl.acm.org/doi/10.1145/2858036.2858192>
- [11] Devendorf, L., Walters, K., Fairbanks, M., Sandry, E. and Goodwill, E. R. 2023. AdaCAD: Parametric Design as a New Form of Notation for Complex Weaving. Proceedings of the 2023 CHI Conference on Human Factors in Computing Systems. (Hamburg, Germany, 2023). <https://doi.org/10.1145/3544548.3581571>
- [12] Endow, S., Rakib, M. A. N., Srivastava, A., Rastegarpouyani, S. and Torres, C. 2022. Embr: A Creative Framework for Hand Embroidered Liquid Crystal Textile Displays. CHI Conference on Human Factors in Computing Systems. (New Orleans, LA, USA, 2022). <https://doi.org/10.1145/3491102.3502117>
- [13] Friske, M., Wu, S. and Devendorf, L. Year. AdaCAD: Crafting Software For Smart Textiles Design. CHI '19. (Glasgow, Scotland, UK, Year). <https://doi.org/10.1145/3290605.3300575>
- [14] Giles, E., van der Linden, J. and Petre, M. Year. Tactile Stories: Interactive E-textile Wall-hangings created by blind and visually impaired makers New York, NY, USA, 2020/10//, Year). 1-3. <https://dl.acm.org/doi/10.1145/3419249.3421233>
- [15] Goveia da Rocha, B., van der Kolk, J. M. and Andersen, K. Year. Exquisite Fabrication: Exploring Turn-taking between Designers and Digital Fabrication Machines. Proceedings of the 2021 CHI Conference on Human Factors in Computing Systems. (Yokohama, Japan, 2021). 1-9. <https://doi.org/10.1145/3411764.3445236>
- [16] Greinke, B., Wood, E., Skach, S., Vilas, A. and Vierende, P. Folded Electronic Textiles: Weaving, Knitting, Pleating and Coating Three-Dimensional Sensor Structures. Leonardo, 55, 3 (2022), 235-239. [10.1162/leon\\_a\\_02183](https://doi.org/10.1162/leon_a_02183)
- [17] Groutars, E. G., Risseeuw, C. C., Ingham, C., Hamidjaja, R., Elkhuizen, W. S., Pont, S. C. and Karana, E. 2022. Flavorium: An Exploration of Flavobacteria's Living Aesthetics for Living Color Interfaces. CHI 2022. (New Orleans, LA, USA, April 29-May 5, 2022) <https://doi.org/10.1145/3491102.3517713>
- [18] Heiss, L., Beckett, P. and Carr-Bottomley, A. Year. Redesigning the trans-disciplinary: working across design, craft and technological boundaries to deliver an integrated wearable for cardiac monitoring. DIS '16. (Brisbane, QLD, Australia, 2016). 691-699. <https://doi.org/10.1145/2901790.2901794>
- [19] Holyoke, J. Digital jacquard design. Bloomsbury Publishing, 2013.
- [20] Huang, K., Sun, R., Zhang, X., Islam Molla, M. T., Dunne, M., Guimbretiere, F. and Kao, C. H.-L. 2021. WovenProbe: Probing Possibilities for Weaving Fully-Integrated On-Skin Systems Deployable in the Field. Designing Interactive Systems Conference. (Virtual Event, 2021). 1143-1158. <https://doi.org/10.1145/3461778.3462105>
- [21] Jiang, M., Nanjappan, V., Liang, H.-N. and Bömer, M. t. 2022. GesFabri: Exploring Affordances and Experience of Textile Interfaces for Gesture-based Interaction. Proc. ACM Hum.-Comput. Interact. (2022) <https://doi.org/10.1145/3534522>
- [22] Jones, L. and Girouard, A. 2022. Learning with Stitch Samplers: Exploring Stitch Samplers as Contextual Instructions for E-textile Tutorials. Designing Interactive Systems Conference. (Virtual Event, Australia, 2022). 949-965. <https://doi.org/10.1145/3532106.3533488>
- [23] Jones, L., Nabil, S. and Girouard, A. Year. Swatchbits: Prototyping E-textiles with Modular Swatches New York, NY, USA, 2020/02//, Year). 893-897. <https://dl.acm.org/doi/10.1145/3374920.3374971>

- [24] Karana, E., Barati, B., Rognoli, V. and Zeeuw van der Laan, A. Material Driven Design (MDD): A Method to Design for Material Experiences. *International Journal of Design*, 9, 2 (2015), 35-54
- [25] Karana, E., Giaccardi, E., Stamhuis, N. and Goossensen, J. 2016. The Tuning of Materials: A Designer's Journey. *Proceedings of the 2016 ACM Conference on Designing Interactive Systems*. (New York, NY, USA, 2016) <https://doi.org/10.1145/2901790.2901909>
- [26] Karana, E., Nimkulrat, N., Giaccardi, E., Niedderer, K. and Fan, J. N. Alive. Active. Adaptive: Experiential knowledge and emerging materials. *International Journal of Design*, 13, 2 (2019), 1-5
- [27] Ku, P.-S., Huang, K. and Kao, C. H.-L. 2022. Patch-O: Deformable Woven Patches for On-body Actuation. *CHI Conference on Human Factors in Computing Systems*. (New Orleans, LA, USA, 2022). <https://doi.org/10.1145/3491102.3517633>
- [28] Ku, P.-S., Shao, Q., Wu, T.-Y., Gong, J., Zhu, Z., Zhou, X. and Yang, X.-D. 2020. ThreadSense: Locating Touch on an Extremely Thin Interactive Thread. *Proceedings of the 2020 CHI Conference on Human Factors in Computing Systems*. (Honolulu, HI, USA, 2020). 1–12. <https://doi.org/10.1145/3313831.3376779>
- [29] Martinez Castro, J. F., Buso, A., Wu, J. and Karana, E. 2022. **TEX(alive): A TOOLKIT TO EXPLORE TEMPORAL EXPRESSIONS IN SHAPE-CHANGING TEXTILE INTERFACES**. *Designing Interactive Systems Conference*. (Virtual Event, Australia, 2022). 1162–1176. <https://doi.org/10.1145/3532106.3533515>
- [30] McQuillan, H. Zero Waste Systems Thinking : Multimorphic Textile-Forms. Doctoral thesis, comprehensive summary, University of Borås, Borås, Sweden, 2020.
- [31] McQuillan, H. and Karana, E. 2023. Conformal, Seamless, Sustainable: Multimorphic Textile-forms as a Material-Driven Design Approach for HCI. *Proceedings of the 2023 CHI Conference on Human Factors in Computing Systems*. (Hamburg, Germany, 2023) <https://doi.org/10.1145/3544548.3581156>
- [32] Meiklejohn, E., Devlin, F., Dunnigan, J., Johnson, P., Zhang, J. X., Marschner, S., Hagan, B. and Ko, J. 2022. Woven Behavior and Ornamentation: Simulation-Assisted Design and Application of Self-Shaping Woven Textiles. *Proceedings of the ACM on Computer Graphics and Interactive Techniques*. (2022). 1-12. <https://doi.org/10.1145/3533682>
- [33] Mikkonen, J. and Pouta, E. 2015. Weaving electronic circuit into two-layer fabric. *Adjunct Proceedings of the 2015 ACM International Joint Conference on Pervasive and Ubiquitous Computing and Proceedings of the 2015 ACM International Symposium on Wearable Computers*. (Osaka, Japan, 2015). 245–248. <https://doi.org/10.1145/2800835.2800936>
- [34] Nabil, S., Kučera, J., Karastathi, N., Kirk, D. S. and Wright, P. 2019. Seamless Seams: Crafting Techniques for Embedding Fabrics with Interactive Actuation. *DIS '19: Proceedings of the 2019 on Designing Interactive Systems Conference*. (San Diego, CA, USA, 2019). 987-999. <https://dl.acm.org/doi/10.1145/3322276.3322369>
- [35] Nimkulrat, N., Kane, F. and Walton, K. *Crafting textiles in the digital age*. Bloomsbury Publishing, 2016.
- [36] Ooms, D., Voskuil, N., Andersen, K. and Wallner, H. O. 2020. Ruta, a Loom for Making Sense of Industrial Weaving. *Companion Publication of the 2020 ACM Designing Interactive Systems Conference*. (Eindhoven, Netherlands, 2020). 337–340. <https://doi.org/10.1145/3393914.3395815>
- [37] Orth, M. *Dynamic Double-Weave*. City, 2007.
- [38] Orth, M. *Pile Blocks*. City, 2008.
- [39] Parisi, S., Rognoli, V. and Ayala-Garcia, C. 2016. Designing materials experiences through passing of time-Material driven design method applied to mycelium-based composites. *Proceedings of the 10th International Conference on Design and Emotion*. (Amsterdam, NL, 2016). 239-25w5.
- [40] Posch, I. 2020. Burglar Alarm: More Than 100 Years of Smart Textiles. *Companion Publication of the 2020 ACM Designing Interactive Systems Conference*. (Eindhoven, Netherlands, 2020). 473–476. <https://doi.org/10.1145/3393914.3395847>
- [41] Posch, I. and Fitzpatrick, G. 2018. Integrating textile materials with electronic making: Creating new tools and practices. *TEI '18: Proceedings of the Twelfth International Conference on Tangible, Embedded, and Embodied Interaction*. (Stockholm, Sweden, 2018). 158-165. <https://doi.org/10.1145/3173225.3173255>
- [42] Posch, I. and Fitzpatrick, G. The matter of tools: designing, using and reflecting on new tools for emerging eTextile craft practices. *ACM Transactions on Computer-Human Interaction (TOCHI)*, 28, 1 (2021), 1-38
- [43] Posch, I. and Kurbak, E. 2016. **CRAFTED LOGIC: Towards Hand-Crafting a Computer**. *CHI EA '16: Proceedings of the 2016 CHI Conference Extended Abstracts on Human Factors in Computing Systems*. (2016, 2016) <https://dx.doi.org/10.1145/2851581.2891101>
- [44] Poupayev, I., Gong, N.-W., Fukuhara, S., Karagozler, M. E., Schwesig, C. and Robinson, K. E. 2016. Project Jacquard: Interactive Digital Textiles at Scale. *Proceedings of the 2016 CHI Conference on Human Factors in Computing Systems*. (San Jose, California, USA, 2016). 4216–4227. <https://doi.org/10.1145/2858036.2858176>
- [45] Pouta, E. and Mikkonen, J. 2019. Hand Puppet as Means for eTextile Synthesis. *Proceedings of the Thirteenth International Conference on Tangible, Embedded, and Embodied Interaction*. (Tempe, Arizona, USA, 2019). 415–421. <https://doi.org/10.1145/3294109.3300987>
- [46] Pouta, E. and Mikkonen, J. V. 2022. Woven eTextiles in HCI — a Literature Review. *Designing Interactive Systems Conference*. (Virtual Event, Australia, 2022). 1099–1118. <https://doi.org/10.1145/3532106.3533566>
- [47] Rocha, B. G. d., Andersen, K. and Tomico, O. 2022. Portfolio of Loose Ends. *Designing Interactive Systems Conference*. (Virtual Event, Australia, 2022). 527–540. <https://doi.org/10.1145/3532106.3533516>
- [48] Rocha, B. G. d., Spork, J. and Andersen, K. 2022. Making Matters: Samples and Documentation in Digital Craftsmanship. *Sixteenth International Conference on Tangible, Embedded, and Embodied Interaction*. (Daejeon, Republic of Korea, 2022). <https://doi.org/10.1145/3490149.3502261>



- [49] Rognoli, V., Bianchini, M., Maffei, S. and Karana, E. DIY materials. *Materials & Design*, 86 (2015), 692-702. [10.1016/j.matdes.2015.07.020](https://doi.org/10.1016/j.matdes.2015.07.020)
- [50] Sun, R., Onose, R., Dunne, M., Ling, A., Denham, A. and Kao, H.-L. 2020. Weaving a Second Skin: Exploring Opportunities for Crafting On-Skin Interfaces Through Weaving. *Proceedings of the 2020 ACM Designing Interactive Systems Conference*. (2020). 365–377. <https://doi.org/10.1145/3357236.3395548>
- [51] Tsaknaki, V. and Elblaus, L. Year. A wearable nebula material investigations of implicit interaction New York, NY, USA, 2019). 625-633. <https://dl.acm.org/doi/10.1145/3294109.3295623>
- [52] Veja, P. An investigation of integrated woven electronic textiles (e-textiles) via design led processes. Doctoral Dissertation, Brunel University London, 2015.
- [53] Walters, K. 2021. Fibre, fabric, and form: Embedding transformative three-dimensionality in weaving. *NORDES 2021 CONFERENCE: Matters of Scale*, Kolding, Denmark, 15-18 August, 2021. (2021, 2021) [https://conference2021nordes.org/wp-content/uploads/2021/08/Nordes-2021-Proceeding\\_150821.pdf](https://conference2021nordes.org/wp-content/uploads/2021/08/Nordes-2021-Proceeding_150821.pdf)
- [54] Wang, Y., Gong, H. and Cui, Z. 2021. ScenThread: Weaving Smell into Textiles. *The Adjunct Publication of the 34th Annual ACM Symposium on User Interface Software and Technology*. (Virtual Event, USA, 2021). 83–85. <https://doi.org/10.1145/3474349.3480235>
- [55] Woop, E., Friederike Zahn, E., Flechtner, R. and Joost, G. Year. Demonstrating a Modular Construction Toolkit for Interactive Textile Applications New York, NY, USA, Year). 1-4. <https://dl.acm.org/doi/10.1145/3419249.3420075>
- [56] Wu, T., Fukuhara, S., Gillian, N., Sundara-Rajan, K. and Poupyrev, I. 2020. ZebraSense: A Double-sided Textile Touch Sensor for Smart Clothing. *UIST '20: Proceedings of the 33rd Annual ACM Symposium on User Interface Software and Technology*. (2020). 662–674. <https://doi.org/10.1145/3379337.3415886>
- [57] Zhou, J., Barati, B., Wu, J., Scherer, D. and Karana, E. Digital biofabrication to realize the potentials of plant roots for product design. *Bio-Design and Manufacturing*, 4, 1 (2021/03/01 2021), 111-122. [10.1007/s42242-020-00088-2](https://doi.org/10.1007/s42242-020-00088-2)