

## Micro-Cantilever Testing Of Cementitious Materials Under Various Loading Conditions

Gan, Yidong; Zhang, Hongzhi; Šavija, Branko; Schlangen, E.; van Breugel, Klaas

**DOI**

[10.21012/FC10.235598](https://doi.org/10.21012/FC10.235598)

**Publication date**

2019

**Document Version**

Final published version

**Published in**

Proceedings of the 10th International Conference on Fracture Mechanics of Concrete and Concrete Structures

**Citation (APA)**

Gan, Y., Zhang, H., Šavija, B., Schlangen, E., & van Breugel, K. (2019). Micro-Cantilever Testing Of Cementitious Materials Under Various Loading Conditions. In G. Pijaudier-Cabot, P. Grassl, & C. La Borderie (Eds.), *Proceedings of the 10th International Conference on Fracture Mechanics of Concrete and Concrete Structures* <https://doi.org/10.21012/FC10.235598>

**Important note**

To cite this publication, please use the final published version (if applicable).  
Please check the document version above.

**Copyright**

Other than for strictly personal use, it is not permitted to download, forward or distribute the text or part of it, without the consent of the author(s) and/or copyright holder(s), unless the work is under an open content license such as Creative Commons.

**Takedown policy**

Please contact us and provide details if you believe this document breaches copyrights.  
We will remove access to the work immediately and investigate your claim.

## MICRO-CANTILEVER TESTING OF CEMENTITIOUS MATERIALS UNDER VARIOUS LOADING CONDITIONS

Y. GAN <sup>\*</sup>, H. ZHANG <sup>\*</sup>, B. ŠAVIJA <sup>\*</sup>, E. SCHLANGEN <sup>\*</sup> AND K. VAN BREUGEL <sup>\*</sup>

<sup>\*</sup> Delft University of Technology (TUD)

Delft, The Netherlands

e-mail: [y.gan@tudelft.nl](mailto:y.gan@tudelft.nl)

e-mail: [h.zhang-5@tudelft.nl](mailto:h.zhang-5@tudelft.nl)

e-mail: [b.savija@tudelft.nl](mailto:b.savija@tudelft.nl)

e-mail: [erik.schlangen@tudelft.nl](mailto:erik.schlangen@tudelft.nl)

e-mail: [K.vanBreugel@tudelft.nl](mailto:K.vanBreugel@tudelft.nl)

**Key words:** Cement paste; Micro-scale test; Micromechanics

**Abstract:** Nanoindentation is usually used to investigate local elastic properties and hardness of materials. In this paper, the nanoindenter served as a loading tool to perform micro scale bending tests and measure the global response of micro-scale specimens. For testing, cement paste cantilever beams with a square cross-section of  $300\ \mu\text{m} \times 300\ \mu\text{m}$  were fabricated using a micro dicing saw. Monotonic, cyclic and sustained loading bending tests were conducted on the beams using the nanoindenter. The load-deflection behaviours of micro-cantilever beams subjected to various loading conditions are presented in this paper. The interpretation of experimental results regarding the measured deflection of beam is discussed. With this micro-scale test method, the fracture strength as well as time-dependent responses of cement paste at the micrometre level can be assessed in a straightforward manner.

### 1 INTRODUCTION

It is well known that the macroscopic performance of cementitious material mainly depend on the material structure and properties at micro-scale [1]. In the past decades, many studies have been devoted to characterizing the fundamental properties of hardened cement paste [2–4]. Among them, nanoindentation has emerged as a powerful tool for this purpose. By indenting a very sharp tip into the surface of a material, local elastic properties and hardness of the material microstructure and nanostructure can be determined [5]. Apart from the mechanical properties, the time-dependent properties of cement paste (i.e. creep) can also been investigated using the nanoindentation technique [6–9]. However, one major concern of this technique is that the

indentation results may be affected by the spatial heterogeneity of the cementitious material [4] as the mechanical properties and geometry of the elastic/plastic zone below the indenter vary with the local material structure. An alternative approach is to create a micro-scale specimen, for example using focus ion beam milling technique, which has been widely applied to other materials [10–15]. The fabricated specimens are then loaded by a blunt indenter tip, such as a flat punch or a custom-made loading probe [16]. In this way the mechanical properties of materials can be assessed. Recently, Schlangen et al. [17] and Zhang et al. [18] developed a procedure to prepare small scale specimens with the application of a precision micro dicing instrument. A range of tests with different

geometries of specimens have been performed, including cubic splitting, cantilever bending and three-point bending [19–21]. These tests provide valuable information of the micromechanical behaviour of cement paste under monotonic loading. Furthermore, it is also interesting to investigate the time-dependent properties of cement paste at micro level. In this paper, the micro-cantilever beams were prepared using the micro dicing saw. Micro-bending tests were performed using the nanoindenter with a cylindrical wedge tip. The responses of beams to monotonic, sustained and cyclic loading were investigated.

## 2 MATERIALS AND SAMPLE PREPARATION

All samples were prepared using standard grade OPC CEM-I 42.5 N cement and deionized water. The water/cement ratio was 0.4. After casting in a cylindrical bottle with 24mm diameter and 39mm height, the cement paste was cured in sealed conditions for 28 days at room temperature (20 °C). Afterwards, slices with a thickness of 2-3 mm were cut from the sample and then ground to obtain smooth and parallel surfaces using a Struers Labopol-5 thin sectioning machine. The slices were then immersed in isopropanol to stop the hydration. For more details of the sample preparation, the reader is referred to [20].

The next step is to prepare the miniaturized cantilever beams. This is achieved by utilizing a precision micro dicing machine (MicroAce Series 3 Dicing Saw, Loadpoint Limited), which is mainly applied to cut semiconductor wafers. Resin blade with the thickness of 250  $\mu\text{m}$  was used and two perpendicular cutting directions were applied in the cutting process. In this way a row of cantilever beams with a square cross section of 300  $\mu\text{m} \times 300 \mu\text{m}$  were obtained. The average cantilevered length was  $1.65 \pm 0.01$  mm. The cutting process is schematically shown in Figure 1. The environmental scanning electron microscope (ESEM) was used to check the cross-section of the beams (Figure 2). It is found that the fabrication process yields an overall accuracy for the cross-sectional dimensions of  $\pm 5 \mu\text{m}$ .

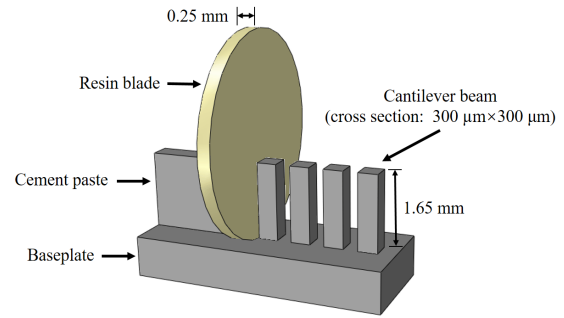

Figure 1: Schematic diagram of sample preparation.

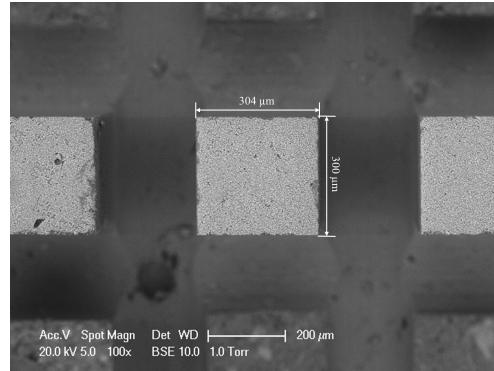

Figure 2: ESEM image of the cross-sections of beams.

## 3 TEST PROCEDURE

A KLA Nano indenter G200 was used to conduct bending tests on the cantilever beams. The tests were conducted at room temperature with the relative humidity of 40%-45%. The experimental set-up is shown in Figure 3. The beams were horizontally attached on a flat wall of the fixed nut using cyanoacrylate adhesive (Loctite Superglue 3). A diamond cylindrical wedge indenter tip (Figure 4) with a length of 200  $\mu\text{m}$  was used to apply vertically line load at the free end of beam.

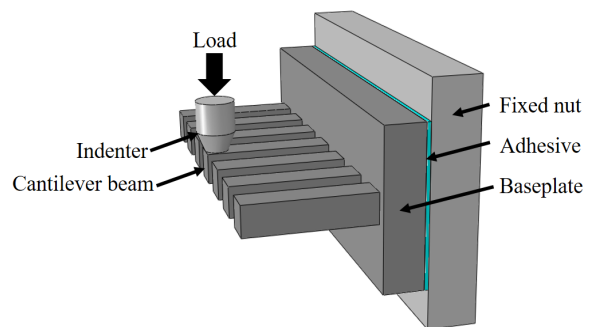

Figure 3: Schematic diagram of test set-up.

Displacement controlled loading procedure with a loading rate of 50 nm/s was used in static tests. The beams were statically loaded until failure. Constant amplitude triangular wave, see Figure 5(a), was used for the cyclic loading. The loading frequency was 1 Hz and the loading ratio between lower load and upper load was 0.1. The applied upper load  $P_{upper}$  ranged from 85% to 95% of the average failure load in static tests. The beams were loaded to failure with several identical loading blocks (500 cycles). For sustained-loading bending tests, after reaching the targeted loading level, the load was kept constant for 800 seconds and then unloaded to zero, see Figure 5(b). The applied load level ranged from 60%-80% of static failure load. In all three loading regimes, the load-displacement curve was recorded by the nanoindenter. After static or fatigue failure, the distance between the load point and the fracture point was measured by the in-situ imaging technique.

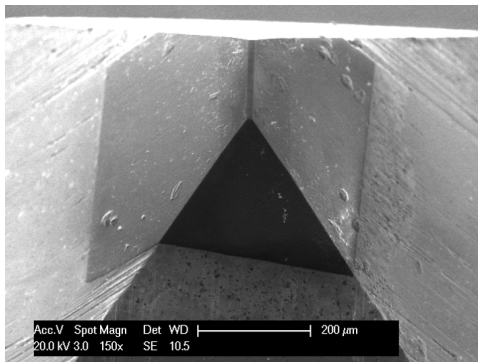

Figure 4: Diamond cylindrical wedge tip.

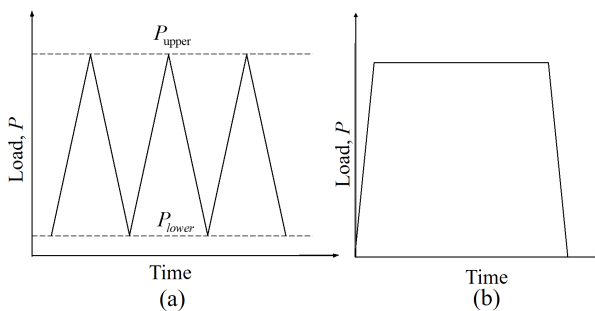
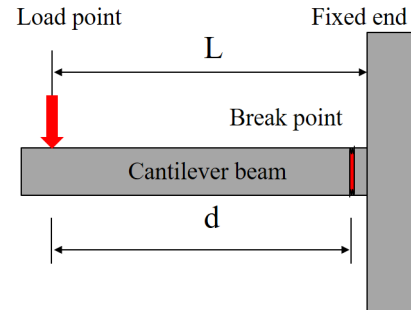

Figure 5: Loading history of (a) the cyclic loading tests and (b) the sustained loading tests.

#### 4 RESULTS AND DISCUSSION

A typical fracture mode is illustrated in

Figure 6. Both static and fatigue fracture exhibit similar failure mode. A major crack always initiated at the beam section around 0-100 μm near the fixed end, which eventually leads to the complete fracture of the beam.



(a)

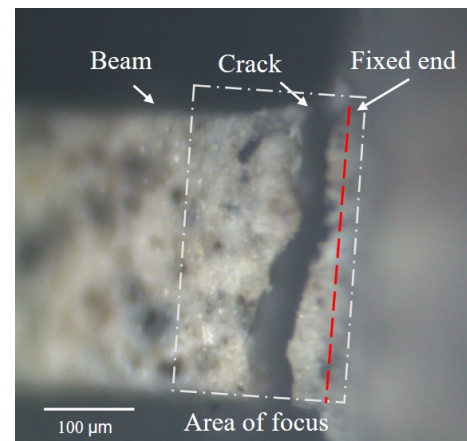

(b)

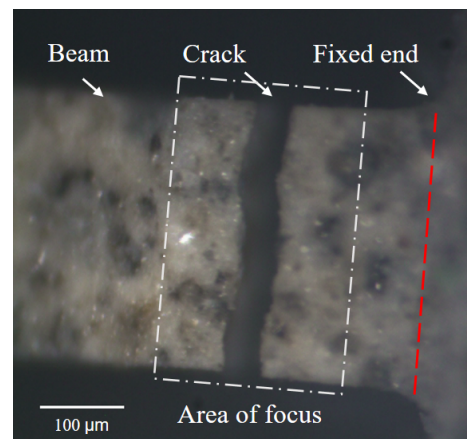

(c)

Figure 6: Schematic diagrams of the fracture mode

The mechanical properties of cementitious beams, in terms of flexural strength and elastic modulus, can be calculated based on the load-displacement curve. For determination of

flexural strength, the maximum load was used according to Equation (1).

$$f_t = F_{\max} dh / 2I_y \quad (1)$$

where  $d$  is the distance between the load point and the fracture point,  $h$  is the side length of the square cross-section, and  $I_y = h^4/12$  is the moment of inertia. The slope of load-displacement curve was used to determine the elastic modulus according to Equation (2).

$$E = kL^3 / 3I_y \quad (2)$$

where  $L$  is the length of the cantilever beam;  $k$  is the slope of load-displacement curve before failure.

It is worth noting that the measured deflection of beams consisting of elastic, plastic as well as viscous deformation should be carefully interpreted considering the boundary conditions and testing duration used in this study. In general, there are several possible sources of additional deformation, such as the local deformation of the connected part at the fixed end of beam, the deformation of the adhesive and the local indentation depth. The first two effects can be evaluated by using the finite element method [20] and also by conducting comparison tests on micro-cantilever beam made of glass. For the assessment of the deflection originating from the third source, comparative tests were conducted by directly indenting on the surface of fixed cement paste block instead of cantilever beam. By applying the same magnitude of load, the measured indentation depth was compared with the beam deflection during the bending tests. However due to the heterogeneous microstructure of cement paste, the indentation depth may exhibit scatter. In current preliminary study, all these effects were not considered in the following presented results.

A typical stress ratio-relative deflection curve for the static test is shown in Figure 7. It can be seen that under increasing monotonic loading the beam exhibits elastic behaviour before the peak load. It is then followed by an overshoot of the indentation tip. This is due to the brittle failure and the fact that the

displacement control of the nanoindenter is not fast enough to capture the post-peak behaviour of the specimen.

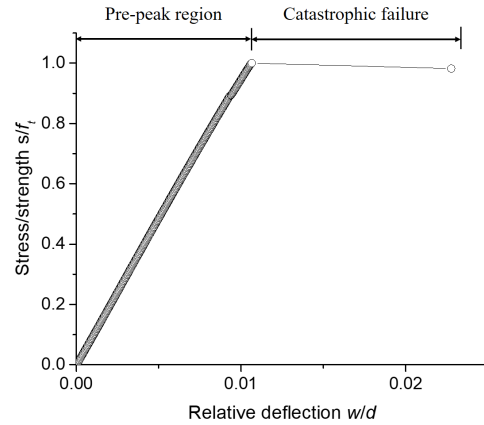

Figure 7: Load-displacement curves of static tests.

Several experimental results of sustained and cyclic bending tests are shown in Figure 8, 9, respectively. For the sustained loading test, the creep behaviour of the beam was observed. Similar findings are also reported in nanoindentation tests [6–8]. For the cyclic loading test, it is shown in Figure 9 that the loading stiffness remained almost constant while the residual deformation increases with the loading cycles. The insignificant change of stiffness indicates that there was little damage accumulated inside the beams. However, the increasing deformation under cyclic loading may be attributed to the time-dependent behavior of cement paste. This cyclic creep phenomenon of cement paste [6] has also been observed in most macroscopic experiments [22,23].

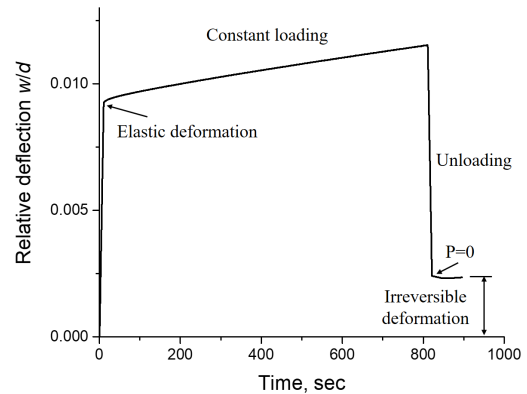

Figure 8: Load-displacement curves of creep tests.

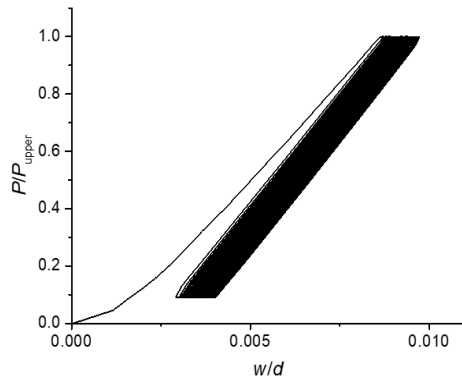

Figure 9: Load-displacement curves of fatigue tests.

## 12 CONCLUSIONS

A nanoindenter was utilized for the direct measurement of micro-cantilever beam deflection subjected to monotonic, sustained and cyclic loading. This experimental method enables us to directly investigate the mechanical properties and time-dependent behaviours of cement paste at micrometre level. For future research, more systematic and quantitative studies will be performed.

## REFERENCES

- [1] Mondal, P., Shah, S. P. and Marks, L., 2007. A reliable technique to determine the local mechanical properties at the nanoscale for cementitious materials. *Cem. Concr. Res.* **37**:1440–1444.
- [2] Hu, C. and Li, Z., 2015. A review on the mechanical properties of cement-based materials measured by nanoindentation. *Constr. Build. Mater.* **90**:80–90.
- [3] Constantinides, G. and Ulm, F. J., 2004. The effect of two types of C-S-H on the elasticity of cement-based materials: Results from nanoindentation and micromechanical modeling. *Cem. Concr. Res.* **34**:67–80.
- [4] Luković, M., Schlangen, E. and Ye, G., 2015. Combined experimental and numerical study of fracture behaviour of cement paste at the microlevel. *Cem. Concr. Res.* **73**:123–135.
- [5] Oliver, W. C. and Pharr, G. M., 2004. Measurement of hardness and elastic modulus by instrumented indentation: Advances in understanding and refinements to methodology. *J. Mater. Res.* **19**:3–20.
- [6] Němeček, J., 2009. Creep effects in nanoindentation of hydrated phases of cement pastes. *Mater. Charact.* **60**:1028–1034.
- [7] Vandamme, M. and Ulm, F., 2009. Nanogranular origin of concrete creep. *Proc. Natl. Acad. Sci. U.S.A.* **106**:6–8.
- [8] Vandamme, M. and Ulm, F., 2013. Nanoindentation investigation of creep properties of calcium silicate hydrates. *Cem. Concr. Res.* **52**:38–52.
- [9] Pichler, C. and Lackner, R., 2009. Identification of Logarithmic-Type Creep of Calcium-Silicate-Hydrates by Means of Nanoindentation. *Strain.* **45**:17–25.
- [10] Němeček, J., Králík, V., Šmilauer, V., Polívka, L. and Jäger, A., 2016. Tensile strength of hydrated cement paste phases assessed by micro-bending tests and nanoindentation. *Cem. Concr. Compos.* **73**:164–173.
- [11] Chen, S. J., Duan, W. H., Li, Z. J. and Sui, T. B., 2015. New approach for characterisation of mechanical properties of cement paste at micrometre scale. *Mater. Des.* **87**:992–995.
- [12] Jaya, B. N., 2015. Can microscale fracture tests provide reliable fracture toughness values? A case study in silicon. *J. Mater. Res.* **30**: 686-698.
- [13] Kiener, D., Motz, C. and Dehm, G., 2008. Dislocation-induced crystal rotations in micro-compressed single crystal copper columns. *J. Mater. Res.* **43**:2503–2506.
- [14] Liu, D. and Flewitt, P. E. J., 2017. Deformation and fracture of carbonaceous materials using in situ micro-mechanical testing. *Carbon.* **114**:261–274.
- [15] Armstrong, D. E. J., Haseeb, A. S. M. A., Roberts, S. G., Wilkinson, A. J. and Bade, K., 2012. Nanoindentation and micro-mechanical fracture toughness of electrodeposited nanocrystalline Ni–W alloy films. *Thin Solid Films.* **520**:4369–4372.
- [16] Darnbrough, J. E., 2013. Micro-scale testing of ductile and brittle cantilever beam specimens in situ with a dual beam

- workstation. *Meas. Sci. Technol.* **24**:055010.
- [17] Schlangen, E., Lukovic, M., Šavija, B. and Copuroglu, O., 2015. Nano-Indentation Testing and Modelling of Cement Paste. In Christian et al (eds), *Proc. of the 10th Inter. Conf. on Creep, Shrinkage, & Durability of Conc. & Conc. Struct. (CONCREEP-10)*, Sep 21-23, 2015, Vienna, Austria; pp.1028–1031.
- [18] Zhang, H., Šavija, B., Figueiredo, S. C. and Schlangen, E., 2017. Experimentally validated multi-scale modelling scheme of deformation and fracture of cement paste. *Cem. Concr. Res.* **102**:175–186.
- [19] Zhang, H., Šavija, B., Xu, Y. and Schlangen, E., 2018. Size effect on splitting strength of hardened cement paste: Experimental and numerical study. *Cem. Concr. Compos.* **94**:264–276.
- [20] Gan, Y., Zhang, H., Šavija, B., Schlangen, E. and van Breugel, K., 2018. Static and Fatigue Tests on Cementitious Cantilever Beams Using Nanoindenter. *Micromachines.* **9**:630.
- [21] Zhang, H., Šavija, B., Luković, M. and Schlangen, E., 2019. Experimentally informed micromechanical modelling of cement paste: An approach coupling X-ray computed tomography and statistical nanoindentation. *Compos. Part B Eng.* **157**:109–122.
- [22] Brooks, J. J. and Forsyth, P., 1986. Influence of frequency of cyclic load on creep of concrete. *Mag. Concr. Res.* **38**:139–150.
- [23] Neville, B. A. M. and Hirst, G. A., 1978. Mechanism of Cyclic Creep of Concrete. *Special Publication.* **55**: 83-102.