

A Bank of Opportunities

Reinventing a bank closer to people

Sophie Soenen - P5 presentation
Interiors Building Cities - Palace

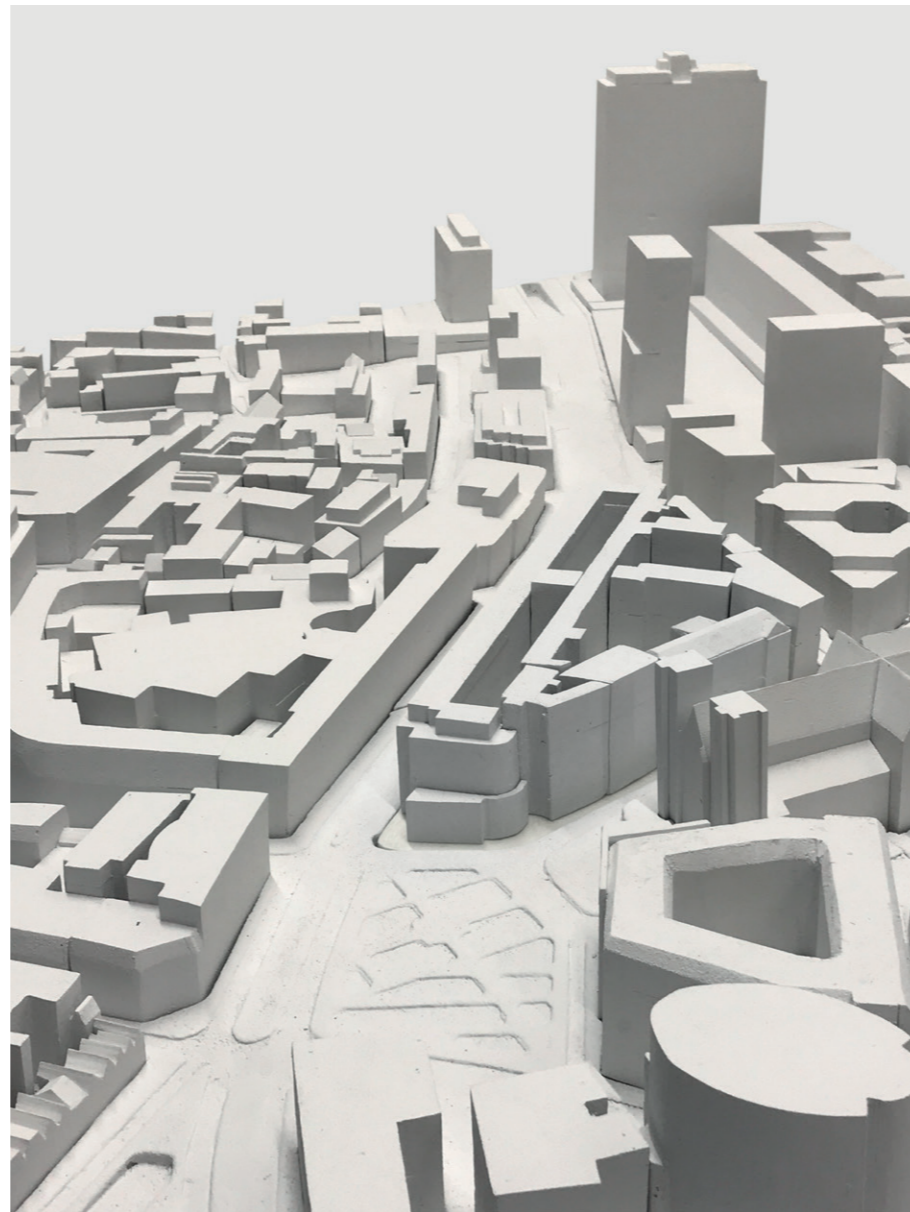

A Bank of Opportunities

*1/ Creating a new vision for the National
Bank of Belgium*

2/ Introducing the National Bank of Belgium

3/ The Bank of opportunities

4/ Creating spaces for people

1| Creating a new vision for the National
Bank of Belgium

What does the Bank of the future looks like ?



A Bank of Opportunities- Main entrance of the National Bank of Belgium

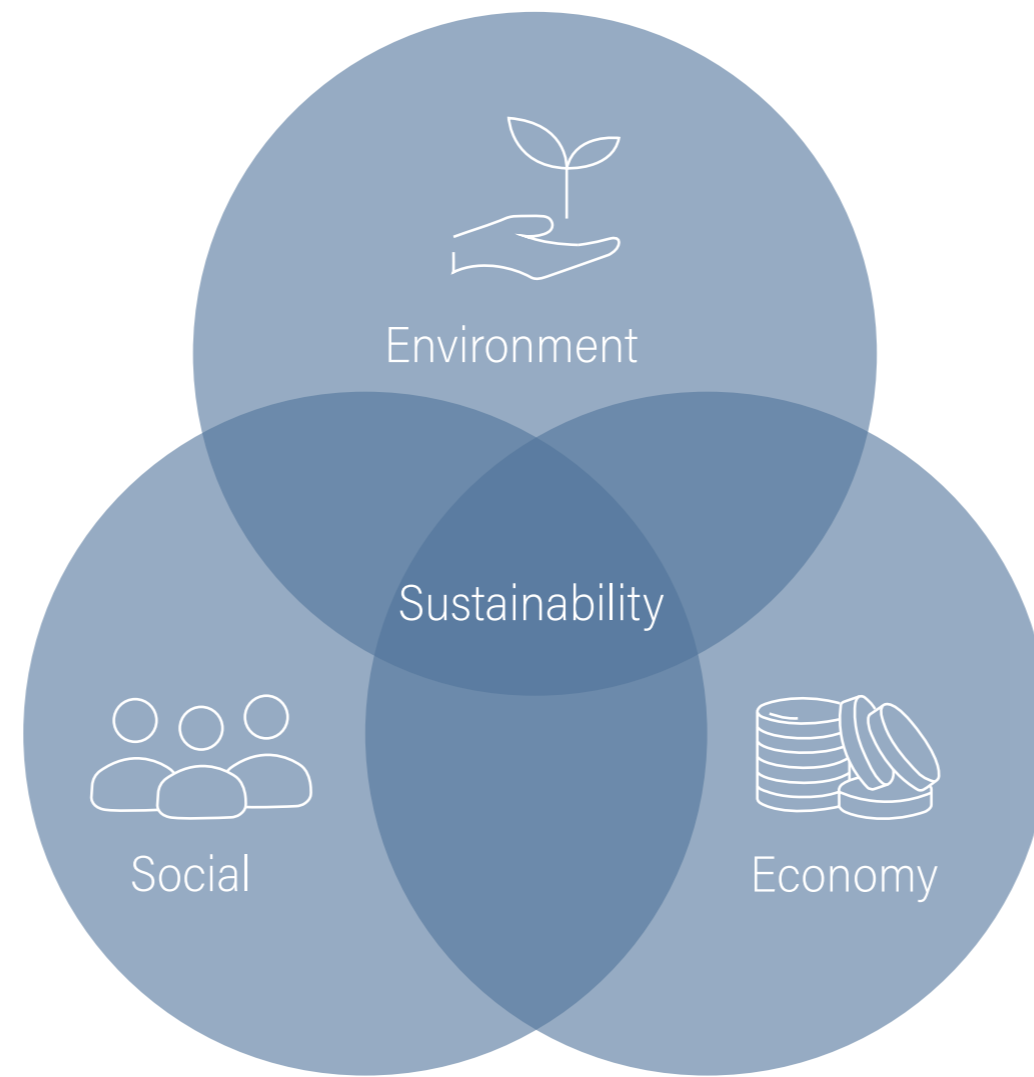

A Bank of Opportunities - A sustainable project



A Bank of Opportunities - *Laying out the intentions for the Bank*

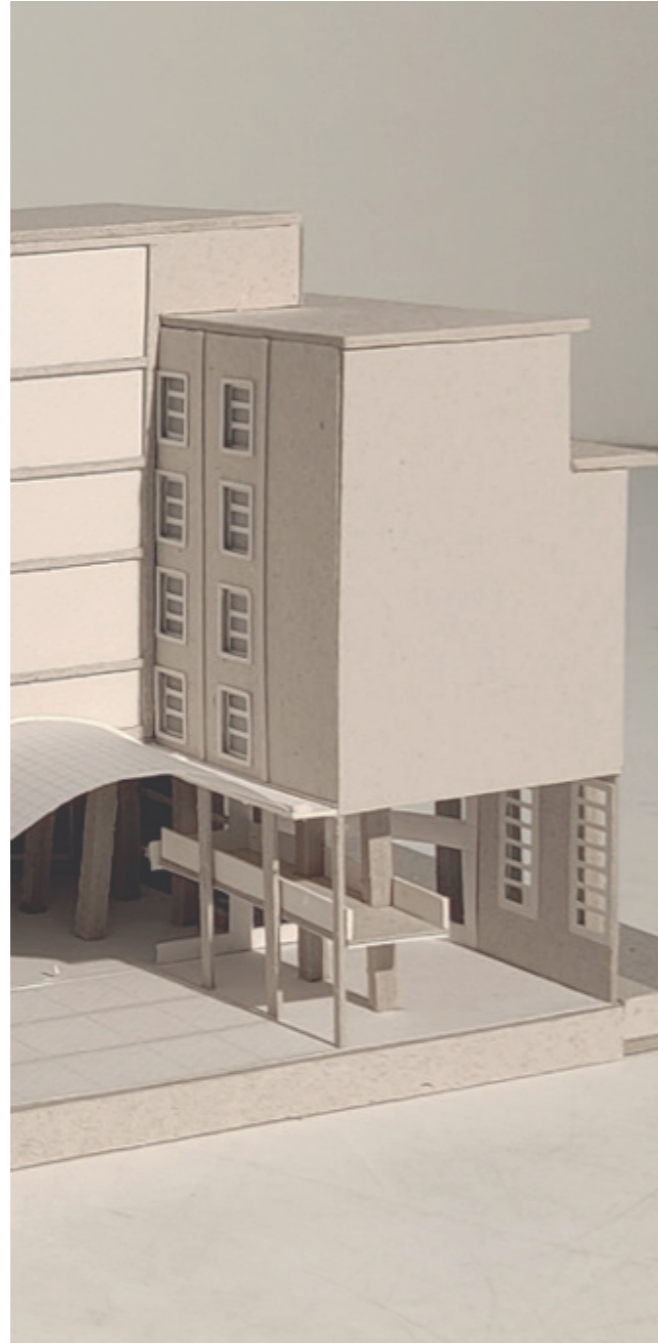

A Bank of Opportunities - *Laying out the intentions for the Bank*

2 | Introducing the National Bank of Belgium

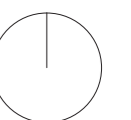

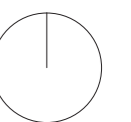
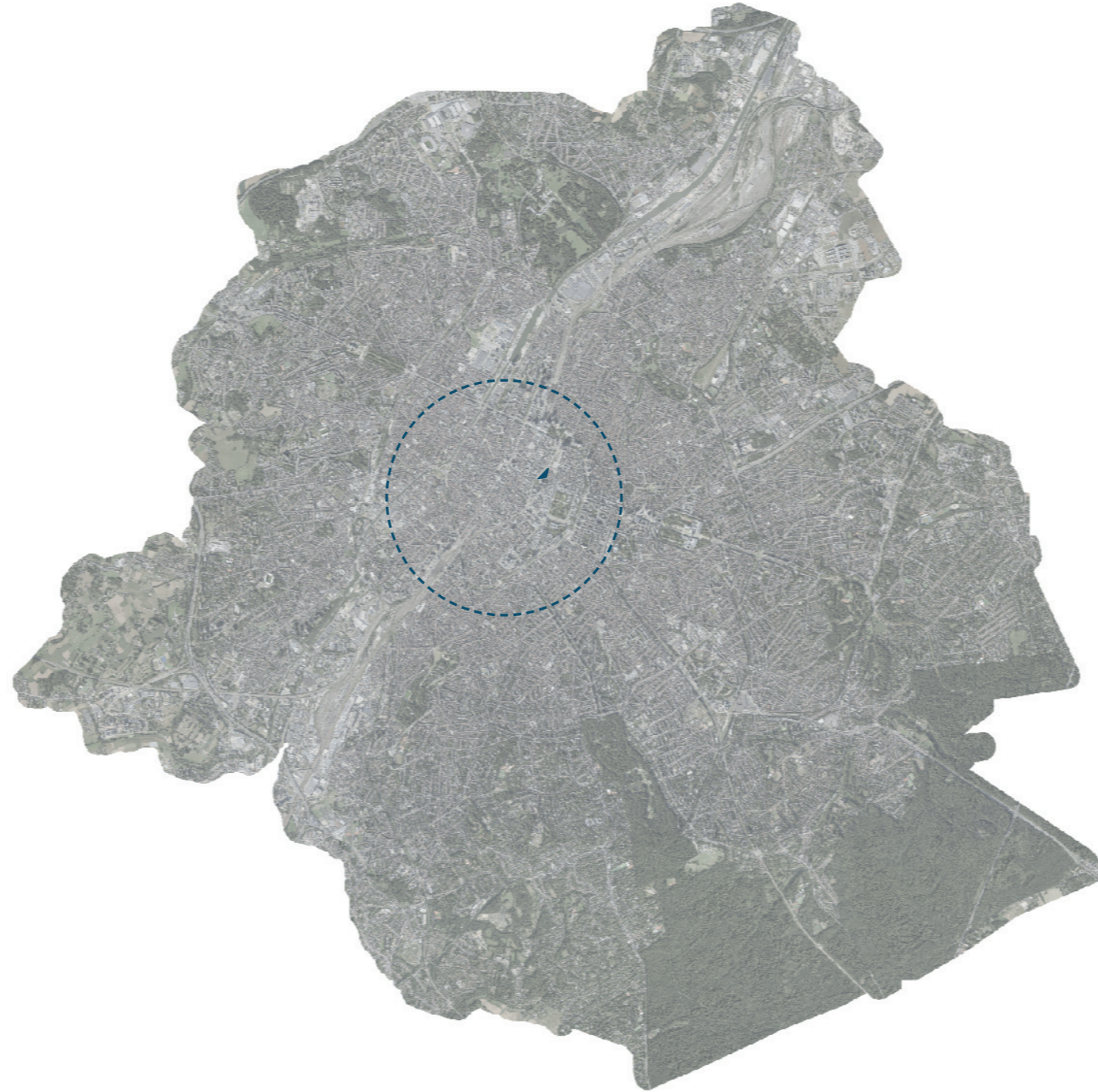

Brussels' city center

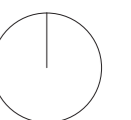

Boulevard Berlaimont



A Bank of Opportunities - *Boulevard Berlaimont*



A Bank of Opportunities - *The monumental facade of the bank*



A Bank of Opportunities - Rue de la Banque



A Bank of Opportunities - *Service entrance*



A Bank of Opportunities - Rue du Bois Sauvage



A Bank of Opportunities - Governor's Hotel

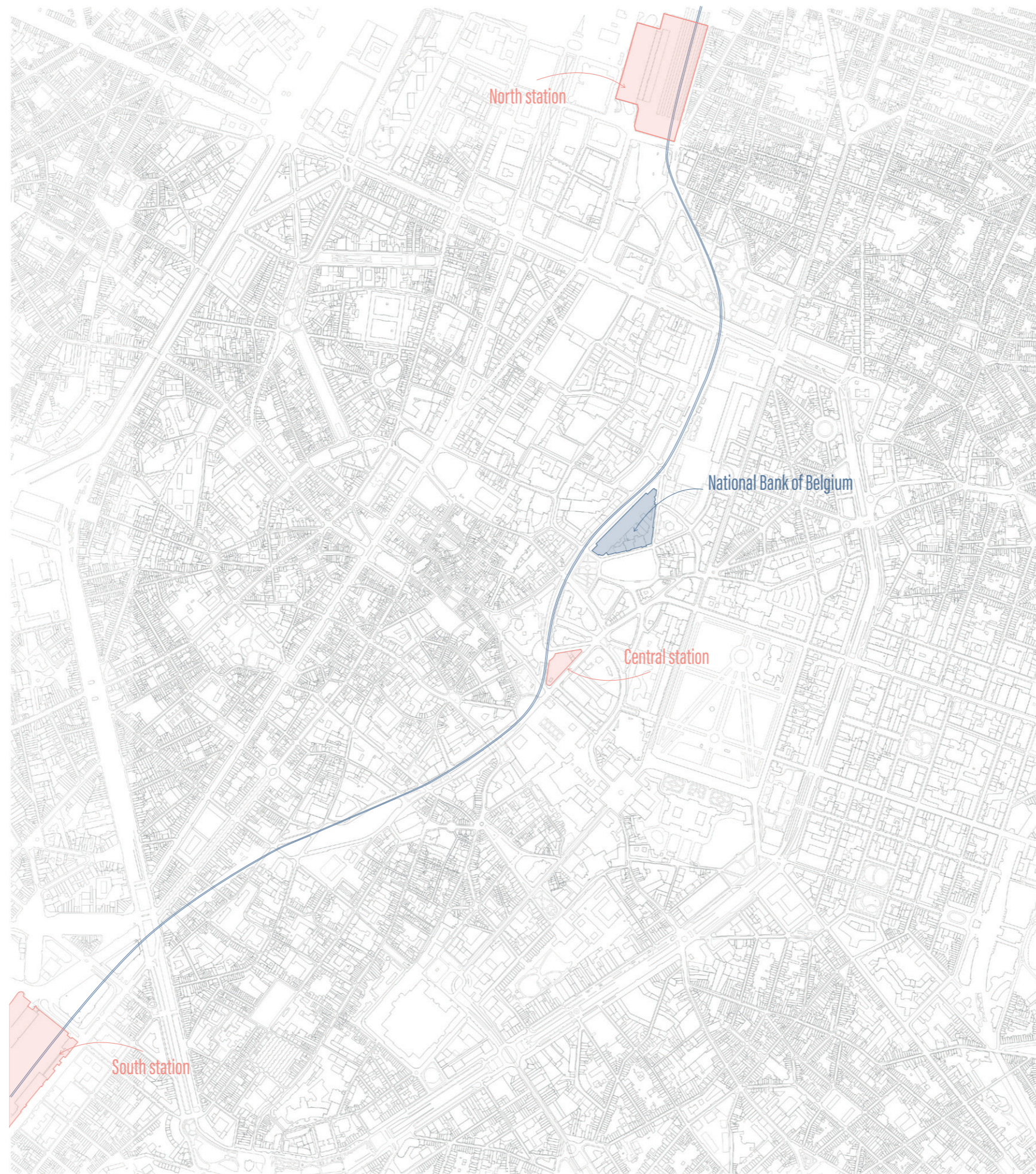

A Bank of Opportunities - *The North - South junction*



A Bank of Opportunities - *The North - South junction*



A Bank of Opportunities - *The North - South junction*

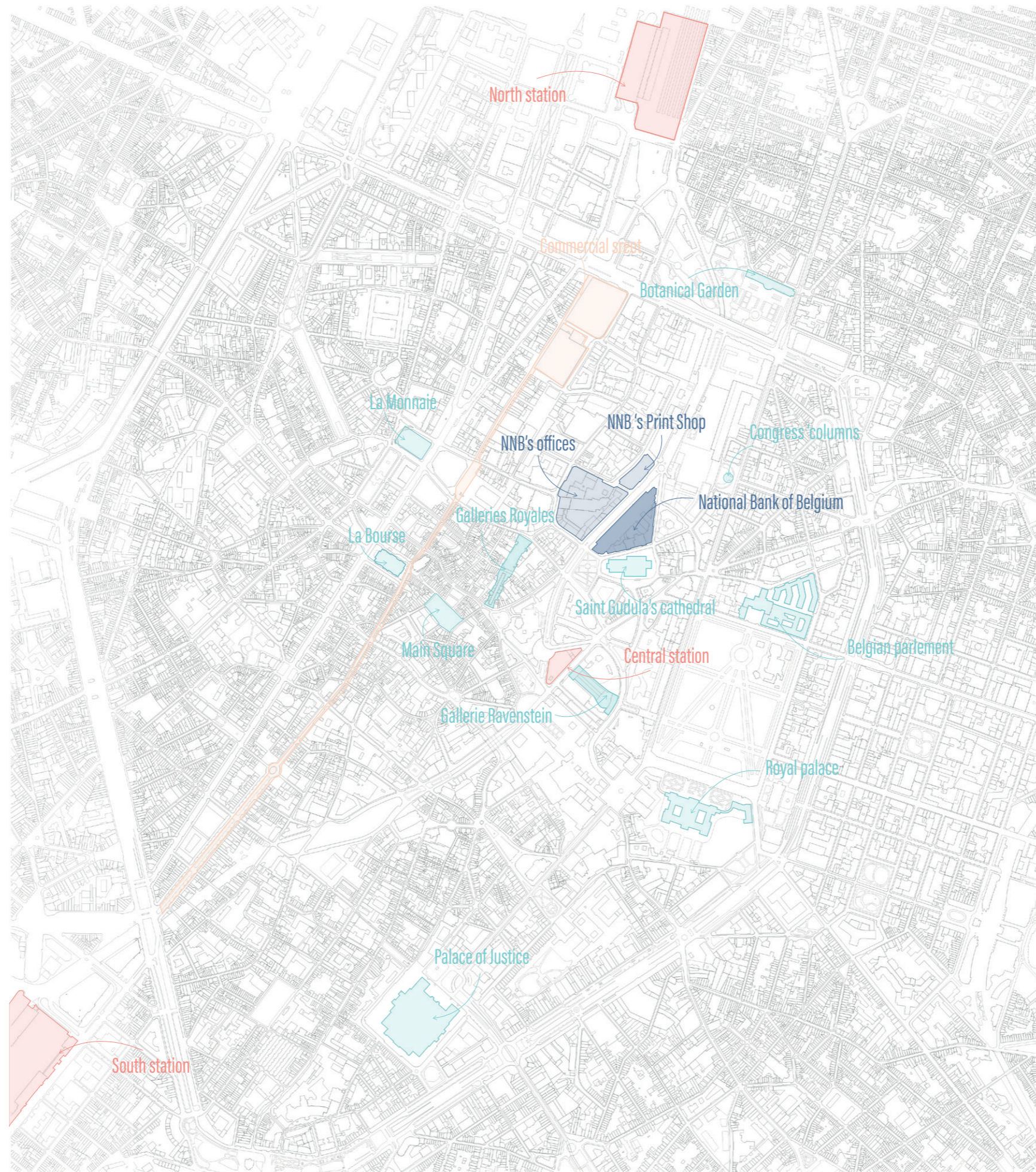

A Bank of Opportunities - *Importance of the location*

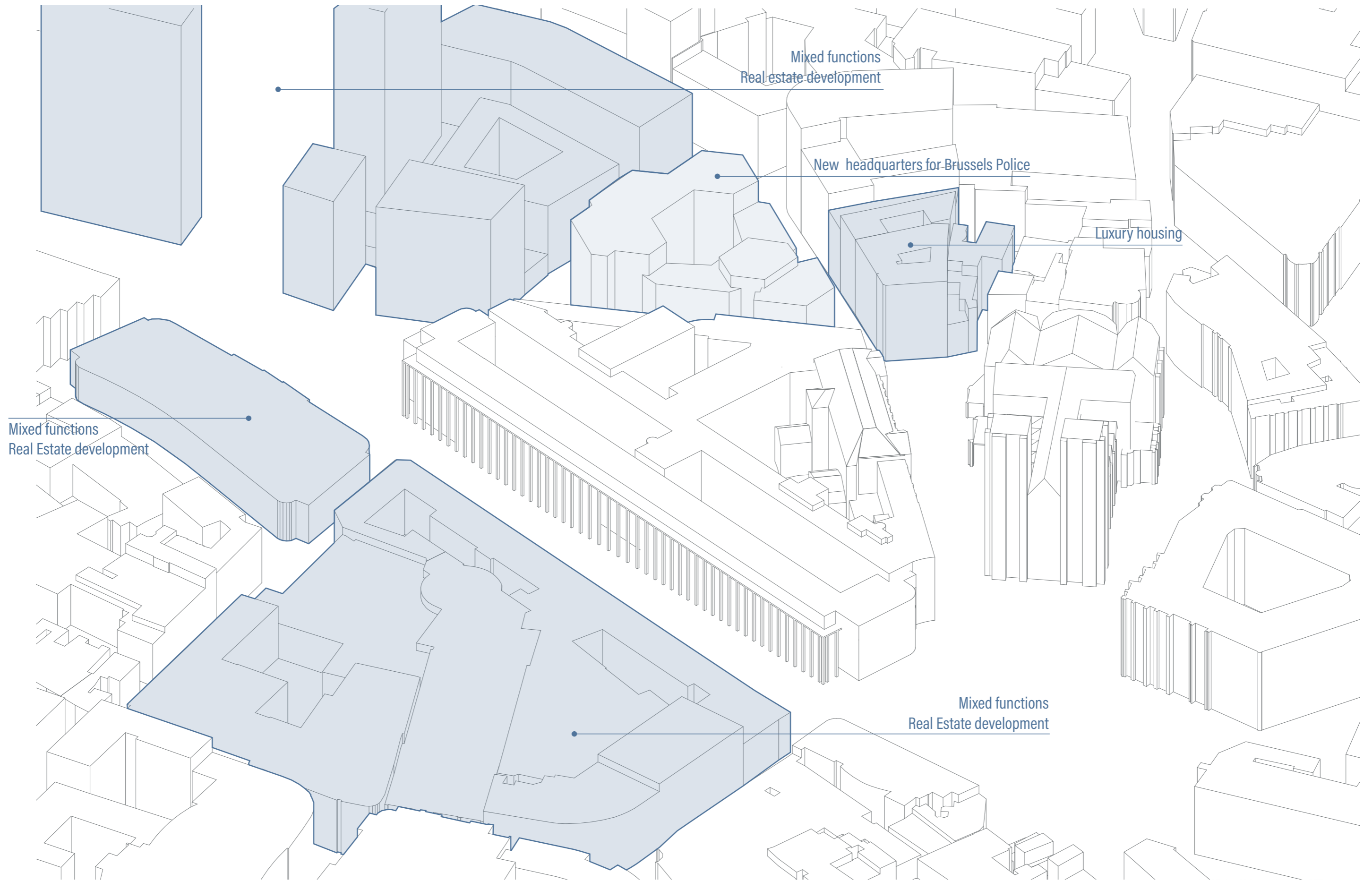

A Bank of Opportunities- *Growing neighbourhood*



A Bank of Opportunities - History of the Neighbourhood

Current situation

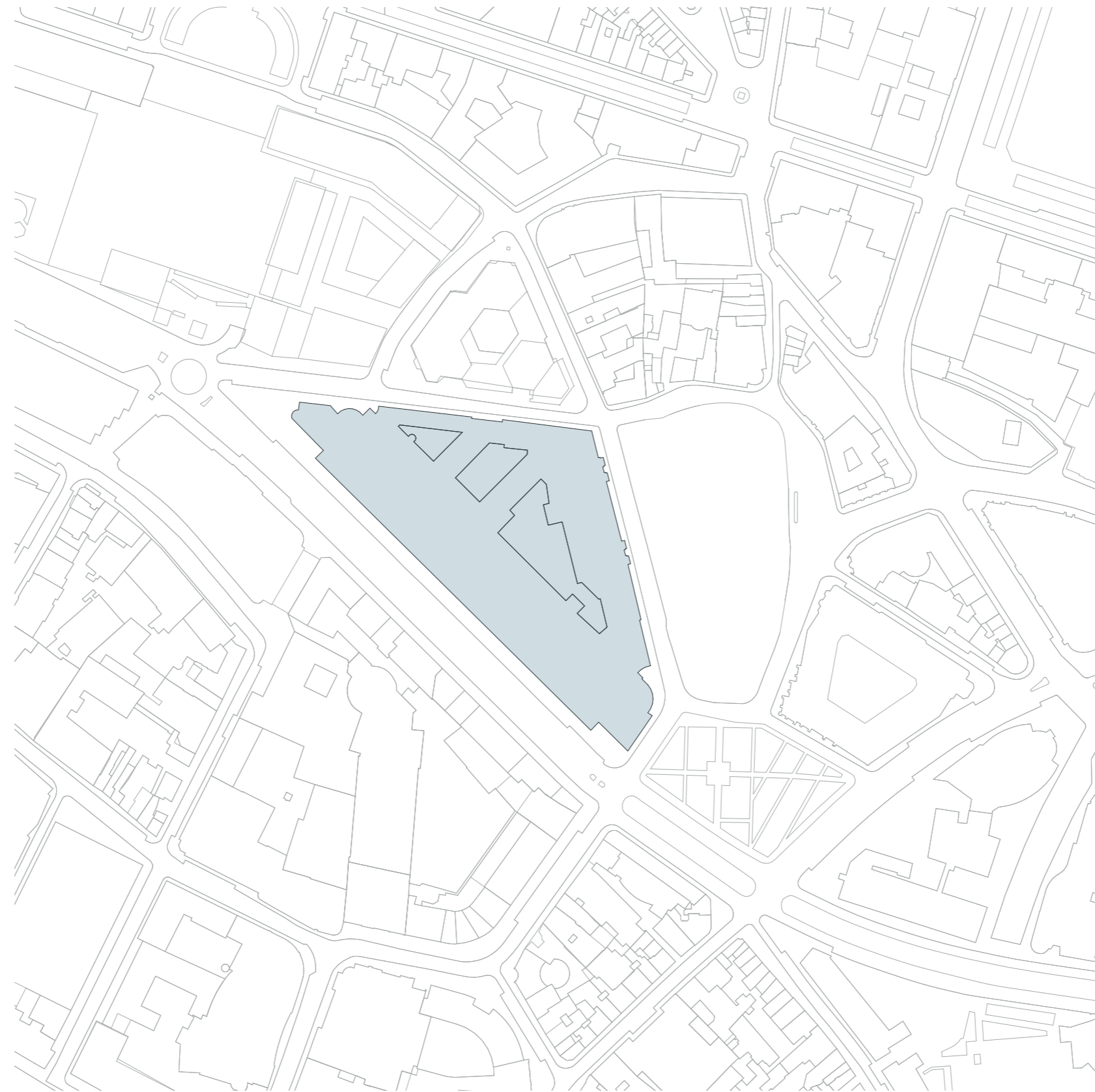

Situation in the past

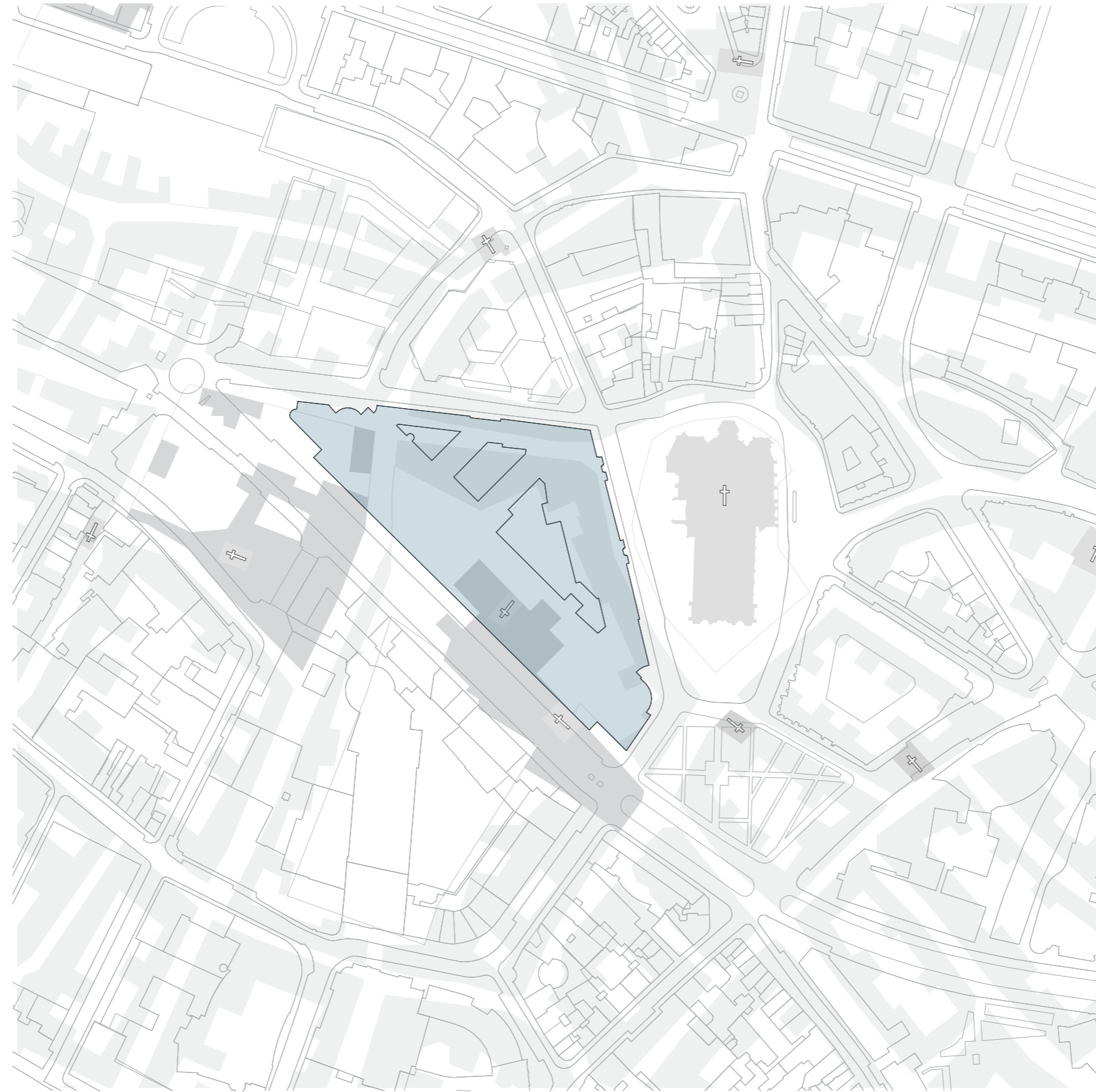



A Bank of Opportunities - *Images of the bank*

3 | The Bank of Opportunities

What if the Bank was working with and for the
community and its people ?



A Bank of Opportunities - Illustrations of the bank's employees



A Bank of Opportunities - Illustrations of the bank during the 80's



A Bank of Opportunities - Illustrations of the bank during the 80's



A Bank of Opportunities - Current situation in the Banking hall

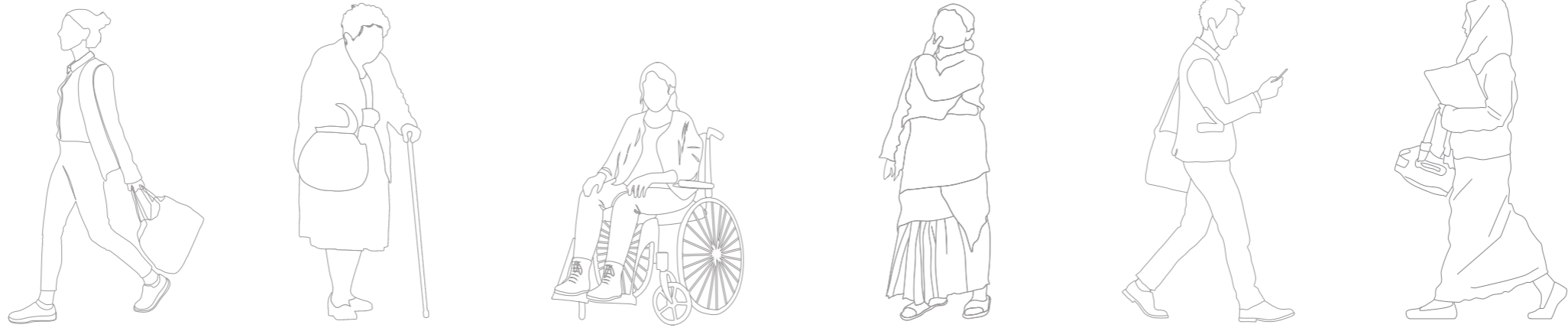

Community spaces «The Harbour»

Library
Exhibition & activity space
Social & civic spaces
Market



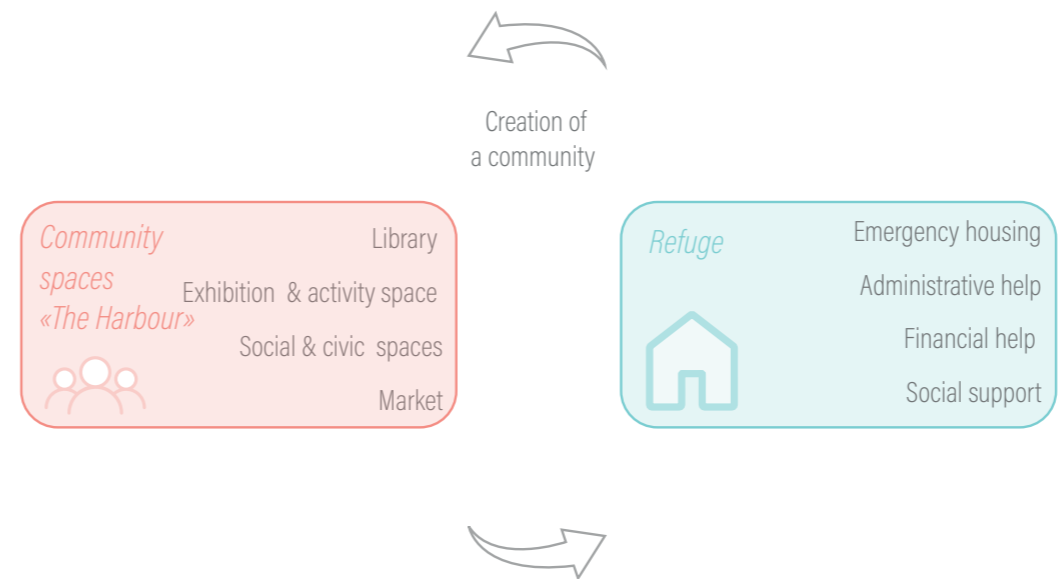

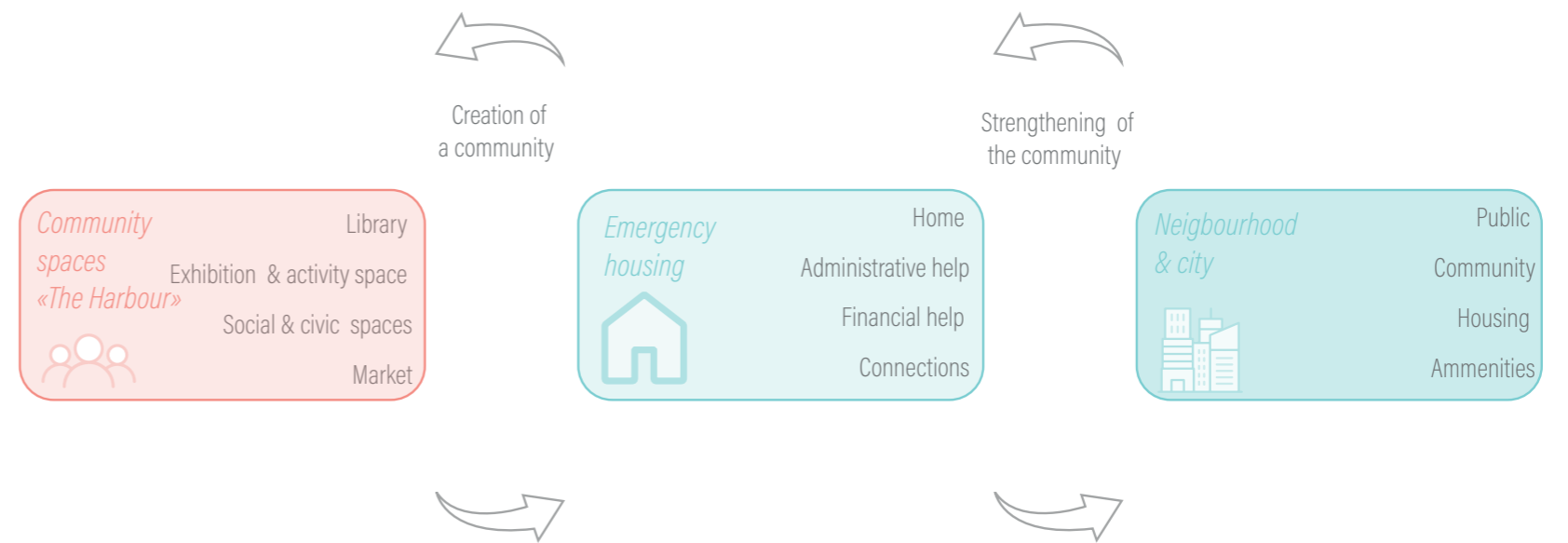

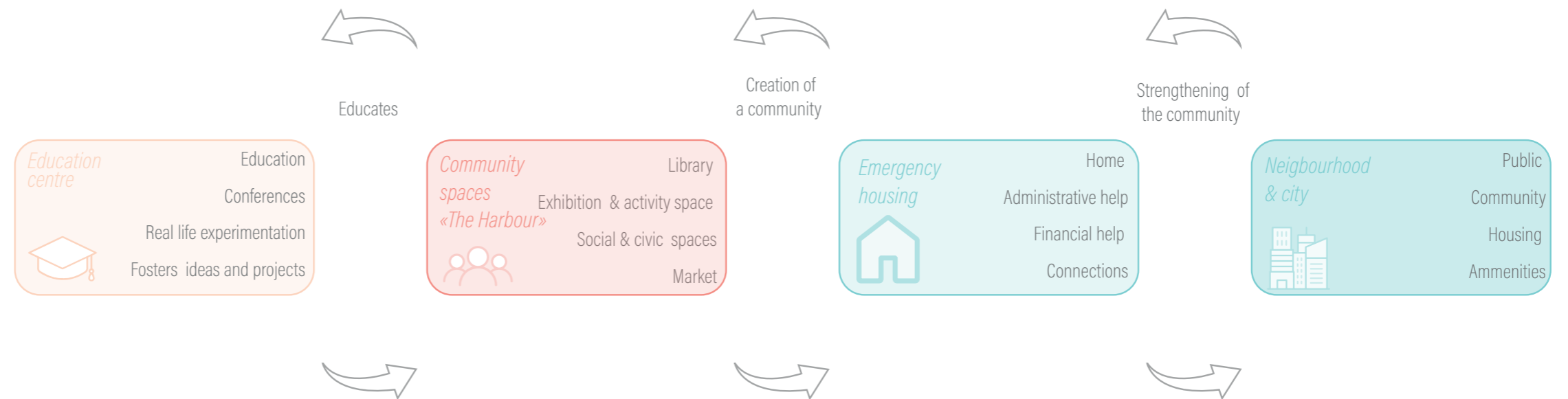

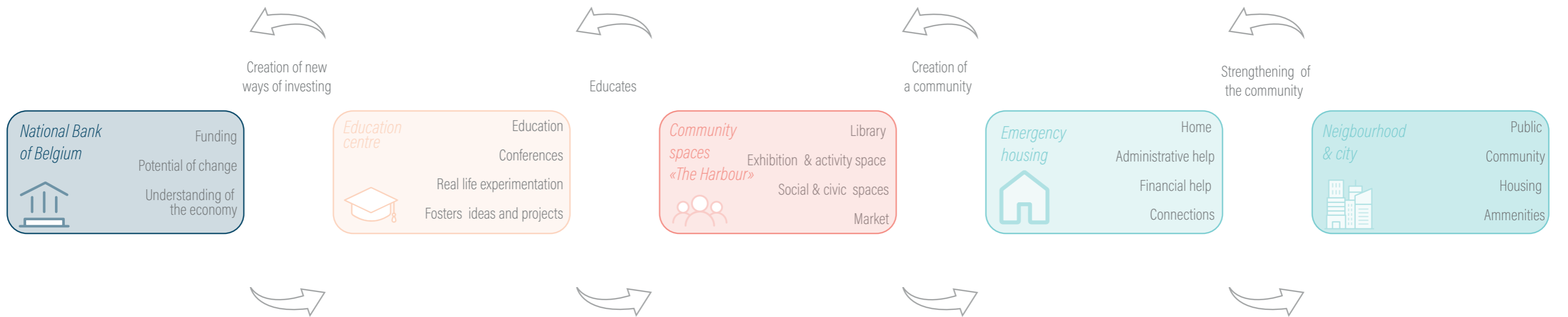

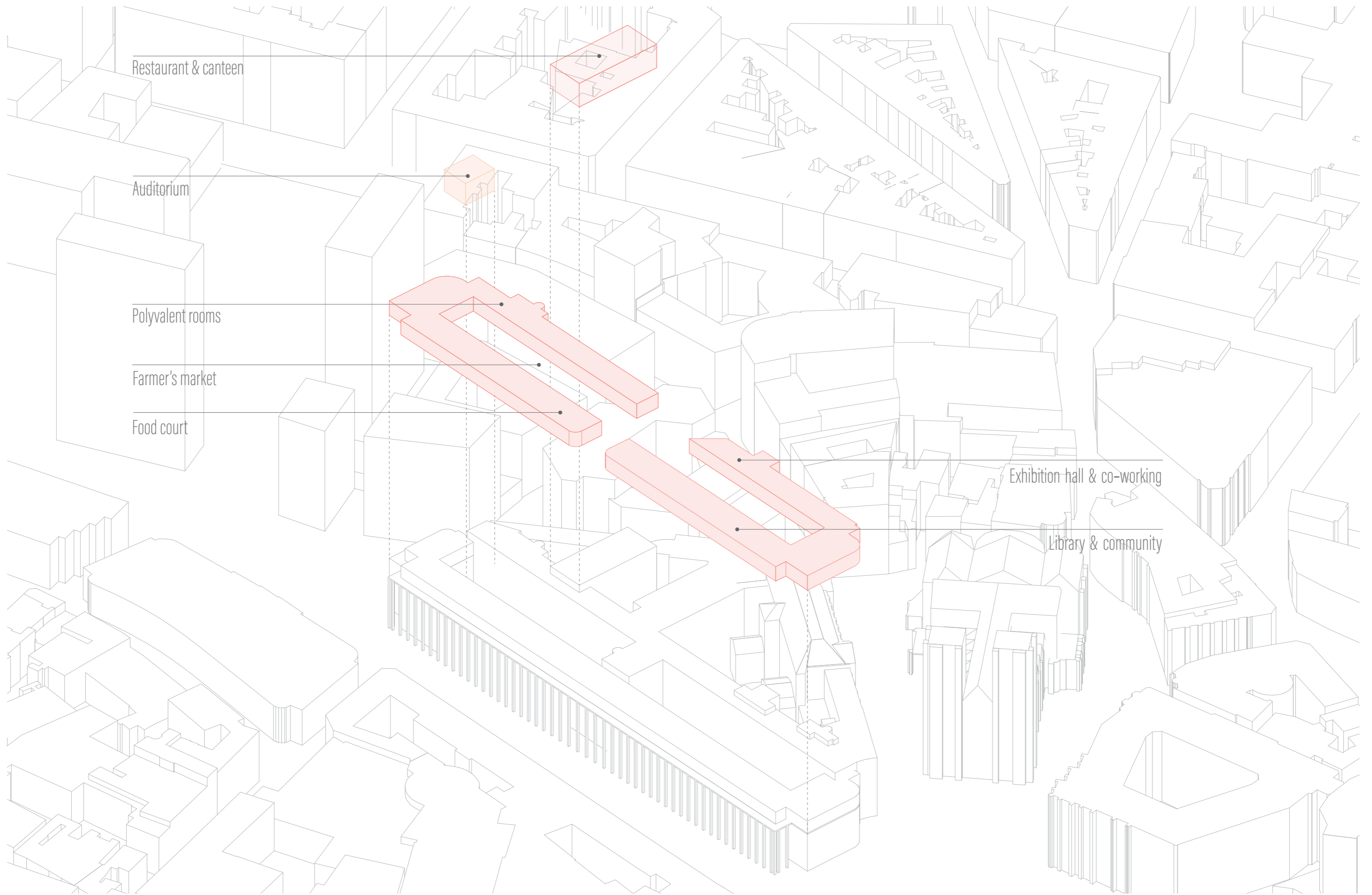

Restaurant & canteen

Auditorium

Polyvalent rooms

Farmer's market

Food court

Exhibition hall & co-working

Library & community

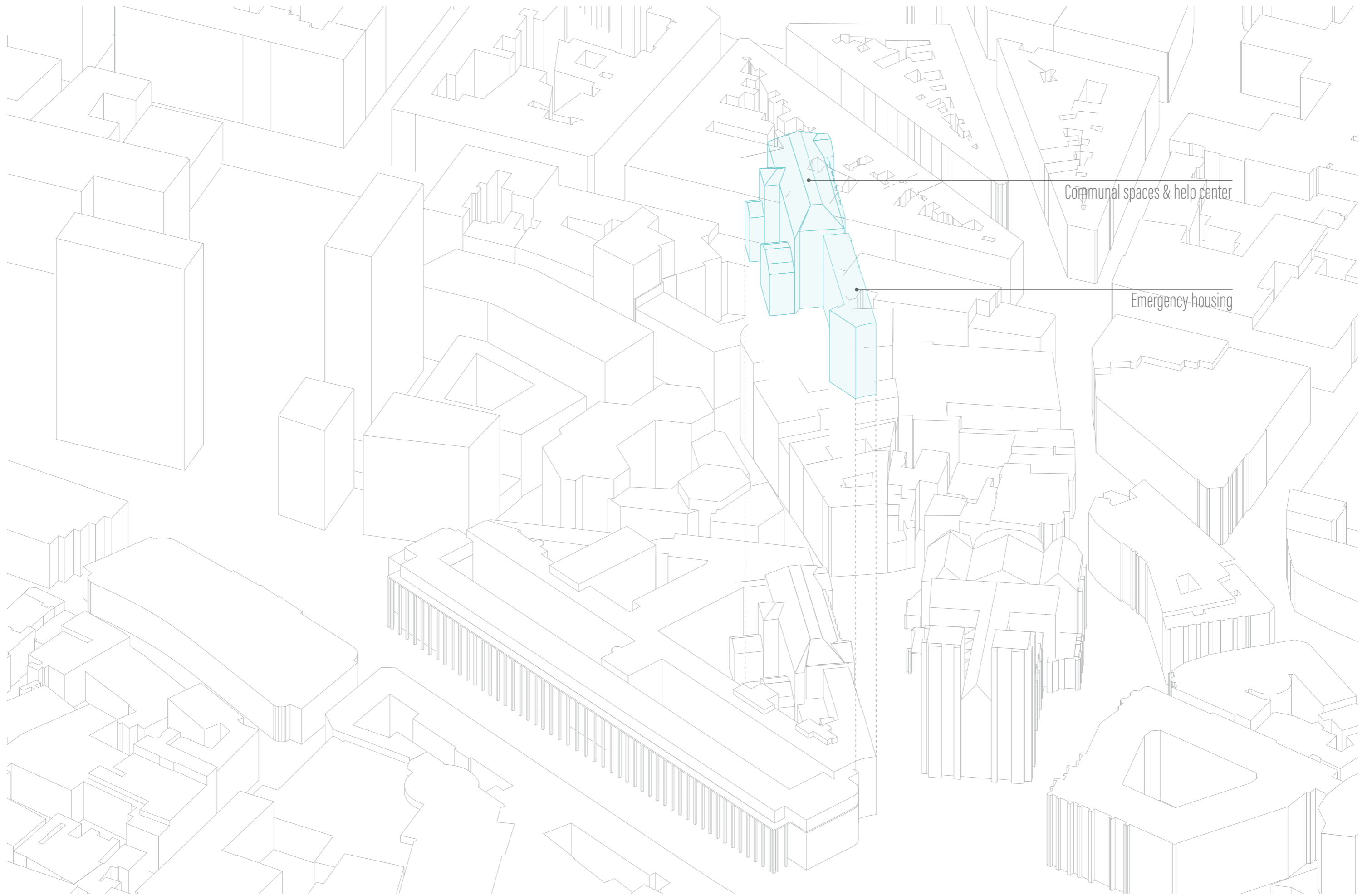

Communal spaces & help center

Emergency housing

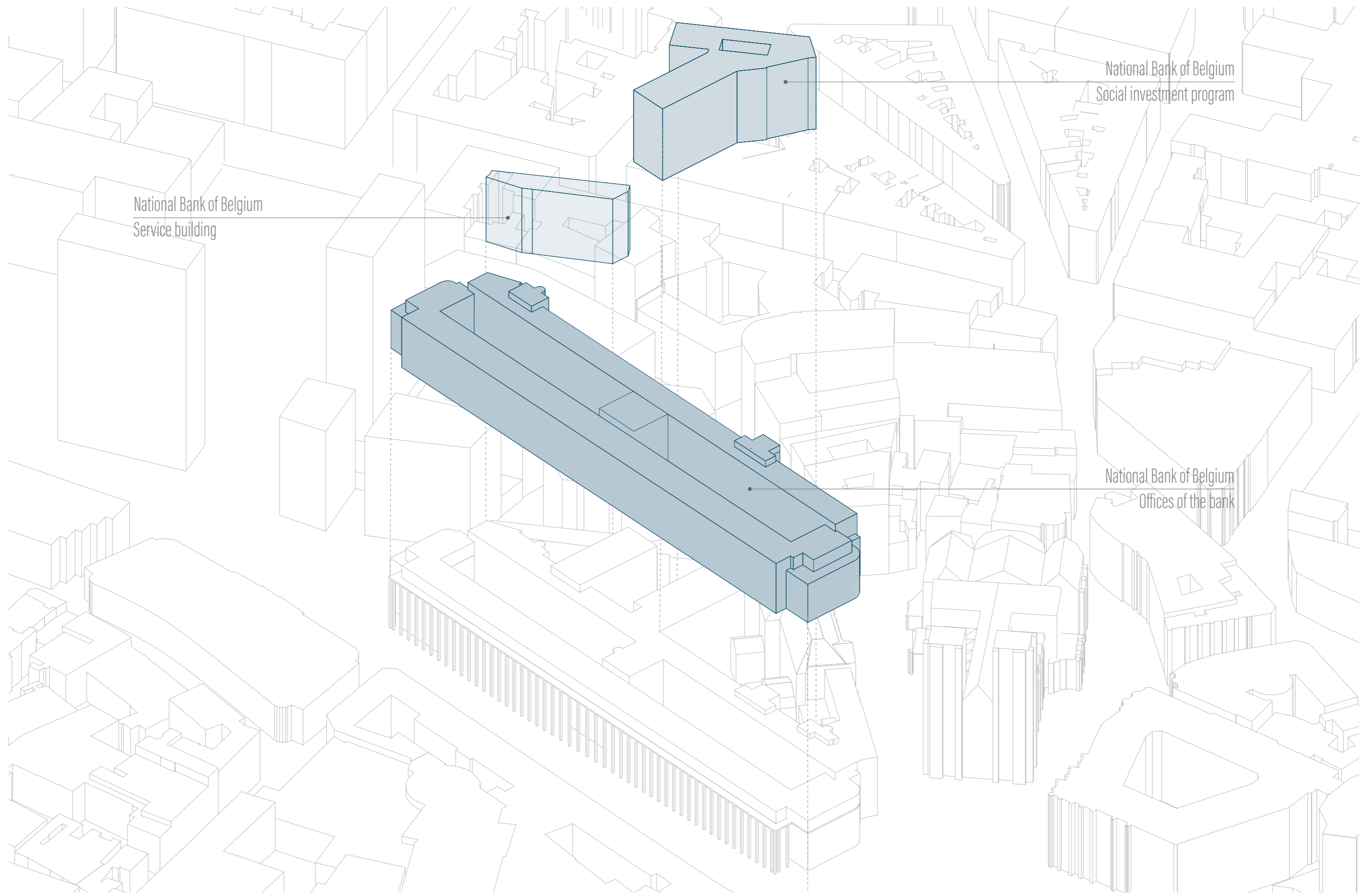

National Bank of Belgium
Service building

National Bank of Belgium
Social investment program

National Bank of Belgium
Offices of the bank

A Bank of Opportunities - Bank program

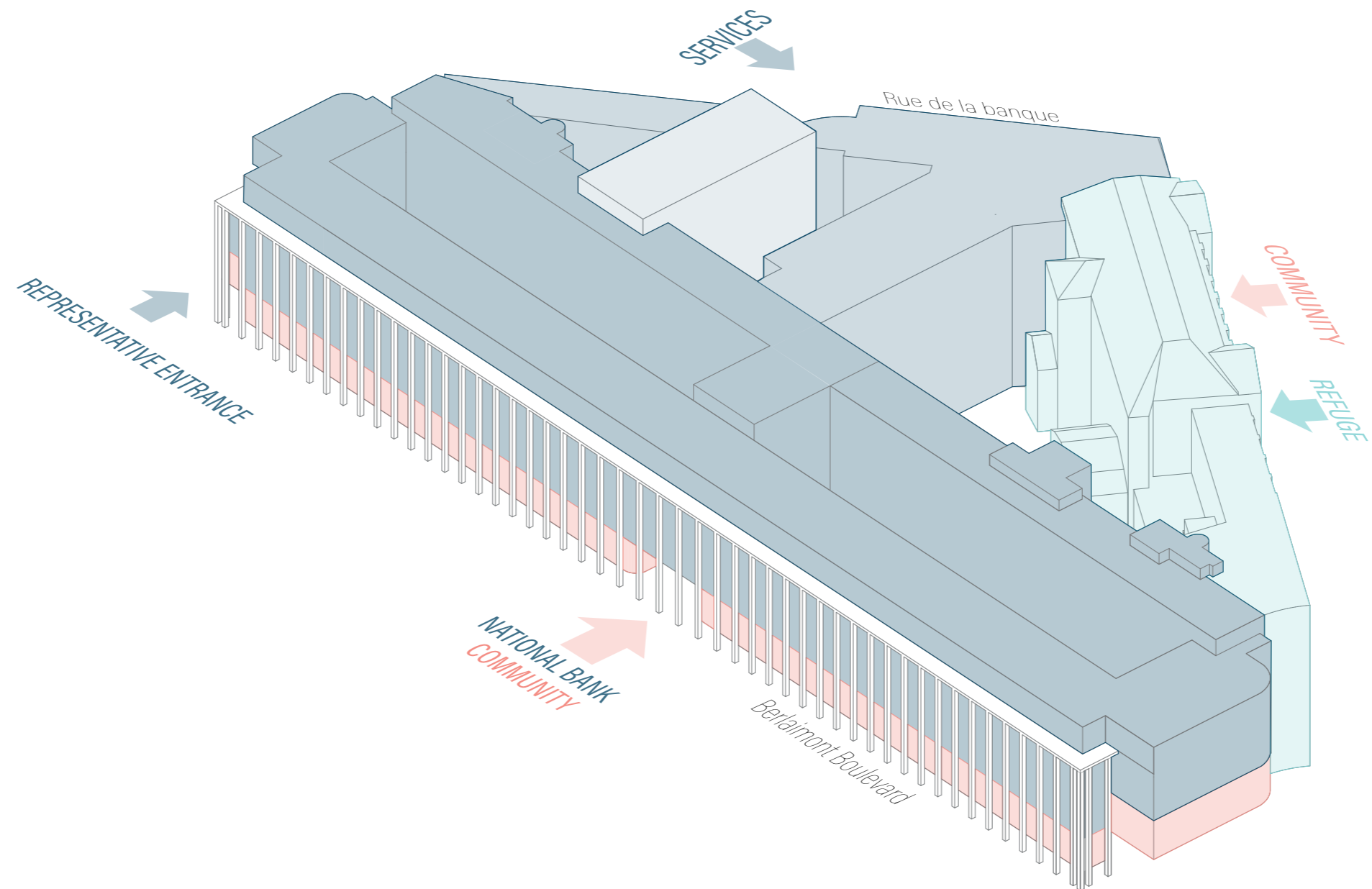

A Bank of Opportunities - Access to the Bank

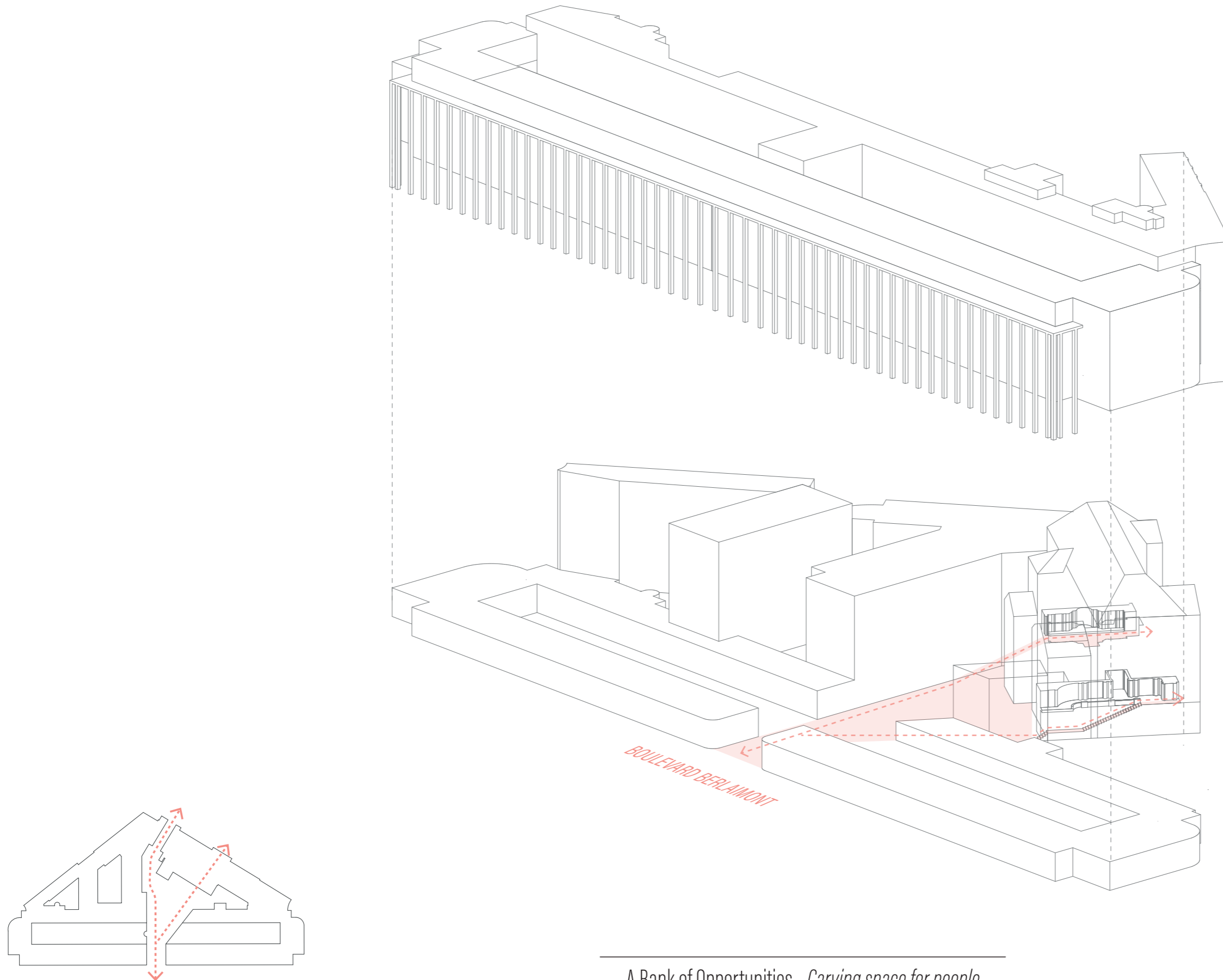

A Bank of Opportunities - *Carving space for people*

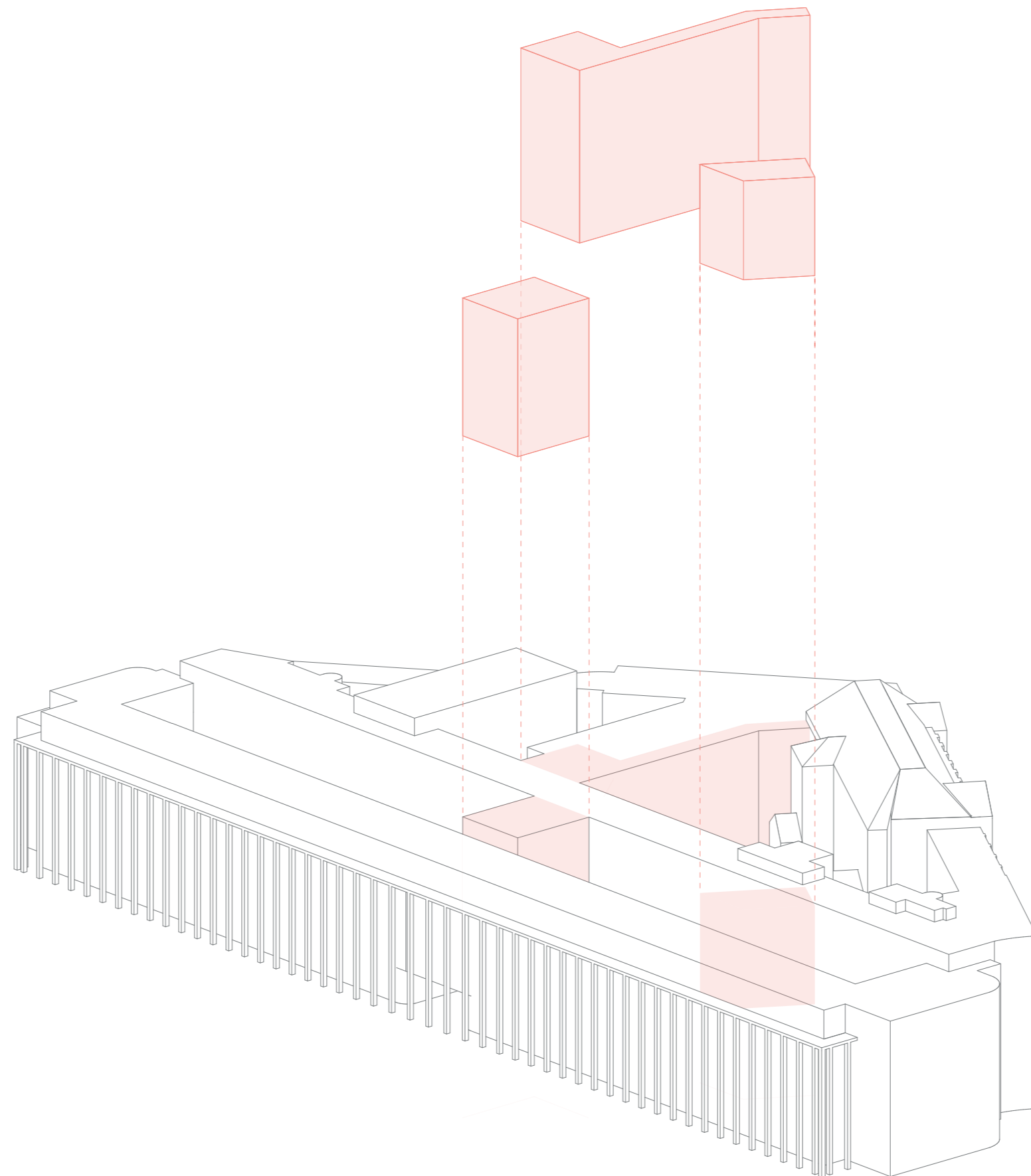

A Bank of Opportunities - *Circulation & circulation cores*

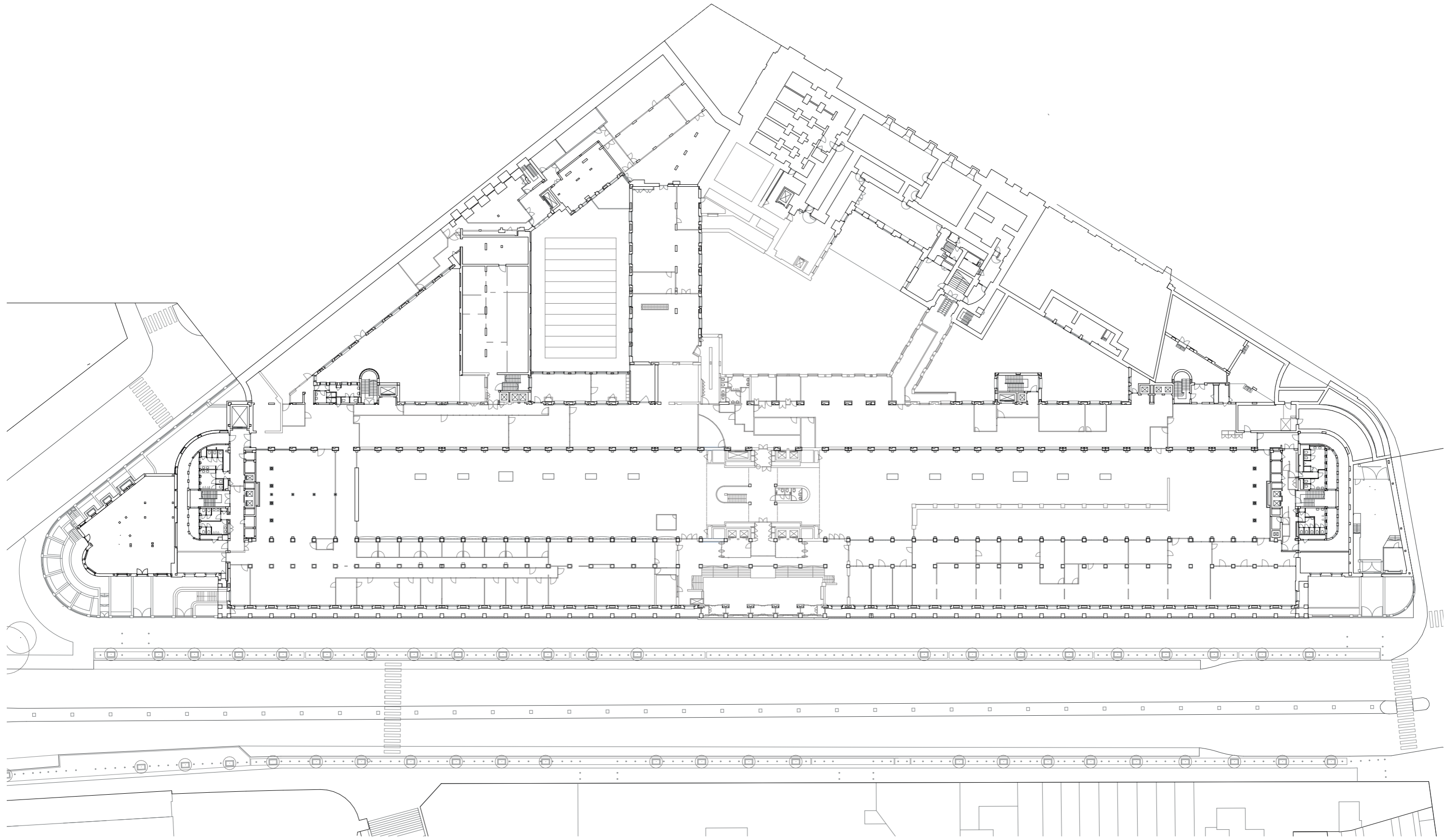

A Bank of Opportunities - *Existing situation*

Groundfloor



Scale
1/500

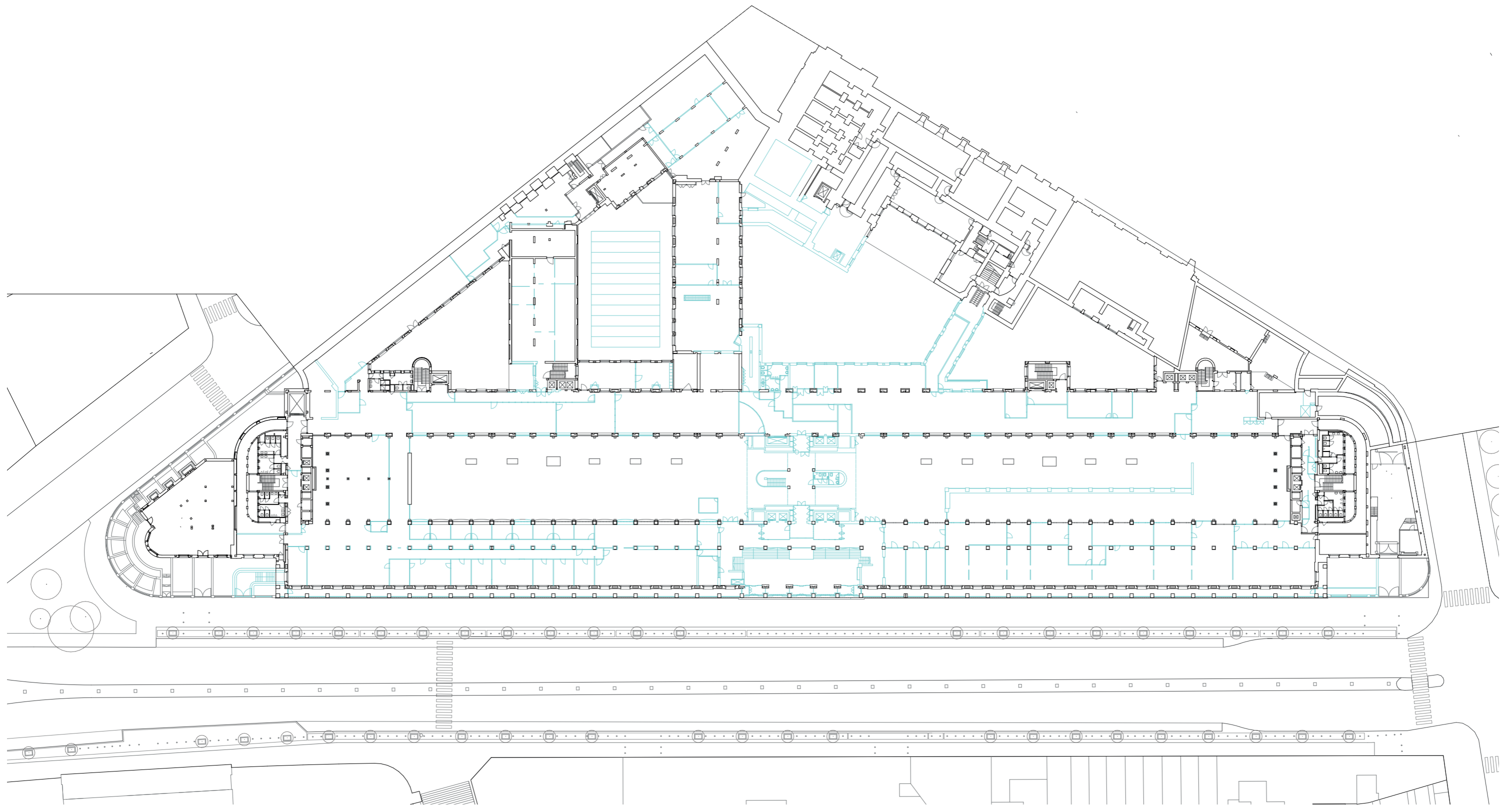

A Bank of Opportunities - *Demolition plans*

Groundfloor



Scale
1/500

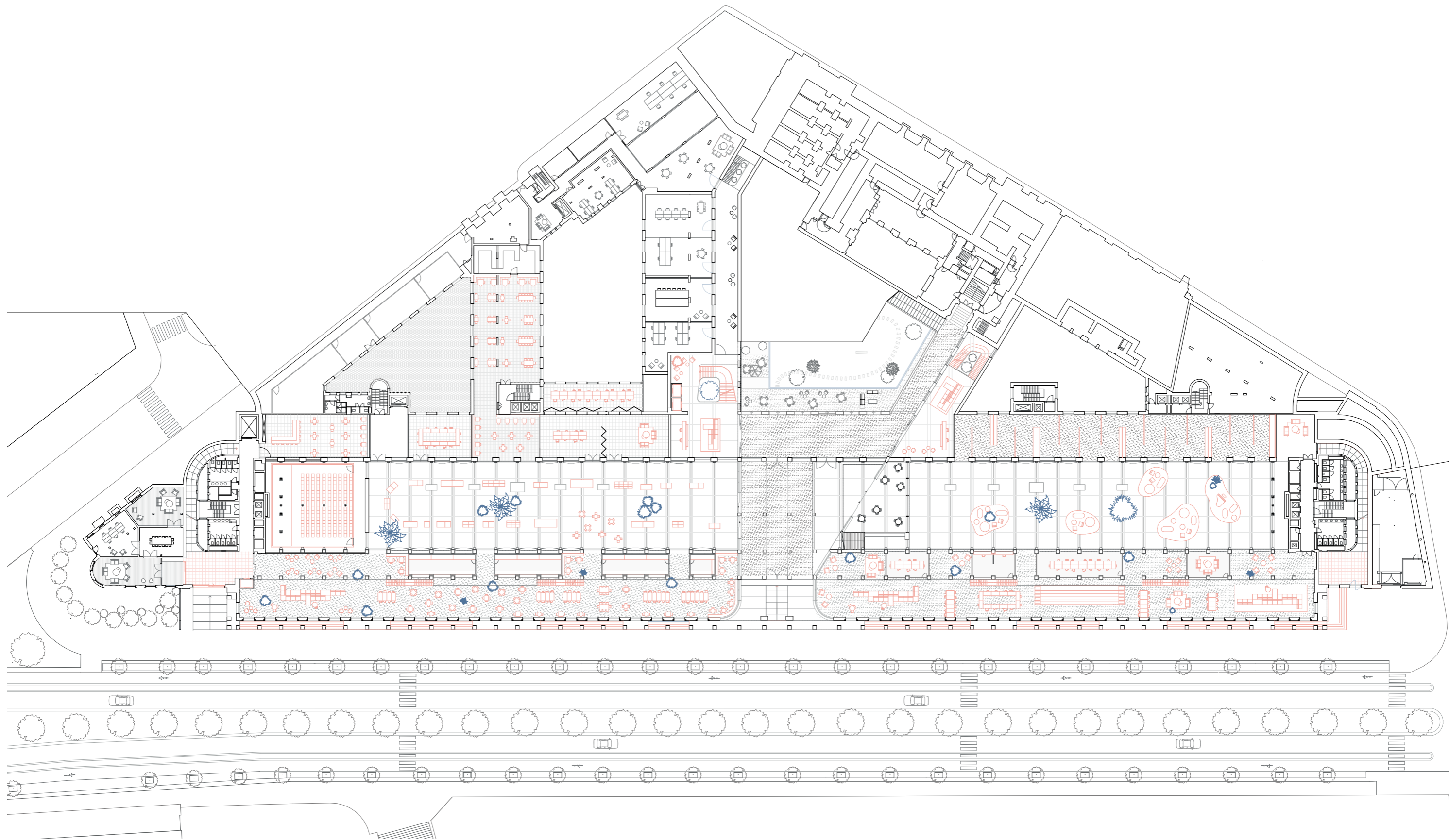

A Bank of Opportunities - *Ground floor plan*

Groundfloor		Scale 1/500
-------------	--	----------------

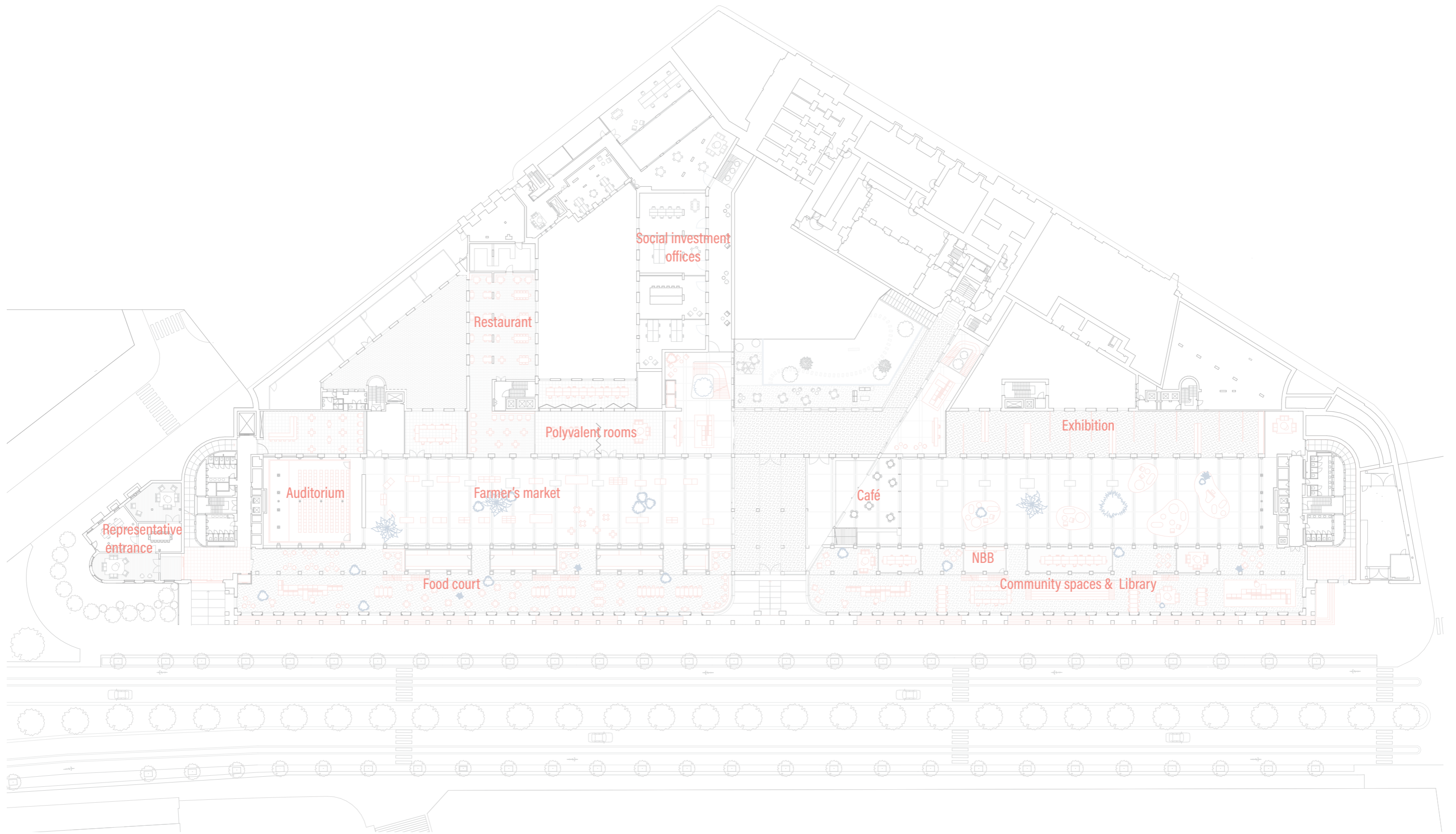

A Bank of Opportunities - *Ground floor plan*

Groundfloor		Scale 1/500
-------------	---	----------------

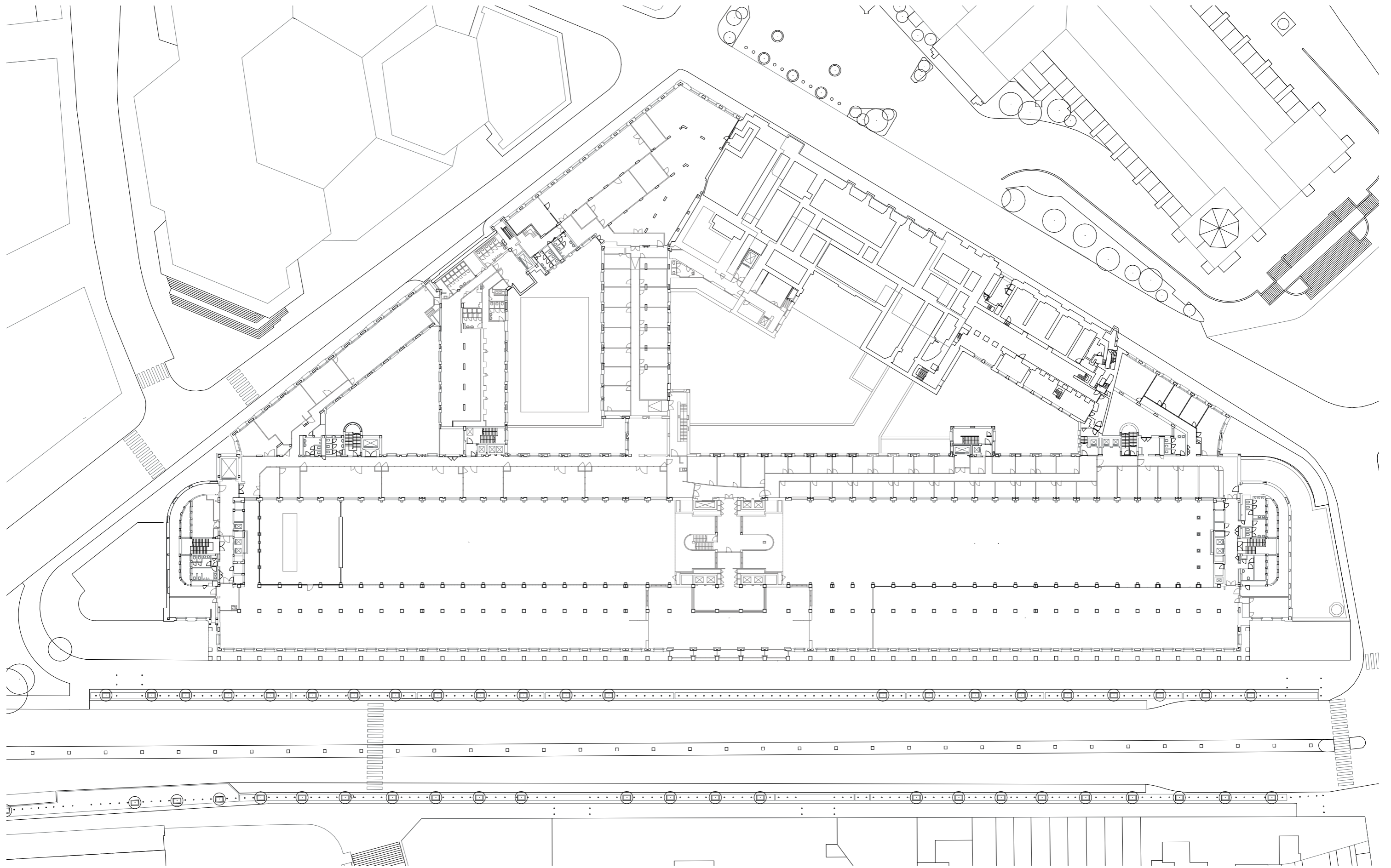

A Bank of Opportunities - *Existing situation*

First floor



Scale
1/500

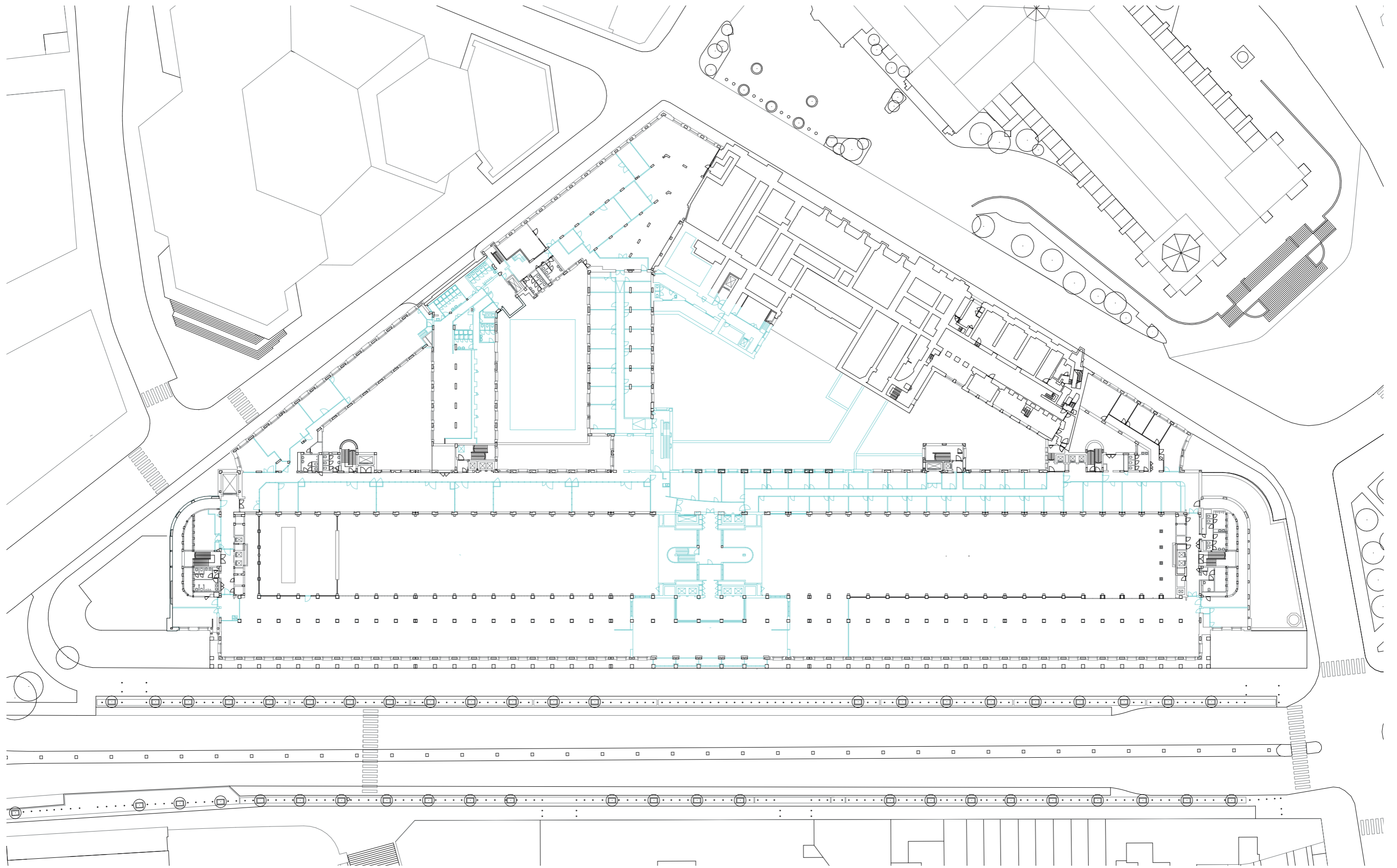

A Bank of Opportunities- Demolition plans - Firstfloor

First floor



Scale
1/500

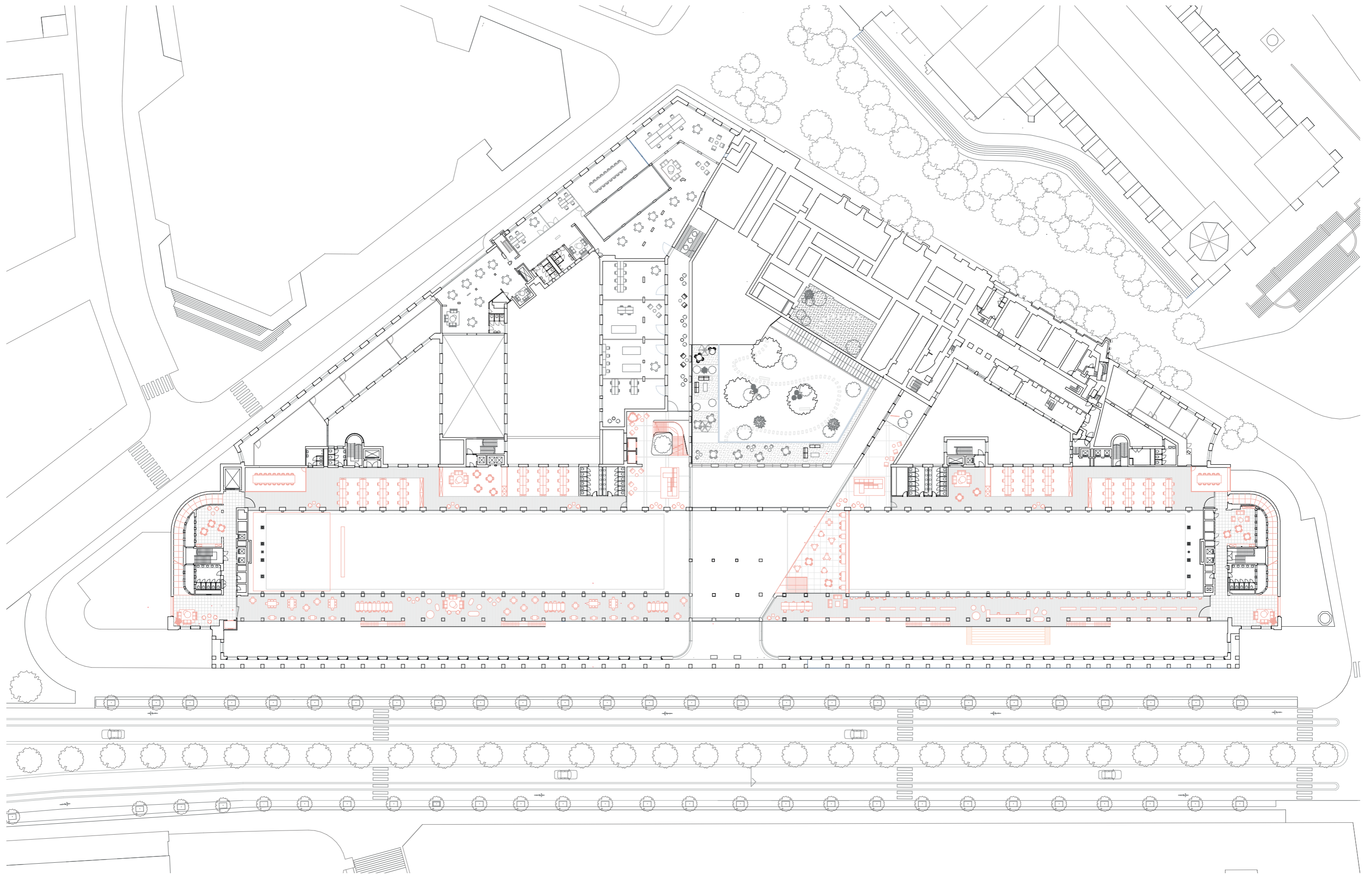

A Bank of Opportunities - *First floor plan*

First floor



Scale
1/500

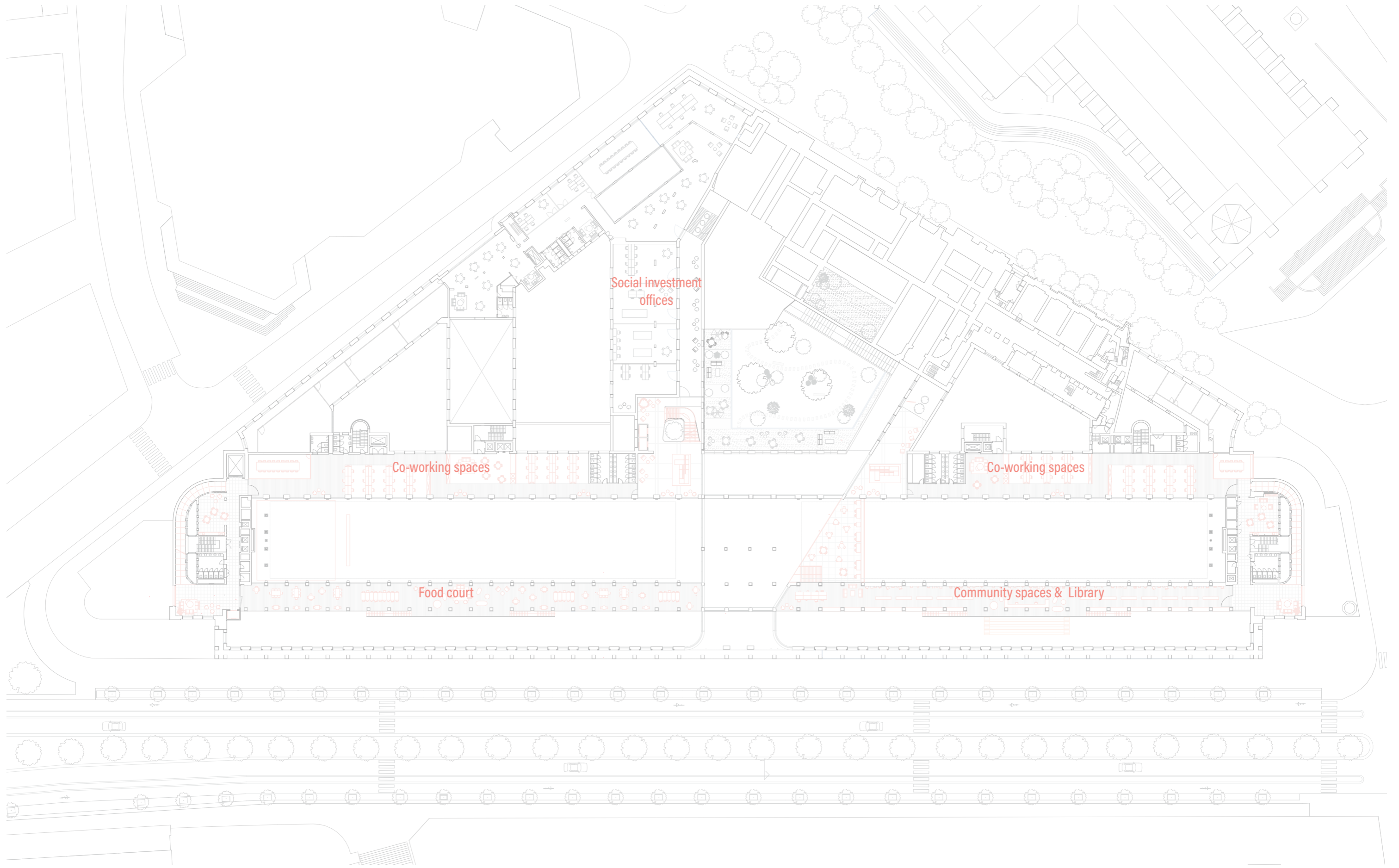

A Bank of Opportunities - *First floor plan*

First floor



Scale
1/500

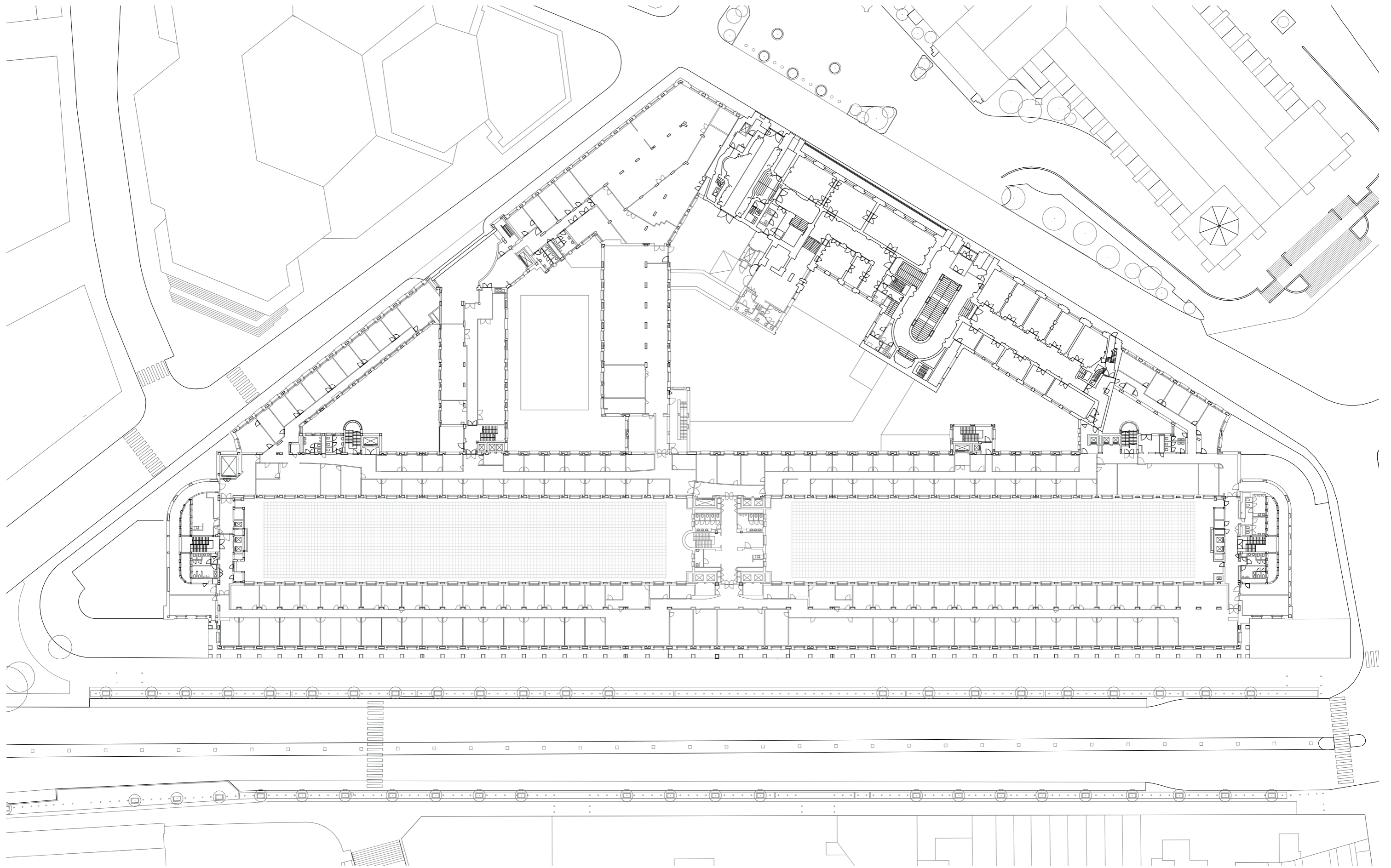

A Bank of Opportunities - *Existing situation*

Second floor



Scale
1/500

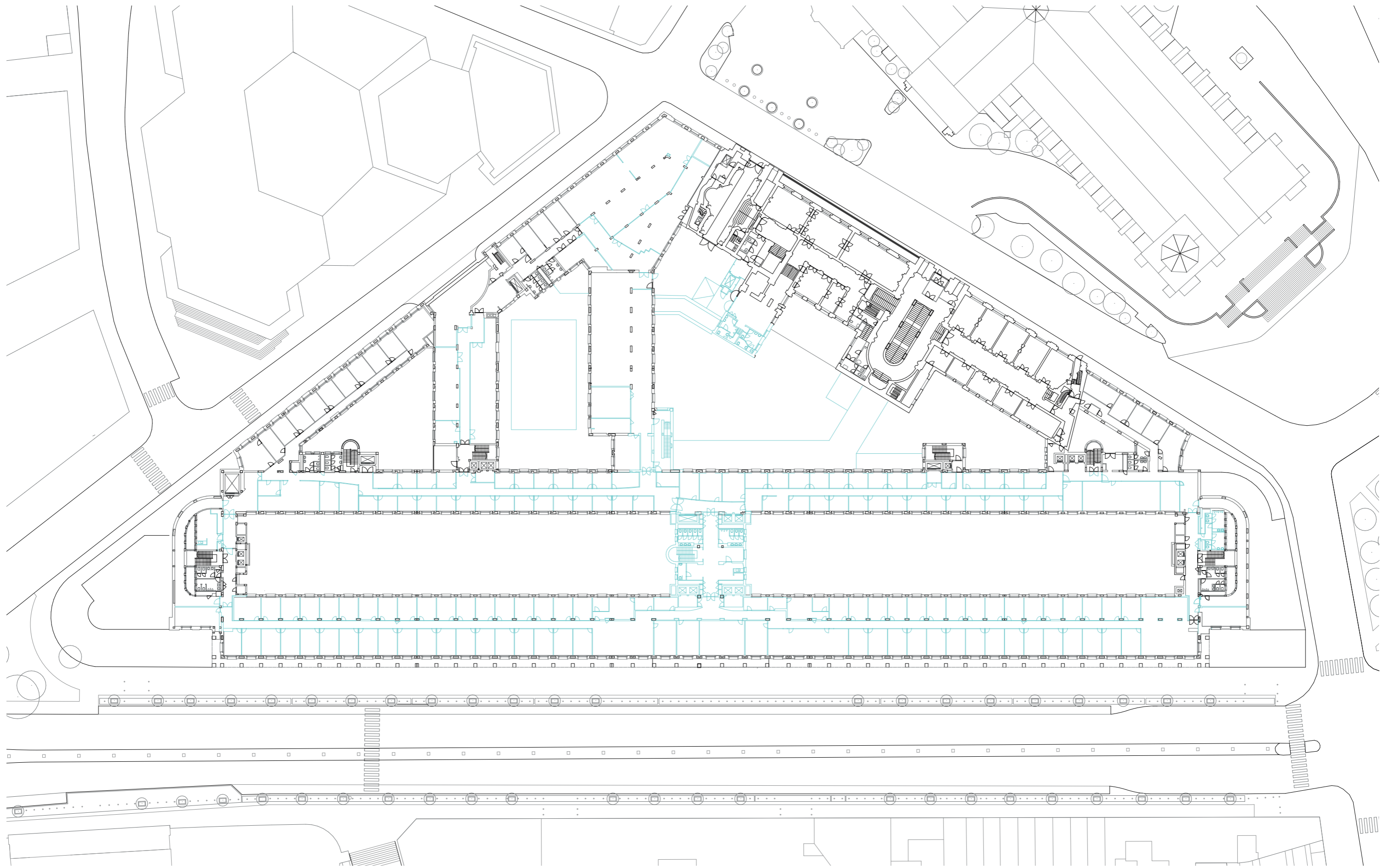

A Bank of Opportunities - Demolition plans - Secondfloor

Second floor		Scale 1/500
--------------	---	----------------

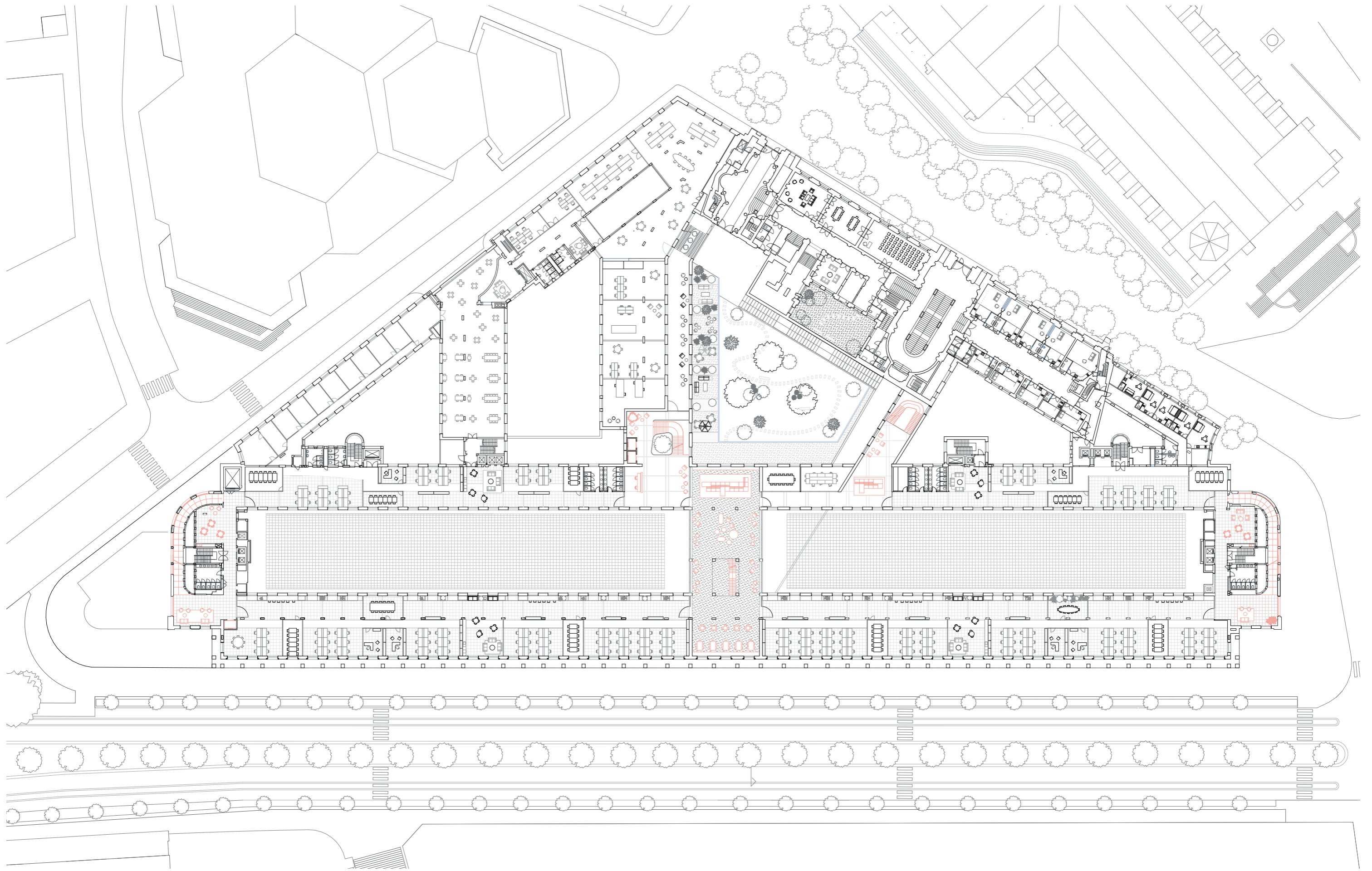

A Bank of Opportunities - *Second floor plan*

Second floor



Scale
1/500

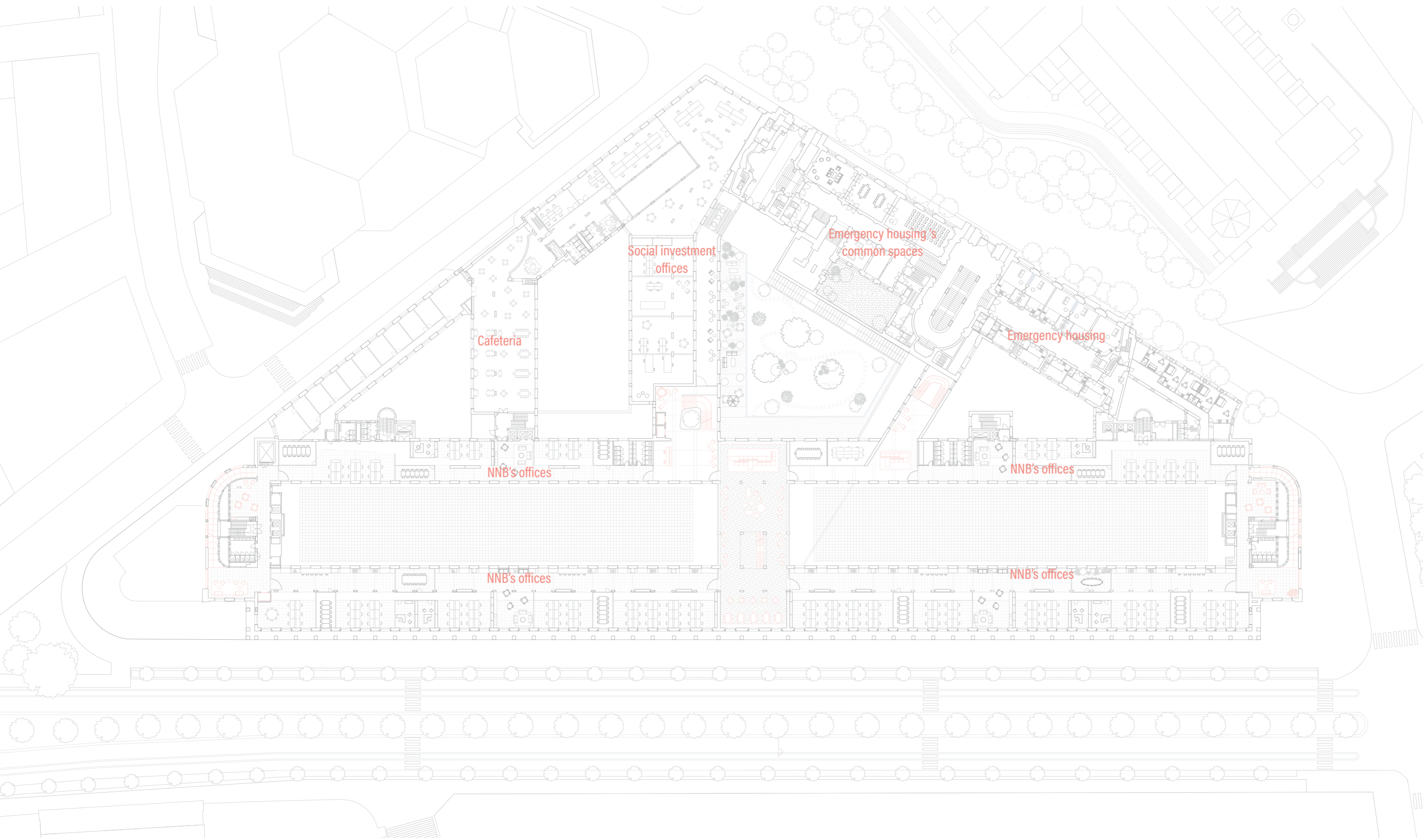

A Bank of Opportunities - *Second floor plan*

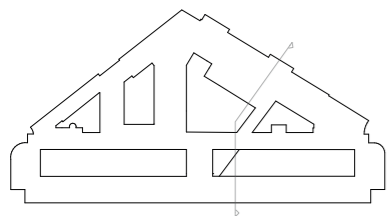
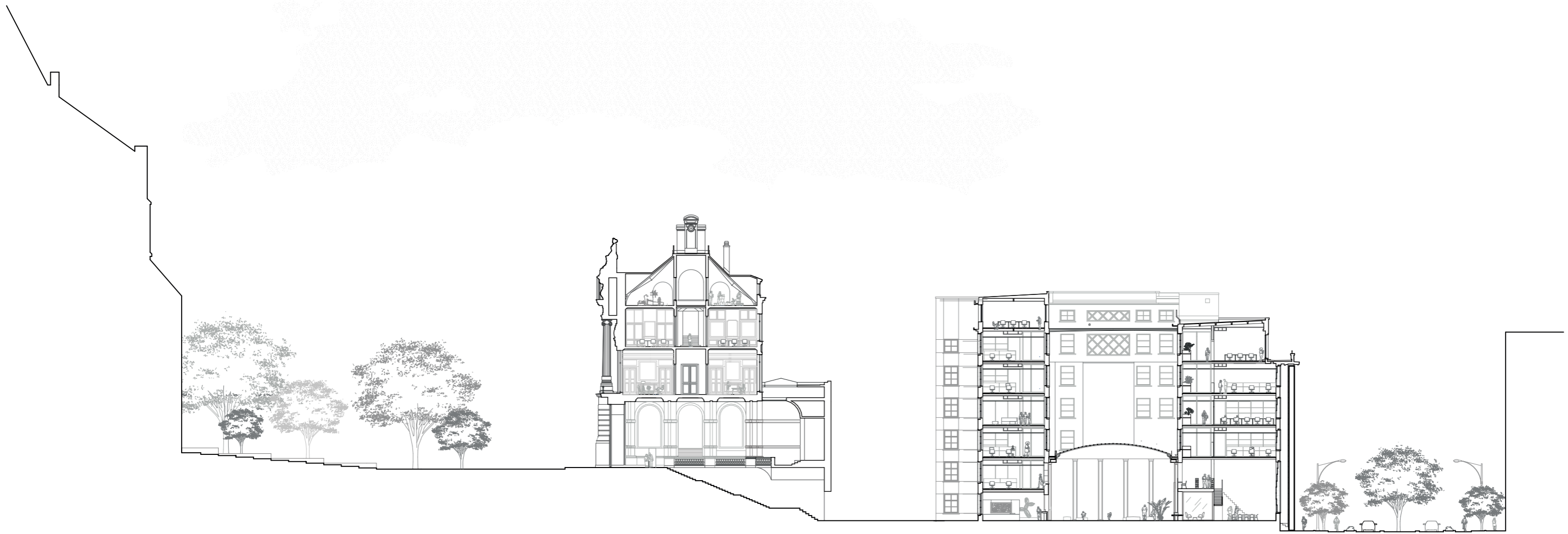

A Bank of Opportunities - *Section in the community hall*

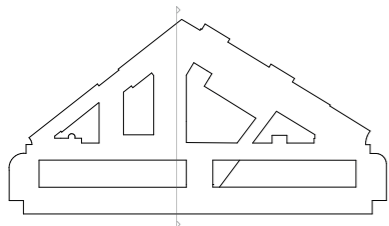

A Bank of Opportunities - *Section in the social investment wing*



A Bank of Opportunities - Facade of the National Bank

4 | Creating spaces for people



A Bank of Opportunities - Opening the Bank



A Bank of Opportunities - Opening the Bank

The people's café

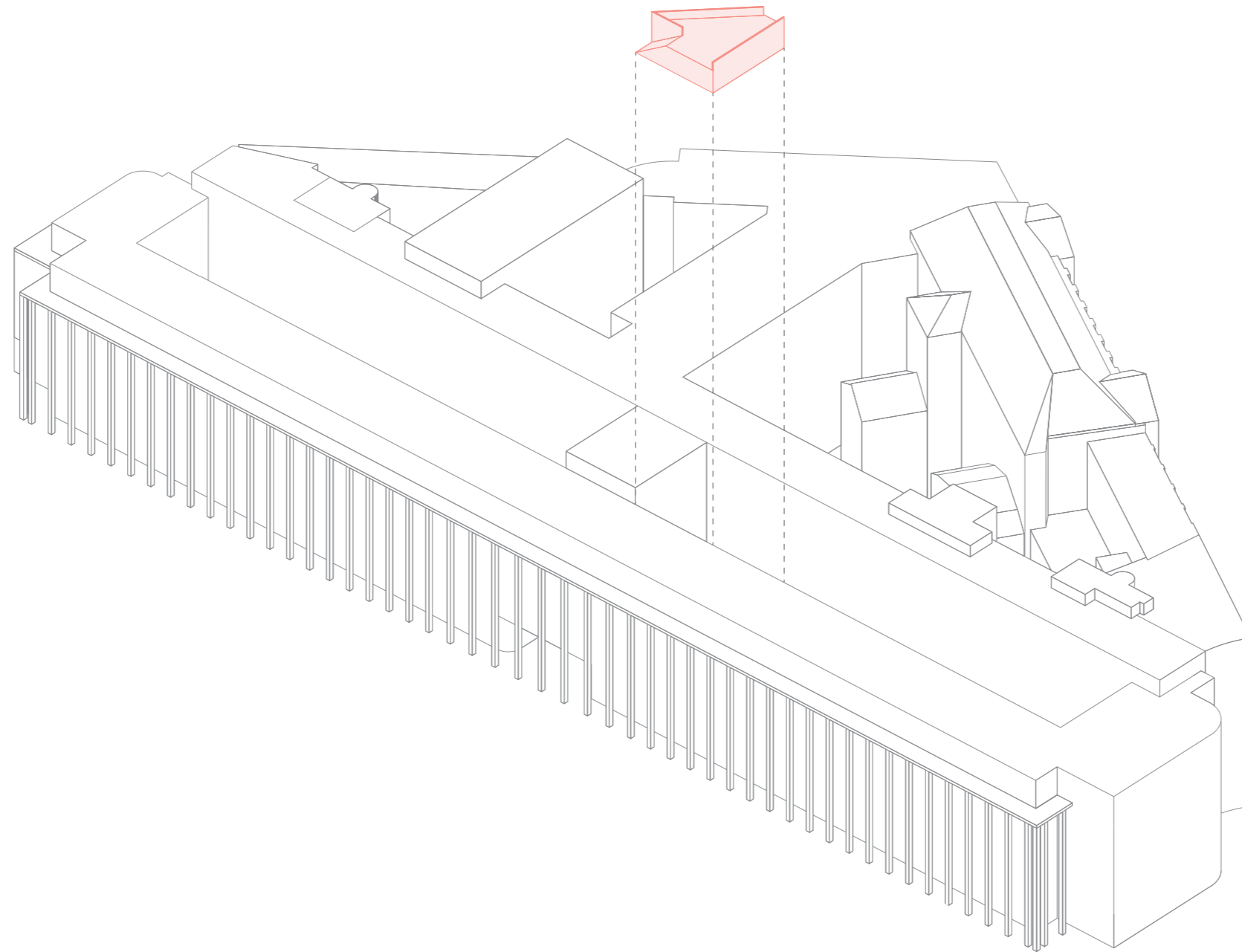

A Bank of Opportunities - *Location of the café*

Lobby

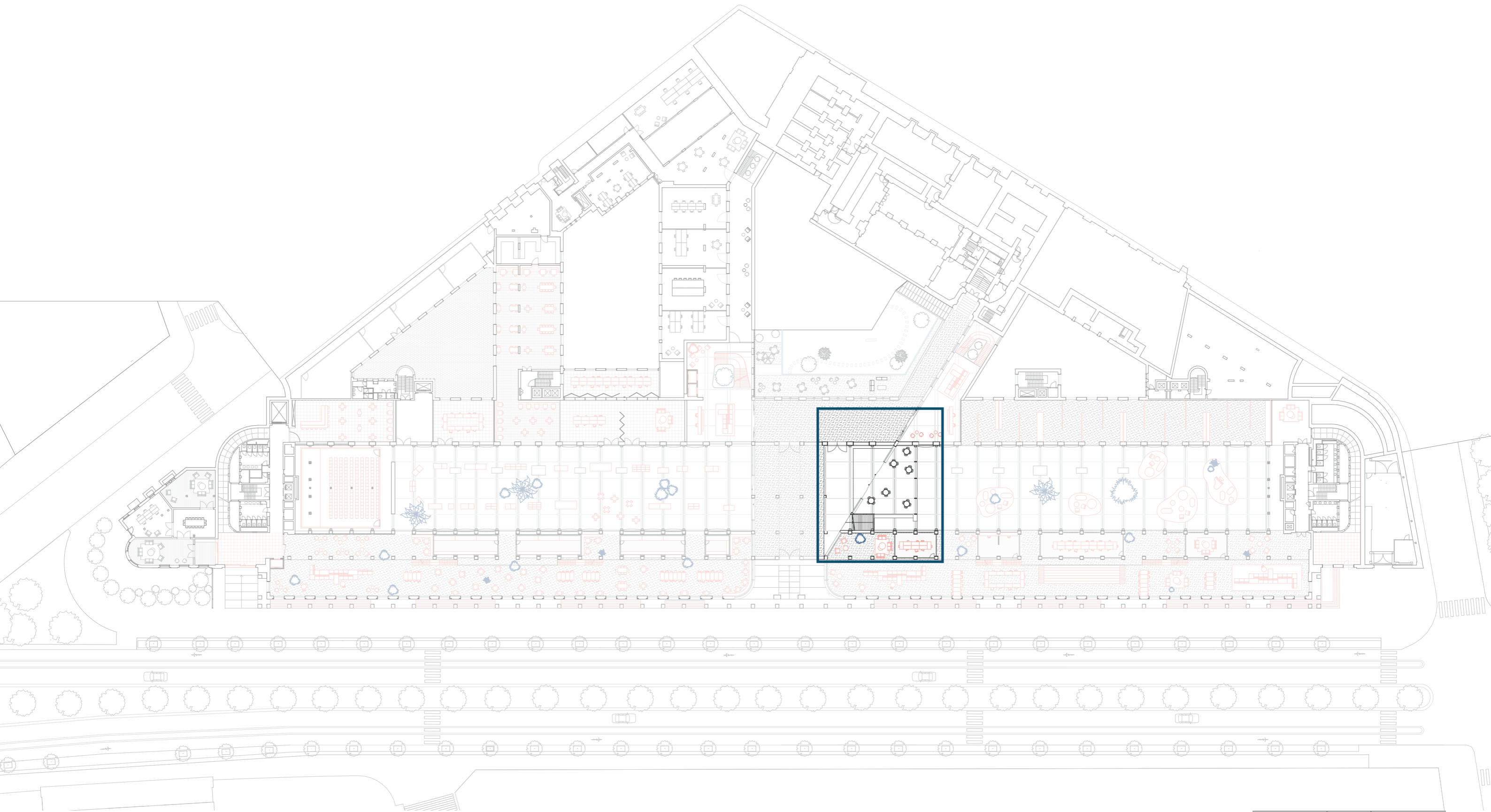

A Bank of Opportunities - *Location of the café*

Groundfloor



Scale
1/500



A Bank of Opportunities - *Opening the entrance*

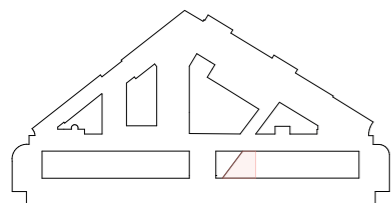

A Bank of Opportunities - *Welcoming the public in the Bank*

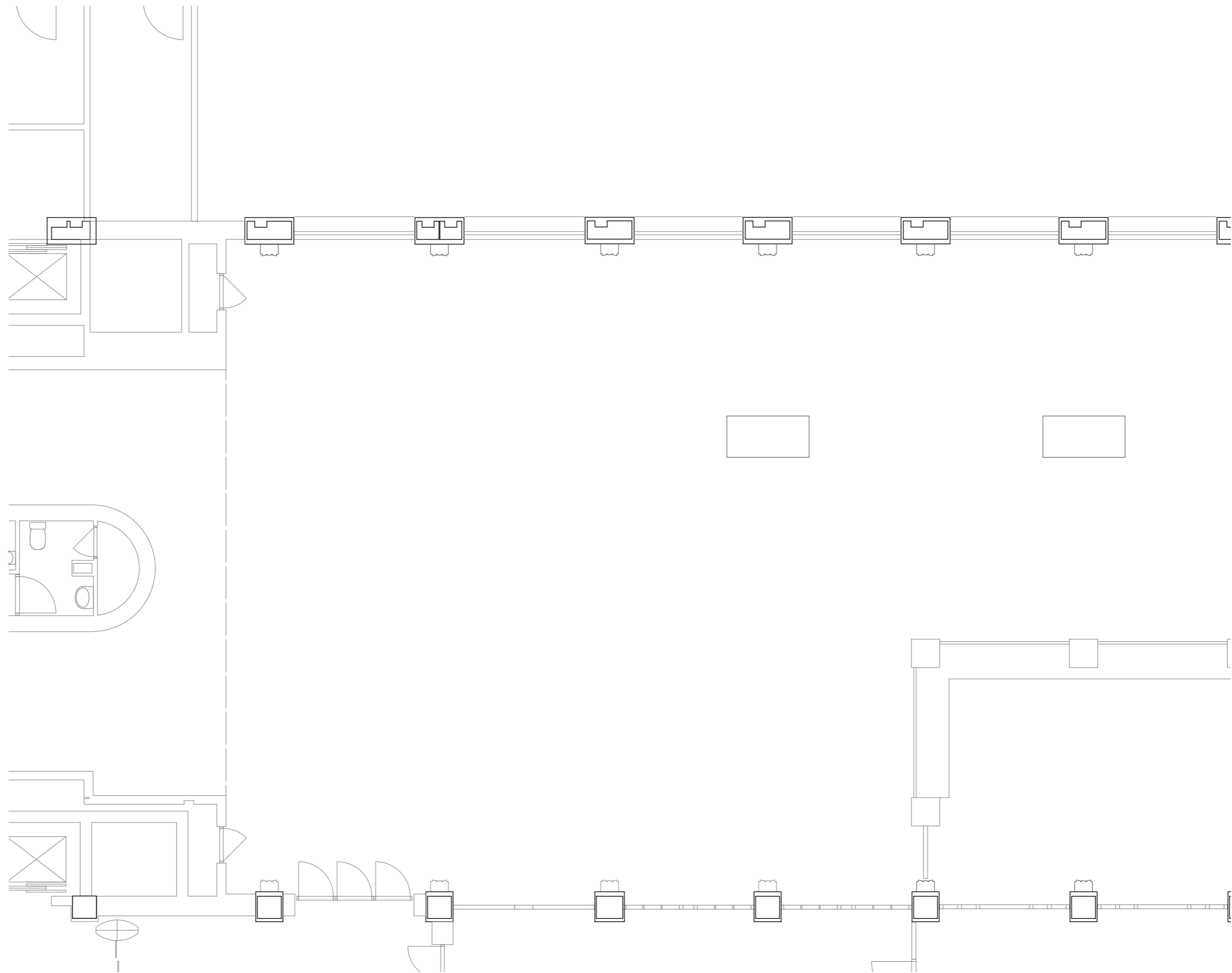

A Bank of Opportunities - *Existing situation*

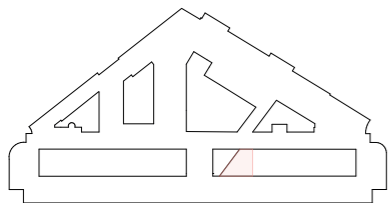
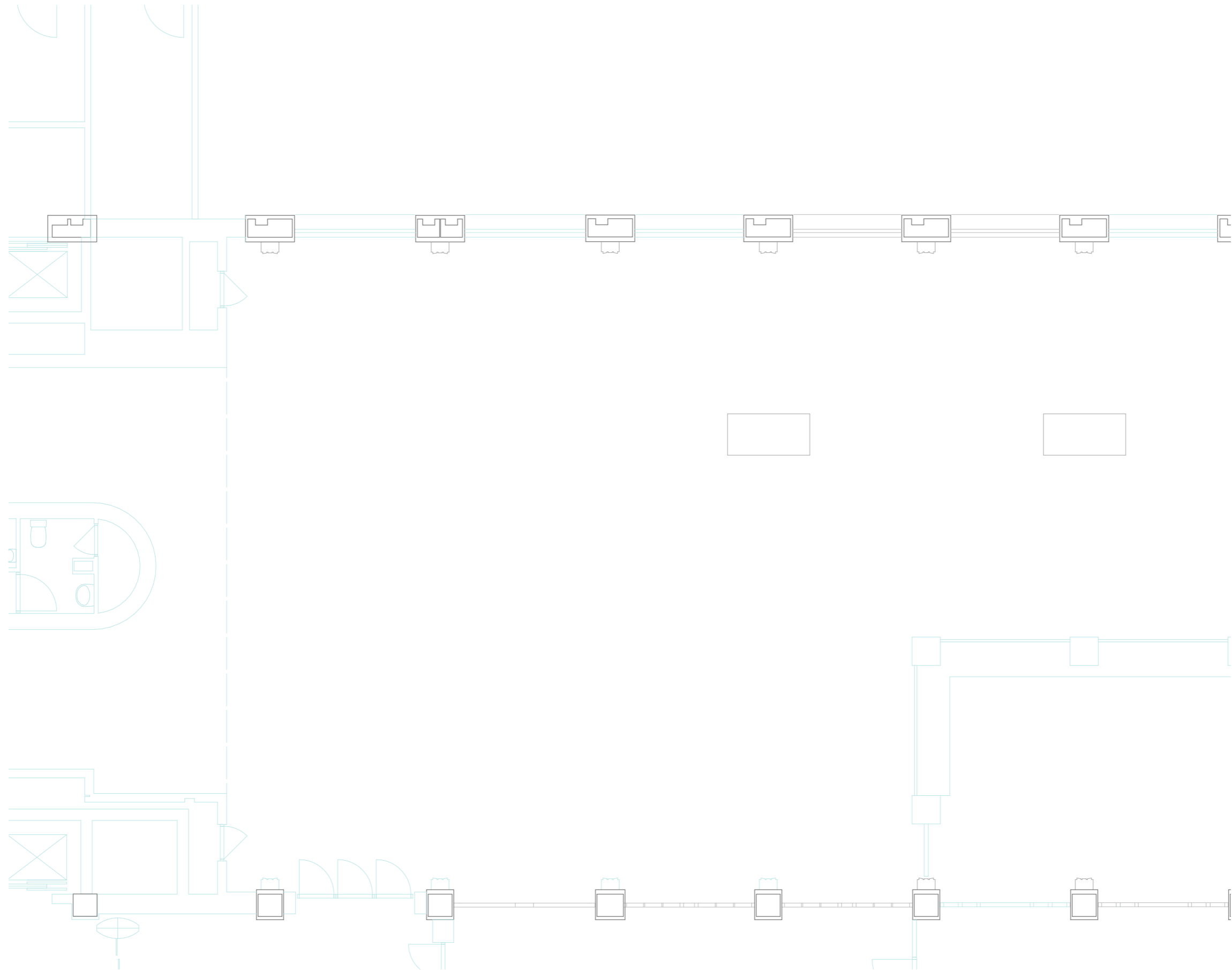

A Bank of Opportunities - *Demolition plan*

Groundfloor



Scale
1/100

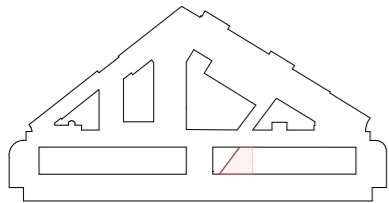
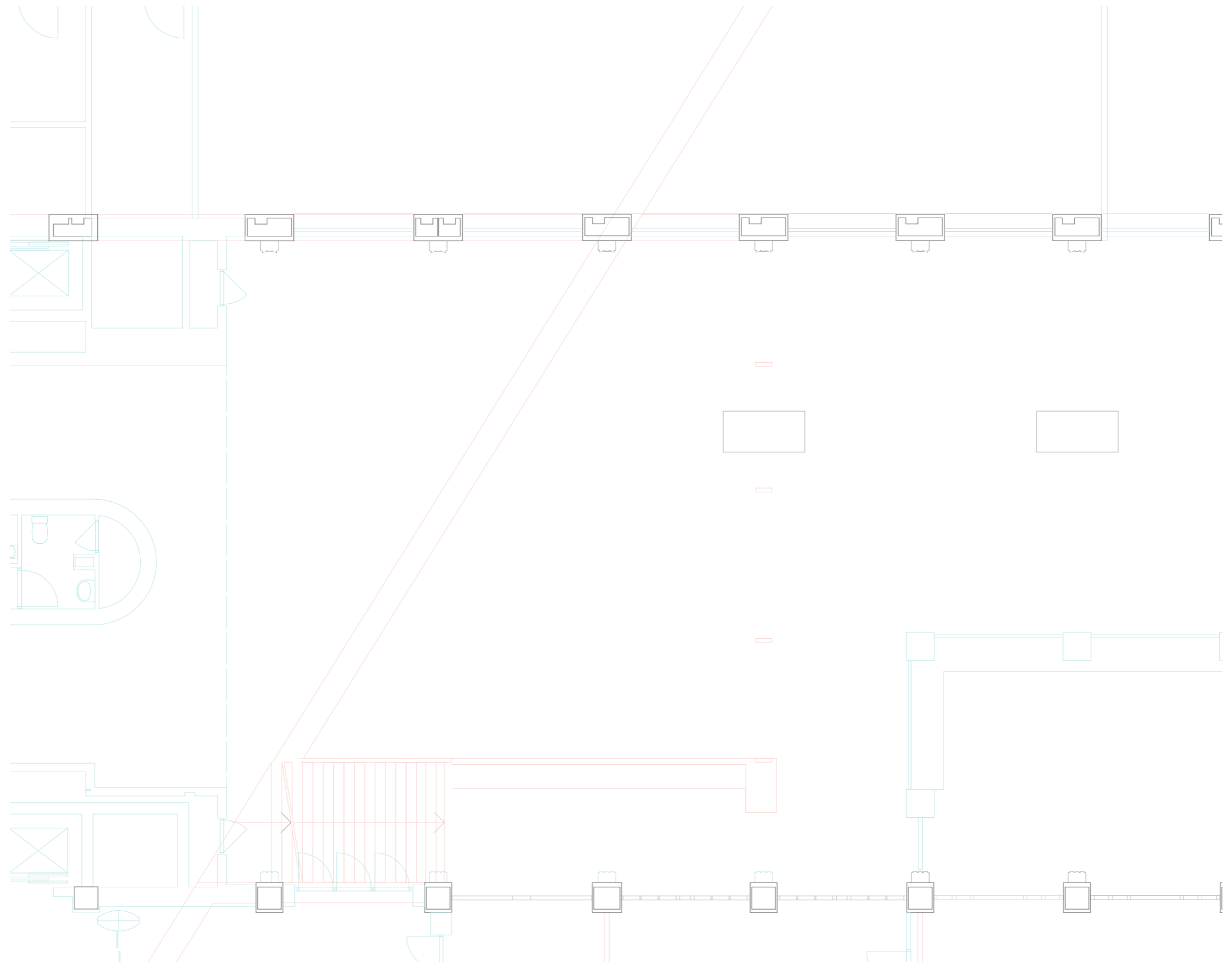

A Bank of Opportunities - *New construction*

Groundfloor		Scale 1/100
-------------	--	----------------

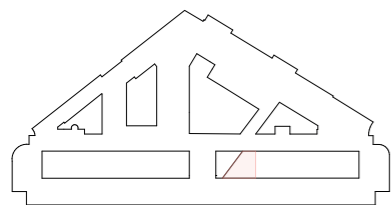
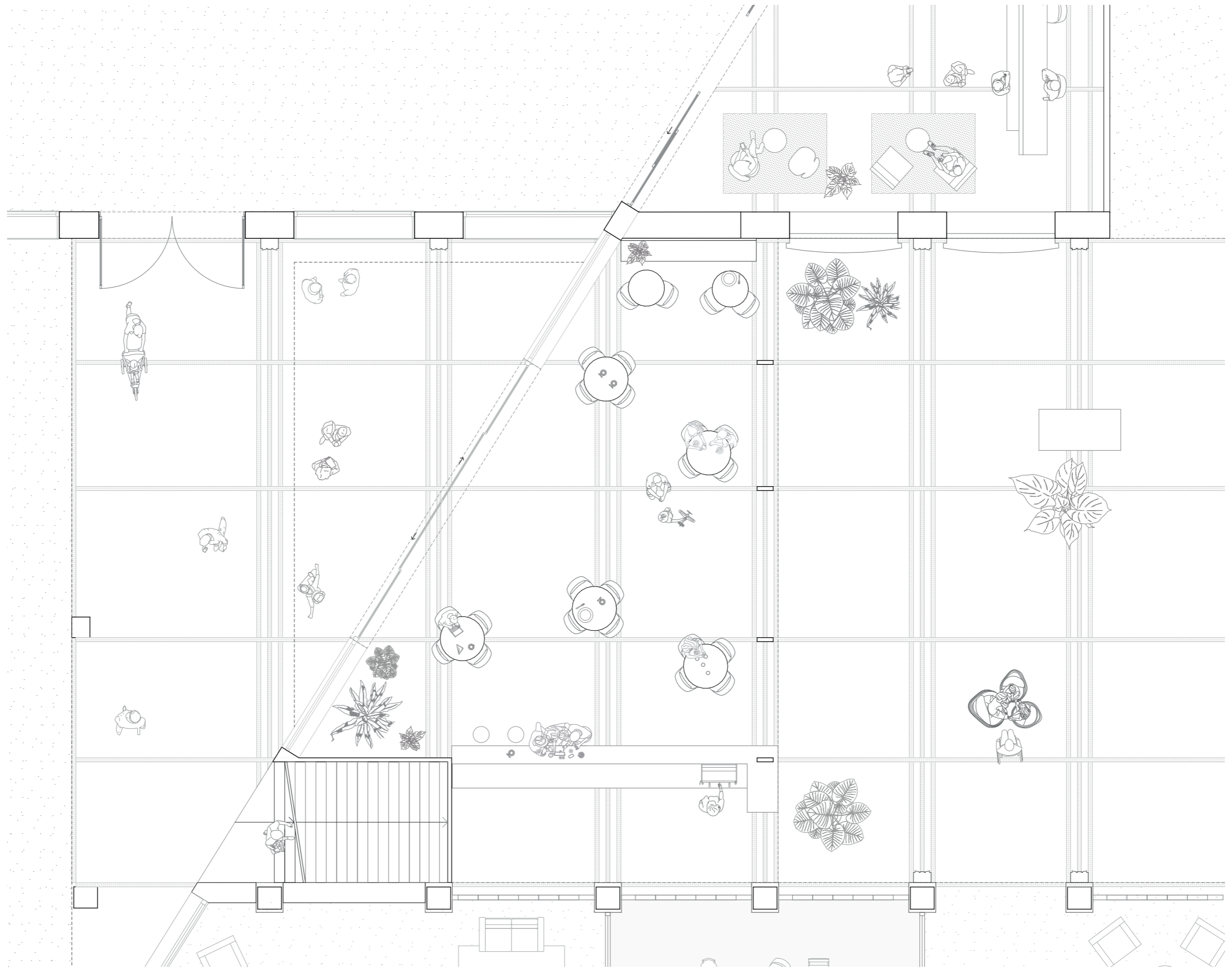

A Bank of Opportunities - *Welcoming the public in the Bank*

Groundfloor



Scale
1/100

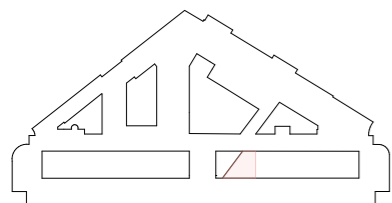
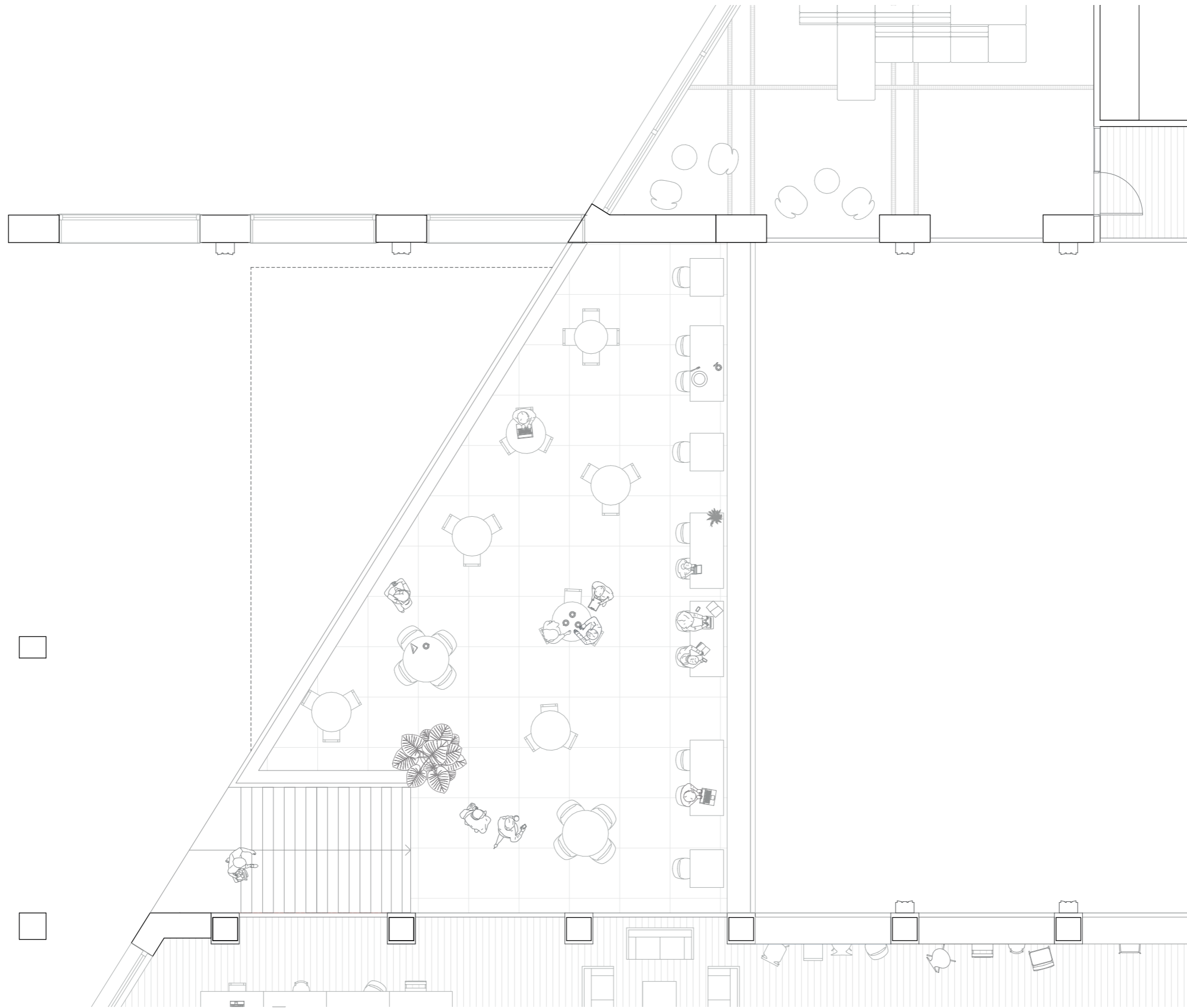

A Bank of Opportunities - *Welcoming the public in the Bank*

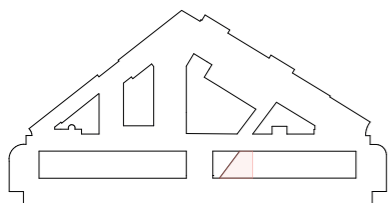
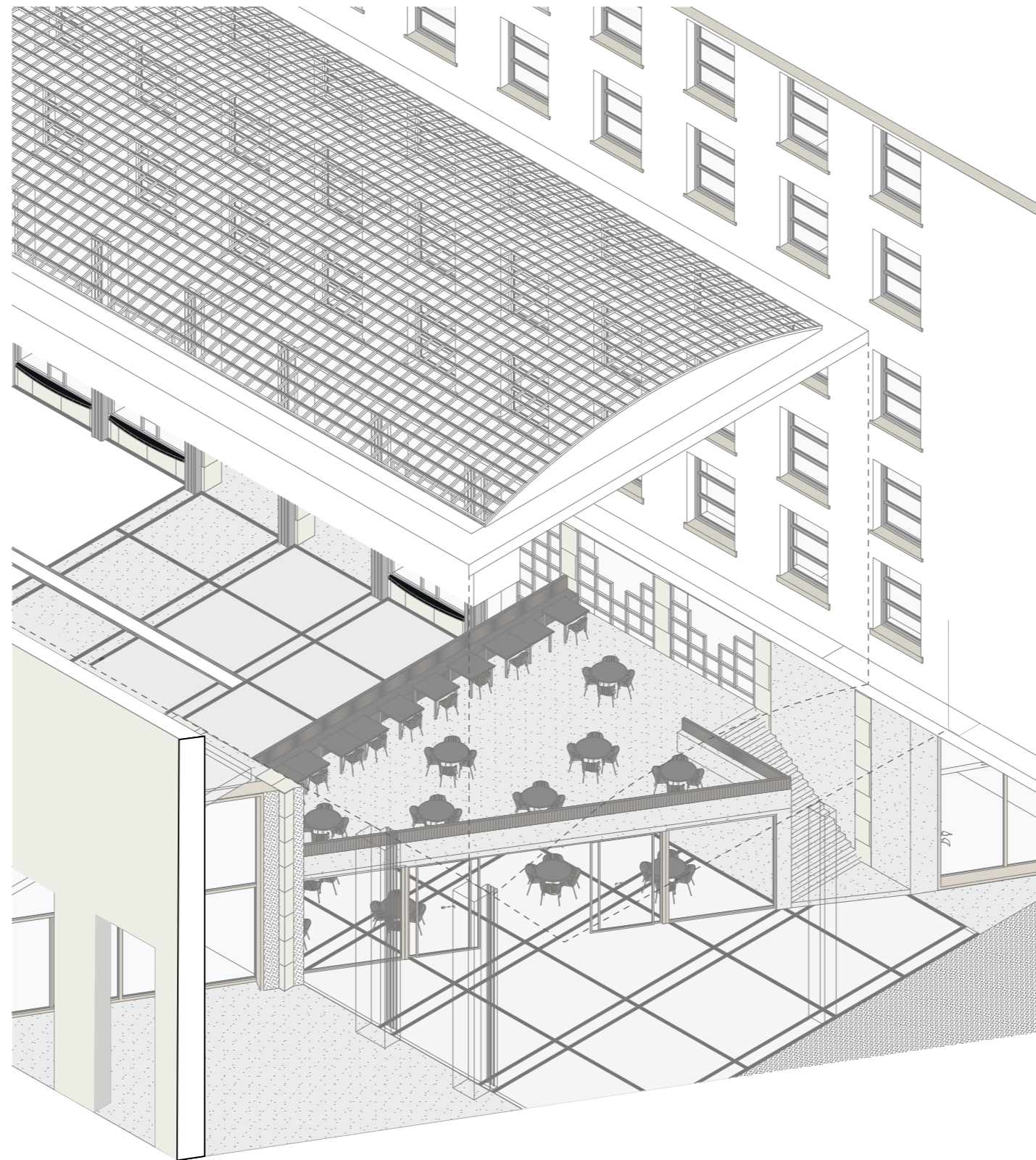

A Bank of Opportunities - *Welcoming the public*

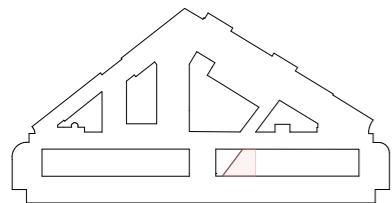
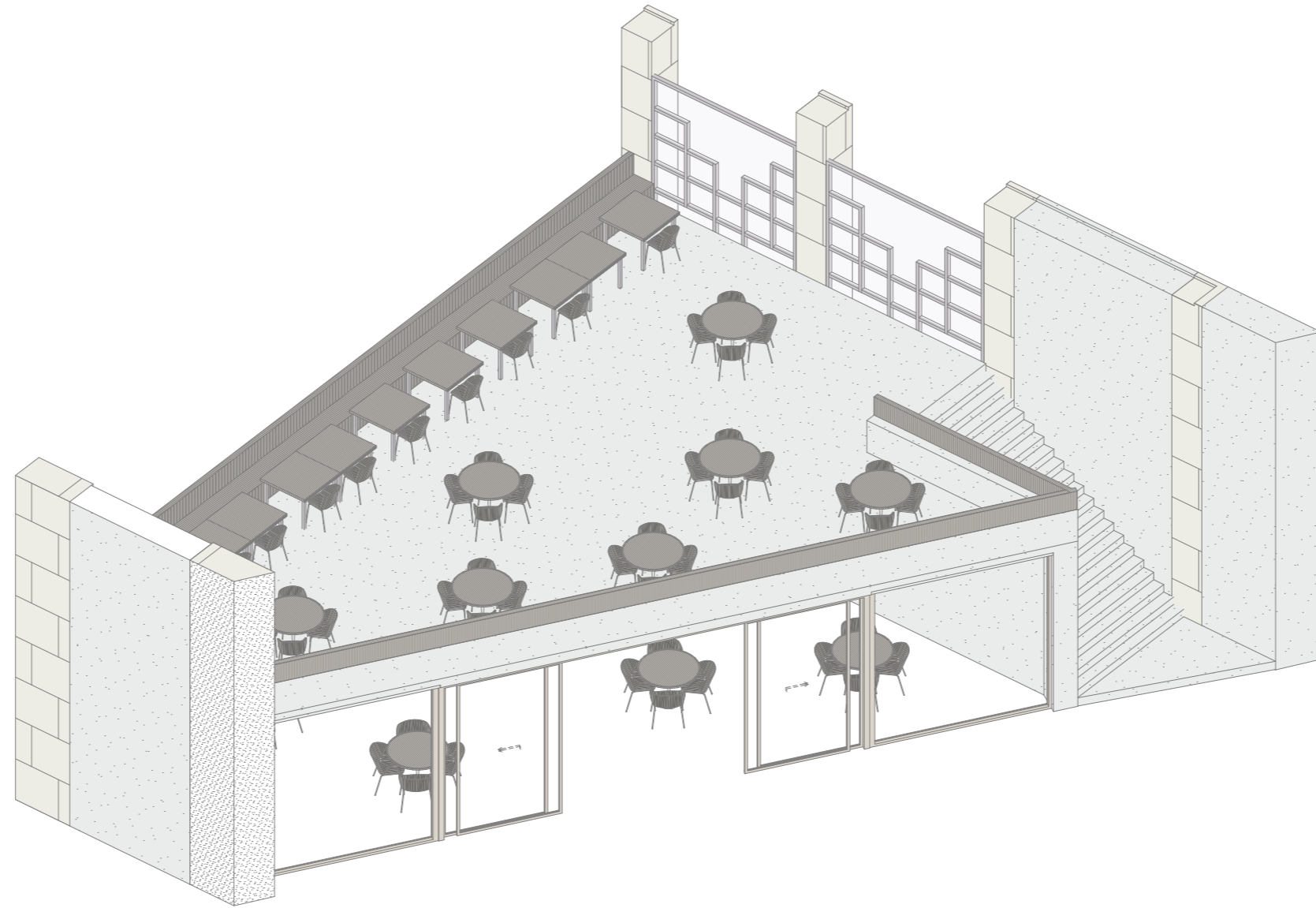

A Bank of Opportunities - *The café as furniture*

The people's hall

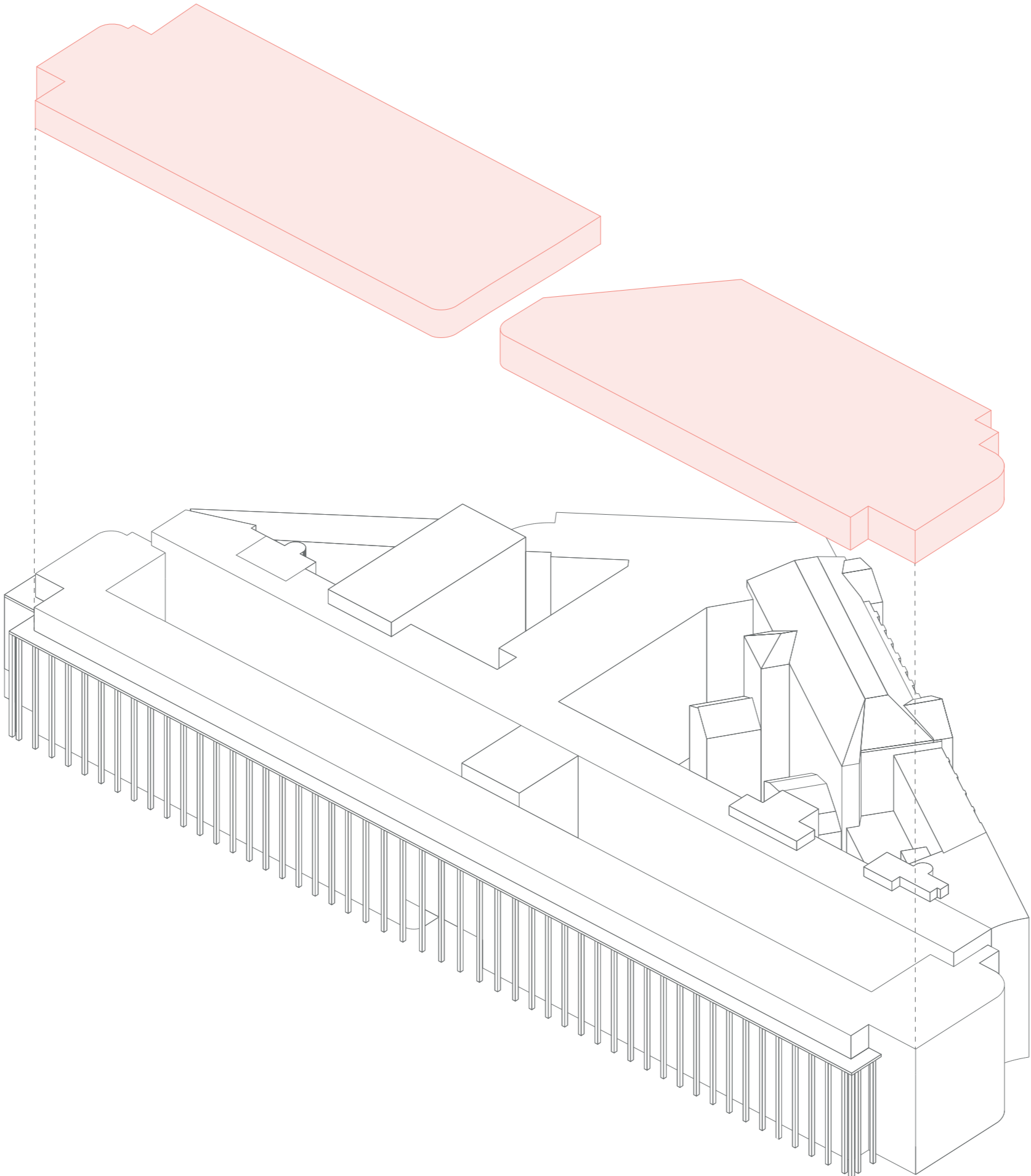

A Bank of Opportunities - Location of the courtyard

Banking halls

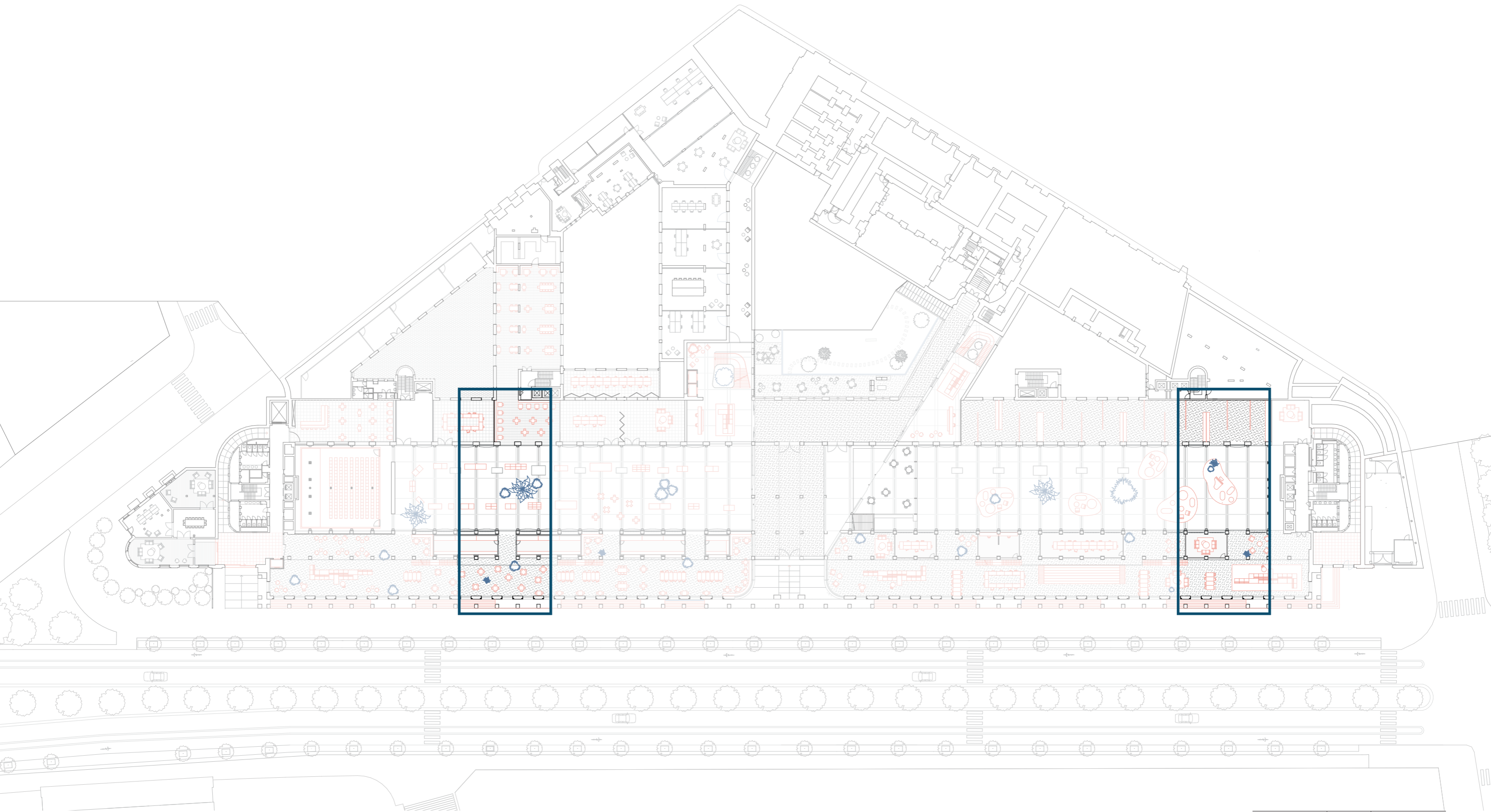

A Bank of Opportunities - *Location of the banking halls*

Groundfloor



Scale
1/500



A Bank of Opportunities - *Reinvesting the banking halls*



A Bank of Opportunities - A space to gather

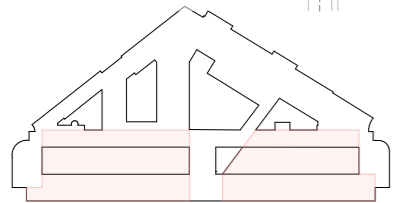
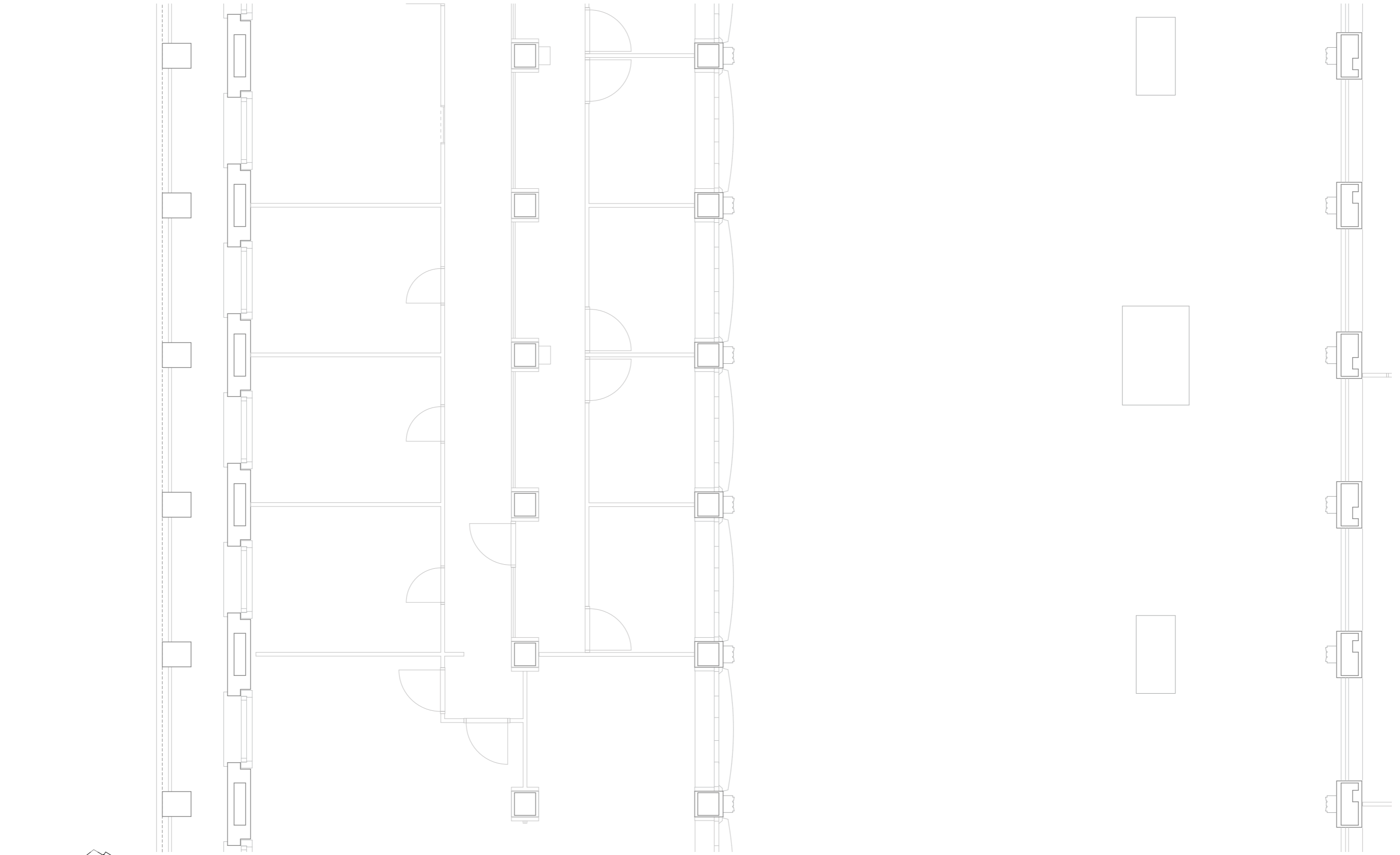

A Bank of Opportunities - Existing situation

Groundfloor		Scale 1/100
-------------	---	----------------

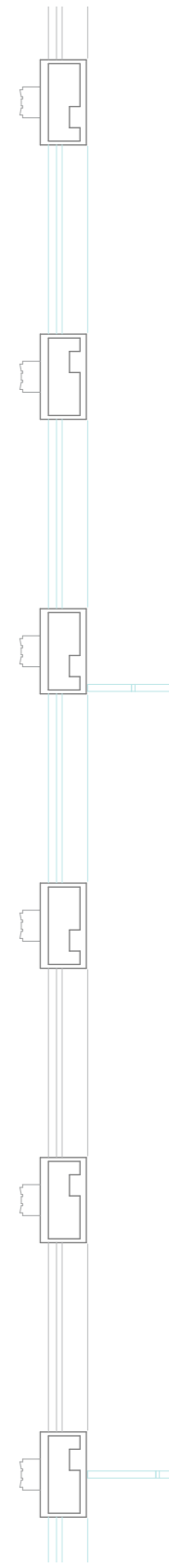
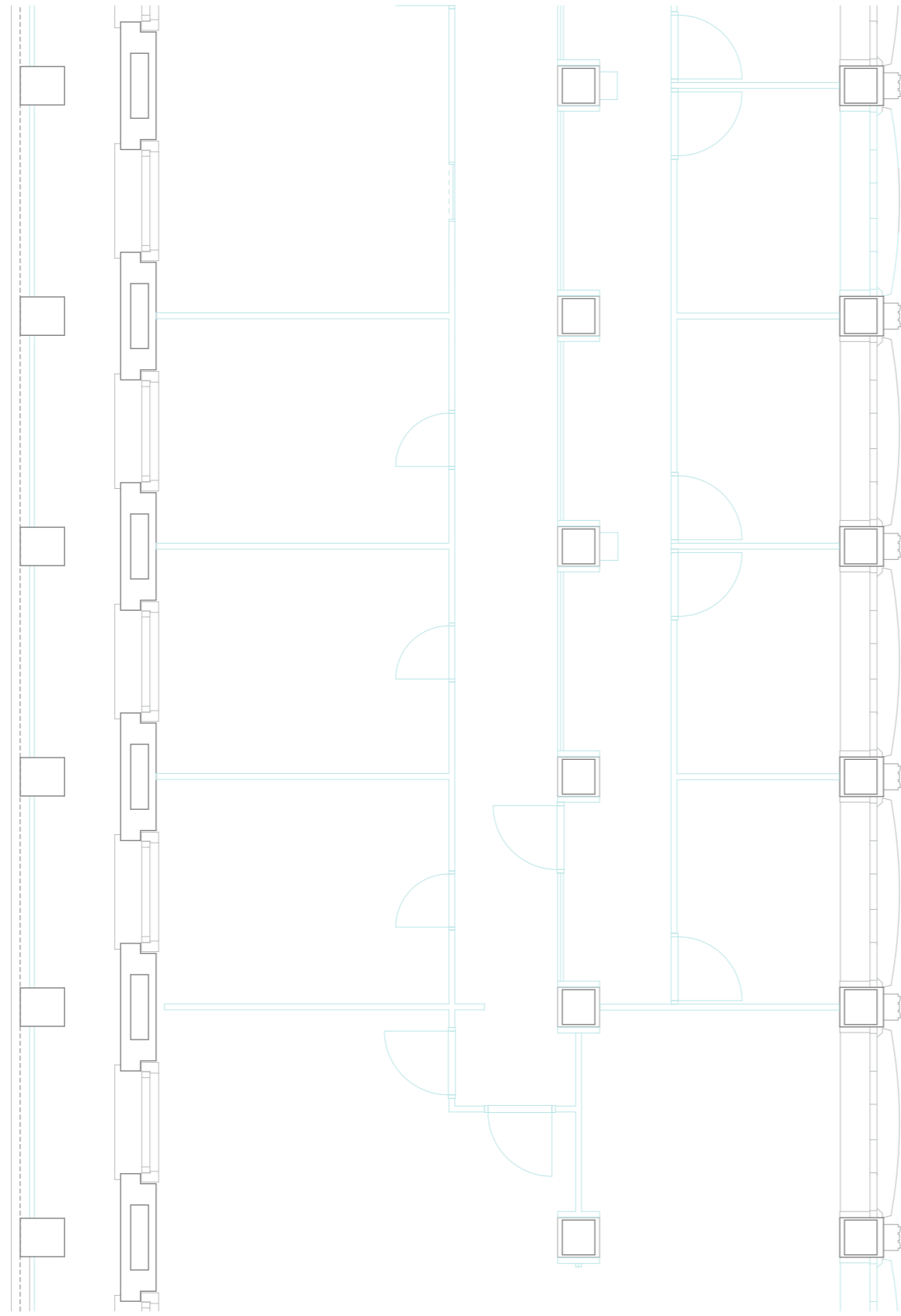
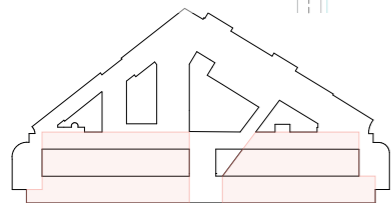

A Bank of Opportunities - New construction

Groundfloor		Scale 1/100
-------------	--	----------------

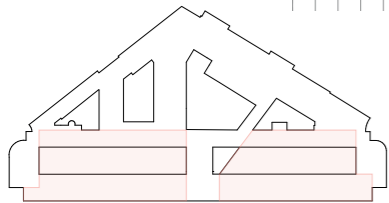
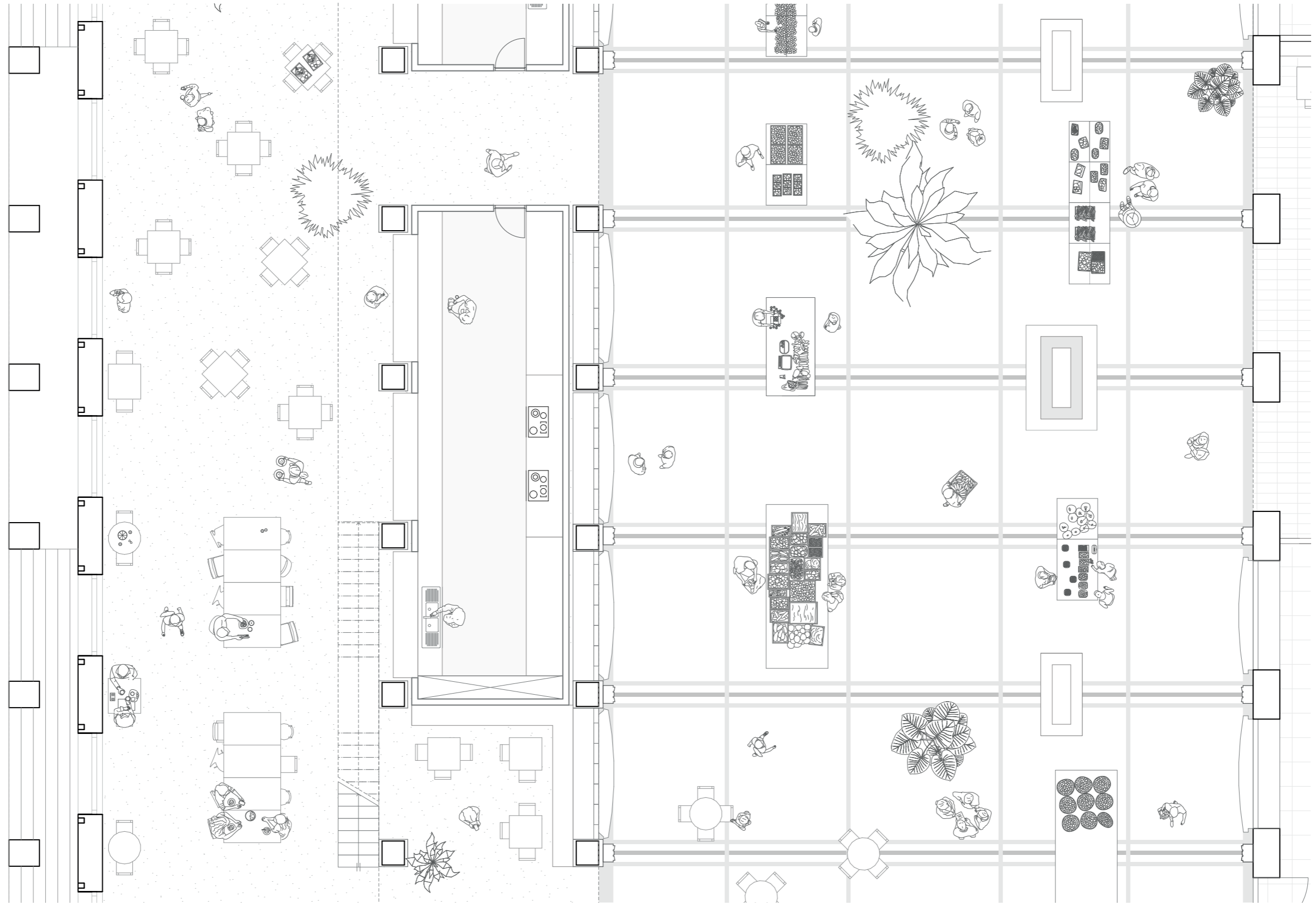

A Bank of Opportunities - *A space to gather*

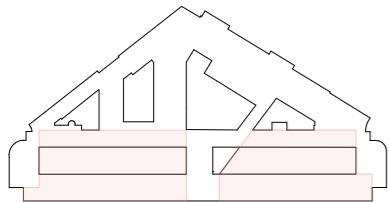
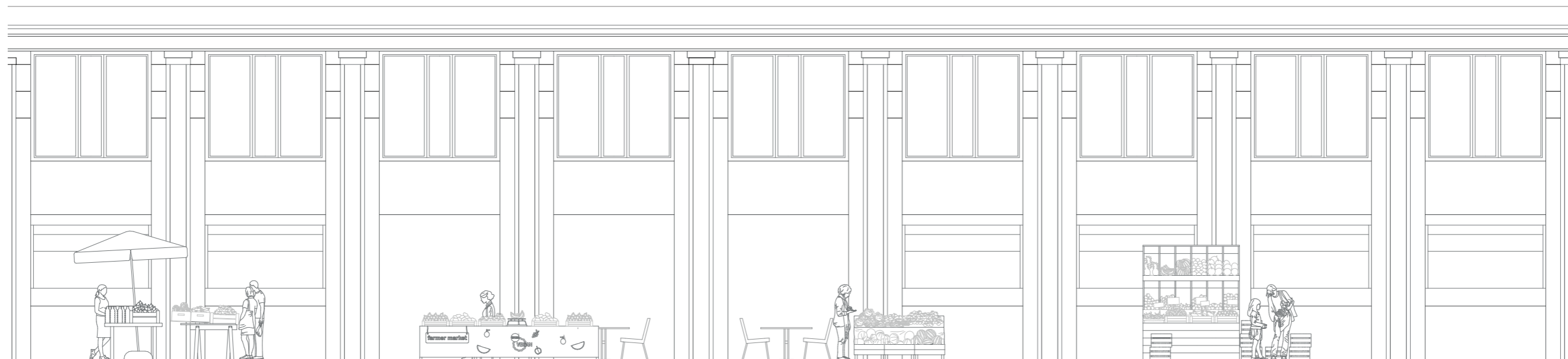

A Bank of Opportunities - *A space to gather*

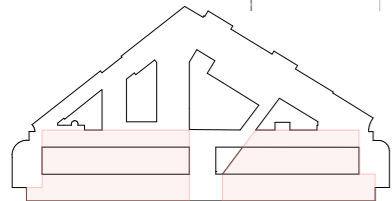
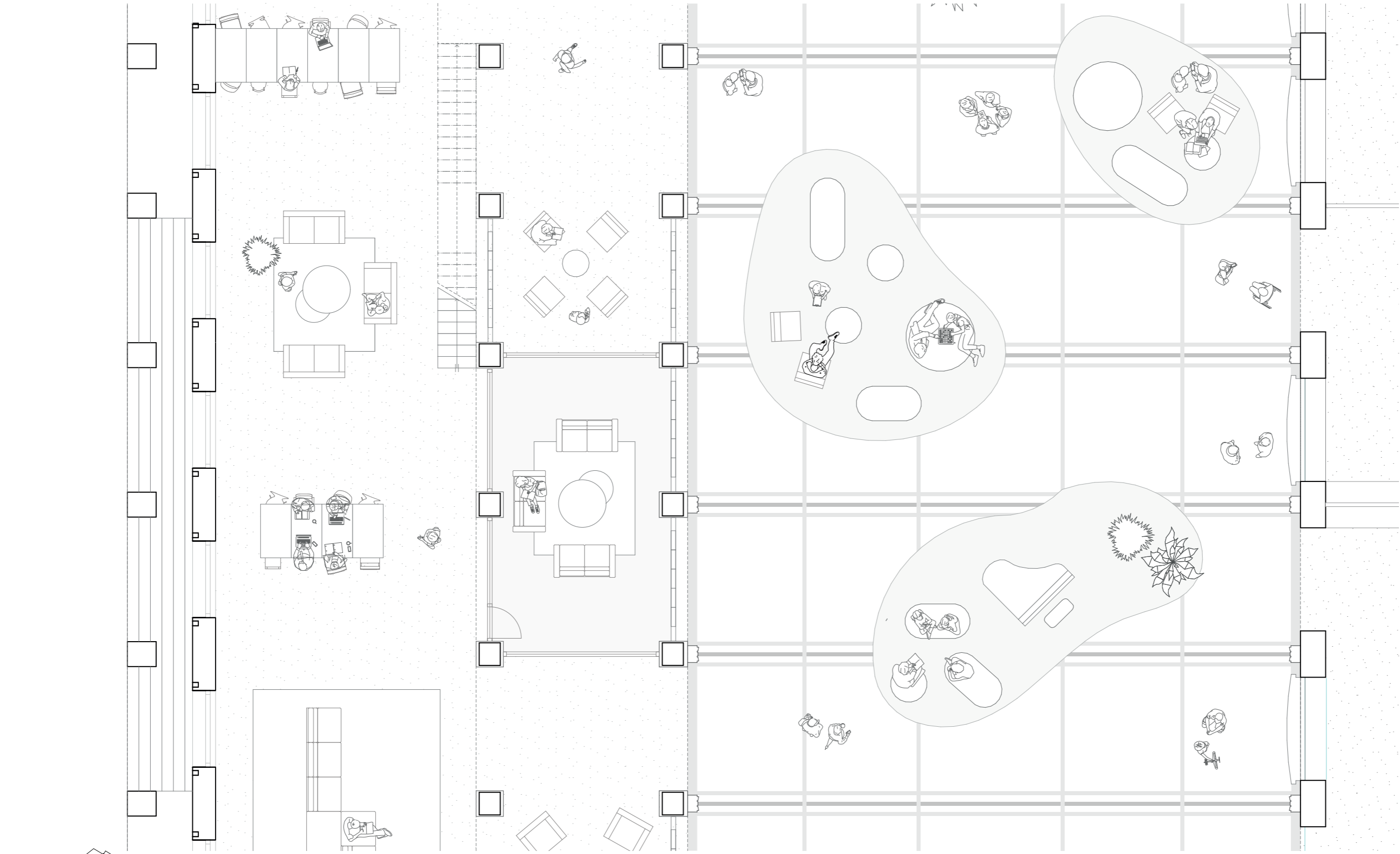

A Bank of Opportunities - *A space to gather*

Groundfloor



Scale
1/100

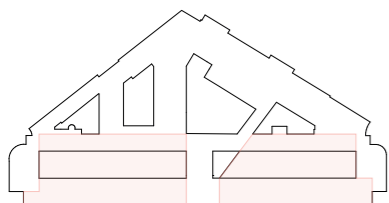
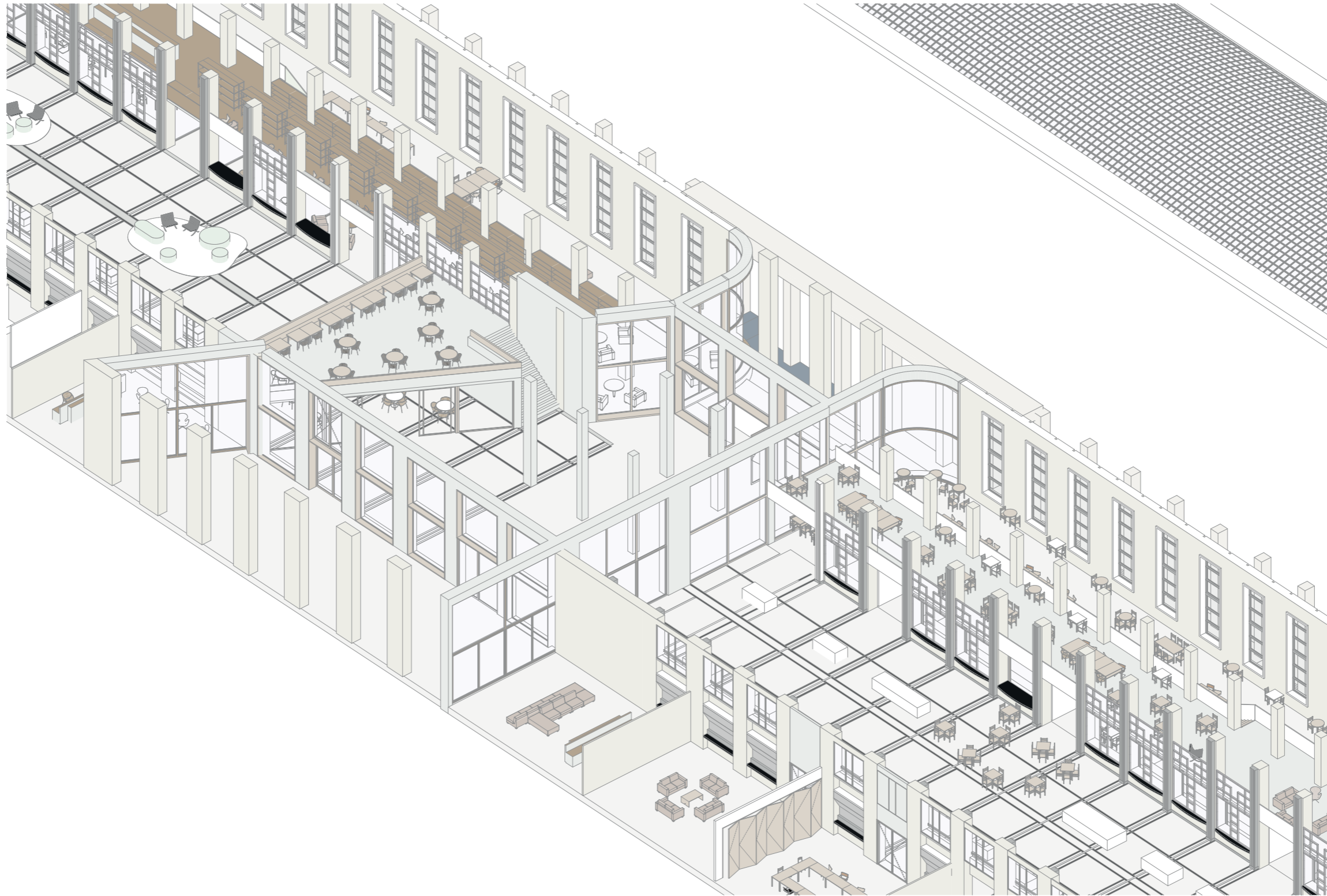

A Bank of Opportunities - People's halls



A Bank of Opportunities - People's halls

The Bank's garden

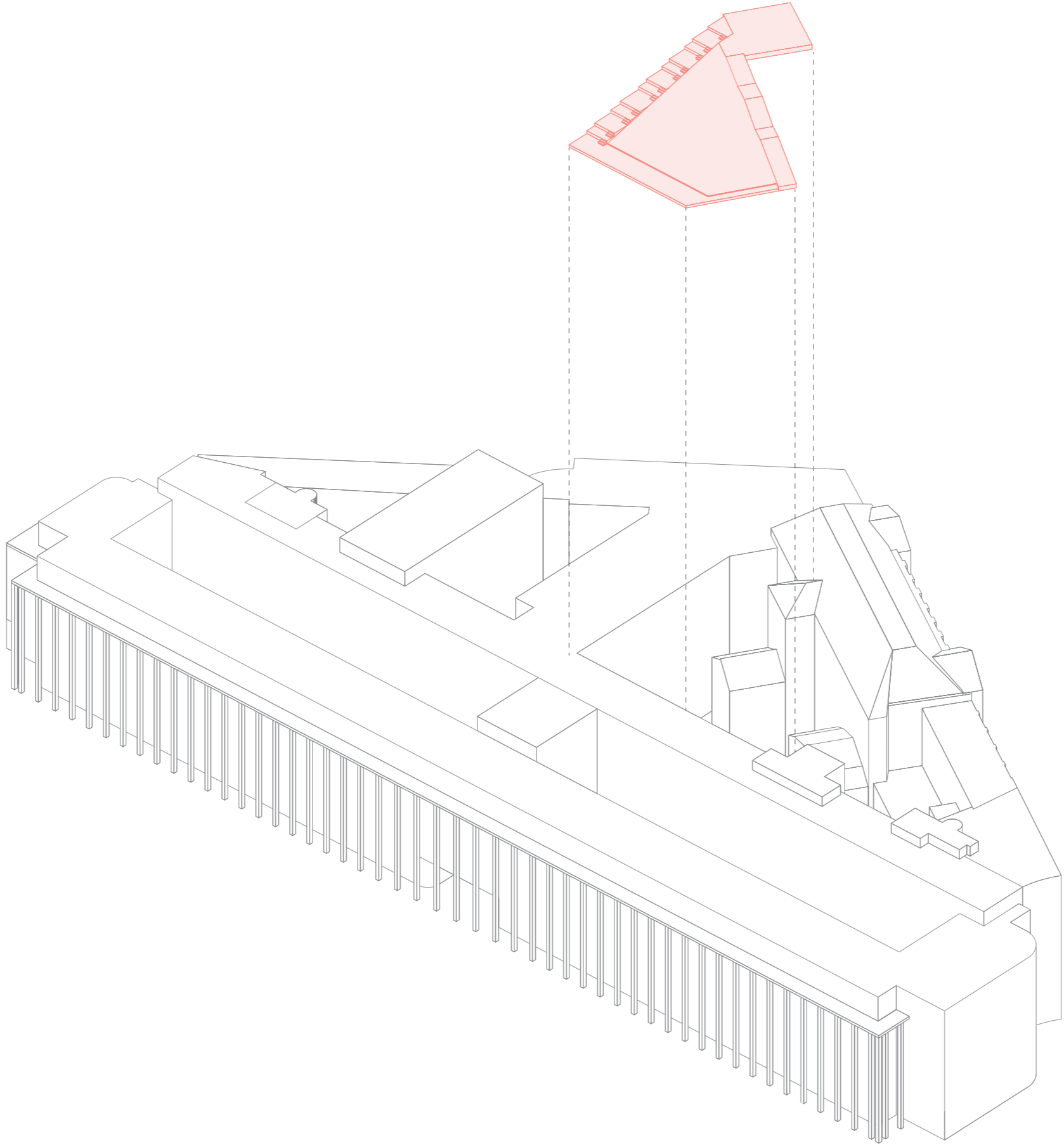

A Bank of Opportunities - Location of the courtyard

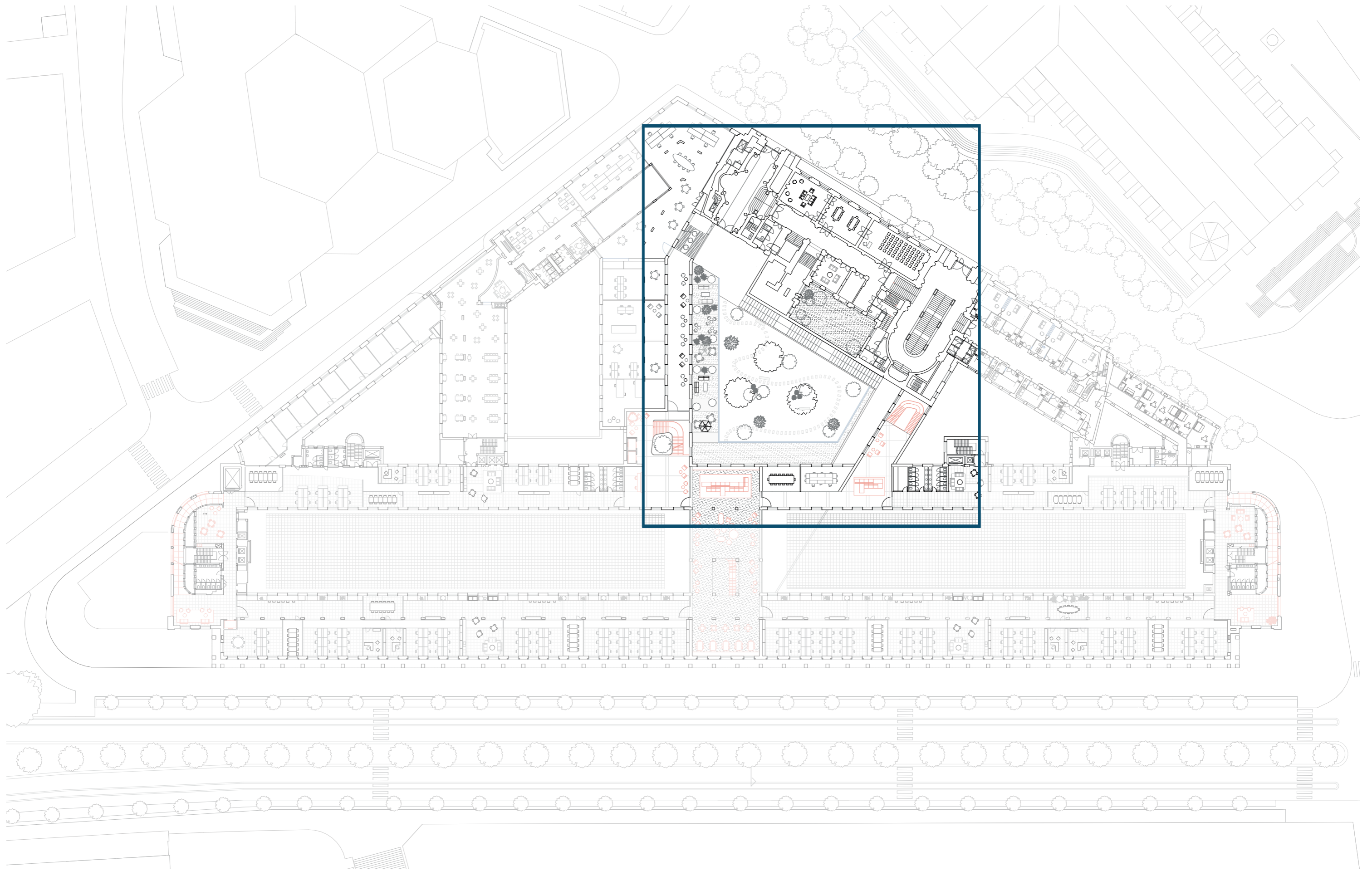

A Bank of Opportunities - *Location of the courtyard*

Second floor



Scale
1/500



A Bank of Opportunities - Re qualifying the courtyard

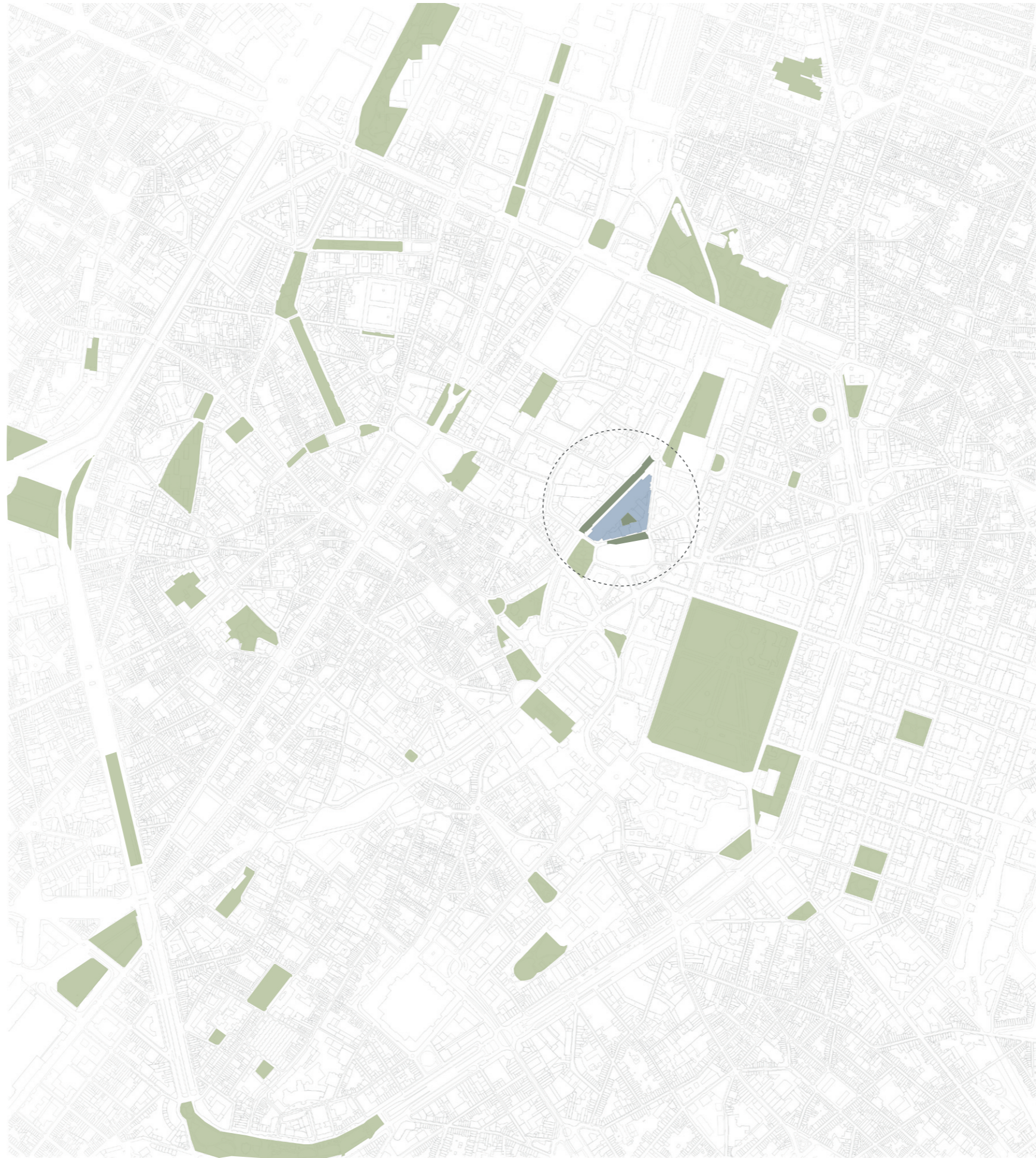

A Bank of Opportunities - *Connection between green spaces*

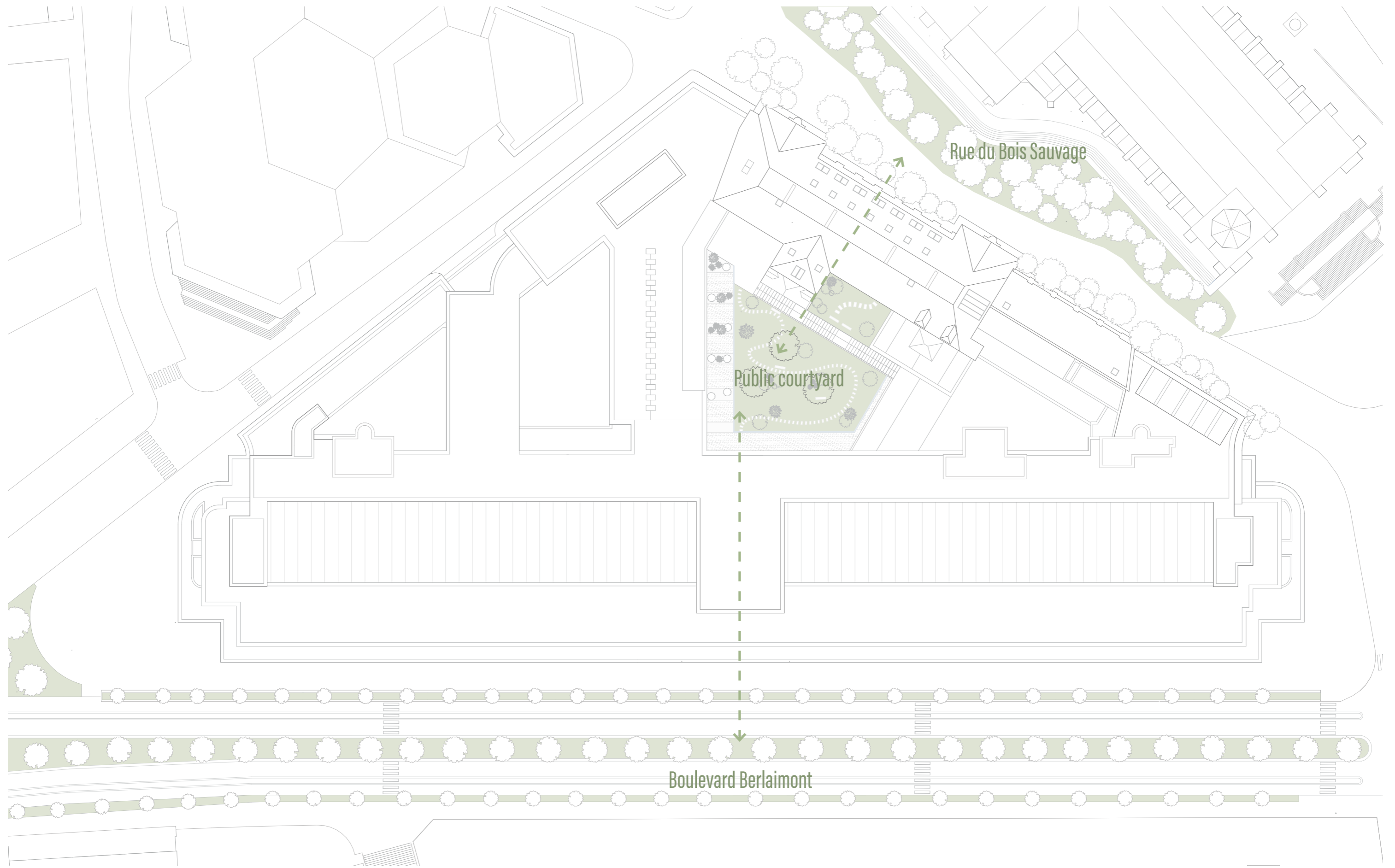

A Bank of Opportunities - *Connection between green spaces*

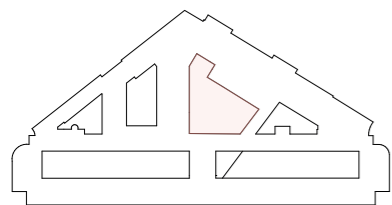
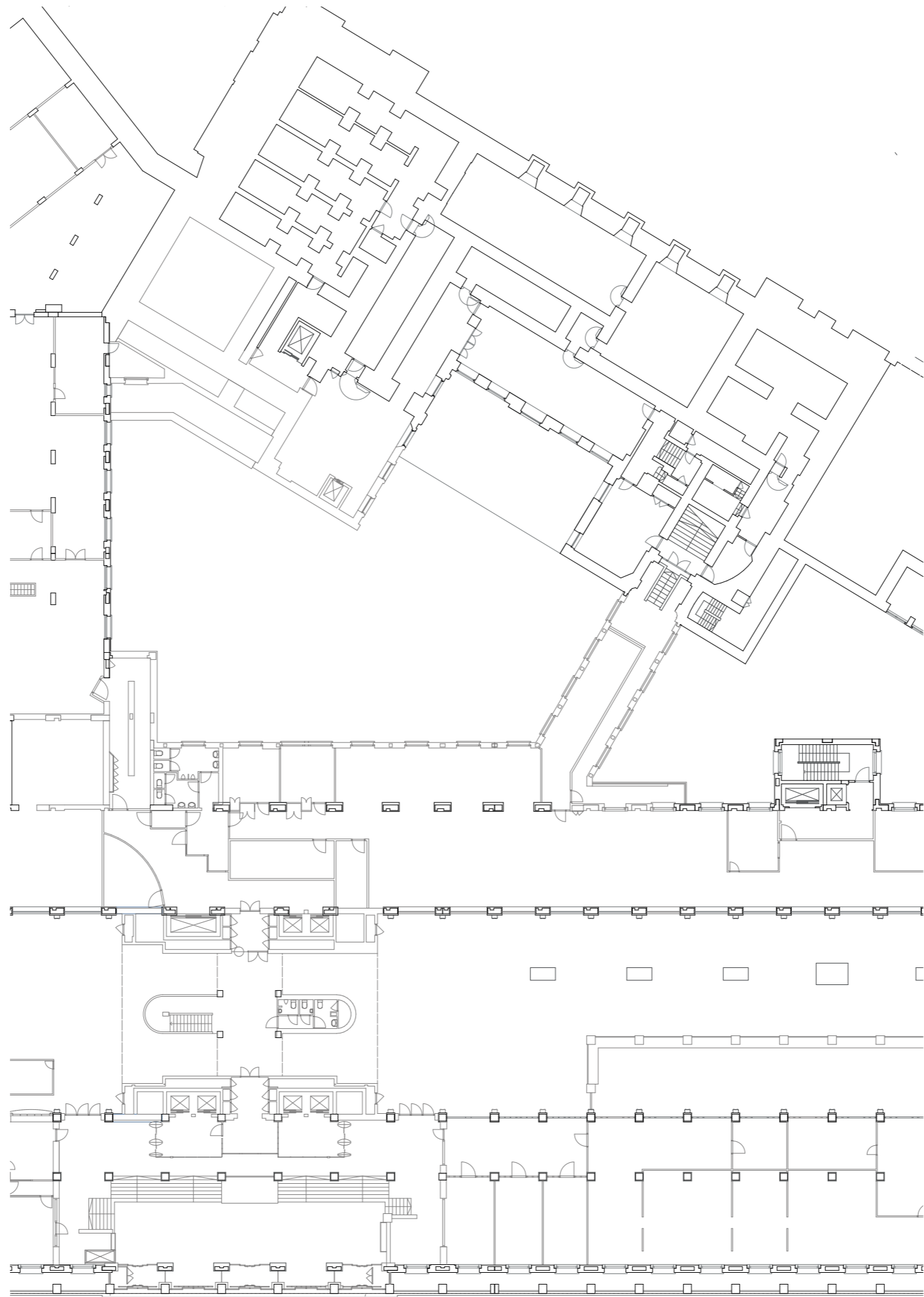

A Bank of Opportunities - Existing situation of the courtyard

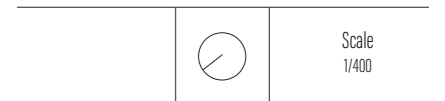

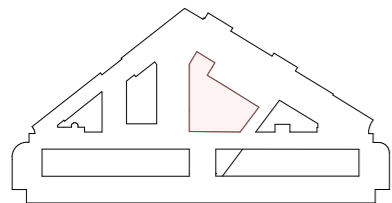
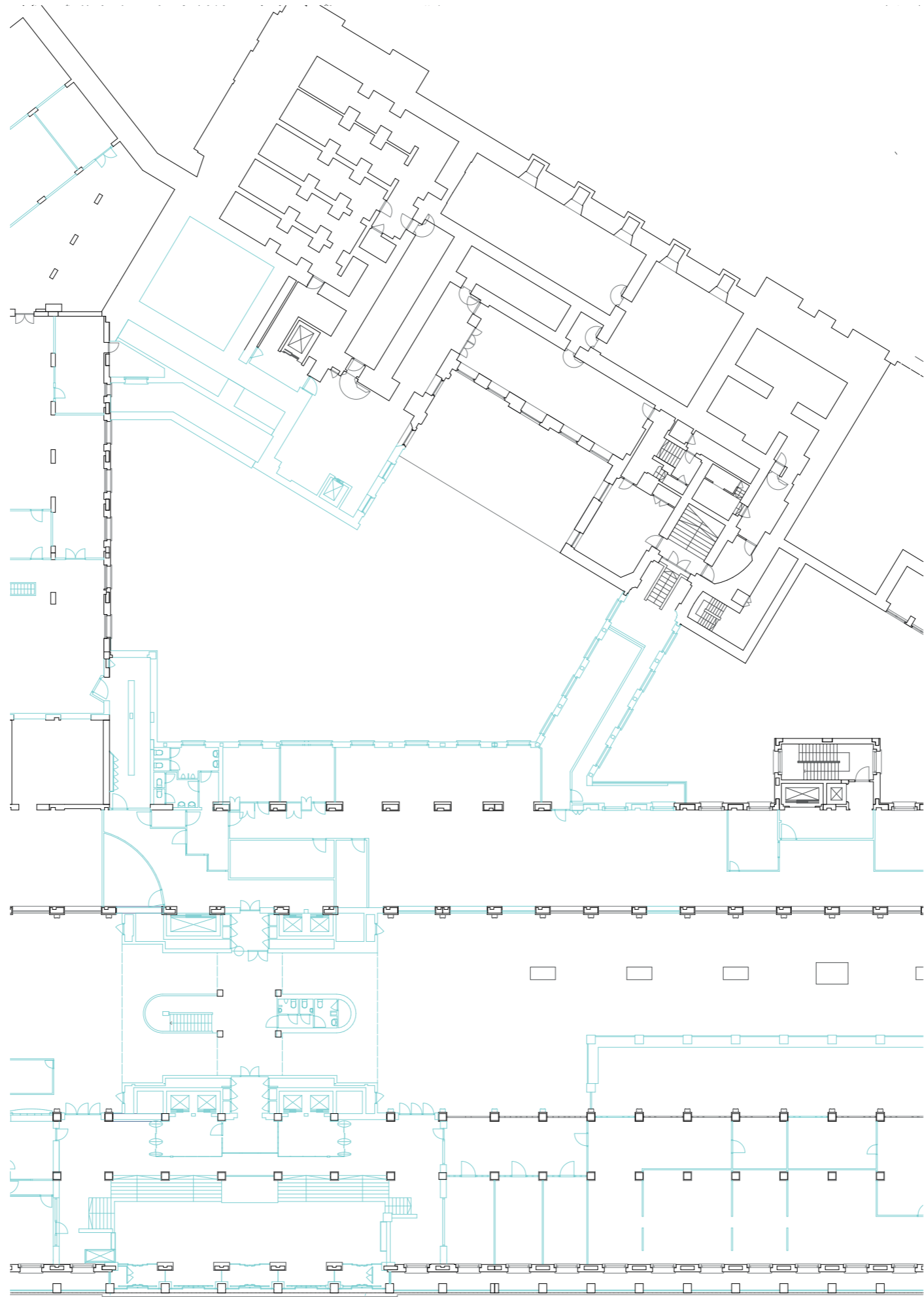

A Bank of Opportunities - Making space for the garden

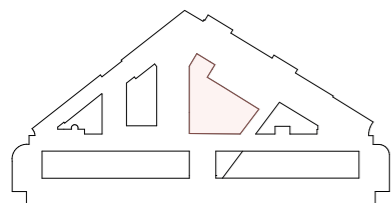
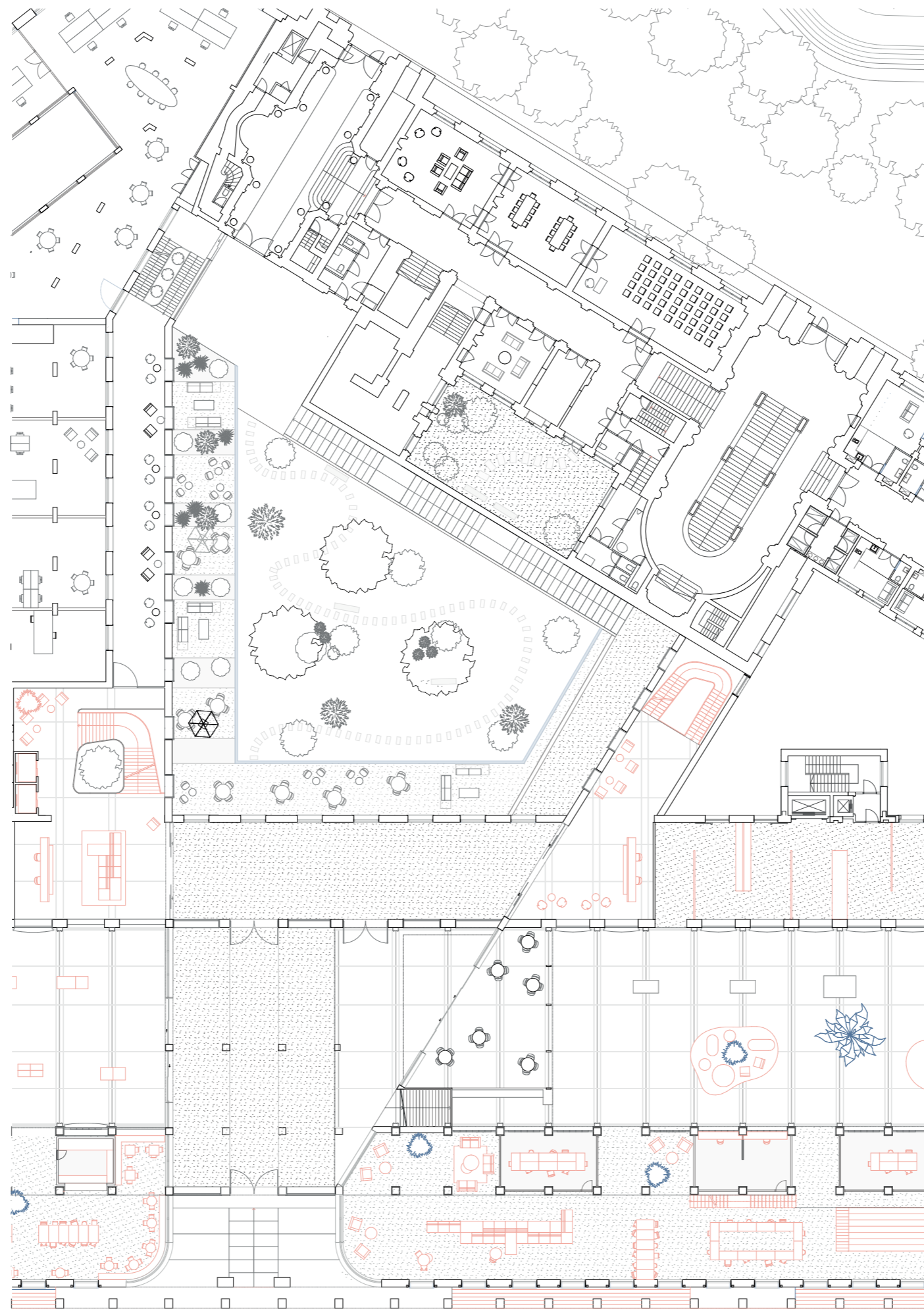

A Bank of Opportunities - *The garden of the Bank*



A Bank of Opportunities - *The garden of the Bank*

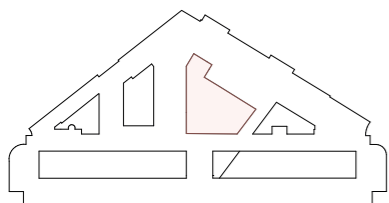

A Bank of Opportunities - *The courtyard as a garden*



La fougère aigle (*Pteridium aquilinum*)



L'Ail des ours (*Allium ursinum*)



La centaurée jacée (*Centaurea jacea*)



La reine des prés (*Filipendula ulmaria*)



L'orchis de Fuchs (*Dactylorhiza fuchsii*)

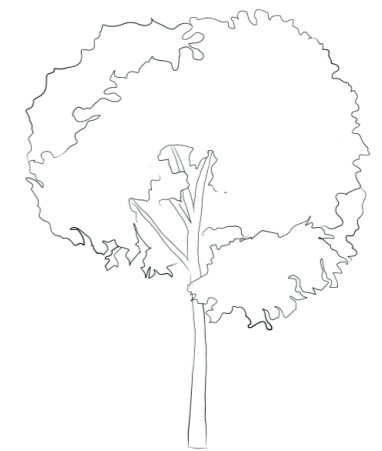

Le hêtre commun (*Fagus sylvatica*)

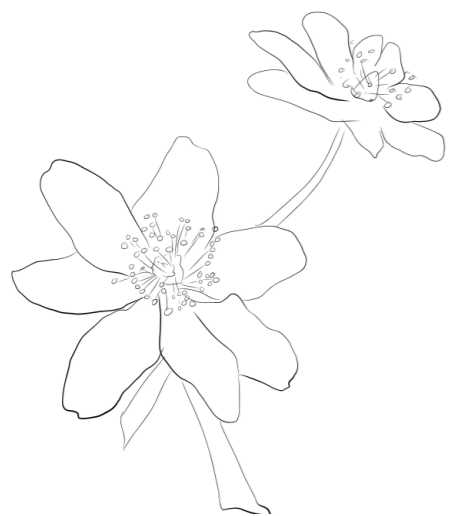

L'anémone sylvie (*Anemone nemorosa*)



La callune (*Calluna vulgaris*)



Le Chêne sessile (*Quercus petraea*)



Le populage des marais (*Caltha palustris*)



La marguerite commune (*Leucanthemum vulgare*)

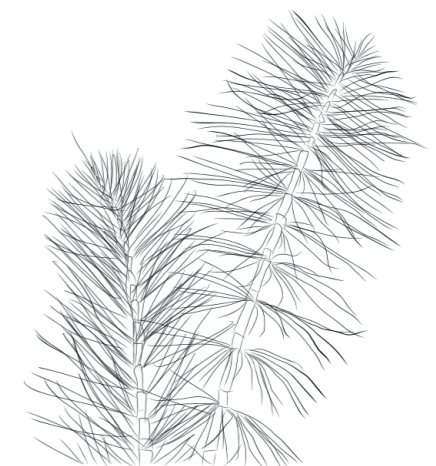

La grande prêle (*Equisetum telmateia*)



The Sublte Bank - *Transversal section*

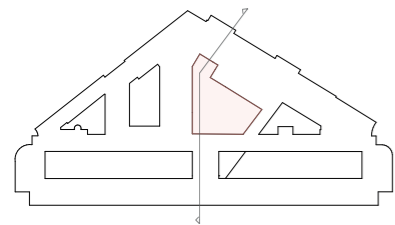

A Bank of Opportunities- *Transversal section*

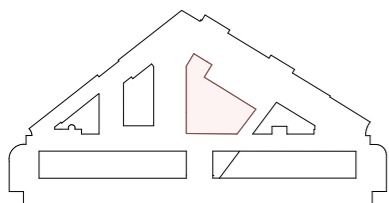
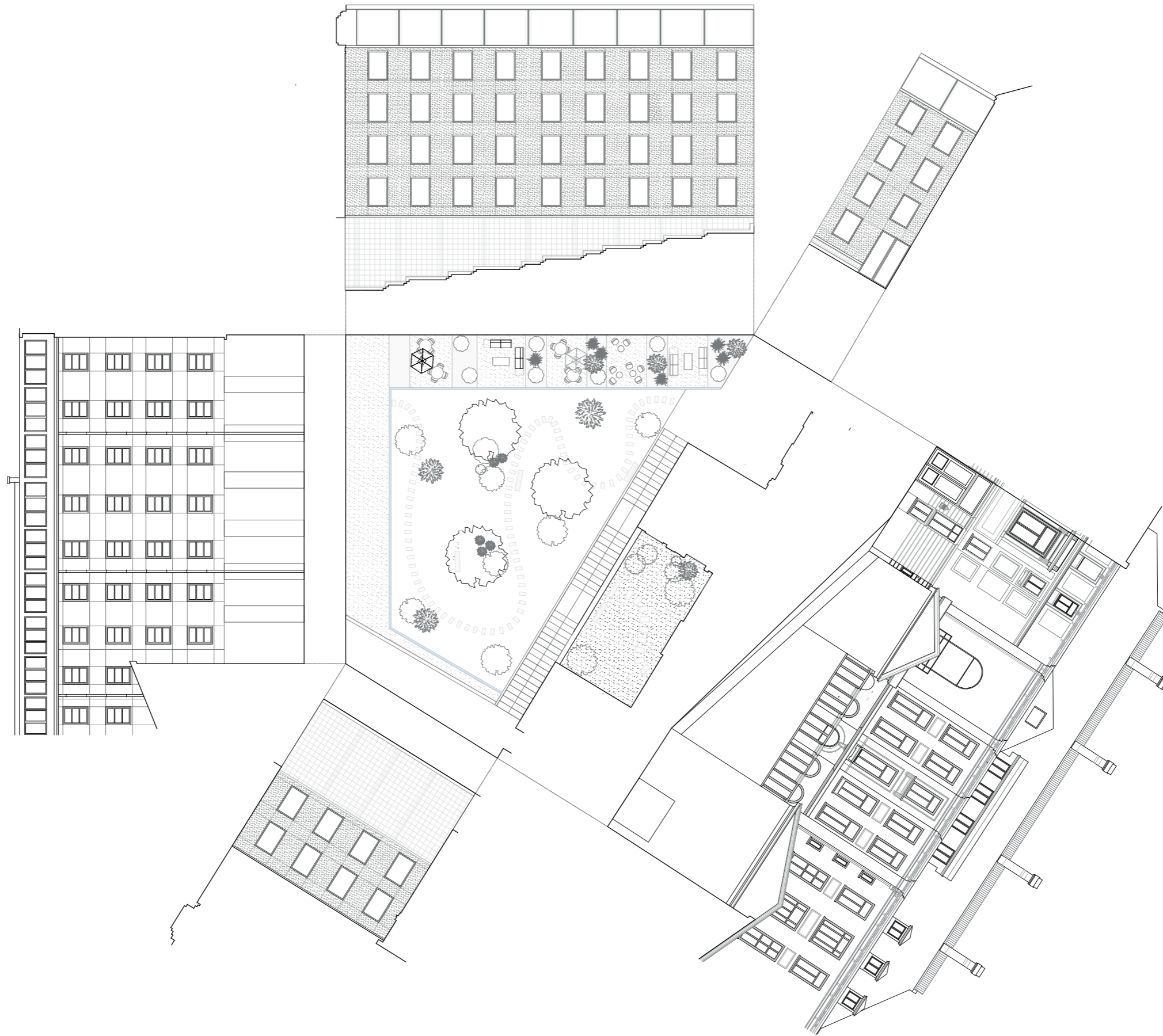

A Bank of Opportunities - *The garden as a scene*



A Bank of Opportunities - *The garden as a scene*

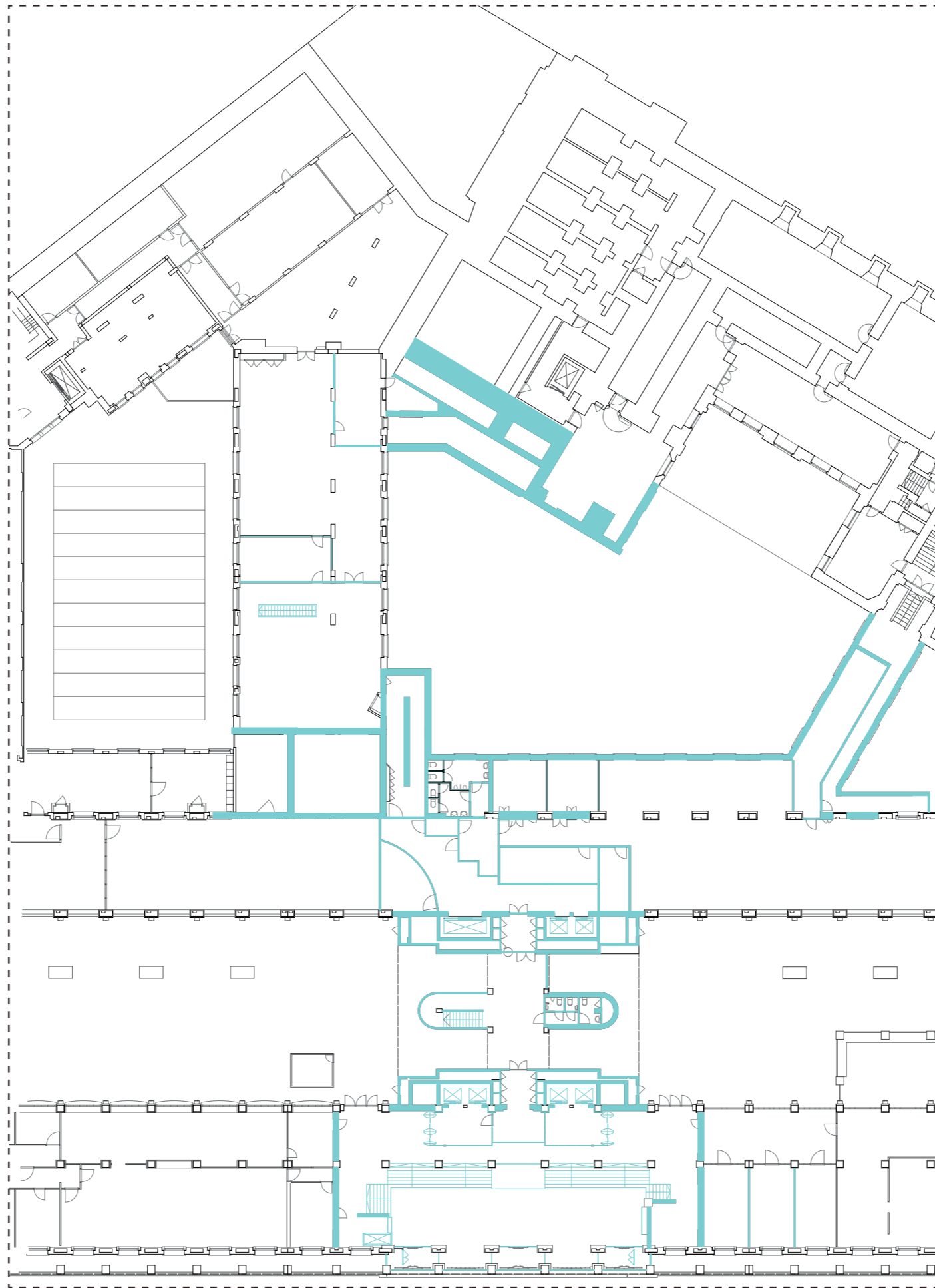

A Bank of Opportunities - *Demolition drawing*

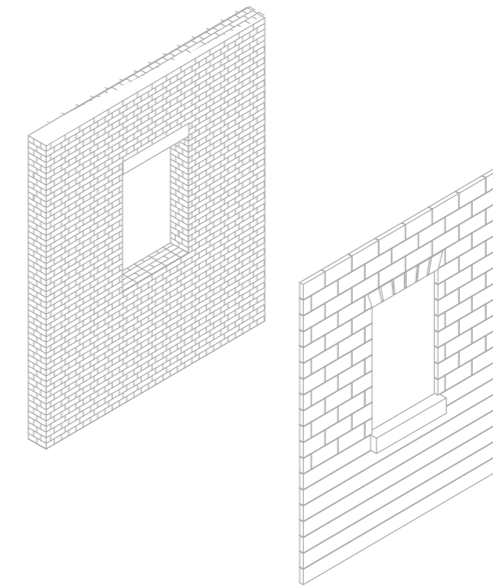
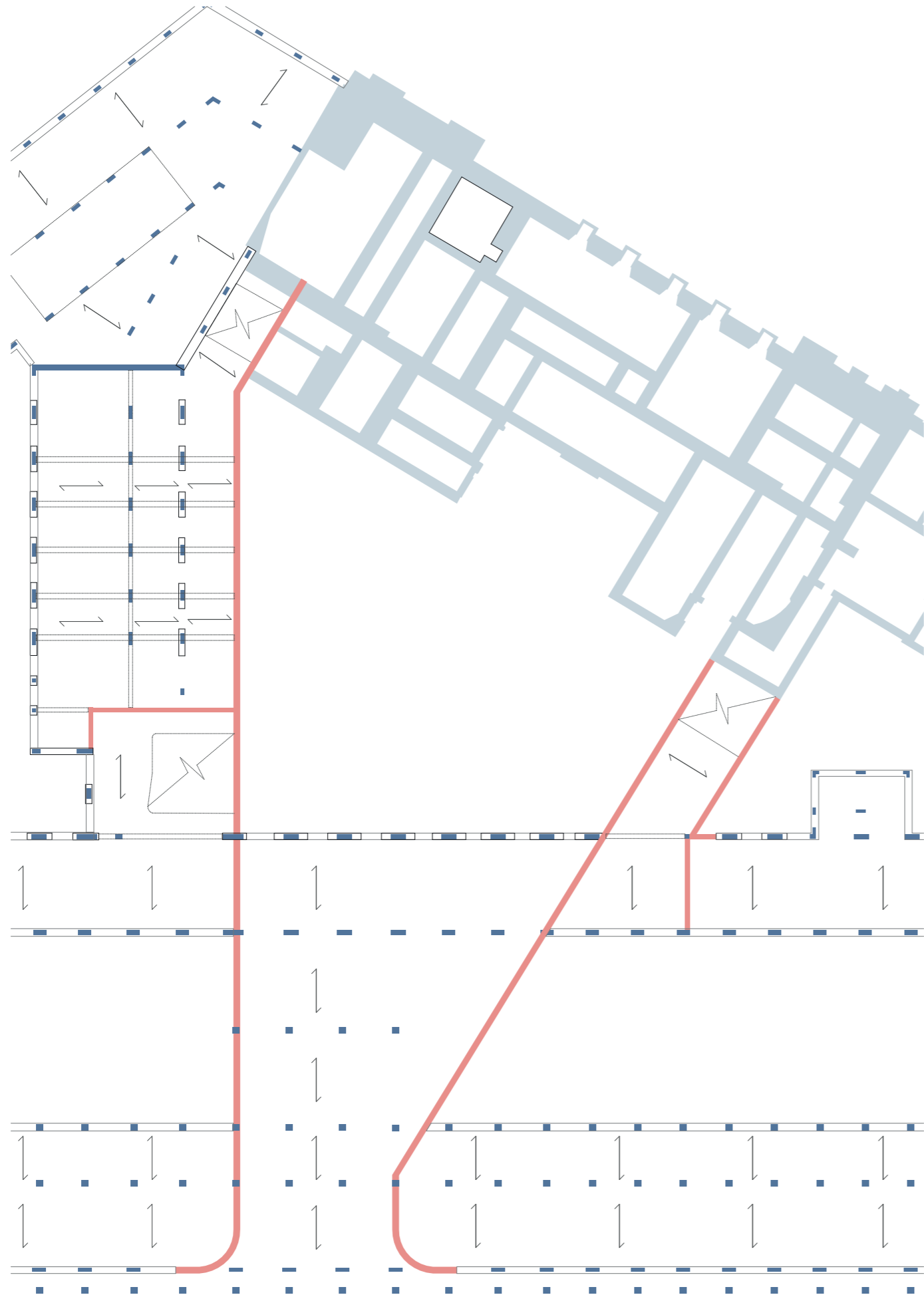

Henri Beyaert - XIXth century- massive brick structure

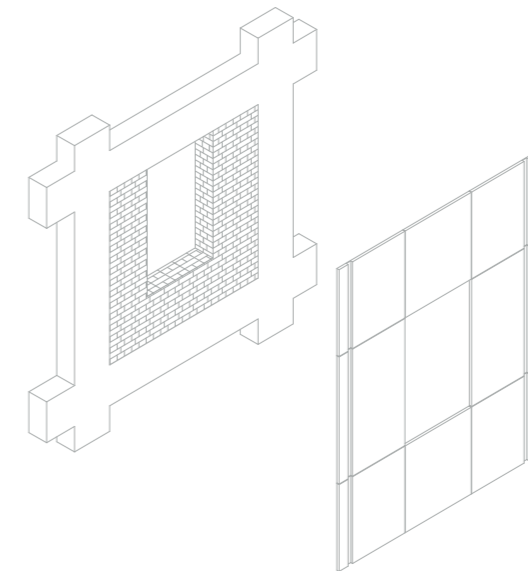

Marcel Van Goethem - 1948 - Concrete structure with brick filling

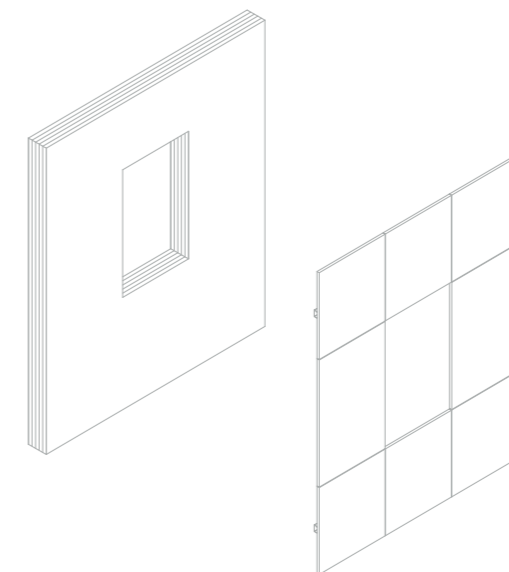

New interventions - CLT structure



A Bank of Opportunities - Taking advantage of the existing

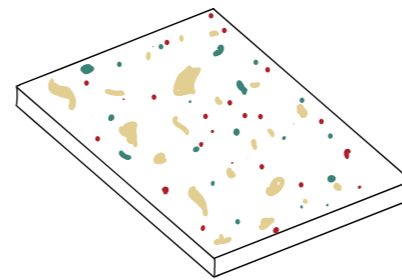
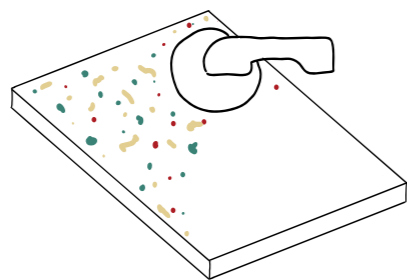
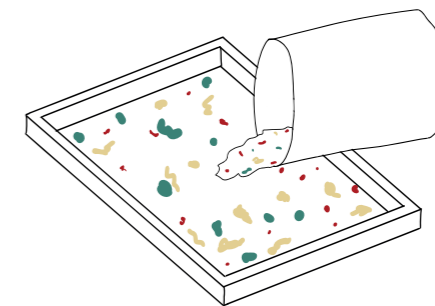
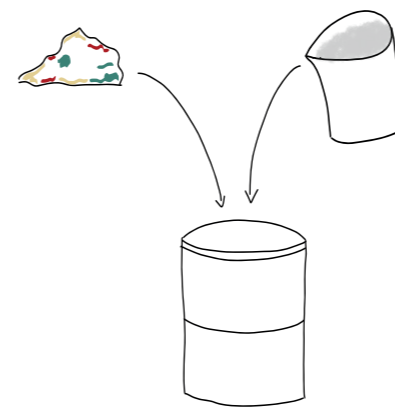
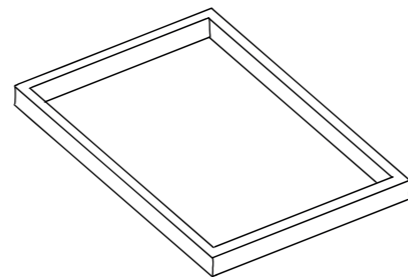
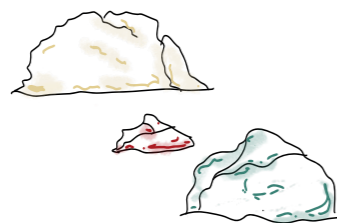
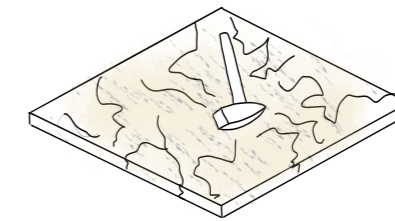
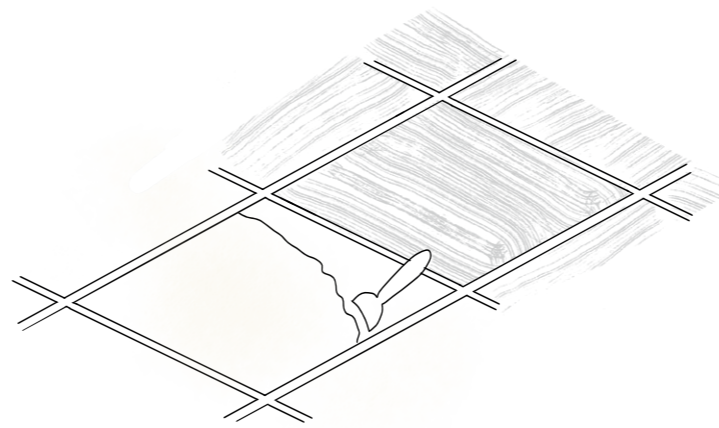
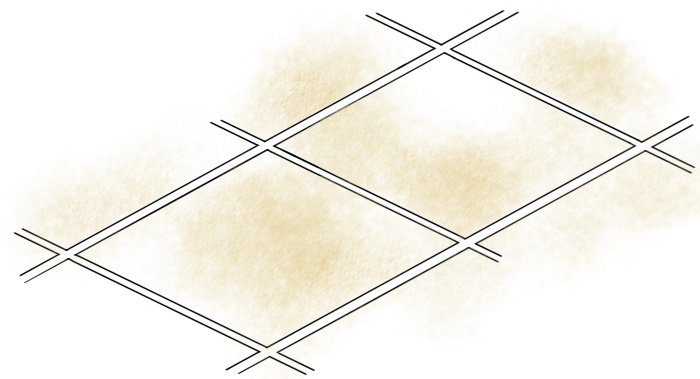

A Bank of Opportunities - *Process of making reused concrete*

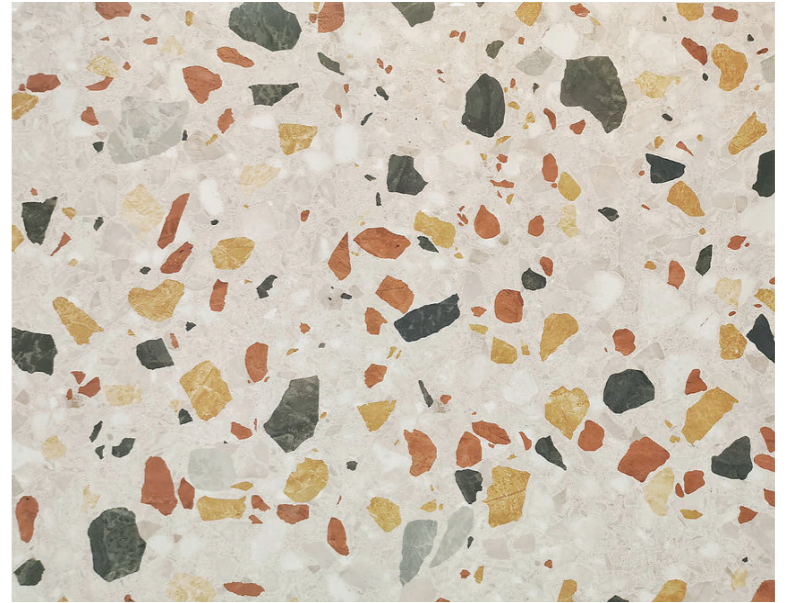
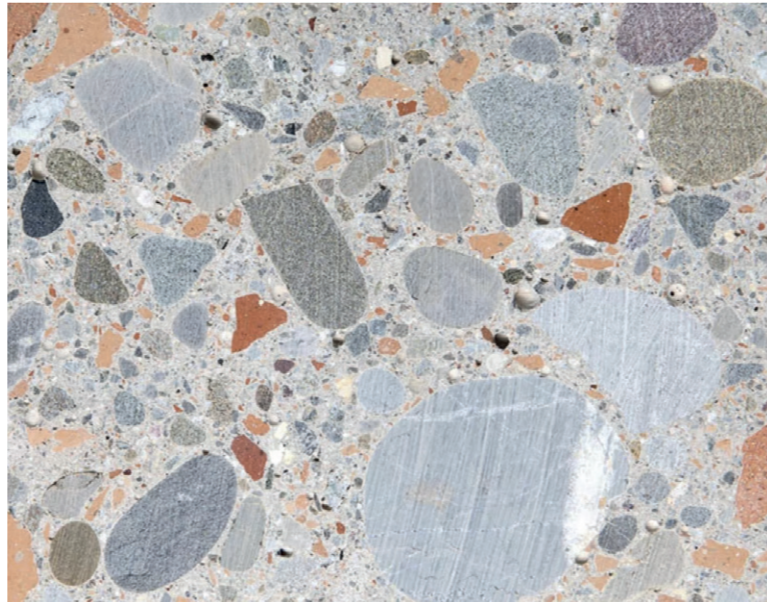
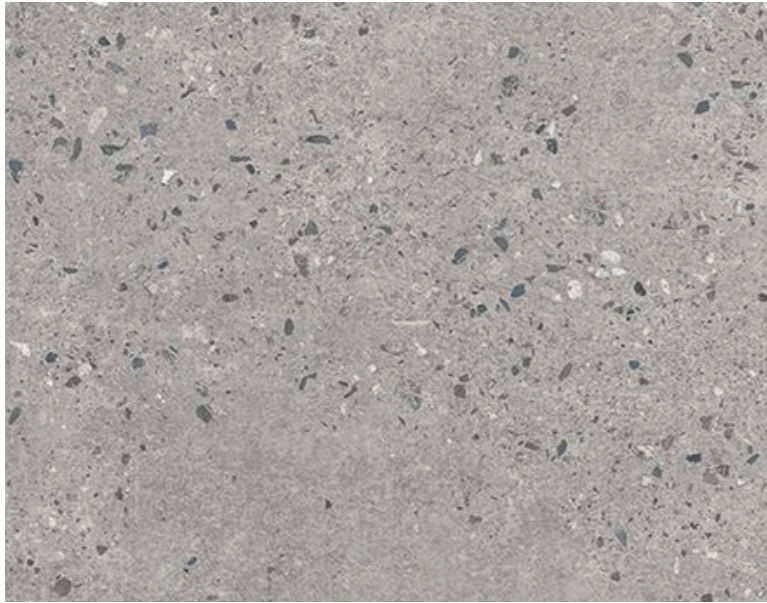

A Bank of Opportunities - Preserving the history of the bank

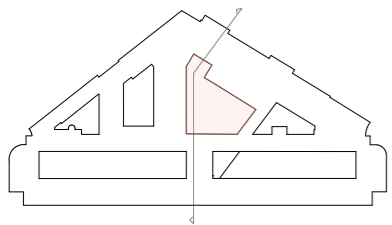
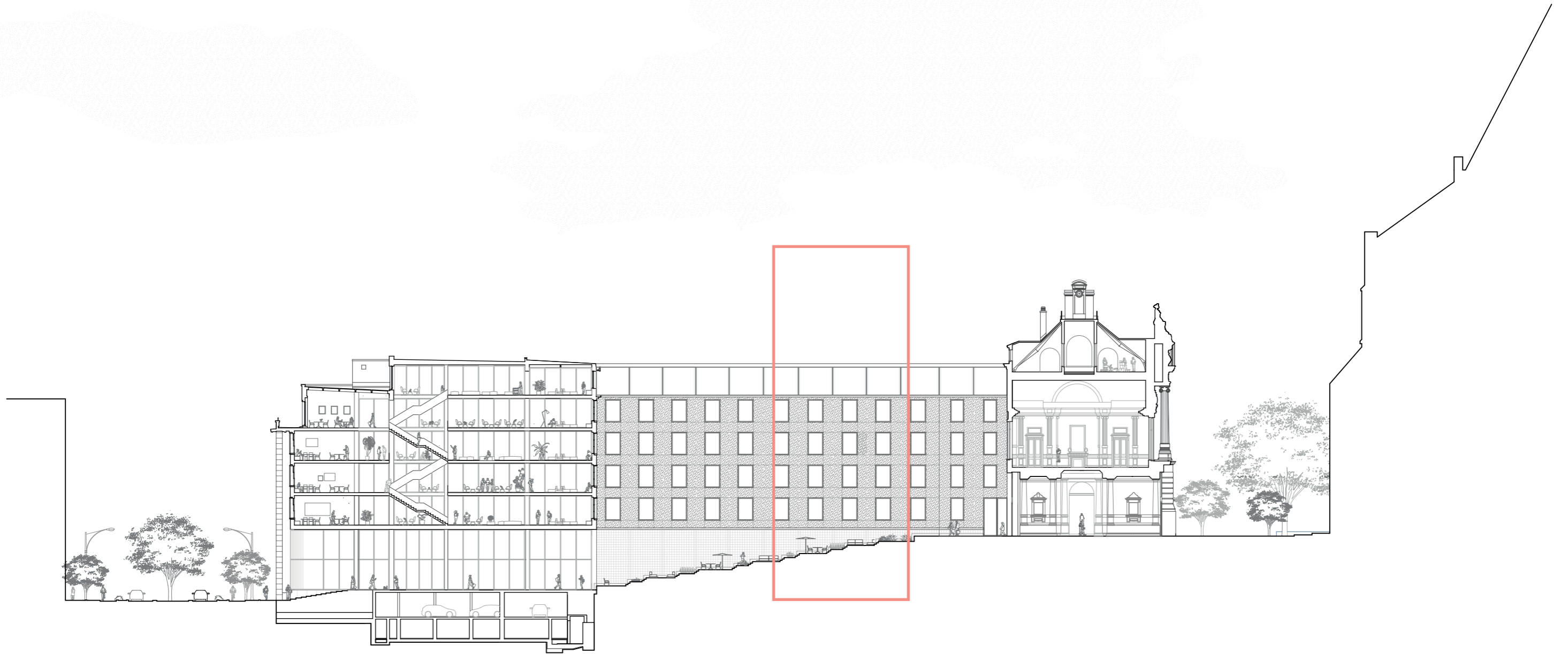

A Bank of Opportunities - *Crafting a new facade*

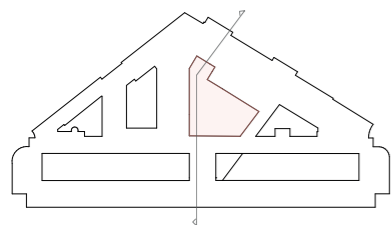
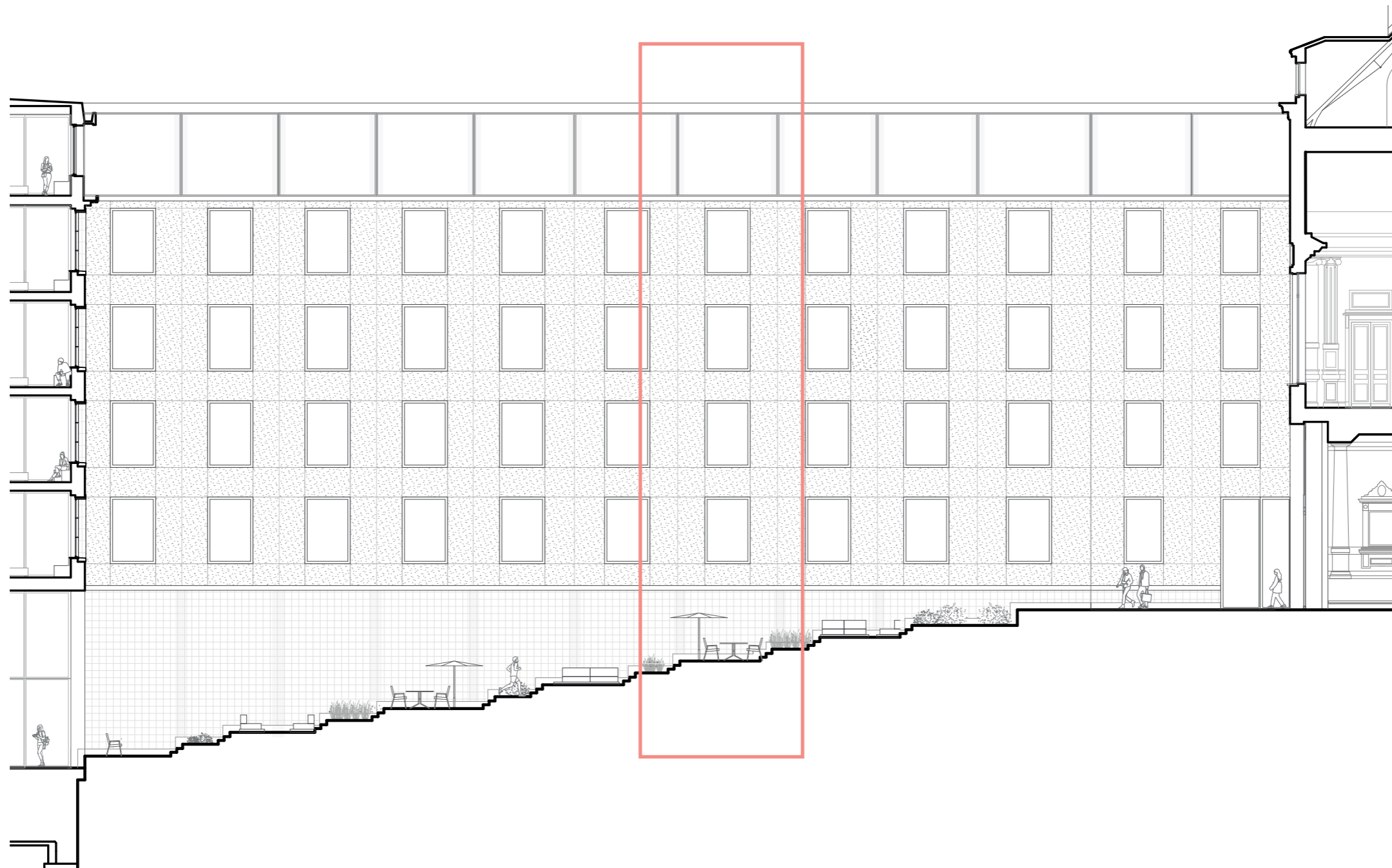

A Bank of Opportunities - *New facade design*

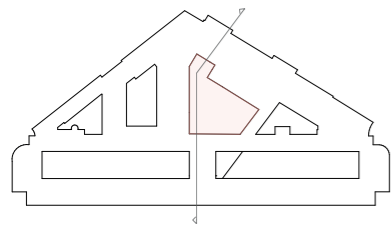
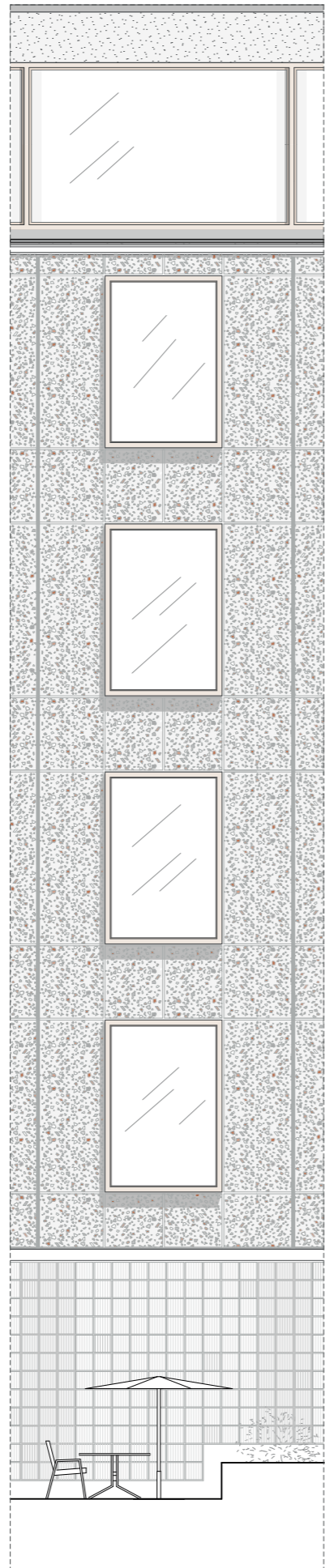

A Bank of Opportunities - *New facade design*

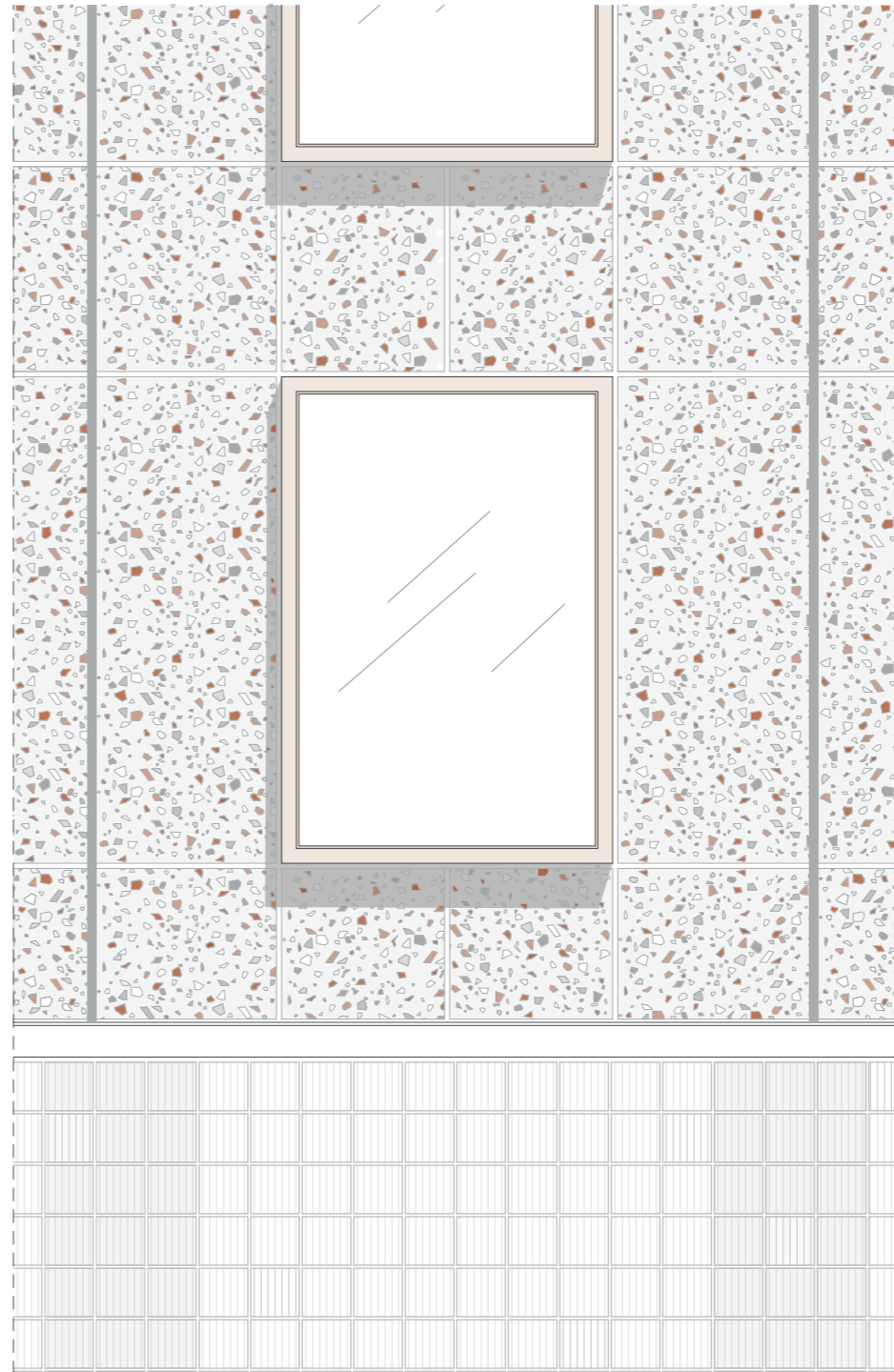
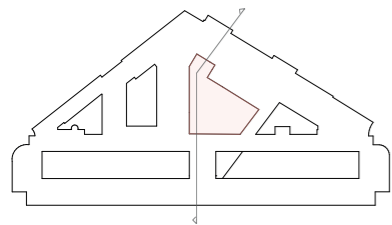
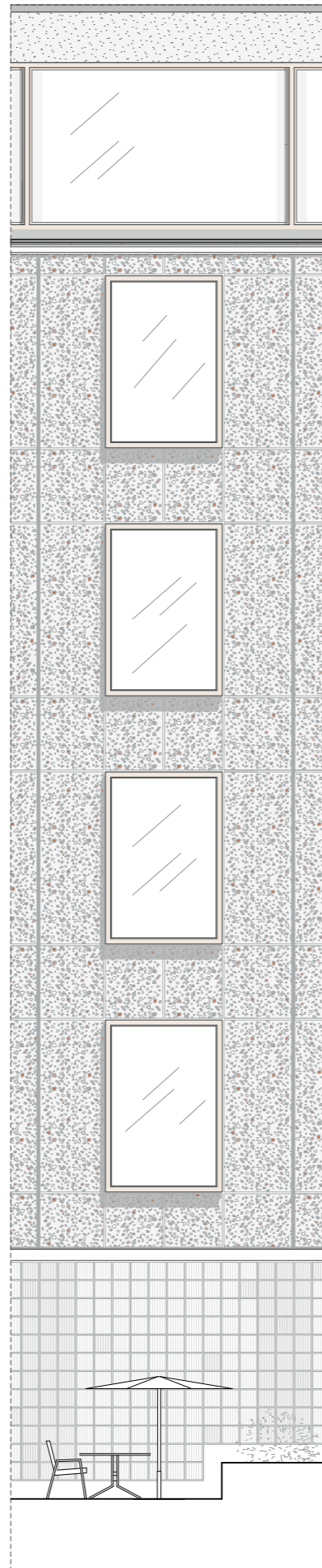

A Bank of Opportunities - *New facade design*

Existing facade

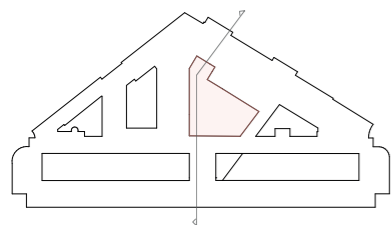

A Bank of Opportunities - Composition of the facade

Existing facade

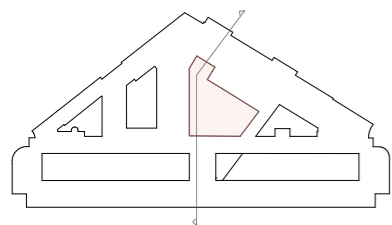
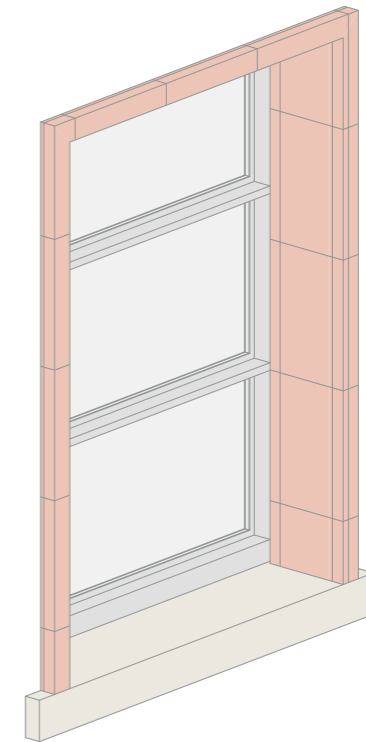
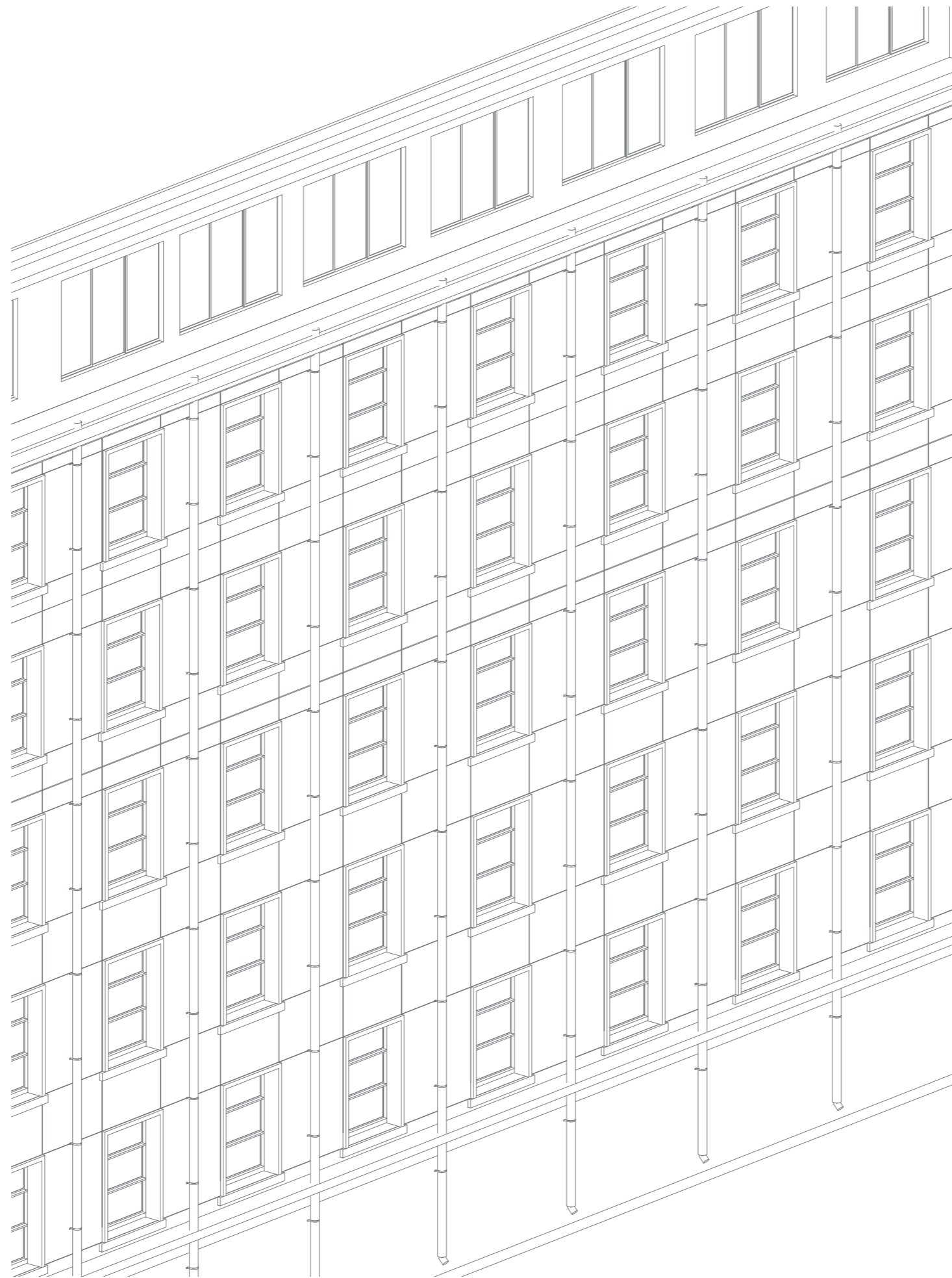

A Bank of Opportunities - Composition of the facade

Windows in negative

New facade

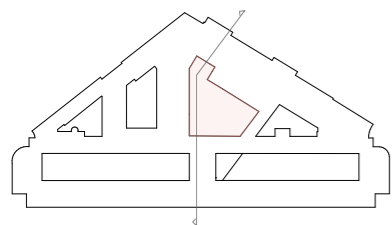
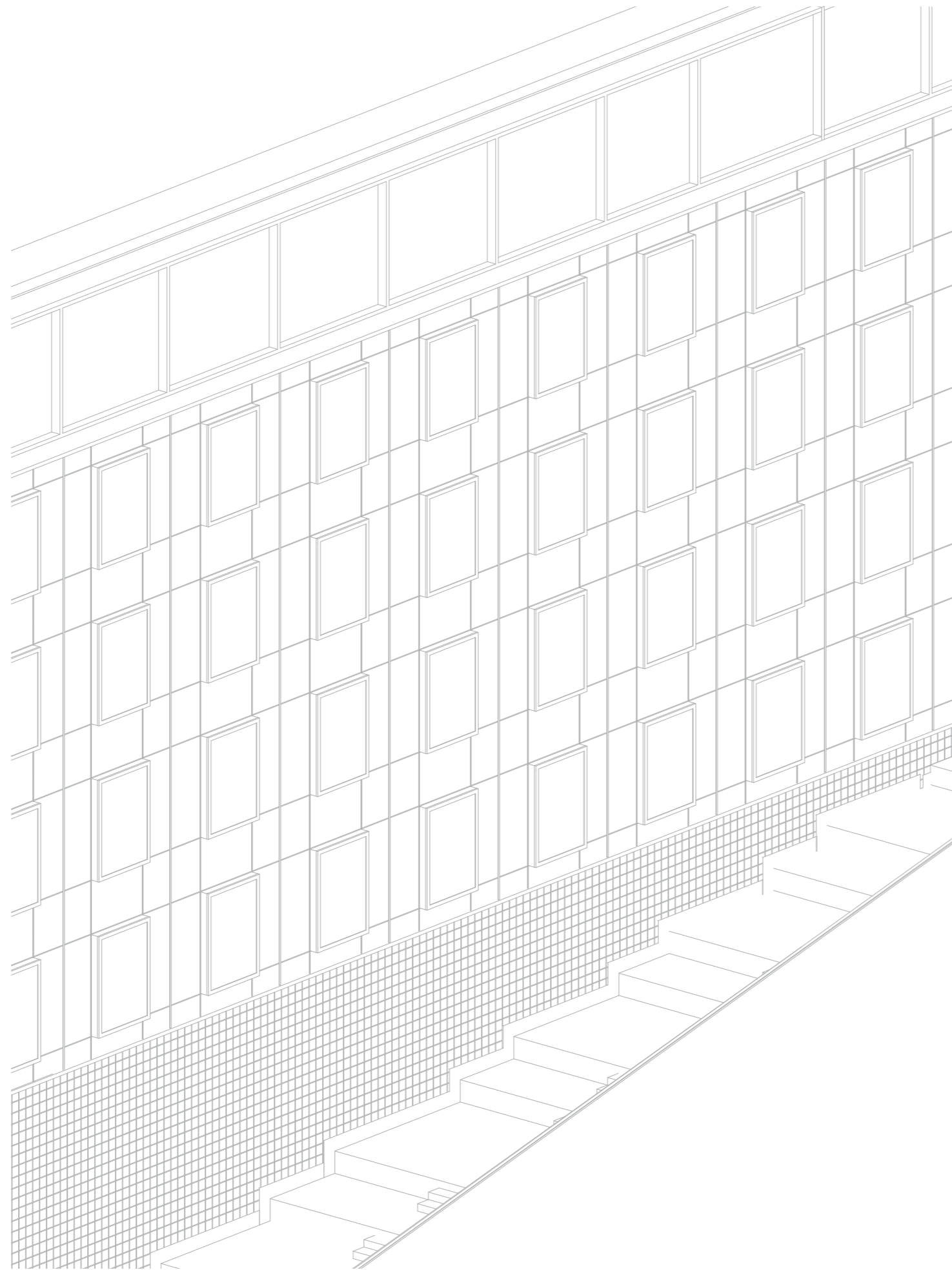

A Bank of Opportunities - Composition of the facade

New facade

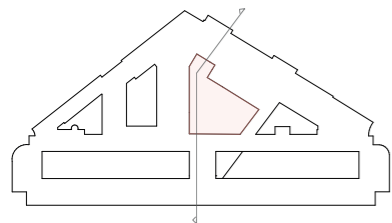
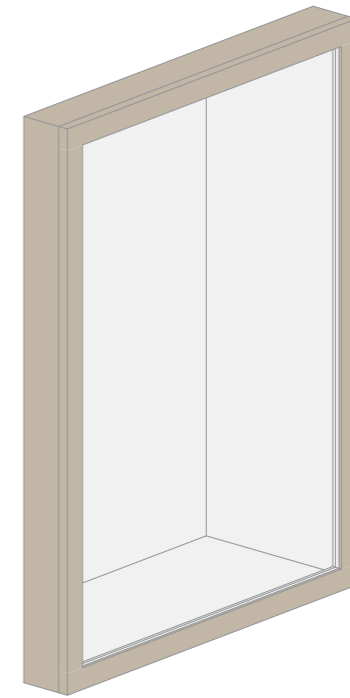
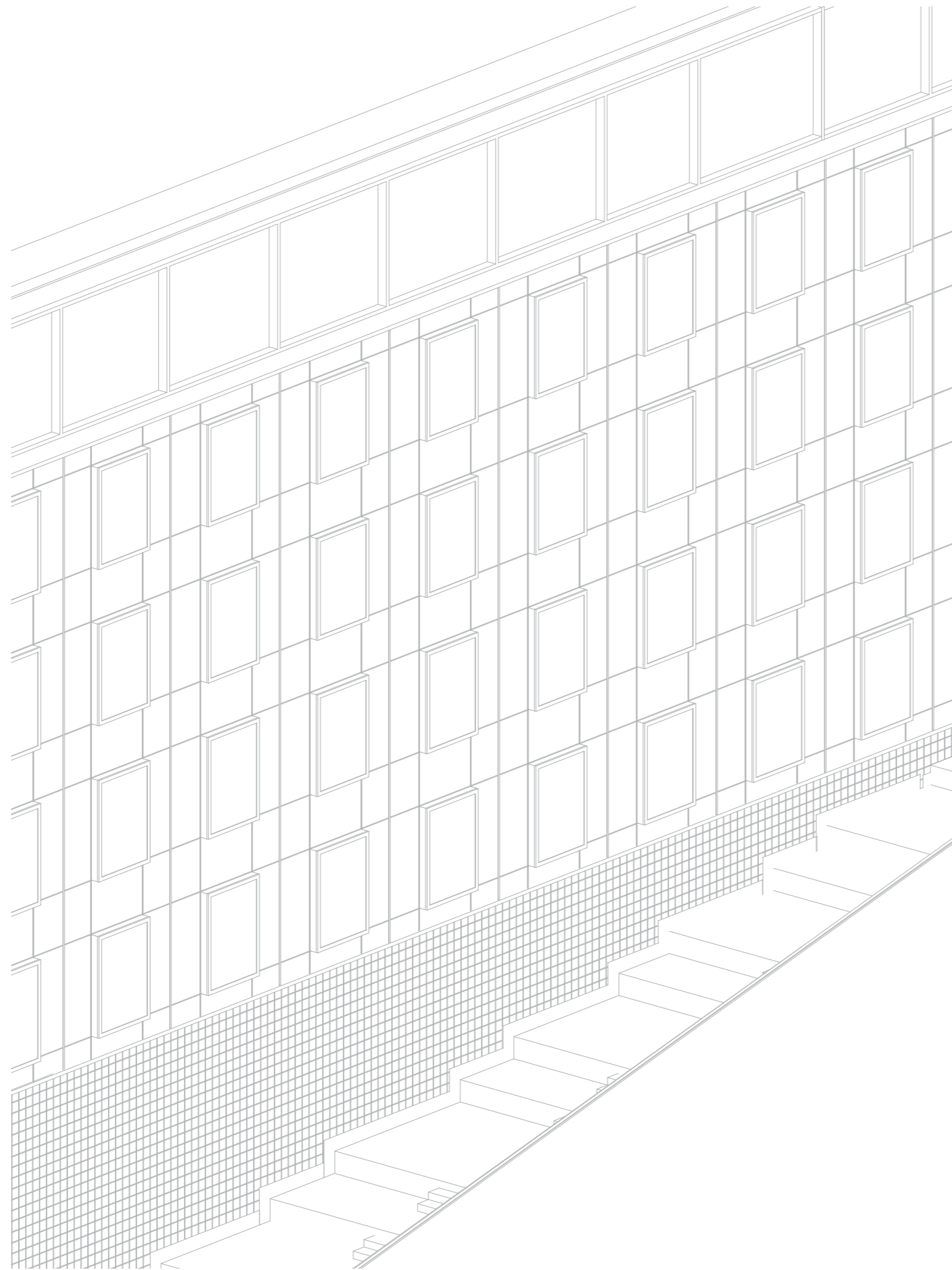

A Bank of Opportunities - Composition of the facade

Windows in positive

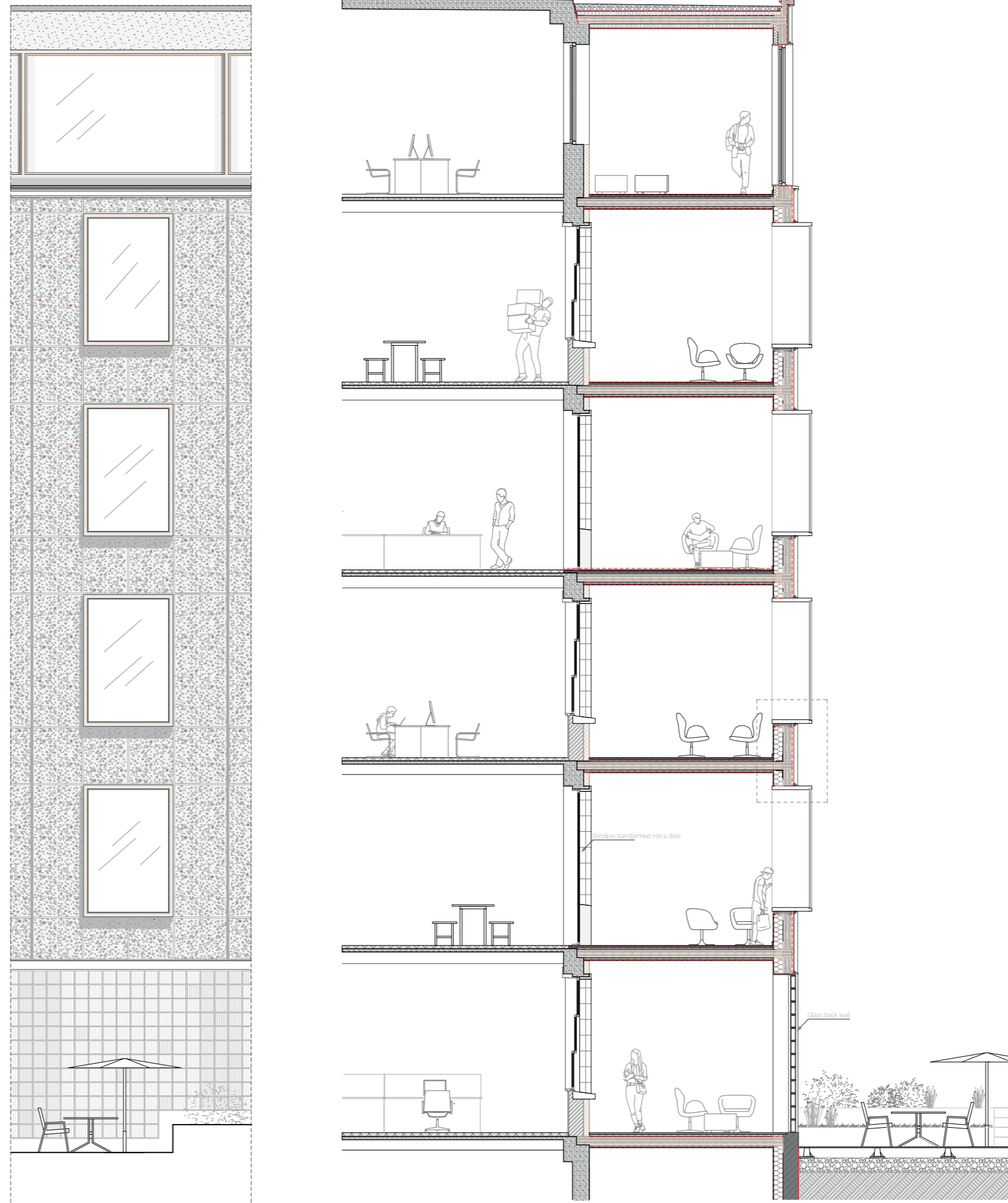
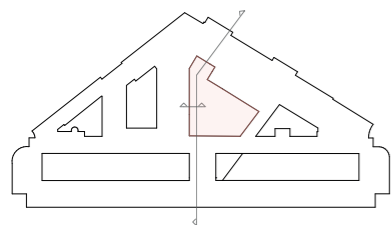

A Bank of Opportunities - *Facade and section*

1/5 Detail

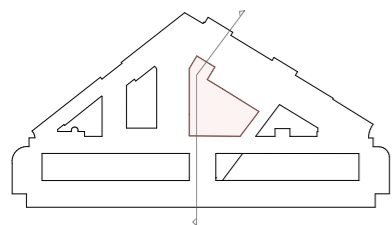
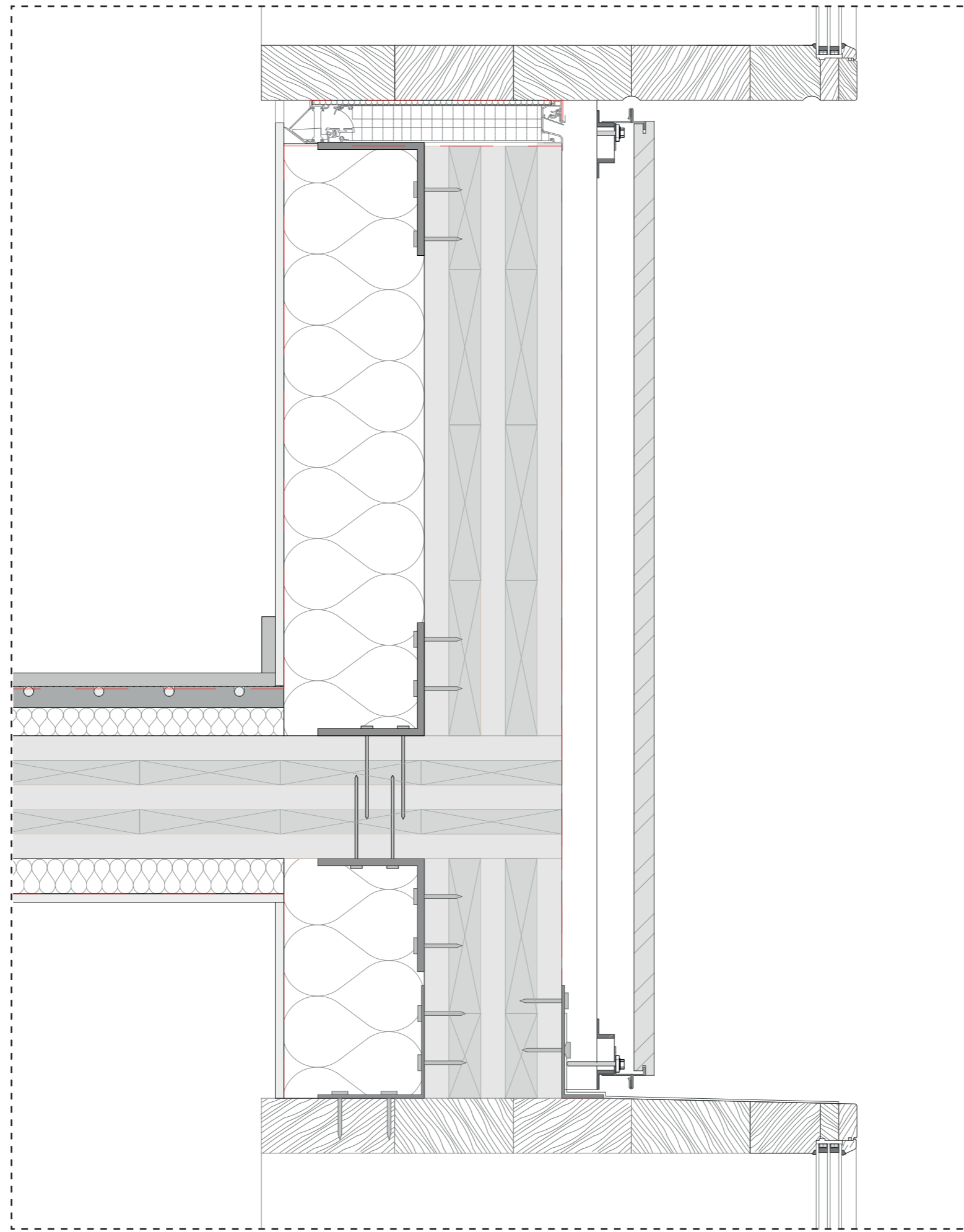

A Bank of Opportunities - Facade design : details

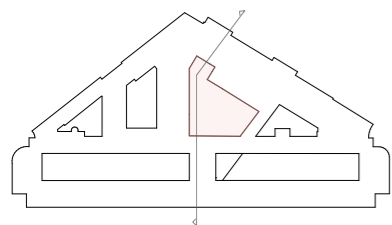
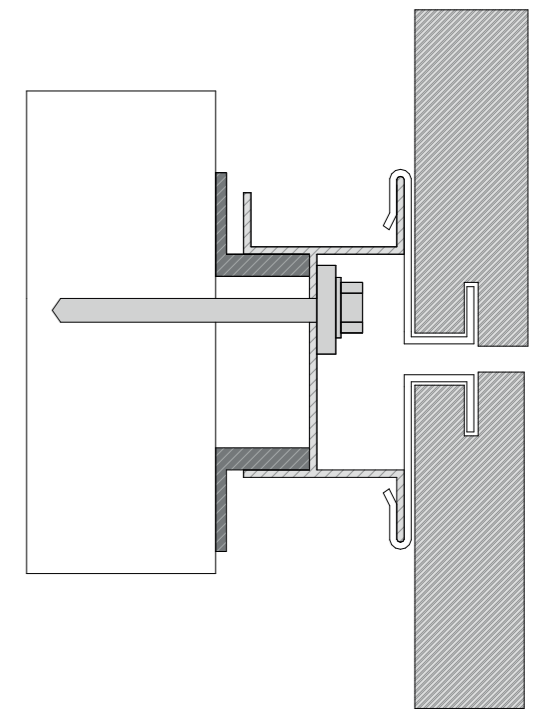
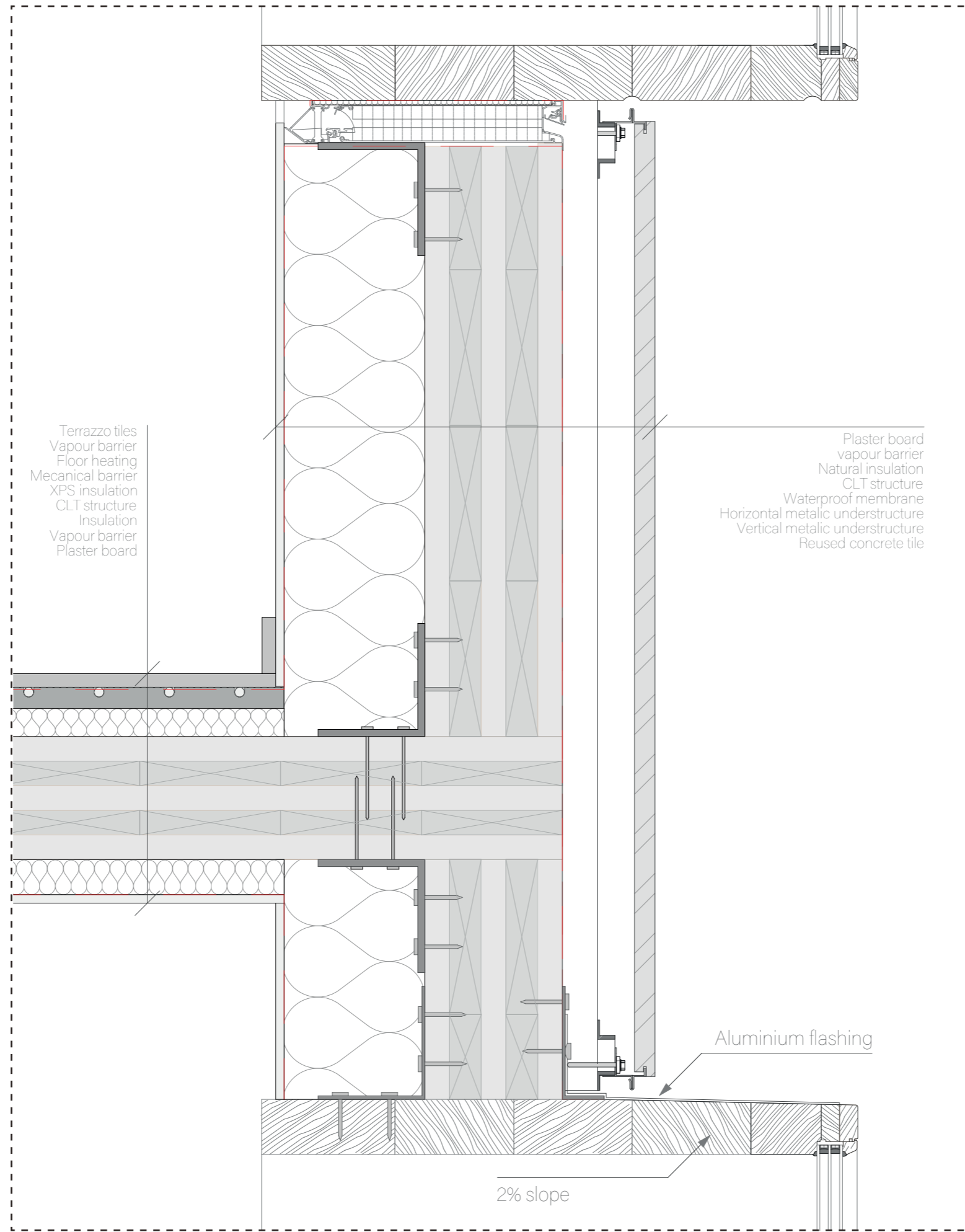

A Bank of Opportunities - Facade design : details

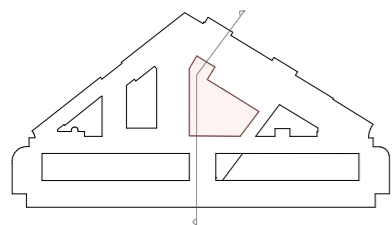
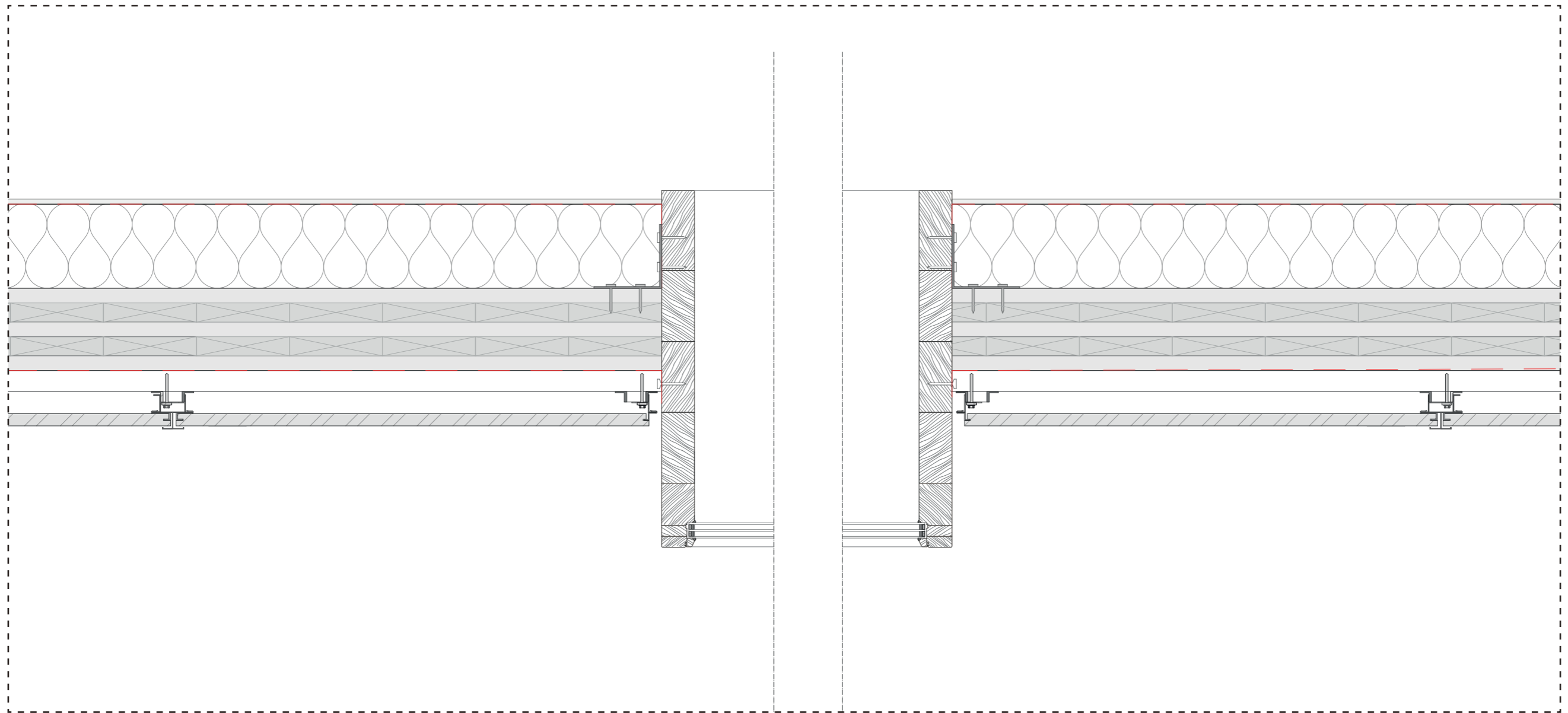

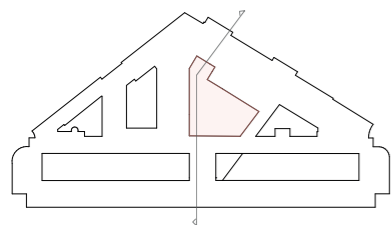
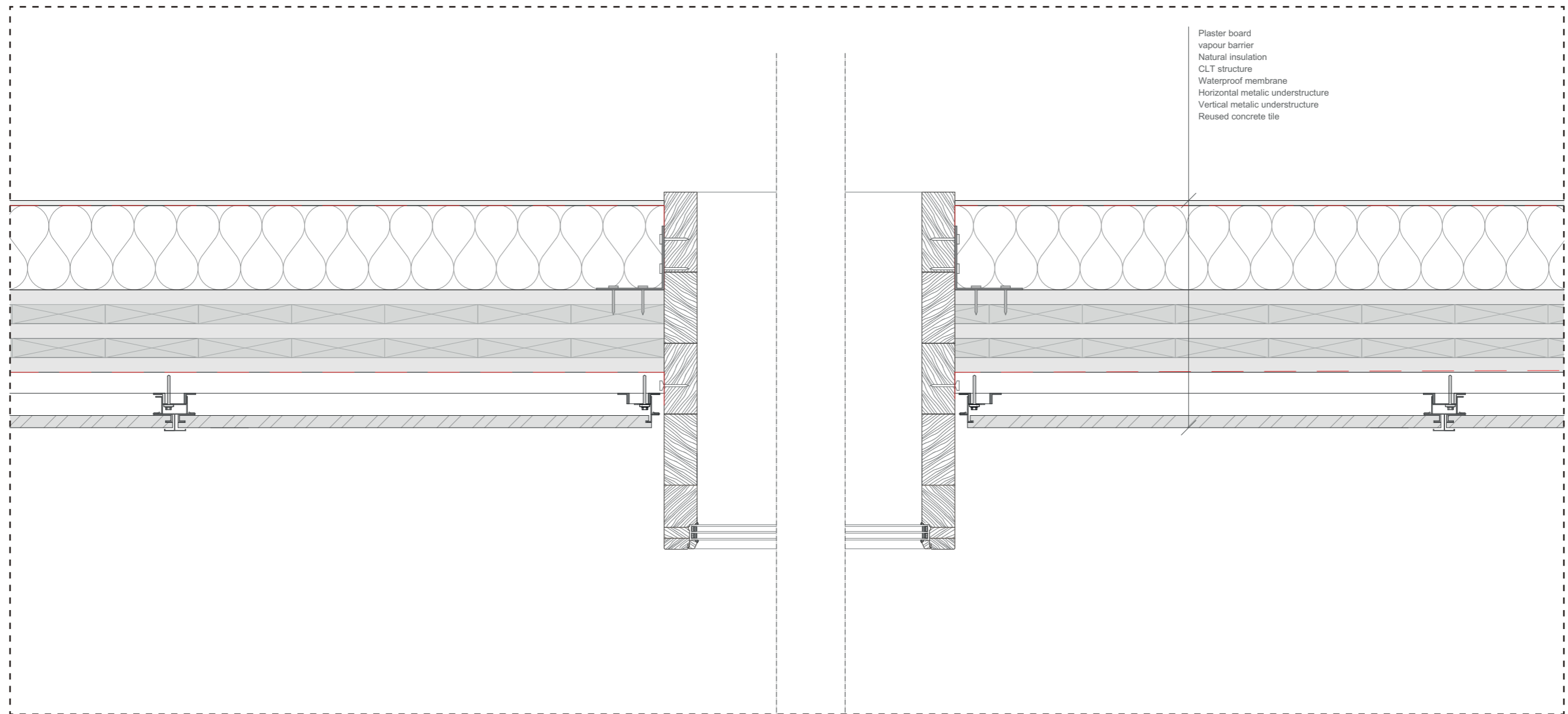

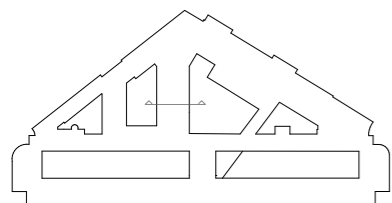
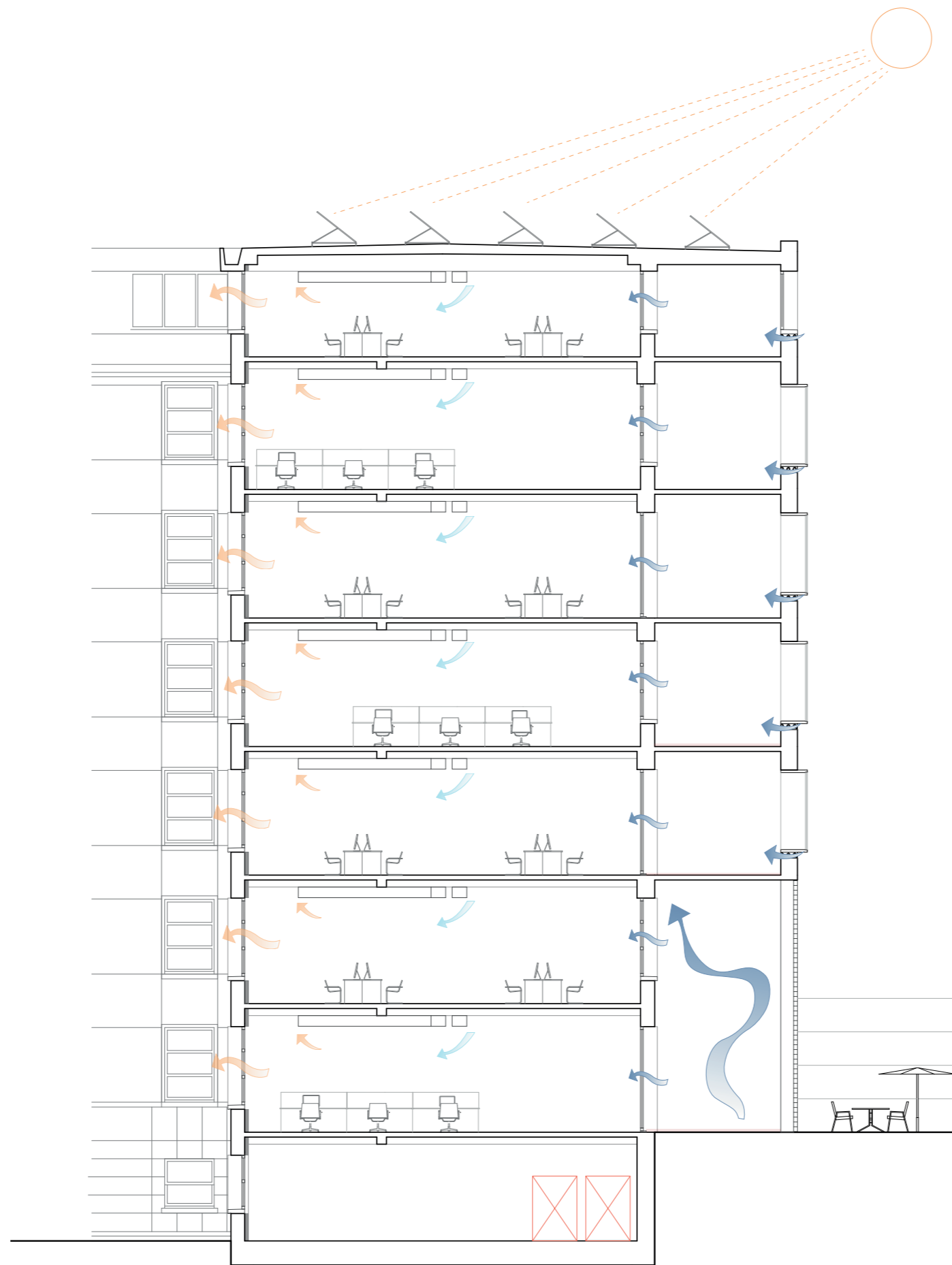

A Bank of Opportunities - *Ventilation strategy*

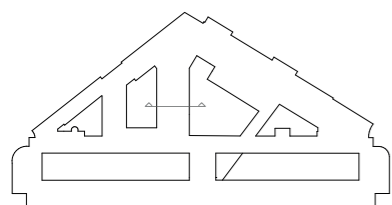
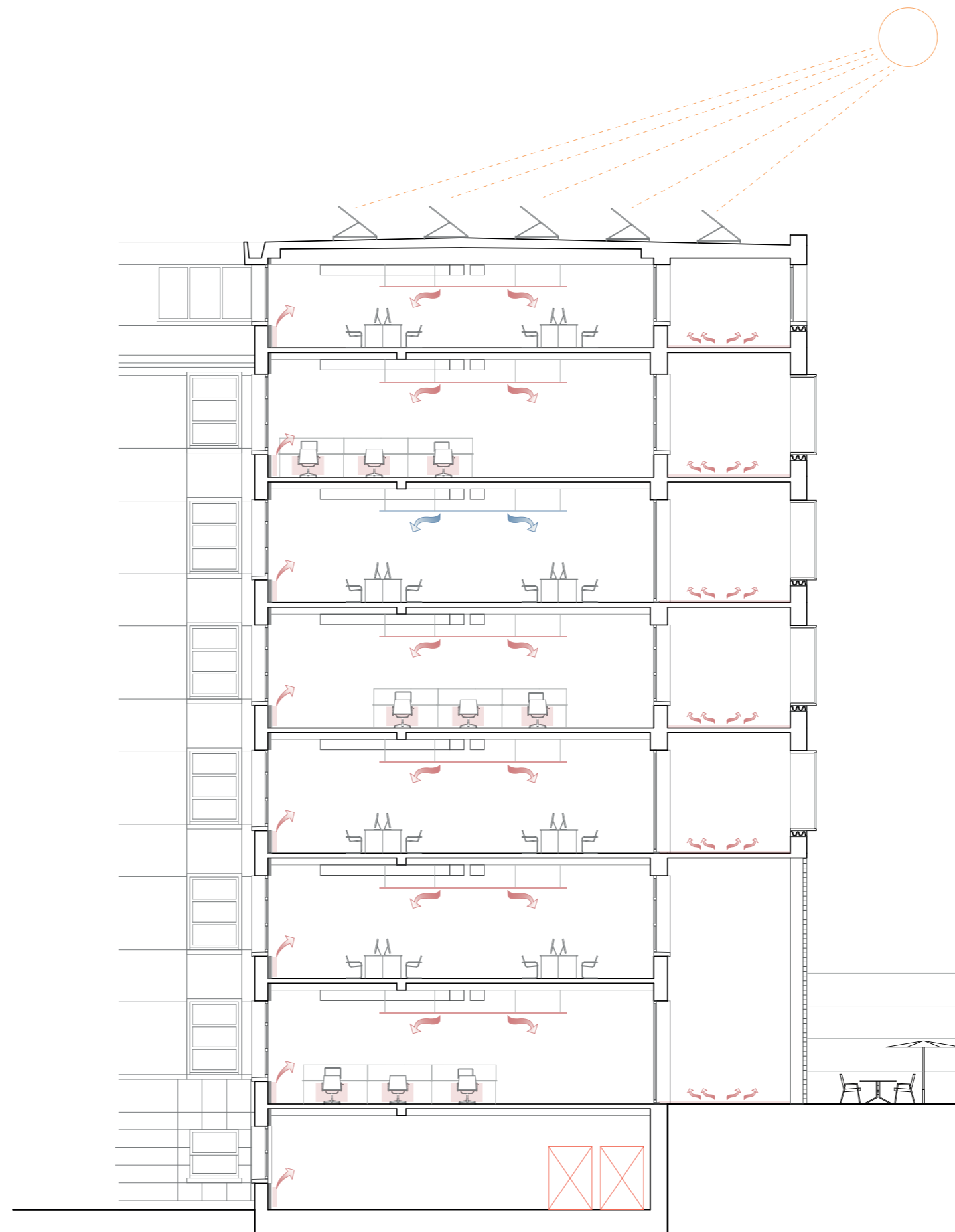

A Bank of Opportunities - *Heating strategy*

National Bank of Belgium's offices

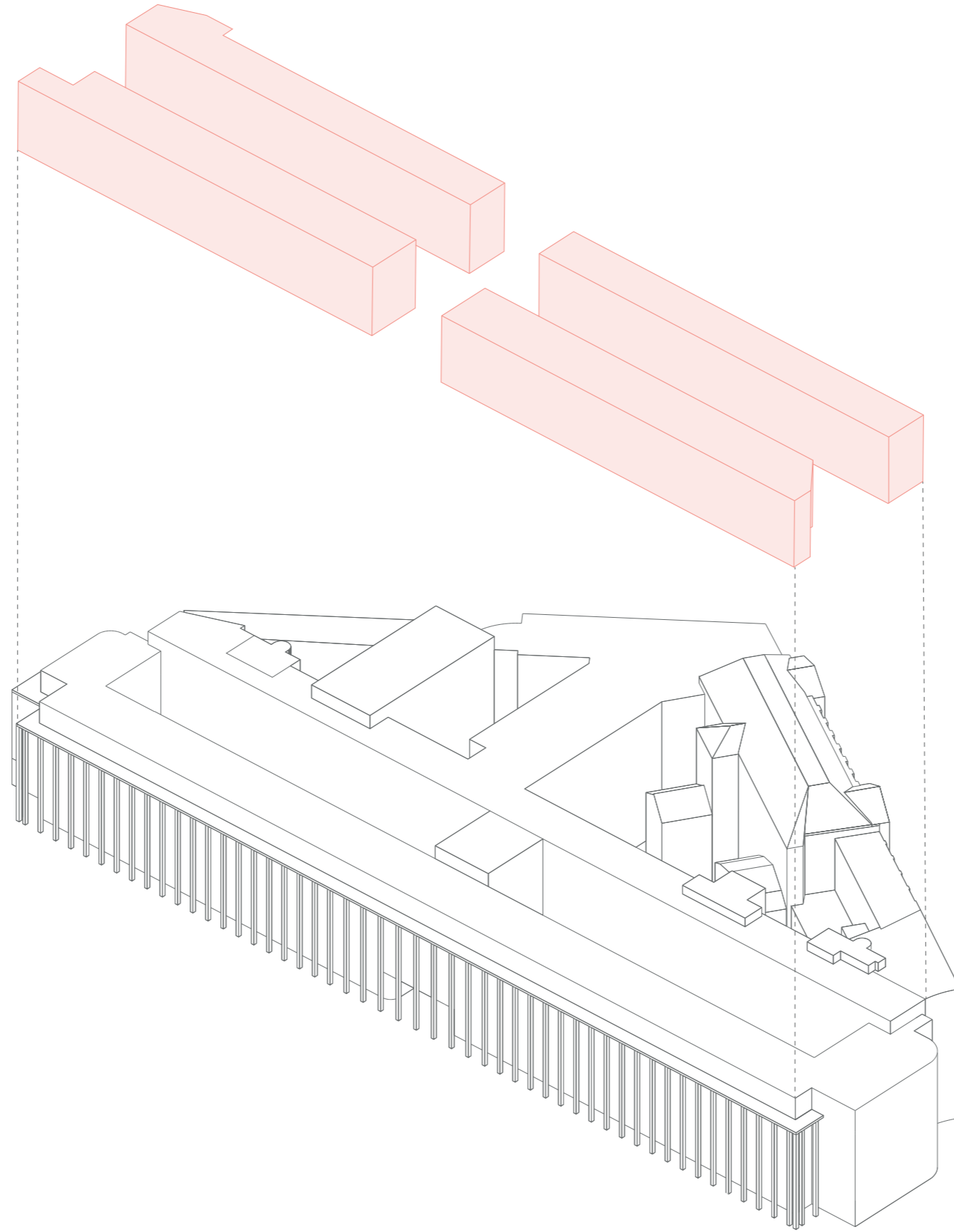

A Bank of Opportunities - Location of the emergency housing rooms

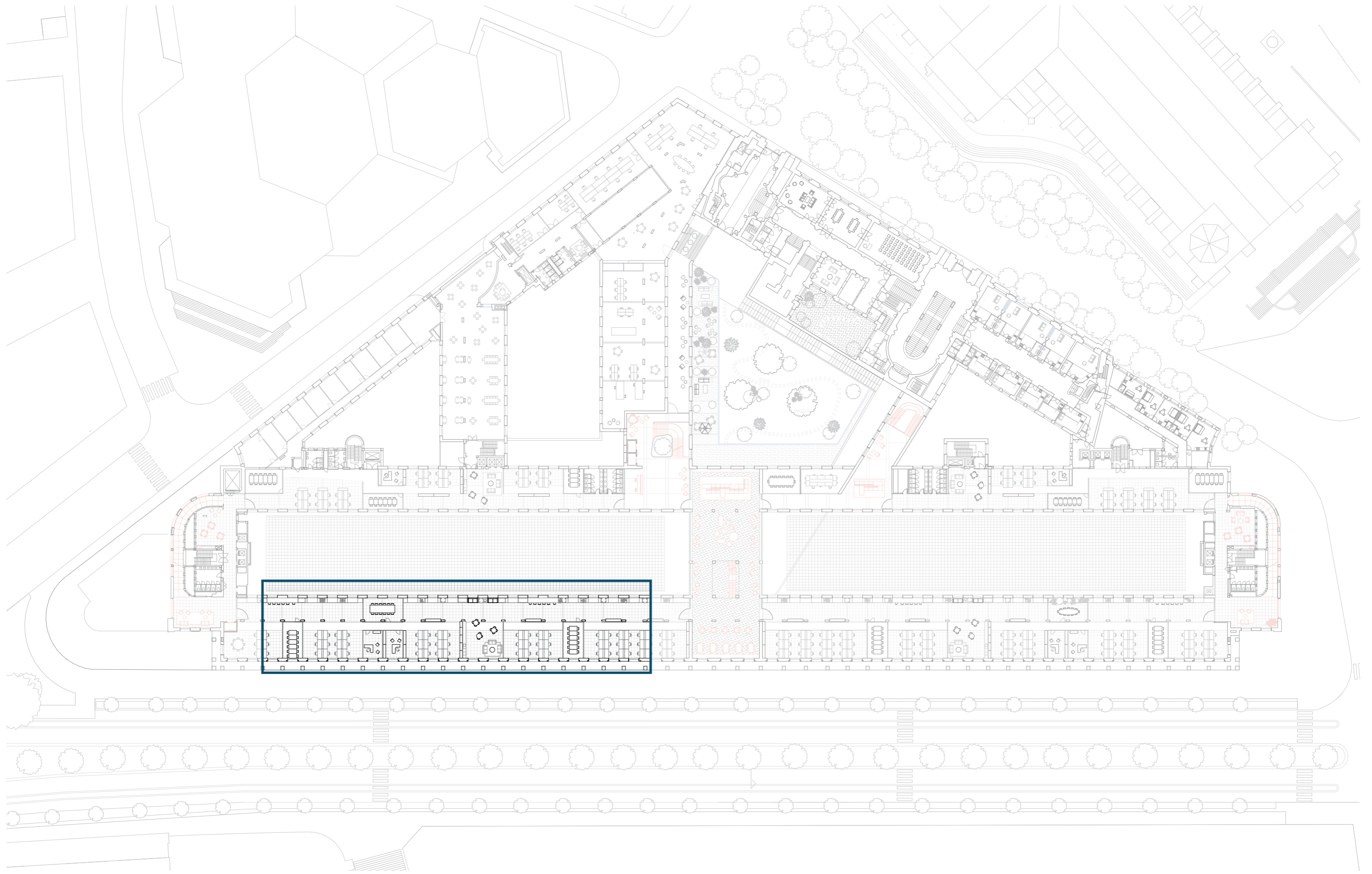

A Bank of Opportunities - Location of the office floor

Second floor



Scale
1/500



A Bank of Opportunities - *The bank's offices*



A Bank of Opportunities - Changing the dynamic of the office

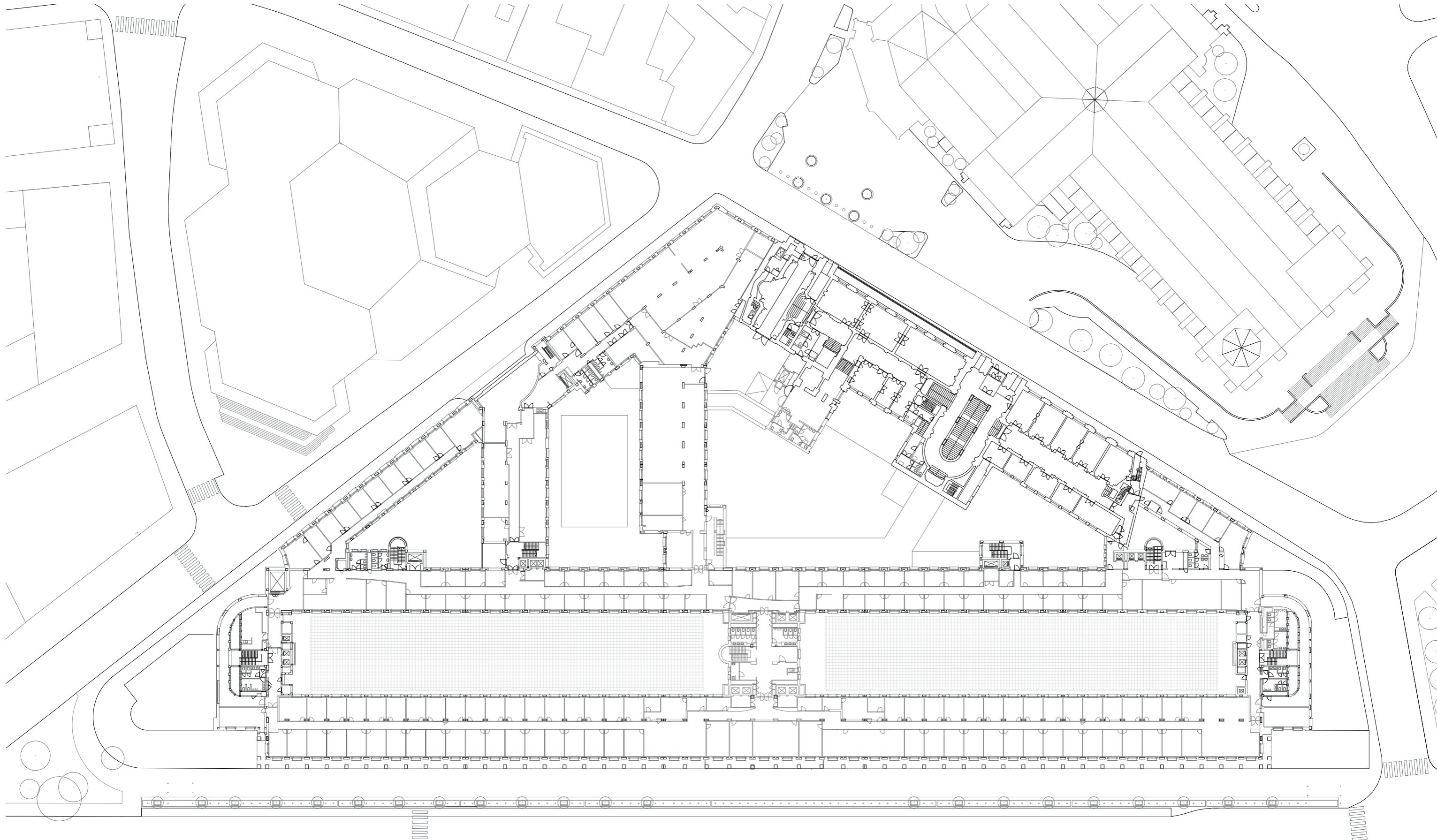

A Bank of Opportunities - *Existing situation*

Second floor



Scale
1/500

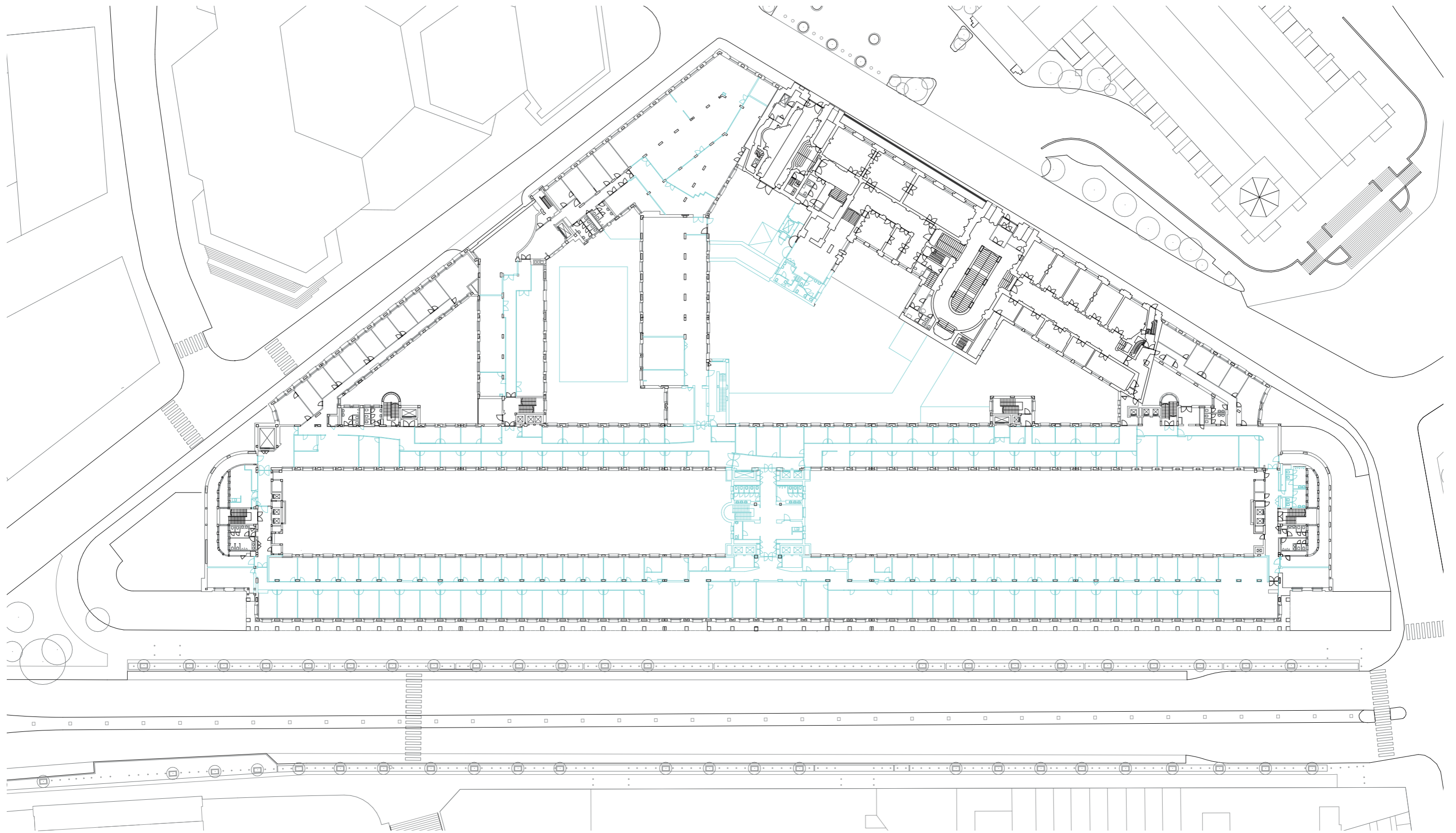

A Bank of Opportunities - Demolition plan

Second floor		Scale 1/500
--------------	---	----------------

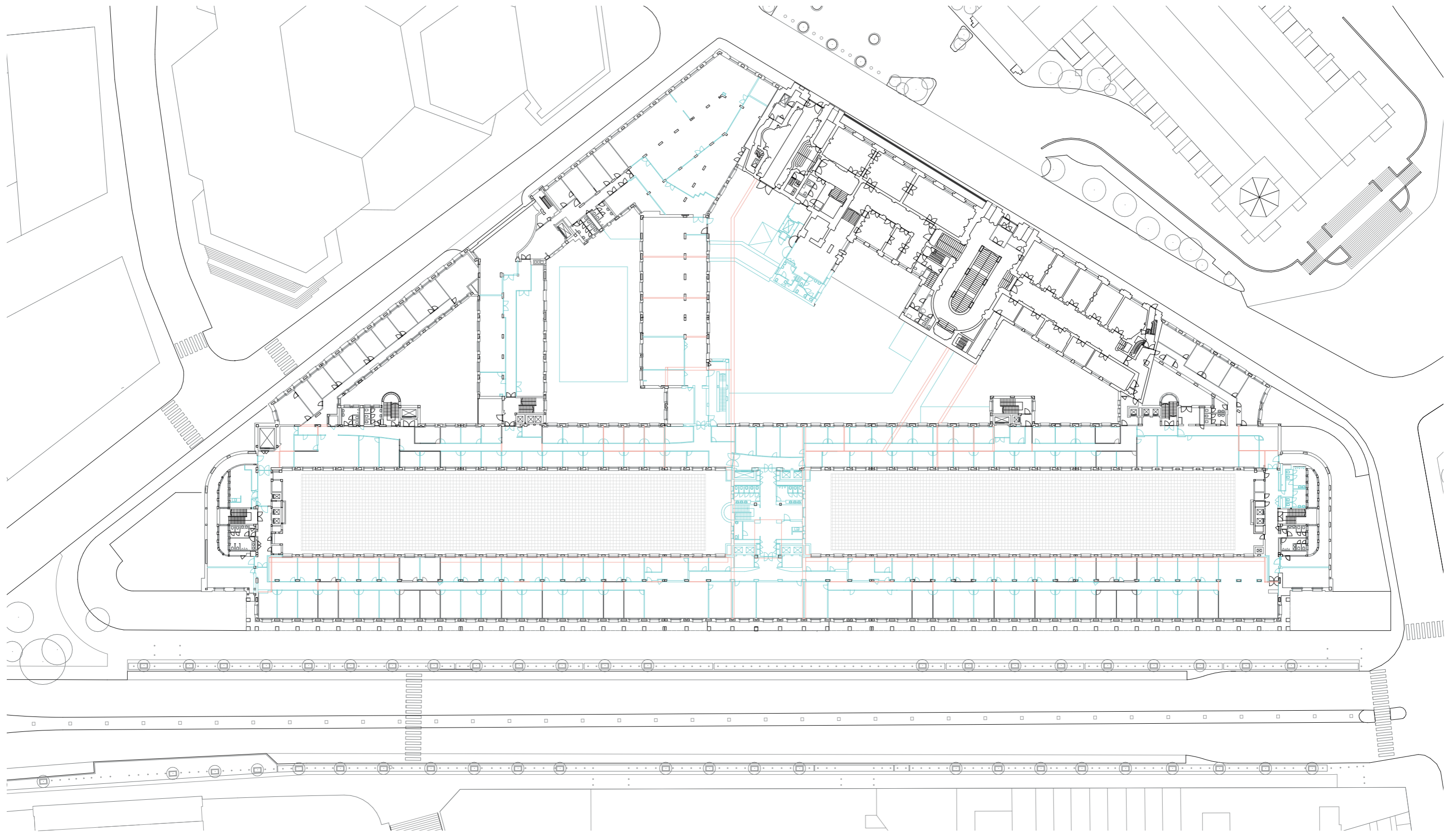

A Bank of Opportunities - *Additions to the building*

Second floor		Scale 1/500
--------------	--	----------------

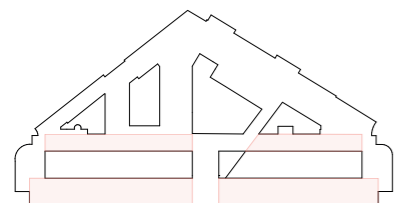
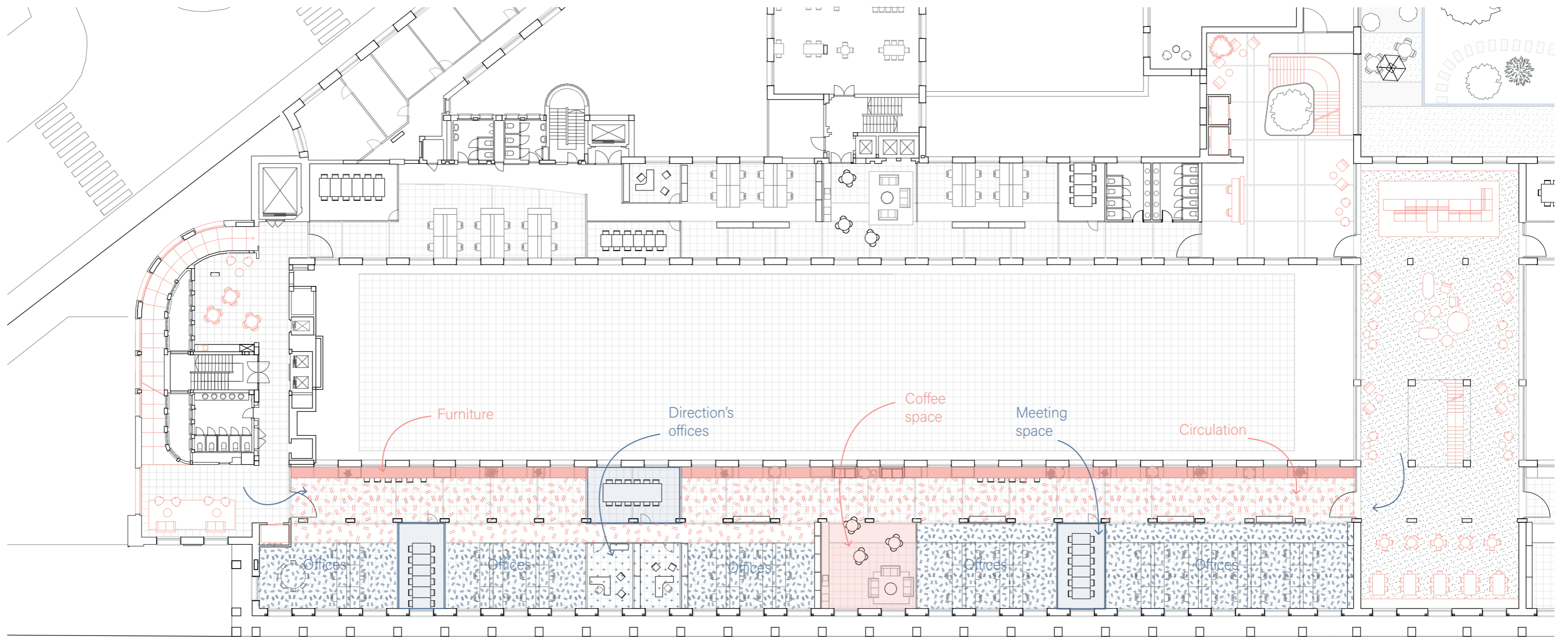

A Bank of Opportunities - Organisation of the office floor

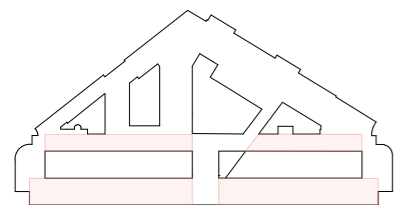
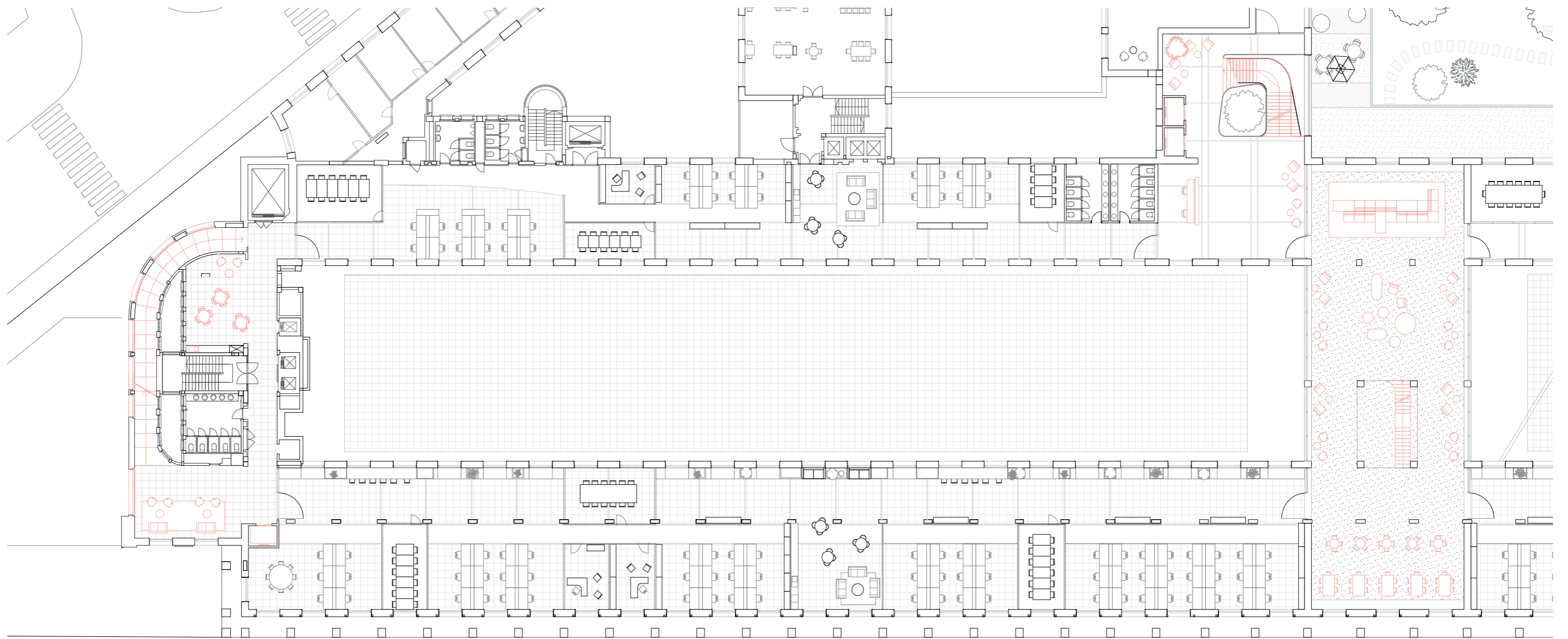

A Bank of Opportunities - Office floor's plan

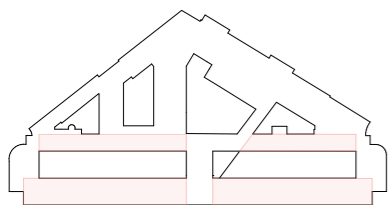
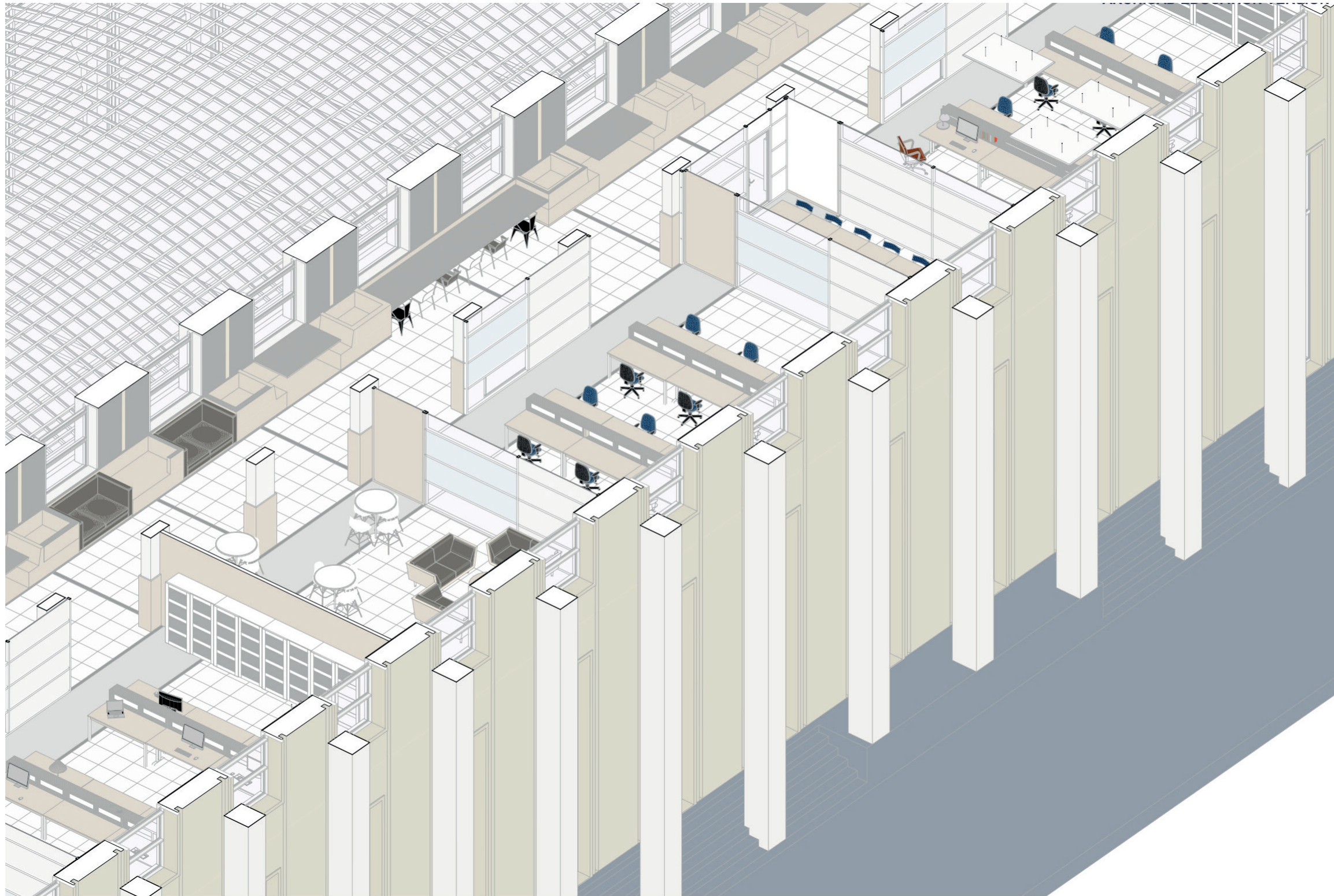

A Bank of Opportunities - Changing the dynamic of the office

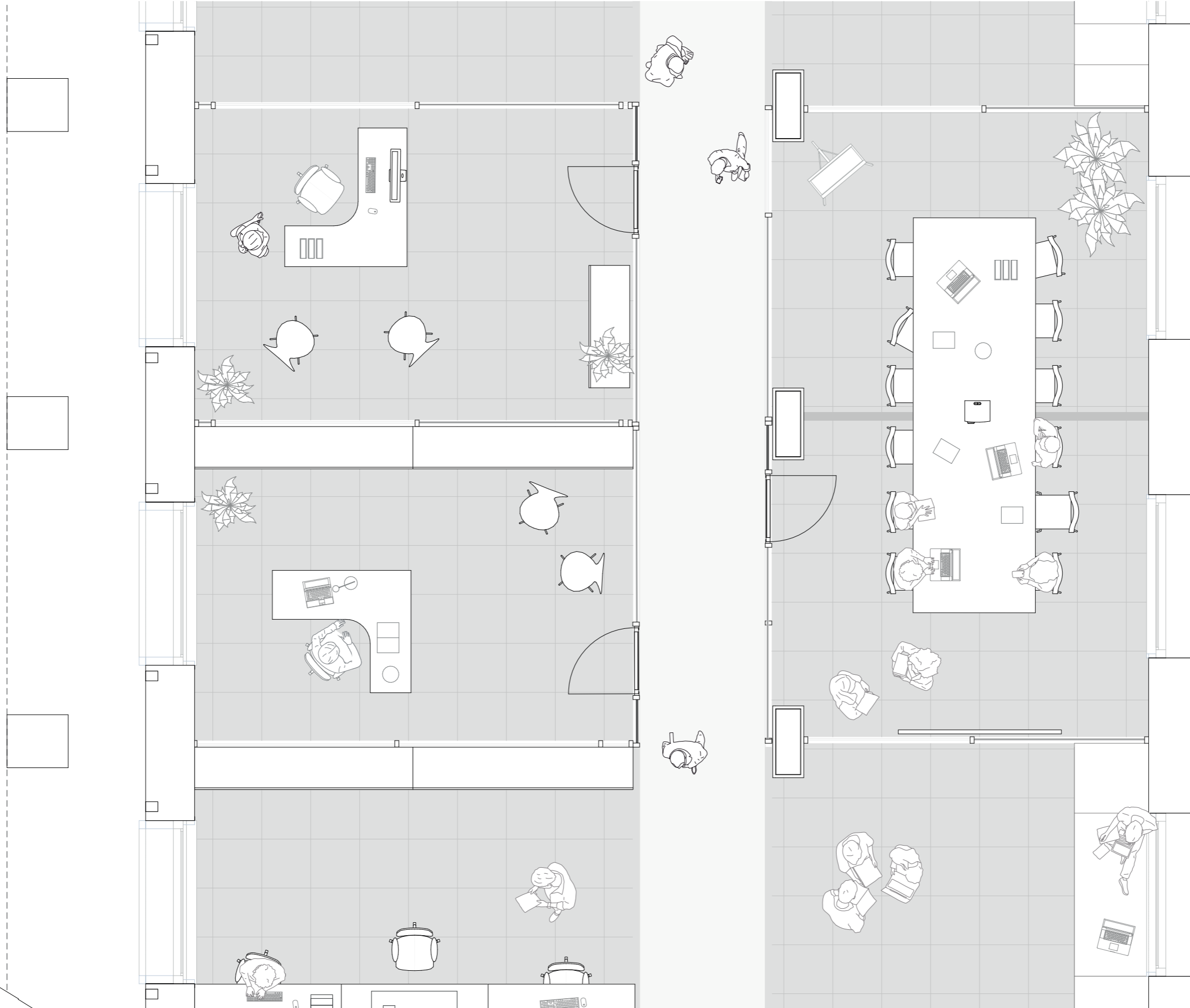
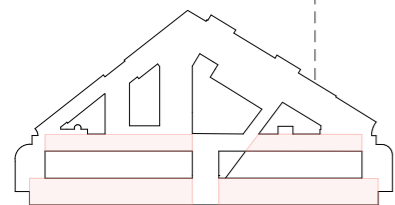

A Bank of Opportunities - Changing the dynamic of the office

Second floor



Scale
1/50

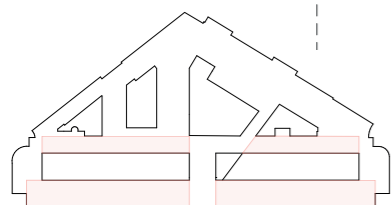
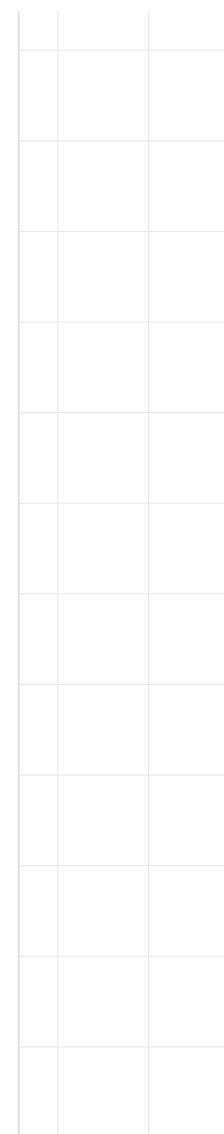
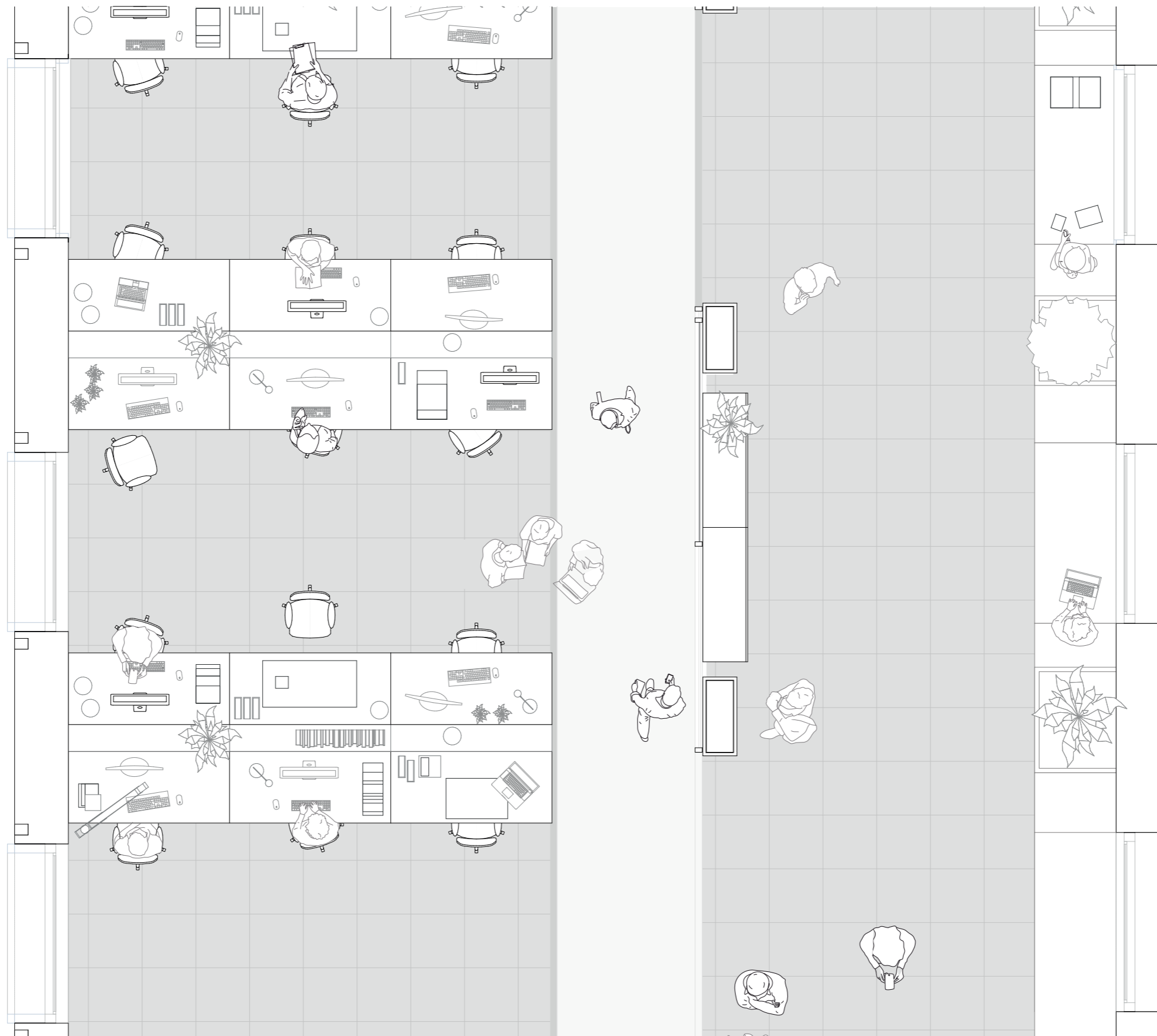

A Bank of Opportunities - Changing the dynamic of the office



A Bank of Opportunities - Changing the dynamic of the office

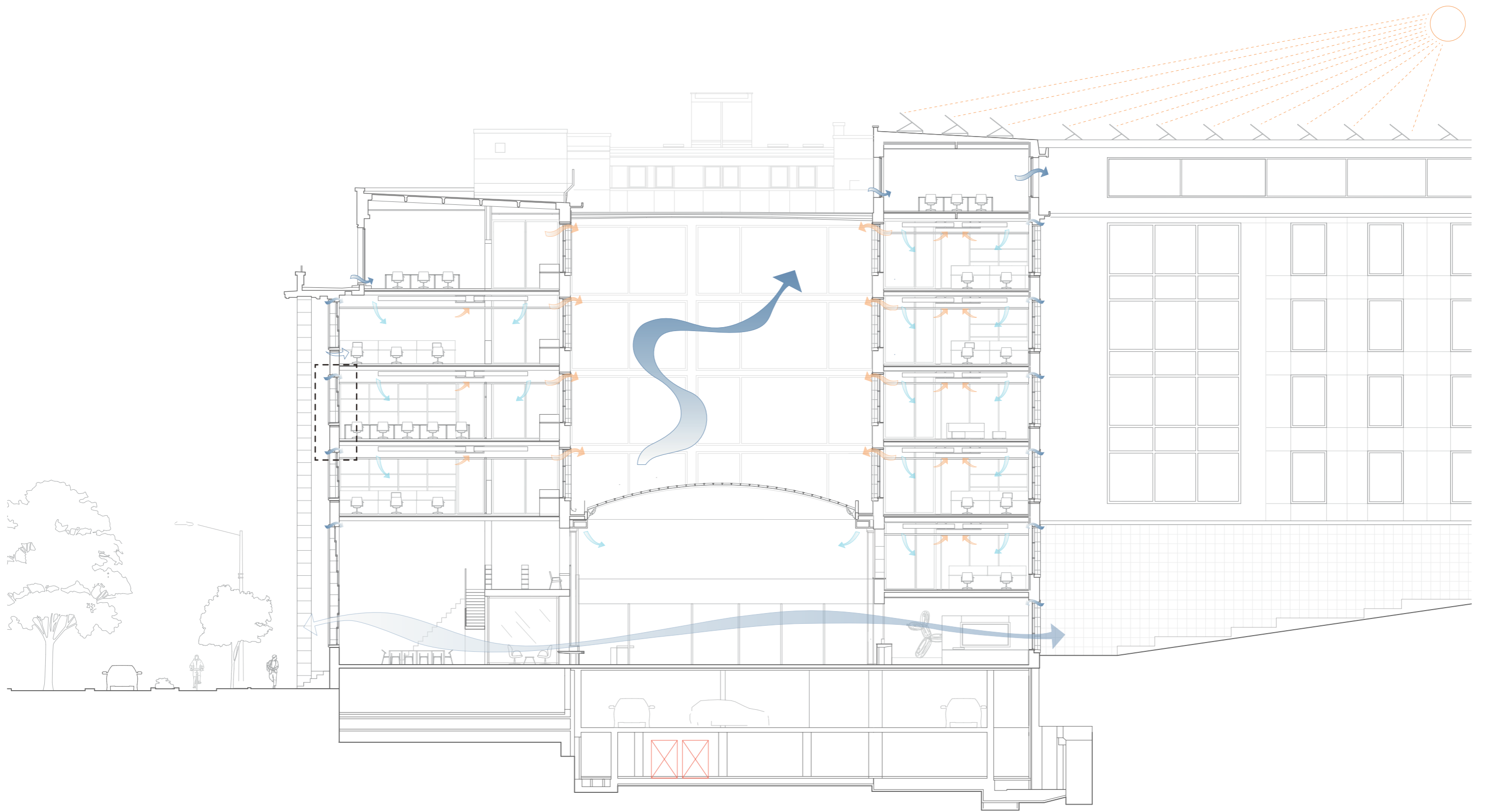

A Bank of Opportunities - Ventilation strategy

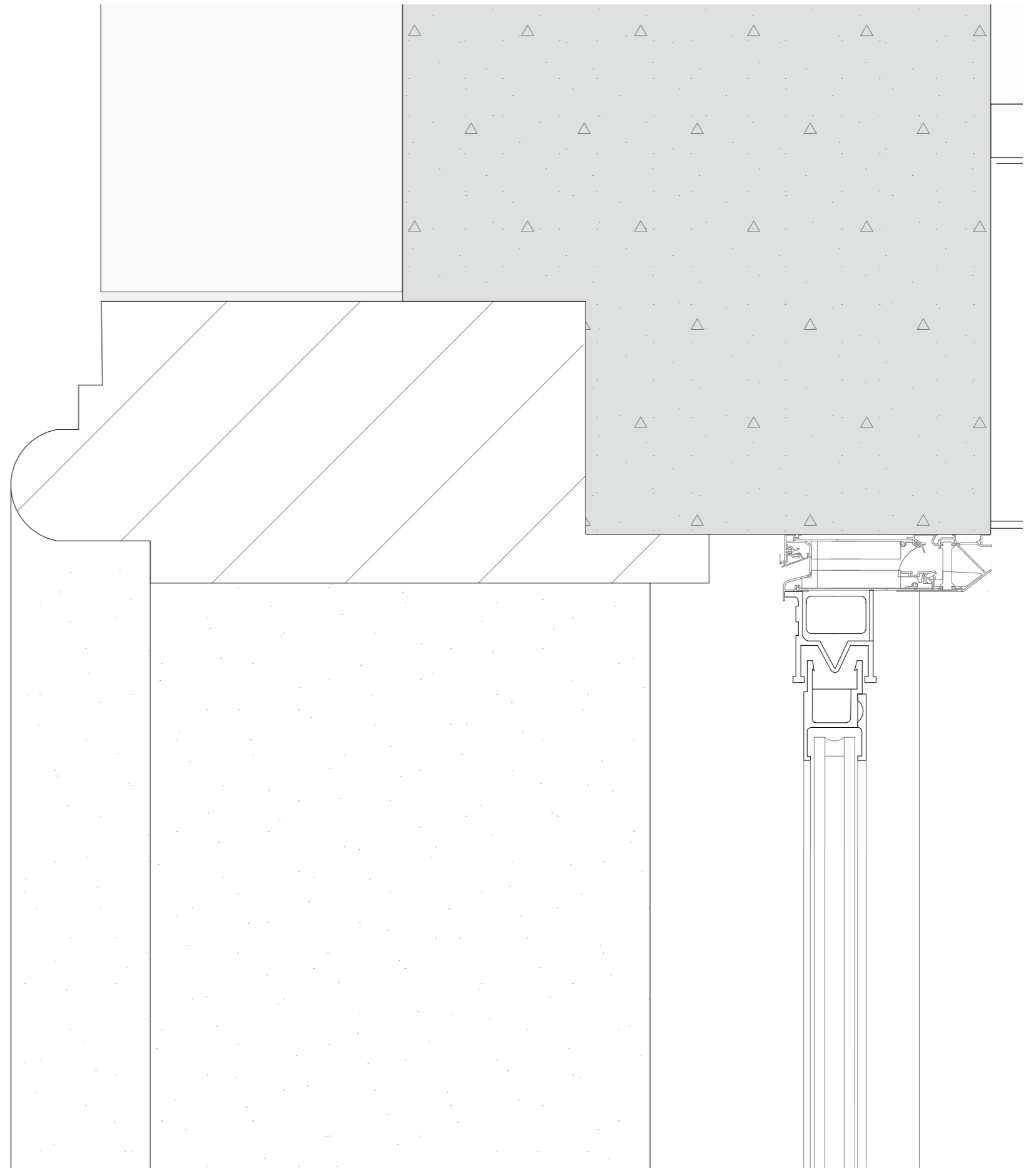
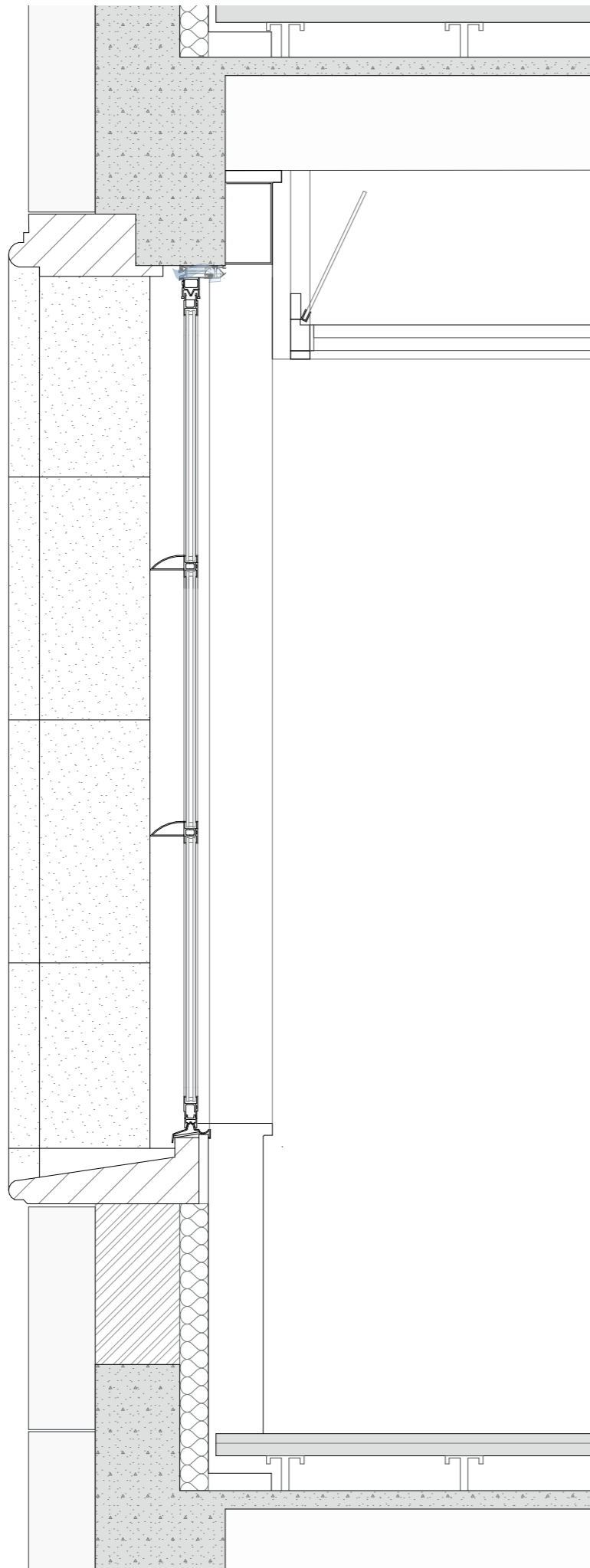

A Bank of Opportunities - Insertion of a ventilation grid

Detail facade		Scale 1/20 & 1/5
---------------	--	---------------------



A Bank of Opportunities - Heating strategy



A Bank of Opportunities - Various heating systems

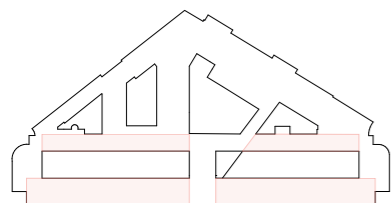
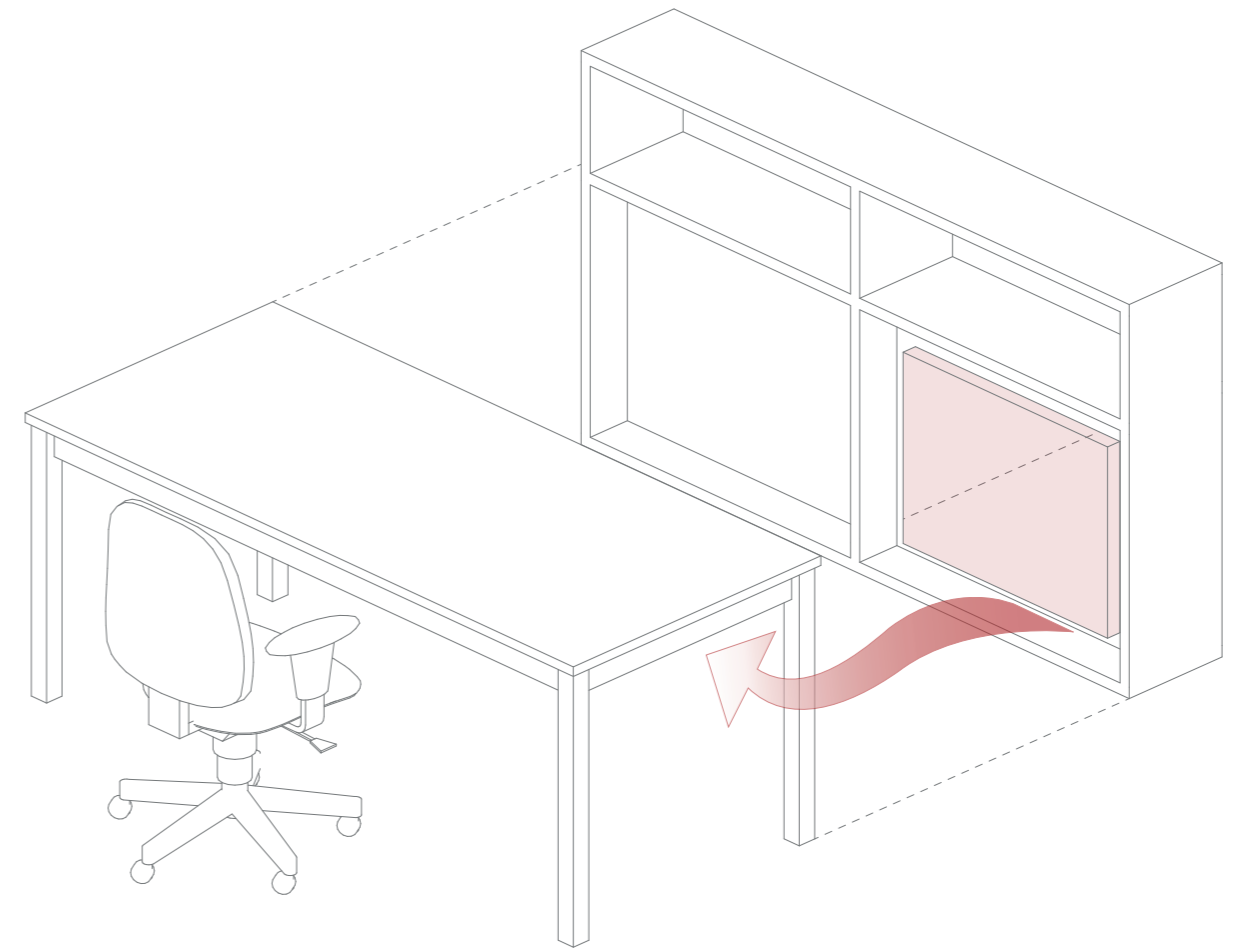

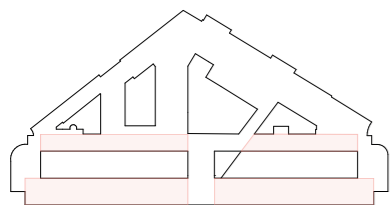
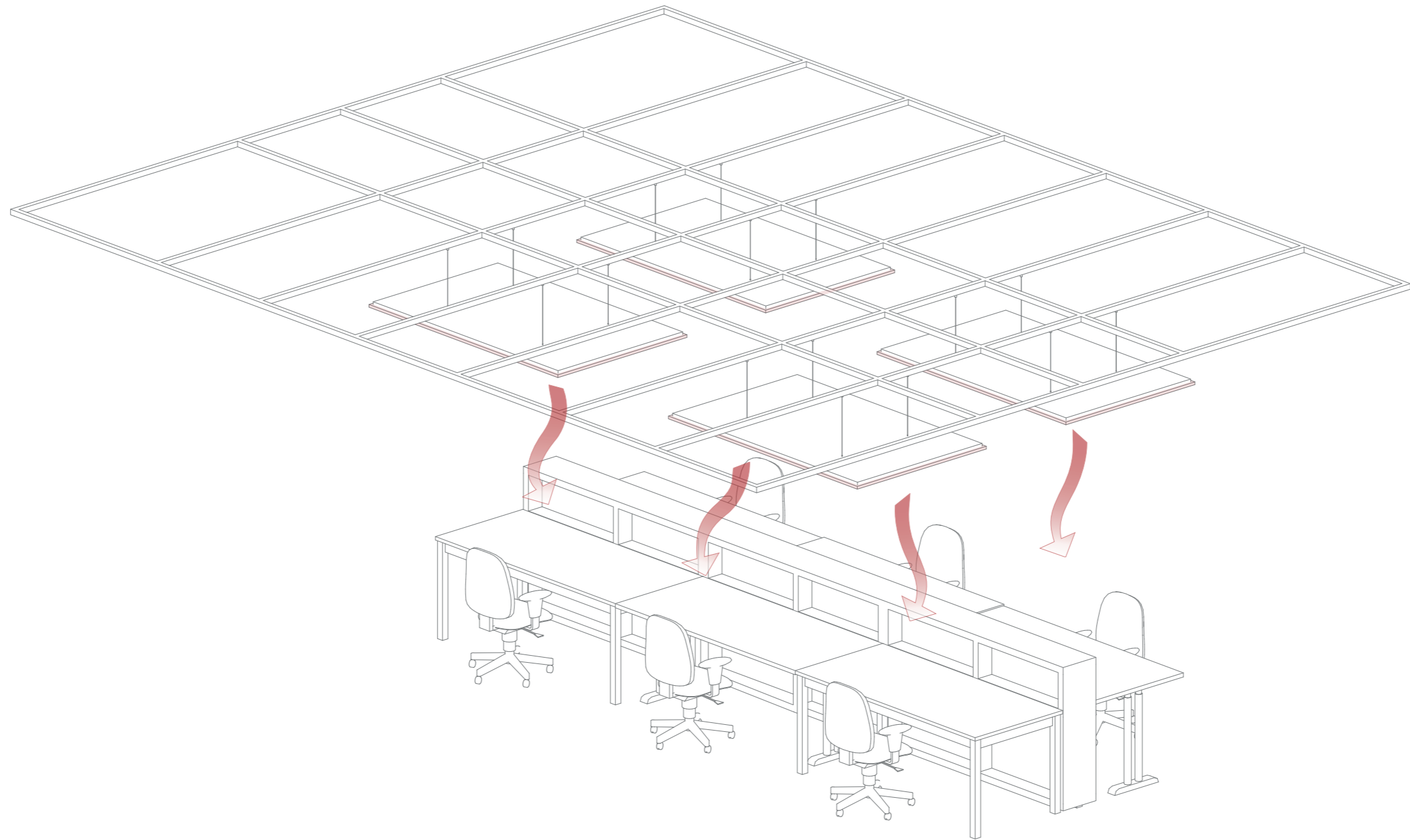

A Bank of Opportunities - Personalised heating systems

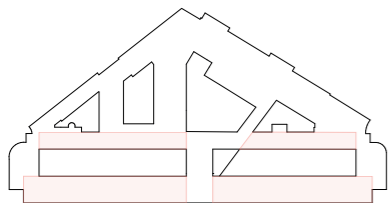
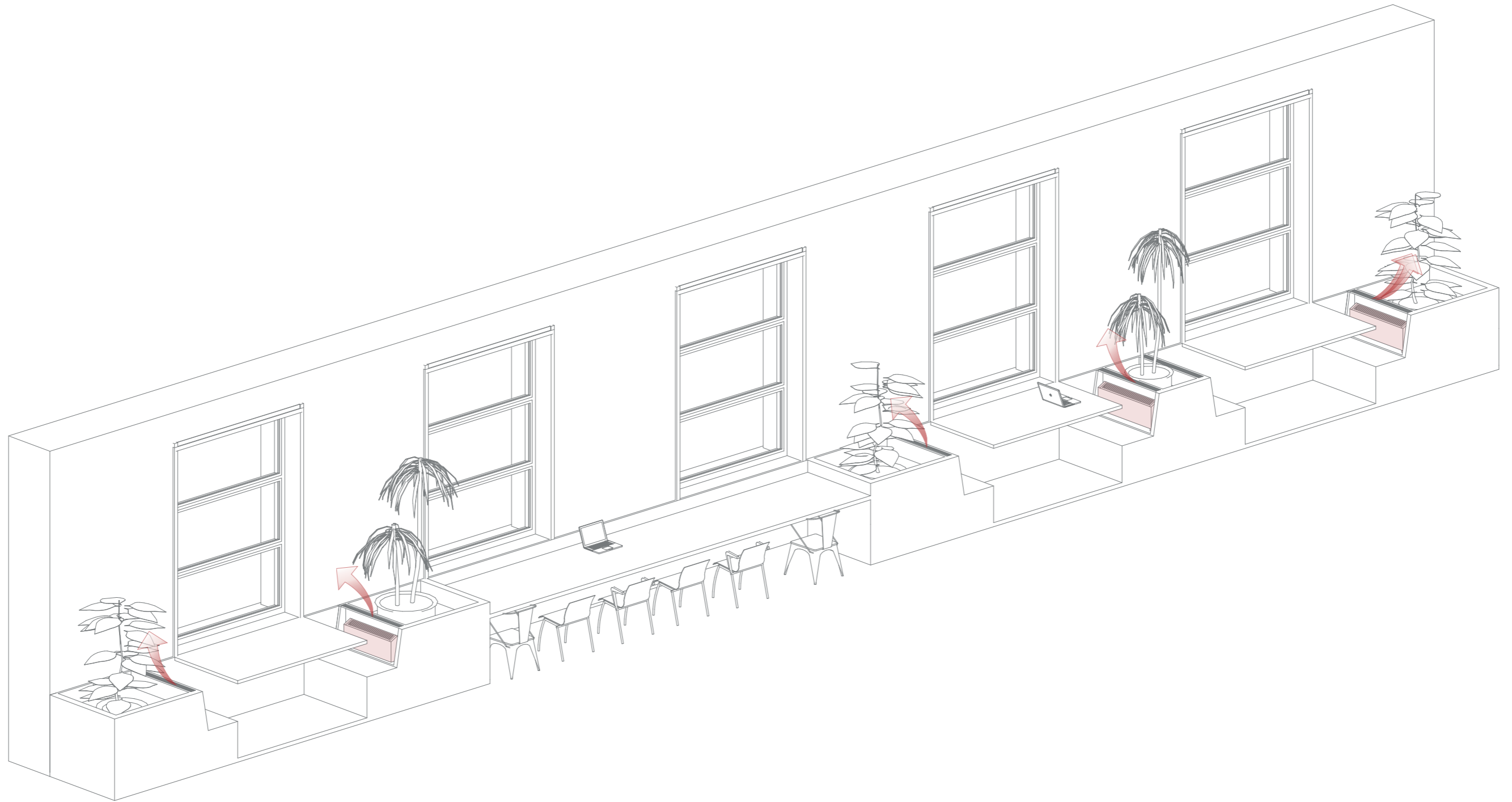

A Bank of Opportunities - Personalised heating systems

The refuge

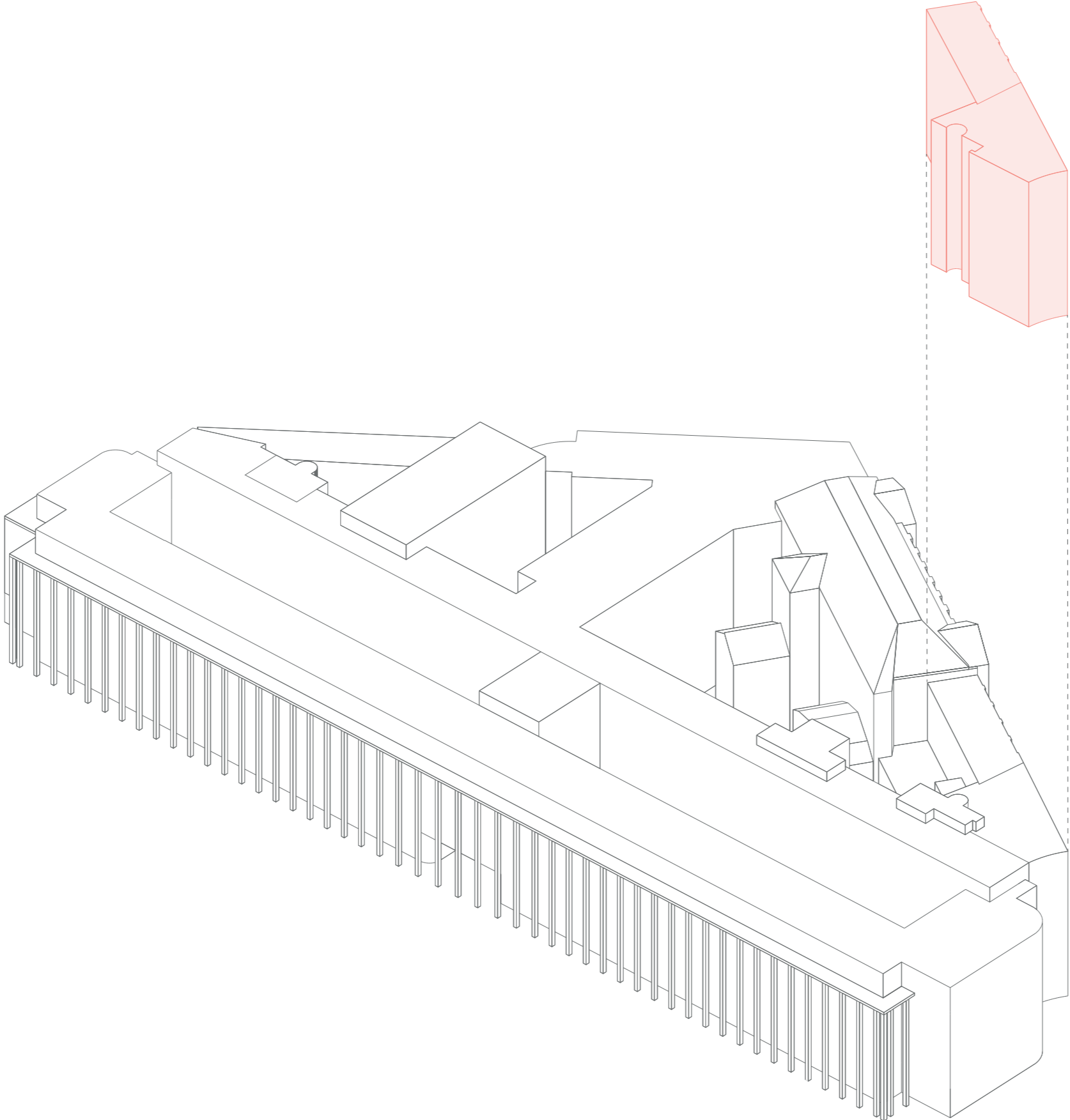

A Bank of Opportunities - Location of the emergency housing rooms

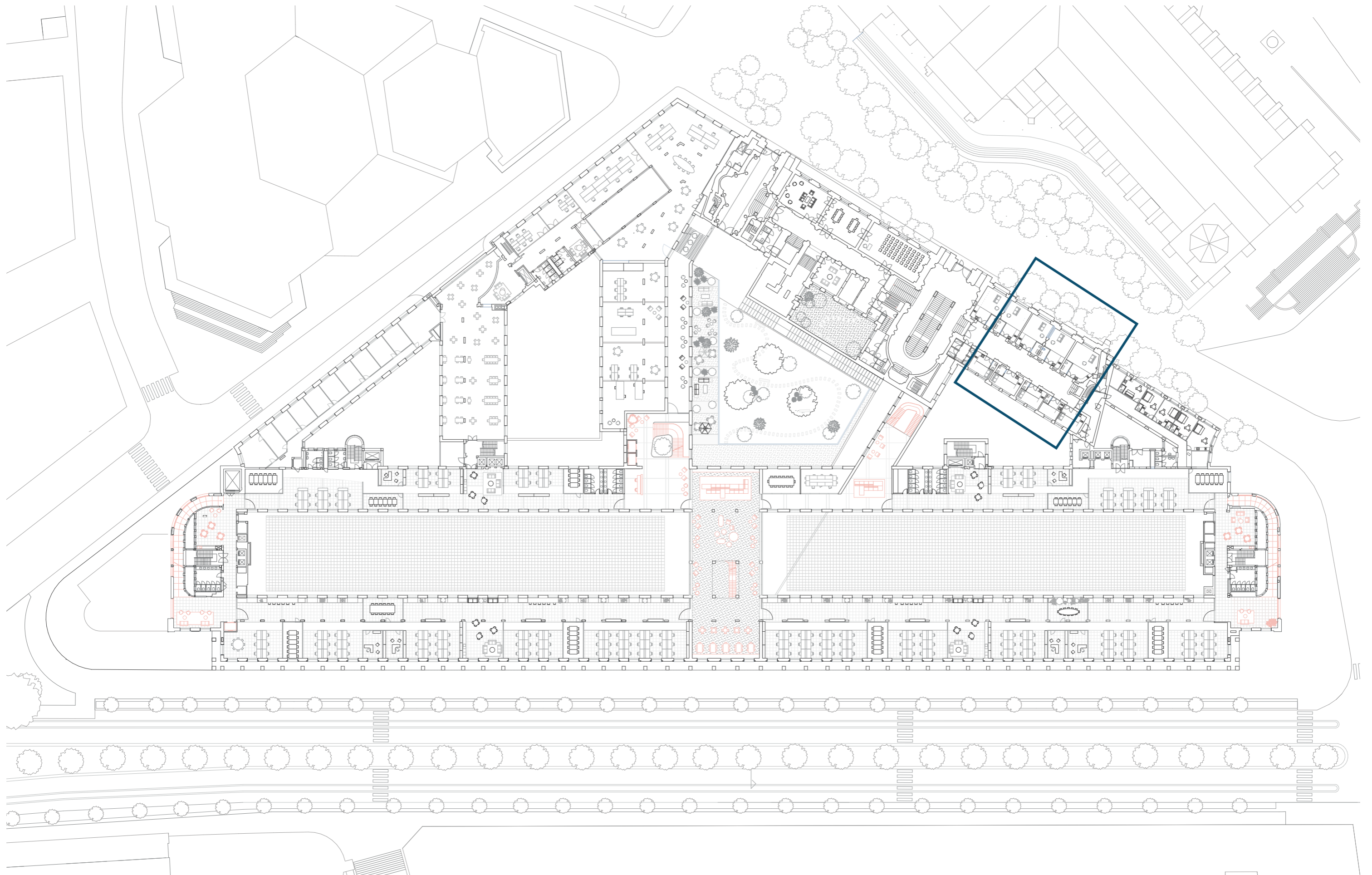

A Bank of Opportunities - *Location of the Refuge*

Second floor		Scale 1/500
--------------	---	----------------



A Bank of Opportunities - Dignifying the people in need



A Bank of Opportunities - Dignifying the people in need



A Bank of Opportunities - A safe space for people

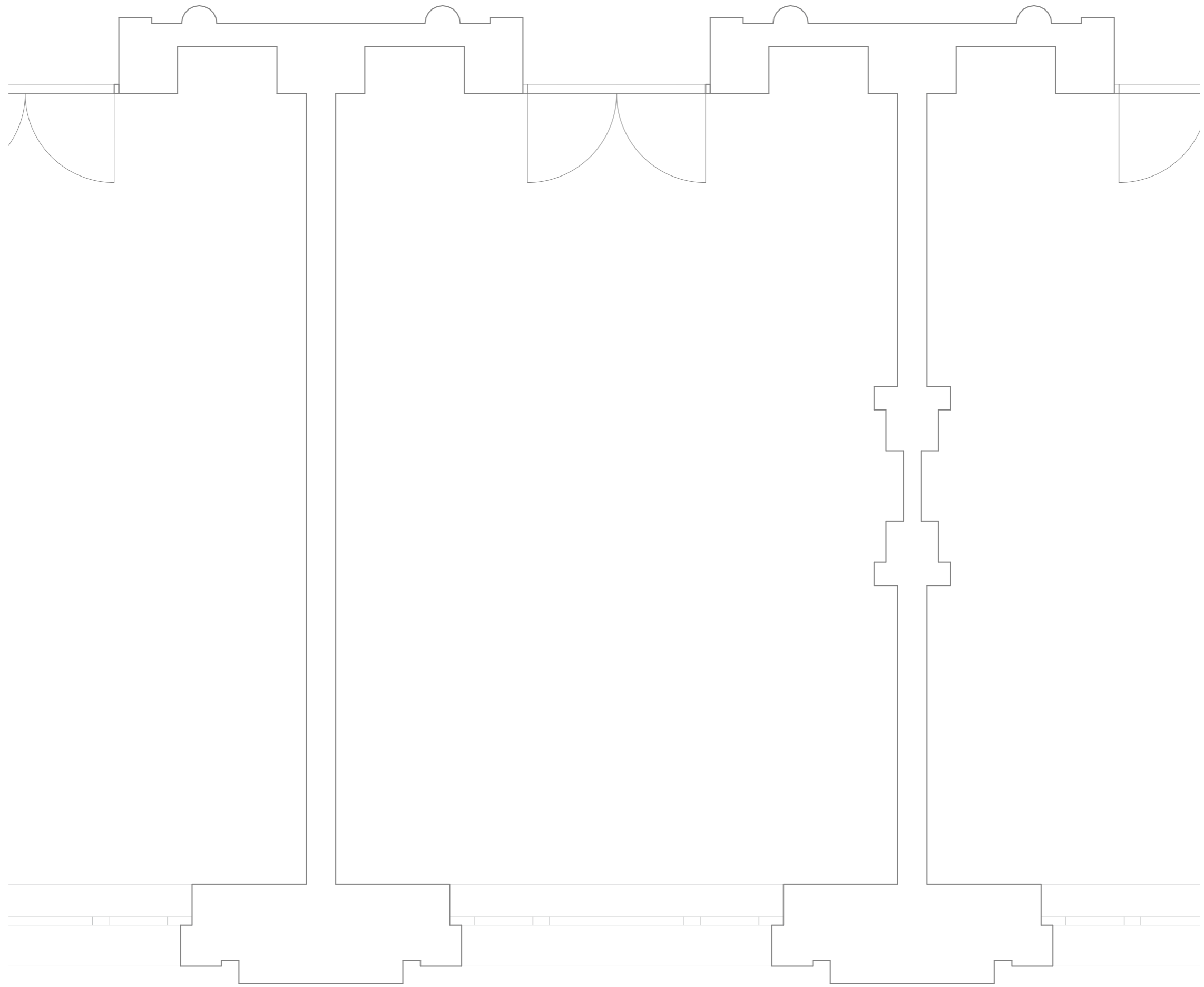

A Bank of Opportunities - Designing from the existing

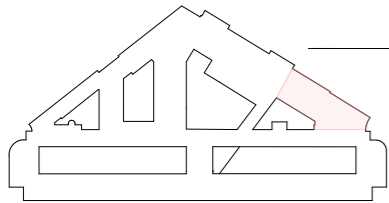
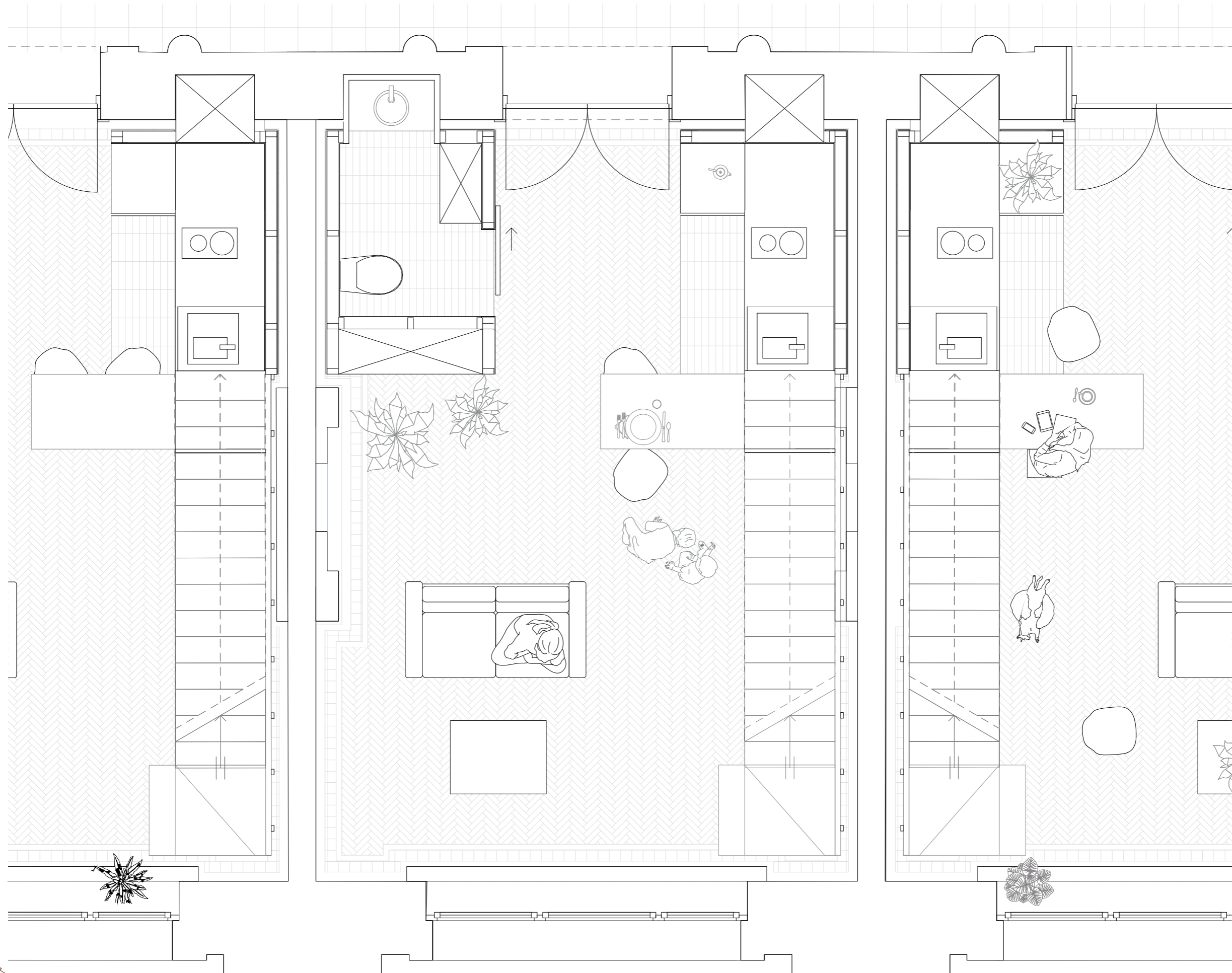

A Bank of Opportunities - A safe space for people

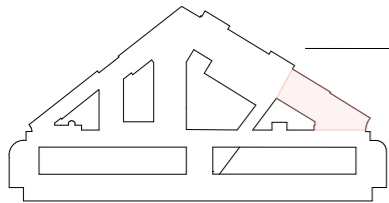

A Bank of Opportunities - A safe space for people

Mezzanine



Scale
1/25

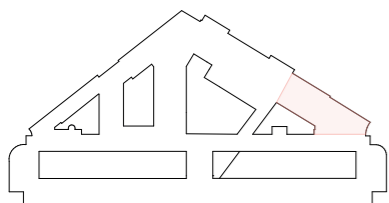
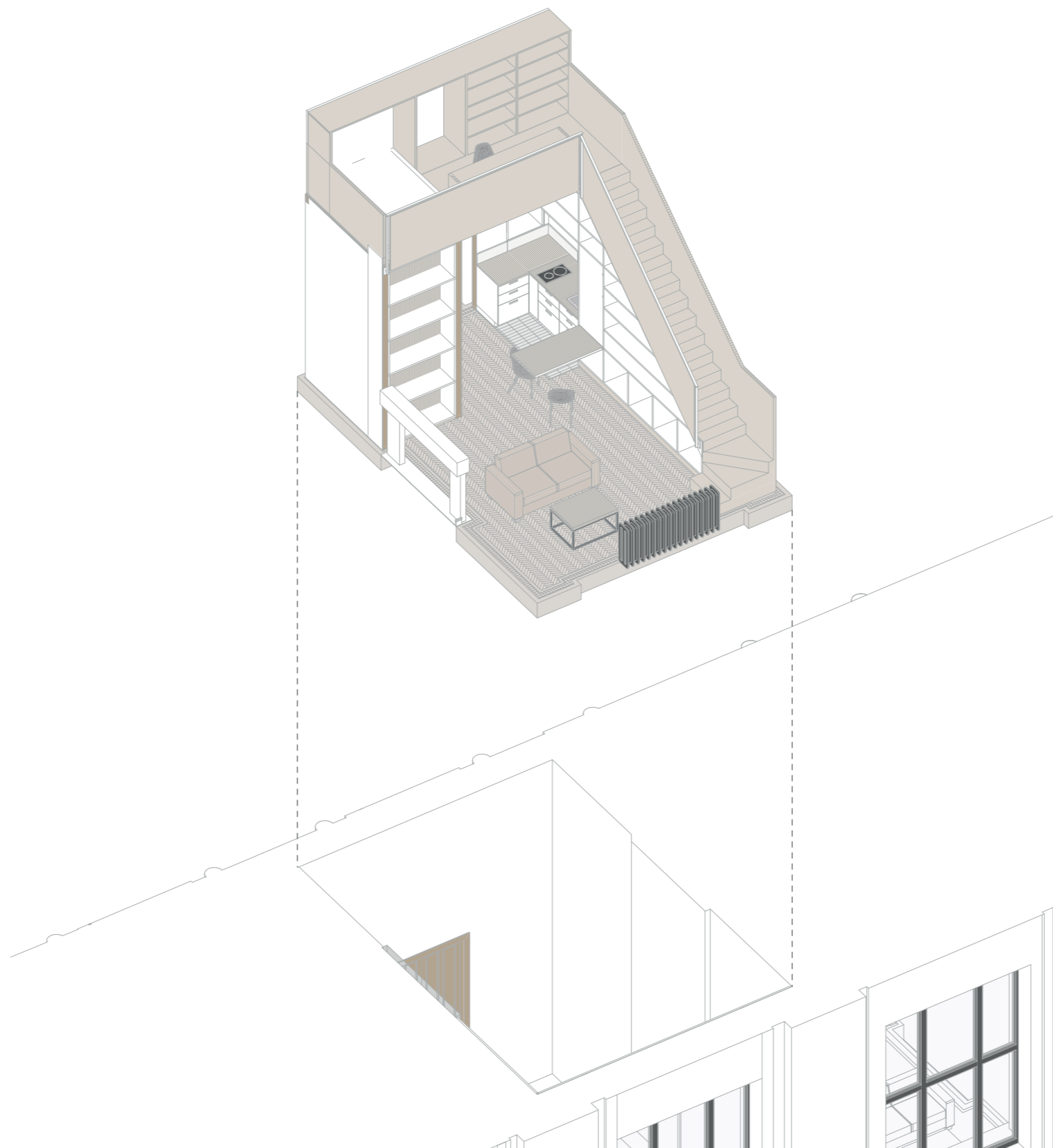

A Bank of Opportunities - The refuge as a furniture

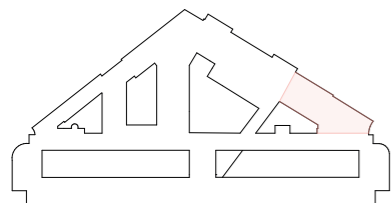
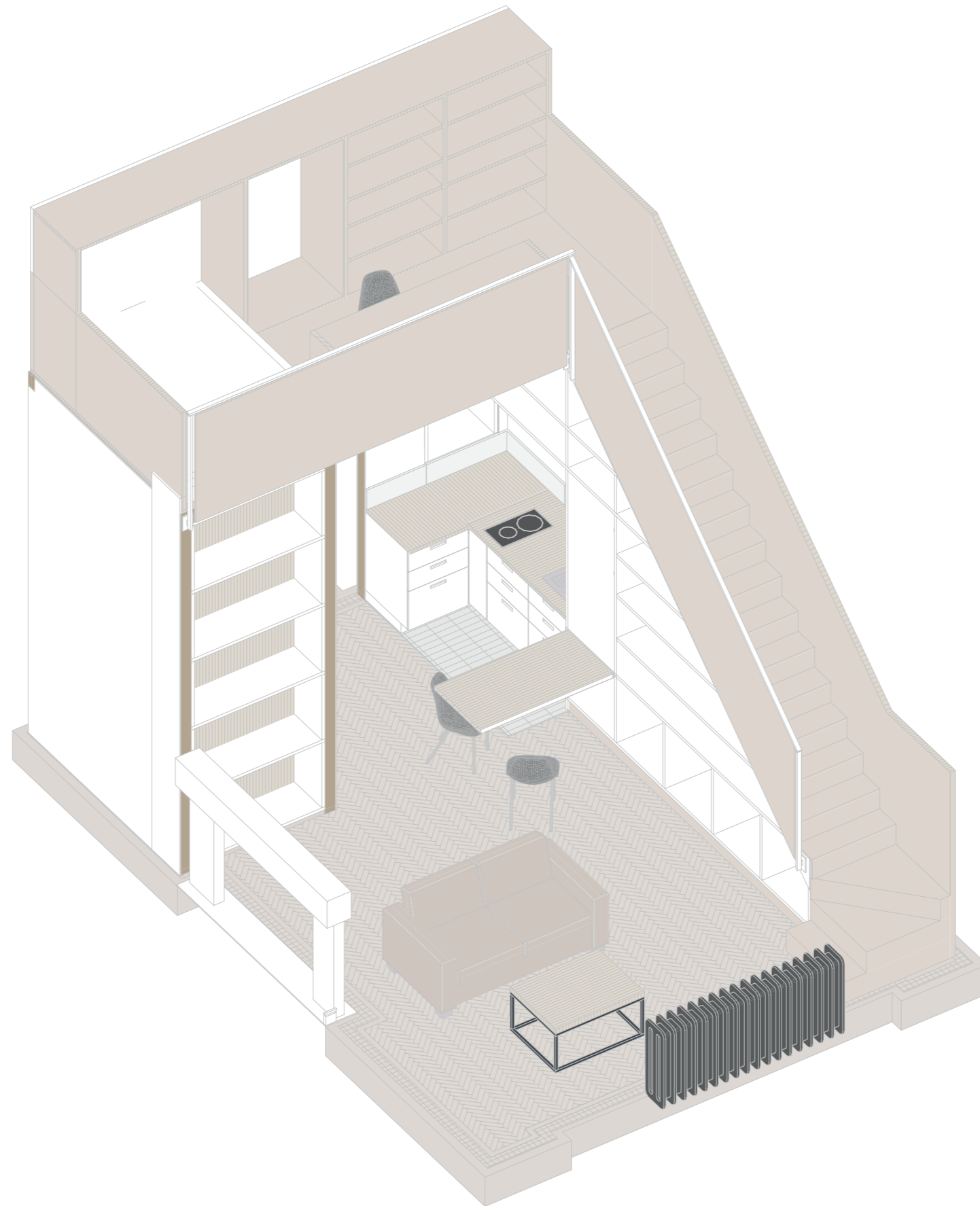

A Bank of Opportunities - Caring for people



A Bank of Opportunities - A safe space for people



A Bank of Opportunities - Conclusion

Thanks for your attention !