

**City-zen: New Urban Energy**  
**Sevilla 'City-zen Roadshow' REPORT**

Martin, C.L.; van den Dobbelsteen, A.A.J.F.; Keeffe, Greg; Pulselli, Riccardo; Vandevyvere, Han; Stevens, Tine; Cardona, Jesús

**Publication date**

2017

**Document Version**

Final published version

**Citation (APA)**

Martin, C. L., van den Dobbelsteen, A. A. J. F., Keeffe, G., Pulselli, R., Vandevyvere, H., Stevens, T., & Cardona, J. (2017). *City-zen: New Urban Energy: Sevilla 'City-zen Roadshow' REPORT*. European Commission.

**Important note**

To cite this publication, please use the final published version (if applicable).  
Please check the document version above.

**Copyright**

Other than for strictly personal use, it is not permitted to download, forward or distribute the text or part of it, without the consent of the author(s) and/or copyright holder(s), unless the work is under an open content license such as Creative Commons.

**Takedown policy**

Please contact us and provide details if you believe this document breaches copyrights.  
We will remove access to the work immediately and investigate your claim.

NEW URBAN ENERGY



# Sevilla Roadshow REPORT

DELIVERABLE **D9.13**

The opinion stated in this report reflects the opinion of the authors and not the opinion of the European Commission. The European Union is not liable for any use that may be made of the information contained in this document.

All intellectual property rights are owned by the City-zen consortium members and are protected by the applicable laws. Except where otherwise specified, all document contents are: "© City-zen project - All rights reserved". Reproduction is not authorized without prior written agreement.

The commercial use of any information contained in this document may require a license from the owner of that information.

All City-zen consortium members are also committed to publish accurate and up to date information and take the greatest care to do so. However, the City-zen consortium members cannot accept liability for any inaccuracies or omissions nor do they accept liability for any direct, indirect, special, consequential or other losses or damages of any kind arising out of the use of this information.



This project has received funding from the European Union's Seventh Programme for research, technological development and demonstration under grant agreement No 608702.

## PROJECT INFORMATION

<b>Project Acronym and Full title</b>	City-zen, a balanced approach to the city of the future
<b>Call Identifier</b>	FP7-ENERGY-SMARTCITIES-2013
<b>Grant Agreement</b>	n° 608702
<b>Funding Scheme</b>	Collaborative Project
<b>Project Duration</b>	60 months
<b>Starting Date</b>	01/03/2014

### MAIN COORDINATOR

<b>Name</b>	Sarah Bogaert
<b>Organization</b>	VITO
<b>Address</b>	Boeretang 200, 2400 Mol (Belgium)
<b>Phone</b>	+32 14 33 58 14
<b>E-mail</b>	sarah.bogaert@vito.be

### CONSORTIUM PARTNERS

N° DoW	Organization	Acronym	Country
1	Vlaamse instelling voor technologisch onderzoek	VITO	BE
2	Stichting Amsterdamse Economic Board	AIM	NL
3	Universiteit van Amsterdam	UVA	NL
4	Westpoort Warmte B.V.	WPW	NL
5	Alliander	LIAN	NL
6	HESPUL Association	HESP	FR
7	The Queens University of Belfast	QUB	UK
8	Th!nk E	THNK	BE
9	KEMA Nederland BV	KEMA	NL
10	Technische Universiteit Delft	TUD	NL
11	Stichting Waternet	WAT	NL
12	Greenspread Projects BV (subject to reservation, provided acceptance by EU)	GREE	NL
13	Sanquin (subject to reservation, provided acceptance by EU)	SANQ	NL
14	AEB Exploitatie BV	AEBE	NL
15	Daikin Airconditioning Netherlands B.V.	DAIK	NL
16	Siemens Nederland NV	SIEM	NL
17	Universita' degli Studi di Siena	UNIS	IT
18	Ville de Grenoble	MUNG	FR
19	Commissariat a l'Energie Atomique et aux Energies Alternatives	CEA	FR
20	Compagnie de Chauffage Intercommunale de l' Agglomeration Grenobloise	CCIA	FR
21	Gaz Electricite de Grenoble	GEG	FR
22	SAS ATOS Worldgrid	ATOS	FR
23	Clicks and Links Ltd&L	C&L	UK
24	Grenoble-Alpes Métropole	METRO	FR

## DELIVERABLE INFORMATION

---

<b>Number</b>	D 9.13
<b>Title</b>	Roadshow with ‘On-site’ Advice & Summary Report
<b>Lead organization</b>	TUD
<b>Author</b>	Prof. Dr. Craig Lee Martin (TUD)
<b>Contributors</b>	Prof. Greg Keeffe (QUB); Prof. Dr. Andy van den Dobbelsesteen (TUD); Dr. Riccardo Pulselli (UNIS); Dr. Han Vandevyvere (VITO)
<b>Reviewers</b>	Prof. Dr. Andy van den Dobbelsesteen (Delft University of Technology); Dr. Riccardo Pulselli (University of Siena).
<b>Nature</b>	R – Report
<b>Dissemination level</b>	PU – Public;
<b>Delivery Date</b>	M12-M60 (01/03/2019)

## VERSION HISTORY

Version	Date	Author/Reviewer	Description
1.0	31/07/2018	Prof. Dr. Craig Lee Martin	Final version

## ACKNOWLEDGEMENTS

The Sevilla Roadshow would not have been possible without the commitments and organisational energy of one individual: Prof. Madelyn Marrero Melendez, highly respected member of the Escuela Técnica Superior de Ingeniería de Edificación (Universidad de Sevilla). Madelyn and her team of sustainability educators gave continuous support during the preparations for the Sevilla SWAT Studio and later Roadshow. The Roadshow team would like to take this opportunity to thank Madelyn and her committed colleagues at the Universidad de Sevilla. We wish them well in their continued efforts to make Sevilla a zero-energy city, and wish them every success in taking the outcomes of the City-zen ‘Sevilla’ Roadshow to the next level of realization.

The Ingeniería de Edificación would be the home of the SWAT Studio and Roadshow during our co-creative efforts to develop a Sustainable City Vision.

## ABSTRACT

---

The City-zen Roadshow travels with a team of internationally recognized experts, in the field of energy planning and design to help develop a sustainable agenda for cities and their neighbourhoods. It will visit 10 cities in total over a 4-year period who are seeking expert guidance on how to become more sustainable and wish to move towards energy neutrality. The overall aim of the Roadshow team, known as 'Roadies', is to work closely with people from the hosting city, whether they be city leaders, energy planners, local architects, professionals, academics, students and of course the citizens themselves. The Roadshow spends 5 days in each hosting city to deliver energy and urban design workshops in which all local stakeholders are welcome and encouraged to join and to take ownership of the final outcomes. Outcomes that will allow the cities recourse, both people and energy, to be directed effectively, by highlighting the energy challenges and potentials to be found in their neighbourhoods, and to finally present a sustainable 'City Vision'.

The following report will describe the activities and outcomes of the City-zen 'Sevilla' Roadshow that took place in Sevilla, between the 20<sup>th</sup> & 24<sup>th</sup> of November 2017.

## TABLE OF CONTENTS

---

<b>PROJECT INFORMATION</b> .....	<b>1</b>
<b>DELIVERABLE INFORMATION</b> .....	<b>2</b>
<b>ACKNOWLEDGEMENTS</b> .....	<b>2</b>
<b>ABSTRACT</b> .....	<b>3</b>
<b>TABLE OF CONTENTS</b> .....	<b>4</b>
<b>CHAPTER 1 – Introduction</b> .....	<b>5</b>
1.1. CITY-ZEN ROADSHOW AND SWAT STUDIO	5
1.2. AIMS	7
1.3. OBJECTIVES	8
1.4. ROADSHOW AT A GLANCE	10
<b>CHAPTER 2 – ROADSHOW COMPONENTS</b> .....	<b>11</b>
2.1. 'FUTURE NEIGHBOURHOODS' - WORKSHOP 1	11
2.2. 'ENERGY WORKSHOP' WORKSHOP 2	15
2.3. 'PERIPATETIC PATHWAYS' - MINI-MASTERCLASS 1	24
2.4. 'PAC-MAN, CARBON CRUNCHING' - MINI-MASTERCLASS 2	28
<b>CHAPTER 3 – SUSTAINABLE ISLAND VISION</b> .....	<b>34</b>
3.1. FINAL DAY	34
3.2. THE PRESENTATION	35

---

## CHAPTER 1 - Introduction

---

### 1.1. CITY-ZEN ROADSHOW AND SWAT STUDIO

The Roadshow travels with a team of internationally recognized experts in the field of architectural design and energy planning to co-create a sustainable 'City Vision' with city stakeholders. Over a 4-year period it will visit 10 cities that are seeking expert guidance on how to become zero energy and carbon neutral. The project has already successfully collaborated with Belfast, Izmir, Dubrovnik and Menorca. The overall aim of the project team is to work closely with people from each hosting city, whether they be city leaders, neighbourhood associations, energy planners, architects, academics, students and of course most significantly the citizens themselves. The project consists of a 5-day event model, a culmination of a 3-month preparation including an educational design studio (the SWAT Studio) that promotes the Roadshow whilst building relationships and trust between all contributing partners. Local stakeholders are welcomed and encouraged to join and to take ownership of the process and the final outcomes, outcomes that will allow the cities resources, people, knowledge and renewable energy potential to be directed effectively over a realisable timescale that will meet their energy transition. The process starts by identifying a neighbourhood's urban lifestyle and energy challenges. Then, on the final day of the event model, a definitive sustainable 'City Vision' is presented to, and by, the city, which responds to all scales of their built and natural environment.

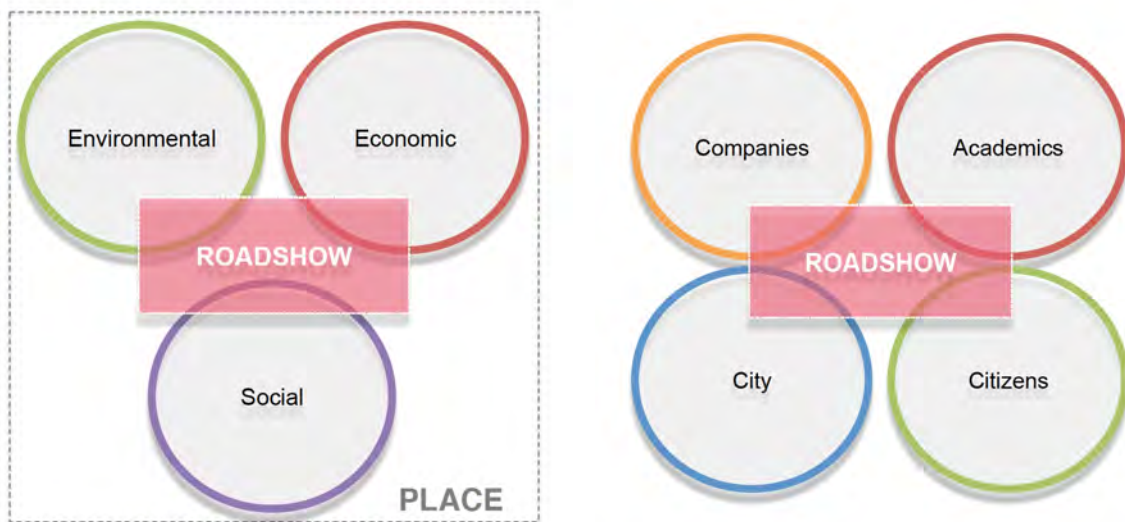

(a) (b)  
*Fig. 1. (a) The Roadshow investigates environmental, economic and social aspects of each Roadshow city to develop a 'City Vision' that is specifically tailored to respond to place. (b) The Roadshow team brings together all stakeholders; it facilitates this 5-day event to propose a sustainable 'City Vision' that is 'owned' by the City itself.*



DAY	Morning/ Afternoon	Time	ACTIVITIES	VENUE / NOTES
<b>DAY 1</b> 20/11/17 (Mon) Theme: 'INTRO'	AM	09:00 - 11:00	SITE VISIT (Roadshow Staff + Invited Guests)	ETS Ingeniería de Edificación Universidad de Sevilla Ave. Reina Mercedes 4-A 41012 Sevilla
		11:00 - 11:30	WELCOME COFFEE	
	PM	11:30 - 11:45	<b>BIENVENIDOS</b> Prof. Madelyn Marrero (Universidad de Sevilla) & Prof. Craig L. Martin (TU Delft)	Salón de Grados
		11:45 - 12:00	<b>Roadshow</b> Prof. Craig L. Martin, Delft University of Technology (TUD)	
		12:00 - 12:15	<b>Taller "Futuro de los Barrios"</b> (Taller 1) Prof. Greg Keefe (QUB)	AULA 2.3b (25) (9:00-15:00)
		12:15 - 12:30	<b>Taller "Energía"</b> (Taller 2) Prof. Andy vd. Dobbela (TUD)	
		12:30 - 12:45	COFFEE	
		13:00 - 13:15	<b>SWAT en Sevilla, Resultados de Sept 2017</b> Eve, Dora, Laura, Michael, Anttoni & Alvaro (Building Tech Students TUD)	
		13:15 - 15:00 +	<b>TECNOLOGÍAS FUTURAS</b> Sustainable technologies and projects in Sevilla	
			LA COMIDA (LUNCH)	
	20:30 +	<b>LA HORA DEL APERITIVO (TAPAS HOUR)</b> Invited guests		
<b>DAY 2</b> 21/11/17 (Tues) Theme: 'MAP FUTURES'	AM	08:30 - 09:00	COFFEE	
		09:00 - 10:30	<b>Futuro de los Barrios Taller</b> 'DROP IN' PERIOD 1 (P1)	AULA A7 y A8 (40) (9:00-15:00)
	PM	11:00 - 14:00	<b>Energía Taller</b> 'DROP IN' PERIOD 1 (P1)	
			COFFEE	
			LA COMIDA (LUNCH)	
		15:00 - 17:00	<b>Futuro de los Barrios Taller</b> 'DROP IN' PERIOD 2 (P2)	AULA A7 y A8 (40) (15:00-19:00)
			COFFEE	
		17:30 - 18:00	<b>Energía Taller</b> 'DROP IN' PERIOD 2 (P2)	
	MERIENDA (MID-AFTERNOON SNACK):			
	18:00 - 19:00	DAY 2 'MAP FUTURES' SUMMARY + WORKSHOP 1 & 2 'CATCH-UP'	ALL WELCOME!	
<b>DAY 3</b> 22/11/17 (Wed) Theme: 'DESIGN'	AM	08:30 - 09:00	COFFEE	
		09:00 - 13:00	<b>JUEGO SERIO 'Go2Zero'</b> COFFEE: 10:30 & 12:00	AULA 2.2b (25) (9:00-15:00-17:00)
	PM	13:15 - 14:15	<b>SEVILLA: UNA CIUDAD DE BAJAS EMISIONES!</b> Your Carbon usage Explained & Turned to Zero by Riccardo Pulselli (University of Sienna)	AULA 2.3b (25) (9:00-15:00-17:00)
			COFFEE	
			WALKING TOUR (LUNCH)	
		14:45 - 17:00	<b>WALKING TOUR</b> TIRO DE LÍNEA-HELÍOPOLIS-POLÍGONO SUR - by Dr Han Vandevyvere (VITO)	
			MERIENDA (MID-AFTERNOON SNACK):	
		18:00 - 19:00	DAY 3 'DESIGN' SUMMARY + WORKSHOP 1 & 2 'CATCH-UP'	ALL WELCOME!
<b>DAY 4</b> 23/11/17 (Thurs) Theme: 'EVALUATE'	AM	08:30 - 09:00	COFFEE	
		09:00 - 10:30	<b>Futuro de los Barrios Taller</b> 'DROP IN' PERIOD 3 (P3)	Salón de Grados
	PM	11:00 - 12:00	<b>Energía Taller</b> 'DROP IN' PERIOD 3 (P3)	AULA 2.2a (40) (9:00-15:00-17:00)
			COFFEE	
		12:30 - 14:00	<b>Futuro de los Barrios Taller</b> 'DROP IN' PERIOD 4 (P4)	AULA 2.3a (40) (9:00-15:00-17:00)
			COFFEE	
			LA COMIDA (LUNCH)	
		15:00 - 17:00	<b>FINAL AGREEMENT &amp; DISCUSSION of CITY VISION</b> ALL WELCOME!	
	MERIENDA (MID-AFTERNOON SNACK):			
	18:00 - 19:00 +	FINAL TASKS / PREPARATIONS (WORKSHOP FACILITATORS)	ALL WELCOME!	
<b>DAY 5</b> 24/11/17 (Fri) Theme: 'OUTRO'	AM	09:30 - 10:00	WELCOME COFFEE	
		10:00 - 11:00	<b>BIENVENIDOS</b> Introduction by the Mayor	Salón de Grados AYUNTAMIENTO 87
		11:00 +	<b>VISIÓN SEVILLA SOSTENIBLE</b> ROADSHOW DISCUSSION DRINKS & CLOSURE	

Schedule by Prof. Craig Martin

Fig. 2. Sevilla Roadshow 5-day timetable

The following describes the underlying approach undertaken in Sevilla and the project neighbourhood of Barrio Tiro de Línea. It will include a brief explanation of the Sustainable 'City Vision' that resulted. City engagement is an exciting and thought-provoking prospect. Many questions arise at the beginning of the journey. Making first contact with a prospective project location, conducting preparations, explanations and agreements is far from an exact science. The method of achieving this successfully has evolved city-by-city and is arguably as valuable as the sustainable solutions that are finally produced. There can be many political, cultural and linguistical obstacles that must be overcome. The outcomes have the power to inspire and potentially be realised post-project. The first questions are:

- Who is 'the City'?
- What are the city's sustainable expectations and aspirations?
- What is the current and future calculated energy demand?
- Where are the urban challenges?
- Are they purely energetic, spatial & social, administrative or a combination of all?
- Does the 'City' even realize or accept they have challenges, despite its desire to be sustainable?

To answer these questions and many more, the project team began the process of identifying the cities that need and want our collaboration. First contact begins with an educational architecture workshop studio (known as the SWAT Studio). This takes place in the months leading up to the project. Developed and led by TU Delft under Prof. Craig Lee Martin, the student-focused workshop facilitates an extended and detailed discussion with city stakeholders. The later 'expert' Roadshow event model is conducted over a 5-day period and is based on 'themes' that guide the evolution of the vision in which expert input is delivered at key points. Each event is constructed to relate to individual citizen experiences and knowledge, this giving confidence in the processes that are extended to relate to streets, neighbourhoods, districts, city and, under some circumstances, the region. The project is not intended to be a one-way stream of information and ideas; instead, the process aims to activate, convince, openly invite and encourage 'the City' to be part of the process at any level that they feel comfortable with. The method includes going out of the studio and into the wider community. To engage with various initiatives and to meet and talk with their members, no matter their age or background. The project leader selects cities that have diverse climates, urban typologies, economies, cultural backgrounds, to ensure that the project develops a highly adaptable and compact, yet replicable approach, whatever the city and its circumstances.

## 1.2. AIMS

The aim is to develop an event model capable of implementation in all cities to co-create a city's sustainable vision with citizens from all backgrounds. Proposals developed exclusively by the project team, and not by the multidisciplinary city stakeholders, would physically and metaphorically leave with the project. Hence, a home-grown solution is key. A legacy must remain in which all participatory groups continue to exchange knowledge and speak with a common voice, making any future research bids, beyond the scope of the City-zen project coherent and effective. The project wishes to extend its agenda by strengthening connections and bringing together a global family of project cities, where experiences can be shared together with collaborative research bid proposals across the European community.

The most important target group are inhabitants of the neighbourhood, city and wider hinterland of the hosting city. Companies and start-ups in the field of technology and sustainability are encouraged to be active participants during the project. A key objective is to reach 600 students across the EU by visiting local universities, colleges and secondary schools. Students are the future. It has been mutually beneficial idea to combine the energy and enthusiasm of architecture, urban planning and building technology focused 'SWAT Studio' Master's students with that of the stakeholders and students of

each hosting city. The student projects, and more significantly the close relationships that were forged whilst conducting them, lay the foundation on which later to build the later intensive 5-day project. Promotion, full participation and dissemination contribute significantly to overall success. As a consequence, the project and student workshop leader encourages any and all interested groups such as municipalities, neighbourhood associations and universities to grasp the opportunity to do so. Taking the time to discuss what is expected and allay any reservations or doubts they may have, it is not the intention of the event to criticize a city’s perceived lack of sustainability. Project team specialists are aware of many complex global and local level challenges toward the energy transition.



Fig. 3. The Sevilla ‘SWAT Studio’ (18<sup>th</sup> to 29<sup>th</sup> of September 2017). A Building Technology MSc’s ‘Onsite’ studio (TU Delft, The Netherlands), an educational precursory event that took place 2 months prior to the start of the Sevilla Roadshow. During the SWAT Studio the aims and objectives of the City-zen ‘Sevilla’ Roadshow would be disseminated on local media streams.

## 1.3. OBJECTIVES

### 1.2.1 Student Engagement

A Master’s level Building Technology student workshop (known as the SWAT Studio), with identical project aims as the expert Roadshow, develops and proposes technologically innovative and contextually driven urban interventions, a key ambition of the workshop being to demonstrate, through building interventions at all scales ranging from façade, building, street, neighbourhood and district, that sustainable lifestyles are possible within existing cities. This student-orientated programme is a precursory educational event to the later specialist project. In Sevilla, at the hosting venue at the Escuela Técnica Superior de Ingeniería de Edificación (Universidad de Sevilla),

student's from both The Netherlands and Sevilla forged pre-project relationships with key city stakeholders, a process allowing project areas to be investigated in detail and data to be collected and accessed. The outputs of each sustainable workshop would be presented on the first onsite day of the project, the workshop making positive connections with academic and municipality leaders and sustainable energy and smart city departments and companies, including the Gerencia de Urbanismo (Ayuntamiento De Sevilla), Instituto Universitario Arquitectura Y Ciencias De La Construccion, Arditec Arquitectura: Diseño y Técnica Código and the Agencia Andaluza de la Energia Consejeria De Empleo, Empresa Y Comercio.

### 1.2.2 Process

In Sevilla, the process began with a collaborative Master's level Building Technology student workshop 2/3 months prior to the project start. Both the workshop and the Roadshow itself were developed to be fun and yet 'intensive'. Components such as seminars, walking tours, design workshops and mini-masterclasses within the 5-day period were strategically timed and citizen focused at key points. The outputs, synchronised with specific project team specialisms in energy and urban design, were qualitatively spatial and quantitatively energy focused, and combined to form the Sustainable City Vision on the final day of the Roadshow.

### 1.2.3 Daily Activities

Daily activities would involve citizens, architects, municipality staff, PhD students, academics and energy consultant's visiting the projects studio base at the Escuela Tecnica Superior de Ingenieria de Edificación, a venue donated by the Universidad de Sevilla. The 5-Day programme was devised in such a way to encourage participants to 'drop-in' and 'drop-out' so that the project workshop activities and Mini-masterclasses could fit into their professional and family schedules, a strategy that would increase city involvement. PechaKucha style presentations (PechaKucha meaning 'chit-chat' in Japanese, a format that keeps presentations concise and fast-paced, facilitating multiple-speaker events) informed the participants of what to expect. Sevilla's stakeholders also contributed on the day with presentations that outline past, present and future aspirations for their city.

The project method aims to foster an intensive working environment, yet one that allows adequate flexibility to ensure maximum participation of stakeholders. It must be respected and appreciated that all stakeholders are likely to have full time jobs and a family life beyond any project, and that their attendance is self-financed. Therefore, it is one of the roles of the project leader to strike a balance during discussions between conveying the urgency of being part of the process, but not to an extent that it distances prospective attendees. Whilst the student workshop (SWAT Studio) is underway, on location many preparations and negotiations take place with stakeholders. Here various visual descriptors are used to communicate what is expected during the Roadshow project.

Images taken during the co-creative and intensive events of previous Roadshows in Belfast, Izmir, Dubrovnik and Menorca are incredibly effective in translating what is to come. Coloured marker pens, rolls of tracing paper, laptops and notebooks are the tools of choice for the project participants. Activities have the same aim, energy neutrality; however, each component is enjoyably diverse and offers new perspectives and skills on how to attain it. Whilst two parallel workshops run continually over the week participants sign up to play a Serious Game entitled 'Go2Zero'. Sevilla's stakeholders had the chance to 'role play', having playful fun whilst experiencing the cause and effect of energy strategy decisions made at the regional, neighbourhood and family household level.



Fig. 4. Sevilla's citizens getting into the game and having 'energetic' role-playing fun whilst learning the implications of energy choices at the large commercial and domestic level.

## 1.4. ROADSHOW AT A GLANCE

The following points list 18 keywords that best describe the story and ambitions of the City-zen Roadshow:

1. **ZERO ENERGY** Aims to develop and demonstrate Zero-Energy Cities with a central role for citizens.
2. **MOTIVATE & EMPOWER** End-users to a long-term energy saving attitude.
3. **CITIZENS** Placed in the heart of a creative process that develops designs, strategies, guidelines and timelines at all scales of their own cities built environment.
4. **NUMBERS** 4 Cities completed - 3 months prep / city - 5 days onsite / city - all citizens - 7 International sustainability experts - 6 cities next.
5. **IMPACT** Healthy lifestyles, environmental comfort, building efficiency, independence from fossil fuel uncertainty. But most of all confidence that sustainability is for all who want it.
6. **TRUST** Citizen's need belief in the process, objectives and solutions, no matter how radical or unfamiliar. Students open the door!
7. **OWNERSHIP** Citizen's take ownership of their built environment without fear of hidden agendas, affiliations or political constraint.
8. **HOMEGROWN** The solutions stay with the people.
9. **WHO IS THE CITY?** Doesn't matter where the ideas come from, as long as they come and begin to be realized.
10. **DISRUPT** Project rocks the status quo to reach zero energy.
11. **GLOCAL** Specialist global expertise combined with local stakeholder energy and knowledge of context and lifestyle.
12. **GRAPHICAL** Use graphical descriptions to get your messages across.
13. **SACRIFICE?** It's not about losing, it's about what you gain. Replacing it with something better for your children and community.
14. **TIMETABLE TO SUIT** Schedule to fit stakeholders, not the other way around. Remember, stakeholders are not on the payroll, they have other daily priorities.
15. **INDIVIDUAL PERSPECTIVE** Make sure activities relate to the people and their experiences. These can be expanded later to other scales.
16. **COMPARISONS** To design what is possible is one thing, to show what has been realized or what can occur under the right circumstances is even better.
17. **HIGHLY VISUAL** Outcomes to be colourful representations of the future, before/after scenarios.
18. **BE INSPIRATIONAL** Encourage 'City Vision' participants to take the lead in the next step!

## CHAPTER 2 – ROADSHOW COMPONENTS

---

Two parallel workshops continue throughout the project week, on arrival stakeholders are guided to select one workshop depending on their interests or specialisms, however migration to each is recommended in order to get a full overview of energy and urban strategies and their implementation. At the end of each day the workshops meet to summarise their findings and to agree on that evenings and the following day objectives. As an example of how the project approaches each city, the following describes the journey and activities undertaken in Sevilla and within one of its typical neighbourhoods – Barrio Tiro De Línea.

### 2.1. FUTURE NEIGHBOURHOODS (WORKSHOP 1 – DAY 1 TO 5)

*Convenor: Prof. Greg Keeffe, Queens University Belfast, UK*

#### 2.1.1 Background

The car has shaped the 20<sup>th</sup> century city. The growth of car usage from the 1950s onwards created real problems for designers; however, many of the solutions to the issue have created bigger urban issues. This is clear in Sevilla, where a car-based strategy for urban design has isolated inner-city areas, by oversizing roads, and creating large-scale defensive architecture alongside the road to counteract its presence. This is the dominant feature of the neighbourhood.

#### 2.1.2 Aim & Objectives

The aim of the workshop was to develop strategies at a range of scales that allow a process-based adaptation of the city to carbon neutrality. The scales utilised were: the city, the neighbourhood, and the building. The city scale is important because city form is the basis for the behaviours engendered in the city. Here urban grain can encourage or discourage car usage, allow safe routes for schoolchildren, and connect the inner city with the countryside. The neighbourhood scale allows us to visualise the commons – i.e. the things we share. This may be things such as smart grids, or other networks, but may also be spaces for meeting, playing or growing. Energy storage is most cost-effective at this scale too, as is car share. In addition, density is one of the key factors in making neighbourhoods function, and many behaviours are linked to this – such as car usage, local economy etc. The house or building scale is crucial, because here we see many of the technologies for neutrality being employed. Technologies such as PV cells, heat-pumps, shading devices, DHW production all have been developed to work at this scale.

#### 2.1.3 Methodology

The workshop starts with an understanding of city form, historic and future growth, urban grain, climate, eco-system services and density. From these initial studies, an understanding of the city as a holistic super-organism is developed. This bioclimatic understanding allows new insights into current trajectories. Urban design is based on understanding urban trajectories and

deflecting or manipulating them, to create new futures in a seamless way. Once a sustainable urban design strategy for the city is developed, we change to the neighbourhood and building scales to look at the issues this strategy creates at the smaller scales. More detail can be developed here, and the solutions become more technological. We then visualise the impact these technological insertions have on the built environment and the lifestyles of the residents.

#### 2.1.4 Experiences & Insights

##### The City

Sevilla is an historic city, and the neighbourhood chosen is in the 19<sup>th</sup> century extension to the South. This extension, originally based on tram cars, has been re-appropriated and extended by car. These arterial roads are over-sized and the connection between them and the neighbourhood is characterised by a very hard edge of apartment blocks of up to 12 stories, limiting the permeability of the neighbourhood with the city.

##### Mobilities.

Due to the extreme latitude (for Europe) and subsequent climate, car usage is very high, the neighbourhood has a large amount of on-street parking, and many commuters leave their car here and walk to work. The large-scale roads that bound the neighbourhood also offer parking for commuters and locals. There is very little public transport that travels through the neighbourhood: most travels on the large radial routes that bypass the neighbourhood.

##### Neighbourhood

The neighbourhood chosen is of reasonable density, consisting of a mix of accommodation blocks, from small villas and terraces to the west, to larger social housing blocks in the east. These blocks range from blocks typically 5-6 storeys high, to some at 10-12 storeys developed in the 1990s. The West of the neighbourhood is characterised by low-rise housing on a ladder street pattern that has high permeability, however the rest of the neighbourhood is more modern and suffers from poor legibility and worse permeability.

The retail centre consists of an indoor market and a small rather dilapidated mall. Both could do with refurbishment. There is no shopping street, and very little useful social space. No concern has been made with regard to the pedestrian anywhere, particularly with regard to thermal comfort and shade in summer. This makes walking difficult during the day and encourages car usage. In addition, the city suffers from extreme heat island effect due to the lack of street trees, which would provide transpirative cooling and shade.

##### Buildings.

Developed as private housing in the 1990s, the apartment blocks are rather basic from an energy point of view: there is no insulation, no external solar shading; secondary roof, or green roof systems. Technologically the buildings are poor too, and there are no renewable systems employed.

#### 2.1.5 Outcomes

##### The neighbourhood

The workshop developed a new strategy plan for the city, which reinvented each neighbourhood as a distinct but connected entity, yet still allowed development.

This created perforated space: new green routes were designed that cut across the neighbourhood making a pedestrian grid that was shaded, offering new routes that were direct and comfortable to encourage walking.



Fig. 5.

New neighbourhood engagement with the road, hereby reducing the scale of the arterial roads. The space gained could be used to develop new social and leisure functions for the neighbourhood, such is the scale of the oversized road.

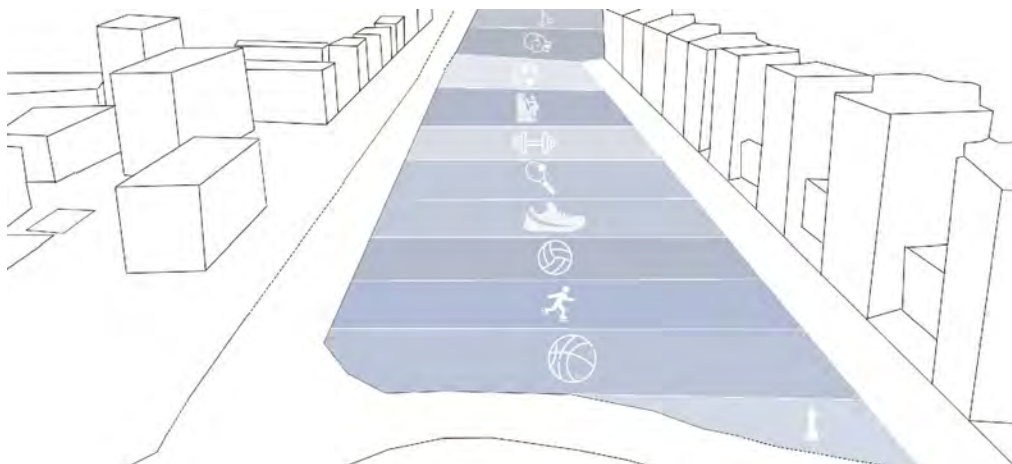

Fig. 6.

#### Building scale

Many of the public spaces in the neighbourhood are oversized and unshaded. The urban design strategy at this scale looked to develop some of the larger squares to improve both shade and density.



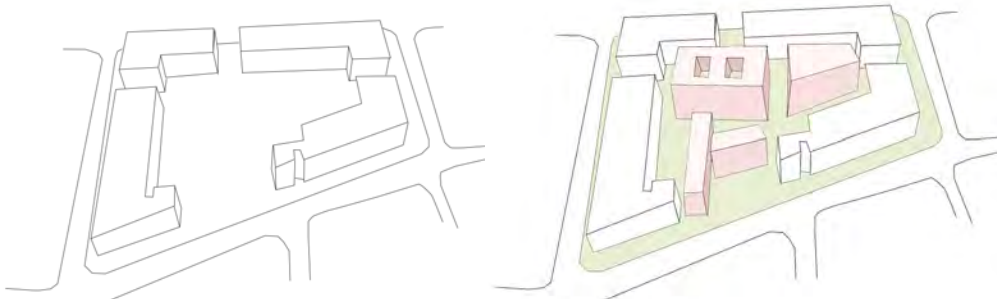

Fig. 7.

Micro-greening was also suggested to radically change the urban condition.



Fig. 8.

### Mobilities

The change of mobilities from car-dominance to a walking city could have a radical effect on the streetscape.



Fig. 9.

### Public space

Finally, by re-engaging the indoor market with its context, the neighbourhood could develop a new vibrant hub that would encourage local engagement and visitors to the area.



Fig. 10.

### 2.1.6 Future Development of the Workshop

The workshop results were excellent, but the engagement with practitioners, city governance and local people could be better. The neighbourhood needs to come together to envision a green future.

Sevilla is in a complex place regarding climate. Summers are already extremely warm and this is exacerbated by the climate-insensitive design that exists in the neighbourhood. The city needs to quickly green itself to prevent rapid overheating, as this will lead to high energy usage re cooling. Urgent but relatively simple action is needed.

NOW



STEP 4: 100% GREEN



Fig. 11.

## 2.2 ENERGY WORKSHOP (WORKSHOP 2 – DAYS 1 TO 5)

Report by Prof. Dr. Andy van den Dobbelsteen, TU Delft, The Netherlands

### 2.2.1 Background, Aim & Objectives

The City-zen Roadshows, part of Work Package 9 of the EU FP7 City-zen programme, have a double-sided meaning: they are used for validation in a real city situation of the methods, tools and strategies developed, and they serve as inspiration for input to these methods, tools and strategies, inserting experiences and ideas coming from the Roadshows. It is strongly linked to the City-zen method developed in Work Package 4, Task 2, using the same team to visit the Roadshow cities.

The main aim of the City-zen Roadshow is to support the city in question, in this case Sevilla, in its energy transition from fossil fuels to renewable sources, whilst improving the living conditions in the city. During the Roadshow all aspects of sustainability – ecological, social and economic – are taken in to account. The specific focus of the energy workshop is on the technical flows – energy, water and materials – with an obvious emphasis on energy.

Stepped objectives of the energy workshop are:

1. Creating a good overview of energy demand, supply and local potentials
2. Converting energy usage to a carbon footprint
3. Finding solutions to get to net zero-carbon developments
  - Reduce the energy demand (urban planning, building design, appliances)
  - Reuse waste energy (program, attune, exchange, store)
  - Produce renewables (sun, wind, water, soil, air, biomass, humans)
4. Involve solutions for non-building sectors:
  - Transportation
  - Waste (water) treatment
  - Economic developments
5. Calculate the carbon emissions reduced and remaining carbon footprint

### 2.2.2 Methodology

The methodology of the Roadshow Energy workshop is largely based on the City-zen Methodology (developed by Work Package 4, Task 2) – see figure 12 – in which, starting from the present situation (technical, spatial, political, social, economic) in a city, including the developments already started, a vision is created for a sustainable future, using scenario planning and inspiring examples, from whence the necessary roadmap can be defined, including essential projects along the way, fed by a catalogue of possible measures.

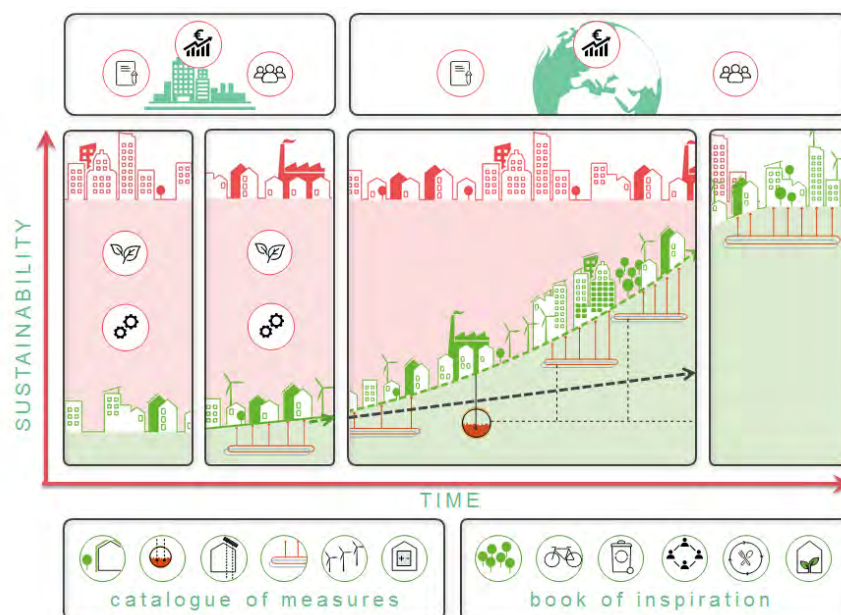

Fig 12. Graphical explanation of the City-zen method – image by Siebe Broersma and Michiel Fremouw (City-zen WP4T2)

The City-zen Roadshow itself has its own methodology, linked to MSc education and providing a very clear outline of the week the Roadshow team visits the city. This was already presented by the Roadshow coordinator, Prof. Craig Lee Martin.

As with other Roadshows we started with an analysis of the local climate, energy infrastructure, consumption figures, energy sources, building methods, supported by excursions into the area studied. In the days after we worked on spatial, technical and functional solutions, repetitively assessing the impact on energy consumption, carbon emissions and socio-economic factors. For the energy approach we used the New Stepped Strategy (Figure 13): 1. Reduce, 2. Reuse, 3. Produce.

Our intermediate results were shared and exchanged with the Urban Design workshop, led by Prof. Greg Keeffe, securing optimal attuning of both workshops.

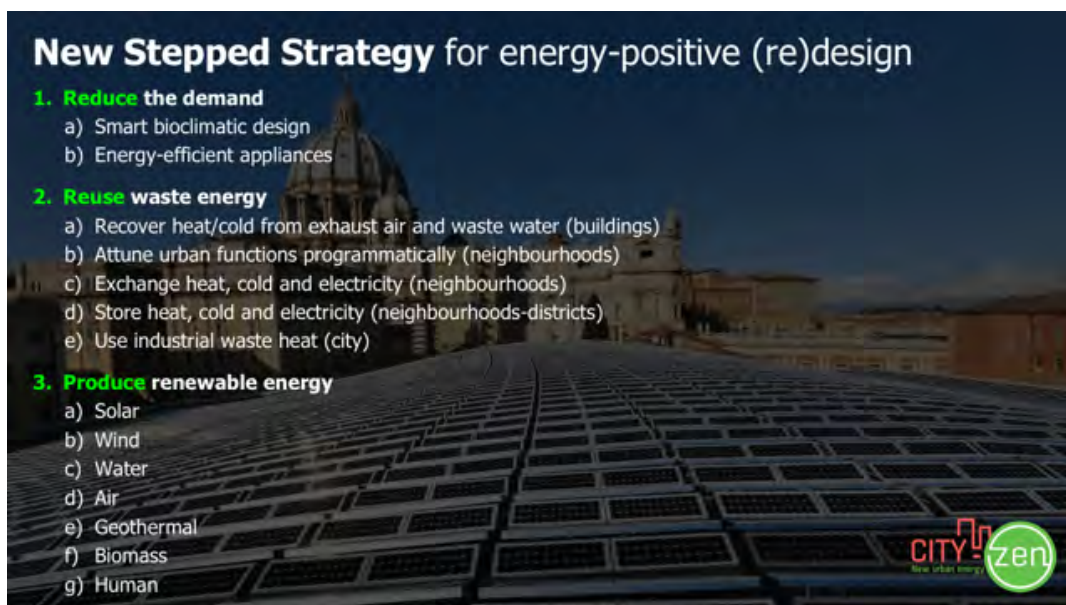
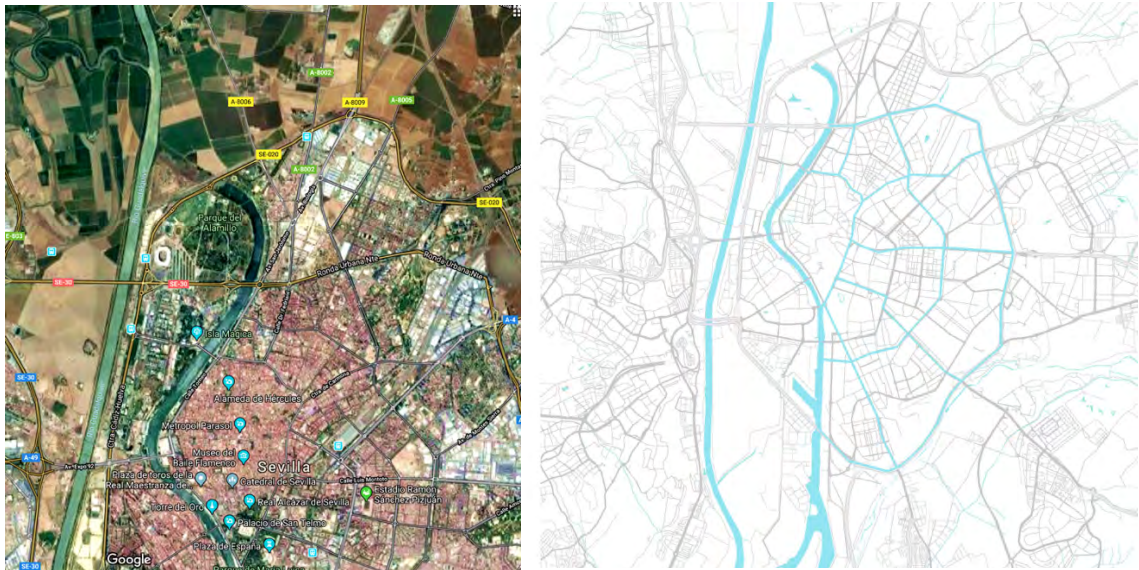

Fig. 13. The New Stepped Strategy and how we wanted to use it in Sevilla

### 2.2.3 Key Outcomes – Sustainable City Vision

From the climate analysis and forecasts based on climate change, Sevilla already has and will even have a greater heat and drought problem. At present-day the city's summers tend to go beyond 40°C easily, a combined effect of the climate and urban heat island, and based on IPCC scenarios, temperatures will become unliveable in a few decades. Therefore, proper water management and cooling strategies are the biggest environmental challenges.



*Fig. 14. The Guadalquivir river's interrupted original course (left, Google Maps) and proposed water veins through the city (right, Roadshow Facilitators)*

We started with studying water, finding that water comes in gusts and stormwater is flushed towards the river quickly. Short periods of heavy rain are followed by long ones with drought. For flood protection, the Guadalquivir river was cut off from its original course in the past, creating a dead end into the city (Figure 14, left). First thing we proposed on the macro-scale, based on the city's relief, was to bring river water into the city, creating cooling veins that could also serve functionally, for plants, fountains and other purposes (Figure 14, right).

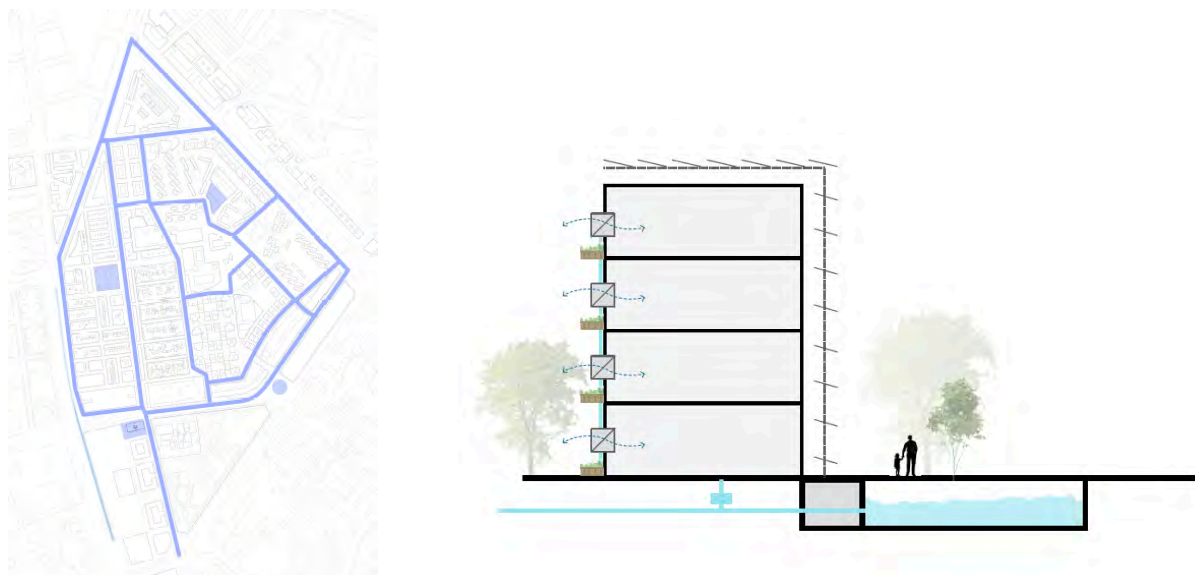
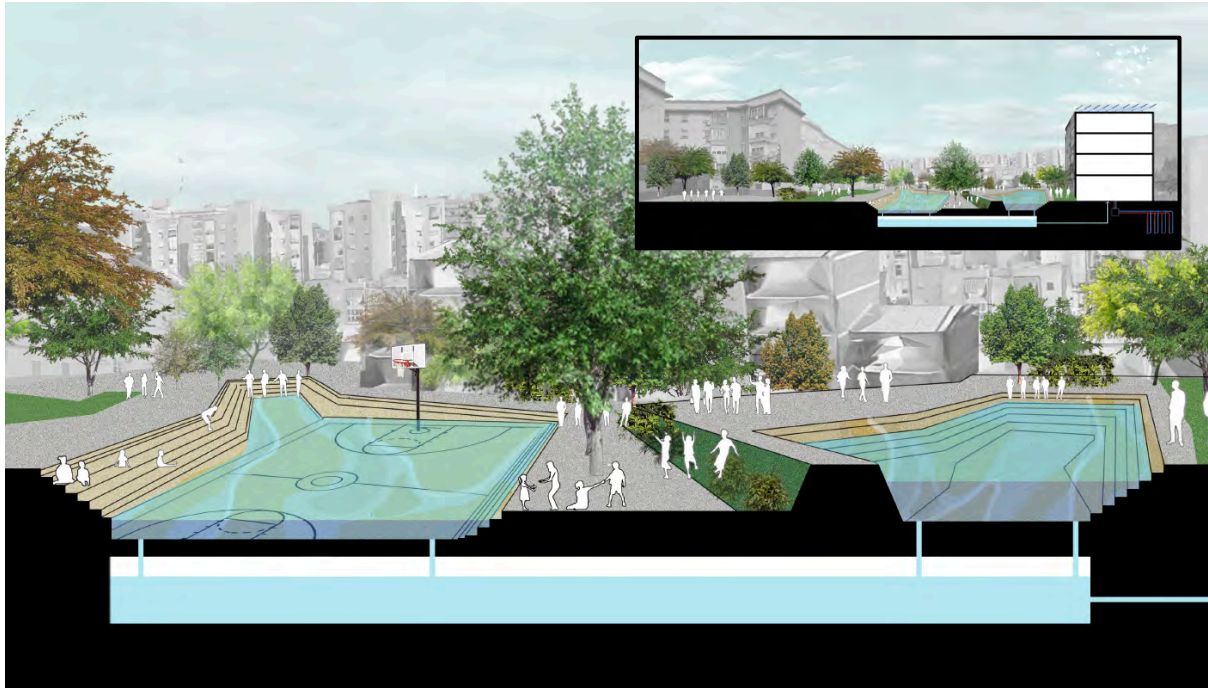

*Fig. 15. Road cisterns for storm water (left) and how collected rain water can be used for buildings and green, and condensation water for plants on buildings (right) – image by Roadshow Facilitators*

At the scale of the district of Tiro de Línea, we proposed to collect all stormwater and store it in new cisterns under larger roads (Figure 15, left). Where possible, buildings could also use basements for water storage, but we understood few of the current buildings had basements. Therefore, the street storage is used for collection, storage and usage by plants and buildings

(Figure 15, right). Since all water becomes urgent in the future, even condensation from air-conditioning units could be collected for plants.

At strategic places in Tiro de Línea we proposed water squares, where the storage of rain water would be combined with public functions, kids' playgrounds and where ventilation and UV radiation from the sun could help to purify and disinfect the open water (Figure 16).



*Fig. 16. Water squares where water from the road cisterns comes to surface, positioned at strategic public places (see inset) – image by Roadshow Facilitators*

Regarding the energy transition of Tiro de Línea we studied the possibilities for energy renovation of existing buildings. Figure 17 (left) gives the basic principles that can be applied to the buildings: passive avoidance of undesired heating up only, wrapping up in post-insulation and window replacement, covering the building with PV (that also shades the building), green coverage. Which solution is most suited depends on the technical, spatial and financial boundary conditions.

For the special condition of an east-west oriented building, a solar skin can be draped over the premise – vertical to east and west elevations, horizontal as an elevated tropical roof – producing a continuous flow of renewable energy throughout the day.

The main remaining issue when opting for maximum solar energy production is electricity storage, to be solved with attuned daytime activities, electric vehicles, heat pumps charging heat and cold storage (see later), or simply: batteries.

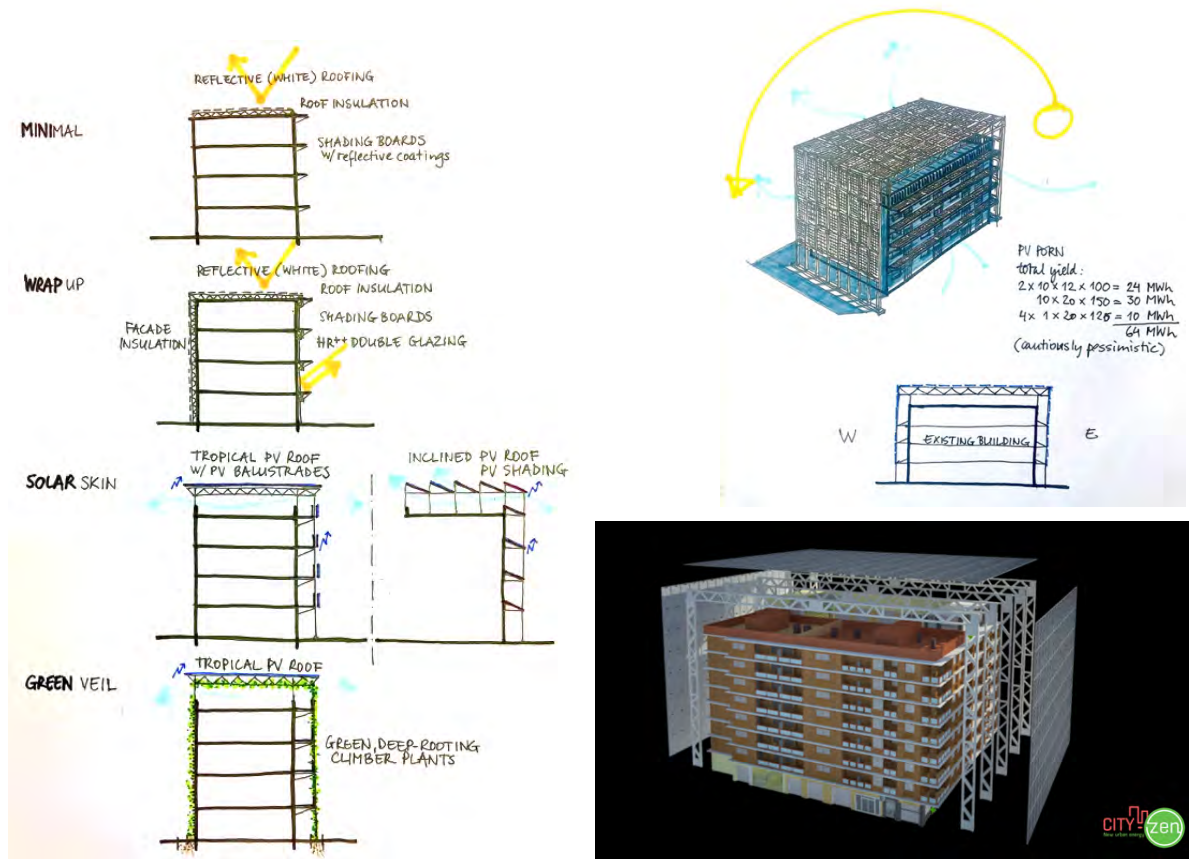

Fig. 17. Energy renovation principles (left) and ‘PV porn’: the maximisation of solar power generation by a skin over the building, from east to west (right) – sketches by Andy van den Dobbelen, exploded view by Álvaro Rodríguez García

As hot and harsh as it seems, the Sevilla climate has a very favourable mean temperature, reflected in the soil’s almost constant temperature around 18°C during the year. This condition is perfect for cooling in summer and pre-heating in wintertime, for which several techniques can be used, passive and active (Figure 18). With an aquifer at 10 m deep, all principles can be applied. The horizontal soil collector however is least suited.

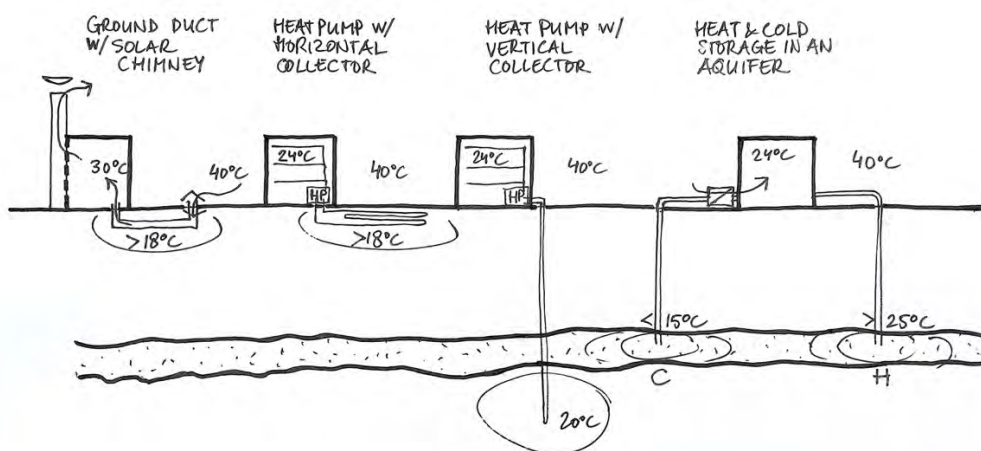

Fig.18. Solutions to make optimal use of the soil’s favourable temperature: air ducts (with solar chimneys for the full passive solution), soil collectors with heat pump (horizontal and vertical), aquifer thermal heat and cold storage – sketch by Andy van den Dobbelen

Based on these soil energy principles, each building can be served, individually, collectively (managed by an energy service company), or communally (with a heat and cold grid in the district). See Figure 19.

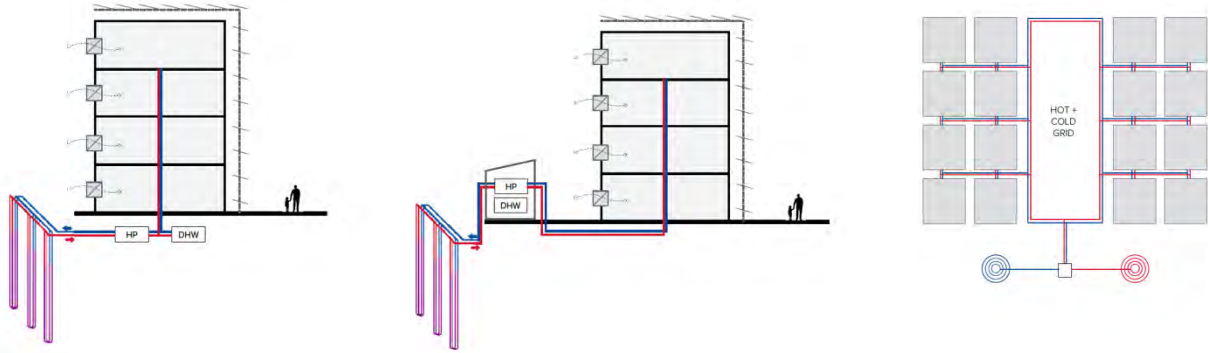

Fig. 19. Soil energy solutions applied individually, collectively and communally – image by Roadshow Facilitators

The application of vertical soil collectors is depicted in Figure 9, where a vast inner courtyard that now provides local climate solutions gets a new infill (see inset) with buildings that offer retail and that create extra shading in the neighbourhood. Furthermore, solar roofs, the road cistern and underground parking can be seen as solutions for other problems identified.

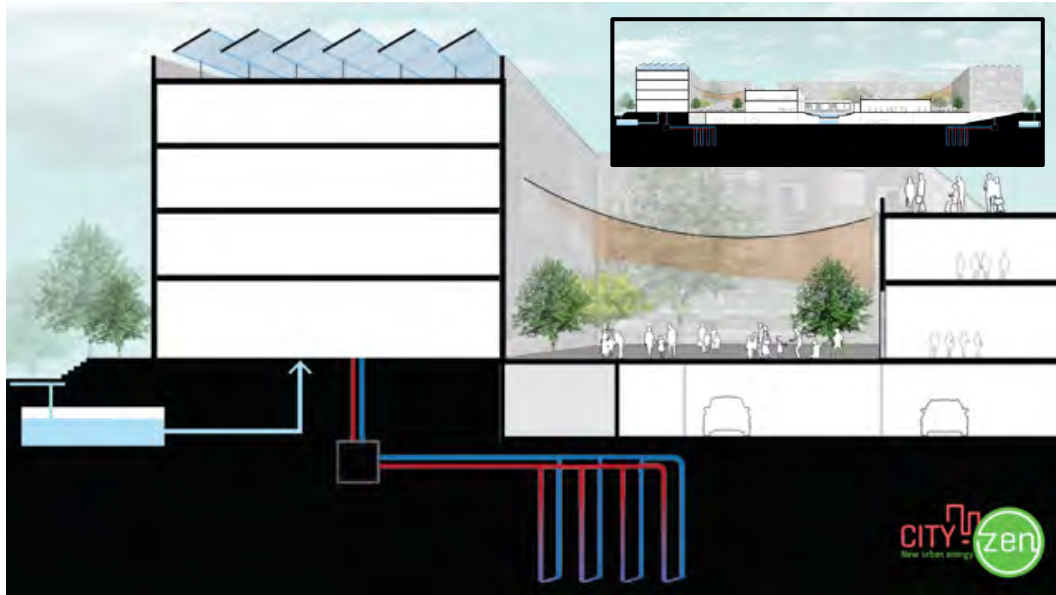

Fig. 20. Detail of 'El Corte Nuevo', an infill plan with new retail and a sustainable energy system – image by Roadshow Facilitators

Dr. Leen Peeters made a calculation of the investment needed for a PV roof, green façade and heat pumps with boreholes for geothermal heat exchange. For a housing block these investments would sum up to an investment of € 10,783. Including annual energy costs for the heat pump and maintenance, a ten-year balance would be € 18,083. If an energy cooperative would sell the solar energy, heat and cold at € 0.15/kWh, in 10 years' time, 120 MWh should be



sold. The yield is however such, that more than 20 years of energy use can be provided with it, making it a feasible solution when an energy cooperative is established.

Another example of a sustainable infill is illustrated by Figure 21, where a green shaded garden provides a better public space than the current petrified surfaces. Energy measures can also be seen in the cross-section.



*Fig. 21. Image of 'Rambla Verde', an infill plan with a green shaded garden – image by Roadshow Facilitators*

The final plan for the Tiro de Línea energy transition – including the transition in water management and green, and including an economic revival of the district – is summarised by Figure 22, depicting green connections, the water collection grid, energy hubs and energy renovation strategies.

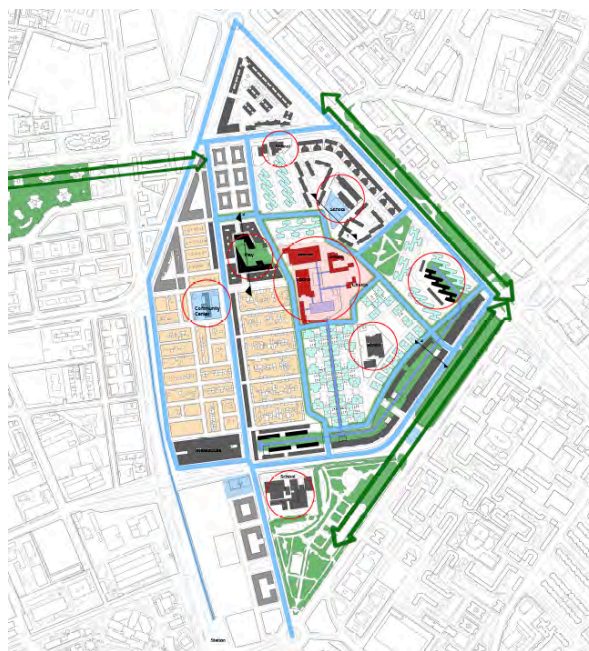

*Fig. 22. Overview of Tiro de Línea Sostenible – image by Roadshow Facilitators*

Figure 23 is a cross-section of Tiro de Línea Sostenible plan, showing vertical collectors with heat pumps, PV roofs, small wind turbines, green facades, a communal heat and cold storage with grid in the central area, and water cisterns and squares, amongst others.

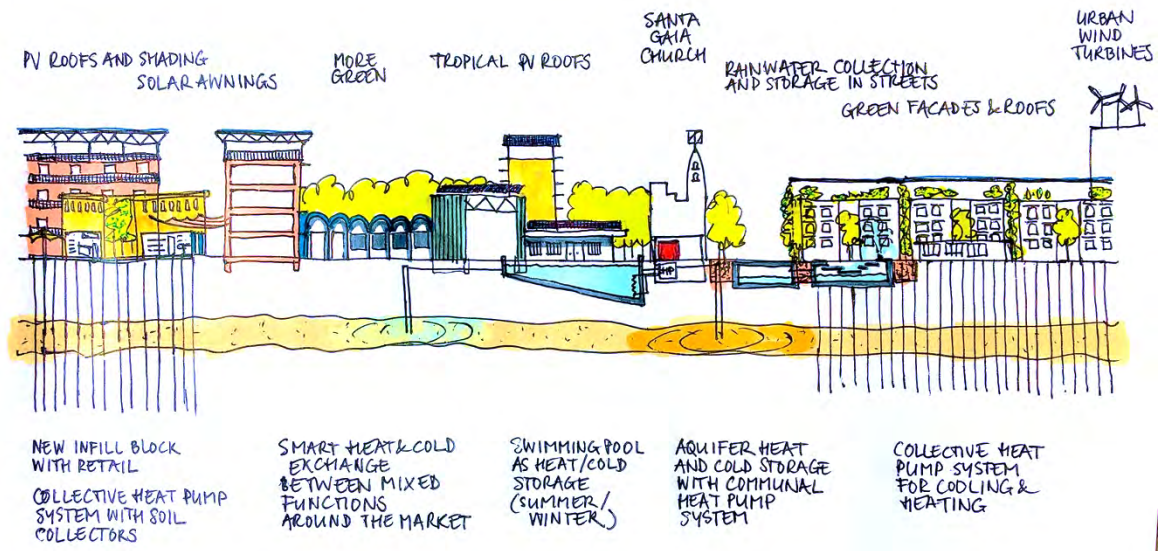

Fig. 23. Cross-section of Tiro de Línea, with all measures taken – sketch by Andy van den Dobbelsteen

#### 2.2.4 Experiences & Insights

The Roadshow week in Sevilla proved a very interesting and effective one. The structural support from Roadshow facilitators, students who had done a SWAT Studio there 8 weeks ago, the presence of an interpreter (Jesús Cardona) and support from the University of Sevilla helped to get through a creative and productive process that otherwise would have been complicated. The boundary conditions were such that within the limited time-frame of 4 days (presenting the results on day 5), the city and the selected district could be visited, studied and provided with solutions over a wide range of aspects. And not the least: it could be demonstrated that a net zero-carbon plan is possible. At the end, all people attending the final presentation acknowledged the quality and importance of the work presented and they urged to get the strategies and ideas adopted by the municipality of Sevilla. Therefore, it was disappointing that no-one of the City proper could attend the presentation, due to another event we could have not foreseen. Nonetheless, we expect a follow-up action may be taken by invitation of the City, or as part of the City-zen Roadshow’s revisit programme.

## 2.3 'PERIPATETIC PATHWAYS' PEOPLE & TECHNOLOGY (MINI-MASTERCLASS 1 DAY 3 – AFTERNOON)

by Dr. Han Vandevyvere, VITO, Belgium & Prof.Dr. Craig L. Martin

*'Peripatetic' definition - comes from the Greek word peripatētikos (from peripatein, meaning "to walk up and down"). It is associated with sharing knowledge whilst Aristotle walked with his guests. The covered walk in the Lyceum where Aristotle taught was known as the "peripatos" (which can either refer to the act of walking or a place for walking).*

### 2.3.1 Background

The 'Peripatetic Pathways' component and associated masterclass are intended at involving local stakeholders in a deep-diving reflection on both technological and non-technological aspects of the transition to a 100% renewable (energy) system. The methodological background of this exercise is rooted in transition theory, however with a strong eye on the opportunities and challenges that come with technological development.

The initial concept of the masterclass was an open seminar. This format has been used in Belfast, Izmir and Dubrovnik. It was however felt that the format could be made more interactive and effective, both in terms of involving local stakeholders and investigating the project area. Therefore, a walking tour through the project area and its thematically relevant surroundings was added at the previous Roadshow in Menorca and continued in Sevilla. For reasons of accessibility to local stakeholders, the languages of the tour were Spanish with English as a backup, while the presentation was translated in Spanish.



*Fig. 24. Concept of walk combined with discussion moments supported by presentation materials. Architect Jesús Cardona Pons collaborated once more in the tour, but translation to Spanish was not required this time as all participants could communicate in English. Nevertheless, and similar to the Menorca tour, his expertise in the field and his familiarity with the Spanish context were of great value for the discussions.*

### 2.3.2 Experiences & outcomes

The walking tour followed a limited parcours, see Fig. 15, as the same participants had already performed an introductory walk through the study area on Monday (see Fig. 1 as well). The public (8 participants) consisted of staff from the University of Sevilla, Jesús Cardona and City-zen Roadshow experts. People from the local authority could not participate due to a conference for local authorities that took place during the same week, and which was hosted by

the city of Sevilla. The interactive walk was guided in tandem by Han Vandevyvere and Jesús Cardona.

The tour focused on 4 aspects of sustainable urban development with a view on carbon neutrality:

1. urban mobility and the dominance of the car in all areas of urban life;
2. possible improvements in green infrastructures and water management;
3. building retrofit versus renewable energy input: balancing the efforts;
4. renewable energy versus the actual policies of the Spanish government and the role of big energy utilities.

These focal points were selected on the basis of analyses from the SWAT studio and the first days of the Roadshow. Discussions focused on how to achieve radical rather than incremental change, while assuring that actions remain affordable from a financial point of view.



Fig. 15. Itinerary of the introductory tour and walking tour for Sevilla.

(1) Regarding mobility it was discussed how the system could be swapped from car based to truly sustainable. As of an example the Avenida de la Palmera was considered, see schemes in Figure 26. Such system could work with an extensive network of urban tram lines and feeder parkings at the borders of the city, as far as local train connections with the hinterland do not provide for sufficient access. In this way a major factor of car pressure on the city centre could be taken away.

Although Sevilla has become famous for its introduction of biking infrastructure, it becomes obvious that the potential for further modal switching is enormous. The fact that the city has a flat topology and a backbone system of very wide urban avenues allows for much of that potential. Biking lanes could be at least doubled or tripled in size, not only for increasing capacity but also for allowing people to ride side by side and have conversations, something that is virtually impossible in the current layout with narrow lanes.



Fig. 26. Swapping the mobility system towards sustainable modes, example for Avenida de la Palmera. Above: proposed scheme, under: actual situation.

(2) Urban surfaces in Sevilla are remarkably desert-like, and water retention and infiltration occurs only to a very limited degree (see Figure 27 for an example). Hence the potential for greening up the city and for additional water buffering (flash floods are famous for the region) is, once again, enormous. Examples of good practices from throughout Europe were presented and discussed.

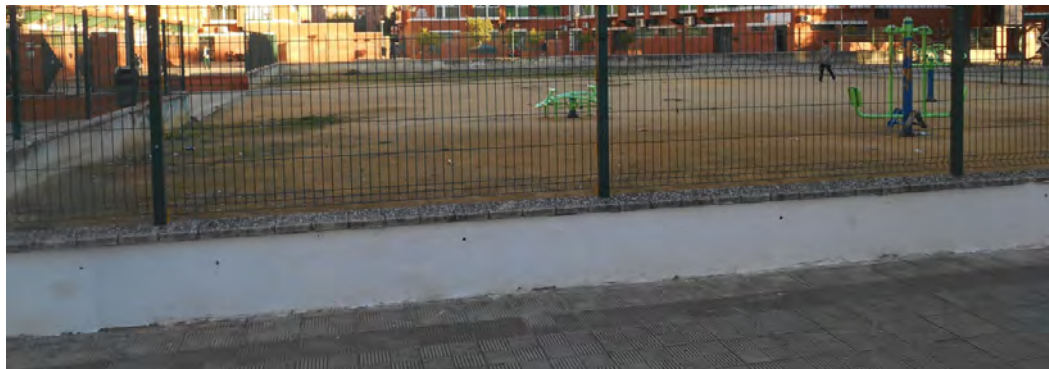

Fig. 27. Lack of green in urban space, impoverishing its social quality and adding up to the urban heat island.

A particular point of attention were the public-private transition spaces, which are often poorly designed but are of major importance for the quality of urban space (see Figure 28). This holds even more for Mediterranean contexts where much of the public life happens outside because of favourable climatic conditions.



*Fig. 28. Poor versus rich urban transition spaces. The latter are very important for achieving a sustainable living style, particularly in Mediterranean cities as the climate stimulates much outdoor activity.*

(3) A limited heating demand as well as a fairly controllable cooling demand in buildings (2-3 hot months per year) make a perfect case for passive design measures and feasible urban retrofit options towards zero carbon functioning. Urban greening would help to (drastically) reduce the urban heat island effect, as much of the actual urban surface in Sevilla is excessively petrified and so the potential for improvement substantial. Building retrofit can be kept relatively simple and cheap when financing for deep retrofit (the preferred option) is not available, on the condition that there is a holistic urban strategy for managing the local climate conditions (e.g. reduction of the urban heat island).

(4) As for Menorca, it became evident that reaching carbon neutrality or 100% renewable energy provision is a less daunting task in Sevilla than in many other parts of Europe, mainly due to the ample availability of sunlight and space for developing RE infrastructures. However, actual Spanish energy policies are not very favourable for the development of decentralized and citizen-based renewable energy production. It can only be hoped that the few energy cooperatives active in Spain can nevertheless set the tone for an energy transition in the real sense of the term, and force a breakthrough in the relative system status quo as it exists today.

### *2.3.3 Insights & future development of the workshop*

Achieving a wide attendance to the tour was hampered by the local authority being fully occupied with hosting another event during the Roadshow week. These are factors that are beyond control of the Roadshow organization. We are indeed dependent on both the agenda and the priorities of local stakeholders, and can only offer opportunities within the best available time and context settings.

Actual discussions during the tour were of high quality as all participants were motivated experts. Our main challenge thus remains wider access to the local community, beyond the interest of these domain experts.

## 2.4 ‘PACMAN, CARBON CRUNCHING’ – CARBON ACCOUNTING EXPLAINED (MINI-MASTERCLASS 2, DAY 4 – AFTERNOON)

*Carbon accounting and carbon mitigation strategy of the City-Zen Roadshow in Sevilla*

*Leader: Dr. Riccardo M. Pulselli, University of Siena, Italy*

### 2.4.1 Carbon Accounting of the Barrio Tiro De Línea

The procedure of greenhouse gas inventory performed during the City-Zen Roadshow has been based on a simplified assessment as a mediate model to address choices. Even though the carbon accounting has been performed in two working days and presents some assumption and approximation (it would require a more detailed inventory and careful review), results are credible and realistic. The assessment has been performed on different reference scales, from the provincial level to the single household (until the individual citizen) taking into account four main sectors of activities: housing, mobility, waste management and water management. The carbon accounting process was performed as in a sequence of steps in order to provide a comprehensive assessment of the state of the art.

Selection/assessment of Emission Factors: most of the Emission Factors (EF: kg CO<sub>2</sub>-eq/unit) used in the assessment are taken from the 2006 IPCC guidelines, except for electricity. Considering the crucial role of electricity use in energy policies, the specific EF was assessed as a first step for the Andalusian region, based on the regional electricity grid mix i.e. 22.9% natural gas, 41.8% coal, 1.5% combustive oil and others, 30.8% renewables (total electricity production: 83 TWh/yr). The emission factor for electricity in Andalucía assessed and used during the roadshow is 0.534 kg CO<sub>2</sub>-eq/kWh.

Greenhouse gas inventory of the Province of Sevilla: most of data was available at the provincial level, mainly referring to the *Agencia Andaluza de la Energía*. Figure 29 shows a graphic-table with main statistical data and the value of Carbon Emission in kg CO<sub>2</sub>-eq per sector of activity. Figure 30 shows the Carbon Footprint for the Province of Sevilla given in t CO<sub>2</sub>-eq and hectares of forestland grabbing, the latter being the equivalent surface of forest that would be needed to absorb all of the carbon emissions. The available forestland in the province actually compensates almost the 70% of the total emission by carbon uptake.

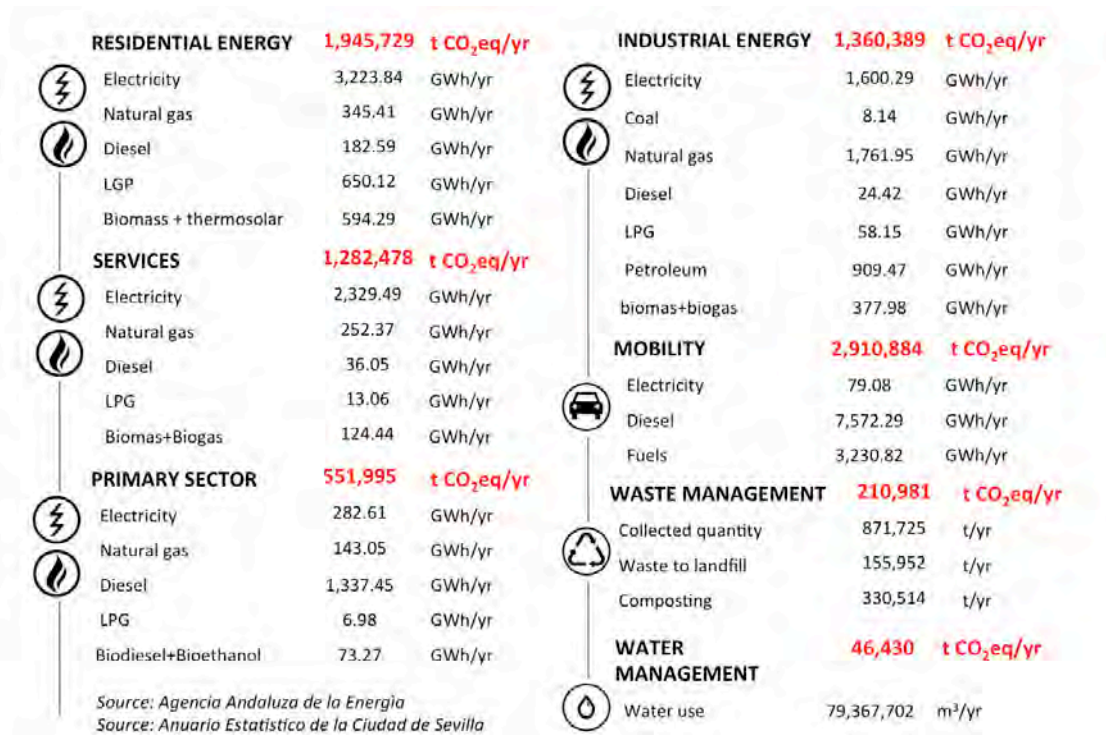

Fig. 29. Graphic-table with raw-data and carbon accounting for the Province of Sevilla.

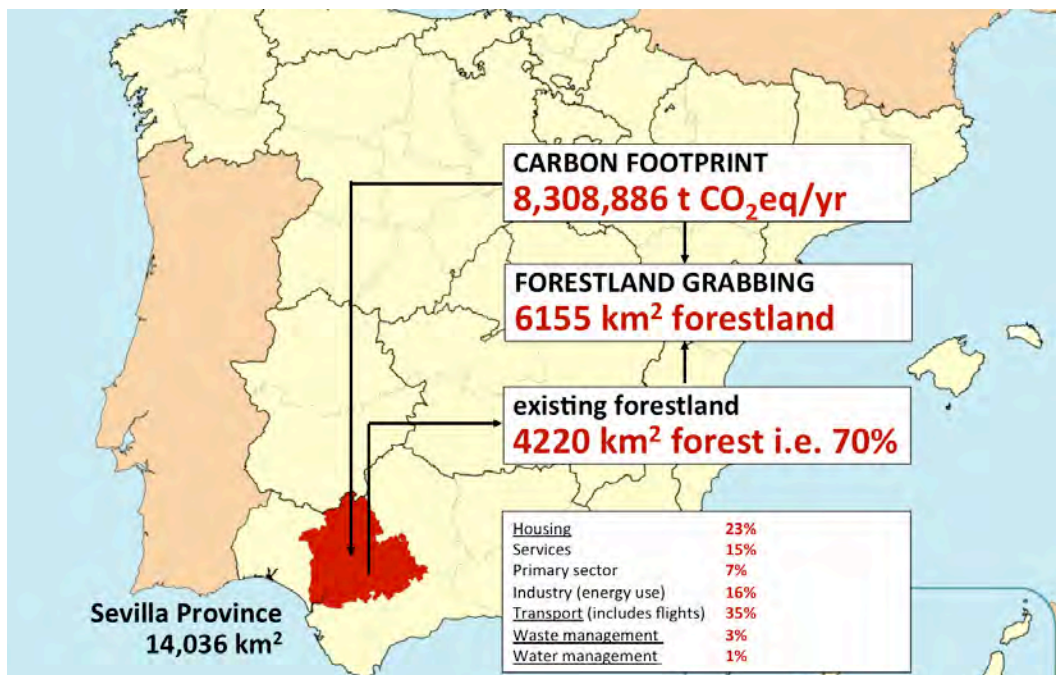

Fig. 30. Outcomes from the greenhouse gas inventory of the Province of Sevilla including emissions in tonne of CO<sub>2</sub>-eq/yr, forestland grabbing and available forestland (70% carbon footprint offset).

Household profile in the Barrio Tiro de Linea (District Sur): in order to assess the carbon footprint of the Tiro de Linea neighbourhood, different approaches were followed: data on energy use in the residential sectors were scaled down from the provincial level based on population and



number of families/households (on average 2.6 inhabitants per family/household in Sevilla District Sur; Ref. *Anuario Estadístico de la Ciudad de Sevilla*). The final outcome was anyhow compared to a set of publications with existing data on building energy demand in Sevilla in order to validate the estimate. Data on mobility was estimated based on the average commuting distance in the neighbourhood and private cars use (1.06 car/family in District Sur) based on a survey by the University of Sevilla. Data on waste was estimated starting from the waste production per capita (449 kg/yr per cap in the province) and the current waste management system (the differentiated rates look good). Water management is estimated based on water use per capita (112 L/day per cap).

The carbon accounting shows 5.25 t CO<sub>2</sub>-eq/yr per household, including energy, mobility, waste and water management, which is below the European average of 5.60 t CO<sub>2</sub>-eq/yr. This is mainly due to a very low energy demand for heating despite the high electricity demand for cooling in summer and the use of private cars for commuting. Figure 3 shows main data and carbon footprint per sector per single household in Sevilla District Sur. The impact of a single household can be potentially compensated by the carbon uptake of 0.39 ha forestland. This corresponds to the size of a football field.

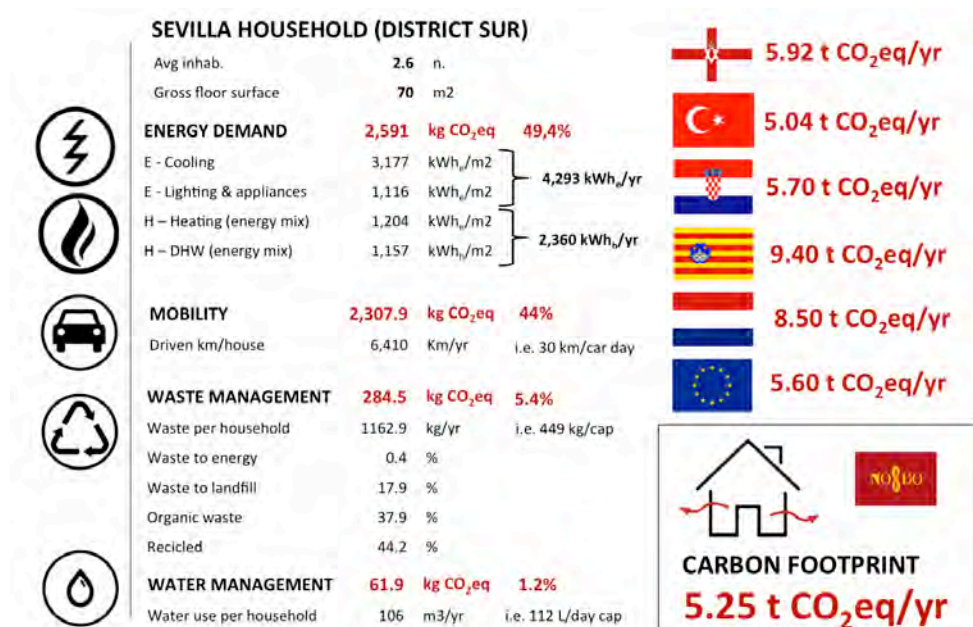

Fig. 31. Carbon Footprint per household in Sevilla District SUR.

Starting from the Carbon Footprint of one single household, assumed as average for the Barrio *Tiro de Línea*, the greenhouse gas emission was estimated for the 5364 households in the neighbourhood. Given due assumptions and approximations, the Carbon Footprint of the neighbourhood is about 20,000 t CO<sub>2</sub>-eq/yr, which corresponds with an equivalent forestland of more than 2000 hectares. Figure 32 shows the forestland grabbing in a map compared to the size of the neighbourhood (same reference scale). Colours in the map show the contribution of different sectors.

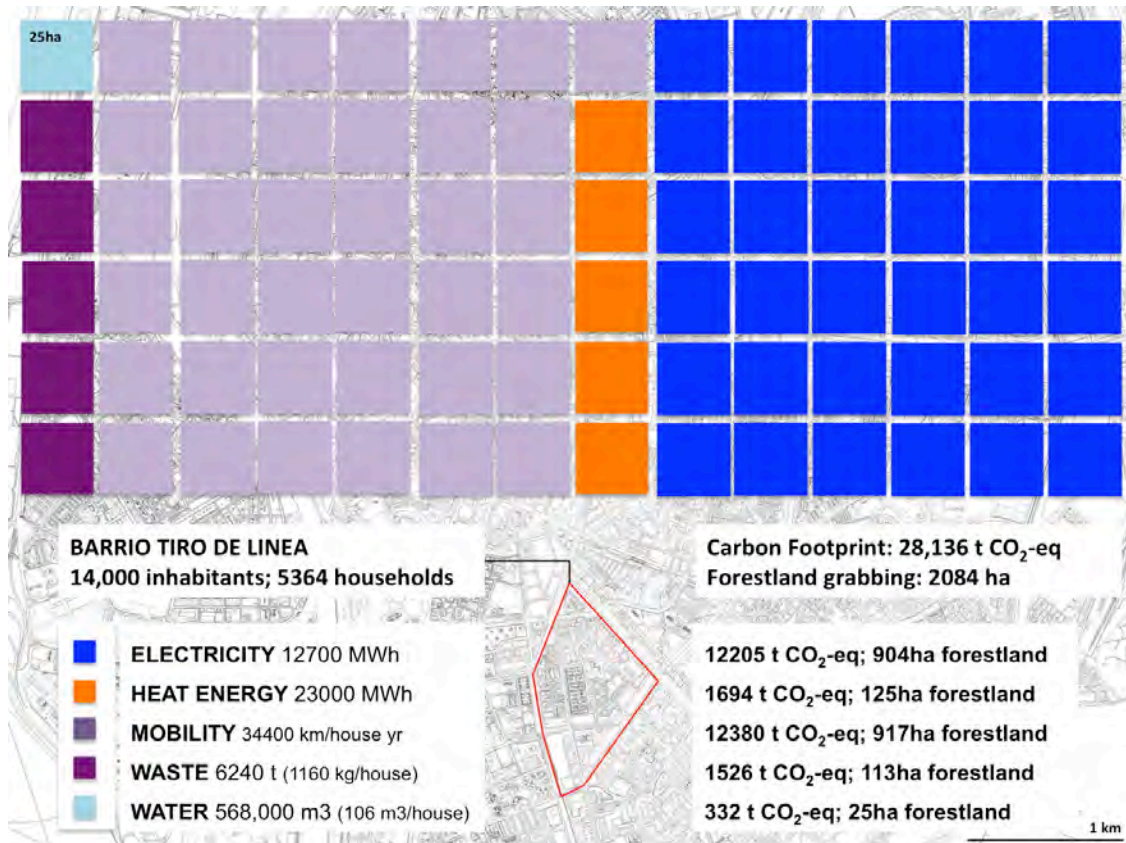

Fig. 32. Representation in terms of equivalent forestland grabbing of the Carbon Footprint of the Barrio Tiro de Línea.

The assessments and representations above were presented and discussed with local facilitators, researchers and stakeholders during the mini-masterclass of Wednesday the 22<sup>nd</sup>, as the state of the art, the starting-point for the city-zen roadshow and the challenge to be faced. The assessment concerned impacts at different scales, from that of the Province (given the availability of statistical data) to those of the single household and the neighbourhood.

During the class, an exercise was also conducted by assessing the specific footprint of some volunteers in the audience. The experiment demonstrated that small behavioural changes in everyday life by individual citizens can provide relevant effects in terms of carbon footprint mitigation. The replacement of the old lamps in the house with led lamps, efficient cooling and heating systems, the use of bikes and public transport instead of private cars, as well as the differentiated collection of waste, are among actions to start the transition process to zero-carbon communities.

### 3.4.2 Carbon mitigation effect of a set of measures to be implemented in the Barrio Tiro de Línea

The carbon accounting method developed during roadshows works as a mediate model that offers the opportunity to quickly figure out an integrated vision of the city of the future combining technologies with other measures at the scales of the neighbourhood, households and individual citizens. Here, the main objective is to provide a visual representation of the impact of the neighbourhood in terms of equivalent forestland and see how the designed measures can contribute to decrease the Carbon Footprint towards a zero-carbon community.

Figure 33 shows the effect of a possible sequence of 14 measures selected among the designed solutions:

- Passive systems: greening, shading, low emission paint (20% houses hypothesized). Expected effect: -50% cooling energy (-1700 MWh).
- Thermal insulation: roof/facade retrofitting (30% houses). Expected effect: -50% cooling energy (-2500 MWh); -75% heating energy (-1450 MWh).
- Behavioural changes: LED lights, air conditioning (80% houses). Expected effect: -50% electric lighting (-2400 MWh).
- Heat pump (household scale): (30% houses). Expected effect: -75% heating (-1500 MWh); -75% DHW (-1400 MWh); +20% electricity (+360 MWh).
- Heat pump (neighbourhood scale): (60% houses). Expected effect: -75% heating (-3000 MWh); -75% DHW (-2800 MWh); +20% electricity (+720 MWh).
- PV panels (building block scale): (30% houses). Expected effect: -100% electricity (-7000 MWh).
- Electric bike sharing: (-15% private car use). Effect: -100% fuel; +20% electricity for appliances.
- Bike to school/work: (-30% private car use). Effect: -100% fuel.
- Electric car recharger station: (10% electric cars). Effect: -100% fuel; +40% electricity for appliances.
- PV panels sharing (neighbourhood scale): (40% houses). Effect: -100% electricity (-10000 MWh).
- Tram line (district Sur scale): (-40% private car use). Effect: -100% fuels.
- Differentiated waste: (100% house). Effect: -70% waste-to-landfill.
- Differentiated waste (avoided landfill): (100% house). Effect: -100% waste-to-landfill.
- Existing parks, New green assets, Renewable Energy surplus (neighbourhood scale).

The Carbon Accounting mediate model, developed to be easily and quickly implemented, provides a reliable ex-ante evaluation of measures that can be designed and implemented at the scale of the neighbourhood, buildings or single households as well as individual citizens. It provides quantitative information and visual representations, to support design and raise awareness.

For increasing attractiveness, the graphic representation simulates the 1980s' Pacman game, but in this case Carbon Pacman eats squares of forestland (25 hectares each) due to energy saving, renewable energy production or other emissions avoided. As far as additional energy inputs are required, the ghost appears to add new squares, for example when the use of heat pumps support the heating demand through renewable energy by using electricity (Carbon Pacman eats orange squares but new blue squares appear) or in case of a transition to electric mobility (Carbon Pacman eats purple squares but new blue squares appear). A consistent electricity generation from renewable sources can contribute to support the electricity demand and let Carbon Pacman move forwards.

The carbon mitigation accounting and its representation through the Carbon Pacman game have been developed as a communication tool to allow the audience understand that, based on a collective and participative process, zero-carbon cities are an achievable goal in the medium term.

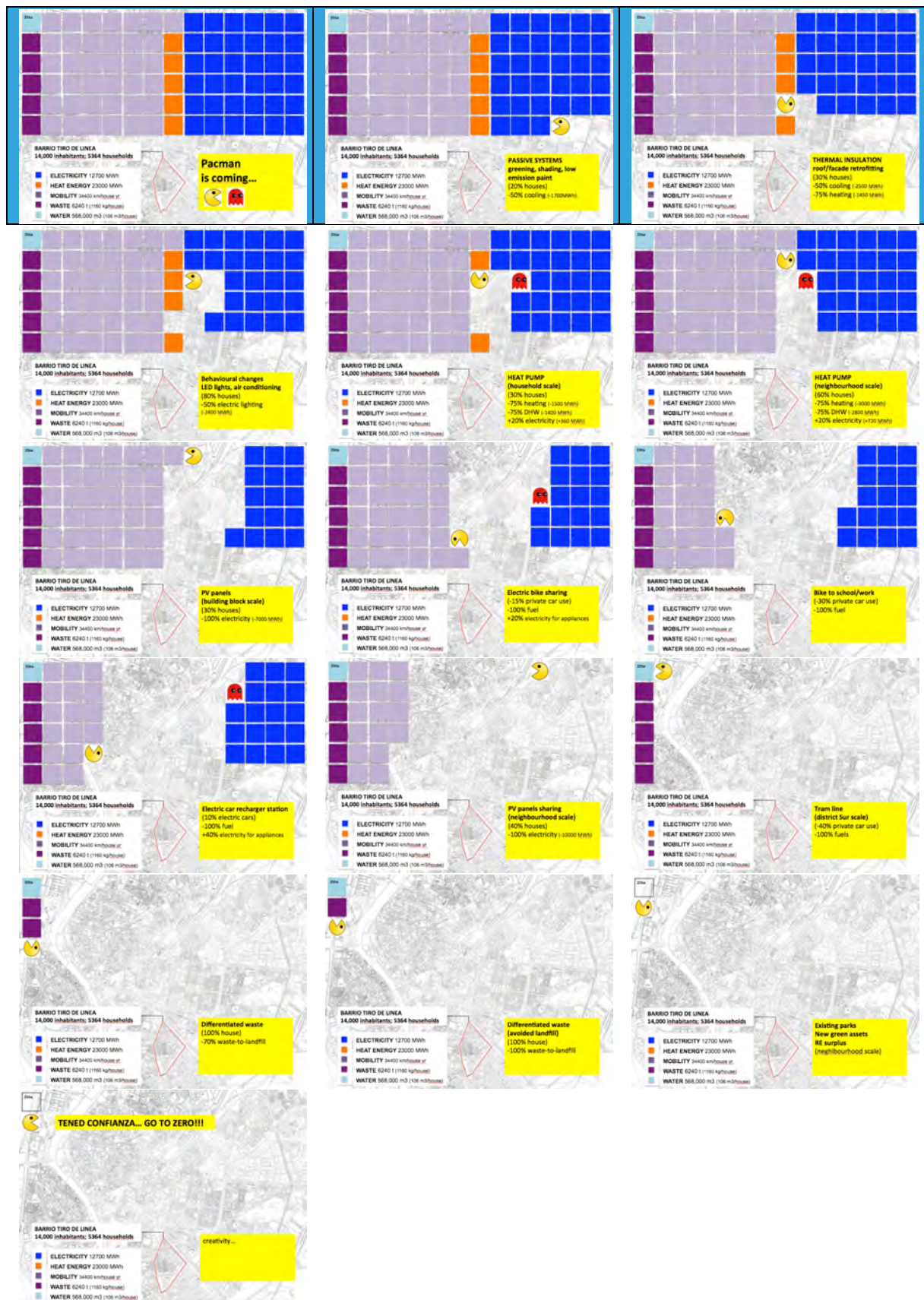

Fig.33. Sequence of Carbon Footprint mitigation measures through the Carbon Pacman game.

### 3 SUSTAINABLE CITY VISION

#### 3.4 FINAL DAY (THE ESCUELA TECNICA SUPERIOR DE INGENIERÍA DE EDIFICACIÓN UNIVERSIDAD DE SEVILLA).

The final day of the Sevilla Roadshow took place in the Escuela Tecnica Superior de Ingeniería de Edificación at the Universidad de Sevilla on the 24<sup>th</sup> of November 2017. The final ‘Sustainable City Vision’ was presented to an audience comprising the city’s Municipality leader’s, members of the Universidad de Sevilla, professionals, students and citizens. Universidad de Sevilla Leaders together with Faculty Professor Madelyn Marrero Melendez began the Roadshow proceedings and introduced the Roadshow team to the audience.



*Fig. 34. The final presentation (Day 5) of the City-zen ‘Sevilla’ Roadshow. The culmination of the 5-day Roadshow was hosted by the Universidad de Sevilla.*



*Fig. 35. The Co-creative 'Hard-core' Sevilla Roadshow Team.*

The final day of the Sevilla Roadshow took the form of five integrated presentations. The first briefly outlined the overall objectives, ambitions, format and activities completed during the week. The second and third components composed the major body of the 'City Vision', these being the 'Energy' workshop presentation, a complementary quantitative approach focused on energy strategies, scenarios and carbon offsetting measures at overlapping scales. The 'Future Neighbourhoods' workshop, more qualitative in nature, including urban planning intervention proposals at the façade, building and neighbourhood and city scale, together with spatial, social and guidelines. These elements would be brought together by urban observations instigated by the walking event and in-depth Carbon investigations that graphically demonstrated how the city would reach zero-carbon by implementing the variously scaled interventions outlined earlier in the presentation.

The project recently became an example of European Commission 'Best Practice'. The Roadshow continues to build upon previous experiences and looks forward to future visits to Roeselare (Belgium), Preston (United Kingdom), Nicosia (Cyprus) and Amersfoort (the Netherlands). The EC has granted an extension to the project with 2 additional Roadshow cities, making 10 in total by 2019. Further additions to the budget now allows Building Technology students from TU Delft to be invited to the Roadshow as 'Workshop Facilitators'. A move giving our young professionals a unique opportunity to experience live city design challenges and to develop the skills necessary to respond to them.

The key to success has been to identify, reach and gain the trust of city inhabitants and 'decision makers'. To achieve this, an exchange of knowledge, experience and commitment continues to be crucial. The Roadshow will continue to develop and implement innovative methods that increase city engagement, awareness and understanding of the solutions needed to counter climate change, become carbon neutral and make cities happier and healthier places to live.

### 3.5 THE PRESENTATION

The 'City Vision' presentation (Roadshow findings) presented at the Escuela Técnica Superior de Ingeniería de Edificación at the Universidad de Sevilla on the 24<sup>th</sup> November 2017 is visible hereafter.



# CITY-ZEN ROADSHOW 'SEVILLA'

20th – 24th  
NOV  
2017



Gerencia de Urbanismo



UACC  
INSTITUTO UNIVERSITARIO  
ARQUITECTURA Y CONSERVACIÓN DE LA CIUDAD HISTÓRICA



Agencia Andaluza de la Energía  
CONSEJERÍA DE EMPLEO, EMPRESA Y COMERCIO



NO8DO  
AYUNTAMIENTO DE SEVILLA



Escuela Técnica Superior de  
Ingeniería de Edificación



## TECNOLOGÍAS FUTURAS

DAY 1  
(MON)

**THE LCA OF A CONSTRUCTION PRODUCT**

**Product**

- Raw material supply
- Transportation
- Manufacturing

**Construction**

- Distribution
- Transportation
- Construction (on-site and temporary)
- Installation

**Use**

- Use of products installed
- Maintenance
- Repair, replacement, refurbishment
- Building's operational use

**OERC02**

Logos for Gerencia de Urbanismo and NO8DO Ayuntamiento de Sevilla.

**Future technologies**

Sustainable technologies and projects in Seville.

**SUSTAINABLE CONSTRUCTION in Andalusia**

Logo for Junta de Andalucía and Agencia Andaluza de la Energía.

**HUELLA DE CARBONO DE MENORCA**

ENERGÍA: 28.640 ha

AGUA: 470 ha

RESIDUOS: 3.800 ha

MOVELIDAR: 18.530 ha

MENORCA: 92.348 habitantes, 111.230 hab. → turistas, 66.400 m<sup>2</sup>

**HUELLA DE CARBONO**

Logo for IME Institut Menorquí d'Estudis.



# TECNOLOGÍAS FUTURAS

DAY 1  
(MON)



# PARALLEL TALLERS

DAYS  
2 - 4





## PARALLEL TALLERS



DAYS  
2 - 4



## PARALLEL TALLERS



DAYS  
2 - 4



## JUEGO SERIO 'Go2Zero'



DAY 3  
(WED)



## JUEGO SERIO 'Go2Zero'



DAY 3  
(WED)



## SEVILLA: UNA CIUDAD DE BAJAS EMISIONES!

	HOUSEHOLD ENERGY USE						
	lighting	appliances	cooling	heating	cooking	TOT	CO <sub>2</sub>
AVG EU	kWh/yr	kWh/yr	kWh/yr	kWh/yr	kWh/yr	kWh/yr	kWh/yr
Madelyn	670	3.177		335	112	4.293	2.264
Jorge	0,5	0,8					
Covadonga	0,4	0,0				2.875	
Patricia	0,4	0,1				566	
Juan	0,4	0,0				258	
Juan	0,5	0,1				633	
Alejandra	0,0	0,2				635	
Pablo	0,3						
Regina	0,7						
John	1,0						

DAY 3  
(WED)



## WALKING TOUR



DAY 3  
(WED)



## WALKING TOUR



DAY 3  
(WED)



## PARALLEL TALLERS

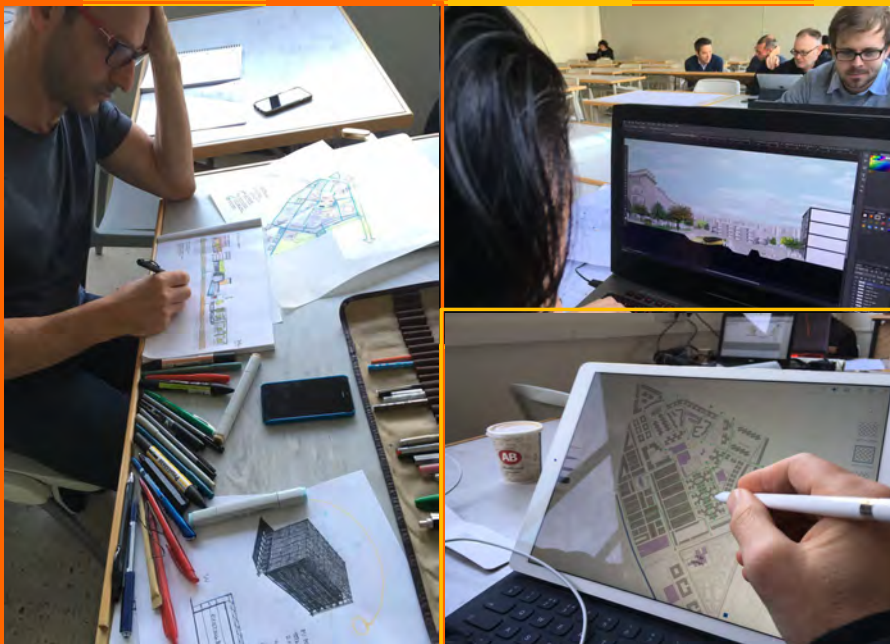

DAY 4  
(THUR)



# VISIÓN SEVILLA SOSTENIBLE

DAY 5  
(FRI)

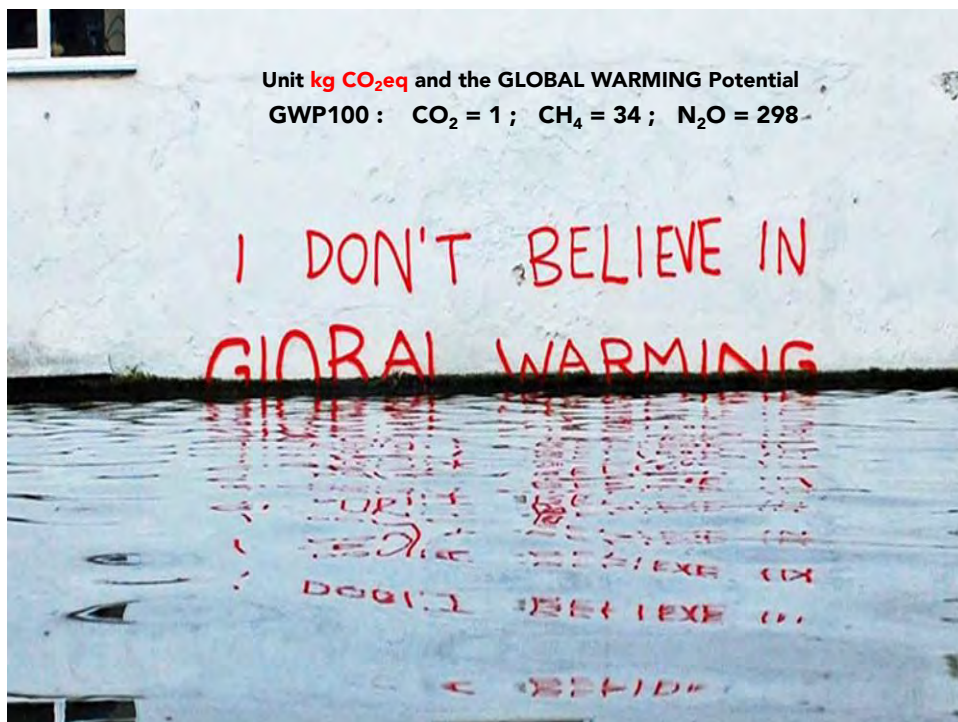

## CARBON ACCOUNTING

ELECTRICITY EMISSION FACTOR



### ANDALUCIA (2015)

Electricity production **83.0 TWh**



**THERMO-ELECTRICITY 54.98 TWh (66.2%)**

Natural gas **19.0 TWh (22.9%)**

Coal **34.70 TWh (41.8%)**

Oil and others **1.28 TWh (1.5%)**



**RENEWABLE 27.98 TWh (30.8%)**

Solar thermal **13.70 TWh (16.5%)**

Solar PV **1.60 TWh (1.9%)**

Hydro **0.59 TWh (0.6%)**

Wind **6.39 TWh (6.2%)**

Biomass **5.70 TWh (5.6%)**

Geothermal –

Biofuel & Waste –

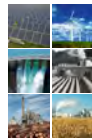

**ELECTRICITY EMISSION FACTOR  
(LCA based)**

**0.534 kg CO<sub>2</sub>eq/kWh**

Source: Agencia Andaluza de la Energia

## CARBON ACCOUNTING

CARBON FOOTPRINT ASSESSMENT OF THE PROVINCE OF SEVILLA



### RESIDENTIAL ENERGY **1,945,729 t CO<sub>2</sub>eq/yr**

Electricity	3,223.84	GWh/yr
Natural gas	345.41	GWh/yr
Diesel	182.59	GWh/yr
LPG	650.12	GWh/yr
Biomass + thermosolar	594.29	GWh/yr

### SERVICES **1,282,478 t CO<sub>2</sub>eq/yr**

Electricity	2,329.49	GWh/yr
Natural gas	252.37	GWh/yr
Diesel	36.05	GWh/yr
LPG	13.06	GWh/yr
Biomass+Biogas	124.44	GWh/yr

### PRIMARY SECTOR **551,995 t CO<sub>2</sub>eq/yr**

Electricity	282.61	GWh/yr
Natural gas	143.05	GWh/yr
Diesel	1,337.45	GWh/yr
LPG	6.98	GWh/yr
Biodiesel+Bioethanol	73.27	GWh/yr

Source: Agencia Andaluza de la Energia  
Source: Anuario Estadístico de la Ciudad de Sevilla

### INDUSTRIAL ENERGY **1,360,389 t CO<sub>2</sub>eq/yr**

Electricity	1,600.29	GWh/yr
Coal	8.14	GWh/yr
Natural gas	1,761.95	GWh/yr
Diesel	24.42	GWh/yr
LPG	58.15	GWh/yr
Petroleum	909.47	GWh/yr
biomas+biogas	377.98	GWh/yr

### MOBILITY **2,910,884 t CO<sub>2</sub>eq/yr**

Electricity	79.08	GWh/yr
Diesel	7,572.29	GWh/yr
Fuels	3,230.82	GWh/yr

### WASTE MANAGEMENT **210,981 t CO<sub>2</sub>eq/yr**

Collected quantity	871,725	t/yr
Waste to landfill	155,952	t/yr
Composting	330,514	t/yr

### WATER MANAGEMENT **46,430 t CO<sub>2</sub>eq/yr**

Water use	79,367,702	m <sup>3</sup> /yr
-----------	------------	--------------------

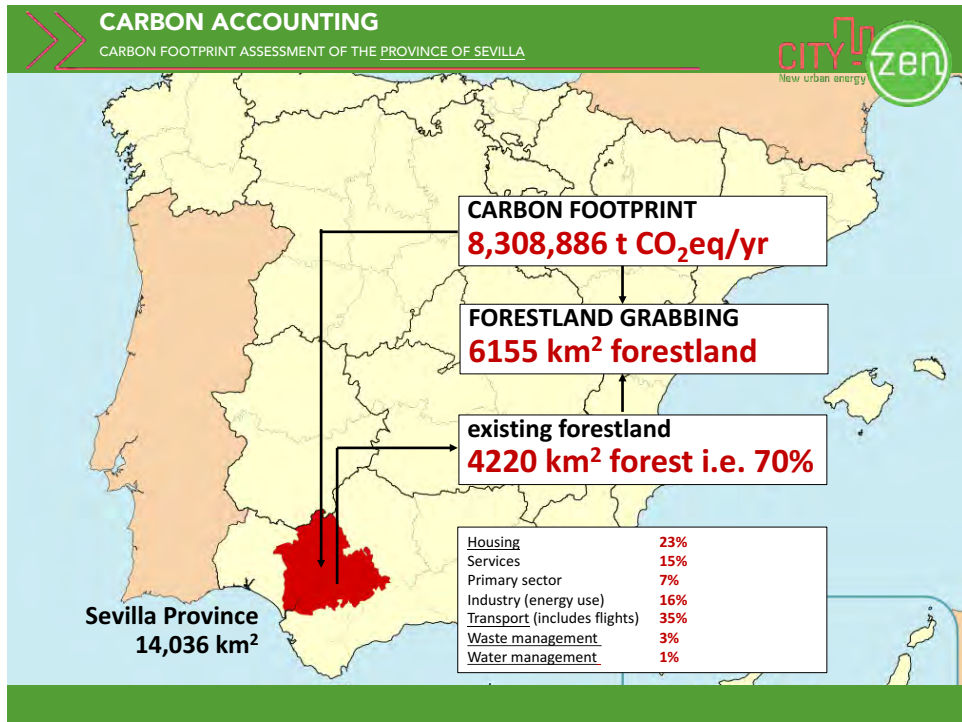

## CARBON ACCOUNTING HOUSEHOLD PROFILE

## CARBON ACCOUNTING

CARBON FOOTPRINT ASSESSMENT OF THE AVG. HOUSEHOLD IN SEVILLA (DISTRICT SUR)



### SEVILLA HOUSEHOLD (DISTRICT SUR)



Avg inhab.	2.6	n.	
Gross floor surface	70	m <sup>2</sup>	
<b>ENERGY DEMAND</b>	<b>2,591</b>	<b>kg CO<sub>2</sub>eq</b>	<b>49,4%</b>
E - Cooling	3,177	kWh <sub>e</sub> /m <sup>2</sup>	} <b>4,293 kWh<sub>e</sub>/yr</b>
E - Lighting & appliances	1,116	kWh <sub>e</sub> /m <sup>2</sup>	
H - Heating (energy mix)	1,204	kWh <sub>e</sub> /m <sup>2</sup>	} <b>2,360 kWh<sub>e</sub>/yr</b>
H - DHW (energy mix)	1,157	kWh <sub>e</sub> /m <sup>2</sup>	
<b>MOBILITY</b>	<b>2,307.9</b>	<b>kg CO<sub>2</sub>eq</b>	<b>44%</b>
Driven km/house	6,410	Km/yr	i.e. 30 km/car day
<b>WASTE MANAGEMENT</b>	<b>284.5</b>	<b>kg CO<sub>2</sub>eq</b>	<b>5,4%</b>
Waste per household	1162.9	kg/yr	i.e. 449 kg/cap
Waste to energy	0.4	%	
Waste to landfill	17.9	%	
Organic waste	37.9	%	
Recycled	44.2	%	
<b>WATER MANAGEMENT</b>	<b>61.9</b>	<b>kg CO<sub>2</sub>eq</b>	<b>1,2%</b>
Water use per household	106	m <sup>3</sup> /yr	i.e. 112 L/day cap



5.92 t CO<sub>2</sub>eq/yr



5.04 t CO<sub>2</sub>eq/yr



5.70 t CO<sub>2</sub>eq/yr



9.40 t CO<sub>2</sub>eq/yr



8.50 t CO<sub>2</sub>eq/yr



5.60 t CO<sub>2</sub>eq/yr

**CARBON FOOTPRINT**  
**5.25 t CO<sub>2</sub>eq/yr**

## CARBON ACCOUNTING

CARBON FOOTPRINT ASSESSMENT OF THE AVG. HOUSEHOLD IN SEVILLA (DISTRICT SUR)



## CARBON FOOTPRINT OFFSET

carbon uptake by urban forestry (i.e. 1.35 kg CO<sub>2</sub>/m<sup>2</sup>)

### SEVILLA HOUSEHOLD

Ref: 2014-2015

People: 2.6 inhab./house

Avg surface: 70 m<sup>2</sup>/house

Electricity: 4293 kWh/yr

Heat: 1204 kWh/yr

(mix: 19% CH<sub>4</sub>, 10% diesel, 37% LPG, 34% RES)

Mobility: 30 km/day x 1.06 car/house

Waste: 1.16 t/house yr

Water: 106 m<sup>3</sup>/house yr



The carbon footprint offset of one household is equivalent to 0.39 ha forestland

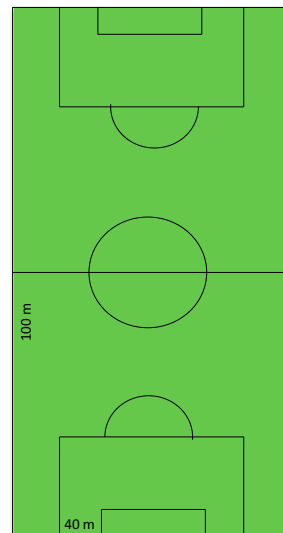

Source: Agencia Andaluza de la Energia; Anuario Estadístico de la Ciudad de Sevilla 2017



CARBON ACCOUNTING  
NEIGHBOURHOOD

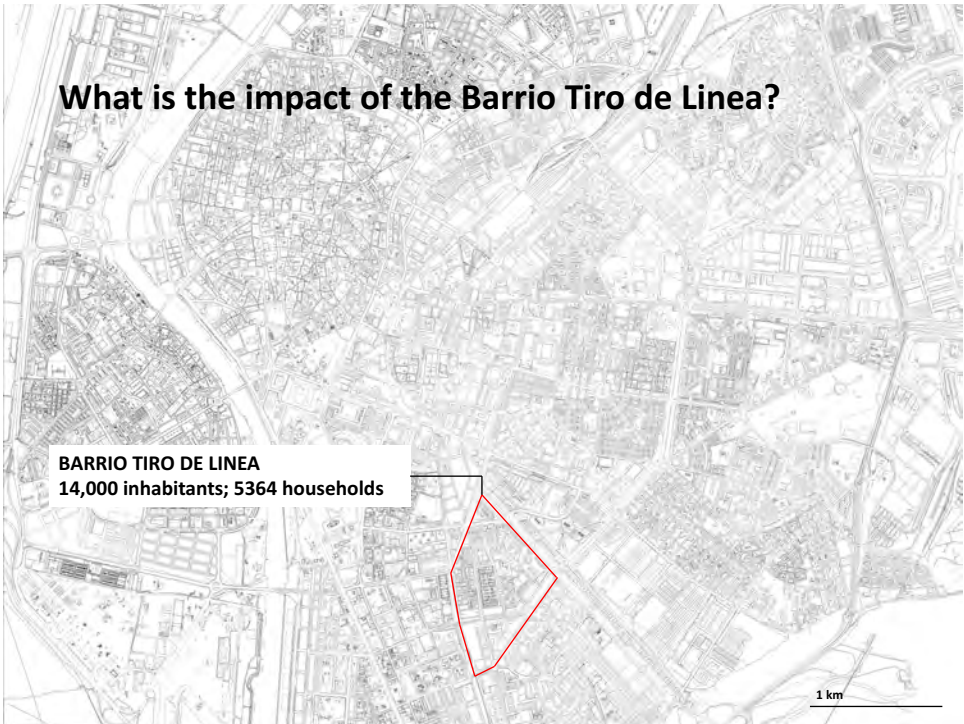

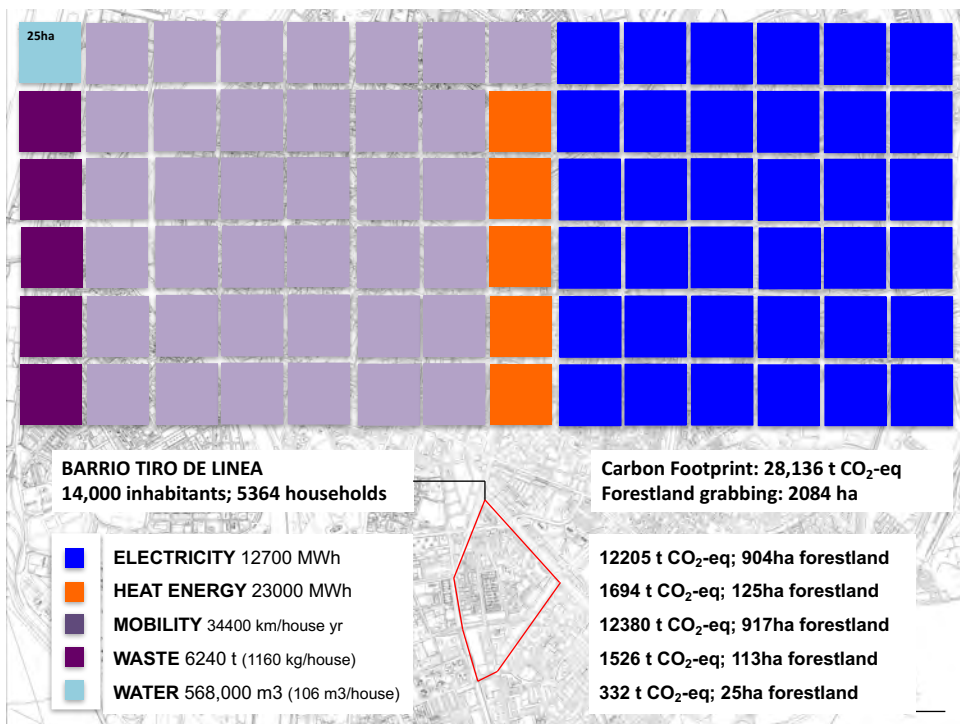
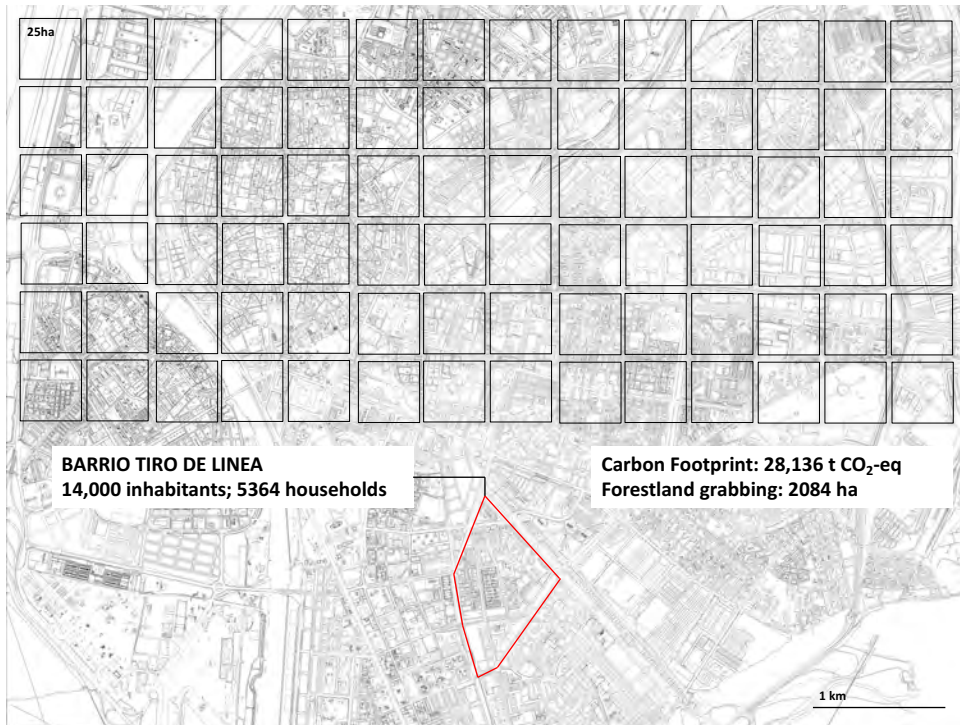



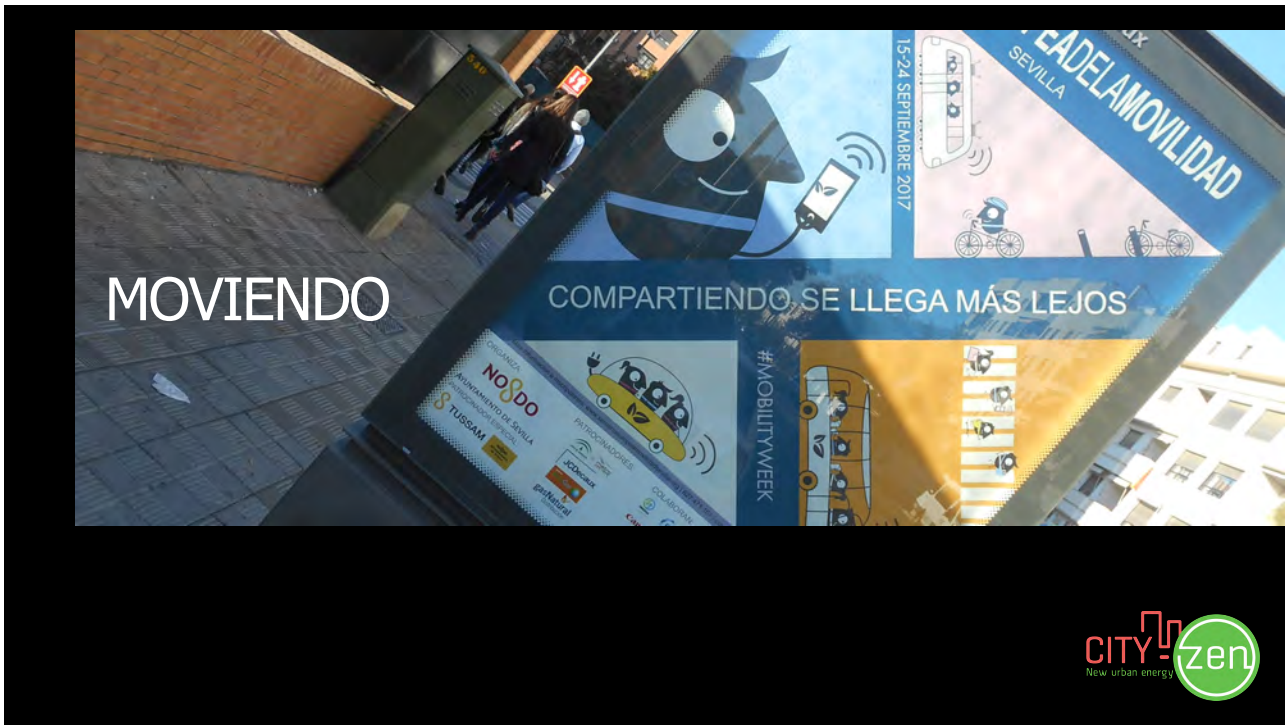

Copenhague expertos en movilidad:  
 Si dejas el espacio para conducir en coche,  
 la gente usará el coche  
 Si dejas el espacio para ir en bicicleta,  
 la gente usará la bicicleta



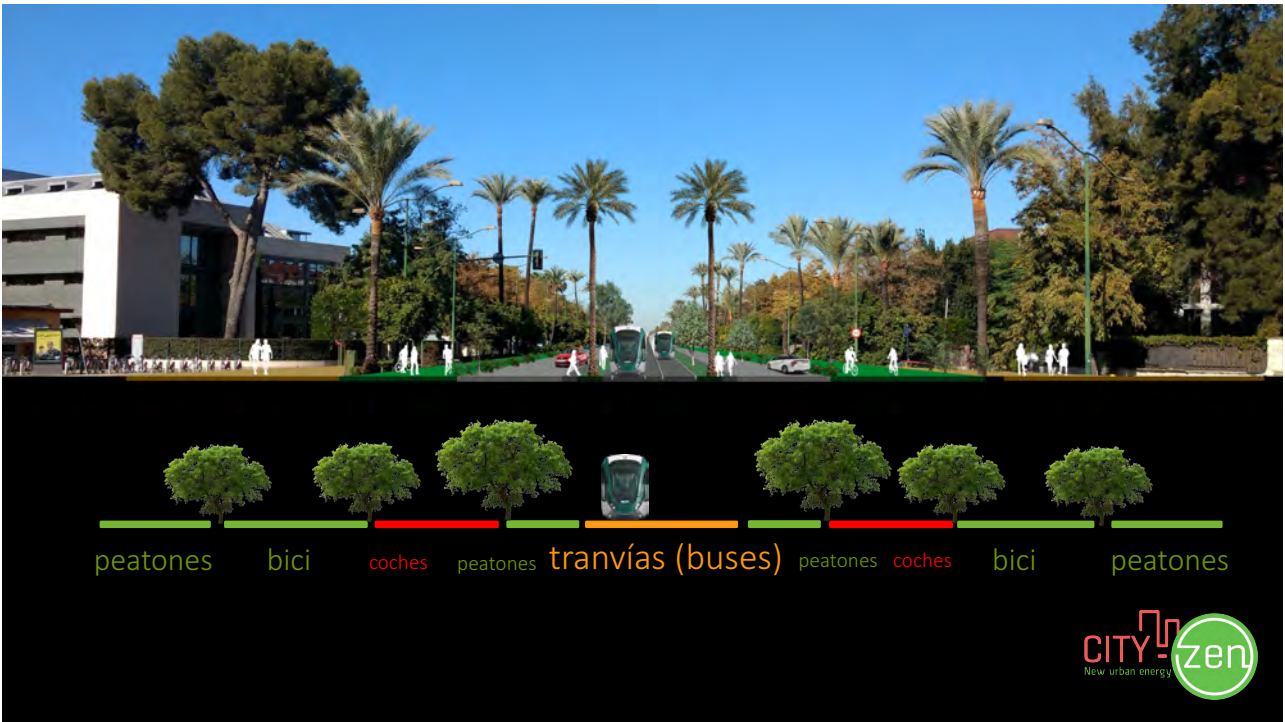



sign in | become a supporter | subscribe | search

find a job | dating | more | International edition

**theguardian**

UK | world | sport | football | opinion | culture | business | lifestyle | fashion | environment | tech | travel

home > world > europe | US | americas | asia | australia | africa | middle east | cities | development

**Cities**  
Cycling the city

## How Seville transformed itself into the cycling capital of southern Europe



Advertisement

100 RESILIENT CITIES

RESILIENT CITIES FOR THE 21ST CENTURY

Manuel Calvo @ The Guardian

**GREEN HEROS**

**CITYzen**  
New urban energy



# GREEN HEROS

Huerta del Rey Moro



# GREEN HEROS





TIRO DE LÍNEA



TIRO DE LÍNEA







# TIRO DE LÍNEA



# GREEN HEROS CTUED



NEVERTHELESS





# DISRUPTIVE CHANGE



## Equipa Urbanista

City-zen roadie

- Prof. **Greg Keeffe** (Queens University Belfast)

Interpreter and guest roadie

- **Jesús Cardona** (Nontropía)

Student facilitators

- **Dora Vancsó** (TU Delft)
- **Laura Solarino** (TU Delft)
- **Antigoni Karaiskou** (TU Delft)



# Equipa Energetica

## City-zen roadies

- Prof. **Andy van den Dobbelsteen** (TU Delft)
- Dr. **Riccardo Pulselli** (Università di Siena)
- **Matteo Maccanti** (Università di Siena)
- Dr. **Han Vandevyvere** (EnergyVille)
- Dr. **Leen Peeters** (Think!E)

## Student facilitators

- **Eva Farrugia** (TU Delft)
- **Michael Cobb** (TU Delft)
- **Álvaro Rodríguez García** (TU Delft)



## CITY-ZEN ROADMAPPING SCHEME

[City-zen WP4T2 team, image by Siebe Broersma and Michiel Fremouw, TU Delft]

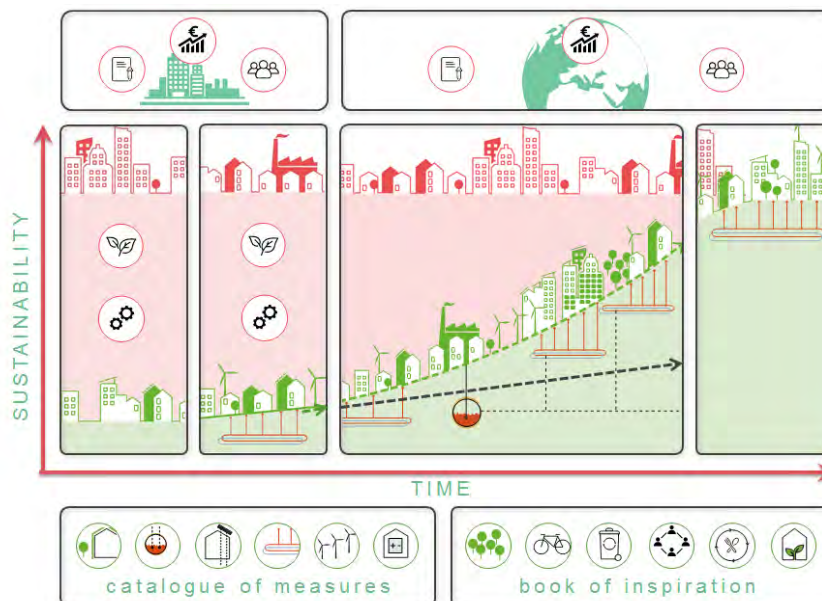

# What does the sustainable city look like in 2050?



Hammarby Sjöstad, Stockholm



## Aims of the Roadshow energy studio

**Main aim: to support Sevilla in its energy transition from fossil fuels to renewable sources**

Stepped objectives

- 1. Creating a good overview of energy demand, supply and local potentials**
- 2. Converting energy usage to a carbon footprint**
- 3. Finding solutions to get to net zero-carbon developments**
  - Reduce the energy demand (urban planning, building design, appliances)
  - Reuse waste energy (program, attune, exchange, store)
  - Produce renewables (sun, wind, water, soil, air, biomass, humans)
- 4. Involve solutions for non-building sectors:**
  - Transportation
  - Waste (water) treatment
  - Economic developments
- 5. Calculate the carbon emissions reduced and remaining carbon footprint**



# Climate data

**Conclusion:** mean temperature  $\approx 18^{\circ}\text{C}$   $\rightarrow$  soil perfect for cooling/pre-heating



Source: ClimateConsultant / IWEC Data



# Water – Guadalquivir & Sevilla

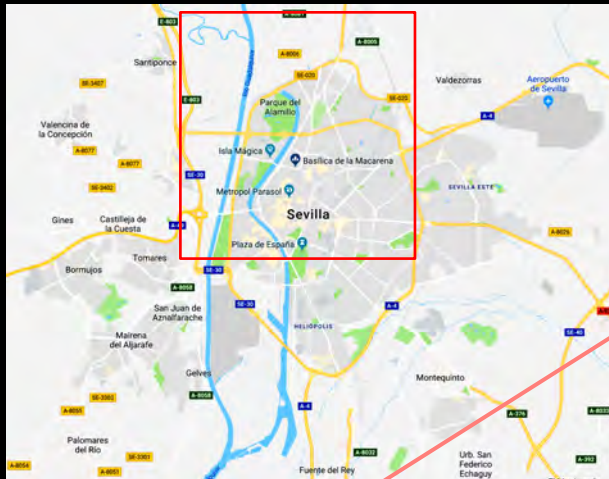

What is happening here?



Escala 1/25000

Mapa geotécnico básico de Sevilla  
Profundidad del nivel freático (m) 5



**MACRO SCALE**  
**WATER IN THE CITY**

Reconnect the city to the Guadalquivir and use flowing water to cool and humidify it





**MACRO SCALE  
WATER IN THE CITY**

Reconnect the city to the Guadalquivir and use flowing water to cool and humidify it

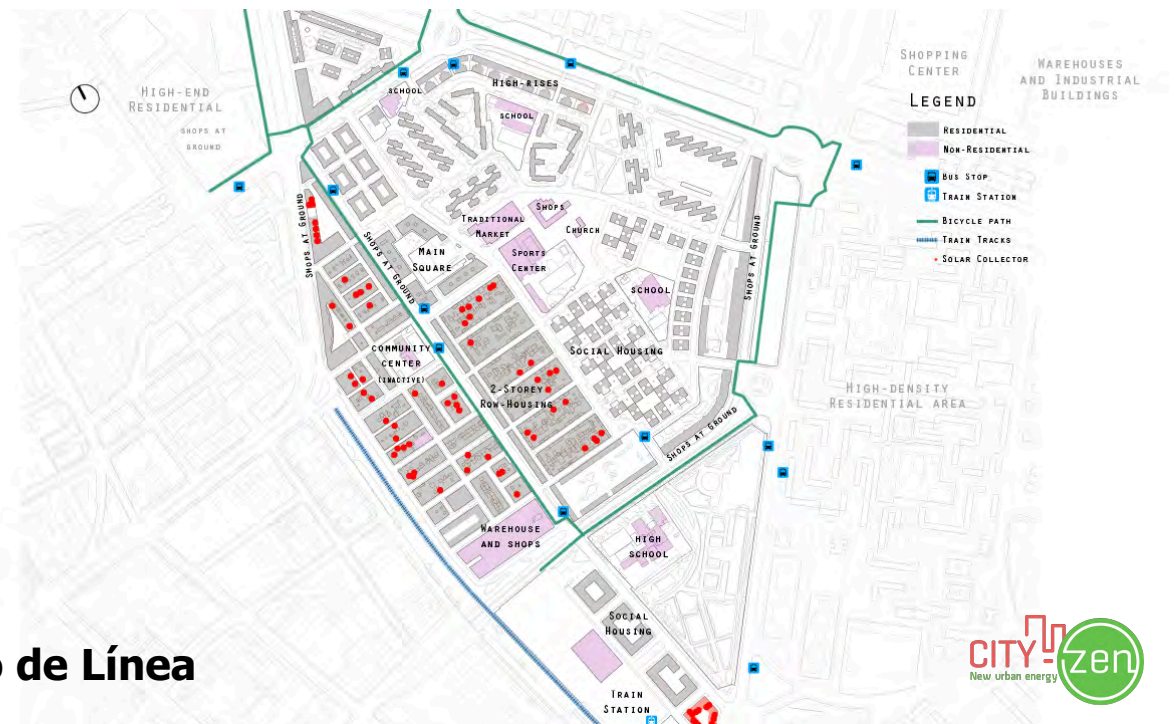

**Tiro de Línea**

**MESO SCALE**  
CAPTURE & STORE

A combination of rainwater collection, filtering, evaporative cooling and a playground.

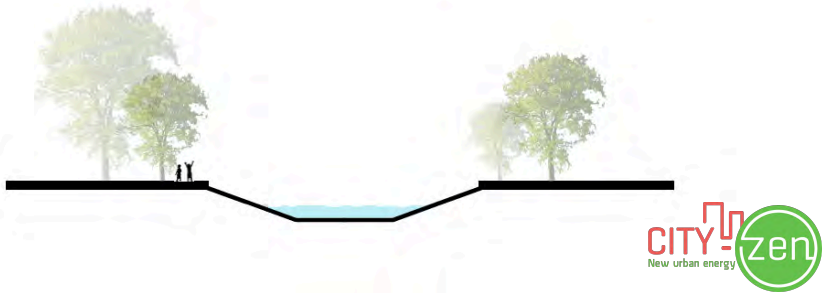
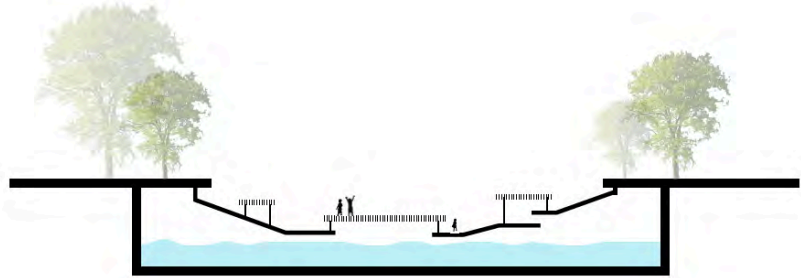

**MICRO SCALE**  
CAPTURE & USE

Use of cisterns underneath the streets which link to the water squares.

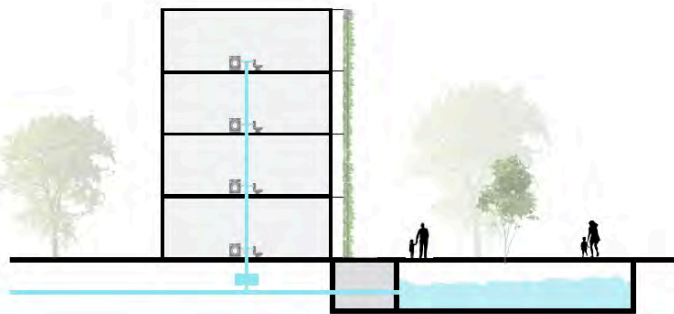

**MICRO SCALE**  
CAPTURE & REUSE  
Condensate Irrigation from Heat Exchangers

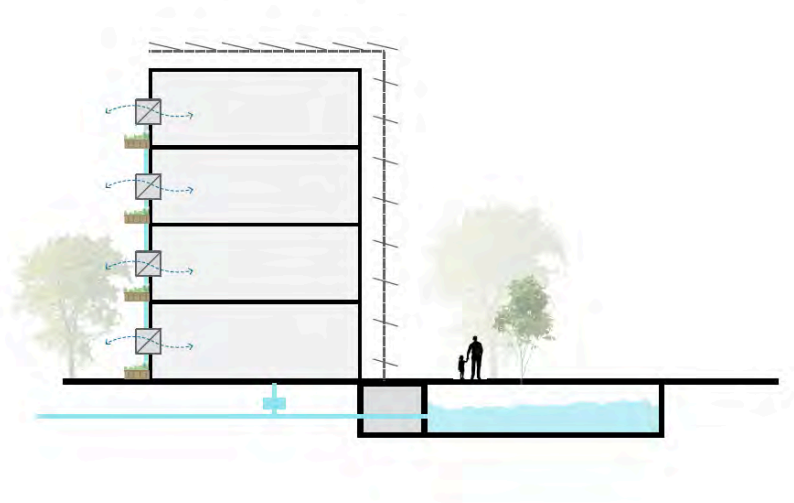

**Tiro de Línea**  
**Water infra**



# Water – green – energy hubs

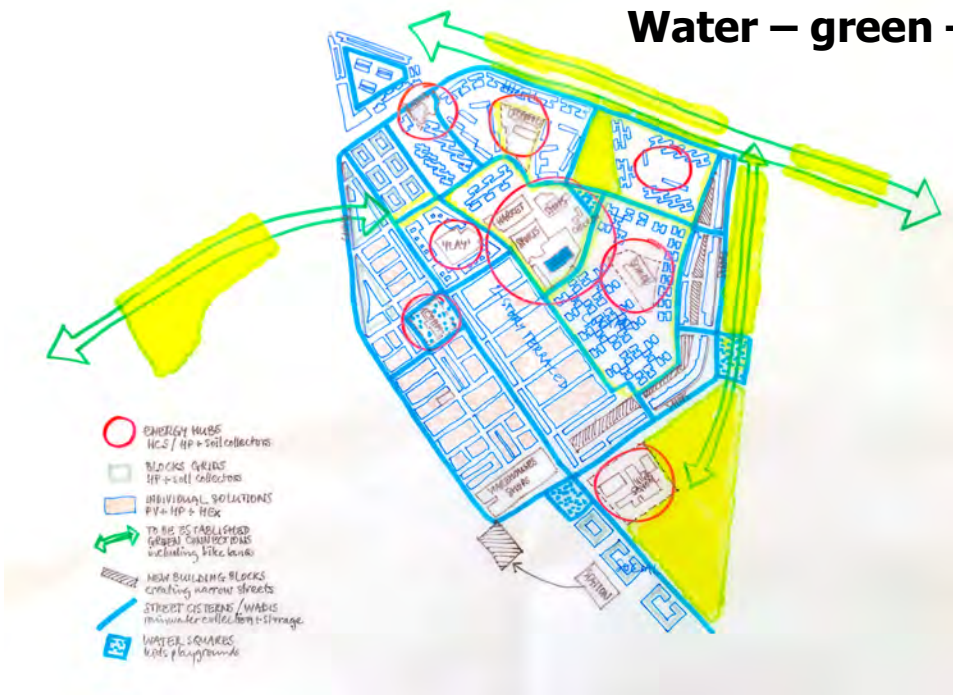

## Urban Heat Island: Normalised Difference Vegetation Index

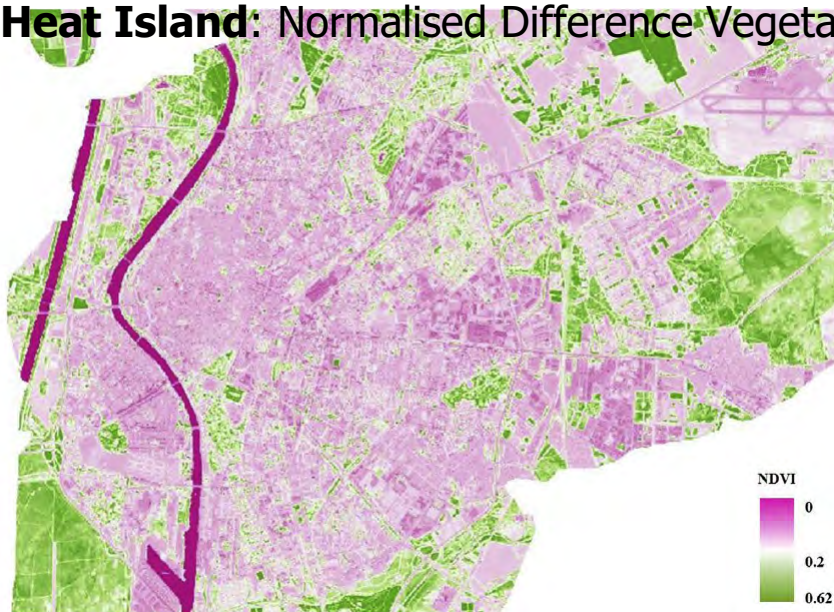

Herrera-Gomez S., Quevedo-Nolasco A., Pérez-Urrestarazu L. (2017); The role of green roofs in climate change mitigation - A case study in Seville (Spain); Building and Environment 123, p. 575-584



## Percentage of green roofs needed due to climate change

**Table 2**  
Estimation of the green roof surface necessary to mitigate  $\Delta T$  due to climatic change.

Period	SERES climatic scenario	$T_{max}^{CC}$ (°C)	$\Delta T_{max}$ (°C)	Landsat 7 ETM+			Percentage of roofs to vegetate (%)
				NDVI <sup>CC</sup> (dim)	$S_{ug}^{CC}$ (ha)	$\Delta A_{gr}$ (ha)	
2011–2040	A2	<sup>a)</sup> 35.5	3.5	0.47	1257	367	20.1
2041–2070	A2	<sup>a)</sup> 34.0	5.0	0.52	1414	524	28.8
2071–2100	A2	<sup>a)</sup> 33.0	6.0	0.56	1519	629	34.5

Herrera-Gomez S., Quevedo-Nolasco A., Pérez-Urrestarazu L. (2017); The role of green roofs in climate change mitigation - A case study in Seville (Spain); Building and Environment 123, p. 575-584



## Different green solutions for different street sections

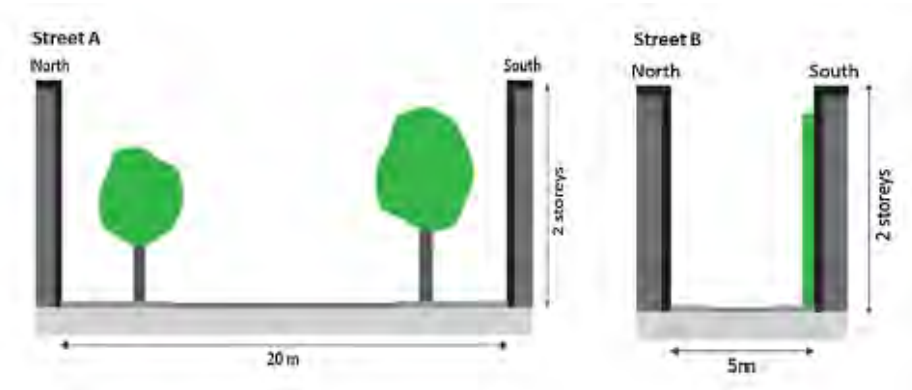

Norton A. et al. (2015); Planning for cooler cities: A framework to prioritise green infrastructure to mitigate high temperatures in urban landscapes; Landscape and Urban Planning 134, p. 127–138



## Percentage of street shaded with different height/widths

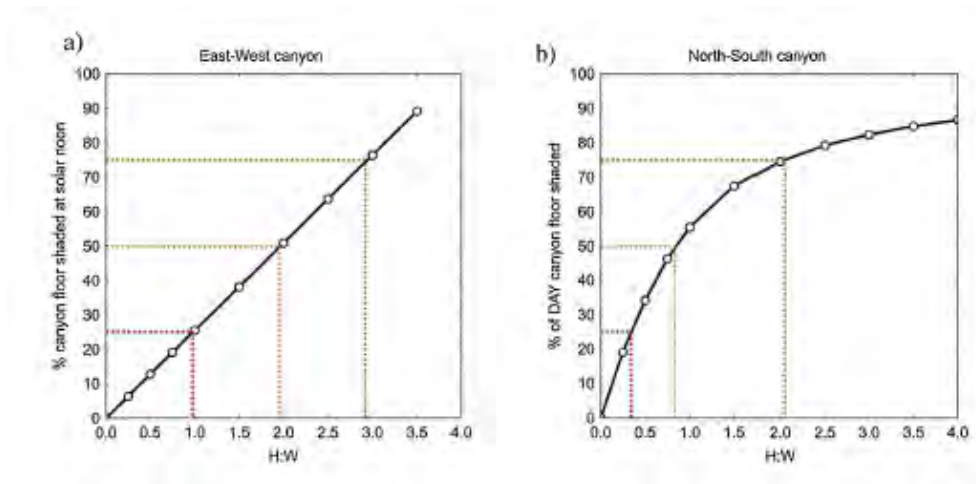

Norton A. et al. (2015); Planning for cooler cities: A framework to prioritise green infrastructure to mitigate high temperatures in urban landscapes; Landscape and Urban Planning 134, p. 127–138



# Streets in danger of overheating

c) Canyon Width

Prioritisation: Street Trees

Canyon Orientation

Canyon Width	Prioritisation: Street Trees									Canyon Orientation
	0.00	0.20	0.40	0.60	0.80	1.00	1.20	1.40	1.60	
Very Wide 40 m	0.00	0.20	0.40	0.60	0.80	1.00	1.20	1.40	1.60	E-W
	0.40	0.60	0.80	1.00	1.20	1.40	1.60	1.80	2.00	N-S
Wide 30 m	0.00	0.20	0.40	0.60	0.80	1.00	1.20	1.40	1.60	E-W
	0.40	0.60	0.80	1.00	1.20	1.40	1.60	1.80	2.00	N-S
Medium 20 m	0.20	0.40	0.60	0.80	1.00	1.20	1.40	1.60	1.80	E-W
	0.40	0.60	0.80	1.00	1.20	1.40	1.60	1.80	2.00	N-S
Narrow 10 m	0.40	0.60	0.80	1.00	1.20	1.40	1.60	1.80	2.00	E-W
	0.60	0.80	1.00	1.20	1.40	1.60	1.80	2.00	2.20	N-S
Metres	4	8	12	16	20	24	28	32	36	Metres
Storeys	1	2	3	4	5	6	7	8	9	Storeys
	Low			Medium			Tall			
	Canyon Height									

■ High priority   
 ■ Moderate priority   
 ■ Lower priority   
 ■ Not a priority

Tiro de Línea

Norton A. et al. (2015); Planning for cooler cities: A framework to prioritise green infrastructure to mitigate high temperatures in urban landscapes; Landscape and Urban Planning 134, p. 127–138



**PASSIVE ENERGY RENOVATION STRATEGIES**  
INNER-CITY DENSITIES - SELF SHADING

INCREASED SHADING MEANS COOLER PATHS TO WALK ALONG AND COOLER BUILDINGS

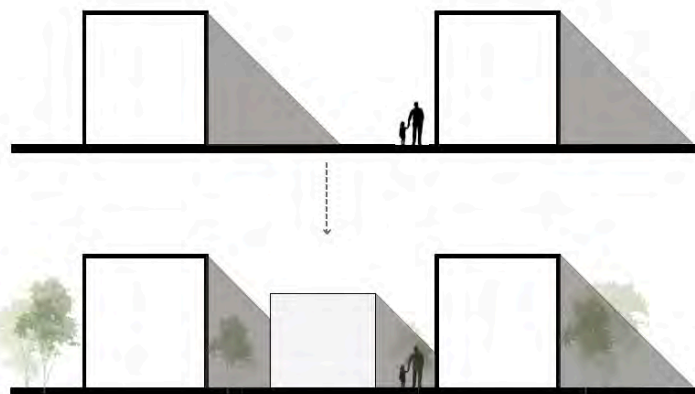

**PASSIVE ENERGY  
RENOVATION STRATEGIES  
INNER-CITY DENSITIES**

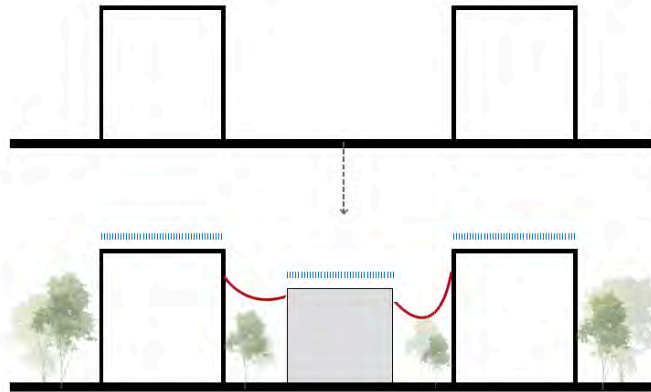

## New Stepped Strategy for energy-positive (re) design

### 1. Reduce the demand

- a) Smart bioclimatic design
- b) Energy-efficient appliances

### 2. Reuse waste energy

- a) Recover heat/cold from exhaust air and waste water (buildings)
- b) Attune urban functions programmatically (neighbourhoods)
- c) Exchange heat, cold and electricity (neighbourhoods)
- d) Store heat, cold and electricity (neighbourhoods-districts)
- e) Use industrial waste heat (city)

### 3. Produce renewable energy

- a) Solar
- b) Wind
- c) Water
- d) Air
- e) Geothermal
- f) Biomass
- g) Human





# Typical facades and roofs

Nombre	Transmitancia	Capas materiales	Secciones
Fachada 1	$U = 2.05 \text{ W/m}^2 \text{ K}$	"1 pie LP métrico o catalán 40 mm < G < 60 mm" + "Enlucido de yeso 1000 < d < 1300"	
Fachada 2	$U = 1.57 \text{ W/m}^2 \text{ K}$	"1 pie LP métrico o catalán 40 mm < G < 60 mm" + cámara no ventilada vertical de 3 cm + "Tabique de LH sencillo [40 mm < Espesor < 60 mm]" + "Enlucido de yeso 1000 < d < 1300"	
Fachada 3	$U = 2.46 \text{ W/m}^2 \text{ K}$	"Enlucido de yeso 1000 < d < 1300" + bloque de hormigón de áridos densos de espesor 140 + "Enlucido de yeso 1000 < d < 1300"	
Fachada 4	$U = 2.15 \text{ W/m}^2 \text{ K}$	"Piedra caliza dura [2000 < d < 2190]"	
Suelo 1	$U = 3.06 \text{ W/m}^2 \text{ K}$	"Mortero de cemento o cal para albañilería y para revoco/enlucido d > 2000" + hormigón con áridos ligeros con densidad entre 1800 y 2000	
Suelo 2	$U = 2.32 \text{ W/m}^2 \text{ K}$	"Mortero de cemento o cal para albañilería y para revoco/enlucido d > 2000" + "FU Entrevigado cerámico-Canto 250 mm" + "Enlucido de yeso 1000 < d < 1300"	

Nombre	Transmitancia	Capas materiales	Secciones
Cubierta1	$U = 1.65 \text{ W/m}^2 \text{ K}$	"Plaquea o baldosa cerámica" + "Tablero de partículas con cemento d < 1200" + cámara horizontal ligeramente ventilada + "FU Entrevigado cerámico-Canto 250 mm" + "Enlucido de yeso 1000 < d < 1300"	
Cubierta2	$U = 0.71 \text{ W/m}^2 \text{ K}$	"Teja de arcilla cocida" + "Tablero contrachapado 700 < d < 900" + "EPS Poliestireno Expandido [0.037 W/(mK)]" + "FU Entrevigado cerámico-Canto 250 mm" + "Enlucido de yeso 1000 < d < 1300"	
Cubierta3	$U = 1.62 \text{ W/m}^2 \text{ K}$	"Teja de arcilla cocida" + "Tablero contrachapado 700 < d < 900" + "FU Entrevigado cerámico-Canto 250 mm" + "Enlucido de yeso 1000 < d < 1300"	

[Gobierno de España/IDAE; Escala de calificación energética – Edificios existentes; Madrid, 2011]

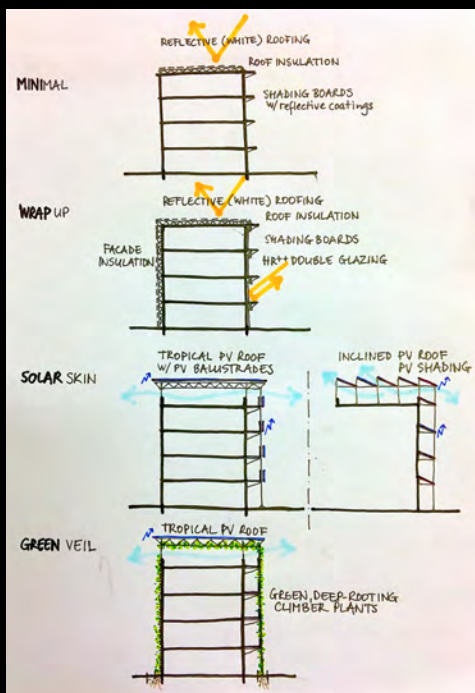

## Energy renovation options

- **Minimal**
  - Simple & cheap
  - Saves most cooling needs
- **Wrap up**
  - More extensive & expensive
  - Saves a lot of cooling and heating needs
- **Solar skin**
  - Technical solution
  - Reduces most cooling needs
  - Produces a lot of electricity
- **Green veil**
  - Green solution
  - Reduces most cooling needs and saves heating
  - Combined with PV roof: produces electricity
- **Combination of all 4 possible**



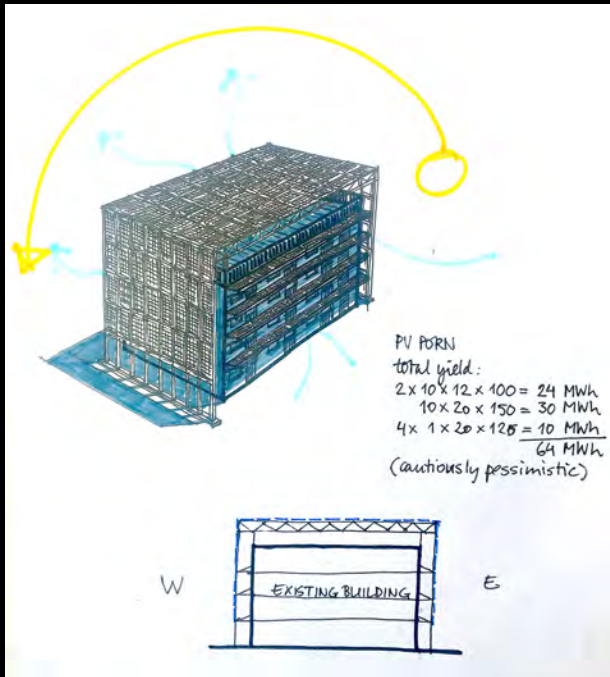

## PV porn

- **PV shell over the building, East to West**
  - Catches sun in the morning, afternoon, evening
  - Continuous production during the day
  - Estimated yield with a 20x10x12 m block: 64 MWh
- **Main issue: electricity storage**
  - Daytime domestic activities
  - Central battery storage
  - Electric vehicles
  - Heat pump charging the heat/cold storage

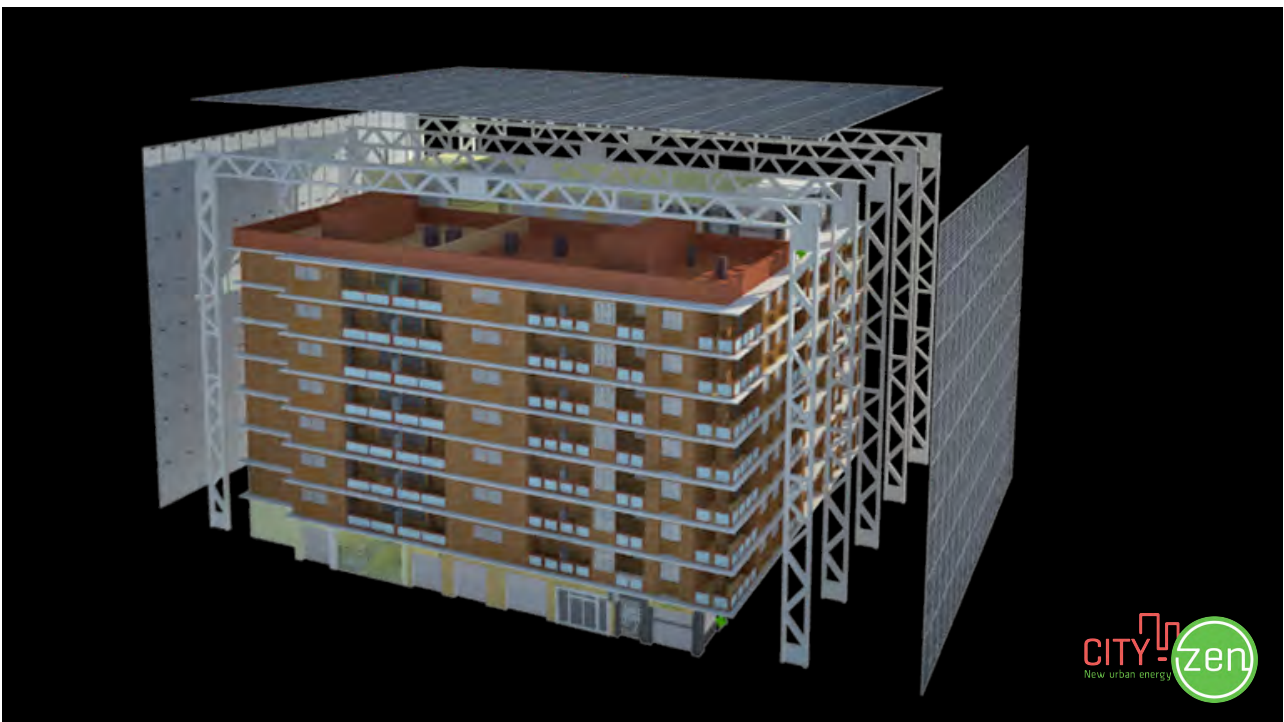

# Soil energy options – from passive to active

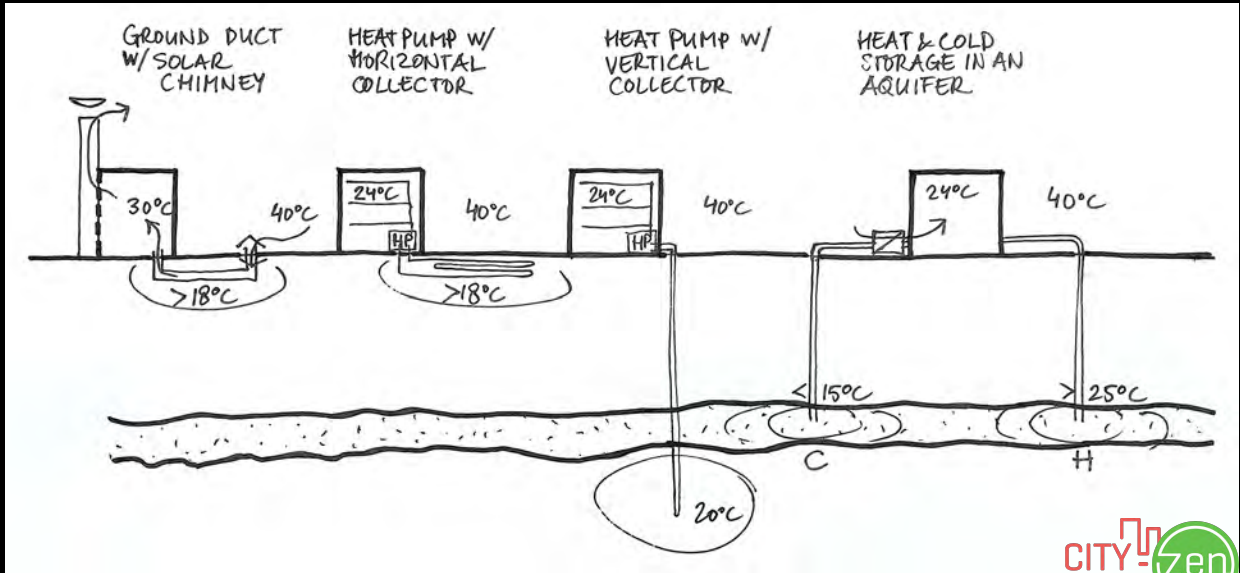

## ACTIVE ENERGY RENOVATION STRATEGIES INDIVIDUAL

Vertical soil collectors, individual heat pumps, PV panels and heat exchangers

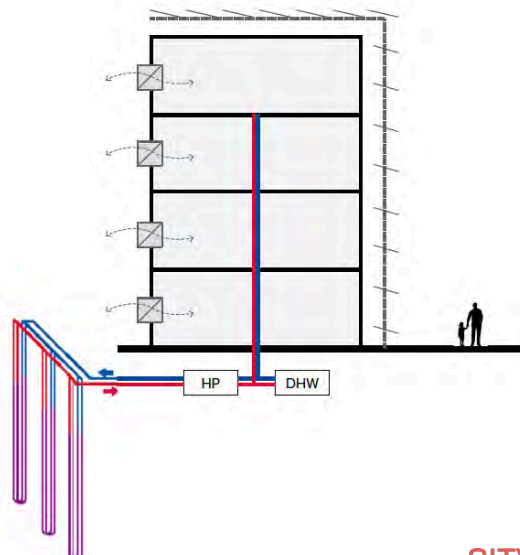

**ACTIVE ENERGY  
RENOVATION STRATEGIES  
COLLECTIVE**

Collective system with a cool/warm air supply and a professionally- managed system.

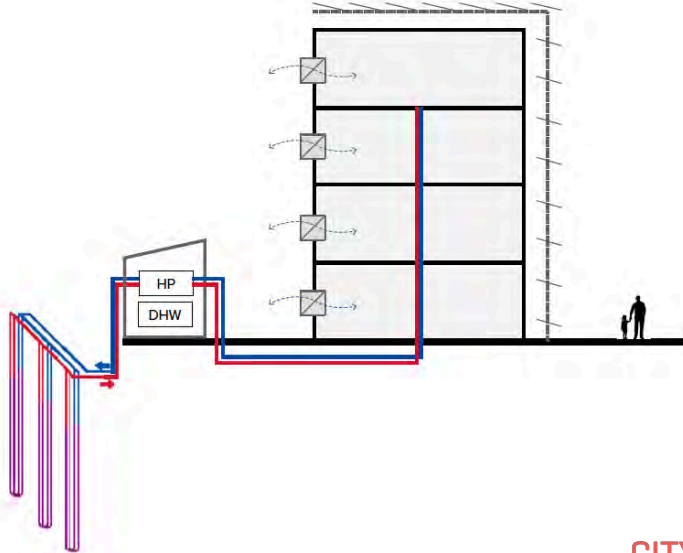

**ACTIVE ENERGY  
RENOVATION STRATEGIES  
COMMUNAL**

A hot and cold grid will supply energy to the neighbourhood on a communal scale.

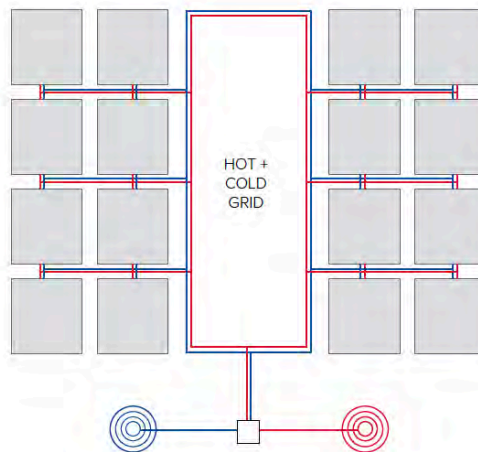

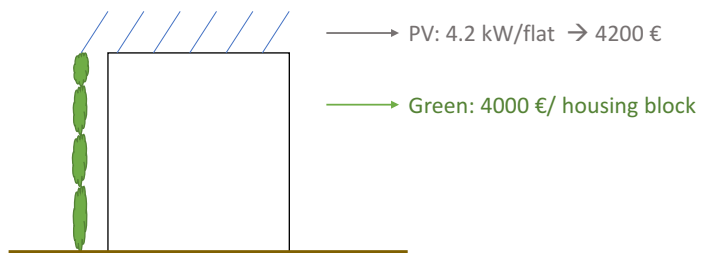
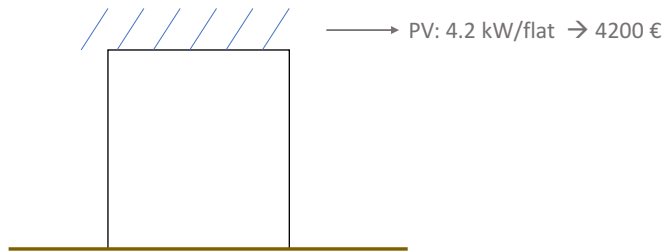

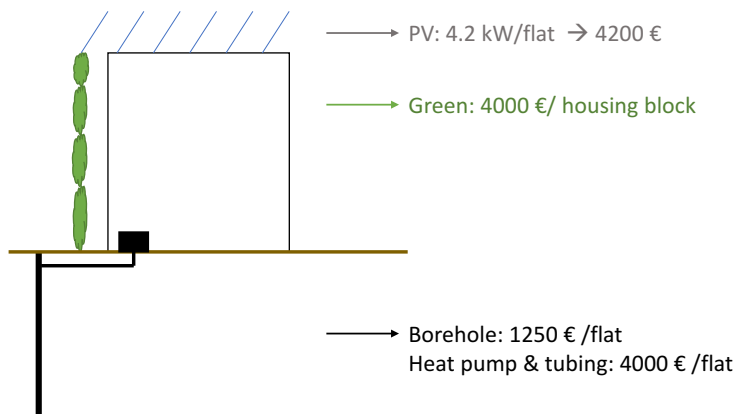
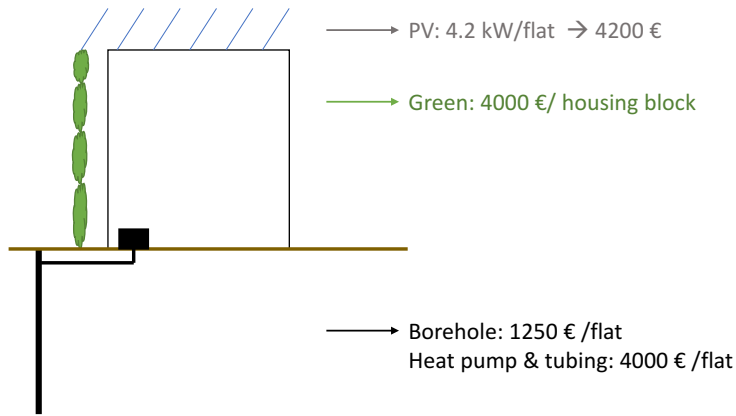

- Investment  $4200 \text{ €} + (4000 \text{ €})/3 + 1250 \text{ €} + 4000 \text{ €} = 10\,783 \text{ €}$
- Annual energy cost 630 €
- Annual maintenance 100 €
- 10 year balance: 18 083 €



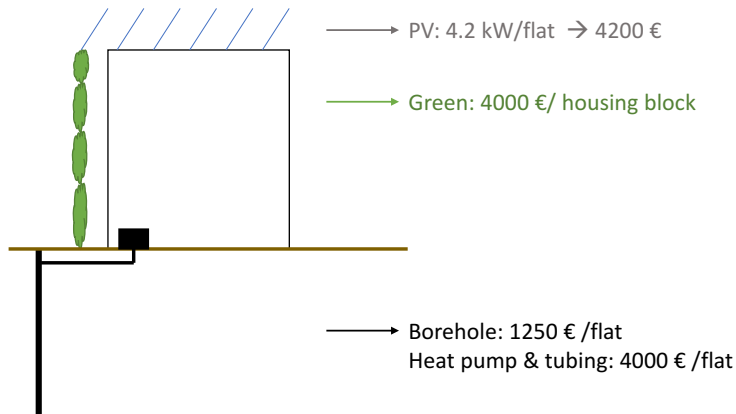

→ ENERGY COOPERATIVE

- Sells heat, cold and electricity @ 0.15 €/kWh
- 10 year balance: 18 083 € → 120 553 kWh

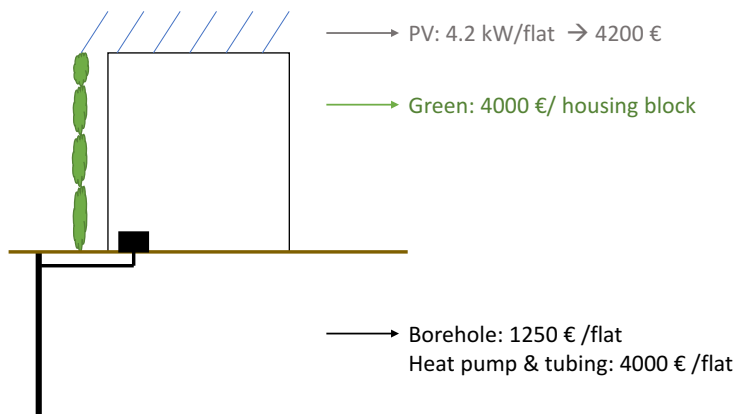

→ ENERGY COOPERATIVE

- Sells heat, cold and electricity @ 0.15 €/kWh
- 10 year balance: 18 083 € → 120 553 kWh > 20 years energy use

> life-time of equipment

## Trash on the streets



## Mierda...



## An energy cooperative could involve waste processing



- Collection of waste
- Repair and reuse
- Recycling
- Digestion of organic waste
- Production of biogas for restaurants





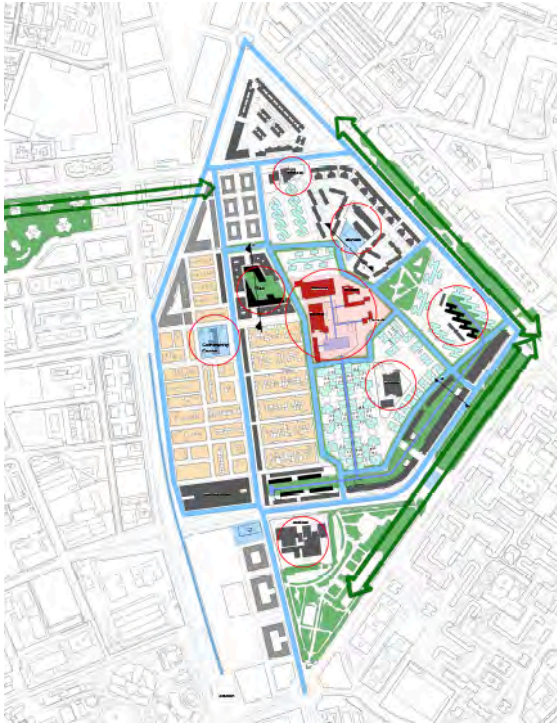

## Tiro de Línea sostenible

- Rainwater collection and usage
- Green infrastructure
- Energy renovation of buildings
- Energy cooperations that serve energy hubs
- Clean waste management
- Sustainable mobility: bikes and electric cars



## El Corte Nuevo

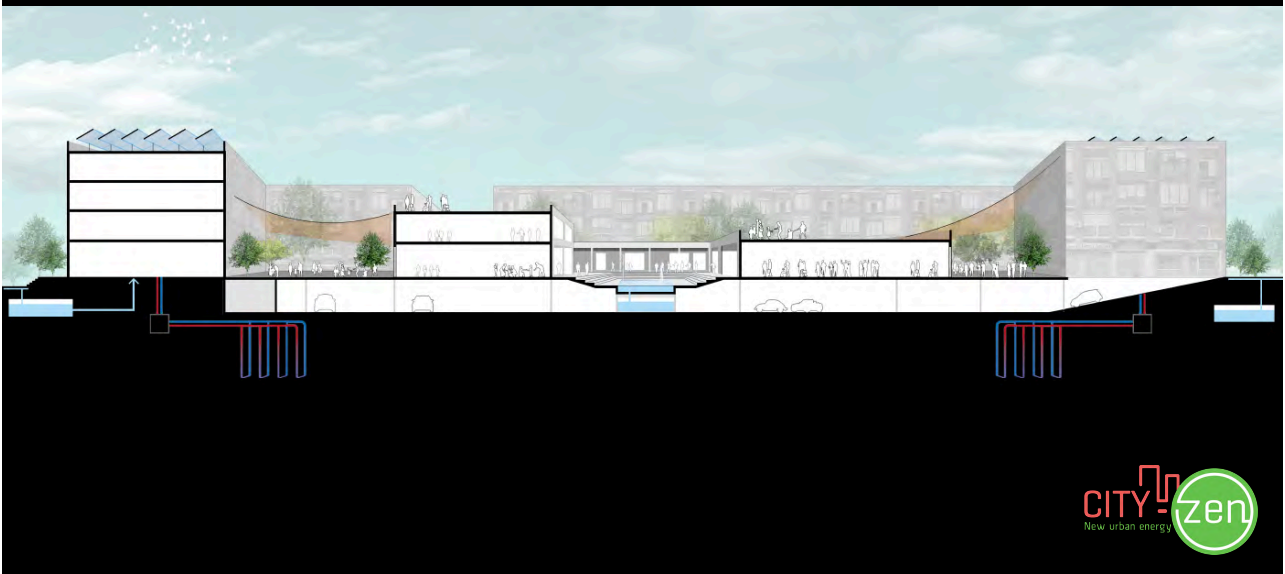

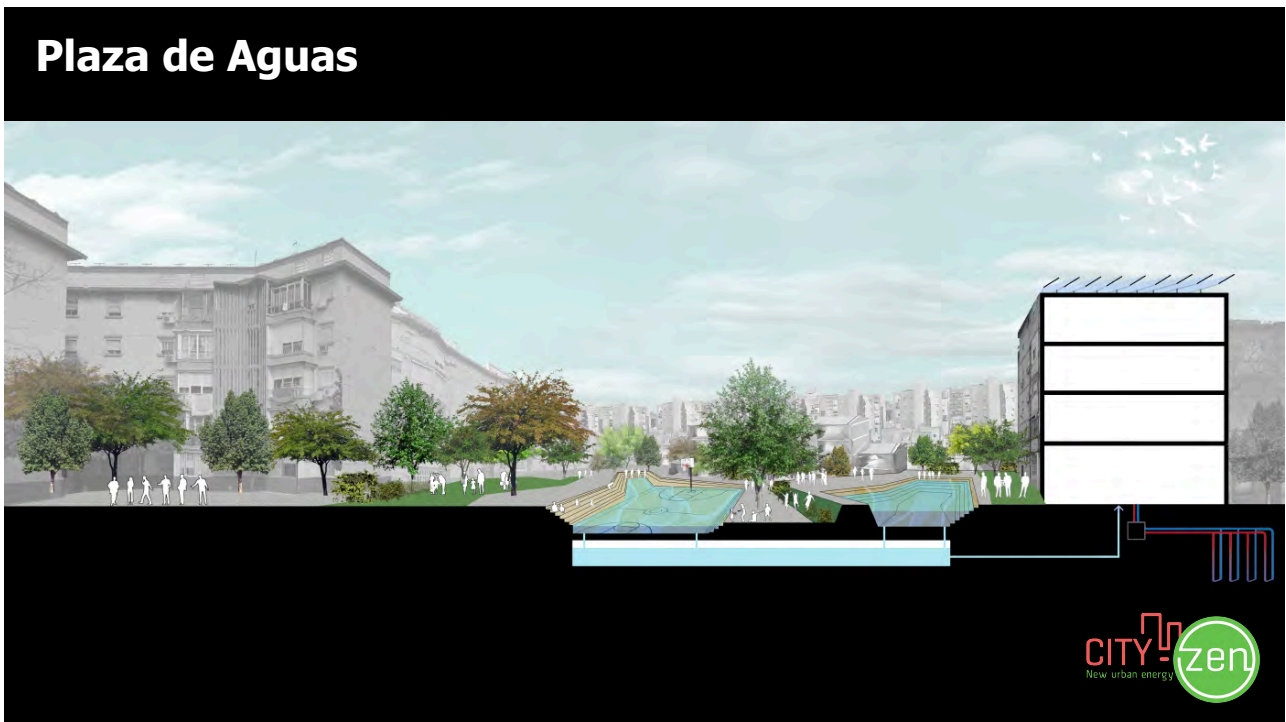
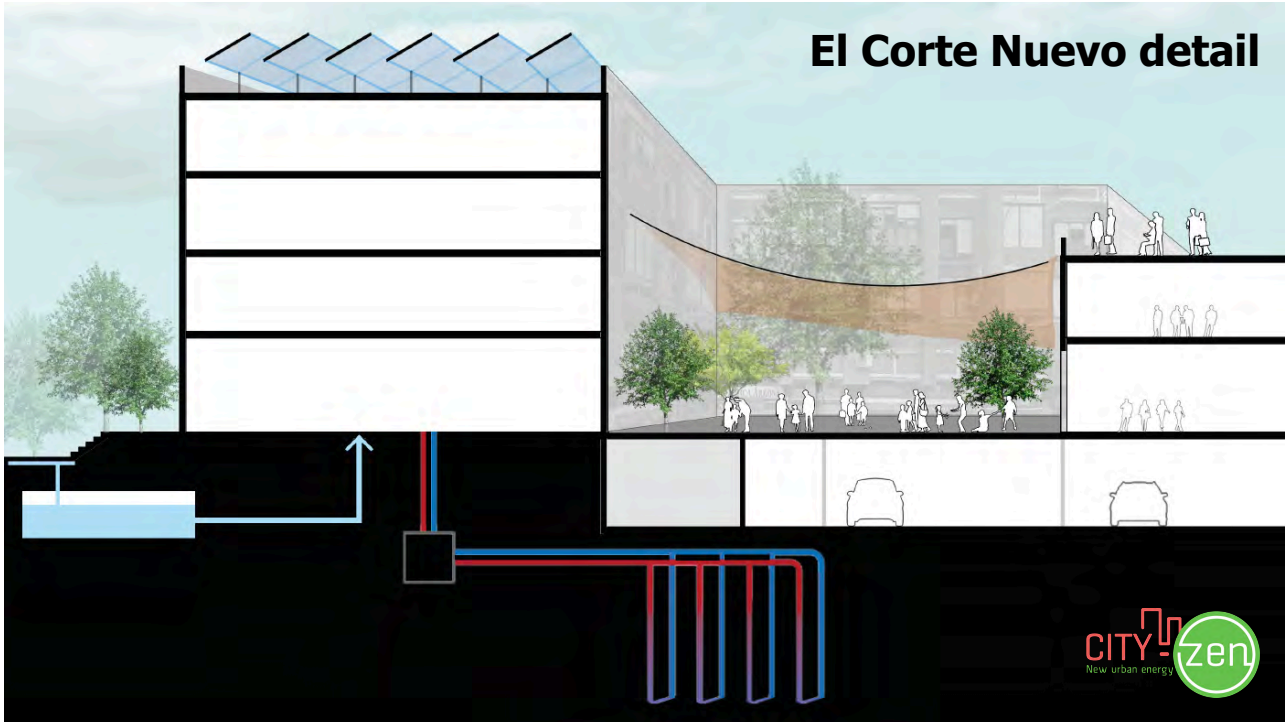

## Plaza de Aguas detail

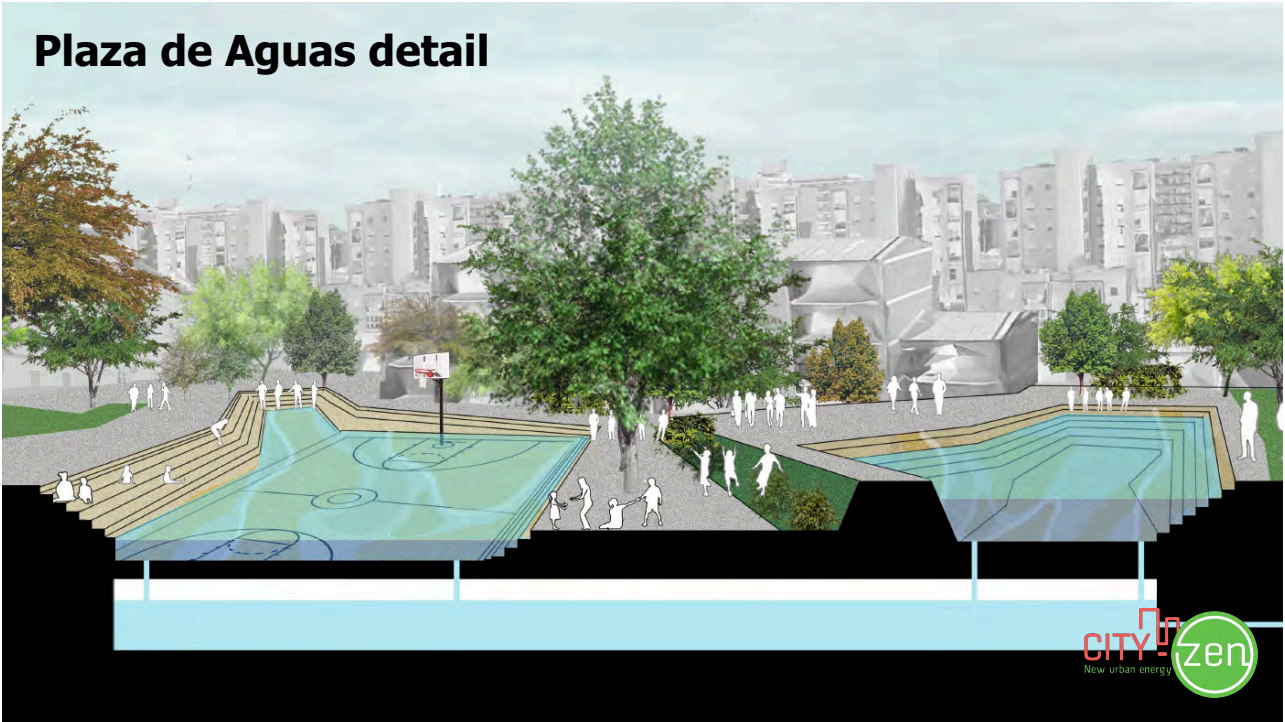

## Rambla verde

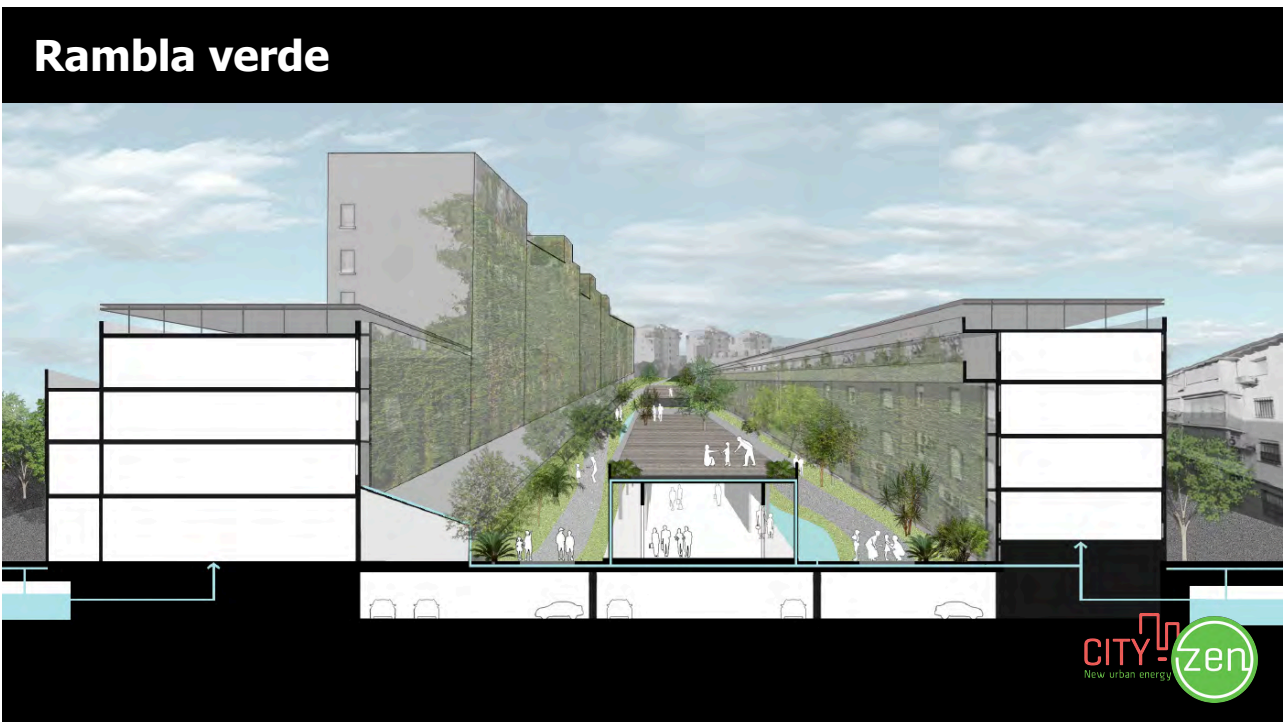

# Tiro de Línea sostenible

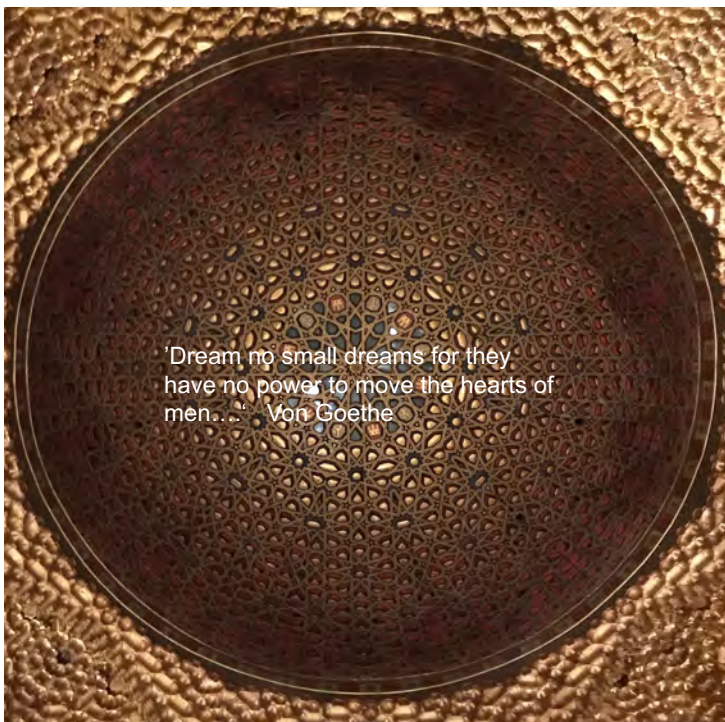
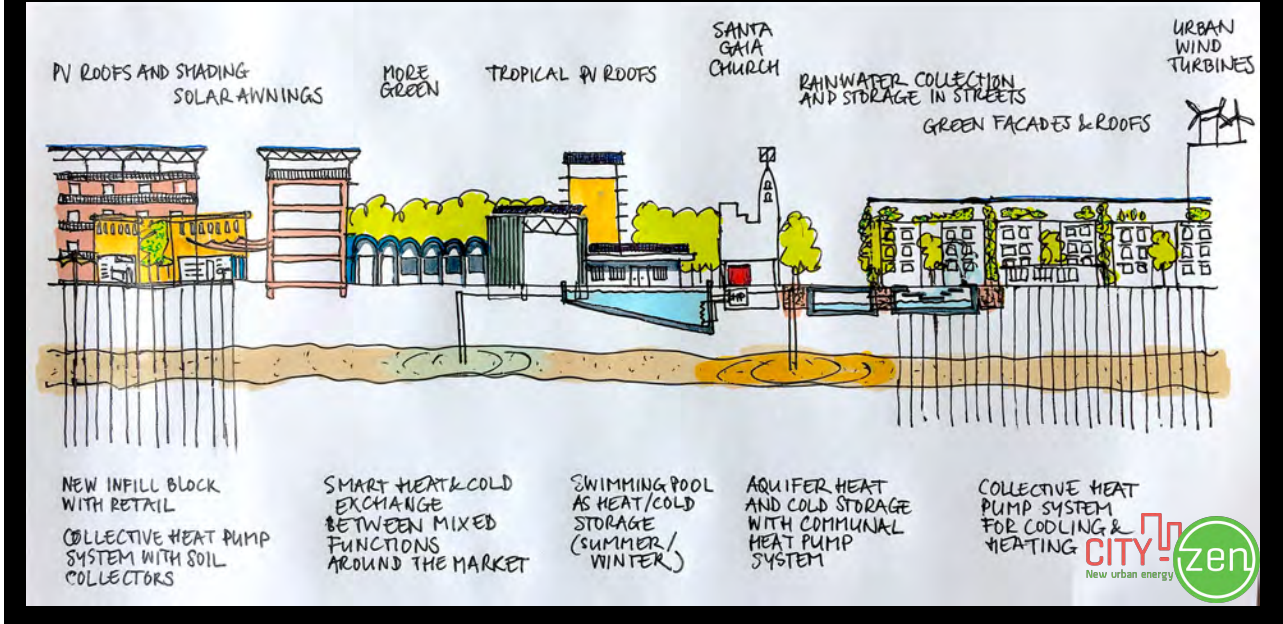

'Dream no small dreams for they have no power to move the hearts of men... Von Goethe

Professor Greg Keeffe

Head of School  
Natural and Built Environment

Queens University  
Belfast.

Dora Vancso  
Laura Solarino  
Antigoni Karaiskou  
TU Delft



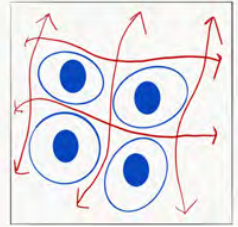
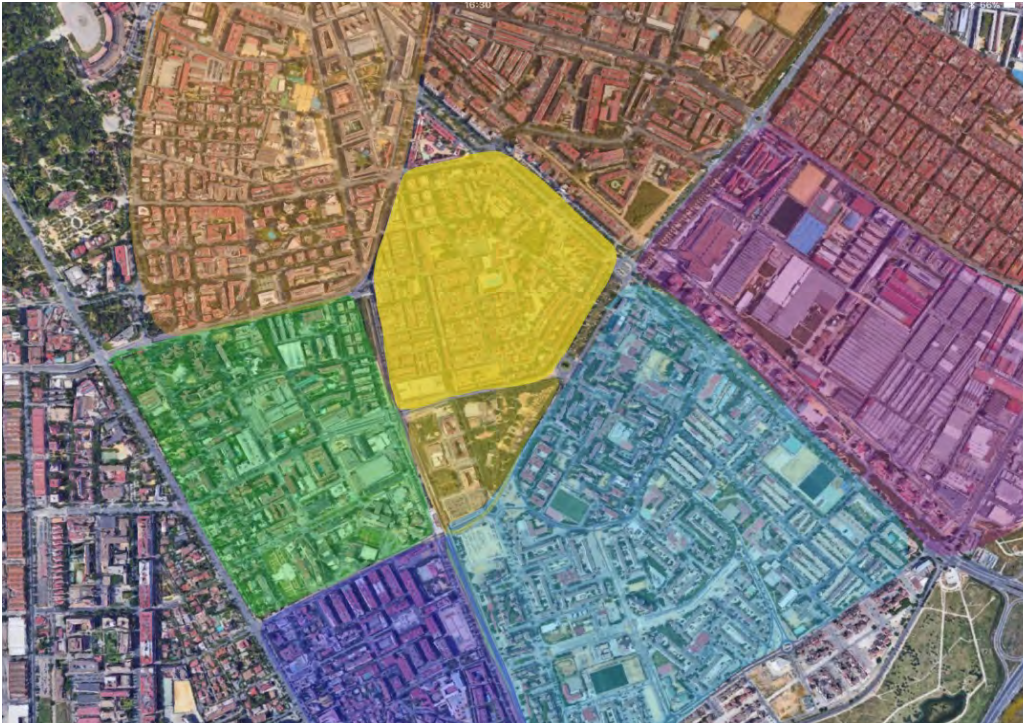

Barrios urbanism

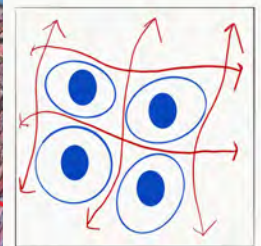
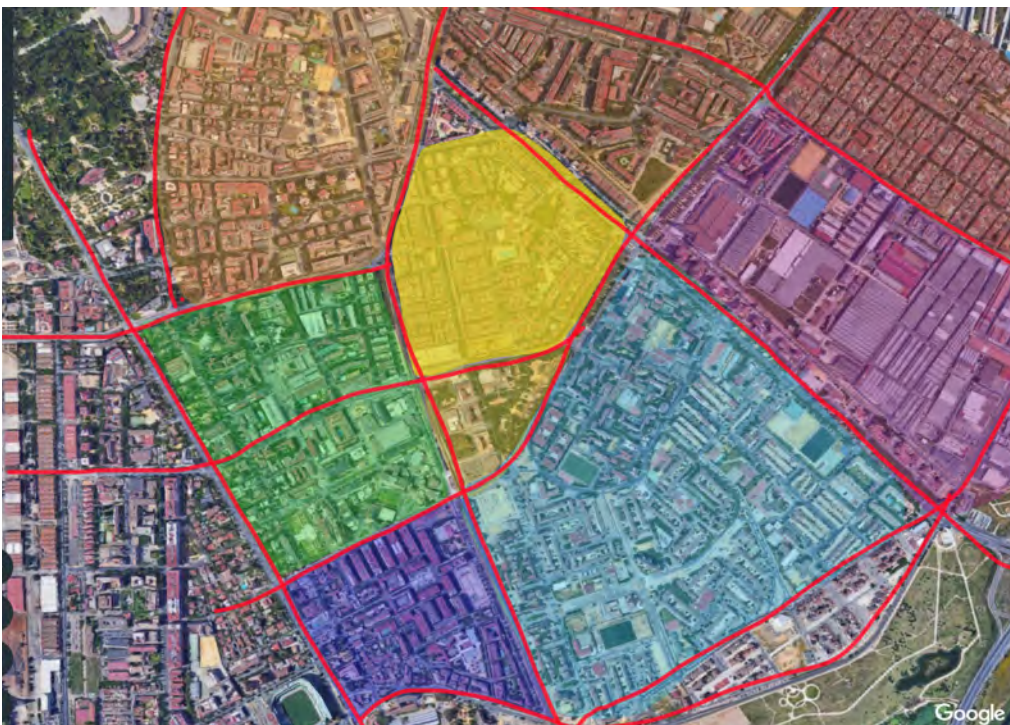

Barrios urbanism



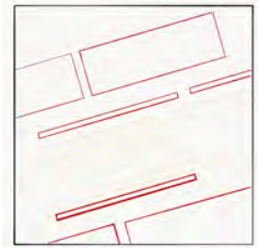

Over-roaded Urbanism

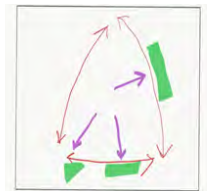

How big is big enough!



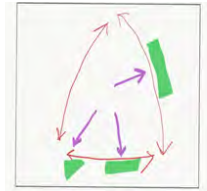

Unpacked Green

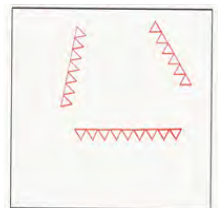

Hard edge



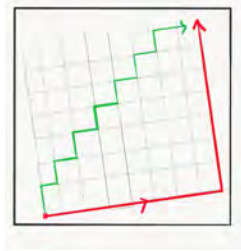

City desire line



Permeable/non-permeable space





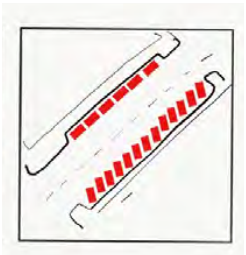

Cars cars and more cars

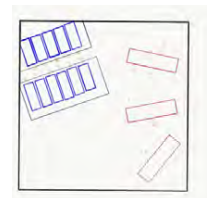

Surveyed and non-surveyed space



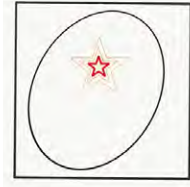

Over-centralised space



Over-scaled external space





Correctly proportioned space



Seville Climate Projections. UK Met Office

Year	Average Temp	Average High	Maximum Temp
2017	19.4	35	45
2070	24	45	55

Climate similar to Dubai by 2070



Correctly proportioned space

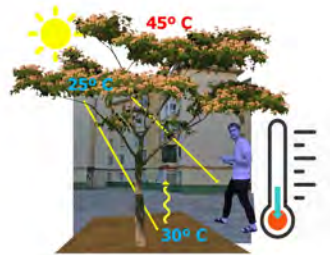
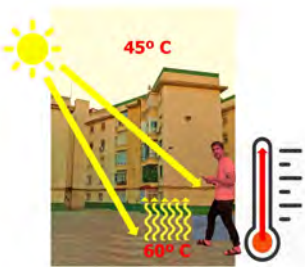



Perforated urbanism

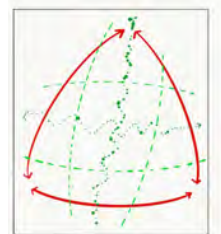

Perforated urbanism



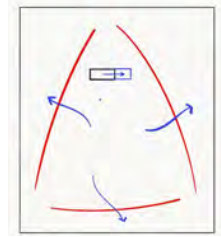
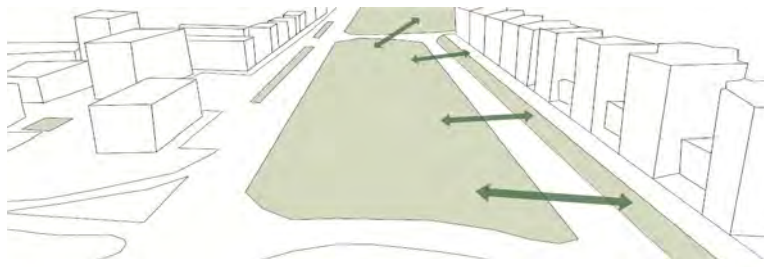

Unpack the neighbourhood

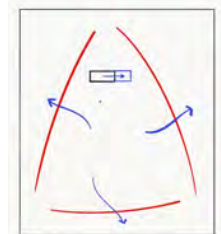
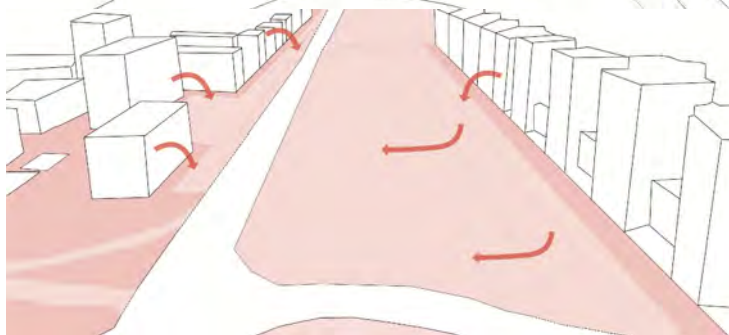
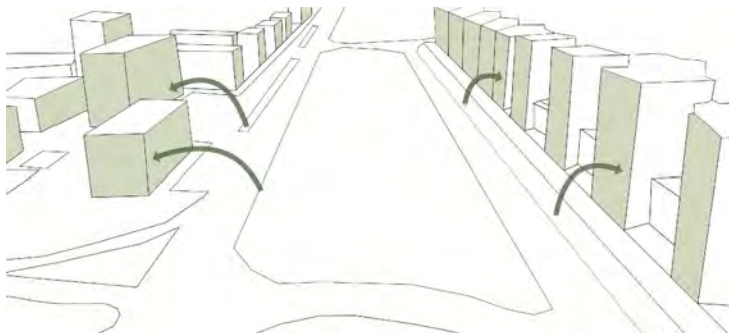

Unpack the neighbourhood



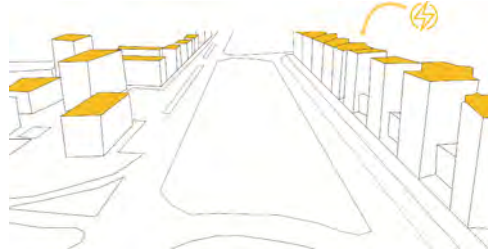
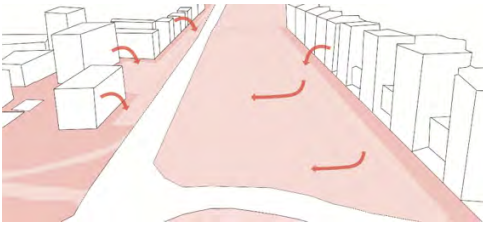

Unpack the neighbourhood

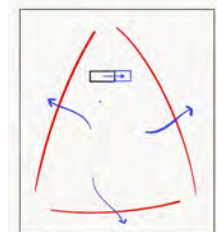
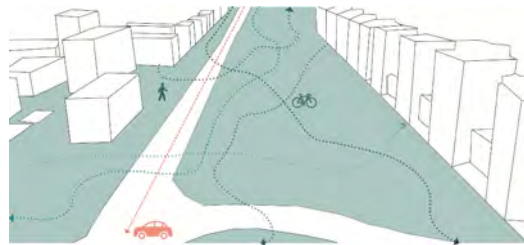

Unpack the neighbourhood



### UNDERGROUND PARKING

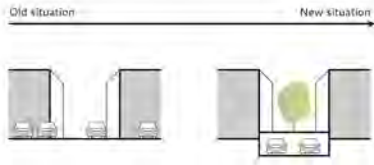

### URBAN OASIS

Shading (trees)  
Vertical farming/gardens  
Rooftop gardens



Unpack green space – make oases

### SHADING (WATER STORAGE+PV)

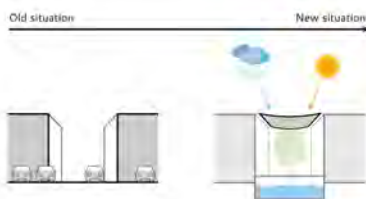

### FROM STREET TO SHARED PAVEMENT

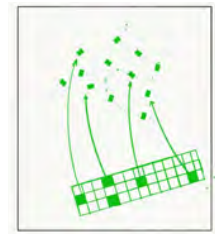
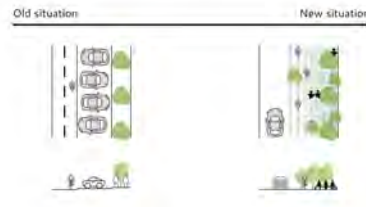

Unpack green space – make oases





Unpack green space – make oases

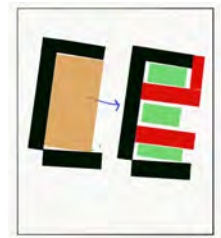
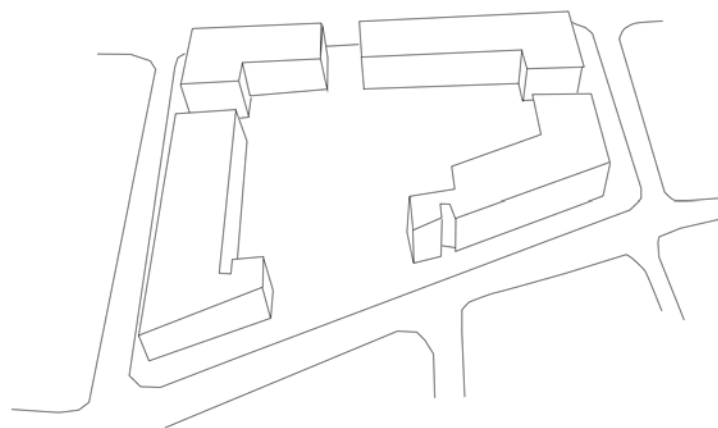

Densify urban space – create shade





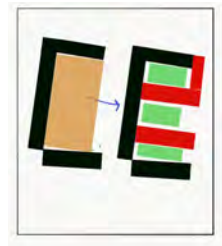

Densify urban space – create shade

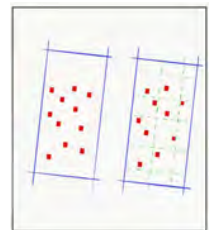
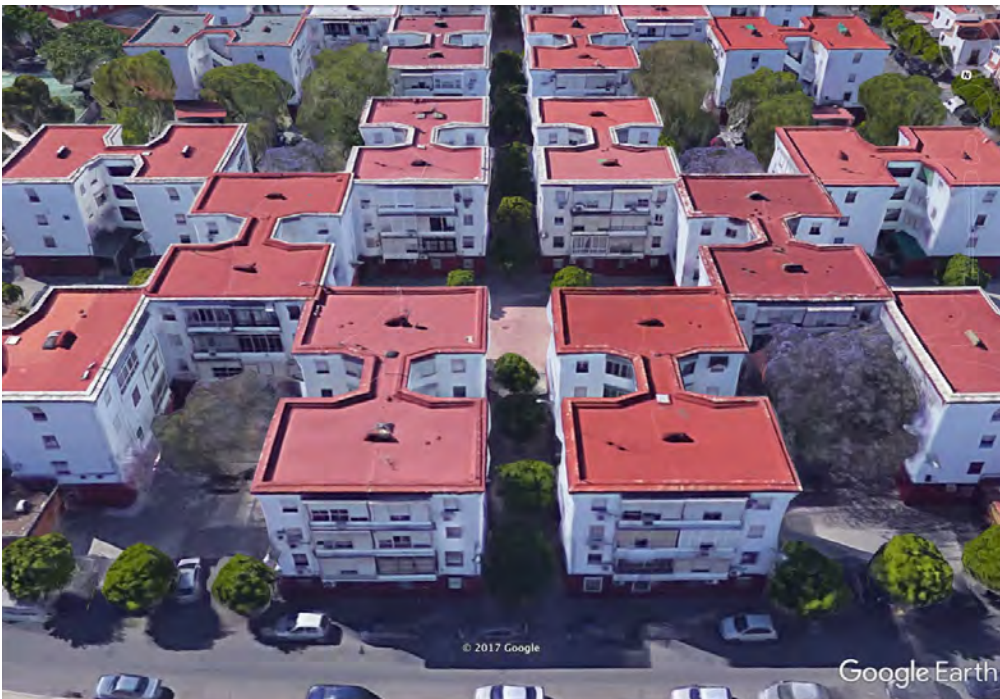

Make small green routes





Make small green routes

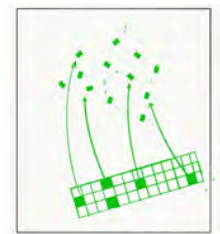
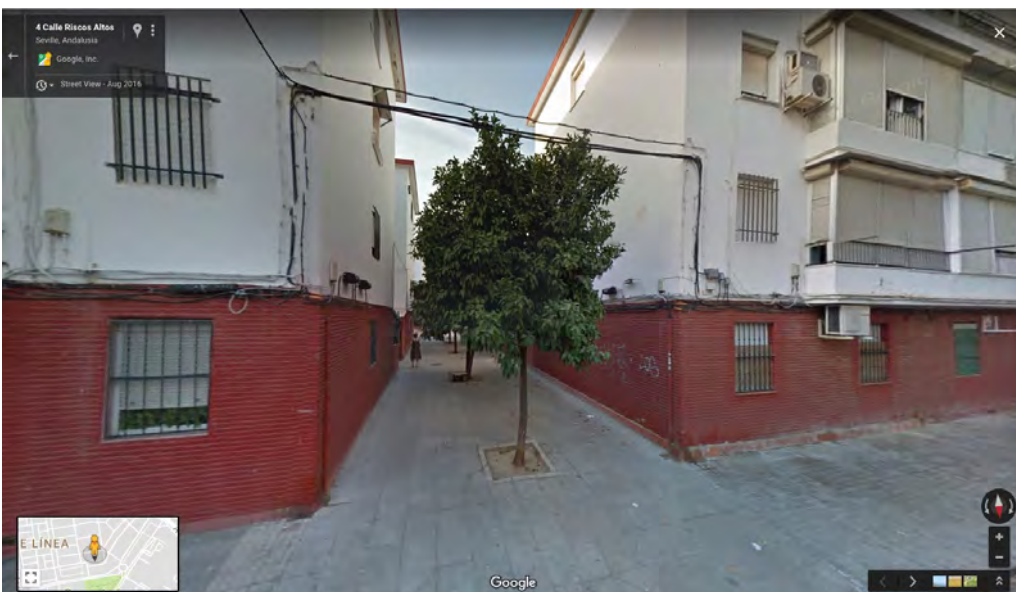

Unpack green space – make oases



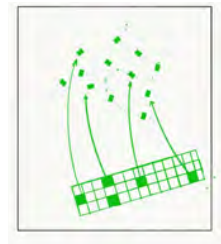

Unpack green space – make oases

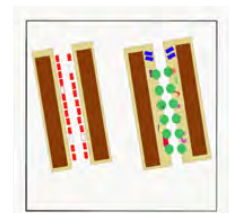

Reclaim the street – with car-share!



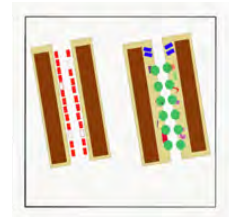

Reclaim the street – with car-share!

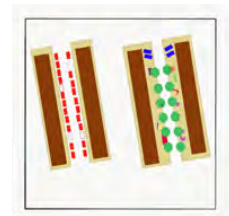

Reclaim the street – with car-share!



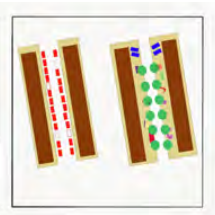

Reclaim the street – with car-share!

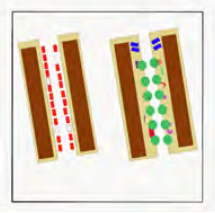

Reclaim the street – with car-share!





Bike-friendly routes go through the neighbourhood

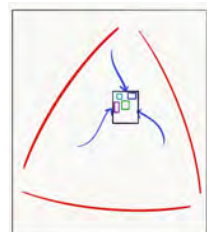

Repack the neighbourhood





Unpacking the market makes new exciting public space



Unpacking the market makes new exciting public space



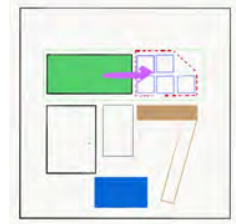
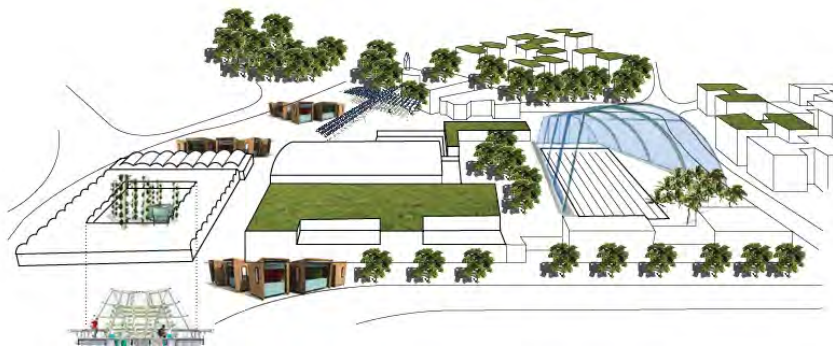

Unpacking the market makes new exciting public space



Unpacking the market makes new exciting public space





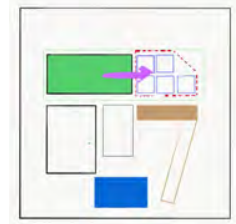

Unpacking the market makes new exciting public space



**NOW**



To conclude



## STEP 1: 25% GREEN



## DIFFERENT GREENS



**MICRO | TINY COURTYARD | RULES**  
 Ability to sit  
 One tree/plant/pot



## STEP 2: 50% GREEN



**MESO | ROOFTOP GARDEN, LARGER COURTYARD | RULES**  
 Ability to sit comfortably and meet friends  
 More greenery  
 Shaded



### STEP 3: 75% GREEN

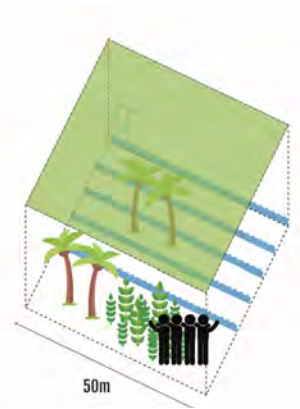

MACRO | STREET, CENTRE (POOL) | RULES  
Activities present  
Fully green  
Shaded  
Water



### STEP 4: 100% GREEN



## CARBON FOOTPRINT MITIGATION MEASURES

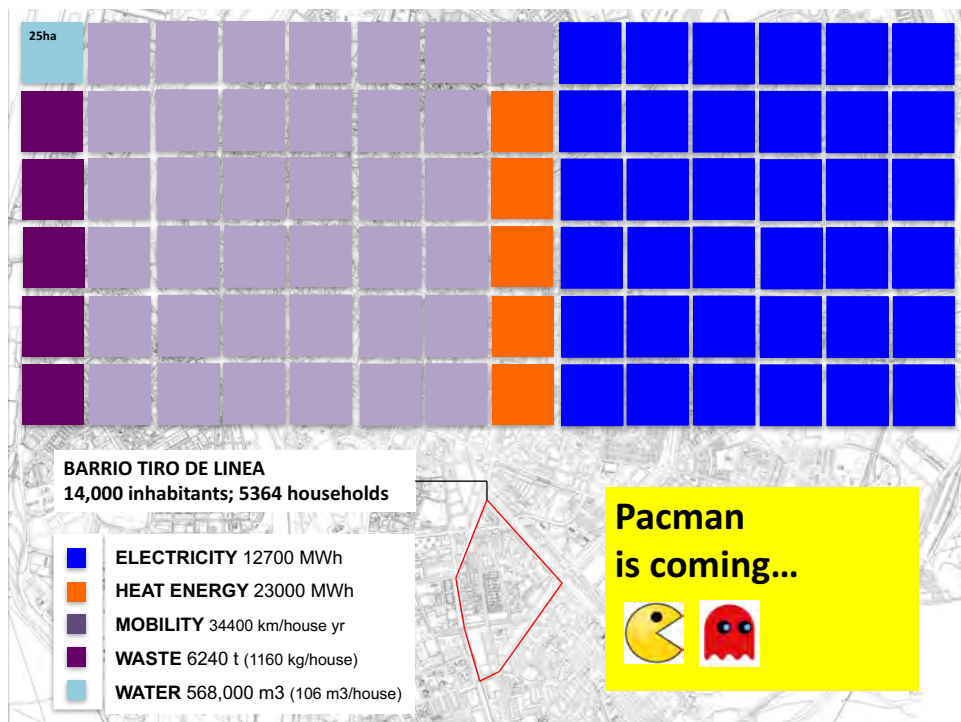

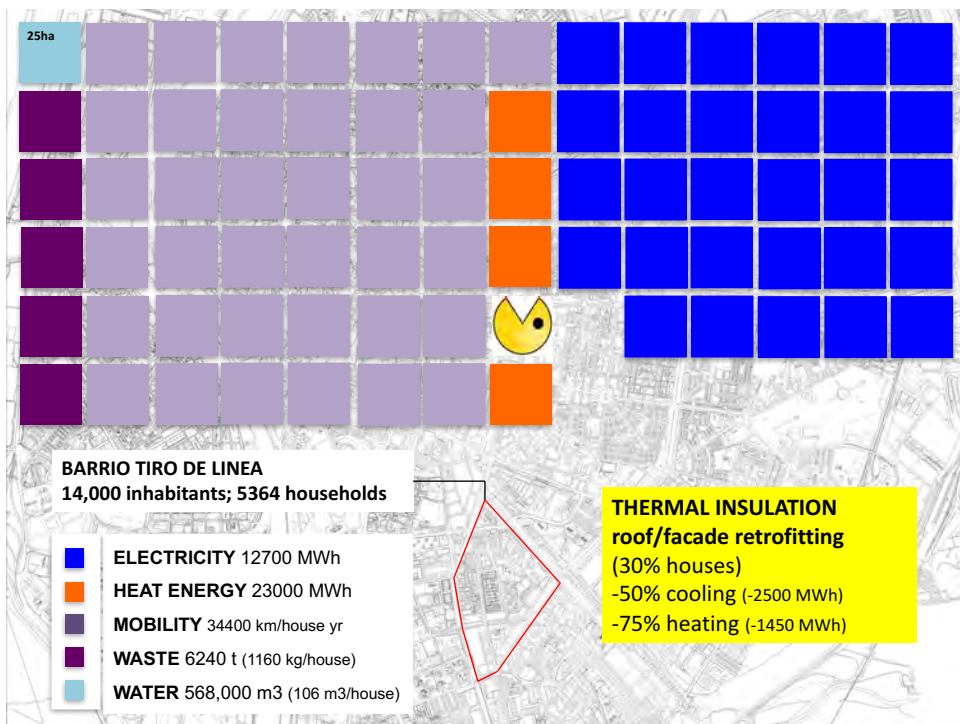
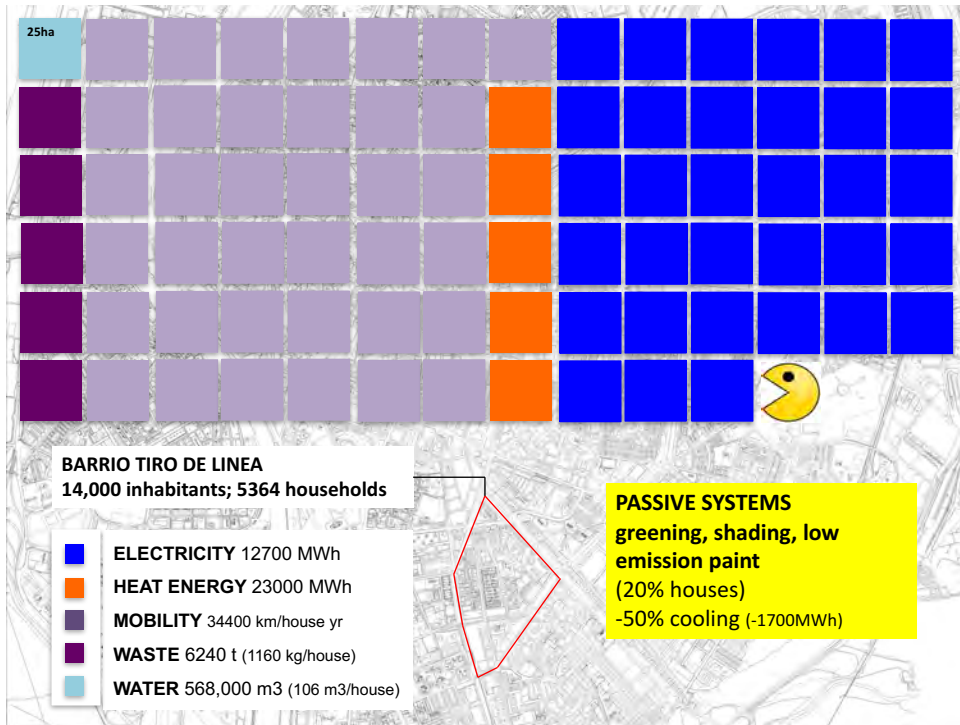

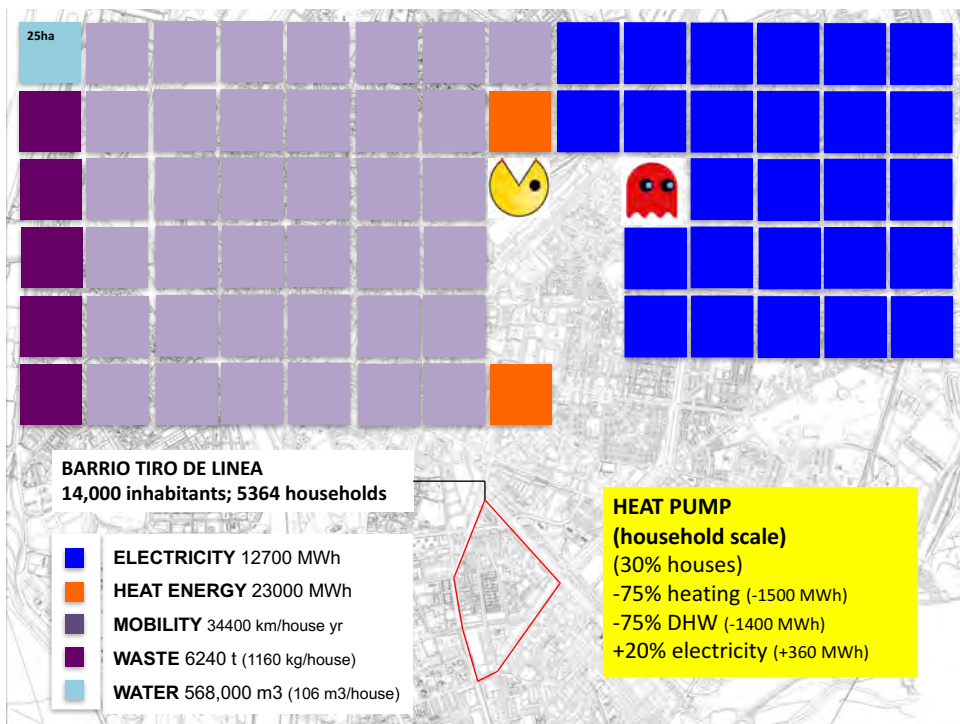
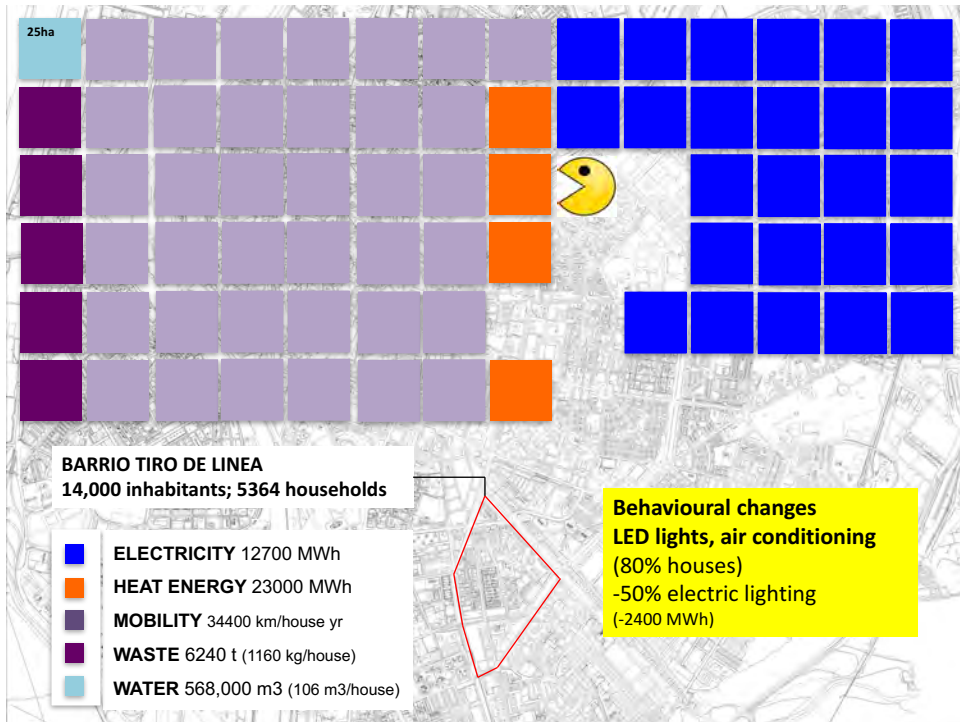

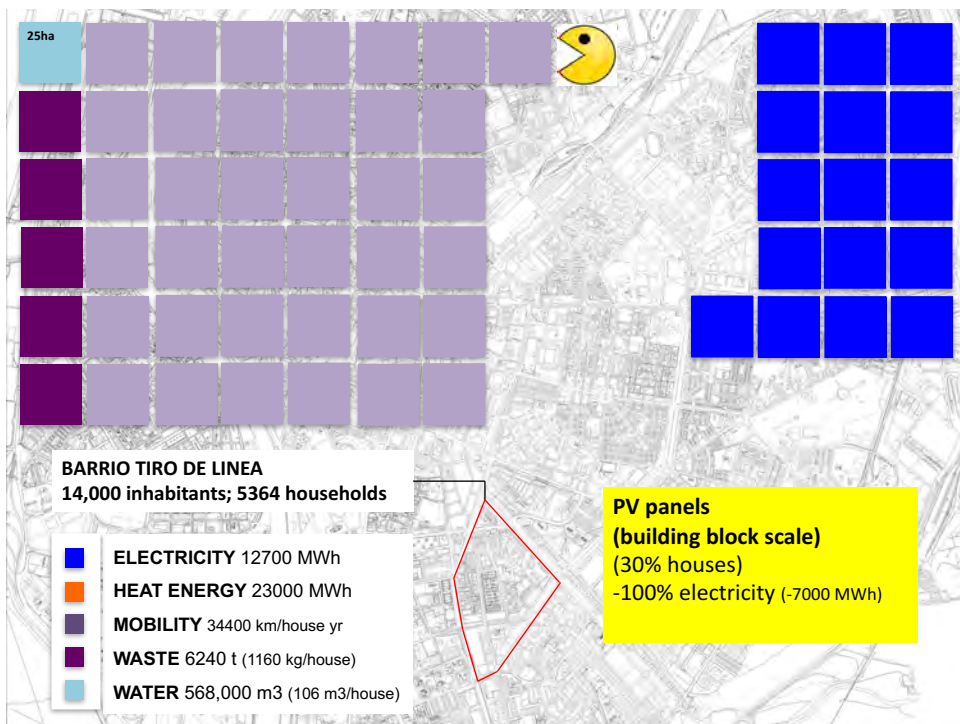
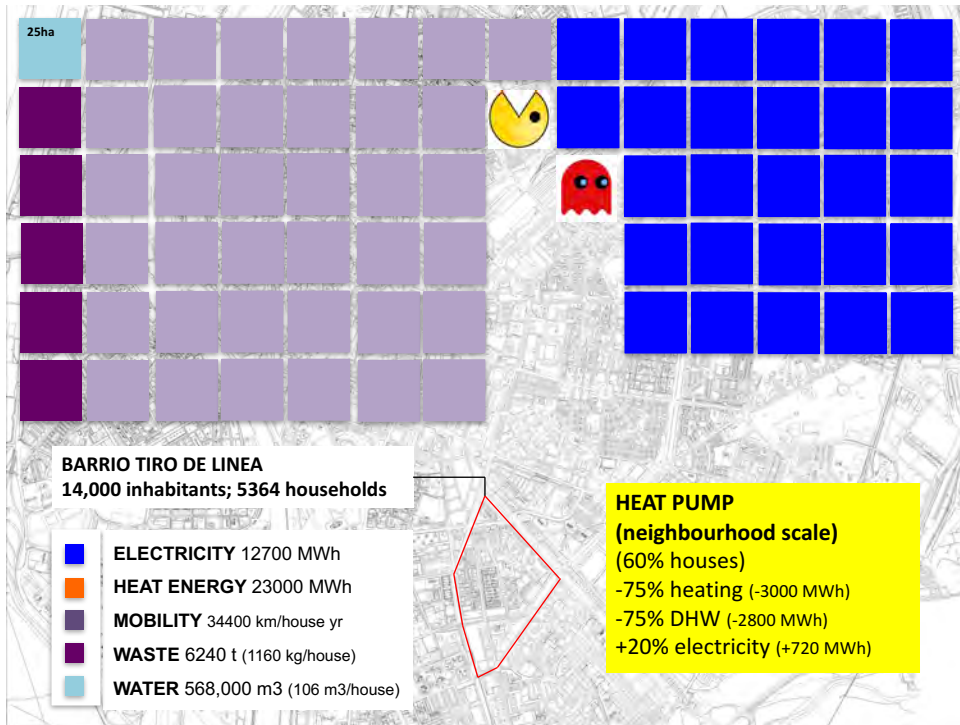

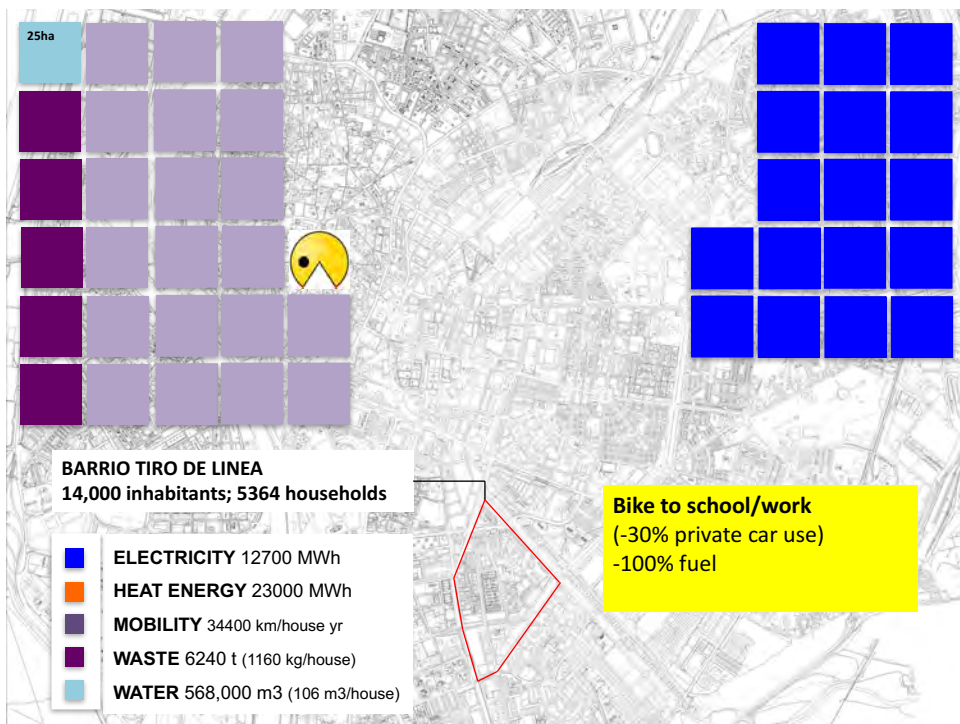
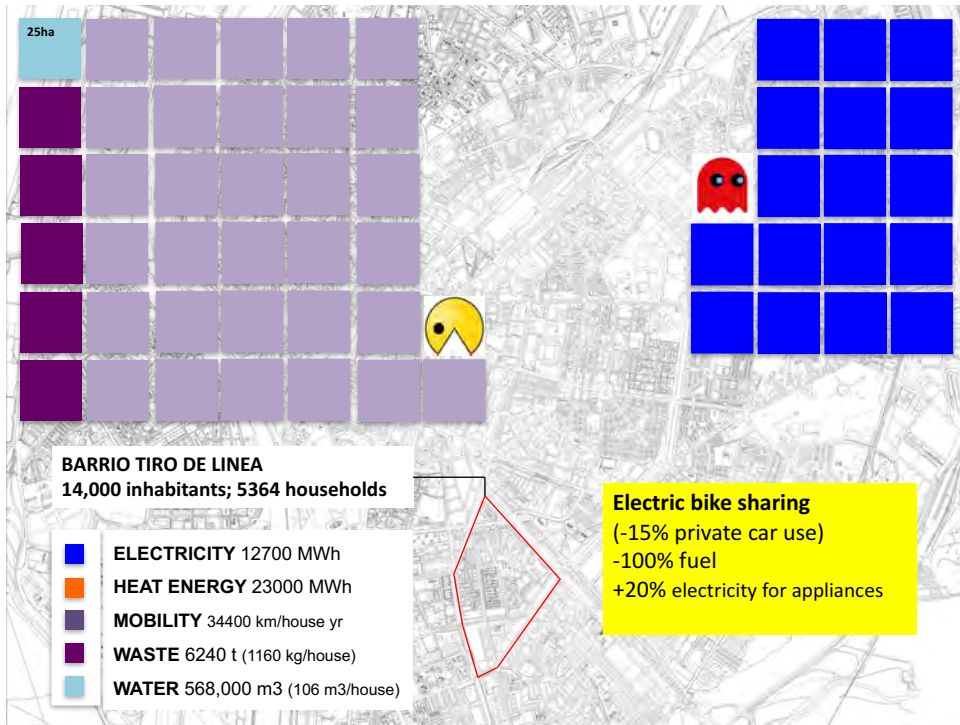



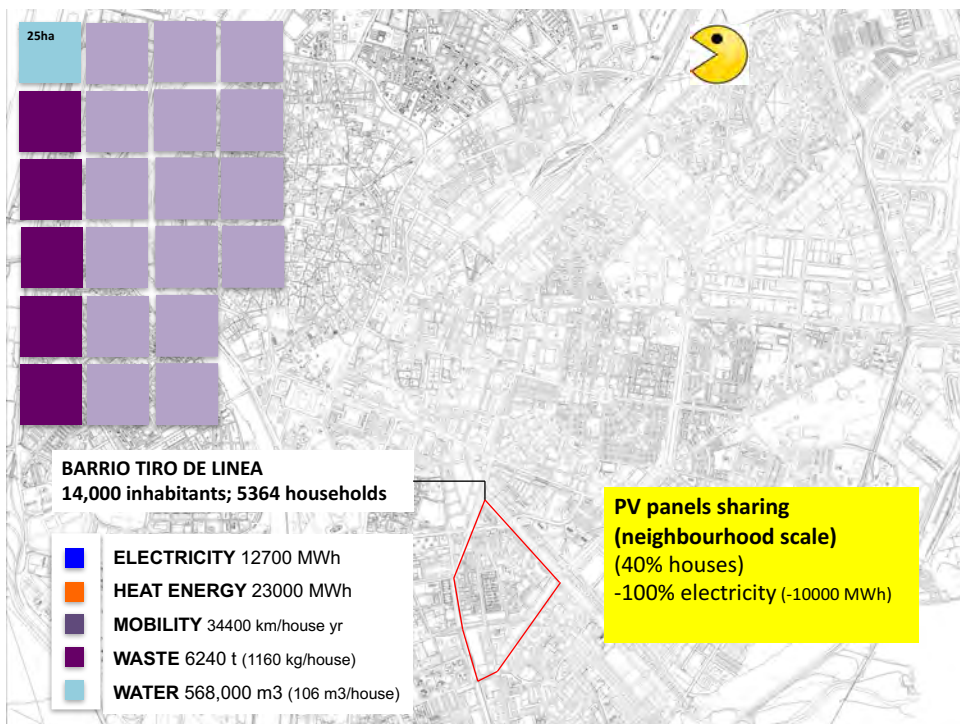
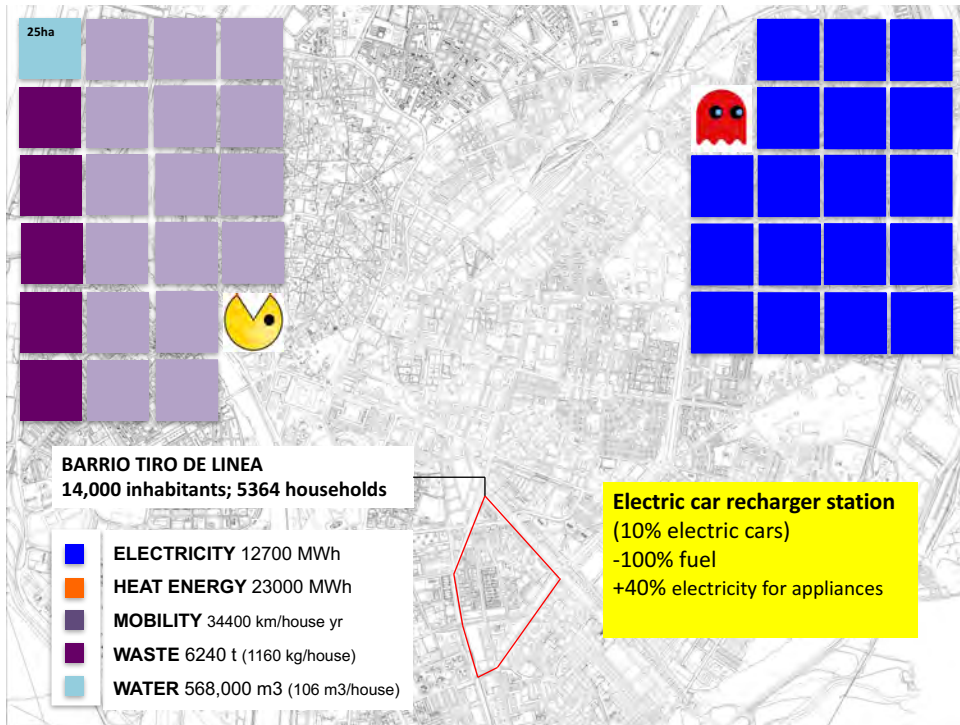

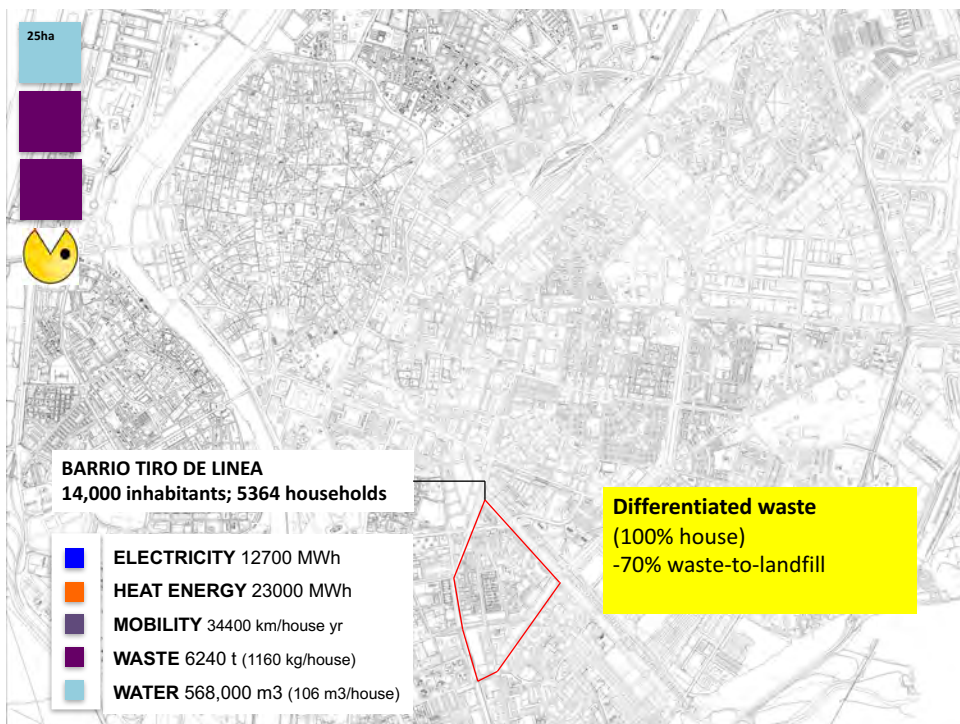
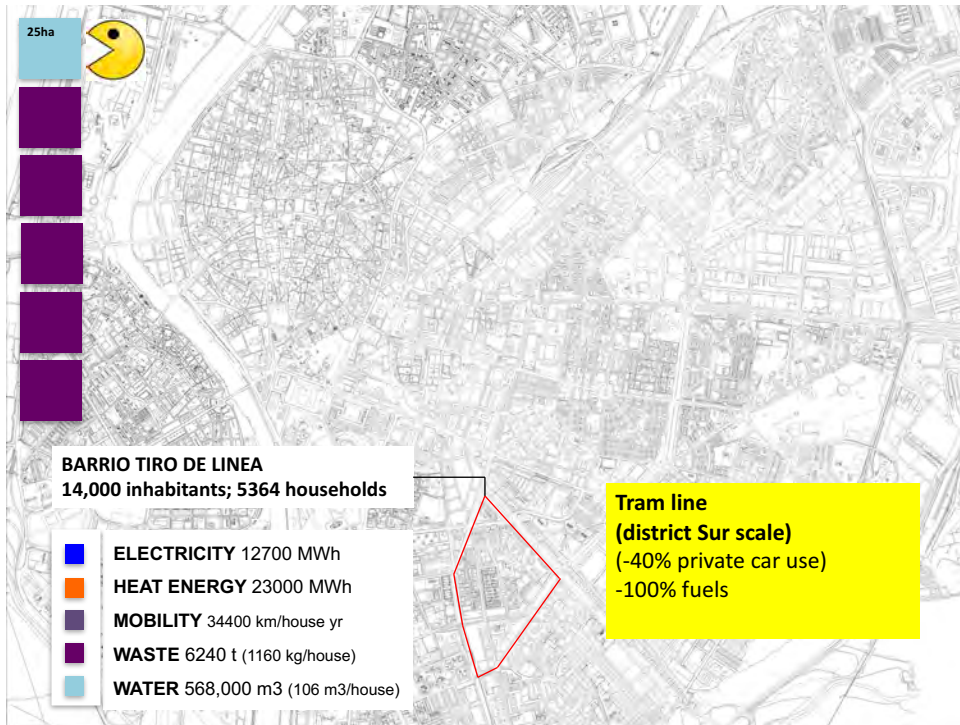

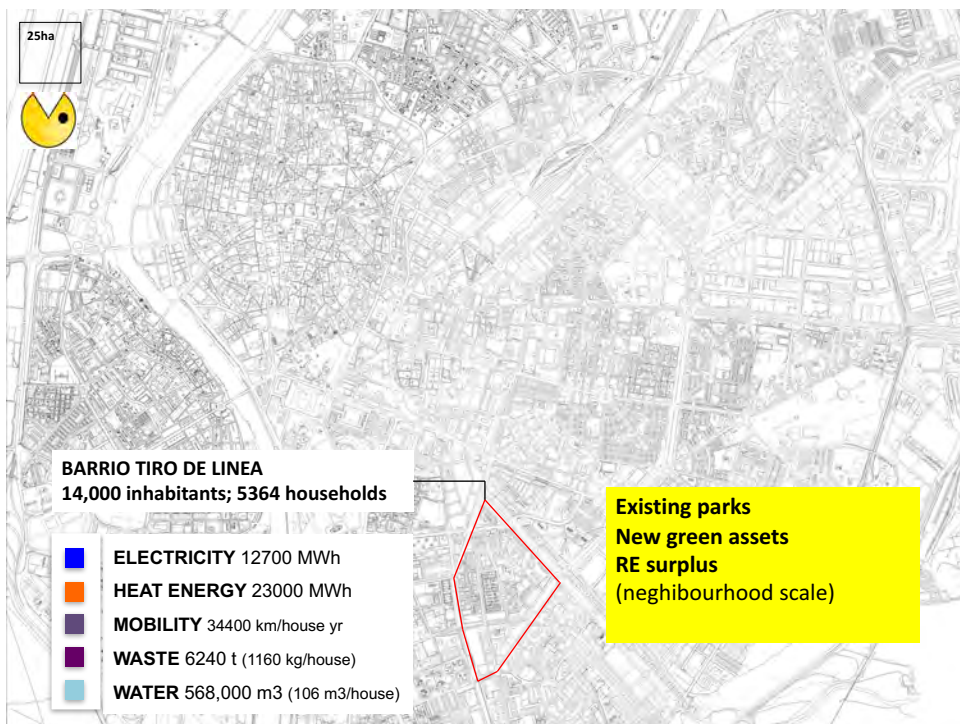
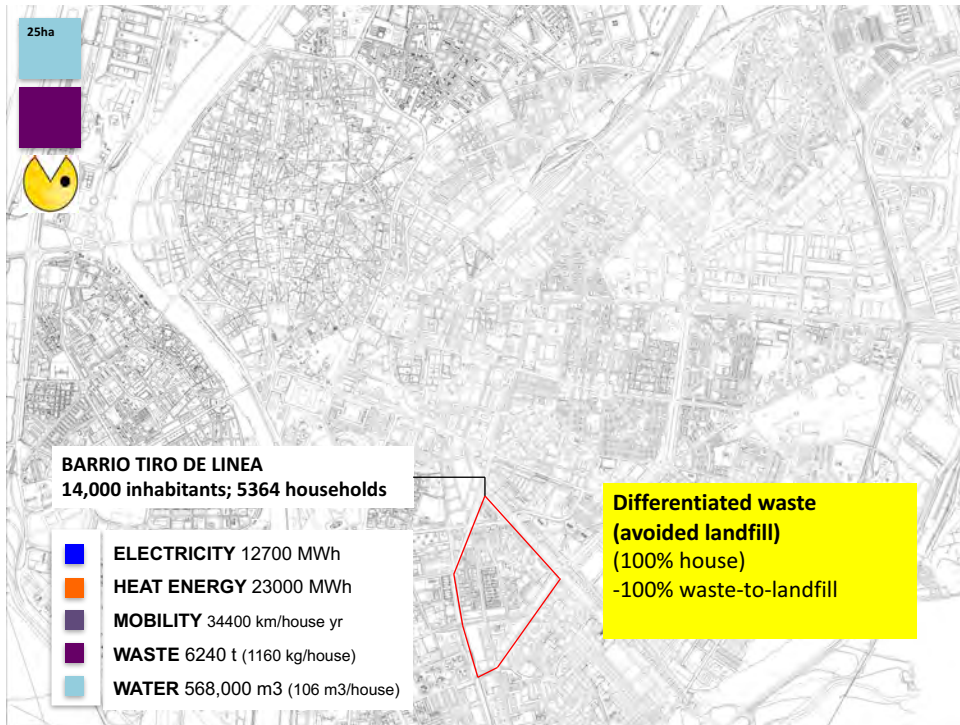

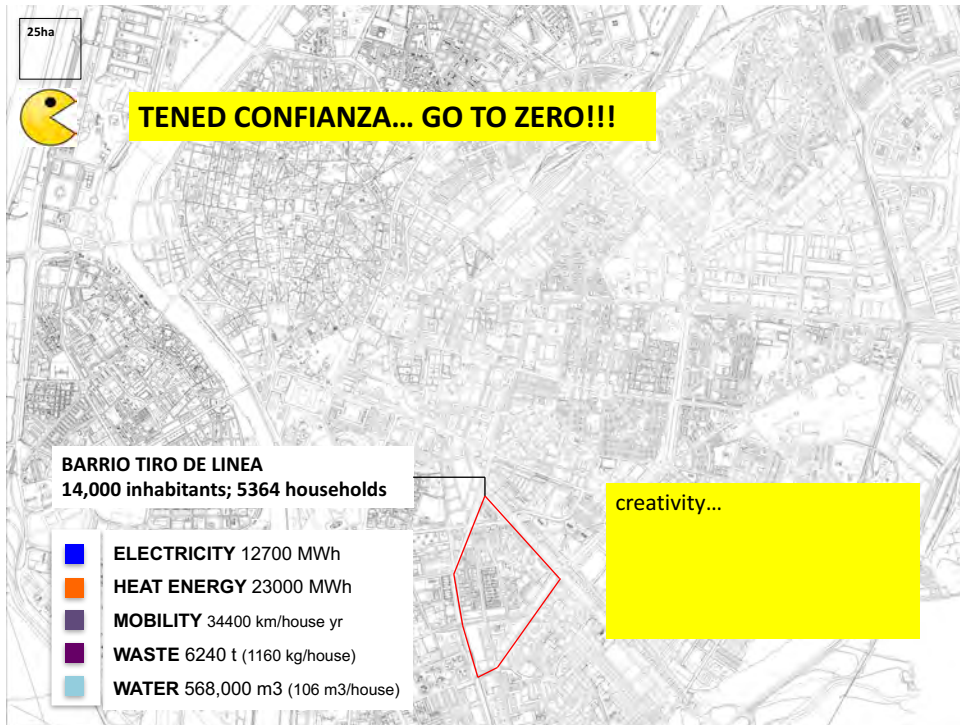

# Roadshow

Sevilla – Taller energía



Co-funded by the European Union's Seventh Programme for research, technological development and demonstration

