THE NEW NEWSROOM

LAMRITHA GANAPATHYI

THE NEW NEWSROOM

The news has always been a public program.

Before the printing press was invented, word of mouth was the primary source of news, gathered and distributed through pubs, inns and markets. The invention of the printing press brought an autonomy in news production, technology made the news more coherent, content controlled and regulated, ensuring that the same news travelled to more people. This, according to Victor Hugo, transferred the responsibility of conveying human thought from architecture to printing, from “the book of stone” to “the book of paper”, which was far more solid and durable; and now to “the book in the cloud”, that is more permanent still through its physical absence.

“This will kill that... Printing will kill Architecture”.¹

“The book of paper” was still monumental, immortalised through its multiplicity. The power and autonomy of the press still ensured grand newsroom buildings, and tall skyscrapers where the paper was produced, that continued to be a prominent part of the public urban environment like the public halls of Fleet Street in London, the Hall of Inscriptions of the Chicago Tribune, and more recently, auditoriums and retail spaces in the New York Times, and event spaces and debate centres as part of the curated public program of the Guardian.

In an era where we have multiple news sources, an overwhelming number of opinions through the social media, every tweet and facebook post, considered news, goes onto the immortal web of the internet; the newsroom is not an autonomous organisation for news production. Though this allows for smaller organisations and different voices that occupy abandoned warehouses, former residential buildings, the multiple contradictory outputs have caused the news to lose its credibility.

The New Newsroom puts the gathering, productive and digestive spaces of the contemporary newsroom within the well traversed path in the city, through the form of an arcade, to renew its relevance within public life, while presenting an opportunity to increase its credibility by being in constant public view.

Born out of industrial overproduction and new goods that flooded the market, arcades in 19th century Europe consolidate and put in public view the new products of industrial luxury. The symmetrical sky-lit interior street acting as a shortcut within the dense city blocks provided a way for the extension of public space on private property. While they were extensions of streets, with interior facades, signage, colours and lights of the commercial establishments, they were covered, protected from the weather, hence behaving like a public drawing room, where the collective *lives, experiences, understands and invents*.²

The New Newsroom utilises these architectural elements, incorporating them into a productive space; the shop windows look into podcast stations and screening rooms, benches along the interior façade act as social space, the street lights give a hazy domestic glow to the productive news floor, that acts as a constant backdrop to a frantic city life.

1 Victor Hugo, *The Hunchback of Notre Dame*: Book V Chapter 2 (Paris: Gosselin, 1835), 1.

2 Walter Benjamin, *The Arcades Project* (United States of America, The Harvard University Press, 2002), 879.

The materials assembled in this catalogue are representative of the research work carried out. The material is organised in the form of chapters, each of them is a collection of reference materials from archives, libraries and newspapers, written material from literature, research papers, websites, and opinion pages, including summaries, connections, findings and conclusions written and drawn by the author.

Organised into four chapters, the studies of newsrooms and arcades in general, and the cases of the Voix du Nord and the Grand Place, in particular, the catalogue shows the development of each of these ideas, phenomena, theories and spaces over time.

The ordering of materials within each chapter does not follow a chronological logic, but rather groups certain concepts, ideas and spaces together through a subjective reading of both found and created material, choosing to see the past, the present and the future simultaneously.

CHAPTERS

A	Grand Place, Lille	7
B	Echo du Nord, Voix du Nord	16
C	Newsrooms	30
D	Arcades	40
	Expert Conversation 1	47
	Expert Conversation 2	52

A

[Grand Place, Lille]

Originally, in the 11th century, the medieval square was used as a bustling wheat market. These days the beautifully preserved historic buildings surrounding the square, together with its myriad of cafes and terraces, still makes it an obvious choice for a rendez-vous and a good place to commence any sight-seeing tour. Around the square there are a number of very impressive buildings.

_ *"The Lille Guide,"* Grand Place with Vieille Bourse – The Lille Guide, , accessed November 20, 2017, <http://www.lille-guide.co.uk/sights/grand-place-with-vieille-bourse.html>.

In the 14th century, the place became a market place, a place of celebration and a place of execution where the death row prisoners were exhibited. The annual fair and daily demonstrations of the army and religious processions also took place in the Grand Place. _ A1

The Grand Place in the 15th and 16th Century was the nerve centre of trade, alleys from it were occupied by a multitude of specialized shops: cheese makers, weavers, shoemakers, potters, silver handlers, the public weight, that contributed to the hustling market on Grand Place. _ A2

The Corps du Garde in the 16th century replaced the meat market leading to Place St. Nicholas on one of the back alleys, forming one of the small network of shortcuts, pedestrian networks only for the well-informed through the city. _ A3

The historic square of Lille, much more than its belfry, is a real symbol of the city of Lille, the "capital of Flanders" and capital of the new Nord-Pas-de-Calais-Picardy region (Hauts-de-France) . The 155 m long and 72 m wide square, now called "Place Charles de Gaulle", Grand Place style, is typical of the urban ensembles of the cities of the former Netherlands. Former marketplace dating from the fourteenth century, it has retained its role of Grand Place as a place of life, celebration and trade. _A4



Grand Place in Lille, 2017 is a major tourist attraction. The Bourse houses the book market and souvenir shops, the square is filled with terraces and cafes. _ A5.

"Bibliothèque municipale de Lille, 44332-1-1, 27". "Lille : La Grand'Place, un jour de Bourse", début XX siècle ; 9 x 14 cm.



LILLE. — La Grand'Place, un jour de 'Bourse. - LL.

A Stock Market day in Grand Place, early 20th Century. The square is filled with a horde of potential investors, also flocking to small businesses that are present in the square. Cry of vendors of stock exchange lists on the street: In the event of a rise in prices, "Rise in the stock market!" In the event of a fall, "Variations in the Stock Market!." The term "fall" was forbidden by the police._A6

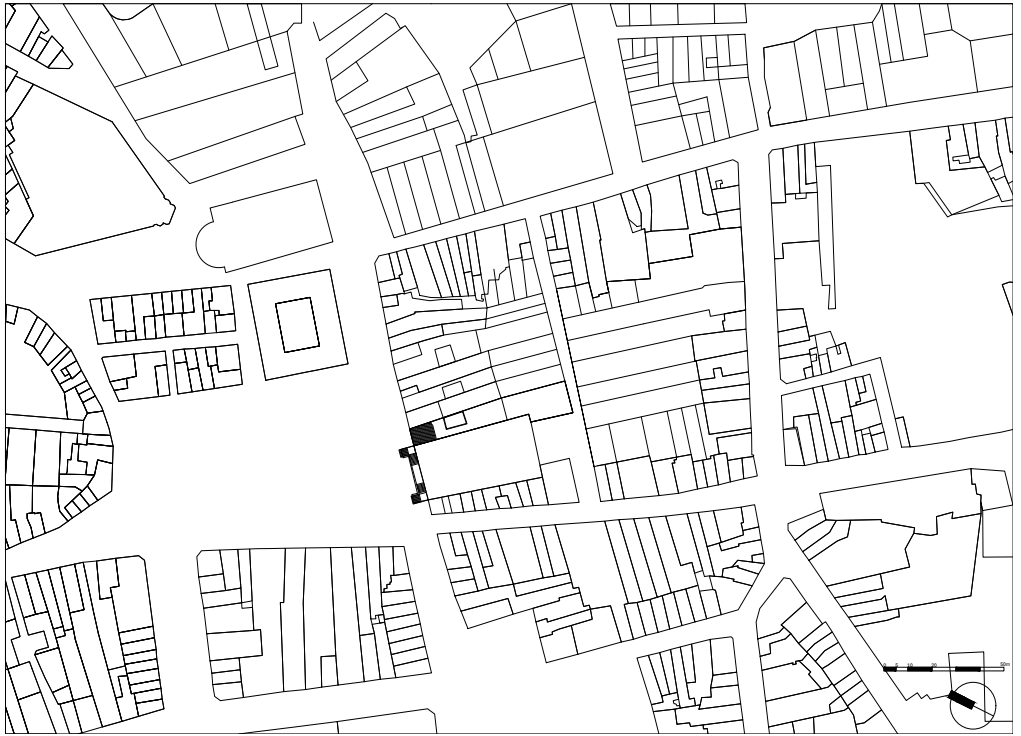

The Echo du Nord, a newspaper for the region was established by printer Vincent Leleux in the commercial market square, its large printing presses operating out of the market. _ A7

Bibliothèque municipale de Lille, 44332-1-1, 26". "Lille : La Grand'Garde". début XX siècle ; 9 x 14 cm.

32. - LILLE. - Le Grand'Garde. - E. C.



© Bibliothèque municipale de Lille - 44332-1-1, 26.

The entrances to the printing press are present on the square, the aerial distinguishing it from the residential buildings and commercial establishments adjacent to it. _A8

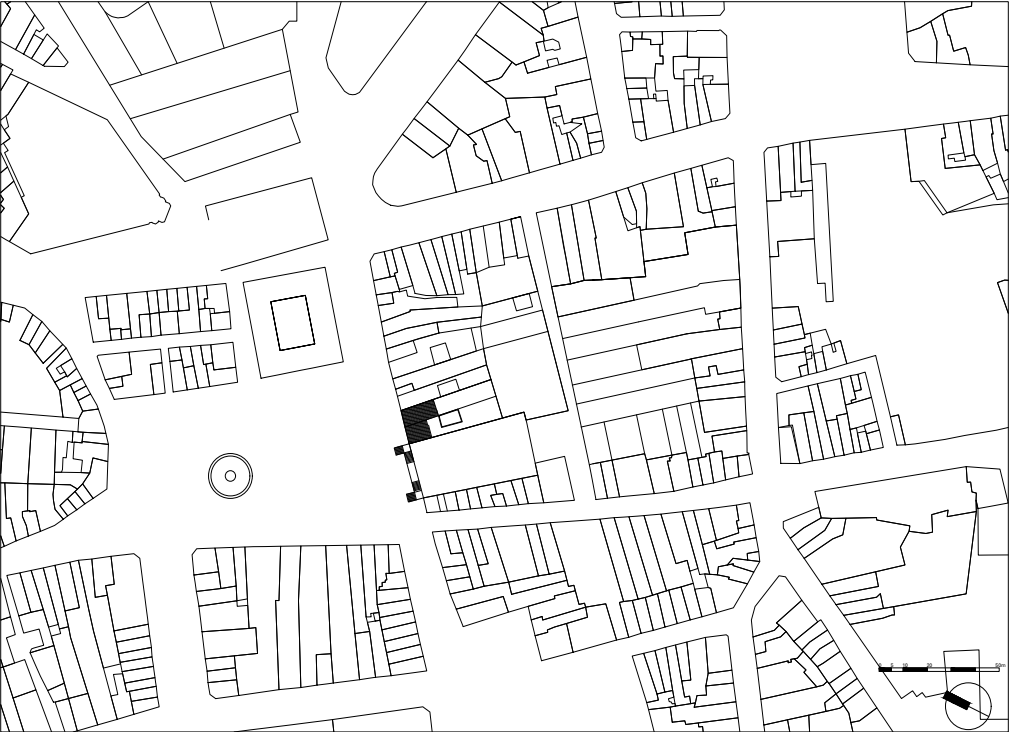

The commemorative column of the Goddess was inaugurated in 1845, to honour the bravery of Lille during the Austrian attacks of 1792. The newspaper offices, at first struggling due to opposition from the Royal Press, grew in size after the declaration of Republic. [A9](#)

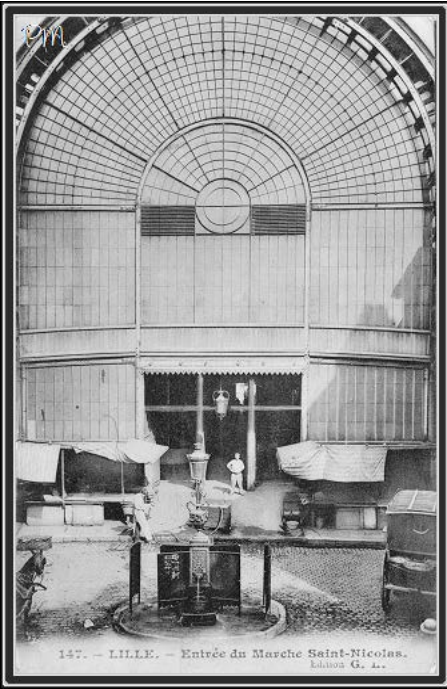

The entrances to the Marche St. Nicholas, with a fountain and square at the back of the facade at Grand Place. [A10](#)



The newspaper was rebuilt in 1936, becoming the tallest and most prominent building on the square, even overpowering the Stock Market and the Grand Garde. _A11



The Grand Place in 1959. _A12



The Grand Place, 2000. The newspaper offices grow in size to occupy the entire block, now one of the largest headquarters building in the historic centre of Lille. _A13



The Grand Place, 2020. The newspaper offices have shrunk, occupying only a small portion of what they used to. _A14

"Bibliothèque Municipale de Lille, carton 25, 8", "Lille : Station de la procession sur la Grand'Place". 16 x 22 cm



The Grand Place, 1918. The procession of Grand Place following the end of the First World War, and the end of the Siege of Lille. _A15



www.alamy.com - HT80G3

The Grand Place, March, 2017. The protests at Grand Place against employee cuts as the Social plan is applied to Voix du Nord. _A16



The Grand Place, 2008. People gather outside the *Voix du Nord* on March 3rd, 2008, to welcome actors and crew of record breaking French film, *Bienvenue chez les Ch'tis*. _A17.

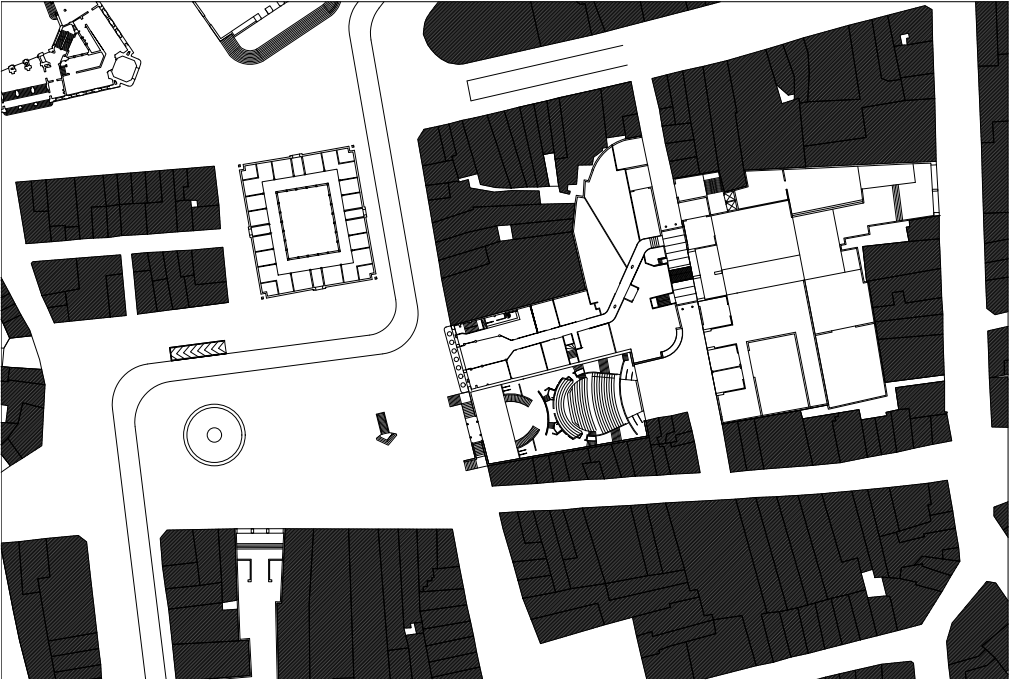

The Grand Place , 2017. The Old Stock Exchange, the offices of the newspaper, the Chamber of Commerce are all permeable at the ground level nail salons, shops selling clothes and electronic products, next to souvenir shops selling fridge magnets of the Bourse, and old copies of the Voix du Nord, with the entrances to the newspaper pushed to Rue St. Nicholas, almost invisible, where they can be accessed only through a checkpoint with manned security. _A18

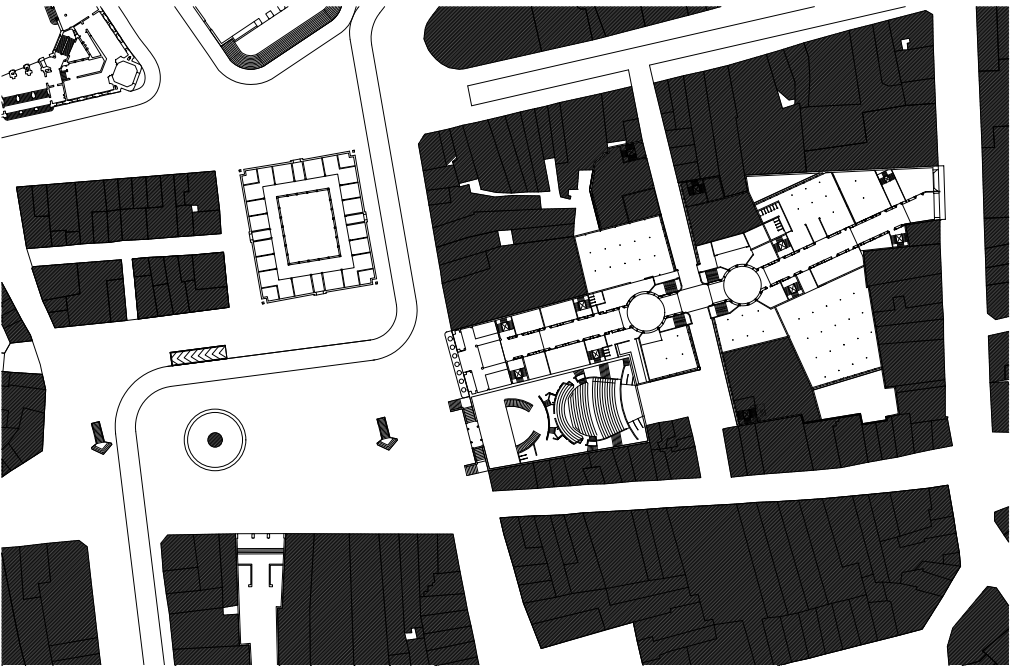

The Grand Place , 2020. There is an arcade connecting the Grand Place, running all the way through the block. There are debate centres, event spaces, screening rooms, that offer a real connection with the central square of Lille. Lille, is experienced through the atmosphere that makes it; not by drinking coffee at the Old Stock Exchange and buying a souvenir. _A19.

B

[Echo du Nord, Voix du Nord]

Echo du Nord was founded in 1819 by Vincent-Jacques-Joseph Leleux, a printer in Lille. The first issue is published August 15, 1819. Defender of liberal principles, it is opposed to the royalist press, represented in particular by the *Quotidienne de Lille*.

- "Grand Écho du Nord." Wikipedia. November 23, 2017. Accessed November 28, 2017. https://fr.wikipedia.org/wiki/Grand_%C3%89cho_du_Nord.

The Grand Echo du Nord was a daily regional newspaper, whose premises - as well as the printing press - were located on the Grand'Place. At the dawn of the first war, some 150,000 numbers were dispatched each day. _B2

During the First World War , the newspaper is requisitioned by the occupier and it is no longer the Great Echo North that is published, but the Liller Kriegszeitung [Lille War Diary] ._B3

The *La voix du Nord* or *the Voice of the North*, a regional french newspaper for the Northern region, with its headquarters at Lille; was built in 1936 replacing the La Echo'du Nord at the same premises and with the same staff._B4

Since 2005, the newspaper after a period of confused ownership and management, is owned by the Belgian based Rossel Group. Under Jean-Michel Bretonnier, editor-in-chief of La Voix du Nord , the newspaper is the first in the regional daily press to pass in colour. On September 19, 2010, the Nord-Pas-de-Calais daily newspaper became one of the first regional newspapers to be available on the iPad. The dailies of the group Voix du Nord are completely colorful", AFP , 2009 (Accessed 28 September 2009) _B5

In January 2017, after the announcement of a large-scale social plan, the newspaper cut a quarter of its staff, i.e .178 posts of which more than 70 jobs of journalists. The social plan is the consequence of the decline in dissemination and publicity, as well as "inadequate turnover on the Internet". According to the Alliance for Press and Media Figures (CMPA), the distribution of La Voix du Nord, the country 's third largest regional newspaper behind West - France and South - West, fell by 4.6% to 217,000 copies between July 2015 and June 2016, in a context marked by a decline in advertising revenue (-5.2% for regional dailies in the first months of 2016). Florian Guadalupe, "Social Plan to" The Voice of the North "：“ Most employees have learned it in ‚Les Echos‘ ,, , ozap.com , January 5, 2017 (Read online) lefigaro.fr and AFP, AP, Reuters Agencies , ,, The Voice of the North: a quarter of the workforce threatened by a social plan._B6



The Echo du Nord, as established in 1819. _B7



The Echo du Nord, Grand Echo du Nord et du Pas de Calais, Liller Kriegszeitung, operating from the same premises. 1918, Lille _B8

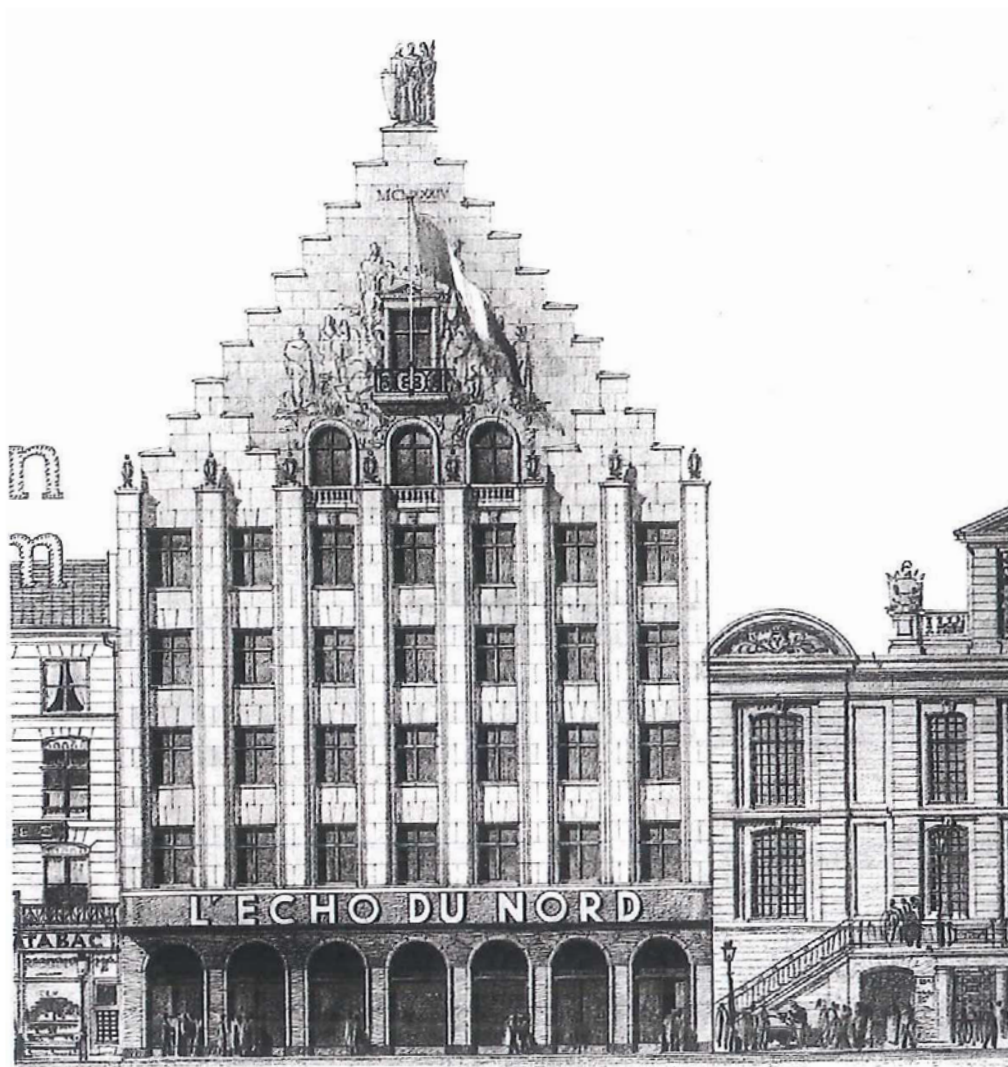

L'Echo du Nord, Façade on Grand Place, 1936 designed by Albert Laprade, Leon Emile Bazin and Ernest Willoqueaux _B9

“The bales floors are separated by cross-shaped pilasters according to local tradition, which end with lily flowers borrowed from the coat of arms of the city. The spandrels are decorated with twenty-eight armoures communes of the region, escutcheons proud cities of the North and Picardy: Armentieres, Roubaix, Bethune, Saint-Pol, Montreuil, Avesnes, Hazebrouck, Amiens ..., way of underlining the vast field of influence of the journal. The pediment, treated as a sparrow, illustrates the motto of the newspaper, “Defending Work in the Northern Region”, and presents a pyramid of characters in bas-relief which symbolize the different trades. Fronton, framing a window monumental balcony treated in the manner of the Renaissance, forms a triangle of some six meters high decorated with bas-reliefs symbolizing the arts and sciences, industry, agriculture, trade and sports. The fact of this generous composition is crowned by a group of statues representing the northern provinces.

The old guild houses, each facade of which referred to a trade, are condensed in an unique building which, dominating the heart of the city, brings together all aspirations, speak for all. Stone Conference on the Industial Engineering of the People of Here.” - (*Maurice Culot, Albert Laprade: Architecte, jardinier,urbaniste, dessinateur, serviteur du patrimoine, 305*) _B10

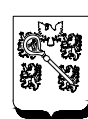
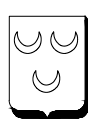
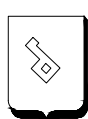
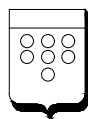
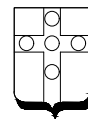
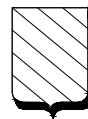
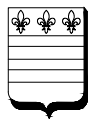
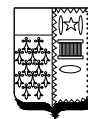
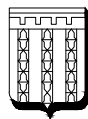



La Voix du Nord, Facade ca. October, 2017. The ground floor has been occupied by a retail gallery_B13

Introduction of information technology into the management of the newspaper, and phasing out of lead and photo-composition made it possible to organise direct input into the agencies for printing. With extension into radio and television programmes, participation with other regional newspapers and weeklies, the La voix du Nord reached the peak of its presence in 1994-95, with subscriptions reaching the peak of 300,000. (La Voix du Nord.“ Wikipedia. June 28, 2017. Accessed July 02, 2017. https://fr.wikipedia.org/wiki/La_Voix_du_Nord)_B14

Galerie Grand Place and fnac store occupy the publicly accessed ground floor in 2017, that leads from Grand Place, crossing through Rue St. Nicholas and Rue du Sec Arembault, along Rue de Paris to Rue de Molinel, as a part of an interconnecting shopping network through the dense inner blocks of the city centre. _B15

Voix du Nord offices in 2020, along with debate centres, screening rooms, event spaces, occupy the passage leading from Grand Place to Rue Sec Arembault, through Rue St. Nicholas, thus having three facades for the newsroom._B16



© Bibliothèque municipale de Lille - J247.

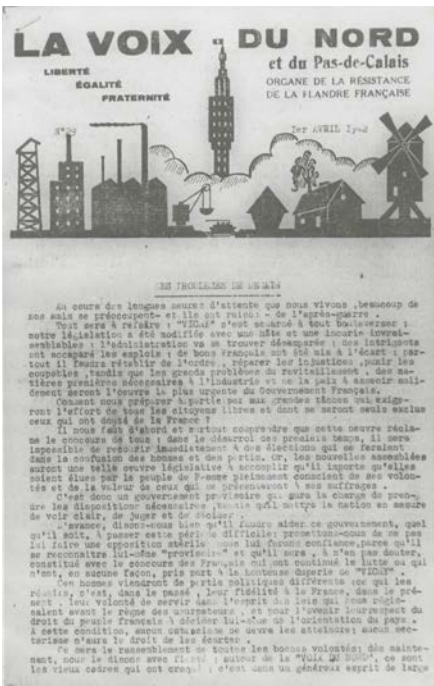

The newspaper format through its stages of evolution, through developing technology, ownership, first with printing presses within the building to outsourced printing in 2017..

_B17

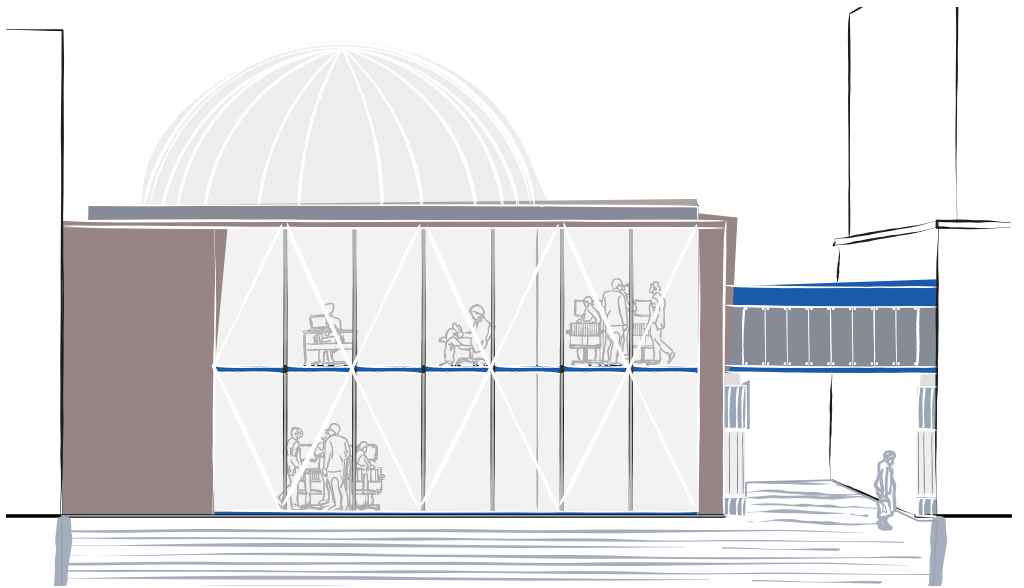

The facades of the newsroom, *Voix du Nord*, 2020 _ B18



Facades at Grand Place, Place St.Martin, and Rue sec de Arembault , mark the opening of the arcade *Voix du Nord*. From vitrines facing the street, and unlocked entrances revealing a depth. From the facade at St. Martin, one can see the newsroom through the glass and steel facade, with vitrines, that stick out onto the street mark the entrances to the arcade.
_B19

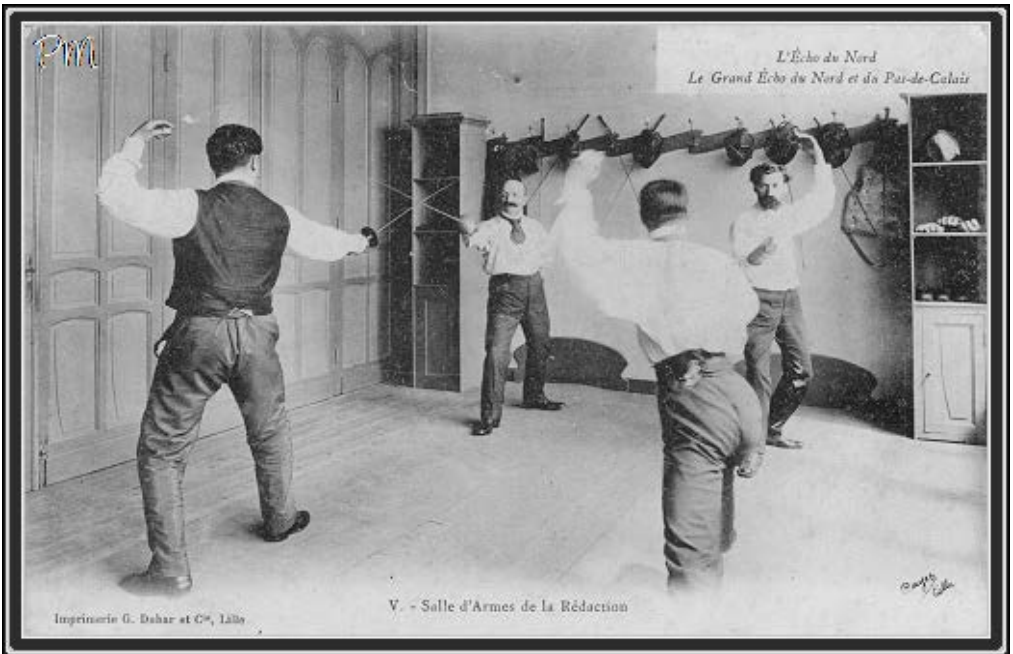
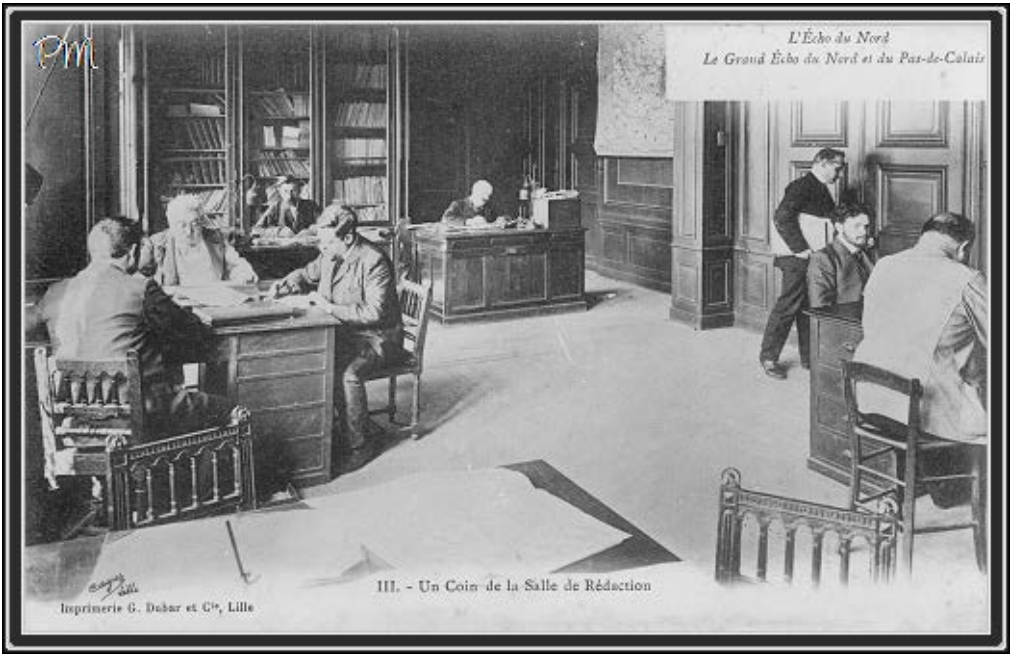

L'Echo du Nord, journalists working and weapons room in the newsroom, pre 1900_B20

La voix du Nord newsroom space and open meeting areas._B21

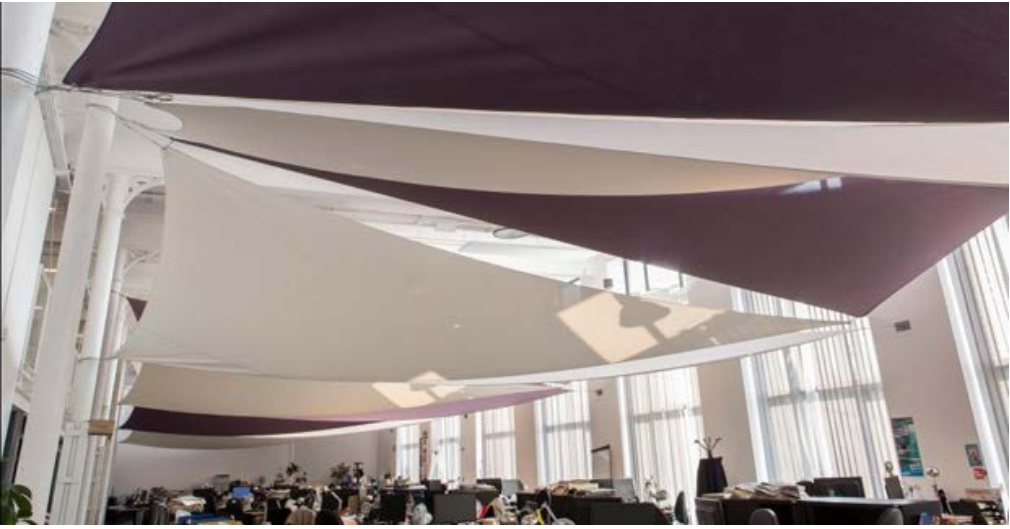

The hot composition system (lead) is gradually abandoned in favor of the cold composition (bromide).

In 1982, the Pilaterie factory was established, and the printing industry switched to Offset printing and four-color printing, moving the printing presses from the building at Grand Place.

In 2009, La Voix du Nord completely renovates its Pilaterie printing fleet, for colorful newspapers and a publication 7 days a week.

In 2012, it installs a new editorial system (CCI) that paves the way for the acceleration of a mixed paper and digital offer. _B22

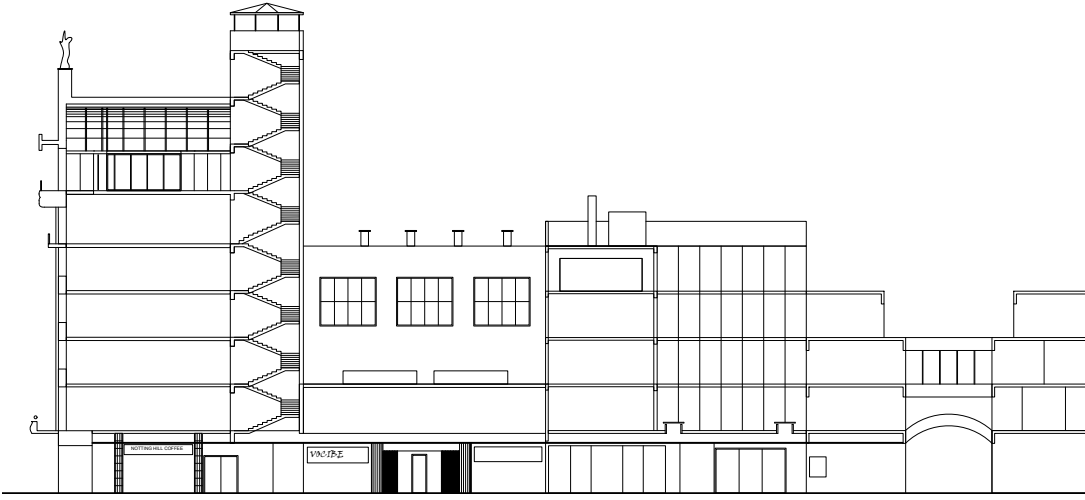

The Galerie Grand Place, 2017, runs from Grand Place to Rue de Arembault, with cafes, nail salons, herbal and electronic stores. The newsroom on the upper floors that have grown over time, are now gradually emptying. _B23

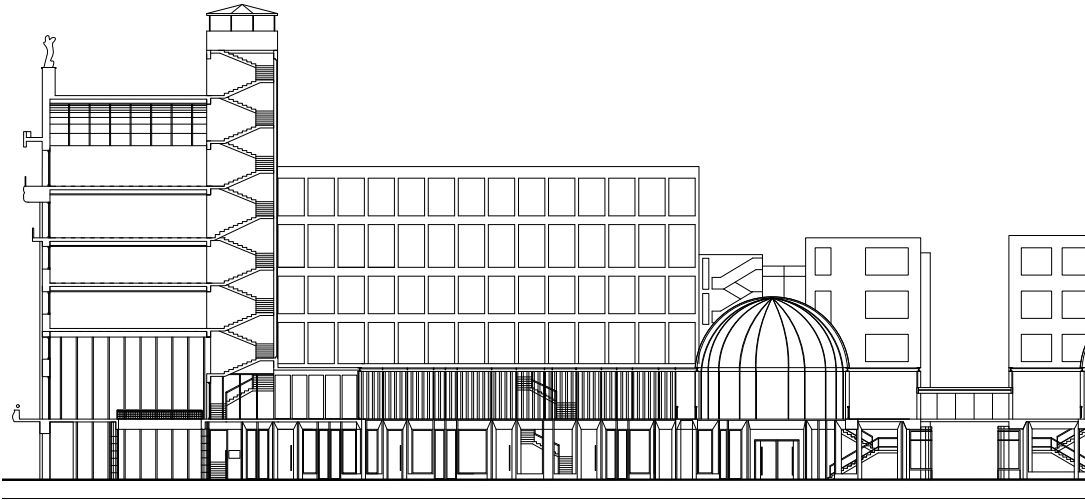

The Arcade Voix du Nord, 2020, runs from Grand Place to Rue de Arembault. Podcast stations, screening rooms, debate centres occupy it, while they also make a quick shortcut through the urban block, while providing access to the residences above. _B24

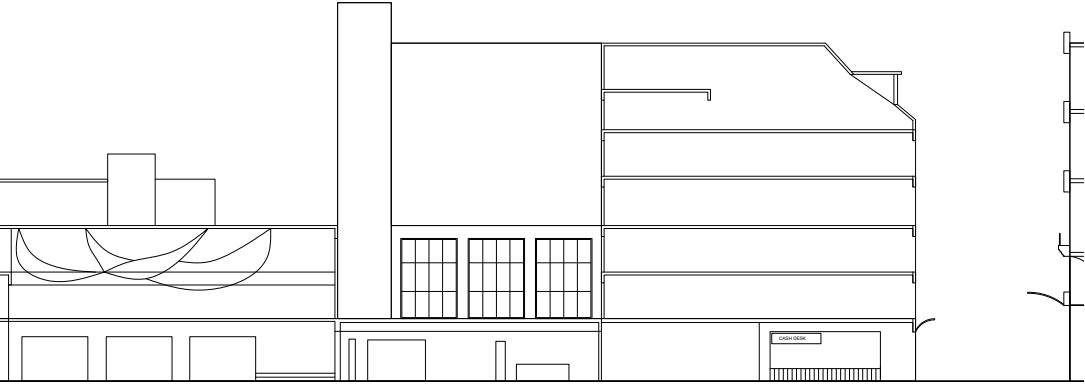

C

[Newsrooms]

“This will kill that. The book will kill the edifice.”

“...the dominant idea of each generation would no longer be written with the same matter, and in the same manner; the book of stone, so solid and so durable, was about to make way for the book of paper, more solid and still more durable.... It meant, “Printing will kill Architecture”.

_ Victor Hugo, *The Hunchback of Notre Dame*: Book V Chapter 2 (Paris: Gosselin, 1835), 1.

Before the printing press was invented, word of mouth was the primary source of news, gathered and distributed through pubs, inns and markets. The invention of the printing press brought an autonomy in news production, technology made the news more coherent, content controlled and regulated, ensuring that the same news travelled to more people. This, according to Victor Hugo, transferred the responsibility of conveying human thought from architecture to printing, from “the book of stone” to “the book of paper”, which was far more solid and durable; and now to “the book in the cloud”, that is more permanent still through its physical absence._C1

In an era where we have multiple news sources, an overwhelming number of opinions through the social media, every tweet and facebook post, considered news, goes onto the immortal web of the internet; the newsroom is not an autonomous organisation for news production. Though this allows for smaller organisations and different voices that occupy abandoned warehouses, former residential buildings, or offices in remote business parks to reach millions, the multiple contradictory outputs have caused the news to lose its credibility._C2

With reporters and photographers utilising video studios inside backpacks, Google glass, smart-phone and smartwatches, and someday drones to cover the news, how much will the newsroom matter?

-Washeck, “What newsroom spaces tell us about the future of Digital Journalism.”
www.mediashift.org_C3

Big buildings in the centre of town, looked upon as the primary source of information are a thing of the past... for journalists of the 1960's, 1970's and 1980's, the newspaper building was one of the city's crown jewels, representing that municipality's integrity in news reporting, press freedom and community advocacy.

- Usher, “Moving the Newsroom-Post Industrial News Spaces and Places”. Tow Center._C4



The New York Times, The BBC Broadcasting House, Huffpost and the Correspondent, BuzzFeed and RTS offices with their urban context. Newsrooms are moving to the outskirts in suburbs, business parks and former industrial areas and hence losing their public presence._C5

The printing presses of 19th century Fleet Street had public halls where people waited for the news to be produced. Grand newsrooms of the early 20th century, like the Tribune tower had a hall of inscriptions proclaiming the freedom of the press and the ethics of the institution, they still distributed their ideas through a network of news stands, newsagents, and paper routes.

_C6

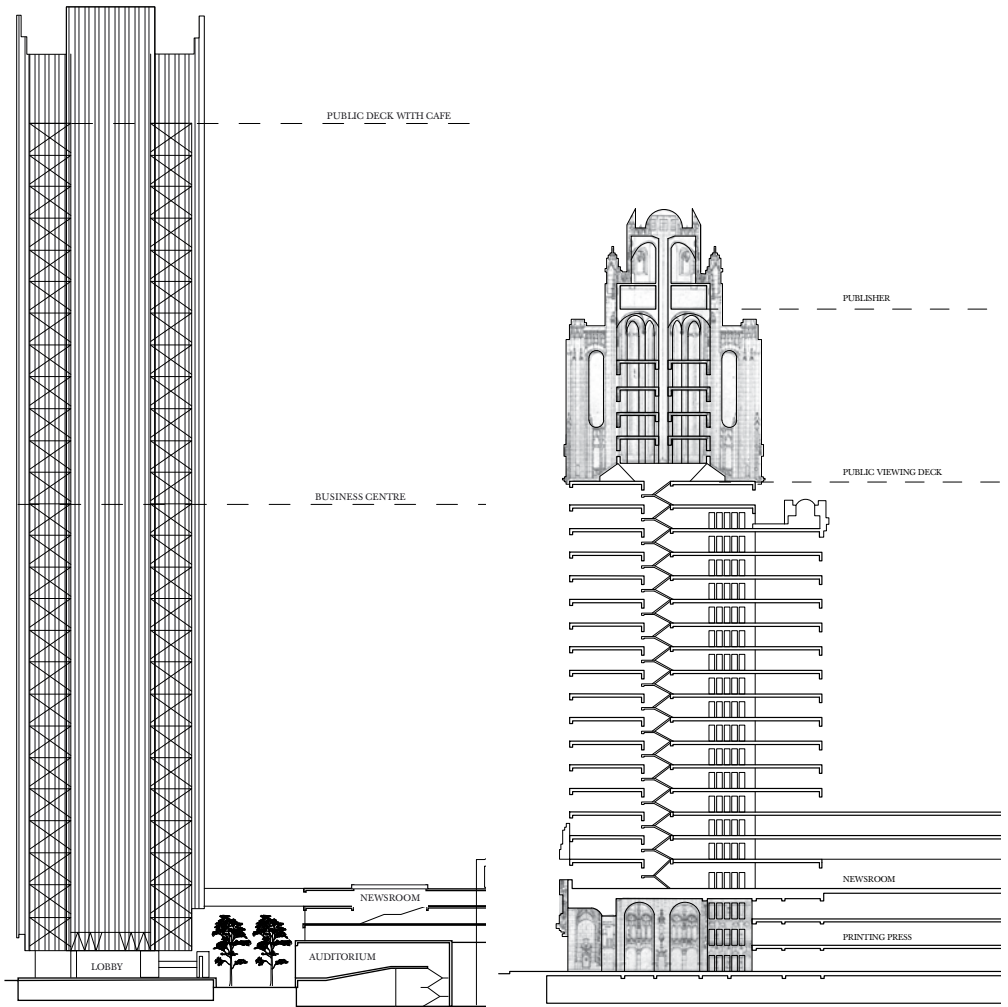

Newsrooms facades - New York Times, Chicago Tribune. Grand newsrooms for large organisations that visualise through the building the ideals of the organisation, through the hall of inscriptions, transparency, and even through a public program consisting of auditoriums and retail spaces._C7

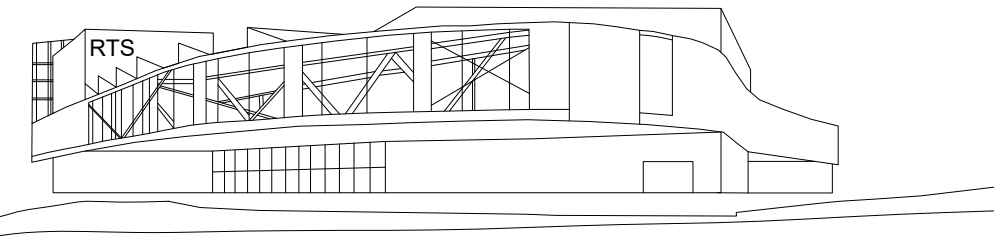
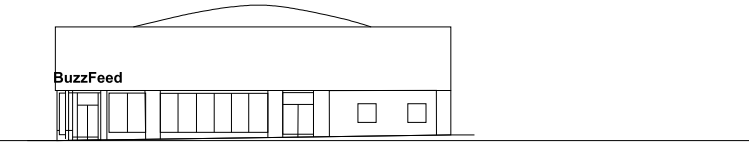

The Correspondent, BuzzFeed, RTS, contemporary news media organisations that operate out of residences, abandoned warehouses and business parks on the outskirts. _C8

The most famous office building, the art-deco masterpiece dubbed the Black Lubyanka, belonged to the Express, which the City of Sound blog describes as “a shining example of what Fleet Street was - a mythologised version of English journalism; a mythologised version of the intellectual life of a city, and a country”. The building is now owned by a merchant bank but the Daily Express and Sunday Express signs remain in the lobby.

_ Mark Oliver, “There will always be a connection,” The Guardian, June 15, 2005, , accessed November 20, 2017, https://www.theguardian.com/media/2005/jun/15/pressandpublishing.uknews2._C8

With reporters and photographers utilising video studios inside backpacks, Google glass, smartphone and smartwatches, and someday drones to cover the news, how much will the newsroom matter?

“What Newsroom Spaces Tell Us About the Future of Digital Journalism.” MediaShift. May 20, 2014. Accessed July 05, 2017. http://mediashift.org/2014/05/what-newsroom-spaces-tell-us-about-the-future-of-digital-journalism/._C9

“But the newsroom’s current organization creates dangers for the print newspaper – and is also holding back our ability to create the best digital report. Today, department heads and other coverage leaders must organize much of their day around print rhythms even as they find themselves gravitating toward digital journalism. The current setup is holding back our ability to make further digital changes, and it is also starting to rob the print newspaper of the attention it needs to become even better.”

- “Journalism That Stands Apart.” The New York Times. January 17, 2017. Accessed December 04, 2017. https://www.nytimes.com/projects/2020-report/._C10

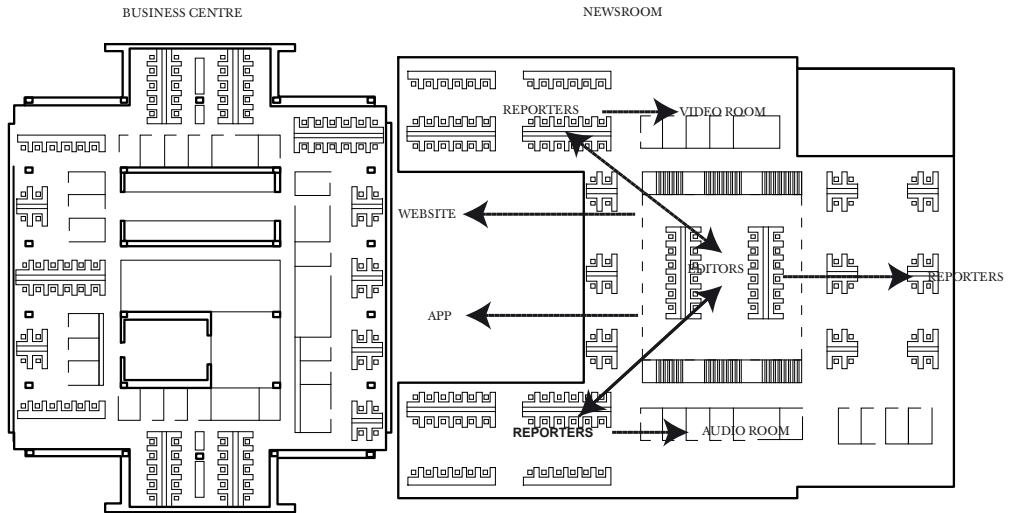

The New York Times organisation structure, 2007. The organisation of the newsroom, with division of tasks organised through the structure of the building is prohibiting it from adapting to the new age. _C11

MANAGEMENT

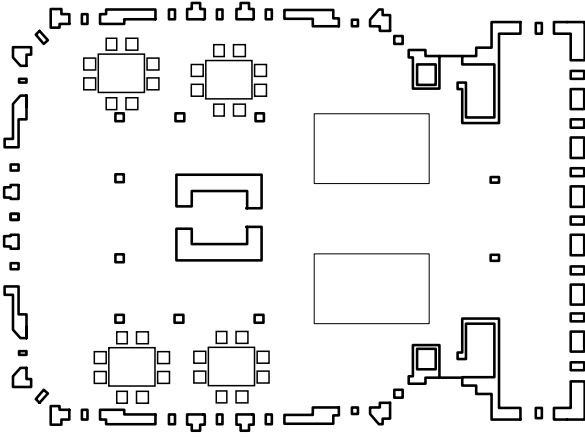

NEWSROOM

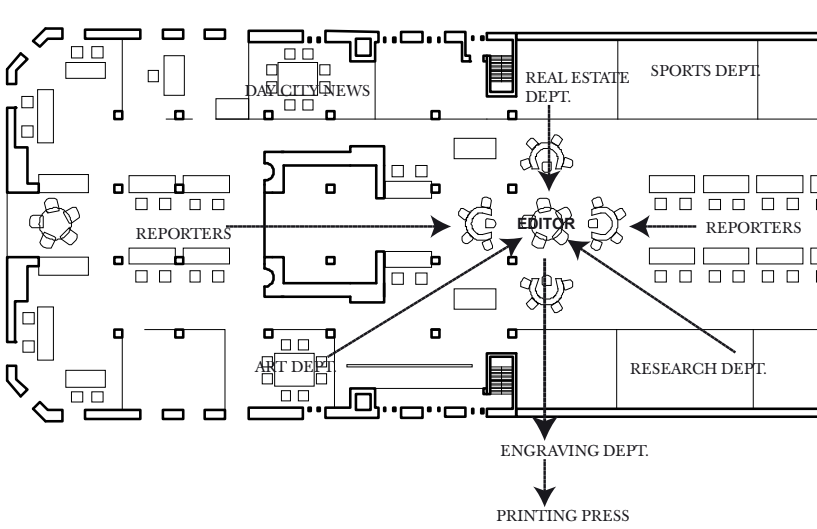

The Chicago Tribune, 1925. The newsroom is organised around a central editorial table, that co-ordinates organises and prepares all the content. _C12

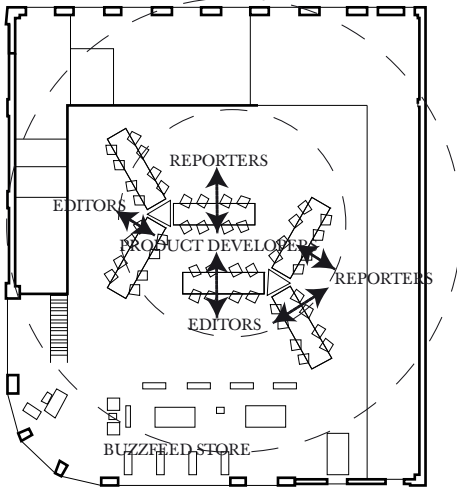
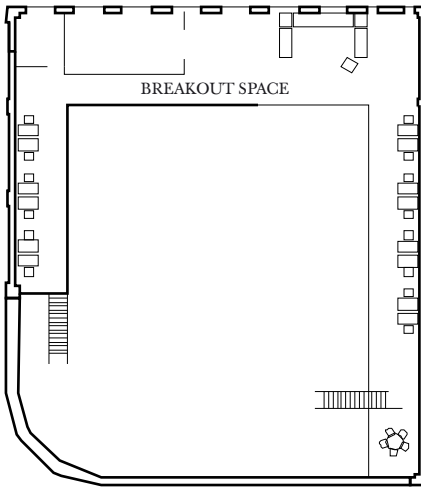

Buzzfeed, Los Angeles. The flexible office space with desks that are not assigned, and adapt according to contemporary trend of work culture where most do not com to work every day. _C13

“We have many journalists who do not work fom their desks everyday. Hence we have flexible workspaces, where only the editor and the deputy editor of each team is allocated a permanent desk, and the rest are free to sit where they please.”

- Dick van Eijk, Editorial Poject Manager, NRC Handelsblad _C14

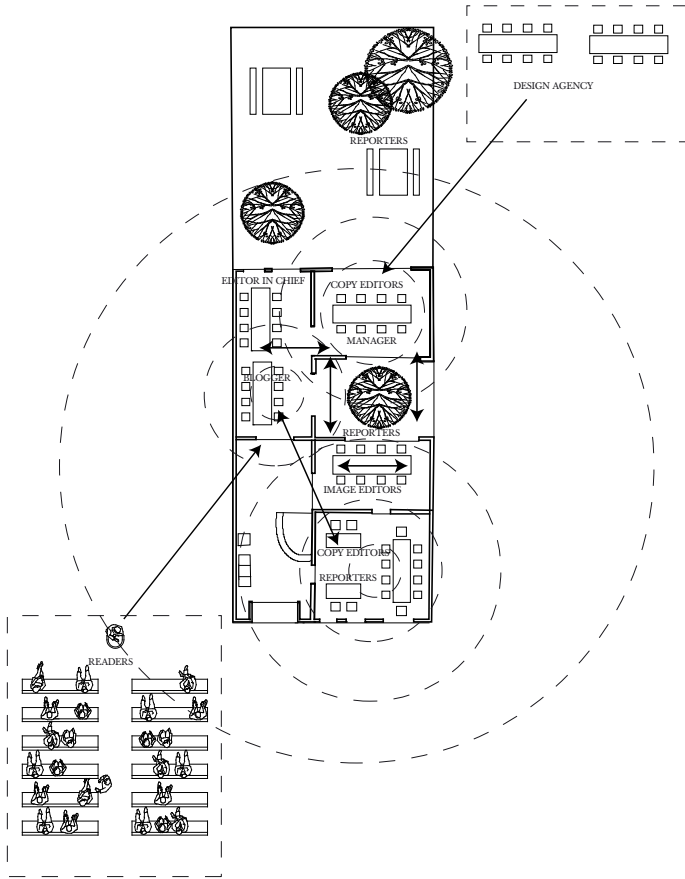

The Correspondent, 2016. The newsroom space consists of three desks, where everybody works together, using the same equipment, in a flexible organisation structure. _C15.

The increasing use of the Internet search function, primarily through large engines such as Google, has also changed the habits of readers. Instead of perusing general interest publications, such as newspapers, readers are more likely to seek particular writers, blogs or sources of information through targeted searches, rendering the agglomeration of newspapers increasingly irrelevant. “Power is shifting to the individual journalist from the news outlet with more people seeking out names through search, e-mail, blogs and social media,” - Nicholls, “Digital Born News Media in Europe”, 12-13. _C16.

“We have quite a small office. We are now around 50 people, and the office is too small. We are currently looking for new office space. At the office we have developers, image editors, social media (correspondents), journalists, all working in the same space. Even the Editor – in-chief does not have his own office.

We all stay work together; it’s kind of like a student dormitory. We even have our own garden, and we work there a lot.”

- Mayke Blok, Platform Editor, The Correspondent_C17.



Fleet Street, London . 1905_C18.

Every paper had its favourite pub or, rather, the pub its staff tended to frequent, for they would often grumble about it. The Telegraph had the King & Keys, a hell-hole. The Express had the Red Lion, in Poppins Court so it was inevitably known as Poppins._C19

The association with publishing began in Fleet Street in 1500 when Wynkyn de Worde built London's first printing press next to St Bride's and the area developed into the home of Britain's newspaper industry. It became the perfect area to gather news, close to the City, the Old Bailey and high court and not too far from (or too close to) Westminster._C20

According to Merriam Websters dictionary, the definition of "Fake news" is expanded as, The printing and dissemination of spurious news is hardly new, but the term fake news is. However, when we say that an English word is "new," we are using a broader meaning of that word than if we were to refer to, say, a musical genre. Fake news appears to have begun seeing general use at the end of the 19th century.

Secretary Brunnell Declares Fake News About His People is Being Telegraphed Over the Country.

—Cincinnati Commercial Tribune (Cincinnati, OH), 7 Jun. 1890

Fake News. The following is handed to us for publication: Sunday's Enterprise says that I and a companion were run over by the Neptune and thrown into the water. As can be proved by more than one, we did not so much as get our feet wet, nor were we helped into the Neptune. Clarence Collins.

—The Kearney Daily Hub (Kearney, NE), 7 Jul. 1890

The public taste is not really vitiated and it does not in its desire for 'news' absolutely crave for distortions of facts and enlargements of incidents; and it certainly has no genuine appetite for 'fake news' and 'special fiend' decoctions such as were served up by a local syndicate a year or two ago.

-The Buffalo Commercial (Buffalo, NY), 2 May 1891

_C21



Characteristic sidewalk newsstand. New York City, 1903. _C22



The Guardian, proposed event space opposite Kings Cross, London, 2015._C23

New practices of media are increasingly trying to establish a public presence by having debates and events, having book and merchandise stores that re-connect physically with an audience that is not restricted to commenting anonymously on blog posts and chat rooms on the internet, in order to establish a trust and credibility to the news that they produce. Other forms of media production like the broadcasting house and the radio stations have had public and cultural programs built into them. In the process of adapting to new media and modes of production, these programs are proposed to be brought back. _C24

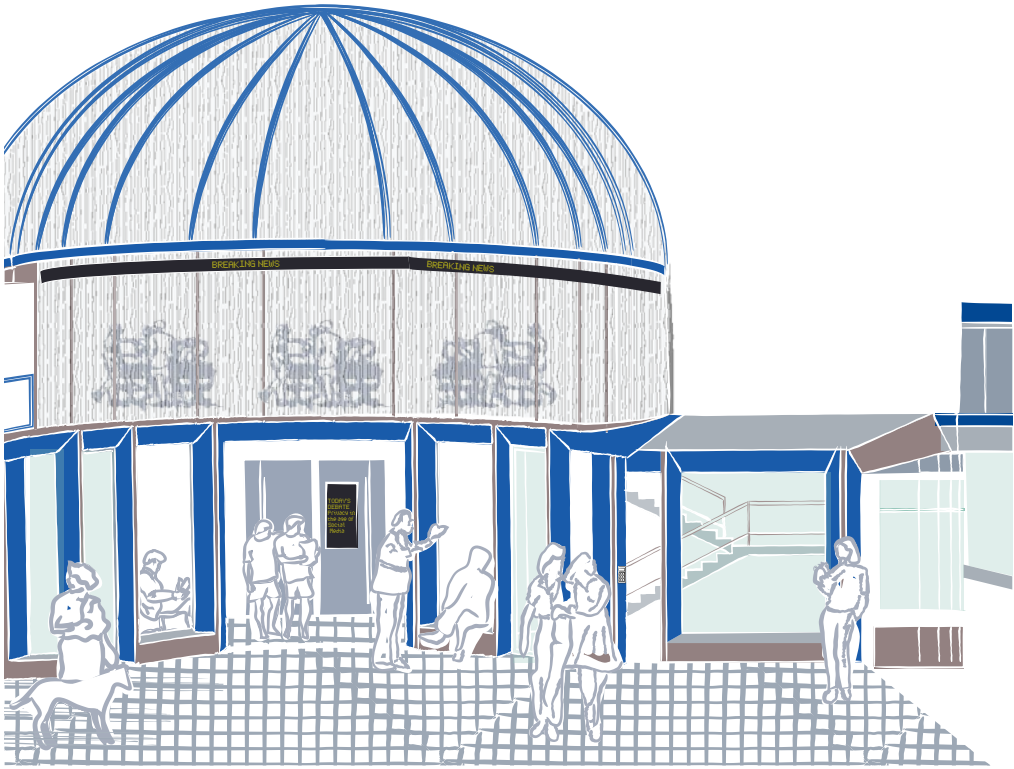

Voix du Nord, 2020. The newsroom is part of a thoroughfare through the city centre. Debate spaces, auditoriums, events and screening rooms line this space. The productive newsroom itself is also a part of this space, and has been brought to the public realm. The flexible spaces, quick meeting rooms for freelancers and vlogging and blogging, tweeting news stations, are all visible, transparent and organised as though they are spaces to run errands and not spend the entire working day._C25.

D

[Arcades]

“In architectural history, the arcade is primarily a pedestrian thoroughfare, a space with a beginning and an end. But this space is bordered or covered by a building which serves its own function. Therefore the function of the arcade itself varies” .

-Johann Friedrich Geist, Arcades: The History of a Building Type(London: The MIT Press,1983),3.

Streets are the dwelling place of the collective. The collective is an eternally wakeful, agitated being that - in the space between the building fronts - lives, experiences, understands and invents as much as individuals do within the privacy of their own four walls. ... Among these the arcade was the drawing room. More than anywhere else, the street reveals itself in the arcade as the furnished and familiar interior of the masses.

-Benjamin, Walter, Howard Eiland, and Kevin McLaughlin. The Arcades Project. Cambridge (Mass.): Harvard University Press, 2003._D1

The arcades were an invention of industrial luxury, corresponding to the form of new means of production, which in the beginning was still governed by the form of the old. These glass-roofed and marble panelled corridors extended through whole blocks of buildings, whose owners joined together for such enterprises. Lining both sides of the corridor were shops, reading rooms and theatres, all selling, marketing and sharing the results of industrial innovation; so that the arcade was a city, a world in miniature._D2

Born out of industrial overproduction and new goods that flooded the market, arcades were born in 19th century Europe to consolidate and put in public view the new products of industrial luxury. _D3

There are relations between the department store and the museum, and here the bazaar provides a link. The amassing of artworks in the museum brings them into communication with commodities, which they offer themselves en masse to the passerby _awake in him the notion that some part of this should fall to him as well.

-Benjamin, Walter, Howard Eiland, and Kevin McLaughlin. The Arcades Project. Cambridge (Mass.): Harvard University Press, 2003._D4

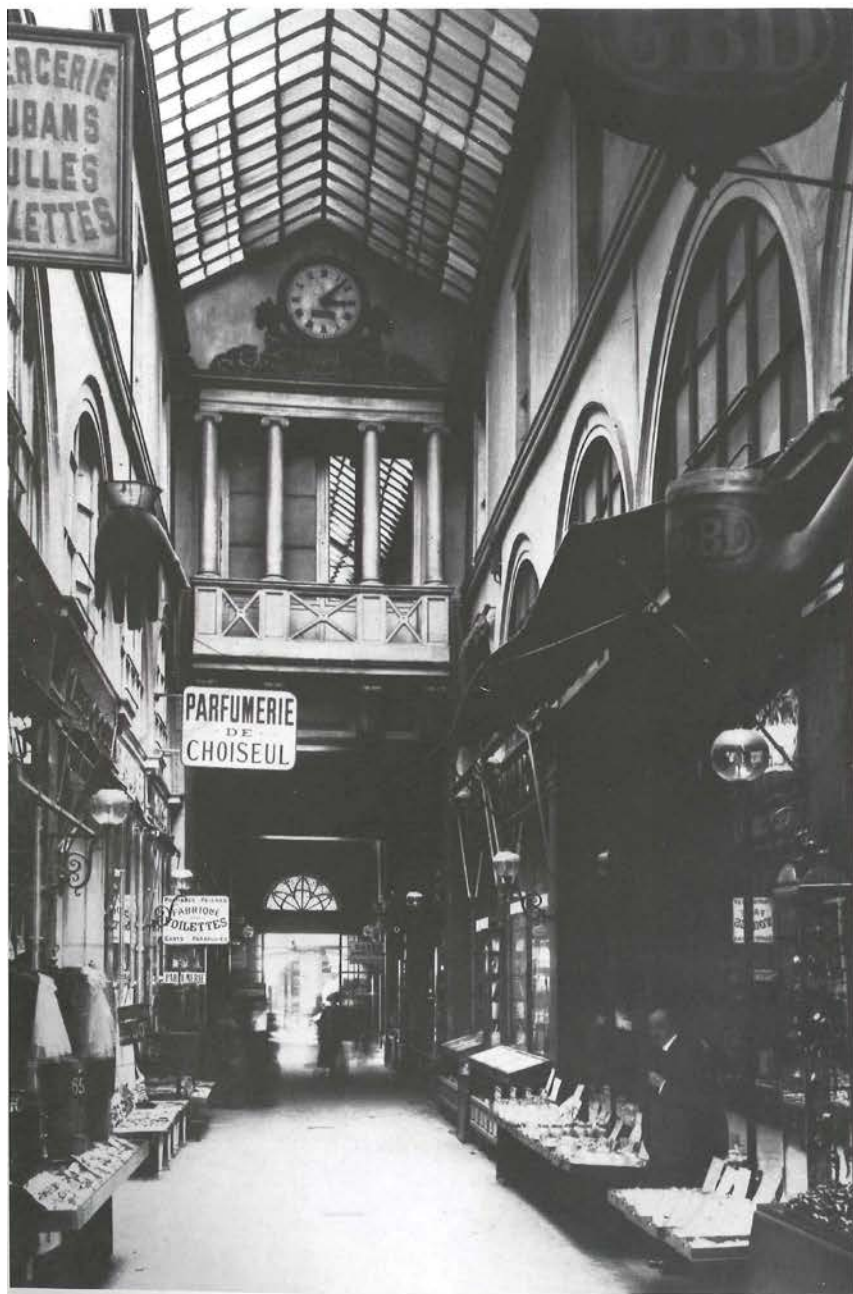

Passage Choiseul, Paris, 1827._D5

Victor Hugo in the Hunchback of Notre Dame, "If it be the rule that the architecture of a building should be adapted to its function.... we can hardly wonder enough at a monument which might equally well be a king's palace, a house of commons, a town hall, a college, a riding school, an academy, a warehouse, a law court or a theatre. For the present it is a Stock Exchange... it is a Stock Exchange in France just as it would be a temple in Greece.

- Victor Hugo, The Hunchback of Notre Dame: Book III Chapter 3 (Paris: Gosselin, 1835), 206-207._D6

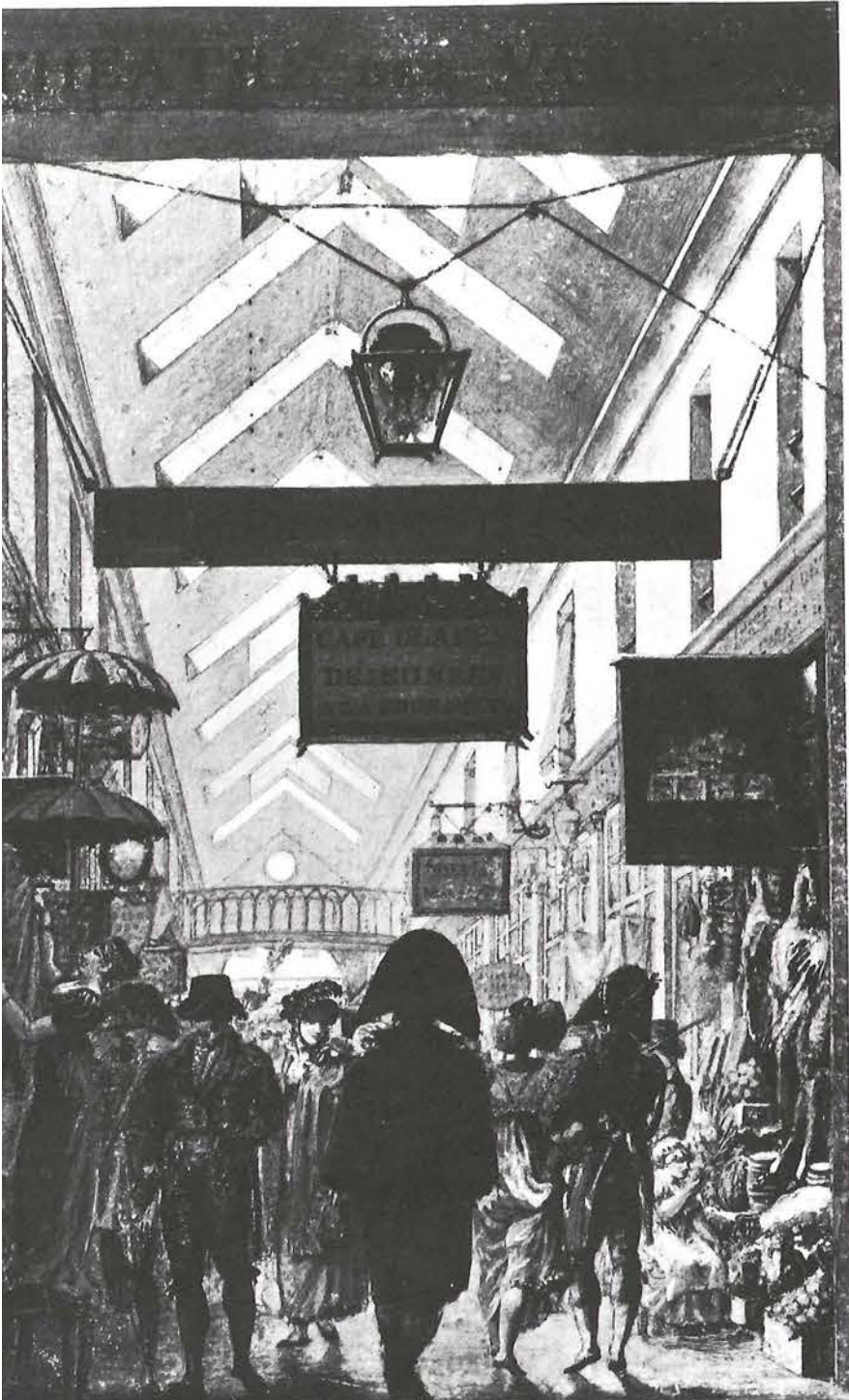

Passage des Panoramas, Paris. Watercolour by unknown artist, 1810._D7

The news in 2017 is overproduced, in order to make sense and to see these manifested in the physical realm, the *Voix du Nord*, a french newspaper, have offices in an arcade building. The space of the arcade, the interior street is filled with the regular activity of the street.

Thongs gather near the screening room ticker tape, when there is breaking news, or when the football game is on. People coming out of the debate centre continue

the discussions outside, a few tourists visiting the square, have taken shelter from the rain. And the clock on the podcast station welcomes the late reveller back to his house in the middle of the night. Many use the space as a quick shortcut to grab a coffee in between work, walk the dog, while ogling at the shop windows of the podcast stations, digital newsstands, screen rooms and the blurred, dream like , constant motion working of the newsroom. _D8.

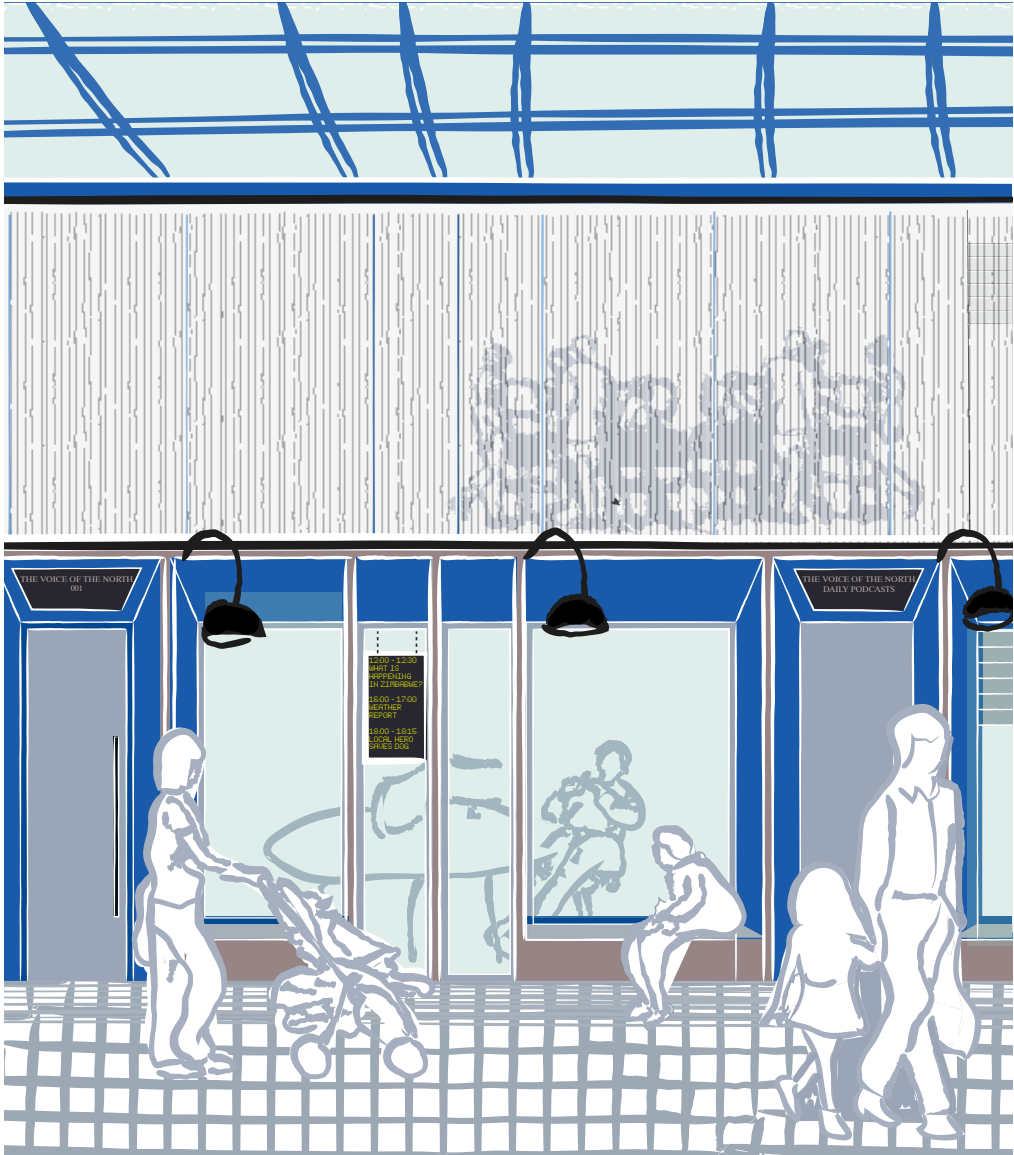



The completely and always open pedestrian public path through the arcade is contrasted with the secured entrances to the both the news floor and the residences above. _D9.

Arcades were seen as extensions of streets, with interior facades, signage, colours and lights of the commercial establishments, they were covered, protected from the weather, sometimes with winter gardens made possible due to the glass and iron construction of the skylights; and act as an ambiguous transition space between the interior and the exterior, and hence the public and the private. _D10

Built from contemporary material and building technology, the arcade brought the new industrial luxury goods to the streets. The glass and iron construction making way for a precast concrete and polycarbonate. The physical goods making way for intellectual content. As there remains no demarcation between the spaces of production, distribution and consumption, all of them considered products of an industry take the form of an arcade. _D11.

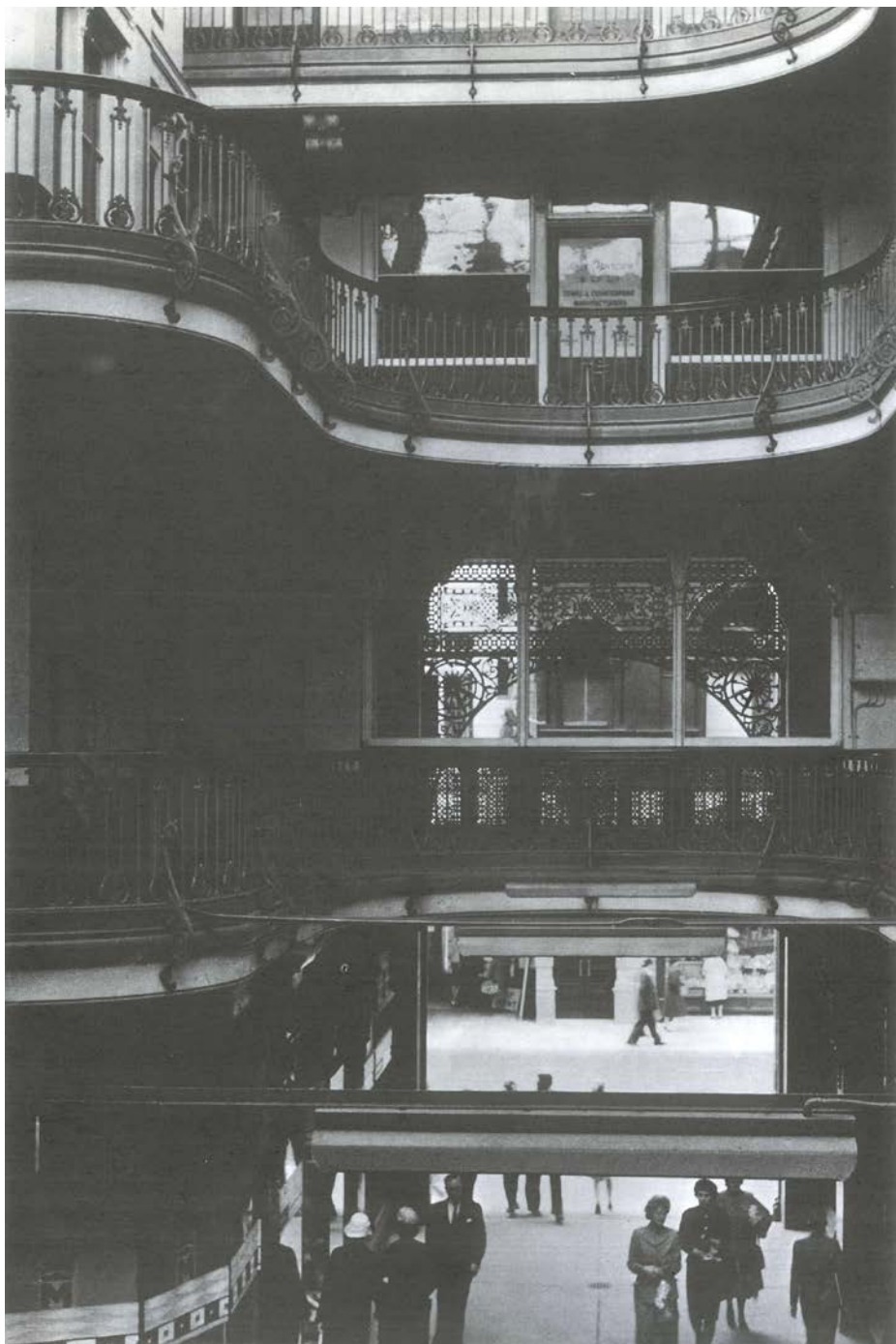

Barton Arcade, Manchester. View from the galleries,1905._D11

The ambiguous space between the public and the private is clarified in the form of an arcade. The threshold space between the inside and outside blurs the boundaries between the private residences and small offices that occupy the upper floors and the public sheltered passage through the ground floor. _D12



Shop windows, Galerie Vero Dodat, Paris, 1836 _D13.

The streets are the dwelling space of the collective.... For this collective, glossy enamelled shop signs are wall decoration; walls with their “Post no Bills”, are its writing desk, the newspaper stands its libraries, mailboxes are bronze busts, and the benches are bedroom furniture.

- Benjamin, Walter, Howard Eiland, and Kevin McLaughlin. *The Arcades Project*. Cambridge (Mass.): Harvard University Press, 2003. _D14

Name

Carmen Buitenhuis

Title

Architect for De Correspondent

Date of conversation

12th October 2017.

Biography

Architect and Landscape designer –
Inside Outside

May 2010 to Jun 2012

Architect and Researcher - Loeh-
mann's Architecture

Nov 2012 to Feb 2015

Freelance Architect and Designer

Jul 2013 to present

Relevance

Carmen Buitenhuis is an architect who has designed spaces for De Correspondent, a Dutch start-up for digital journalism that attempts to reinvent the news to provide background information and not reports on specific events that occur. Carmen has from their initial location been the architect who translates their desire for a non-hierarchical newsroom that is open to communication, input and feedback from the readers, into a physical space.

She is currently focusing on the Correspondent moving to their own office space, and is outlining the program and areas required of a contemporary newsroom that wishes to stay relevant in the current situation.

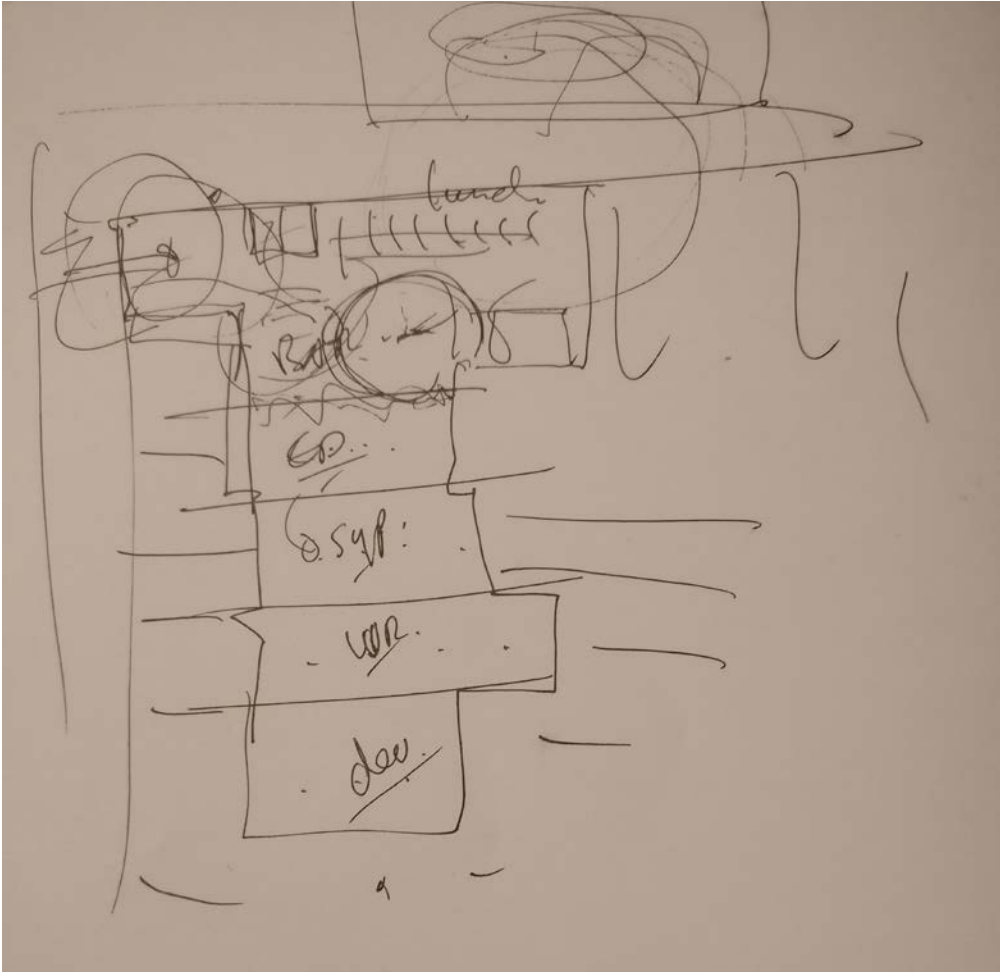

Drawing made during the conversation about the office layout of the Correspondent

Can you tell me something about the work that you do for De Correspondent?

I have been with the Correspondent from the beginning, when they were just a start-up occupying one cube of a co-working space in Amsterdam. Since then, though we have been forced to mainly work with what was already available in terms of furniture – three tables and an assortment of office furniture – everybody was forced to work together on these same tables, placed next to a coffee bar. All the staff was just hanging around the bar, drinking and talking, and sharing ideas; though most confess they go home if they have to do any actual work.

They then moved to another space, but now are getting too big to fit in anymore. We were on the lookout a few months ago to find new office space, and though we got just the thing when we found an empty office building in central Amsterdam, but it did not go through. Now, though we have found another location, they will not be moving there till later. So they are spending some time and money to renovate the current space they have in Amstel, Amsterdam.

Have you worked out how much area you will require for their new premises, incorporating any new programs that will be curated specifically for the newsroom?

Let me clarify what you mean by the newsroom, do you mean everything that is involved?

Yes, everything that is involved from the production to the distribution and the consumption of the news; mainly gaining from a historic perspective of the newsroom, where everything happened under one roof.

Are there any specific spaces that you think need to be incorporated within a newer idea of a newsroom? Like event spaces?

They were looking at about 900 square metres, for around 75 journalists who work

full time, and 50 other freelance journalists, who currently do not have a space within the office to work in. They also wish to have many event spaces, to connect with their members, but also organise workshops and debates about topics that are of current interest.

Most events have from 150 to 200 people, but some have up to 5000 or more. For example, they recently had an event about privacy, where they taught people how to secure their personal computers, which had almost 5000 people. They also hold what they called election guides that also receive thousands of people.

We have begun to outline basic requirements to figure out the size of premises that needs to be rented. They want a few spaces for events of all sizes, from 150 to 5000 people. And many meeting rooms, again of all sizes – from Monday morning meetings for all the 50 employees, to team meetings that are only for the developers, or the writers, and the image editors, to small meeting spaces for just two people, as they tend to work closely together with a few people during the development of the story.

Could you tell me what is the basis of the current renovation of the spaces that you are carrying out?

They were currently all working on three desks that they had from the previous work space, and everything was getting uncomfortable, they needed space to work, nobody was feeling productive in the office environment. We are currently remodelling this space to use more efficiently, but not losing the charm of a space that you can just hang out in. The building sits on a corner, with houses all around it. The space occupies the negative of the courts of the houses around it. The entrance is to the corner, with a coffee bar and lunch spaces occupying almost 50% of the space. These spaces can be seen from the street, are cut-off by large folding doors, to

the street. They have just rented another space on the other side of the street, that they use for some events; and in the case of the event, the folding doors on both the spaces are opened up to connect them as one space, through the side street that separates the two buildings.

The work space, we separated, not based on hierarchy exactly, but I felt that in order to be productive, at least the developers have to sit in the same space; one in each corner of the office is not going to be easy for anyone, nor productive in work output. So the spaces are then demarcated based on noisy to quiet; considering the area around the coffee bar as the noisiest – the chief editors, publishers and the social media team sit closest to the bar, and the writers farthest as they tend to work quietly when working on their own story.

Do the editors sit together, and then doesn't the office layout also follow a hierarchical method?

They were really against it, creating what they call a central desk. In the previous space, we tried to have an open seating plan which was not really working, so now the chief editors, the book publishers and the social media team that organise all the events sit together.

And other teams accordingly. The developers need their own room, where they do what they call stand up sessions. They set up the layout on standing boards, and test out a few samples.

They are expanding their offices to the United States, and travel to and fro a lot. They were insisting on a skype room to conduct calls every day to their associates in New York, where one wall would be the screen, with the meeting table touching it, so it feels they are having a conversation across the same table, and not across the Pacific.

They also need rooms to shoot videos, blogs, and photoshoots, and record audios. They sometime make movies for their input and are looking to update their instruments and get a proper room.

What about the entrance desk like a reception or an information desk? Is it

something that is considered necessary? Like the public lobby of an office space?

We are considering the same issues. We constantly have a conversation that it's not necessary to have one. It can be much more informal and not intimidating. They do not want a person always manning the reception desk, and not being a part of the office. Right now we have come with, what I call a temporary solution; to have the reception desk as the coffee bar. They are also dreaming of an information desk and interactive welcome board, as they now see in many offices in New York they visit often. Like a screen that will show some articles, and let you know who to meet and how you navigate in the space. Now though most people that visit are confused, suddenly confronted by like 20 people all at once, they are hesitant and do not always know what to do.

Do the deadlines or time-flow affect how the office layout is made? Considering everything does not have a fixed deadline.

They have recently started to make deadlines stricter because if the writers submit their part only by 6pm, then the editors and developers have to work after that. They work with a pre-layout system, that the developers first lay out the story in the layout discussed, and then the writers work on the same file, sending it to an editor once finished.

Do reporters "publish" their own articles or is it done from a central desk?

Good question, but I am not really sure, I suspect that there is a central desk involved in the actual publication. Earlier with a fewer employees, they released stories through the day, but now they try and stick to three time slots during the day, so they have a deadline system.

The final question, have you reached any conclusion about working in separate desks or all together on one? Is there a preferred method?

From the beginning they did not want

to have separate working desks, but this current method of everyone working together is not really working. We have definitely said that all teams are going to have to be seated separately. It is important to work individually as well, because most of the journalists work is done independently, and now they are forced to go home to have that calm to be able to work. The word “cubicle” is kind of hanging in the air; nobody has said it out loud yet. I think there is a way to work separately, but not be separated by a wall or a partition system, and that would be great. That’s why we were thinking of many two person meeting rooms, so if organised that way maybe we could have larger work desks for many, and still have the ability to work individually if needed.

Expert Conversation 1

Name

Mayke Blok

Title

Platform Editor, De Correspondent

Date of conversation

5th July 2017.

Biography

2014-present Platform editor, De Correspondent

Relevance

De Correspondent is a Dutch digital news media company established in 2014. Based on membership revenue model, with no advertising, it has been successful in getting almost 60,000 subscriptions with only 50 employees.

In a short time they have become well-known for their hard hitting journalism, covering global issues such as climate change, immigration, etc., while putting them across in a local context.

They are currently expanding their offices, also publishing in English, and opening an office in New York.

By re-inventing the daily news, that is not always delivered at the same time, requiring a lot of production time, De Correspondent is re-inventing new ways or journalism that responds to the current consumer market for news.

Considering the work being done at De Correspondent, how do the journalists work? Individually or in teams. How is the workflow organised. Do they share the same space ?

We have quite a small office. We are now around 50 people, and the office is too small. We are currently looking for new office space.

At the office we have developers, image editors, social media (correspondents), journalists, all working in the same space. Even the Editor -in-chief does not have his own office.

We all stay work together; it's kind of like a student dormitory. We even have our own garden, and we work there a lot.

Do the journalists work in teams, or do they work on stories alone? And who are they involved with closely during their research ?

They do work together, our correspondents.. We call them our correspondents. They all have their own subjects they are interested in; like climate change, privacy or economics. They work on these topics alone. They mostly work together with image and text editors to make the story better.

Sometimes they collaborate and work together on stories with someone from another specialty, like the economic correspondent with the statistics correspondent. We are quite a small group and really close, it's easy to work together. We're not just colleagues, we're friends.

And when we are all working together it becomes easy to merge ideas, and get input from the others, say "Hey do you want to work together on this?"

I see that you work closely with a design agency; Do you work with them regularly in the office space?

Two of our founders also found the design

agency that is Momkai. They work in a different office space as they also do third party projects.

We do work with them a lot, I was even there yesterday, and I worked over there. We have a weekly meeting, the developers kind of switch working for Momkai, and then here.

Big difference is that the design agency is up there and decisions are over there, and the editorial teams is here in my office.

Does the design agency only get involved in the overall design development and strategy for the website, or do they also work on individual stories with each correspondent?

More on the development on the website. Sometimes they work on campaigns and stories. But we have an in-house image editors and a digital design team that work with the correspondents.

Most of these people used to work with Momkai, and it just became easier to have them in the newsfloor. We eventually are looking to share the office space with Momkai. They currently are in a different part of Amsterdam, but there is office space freeing up in their building and we might move there eventually.

You have developers in your news floor. According to your website they help in new ways of storytelling to reach new audiences? How does this relate to the everyday work that the correspondents do?

We have a philosophy here at the Correspondent, that everybody here has the same mission. Which is to provide context to the news and we all take a part in that goal. The developers also work on the website, within the mission to create ways in which these news stories could be better contextualised. They sometimes work together with the correspondents; they build a tool for a story.



Small example, one of our correspondents was writing an article about emoji's, and we did not have emoji's on our platform. Working together with the developers, to have the option on the platform, and they were added.

The great thing about having them on the newsfloor is that they read the articles, not only when they are finished, and have a proper insight into the articles that they are making a design structure for.

I would like to know about the deadlines and time management? Do you work on a strict schedule for each article? Do you know when the article is expected to be published when you begin?

Well we wish!!

Every news organisation has a deadline and so do we. But sometimes, you know how it is, something doesn't come through and it falls through.

We have a publishing schedule. We generally try to publish a big news story every morning; we call it the "story of the day". That's when we send out our daily newsletter. During the day we publish other stories – news stories, podcasts, extensions etc.

We try and stick to the time that there is high traffic on our website, like the early morning, during the train journeys, and in the evening. But I don't think it really matters as what matters more is when you push it on social media.

The podcasts and the videos you were mentioning, do you have the facilities in the office to help you with that?

When we move to the new office, we want our own podcast and video studio. Right now we only have a video studio that is just a screen

Right now our correspondent who makes the podcasts shoots them from her attic.

I see that you have weekly newsletters that directly connect the reader to the correspondent. How does this help in the workflow of the story, and does it influence the story? Or

is it to keep the reader informed of the work of the correspondent?

It's both. The correspondents follow their own interests but they get feedback from the readers. When they start a new series, they call out to the readers. "Do you know anybody I should talk to, what books do I read? Do you have any expertise on the matter that you can guide on?"

It is not only a nice benefit of being a member, but I believe it makes our journalism stronger. When we are connected to so many people with expertise we can put it to good use and help remove some blind spots.

One of our correspondents is going to Brazil next week, and he gets input from his readers on whom he has to interview, what questions he should be asking?

On a related note, how important is it for the Correspondent to create transparency in the way that you work, given that you are a membership and subscription driven business and do not rely on any marketing or advertisement revenue?

It is very important to be transparent in the working. This could be acknowledging the input of the readers on some stories, making corrections. And being open about where the money from the subscriptions is being spent. Show that we respect their privacy, and of our correspondents.

We try and create as many opportunities for this interaction with the readers, for them to see the system and to comment on it.

Is this interaction that you mention only restricted to the digital platforms?

We believe that we should have offline interactions also with our members. We have a speaker's agency that organises many talks and workshops by the correspondents. For our expansion to the US, we are currently working with the NYU. A professor will be coming to Amsterdam in two weeks to hold interviews with our members to get their feedback on the correspondent.

So we organise many large events, and small interactions with our readers. Some

campaigns are targeted at a bigger audience than others.

Do you imagine these spaces for events, and interactions to be a part of the office space that you will move into?

Yes! Very much so. We would love to have a space like that.

At least something like a coffee corner, where we could casually talk and buy some of the books we make. Right now people just walk in to the offices and start talking. We have to be nice and hear them out, cannot just get back to work, as we all share the same space. But we would also generally like workshop spaces and event spaces where we could invite experts and readers and talk to them.

THESIS PROJECT
THE BERLAGE CENTRE FOR ADVANCED STUDIES IN ARCHITECTURE AND URBAN
DESIGN



Passage Choiseul, Paris, 1827_D1

The arcades were an invention of industrial luxury, corresponding to the form of new means of production, which in the beginning was still governed by the form of the old. These glass-roofed and marble panelled corridors extended through whole blocks of buildings, whose owners joined together for such enterprises. Lining both sides of the corridor were shops, reading rooms and theatres, all selling, marketing and sharing the results of industrial innovation; so that the arcade was a city, a world in miniature. -Walter Benjamin, *Convolute A: Arcades Project* (United States of America, The Harvard University Press, 2002), 32 _D2

Born out of industrial overproduction and new goods that flooded the market, arcades were born in 19th century Europe to consolidate and put in public view the new products of industrial luxury. _ D3

2017 is overproduced, in order to make sense and to see these manifested in the physical realm, the Voix du Nord, a french newspaper, have offices in an arcade building._D4

"In speaking of the inner boulevards,' says the Illustrated Guide to Paris, a complete picture of the city on the Seine and its environs from the year 1852, "we have made mention again and again of the arcades which open onto them. These arcades, a recent invention of industrial luxury, are glass-roofed, marble-paneled corridors extending through whole blocks of buildings, whose owners have joined together for such enterprises. Lining both sides of these corridors, which get their light from above, are the most elegant shops, so that the arcade is a city, a world in miniature, in which customers will find everything they need. During sudden rainshowers, the arcades are a place of refuge for the unprepared, to whom they offer a secure, if restricted, promenade-one from which the merchants also benefit."

- Walter Benjamin, *Convolute A: Arcades Project* (United States of America, The Harvard University Press, 2002), 32 _D5

A Typology of the Arcade

	1 Entrance	2 Entrances Straight/Parallel	3 Entrances Straight/Perpendicular	4 Angle	5 Double Angle	6 Angle/Diagonal	7 Right Angle	8 Diagonal	9 Y Shape	10 T Shape	11 H Shape	12 Cross	13 Double Cross	14 Quadruple Cross
a														
b														
c														
d														

	No Facade	1 Facade	2 Facades Straight	3 Right Angle	4 1 Corner	5 2 Corners	6 3 Corners	7 1 Corner	8 2 Corners	9 3 Facades	10 4 Facades
a											
b											
c											
d											

55 Spatial types

56 Building types

The typology of an arcade, including the spatial types and building types, as drawn by Johann Friedrich Geist. *Geist, Arcades: The History of a Building Type*, (London, The MIT Press, 1983), 92. _D6

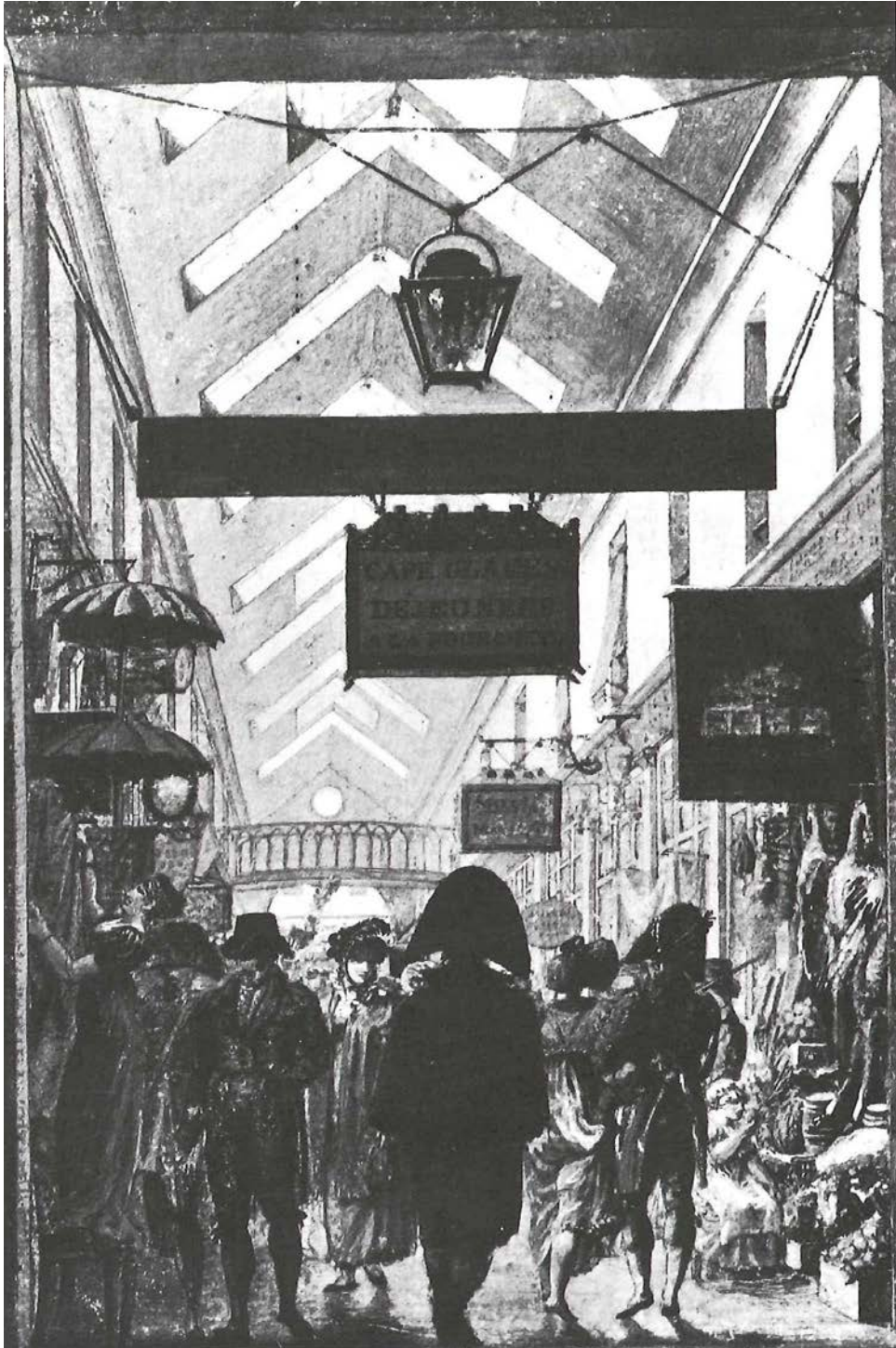

The Passage des Panoramas, Paris. Watercolor by unknown artist, ca. 1810. _D7

Streets are the dwelling place of the collective. The collective is an eternally wakeful, agitated being that - in the space between the building fronts - lives, experiences, understands and invents as much as individuals do within the privacy of their own four walls. ... Among these the arcade was the drawing room. More than anywhere else, the street reveals itself in the arcade as the furnished and familiar interior of the masses.

-Benjamin, Walter, Howard Eiland, and Kevin McLaughlin. The Arcades Project. Cambridge (Mass.): Harvard University Press, 2003. _D8



Leeds Arcade, 1889_D9

Arcades as pedestrian thoroughfares. Act as shortcuts through the city, passages to those who know them well. Shop windows filled with consumer products attract the attentions of passers-by. _D10

The space of the arcade, the interior street is filled with the regular activity of the street. Throngs gather near the screening room ticker tape, when there is breaking news, or when the football game is on. People coming out of the debate centre continue the discussions outside, a few tourists visiting the square, have taken shelter from the rain. And the clock on the podcast station welcomes the late reveller back to his house in the middle of the night. Many use the space as a quick shortcut to grab a coffee in between work, walk the dog, while ogling at the shop windows of the podcast stations, digital newsstands, screen rooms and the blurred, dream like , constant motion working of the newsroom. _D11

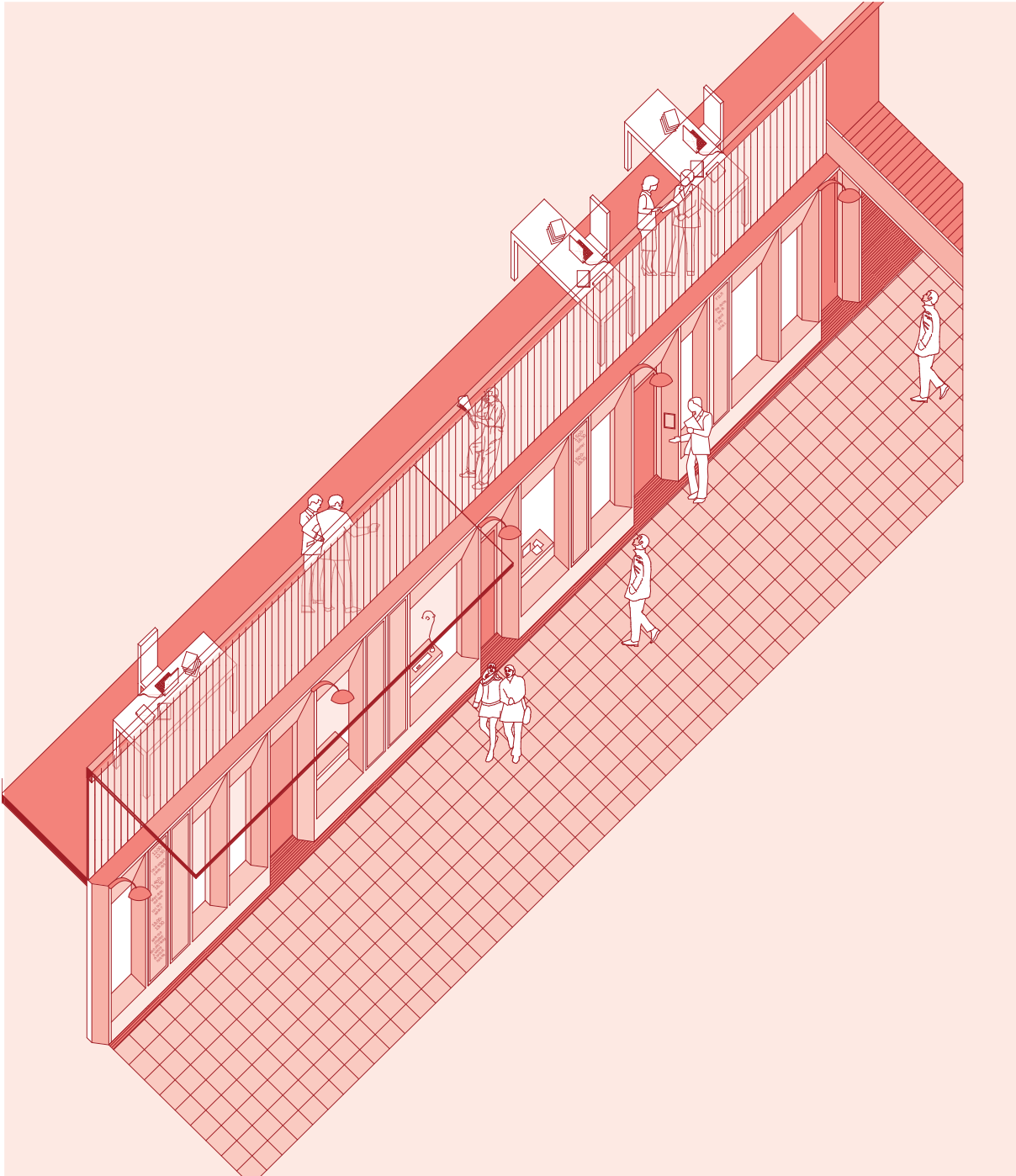

Cry of the vendors of stock-exchange lists on the street: In the event of a rise in prices, 'Rise in the stock market!' In the event of a fall, "Variations in the stock market!" The term fall" was forbidden by the police.

-Benjamin, Walter, Howard Eiland, and Kevin McLaughlin. The Arcades Project. Cambridge (Mass.): Harvard University Press, 2003._D12



Autun Arcade, 1834_ D13

Arcades are houses or passages having no outside - like a dream

-Benjamin, Walter, Howard Eiland, and Kevin McLaughlin. *The Arcades Project*. Cambridge (Mass.): Harvard University Press, 2003._D14

“In architectural history, the arcade is primarily a pedestrian thoroughfare, a space with a beginning and an end. But this space is bordered or covered by a building which serves its own function. Therefore the function of the arcade itself varies” .

-Johann Friedrich Geist, *Arcades: The History of a Building Type*(London: The MIT Press,1983),3. _D15

The newsroom of the “Voix du Nord” is located in an arcade. The newsroom of 2018, freed from the programmatic requirements of machinery and organisation takes over the residual spaces of the arcade._D16



Galerie Vero Dodat, Paris, 1836. _D17

The merchandise spills out into the arcade space. The shadows of the different roofs, elements and sun shades in the closed arcade space attach a dream like quality to this transition. _D18

The shops gain an additional depth when the display is put outside. It blurs the boundaries between the shop and the arcade itself. _D19



Shop windows, Galerie Vero Dodat, Paris, 1836 _D20

“Shops on the old model, devoted to trades found nowhere else, surmounted by a small, old-fashioned mezzanine with windows that each bear a number, on an escutcheon, corresponding to a particular shop. From time to time, a doorway giving onto a corridor; at the end of the corridor, a small stairway leading to these mezzanines. Near the knob of one of these doors, this handwritten sign:

The worker next door
would be obliged in closing the door,
you refrained from slamming it.

(Leautaud, “Vieux Paris,” *Mercure de France* [1927], pp. 502-503)

-Benjamin, Walter, Howard Eiland, and Kevin McLaughlin. *The Arcades Project*. Cambridge (Mass.): Harvard University Press, 2003. _D21

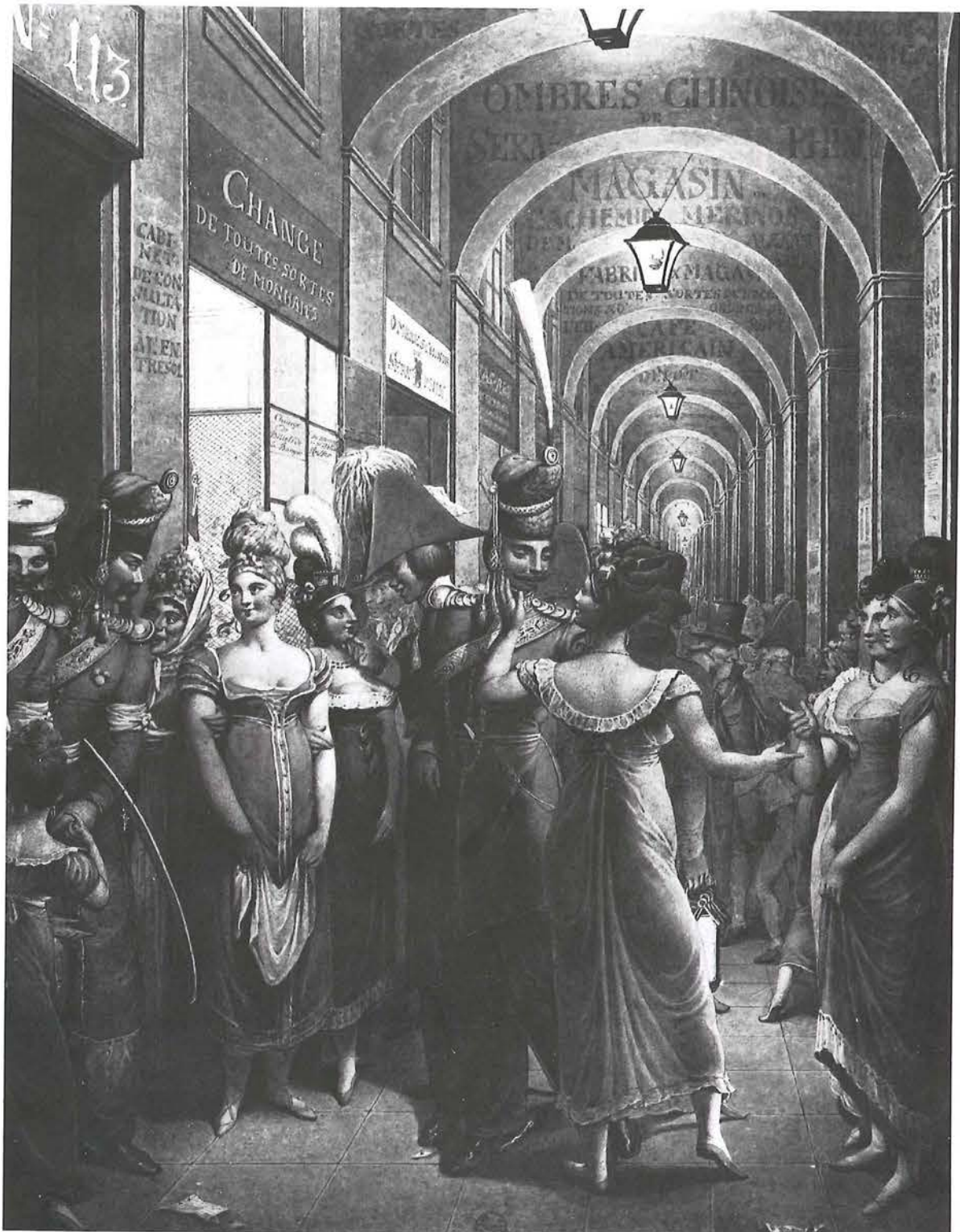

Paris, Palais Royale Galleries, 1815, shown in watercolour, *La Sortie du Numero 113*

— Benjamin, Walter, Howard Eiland, and Kevin McLaughlin. *The Arcades Project*. Cambridge (Mass.): Harvard University Press, 2003. _D22



The display windows look into podcast stations and workstations. _D23

Operators surrounded by a range of technical equipment, some freelance and part-time journalists use the quickly accessible desk, unallocated desk space to do their work. These activities, the acts of producing and the product rolled into one, are seen through the display windows. Seeing messy desks, people in thought, someone speaking into the microphone, a meeting of the sports desk journalists, as the products of the newsroom, displayed in the windows; showing to the world that are to be trusted. _D24

The cafes are filled
 With gourmets, with smokers;
 The theaters are packed
 With cheerful spectators.
 The arcades are swarming
 With gawkers, with enthusiasts,
 And pickpockets \vTiggle
 Behind the flaneurs

Ennery and Lemoine, Paris la nuit, cited in H. Gourdon de Genouillac, Les Refrains de 1830la de a 1870 (Paris, 1879), pp. 46-47.-_D25

And those who cannot pay for ... a shelter? They sleep wherever they find a place, in passages, arcades, in corners where the police and the owners leave them undisturbed." Friedrich Engels, *Die Lage der arbeitenden Klasse in England*, 2nd ed. (Leipzig, 1848), p. 46 ("Die grossen Städte").

- _ Benjamin, Walter, Howard Eiland, and Kevin McLaughlin. *The Arcades Project*. Cambridge (Mass.): Harvard University Press, 2003. _D25

The screening rooms have an audience seated in rows, and people from the arcade looking in. The depth of the pre cast concrete structure gives a depth, sometimes acting like a bench, that could extend the activity into the corridor and the corridor into the screening room. _D26



The arcade acts as a social space. A gathering a group of friends, meeting new people, activities that spill out onto the space of the arcade itself. _D27

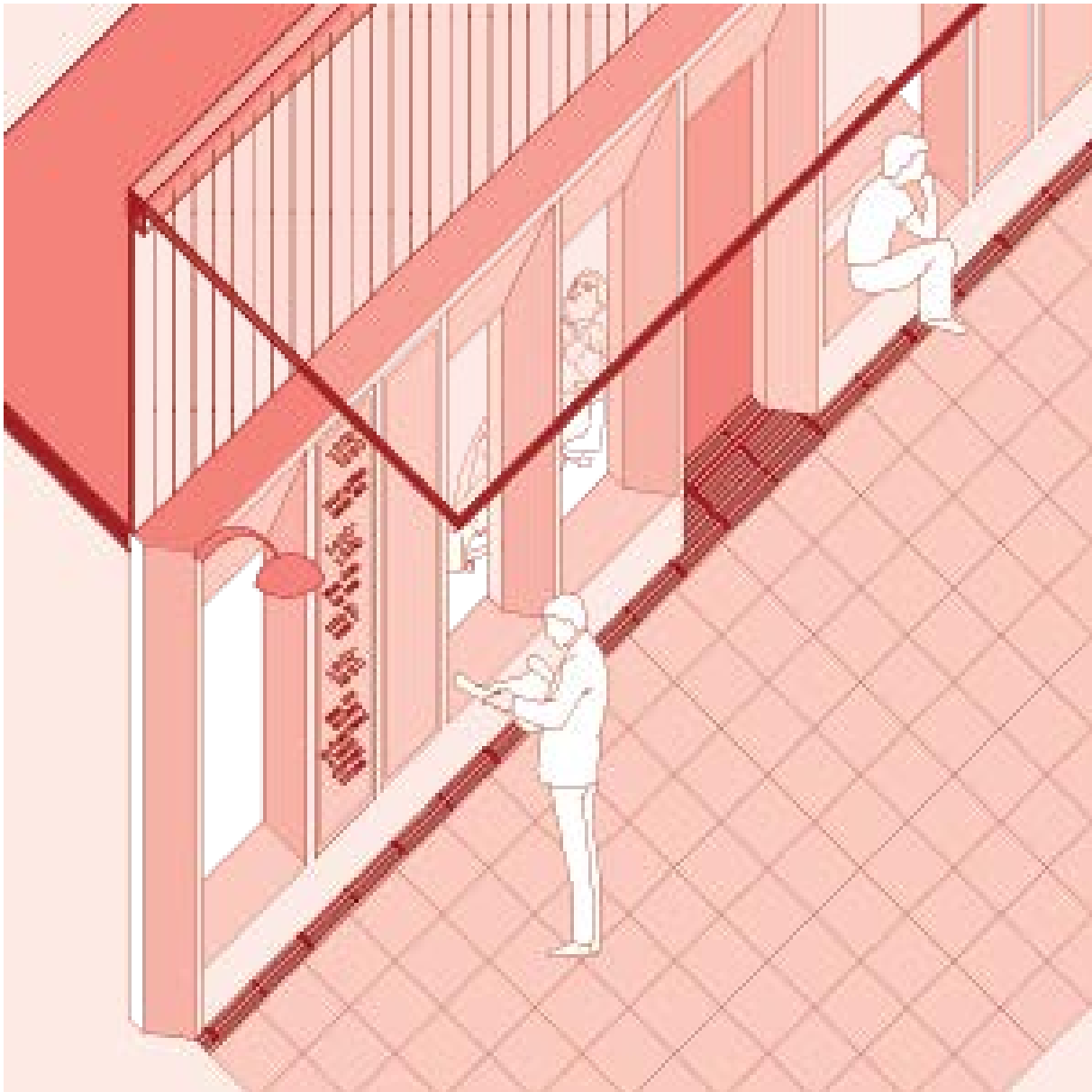

The digital signage displays the events and schedules, the live football scores and the news as it unfolds. The display windows carrying digital signage, show the activities of the newsroom, and in real time, the products that it produces ; i.e.; the news.
_D28

Victor Hugo in the Hunchback of Notre Dame, “If it be the rule that the architecture of a building should be adapted to its function.... we can hardly wonder enough at a monument which might equally well be a king’s palace, a house of commons, a town hall, a college,a riding school, an academy, a warehouse, a law court or a theatre. For the present it is a Stock Exchange... it is a Stock Exchange in France just as it would be a temple in Greece.

- Victor Hugo,The Hunchback of Notre Dame: Book III Chapter 3(Paris: Gosselin, 1835), 206-207._D29

There are relations between the department store and the museum, and here the bazaar provides a link. The amassing of artworks in the museum brings them into communication with commodities, which they offer themselves en masee to the passerby _awake in him the notion that some part of this should fall to him as well.

-Benjamin, Walter, Howard Eiland, and Kevin McLaughlin. The Arcades Project. Cambridge (Mass.): Harvard University Press, 2003._D30

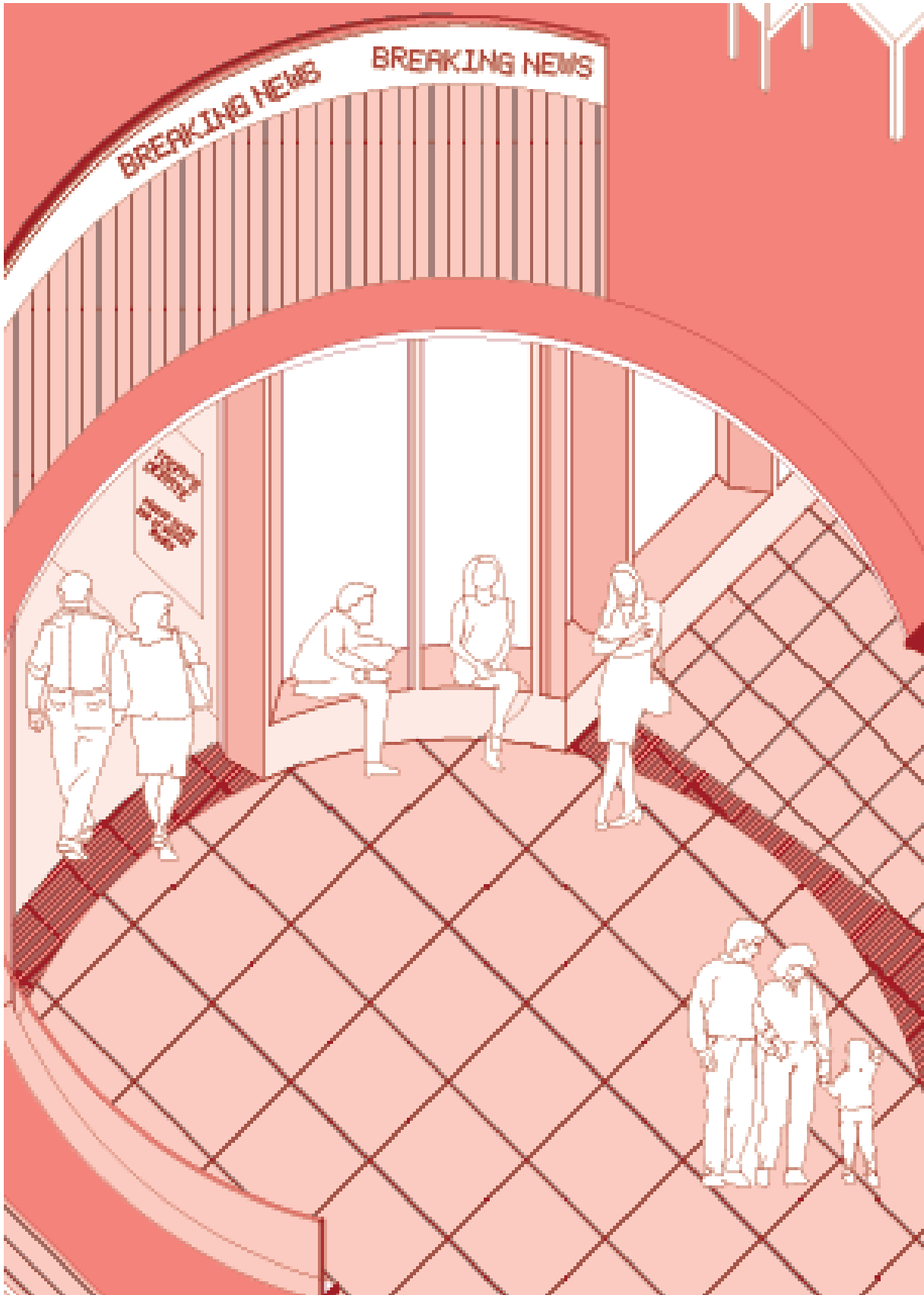

The activities of the newsroom spill over onto the spaces of the arcade. The public program of the newsroom, debates and discussions continuing in the corridor, in earshot of a journalist entering the newsfloor. The passers-by look into a filled meeting room, or friends just having a quick chat away from the rain. _D31

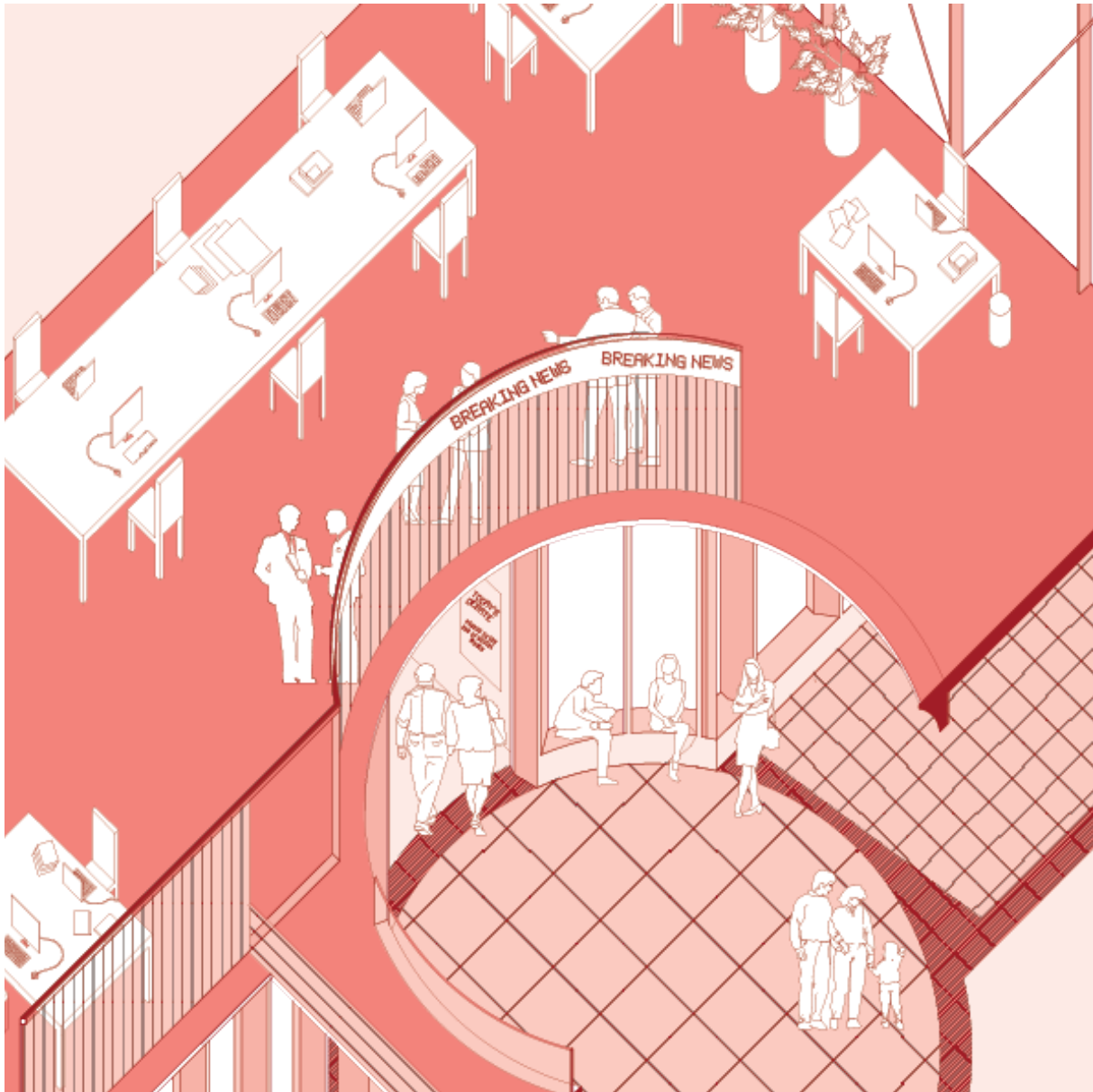

The boundary between the public and private is blurred in an arcade. The productive news floor occupies the same space of debates and small informal social gatherings, only separated by a translucent polycarbonate. _D32

The streets are the dwelling space of the collective.... For this collective, glossy enamelled shop signs are wall decoration; walls with their "Post no Bills", are its writing desk, the newspaper stands its libraries, mailboxes are bronze busts, and the benches are bedroom furniture.

- Benjamin, Walter, Howard Eiland, and Kevin McLaughlin. *The Arcades Project*. Cambridge (Mass.): Harvard University Press, 2003, 574. _D33

Think of the arcade as watering place. What we would like is to stumble upon an arcade myth, with a legendary source at its center-an asphalt wellspring arising at the heart of Paris. The tavern advertising beer "on tap" still draws on this myth of the waters. And the extent to which healing is a rite de passage, a transition experience, becomes vividly clear in those classical corridors where the sick and ailing turn into their recovery, as it were. Those halls, too, are arcades.

-- Benjamin, Walter, Howard Eiland, and Kevin McLaughlin. *The Arcades Project*. Cambridge (Mass.): Harvard University Press, 2003, 409. _D34



The ambiguity between the public and the private, and the inside and the outside always existed in an arcade..
Barton Arcade , Manchester, view from the galleries, 1905._D35



Gallery Vivienne, Paris, 1967 _D36

Windows with drawn curtains are hidden in plain view in the arcade. _D37

Open windows show a glimpse of activity into the domestic interiors, that provides the arcade with a sense of interior that is simultaneously associated with a street like view leading to another street. The decorations, the large domed roof structures imitative of a monumentality gain a different meaning juxtaposed with domestic windows, shop signage and a street. _D38

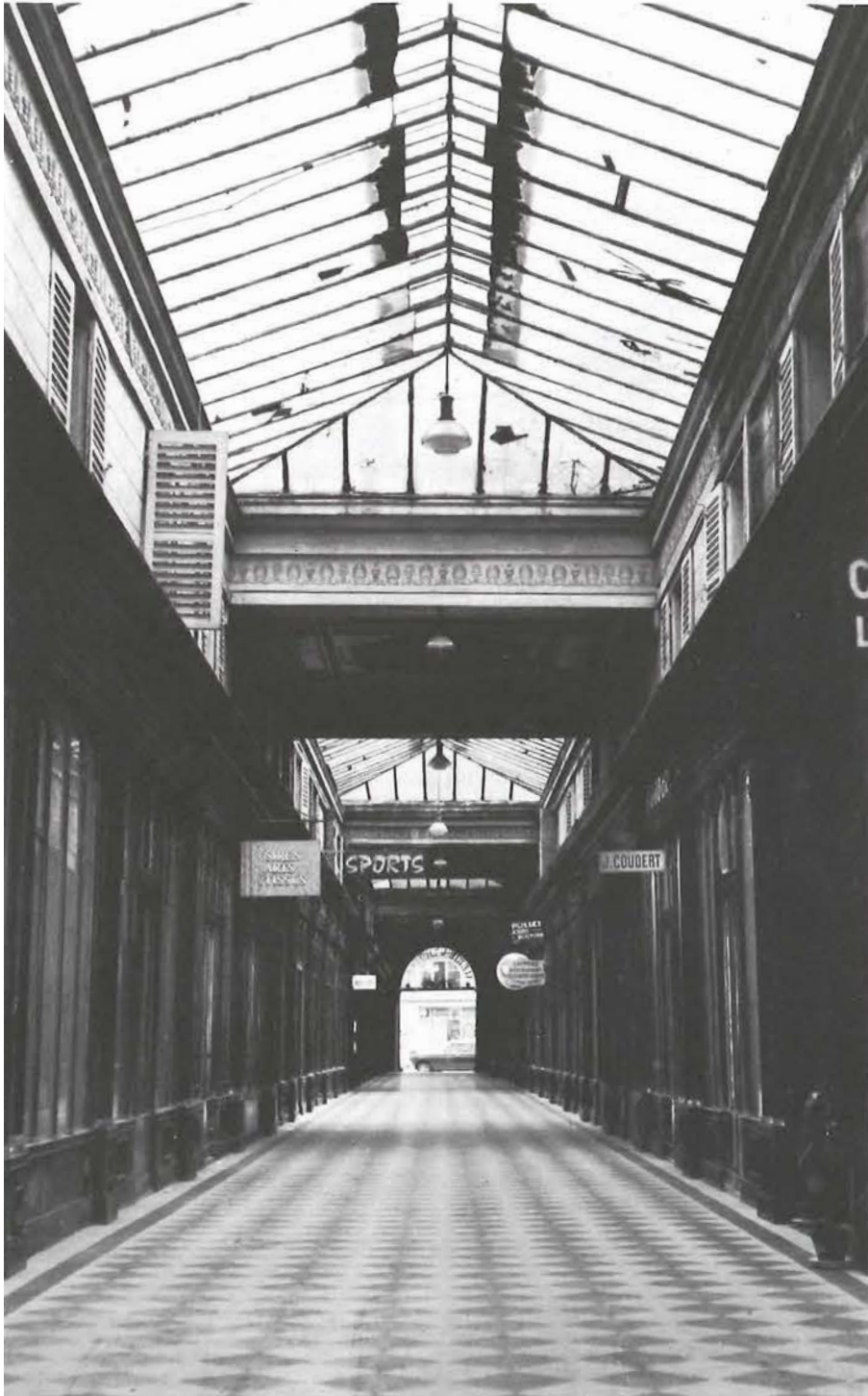

Windows of residences give a glimpse into a domestic activity. assage des Panoramas, Paris 1934. _D39

Ambiguity of the arcades as an ambiguity of space. Readiest access to this phenomenon would be afforded by the multiple deployment of figures in the wax museum. On the other hand, the resolute focus on the ambiguity of space, a focus obtained in the arcades, has to benefit the theory of Parisian streets. The outermost, merely quite peripheral aspect of the ambiguity of the arcades is provided by their abundance of mirrors, which fabulously amplifies the spaces and makes orientation more difficult. Perhaps that isn't saying much. Nevertheless : though it may have many aspects, indeed infinitely many, it remains-in the sense of mirror world-ambiguous, double-edged.

- Benjamin, Walter, Howard Eiland, and Kevin McLaughlin. *The Arcades Project*. Cambridge (Mass.): Harvard University Press, 2003, 878. _D40



The ambiguous space between the public and the private is clarified in the form of an arcade. The threshold space between the inside and outside blurs the boundaries between the private residences and small offices that occupy the upper floors and the public sheltered passage through the ground floor. _D41



The accesses to residences above are through the arcade. Only a door with security access separates them from the newsroom spaces. As the office hours of the offices are over, the lights get turned off in the newsroom, the shop windows still display the ticker tape, the arcade remains open for the residents returning home._D42

Built from contemporary material and building technology, the arcade brought the new industrial luxury goods to the streets. The glass and iron construction making way for a precast concrete and polycarbonate. The physical goods making way for intellectual content. As there remains no demarcation between the spaces of production, distribution and consumption, all of them considered products of an industry take the form of an arcade._D43

The difference between something that is seen, something you interact with through its use. A shop as a window and a shop as a place for consumption. Is translated as interaction through a window, and interaction through contribution, or interaction through movement._D44

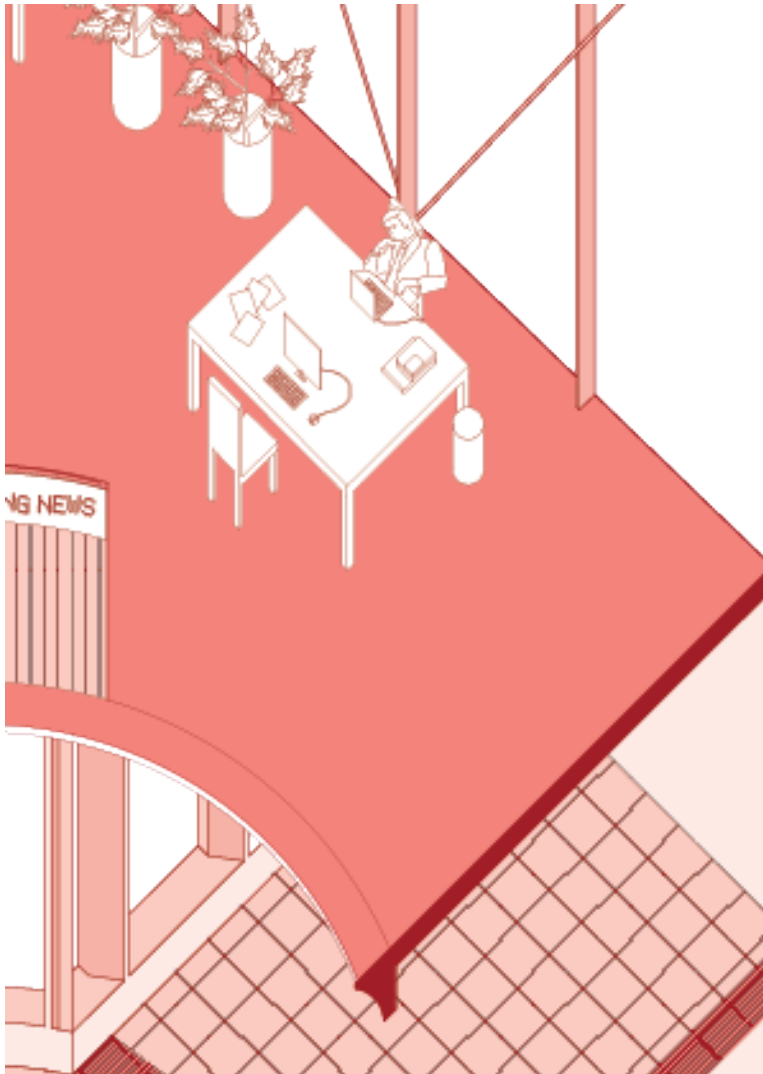

Lone journalist finishing a late night deadline. _D45

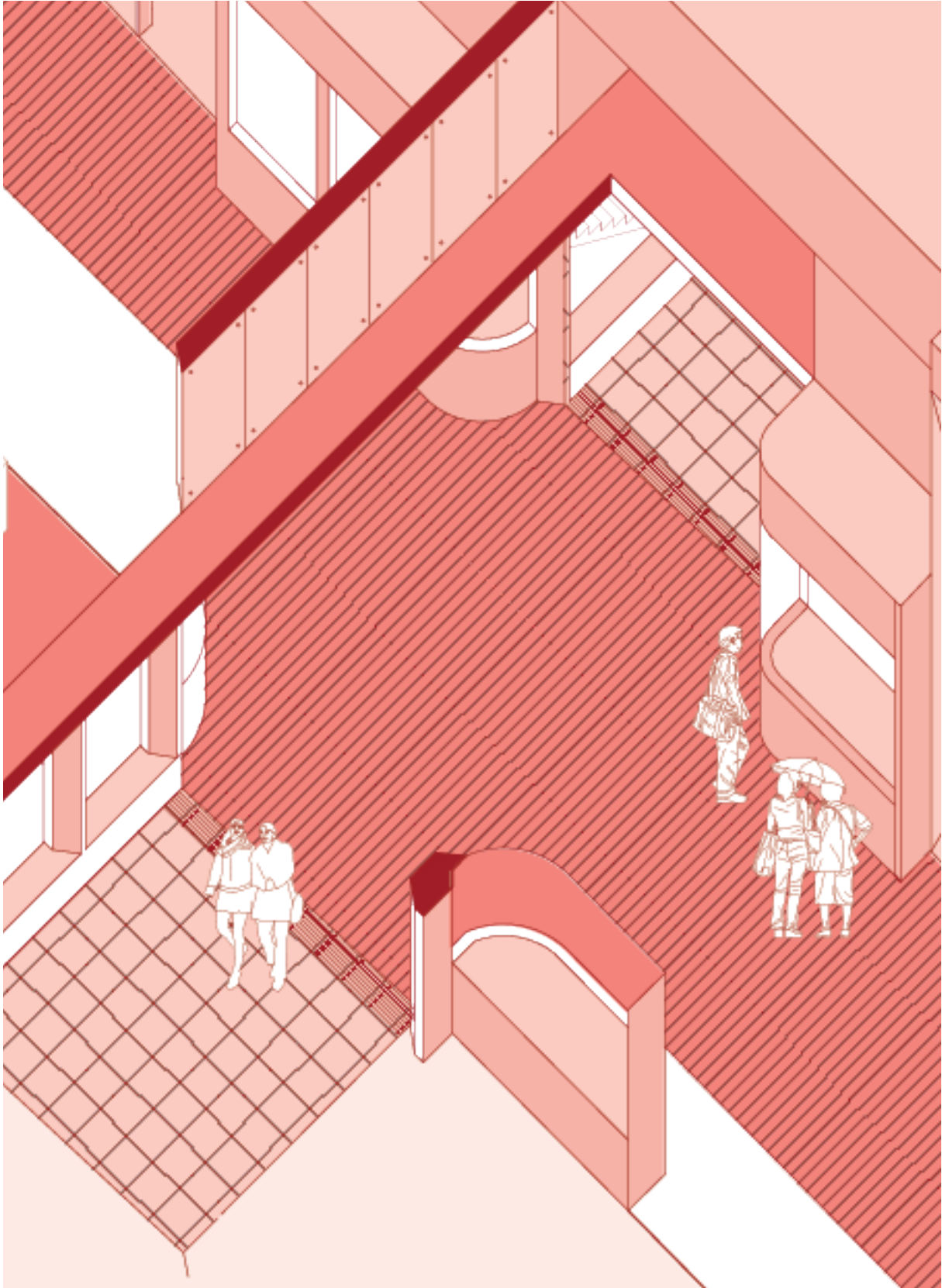

The curved vitrines act as the separation between the exterior and interior in the absence of a doorway._D46

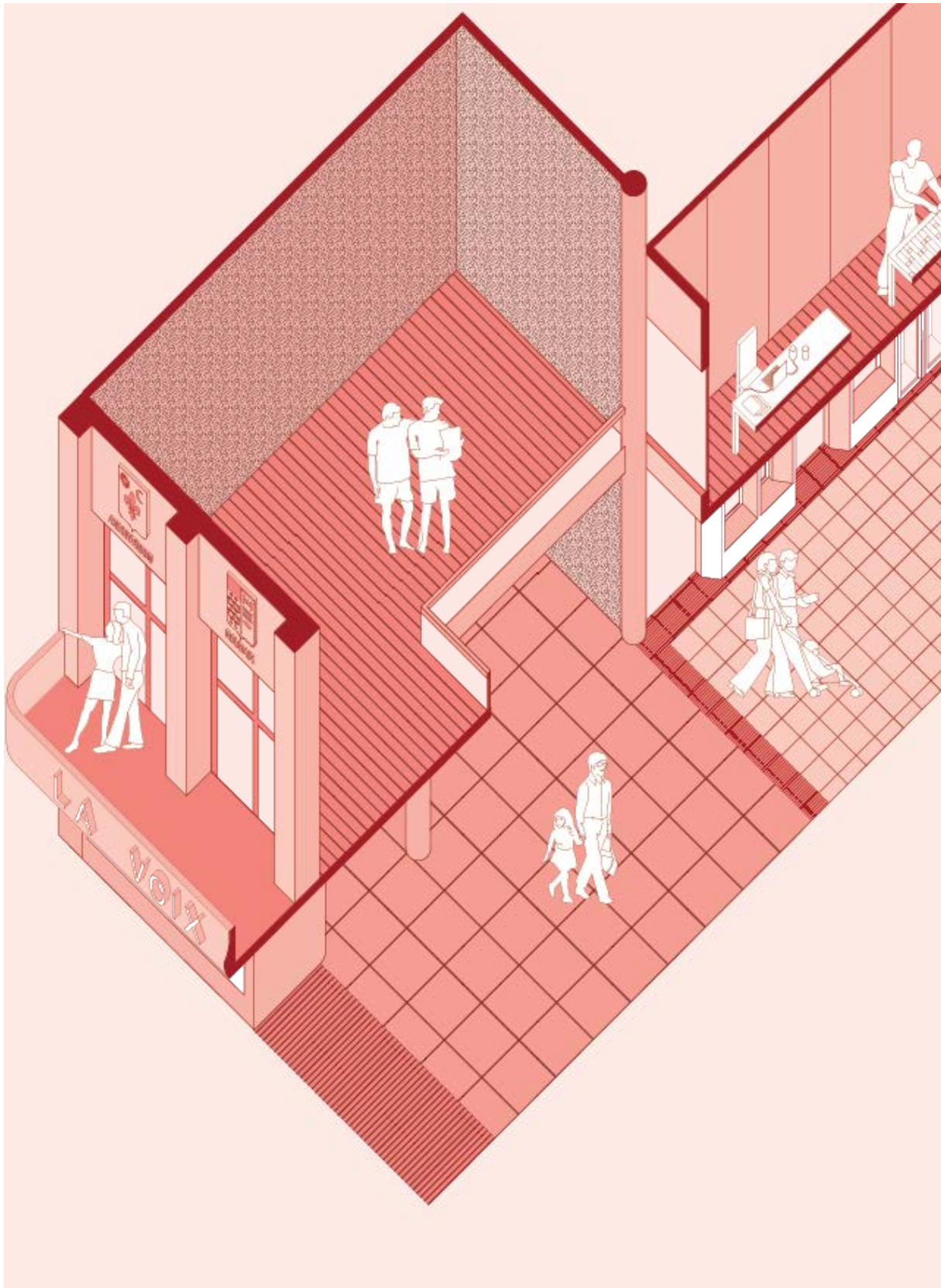

A space of transition from the old to the new. As you enter the facade of the symbolic 1930's building at Grand Place, the extended balcony as a canopy, and the original atrium makes way for the pre-cast concrete columns and the aluminium frames of the new arcade, the radio station on the upper floor visible through the clear glass window, the aluminium frame of which is adjacent to the existing marble column._D47

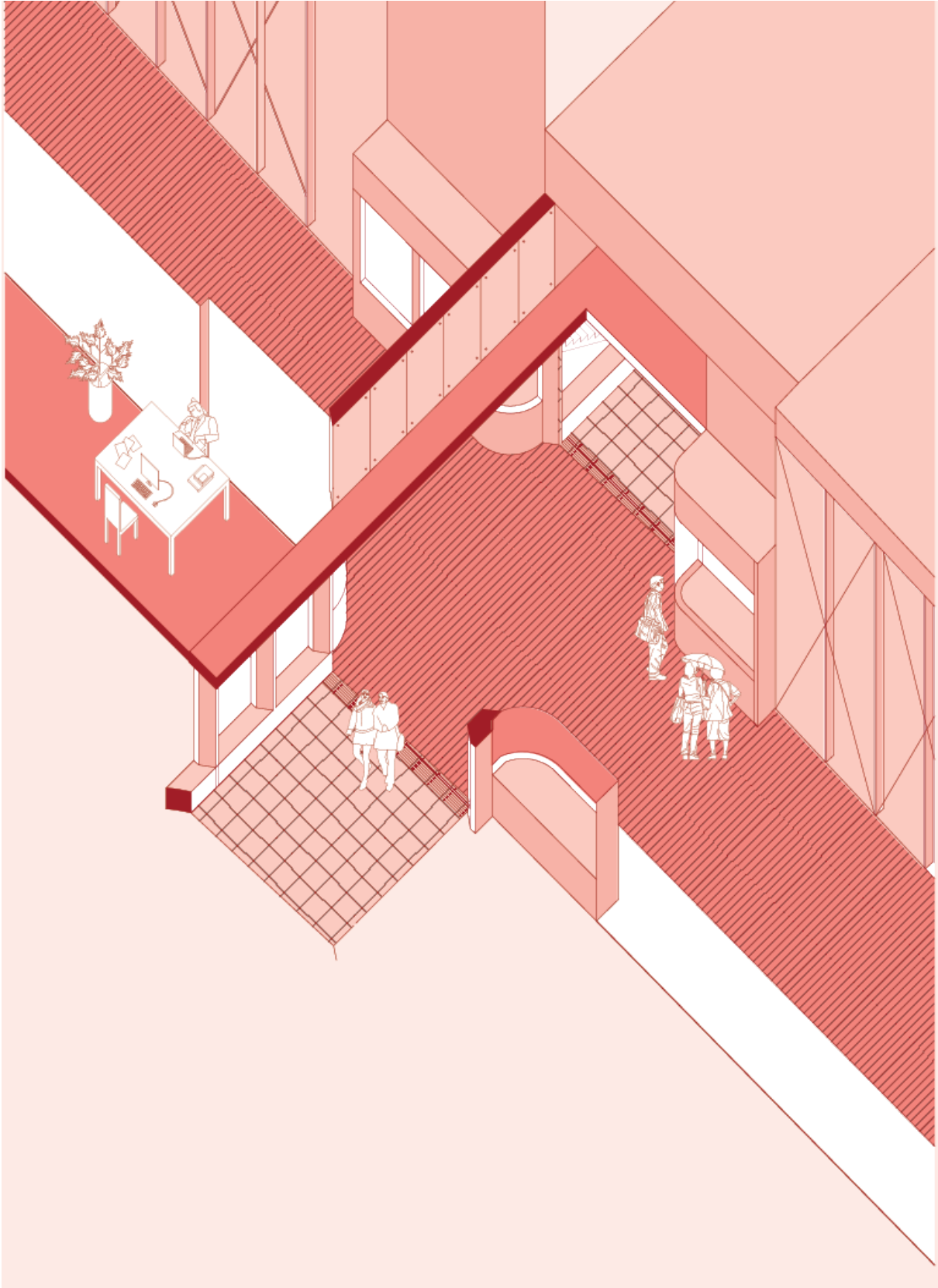

The arcade, takes the shape of a cross. The sky-lit newsroom arcade dissected through the middle by an open air alleyway for service trucks, small shops, residences, and exits to the theatre. The space of the intersection is marked by the extension of the roof connecting the spaces of the newsroom floor. _D48

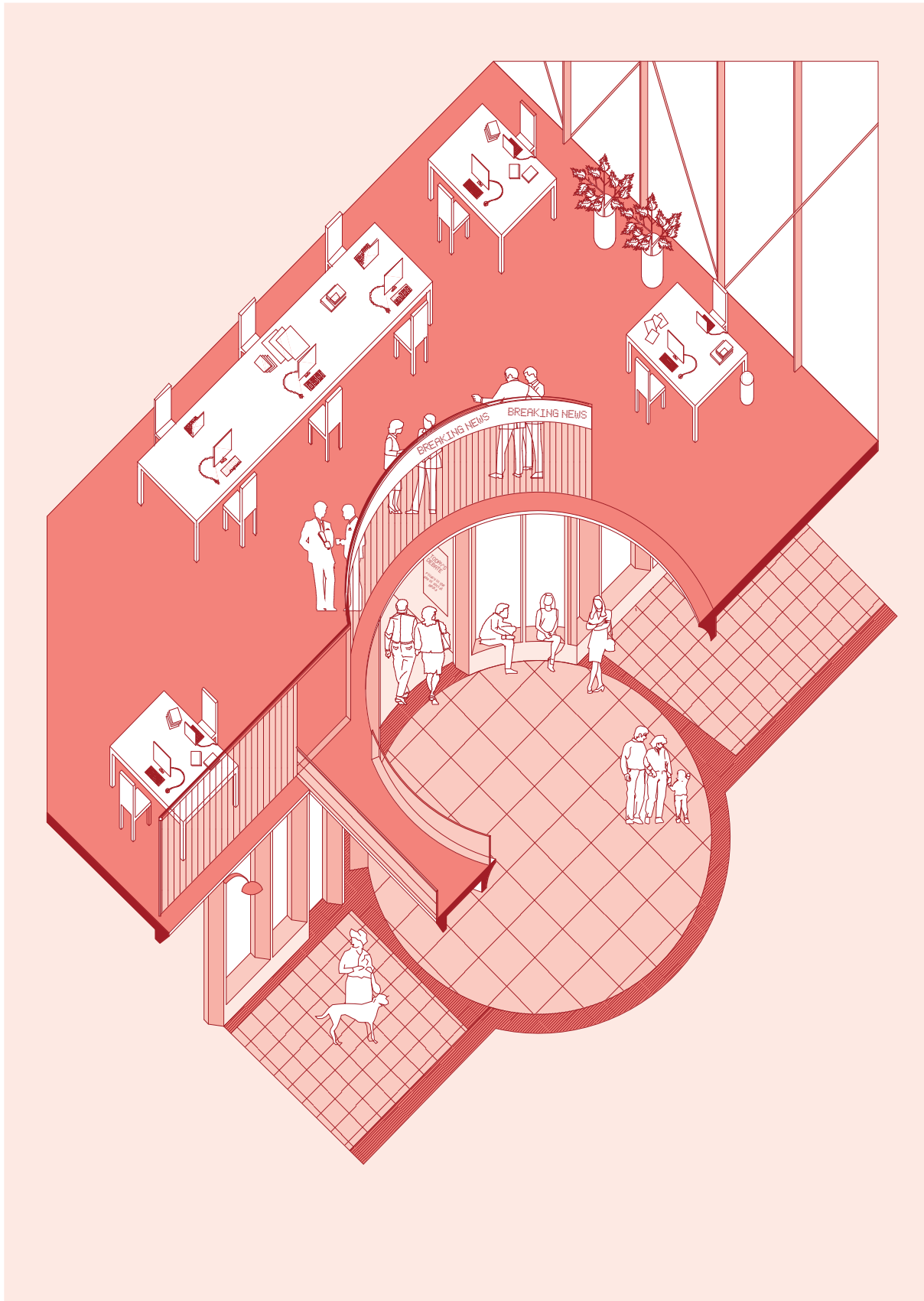

The face of the newsroom is in between the productive and the civic, between the symbolic and the functional. A contemporary interpretation of the symbolism of the news media. The arcade simultaneously creates and reveals the newsroom. _D49

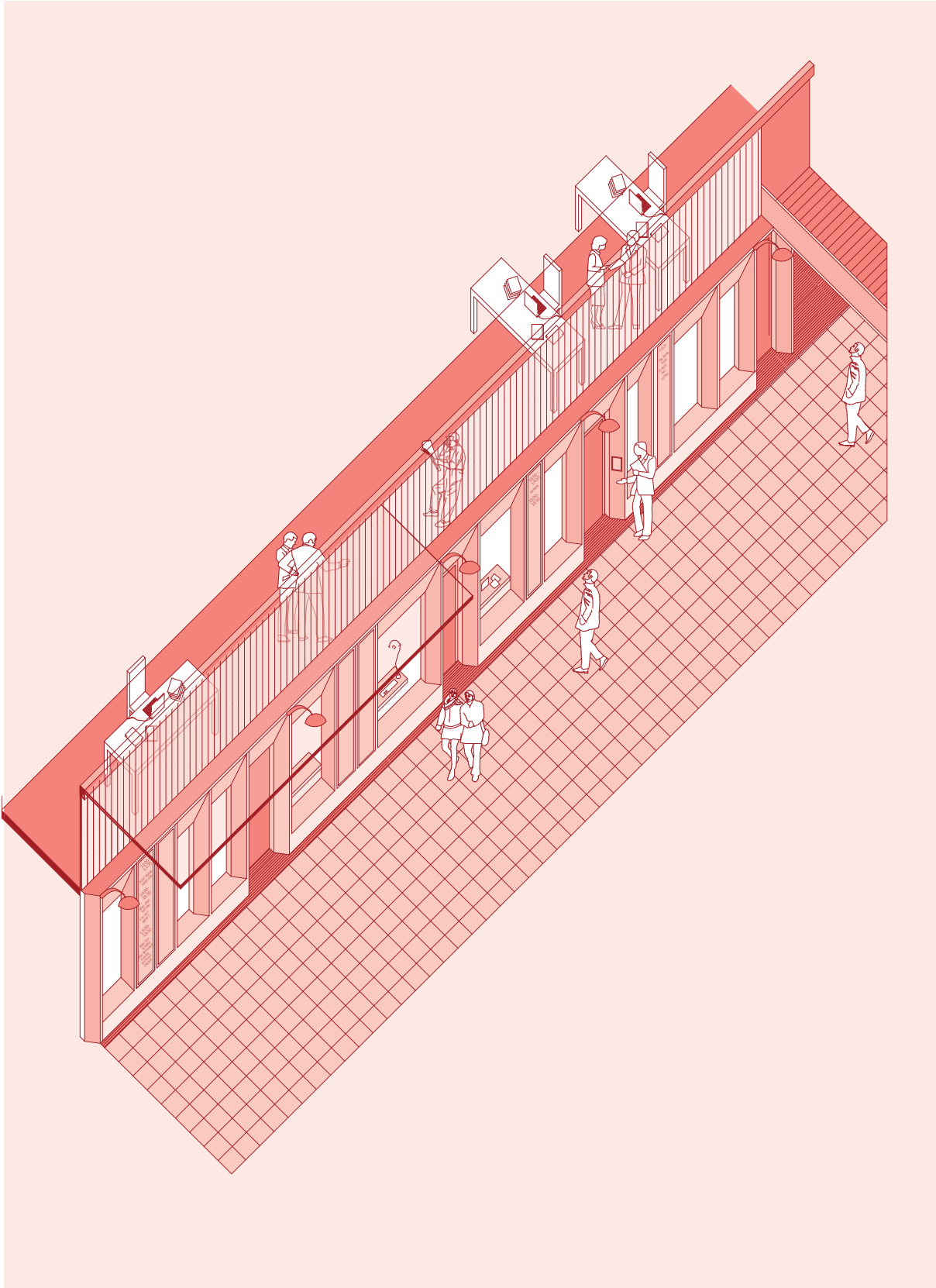

The facade of the newsroom as seen from the interior of the arcade through curated windows, and blurred shapes visible through the translucent polycarbonate wall._D50



© Bibliothèque municipale de Lille - portefeuille 65, 1.

Echo du Nord was founded in 1819 by Vincent-Jacques-Joseph Leleux, a printer in Lille. The first issue is published August 15, 1819. Defender of liberal principles, it is opposed to the royalist press, represented in particular by the *Quotidienne de Lille*.

- "Grand Écho du Nord." Wikipedia. November 23, 2017. Accessed November 28, 2017. https://fr.wikipedia.org/wiki/Grand_%C3%89cho_du_Nord._B1

Grand_%C3%89cho_du_Nord._B1

After the proclamation of the Republic, the freedom of the press is more effective but the newspaper is opposed then to the Messenger of the North, representative of the radical democracy. After the coup of December 1851, the newspaper is again suspended and its editor, Leon Gramain, imprisoned. The newspaper is allowed to reappear in 1852, when Alexandre Leleux, manager since 1836, takes over from his father as editor and owner of the newspaper.

"Grand Écho du Nord." Wikipedia. November 23, 2017. Accessed November 28, 2017. https://fr.wikipedia.org/wiki/Grand_%C3%89cho_du_Nord._B2



October 7th, 2017. A photograph of the entrances to fnac store and Notting Hill Coffee in the La Voix du Nord building, Grand Place, Lille. _B3

La Voix du Nord is a regional newspaper of the North of France belonging to the group's Voice , a company belonging to the Belgian media group Rossel Group .

- "La Voix du Nord" Wikipedia. September 15, 2017. Accessed October 25, 2017. https://fr.wikipedia.org/wiki/La_Voix_du_Nord. _B4

The Voix du Nord published in 1950 the supplement Voices of the waves with the complete programs of radio and television broadcasts . The newspaper participated in 1955 in the creation of the cycle race The Four Days of Dunkirk . In 1955, the circus of La Voix du Nord was launched , and in 1961 , the first tour of the beaches, in which, in 1963 , a car-podium took part.

It is from 1966 that a technical revolution begins, with the introduction of computer science in the management of the newspaper and the gradual removal of lead for photocomposition and telecomposition , which allows the organization of the direct entry into the agencies.

- "La Voix du Nord" Wikipedia. September 15, 2017. Accessed October 25, 2017. https://fr.wikipedia.org/wiki/La_Voix_du_Nord. _B5

The Grand Echo du Nord was a daily regional newspaper, whose premises - as well as the printing press - were located on the Grand'Place. At the dawn of the first war, some 150,000 numbers were dispatched each day. _B6

During the First World War , the newspaper is requisitioned by the occupier and it is no longer the Great Echo North that is published, but the Liller Kriegszeitung [Lille War Diary] . _B7

The *La voix du Nord* or *the Voice of the North*, a regional french newspaper for the Northern region, with its headquarters at Lille; was built in 1936 replacing the La Echo'du Nord at the same premises and with the same staff. _B8

Since 2005, the newspaper after a period of confused ownership and management, is owned by the Belgian based Rossel Group. Under Jean-Michel Bretonnier, editor-in-chief of La Voix du Nord , the newspaper is the first in the regional daily press to pass in colour. On September 19, 2010, the Nord-Pas-de-Calais daily newspaper became one of the first regional newspapers to be available on the iPad. The dailies of the group Voix du Nord are completely colorful”, AFP , 2009 (Accessed 28 September 2009) _B9

In January 2017, after the announcement of a large-scale social plan, the newspaper cut a quarter of its staff, i.e. 178 posts of which more than 70 jobs of journalists. The social plan is the consequence of the decline in dissemination and publicity, as well as “inadequate turnover on the Internet”. According to the Alliance for Press and Media Figures (CMPA), the distribution of La Voix du Nord, the country 's third largest regional newspaper behind West - France and South - West, fell by 4.6% to 217,000 copies between July 2015 and June 2016, in a context marked by a decline in advertising revenue (-5.2% for regional dailies in the first months of 2016). Florian Guadalupe, “Social Plan to “ The Voice of the North “: “ Most employees have learned it in ,Les Echos’ ” , ozap.com , January 5, 2017 (Read online) lefigaro.fr and AFP, AP, Reuters Agencies , ,, The Voice of the North: a quarter of the workforce threatened by a social plan. _B10

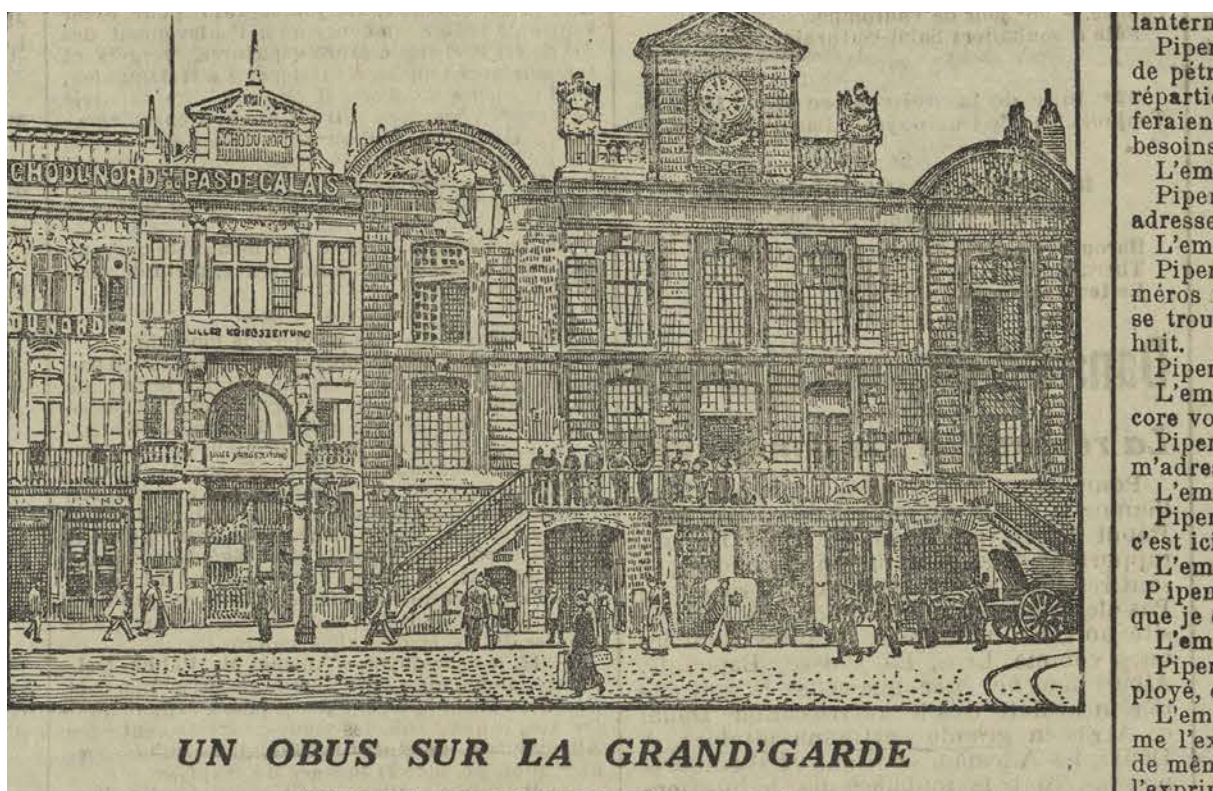

The Echo du Nord, Grand Echo du Nord et du Pas de Calais, Liller Kriegszeitung, operating from the same premises. 1918, Lille_B11



Public halls and entrances to the Printing Press, Echo du Nord, pre 1900. _B12

Liller Kriegszeitung was a German language newspaper published in Lille for the occupying troops, and the first of its kind. It was printed on the presses of the regional newspaper Echo du Nord which had been requisitioned for the purpose.

Liller Kriegszeitung was published weekly but a single-page supplement appeared every afternoon with the latest news and various sister publications were also printed, such as Lille in deutscher Hand. The occupying forces could buy other German newspapers from the Crédit Lyonnais Bank on rue Nationale which had been requisitioned and turned into a newsagent's shop.

Claudine Wallart, Head Curator of Heritage at the Archives Départementales du Nord (Nord Records Office)_B13

The first page is barred with a title on six columns: "The Northern Region is free." The freedom and independence were paid a high price: the jail, the torture, the death camps for over 530 people, who wrote, printed and distributed the newspapers.

"La Voix du Nord" Wikipedia, September 15, 2017. Accessed October 25, 2017. https://fr.wikipedia.org/wiki/La_Voix_du_Nord. _B14

N° 66 Mardi 5 Septembre 1944

VOIX DU NORD

Prix : UN FRANC Prix : UN FRANC

Rédaction et Administration : 8, Grande-Place, LILLE

La région du Nord est libre

Les Alliés pénètrent en Hollande

Ils ont atteint la frontière allemande sur un large front

Les Alliés pénètrent en Hollande

Ils ont atteint la frontière allemande sur un large front

5 Septembre. — En dernière minute, on apprend que les troupes américaines ont franchi la frontière hollandaise et ont atteint la ville de Breda, à 16 km de la mer.

D'autre part, les unités alliées opérant en Belgique ont atteint, ce soir, la FRONTIÈRE ALLEMANDE sur un large front.

Les correspondants de presse alliés déclarent qu'il faut s'attendre à des nouvelles sensationnelles.

Hier soir, un correspondant de presse a annoncé que les troupes américaines étaient entrées en Allemagne et avaient atteint le Rhin.

Cette nouvelle n'a toutefois pas encore été confirmée.

Autre Bruxelles et Anvers Gand, Liège et Namur seraient libérées

Le radio national belge de la Libre Belgique a diffusé son bulletin de Bruxelles et d'Anvers, Liège, Namur et de la libération de nos deux villes n'a toutefois pas encore été annoncé officiellement.

Les blindés, qui avançaient à toute allure, ont été arrêtés par les canons d'infanterie et les avions qui attaquèrent les chars. Parfois, des forces de la résistance et la libération de leur pays.

Les Allemands ont été vaincus et ont dû se rendre sans conditions.

Comment les troupes britanniques ont parcouru 200 km en quatre jours.

Le correspondant de l'Aviation.

Les premières déclarations de M. Roger Verlomme

"Dans la discipline et le respect des libertés recouvrées, vous contribuerez à assurer la paix sociale qu'il importe de préserver"

Lundi soir, au poste de Radio-Libre, M. Roger VERLOMME, Conseiller du Gouvernement pour le Nord et le Pas-de-Calais, a prononcé l'allocution qui suit :

« Les troupes alliées ont évacué notre région. Le magnifique et gigantesque effort de guerre des Alliés, leur courage et leur tenacité indomptable ont eu raison de l'infanterie machine de guerre allemande qui, terrassée, s'est enfuie. »

« Les victoires à venir nous assurent la victoire définitive. Le régime d'oppression qui nous opprimait depuis juin 1940 a pris fin. »

« Les divisions reconstituées l'espérance du général de Gaulle et qui se sont couvertes de gloire en Afrique, en Italie et dans les batailles de France, appartenant aux armées alliées, qui combattent maintenant sur le sol français, une aide héroïque dont elles approuvent hautement la valeur. »

« Les Forces de la Résistance de notre région, dont l'action prodigieuse a marqué le pas allemand français de France, nous libèrent dans un élan irrésistible de la servitude de l'ennemi. »

« Dans les départements du Nord et du Pas-de-Calais, comme dans les autres régions, et depuis quatre années, des hommes appartenant à tous les partis, nous par leur foi inébranlable dans les destinées de la patrie, se sont unis au sein de la Résistance dans le combat pour la liberté. »

« Ils ont, par leurs exemples et leurs sacrifices, galvanisé les énergies et forgé les liens. Ils ont été les conseillers précieusement, des guides sûrs, qui ont permis de vaincre. »

« Les décisions que les éléments commandés ont été prises. »

« Aujourd'hui, enfin, nous sommes libres. La France peut reprendre son vrai visage. Dès les décisions que les éléments commandés ont été prises, pour assurer, dans la dignité républicaine, le fonctionnement normal des pouvoirs publics, nous nous sommes attachés à ce que le rétablissement de l'ordre administratif, économique et social de notre région. »

« Dans l'esprit et la solidarité, nous attirons les hommes de ceux qui ont souffert de la victoire, et nous espérons que vous contribuerez à assurer la paix sociale qu'il importe de préserver. »

« Dans l'esprit et la solidarité, dont vous avez donné le bon exemple en milieu des épreuves, nous espérons que vous contribuerez à assurer la paix sociale qu'il importe de préserver. »

« Dans l'esprit et la solidarité, dont vous avez donné le bon exemple en milieu des épreuves, nous espérons que vous contribuerez à assurer la paix sociale qu'il importe de préserver. »

« Dans l'esprit et la solidarité, dont vous avez donné le bon exemple en milieu des épreuves, nous espérons que vous contribuerez à assurer la paix sociale qu'il importe de préserver. »

Les premiers chars anglais, passant sur la place de Lille, sont acclamés par la foule.

Les Allemands s'enfuient de Finlande

5 Septembre. — Le Finlandais qui s'enfuit de Finlande, après avoir été défaits par les Russes, a été vu dans la région de Helsinki. Le gouvernement finlandais a annoncé qu'il s'agit d'un ennemi qui s'enfuit de Finlande. Le correspondant de l'Aviation.

Le Comité Départemental de la Libération

« Vous les noms de ceux qui ont souffert de la victoire et de la libération de la France et de la Belgique. »

Edition of La Voix du Nord, September 5, 1944_B15

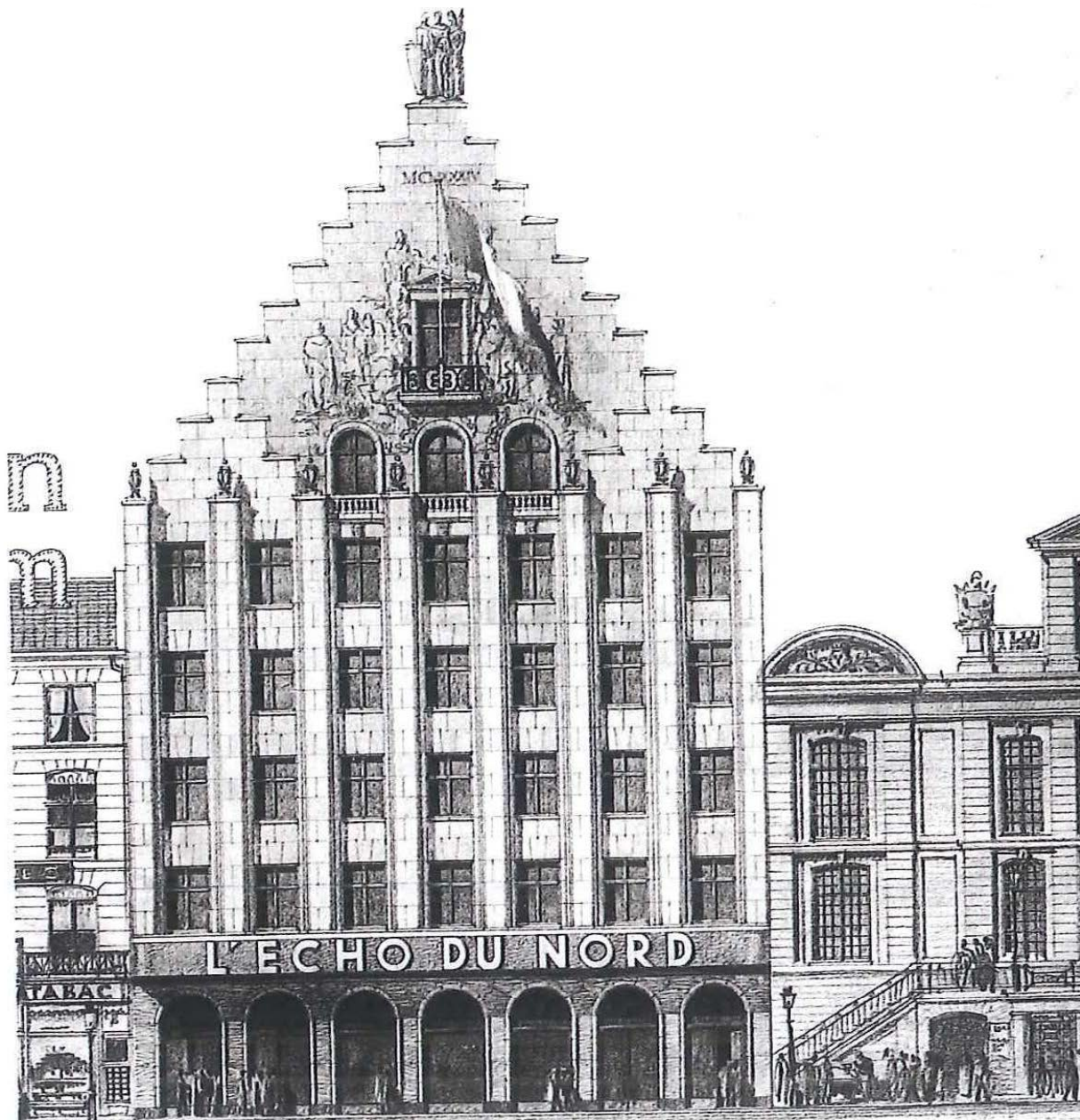

L'Echo du Nord, Façade on Grand Place, 1936 designed by Albert Laprade, Leon Emile Bazin and Ernest Willoqueaux _B16

“The bales floors are separated by cross-shaped pilasters according to local tradition, which end with lily flowers borrowed from the coat of arms of the city. The spandrels are decorated with twenty-eight armoures communes of the region, escutcheons proud cities of the North and Picardy: Armentieres, Roubaix, Bethune, Saint-Pol, Montreuil, Avesnes, Hazebrouck, Amiens ..., way of underlining the vast field of influence of the journal. The pediment, treated as a sparrow, illustrates the motto of the newspaper, “Defending Work in the Northern Region”, and presents a pyramid of characters in bas-relief which symbolize the different trades. Fronton, framing a window monumental balcony treated in the manner of the Renaissance, forms a triangle of some six meters high decorated with bas-reliefs symbolizing the arts and sciences, industry, agriculture, trade and sports. The fact of this generous composition is crowned by a group of statues representing the northern provinces.

The old guild houses, each facade of which referred to a trade, are condensed in an unique building which, dominating the heart of the city, brings together all aspirations, speak for all. Stone Conference on the Industrial Engineering of the People of Here.” - (*Maurice Culot, Albert Laprade: Architecte, jardinier,urbaniste, dessinateur, serviteur du patrimoine, 305*) _B17



The coat of arms of the 28 cities to which the newspaper L'Echo du Nord circulated to as of 1936._B18



The Editorial meeting room at the top of the new building, 1936. It has a balcony overlooking the Grand Place of Lille, the highest vantage point on the square.

Maurice Culot, Albert Laprade: Architecte, jardinier,urbaniste, dessinateur, serviteur du patrimoine, 309)_B19



The “Voix du Nord”, tallest building on Grand Place, 1959 _ B20

The years 1994 / 1995 marked two important milestones in the development process. With the participation of other regional dailies, weeklies, partners and subsidiaries, La Voix du Nord is increasing its Euroregional presence. Today, with 35 companies, La Voix du Nord is committed, with this set of multiple media, on the path of multimedia.

However, since 1989 , the Lille press group has not been immune to capital battles. A well-informed book, *La Voix du Nord, a secret history* , published in 2005 by Lumières de Lille publishes the financial operations that shook the newspaper in Lille.

First controlled by a hard core of executives who launched a buyout of the company by its employees (RES), the group was then shuffled between 1998 and 2003 in the hands of the Belgian press group Rossel , itself under the control of the Socpresse (ex- Hersant group).

-”La Voix du Nord”Wikipedia. September 15,2017. Accessed October 25, 2017. https://fr.wikipedia.org/wiki/La_Voix_du_Nord. _B21



The offices of senior journalist and editor, Voix du Nord, 1960.
-Maurice Culot, *Albert Laprade: Architecte, jardinier, urbaniste, dessinateur, serviteur du patrimoine, 310*_
B22

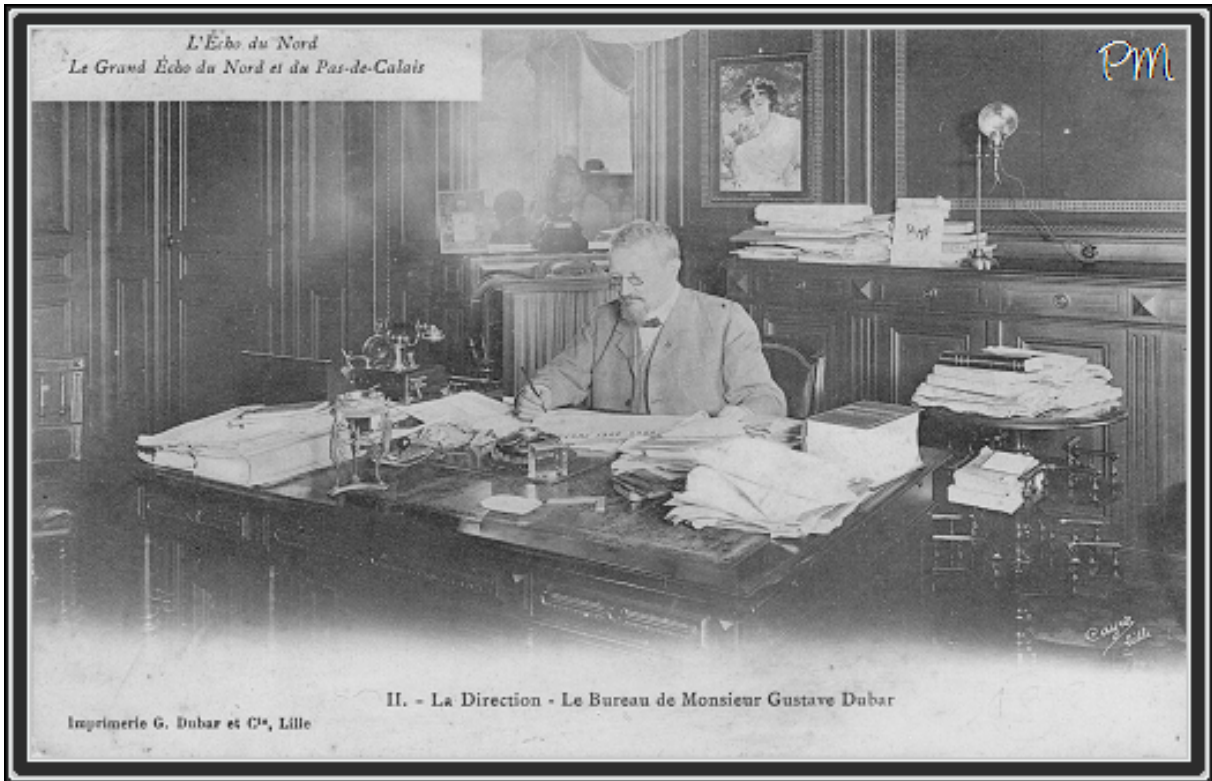

Offices of Editor in Chief, Echo du Nord. Pre 1900

Echo du nord, le grand echo du nord et du pas de calais, la voix du nord. Accessed January 28, 2018. http://www.lilledantan.com/echo_du_nord.htm._B23

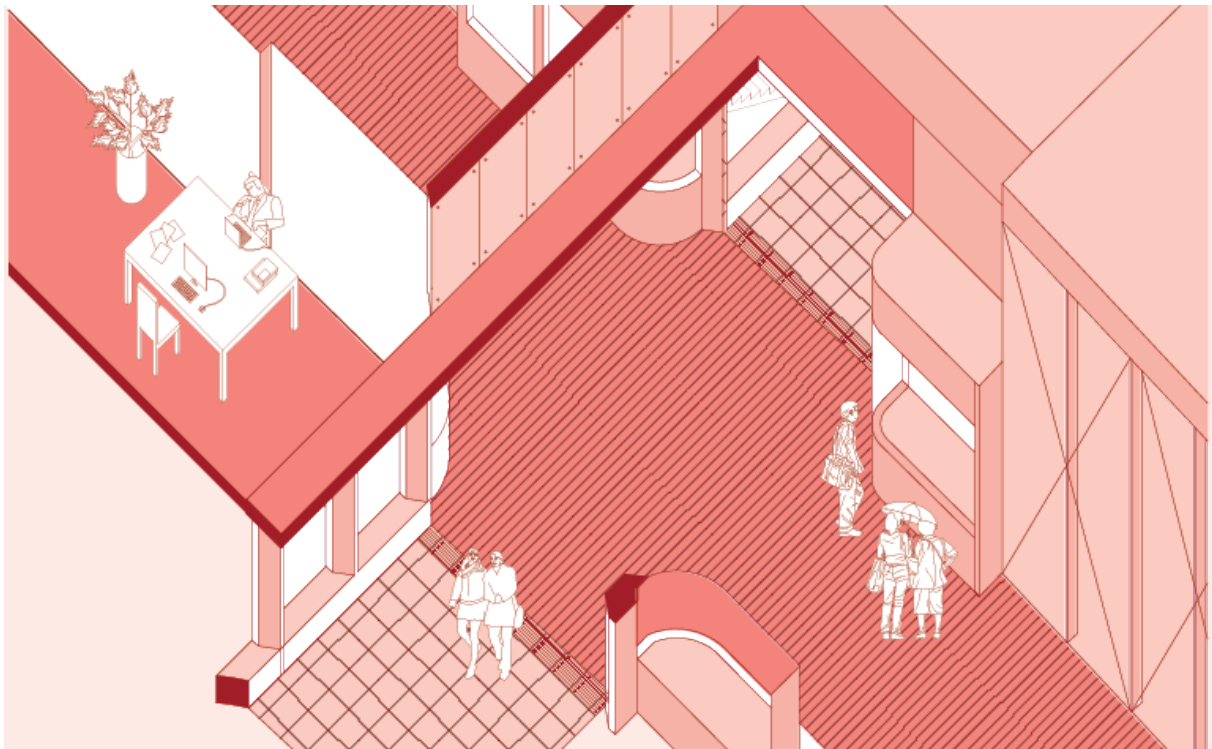

A journalist editing an article, before uploading on the website and smartphone, 2020, La voix du Nord._B24

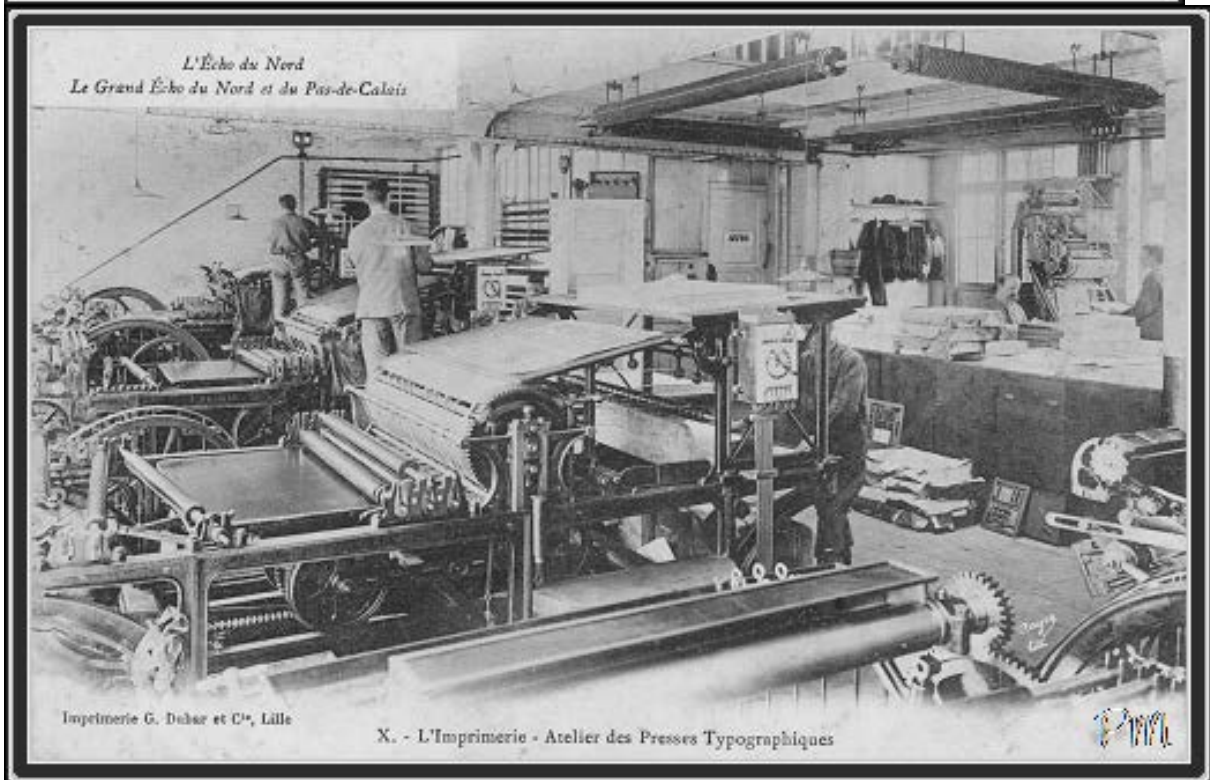
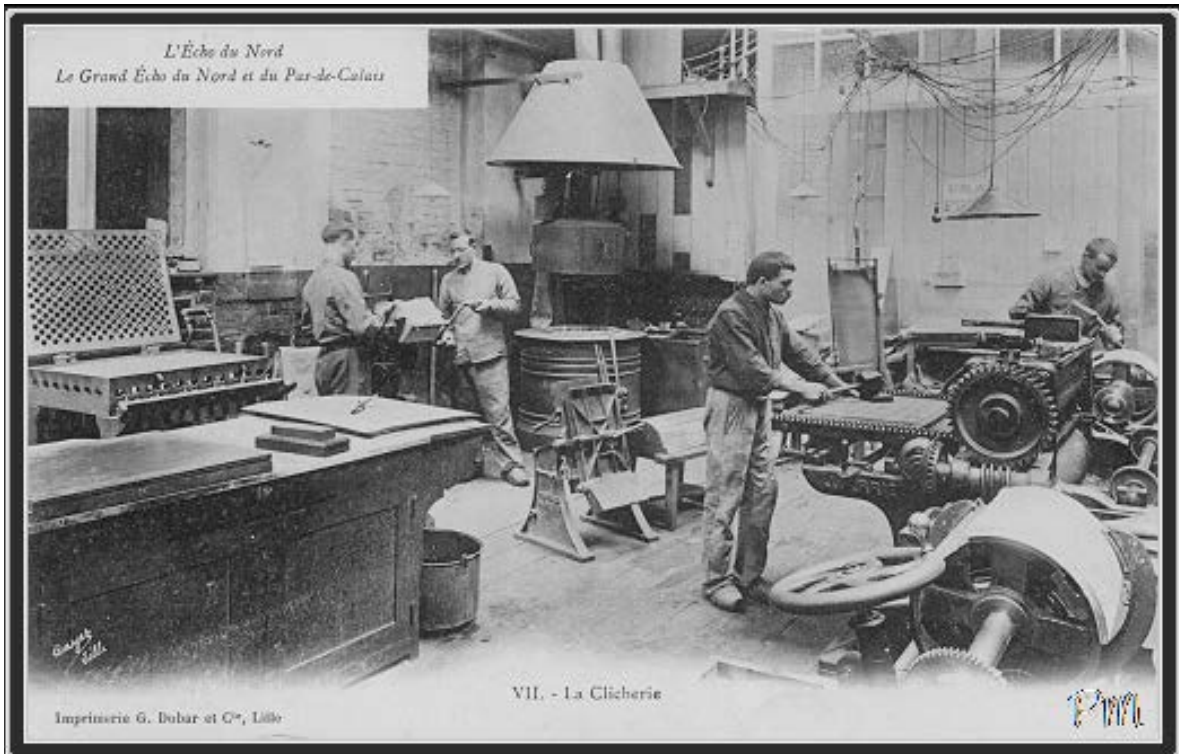

Prototype and typography printing, Echo du Nord, pre 1900.

Echo du nord, le grand echo du nord et du pas de calais, la voix du nord. Accessed January 28, 2018. http://www.lilledantan.com/echo_du_nord.htm. B26

The spaces for production have specific spatial requirements for the large machinery and processes of production_B27



Newspapers , for a circulation of 150,000 is being packaged for transport, early 20th century. Echo du nord, le grand echo du nord et du pas de calais, la voix du nord. Accessed January 28, 2018. http://www.lilledantan.com/echo_du_nord.htm._B28



The news dissipated through the iPad application, *La Voix du Nord*, 2017_B29

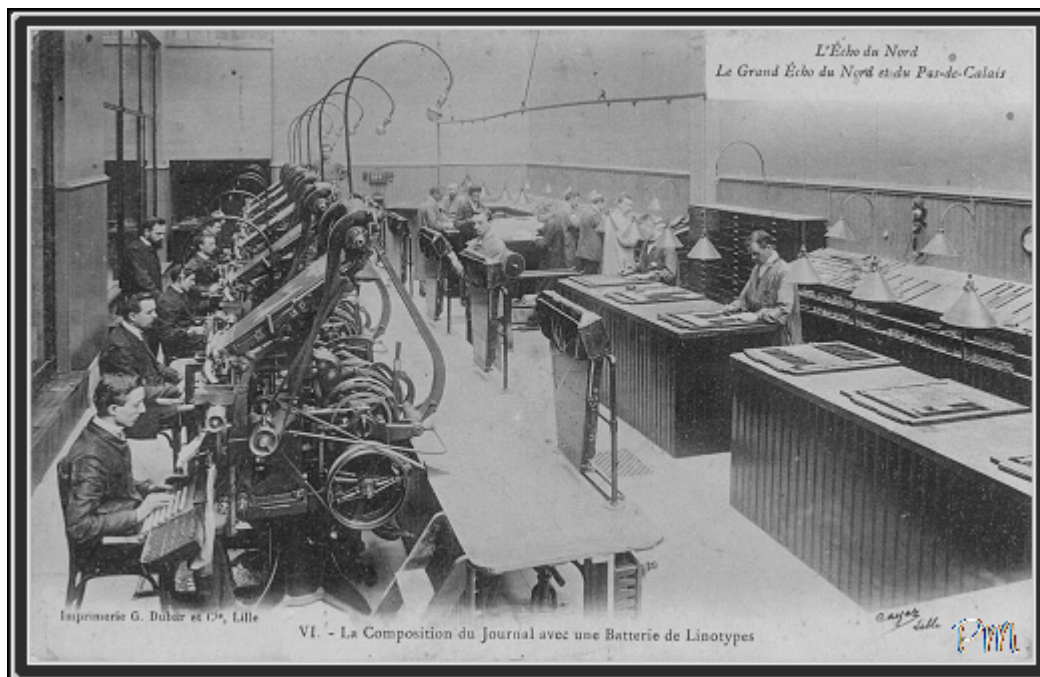

Printing composition, Echo du Nord, pre 1900

Echo du nord, le grand echo du nord et du pas de calais, la voix du nord. Accessed January 28, 2018. http://www.lilledantan.com/echo_du_nord.htm._B30

Introduction of information technology into the management of the newspaper, and phasing out of lead and photo-composition made it possible to organise direct input into the agencies for printing.

With extension into radio and television programmes, participation with other regional newspapers and weeklies, the La voix du Nord reached the peak of its presence in 1994-95, with subscriptions reaching the peak of 300,000.

„La Voix du Nord.“ Wikipedia. June 28, 2017. Accessed July 02, 2017. https://fr.wikipedia.org/wiki/La_Voix_du_Nord _B31

Since 2005, the newspaper after a period of confused ownership and management, is owned by the Belgian based Rossel Group. According to Jean-Michel Bretonnier, editor-in-chief of La Voix du Nord , the newspaper is the first in the regional daily press to pass in colour. On September 19, 2010, the Nord-Pas-de-Calais daily newspaper became one of the first regional newspapers to be available on iPad.

„ The dailies of the group Voix du Nord are completely colorful, „ AFP , 2009 (Accessed 28 September 2009) The Voice of the North“ is now flipping through and reading on the iPad , La Voix du Nord , 2010 (Accessed 19 September 2010) _B32



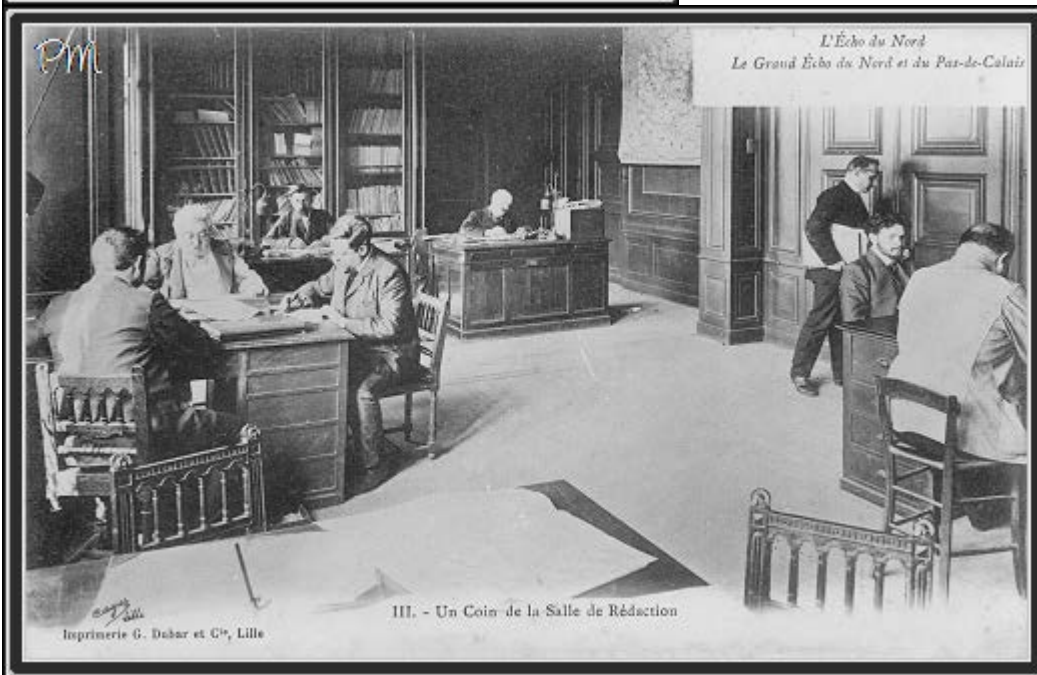

The corner of the Newsroom, Echo du Nord, 1900.

Echo du nord, le grand echo du nord et du pas de calais, la voix du nord. Accessed January 28, 2018. http://www.lilledantan.com/echo_du_nord.htm._B33

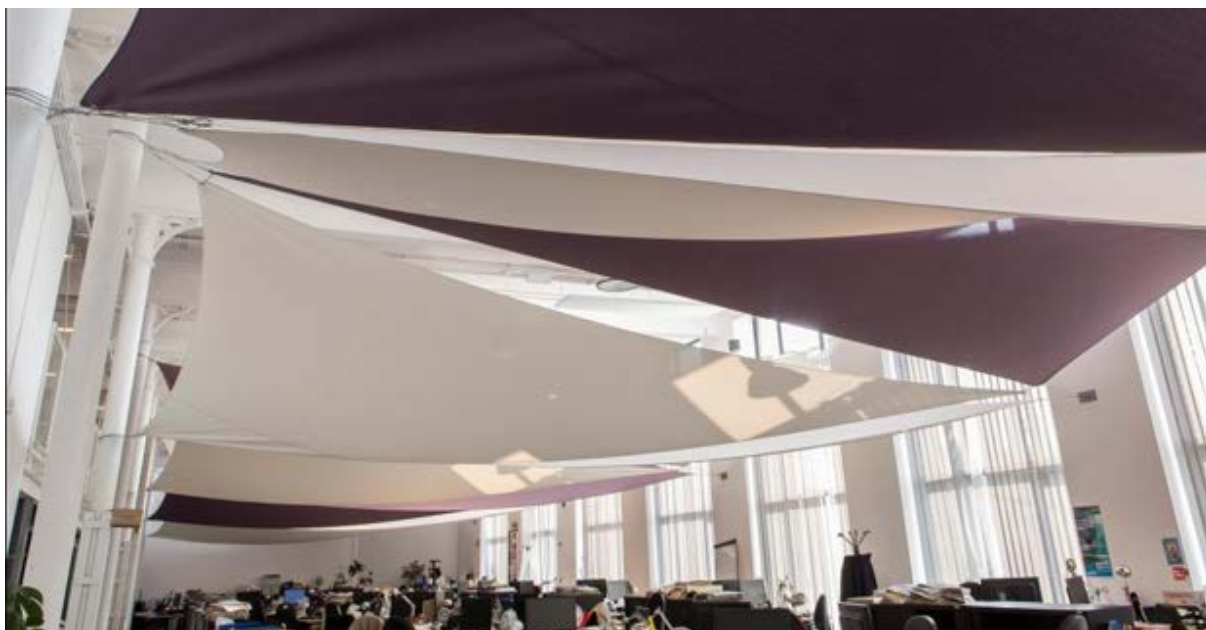

Newsroom, La Voix du Nord, 2016._B34

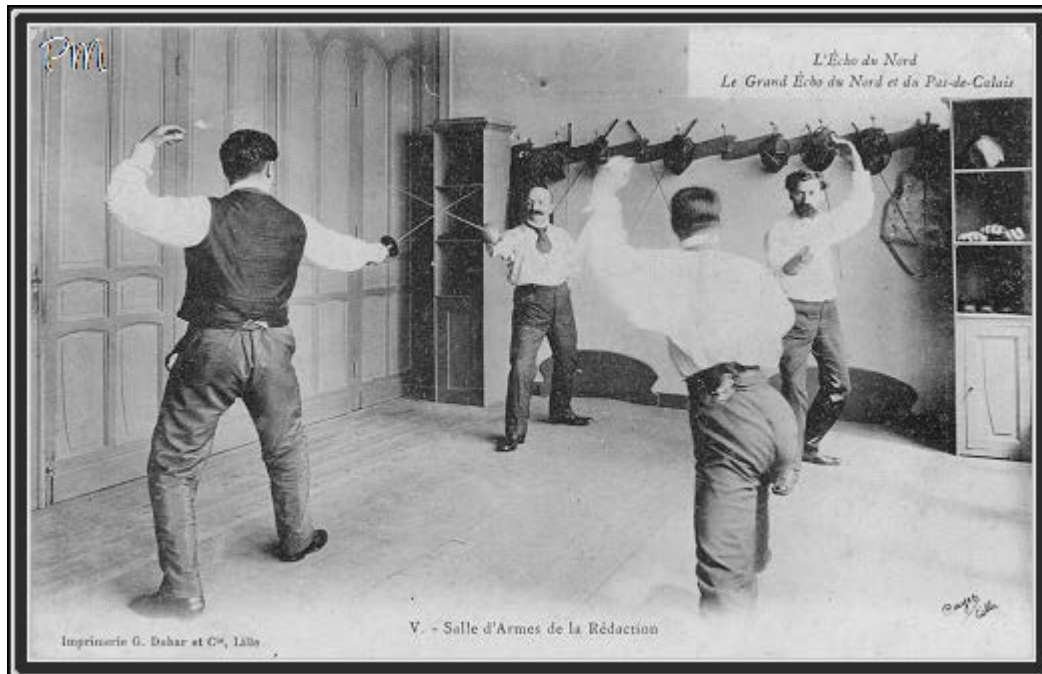

The weapons room in the newsroom,Echo du Nord, 1900.

Echo du nord, le grand echo du nord et du pas de calais, la voix du nord. Accessed January 28, 2018. http://www.lilledantan.com/echo_du_nord.htm._B35



Part of the newsroom. Journalists look at a screen showing the website of the newspaper. _B36



The Contact FM offices inside the offices of the Voix du Nord, 2016. _B37



The control room for audio inside the offices of the Voix du Nord, 2016._B38

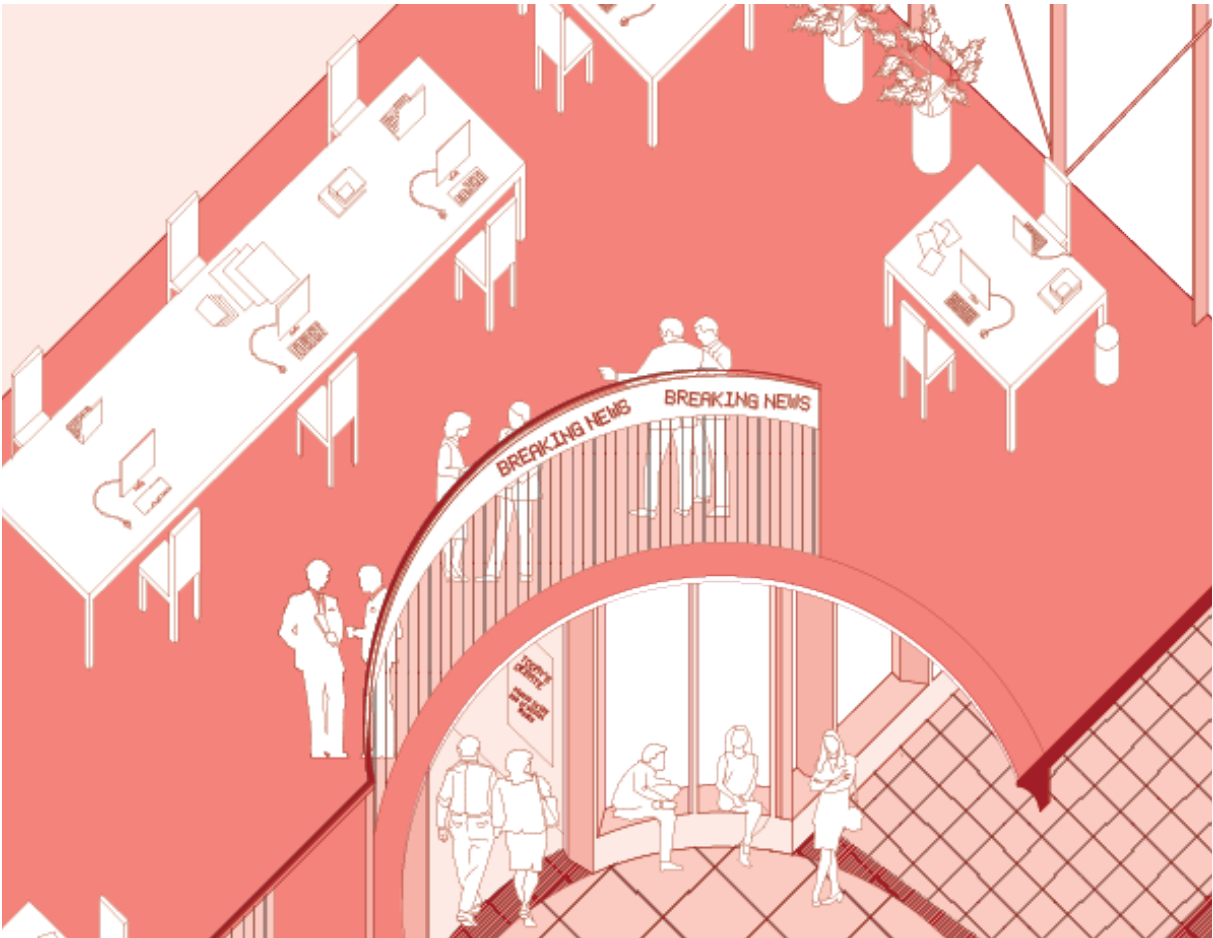

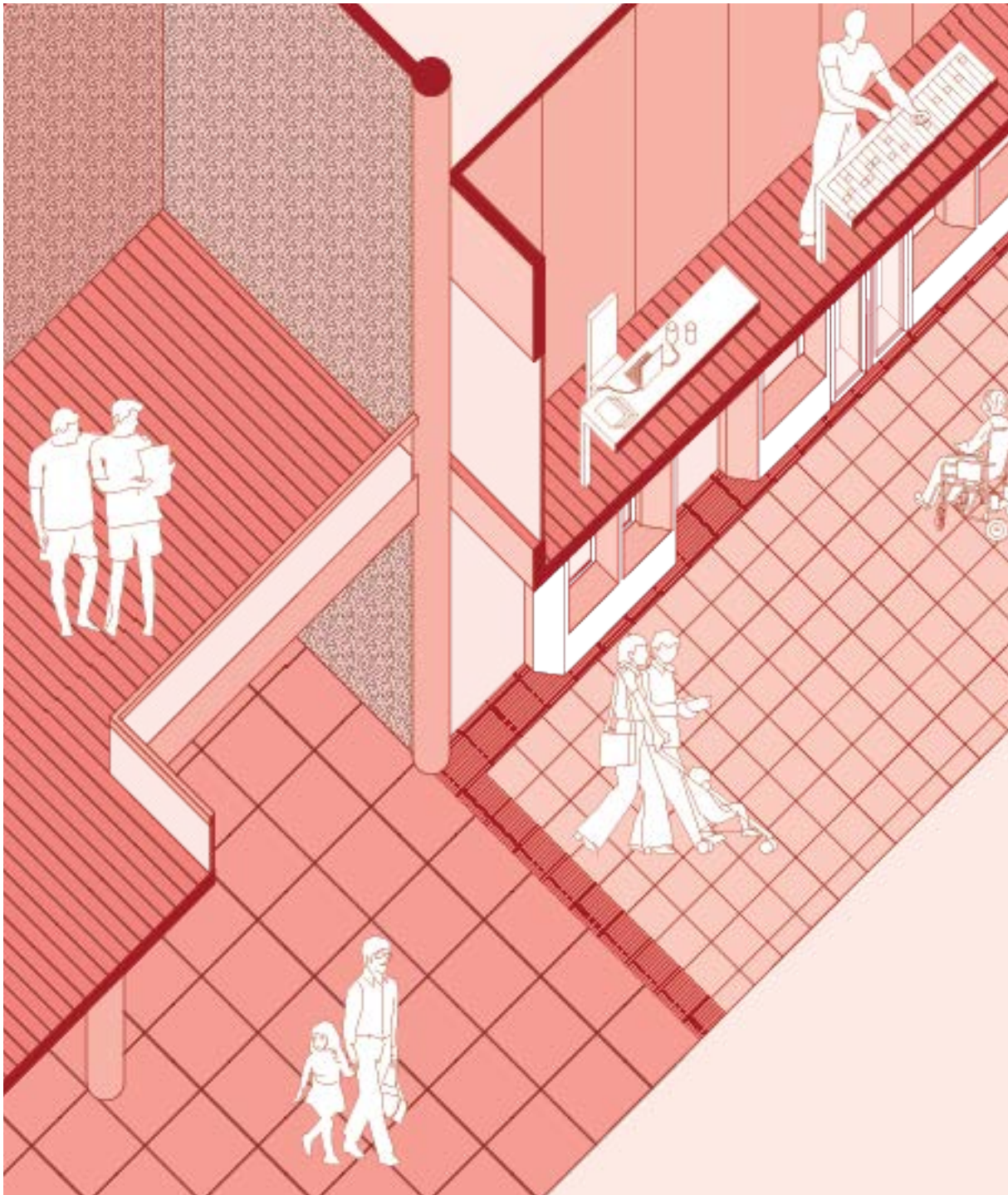

The offices of the newsroom of the Voix du Nord, 2020. It is separated from the arcade that cuts through it by a translucent polycarbonate. _B39

The radio stations, visible on entering the arcade from Grand Place is open, visible to the pedestrian using the shortcut through the arcade. _B40

The arcade Voix du Nord, where the main business is the news. The radio station, workstations, podcast studios, meeting rooms are located along it. The Voice of the North is gathered, processed, published and transmitted within this arcade space. _B41

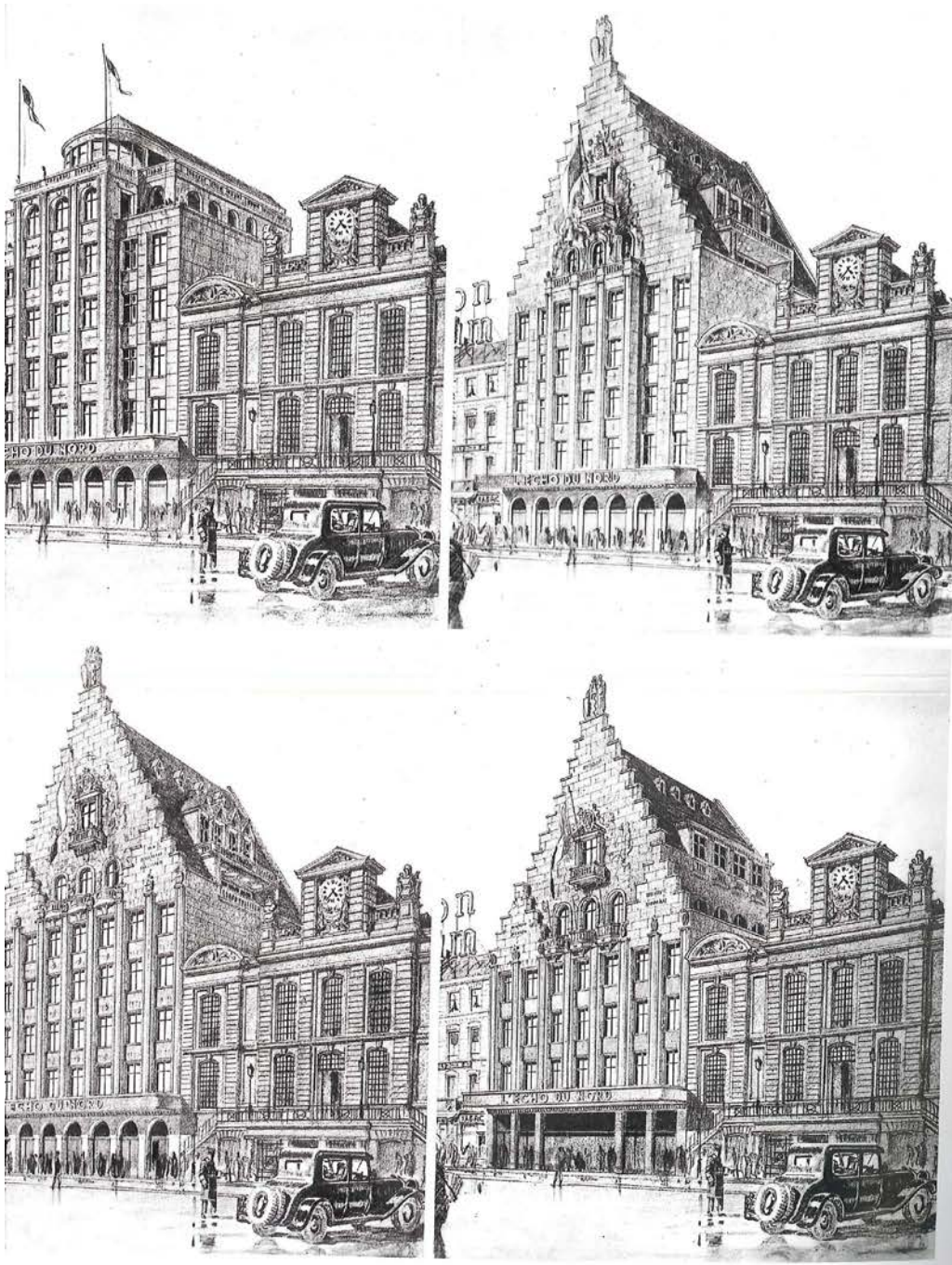

Facade studies for the Voice of the North by Albert Laprade, 1936.

-Maurice Culot, *Albert Laprade: Architecte, jardinier, urbaniste, dessinateur, serviteur du patrimoine*, 310)_
B42

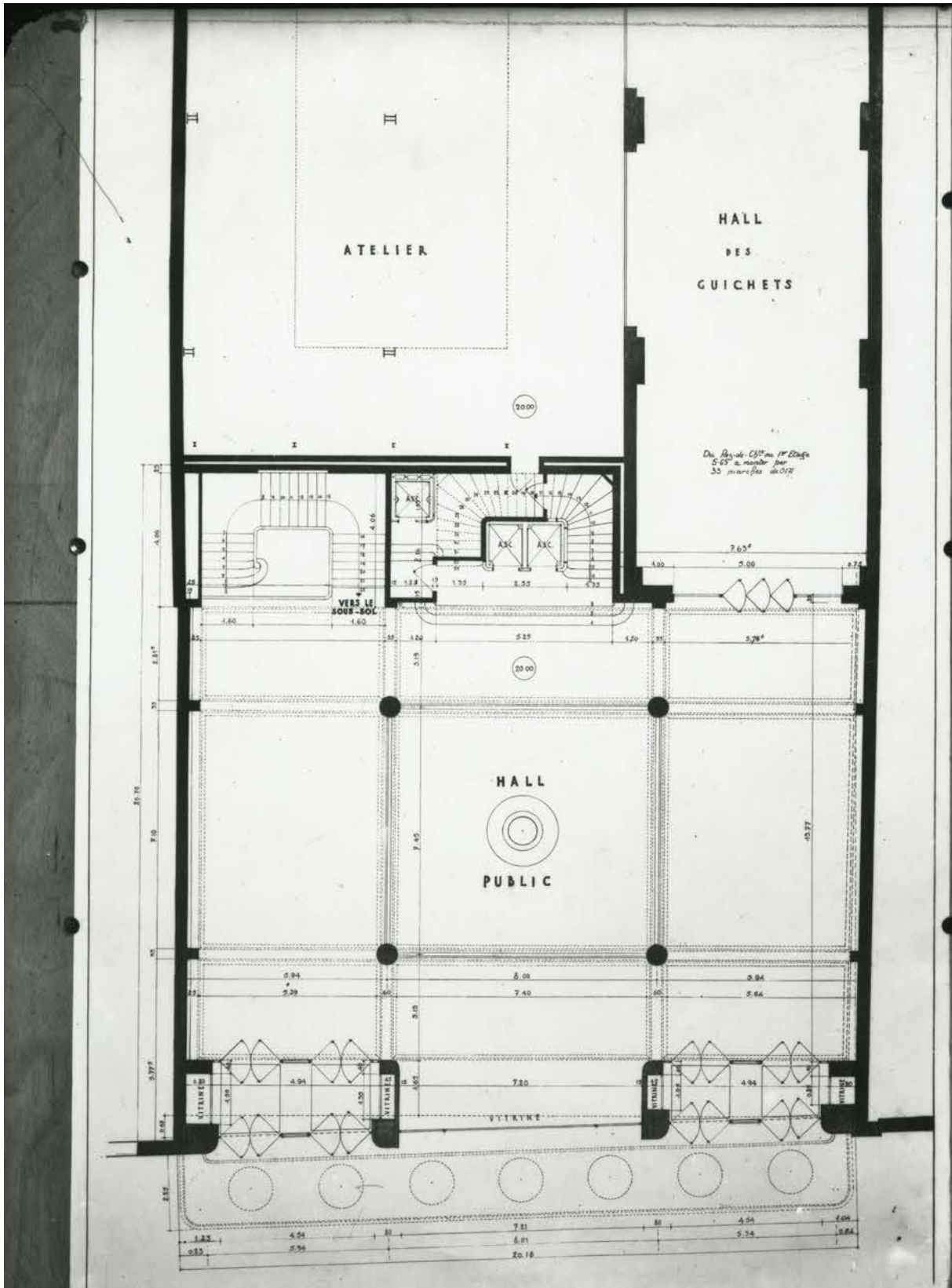

Partial ground floor plan of the entrances to the Voice of the North, Albert Laprade.

1934-1936. Immeuble du journal L'Echo du Nord, Lille (Nord) : vue d'un plan du rez-de-chaussée, n.d. (cliclé anonyme). Dossier : 403 AP 7777. Cite de Archive, Paris. _B43



La Voix du Nord

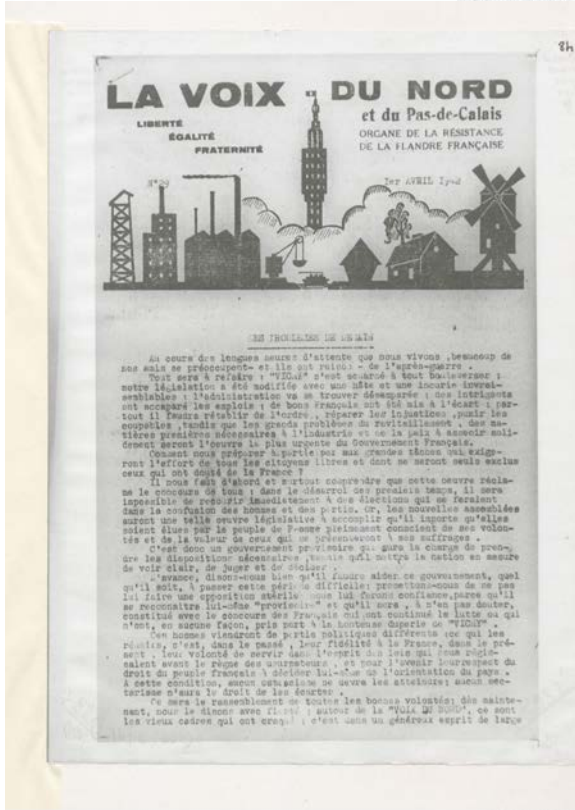

Bibliothèque municipale de Lille - 13347

LILLE - MARCO - LAMBERSART

LA VOIX DU NORD

LUNDI 24 AVRIL 2017 87^e ANNÉE - N° 23114 - 1,25 €

PRÉSIDENTIELLE 2017

Emmanuel MACRON 23,77 %

Marine LE PEN 21,70 %

INÉDIT

LIRE PAGES 2 À 11, 46 À 51 ET 63

AIRFRANCE
FRANCE IS IN THE AIR
AMSTERDAM, OUVRE-TOI!
COMPAGNIE LILLE-AMSTERDAM
ÉVÈLE POUR DÉPARTER

RÉGION
Marine Le Pen en tête dans le Nord et dans le Pas-de-Calais

The hot composition system (lead) is gradually abandoned in favor of the cold composition (bromide). In 1982, the Pilaterie factory was established, and the printing industry switched to Offset printing and four-color printing, moving the printing presses from the building at Grand Place. In 2009, La Voix du Nord completely renovates its Pilaterie printing fleet, for colorful newspapers and a publication 7 days a week. In 2012, it installs a new editorial system (CCI) that paves the way for the acceleration of a mixed paper and digital offer. _B44

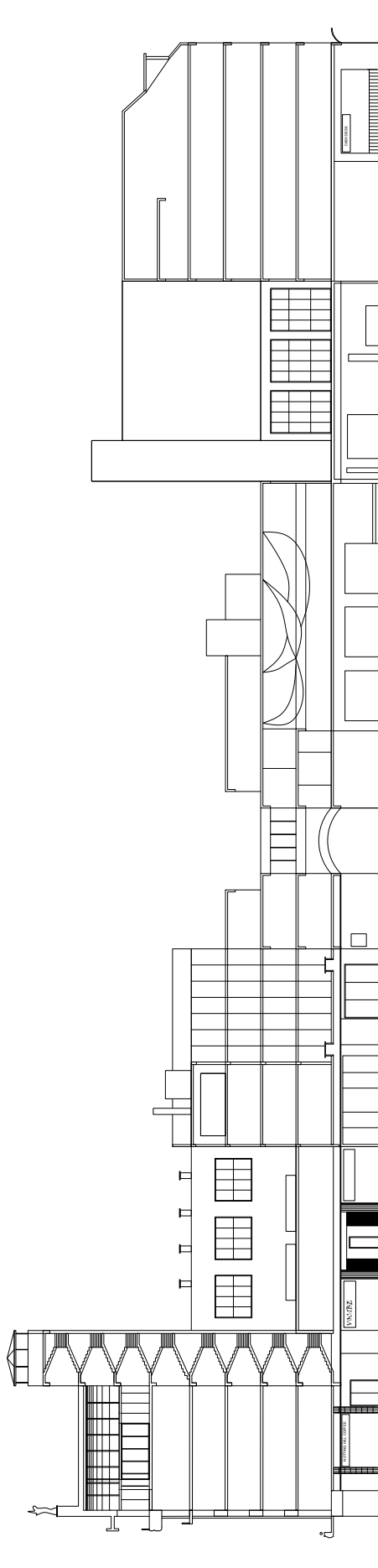

The Galerie Grand Place, 2017, runs from Grand Place to Rue de Arembault, with cafes, nail salons, herbal and electronic stores. The newsroom on the upper floors that have grown over time, are now gradually emptying. _B45

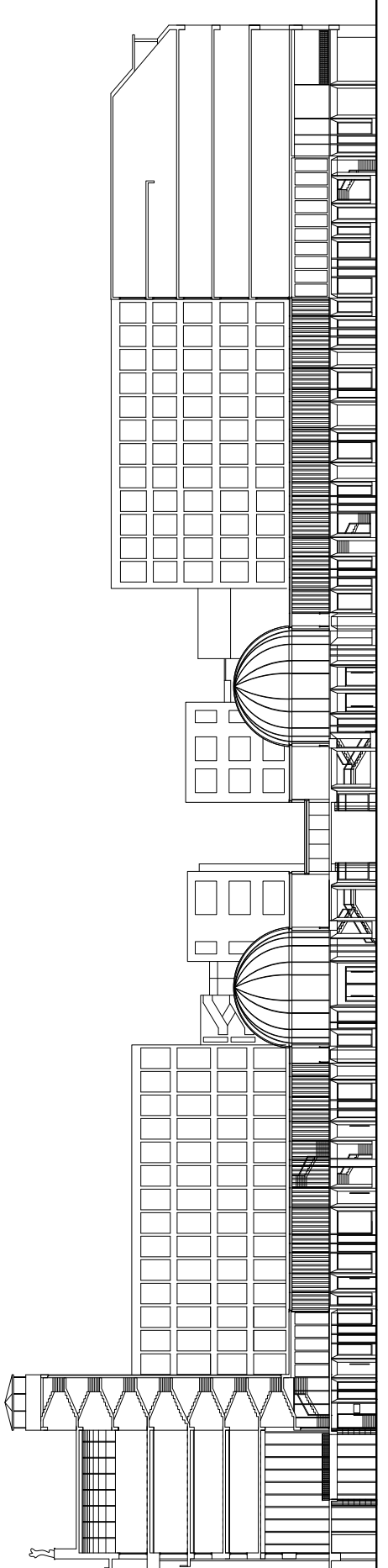

The Arcade Voix du Nord, 2020, runs from Grand Place to Rue de Arembault. Podcast stations, screening rooms, debate centres occupy it, while they also make a quick shortcut through the urban block, while providing access to the residences above. B46

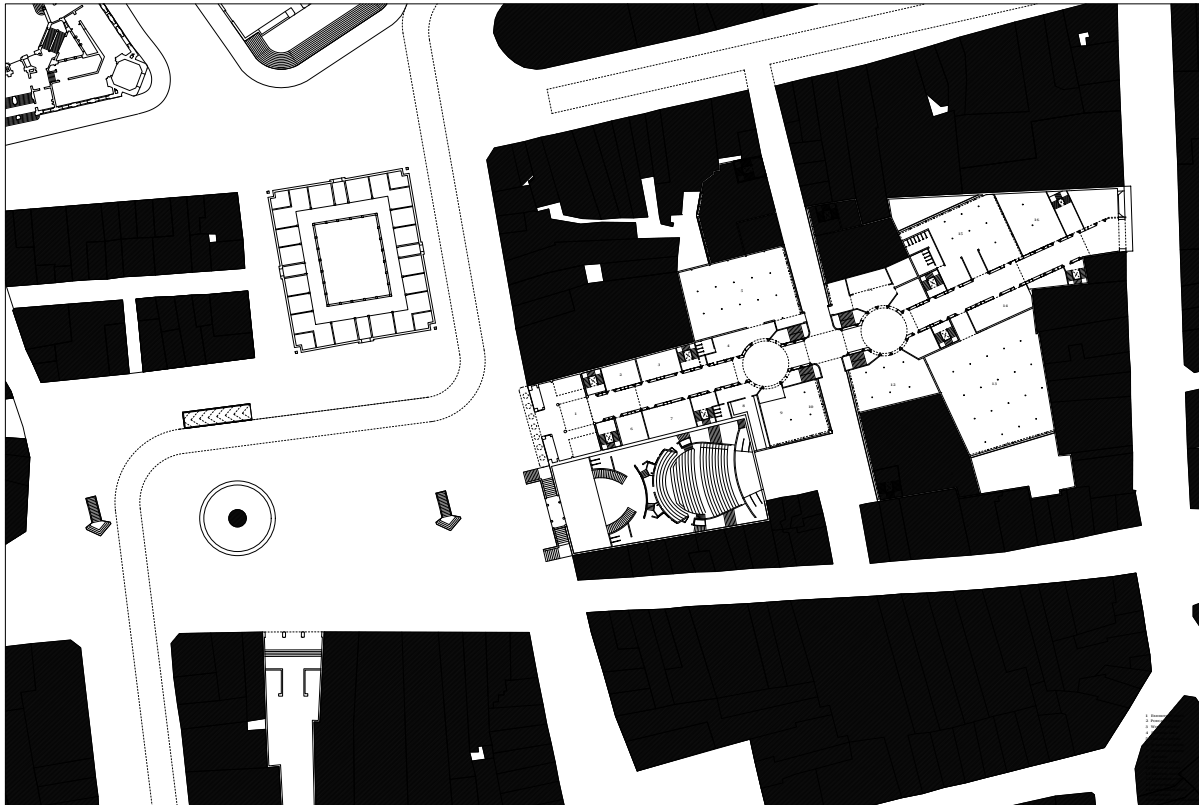

S i i i l r

The productive newsroom occupies this space in between the public and the private. The symbolic facade on Grand Place is extended through the arcade, in a way that has no beginning and end.

The productive spaces freed of programmatic requirement occupy the residual spaces of the arcade. _ B47

A Nolli Plan of Rome, showed the publicly accessible and inaccessible parts of a city. The Stock Exchange, Opera, Chamber of Commerce, the Theatre form a part of this public network, now the Newsroom does as well. Productive and representative spaces, both symbolic and functional occupy the public realm. _B48

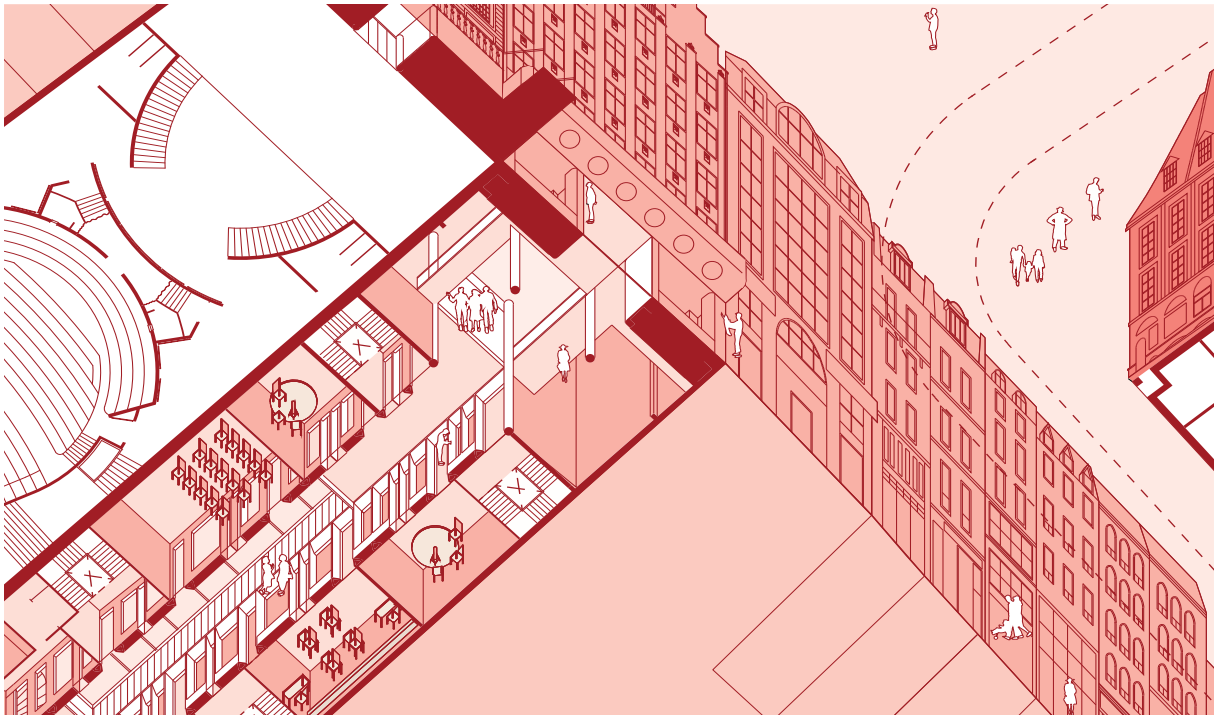

Originally, in the 11th century, the medieval square was used as a bustling wheat market. These days the beautifully preserved historic buildings surrounding the square, together with its myriad of cafes and terraces, still makes it an obvious choice for a rendez-vous and a good place to commence any sight-seeing tour. Around the square there are a number of very impressive buildings. _A1

_ "The Lille Guide," Grand Place with Vieille Bourse – The Lille Guide, , accessed November 20, 2017, <http://www.lille-guide.co.uk/sights/grand-place-with-vieille-bourse.html>.



The Grand Place of Lille, before the siege of 1792 _A2

In the 14th century, the place became a market place, a place of celebration and a place of execution where the death row prisoners were exhibited. The annual fair and daily demonstrations of the army and religious processions also took place in the Grand Place. _ A3

The Grand Place in the 15th and 16th Century was the nerve centre of trade, alleys from it were occupied by a multitude of specialized shops: cheese makers, weavers, shoemakers, potters, silver handlers, the public weight, that contributed to the bustling market on Grand Place. _ A4

The Corps du Garde in the 16th century replaced the meat market leading to Place St. Nicholas on one of the back alleys, forming one of the small network of shortcuts, pedestrian networks only for the well-informed through the city. _ A5

The historic square of Lille, much more than its belfry, is a real symbol of the city of Lille, the “capital of Flanders” and capital of the new Nord-Pas-de-Calais-Picardy region (Hauts-de-France) . The 155 m long and 72 m wide square, now called “Place Charles de Gaulle”, Grand Place style, is typical of the urban ensembles of the cities of the former Netherlands. Former marketplace dating from the fourteenth century, it has retained its role of Grand Place as a place of life, celebration and trade. _A6



Grand Place in Lille, 2017 is a major tourist attraction. The Bourse houses the book market and souvenir shops, the square is filled with terraces and cafes. _ A5.

"Bibliothèque municipale de Lille, 44332-1-1, 27". "Lille : La Grand'Place, un jour de Bourse". début XX siècle ; 9 x 14 cm.



A Stock Market day in Grand Place, early 20th Century. The square is filled with a horde of potential investors, also flocking to small businesses that are present in the square.

Cry of vendors of stock exchange lists on the street: In the event of a rise in prices, "Rise in the stock market!" In the event of a fall, "Variations in the Stock Market!." The term "fall" was forbidden by the police._A6

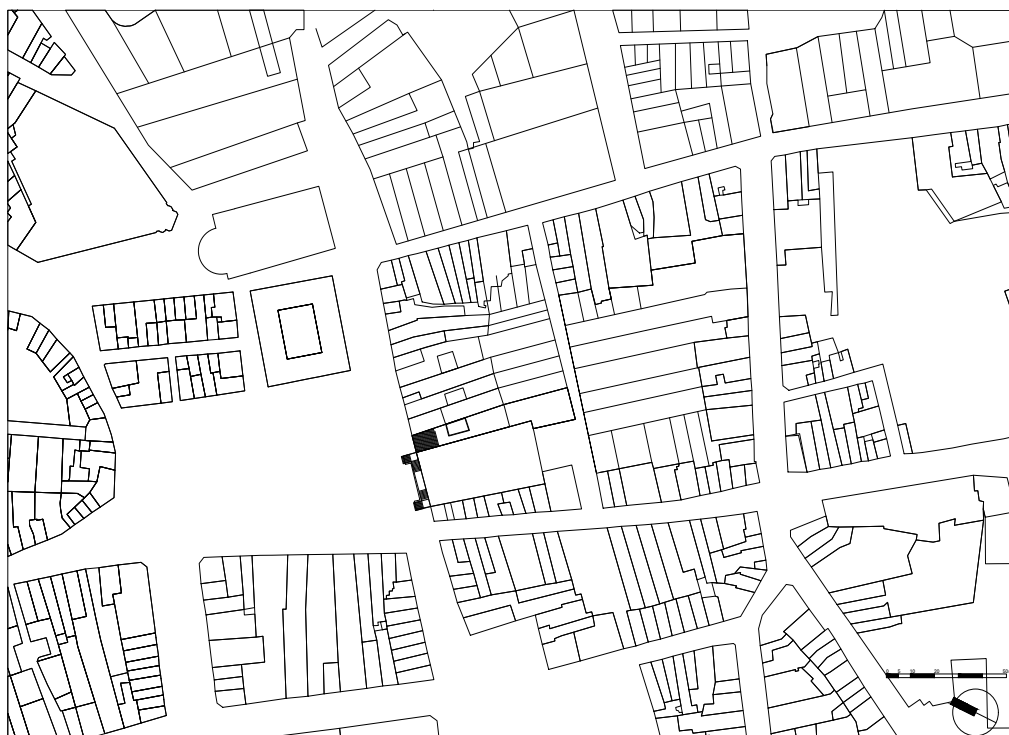

The Echo du Nord, a newspaper for the region was established by printer Vincent Leleux in the commercial market square, its large printing presses operating out of the market. _ A7

Bibliothèque municipale de Lille, 44332-1-1, 26. "Lille : La Grand'Garde". début XX siècle ; 9 x 14 cm.

32. - LILLE. - Le Grand'Garde. - E. C.



9 Bibliothèque municipale de Lille - 44332-1-1, 26.

The entrances to the printing press are present on the square, the aerial distinguishing it from the residential buildings and commercial establishments adjacent to it. _A8



The commemorative column of the Goddess was inaugurated in 1845, to honour the bravery of Lille during the Austrian attacks of 1792. The newspaper offices, at first struggling due to opposition from the Royal Press, grew in size after the declaration of Republic. A9

"Bibliothèque municipale de Lille, 44332-1-1, 18". "Lille : La Grande Place". début XX siècle ; 9 x 14 cm.



© Bibliothèque municipale de Lille - 44332-1-1, 18.

The Grand Place of Lille, in the early 20th century A10

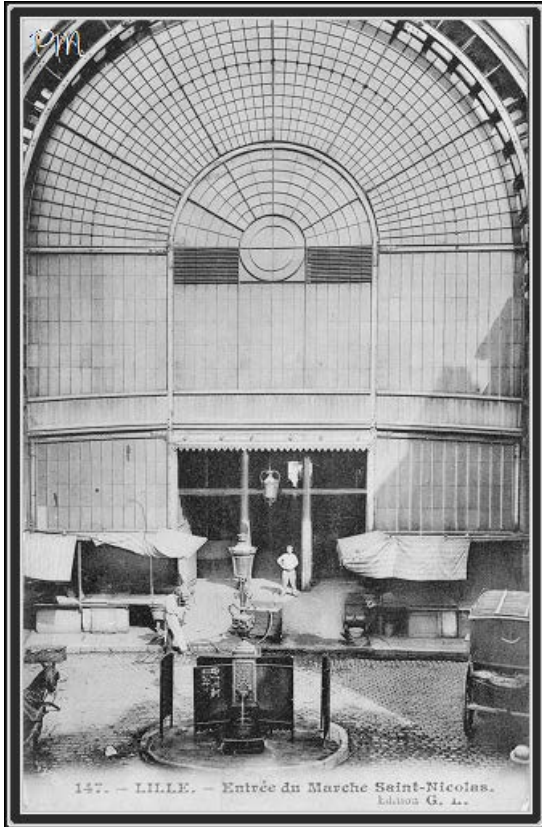

The entrances to the Marche St. Nicholas, with a fountain and square at the back of the facade at Grand Place._A11



The Rue St.Martin , October,2017. The back exits to theatre du Nord and the main entrances of the La Voix du Nord._A12

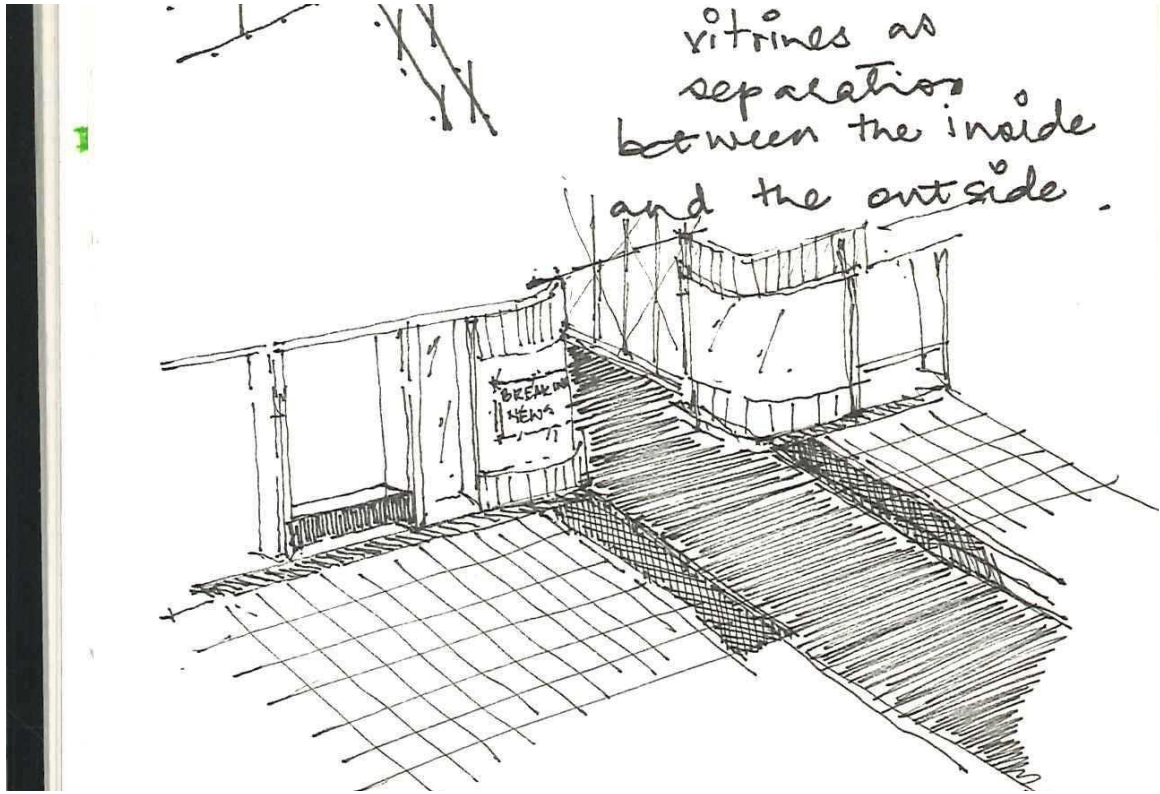

The arcade of the newsroom joins the Rue St.Martin. Without a doorway, the inside and outside are separated through a curved vitrine.

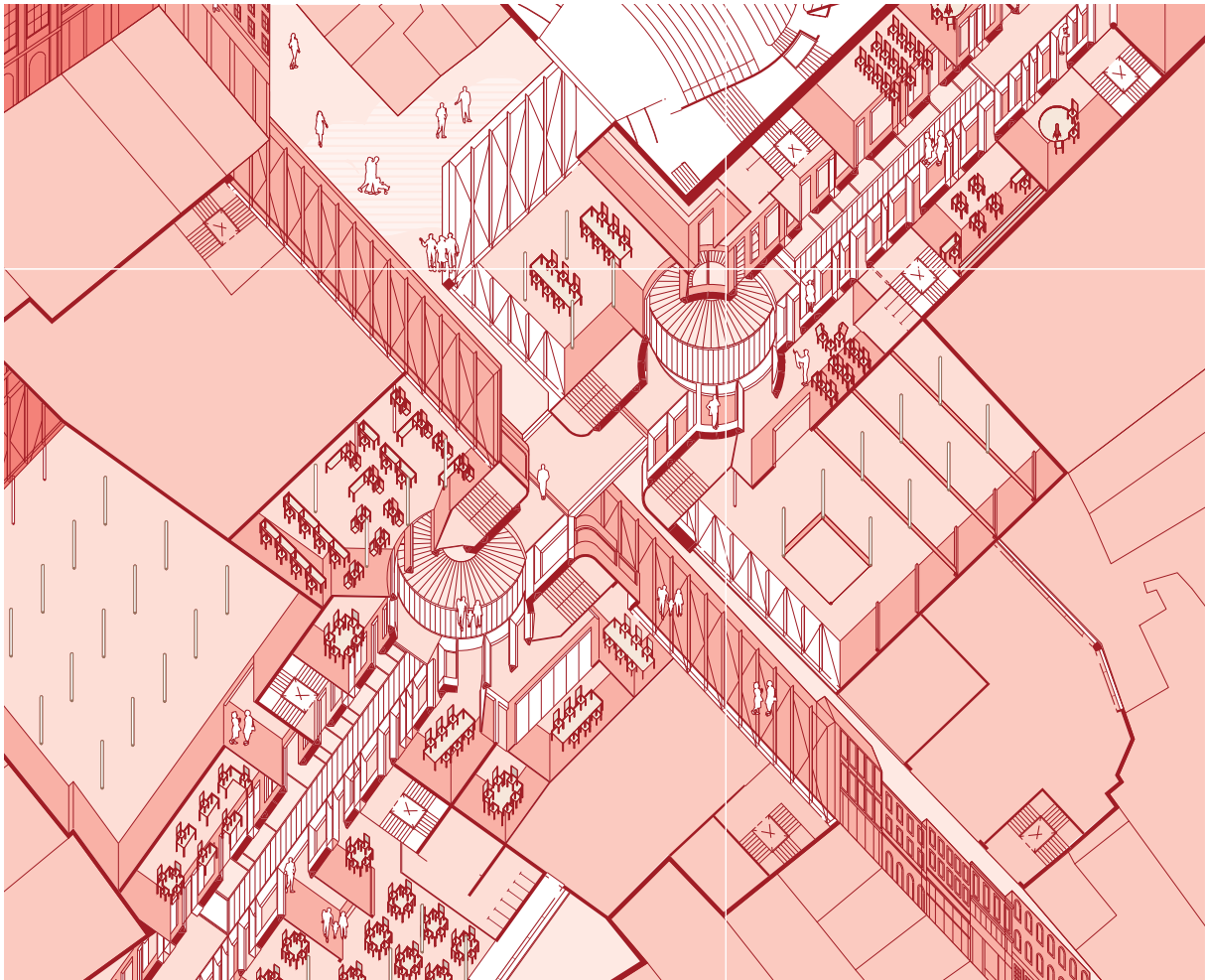

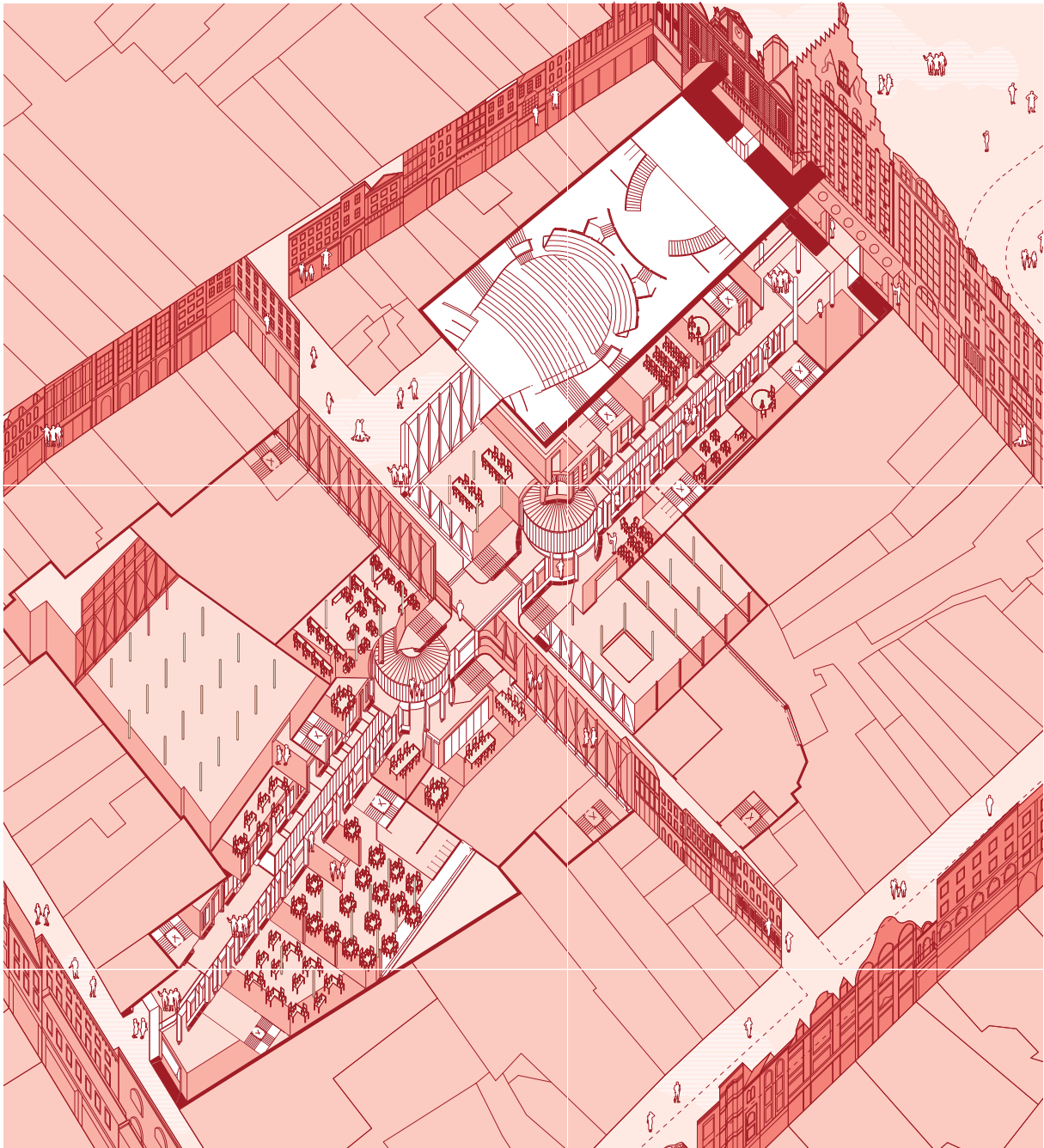

The Voice of the North occupies the residual spaces of the arcade. Freed from its programmatic requirements, it occupies odd shapes and corners, occupying integral and public part of the city even in its shrunk state._B51



The newspaper was rebuilt in 1936, becoming the tallest and most prominent building on the square, even overpowering the Stock Market and the Grand Garde. _A11



The Grand Place in 1959. _A12



The Grand Place, 2000. The newspaper offices grow in size to occupy the entire block, now one of the largest headquarters building in the historic centre of Lille. _A13



The Grand Place, 2020. The newspaper offices have shrunk, occupying only a small portion of what they used to. _A14

"Bibliothèque Municipale de Lille, carton 25, 8°. "Lille : Station de la procession sur la Grand'Place", 16 x 22 cm

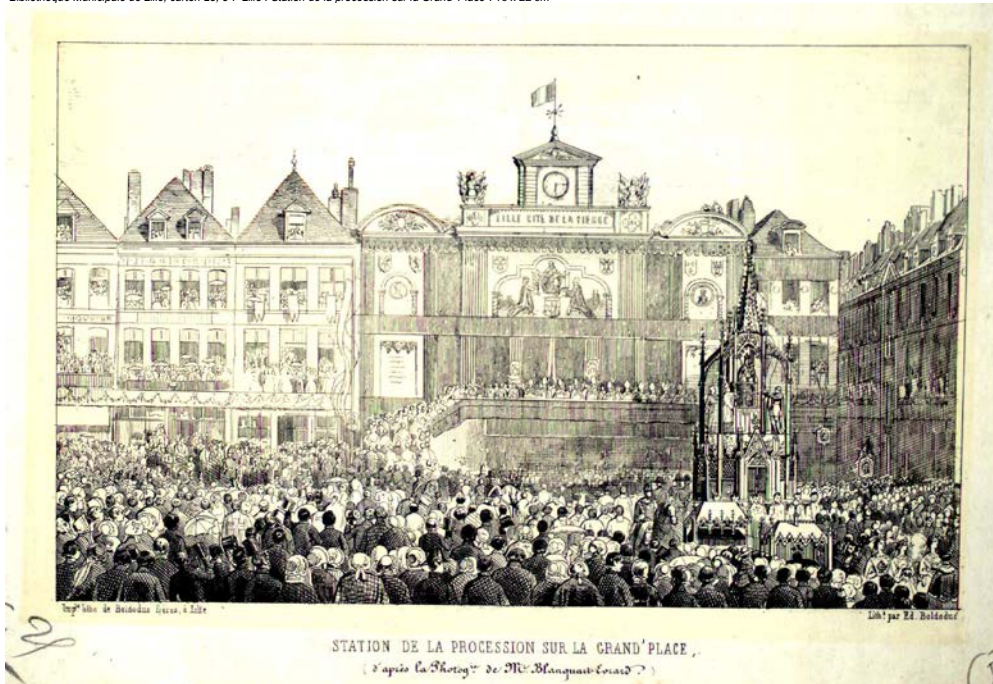

The Grand Place, 1918. The procession of Grand Place following the end of the First World War, and the end of the Siege of Lille. _A15



www.alamy.com - HT80G3

The Grand Place, March, 2017. The protests at Grand Place against employee cuts as the Social plan is applied to Voix du Nord. _A16



The Grand Place, 2008. People gather outside the *Voix du Nord* on March 3rd, 2008, to welcome actors and crew of record breaking French film, *Bienvenue chez les Ch'tis*. _A17.

The symbolic facade of the Voice of the North, has become the backdrop of the Grand Place of Lille. Though on most days is masked by the fnac store, cafes and terraces, a place for tourists to take a picture, and the newsroom hidden behind the facade. Sometimes it shows itself out in the open, as more than just a facade, through the activities of the news itself. _A18

A city centre is representative of a city. Contains the activities and institutions that are essential to it. Over-taken by a beautification of an older architecture, these places are now becoming tourist hubs, represented through their selfies and token photographs. _A19

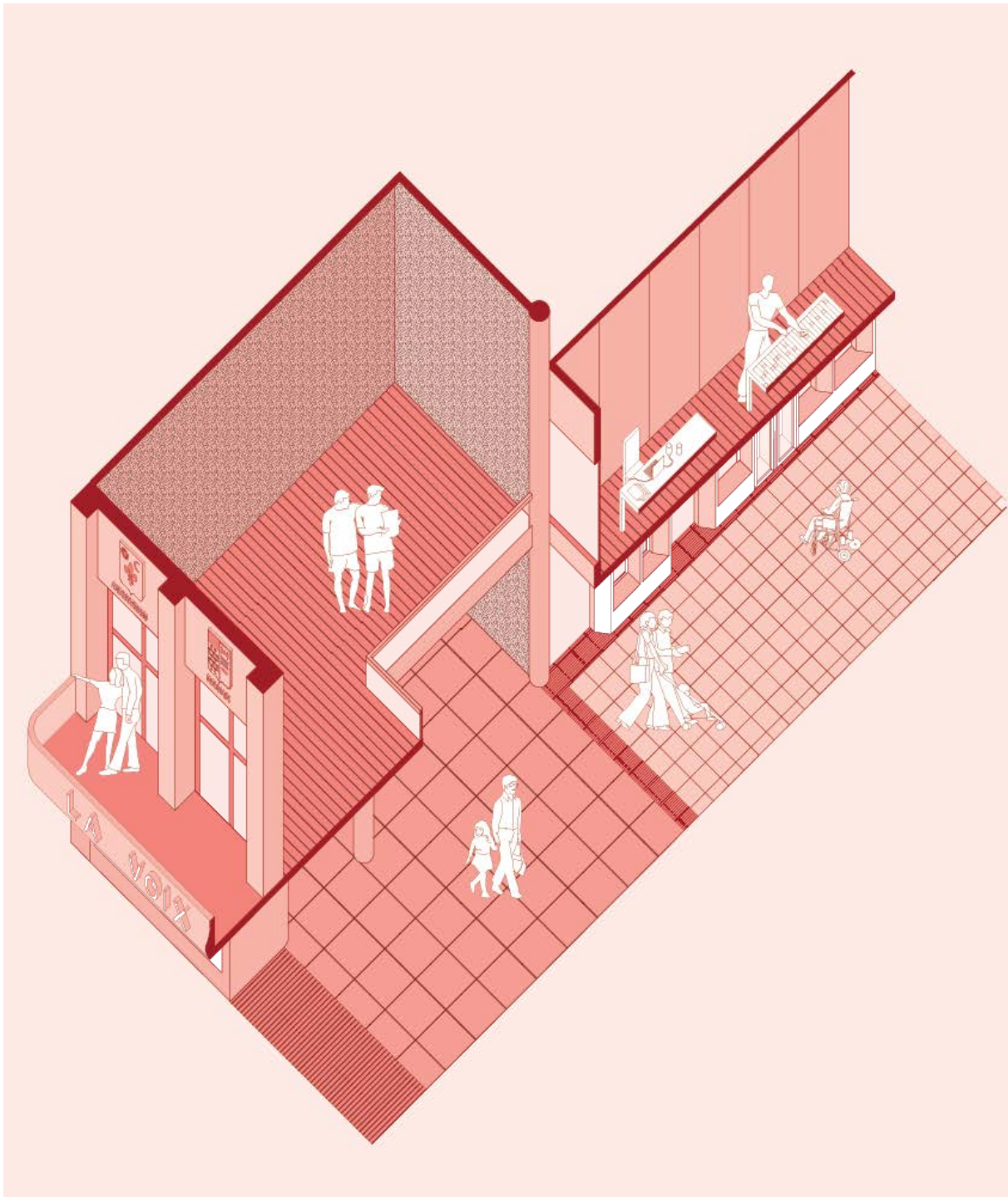

The facade at Grand Place is extended inward. As you enter the facade of the symbolic 1930's building at Grand Place, the extended balcony as a canopy, and the original atrium makes way for the pre-cast concrete columns and the aluminium frames of the new arcade, the radio station on the upper floor visible through the clear glass window, the aluminium frame of which is adjacent to the existing marble column. The threshold spaces are only defined through changes in the materiality._A20

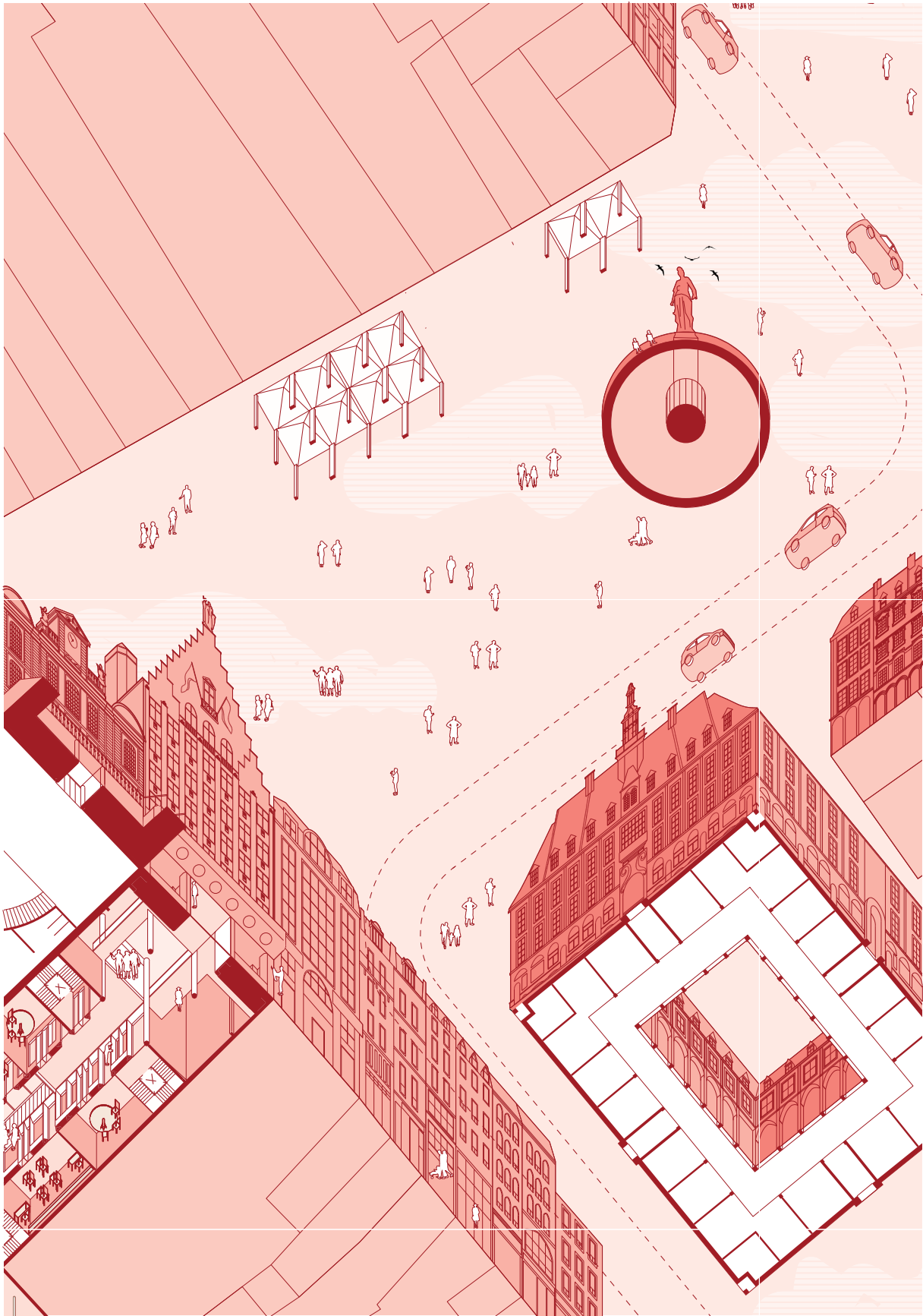

The Grand Place 2020. The facades of Grand Place extend also in the interior._A21



The Grand Place from the Alcide, 2010 _A22

"Bibliothèque municipale de Lille, Fonds Lefebvre, 11, 14". "Lille : La Grand'Place". 1900 ; 14 x 8,9 cm.



V.D.

LILLE — La Grand'Place

B.

© Bibliothèque municipale de Lille - Fonds Lefebvre 11, 14.
The Grand Place from the Alcide, early 20th century_A22

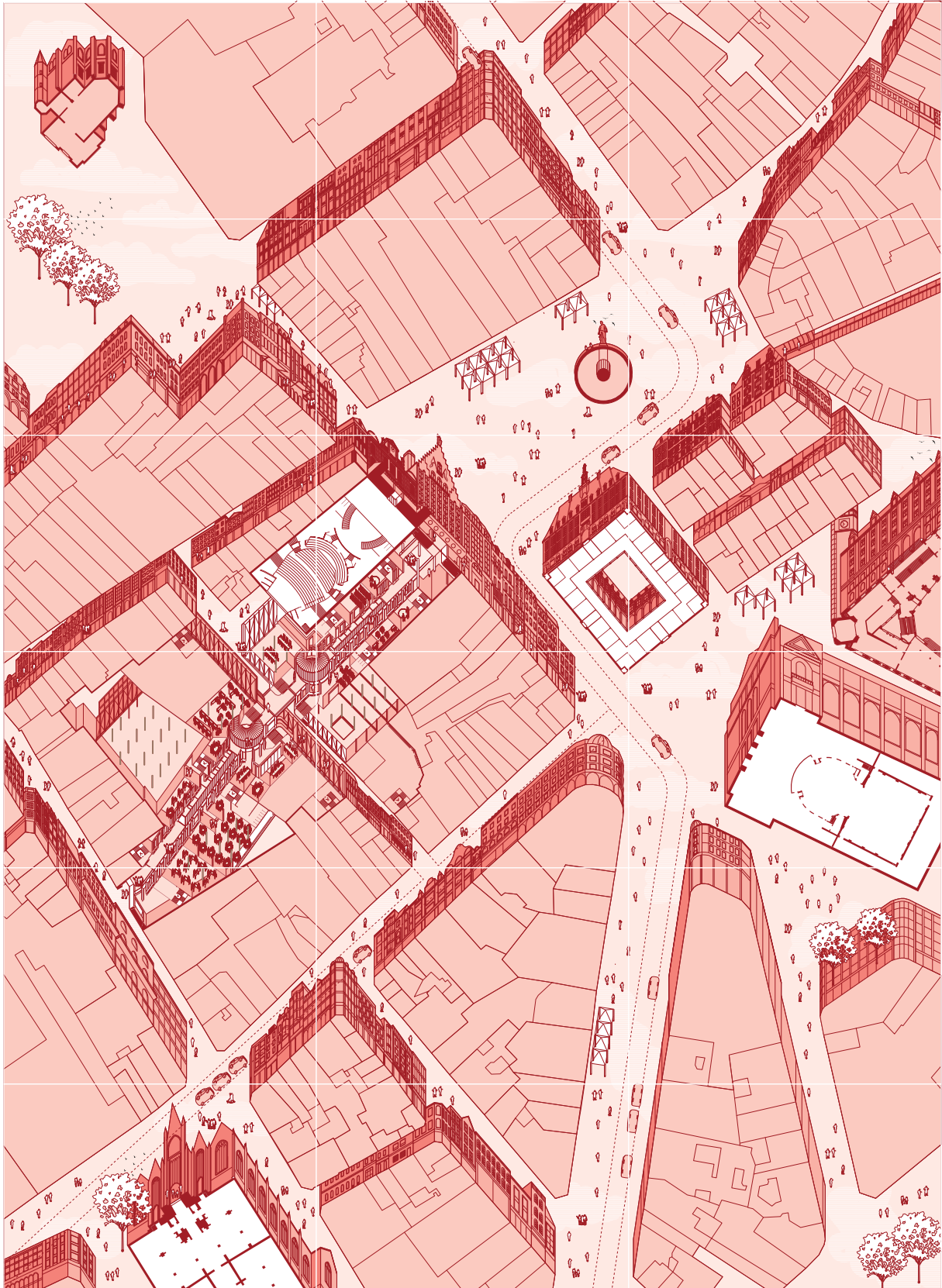

The arcade forms a part of the urban network of the city centre of Lille. A connection of squares, streets, alleyways, terraces and shortcuts. _A23

*Bibliothèque municipale de Lille, CP 277. "Lille. Entrée des troupes anglaises (Grand Place). 1914-1918 ; impr. photomécan. (carte postale) ; photographie : 88 x 141 mm



The english troops arrive in the Grand Place, Lille. _A24



Grand Place, Lille, the centre of city life. _A25

"Bibliothèque municipale de Lille, CP 221". "Lille. Le café Jean avant l'écroulement". 1914-1918 : Impr. photomé. (carte postale) : 88 x 137 mm



Lille, Grand Place, being reconstructed after destruction during German occupation in between 1914 and 1917. _A26

“This will kill that. The book will kill the edifice.”

“...the dominant idea of each generation would no longer be written with the same matter, and in the same manner; the book of stone, so solid and so durable, was about to make way for the book of paper, more solid and still more durable.... It meant, “Printing will kill Architecture”.

_ Victor Hugo, The Hunchback of Notre Dame: Book V Chapter 2(Paris: Gosselin, 1835), 1.



Before the printing press was invented, word of mouth was the primary source of news, gathered and distributed through pubs, inns and markets. The invention of the printing press brought an autonomy in news production, technology made the news more coherent, content controlled and regulated, ensuring that the same news travelled to more people. This, according to Victor Hugo, transferred the responsibility of conveying human thought from architecture to printing, from “the book of stone” to “the book of paper”, which was far more solid and durable; and now to “the book in the cloud”, that is more permanent still through its physical absence._C1

In an era where we have multiple news sources, an overwhelming number of opinions through the social media, every tweet and facebook post, considered news, goes onto the immortal web of the internet; the newsroom is not an autonomous organisation for news production. Though this allows for smaller organisations and different voices that occupy abandoned warehouses, former residential buildings, or offices in remote business parks to reach millions, the multiple contradictory outputs have caused the news to lose its credibility._C2

With reporters and photographers utilising video studios inside backpacks, Google glass, smartphone and smartwatches, and someday drones to cover the news, how much will the newsroom matter?

-Washeck, “What newsroom spaces tell us about the future of Digital Journalism.”

www.mediashift.org _C3

Big buildings in the centre of town, looked upon as the primary source of information are a thing of the past... for journalists of the 1960's, 1970's and 1980's, the newspaper building was one of the city's crown jewels, representing that municipality's integrity in news reporting, press freedom and community advocacy.
 - Usher, "Moving the Newsroom-Post Industrial News Spaces and Places". Tow Center_C4



The New York Times, The BBC Broadcasting House, Huffpost and the Correspondent, BuzzFeed and RTS offices with their urban context. Newsrooms are moving to the outskirts in suburbs, business parks and former industrial areas and hence losing their public presence._C5

The printing presses of 19th century Fleet Street had public halls where people waited for the news to be produced. Grand newsrooms of the early 20th century, like the Tribune tower had a hall of inscriptions proclaiming the freedom of the press and the ethics of the institution, they still distributed their ideas through a network of news stands, newsagents, and paper routes.

_C6



Fleet Street, London . 1905_C7.

Every paper had its favourite pub or, rather, the pub its staff tended to frequent, for they would often grumble about it. The Telegraph had the King & Keys, a hell-hole. The Express had the Red Lion, in Poppins Court so it was inevitably known as Poppins._C8

The association with publishing began in Fleet Street in 1500 when Wynkyn de Worde built London's first printing press next to St Bride's and the area developed into the home of Britain's newspaper industry. It became the perfect area to gather news, close to the City, the Old Bailey and high court and not too far from (or too close to) Westminster._C9

According to Merriam Websters dictionary, the definition of “Fake news” is expanded as, The printing and dissemination of spurious news is hardly new, but the term fake news is. However, when we say that an English word is “new,” we are using a broader meaning of that word than if we were to refer to, say, a musical genre. Fake news appears to have begun seeing general use at the end of the 19th century.

Secretary Brunnell Declares Fake News About His People is Being Telegraphed Over the Country.
–Cincinnati Commercial Tribune (Cincinnati, OH), 7 Jun. 1890

Fake News. The following is handed to us for publication: Sunday’s Enterprise says that I and a companion were run over by the Neptune and thrown into the water. As can be proved by more than one, we did not so much as get our feet wet, nor were we helped into the Neptune. Clarence Collins.
–The Kearney Daily Hub (Kearney, NE), 7 Jul. 1890_C10



Channel 4 News Documentary on thr rise of Fake news_C11

The term “fake news” has been named Collins’ Word of the Year 2017.

Usage of the term - which has often been used by US President Donald Trump - has risen by 365% since 2016.

Defined as “false, often sensational, information disseminated under the guise of news reporting”, “fake news” will now be added to the next print edition of Collins Dictionary.

Lexicographers, the people who compile dictionaries, found other politically relevant words had been significant over the last 12 months, including “antifa”, an abbreviation of “anti-fascist”, and “echo chamber”, which refers to those who share their opinions in environments, especially social media, where the only people who hear or read their views will be of a similar disposition.

Hunt, Julia. “Fake news’ named Collins Dictionary’s official Word of the Year for 2017.” The Independent. November 02, 2017. Accessed January 28, 2018. <http://www.independent.co.uk/news/uk/home-news/fake-news-word-of-the-year-2017-collins-dictionary-donald-trump-kellyanne-conway-antifa-corbynmania-a8032751.html>._C12

News > UK > Home News

'Fake news' named Collins Dictionary's official Word of the Year for 2017

Orwellian coinage popularised by US President Donald Trump and his team during the presidential election campaign defines its moment, according to leading lexicographers

Julia Hunt | Thursday 2 November 2017 08:30 GMT | [413 comments](#)



[Click to follow](#)
The Independent Online



White House Counsellor Kellyanne Conway and her boss became closely associated with the terms 'fake news' and 'alternative facts' this year. Chris Kleponis-Pool/Getty Images

The term "fake news" has been named Collins' Word of the Year 2017.

Usage of the term - which has often been used by US President Donald Trump - has risen by 365% since 2016.

Hunt, Julia. "Fake news' named Collins Dictionary's official Word of the Year for 2017." The Independent. November 02, 2017. Accessed January 28, 2018. <http://www.independent.co.uk/news/uk/home-news/fake-news-word-of-the-year-2017-collins-dictionary-donald-trump-kellyanne-conway-antifa-corbynmania-a8032751.html>_C13

The public taste is not really vitiated and it does not in its desire for 'news' absolutely crave for distortions of facts and enlargements of incidents; and it certainly has no genuine appetite for 'fake news' and 'special fiend' decoctions such as were served up by a local syndicate a year or two ago.

—The Buffalo Commercial (Buffalo, NY), 2 May 1891_C14

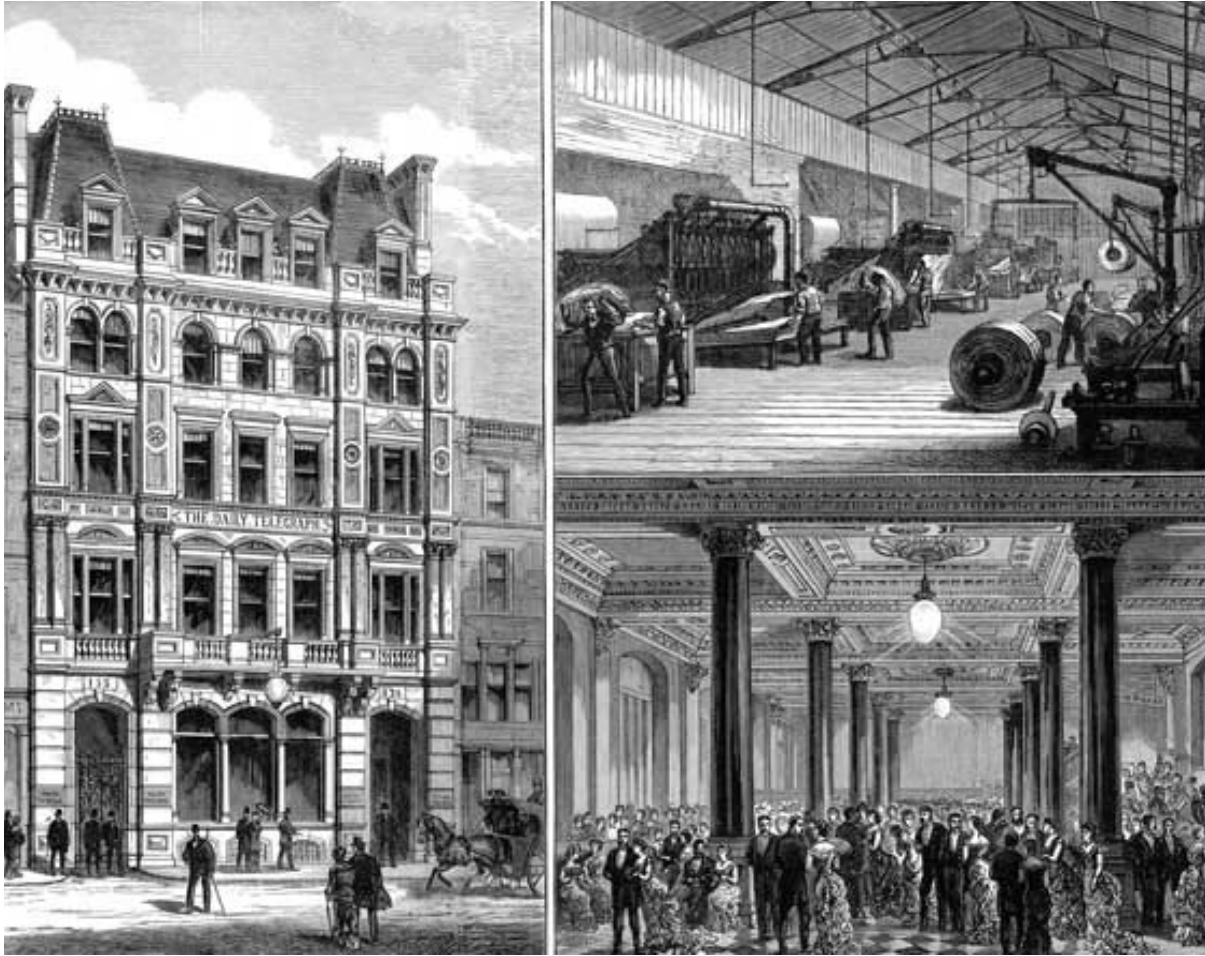

The Daily Telegraph on Fleet Street in London had public halls where the news was received.

“ The Daily Telegraph ,” Wikimedia Commons, May 26, 2009. //commons.wikimedia.org/w/index.php?title=User:Willsrly/commons/Credits/Citations&oldid= 21707728 (accessed January 28 2018). _C15



Characteristic sidewalk newsstand. New York City, 1903.
Detroit Publishing Co., Copyright Claimant, and Publisher Detroit Publishing Co. [A Characteristic sidewalk newsstand sic, New York City]. New York, ca. 1903. Photograph. Retrieved from the Library of Congress, <https://www.loc.gov/item/det1994009026/PP/>. (Accessed January 28, 2018.)_C16



The Guardian, proposed event space opposite Kings Cross, London, 2015._C17

New practices of media are increasingly trying to establish a public presence by having debates and events, having book and merchandise stores that re-connect physically with an audience that is not restricted to commenting anonymously on blog posts and chat rooms on the internet, in order to establish a trust and credibility to the news that they produce.

Other forms of media production like the broadcasting house and the radio stations have had public and cultural programs built into them. In the process of adapting to new media and modes of production, these programs are proposed to be brought back. _C18

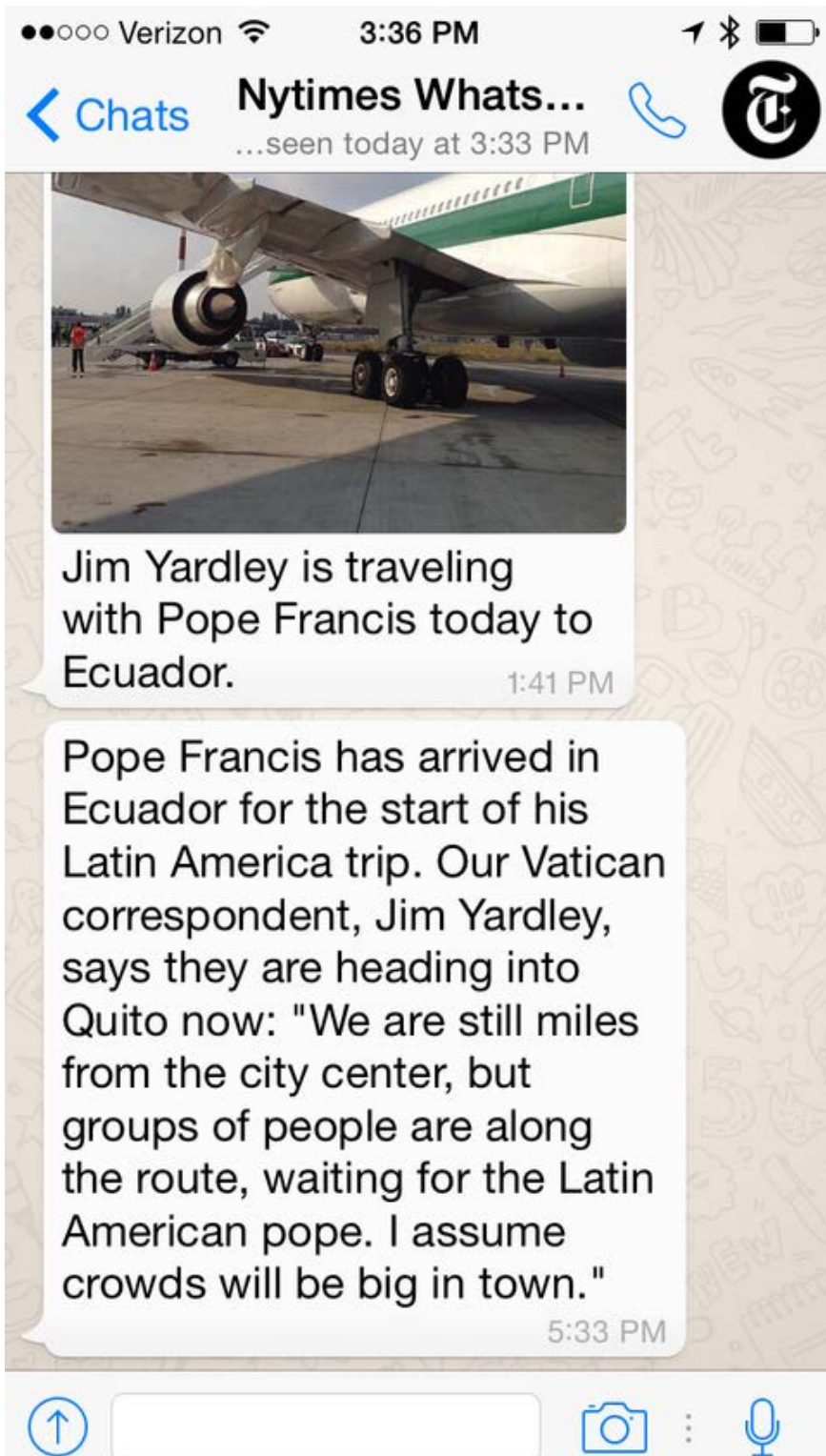

News is delivered personally via whatsapp_C17



NBC Nightly News @nbcnightlynews
America's #1 evening news broadcast. Tweets by @newsdel & @braddjaffy. Join us on Facebook <http://facebook.com/nbcnightlynews>

Following



NBC News @NBCNews
A leading source of global news and information for more than 75 years. Have a news tip or question? Ask @rozzzy, @lou_dubois, @jbaiaata or @anthonyquintano.

Following



CNN Breaking News @cnnbrk
CNN.com is among the world's leaders in online news and information delivery.

Following



The screenshot shows the website interface for 'LA VOIX DU NORD'. The main headline is 'Au 9e jour de mobilisation, la tension ne redescend pas dans les prisons' (On the 9th day of mobilization, the tension does not decrease in the prisons). A sub-headline reads 'SURVEILLANTS EN COLÈRE' (Guards in anger). Below the headline, there are two bullet points: '« On a tous été agressés au moins une fois »' (We have all been assaulted at least once) and 'Dans le Nord et le Pas-de-Calais, des établissements pénitentiaires surpeuplés' (In the Nord and Pas-de-Calais, overcrowded penitentiary establishments). The website also features a weather widget for Lille, a 'Lactu de votre commune' section with a list of municipalities, and a search bar for 'VOTRE COMMUNE'.

Twitter feed of leading newspapers and the website interface of the Voix du Nord. Contemporary forms of news dissemination, that do not depend on the single deadline. The work of the journalist is not cyclic but dependant only on the news story._C18



The BBC Broadcast House, Radio Station, 1932. The room is organised around the processes of the technology itself. _C19



BBC Broadcast House, London, 1932. The aerial distinguishes it as a broadcasting house._C20



BBC Broadcast House, London, 2016. The new addition by HOK architects added more television stations and a publicly accessed entrance space_C21

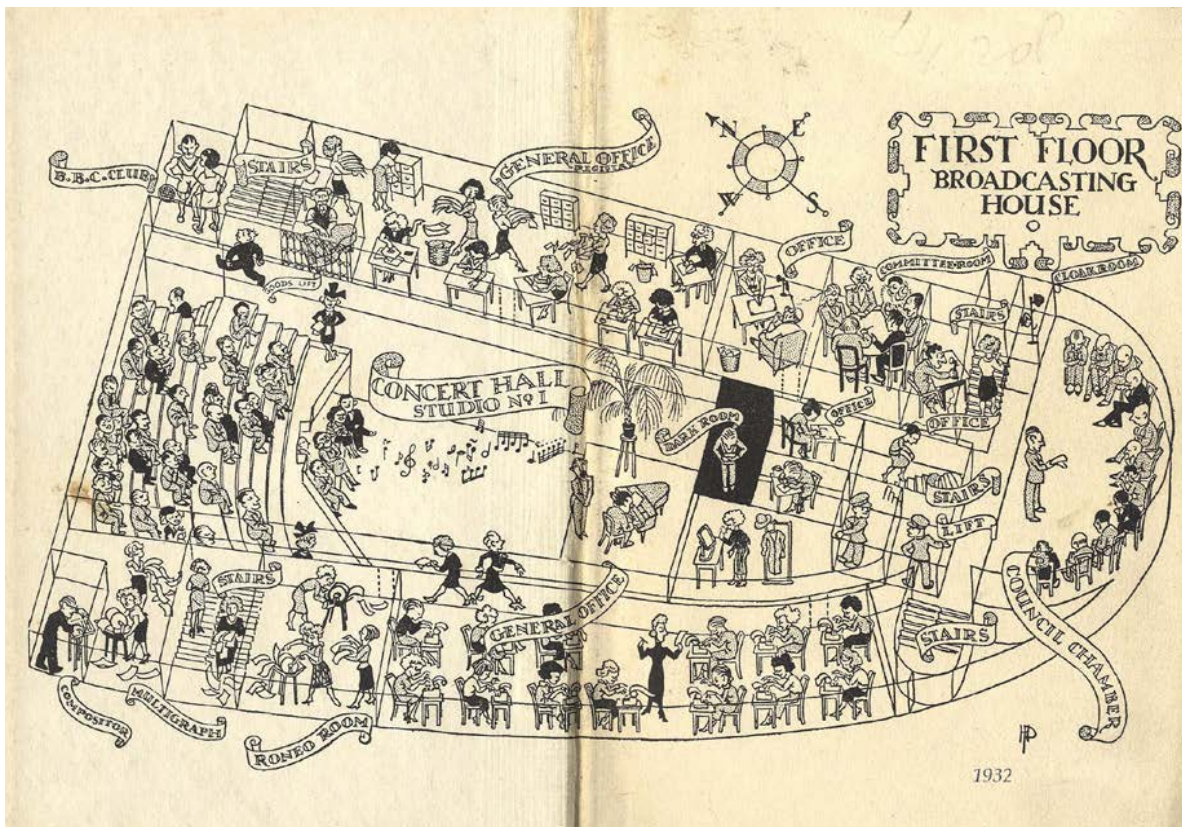

BBC Broadcast House, London, 1932. The concert hall is central to the newsroom. The news has a public and cultural program built into it. _C22



The New York Times, Manhattan, 2007_C23



Buzzfeed, London, 2015. Relaxed and flexible office spaces that reflect a contemporary work culture._C24



The New York Times, Editorial board, 1967_C25



Chicago Tribune Newsroom, 1956._C26

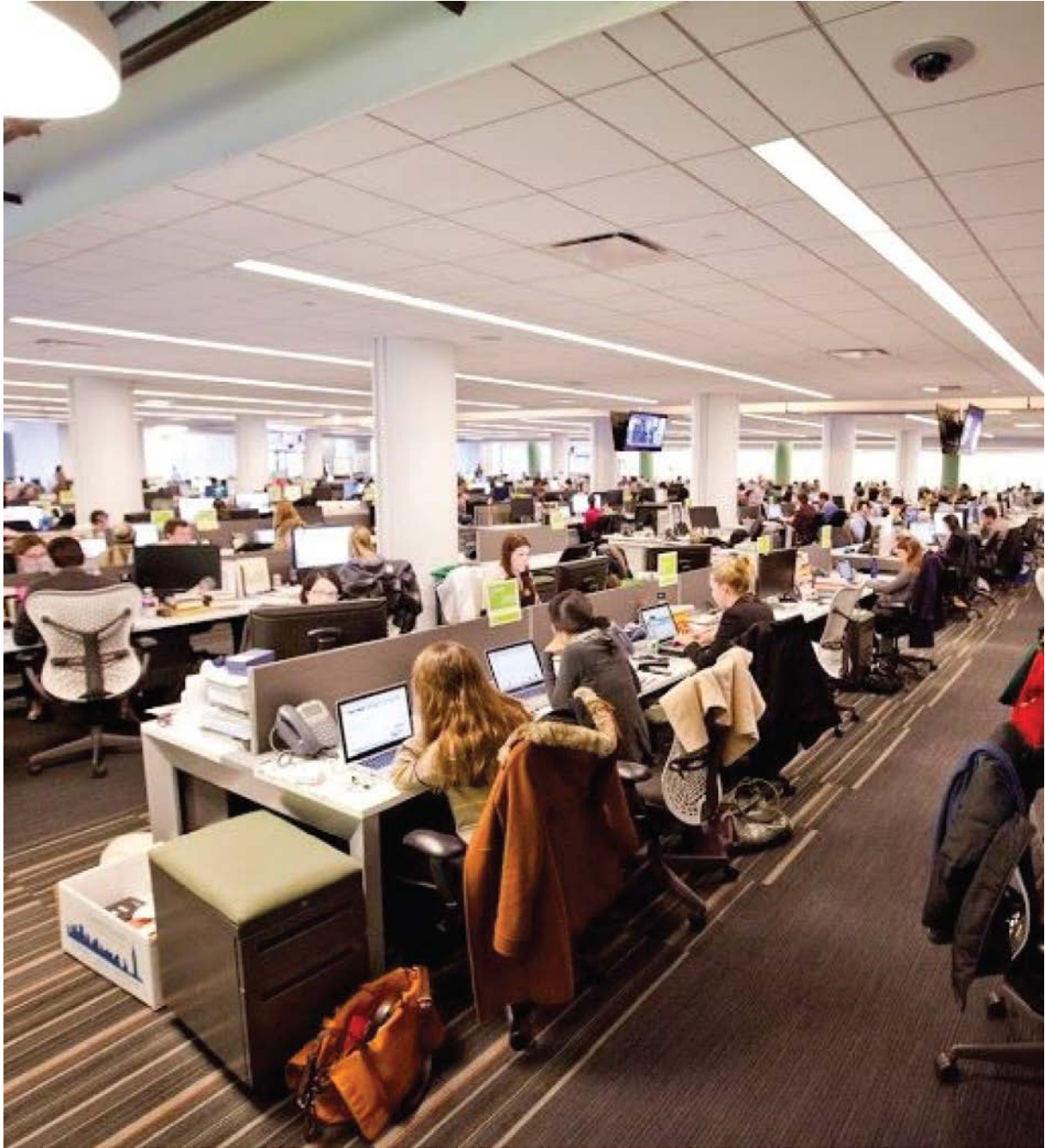

Huffington Post, New York, 2016. _C27



Donald Trump become President of the United States of America, January 20, 2017._C28

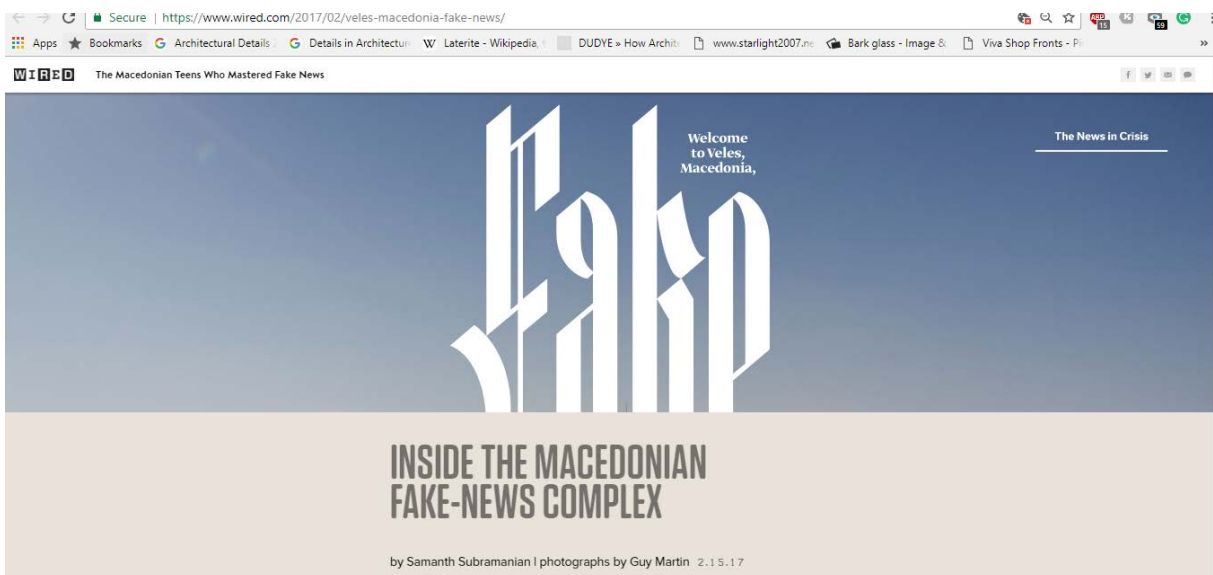

The Wired article on Fake News complexes in Veles, Macedonia_C29

Journalism overproduction

The colossal increase in the quantity of available information raises a possibility – and a strategic dilemma for publishers – never previously encountered in journalism: overproduction. What was scarce is now in glut. Far more reporting is copied from other media than journalists generally admit and this was the case long before the internet made it easy. The internet revealed to a global audience how much journalism is a variant or a direct copy of a template produced by the first story into the field. This has huge consequences for newsrooms and the deployment of journalists;²⁵

Brook, George, *Out of Print: Newspapers, Journalism and the Business of News in the Digital Age*, (Kogan Page Publishers, 2013), 97._C30

THE Sun JUST 40p
 Wednesday, March 9, 2016 BRITAIN'S BEST-SELLING PAPER thesun.co.uk

EXCLUSIVE Madonna meltdown over Rocco
 SEE PAGE 7

WIN £50k HOME MAKEOVER
 SEE 4-PAGE PULLOUT

EXCLUSIVE: BOMBSHELL CLAIM OVER EUROPE VOTE

QUEEN BACKS BREXIT

EU going in wrong direction, she says

By TOM NEWTON DINN, Political Editor
 THE Queen was hailed as a backer of Brexit yesterday after details emerged of an alleged bust-up between her and Nick Clegg over Europe.
 Her Majesty is said to have let rip at the then Deputy PM during a lunch at Windsor Castle, telling pro-European Mr Clegg that she believed the EU was heading in the wrong direction.
 A source said: "People were left in no doubt about her views on Europe."
 Full Story - Page Two



The Sun headlines, Wednesday March, 9, 2016._C31

**ÉDITORIAL**JEAN-MICHEL
BRETONNIER
RÉDACTEUR EN CHEF**Le grand dégage**

Certains attendaient des surprises. Annoncées depuis plusieurs semaines, elles ont été confirmées et amplifiées hier soir. Un candidat de 39 ans, inconnu il y a trois ans, bien placé pour être le prochain président de la République ; un parti d'extrême droite qualifié une nouvelle fois pour le second tour ; le représentant de la droite républicaine sorti dès le premier ; le candidat du Parti socialiste tombé sous les 10 %.

Ces surprises étaient en germe dans les alternances et les cohabitations à répétition, la montée de l'abstention, l'émergence du Front national. Pour une partie grandissante des électeurs, la classe politique était en échec. Échec à réduire le chômage, à protéger de la mondialisation, à maintenir les repères d'une certaine identité, à promettre aux enfants des jours meilleurs que ceux de leurs parents.

Les Français ont fini par renverser la table, hier, mais sans casser la vaisselle. Ils ont envoyé au musée les partis traditionnels et promu ce qui s'annonçait comme antisystème, un populisme de droite, un populisme de gauche et un extrême centre. C'est sans doute le début d'une nouvelle ère politique, mais pas la promesse du chaos. S'opposent deux personnalités qui n'ont jamais gouverné, mais représentant deux mouvements antinomiques.

Emmanuel Macron est bien le négatif de Marine Le Pen. Sa rivale opposera le camp des « patriotes » à celui des « mondialistes ». Lui axera sa campagne de second tour sur le rassemblement des « patriotes » contre les « nationalistes ». À lui de donner « au dégaisme » qui a triomphé hier soir un contenu constructif et prospectif. Il ne s'agit pas de retrouver un légendaire âge d'or, ou de viser une utopie, mais de construire un futur meilleur.

Emmanuel Macron vient de réussir un miracle politique. Il lui restera, s'il gagne le 7 mai, à en réaliser un second, en obtenant la majorité absolue à l'Assemblée nationale. ■

INÉDIT

LIRE PAGES 2 À 11, 46 À 51 ET 63



AIRFRANCE KLM

France is in the air - La France est dans l'air. 4 vols par semaine.

AIRFRANCE
FRANCE IS IN THE AIR**AMSTERDAM, OUVRE-TOI !**
NOUVEAU LILLE-AMSTERDAM

4 VOLS PAR SEMAINE

AIRFRANCE FR

RÉGION**Marine Le Pen**
en tête dans
le Nord et dans
le Pas-de-Calais



De Roed Hoed, deate centre in Amsterdam, 2017._C33

New practices of media are increasingly trying to establish a public presence by having debates and events, having book and merchandise stores that re-connect physically with an audience that is not restricted to commenting anonymously on blog posts and chat rooms on the internet, in order to establish a trust and credibility to the news that they produce.

Other forms of media production like the broadcasting house and the radio stations have had public and cultural programs built into them. In the process of adapting to new media and modes of production, these programs are proposed to be brought back. _C34



Conference on Internet journalism, Canary Wharf, London _C35



Discussion on Brexit, Brussels, 2016._C36

The most famous office building, the art-deco masterpiece dubbed the Black Lubyanka, belonged to the Express, which the City of Sound blog describes as “a shining example of what Fleet Street was - a mythologised version of English journalism; a mythologised version of the intellectual life of a city, and a country”. The building is now owned by a merchant bank but the Daily Express and Sunday Express signs remain in the lobby.

_ Mark Oliver, “There will always be a connection;” The Guardian, June 15, 2005, , accessed November 20, 2017, https://www.theguardian.com/media/2005/jun/15/pressandpublishing.uknews2._C37

With reporters and photographers utilising video studios inside backpacks, Google glass, smartphone and smartwatches, and someday drones to cover the news, how much will the newsroom matter?

“What Newsroom Spaces Tell Us About the Future of Digital Journalism.” MediaShift. May 20, 2014. Accessed July 05, 2017. http://mediashift.org/2014/05/what-newsroom-spaces-tell-us-about-the-future-of-digital-journalism/._C38

“But the newsroom’s current organization creates dangers for the print newspaper – and is also holding back our ability to create the best digital report. Today, department heads and other coverage leaders must organize much of their day around print rhythms even as they find themselves gravitating toward digital journalism. The current setup is holding back our ability to make further digital changes, and it is also starting to rob the print newspaper of the attention it needs to become even better.”

- “Journalism That Stands Apart.” The New York Times. January 17, 2017. Accessed December 04, 2017. https://www.nytimes.com/projects/2020-report/._C39



The Daily Express, London, Fleet Street, 1933. Designed by Sir Owen Williams. _C40

MANAGEMENT

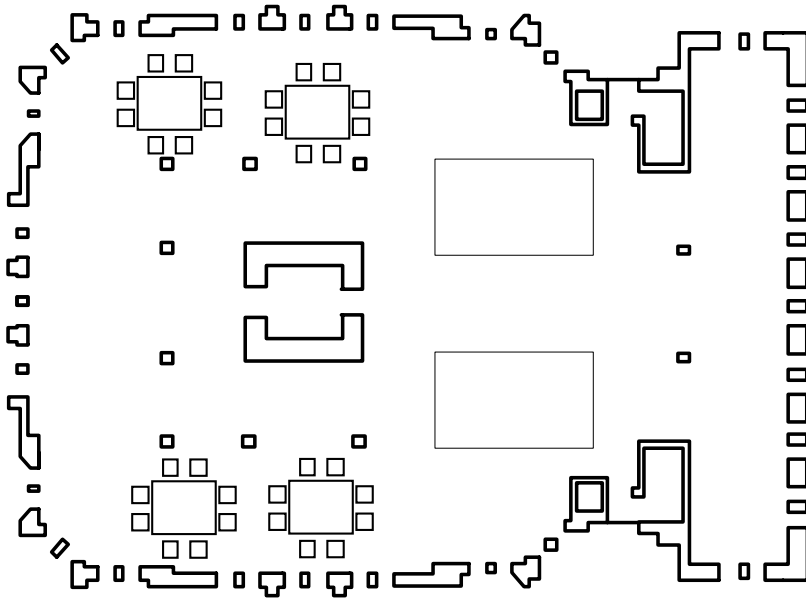

NEWSROOM

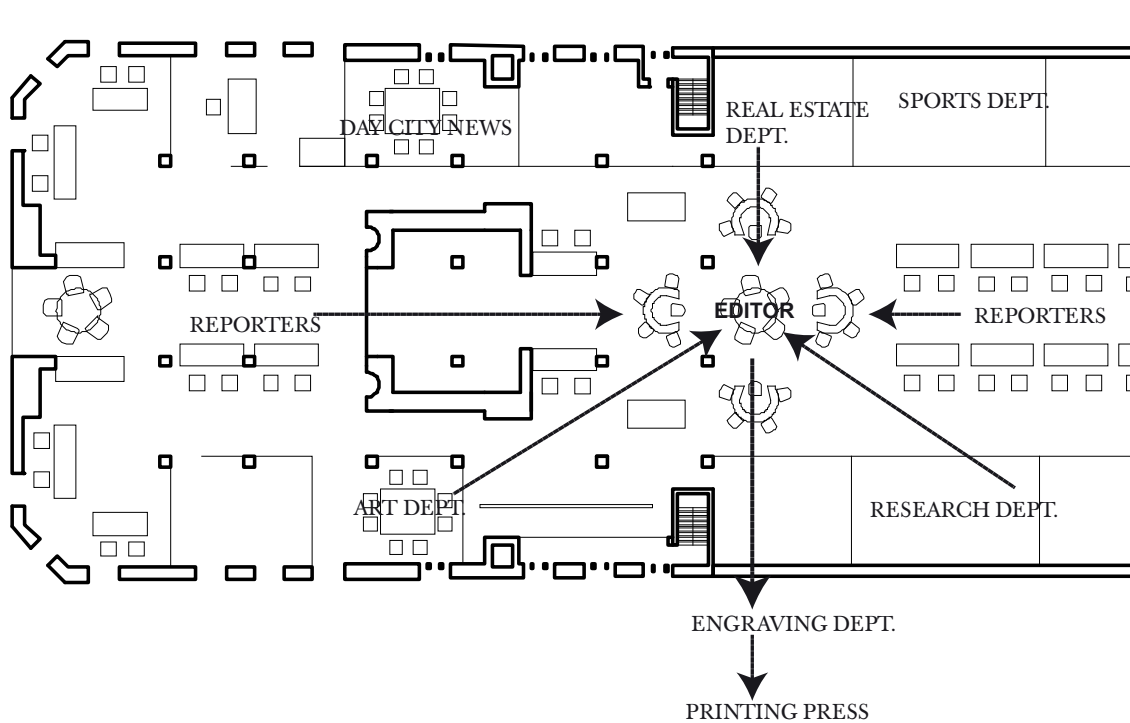

The Chicago Tribune, 1925. The newsroom is organised around a central editorial table, that co-ordinates and prepares all the content. _C41



Entrances to the Hall of Inscriptions, Tribune Tower. Photograph taken on 12th January, 2005

The room contains embedded in it, artefacts from the 50 States of the United States of America, and pieces from all over the world, including the pyramid of Giza and the Taj Mahal._ C42

The Hall of Inscriptions contains references made to the ‘freedom of the Press’, and the ethics of the Chicago Tribune.

Give me but the liberty of the Press
And I will give to the minister a venal house of peers
I will give im a corrupt and Servile House of Commons
I will give him the full swing of the patronage of the Office
I will give him the whole host of ministerial influence
I will give him all the power that place can confer upon him
To purchase up submission and ovrawe resistance
And yet, armed with the liberty of the Press,
I will go forth and meet him undismayed
I will attack the mighty facbric of that mightier engine
I will shake down from its height of corruption
And bury it beneath the ruins of
The abuses it was meant to shelter

–Richard Brinsley Sheridan, inscribed on th walls of the Hall of Inscriptions, C43

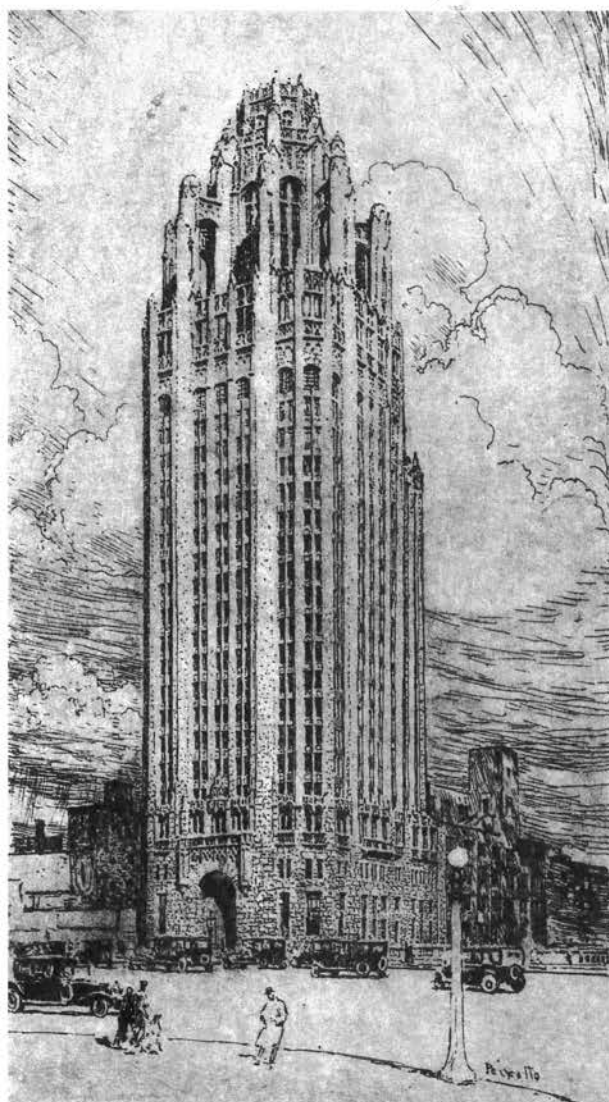

THE
INTERNATIONAL
COMPETITION
FOR A NEW
ADMINISTRATION
BUILDING
FOR
THE CHICAGO
TRIBUNE
MCMXXII

CONTAINING
ALL THE DESIGNS SUBMITTED
IN RESPONSE TO
THE CHICAGO TRIBUNE'S
\$100,000 OFFER COMMEMORATING
ITS SEVENTY FIFTH
ANNIVERSARY, JUNE 10, 1922

40 0047310 3



Drawing by John Meade Hood and Raymond Howell, the winning entry for the Tribune Tower on the cover of a publication about the Tribune Tower competition, 1922. C44

An international competition for the “most beautiful building in the world” was conducted in 1922, inviting entries from prominent architects the world over. The winning entry by John Meade and Raymond Howells is a baroque atyled skyscraper, that translated the hierarchy of the organisation vertically. The publisher Robert Mc Cormick occupied the rooms that was situated in between the buttresses that flagged the top of the tower. C45

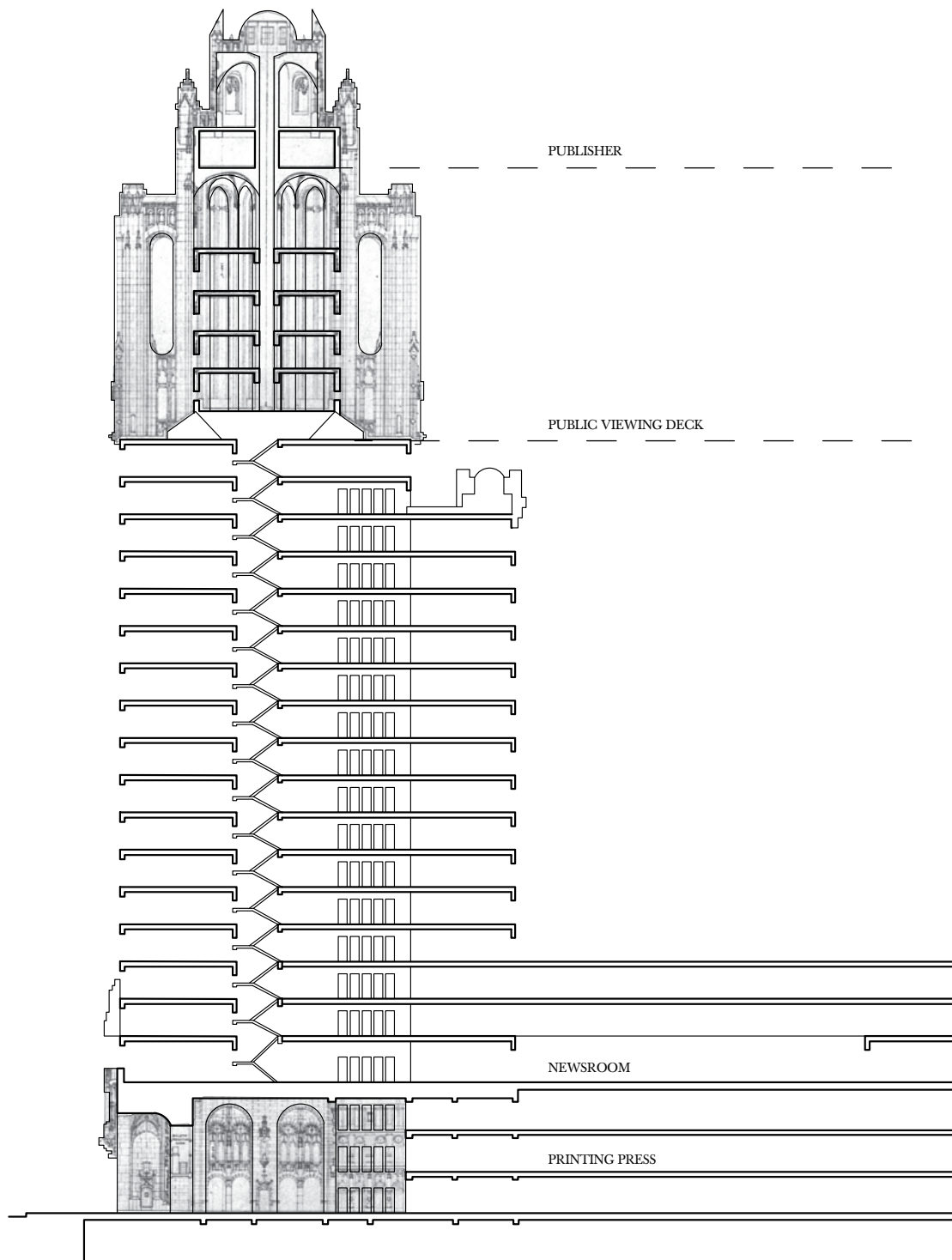

Organisation Structure of the Chicago Tribune, 1967 The public viewing deck and restaurants on the 34th storey invited visitors to take an elevator through the building. _C46



New York Times Building on Times Square was inaugurated by the ball drop on New Year's Eve, 1905. Even though the newspaper moved out of the tower by 1923, the ball drop that happens annually, one of the globally most watched events on New Year's Eve, is still associated with the New York Times, that now operates from Eighth Avenue, New York. _C47



The New York Times Building, on No. 1, Times Square, New York. The building lent its name to the most visited square in New York. _C48

On November 6, 1928, an electronic news ticker known as the Motograph News Bulletin (colloquially known as the “zipper”) was introduced near the base of the building. The zipper originally consisted of 14,800 light bulbs, with the display controlled by a chain conveyor system inside the building; individual letter elements (a form of movable type) were loaded into frames to spell out news headlines. As the frames moved along the conveyor, the letters themselves triggered electrical contacts which lit the external bulbs (the zipper has since been upgraded to use modern LED technology). The first headline displayed on the zipper announced Herbert Hoover’s victory in that day’s presidential election. The zipper was used to display other major news headlines of the era, and its content later expanded to include sports and weather updates as well. On the evening of August 14, 1945, the zipper was famously used to announce Japan’s surrender from World War II to a packed crowd in Times Square. _C49



The ticker on the Times building New York, displaying news of the Japanese surrender in World War II._C50

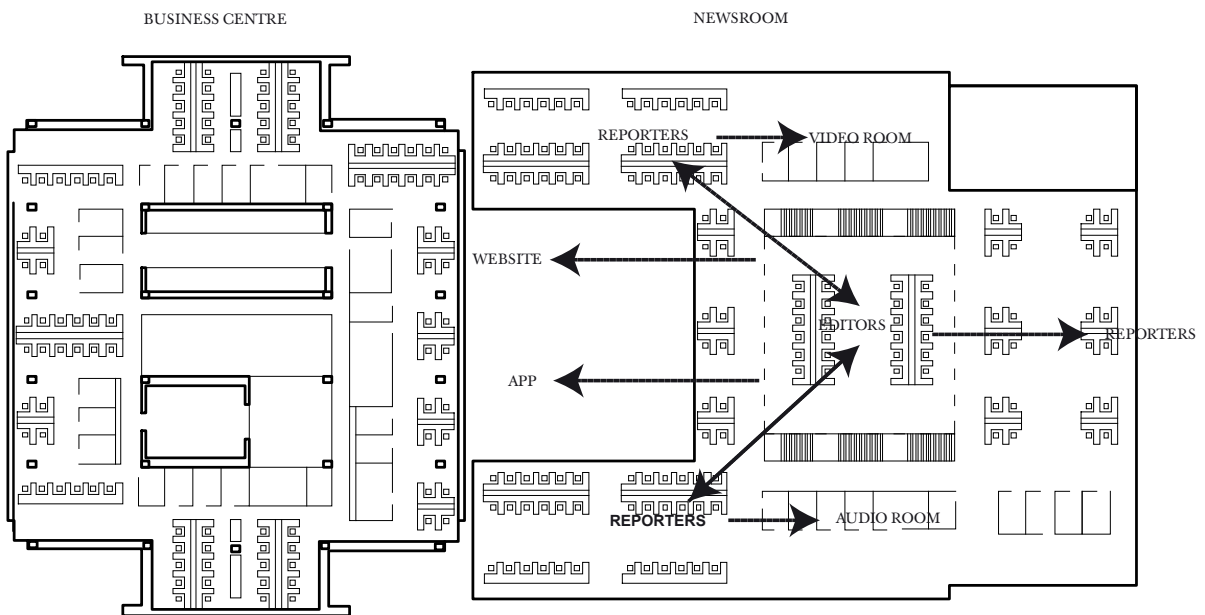

Organisation structure of the New York Times, designed by Renzo Piano, 2007._C51

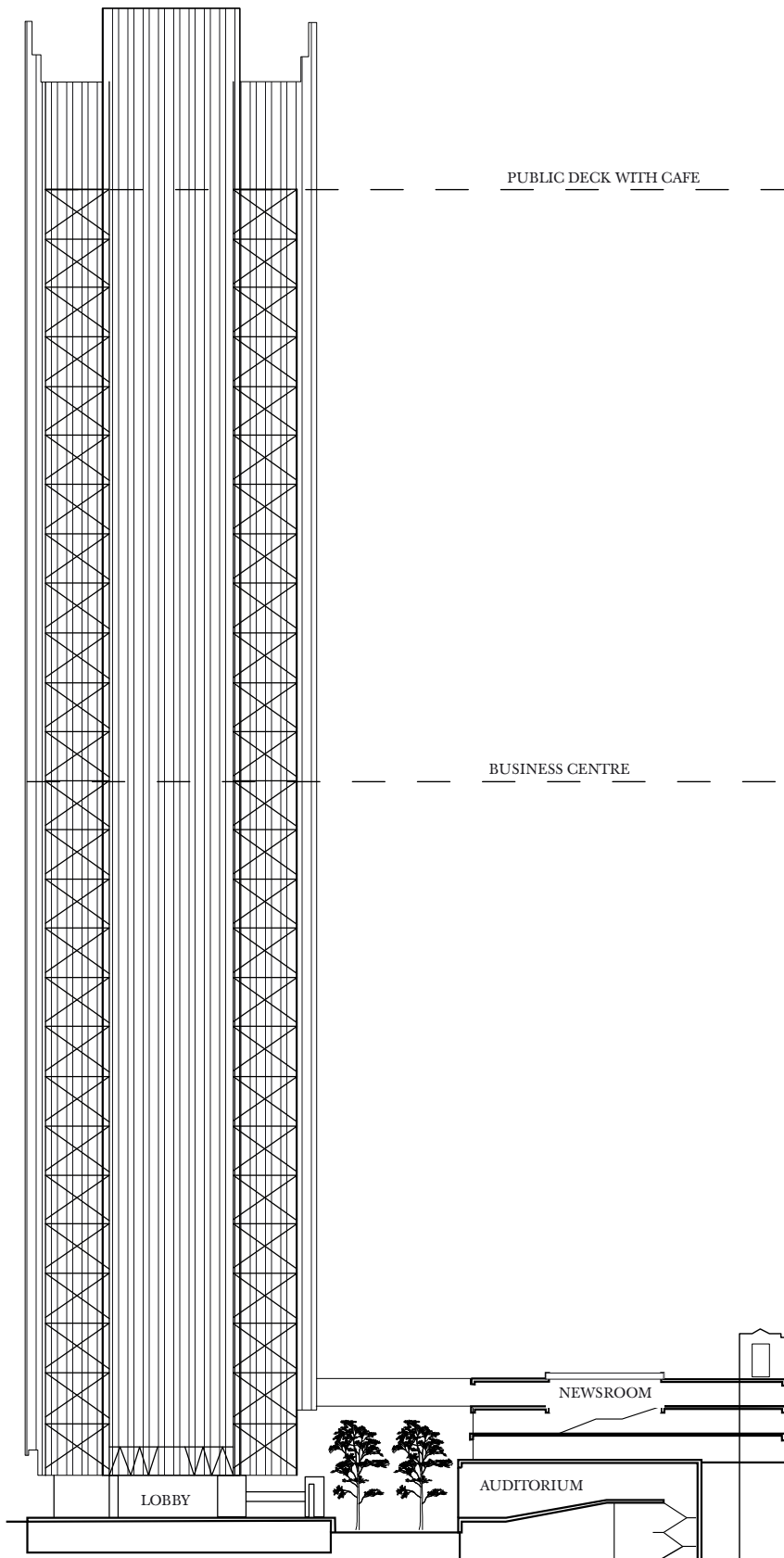

The New York Times building on 8th Avenue, contains a pedestrian path on the ground floor, through its lobby, containing auditoriums, restaurants and some retail. The newsroom occupies the back of the building, while the tower is devoted to the business center. _ C52



The results of the second re-visit to the Tribune Tower Competition, Chicago Biennial, 2017._C53

The Tribune Considering Redevelopment of Landmark Tower

11

By Al LaTrace | Dec 12, 2014, 11:15am CST

SHARE MORE



renderings via the Chicago Tribune

TRENDING



MAPPING THE WEST LOOP'S UNPRECEDENTED DEVELOPMENT BOOM



TALLEST RESIDENTIAL BUILDING IN CHICAGO AIMED AT ULTRA-WEALTHY REACHES MILESTONE



The Tribune Media company is trying to make good on its real estate assets, and in addition to redeveloping some of its property along Chicago Avenue, the company has just announced that it is also

December 12, 2014. News from the blog Chicgo curbed. _C54

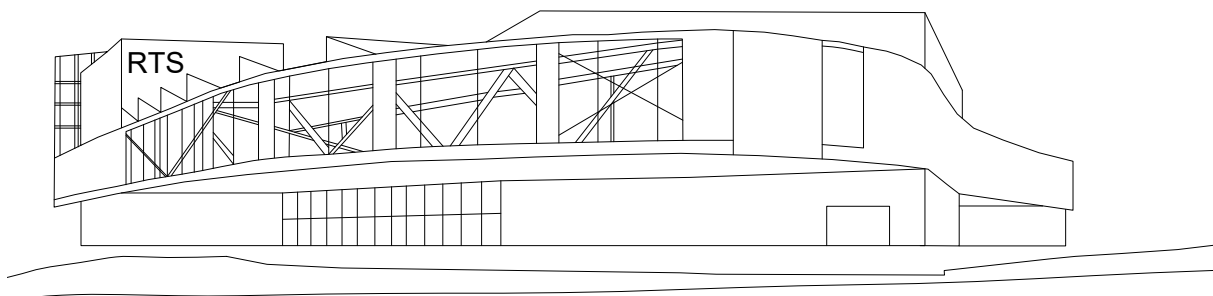
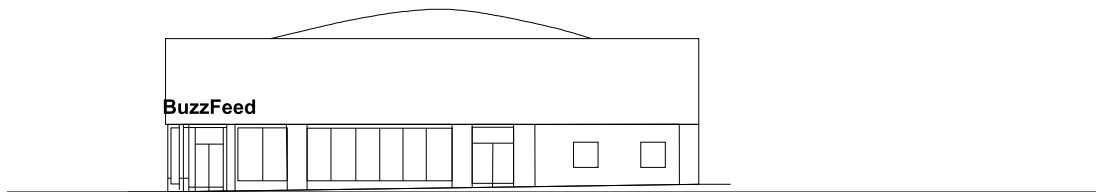

The Correspondent, BuzzFeed, RTS, contemporary news media organisations that operate out of residences, abandoned warehouses and business parks on the outskirts. _C55

The new building for RTS (Radio Télévision Suisse) is positioned in the heart of the double campus of EPFL and UNIL. It will function as a 'hinge' between the two campuses, as well as between fields of education and research, and between classical broadcasting and contemporary media.

The project consists of four separate volumes, supporting a disc-like volume suspended 7 meters above ground. The volumes include a large television studio, a concert hall, a media library and the RTS's administration. The suspended volume, the 'Champ', contains the different redactions and broadcast studios, organised as a 'field' of landscape offices.

- The description of the new offices of the RTS in Lausanne designed by Office KGDVS, competition entry, 2016. <http://officekgdvs.com/projects/#office-176> _C56



Headquarters of BuzzFeed, Los Angeles, occupies an abandoned strip mall in the suburbs of Los Angeles._C57



Headquarters of The Correspondent, Amsterdam, 2016, occupies a residential building in Amsterdam_C58

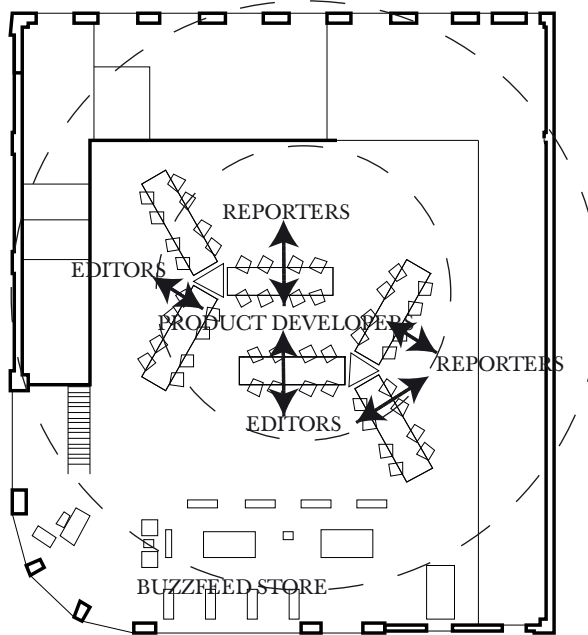
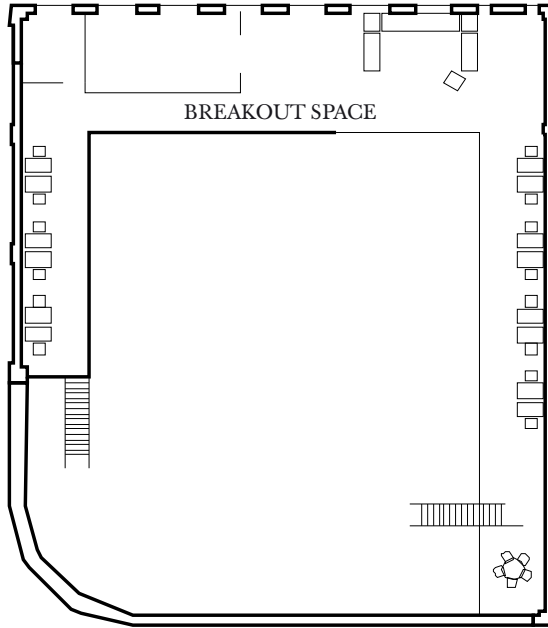

Buzzfeed, Los Angeles. The flexible office space with desks that are not assigned, and adapt according to contemporary trend of work culture where most do not com to work every day. _C59

“We have many journalists who do not work fom their desks everyday. Hence we have flexible workspaces, where only the editor and the deputy editor of each team is allocated a permanent desk, and the rest are free to sit where they please.”

- Dick van Eijk, Editorial Poject Manager, NRC Handelsblad _C60

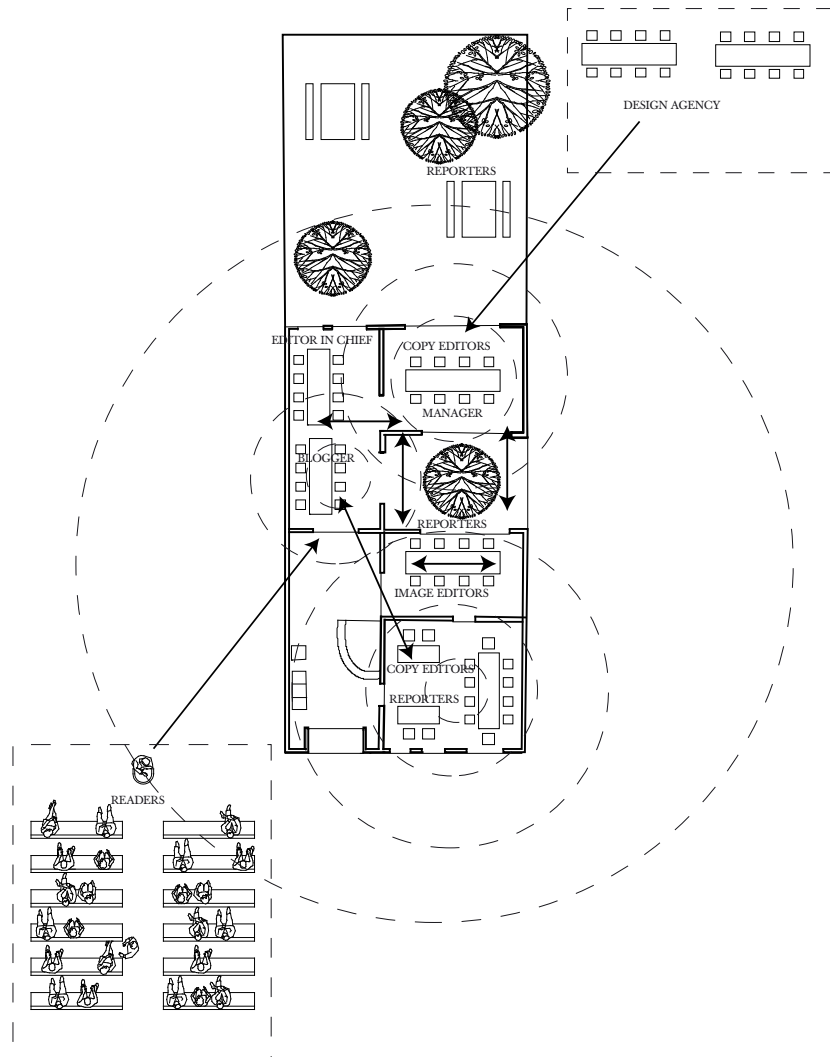

The Correspondent, 2016. The newsroom space consists of three desks, where everybody works together, using the same equipment, in a flexible organisation structure. _C61.

The increasing use of the Internet search function, primarily through large engines such as Google, has also changed the habits of readers. Instead of perusing general interest publications, such as newspapers, readers are more likely to seek particular writers, blogs or sources of information through targeted searches, rendering the agglomeration of newspapers increasingly irrelevant. “Power is shifting to the individual journalist from the news outlet with more people seeking out names through search, e-mail, blogs and social media,” - Nicholls, “Digital Born News Media in Europe”, 12-13. _C62.

“We have quite a small office. We are now around 50 people, and the office is too small. We are currently looking for new office space. At the office we have developers, image editors, social media (correspondents), journalists, all working in the same space. Even the Editor – in-chief does not have his own office. We all stay work together; it’s kind of like a student dormitory. We even have our own garden, and we work there a lot.” - Mayke Blok, Platform Editor, The Correspondent _C63.

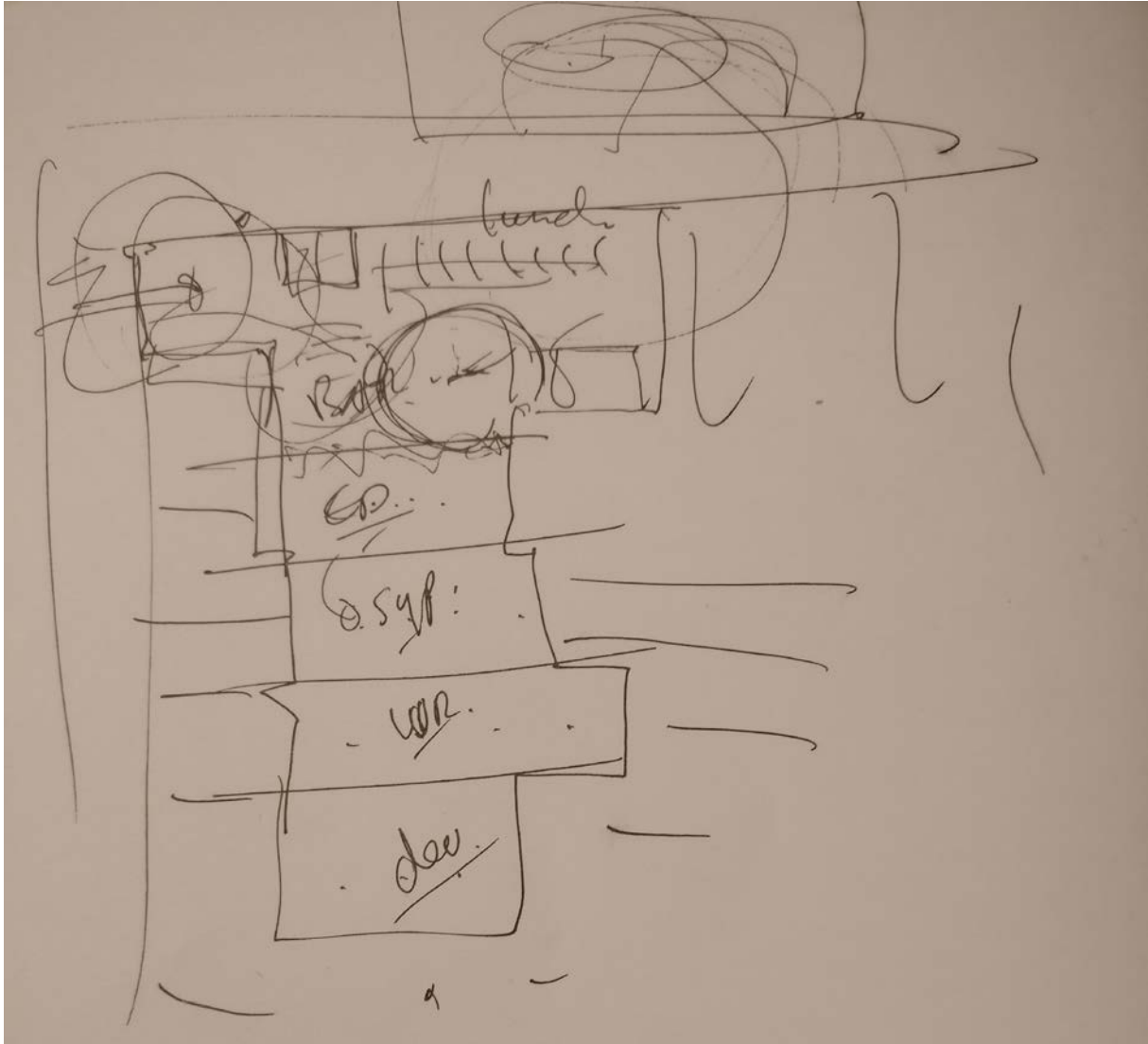

Sketch made during conversation with Carmen Buitenhuis, in Amsterdam, October 13th 2017, the designer of the offices for The Correspondent, describing the current layout and operation. _C64

The offices and the event spaces are separated only by a coffee and drinks bar. A social space that serves both the readers and the journalists. _C65