



AR3AH110 HA
P5 Presentation

Johannes Düber
26.06.2019





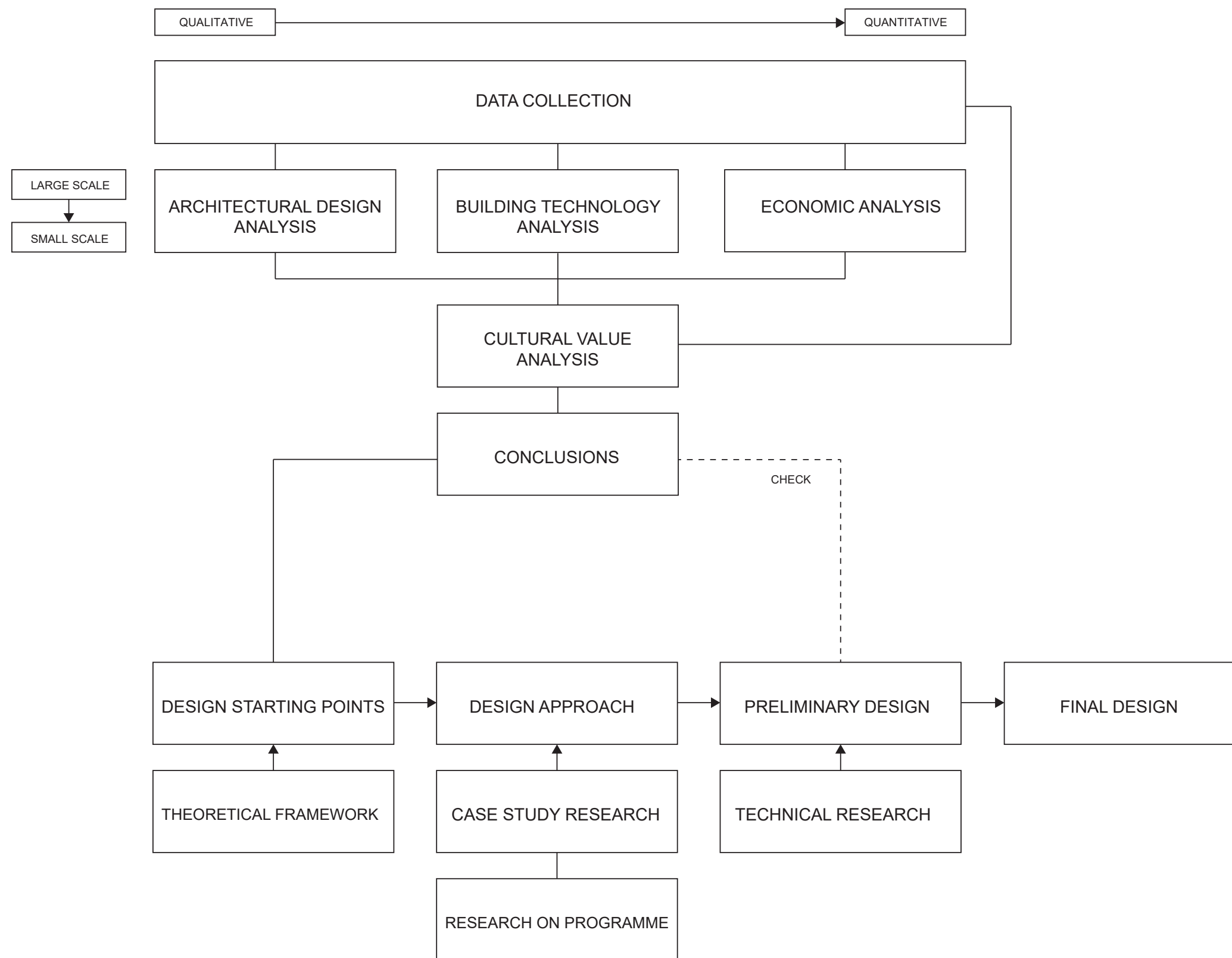

PART 01

What are the qualities/
Cultural Values of Reuversweerd?

PART 02

How can the historic layers of
the site be preserved and made
“experienceable”?

Contents

Part 1

Analysis - Conclusions - Design Starting Points

Part 2

Programme - Site Concept
Walkway
Main House/ War Damages
Functional Core
Sustainability Strategies

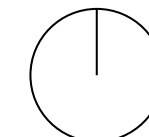
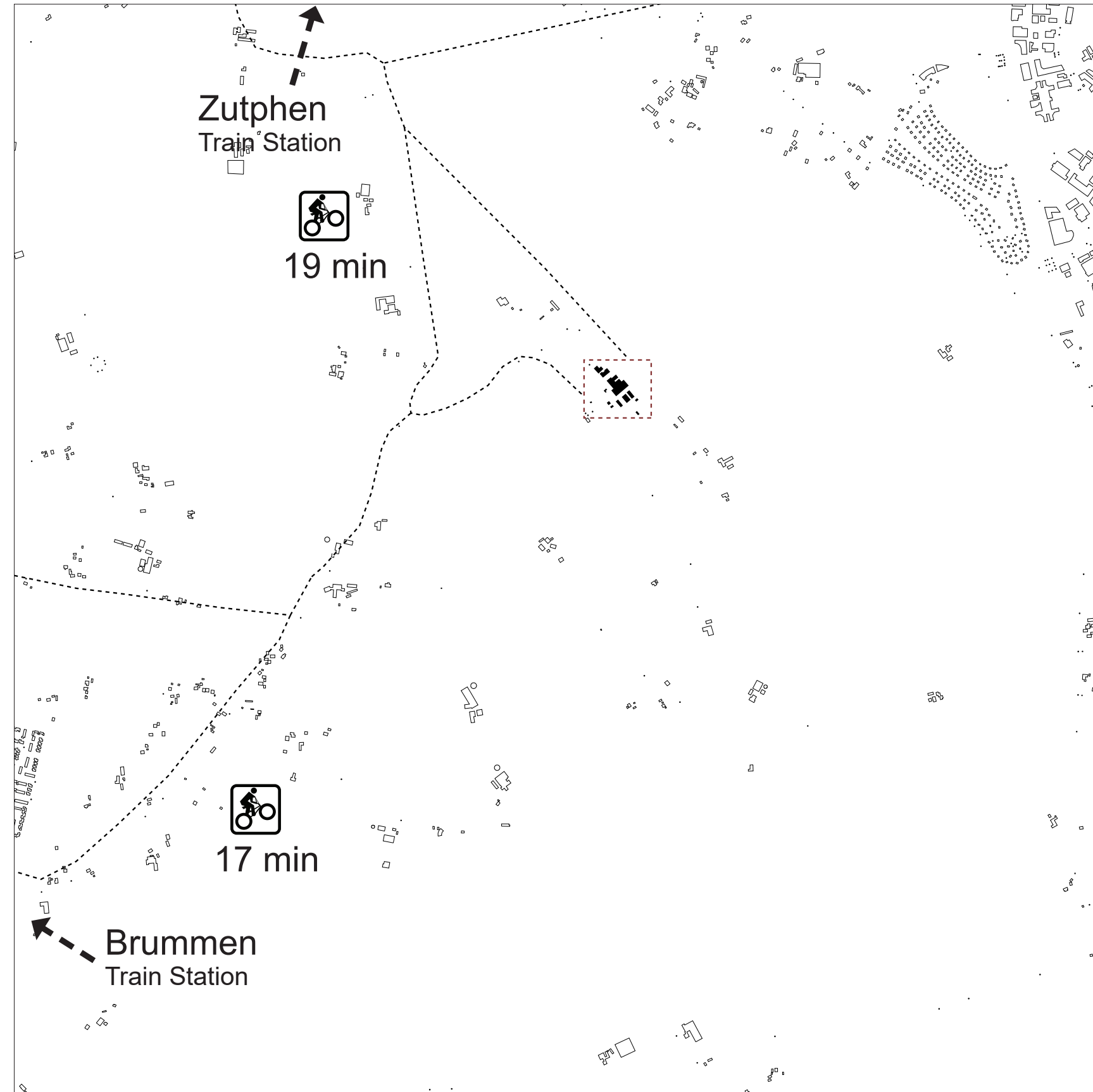

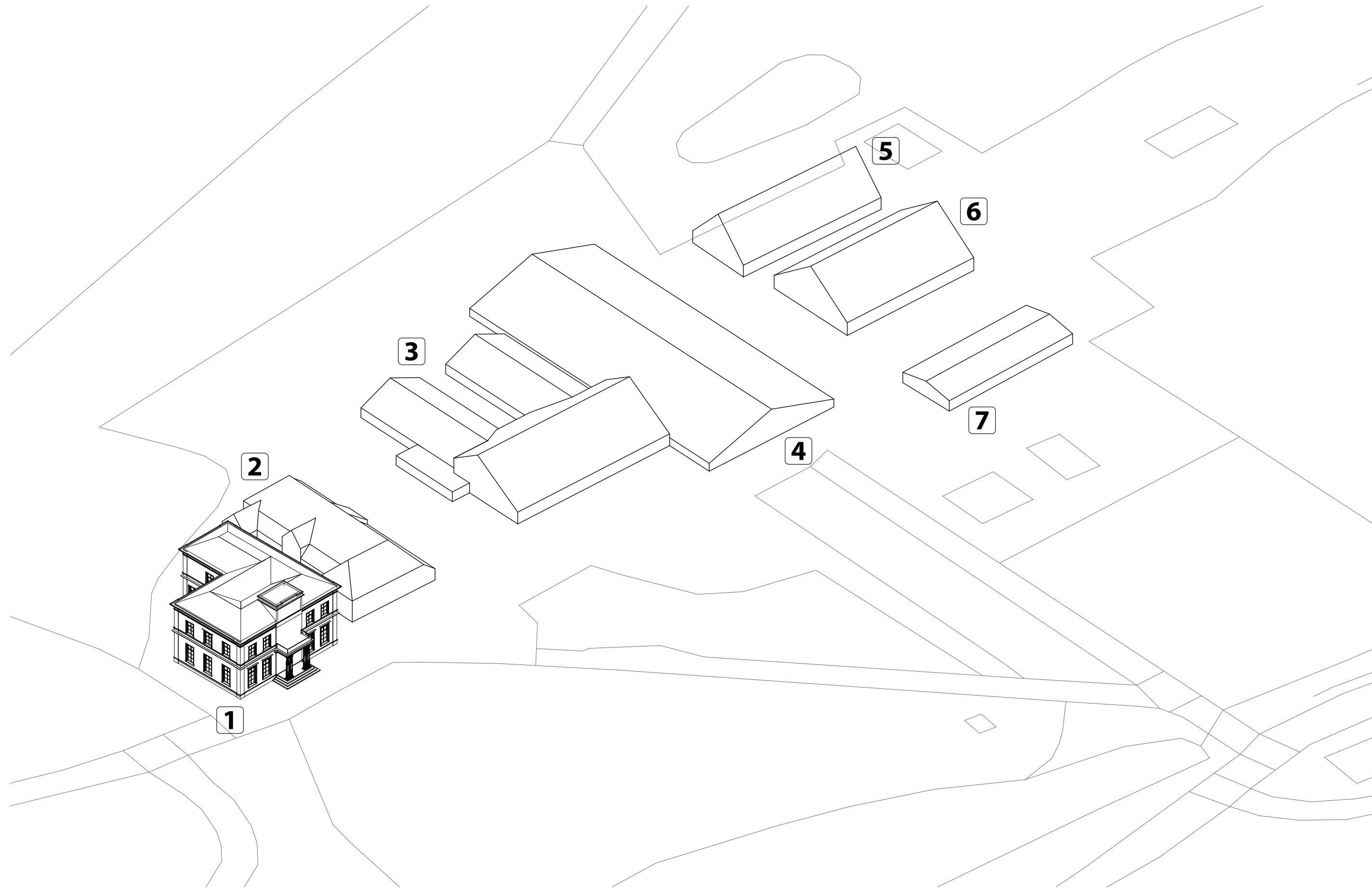

- 1 Main House - 1845
- 2 Farmhouse - 1800
- 3 Main Stable - 1952
- 4 Cubicle Stable - 1975
- 5 Ankerschuur - 1921
- 6 Horse Stable - 1921
- 7 Heifer - 1973

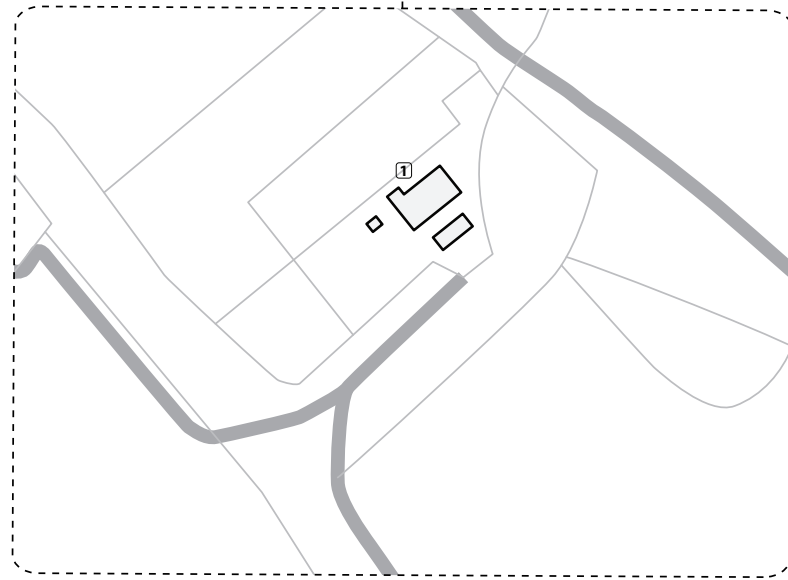

1843

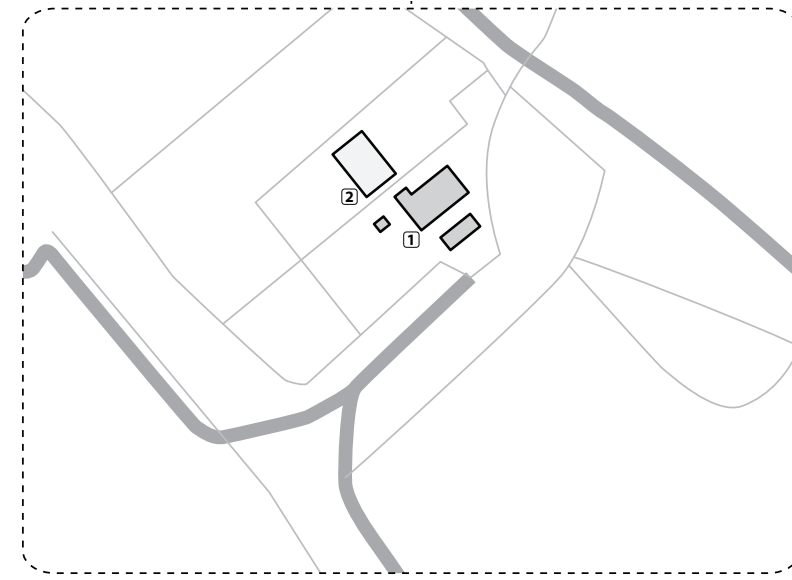

1849

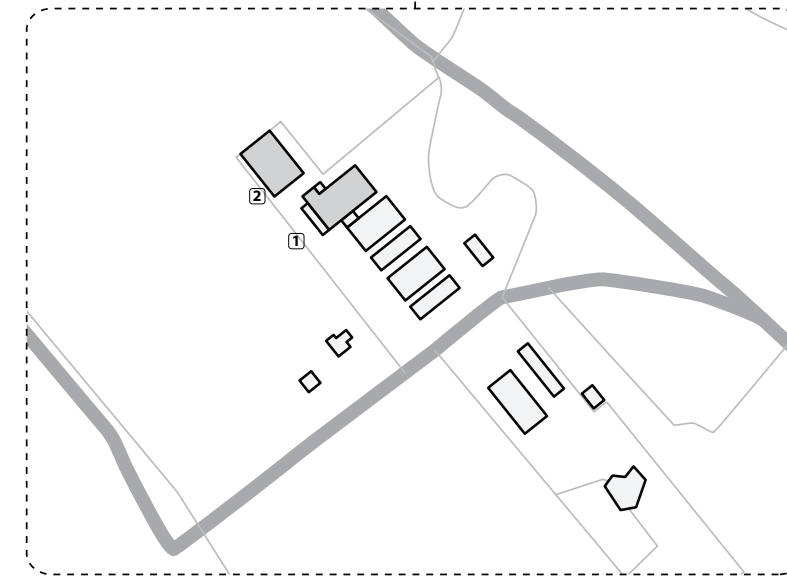

1886

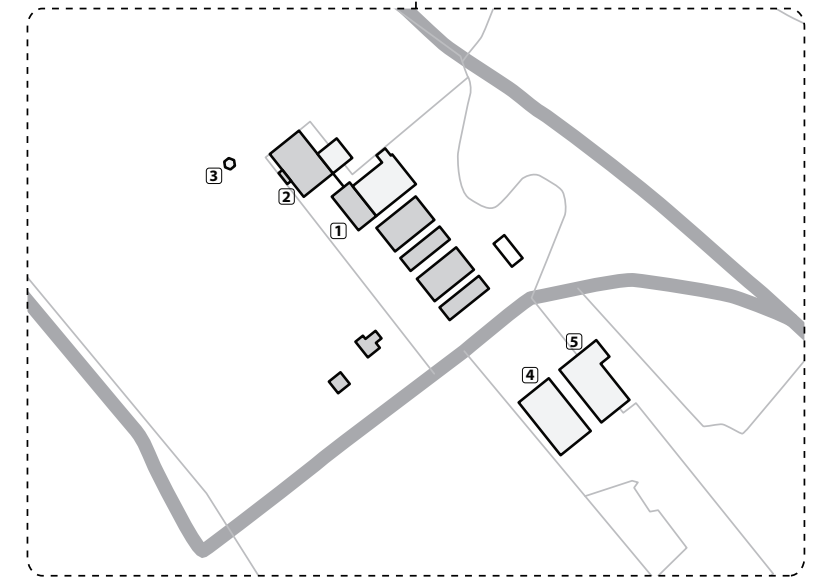

1924

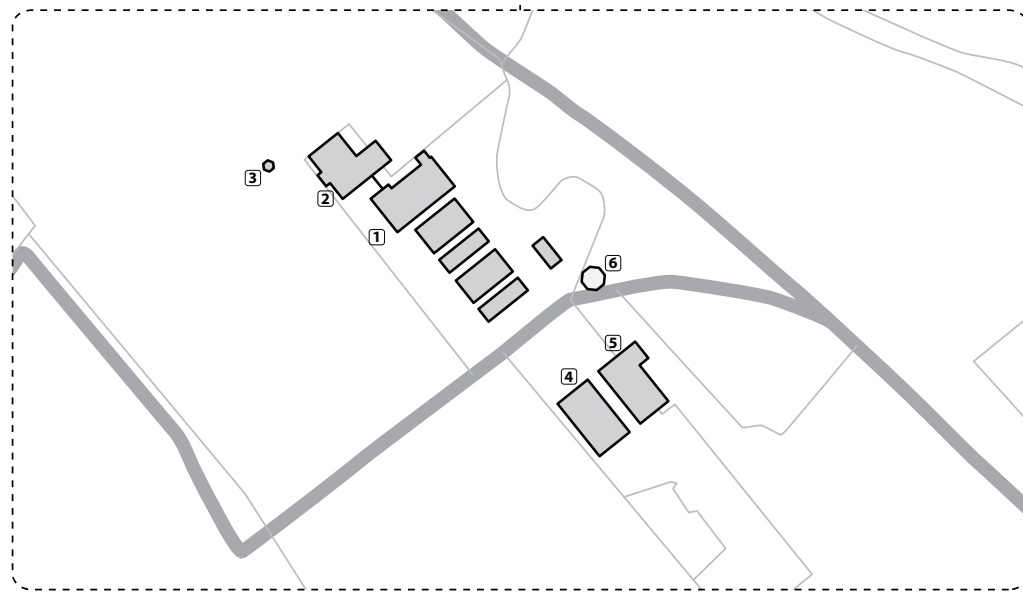

1935

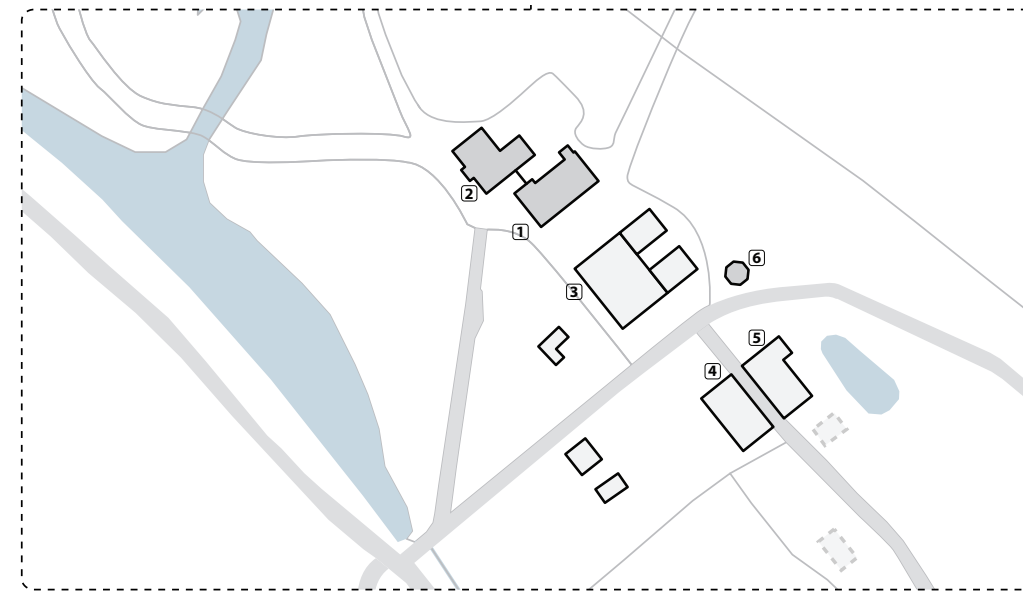

1958

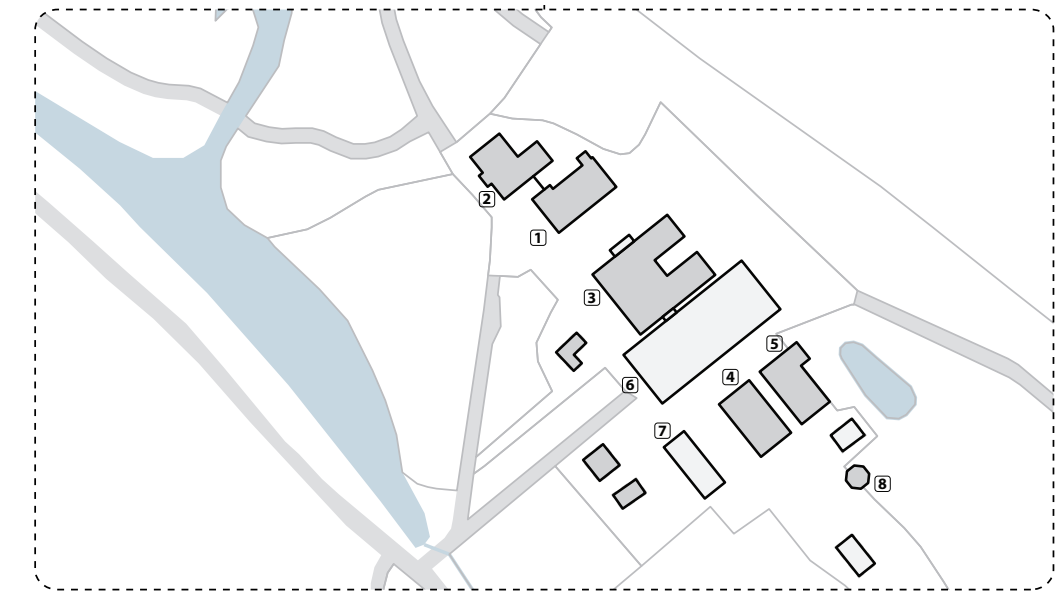

1978





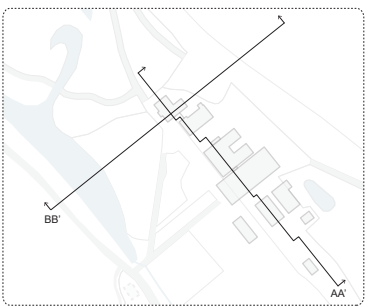
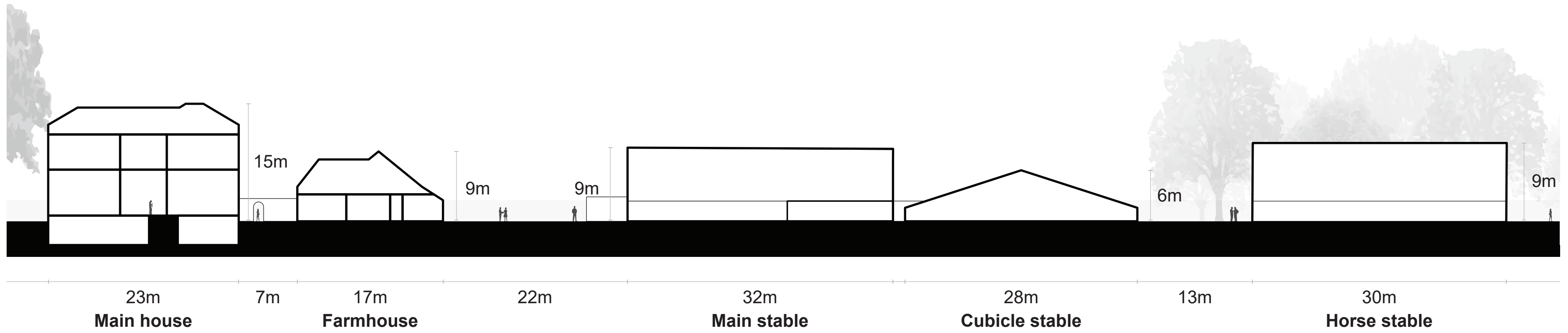















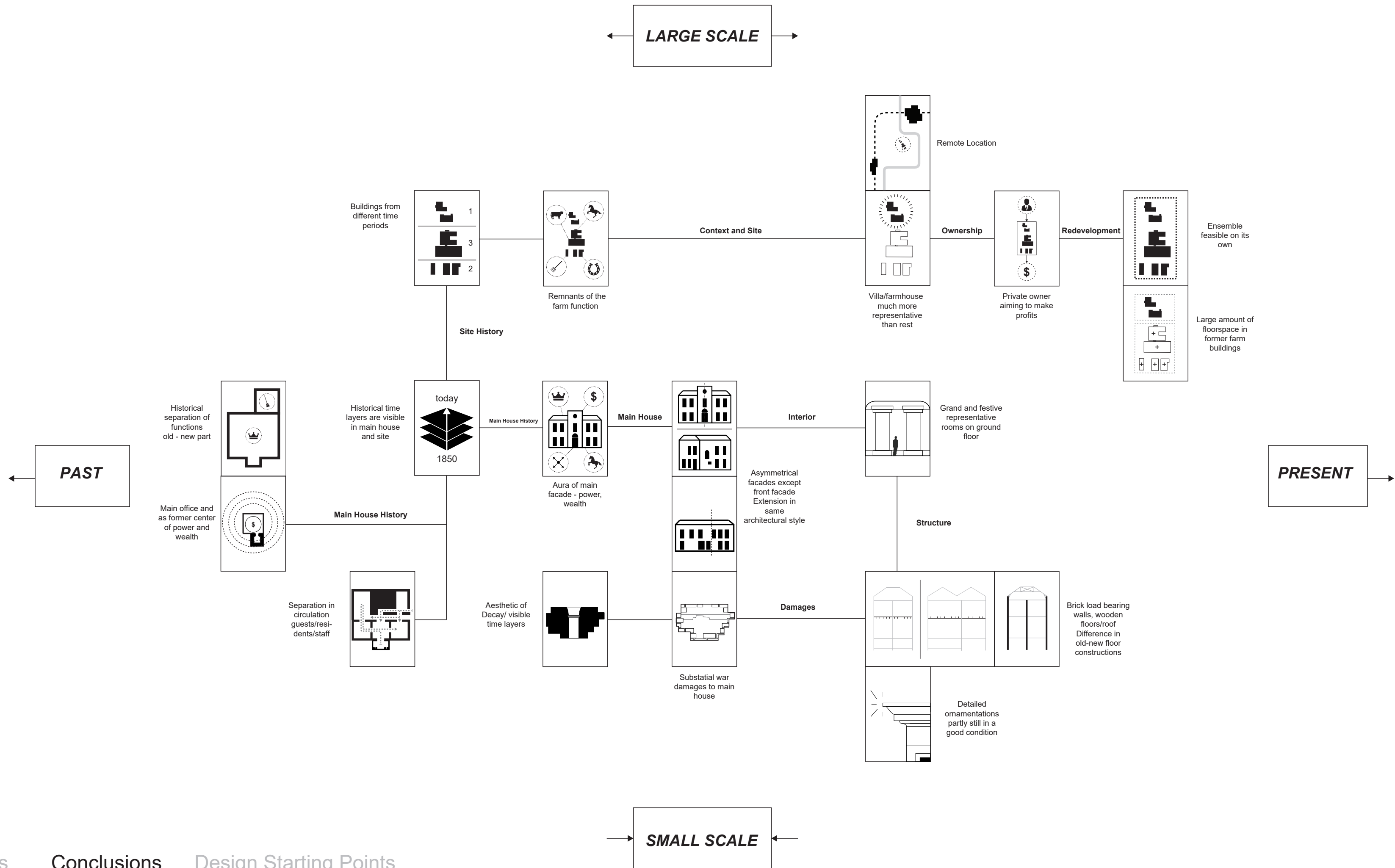

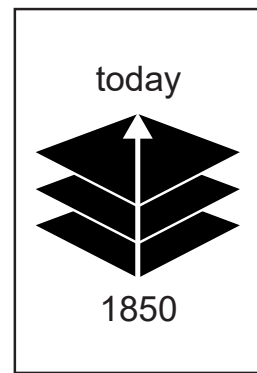

- Keep time layers visible
- Make time layers central to design

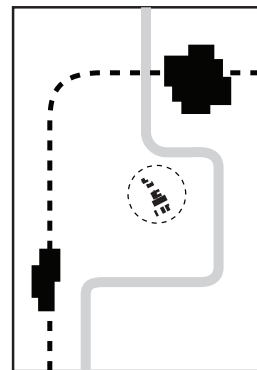

- Retreat to nature
- Attract guests - keep on site

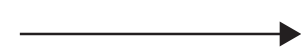
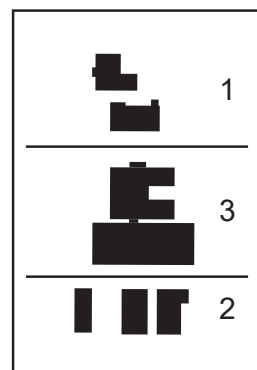

- Keep special character of site - time layers
- Accommodate different functions
- Design connecting elements

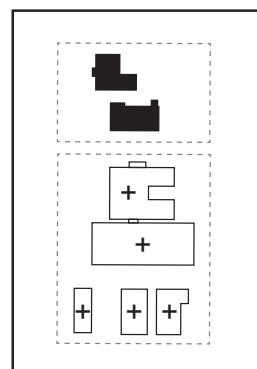

- Make use of the huge floor space available on site
- Include all buildings in design concept

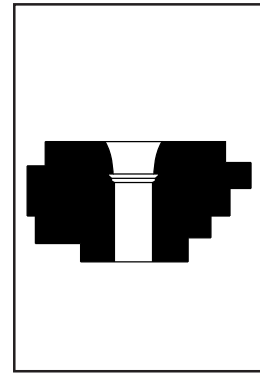

- Keep war damages (in parts)
- Use WD to create unique spatial qualities (visual connections, atmosphere)

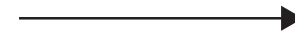
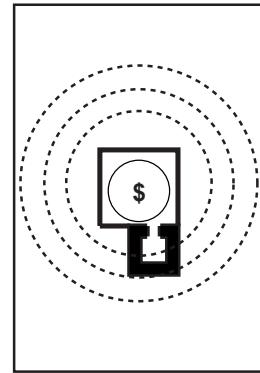

- Office and vault as important part of new design
- Open for public

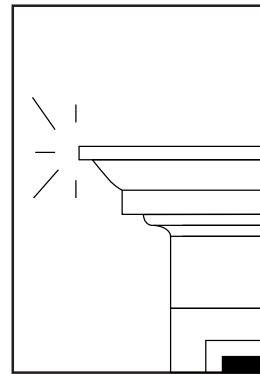

- Maintain the beauty of the existing buildings and incorporate into new design

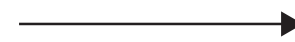
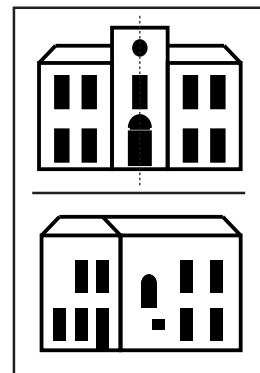

- Intervention possible on back facade

1. Establish new connections
2. Preserve the original building fabric
3. Offer additional programme

considering memory, sustainability and feasibility

Part 2

Design Concept

How can the historic layers of the site be preserved and made “experienceable”?

Programme

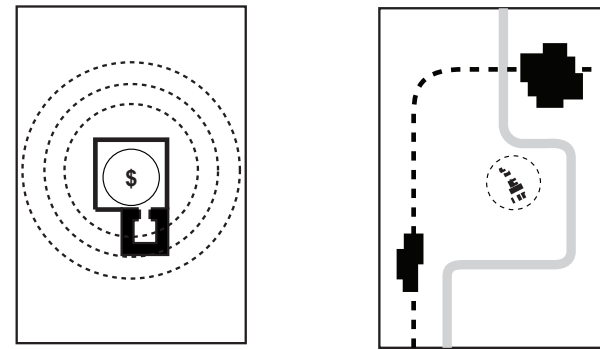



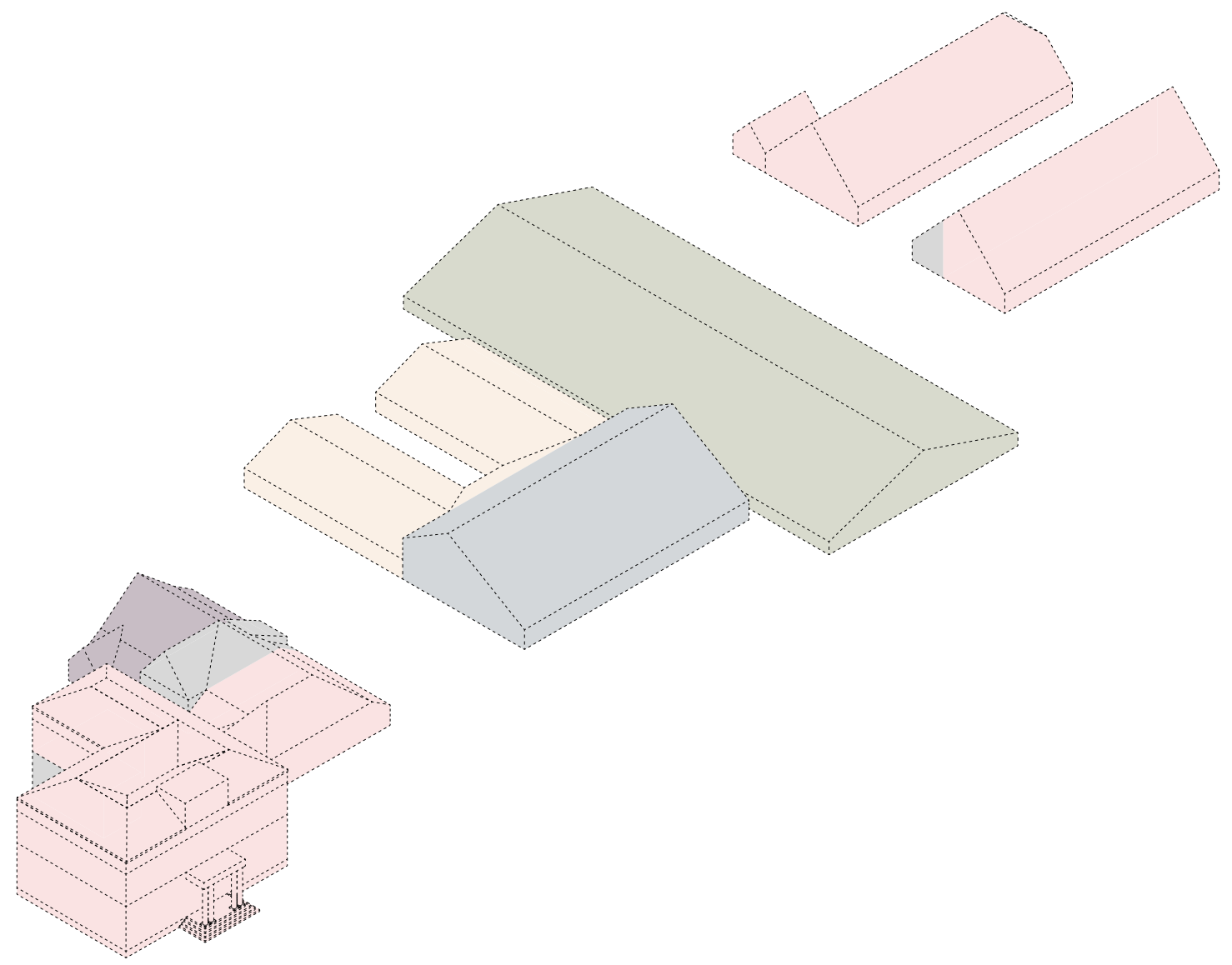

1. Site stays open for Public
2. Revenue is created through Hotel and Restaurant/ market
3. Variety of Functions to attract Visitors

HOTEL + CULTURE and NATURE

HOTEL + RESTAURANT and GREENHOUSE
APARTMENT MARKET GARDENS
HOTEL EVENT SPACE



KEY

- | | | |
|--|--|---|
|  Hotel,
Event Space |  Walkway/
Museum |  Market,
Restaurant |
|  Kitchen,
Service Area |  Office |  Greenhouse,
Shop |

Site Concept

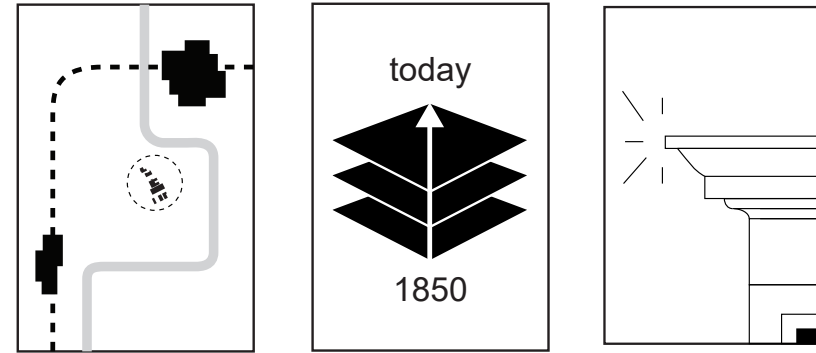

1. Attraction for Visitors
2. Intervention to make the time layers experience-able
3. Inspired by the existing buildings

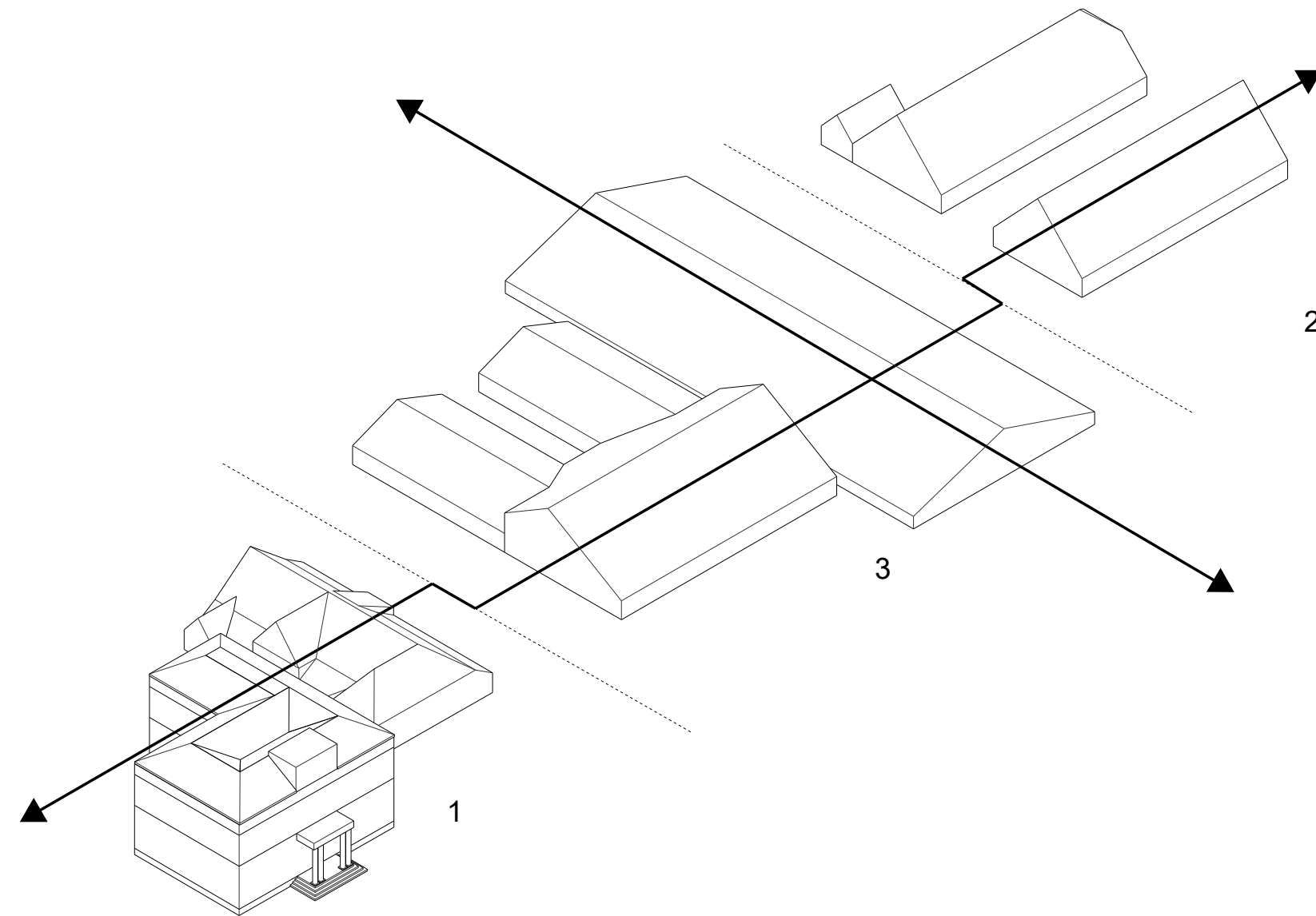

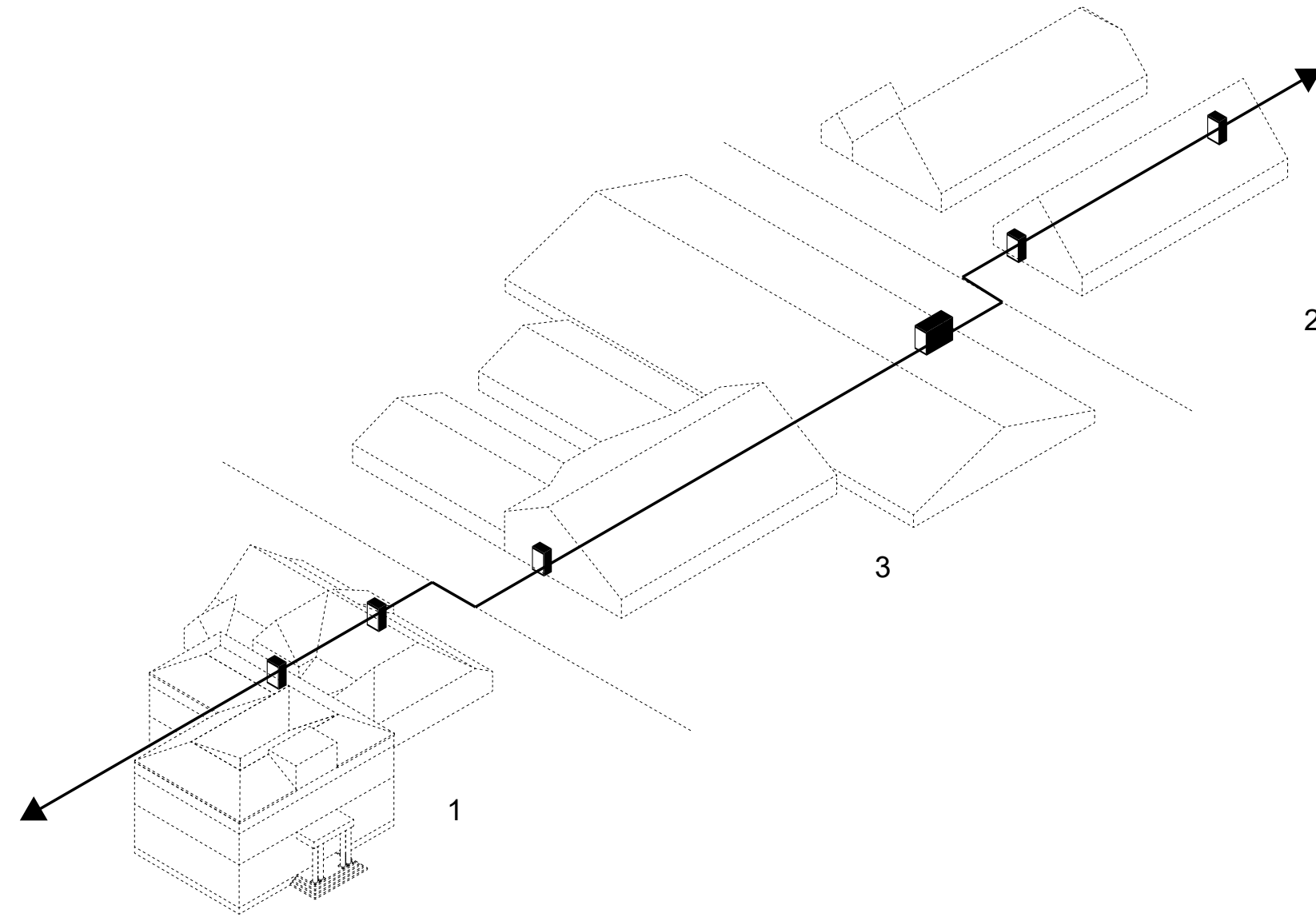

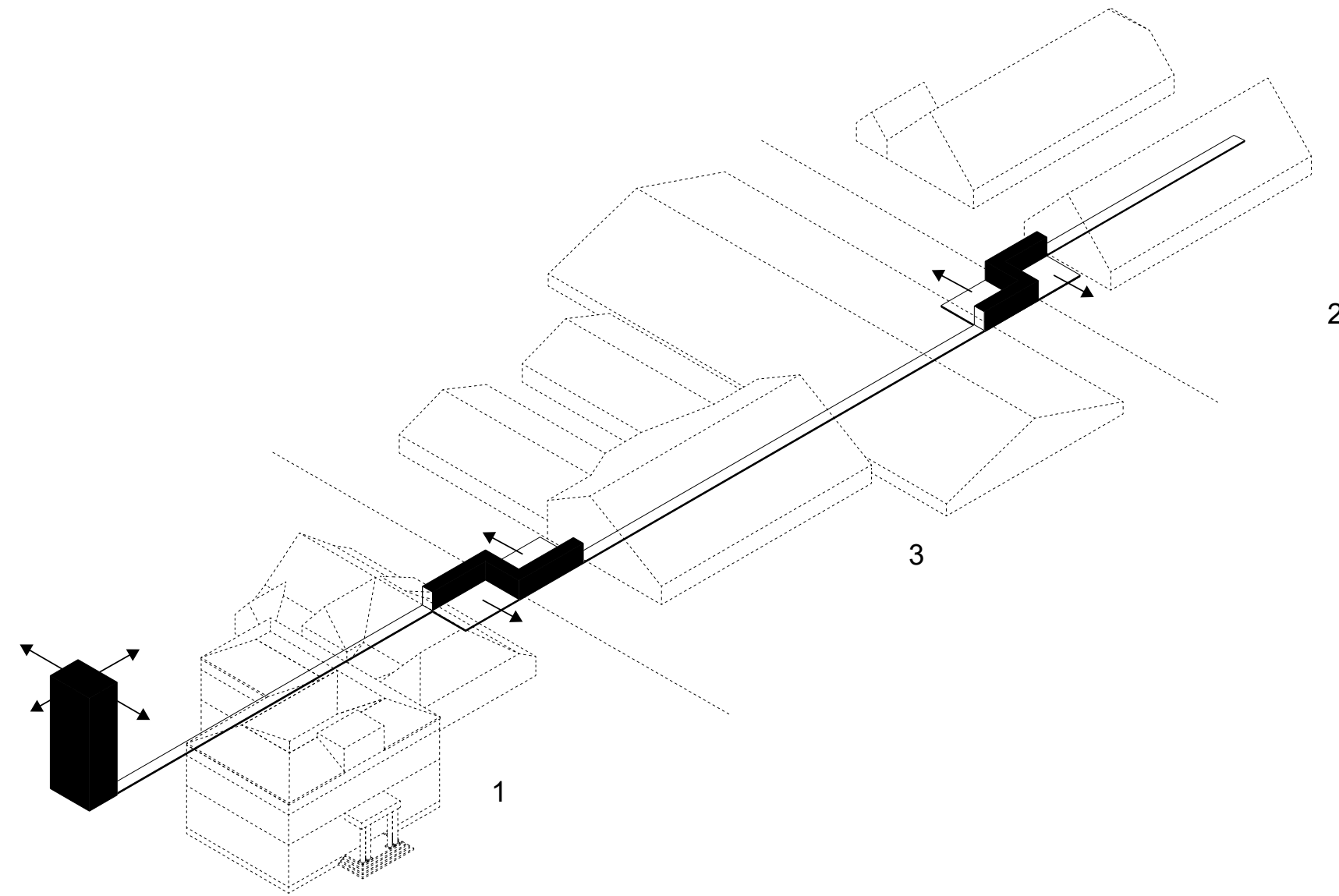

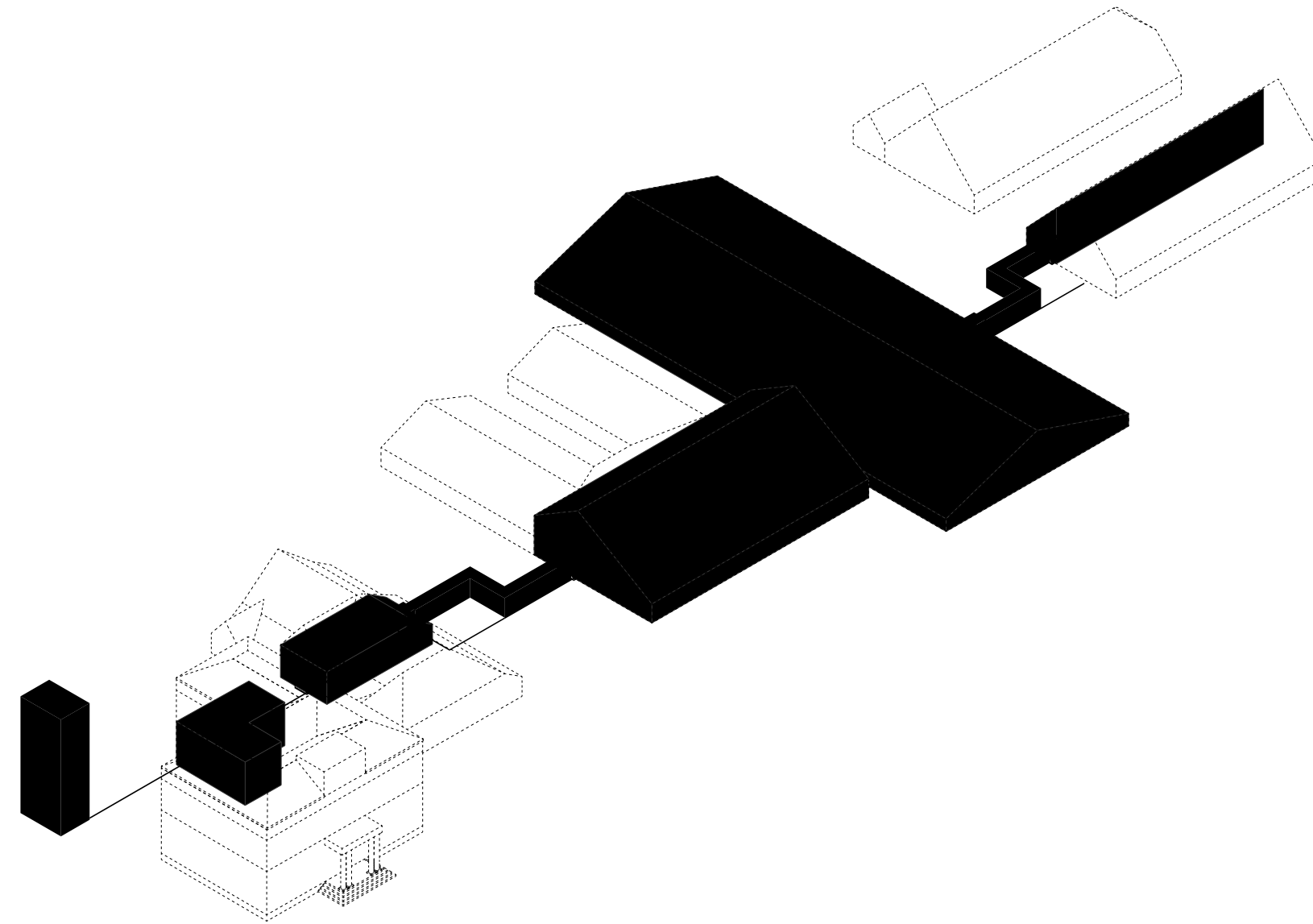

KEY

Public

Private

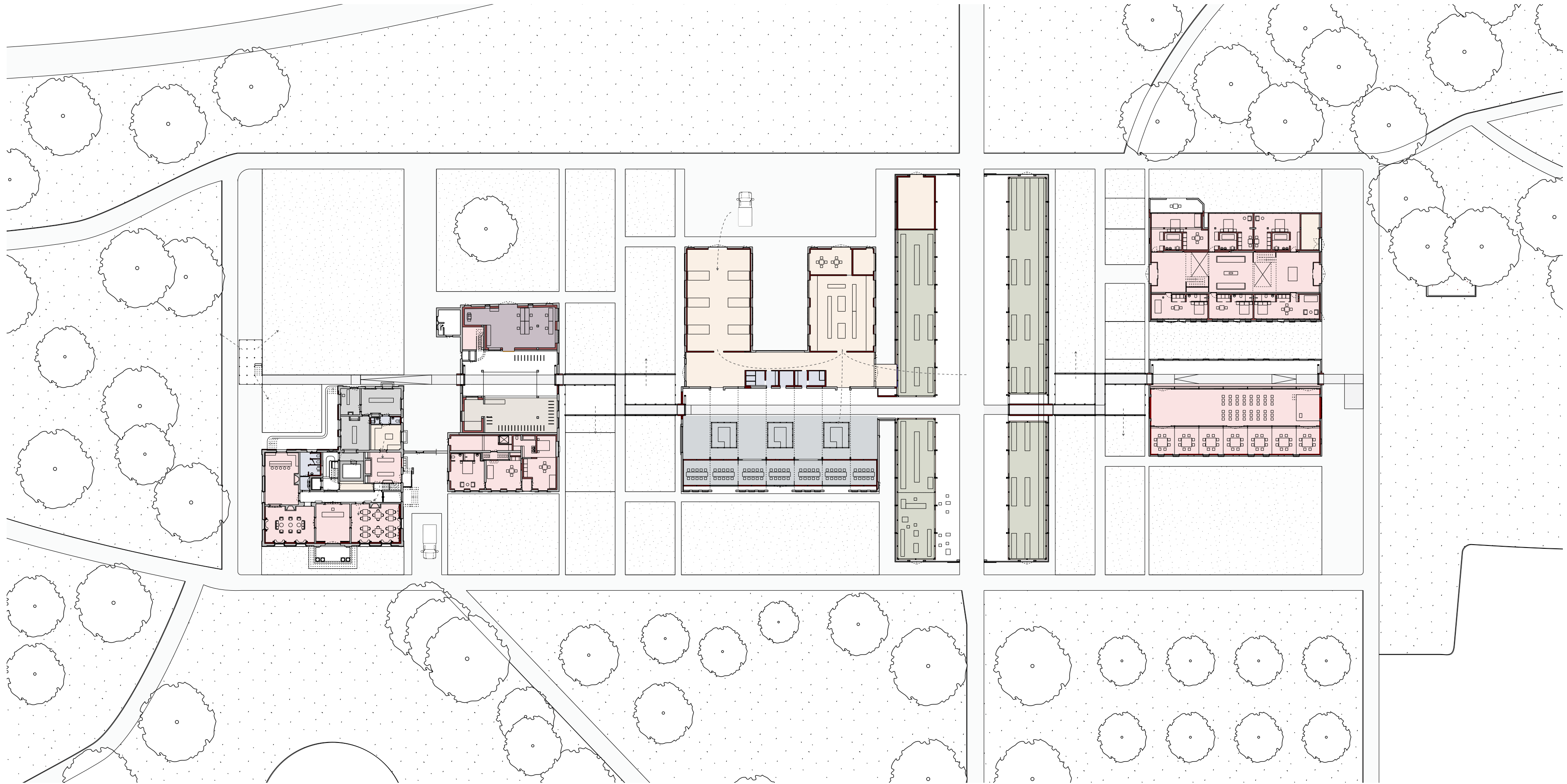

Programme and Site Concept

Walkway

Main House and War Damages

Functional Core

Sustainability Strategies

- Hotel, Event Space
- Kitchen, Service Area
- Office
- Market, Restaurant
- Walkway/Museum
- Greenhouse, Shop

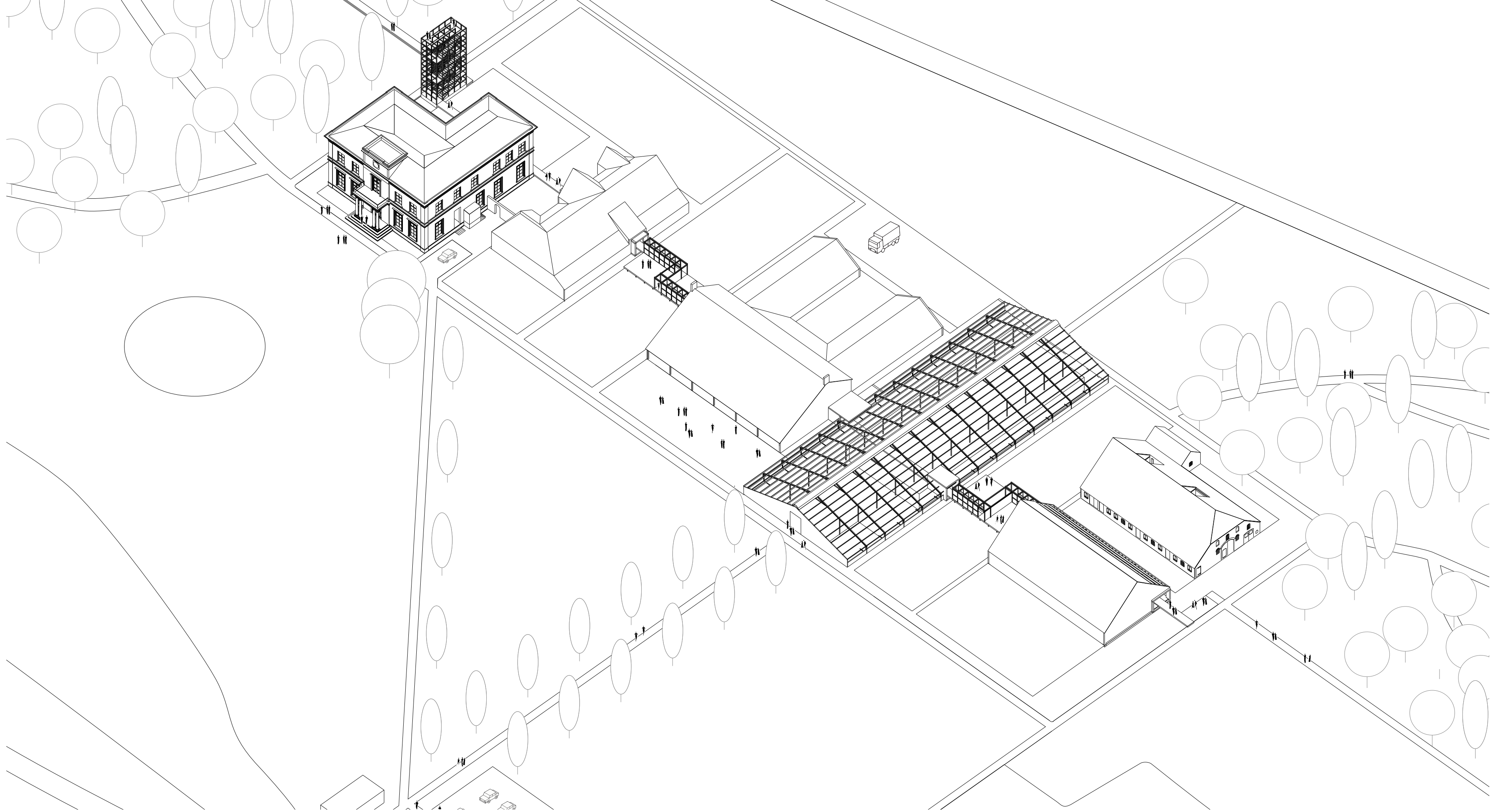

Walkway in Detail

“Establish new connections”



Programme and Site Concept

Walkway

Main House and War Damages

Functional Core

Sustainability Strategies

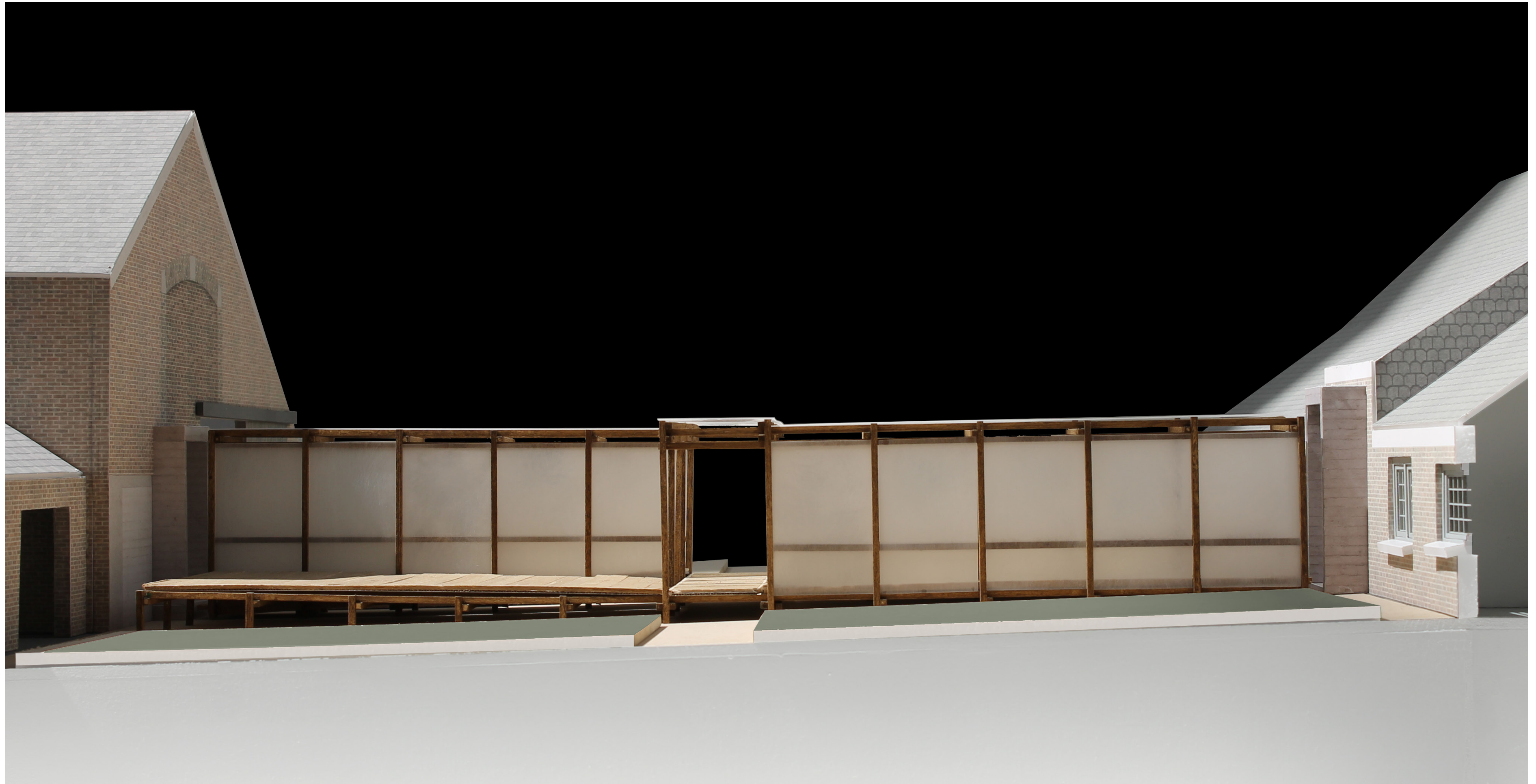

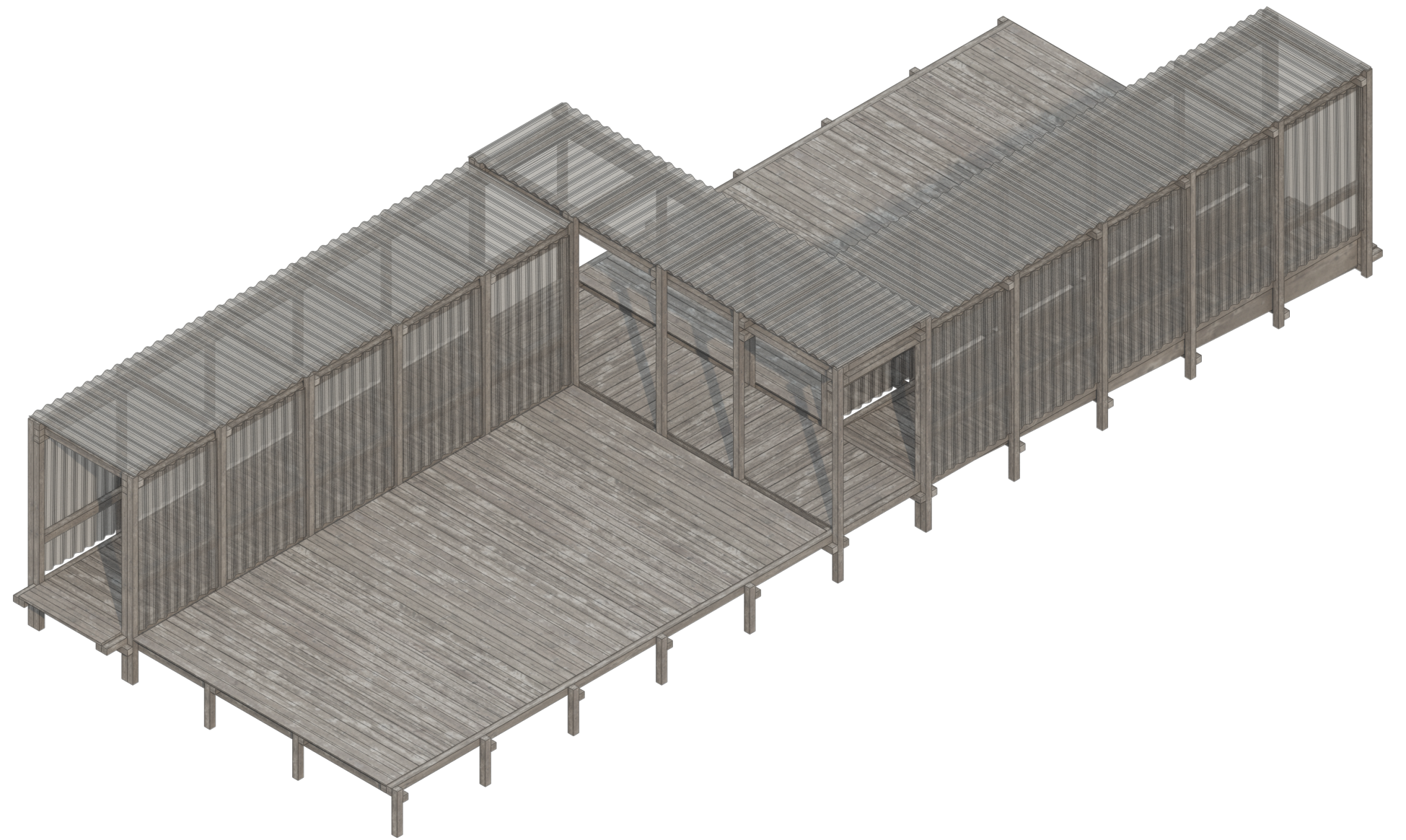
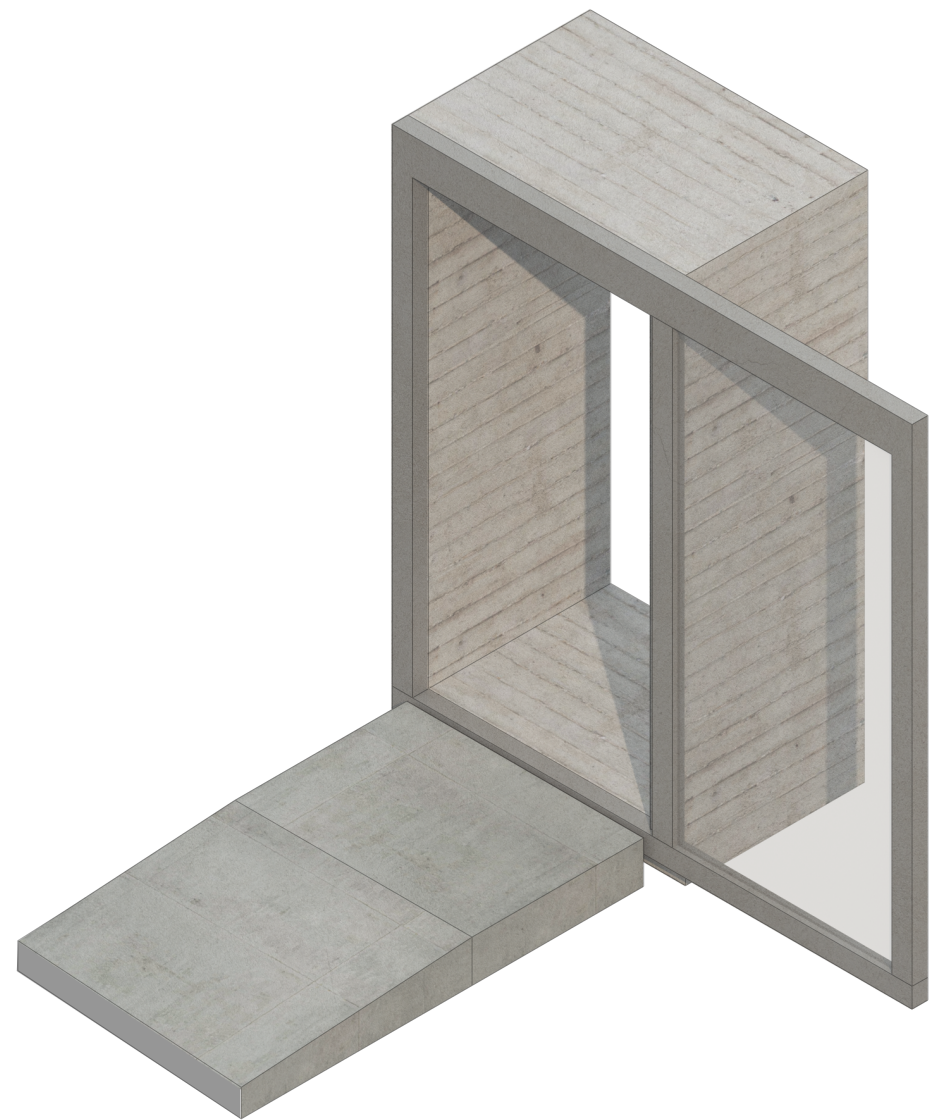



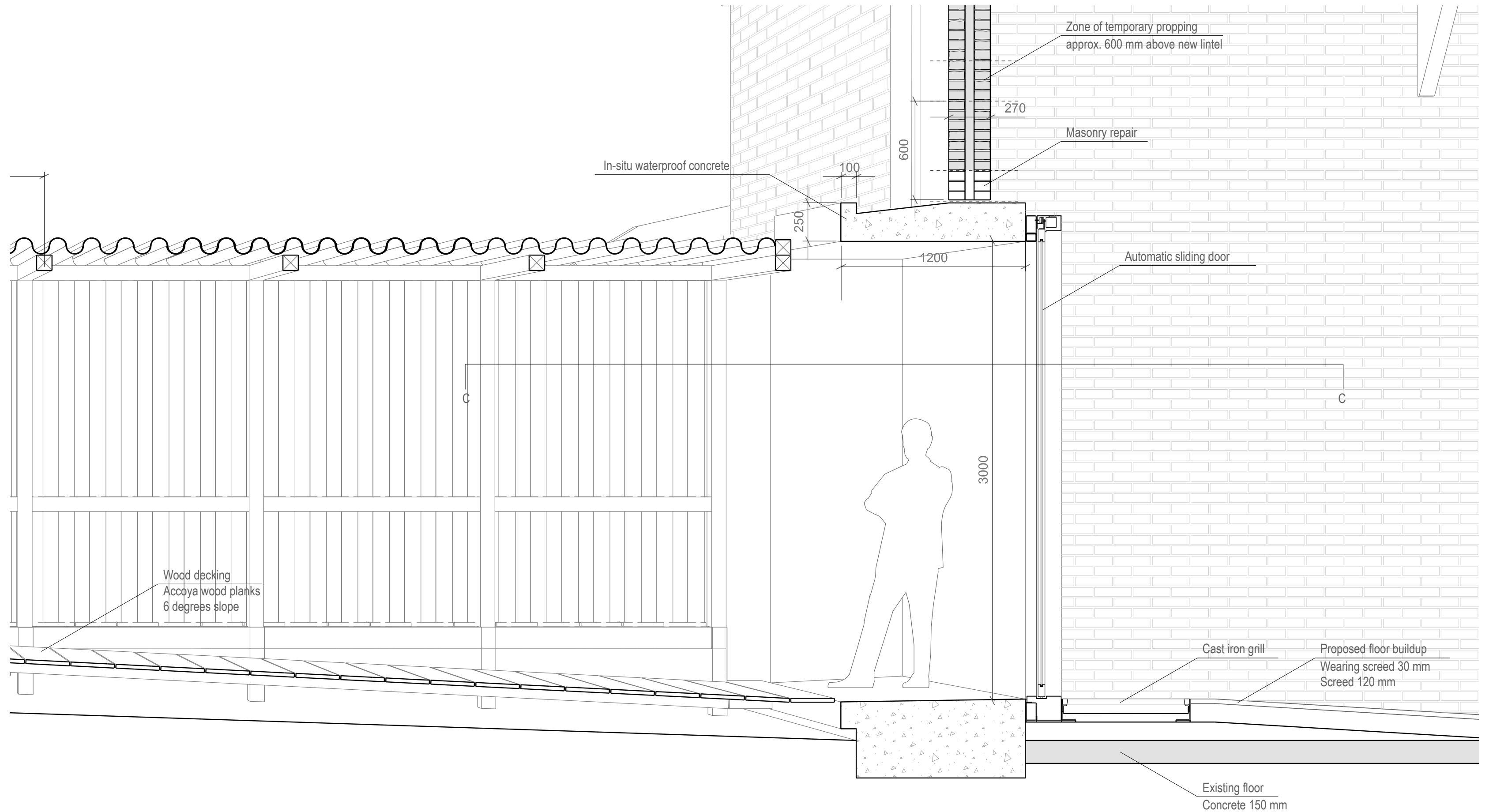

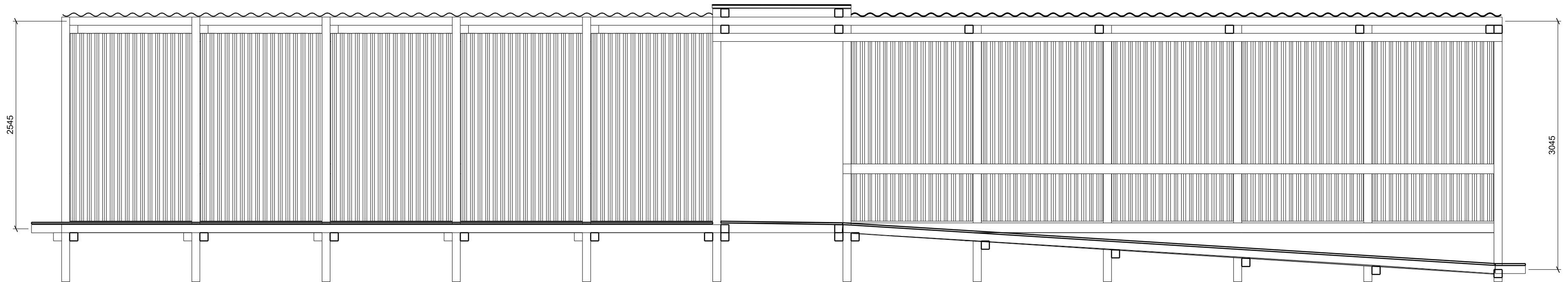
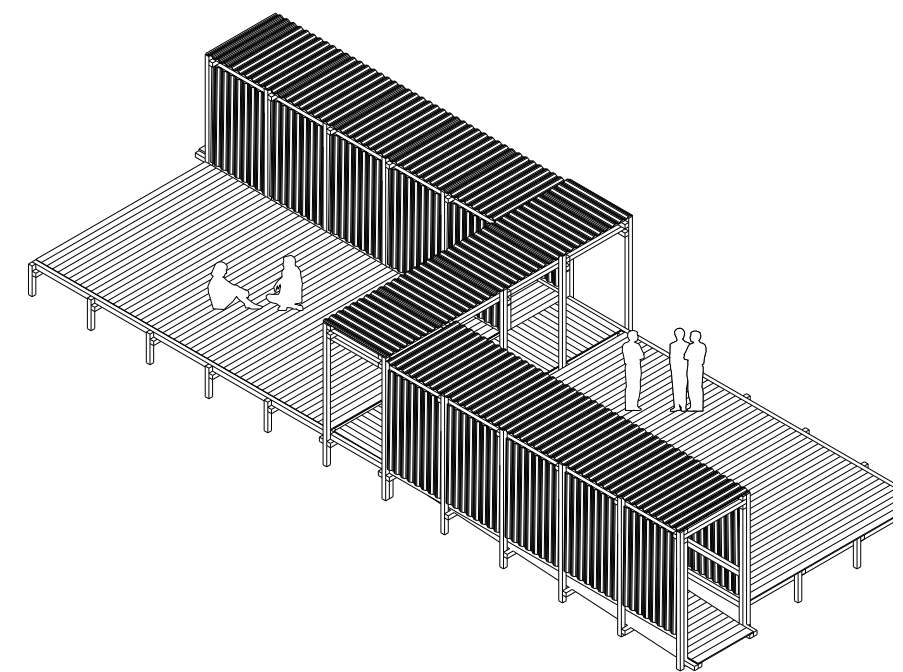
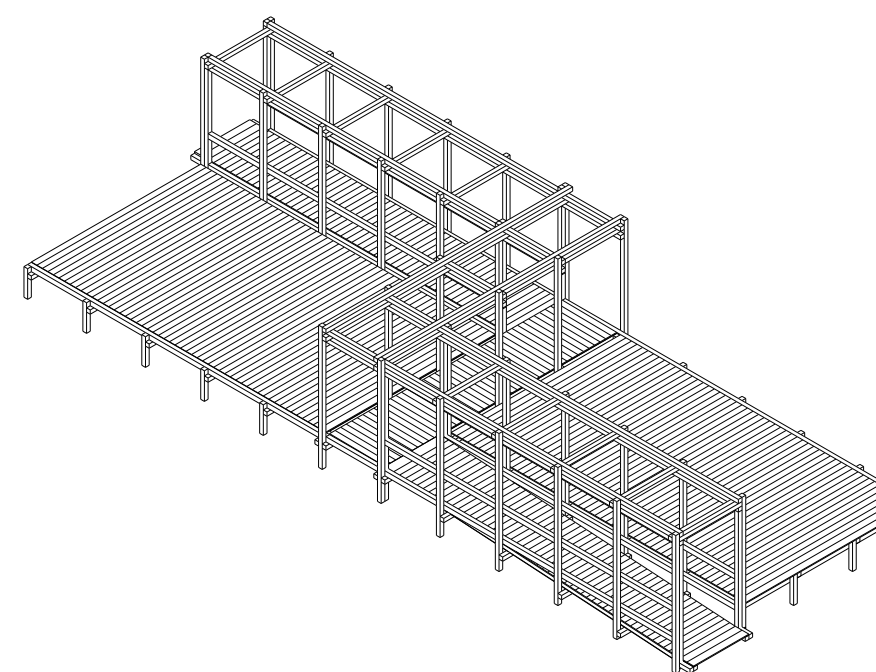
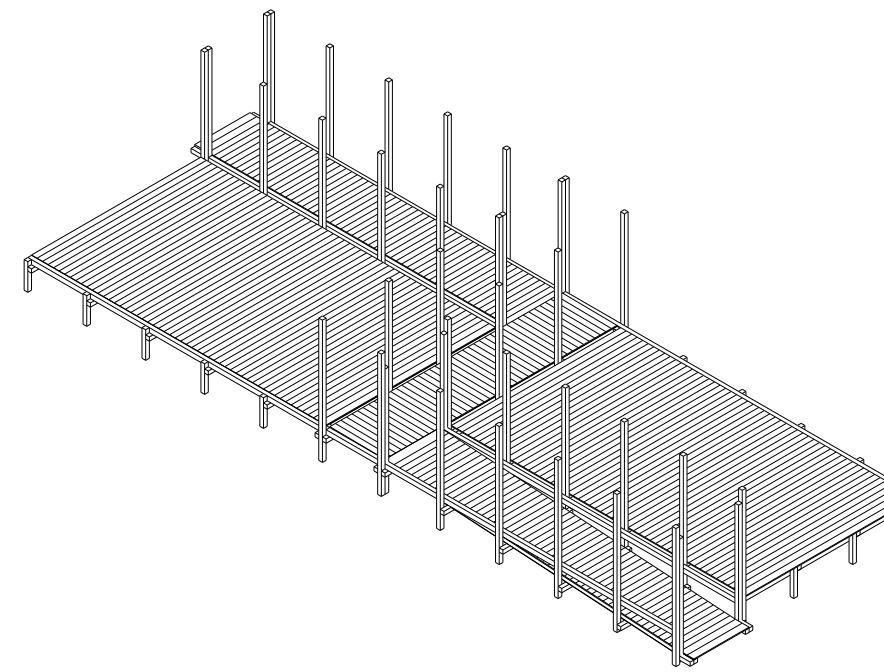
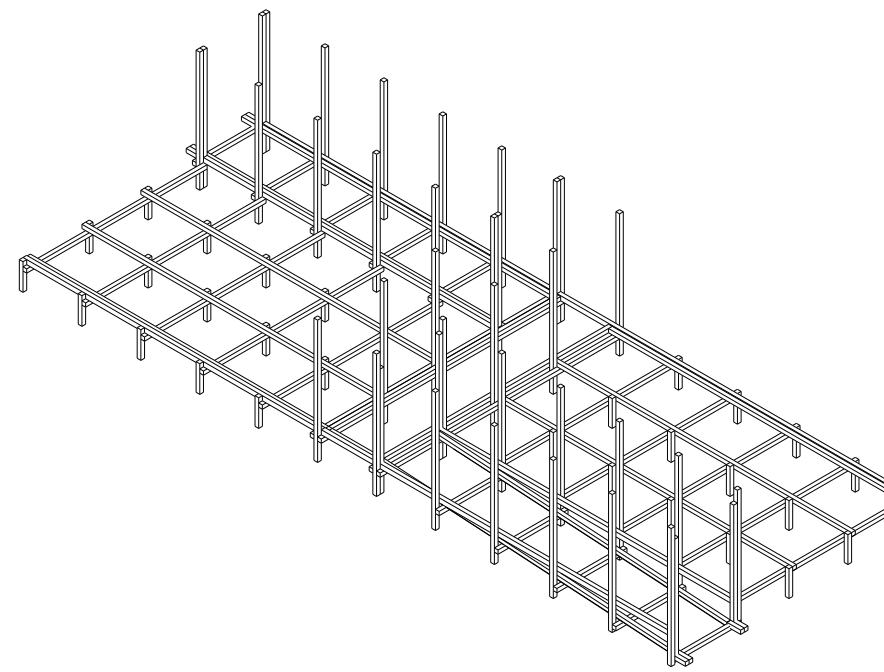



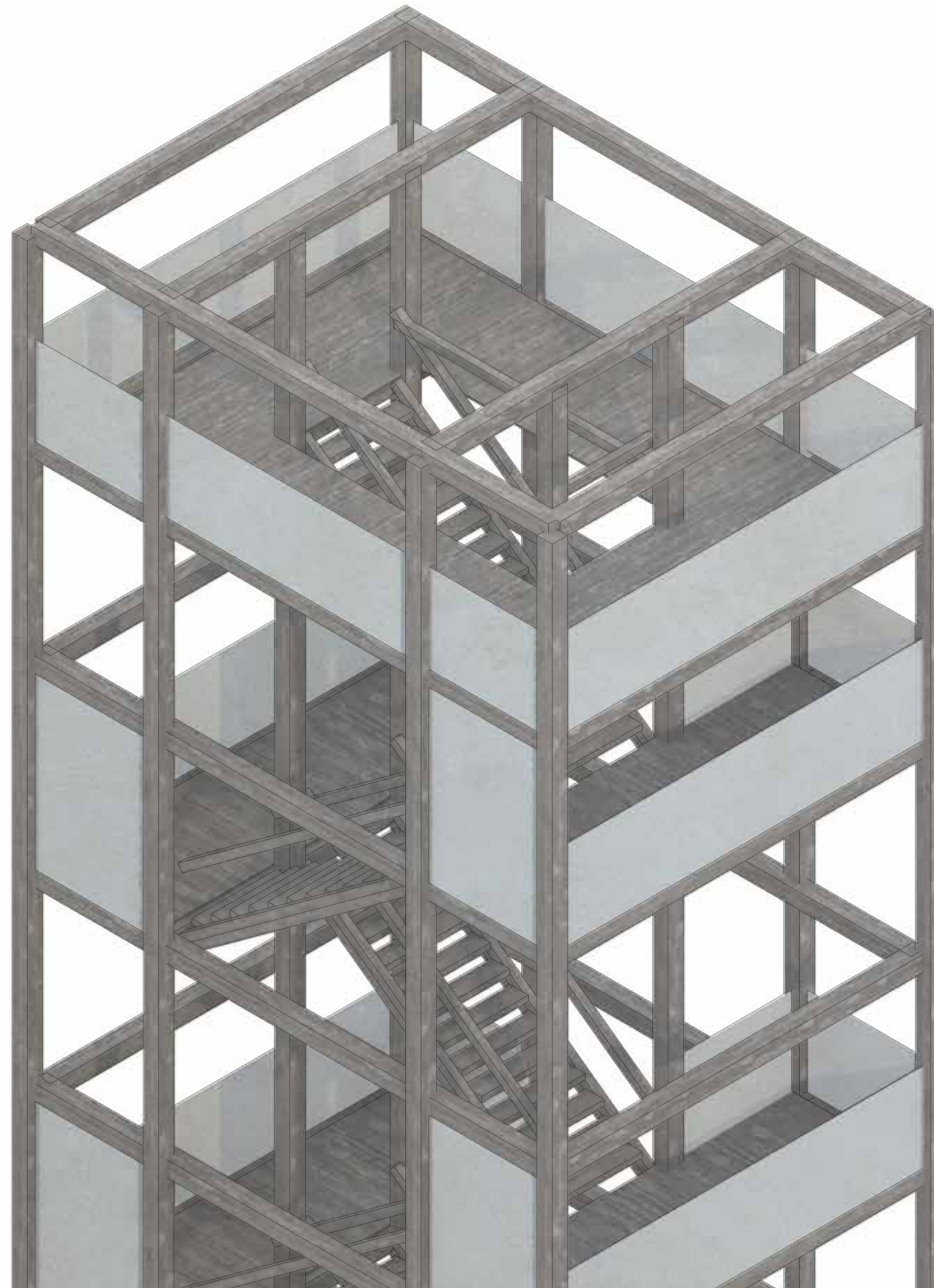

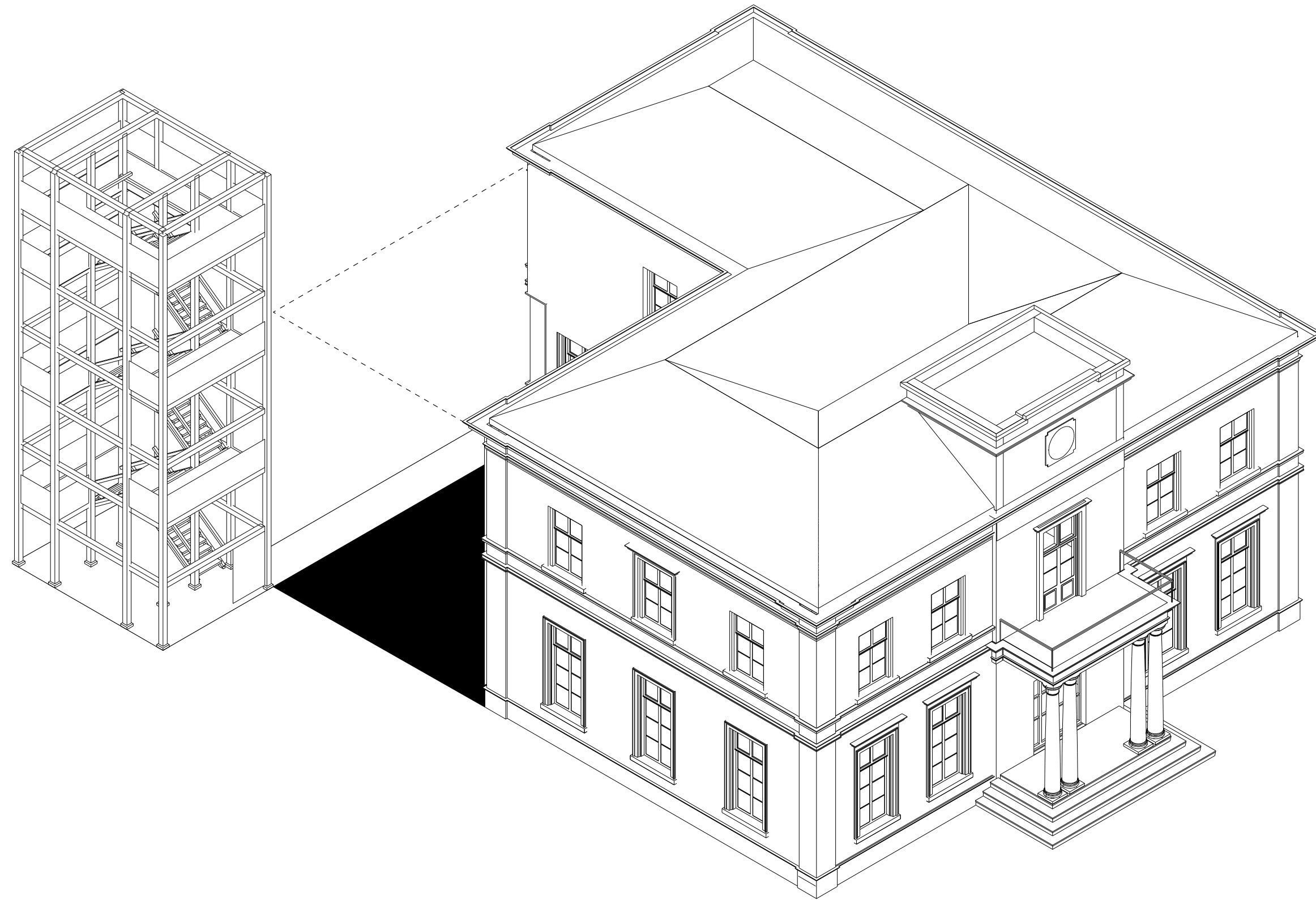

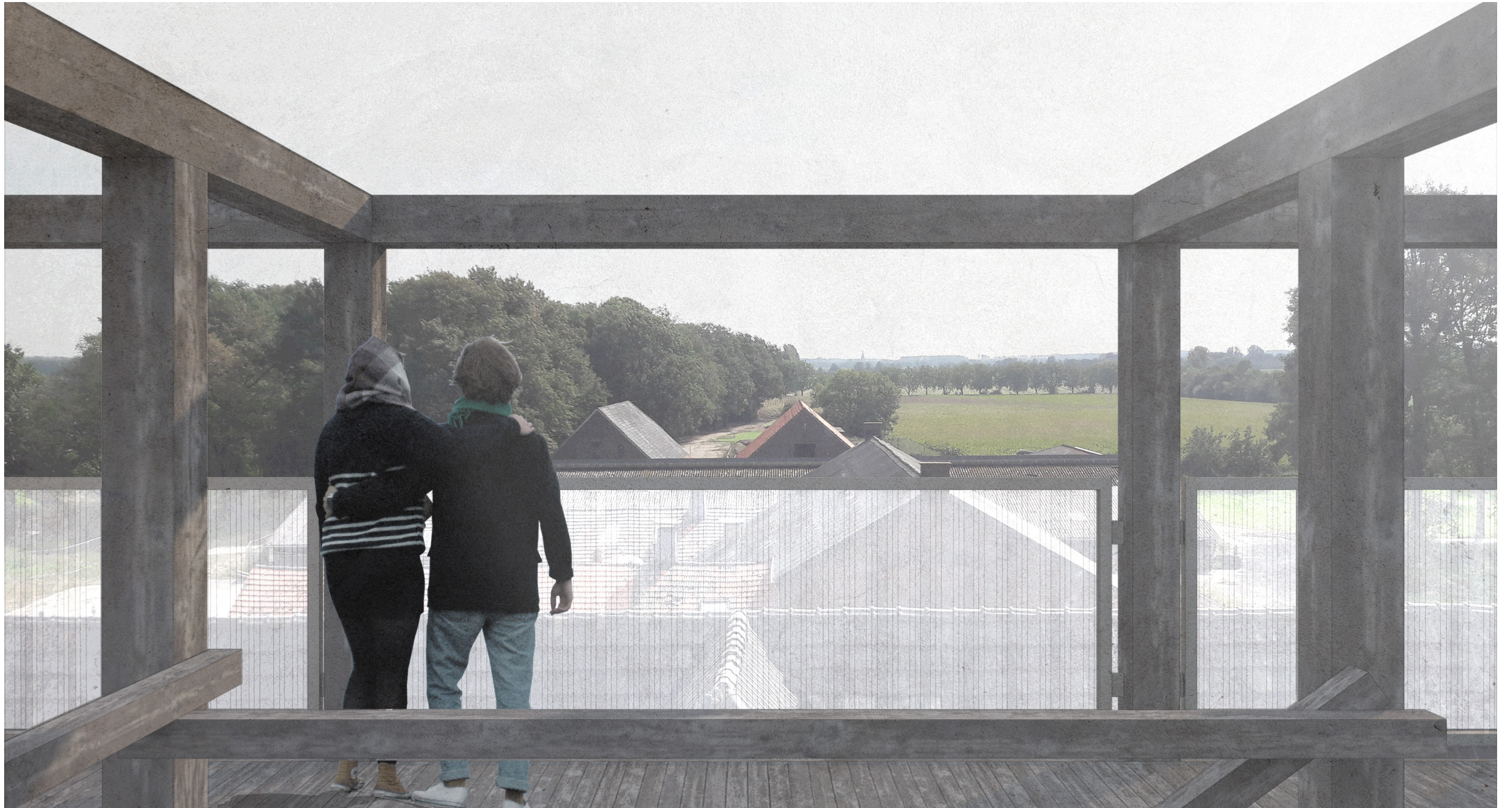

Main House and War Damages

“Preserve the original building fabric”

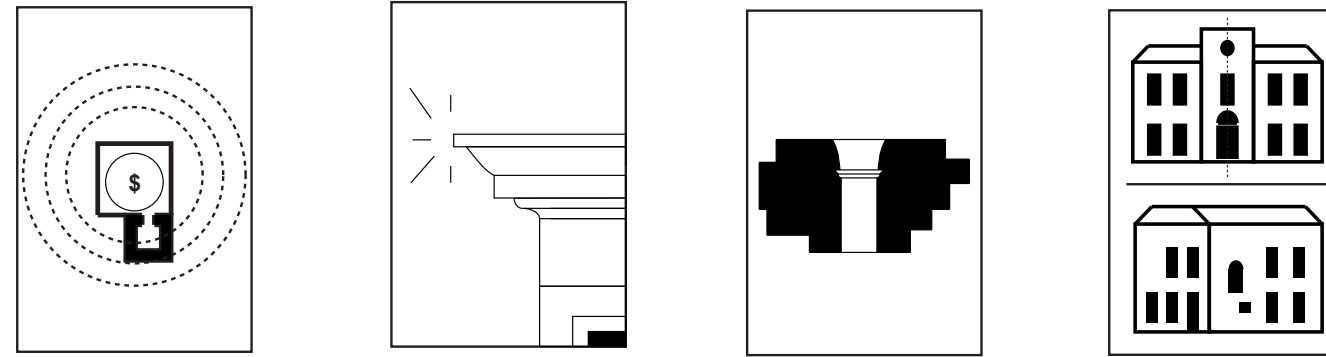

1. Transform old office and vault into a museum
2. Maintain original building layout and atmosphere
3. Maintain WD
4. Potential for intervention on BOH facade

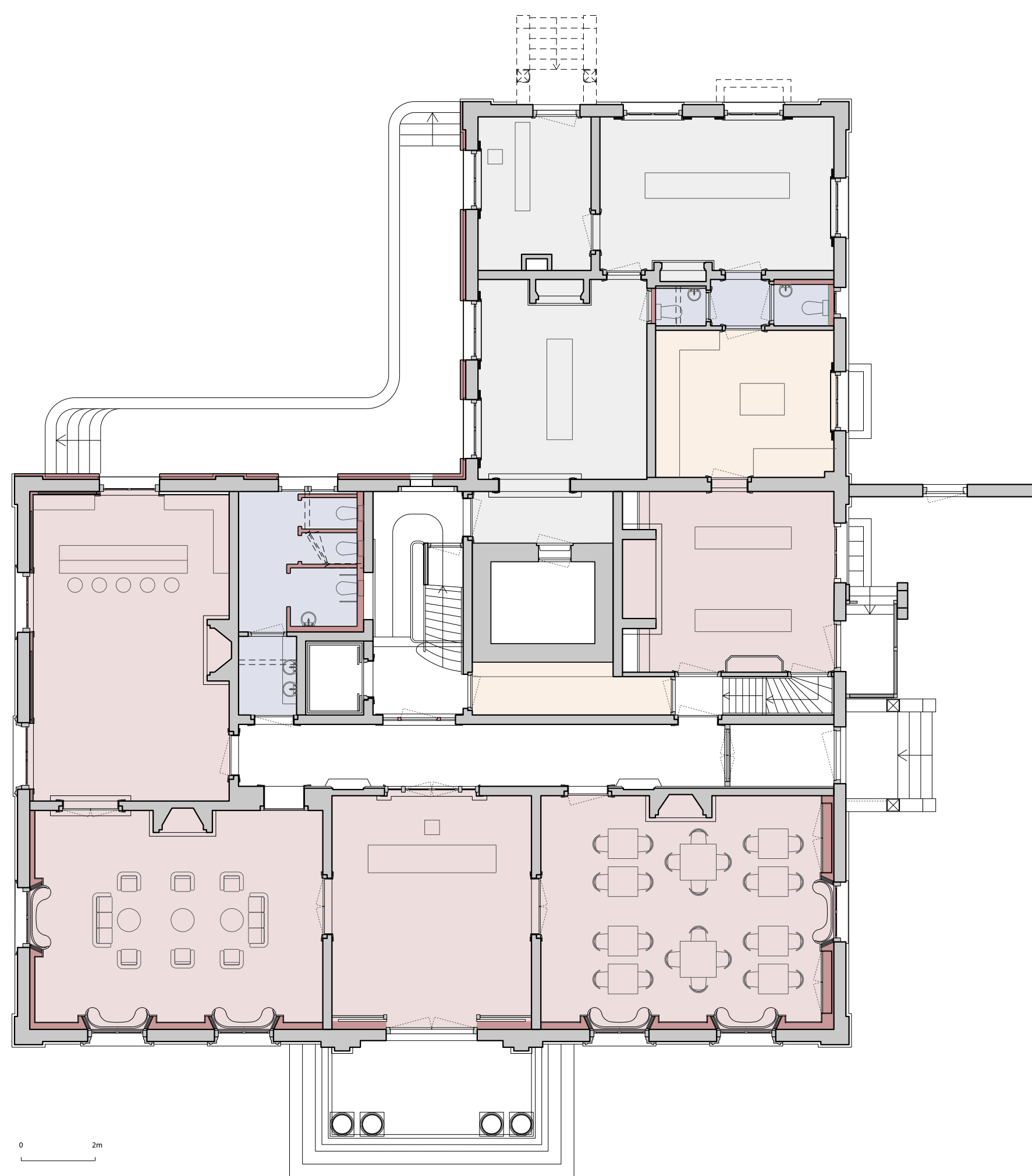

KEY

- Hotel Common Rooms
- Museum
- Kitchen, Service Area
- WC

0 2m

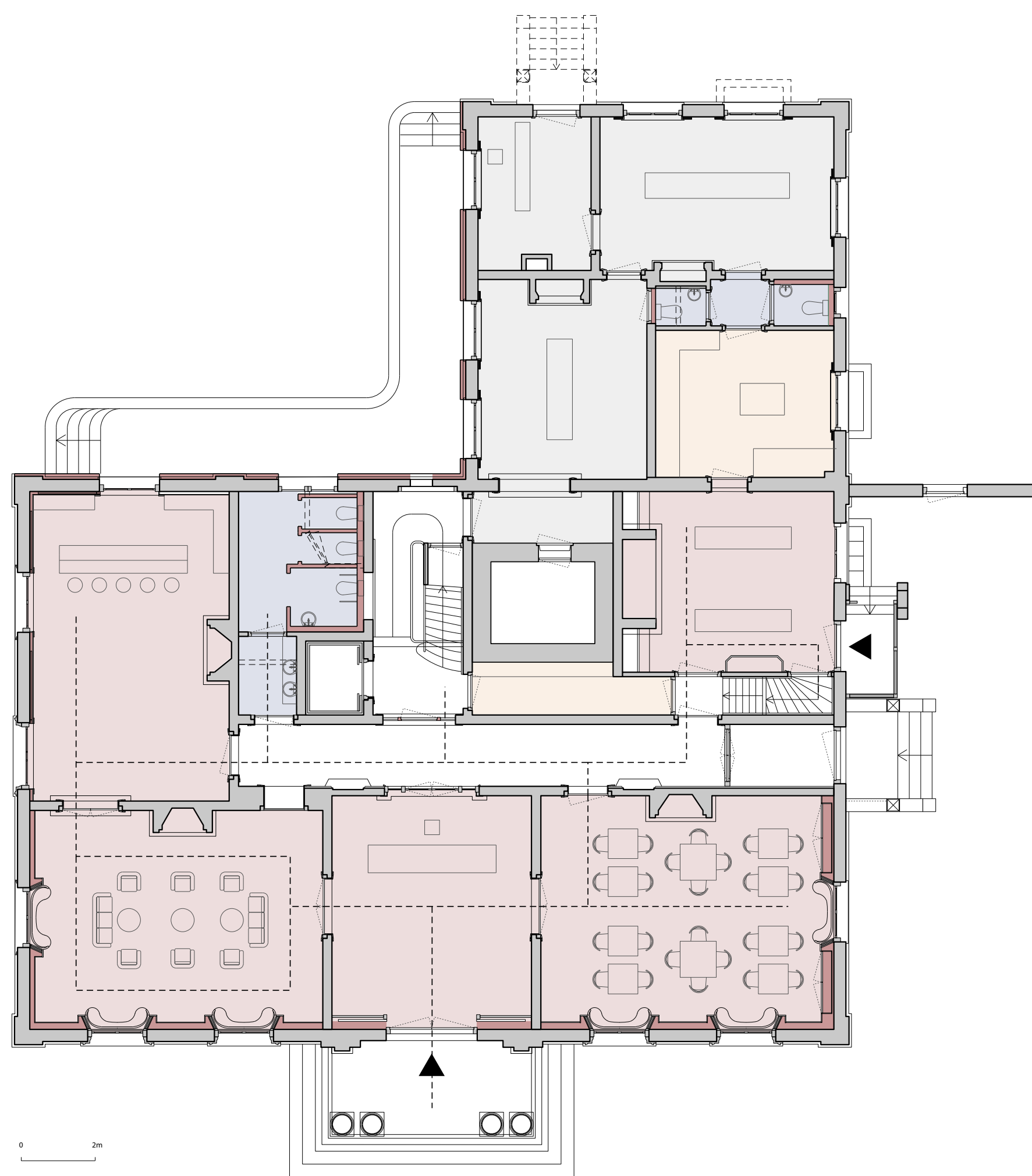

KEY

- Hotel Common Rooms
- Museum
- Kitchen, Service Area
- WC

0 2m

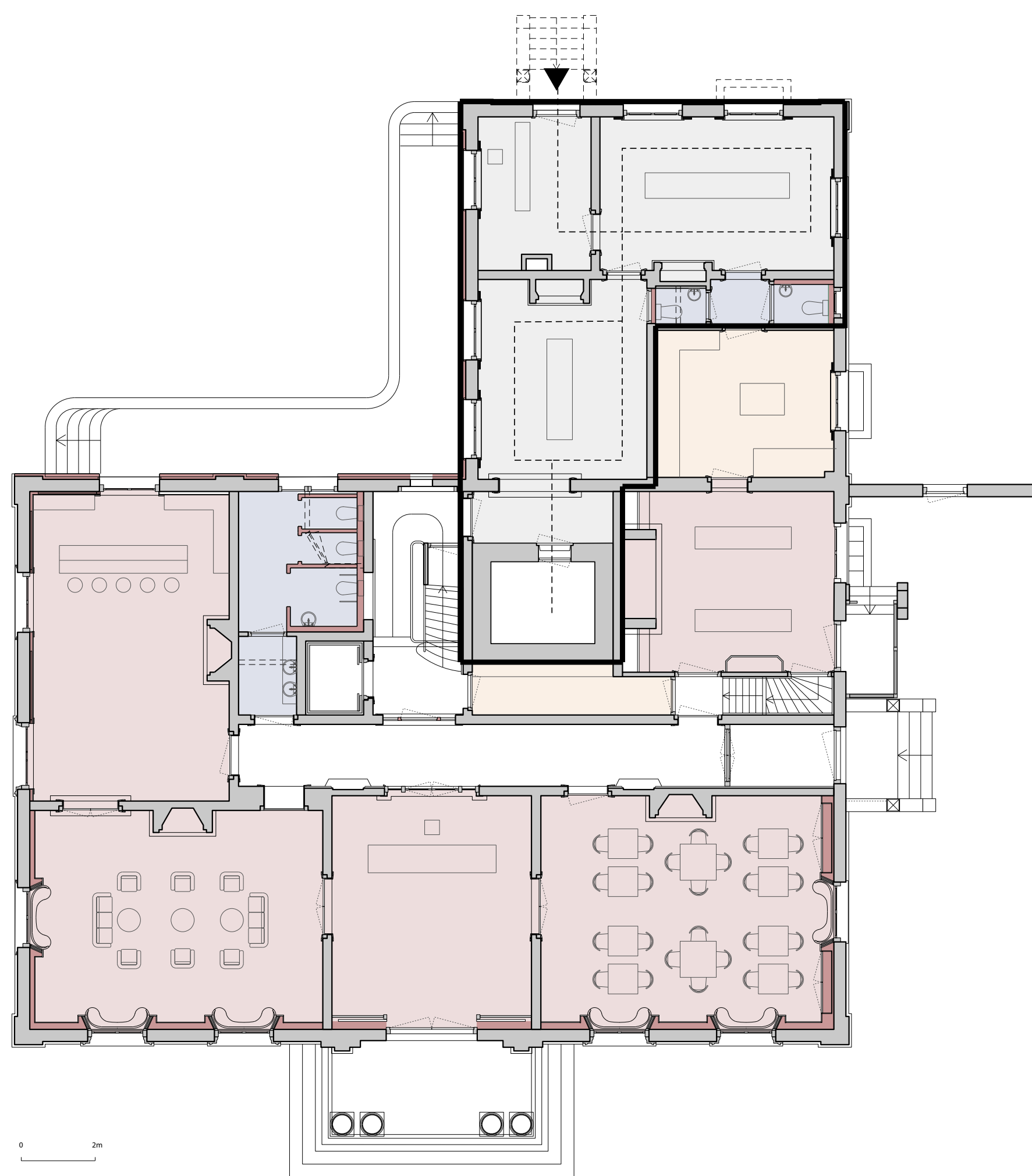

KEY

- Hotel Common Rooms
- Museum
- Kitchen, Service Area
- WC

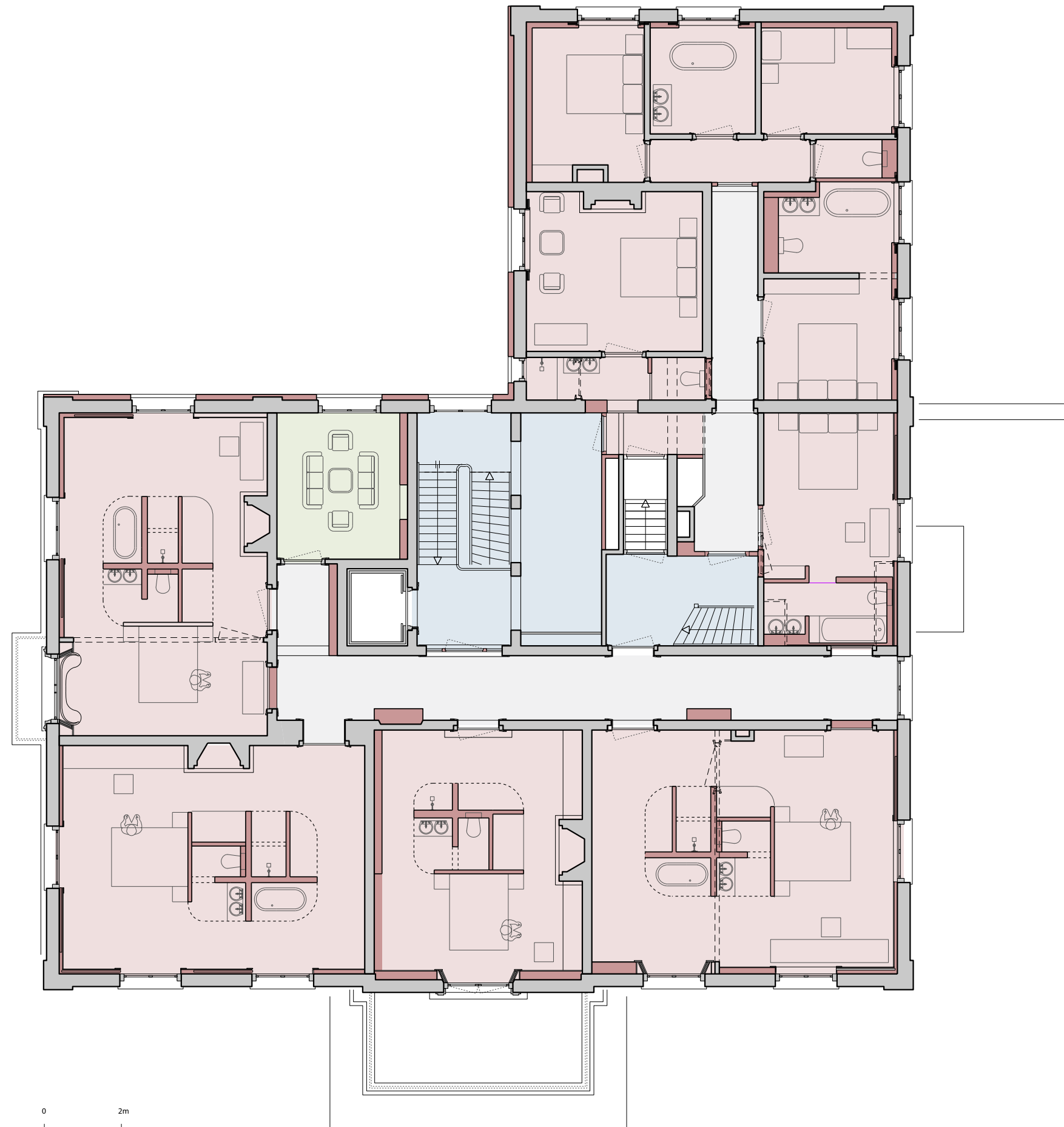

KEY

-
 Hotel Rooms
-
 Circulation
-
 Common Room
-
 Corridor

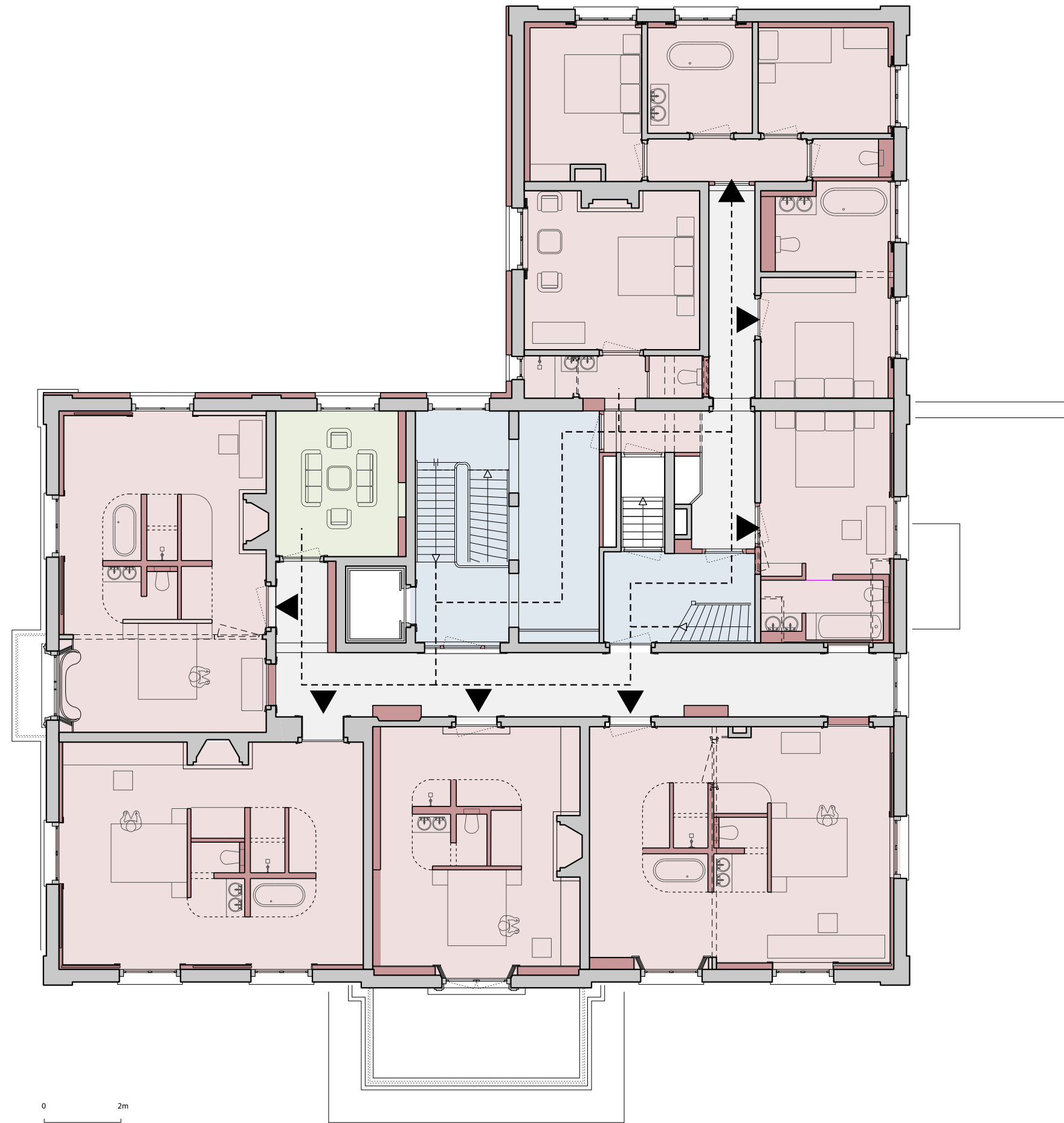

KEY

- Hotel Rooms
- Circulation
- Common Room
- Corridor

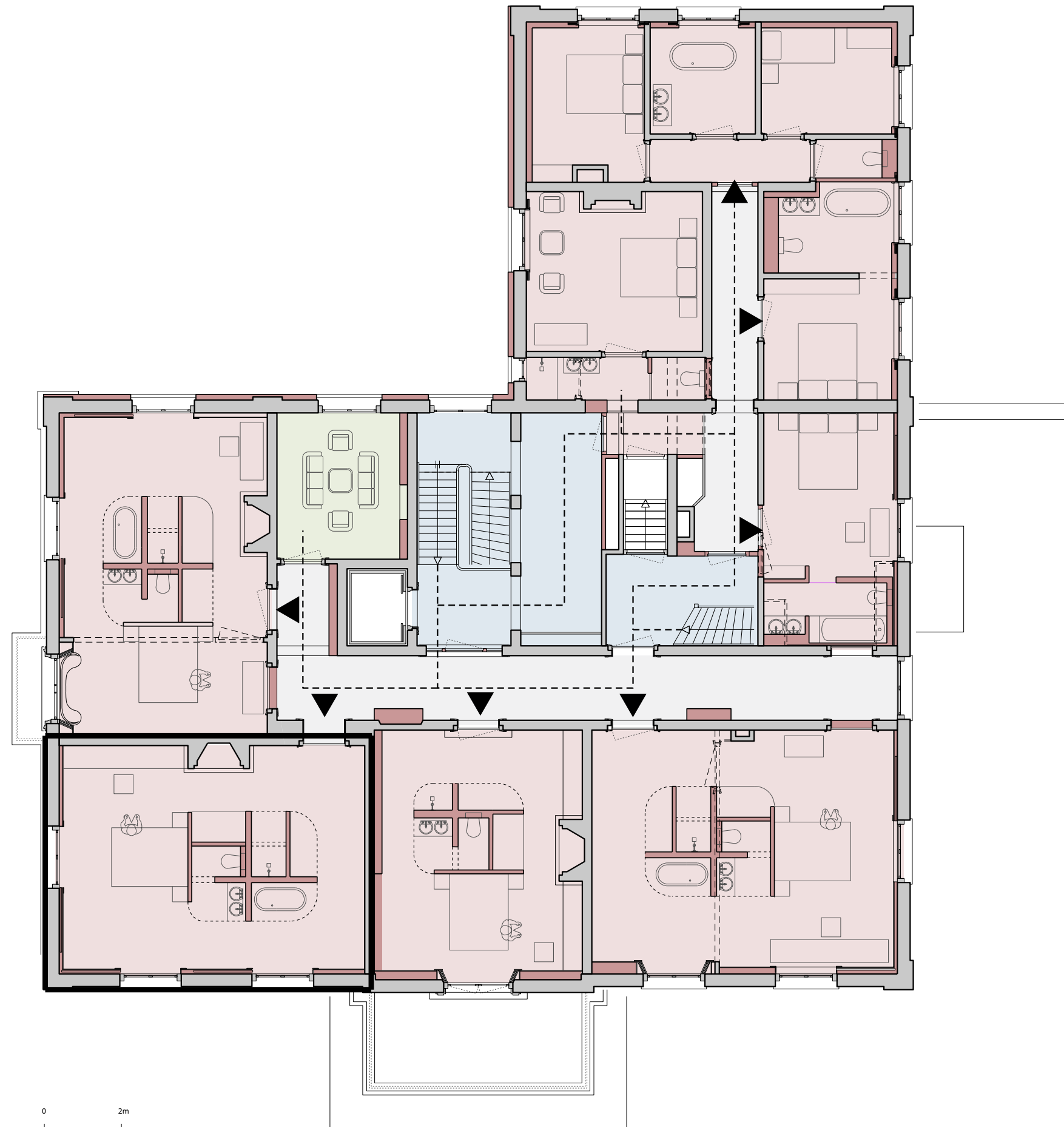

KEY

 Hotel Rooms	 Circulation
 Common Room	 Corridor

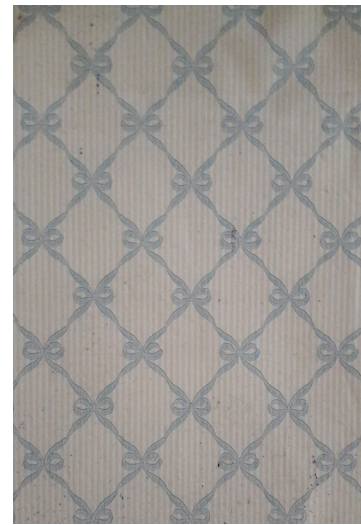





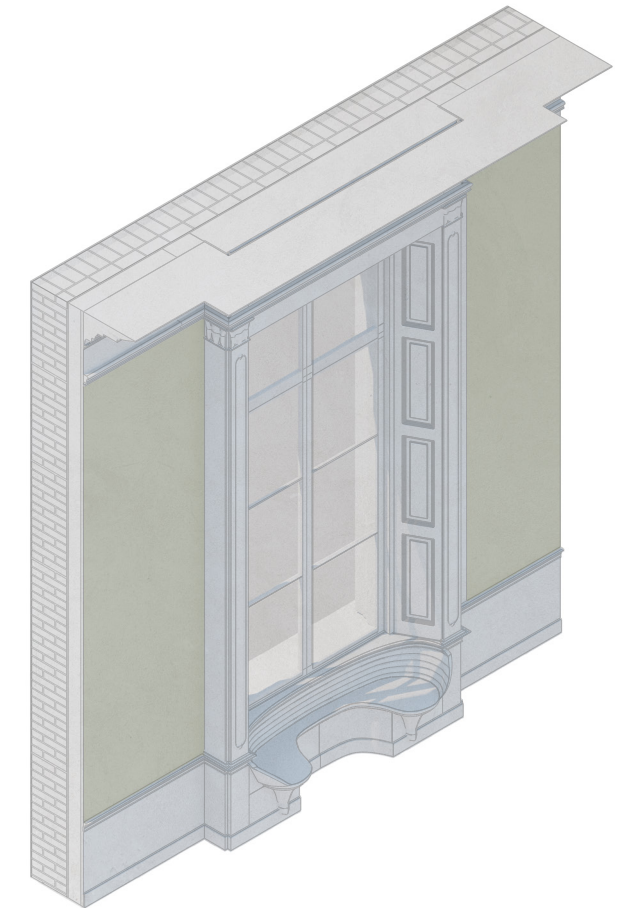
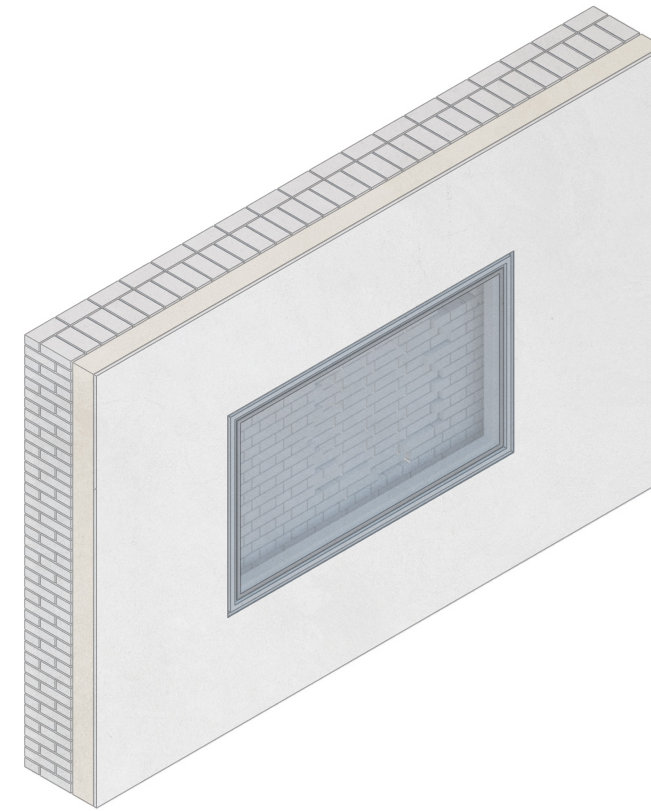
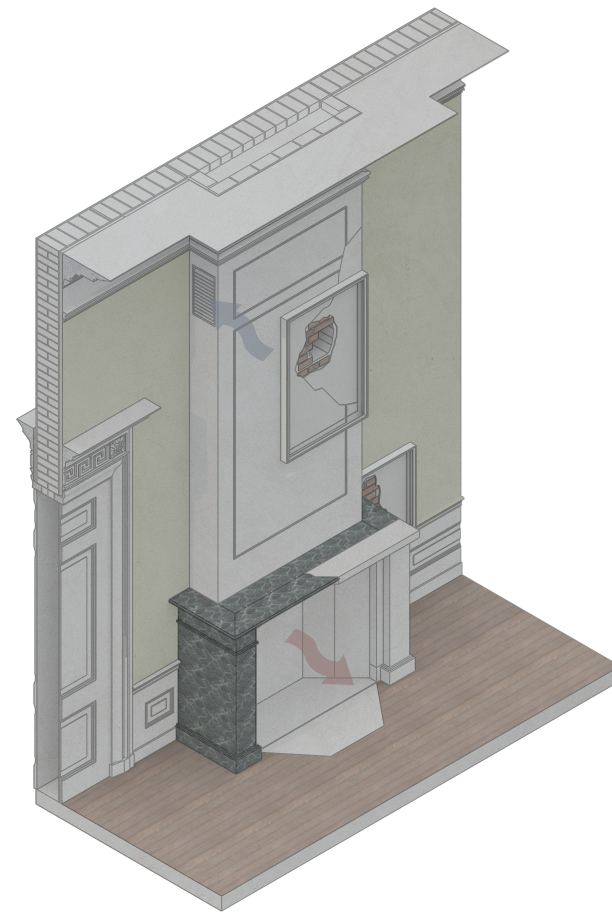
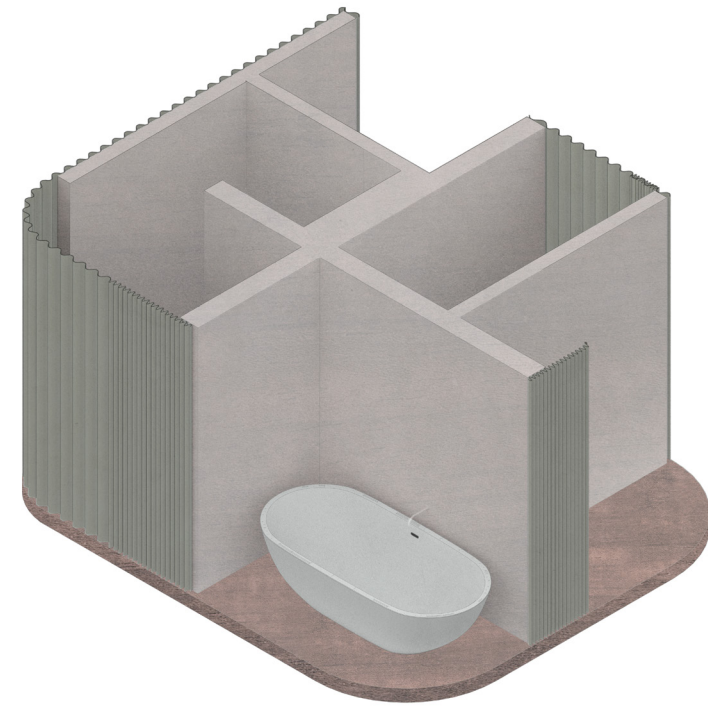

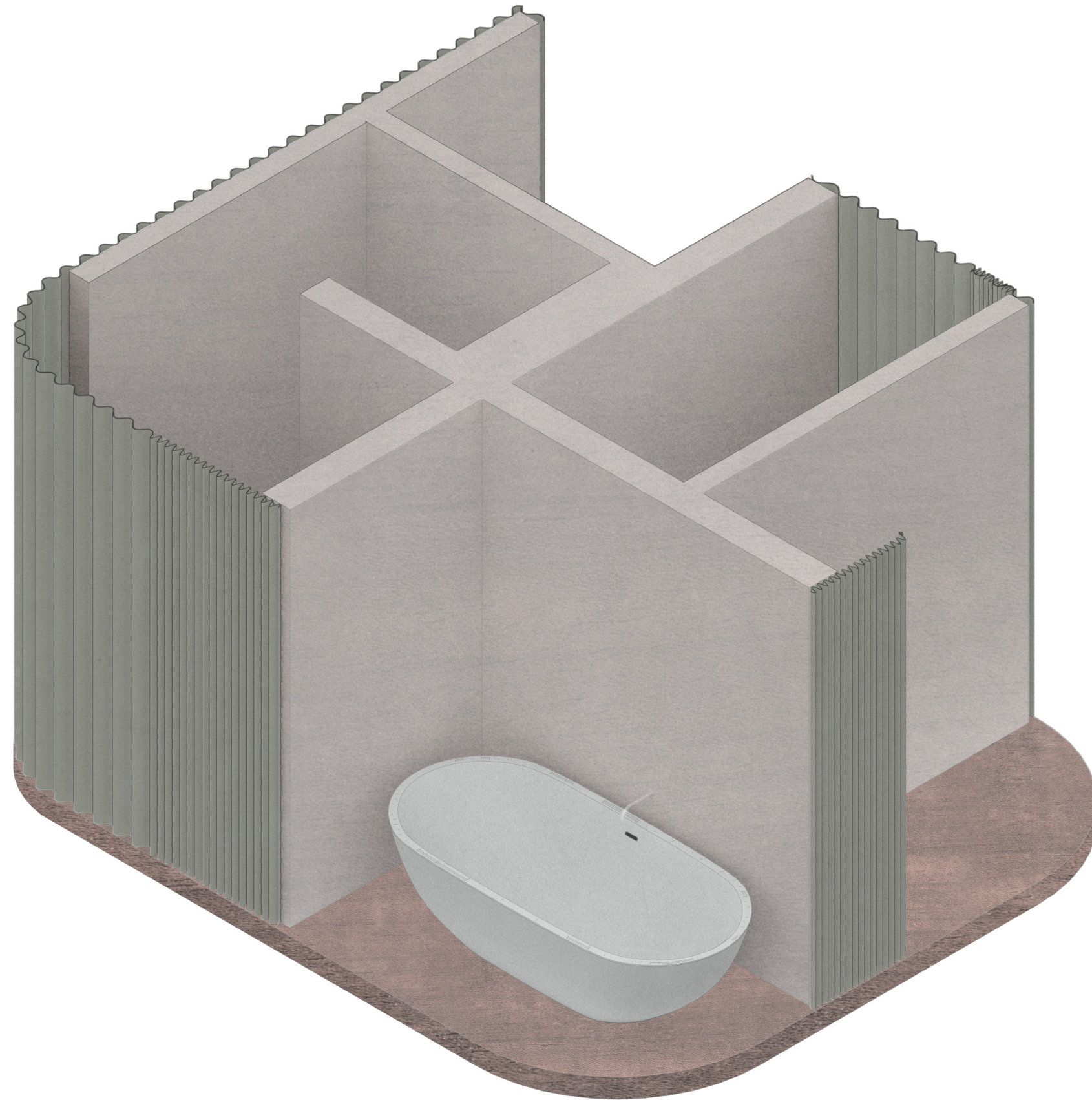

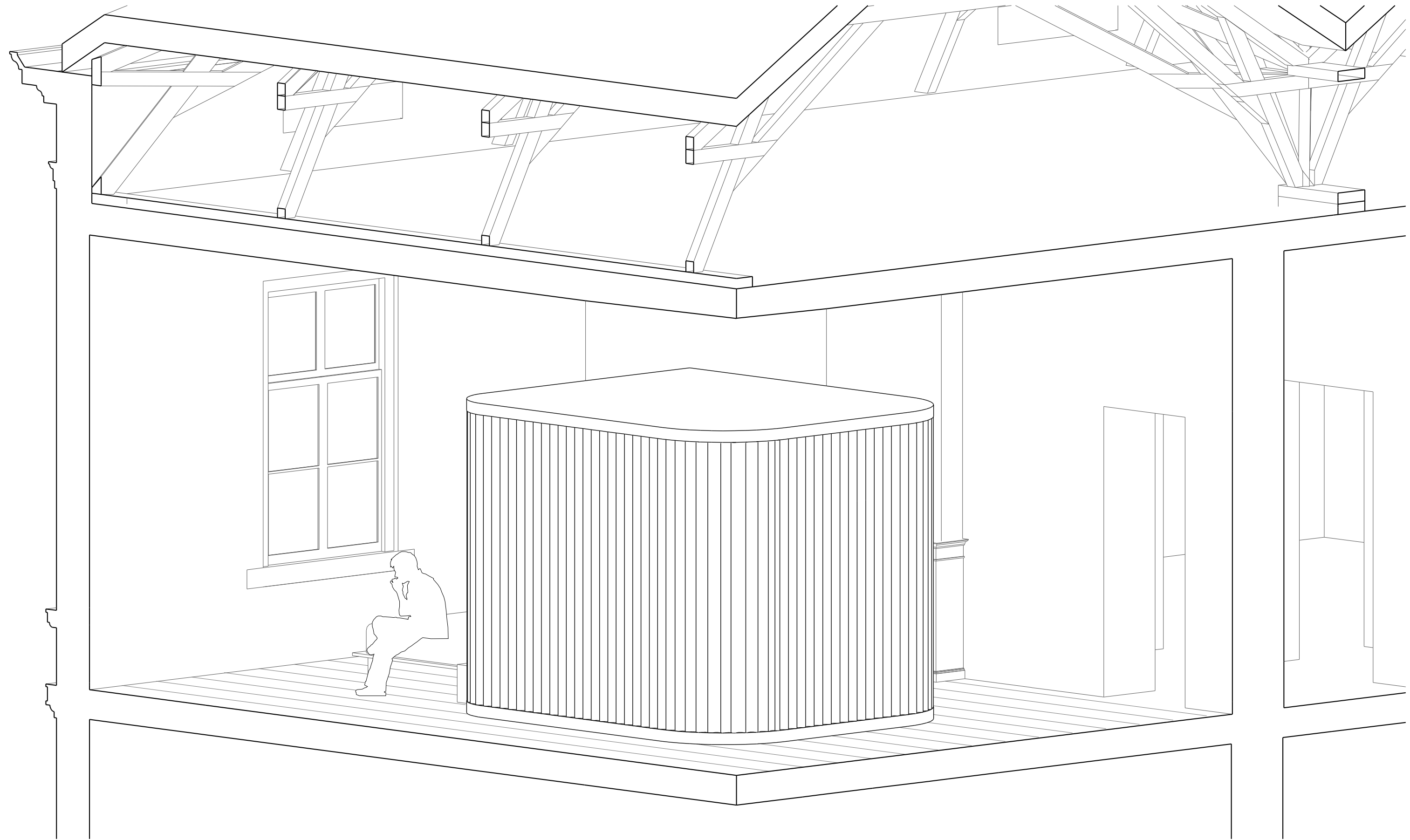

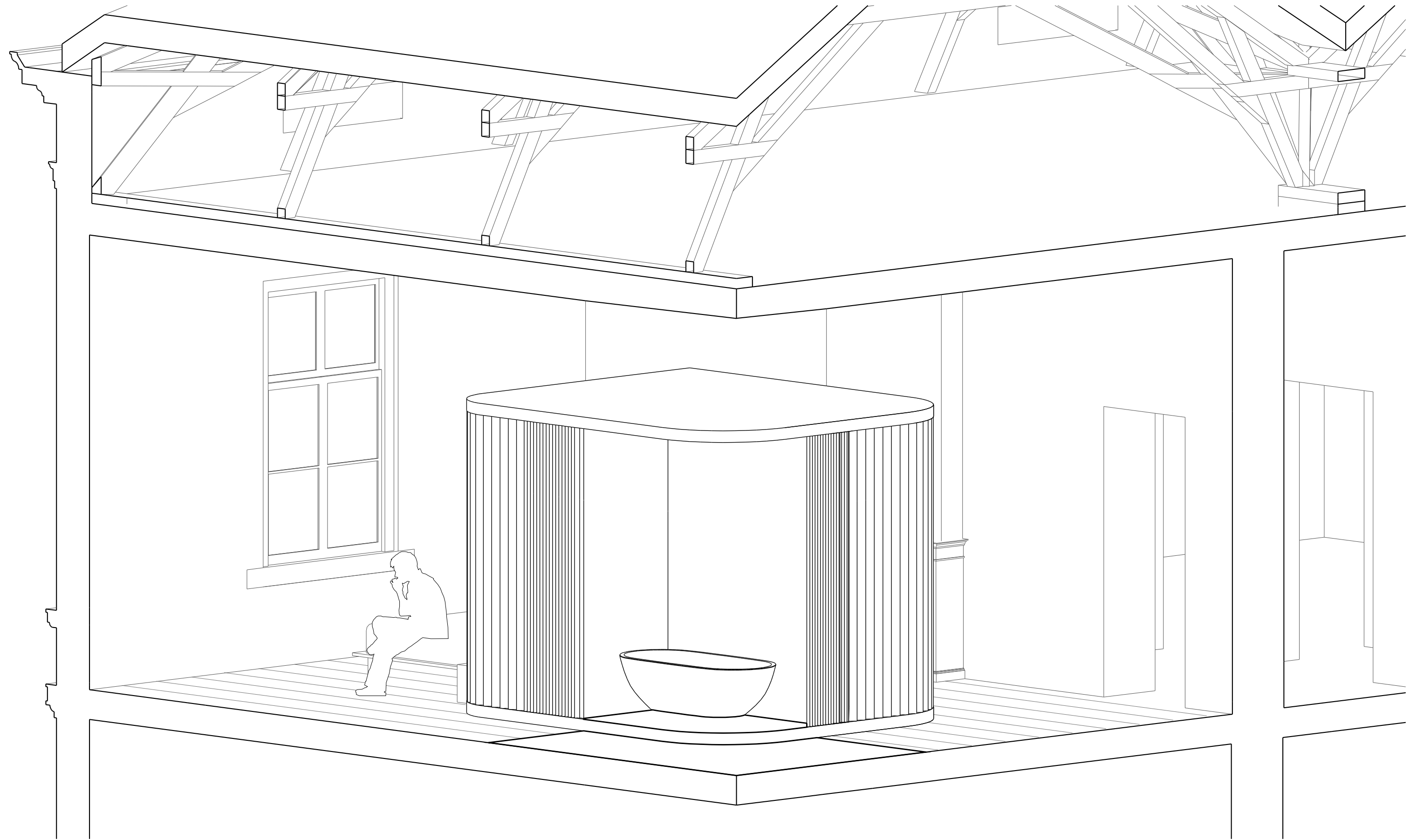

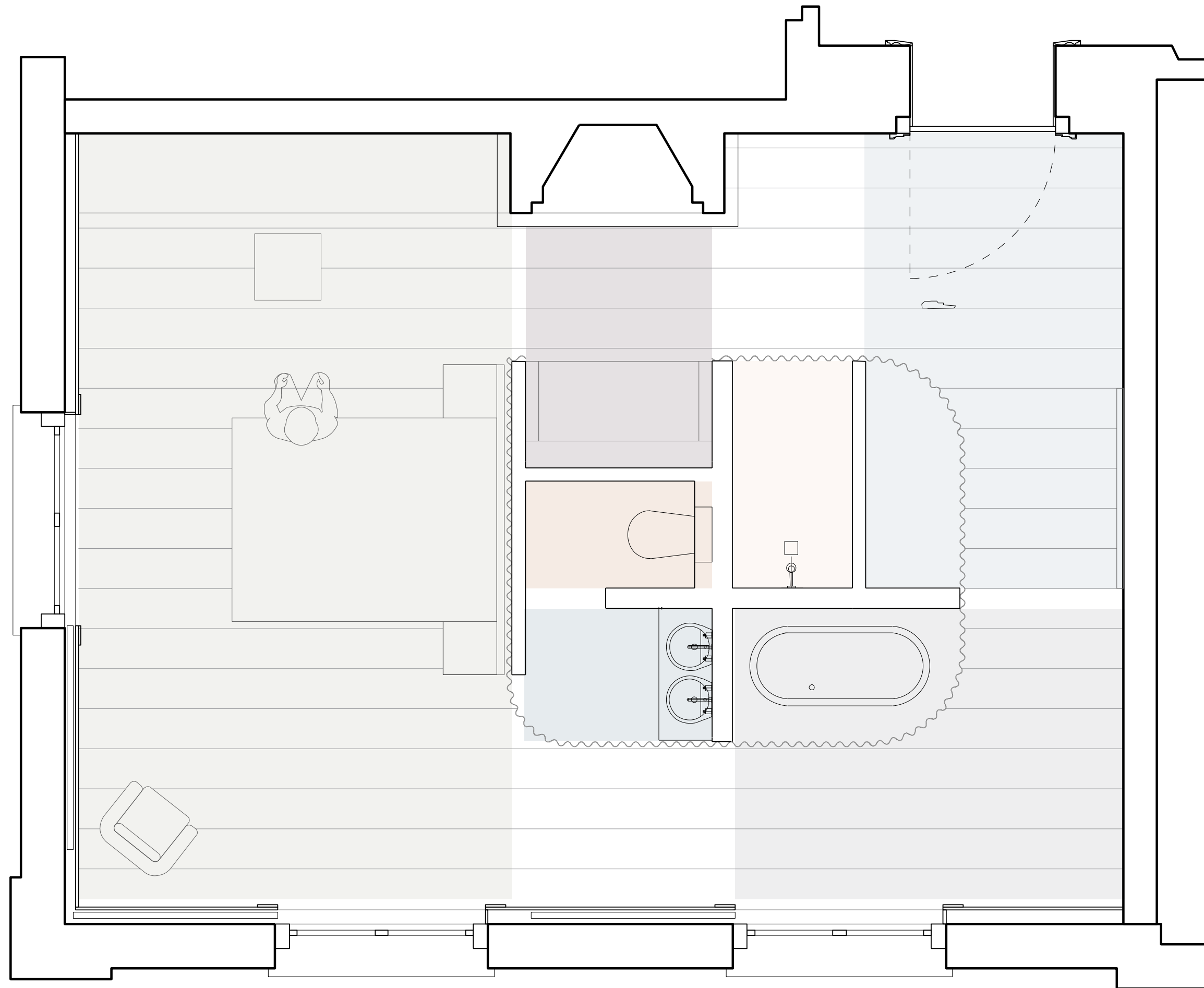

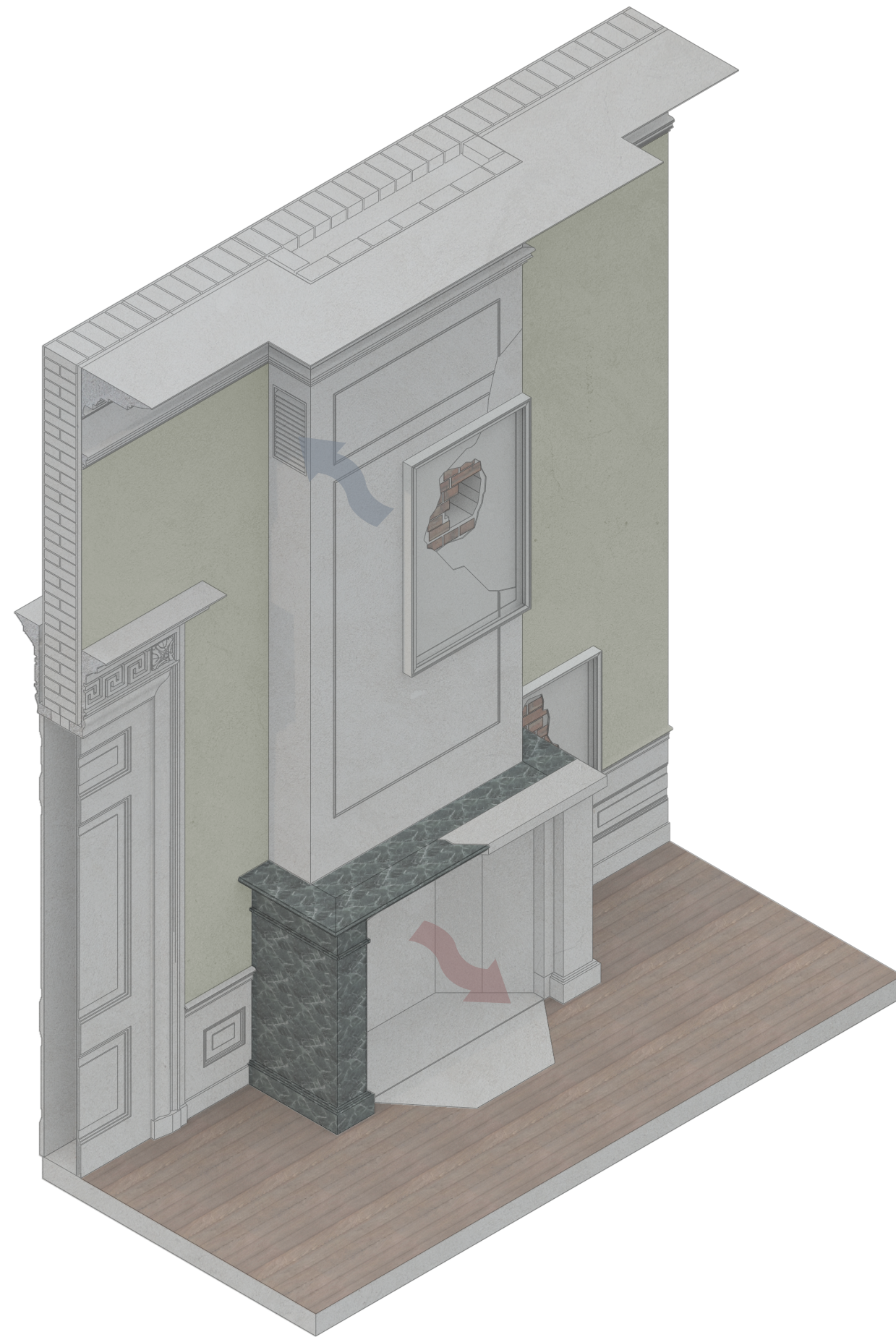

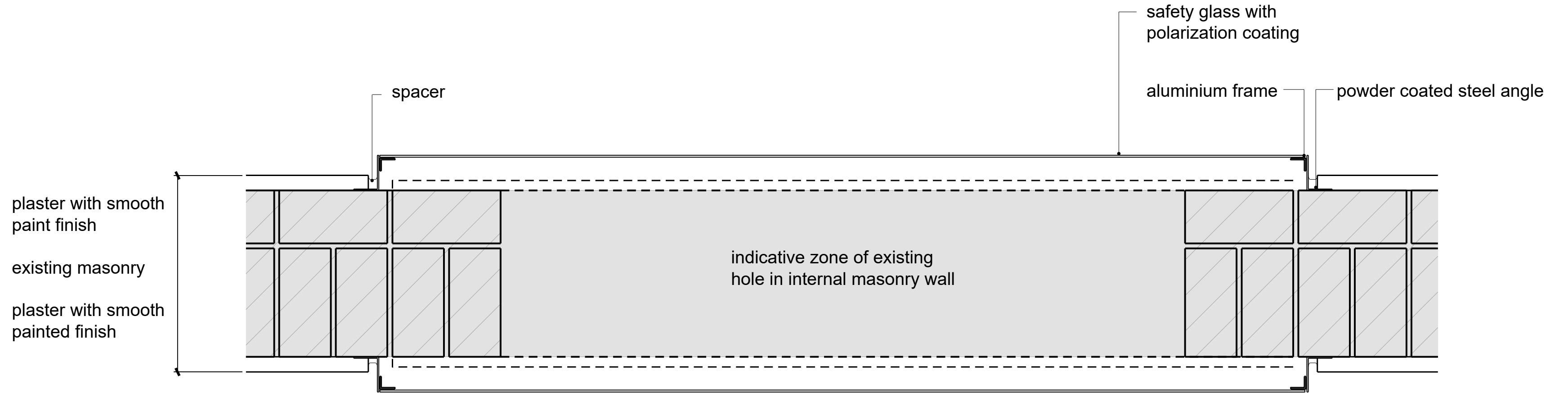



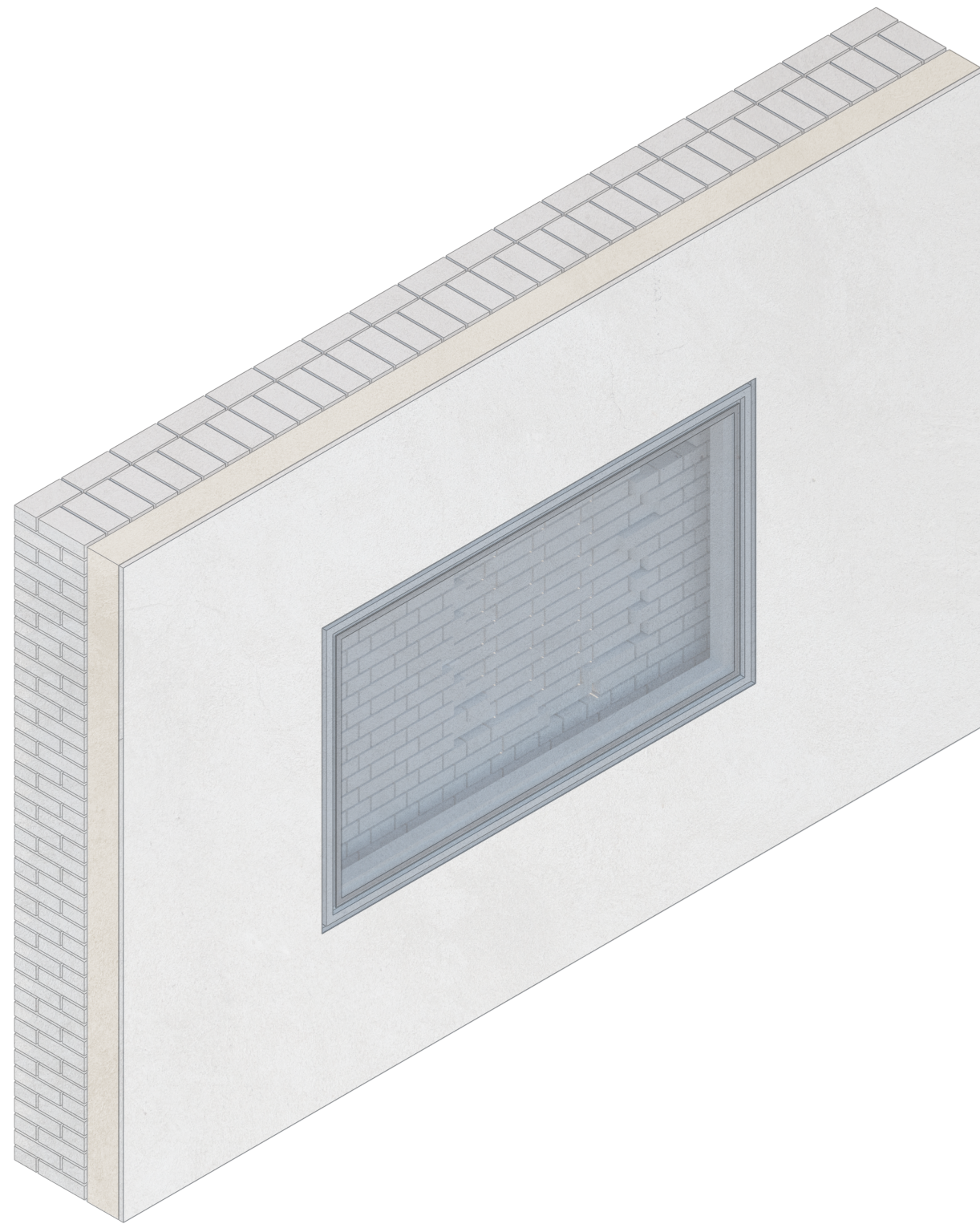
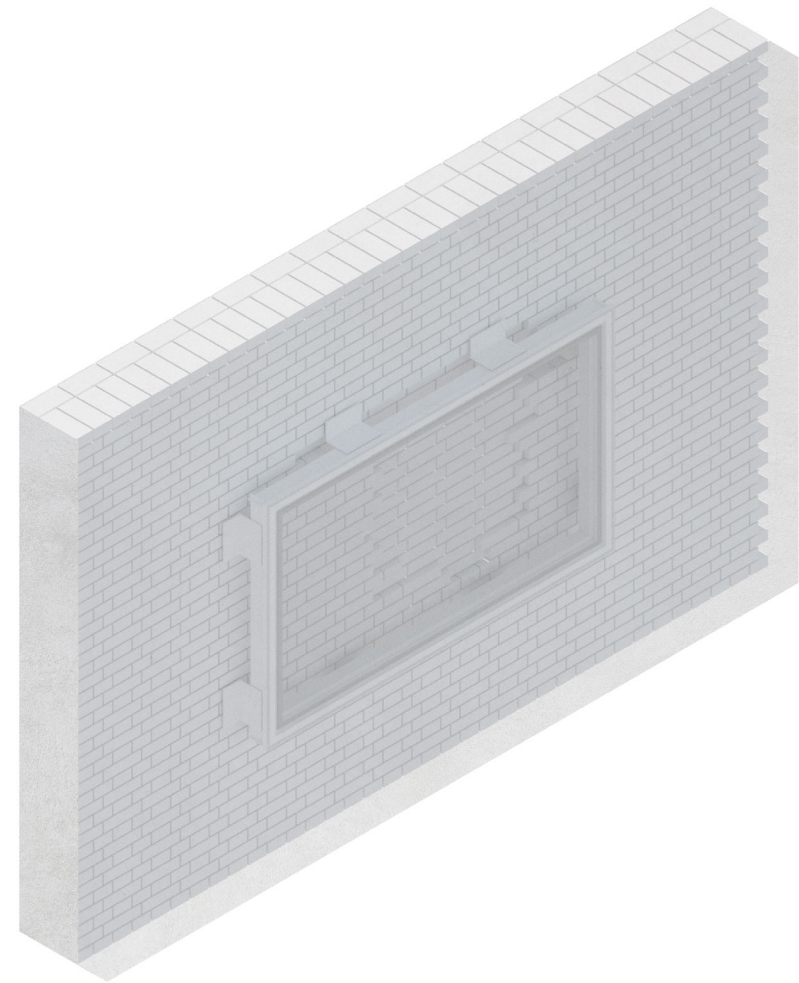

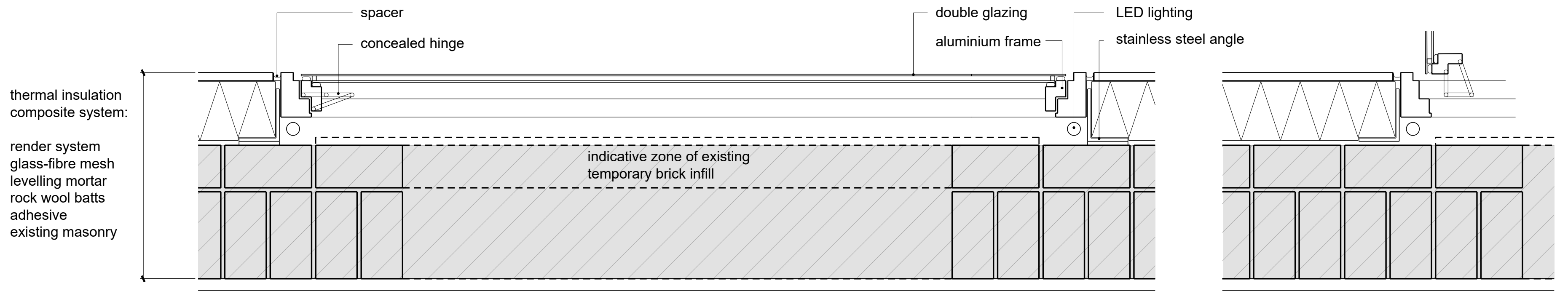



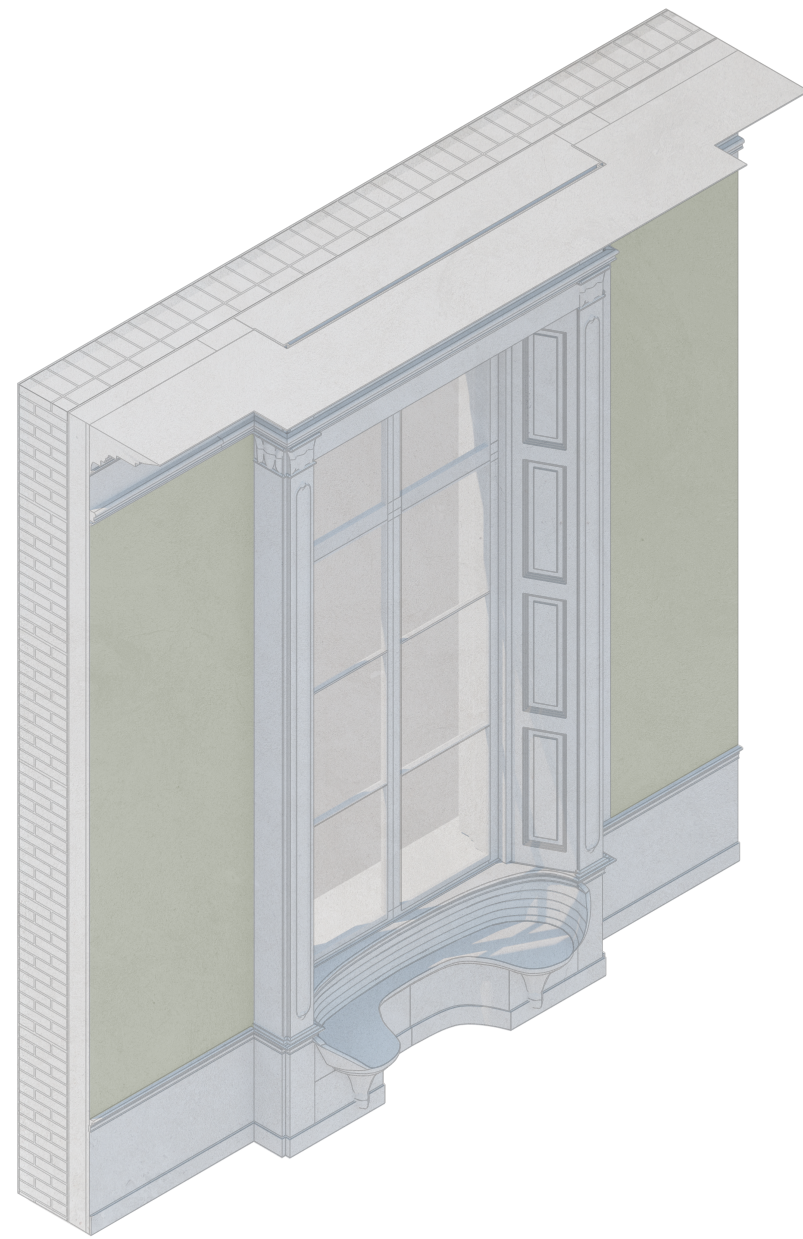

Thermal protection

$U = 0,25 \text{ W}/(\text{m}^2\text{K})$

Interior insulation: No requirement*



Moisture proofing

Condensate: 496 g/m²
Dries 43 days
Drying reserve: 559 g/m²a

Heat protection

Temperature amplitude damping: 83
phase shift: 23,5 h
Thermal capacity inside: 71 kJ/m²K

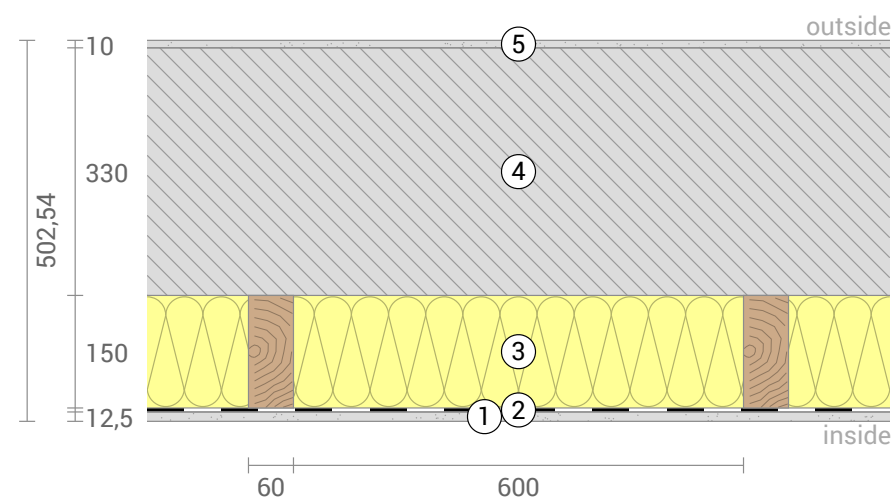

- ① Fermacell Gipsfaser-Platte 12,5mm (12,5 mm)
- ② isofloc active
- ③ Cellulose (150 mm)
- ④ solid brick 1400 kg/m³, DIN 105 (330 mm)
- ⑤ Gypsum plaster (10 mm)

Humidity

The temperature of the inside surface is 17,4 °C leading to a relative humidity on the surface of 59%. Mould formation is not expected under these conditions. The following figure shows the relative humidity inside the component.

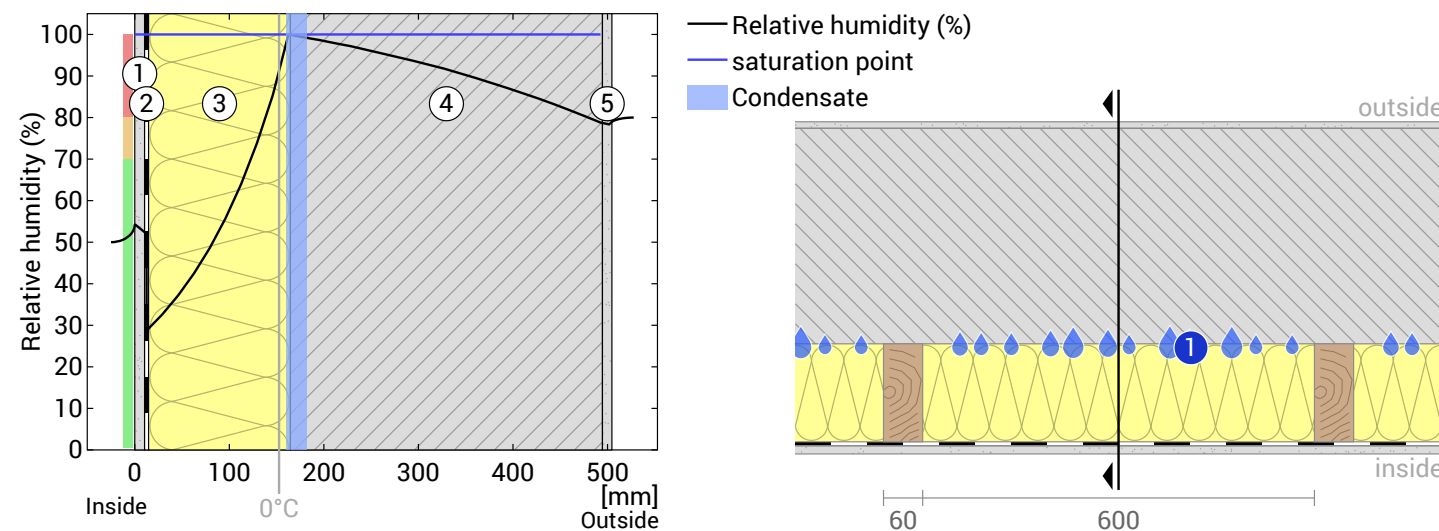

- ① Fermacell Gipsfaser-Platte 12,5mm...
- ② isofloc active
- ③ Cellulose (150 mm)
- ④ solid brick 1400 kg/m³, DIN 105 (...)
- ⑤ Gypsum plaster (10 mm)

Source: <https://www.ubakus.de/u-wert-rechner>

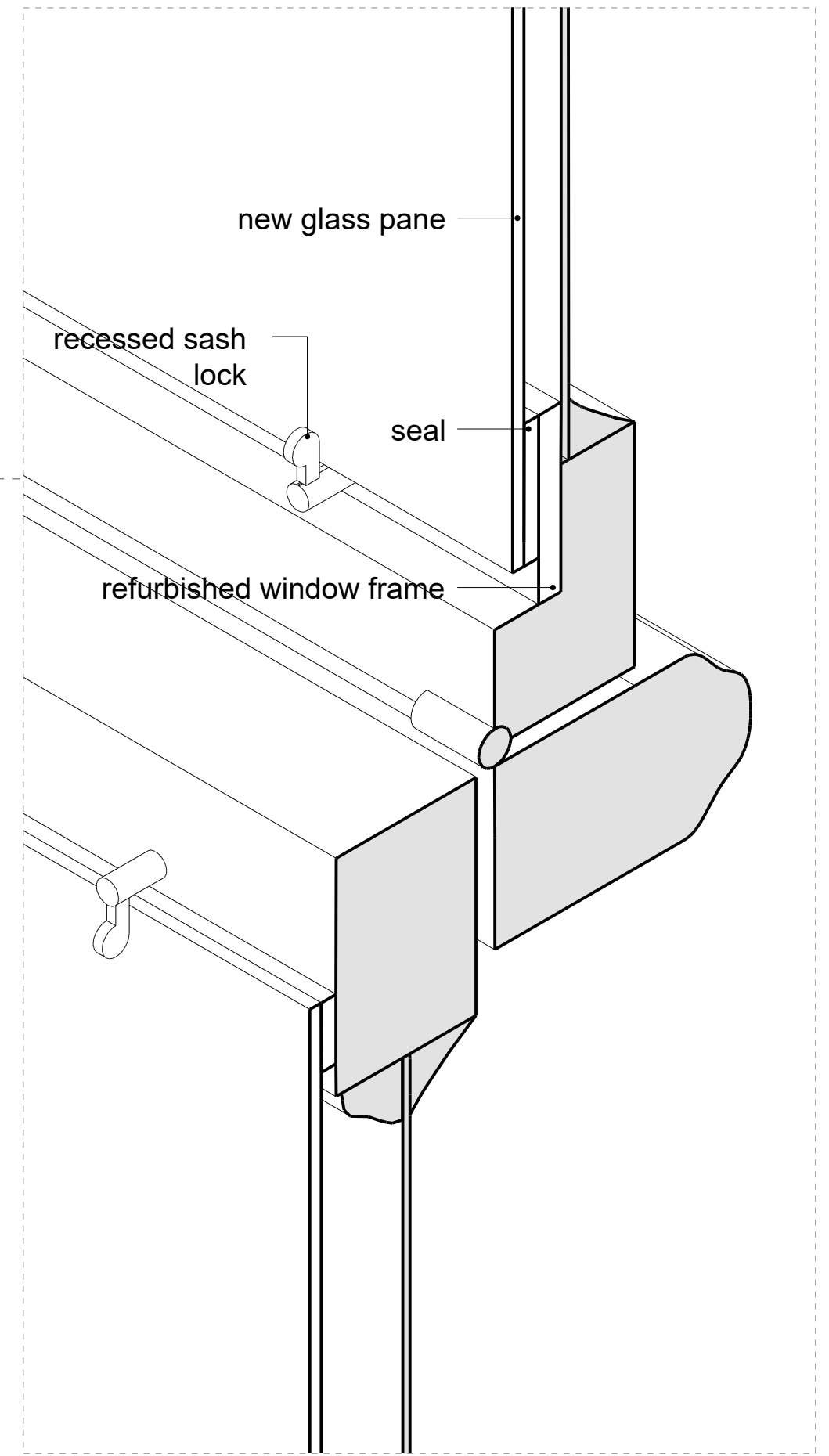



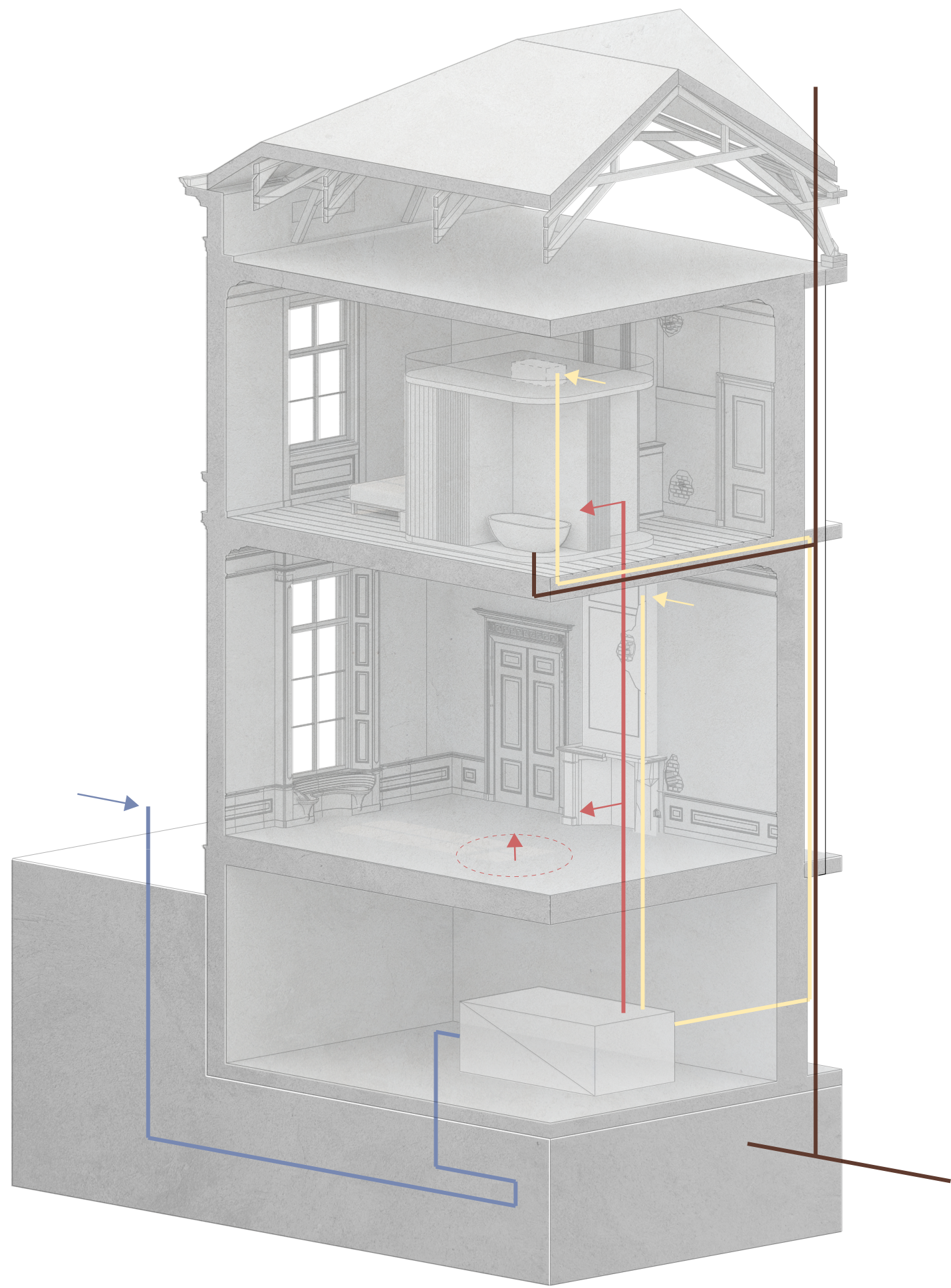

The Functional Core

“Offer additional programme”

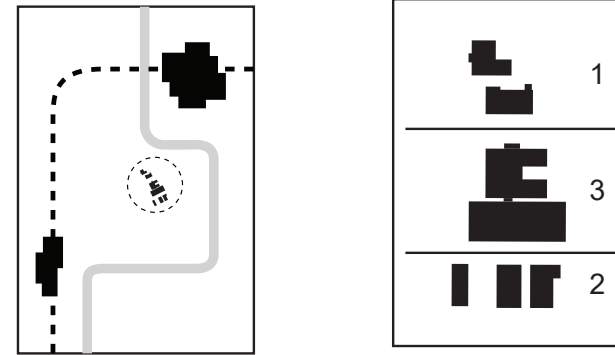

1. Additional Programme to attract visitors
2. Reactivation of Barns through small scale interventions

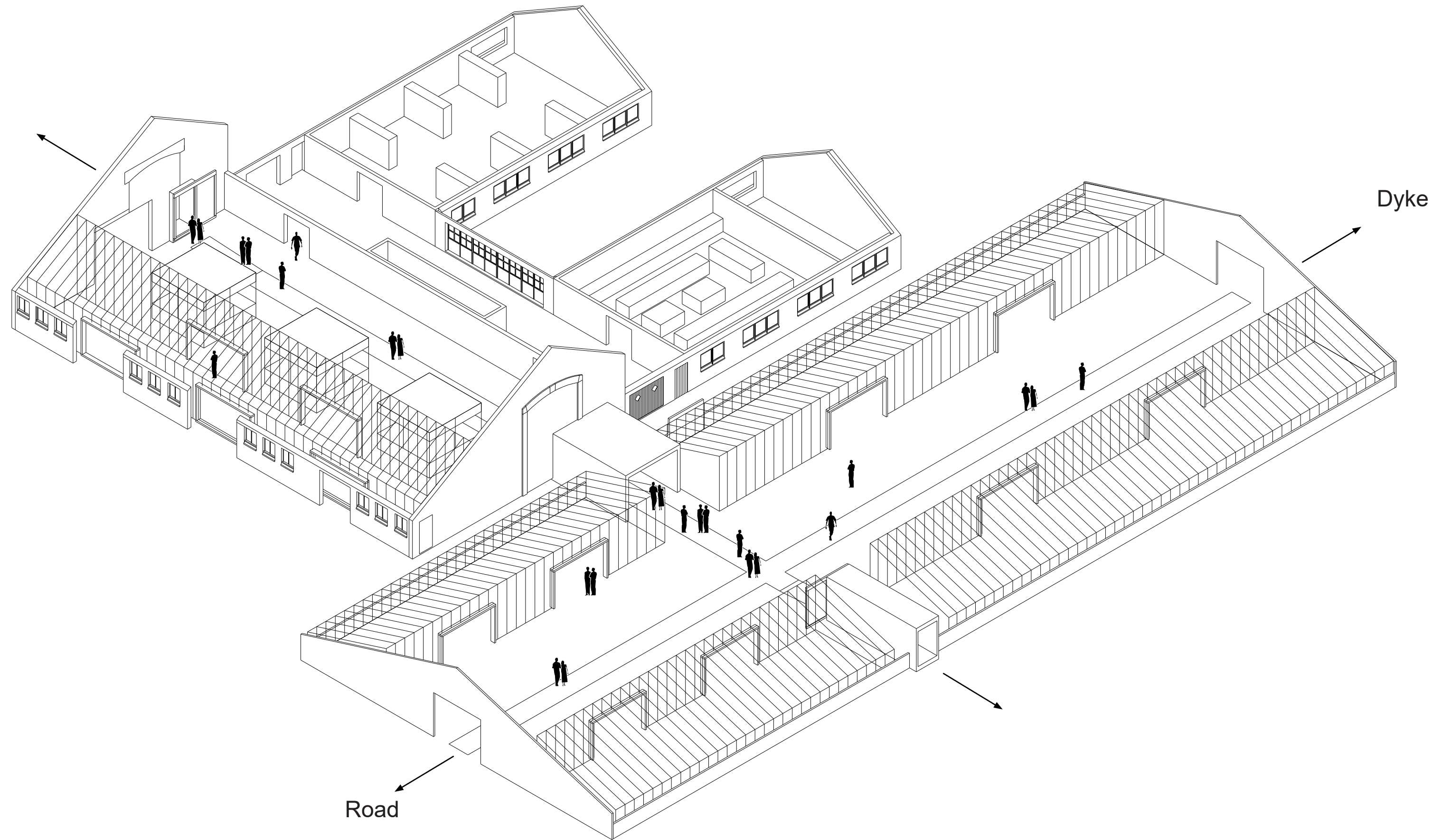

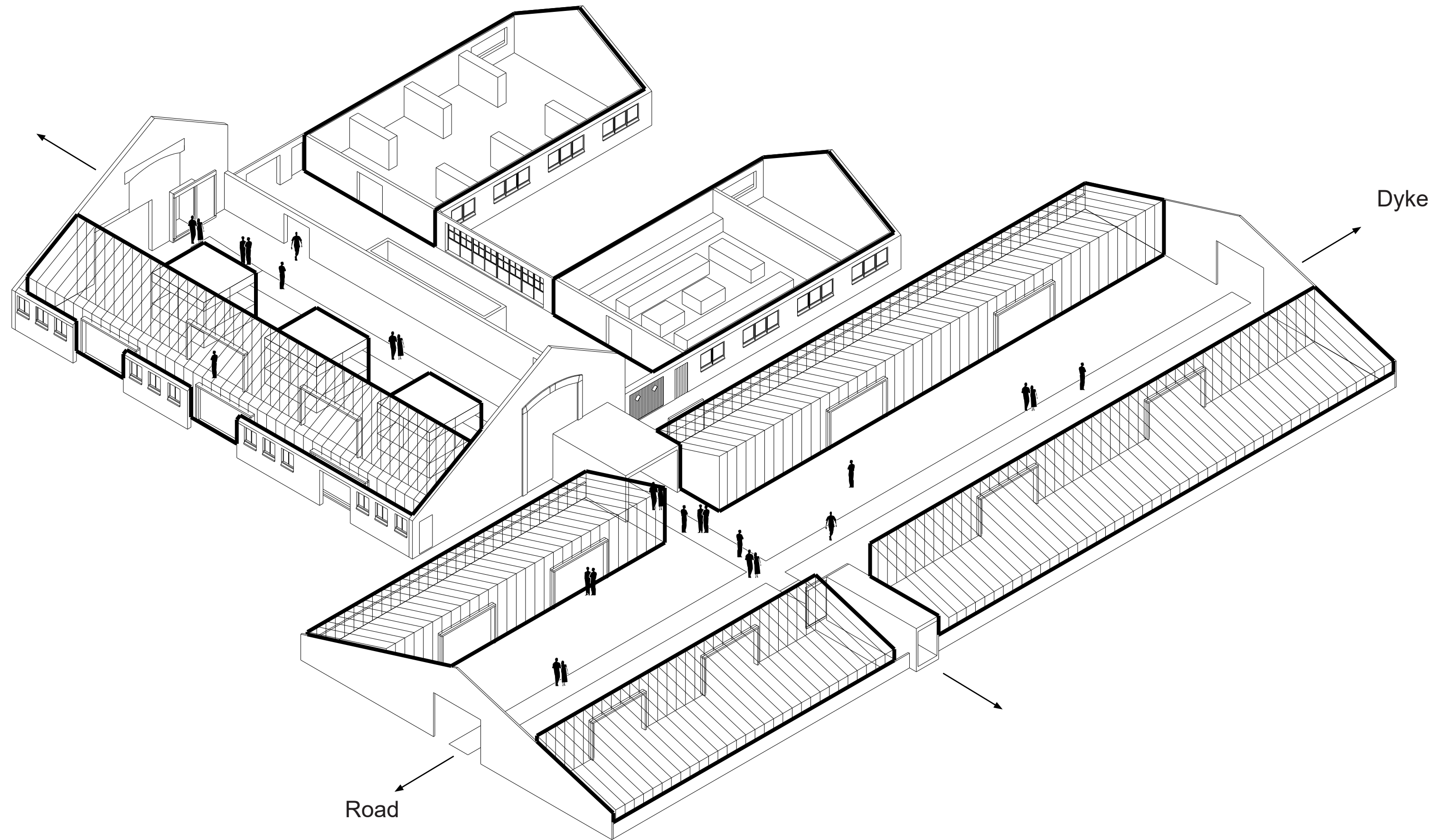

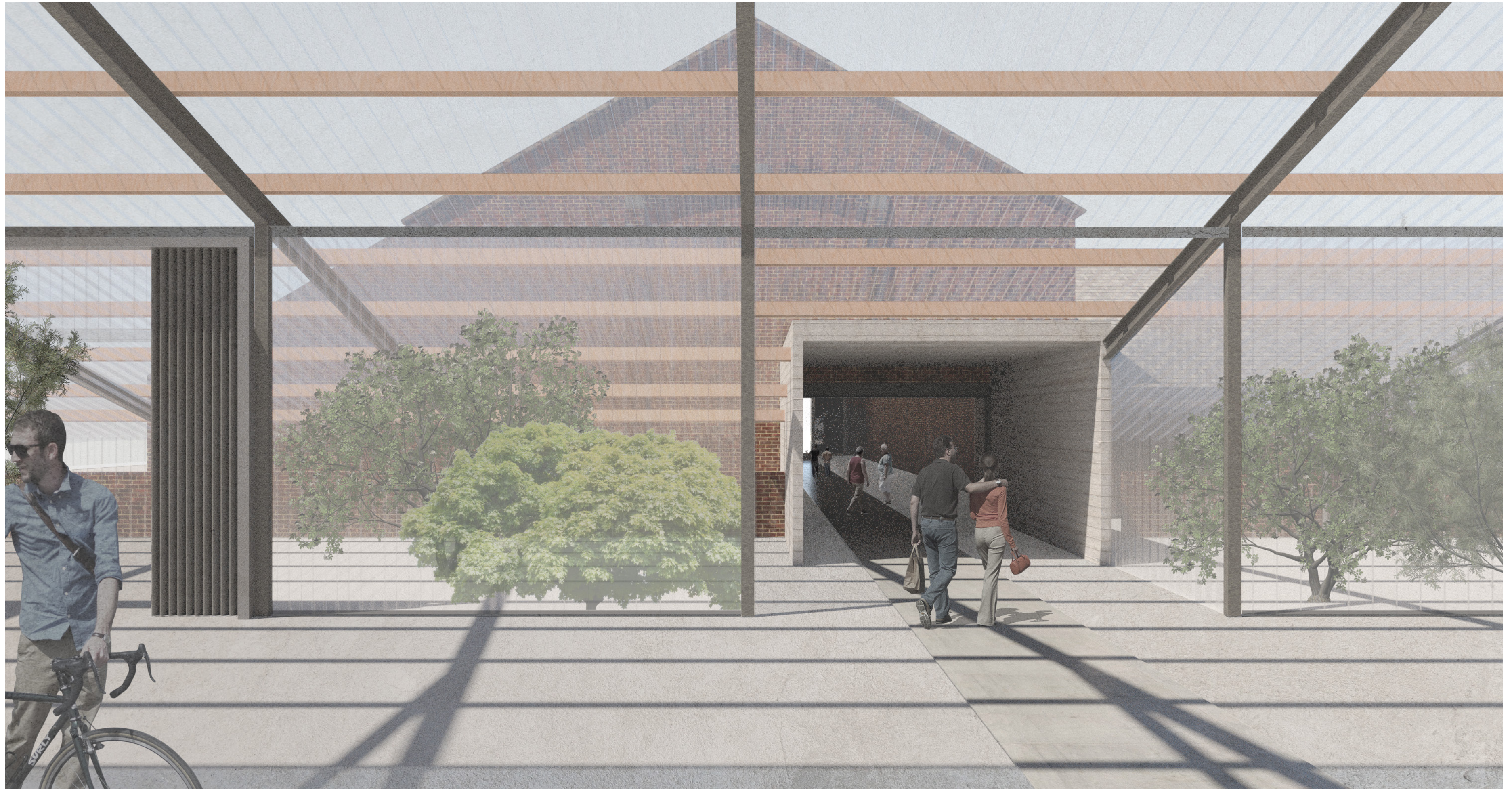



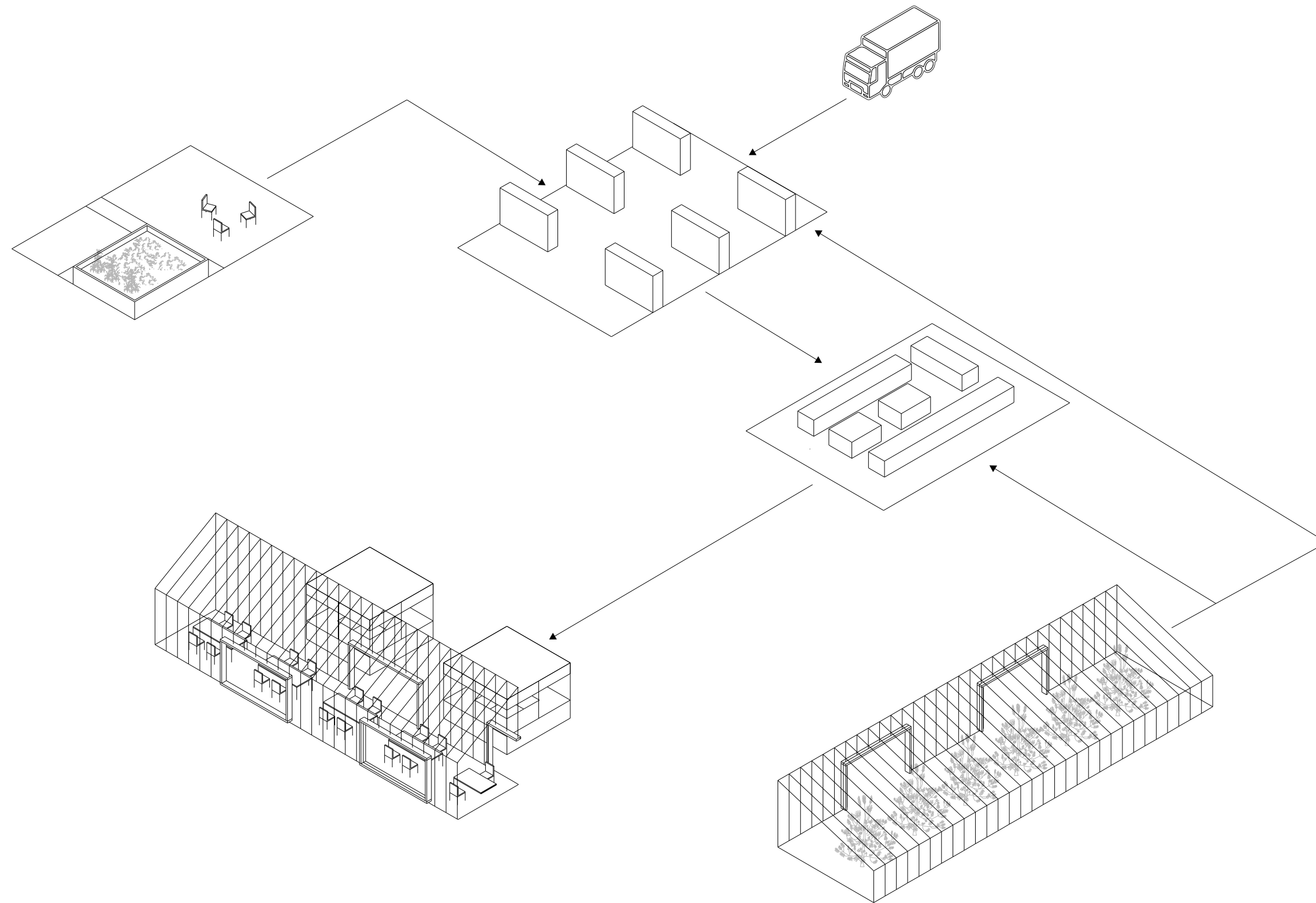

- Produces food
- Retreat to nature
- Educational function

Sustainability Strategies

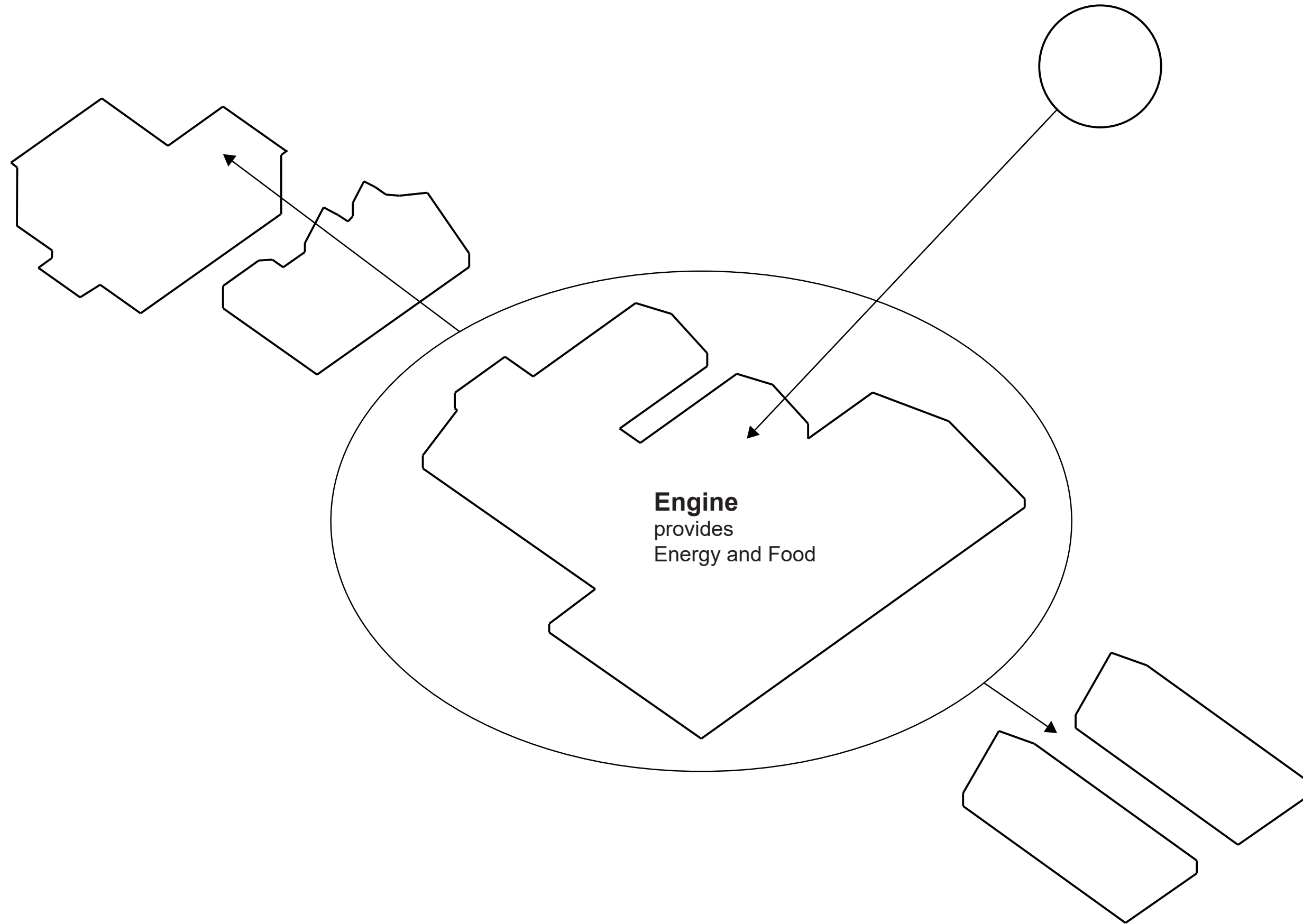

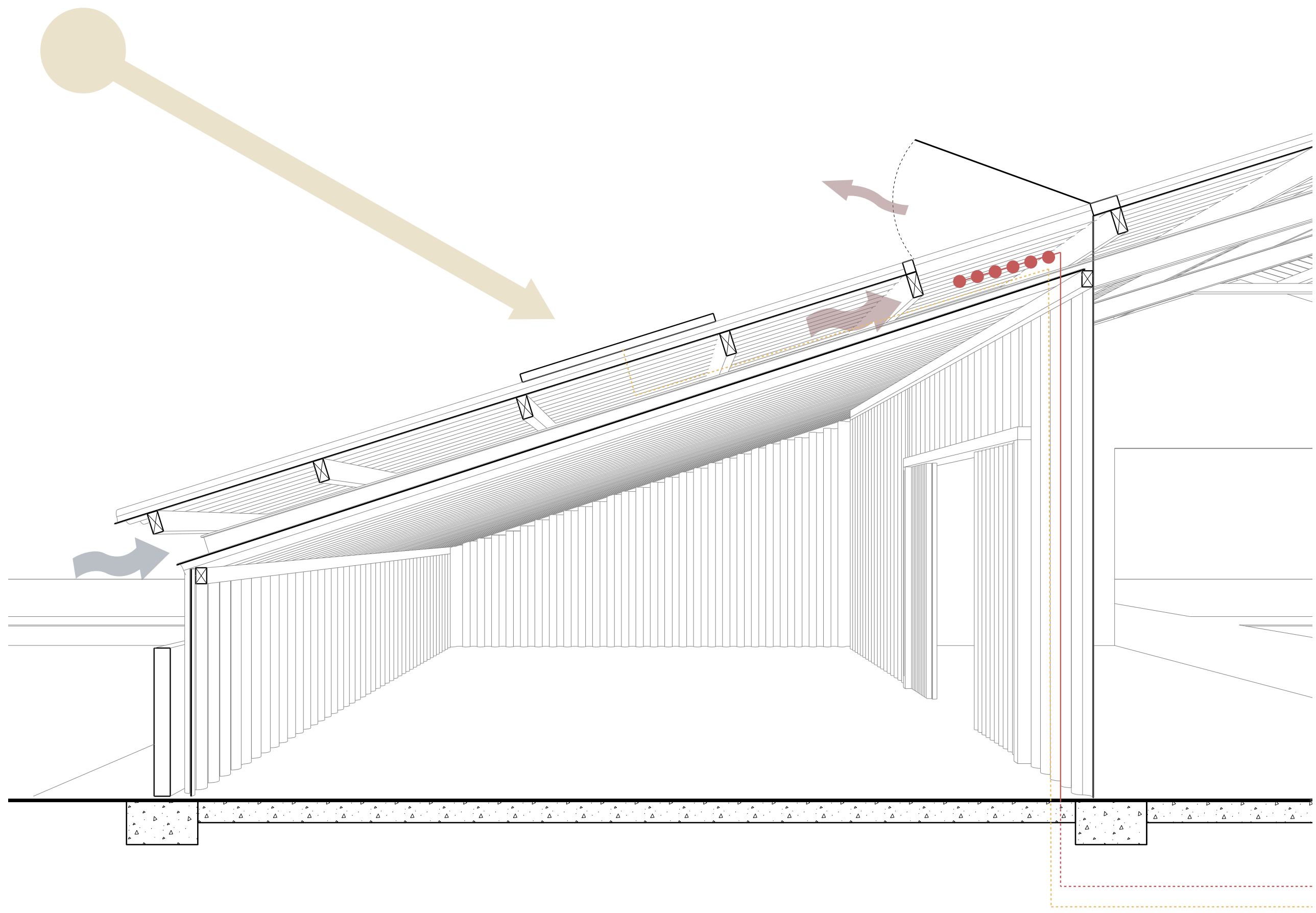

- Solar energy harvesting
- Food harvesting

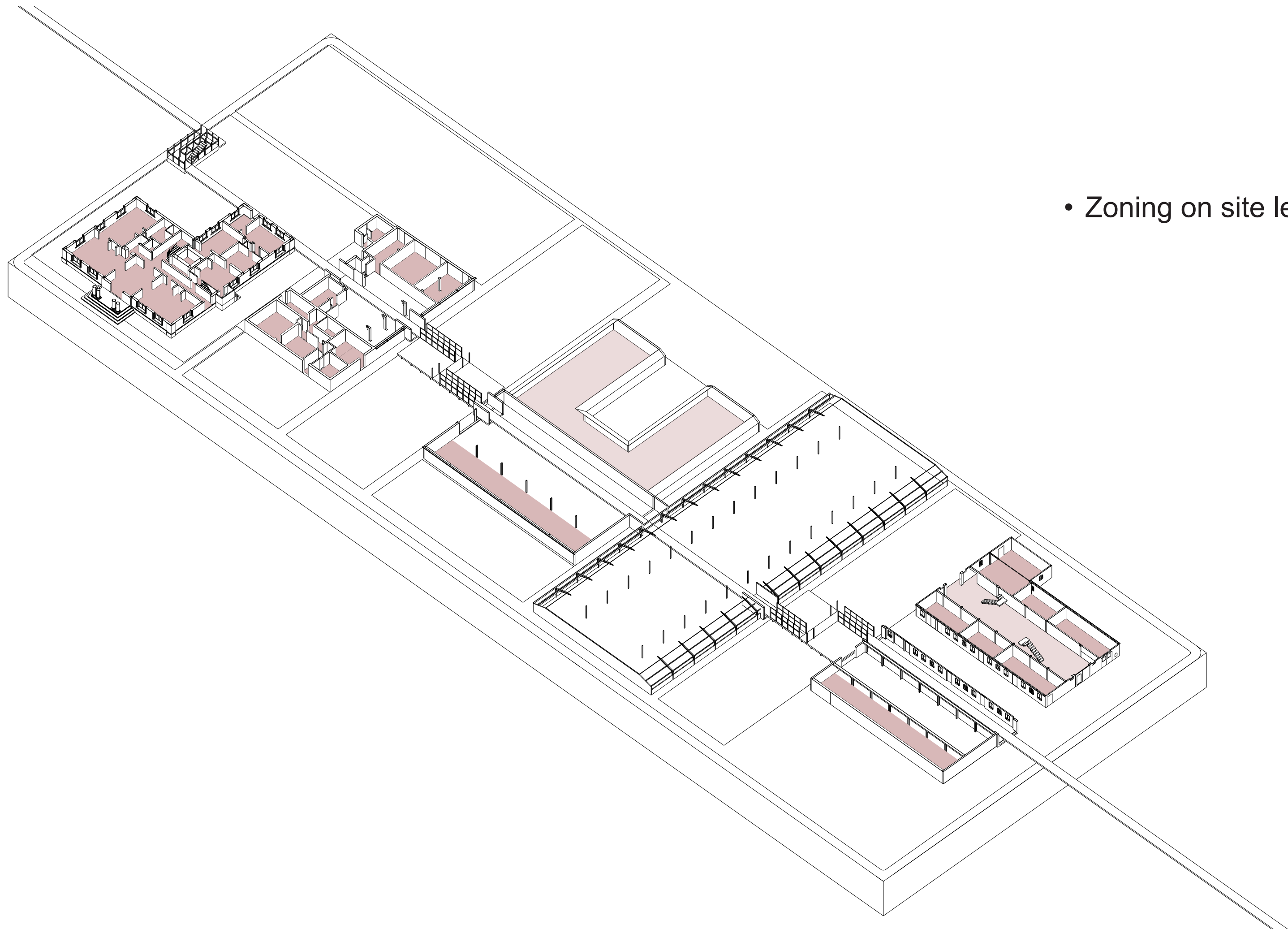

- Zoning on site level

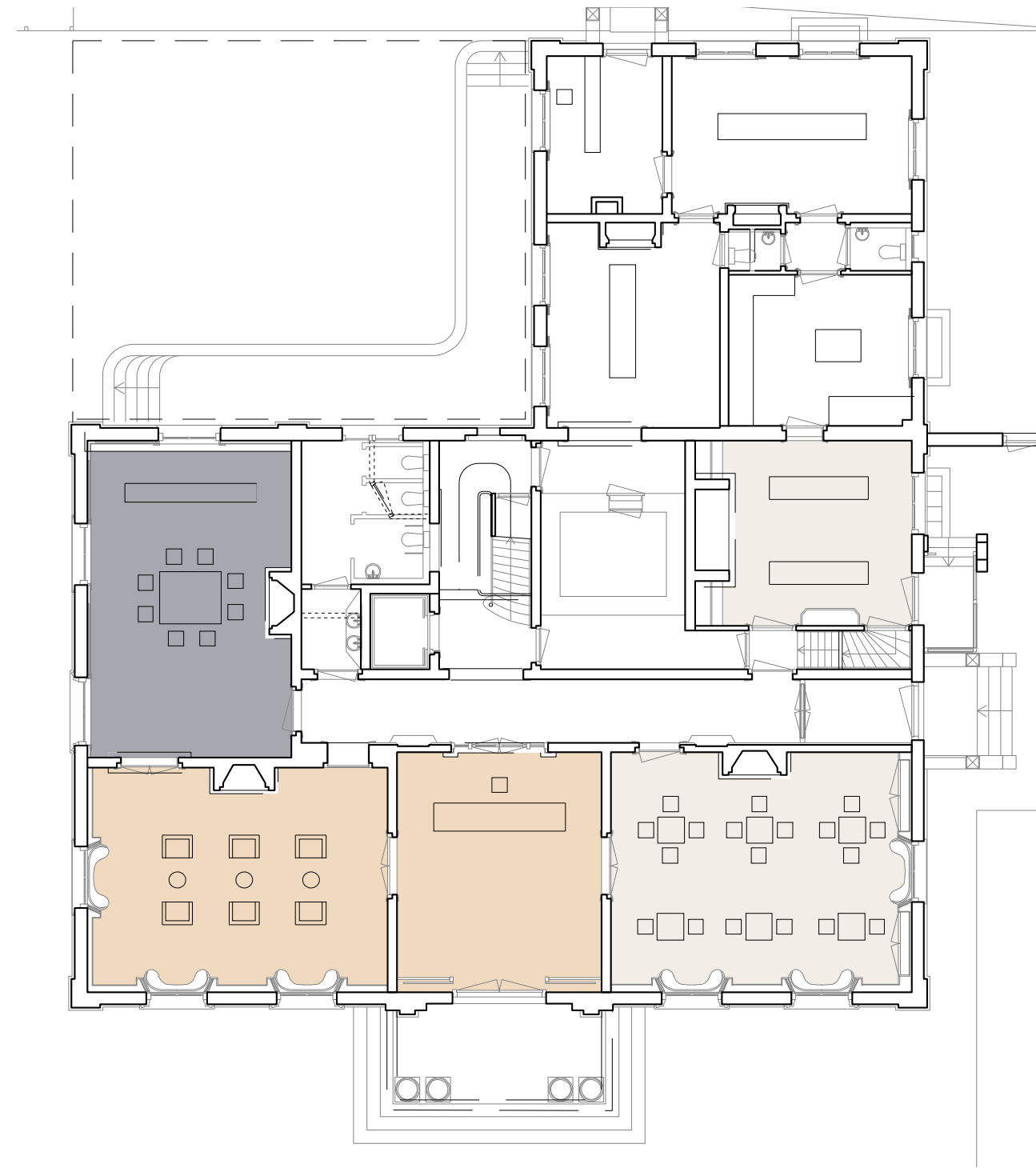
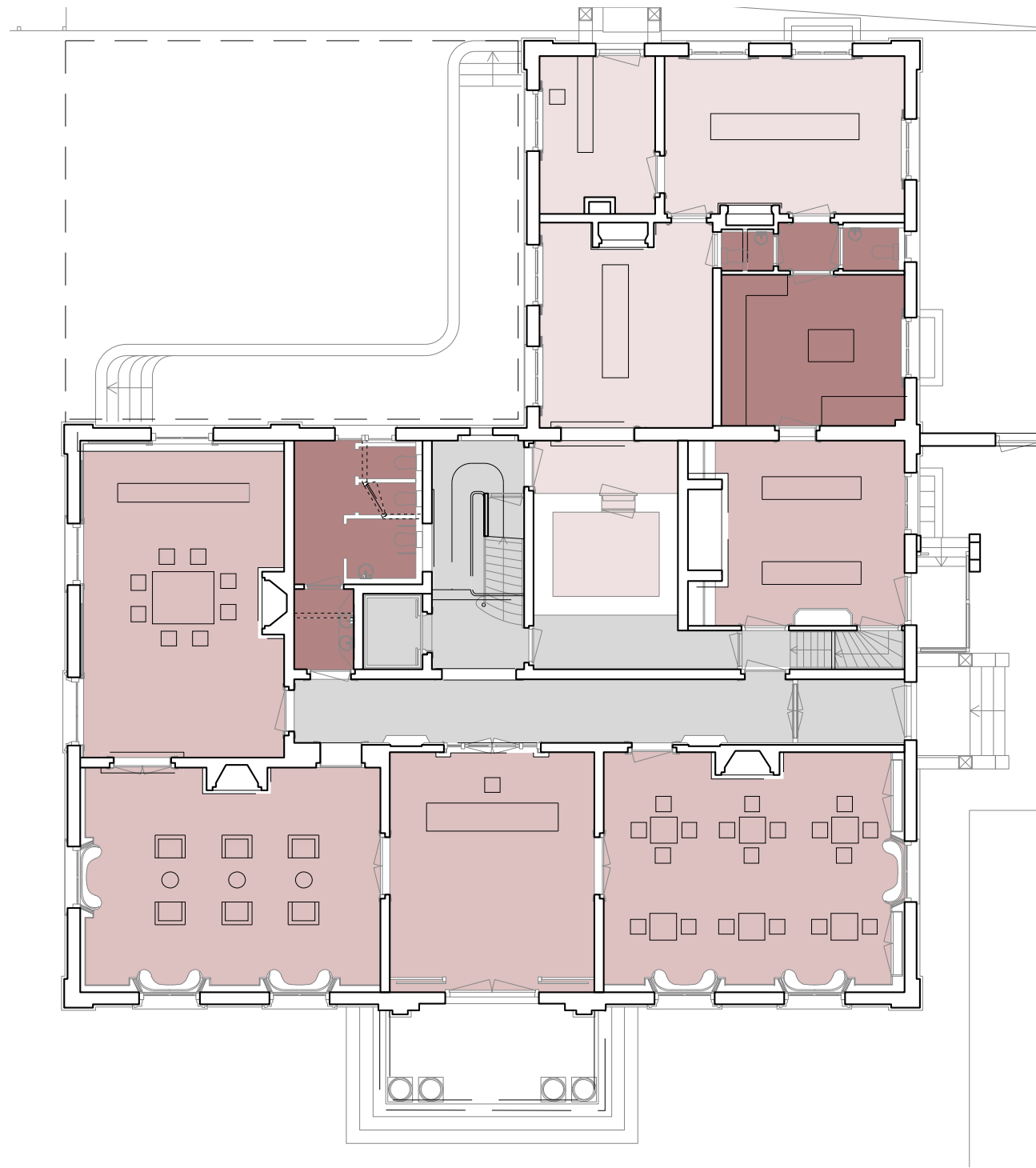

• Zoning on building level

KEY

Conditioning

- Constant
- Constant Low
- Temporary High
- None

Temporary Usage

- Morning
- Evening
- Day

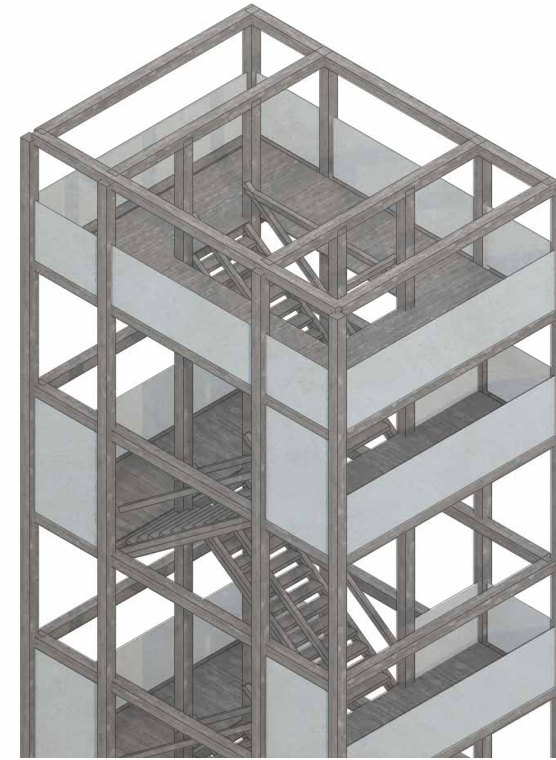
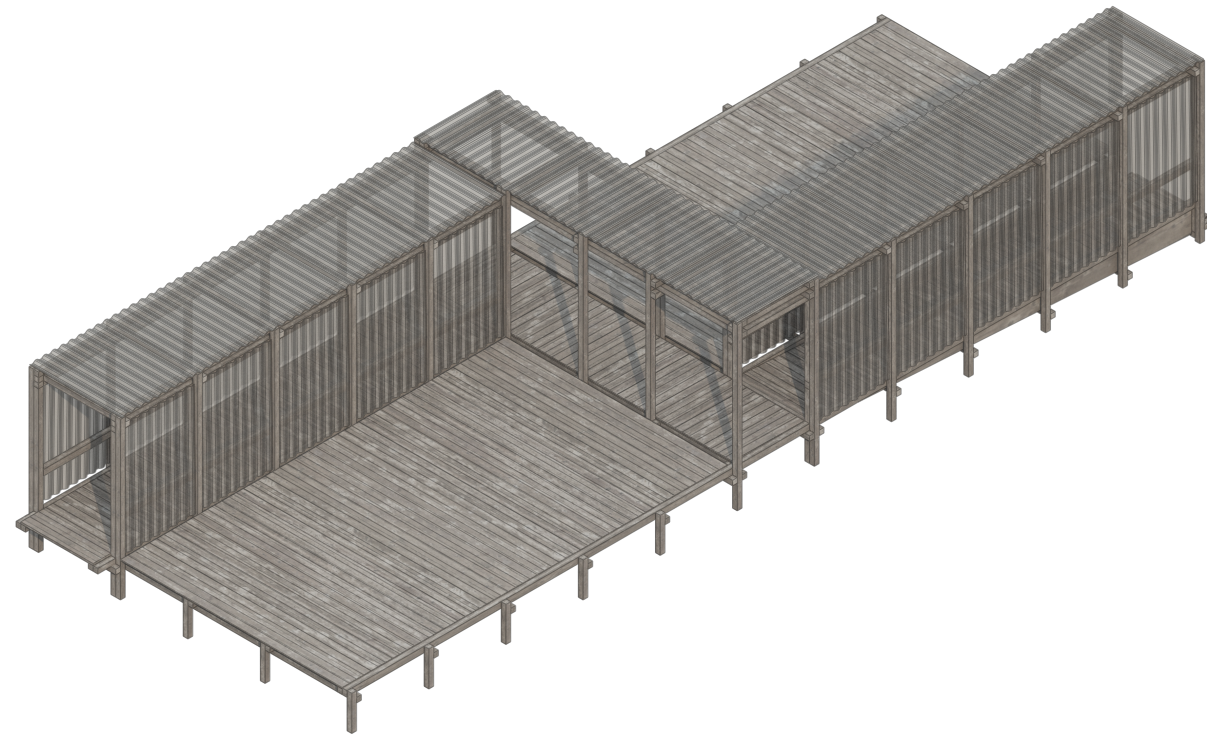

- Small scale interventions
- Recycled/ low carbon materials

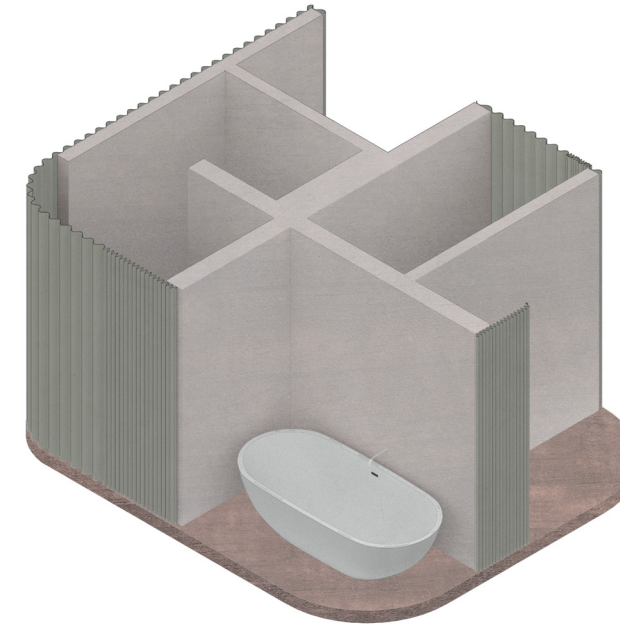
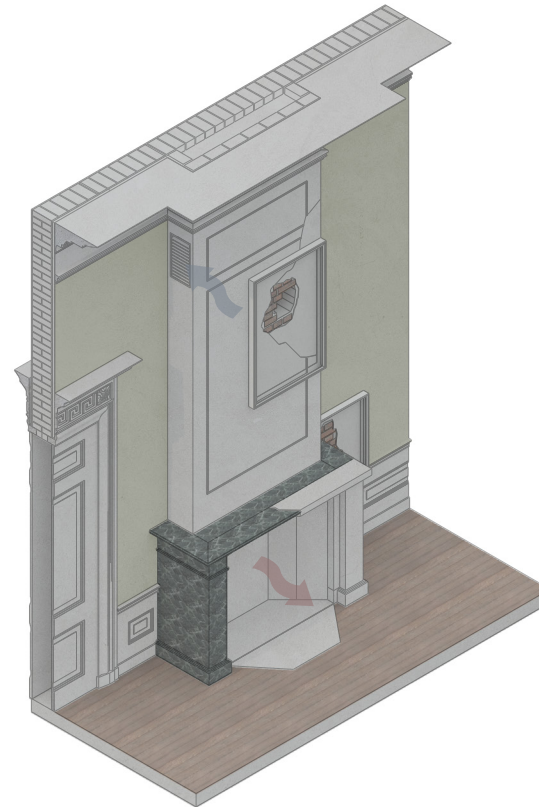
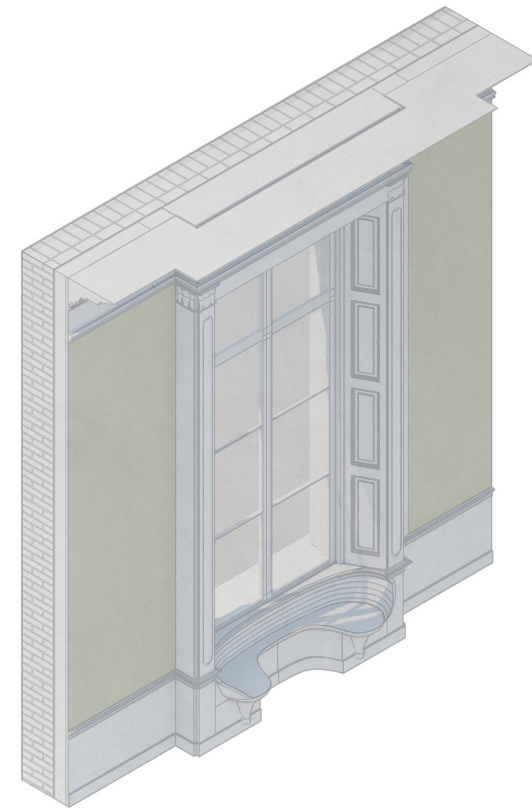
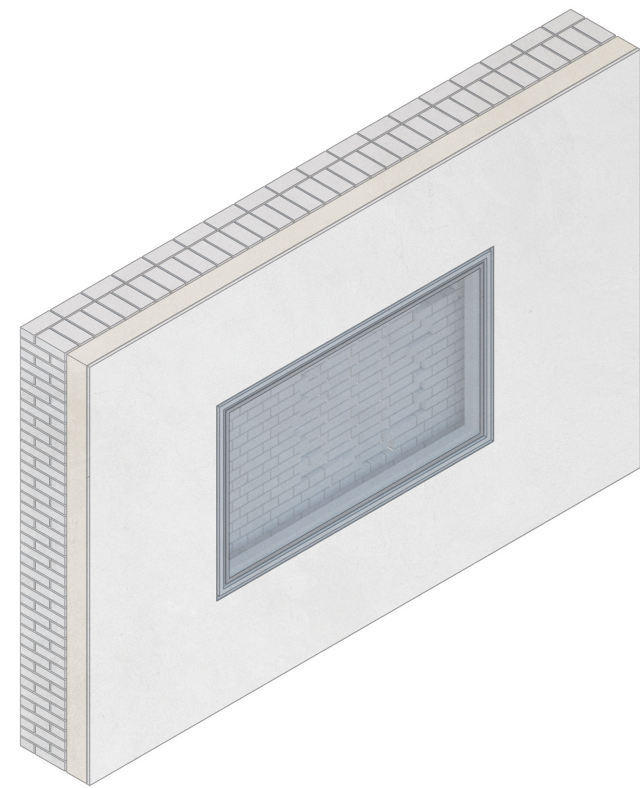

Programme and Site Concept

Walkway

Main House and War Damages

Functional Core

Sustainability Strategies

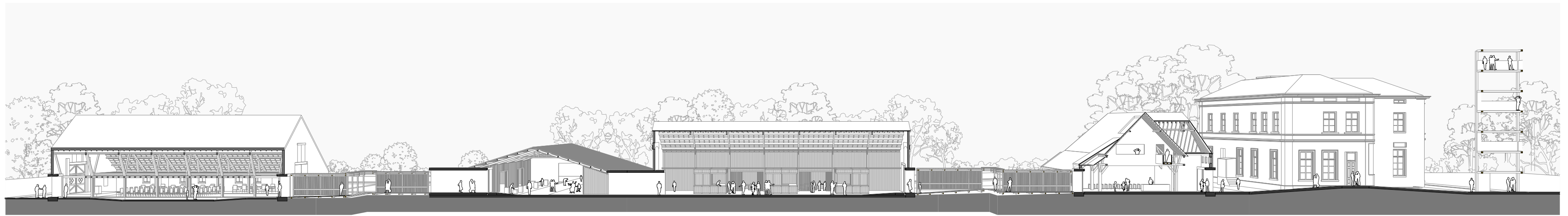

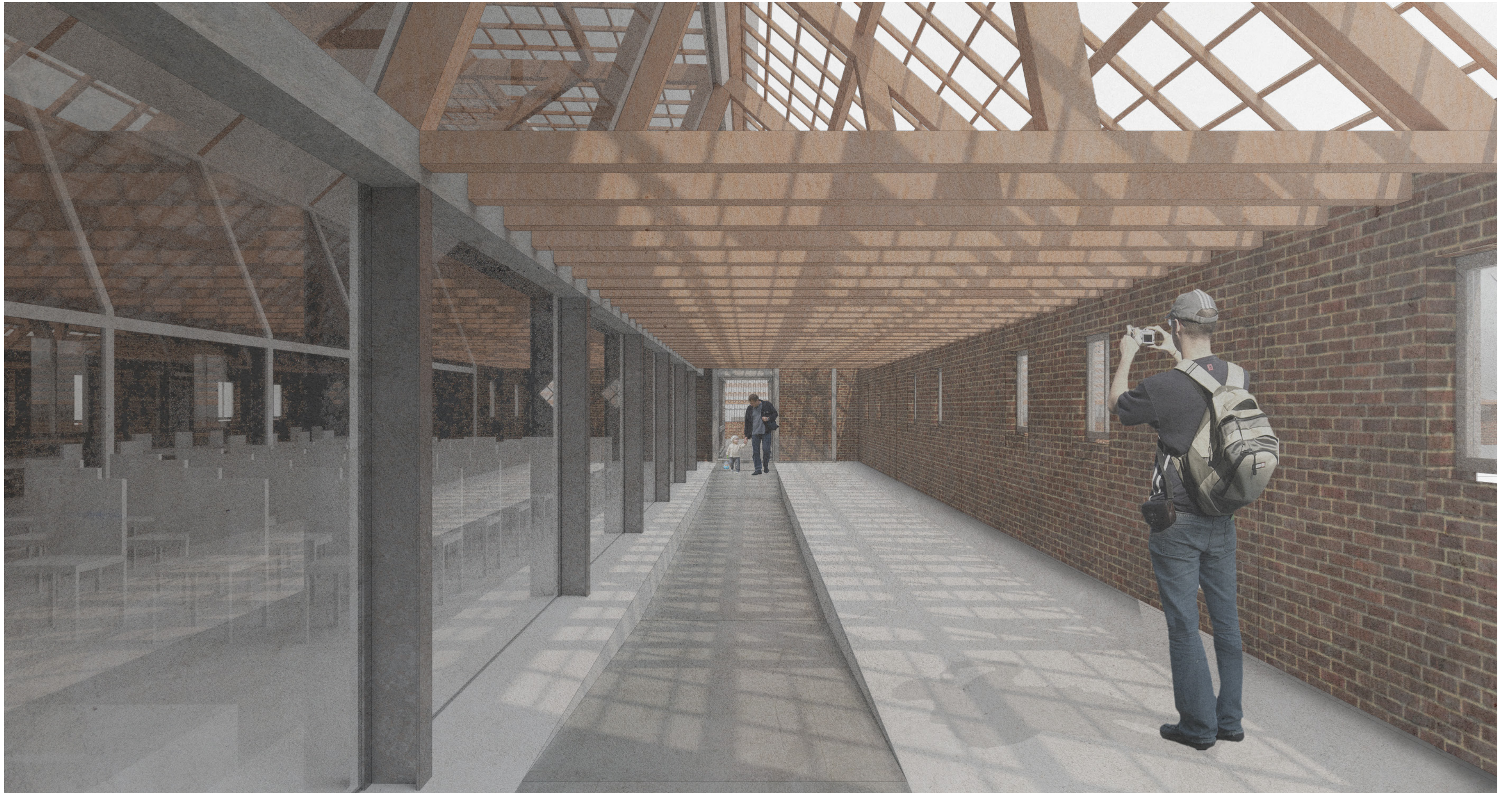

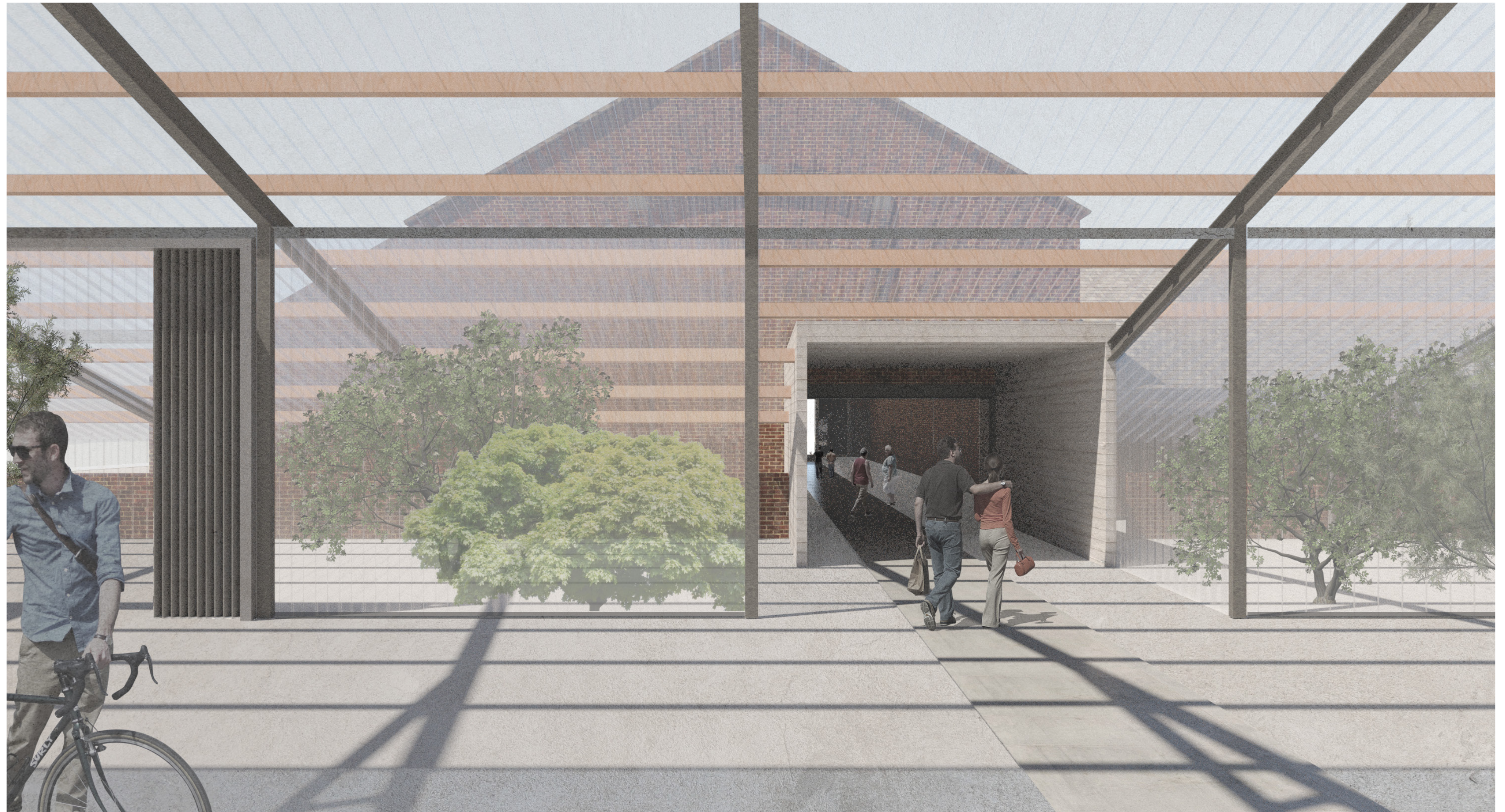

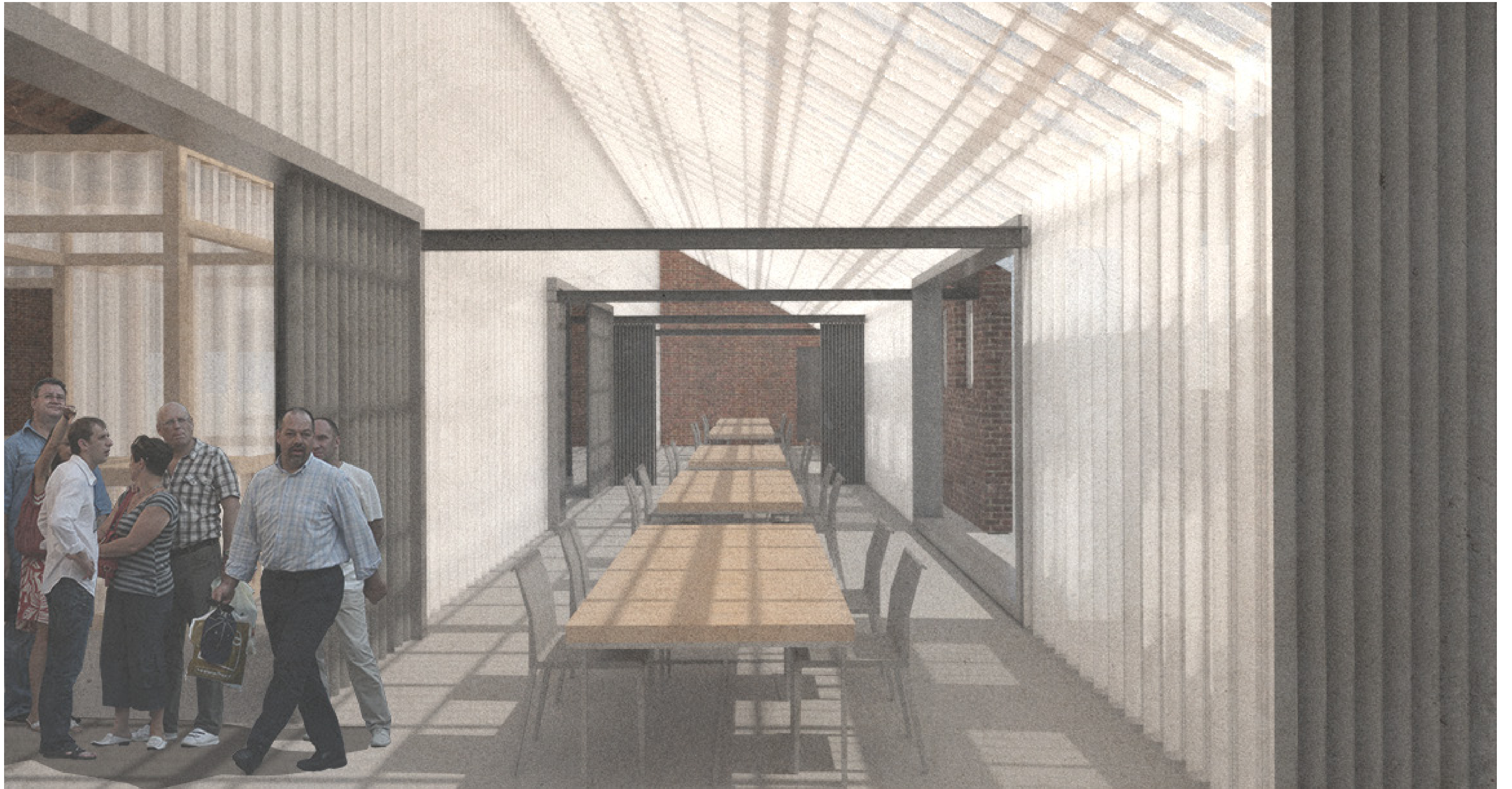





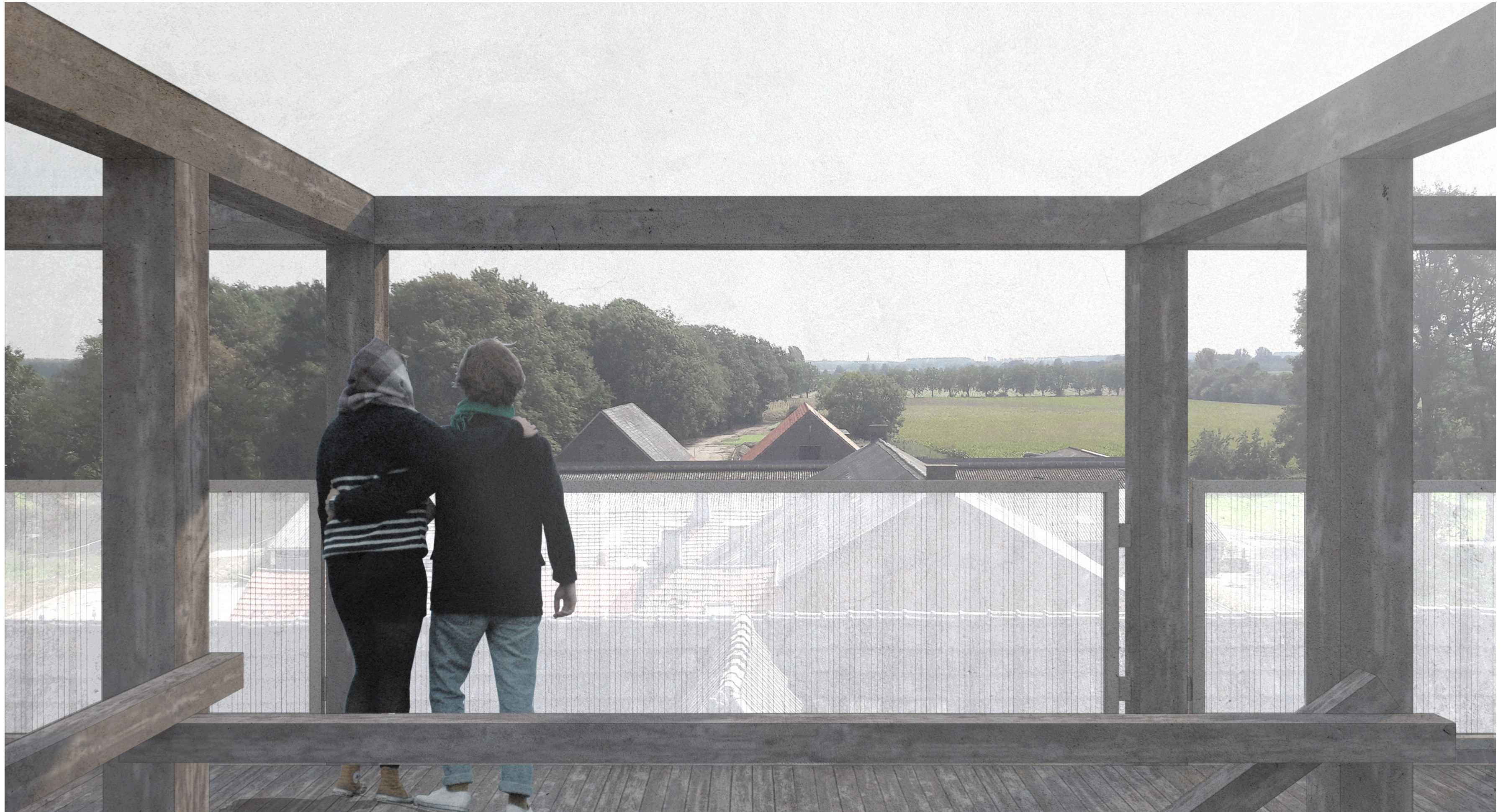

Thank You.