

Influencing the queue configuration to increase bicycle jam density and discharge rate: An experimental study on a single path

Wierbos, M.J.; Knoop, V.L.; Bertini, R.L.; Hoogendoorn, S.P.

DOI

[10.1016/j.trc.2020.102884](https://doi.org/10.1016/j.trc.2020.102884)

Publication date

2021

Document Version

Final published version

Published in

Transportation Research Part C: Emerging Technologies

Citation (APA)

Wierbos, M. J., Knoop, V. L., Bertini, R. L., & Hoogendoorn, S. P. (2021). Influencing the queue configuration to increase bicycle jam density and discharge rate: An experimental study on a single path. *Transportation Research Part C: Emerging Technologies*, 122, 1-15. Article 102884. <https://doi.org/10.1016/j.trc.2020.102884>

Important note

To cite this publication, please use the final published version (if applicable). Please check the document version above.

Copyright

Other than for strictly personal use, it is not permitted to download, forward or distribute the text or part of it, without the consent of the author(s) and/or copyright holder(s), unless the work is under an open content license such as Creative Commons.

Takedown policy

Please contact us and provide details if you believe this document breaches copyrights. We will remove access to the work immediately and investigate your claim.



ELSEVIER

Contents lists available at [ScienceDirect](https://www.sciencedirect.com)

Transportation Research Part C

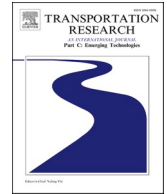
journal homepage: www.elsevier.com/locate/trc

Influencing the queue configuration to increase bicycle jam density and discharge rate: An experimental study on a single path

M.J. Wierbos^{a,*}, V.L. Knoop^a, R.L. Bertini^b, S.P. Hoogendoorn^a^a Delft University of Technology, Department of Transport & Planning, Delft, the Netherlands^b Oregon State University, School of Civil and Construction Engineering, Corvallis, United States

ARTICLE INFO

Keywords:

Bicycle
Cycling experiment
Queue discharge rate
Jam density

ABSTRACT

Congestion in bicycle traffic is a daily occurrence at many urban intersections. It is known that a higher density in the queue leads to a higher discharge rate. In theory, higher jam densities than those currently observed in practice are feasible. This leads to our hypothesis that the delay at intersections can be further reduced when cyclists are encouraged to queue up closer together. To explore this option, we carried out an experiment in which the queue configuration was influenced to increase the jam density. This paper presents ways to increase the queuing density, up to twice the density found without instructions. Results show that increasing the jam density does indeed increase the queue discharge rate; this also holds for jam density values that exceed those observed in normal queuing conditions. The efficiency of the queue discharge process, captured by the discharge rate, was found to increase by 40% when cyclists queue up closely together. Qualitative comparison of the queuing positions and discharge patterns showed that the discharge sequence is largely determined by the queuing position, and that cyclists keep a distance from each other in both time and space during the queue discharge phase. When applied in practice, these findings can be used to update the signal length and green phases for all traffic, thereby reducing congestion in urban areas.

1. Introduction

Using the bicycle to travel from A to B is popular in countries with a well-established cycling culture, such as the Netherlands and Denmark. Bicycle usage in the Netherlands is increasing (Harms and Kansen, 2018), which is a positive trend from a health and sustainability point of view (Forsyth and Oakes, 2015), but it also raises challenges. For some, the challenge is to understand cyclists to further promote cycling (Harms et al., 2016), while others are investigating ways to reduce delays for cyclists (Paulsen and Nagel, 2019). The urban infrastructure is struggling to handle the increased bicycle traffic flow, especially during the peak hours, resulting in congestion. Congestion predominantly occurs at controlled intersections which act as bottlenecks for cyclists, resulting in queues and delays. Cyclists have to wait more than one cycle length before they can traverse the intersection, which occurs on a daily basis in Amsterdam, Utrecht and other cities in the Netherlands with high cyclist volumes.

A possible solution to reduce congestion is to ensure that more cyclists are able to pass the traffic signal during the green phase. Simply lengthening the green time would negatively affect the other traffic which is undesirable. Another option could be to optimize the queue discharge process, e.g. the queue discharge rate and average speed of cyclists during the queue dissipation. Previous research

* Corresponding author.

E-mail address: m.j.wierbos@tudelft.nl (M.J. Wierbos).

<https://doi.org/10.1016/j.trc.2020.102884>

Received 24 February 2020; Received in revised form 9 October 2020; Accepted 12 November 2020

Available online 10 December 2020

0968-090X/© 2020 The Authors.

Published by Elsevier Ltd.

This is an open access article under the CC BY license

(<http://creativecommons.org/licenses/by/4.0/>).

(Goñi-Ros et al., 2018; Kucharski et al., 2019; Wierbos et al., 2020) has shown that the queue discharge rate is positively influenced by the jam density, which is the average number of stopped cyclists per squared unit of space. Although more factors could play a role here as well, this effect of jam density implies that the queue discharge process can be optimized by increasing the density of the queue.

The maximum observed jam density in practice is below what should be possible in theory, based on the physical dimension of bicycles. To reach higher jam densities, the queue formation process must be influenced e.g. by encouraging people to queue up closer together or providing predetermined waiting positions. It is, however, unknown whether creating denser queues can be achieved in practice and if so, whether the positive relation between jam density and queue discharge rate then holds. These questions are addressed in this study by means of a controlled experiment in which the participants are asked to perform multiple repetitions of cycling, forming a queue, and continuing to cycle after a signal turns green. In the meantime, different instructions were provided on how to form the queue. The discharge process was recorded on video and analyzed for each configuration to identify the impact of the configuration and resulting jam density on the queue discharge rate and discharge speed.

The paper continues with providing additional background information on macroscopic quantities and other findings in bicycle queue formation in Section 2. Then, Section 3 describes the experiment setup, the data analysis plan, and the experimental execution. Section 4 gives the results and its interpretations. Section 5 shows the practical implication of the main finding, and Section 6 discusses the results and gives direction for future research. Section 7 closes the paper by presenting the main conclusion.

2. Background on macroscopic quantities and bicycle queue formation

The literature on bicycle traffic flow has gradually expanded over the past several years. Earlier work primarily focused on single file movements and uninterrupted bicycle traffic flow, reporting on e.g. mean speed and gap acceptance, speed, volume and passing movements (Botma and Papendrecht, 1991) and capacity and level of service (LOS) (Navin, 1994; Allen et al., 1998). More recently, the traffic dynamics of bicycle traffic flow are further studied by means of large-scale bicycle experiments, either focusing on single lane movements to enable comparison with car traffic (Mai et al., 2013; Zhang et al., 2013; Jiang et al., 2016; Zhao and Zhang, 2017), or multi-lane bicycle flow to investigate the characteristics of bicycle traffic flow when overtaking is allowed (Gavriliidou et al., 2019; Guo et al., 2019).

Besides the uninterrupted behavior, traffic flow at intersections has gained increasing attention since they are the main bottlenecks for bicycle traffic flow. One of the first analyses on cycling behavior while approaching an intersection was done by Opiela et al. (1980), reporting on arrival patterns, approach speeds, and crossing gap acceptance characteristics. In the dissipation phase of a queue, important aspects are the capacity, queue discharge rate and the jam density. The capacity is the maximum number of cyclists that can pass the intersection per unit of time, usually converted to one hour, while taking into account the cycle length. The capacity therefore depends on the green interval and total cycle length (Wang et al., 2011). The queue discharge rate, or saturation flow, is the average number of cyclists that pass the traffic signal per unit of time. This flow is only measured during the green interval and does not take the waiting time into account, resulting in a higher value than the capacity.

Reported values of saturation flow show a wide variation which can be related to e.g. time of day, width of the path, topography or bicycle type. The influence of bicycle type on the capacity was studied by Zhou et al. (2015), Jin et al. (2015). They found that the presence of electric bikes besides conventional bikes increases the capacity, while cyclists transporting cargo decrease the capacity. Jin et al. (2015) introduced a bicycle equivalent unit to convert the capacity of a mixed stream of bicycles into a standardized flow rate of conventional bikes. Seriani et al. (2015) observed that the saturation flow during the morning peak hour exceeds that of the afternoon peak for sites in London and Santiago de Chile. Furthermore, a near linear relation was obtained between path width and saturation flow, meaning that the saturation flow nearly doubles when the path width changes from one to two meters. Raksuntorn and Khan (2003) studied the queue discharge rate at four intersections in different American cities and found that cyclists form multiple adjacent queues when the path width increases. Furthermore, the saturation flow shows a step-wise increase with the formation of a new lane. The differentiation into lanes is also described by Botma and Papendrecht (1991) who used theoretical sublanes to identify whether a cyclist is constrained by a cyclist in front or not. This qualification is used to determine the headway of a cyclist, which in turn is useful to estimate capacity as was done by Hoogendoorn and Daamen (2016) by proposing a bicycle headway model. Recently, Yuan et al. (2019) introduced a new method based on empirical data to determine the number of sublanes for bicycle traffic. They found that the observed number of sublanes is less than the theoretical number, which results in a reduction of the capacity estimate. Furthermore, the observed number of sublanes, as well as other variables e.g., start-up time and saturation headway, were found to be highly stochastic.

The jam density is the result of the queue formation process, which in turn results from the cyclists' decisions on where to stop (Gavriliidou et al., 2019). During this process, cyclists spontaneously form multiple channels which results in different dimensions and density of the queue. A higher jam density leads to an increase in queue discharge rate as was found by Kucharski et al. (2019) based on queues of 2–7 cyclists in Krakow and Goñi-Ros et al. (2018) who observed queueing events with 7–19 cyclists at an intersection in Amsterdam. These findings imply that the efficiency of the queue discharge process increases when the jam density is higher. However, it is unknown whether higher discharge rates are indeed obtained for higher jam density and under which circumstances denser queues could be formed. For pedestrian movements it is known that a bottleneck results in a loosely formed queue, whereas a train boarding leads to a densely formed queue (Kneidl, 2016). These situations have not been categorized for bicycle movements yet but one can observe in Amsterdam that a queue at an intersection is less dense than the queue of cyclists in front of a ferry. At intersections, the reported jam densities in literature vary between 0.56–0.65 bicycles/m² (Deng and Xu, 2014), 0.20–0.60 bicycles/m² (Wierbos et al., 2020) and 0.31–0.65 bicycles/m² (Goñi-Ros et al., 2018). In theory, higher jam density values should be possible and leading to less congestion. However, it is unknown if the jam density can reach a higher value in practice and if so, whether the positive relation

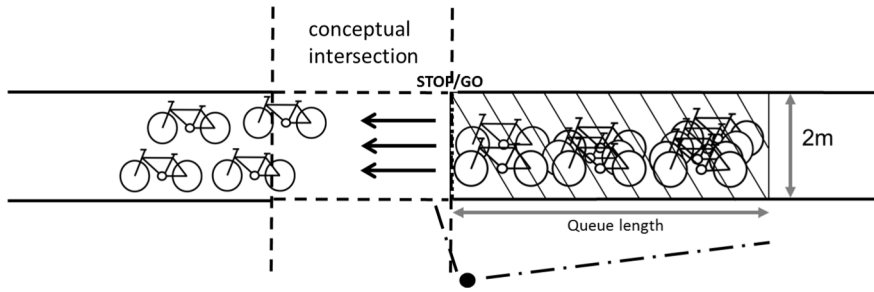

Fig. 1. Draft of the experiment setup. The dotted line indicates the stop line, the black dot is the camera position, and the dash dotted lines visualize the camera view.



Fig. 2. Snapshot of the camera view.

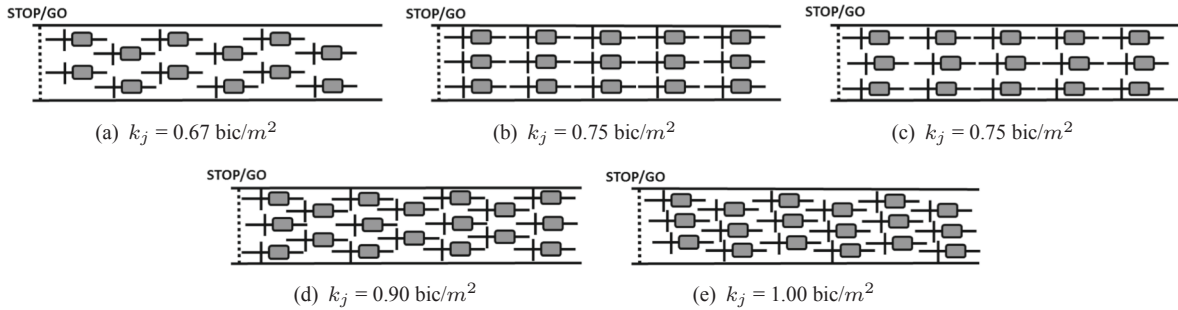

Fig. 3. Tested queue configuration with theoretical jam densities.

between jam density and discharge rates holds for jam densities exceeding 0.65 cyc/m^2 . This specific knowledge gap is the topic of our study. We aim to understand the link between the density of the queue and the discharge process, especially in situations with a high jam density. A key aspect in reaching these higher density values is to find effective ways to influence the queue formation process.

3. Research approach

The primary aim of this study is to investigate whether the jam density can be positively influenced by giving different queuing instructions to the cyclists. And if so, we aim to quantitatively describe the influence of jam density on queue discharge rate for the observed jam density range. The secondary aim is to better understand the underlying processes of the queue discharge. Section 3.1 describes the setup of the controlled experiment, Section 3.2 presents the data extraction and analysis plan, split up into the primary and secondary aims, and Section 3.3 describes the experimental execution.

3.1. Experimental setup

The behavior is studied in the setting of a controlled experiment because we are interested in density values that have not yet been recorded in real-life situations. In the experiment, we ask a group of cyclists to cycle on a two-meter-wide path until they reach a stop line where a person is holding a red 'STOP' sign or a green 'GO' sign, mimicking a traffic signal. When the sign indicates STOP, the cyclists stop and form a queue; when the sign states GO, the cyclists restart cycling and the queue dissipates. A sketch of the setup is shown in Fig. 1. The movements between the stop line and 17 m upstream are captured by a camera that captures the movements at a rate of 25 frames per second. Fig. 2 shows the view of the camera. The experiment is held in a closed terrain which has no gradient and is free of other traffic to minimize external influences. The design of the experiment was tested and approved by the ethics committee of Delft University of Technology.

We repeat the sequence of arriving, queuing and clearing multiple times while providing different guidance on how to form the queue. First, no queuing instructions are given to capture the uninfluenced behavior. Then, we start to intervene and ask the



Fig. 4. Example of a queue showing the cross-section (yellow) and queue length (white) that is used for the analyses (a) and the constructed image in space and time (b) showing the lateral position and passing time of all front wheels indicated with red dots. (For interpretation of the references to color in this figure legend, the reader is referred to the web version of this article.)

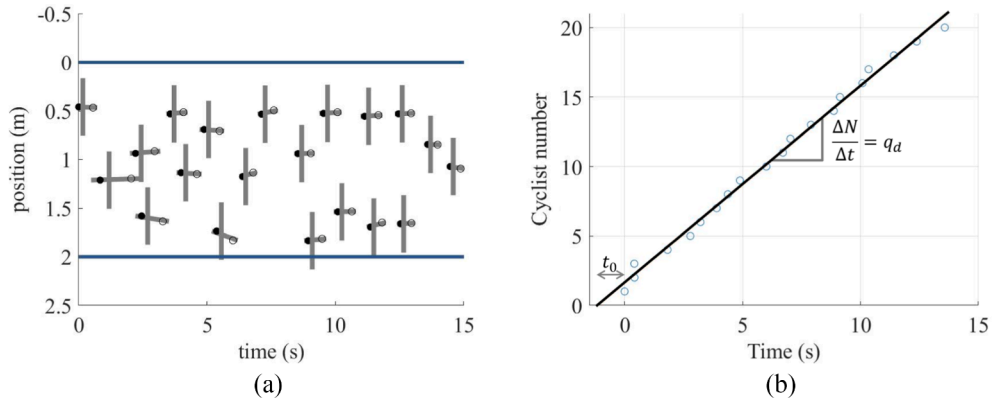

Fig. 5. The digitized version of 4b showing the lateral position and passing time of all bikes (a). The front wheel is indicated with the filled dot, the rear wheels with the open dot. (b) shows an example of the regression analysis to obtain the queue discharge rate.

participants to queue up more closely, without giving further information on how to do this. Then, we ask them to queue up on pre-assigned spots in pairs, in threes or a mixture. These spots are indicated with colored markings on which the cyclists place their front wheel. Each formation has its own symbol and color, as shown in Fig. 2. Fig. 3 shows the different queuing formations that were tested:

- (a) In pairs, staggered
- (b) In threes and side by side
- (c) In threes and v-shape where the middle cyclist is placed slightly backwards
- (d) Alternating in pairs and in threes
- (e) In threes with a shift

These configurations are chosen such that the density is higher than the highest jam density of $0.65 \text{ bic}/\text{m}^2$ (Goñi-Ros et al., 2018) that has been reported so far. In theory, the configurations (b) and (c) result in comparable jam density but the queue discharge rate might be different since the configuration can influence the process to start moving. More configurations are possible, especially when relaxing the constrained of a 2 m-wide path. However, the capacity does not scale linearly to the width of the path (Wierbos et al., 2019). Changing the path width would thus affect the discharge rates and is expected to diffuse the effect of jam density. For this reason we look only at different configurations within a fixed path width. Following the findings of Gavrilidou et al. (2019), a bicycle length of 1.80 m and handle bar width of 60 cm is used to place the markings on the path. An additional 10 cm is added on each side for every cyclist, resulting in a lateral spacing of 80 cm when the cyclists are placed in threes and side-by-side. Each configuration is repeated thrice to capture the fluctuations that will occur due to the stochastic nature of cyclists' behavior. Furthermore, we encourage cyclists to change order every time to minimize the influence of personal preferences in speed and reaction time.

3.2. Data extraction and analysis methods

The sequence of arriving, queuing and continuing cycling is called a run hereafter. We split the analysis of all runs into two parts, in line with our primary and secondary objectives.

3.2.1. Jam density and queue discharge rate

The primary objective is to quantify the relation between the jam density (k_j) and the queue discharge rate (q_d) for high jam density situations. To this end, the jam density and queue discharge rate need to be determined. The former is determined using the length of the queue, which is recorded for each run and measured after the experiment has finished. Since the number of participants is kept the

same, a dense queue results in a shorter queue than a queue with low density. The jam density for each run is therefore determined by the number of cyclists within the queue (N) and the dimension of the queue (A), which is the queue length (L) times the path width of two meters:

$$k_j = \frac{N}{A} = \frac{N}{2L} \quad (1)$$

The data extraction for the queue discharge phase is done using the lateral cross-section technique described in [Knoop et al. \(2009\)](#). This technique extracts the pixels along a cross-section of each video still and merges the slices from consecutive frames into a new figure. We take the stop line for our cross section, see the yellow line in [Fig. 4a](#). The resulting image shows the passing times and lateral positions of the cyclists, see [Fig. 4b](#). When a cyclist passes with a low speed, the wheel will occupy the cross-section for a longer time period and therefore has a larger size in the image than a wheel of a fast-moving cyclist. The position and time of the wheel centers are identified and indicated with red dots. [Fig. 5a](#) is an example, showing the passing moments of all cyclists of a run.

The queue discharge rate is determined using the individual passing moments of the cyclists and combining them in a cumulative curve. To minimize the influence of individual fluctuations in e.g. reaction time and speed, we perform a linear regression analysis, resulting in the following model:

$$N = q_d(t_i - L). \quad (2)$$

Here, N is the cyclist number, q_d is the queue discharge rate in cyclists per second, t is the time in seconds at which the N th-cyclist passes the stop line and $L = \frac{t_0}{q_d}$ is a constant which depends on the queue discharge rate and the start-up time t_0 of the first cyclist. The slope of the regression line is the measure for the average queue discharge rate which we use for our further analysis $\frac{\Delta N}{\Delta t} = q_d$, see [Fig. 5b](#). The jam density and queue discharge rate for each run are then coupled and a regression analysis is performed to quantify the influence of the jam density on the queue discharge rate.

3.2.2. Speed and queue configuration

The secondary objective is to better understand the underlying processes of the queue discharge. To this end, we perform two analyses. First, we investigate the individual and average speeds of cyclists during the queue discharge process and second, we compare the queue configuration to the discharge pattern.

The individual speeds (v_d^i) are extracted using the passing times (t) of the front and rear wheels and the distance between the two wheels (r), which equals the average length of a bike, i.e. 1.80 m ([Gavriilidou et al., 2019](#)), minus twice the radius of a wheel, which is approximately 0.35 m for an 28-in. wheel, $r = 1.80 - 2 \cdot 0.35 = 1.10$ m:

$$v_d^i = \frac{r}{t_{\text{rear}}^i - t_{\text{front}}^i}. \quad (3)$$

The average speed V_d during the queue discharge phase is the harmonic mean of the individual speeds:

$$V_d = \left(\frac{1}{n} \sum_{i=1}^n \frac{1}{v_d^i} \right)^{-1}, \quad (4)$$

in which n is the total number of cyclists that are participating in that run. A regression analysis is performed to grasp the influence of the jam density on the average speed during the discharge.

To grasp the underlying mechanisms of the obtained relations, we qualitatively describe the different queue configurations and their effects on the observed patterns during the discharge phase. This is done by following each cyclist during the discharge process and comparing it to the queue position with the speed, ranking and lateral placement on the path while passing the stop line. Different colors are used to visualize the position of cyclists in the queue matched to their ranking in the discharge phase.

3.3. Experiment execution

The experiment was held at the Green Village terrain which is a living lab and test facility of Delft University of Technology. The terrain was closed for visitors to eliminate possible disturbance by other traffic. The experiment was held on the 7th of August in 2019 which was a dry and partly clouded day with a moderate breeze (4 Beaufort). These wind conditions are common in the Netherlands and are not expected to have influenced the outcomes. A total of 20 people participated in the experiment of which the majority was student, between 20 and 25 years old and held the American nationality. Twelve of the twenty participants were male, implying that the group consisted predominantly of young male adults. All cyclists participated on a classic 'oma fiets'-type of bike with single speed and back-pedal brakes, which is commonly used in the Netherlands. These rental bikes had been used in the days before the experiment so everyone had time to become familiar with this type of bike. The participants were asked to fill in a short questionnaire about their cycling experience and confidence while cycling. The results are presented in [Fig. 6](#). 40% of the participants indicated that they use the bike multiple times per week which is below the European average of 85% that is reported in [Prati et al. \(2019\)](#). On the other hand, the participants rated their confidence while cycling on average an 8.3, on a scale of 1 to 10. Furthermore, the age at which they learned how to cycle was on average at age 6. So although their cycling frequency is below average, their confidence and familiarity with riding a bicycle is high.

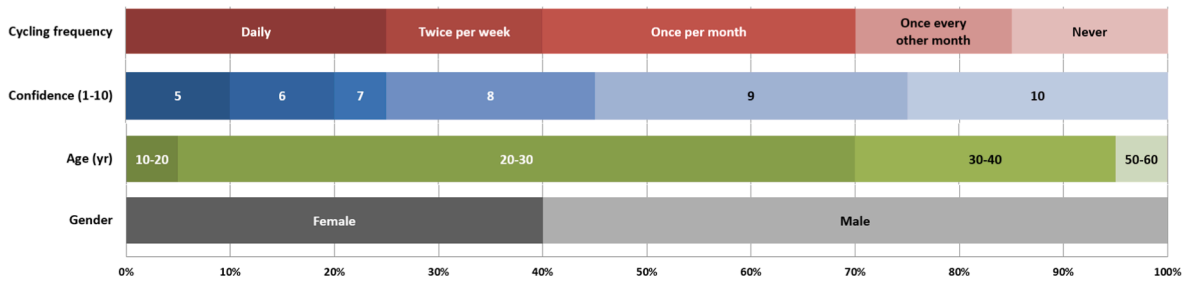

Fig. 6. Results from the questionnaires filled in by 20 participants.

Table 1

Details of the runs that were performed during the experiment.

Run #	Configuration	Instructions	Jam density bic/m ²	Discharge rate bic/s/m
1		None	0.62	0.59
2		None	0.67	0.54
3		None	0.67	0.57
4		None	0.69	0.54
5		Queue up closely	1.18	0.68
6		Queue up closely	1.09	0.71
7	(a)	In pairs	0.71	0.64
8	(a)	In pairs	0.71	0.61
9	(a)	In pairs	0.72	0.67
10	(b)	Side by side in threes	0.85	0.66
11	(b)	Side by side in threes	0.81	0.70
12	(c)	In threes and v-shape	0.77	0.58
13	(c)	In threes and v-shape	0.79	0.66
14	(c)	In threes and v-shape	0.71	0.50
		Break		
15	(d)	3-2-3	0.99	0.70
16	(d)	3-2-3	1.11	0.78
17	(d)	3-2-3	1.11	0.71
18	(d)	3-2-3	1.07	0.80
19	(e)	3-3-3 with shift	0.99	0.67
20	(e)	3-3-3 with shift	0.99	0.68
21	(e)	3-3-3 with shift	0.99	0.72
22		Queue up normal and feel comfortable doing	0.95	0.65
23		Queue up closely	1.31	0.81

The sequence of arriving, queuing and clearing was repeated 23 times. Most runs were consecutive so the cyclists continued cycling in between runs. The cyclists were only stopped when new queuing instructions had to be given. By mistake, configuration (b) 'side-by-side in threes' was not repeated 3 times as initially planned but only twice. On the other hand, the runs without instructions and 3-2-3 on indicated positions (d) was repeated four times because the first cyclists of the group had already passed the point where new instructions could be given. An overview of all runs is presented in Table 1.

4. Results

This section describes the findings of the analyses by first zooming in on the relation between jam density and the queue discharge rate in Section 4.1, and then describing the speed and comparison of the queue configuration and discharge patterns in Section 4.2.

4.1. Relation jam density and queue discharge rate

The observed jam density values range between 0.6 and 1.3 bic/m², as can be seen in Fig. 7. The normal runs without queuing instructions resulted in the lowest jam densities between 0.6 and 0.7 bic/m², which are in agreement with the value of 0.65 bic/m² reported in literature (Goñi-Ros et al., 2018). The jam density increased when we began to provide instructions on how to form the queue. Meanwhile, the variation in jam density is small for runs with similar instructions, which can be expected since we asked cyclists to queue up on pre-assigned spots. The exception are the runs without instructions and where cyclists were asked to queue up closely. Here, the cyclists were free to pick their own position, which resulted in a higher variation in jam density. When ordering the jam densities from low to high, we roughly find the following order: No instructions, in pairs (a), in threes with v-shape (c), in threes

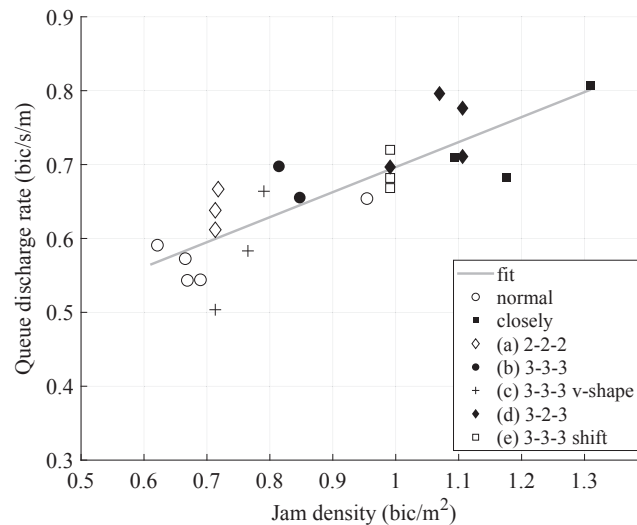

Fig. 7. Jam density and the queue discharge rate.

side by side (b), in threes with a shift (e), alternating 3-2-3 (d) and queue up closely. The latter instruction resulted in jam densities between and 1.3 bic/m^2 , which is close to twice the uninfluenced jam density. These results show that the density of a queue can indeed be positively influenced by giving instructions.

Three other results regarding jam density are highlighted: First, the configurations (b) and (c) were expected to result in similar jam densities. However, the results of the experiment show a slight difference; configuration in threes with v-shape (c) resulted in slightly lower densities than when the cyclists were queued up side-by-side (b). Second, the configuration where cyclists queued up in threes with a shift (e) was expected to result in higher density than when the cyclists alternately queue up in pairs and threes (d). However, the results from the experiment show the opposite although the differences are small. Apparently, the available space can be used more efficiently in the 3-2-3 setup. Last, one of the normal runs resulted in a higher jam density than expected. This run was done near the end of the experiment, so after the cyclists had been asked to queue up closer together. It is unclear whether this result is caused by an increasing familiarity with the experiment setting or if the participants got used to queuing up close together which changed their perception of normal.

The obtained queue discharge rates vary between 0.5 and 0.8 bic/s/m and increases with increasing density. In uninfluenced queuing conditions, the discharge rate varied between 0.54 and 0.60 bic/s/m , which is below the expected value of 0.65 bic/s/m from literature (Goñi-Ros et al., 2018; Wierbos et al., 2020). This might be explained by the level of experience in cycling. Some participants indicated that they rarely cycle in daily life, which could increase the reaction time and acceleration process. Another factor of influence could be the absence of haste in the setting of a controlled experiment and that no other cyclists were coming from behind. The highest queue discharge rates were obtained in two runs with a 3-2-3 configuration of the queue and a run in which the cyclists queued up closely. Most other runs show a queue discharge rate between 0.6 and 0.7 bic/s/m , except for a run with configuration (run e), in threes and in v-shape. The video recordings showed that two consecutive cyclists were talking to each other in the queue. Due to inattention of the front cyclist, the reaction time to restart moving was increased and the cyclists behind were delayed resulting in a lower discharge rate.

The jam densities and discharge rates combined show a positive relation, which confirms that the discharge flow can be positively influenced by increasing the density of the queue. Linear regression analyses to the data results in the model: $q_d = Q_0 + \beta k_j$ with regression constant $Q_0 = 0.36 \text{ bic/s}$ and the coefficient $\beta = 0.34 \text{ m}^2/\text{s}$. The R-squared value of the model is 0.70. The regression analyses was also performed for a quadratic fit, but this model resulted in a lower R-squared value. The obtained model means that when 20 cyclists are waiting at a controlled intersection on a 2 m wide path, the minimum green time needed to clear the queue is approximately 18 s for a queue of jam density of 0.6 bic/m^2 , while this decreases to 13 s when the jam density is increased to 1.2 bic/m^2 . Doubling the jam density will therefore lead to an efficiency gain in the discharge process by approximately 40%.

The obtained positive relation between jam density and queue discharge rate is in agreement with literature. However, the magnitude of the relation is different. The positive response of the queue discharge rate to increasing jam density is stronger in Goñi-Ros et al. (2018) for jam densities between 0.3 and 0.65 bic/m^2 than the impact on queue discharge rate in the density range of $0.6 - 1.3 \text{ bic/m}^2$ of our study. The difference could result from the different setting, namely a real-life situation versus a controlled experiment. Alternatively, the relation between jam density and queue discharge rate is not linear but follows a quadratic or different relation instead where the positive relation flattens for higher jam density.

4.2. Speed and queue configuration

The average cycling speed during the queue discharge phase varied between 5 and 8 km/hr , and decreases with increasing density, see Fig. 8a. This data is highly influenced by the start-up process of the first cyclists, as can be seen in Fig. 8b. Here, the individual

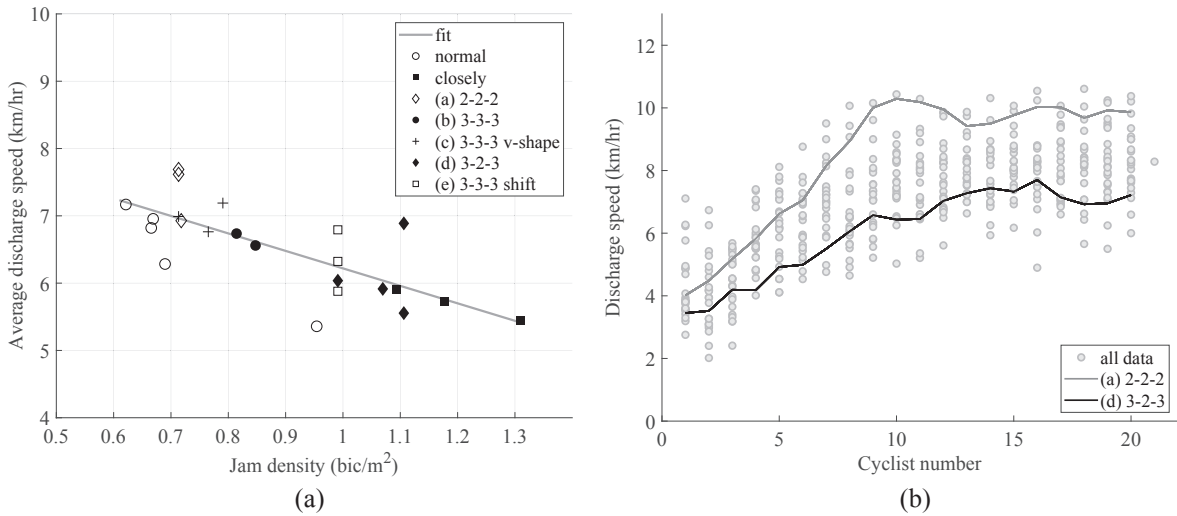

Fig. 8. Results of the experiment, with (a) the queue discharge rate and (b) the average speed that cyclists had while passing the stop line.

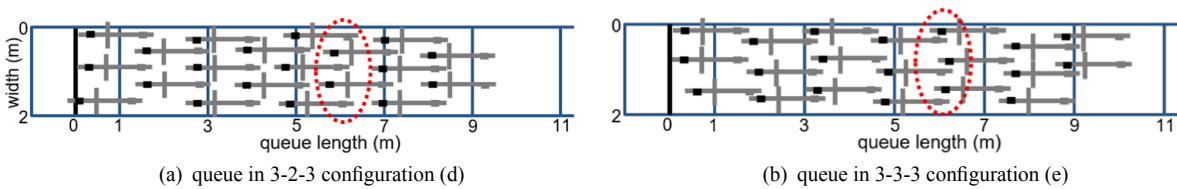

Fig. 9. Observed queue configurations of run 18 (a) and 20 (b). Within the red markings is the difference in wheel placement, black is front wheel and grey dot is rear wheel. (For interpretation of the references to color in this figure legend, the reader is referred to the web version of this article.)

speeds of all cyclists are plotted, together with the moving average of a run with a pairwise configuration and 3-2-3 configuration (high density). This shows that the first 8–12 cyclists are still accelerating while passing the stop line, while the later cyclists have more or less reached a constant speed. The moving averages of two runs are highlighted to illustrate the differences between runs, showing that the speed is higher in runs with a pair-wise queuing configuration and lower in a setting with alternately pairs and threes which has a high density.

When combining the average discharge speed and the jam density, Fig. 8a shows that the average discharge speed decreases with increasing jam density. Linear regression analyses on the average speed data results in the model: $v_d = V_0 + \alpha k_j$, with regression constant $V_0 = 8.82$ km/hr and the coefficient $\alpha = -2.60$ (km/h)/(bic/m²). The R-squared value of the model is 0.57. This negative relation can be explained by the observation that cyclists have less space to manoeuvre in a dense queue, resulting in reaction behavior instead of anticipation behavior. In low density queues, cyclists can anticipate upon the movement of someone in front and already decide to start moving as well, while in a dense queue, the cyclists must wait until the person in front has moved away until they have space to start pedaling.

The qualitative analysis of the queue configurations and the discharge patterns of all runs have led to insights into the cyclists' behavior. Based on the queue configurations only, two observations are made: First, in the runs without instructions, the cyclists used the total width of the path but there was a slight tendency to stop more to the right-hand side of the path. Second, some cyclists chose a spot close to others, while other cyclists preferred to leave a gap of 1 to 2 meters. This last preference was overruled when cyclists were asked to queue up closely. The cyclists then used the full width of the path and placed their front wheel next to the rear wheel of a predecessor, resulting in a compact queue.

The difference in wheel positioning could also explain the higher density than expected in the 3-2-3 configuration. Fig. 9 shows two examples of observed queue configurations in configuration (d) and (e). When looking more closely at the wheel placement of queued-up cyclists, you see that the front wheels of consecutive cyclists are placed more forward in the 3-2-3 configuration, and further backwards in the 3-3-3 configuration (e). This indicates that when the lateral distance between adjacent cyclists is larger, the longitudinal distance between consecutive cyclists can be smaller, which in the situation of the 3-2-3 configuration leads to a higher density than the 3-3-3 configuration.

Based on the coloured analyses of the discharge patterns the following four observations are made:

- The cyclists more or less maintain their ranking, meaning that little overtaking actions take place and the queue position mostly determines the discharge sequence. An example of this is visualized in Fig. 10a and b. Here, the blue cyclist indicated by the dashed circle, is queued up closely behind the red one, but it has a lower speed and uses 2.5 more seconds in the discharge process. The subsequent cyclists do not overtake but wait instead, thereby maintaining the same ranking.

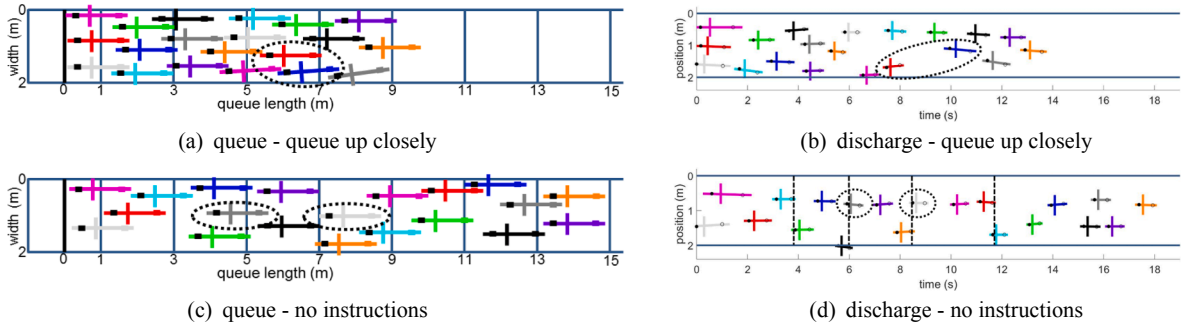

Fig. 10. Observed queue and discharge configurations.

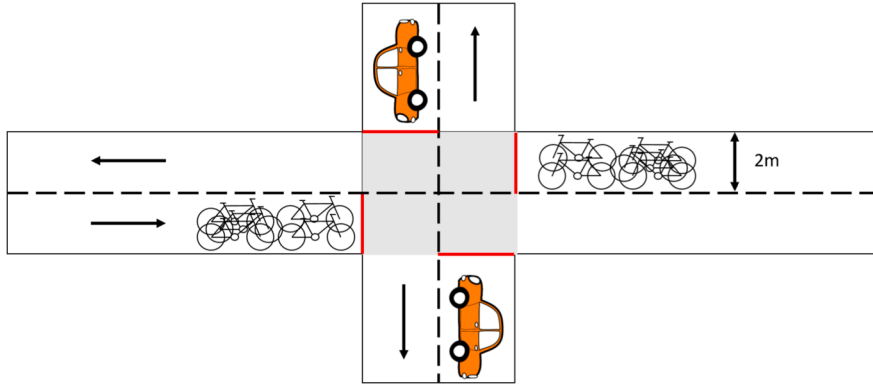

Fig. 11. Sketch of bicycle-car intersection.

- Some cyclists that are queued up in the middle merge towards the right-hand side of the path during the discharge process. This observation is highlighted by the dotted circles in Fig. 10c and d.
- More cyclists cycled out of bounds when the jam density was high. This was partly caused by the fact that the starting position was already closer to the path edges, and partly because the average discharge speed was lower which led to more swaying behavior.
- Cyclists did not cycle side-by-side during discharge, but rather kept a distance to others in time and space. This behavior is illustrated by the dashed vertical lines in Fig. 10d showing that the rear and front wheels pass the stop line simultaneously.

The full list of queue configurations and discharge patterns are presented in Appendix A.

5. Practical application

An example is given to illustrate how the findings regarding jam density and discharge rate can be applied in practice by updating the signal length. From the results of the experiment, we know that the efficiency of the queue discharge process can be improved by influencing the queue formation process to reach higher jam density. This means that the capacity of the intersection can be increased such that more cyclists can enter the intersection compared to the uninfluenced situation. The benefit of the increased capacity can be used to adjust the cycle length based on the new discharge rate for cyclists. As a result, the red times and associated delay reduce for all traffic participants. The remaining of this section discusses an example.

We will calculate the optimal cycle length for an intersection between cars and cyclists, based on two different discharge rates for cyclists; first the uninfluenced situation, then with queuing instructions. We use a simplified calculation for optimal cycle time (C). As input, we have the ratios between demand (D) and discharge rate (Q_{dis}) for each of the streams, and the clearance time (T_{clear}), i.e. the time the intersection cannot be used due to yellow time or safety bounds between directions. The fraction of green time required for each of the streams is D/Q . For a two-phase intersection, with cars and bicycles having one phase each, the time remaining for the clearance time is hence:

$$T_{clear} = C^* \left(1 - \frac{D_{car}}{Q_{dis,car}} - \frac{D_{bic}}{Q_{dis,bic}} \right). \quad (5)$$

If the clearance time, the demands and the capacities are known, this equation can be reverted to find the cycle time:

$$C = T_{clear} / \left(1 - \frac{D_{bic}}{Q_{dis,bic}} - \frac{D_{car}}{Q_{dis,car}} \right) \quad (6)$$

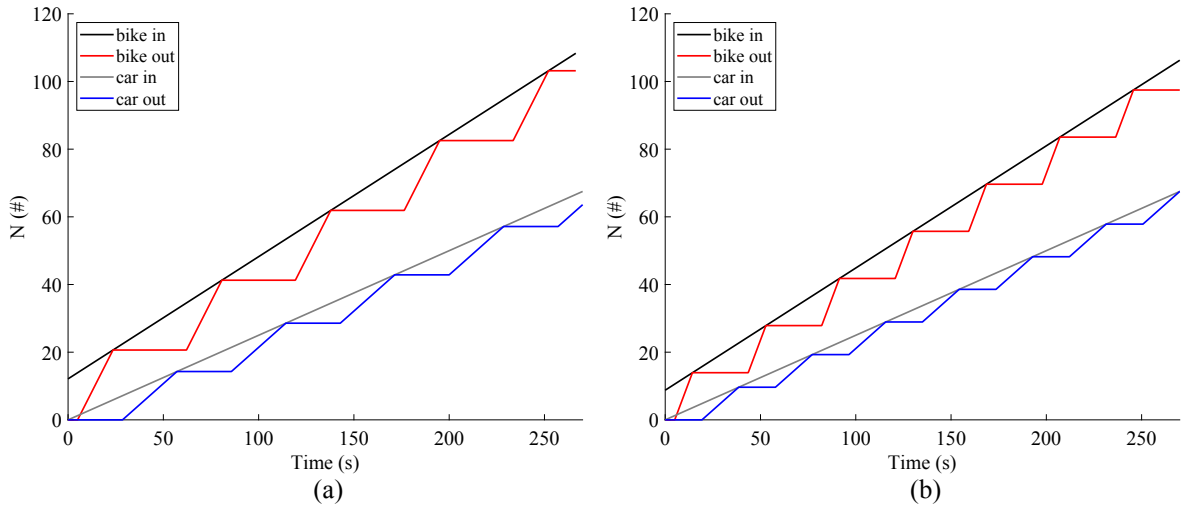

Fig. 12. Cumulative flow curves for cars and cyclists for the situation of uninfluenced jam density (a) and increased jam density (b).

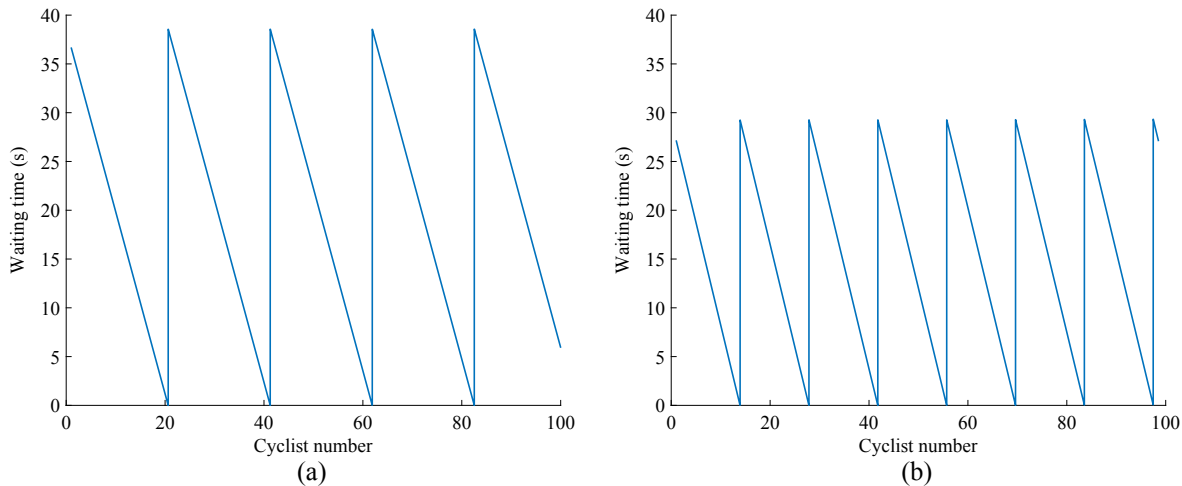

Fig. 13. Waiting times per cyclist in the situation of uninfluenced jam density (a) and increased jam density (b).

We will construct cumulative flow curves for cyclists and cars. These increase linearly with time if the flow is constant (inflow), and are constant for no outflow. The area between the curves is the delay. For more information on cumulative curves, we refer to [Daganzo \(2008\)](#). We construct the inflow and outflow curves for both directions separately.

In the example, we consider an intersection with a two-phase traffic signal, in particular one where a stream of cyclists crosses a stream of car traffic, see [Fig. 11](#). The design is roughly based on the intersection between Catharijnesingel and Vredenburgviaduct in Utrecht, the Netherlands. It represents two-directional traffic for both cyclists and cars in a busy city center. The total width of the cycle path is 4 m, so 2 m per direction; the cars have one lane in each direction. During peak hours, the cyclist demand per direction is around 1300 cyclists per hour and for cars this is around 900 cars per hour per direction ([Municipality Utrecht, 2020](#)). We assume a queue discharge rate of 1800 veh/h. For this intersection, we consider a combined clearance time (T_{clear}) of 10 s, which includes all red and yellow times for both signal changes combined.

For the uninfluenced situation, we take a discharge rate of 0.56 bic/s/m (see [Fig. 7](#)) which translates into an hourly rate of 4000 bic/h. Based on these numbers, a cycle length of 57 s is found optimal, with a green interval of 19 s for cyclists and 29 s for cars.

For the case with increased queuing density, these numbers change. The optimal cycle length decreases when the bicyclist discharge rate increases due to the influenced jam density. Now, we assume a queue discharge rate of 0.75 bic/s/m, based on the average value obtained in a 3-2-3 configuration. The hourly discharge rate for cyclists is thus 5400 cyclists per hour. Entering the new numbers in [Eqs. \(5\) and \(6\)](#), leads to an optimal signal length of 39 s, with a green interval of 9 s for cyclists and 19 s for cars. The higher discharge rate for cyclists thus results in a shorter cycle length.

The resulting cumulative flow curves are shown in [Fig. 12](#). Here, the inflow and outflow are depicted in time, showing a constant inflow based on the demand and zigzagging pattern for the outflow where the curve is horizontal during red interval and increases with the queue discharge rate during the green interval. The area between the inflow and outflow curves represents the waiting time for

cyclists and cars. Comparing the total waiting time for the two situations shows that the changed signal reduces the waiting time for cyclists with 24% and 32% for cars.

The impact of reducing the cycle length is also illustrated in Fig. 13, which shows the waiting time for individual cyclists. The maximum delay per cycle is 39 s in the uninfluenced situation, and this reduces to 29 s in the situation with a 3-2-3 queue configuration. The average waiting time per cyclist reduces with 4.6 s, and that per car with 4.7 s. When combining this for all traffic in a two hour peak period, the delay reduction adds up to 140 min for cars and 200 min for bicyclists.

6. Discussion and future research

A positive relation was found between jam density and queue discharge rate within the density range of 0.6 to 1.3 bic/m². The magnitude of the impact of increasing jam density is less in our study than reported in the literature for densities between 0.3 and 0.65 bic/m². Possibly, the specific characteristics of our sample play a role here, e.g. only single-speed bicycles, below-average cycling frequency in daily life, or absence of haste. Future research in a real-life setting covering the full range of jam densities could help to identify the nature of the positive relation between jam density and queue discharge flow.

The average speed during the queue discharge process decreased when the jam density increased, indicating that cyclists are hindered in their movements due to the proximity of other cyclists. It would be interesting to see if this effect leads to a stagnation or decrease in queue discharge rate for jam density values that exceed the highest value observed in this study.

The comparison of the queuing positions and discharge patterns resulted in the following observations: the discharge sequence is mostly determined by the queuing position, cyclists keep a distance to each other in both time and space during the queue discharge phase, and more cyclists use the path edge or beyond when the jam density increases. The work of Goñi-Ros et al. (2018) reports on cyclists moving onto the road or the sidewalk during the discharge process but it does not specify under which density conditions this behavior occurs. It would be interesting to see if this enhanced 'out of bounds'-movement is also observed in real-life situations where side curbs and the presence of other traffic might prevent cyclists from moving out of bounds.

The quantitative analysis confirmed that increasing the jam density has a positive effect on the queue discharge rate, also for values of jam density that have not been observed before. The efficiency of the queue discharge process, measured in discharge rate, increased by 40% when comparing the situation with the highest jam density to an uninfluenced situation. Introducing control measures to increase the jam density is therefore a promising way to reduce congestion at intersections.

The delay at intersections can be reduced the most when cyclists are asked to queue up closely and when they use pre-assigned spots in a configuration of alternately in pairs and threes on a 2 m-wide bicycle path. An interesting next step is to test this finding in daily traffic, and to study which measure is most effective in encouraging cyclists to queue up more closely. This could be done e.g. by placing visual signs asking cyclists to queue up closely, or adding a Formula-1-like starting grid on the path, indicating the cyclists to queue up alternately in pairs and threes.

Our findings are based on a homogeneous composition of the queue regarding bicycle type and social setting. The results may differ in practice when other means of transportation are also present on the bicycle path or when social groups stick together and do not queue up according to the optimal configuration. Examples are cargo bikes which have different dimensions, electrically driven bicycles which have atypical acceleration patterns or small children who stay next to their parents. Nevertheless, increasing the jam density is a promising way to reduce congestion at intersections.

7. Conclusion

A controlled experiment showed that giving queuing instructions to cyclists can increase the jam density. Jam densities between 1.1 and 1.3 bic/m² can be achieved, which is approximately twice the density found in normal conditions. All queuing instructions have led to jam densities that exceed the values obtained in normal queuing conditions. The highest jam densities were observed when participants were asked to queue up closely and when they positioned themselves in a configuration that alternated in pairs and threes. The higher queue densities led to higher queue discharge rates for cyclists, up to 40% higher than in uncontrolled conditions. This paper explored the effect of intervening in the queue formation process in an experimental condition. Next step would be to verify the results in a field test. Once implemented, the signal control can be adapted to the higher queue discharge rate for cyclists, which will reduce the delay for all traffic participants.

CRedit authorship contribution statement

M.J. Wierbos: Conceptualization, Investigation, Formal analysis, Writing - original draft. **V.L. Knoop:** Conceptualization, Investigation, Writing - review & editing, Supervision. **R.L. Bertini:** Investigation, Writing - review & editing. **S.P. Hoogendoorn:** Funding acquisition, Supervision.

Acknowledgment

This research was supported by the ALLEGRO project, which is financed by the European Research Council (Grant Agreement No. 669792) and the Amsterdam Institute for Advanced Metropolitan Solutions. We thank the students from the University of South Florida Sustainable Urban Mobility course, and colleagues Giulia Reggiani, Martijn Sparnaaij and Alphonse Vial for their assistance in the experiment.

Appendix A

Figs. A.1–A.3.

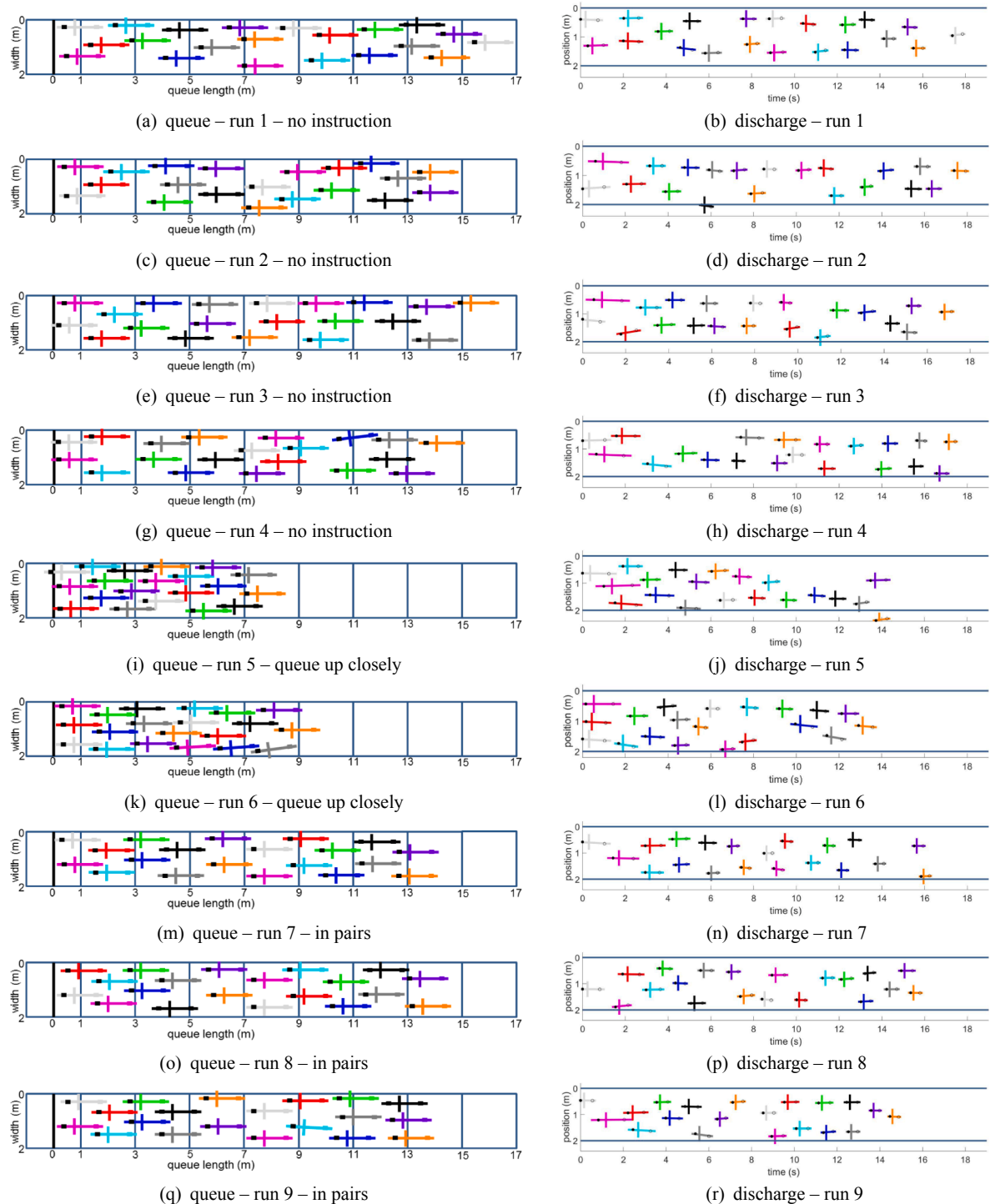

Fig. A.1. Observed queue configurations and discharge patterns of run 1–9.

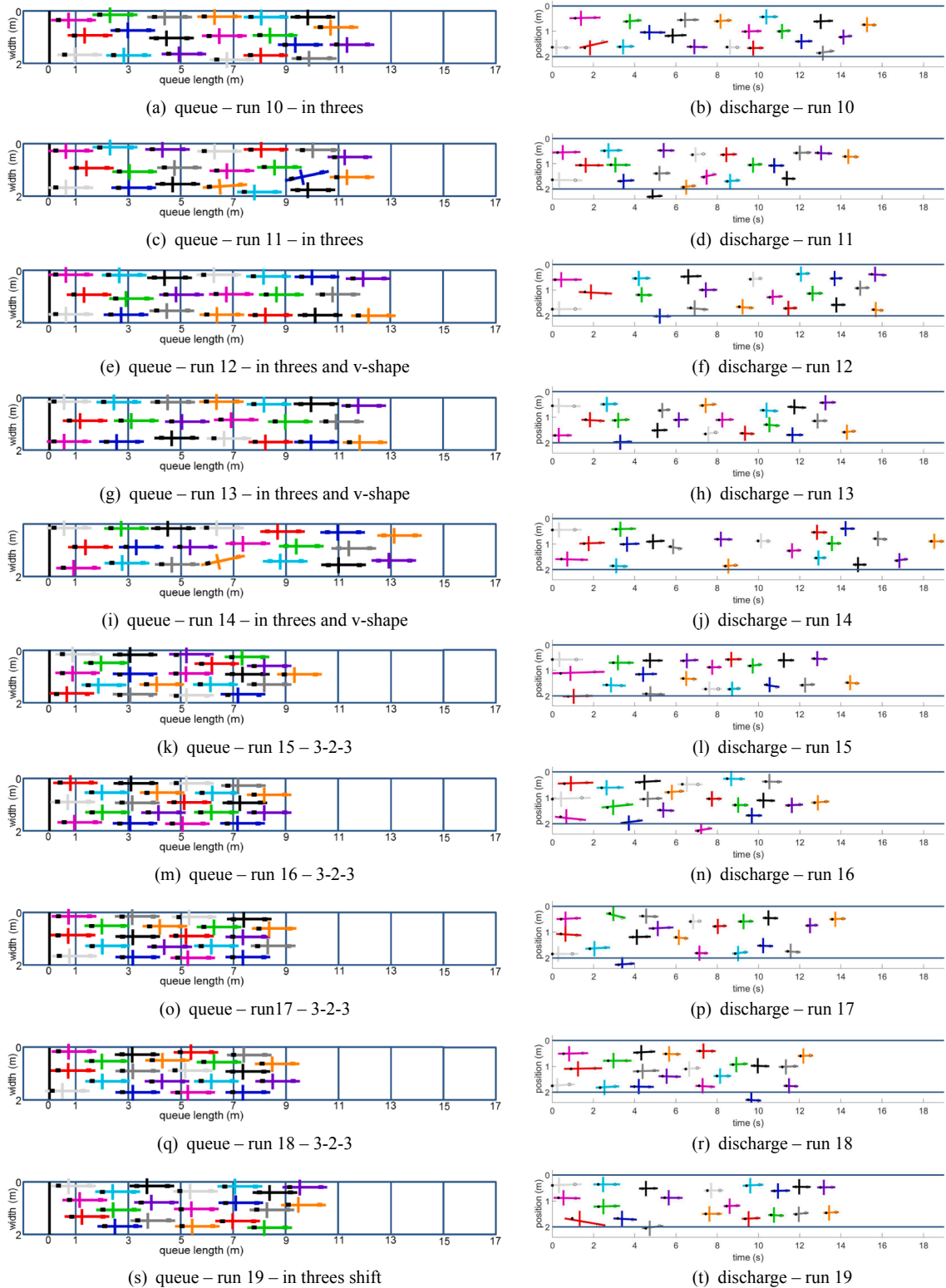

Fig. A.2. Observed queue configurations and discharge patterns of run 10–19.

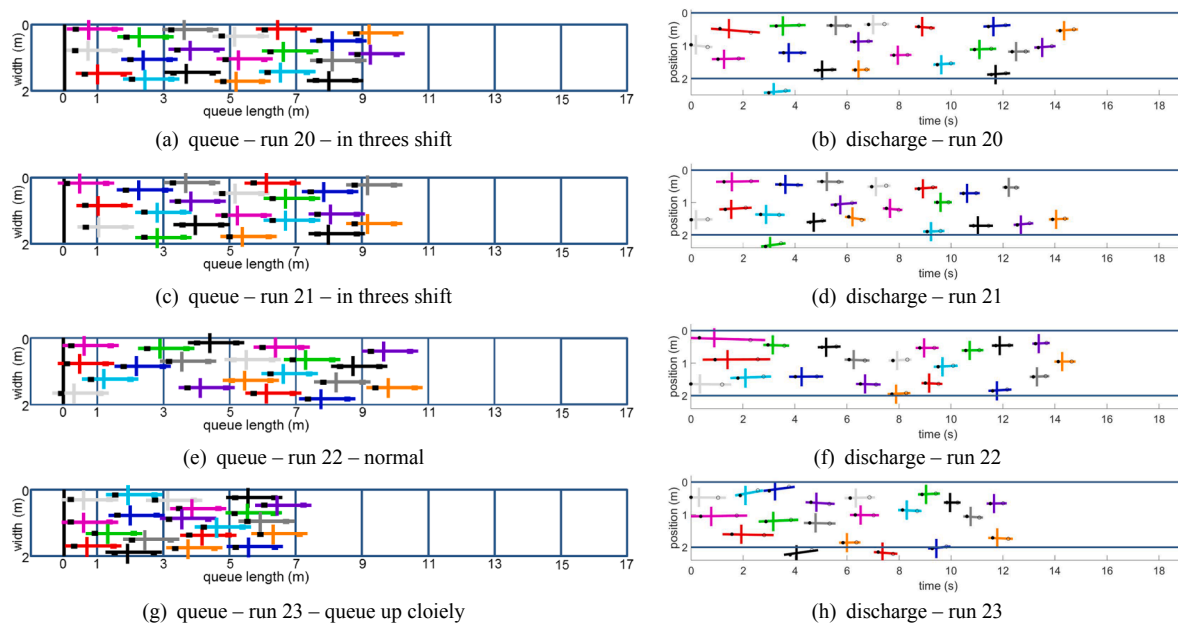

Fig. A.3. Observed queue configurations and discharge patterns of run 20–23.

References

- Allen, D., Roupail, N., Hummer, J., Milazzo, J., 1998. Operational analysis of uninterrupted bicycle facilities. *Transp. Res. Rec.* 1636 (1), 29–36.
- Botma, H., Papendrecht, H., 1991. Traffic operation of bicycle traffic. *Transp. Res. Rec. J. Transp. Res. Board* 1320 (1), 65–72.
- Daganzo, C.F., 2008. Cumulative plots. In: *Fundamentals of Transportation and Traffic Operations*. Emerald Group Publishing Limited, pp. 25–46 (Chapter 2).
- Deng, X.H., Xu, J., 2014. Study on bicycle flow characteristics at intersections. In: Mohammadian, Goulias, Cicek, Wang, Maraveas (Eds.), *Civil Engineering and Urban Planning III*. Taylor & Francis Group, London, pp. 393–399.
- Forsyth, A., Oakes, J.M., 2015. Cycling, the built environment, and health: results of a midwestern study. *Int. J. Sustain. Transp.* 9, 49–58.
- Gavriilidou, A., Daamen, W., Yuan, Y., Hoogendoorn, S.P., 2019. Modelling cyclist queue formation using a two-layer framework for operational cycling behaviour. *Transp. Res. Part C: Emerg. Technol.* 105, 468–484.
- Gavriilidou, A., Wierbos, M.J., Daamen, W., Yuan, Y., Knoop, V.L., Hoogendoorn, S.P., 2019. Large-Scale Bicycle Flow Experiment: Setup and Implementation. *Transp. Res. Rec. J. Transp. Res. Board* 2673 (5), 709–719.
- Goñi-Ros, B., Yuan, Y., Daamen, W., Hoogendoorn, S.P., 2018. Empirical analysis of the macroscopic characteristics of bicycle flow during the queue discharge process at a signalized intersection. *Transp. Res. Rec.* 2672 (36), 51–62.
- Guo, N., Jiang, R., Wong, S.C., Hao, Q.-Y., Xue, S.-Q., Hu, M.-B., 2019. Bicycle Flow Dynamics on Wide Roads: Experiment and Modeling arXiv:1904.06084.
- Harms, L., Bertolini, L., Brömmelstroet, M.T., 2016. Performance of municipal cycling policies in medium-sized cities in the Netherlands since 2000. *Transp. Res. Part C* (1), 134–162.
- Harms, L., Kansen, M., 2018. *Cycling Facts*. Technical report.
- Hoogendoorn, S., Daamen, W., 2016. Bicycle headway modeling and its applications. *Transp. Res. Rec. J. Transp. Res. Board* 2587 (1), 34–40.
- Jiang, R., Hu, M.-B., Wu, Q.-S., Song, W.-G., 2016. Traffic dynamics of bicycle flow: experiment and modeling. *Transp. Sci.* 51 (3), 998–1008.
- Jin, S., Qu, X., Zhou, D., Xu, C., Ma, D., Wang, D., 2015. Estimating cycleway capacity and bicycle equivalent unit for electric bicycles. *Transp. Res. Part A: Policy Pract.* 77, 225–248.
- Kneidl, A., 2016. How do people queue? A study of different queuing models. In: Knoop, V.L., Daamen, W. (Eds.), *Traffic and Granular Flow '15*. Springer International Publishing, pp. 201–208.
- Knoop, V.L., Hoogendoorn, S.P., van Zuylen, H.J., 2009. Processing traffic data collected by remote sensing. *Transp. Res. Rec. J. Transp. Res. Board* 2129 (1), 55–61.
- Kucharski, R., Drabicki, A., Żyłka, K., Szarata, A., 2019. Multichannel queuing behaviour in urban bicycle traffic. *Eur. J. Transp. Infrastruct. Res.* 19 (2), 116–141.
- Mai, X., Lv, W., Wei, X., Song, W., Jiang, R., 2013. Analyzing the characteristics of unidirectional bicycle movement around a track based on digital image processing. *Procedia Eng.* 62, 519–524.
- Municipality Utrecht, 2020. *Traffic Counts Utrecht*. <http://mobiliteitsdata-utrecht.nl/tellingen/> (accessed September 25, 2020).
- Navin, F.P.D., 1994. Bicycle traffic flow characteristics: experimental results and comparisons. *ITE J.* 64 (3), 31–37.
- Opiela, K.S., Khasnabis, S., Datta, T.K., 1980. Determination of the characteristics of bicycle traffic at urban intersections. *Transp. Res. Rec.* 743, 30–38.
- Paulsen, M., Nagel, K., 2019. Large-scale assignment of congested bicycle traffic using speed heterogeneous agents. *Procedia Comput. Sci.* 151, 820–825.
- Prati, G., Fraboni, F., De Angelis, M., Pietrantoni, L., Johnson, D., Shires, J., 2019. Gender differences in cycling patterns and attitudes towards cycling in a sample of european regular cyclists. *J. Transp. Geogr.* 78, 1–7.
- Raksuntorn, W., Khan, S.I., 2003. Saturation flow rate, start-up lost time, and capacity for bicycles at signalized intersections. *Transp. Res. Rec. J. Transp. Res. Board* 1852 (1), 105–113.
- Seriani, S., Fernandez, R., Hermosilla, E., 2015. Experimental study for estimating capacity of cycle lanes. *Transp. Res. Procedia* 8, 192–203.
- Wang, Y.G., Wei, G., Zhu, X., Pei, Y.L., 2011. Capacity of bicycle platoon flow at two-phase signalized intersection: a case analysis of Xi'an City. *Promet - Traff. Transp.* 23 (3), 177–186.
- Wierbos, M.J., Knoop, V.L., Goñi-Ros, B., Hoogendoorn, S.P., 2020. The influence of jam density and merging cyclists on the queue discharge rate. *J. Adv. Transp.* 2020, 1–10.
- Wierbos, M.J., Knoop, V.L., Hänsseler, F.S., Hoogendoorn, S.P., 2019. Capacity, capacity drop, and relation of capacity to the path width in bicycle traffic. *Transp. Res. Rec.* 2673 (5), 693–702.
- Yuan, Y., Goñi-Ros, B., Poppe, M., Daamen, W., Hoogendoorn, S.P., 2019. Analysis of bicycle headway distribution, saturation flow and capacity at a signalized intersection using empirical trajectory data. *Transp. Res. Rec. J. Transp. Res. Board* 2673 (6), 10–21.

- Zhang, J., Mehner, W., Andresen, E., Holl, S., Boltes, M., Schadschneider, A., Seyfried, A., 2013. Comparative analysis of pedestrian, bicycle and car traffic moving in circuits. *Procedia Soc. Behav. Sci.* 104, 1130–1138.
- Zhao, Y., Zhang, H., 2017. A unified follow-the-leader model for vehicle, bicycle and pedestrian traffic. *Transp. Res. Part B: Methodol.* 105, 315–327.
- Zhou, D., Xu, C., Wang, D.-H., Sheng, J., 2015. Estimating capacity of bicycle path on urban roads in Hangzhou, China. In: *TRB 94th Annual Meeting Compendium of Papers*.