

# technology

## **The Zone of Disassembly**

*Unveiling the hidden flows of e-waste*

North Sea: Landscapes of Coexistence  
Transitional Territories Studio 2018-2019



## Index

Abstract	5
1. Case	7
2. Climate design	11
3. Structure	15
4. Facades	21
5. Detail	14
6. Conclusion	43





## Abstract

Material possession has become our objective for existence. Capital surrounds and defines us. The high dynamics of global flows dominate the planetary web of connectivity. Consumption, production, and assembly have become the holy trinity of the neo-liberal realm we live in. It is a manifestation of the global dynamics, neglecting distances, identity and time, yet celebrating purpose, capital, and proliferation. Meanwhile, the aftermaths of these actions remain concealed. The Zone of Disassembly reacts to this imbalance and aims to track, unveil and transform one of the consumption's tangible outcomes: the e-waste.

Currently, the e-waste is the fastest-growing stream of waste. The contradicting nature of this matter has defined the dualistic nature of this type of waste: value and toxicity have become fundamental terms when mentioning e-waste. Yet both of them could easily exist in unison when the issue is being tackled carefully. This project resembles a critique toward the current policies regarding e-waste: incompetent formulation of recycling practices and lack of contemporary, adequate methodology results in the conscious exclusion of these so-called ore-streams results in huge economic, natural and ecological losses. 'The Zone of Disassembly' derives from the question of territory and formulates a spatial intervention that has the potential to unveil the North Sea hidden e-flows. It is articulated via two interconnected spatial agencies, which establish an infrastructural threshold: the waste archipelago and the waste plant.

Key words: e-waste, disassembly, territory, hidden flows



Case

## Case

For the development of the build technology a small fragment of the building has been chosen. Yet, the repetitive nature of the façade and the construction technology allow complete understanding of the technological aspects of the project. The position of the 'Hazardous Disassembly' unit is just in the middle of the building. The organisation of the plans show us that the ground floor is the public area of the building. On the second (and third) floor, typically one can find laboratories and offices, where cognitive labour is being performed. The most significant part of the manual disassembly plant remains the attached warehouse, which covers the previous two area. It appears to be a closed unit, yet to distinct roof-shapes characterize each one of the manual disassembly units.

The following building technology research will dive into the technical aspects of the building, elaborate on the climate design, the technical connection between automated and manual labour, and explain in detail the 'visual permeability concept of the land-project.

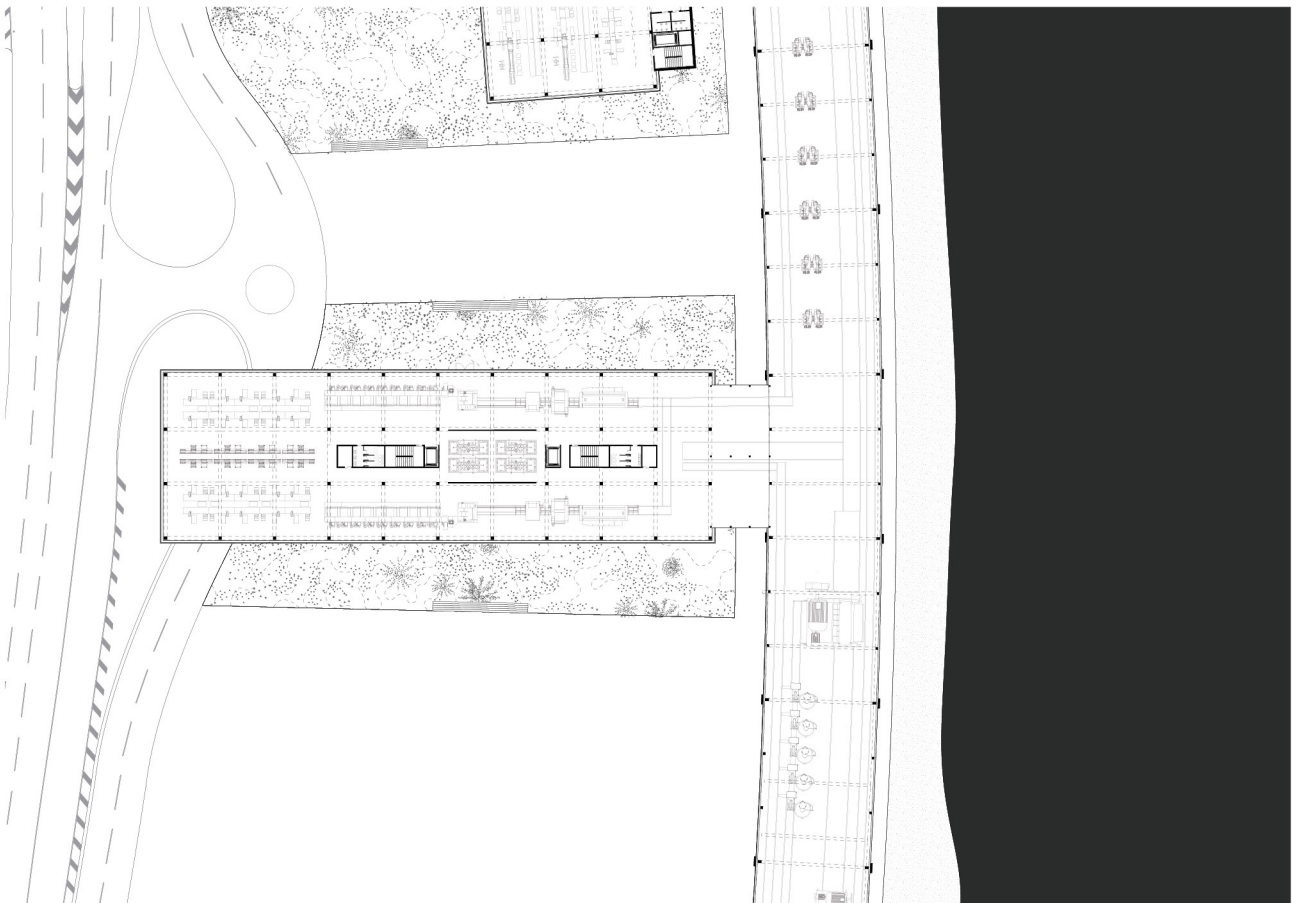
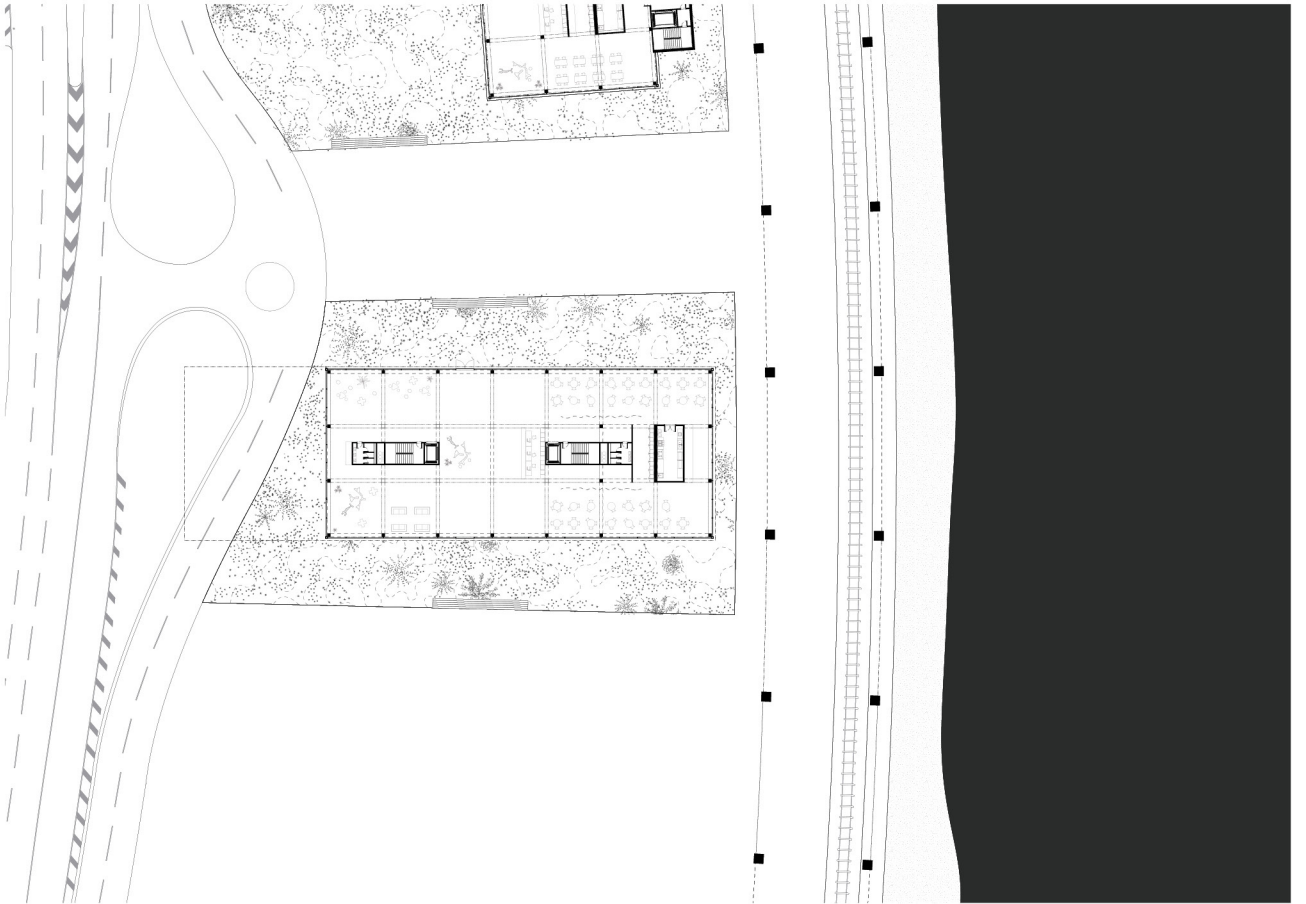



## Climate Design

## Climate

The design of the plant's climate plays a crucial role in the concept regarding the co-existence of manual and automated labour. The concept is repetitive along the entire length of the curved automated 'spine'. It tries to establish an energetic symbiosis between the 'urban mining' industry and the human dedicated areas.

To do so, the hot air generated by the machines in the 'spine' is being extracted via the mechanical ventilation with heat recovery and use to preheat the liquid heating/cooling the manual units. Furthermore, the building also takes advantage of the close proximity it has to the river, and has a water-source pump located in every 'manual unit'. This way the rather constant temperature of the Elbe river utilizes to support the temperature comfort and technical demands of the entire plant.

The roof top is being covered with PV panels which generate energy for the low energy heating. The industrial machines, however, gain their electricity via the local energy grid, which is being step up by the 'internal' transformer located in the service building of the plant.

- High voltage electricity
- Low voltage electricity
- Ventilation
- Liquid cooling system
- Liquid heating system

- 1 Medium to high voltage electricity transformer
- 2 Mechanical ventilation with heat recovery
- 3 Transformer / Inverter
- 4 Water source heat pump
- 5 Preheating unit
- 6 Water pump
- 7 Heat exchanger for ventilation
- 8 Mechanical ventilation with heat recovery
- 9 PV panels



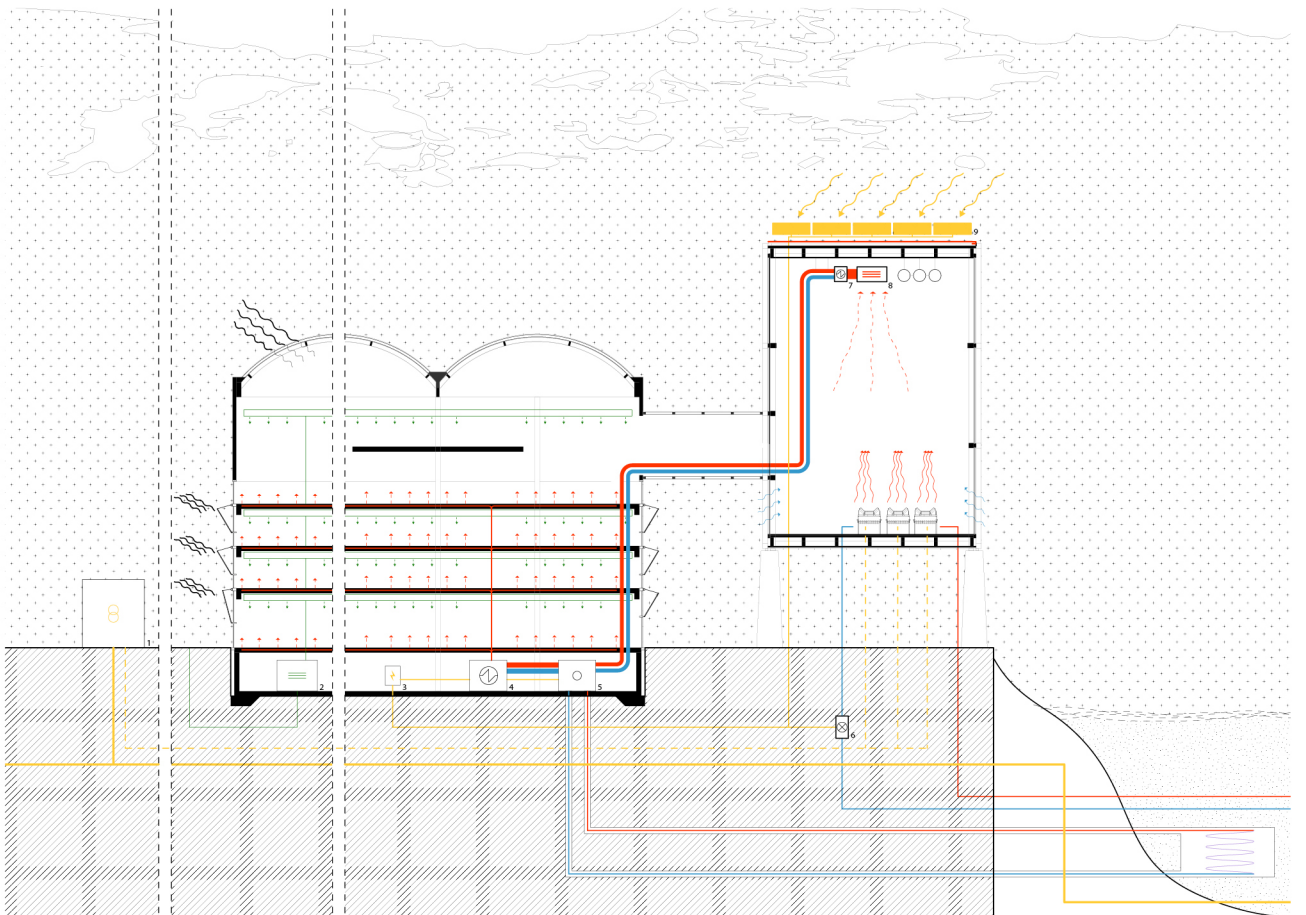
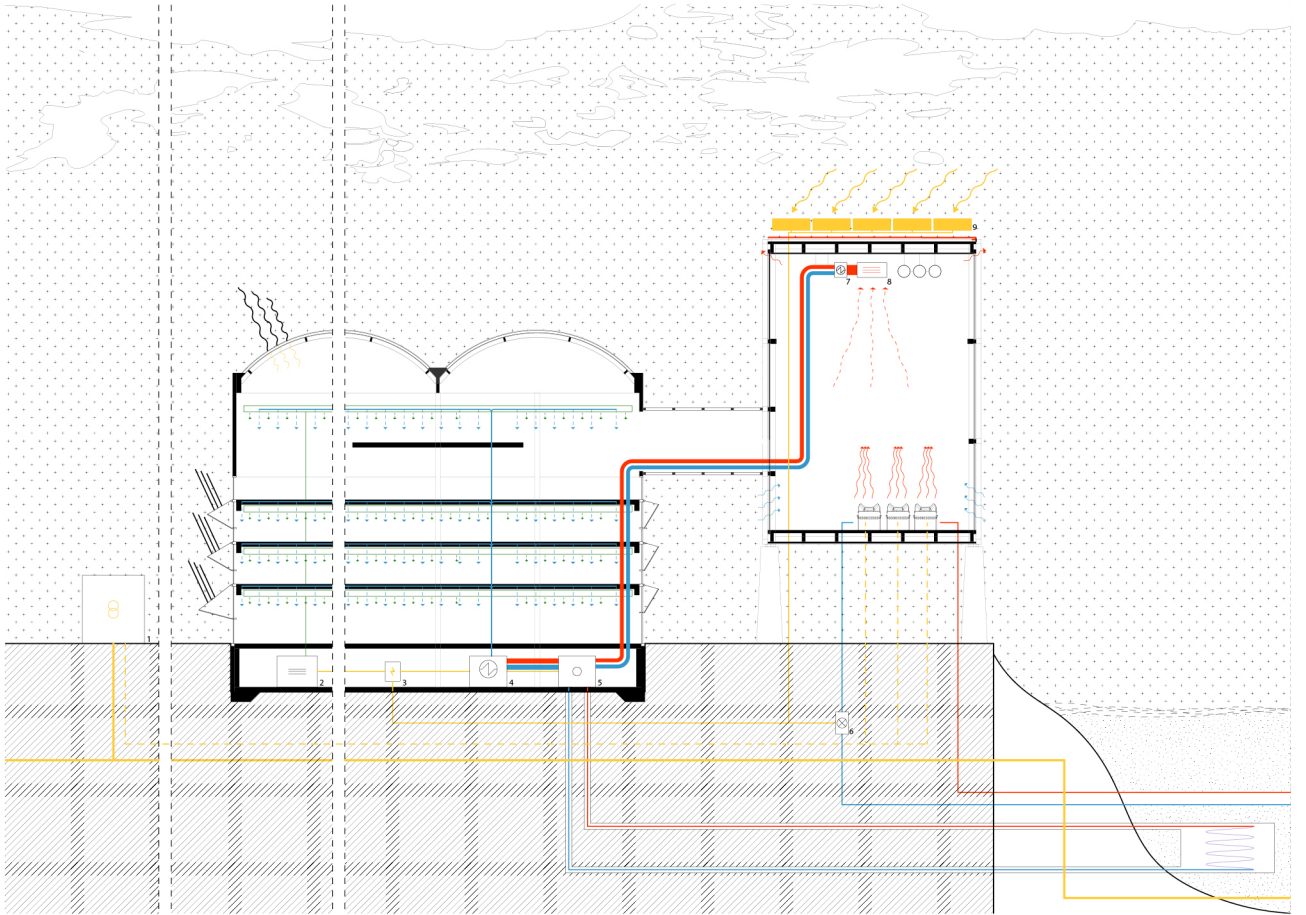



Structure

## Plant | Automated

The structure of the entire belt is rather linear. It consist of 60 similar units which have size of 24m x 16m. The entire building is being placed on concrete pillars which then continue into the steel frame of the plant. Tension rods are being places along the entire façade to sustain the visual aesthetics of the visually exposed areas.

The structural concept of the building is vital for the project. The polycarbonate façade, which exposes the internal processes of automated disassembly is crucial for the connectivity between the design and the public. The spiritless spine lacks on any distinctive visual signs, and it appears to be just a skeleton, sustained by its functional aspect. The repetitively also highlights the monstrous size of the plant, building a spatial contradiction. The 'showcase' façade acts as an alerting sign in the city of Hamburg, which demands the social attention regarding the European (and also planetary) e-waste policies.

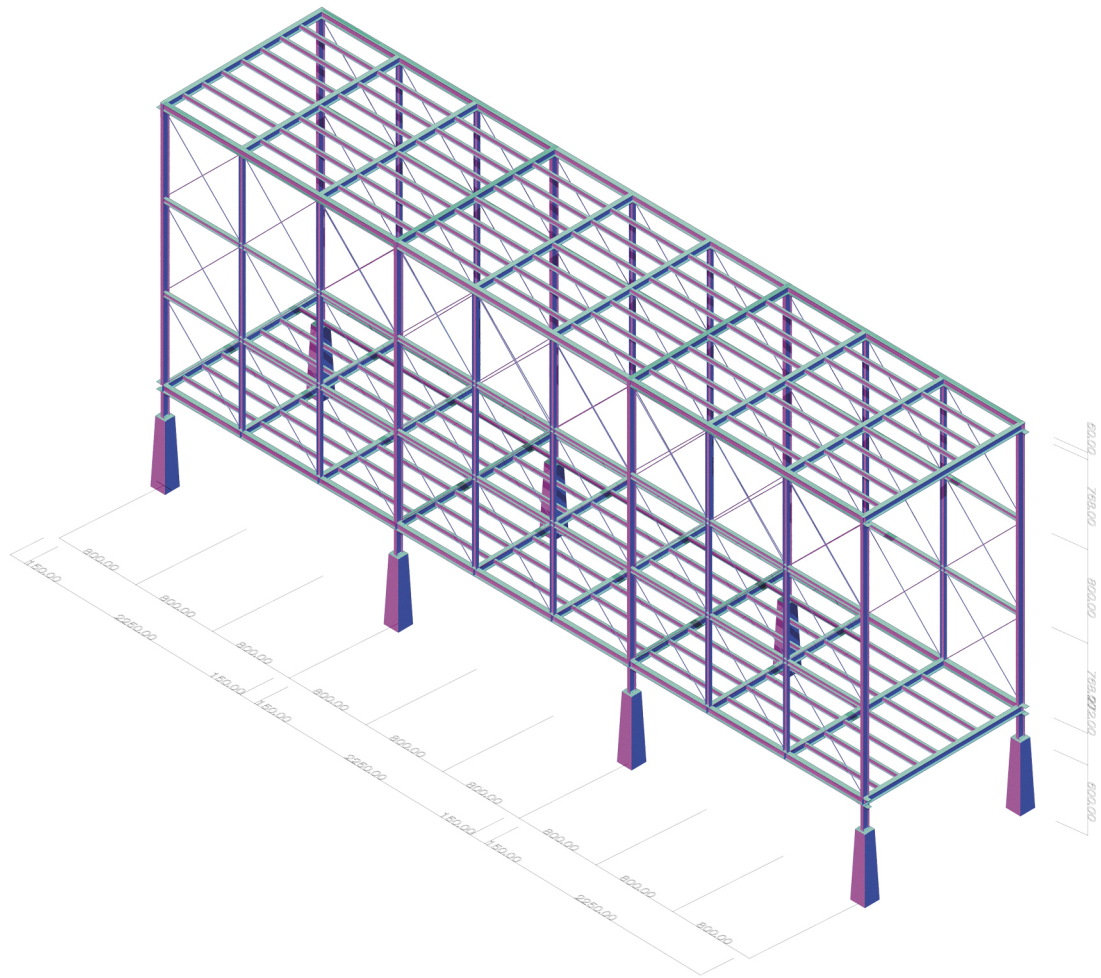

## Plant | Manual

The manual plants have similar concept to the automated area of the project. They also have rather simple structure defined by a grid 8x8m, being covered with a clear glass façade. The elevation of every side is similar, which leaves no dark interior areas, creating an illusion of the missing façade. Therefore one can see the entire interior of the office/lab floors and the public such. In this case once again the building becomes a skeleton which exposes the interior and its functionality. The rough appearance and linearly aligned façade also cast no shadow and add no plasticity to the elevation, once again highlighting the internal parts of the building.

The distinct volumes on the top of every manual plant are the only characterizing objects on the site. Their copper façade encloses entirely the interior, which host the manual disassembly on site. The translucent roof are the only source of sun light, yet they also characterize each one of the volumes which correspond to the distinct performance objectives of every unit.

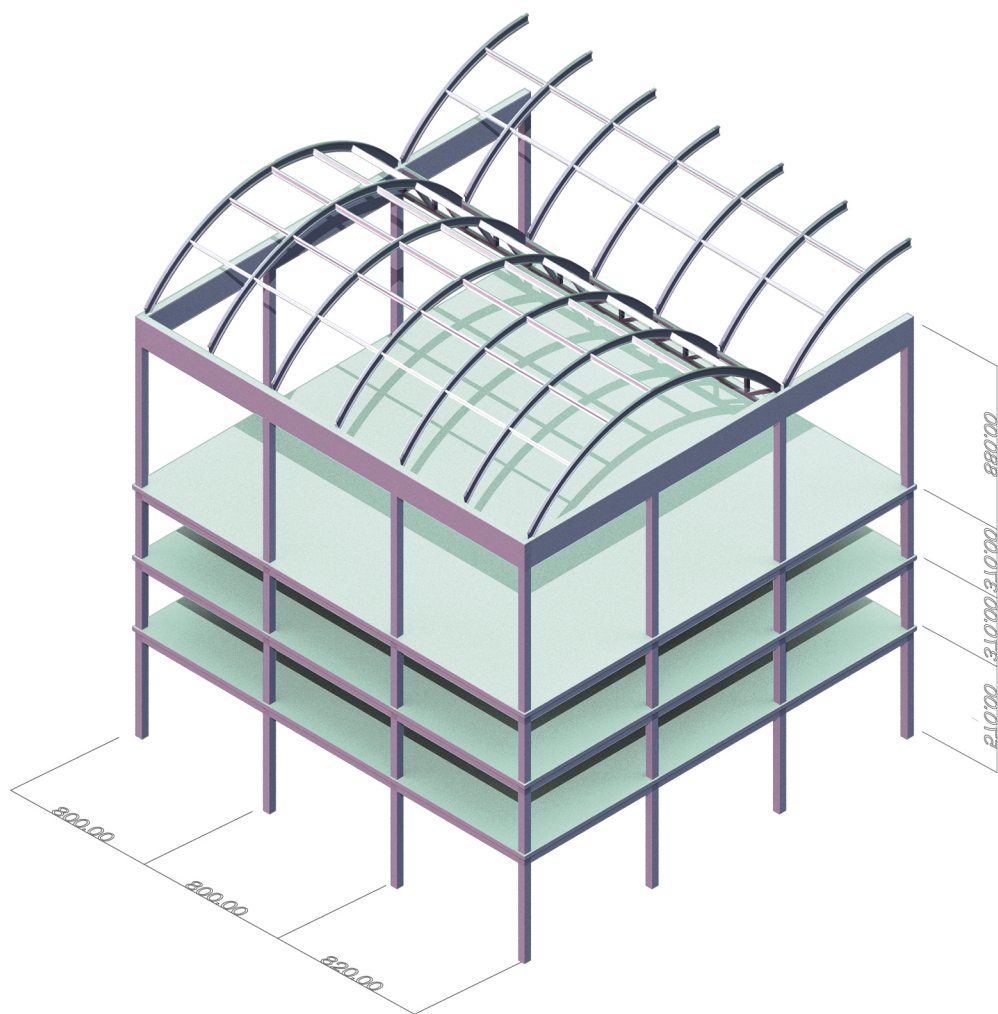





## Facades

## Facade | Manual Disassembly

1. Concrete - 300 mm
  2. Plaster plate on rail structure- 10 mm
  - 3.OSB - 13 mm
  3. Soft insulation - 125 mm
  4. Slotted C channel - 125 mm
  5. Double skin for insulation - 70 mm
  6. Secondary metallic structure for cladding - 70 mm
  7. Vertical cladding in anodized aluminium - 20 mm
  8. Corrugated Copper Sheet
- 

1. Floor finish - 20 mm
  2. Floor screeds/underfloor heating system- 50 mm
  3. Acoustic insulation - 50 mm
  4. Concrete- 200 mm
  5. Smart ceiling
    - a. mechanical ventilation
    - b. fire sprinklers system
    - c. radiant ceiling cooling - 40 mm
    - d. intuitive LED lighting
    - e. galvanized steel grating suspended ceiling - 30 mm
- 

1. Concrete - 350 mm
  2. Insulation - 230 mm
  3. Waterproof membrane
  4. Soil
-

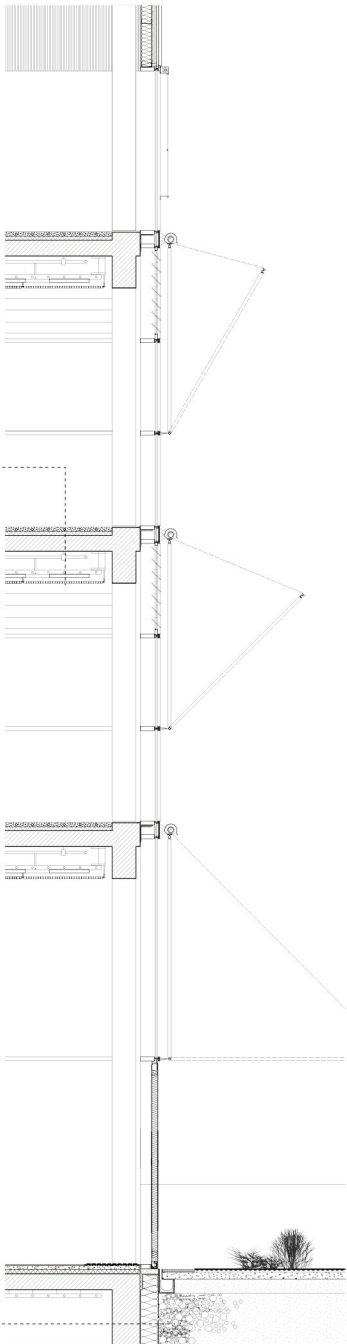
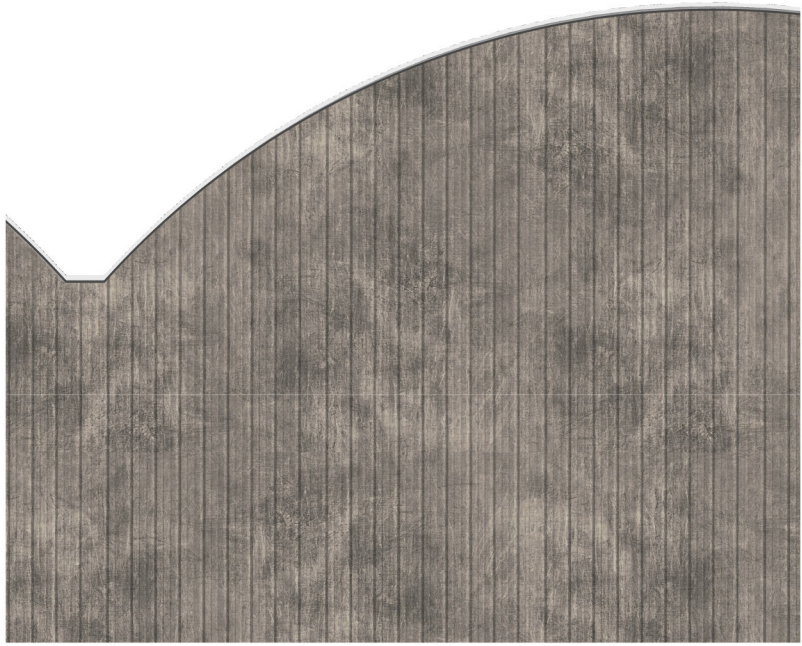
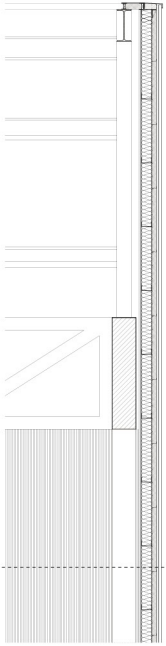

## Facade | Automated Disassembly

1. Galvanized steel grating pannel - 30 mm
  2. Adjustable pad - 100-150 mm
  3. Water Membrane
  5. Double layered structure for insulation - 200 mm
  6. Vapour Barrier
  7. Double layered structure for insulation (OSB) 20mm - xx mm
  8. Corrugated Steel / High density insulation - 100 mm
  9. Double layered structure for insulation (OSB) - 20 mm
  10. Steel frame- HEB 60010. Steel frame - IPE 180 mm
- 

1. Galvanized steel grating pannel - 30 mm
  2. Adjustable pad - 140 mm
  3. Concrete Slab - 100 mm
  4. Soft insulation - 430 mm
  5. Double layered structure for insulation - 20 mm
  6. Soft insulation -150 mm
  7. Double layered structure for insulation - 20 mm
  8. High density insulation - 100 mm
  9. Double layered structure for insulation - 20 mm
  10. Steel frame - HEB 600
  11. Galvanized steel grating suspended ceiling - 30 mm
-

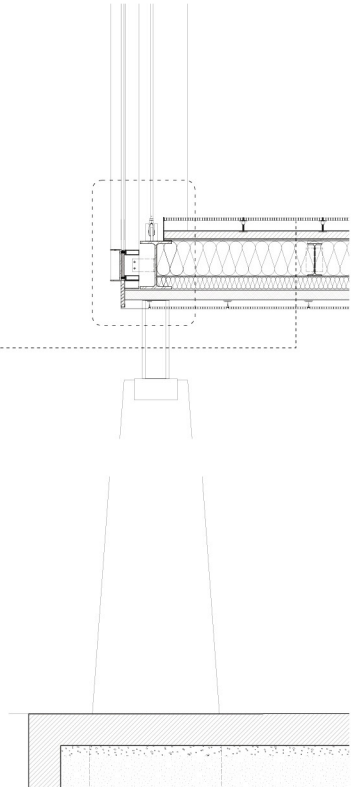
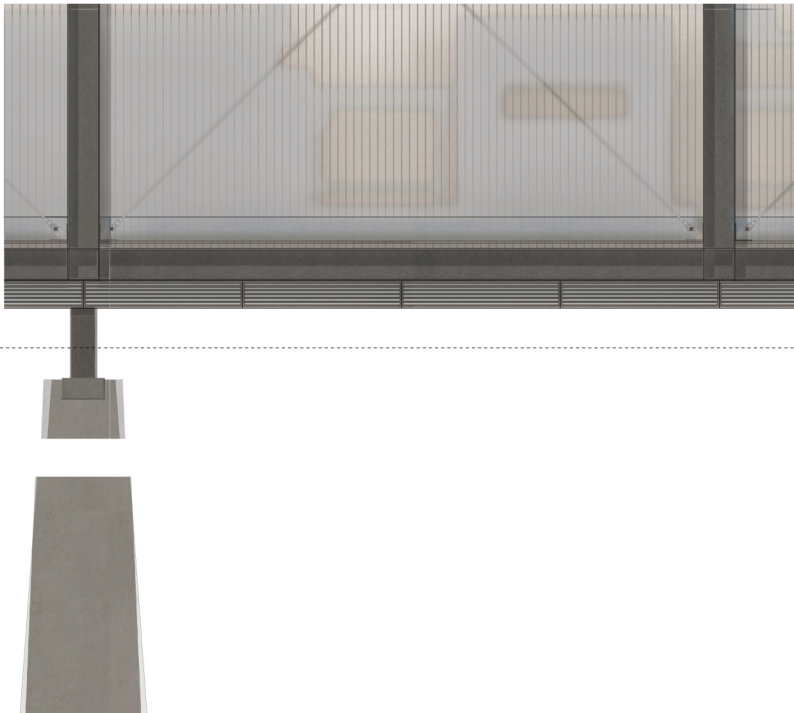
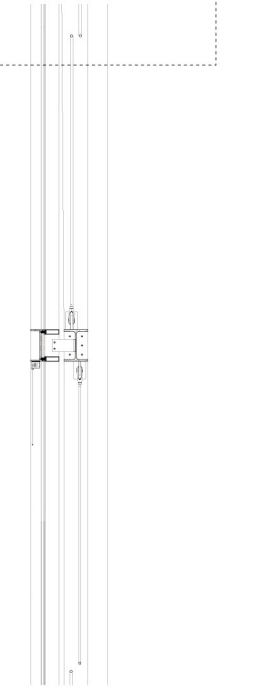
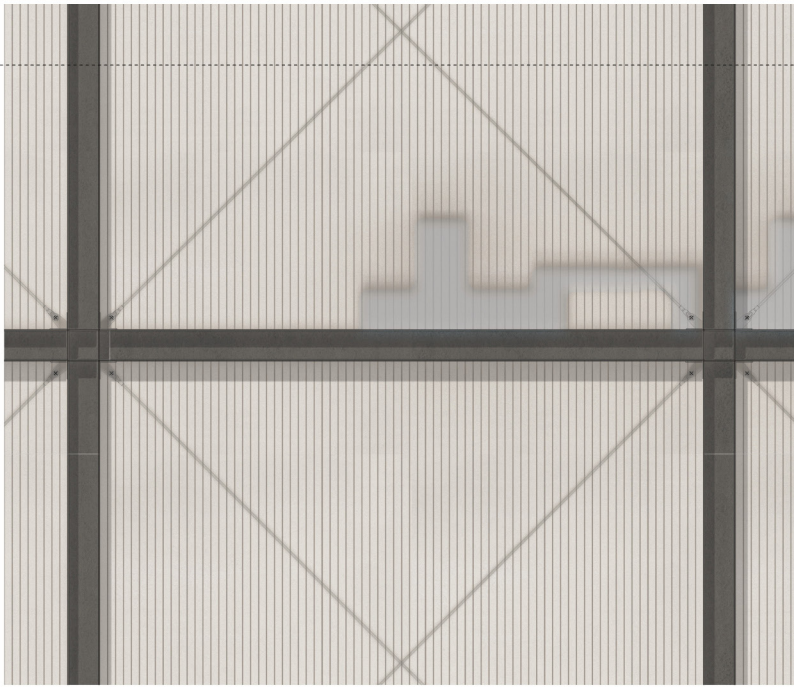
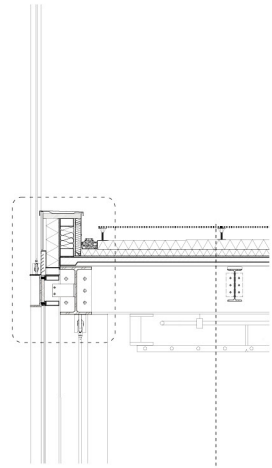
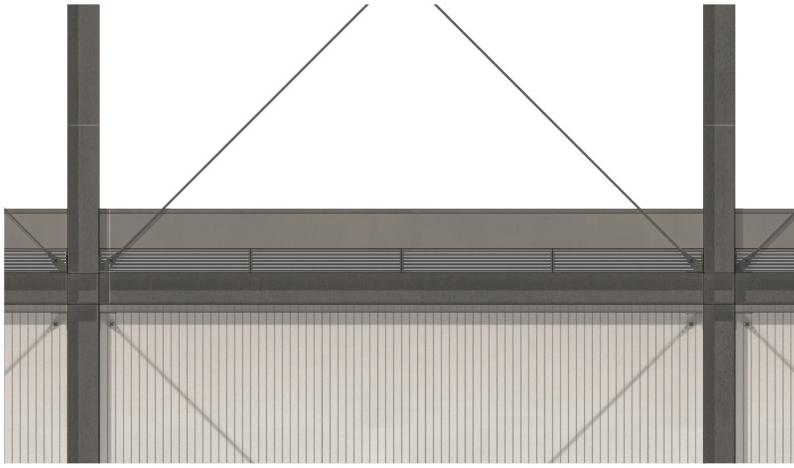

## Functional composition

1. Corrugated sheet - 10 mm
  2. Water Membrane
  3. XPS - 120 mm
  4. Double layered stucture for insolation (OSB) - 20mm
  5. Vapour Barrier
  5. Insolation - 80 mm
  6. Double layered stucture for insolation (OSB) - 20mm
- 

1. Corrugated sheet - 10 mm
  2. Water Membrane
  3. XPS - 120 mm
  4. Double layered stucture for insolation (OSB) - 20mm
  5. Vapour Barrier
  5. Insolation - 80 mm
  6. Double layered stucture for insolation (OSB) - 20mm
-

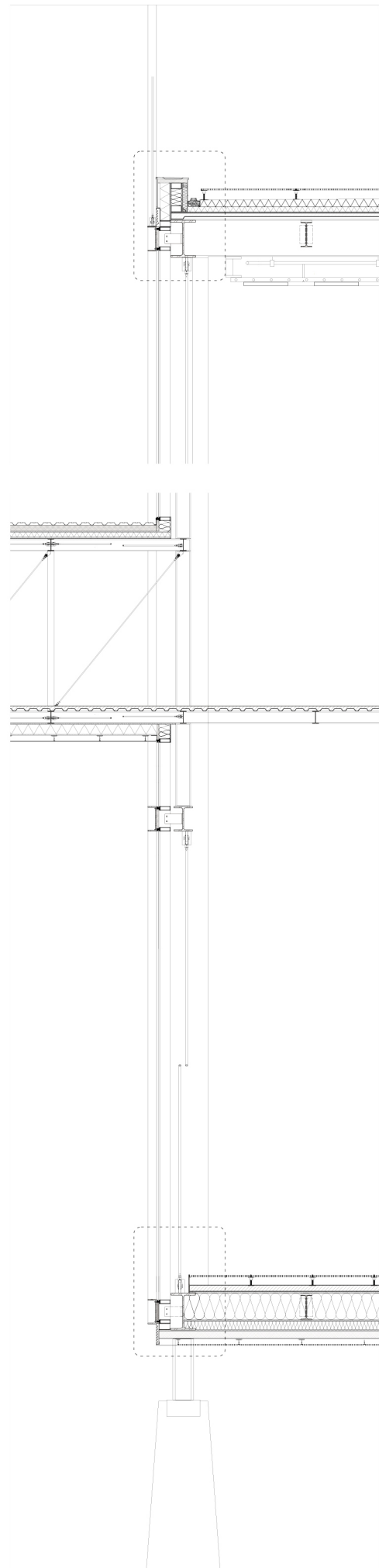
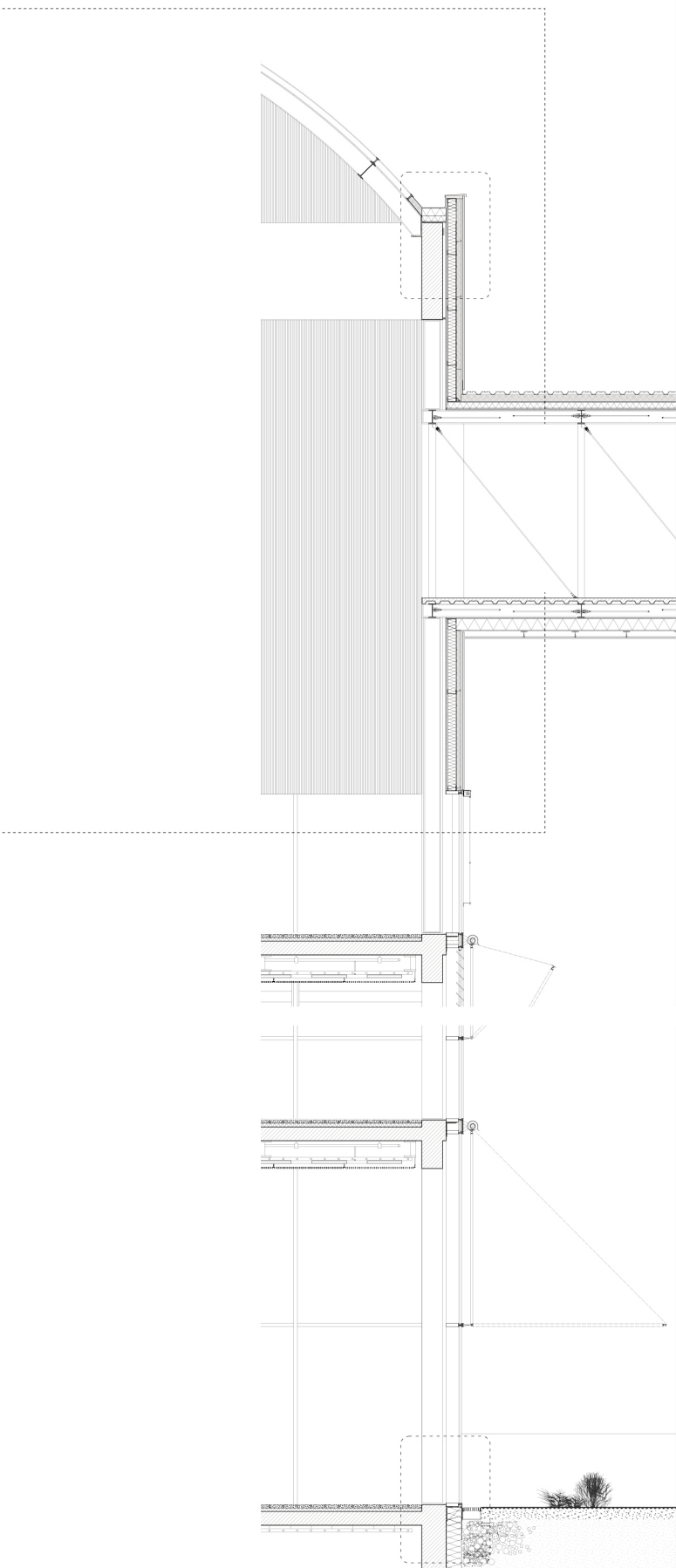





## Details

## Detail A v.1

1. Aluminium galvanized parapet coping
2. Light steel rectangular profile to support parapet
3. Light duty stainless steel metal grating
4. Insulation cut to achieve full (5)
5. Adjustable pedestal decking foot
6. L profile curtain wall support
7. Fan vent unit
8. Tension rod
9. Trickle vent
10. Vertical support system facade
11. Anodized aluminium

Steel Frame: HEB 600

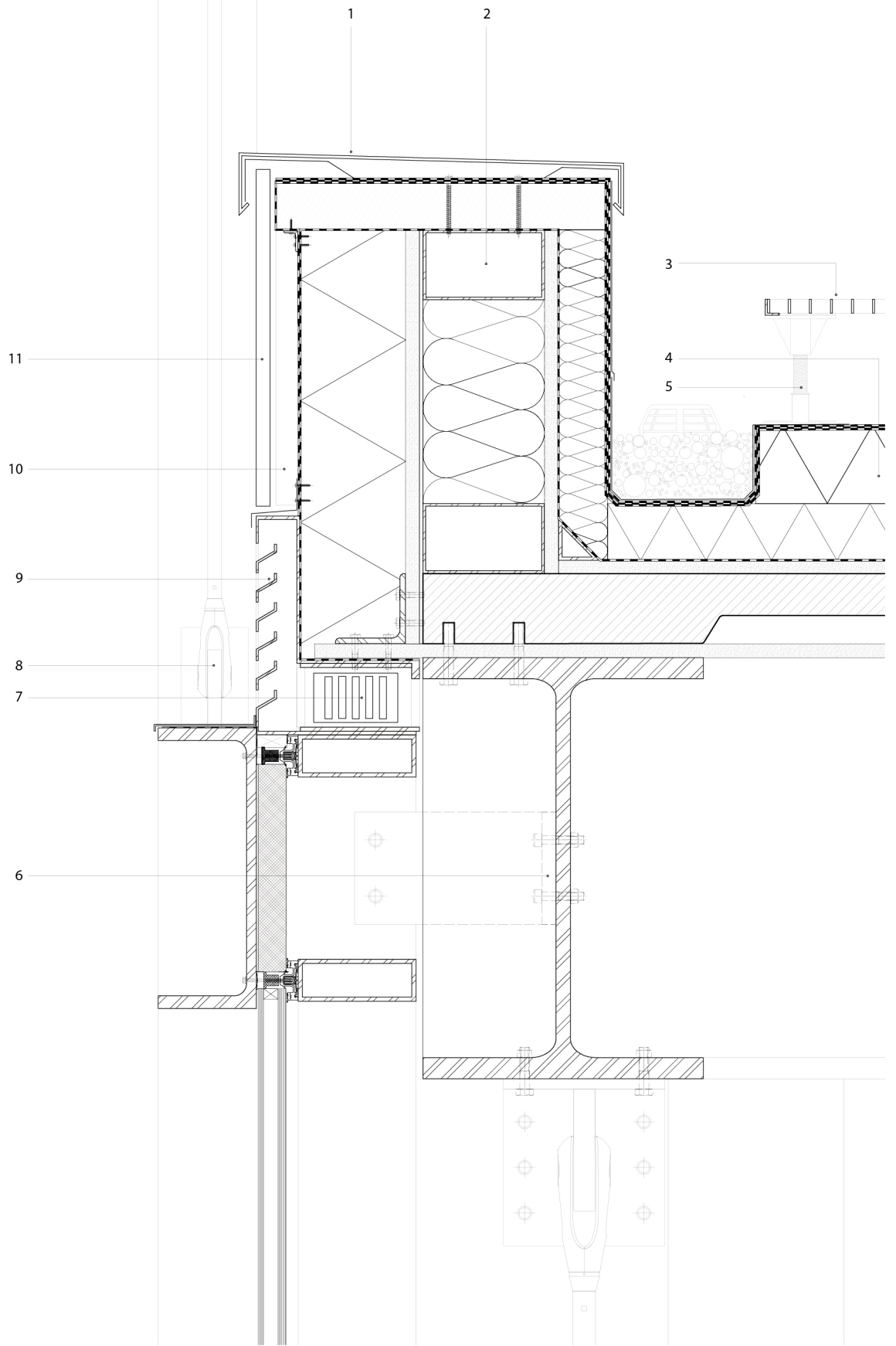

## Detail A v.2

1. Silicon movement joint
2. OSB 9mm
3. Screed
4. Vapour barrier
5. Damp roof course
6. Light duty stainless steel grating
7. Mild steel industrial suspended ceiling
8. Anodized aluminium metal soffit

Steel Frame: HEB 600

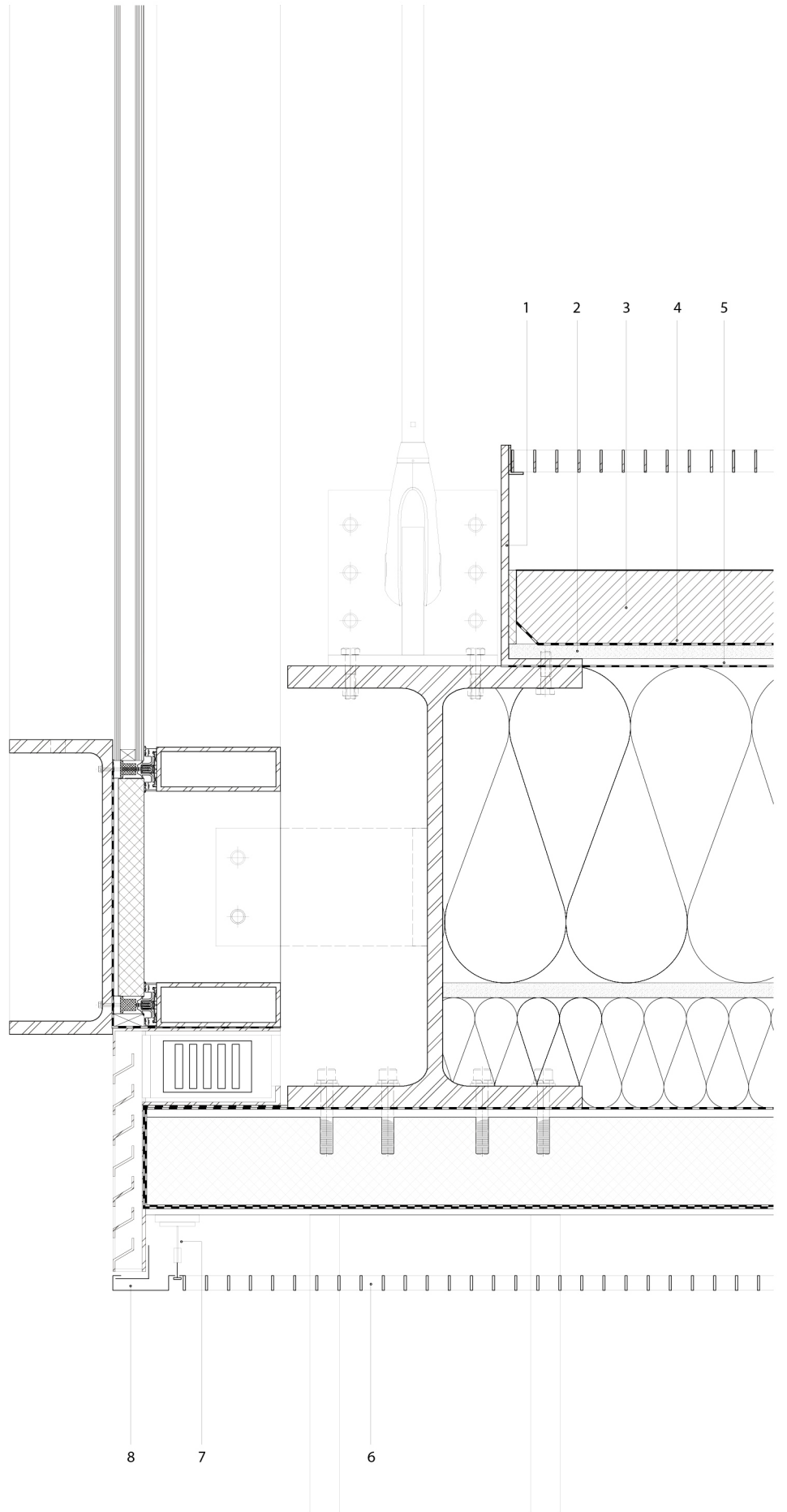

## Detail A h.1

1. Steel Frame: HEB 400
2. Glazing Bar
3. UPE 400
4. Facade Support Bracket
5. Rigid Insulation
6. Tension Rod
- 7 Light duty stainless steel metal grating

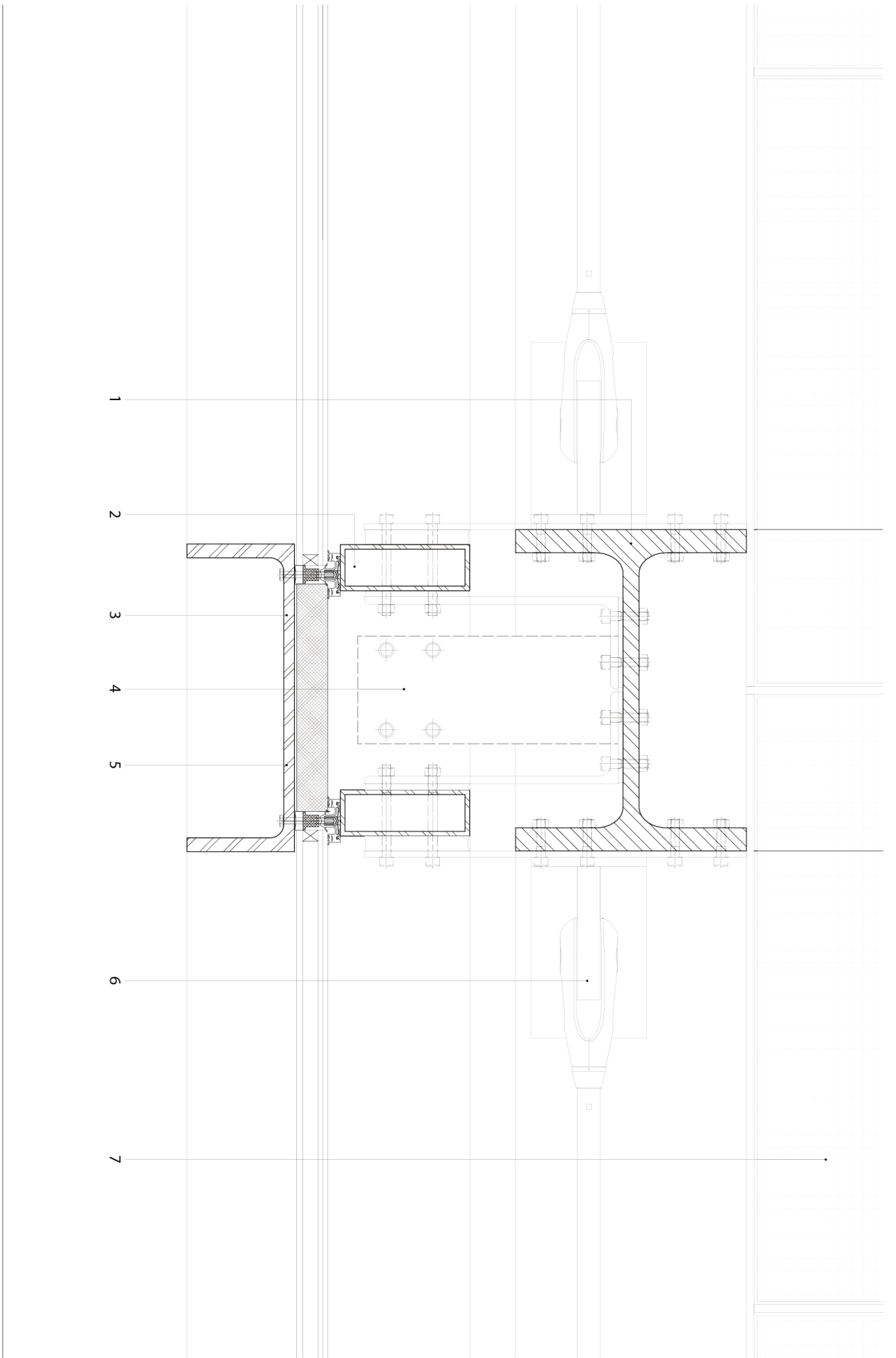

## B v.1

1. Aluminium galvanized parapet coping
2. Hardwood
3. Corrogated copper panel (xx X xx mm)
4. Metal sheet to fix rigid insulation
5. Rockwool insulation
6. Metal vertical bracing to fix facade element
7. Z section to fix vertical bracing
8. Top hat horizontal steel element
9. Translucent polycarbonate sheet
10. Glazing bar
11. XPS insulation
12. Double layer bitumen roof membrane
13. OSB sheathing
14. Ruber band
15. I-Beam
16. Stainless steel angle bracket
17. OSB sheathing
18. Gypson plaster board



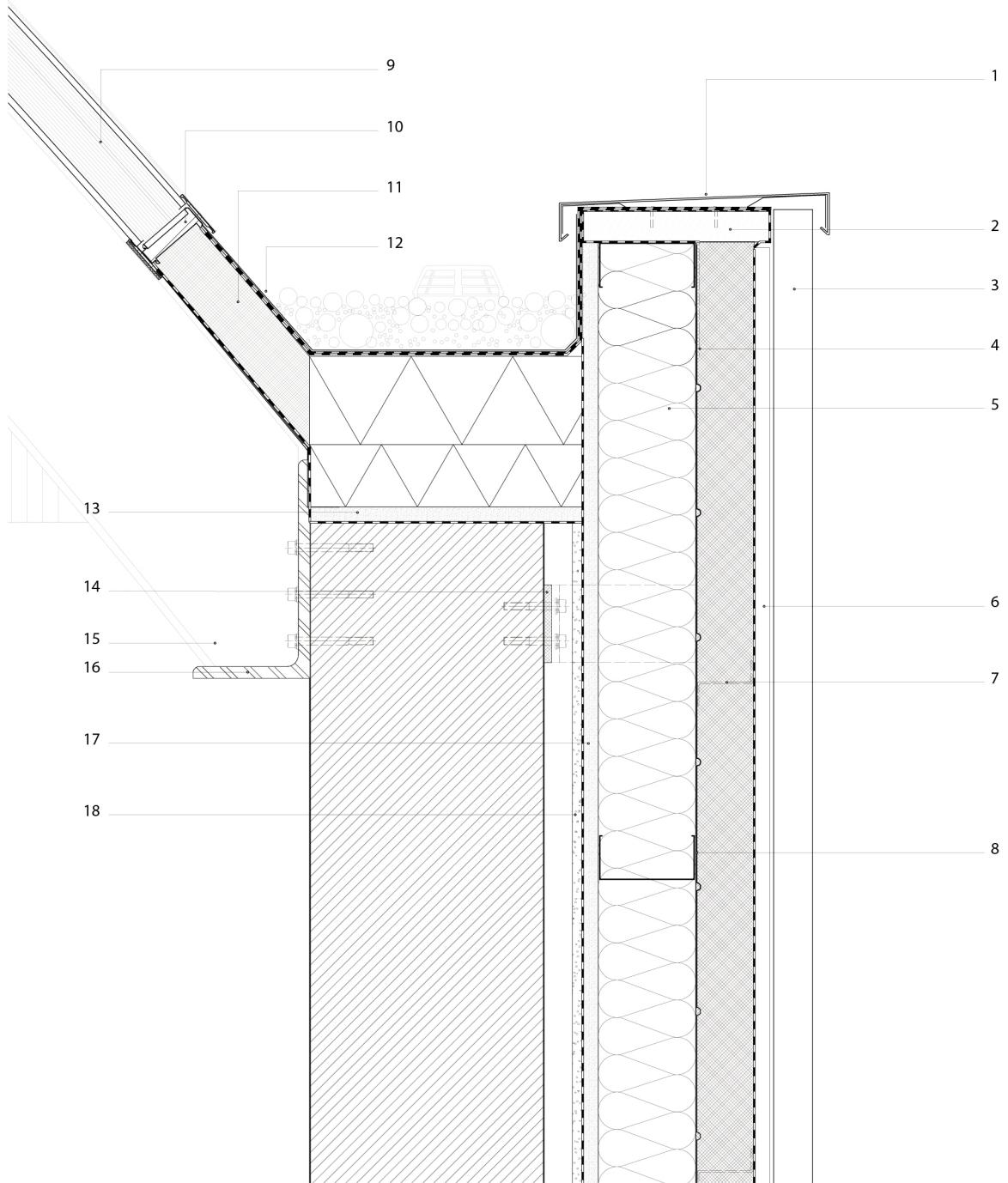

## B v.2

1. Glazing
2. Glazing bar
3. Insulated door leaf
4. Pre compacted sand
5. Reconstituted portland stone
6. Prefab gutter support structure
7. Linear gutter
8. Foamlglas
9. Metal threshold
10. Fixed door mat
11. Screed coat on liquid underfloor heating
12. Rigid acoustic insulation
13. Polished concrete finish
14. Ruber band
15. Facade support L profile
16. Gutter support L profile
17. Bitumen barrier
18. Stonewall insulation

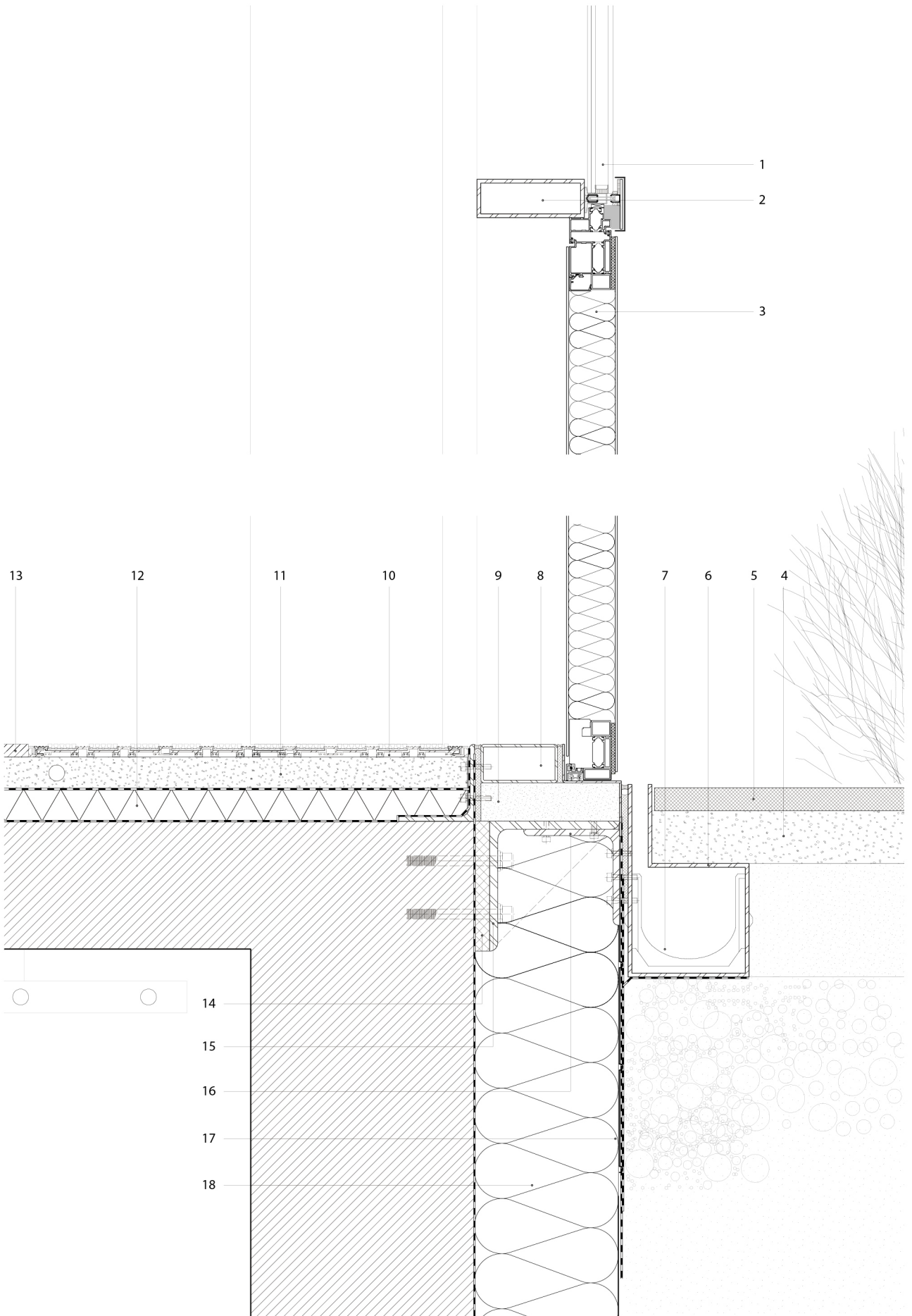

## B h.1

1. Fixed door mat
2. Insulated door leaf
3. Linear gutter
4. Light stainless steel grating

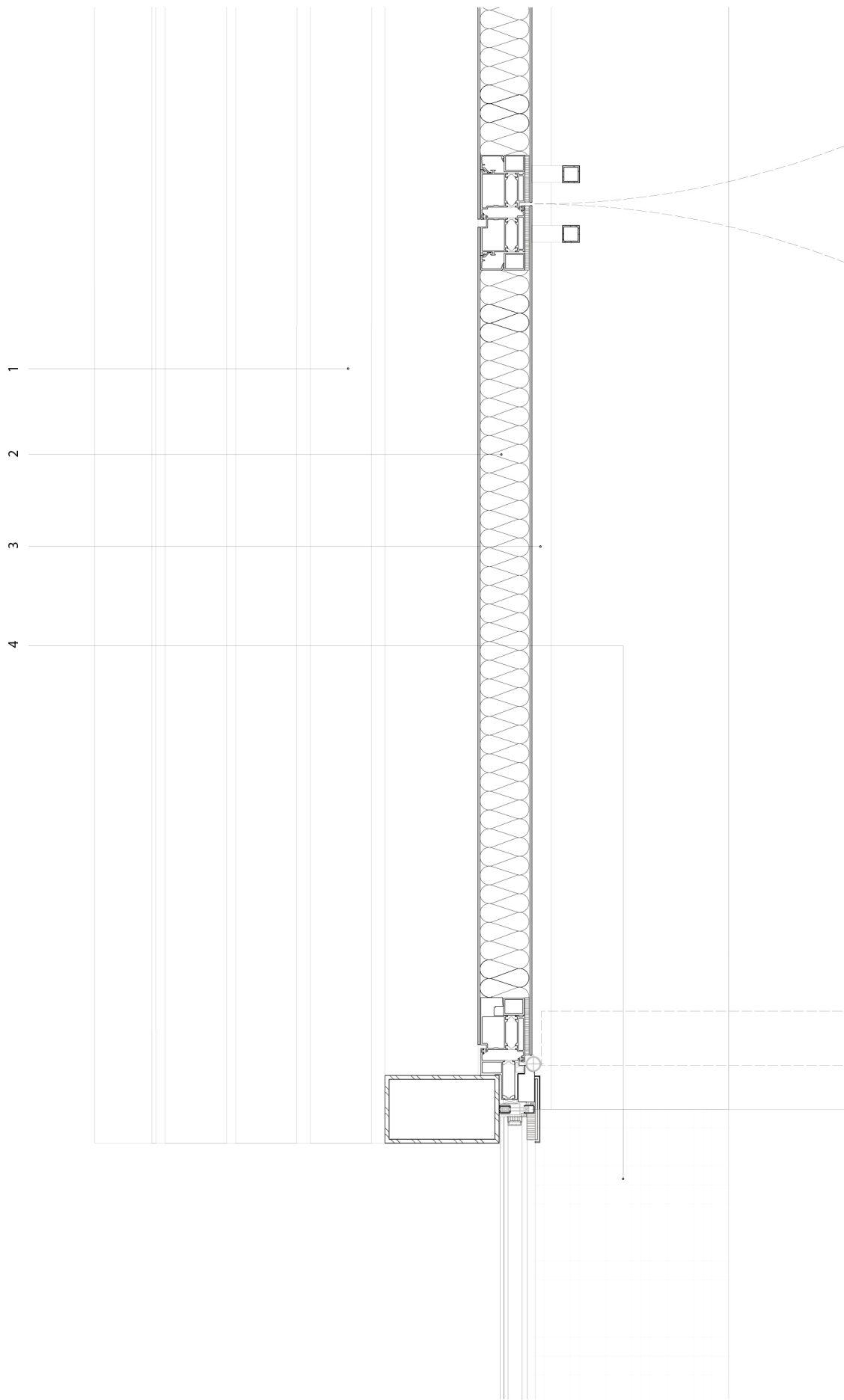



## Conclusion

In the process of designing this utopian project, which size imposes the difficulties to comprehend its performance, building technology plays crucial role to build up the argumentation for it. Although such monolithic object could hardly be constructed in any of the current democratic European states, the technological aspect of the building relies on its simplicity to facilitated the objective of the project.

Being the final scale of “The Zone of Disassembly” the detailing concludes the entire argument and close the multiscale approach preached by our studio. Again highlighting the repetitive nature of this large scale, territorial intervention one can still seize the quality of the architectural aspect in the 1:5 details, and the developed facades studied. Those inform about the design quality of the architecture and the connectivity it has to its context, yet also about the connectivity it establishes with the social layers of the city and the visitors, by exposing to the various disassembly procedures.

The studies of potential functional symbioses between humans and machines, regarding the technical aspect of the building also rises many questions regarding the close future. The current age of automation of almost every industry poses many unsolved issue, which however have huge potential for mutual benefits and coherent co-existence.





