

## Preface

The studio of Cross Domain Stad van de Toekomst (City of the Future) is a multidisciplinary graduation studio that puts the question of how to design and to develop an inner-city transformation area into an urban or architectural development for the near and far future. This studio focuses on the urgent social, local and spatial tasks in the area, which differs from a wide range of demands. With close companionship with the homonym multidisciplinary research initiative launched by the BNA (Bond van Nederlandse Architecten), the biggest municipalities of the Netherlands and DIMI, the City of the Future is working towards an integrated way of sharing perspectives about our multi-faced future challenges of urban environments.

This document is the result of Project HUMAM's graduation studio, which is firmly connected with the Cross Domain Studio lab. The studio offers the opportunity to discover the relationship between architecture and emerging technology, which can offer new outcomes and possibilities for our city of the future.

To conclude, I hope this project will spark the interest of other students, stakeholders and other interested parties to undertake working beyond your level of perspective in a challenging yet appealing environment.

I hope you enjoy reading.

Mesut Ulkü

Project HUMAM (Hub for Urban Mobility for Amsterdam Metropolitan Area)

TU Delft - Faculty of Architecture BK

*2018/2019*

  
**TU Delft**

**DIMI**

**PACT**

**UNS**  
UNSTUDIO

 **RADD.**  
RESEARCHLAB AUTOMATED DRIVING DELFT

**X** Gemeente  
**X** Amsterdam  
**X**

**eb**  
**S**



The report starts in Chapter 1 with an introduction of Amsterdam city and the problems the city will occur in the near future. In this chapter, the problem statement, the collaboration with the municipality of Amsterdam, with main stakeholder representative Jurgen Krabbenborg, was initiated. Furthermore, this chapter illustrates a brief story of the history and growing ambitions of the city. The most important aspect of this chapter is illustrating the use of the car. Chapter 2 delves into the ambition of specific stakeholders. This chapter mainly focuses in particular on the response to this growing problem of having too many cars in the city and to strive for higher density. In order to gain more support, various parties were interviewed. This interview was conducted with collaboration of my (mainly interim) graduation partner Gabriel Garcia of the Geomatics faculty. By interviewing not only the municipality but also architects and specialists of self-driving cars (Team RADD), connections could be made that contributed to the final design for this project.

To get more insight on other projects, several reference projects were analysed based on the coherence of efficiency and innovation in architecture and technology, to be found in chapter 3. Although some references are (and will be) still very futuristic, they do offer prospects with the technological possibilities that exist today. Based on the inspiration and the future problem in Sloterdijk, chapter 4 will illustrate the method of application of research. This chapter includes the essay for the City of the Future publication, which analyses the position of the architect due to upcoming technologies.

In order to understand the impact of the hub in the city, the “3 themes” will be introduced that is related to

the design choices in this project, which is illustrated in chapter 5. It mainly focuses on the effects of having a hub. How the architecture can benefit from this development. Chapter 6 is composed by different ways of investigating the most optimal location for the hub and the radius the hub should accommodate. This chapter serves to share insights from the PBL (Plan Bureau Leefomgeving) that analysed when people are taking the car or the bicycle based on comfort and distance.

Based on this information of the previous chapters, chapter 7 will dive into the social opportunities of a hub, serves to assess the design through the given criteria of the three themes and given program, leading towards the optimal solution towards a car-free environment.

The final chapter consists of the conclusion and recommendations for the selection of the elements a mobility hub must contain.

### **Autonomous vehicle (AV) -**

“Also known as Self-driving car or driverless car. A vehicle in which human drivers are never required to take control to operate the vehicle safely”.

### **Baby Hub -**

“The smaller version of a Mothership, while it still perceives the same functions”.

### **Big data -**

“Extremely large data sets that may be analysed computationally to expose patterns, trends and associations, specifically relating to human behaviour and interactions”.

### **CAD -**

“Computer-Aided Design software is used by architects, engineers and others to create precision drawings or technical illustrations”.

### **Cell -**

“Based on the project theme of HUMAM, a cell represents the zone within the radius of having a hub. Within one cell, no manual (traditional) cars are allowed to enter. Therefore AV’s should replace this and can enter or leave the cell”.

### **Density -**

“Term used in urban planning and design to refer to a number of people inhabiting a given urbanised area”.

### **(Mobility) Hub -**

“Consist of major transit possibilities and the surrounding area. They serve a critical function in the regional transportation system as the origin, destination,

or transfer point for a significant portion of trips”.

**Mothership Hub -**

“A hub regarded as the main base, source, or headquarters. A Mothership needs to be seen as the biggest hub meant for large regional transportation systems”.

**Partially Autonomous vehicle (P-AV) -**

“May require a human driver to intervene if the system encounters uncertainty”.

**P.E.T. -**

“Personal Electronic Transport system, where cars and people are living together. The car can be seen as a pet, that provides electric energy as battery for sustainable living”.

**Point cloud -**

“A set of data points in space in two or more dimensions to measure external surfaces of objects around them”.

**PV panels -**

“Also known as photovoltaic panels. These panels can capture sunlight energy and convert it into electricity”.

**Voronoi -**

“A Voronoi is a partitioning of a plane into regions which is based on a (mathematical) specific set of points which are specified beforehand. In this case, the Voronoi represents the urban region that should consist of a bigger or smaller hub, based on the existing urban infrastructure”.

## Table of chapters

### 1. The problem

1.0 Introduction	20
1.1 The origin of the city	21
1.2 The growing problem	24
1.2.1 The Havenstad Transformation Strategy	27
1.3 The crash of Teleport	29
1.3.1 The birth of Sloterdijk	29
1.4 The four themes that characterise Sloterdijk	30
1.5 The main source of the problem	35
1.6 Habituation	37
1.7 The problems of higher lifestyle needs	38
1.8 The parking calculation	40

### 2. The ambition

2.0 Introduction	44
2.1 The connectivity ambition	46
2.2 The three ambitions	48
2.3 The ambition for a hub	50
2.4 The interview	50
2.4.1 The interview: Amsterdam	52
2.4.2 The interview: UNStudio	52
2.4.3 The interview: BNA	53
2.4.4 The interview: RADD	53

### 3. The references

3.0 Introduction	60
3.1 Reference projects	64

### 4. The method

4.0 Introduction	74
4.1 Towards the 'optimum'	76
4.2 Data and design	77
4.3 The flowchart towards design	94

## **5. The themes**

5.0 Introduction	98
5.1 Theme 1: Freedom	100
5.2 Theme 2: Experience & Efficiency	102
5.3 Theme 3: Well-being	104

## **6. The emergence**

6.0 Introduction	108
6.1 Location determination based on parameters	110
6.1.1 Data as a source for location determination	110
6.2 The radius for the hub	110
6.3 The comfortable travel time-table	116
6.4 The Baby hub	118
6.5 The Masterplan	118
6.6 The cell structure	120
6.6.1 Application of the cell structure	122
6.7 Program of requirements	124
6.8 Priority scheme for future changes	126

## **7. The opportunity**

7.0 Introduction	128
7.1 Redefining parking and living	130
7.2 Flexible program	130
7.3 The mobile battery	132

## **8. The results**

8.0 Introduction	134
8.1 Site	138
8.2 Hub sizes	142
8.3 Main programs	144
8.4 Transportation scheme	146
8.5 Drawings	146
8.6 Conclusion	182
8.7 Recommendation	183

<b>A. Bibliography:</b>	185
-------------------------	-----

<b>B. Appendices:</b>	191
-----------------------	-----

## Abstract

This report is the result of my research for the graduation project of Project HUMAM; Hub for Urban Mobility for the Amsterdam Metropolitan area. The project focuses on the future demands of the Amsterdam Municipality in which they expect an increase of 70.000 new households and 50.000 new working areas over the coming 30 - 40 years in Havenstad area.

More people are moving from their village to the city or the suburbs, creating a full expanse of the city boundary and less space to accommodate the residents. However, the Municipality acknowledge the fact that this growth also brings difficulty in the accommodation of the expected households. Amsterdam Havenstad has been chosen to be the new urban core for these developments. The area is well-known for its extensive industries and enterprises, making this area rich and profound for the economic heart of the city, which will make its shift towards a mixed-use region for industry and residents. To accommodate these amount of people, the Municipality sees new opportunities in technological innovations and sees the use of a car as a potential problem in terms of land-use and health.

Therefore, project HUMAM will analyse and research the Sloterdijk area, to accommodate a transportation hub for the city. This hub enables the district to ban the car and put the focus on Automated Vehicles and shared possibilities. To keep Sloterdijk connected, the hub will perform as the catalyst for the area. This project tries to posit a vision of a future where anyone in the city can go wherever they want, whenever they want to, and accordingly, a place where we share our spaces in total connectivity with our mechanic neighbours.

Project HUMAM will be the landmark of innovation and offers solutions to this growing problem.

*“Something great is coming.”*

SOME-  
THING  
GREAT  
IS  
COMING





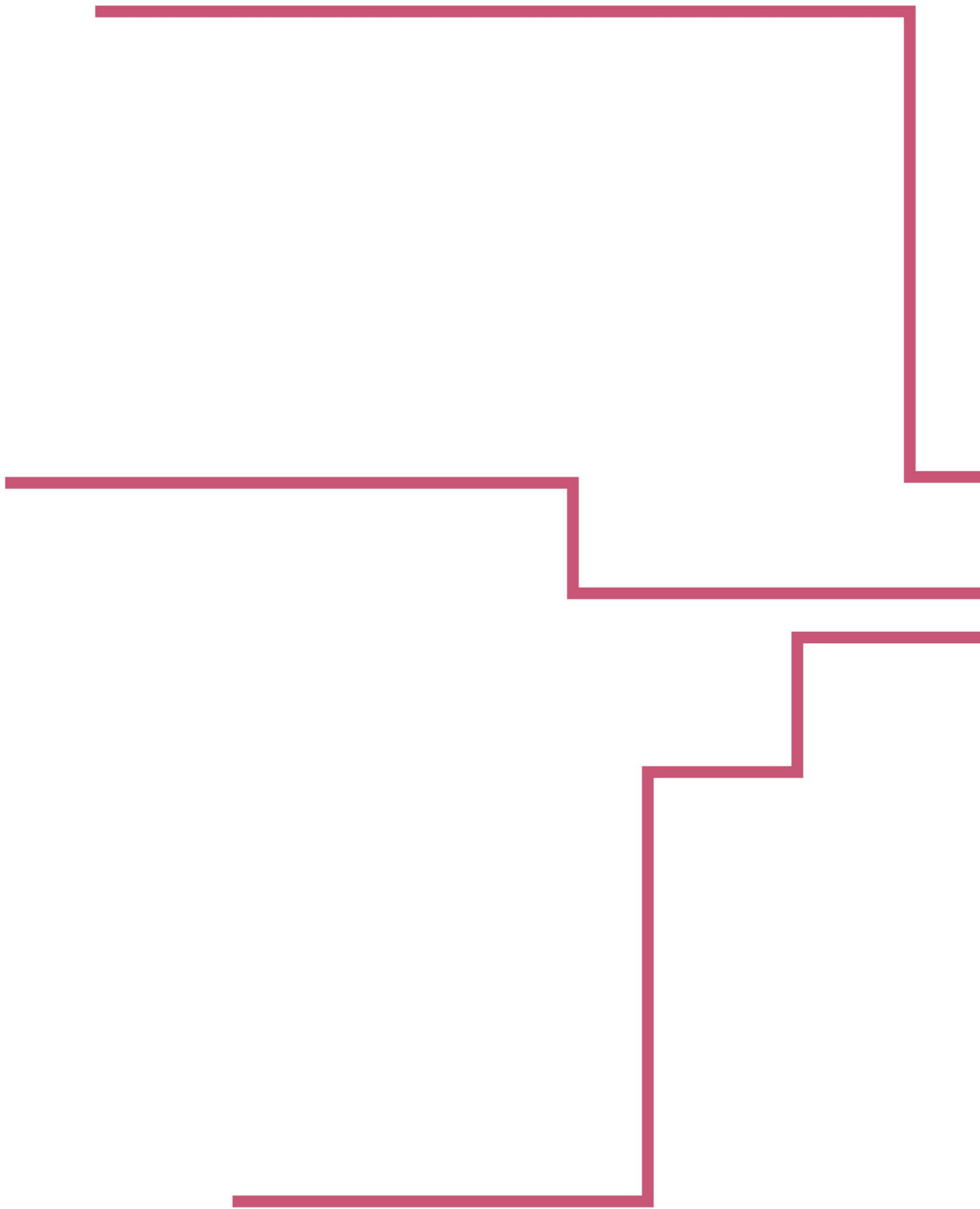

*THE  
MOBILITY*



*HUB*

*OF THE  
FUTURE*



Fig 1: Map of The Netherlands including main train station lines. Source: (Own illustration)

▲ 1:20,000



## 1.0 Introduction

Amsterdam is characterised by its rich history and remarkable growth over the hundreds of years. For Amsterdam Sloterdijk, this expansion was mainly focused on the industrial sectors, resulted in an area where only a fraction of the people lives. The leading cause of these differences between Sloterdijk and its adjacent regions can be summarised by the so-called four-problem factors; mono-functional, car-dominance, too many open areas, and the separation between Havenstad and the rest of Amsterdam. In order to house thousands of people here within the expected decades, the problems of this area should be made clear.

According to the Municipality, one of the problems that cover up most of the problems is the automobile. For many years, we have all been raised with the ambition of the car in our street scene. However, we are not always aware of the causes that these means allow us; poor health, fine dust particles, no public space, congestion, accidents and so on. By looking at innovative possibilities, there must be a balance between a healthy and sensible choice.

# CHAPTER 1

THE PROBLEM

- 1. The problem
- 2. The ambition
- 3. The references
- 4. The method
- 5. The themes
- 6. The emergence
- 7. The opportunity
- 8. The results
- A. Bibliography
- B. Appendices

### 1.1 The origin of the city

Recognising the historical characteristics is essential to get insights into the upcoming plans of Amsterdam (figure 3). According to the Amsterdam writer Feddes (Feddes, 2014), the city produced a long and eventful history of growth since its existence somewhere the 12th century. During that time, fishers used to live along the big river of the Amstel. Thanks to Floris the 5th, the city of 'Amstelledamme' was created. The city was recognised as a transportation place for goods mainly by water.

After many years of further developments, during the 16th century, the government decided to create a more sophisticated urban planning and architecture for the city. Primarily, the fortifications became necessary to protect the city from 'the outside world'. Furthermore, in 1613, three new cities were created: Westhaven, de grachtengordel and the Jordaan. In order to provide the city of Amsterdam with better international relationships, the government decided to improve the City Hall in 1648 in style of 'Hollandse Classicism.' Moreover, the city hall became a famous landmark in the city which also acts as an identity to mark its wealth. (Feddes, 2014)

However, it became worst and became well-known for its nickname "the city of the beautiful virgin with bad veins." It was nicknamed due to the high amount of trash that terrorised the city. Later the opposite happened in 1652, where the Zoning-plan was initiated to clean the city.

During the late 19th century, the Industrial Revolution started to transform the city, caused many social and economic problems but also led to the emerging of new public buildings such as the Rijksmuseum (1889), Central Station (1895) and the Stedelijk Museum (1895).

Fig 3: History of growing Amsterdam 1725-2009 maps. Source: (Own illustration)

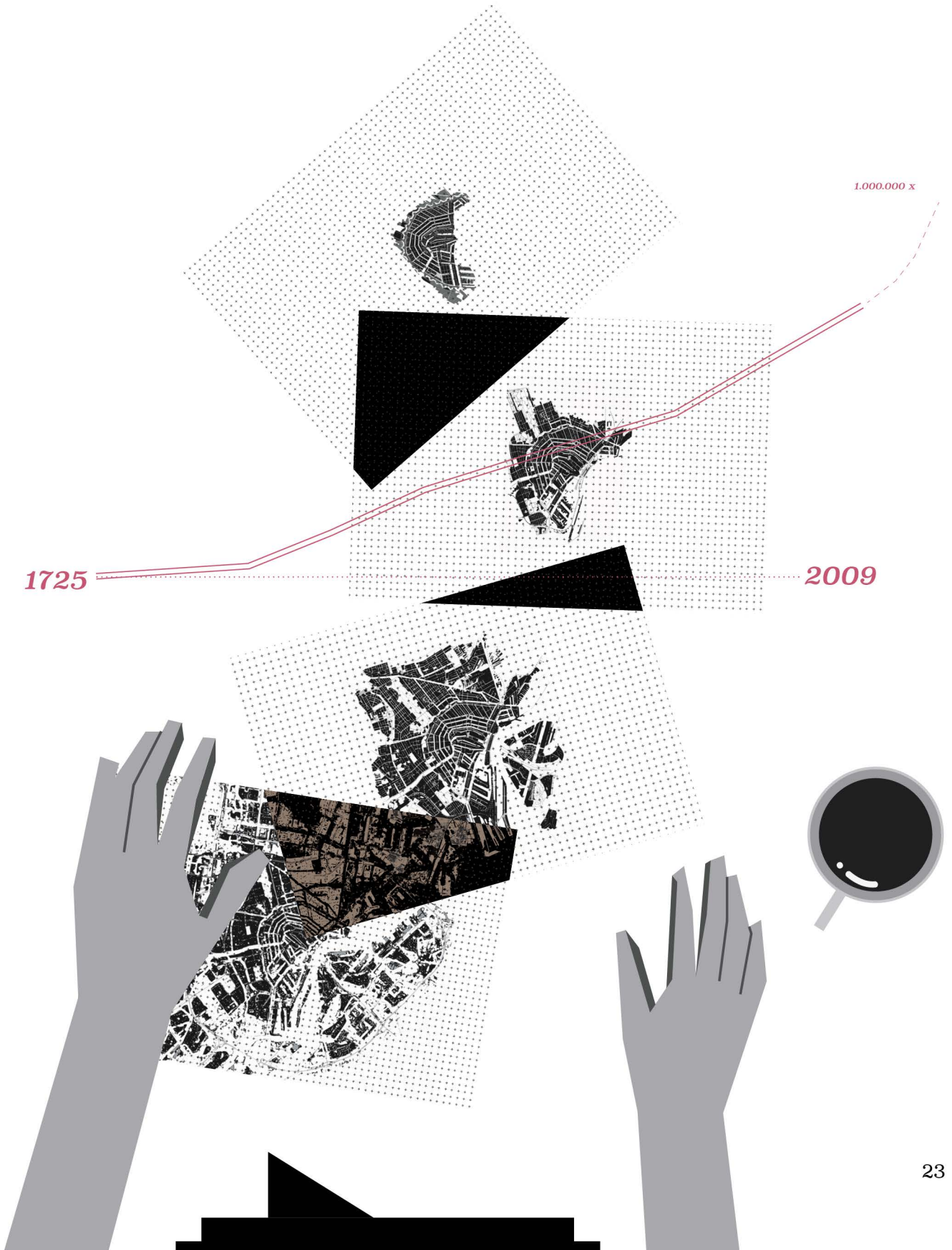



After the devastating World Wars which resulted in bombardments, food shortages, and deportation of the Jews, the municipality saw no other way than rebuilding the city from the ground up. After that, the city started to flourish again and started to show significant economic developments.

### 1.2 The growing problem

Many years later in 2015, the municipality is expecting an explosive growth from 821.000 to over 1 million inhabitants in 2025 (CBS.nl), which is shown in figure 4. These patterns of growth are due to the growing number of tourists and the shift from living in the village to the city. However, according to the CBS, this rapid growth is just a mere fraction of the whole story. The result of this advancement also shows the future problems of traffic congestion, lack of space and a decline of the urban quality.

Thus far, the city is already struggling with a recurring shortage of housing, offices, hotels and leisure facilities. With the densification of the city, the increasing tourism and the ever-growing attraction for companies, this shortage problem will increase over the coming years, according to the Municipality of Amsterdam.

However, these numbers cannot be seen as unique to a city like Amsterdam; many cities have experienced such growth, where Brooklyn and Queens are starting to arise because of the growing fame of neighbouring Manhattan (Tschumi, 1994). Unfortunately, like Manhattan, Amsterdam does not have adjacent regions that can offer this growth. Currently, the city is surrounded by its protected areas of green, water and the main airport

Fig. 4: Inhabitants Amsterdam from 1300 - 2017 and expected. Source: CBS.nl, (Own illustration)

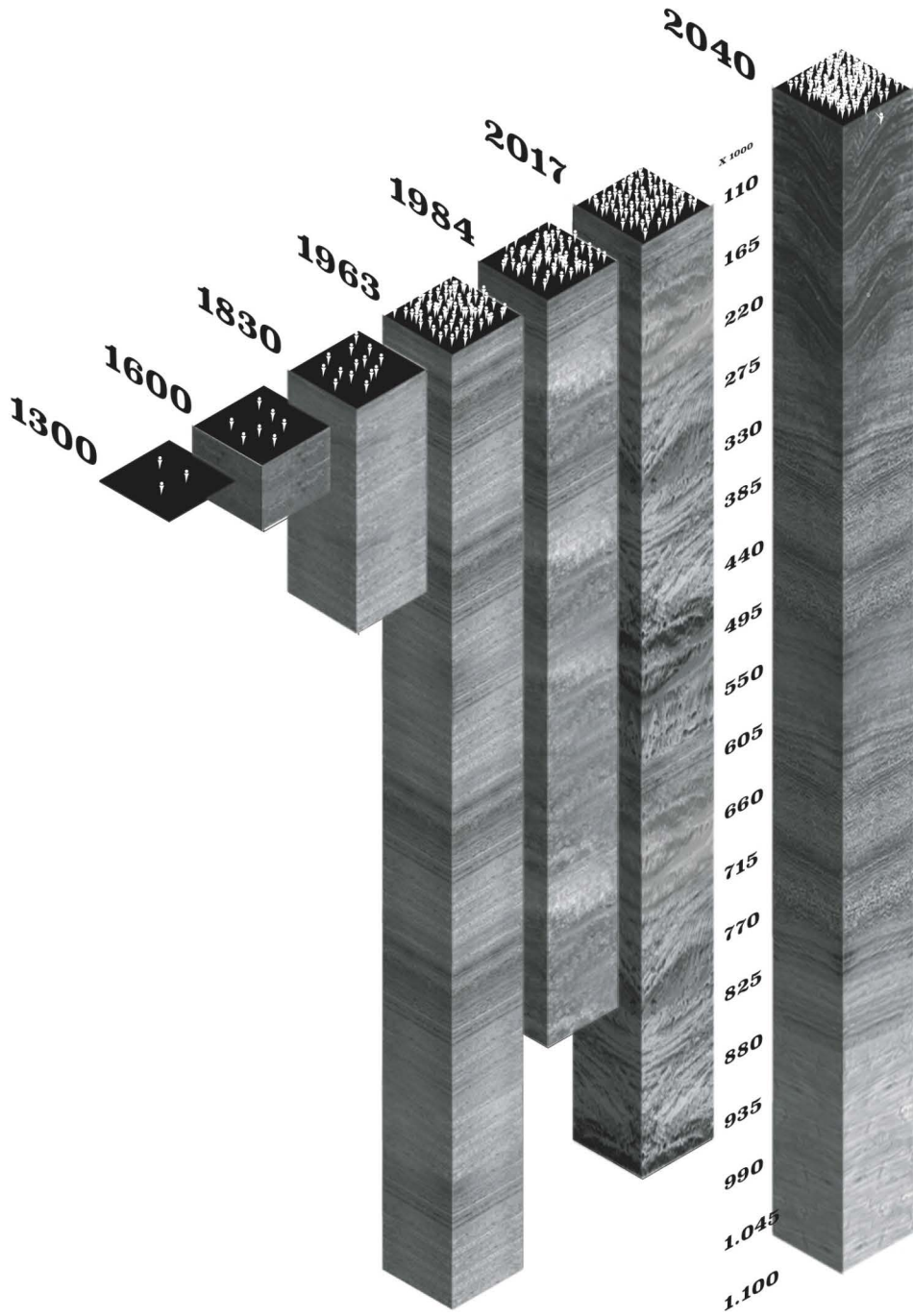



Fig. 5: Sloterdijk then and Teleport now. Source: TU Delft Summer School, (Owen illustration)

of Schiphol. To prevent this problem, the Municipality stated that a metropolitan structural plan and future innovations of the entire region is therefore necessary.

### **1.2.1 The Havenstad Transformation Strategy**

Five years ago, the city council of Amsterdam adopted the so-called “Havenstad Transformation Strategy.” With this plan, the council gave the official approval for the phased transformation of the area and industrial area within the Ring A10 with a fundamental aim; to develop this area into a mixed urban area consisting 70.000 new residents and room for 28,000 jobs.

Understanding the latter, the pressure on the Amsterdam housing market is increasing. For this reason, the municipality of Amsterdam has set ambitious goals for Havenstad to realise a well-connected, highly residential and working environment with high densities in a sustainable, attractive and healthy living environment. (Boomen, Hinterleitner, & Boer, 2017)

The growth of the urban knowledge economy, which needs interaction and proximity, requires neighbourhoods with a broader mix of functions — residential areas where work can be done due to the presence of small-scale offices and companies. Functioning is also necessary for maintaining economic diversity.

According to the Municipal development strategy documentations, many people, including Amsterdammers, know very little about the Sloterdijk area. At most, they have been at Sloterdijk station. However, it is an area that is struggling with problems; a place where in recent years urban dwellers and companies would instead not come. This notion seems to be in a shift, as the development slowly but steady moves towards Sloterdijk.

A development to transform the multi-functional area for residents, businesses, hotels and other amenities.

For many people however, Sloterdijk can be seen as an area without any historical significance. Across the Sloterveer river, the water once surrounded about five kilometres south-western from the city, between Sloterdijk and Sloten. In the 19th century, the first railway line of the Netherlands was constructed towards the North Sea. As a result of further development, the port cultivated itself and was born as the industrial landmark for the city. (Feddes, 2014)

After the Second World War, the Westelijke Tuinsteden were built outside the Haarlemmerweg, and the area around the site of the current Sloterdijk station was planned in a mainly functional manner, such as having offices around a junction of motorways and railways. Many years later, during the 1980s, the area was renamed 'Amsterdam Teleport' which includes an almost futuristic infrastructure. Thanks to this development, Sloterdijk became a well-connected area with the rest of the country. It became a fundamental crossing station that links Amsterdam Central, Haarlem, Zaandam and Schiphol from one zone. Apart from the train station, a metro line was constructed as well, which was able to run from Sloterdijk to Amsterdam South-East, making it much more convenient for people to travel with different services. Last of all, since 2003 trains from North-Holland province can drive directly to Schiphol via Sloterdijk. (Feddes, 2014)

However, although these developments were made, it all became still insufficient for the success of Sloterdijk.

Starting from the nineties, Sloterdijk had to deal with the inner city and greater business locations such as the

Zuidas. However, many big companies still decided to locate their business in the Zuidas, which resulted in a higher vacancy rate in Sloterdijk. According to Hans Soekkha, who wrote his book of ‘Telematics - Transportation and Spatial Development’ that “Sloterdijk Teleport area can be seen as the node for regional and infrastructural communications.” Unfortunately, due to the rapid technological developments, Teleport lost its unique selling-point and had too little to compensate. Its public space was not inviting, and the lack of other functions (like shopping, catering, housing) made it impossible for companies and residents to settle down. Besides, people had the intentional feeling that Sloterdijk was far away from the rest of the city, while it is directly behind the Westerpark and from Amsterdam-West directly above the Haarlemmerweg. (Soekkha, 2014)

### **1.3 The crash of Teleport**

Since a couple of years ago, the area has been a problem for the municipality and the city districts. In 2011, the plans for more shops, amenities and a new station entrance were stranded. A lot of planned new office building did not get off the ground, which means that unoccupied, empty plots still can be found in many places. Moreover, the area is known for its mono-functionality, with no interaction with the environment. There are virtually no functions for which people come to Sloterdijk, other than for work or business (Fig. 6).

#### **1.3.1 The birth of Sloterdijk**

Despite the misery of recent years, Sloterdijk could soon take up a new, lively place on the collective mind map. The plans were described in 2008 “Amsterdam Teleport: nieuwe ronde, new kansen” (new round new opportunities) were soon overtaken by financial and property crises and other urban developments. In 2012, the delegation decided to change the name of Teleport

to Sloterdijk to start this region as the source for mixed-use living and working. Some measures have been taken into account such as the reduction of offices from 90 to 60 per cent in order to create a more diverse area. Therefore, the municipality hopes to attract many construction groups and small developers (Plan Amsterdam 5, 2008).

Concerning business, Westport (Sloterdijk including its harbour area) became a more vibrant and liveable area as well. Moreover, the municipality started to adorn the media by showing-off their growing numbers and better results of Sloterdijk, to make clear that this area will be the engine of the city. With that being said, ignoring Sloterdijk could lead to a much greater loss; the area is well-known for its extensive infrastructure; it is well-connected by road, rail, water and close distance to Schiphol airport (Plan Amsterdam 5, 2008).

### **1.4 The four themes that characterise Sloterdijk**

With the historical understanding in mind, Sloterdijk area can be divided into four major problems currently facing. These problems are based on earlier research during the MSc II, City of the Future studio, where the area has been analysed on different levels; from occupancy until road use (also see photos taken in Appendix B2). The following paragraph describes these four significant problems.

Monofunctional (Fig. 7-a):

The Havenstad area (Sloterdijk in particular), is characterised by its industry. Although the large industry and a high employment rate, still not many people are living in that area. This low rate of residents is the result of a monofunctional existence of the area where the infrastructure is only needed during working days. In the evenings and weekends, it was observed that the area suffers a quiet existence.

Fig 6: Iso diagram of characteristics part of Sloterdijk. (Own illustration)

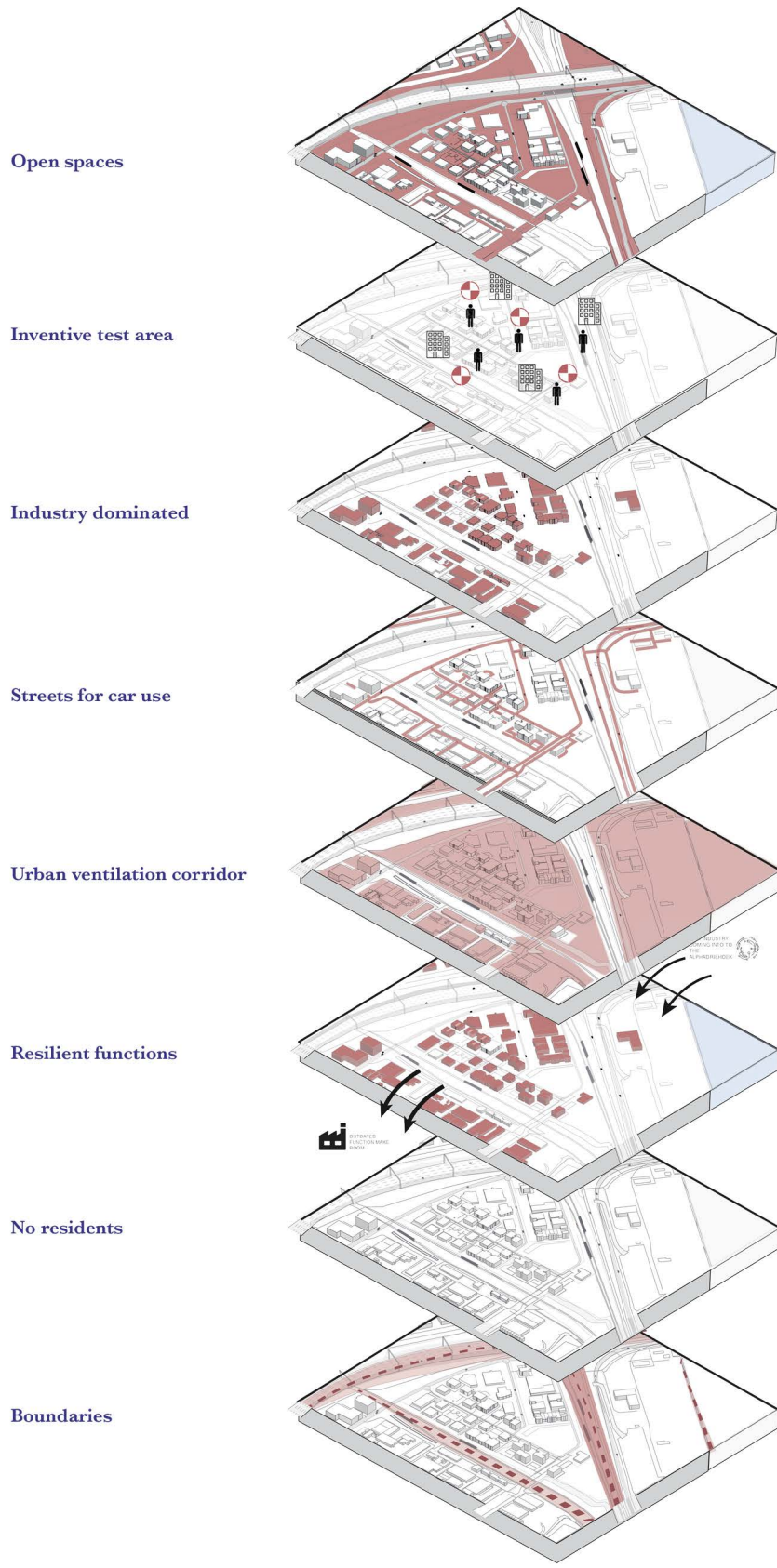



Furthermore, these organisations do not show any social or architectural cohesion with its neighbouring surrounding; the mainly concrete masses can be found all over the area. Besides its monofunctional existence, other smaller functions can be found as well in Havenstad. Such as a mosque, graveyard and a public park.

Car-dominated (Fig. 7-b):

This continuation of monofunctional spaces in Havenstad also results in car domination. During rush hours, the streets are characterised by cars during the weekdays. However during the weekends, while the area is entirely made for cars and other utility vehicles, is rather quiet and empty. Because project Teleport during the '80s instead focused on the large industries, hardly any care was given to lively the public spaces. It is somewhat more convenient to travel by car than to walk or taking the bike.

Abandoned spaces (Fig. 7-c):

The area suffers from an enormous amount of unused space facilities that are mainly focused on car use and freight traffic. Furthermore, there are no sports field or other public functions to be found in the area. In fact, in the Alfa Driehoek region of Havenstad, which covers up almost 900.000m<sup>2</sup>, only consist of one household. The problem of the abandoned spaces becomes clear during the weekends, in which most of the offices and industry are closed, resulting in an empty and 'useless' space.

Connected yet separated (Fig. 7-d):

Although Sloterdijk is characterised by well-connected infrastructure, it is still seen as a separate part of the city. The area connects itself from the A10 and A5 highway, which is ironically one of the busiest highway locations of the Netherlands. Furthermore, it is relatively easy to access Havenstad gebied, especially Sloterdijk Centrum region by car, bicycle, metro and train. There-



Fig 7: The four main characteristics of Sloterdijk: (Owen illustration)

*"DESIGNING  
THE CITY  
FOR THE  
PEOPLE,  
NOT FOR  
VEHICLES"*

*- J. GEHL  
CITIES FOR THE PEOPLE*

fore, because of its mono-functionality, people without relation to the companies in Sloterdijk see no reason to travel in this area and therefore rather avoid it.

### **1.5 The main source of the problem**

It may be clear that the government recognises the car as a potential threat in the area of Sloterdijk. However, Amsterdam did not initiate the plans for a car-free (or reduced) city. Over the years, cities like Shanghai and São Paulo trying to reduce car dominance in the city. A specific example of this development can be found in the book of Jan Gehl; *Cities for the people*. Similar to the problems of Sloterdijk, Gehl faced the same issue in the city of New York, where the car is taking almost all the spaces left, resulting in having an infrastructure that is similar to fifty years ago, which is, according to Gehl, not in balance with the society. “We are designing the city for the people, not for the vehicles.” (Gehl, 2010)

Likewise, back in the Netherlands, the problems can be seen in a quite similar way. According to CBS, every year there is a significant growth in car ownership, resulting in an increase of m<sup>2</sup> roads and highway congestion. Moreover, this issue also counts on health perspective such as getting the car, going to work or take the kids to school; the car is inextricably linked to our social lifestyle.



*Fig 8: Illustrated wish of Municipality. (Own illustration)*

### 1.6 Habituation

In my opinion, the way we are travelling by car can be seen as highly inefficient. According to the Tesla and Space-x owner Elon Musk, there is no explanation of having all buildings in 3D like skyscrapers, but not for roads, which are still all 2D. Physical space will, therefore, be more divided and blend into the infrastructure, rather than the buildings are defined by the grid of the existing roads. Besides the urbanistic perspective, thinking of social well-being can also be seen as an essential factor to reconsider the car in the area (Peden, 2004). People often misunderstand the fact of how many traffic accidents occur in the world. Everyone in our near environment is familiar or was involved in a car accident with physical, mental injury or death. In my perspective, traffic accidents in our society are more or less ‘accepted’. We have accepted that there were six hundred deaths and thousands of injuries in the Netherlands each year (Reason, 1990). What number of injuries do we ‘accept’ for car accidents? Zero or one hundred?

Technology-wise, our world is changing, and this also reflects our social life; we are more productive and want to get things done quicker and more efficient. With the rise of smart, innovative technologies, it will lead to a breakthrough of mobility where the autonomous car is leading the future of opportunities. Since October 2018, Google’s Waymo already enrolled 40.000 level 4 automated vehicles in California. On the other side of the world, in Asia, China’s internet company Baidu is planning to enrol thousands of self-driving cars on the public roads as well. When looking at this development, it took us only four years to run from Autonomous Level 0 (driver without driving technological tools to level 4. Level 5 is the maximum and is seen as full of autonomous without any human intervention. To see the benefits of having Automated Vehicles on our road,

CES (Consumer Electronics Show) in Las Vegas gave in their conference of why we should embrace this development in our life. According to the research of Cambridge University, 90 per cent of the number of traffic accidents arising from human errors can be reduced. This development leads to lower healthcare costs, insurance and property. Therefore, it is the reason for addressing ancient infrastructure by making it smarter and more efficient. Although this problem can be seen as a political issue, architects and urban builders will very likely be seen as the pioneers of this development, which could resolve our congestion and the way we will move to work and or home. Furthermore, more public space will be created in mostly dense cities and parking garages, and parking spaces are hardly necessary.

In my perspective; freedom is also the freedom to move you safely. However, to ensure the safety of our society and to host the highly increased number of residents, there must be a substantial solution to address these issues.

### **1.7 The problems of higher lifestyle needs**

A principal item that illustrates the patterns of our lifestyle needs can be translated into the theoretical framework of Luca Bertolini (Bertolini, 2011). Bertolini illustrated the direct link of car ownership that leads to our social-economic growth, shown in figure 9. However, while the higher lifestyle needs are increasing, making people fleeing the city towards the outskirts or suburbs, it also leads to a yet undesirable city atmosphere, causing no or less public transport and less public space. At the same time, Bertolini sees similarities with the increase of personal mobility. While the growth of personal ownership of cars is expanding,

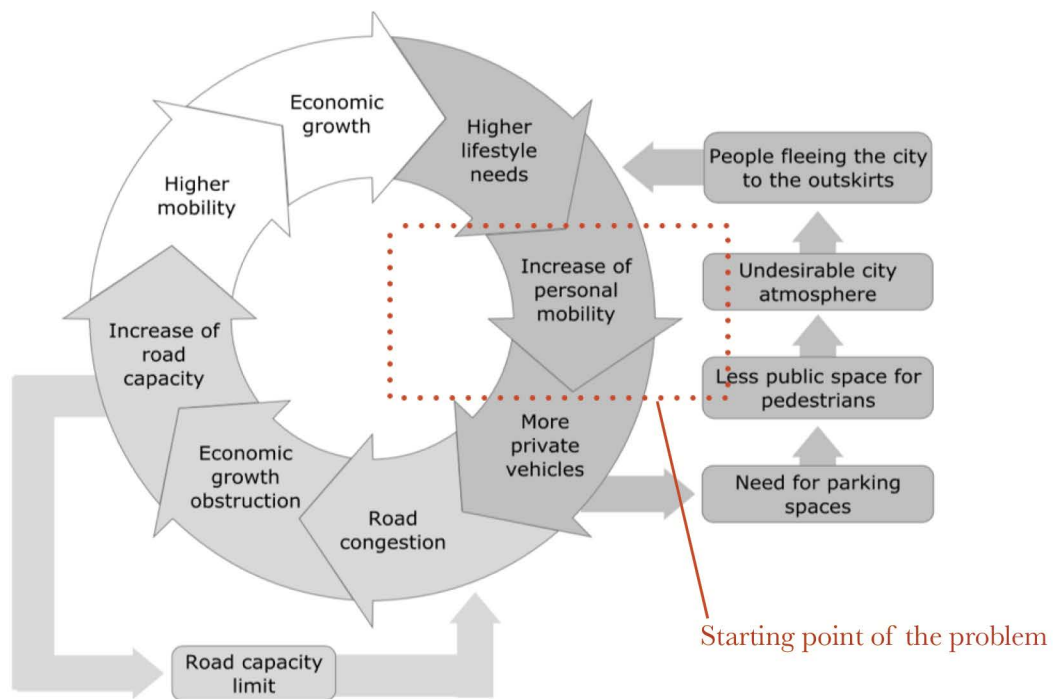

Fig. 9: Car ownership links to socio-economic growth. Planning for pedestrians: a way out of traffic congestion, Bertolini, L., Morar, T.



Bertolini noticed that study almost always resulted in a growing number of road congestion, growth obstruction and overall; the increase of road capacity. This development proves that more roads are a necessity for our own lifestyle needs. These compromises are affecting our built environment, as well as other traffic participants like pedestrians and cyclists (Bertolini, 2011).

Furthermore, when there is a significant growth in private car ownership, the quality of the urban environment and raises the unsafe feeling in the area decreases rapidly. For example, children are less likely to walk or play freely on the sidewalk where many cars are parked, because parents are less able to guarantee their safety than when there are no cars. Therefore, people are continually searching for a better and safer environment to spend time with things that matter the most, instead of time spent in traffic delays, which stops the people from engaging in leisure activities.

Project HUMAM puts the focus on the ‘source’ of the problem; the increase of personal mobility. While society is still in its higher lifestyle needs, an increase in mobility should be excluded. Sloterdijk area already consists of many roads for the expecting residents but is unable to house the expected 70.000 in Havenstad if no drastic measures are taken. Therefore, it is essential to understand the limitations.

### **1.8 The parking calculation**

An overall rough calculation needs to be done to understand the limitations of the area, based on the basic calculations of the CROW (Centrum voor Regelgeving en Onderzoek in de Grond-, Water- en Wegenbouw en de Verkeerstechniek) (Crow, 2018). Specifically, in Sloterdijk centrum area, there is currently space for an approximate 6.728 cars. This amount can drive on the road and park at a designated parking lot or on the streets. The cal-

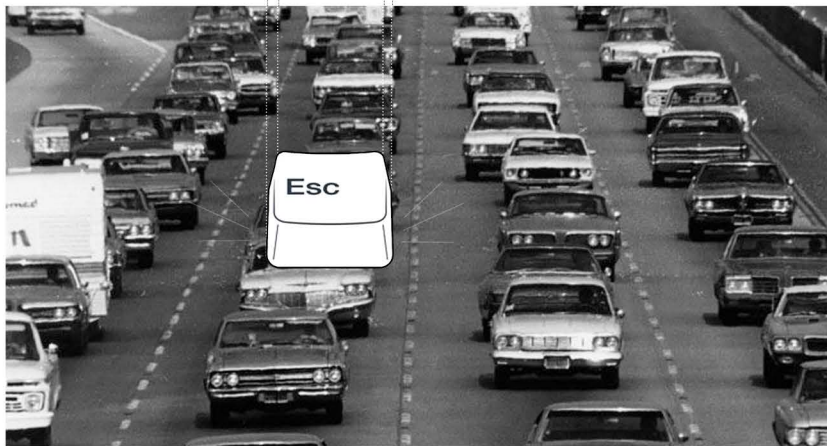
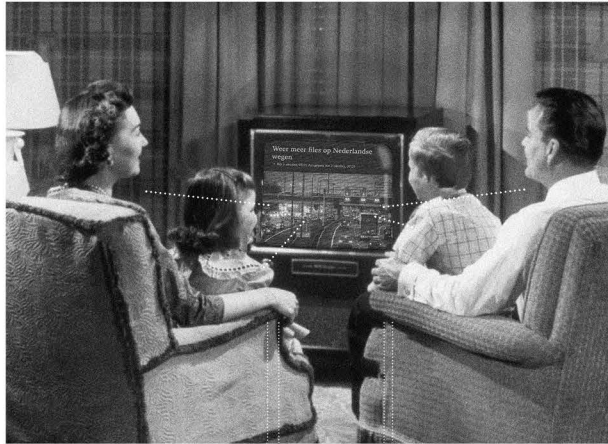

*Fig. 10: The car is potential problem for densifying cities and social health: (Owen illustration)*

culatation is done by using the car ownership-data of CBS. Taken into account that our current factor of 1,2 car ownership per household will be similar 20 years from now, the results show that the current number of cars in the area, 6.728, will increase to 27.000 if the municipality does not undertake any action and therefore keeps adding more roads and parking places. To illustrate; if one average parking spot is about 5m x 2,5m, this will result in 337.500m<sup>2</sup> of space labelled as parking. Moreover, this growth also results in a mobility increase of 4x, which will undoubtedly lead to more difficulties in the realisation of 70,000 households.

The problem, shown in figure 11, may be apparent that with the ambition to grow in densifying the space by new residential, a higher number of offices and enterprises and a better public space, other measures will have to be taken in to consideration to accommodate the number of expected residents and to strive for a quieter, cleaner and social neighbourhood.

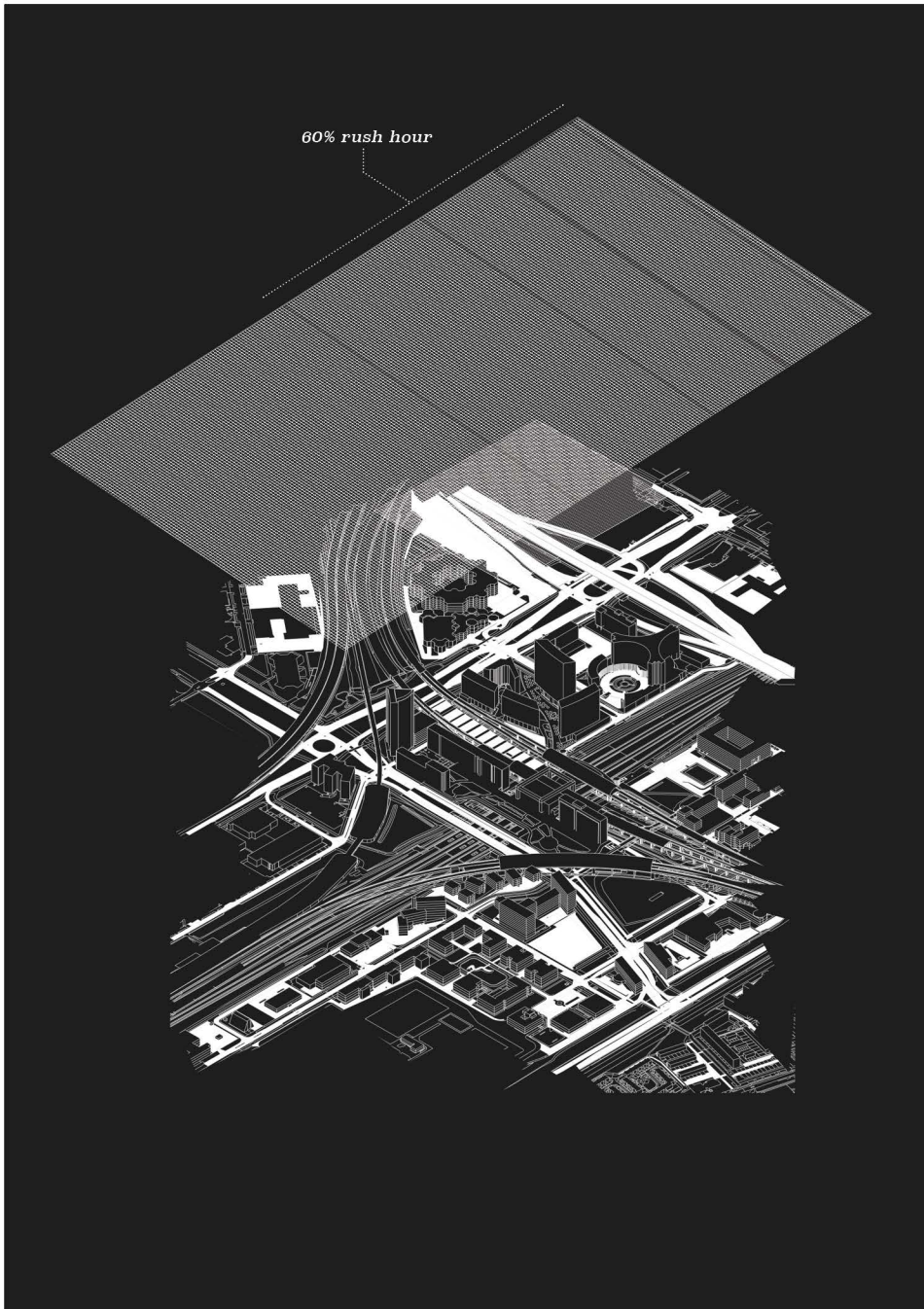

*Fig. 11: It proves that more cars in the future leads to an increase of traffic congestion. The small white tiles representing parking places if we continue the way we are living: (Oxen illustration)*

## 2.0 Introduction

The given calculations can be seen as a clear evidence that the municipality needs to come up with different ideas. Housing more people will lead to more congestion, health problems as well as, according to Bertolini, an obstruction in growth of the city. The municipality has been working on Sloterdijk for years and therefore wants to get rid of the monotonous industrial character and sees opportunities in mixing functions.

This chapter focuses on the ambitions of the municipality, my ambitions for this research while working with Gabriel Garcia from Geomatics, but also the interviews and discussions that took place during this research. These ambitions together will be the framework of the project that will steer in an innovative way.

The ultimate goal should be to address the dysfunctionality of the existing space and at the same time consider the hub as a new, high-quality space of the city of the future.

C  
H  
A  
P  
T  
E  
R

# 2

THE AMBITION

- 1. The problem
- 2. The ambition
- 3. The references
- 4. The method
- 5. The themes
- 6. The emergence
- 7. The opportunity
- 8. The results
- A. Bibliography
- B. Appendices

### 2.1 The connectivity ambition

According to the given documents and several talks with the Municipality, their main ambition is to house these thousands of people in the Havenstad area. This growth is including the transformation of the neighbouring Coen- and Vlothaven. Therefore, the municipality created a development strategy that underlines the conditions of the expected facts and risks. Looking at our current social economy, the rise of the knowledge and innovation society leads to higher demand for mixed urban environments such as Haven-Stad. This development involves a mix of small-scale business space (100 to a maximum of 5000 m<sup>2</sup>), which can be filled with office-like concepts from the creative knowledge and innovation economy, but also with workspaces for crafts, small-scale productive services, urban services and technical incubators. These latter functions depend to a greater or lesser extent on the supply and removal of goods. Furthermore, such an extensive transformation is not just about living and working, but about realising a complete piece of the city with all the accompanying urban facilities such as schools, sports, art and culture, recreation and green space.

The realisation of high densities while maintaining a healthy living climate can only be achieved if Havenstad shows great development in accessibility. However, the current car network both the ring A10 and the underlying road network are not able to handle much more car traffic. In order to be able to guarantee accessibility, high-quality public transport, bicycle and pedestrians are used in the ratio (modal split): public transport 30%, bicycle 30%, pedestrians 25% and car 15%. Moreover, the municipality wants to create two different housing ratios for the environment: The growth of Havenstad by 80:20. 80% living, 20% working.

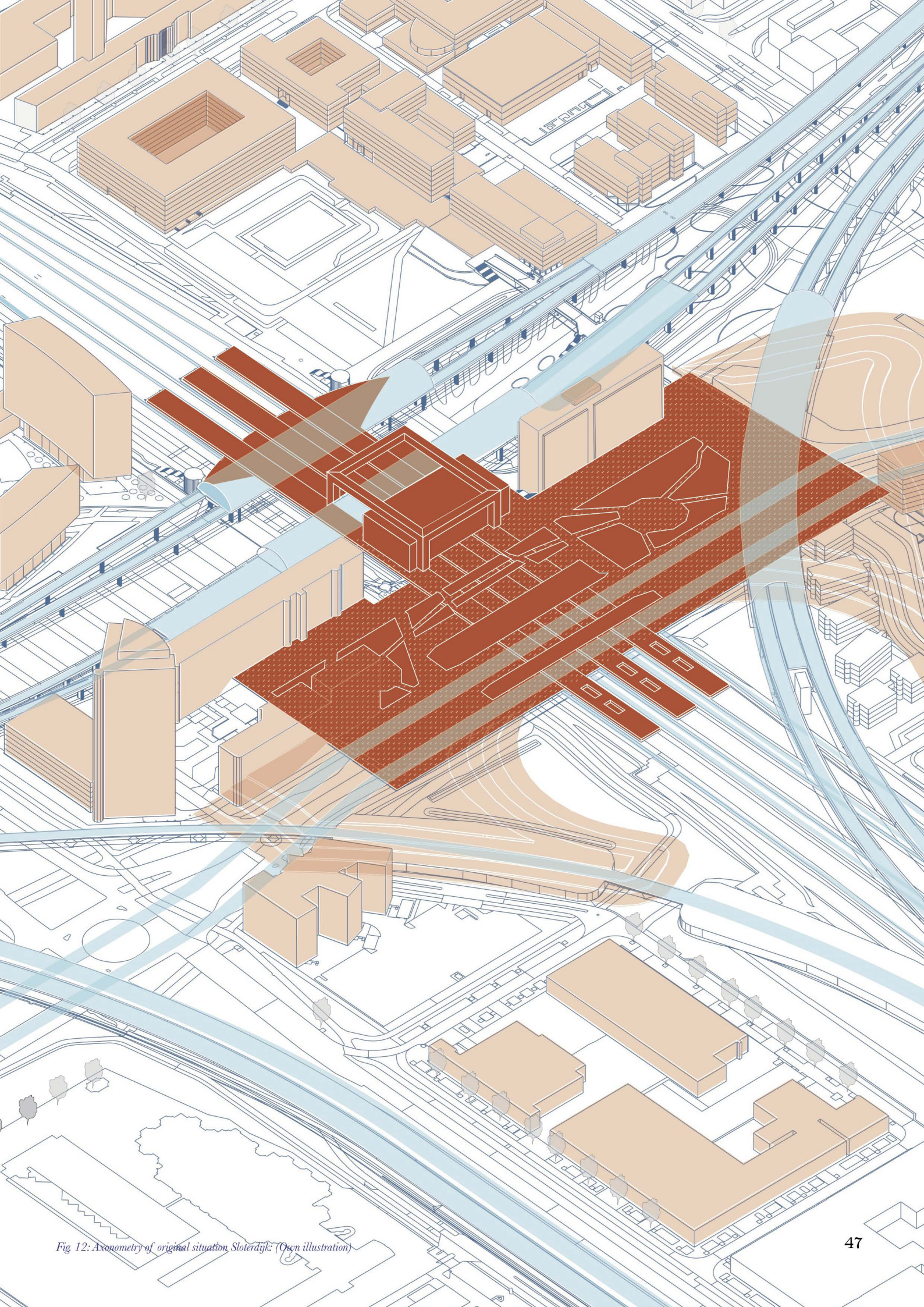

Fig. 12: Axonometry of original situation Sloterdijk: (Own illustration)



Therefore, to reach these ambitious goals, the problems for the expected housing in 2050 when the local population amount will grow towards the 70.000. Therefore, in order to make Havenstad one of the innovation cores of the city that represents, innovation, mix-use and density, the municipality sees the opportunity to create this city part without the interference of the car. According to (CBS.nl), it is known that the urban occupancy for cars and parking takes up 55% of the total public landscape. (Leftover 33% pedestrian and 12% cycling).

### 2.2 The three ambitions

With all the various ambitions of the municipality to improve the city, it is essential to frame down these initiatives to three main themes that will represent the guideline for project HUMAM (Fig. 13).

1. Car-free zone; No cars allowed in the area for a specific radius. The solution for storing the cars is necessary including alternative transportation to home, work or other facilities.
2. Improved infrastructure; Currently, Havenstad is accessible by train, metro, car, bicycle and by walking. To improve the area for a car-free zone, an improvement of the current infrastructure together with smart mobility is highly regarded.
3. Mixed-use industry; Currently, Havenstad consists of mainly large industries and enterprises. The municipality strives for a highly dense area but with respect of the existing industries. Therefore, a mixed-use industry combined with residential will take place in the area. This urban development strategy for living spaces blends residential, commercial, cultural, institutional and entertainment uses, with the integration of physical and functional development for the pedestrian.



Fig 13: Summarized image of goals from municipality: (Own illustration)

Figure 14 illustrates the usage of the Havenstad area by different functions. Currently, it consists mainly of industrial activity, from light to heavy, with incidental space for offices and creative activities. Companies are a natural part of the desired urban environment, with a mix of housing and work and a sizeable economic diversity. In Havenstad there is room for existing and new production companies that fit within this profile.

### 2.3 The hub

With the understanding of the future car problem and high density in the area and the dominating industry character, a mobility hub could solve the transit zones in the area, combined with various levels of different services, such as transfer, shopping and living. Furthermore, this also requires a surrounding of a high residential and employment development potential within a certain radius of the urban landscape. These hubs are places of connectivity which includes different modes of transportations, to make rapid transit possible.

As discussed earlier, the municipality strives for car-free zones for Sloterdijk, which is not suitable for space, but also social health. In order to create a hub that can address the car problem, can be an ensemble as recognition for a future-striving for healthy and car-free life, while still maintaining the higher densities, the main question for this research will be: *How can the design of a transit hub address the car problem and the expected higher density in Sloterdijk area?*

### 2.4 The interview

To talk about the potentials of a hub, several interviews have been conducted to get a clear vision how different stakeholders see this development. During this research (shown in figure 15), four interviews had been given to the Municipality of Amster-

Fig 14: Map of functions in Sloterdijk, including future expectations: (Oxen illustration)



**Now**

- 521.922 m2
- 14.036 jobs
- 0 houses
- 0 schools
- 0 hospitals
- 0m2 sport

**Future**

- 1.058.264 m2
- 15.515 jobs
- 7.410 houses (2019)
- 5 schools
- 5 hospitals
- 14.820m2 sport

\*Source: Amsterdam municipality

dam, architecture firm UNStudio, stakeholders of the BNA City of the future, as well as an interview with the RADD, specialized in automated vehicles.

### **2.4.1 The interview: Amsterdam**

The Municipality can be seen as the initiator of this project, in which they much embrace the arrival of a mobility hub due to lack of time and the desire for investigations in innovations. However, the Municipality also acknowledged that several innovations like the mobility hub that will take away the car also might lead to higher housing price that will not be affordable to the people anymore. Therefore, they believe in a high-quality space that consists of a substantial amount of public places as fair compensation; a safe, convenient and attractive place.

The Municipality continues that they already start to build residential units in Havenstad (particularly Sloterdijk) area. If the mobility hub could be favourable for the area, it needs to be initiated as soon as possible.

### **2.4.2 The interview: UNStudio**

The Amsterdam architecture firm UNStudio believes that mapping out the user groups to understand their demands. If the car is taken away, an alternate transport with the same quality and capacity should be introduced as well. One example given is the Automated Vehicle, that could be able to still drive in the car-free area, but autonomous and with a different speed than regular cars. Furthermore, those cars could play a crucial role because they will stay within a certain radius in the area, but they will also act safer because of the number of sensors that sense its surroundings.

Another interesting part is the perhaps more democratic part; let the people decide. If the inhabitants around

the hub could decide themselves how much they are willing to travel, to share and to give up their car as a suitable replacement for more public space. To let people understand the hub serves its purpose to a specific group of people (the people without cars), it should be designed as a landmark for the city. This landmark should stand out from its surroundings and recognizable for the people who want to enter the North-West of the city. Moreover, it could play an example for other future landmarks as well, all over the world.

### **2.4.3 The interview: BNA**

The design study ‘The City of the Future’ ran from January to late November 2018. On the basis of five test locations of 1 x 1 km in Amsterdam, Rotterdam, The Hague, Utrecht and Eindhoven, new ways of making city were examined. The question was how we can link building assignments to energy transition, innovations in transport, circular economy and other system and network innovations in times of the next wave of condensation. The team of Makers-stad proposes to create a city district with a mix of 60% housing, 30% activity and 10% space for future developments. This division gives space to the unforeseen. In order to ensure that the development remains spatially solid, the team designs a robust framework for mobility, heat, water, data and electricity as a collective investment, with freedom for a patchwork of new coalitions between government, companies, citizens and knowledge.

Another firm immediately stated by working simultaneously on all scales, driven by technology will lead to a efficient and quick-responsive city. This means they use is a low-threshold digital platform that works with feedback loops that map out the different and changing needs of city dwellers, enabling the city to respond more quickly and efficiently.

### 2.4.4 The interview: RADD

During the interview, societal and ethical aspects became a guideline, by not talking architectural, but more about the impact of the hub to the society and what it will change the daily living standards. They see the Automated Vehicle as a potential solution for the problem of denser population.

While the initiation of a mobility hub may sound attractive for the people, there will be concerns as well. By removing the car from the people, is also removing a bit of their privacy. If the Automated Vehicle can replace and therefore solve this gap of quick accessibility, also means that the consumers will be part of the big-data factories, that needs to gather data about personal information, destination, travel purposes, speed and surrounding. This continues monitoring of Automated Vehicles will lead to concerns that consumers information might be produced to advertising and an invasion of their privacy. This might lead to a future invasion of people's privacy.

However, the team sees the self-driving car as a possible solution to solve the car problem. Through proper regulation, IT and security. A mobility hub will provide many opportunities for this and will become the cradle for innovations in which architecture, urbanization and technology come together. "With the creation of the hub in Sloterdijk, new opportunities will arise in the area of public space, experience and the well-being of residents. Buildings will no longer be bound to a fixed grid of infrastructure, but will require new challenging methods to make it as comfortable as possible".

Interview Jurgen Krabbenborg AMS. There is so much more possible to do with the data and development for this complex, mobil...

**Transcript interview** ... times on the same road, what made him do that? Does the data ... mobility sometimes like taking a bike. We need to combine ... there are still gaps. We see that the people are growing in ... stores, they all predict the amount of growth will be huge. The ... Amsterdam is currently the biggest employment area in the Netherlands. We need to build housing and need to remain our working spots (keeping the value). To continue, there was a huge vacancy 12 years ago. But now these ... been filled up very well and we are not going to build new offices anymore; only residential buildings. But now there is a new demand for new offices again, after 12 years. The last 2 years we see a lot of international companies coming, which is not a demand for new offices. Ruimte voor de stad' (Room for the city) is a policy strategy of the municipality from a year ago. They made a report (given documents) of the red area (like Sloterdijk 1) where more density is expected. If we need to look at this right now again, the plans remain so far but we need more speed. Inhabitants are coming quickly so we need to act quicker, it's not only about densification and quality but also about green, sustainability, accessibility, the whole package. In architecture field, we need a shift where we need more green, balconies, more livable space and attracting area. Currently there are 7 big buildings to be built in Sloterdijk area. In Sloterdijk area part we need a lot of social housing, however, we get a lot of critics, because it still needs to be affordable. This collar is saving 40-40-20: That's social housing 40% mid-segments and 20% market. In order to get our goal of minimum 40.000 and maximum 70.000 new residents we need to get rid of bad-environmental companies. (Gabo: like the ugly chimney) We need the larger extensive functions but we also need reservation space. In the harbor area to move in companies from elsewhere being redeveloped so we can close them down with too many buildings. Mix usage will be the key for this development (in drive) of the vision documents of all the projects. Interview with UNStudio Amsterdam, Design and data are just tools we use at UNS that is just an approach for a project. This tool just sees the intent we are bringing back to our citizens, density, diversity, etc. But what do we need in a city and how can we accommodate change and so on. Data is a very important tool in our design to make it high quality where people want to go. In airport design, in here, you need to map out your vision. From your email and when you are out of the office, you make the same connections, while they are not using the car in order to accommodate the people. It is a cool testimony to see how you go from one way all the way to be another way an urban out the user groups, you have residents, every they have sub-groups (family, single, etcetera), which are all dependent in different modes of transportation. You can find an appropriate mobility experience for this group, and you need to understand what kind of people are on this journey of the hub, "what happens when its raining?" for example? to maintain the comfort or even improve it in real life, this is a complicated to achieve the tailor-made area. Gabo: If you make it uncomfortable for cars, people will embrace public transport. If you want a city without cars, sometimes we need to create policies, where there is the condition you have perfectly, but diminish the use of car. Another interesting part is also to see it more democratic, let the people decide. Let the people who are willing to share, or willing to give up the car as a replacement for more public space for example, but to deal with appropriate mobility transport system, you are already close to the city center but why do you want to transfer? You need to make it very smooth or comfortable. You need to take away the heavy traffic in the city center. People also see the hub as a landmark. Aldo Rossi came with this notion of libraries, museum, churches etcetera are landmarks in the cities, the hub could be this as well. Our project of A10 Lelylaan was given by the municipality. It was a very quick project where we want to understand the impact of this project. The calculations were mostly rough, like transfer to AV's, where we spent out areas of before. After analysis, here you need to really dig into the data which was for now just a quick research, but makes clear that data makes a big difference. But it's still in an initial phase. Our intention was that is besides a hub and landmarks, it's more a transfer possibility and understanding for the people. The difficulty of projects like this is that other initiator stakeholders are very old-fashion (like the RWS RijkswaterStaat). I spoke to the director, what to do with the sight of the area? First of all we want to transform the infrastructure from problem to an attraction. This will be done by adding more blue and green in its context. One step is to spread the mobility hub on several points and iteration these will be done. We can use the service water as a quality we can allow in the form this into a value, where water become part of public space. Again, how to make it attractive to the people. First we have created a hub that is distributed as a station. The idea is to create a network, that will create a new quality in the space, that will also have shops and city-related activities. Furthermore, people will start colonizing with the help of different stakeholders. They are the energy of the society, it's more a transfer possibility and integrated. Overall, all these qualities that is able to change the site. The idea of the City of the Future is to create conditions. These conditions start making the city of the future, it does not come by itself. When looking back to the city, we must tell the general amenities with the city hub, like airports and centers. And in this way, we create a possibility for the new inhabitants, connected with the different cases around the city. Concluding, the city of the future illustrates the local, economical, historical and morphological aspect. To reach global climate adaptations, energy transition and mobility are just added values. They are not a solution, they are the input as a set of conditions. (Oscar Vos) Havenstad was een venging aan industrie en innovatie die als basis geldt als blauwdruk voor de toekomst. Ik zie de elementen in de architectuur als vaste checkpoints voor het gebied. Nu in Amsterdam, blijft de stad voor iedereen beschikbaar en bereikbaar? Hoe maken we de stad klimaat adaptief? Hoe speel ik in op deze realiteiten. Dit zijn de thema's die hier rond zwellen, en die voor een deel gereedschap zijn voor een deel locatie specifiek. De steunpilaar is de stad op de haven. De plek waar een mix van wonen, werken en industrie moet gaan plaatsvinden. Het huidige gebied is erg monofunctioneel. De ambitie van de gemeente Amsterdam is om te zeggen ze 80% wonen en 20% werken. Om een goede circulaire goed functionerende stad te maken die in balans moet zijn. Wij die verhoudingen veranderen: 80% wonen en 20% werken. Hierbij gebruiken we de resterende 10% als 'buffer' ruimte voor voorzieningen en ruimte voor ontwikkelingen die wij nog niet weten. Het is een lerende stad, die steeds slimmer wordt. Er zijn 3 strategieën: Mengen, Ruimte-tijl, Collectiviteit. Mengen in personen die verschillen, voor toekomstige ontwikkelingen. Samen ruimtelijk beleid. Omdat die plekken gevuld moeten worden. Hoe kunnen we meer ruimte voor meer mensen beschikbaar maken? Ook voor openbare ruimte voor mobiliteits transitie. Hierbij is een robuust structuur nodig, in een gemixt structuur. Om dit te doen, dienen er coalities ontstaan, dus niet de standaard partij. Wij denken dat het in kleinere stappen moet. Verschillen in kleinere stappen. Het duurt de stad duurzamer maken. De plannen moeten met innovaties om kunnen gaan en het scenario model. Dit is niet het 'bad' kip' model. Wij zien de haven en mobiliteit als draagvlak voor Havenstad. Havenstad is een soort versmelting tussen stad, haven en industrie aan elkaar. Dit is het resultaat van richtheden waarbij ze reageren op knopen, lijnen en structuren. Ook deze zullen ontwikkelen met de tijd. De menselijke maat die in balans zijn, van groen en blauw elkaar ontmoeten op deze schaal. Wij hebben een dichtheid van 30, wat betekent wat voorstellen dat soort wonen? Hoe gaan we binnen de coalitie maken, ook met de omringende buuren zorgen dat we daar ook naar kunnen knopen. Als je binnen de hoofdstructuur de kans geeft de samen op te lossen, zal dit resulteren in grote kans en slagen. Je eigen grond blijft en zal weinig opleveren. Binnen zo'n cluster is het hoofdstructuur dat adaptief zal werken. Binnen en buiten ontstaat een collectieve ruimte en tegelijkertijd, maar adaptief. Het geeft een gevoel van stad, maar het kan ook een hele leefbare stad worden, dan worden er vragen die zij onszelf gesteld hebben. (Roy Plevier) Werken, verschillende schalen werken, zoals gebiedsplan, gebiedstechnieken. Havenstad zal als een 'mini' stad worden ontwikkeld op veel intimer en exclusiever en 'aankleef' er zal zijn. Ook kunnen verschillende eigenaarschap creëren. Hierin kunnen energie en mobiliteit zien we kansen om de stad met de haven te koppelen. De stad moet niet meer worden, een rijk infrastructuur. Het publiek domein moet uiterst belangrijk zijn met veel opbouw, waarbij de mensen de stad 'maken'. Zo kom je de 'zachte' en 'harde' waarden tegen van de mensen. We zien ook kansen andere steden aan elkaar te 'smelten', waarbij havenstad veel overeenkomsten heeft, maar ook verschillen, zoals het water. Stedeling die centraal staat voor onze studie. Omringd met techniek.

**Transcript interview** ...

**UNStudio** ...

**Transcript interview** ...

**BNA City of the Future** ...

Fig 15: Notes of interview with Munic., UNStudio, BNA: (Own illustration)



*ONE HUB*

*THAT CAN*

*CHANGE*

*THE ENTIRE*

*CITY*

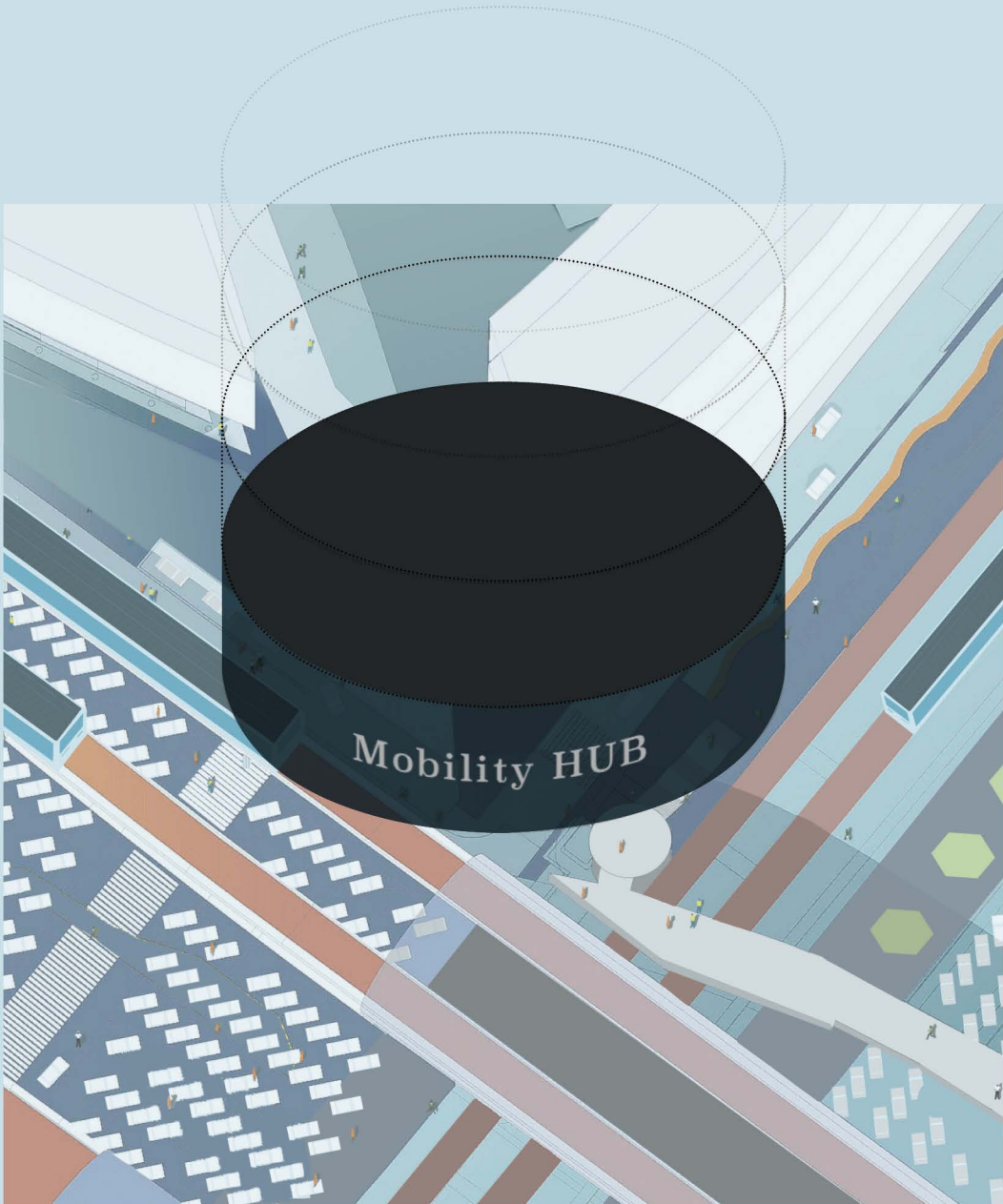

Fig 16: Illustration of a hub 'landing' on the area: (Own illustration)



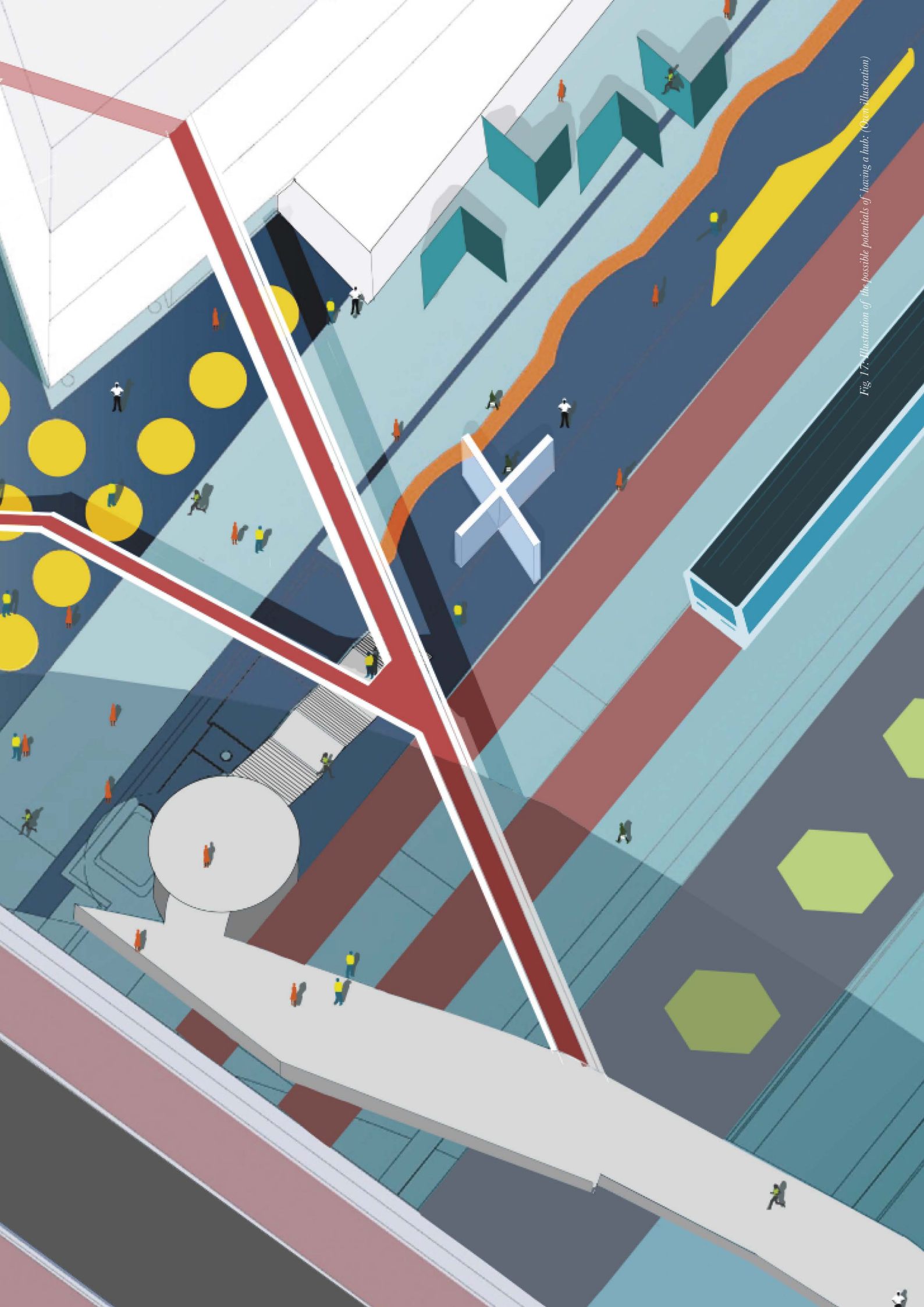

Fig. 17. Illustration of the possible potentials of having a hub: (Open illustration)

### **3.0 Introduction**

The idea of the node for different transportation is not a new phenomenon. Although the name of a 'hub' can be found in various terms of elements, it serves its most important asset; efficiency between two or multiple joints. These reference projects became highly relevant during my research for this project. Here I take a position of investigating various designs that became prominent in their behaviour towards a new era for society.

C  
H  
A  
P  
T  
E  
R

3

THE REFERENCES

- 1. The problem
- 2. The ambition
- 3. The references
- 4. The method
- 5. The themes
- 6. The emergence
- 7. The opportunity
- 8. The results
- A. Bibliography
- B. Appendices

1500

1800

1900

**Leonardo da Vinci – The Self-Propelled Cart, 1480**

Da Vinci’s design prescribed a path for the first autonomous vehicle ever created that was intended for use in the theatre. The Self-Propelled Cart was powered by a set of high-tension spiral springs that is able to travel along the path towards its intended destination. It even got a remotely-controlled handbrake. However, the Self-Propelled Cart never became a huge hit, while the automotive community considers this invention of Da Vinci as one of the first automated mobile vehicles in history.

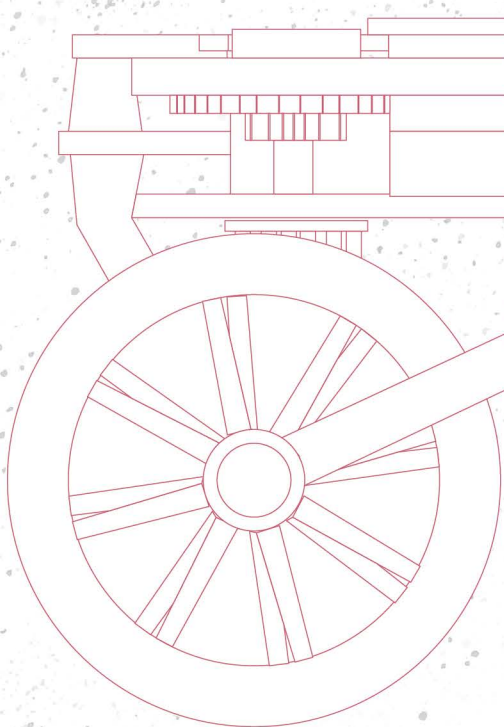

**Mechanical Mike aircraft autopilot, 1933**

During long travel times of several wars, the development of an autopilot system for long-range aircraft was created. This object called the Mechanical Mike was a prototype that was planning to serve a 13,000-mile flight, around the world in 1933. By using special techniques such as gyroscopes were able to keep the plane on its altitude and stable in the air. Furthermore, this rather compact system was even able to measure its distance and to calculate its accurate direction, making this autopilot system an integral part of the autonomous vehicle tech today.

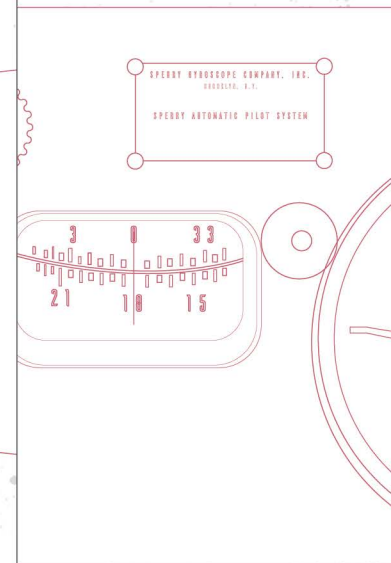

**Whitehead Torpedo, 1868**

The inventor of this weapon was Robert Whitehead, where he created a torpedo that was built for the USA Marines allies. This torpedo was able to propel itself underwater instead of manual ignition, proved to be a radical game-changer for the worldwide naval fleets. This semi-autonomous torpedo was able to travel several hundred yards underwater while maintaining its depth thanks to a inventive pressurization system called “The Secret.” Ever since this creation of the Whitehead Torpedo, battles during the wars became the creation foundation for automated weaponry, aircrafts and other autonomous devices.

**Tsukuba**

Autonomous level 0

Autonomous level 1

Fig 18: Brief history of Automation towards the AV: (Own illustration)

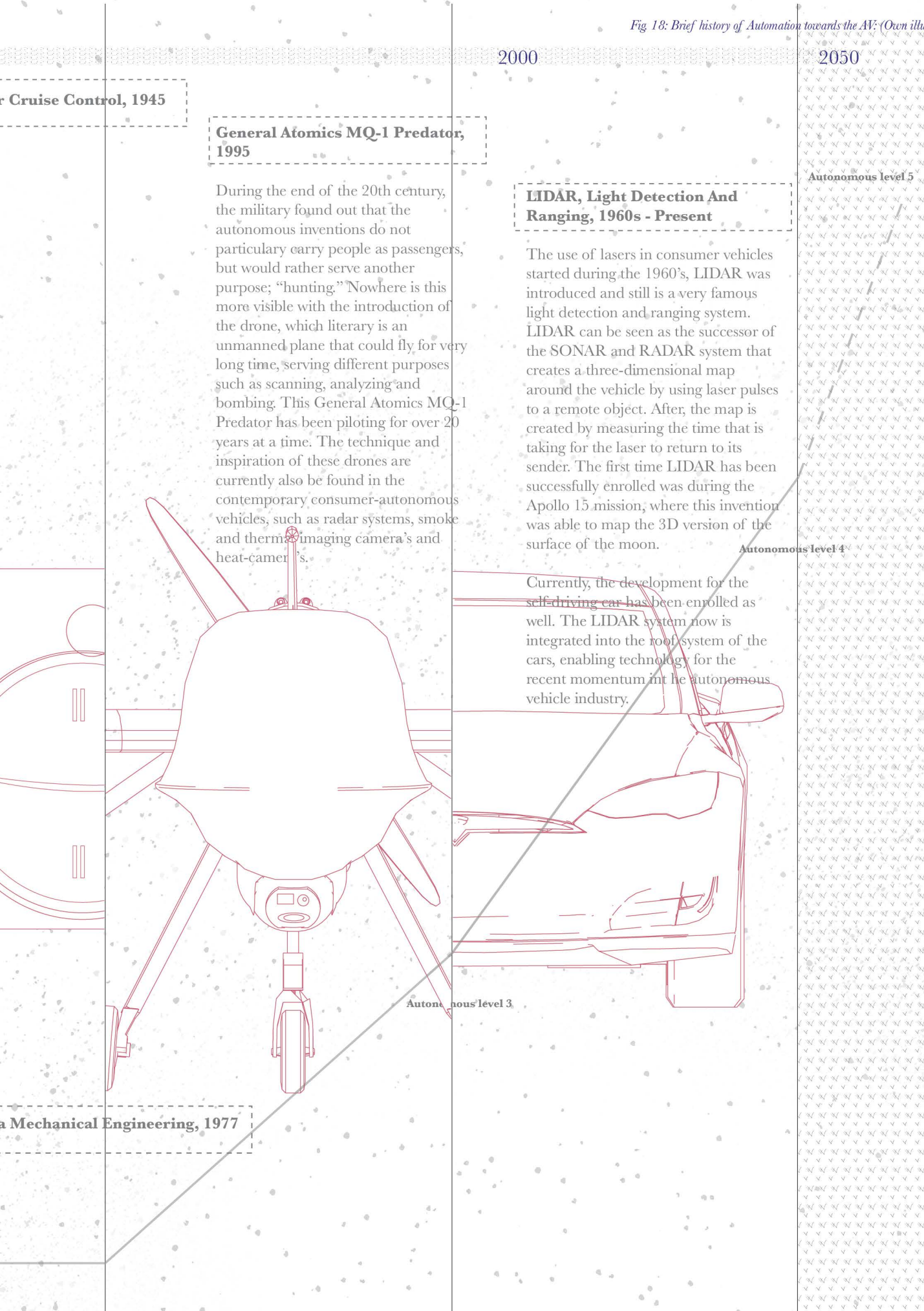

Cruise Control, 1945

General Atomics MQ-1 Predator, 1995

During the end of the 20th century, the military found out that the autonomous inventions do not particularly carry people as passengers, but would rather serve another purpose; "hunting." Nowhere is this more visible with the introduction of the drone, which literary is an unmanned plane that could fly for very long time, serving different purposes such as scanning, analyzing and bombing. This General Atomics MQ-1 Predator has been piloting for over 20 years at a time. The technique and inspiration of these drones are currently also be found in the contemporary consumer-autonomous vehicles, such as radar systems, smoke and thermal imaging camera's and heat-camera's.

2000

LIDAR, Light Detection And Ranging, 1960s - Present

The use of lasers in consumer vehicles started during the 1960's, LIDAR was introduced and still is a very famous light detection and ranging system. LIDAR can be seen as the successor of the SONAR and RADAR system that creates a three-dimensional map around the vehicle by using laser pulses to a remote object. After, the map is created by measuring the time that is taking for the laser to return to its sender. The first time LIDAR has been successfully enrolled was during the Apollo 15 mission, where this invention was able to map the 3D version of the surface of the moon.

2050

Autonomous level 5

Autonomous level 4

Currently, the development for the self-driving car has been enrolled as well. The LIDAR system now is integrated into the roof system of the cars, enabling technology for the recent momentum in the autonomous vehicle industry.

Autonomous level 3

Autonomous level 2  
Mechanical Engineering, 1977



*Building as inclusive city (Banham & Herron, 1995)*

### **3.1 The Walking City - Ron Herron, 1966**

A project that made the city move, not the people. The units of Herron's Walking city represent a certain high-tech utopianism, where utility vehicles such as military submarines are combined with periscoping "legs." This walking creature represents mobility and flexibility as one entity; everything is inclusive and redefines a new architecture of circulation. Thanks to its moveable structure, the city with legs is a city that not only walks but adapts to endless change over time. Therefore, there is no need to leave the Walking City, while everything is included. While these kind of technological developments are still far away from its reality, the idea of the inclusive city is becoming more visible.

Fig. 19: Ron Herron's interpretation of a walking city: (Own illustration)

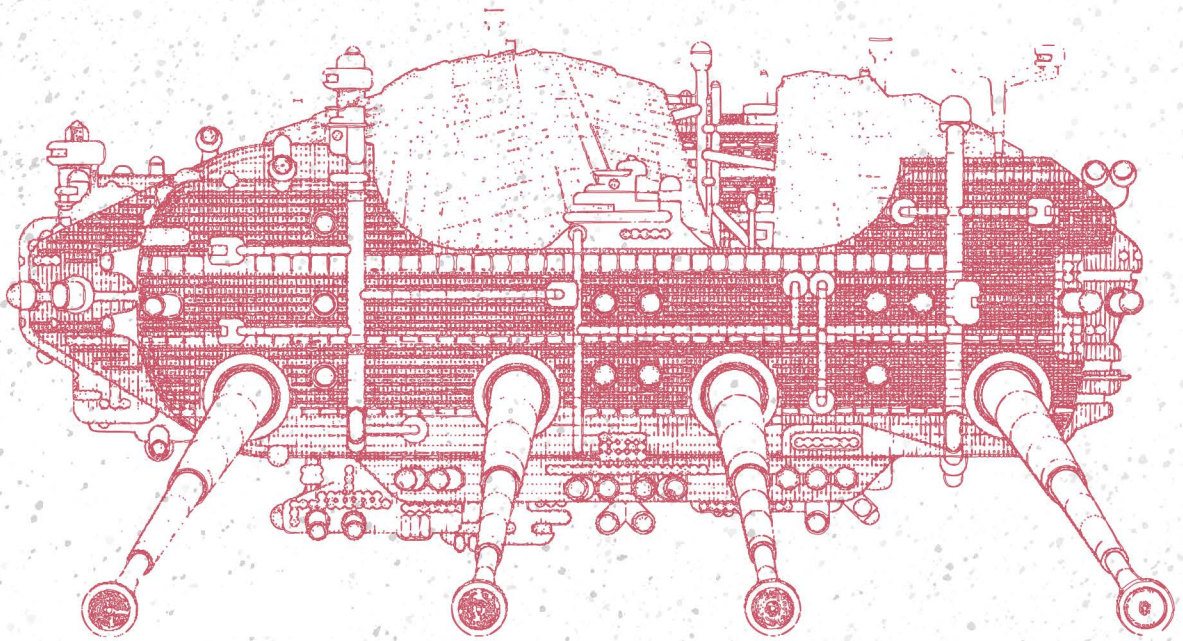

*Building as an efficient entity (Nota Verkeer en Vervoer, 1998)*

### **3.2 Transferia - TU Delft, 1998**

Mobility is increasing every year. However, the increase use of the car has adverse consequences. The accessibility of the urban areas is deteriorating due to the congestion on the roads. The environment is being damaged as a result of the emission of harmful gases, and the landscape is becoming increasingly fragmented as a result of the expansion of the road network. One of the solutions to these problems is to promote the use of public transport. To attract more travellers to use public transportation, it is necessary to set up a public transport system that can compete with the car system. If it is considered that public transport cannot meet every movement requirement and that the train often already forms a good alternative for the car at a longer distance. The concept of Transferia has been introduced in the “*Tweede Structuurschema Verkeer en Vervoer*” publication. The transferia can be seen as a mini-hub for mobility and efficient transferring.

Fig 20: A combination of parking and transferring. Early idea of a mobility hub: (Own illustration)

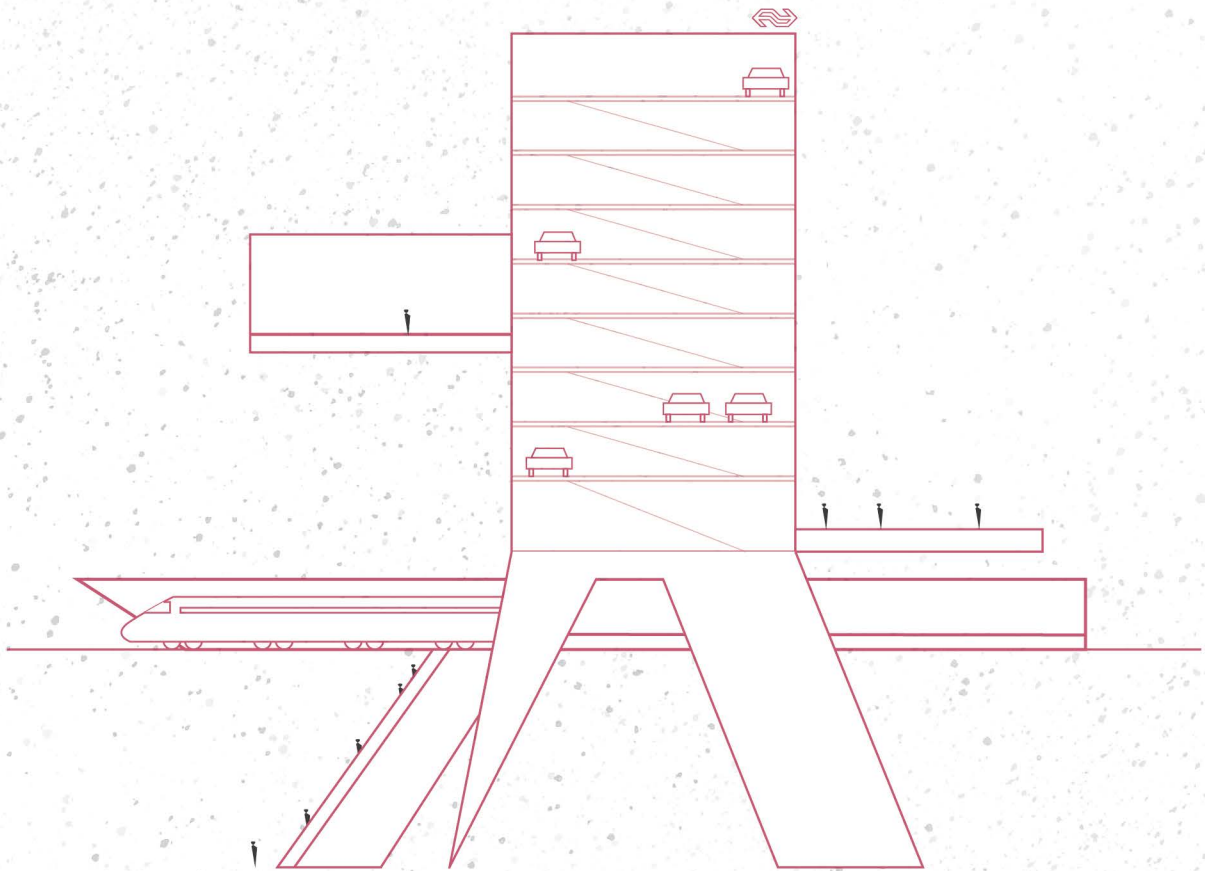

*Building as city*

### **3.3 Corviale Rome - Fiorentino, 1972**

Corviale is an almost 1 kilometre long residential complex in the area of the city of Rome in Italy. Designed in 1972 by a group of architects led by Mario Fiorentino. The plan was to solve the lack of workers' housing in Rome. When the building was delivered in 1983, it accommodated 9500 residents including other facilities such as a school, commercial areas, recreation facilities and church. The building was mainly built to encourage social contacts between the occupants. The complex is based on the ideas of social housing from Le Corbusier: all infrastructure is located in the building to promote social contacts. Moreover, this type of habitation would prevent the advance of the city to the countryside.

Fig 21: Corviale 1km "city in a building" principle: (Own illustration)

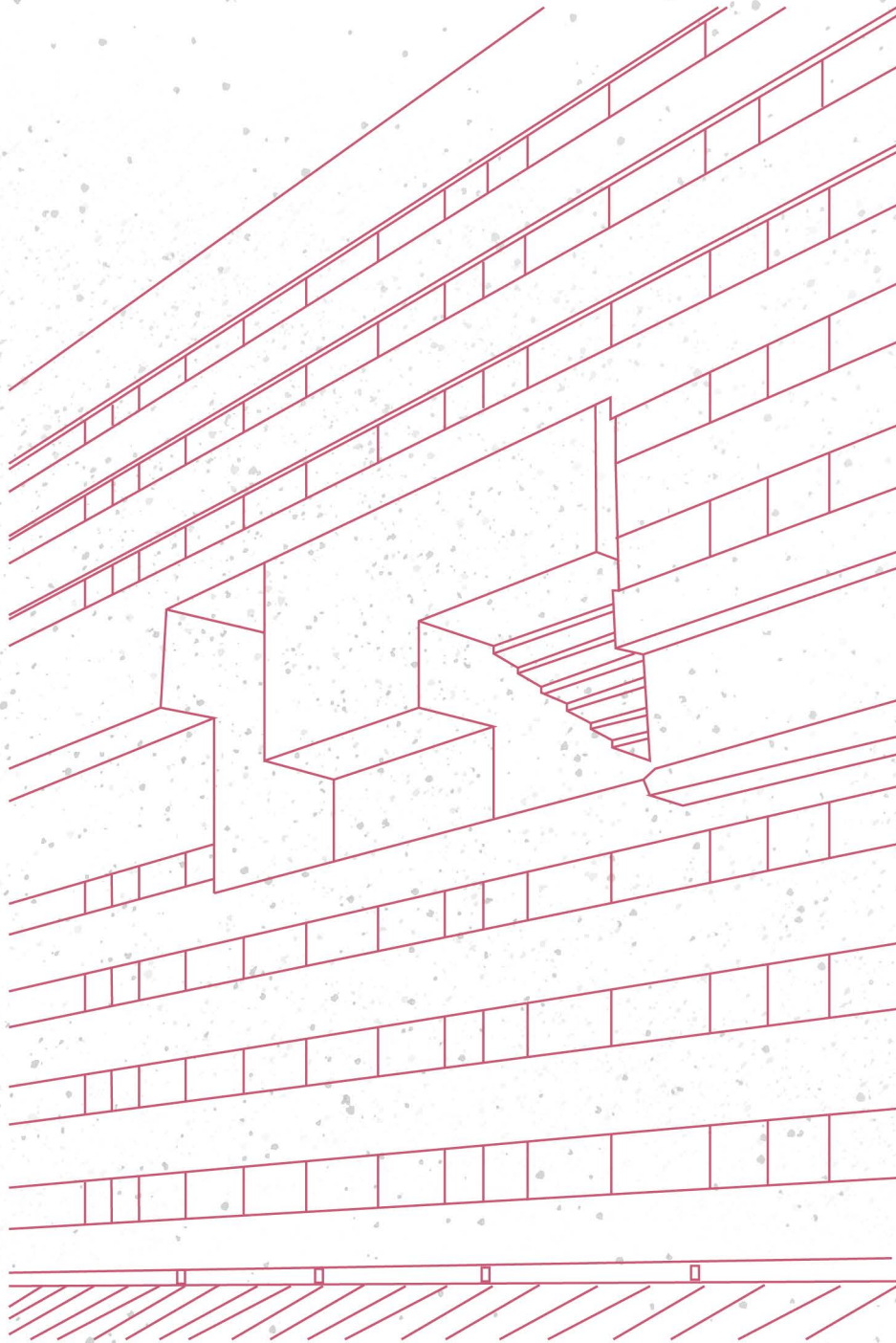

### *Building as a continuation*

#### **3.4 Fiat Lingotto Torino - Matté Trucco, 1922**

The construction of this factory started in 1916 and opened in 1923 for the Fiat Automobili Group in Torino Italy. It was planned to be the largest car factory in the world, with its unusual five-floor system with raw materials that are connected by a concrete spiral ramp for the cars. The production the cars started from the ground floor that went up through the building. Finished cars emerged at rooftop level to go on a test track. This factory was seen as the avant-garde in the world of architecture, thanks to its compact yet efficient process. Le Corbusier called it “one of the most impressive sights in industry”.

This project demonstrates a new path of efficiency by identifying the production process through spirals within a particular framework. The result is a smooth process that offers everything for the car.

Fig. 22: Lingotto building where "flow" is the guided theme: (Own illustration)

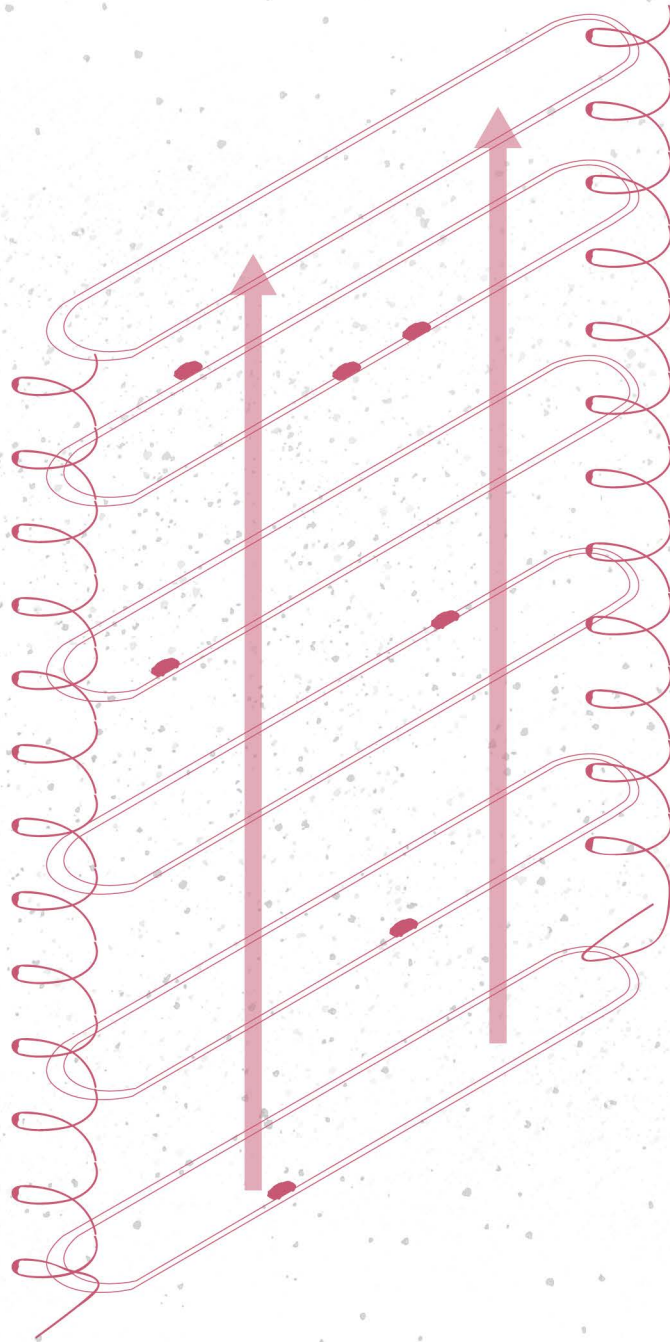



*Building as an accessibility*

### **3.5 Uber AIR Skyport-Humphreys & part., 2018**

This proposal led by Humphreys & partners architects used natural elements in the design as a solution to a technical issue; drones as a swarm. The building emerged from an oval shape making it accessible for many drones. The beehive structure became an essential element which enables light, infrastructure and typological recognition.

Fig 23: Idea of hub that also serves as drone-attractor for deliveries: (Own illustration)

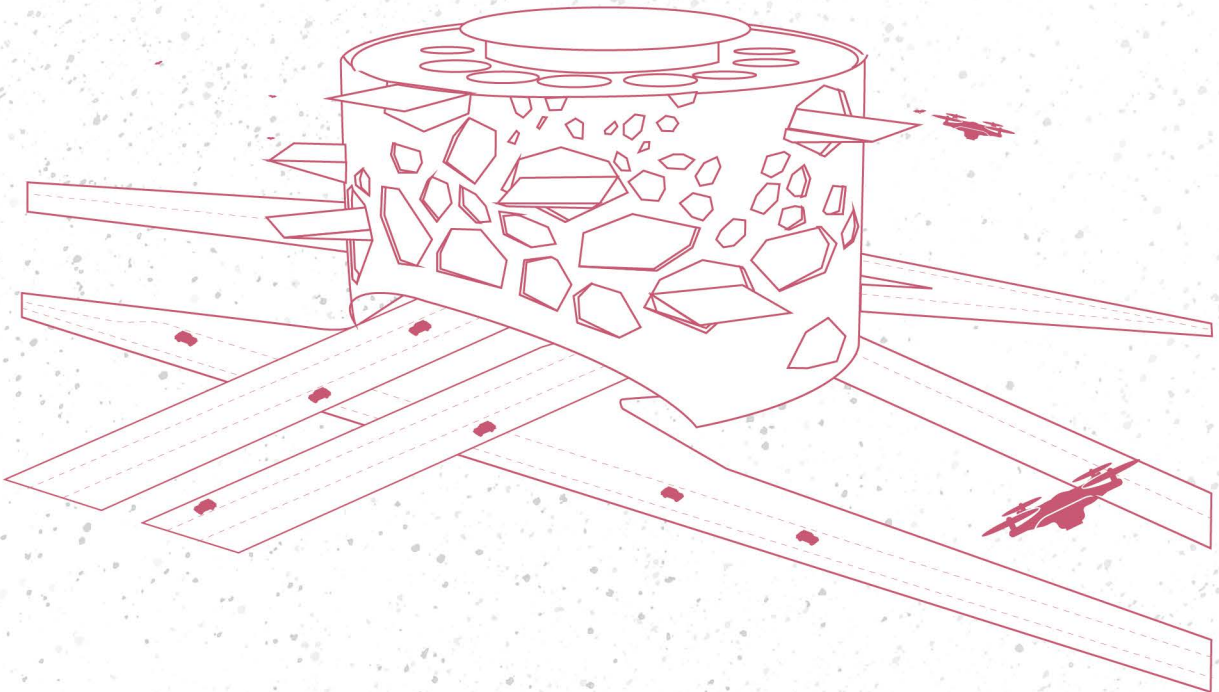

#### **4.0 Introduction**

The following chapter will focus on the conducted research method for this project. This research method will be done by a research by design method. This method is a kind of inquiry in which design is a substantial chapter of the research process. During this project, the architectural design process creates a route that leads to new insights and observations.

C  
H  
A  
P  
T  
E  
R

# 4

THE METHOD

- 1. The problem
- 2. The ambition
- 3. The references
- 4. The method
- 5. The themes
- 6. The emergence
- 7. The opportunity
- 8. The results
- A. Bibliography
- B. Appendices

### 4.1 Towards the ‘optimum’

There are many different options for finding the most optimal hub for the city. Some do interviews, which is based on giving interviews and observations, while other researchers are conducted by doing surveys and experiments, which is more close to quantitative research. Whereas history has always focused on either qualitative or quantitative, you see today that one makes the combination into these two forms. Heading the 21st century, the scientist John Creswell noticed that starting from the 1990s, a shift to mixed method approaches which integrates both quantitative and qualitative methods (Creswell & L., 2018). This term “mixed methods” refers to both mixing variables or quantitative and qualitative data within a single investigation or inquiry. Mixing the two methodologies permits a more complete and synergistic utilization of data or analysis that is leading towards the optimal state of design.

However, it remains a mystery when you can reach the ‘optimum’ of a specific goal that is set there. During the research into this optimum for a hub in the city, many factors play a role in the design phase. One factor can be the ethical issues; How do you experience the journey to the train station? What emotions play a role in high-rise buildings or social rental housing? Moreover, to what extent do finances play a role in the choice of means of transport in your journeys? According to the Netherlands Plan Bureau for the Living Environment (PBL)(Snellen, 2014), Dutch people sees a pleasant and comfortable travel experience as a high priority. Higher than for example the travel time. To clarify; if the journey to a destination takes longer, but if the journey is more comfortable, then it seems to feel shorter than a shorter journey but with a less pleasant experience.

If a transport hub makes it possible to make the area car-free, this can logically result in more public space than a higher density for the city. It opens up more opportunities for liberties that the municipality or community can implement. Where the city is no longer surrounded by the infrastructure of motorways and parking spaces (learning from Barcelona) but is more focused on the dynamics in urban design. The experience towards the hub can, therefore, lead to a newer pointcloud system.

#### **4.2 Data and design**

During the start of the master track architecture at TU Delft, interest began to grow in the so-called ‘digital architecture’. Digital architecture is a vision in which new technologies such as coding and big data play a major role in the design decision making of the architect. Big data is also often seen as the ‘key’ to both worlds of qualitative and quantitative research since the parameters here are not looked at specific elements, but at our way of life; how we travel, our patterns, financial expenditures, etc. It is especially interesting that big data not only focuses on structural or infrastructural aspects but also on very general issues that can make a major contribution to design. A visual pattern can be seen in architecture that is associated with new techniques such as big data. An example of this is during the MSc I Why Factory project, in which research was carried out into an ‘optimal’ building based on human needs. Not everyone has the same needs and preferences, but what if the system can adjust to your preferences there automatically?

For this project, project HUMAM there is a growing interest to find the most optimal location of the hub. To find this location, various factors lead to the

decision making where the hub should go, and in which direction the orientation for mobility will lie. The sources of inspiration obtained from the previous studios (The Why Factory and Complex Projects) are therefore combined in this investigation into the identification of a more optimal location.

The following chapter will be devoted to the extent to which big data can contribute to the efficiency process for the architect.





### Introduction

We often are not aware of it, but everywhere in the world people are measured and 'scored' to predict their future behaviour. It can be observed in recent decades that data has become one of the most significant source of information in this era which encompasses our daily habits such as swiping, liking and emailing. However, these daily gadgets that we are using in our social life, such as lamps and wearables, are informing our understanding of our daily activities, thus accumulating data. Thanks to this pool of big data, credit rating agencies can predict and calculate what we do with our money, if we commit fraud or even have the ability to track our daily behaviour, to measure our health. These predictions can also be brought forward in other aspects of our daily behaviour, such as the way we live, the way we travel, or the groceries we buy; every track record of our daily activities are linked to big data sources is linked to servers and cloud networks.

When reflecting on the foundations of our environment concerning data, architecture and urban design both play a critical role. More clients become interested in linking our daily pattern to architecture and urbanism to improve the design and presence of desired facilities on a quantitative level. Take, for example, the entertainment company Walt Disney Co., where the production company applied location tracking devices to optimise the sales-performance of the park. The collection of big data however, does not stop with smart equipment and other 'invisible' systems. Architects and urban planners have also acknowledged the application of big data that manifests itself in a physical setting. Although not much has been written about the application of big data in the built environment, during my

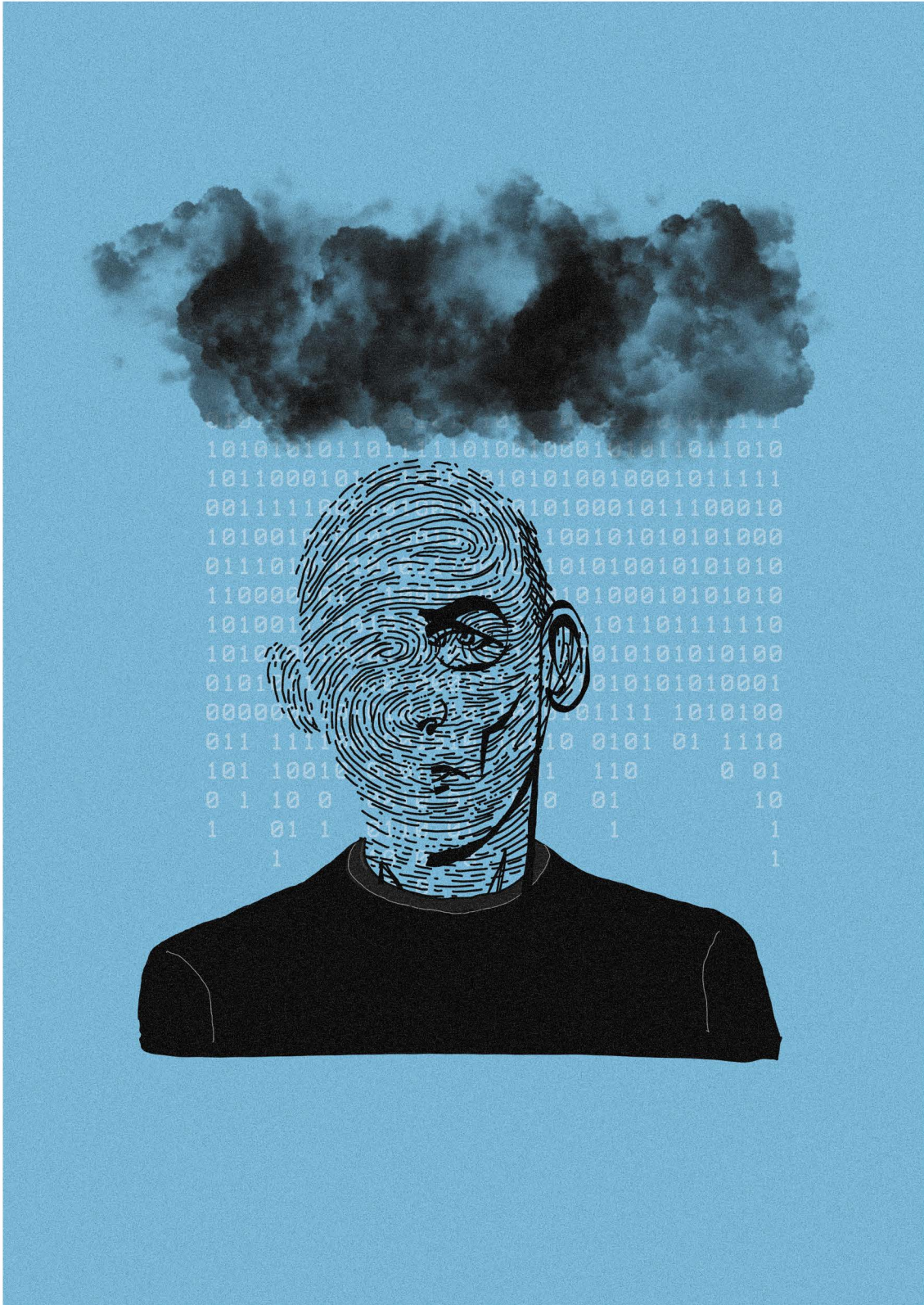

Fig 24: Data and architecture. "The architect may no longer be needed" - Koolhaas. (Own illustration)

study at the TU Delft, I noticed that architects tend to structure their findings on technological developments from a stylistic and philosophical perspective.

This understanding of big data as a source in architectural discourse can be reflected in my City of the Future, Cross Domain studio, resulting in the starting position of my position paper from contemplating how we can design a city of future demands. During my graduation project, I worked closely with the Amsterdam Municipality as the main stakeholder for an investigation into the Amsterdam Sloterdijk area, located in the Havenstad district, where they anticipate problems due to the expected placement of 70.000 new households over the next 30 - 40 years. However, these expected numbers does not only represent the great scale of the project; looking towards 2040 or 2050 also brings uncertainties with the rapid change of technology and upcoming new ways of transportation, like the autonomous vehicle.

When reflecting on the traditional practice of an architect, I experienced often endless processes of re-designing a project due to the changing needs of society and other expectations of the client. Although this process of trial and error has been regarded as the norm in the architectural field, technology can help to close this gap of inefficiency. Moreover, I have observed an interesting growth in the use of big data as the primary source in realising a project with fewer flaws and at a higher efficiency rate compared to the traditional method. This observation has already emerged in companies such as MVRDV and Perkins+Will. They take advantage of technology whenever there is the opportunity, by encouraging a multidisciplinary interaction between the architect and the data engineer.

I therefore also share the belief on the changing position of the architect in an era of technological developments. A particular field of architects are changing their position as a “data-technician.” It is known that the architect is to be the synthesiser of information, the decision-maker in the design process. Nowadays, I noticed that the position of architects is understood as mixed-consultant between different parties, where big data plays the main role in this shift.

Despite this advanced development in the efficiency of the architect, it also raises the real issue addressed in this research paper: How much is data able to play a role in this profession? Also, is big data influencing the position of the architect? As a result, the main question of this study is as follows:

*How can big data contribute to the efficiency of the architect's work process?*

#### Method

This position paper deals with the changing position of the architect in an era of technological developments. The method employed is based on the analysis of prominent architects who are using big data in their practices; I will argue whether preliminary axioms about this position, collected by theoretical frameworks and literature, are valuable for architectural design research. As a result, I aim to establish insight into the possible applications of data in the research by design process, in order to create an empirical foundation for optimising design efficiency.

The complexity of big data in the architectural dis-

course calls for a carefully selected strategy, which contributes to the efficiency of the design process. Initially, the term big data can be understood as an extensive set of quantitative values, that can be processed computationally to understand its patterns, trends and similarities in different fields. This practice can also be tracked back to the changing architecture industry, where I as a student, I experienced first-hand that designing buildings no longer is dependent solely on pen and paper. In fact, with access to specific data, architects can design in a more safe and efficient manner. At present, there are many ways that big data is used as a tool in our profession. The methods of dealing with data will be demonstrated as follows.

An architect that uses data to inform design is the Rem Koolhaas. In his book *Elements of Architecture*, He embraces the changing position of the architect, that is currently in a progressively diminishing sphere of importance, as buildings has become more involved with technology as a framework during the design process. In his book, an example was given of this technological advancement, where a window of a building that was traditionally built by a craftsman, has now become a product designed by engineers and technicians where the size and structure are based on data-related outcomes. Koolhaas shares his vision on the changing responses of this profession. Therefore, he noticed that the scope of the architect is reducing significantly because of technological advancement, resulting in the increase in liability and legal aggression which leads to the diminishing responsibility of the architect . “The architect may no longer be needed.”

On the contrary, special attention to the method of us-

ing big data was stated by Koolhaas, indicating that our speechless buildings are on the verge of learning to ‘understand’ peoples behaviour. This verge of ‘computational’ architecture enables the profession to represent an incredible change in architecture. During the Venice Biennale of 2014, together with Nest CEO Tony Fadell, Koolhaas rounded off his speech with the conclusion that technological benefits such as big data is representing the avant-garde of architecture. The architect, therefore, mostly tends to diverge towards a repetition of typological history due to the constrains in freedom. In my opinion, Koolhaas and Fadell embraces technological developments because of the monotonous recurrence of our historical and architectural ancestors. Besides, I also believe that he recognises technological innovations as a benefit to evoke new opportunities.

#### Data as extreme

While Koolhaas addresses the use of big data as a tool to break historical recurrence, the architect Winy Maas from the Why Factory studio conducted research on the full efficiency of big data in architectural discourse in his book *City Shock*. Both latter architects are profound in their work and expertise in which they put great influence to our society, but do not share their architectural representation.

While working on the project in the Why Factory at the TU Delft (2017), I had the opportunity to conduct research on the most effective and efficient method of using data to design a housing block. This housing block is designed without any architectural/human intervention to create the ‘optimum’ in building design for the people. While creating this optimum arrangement, the building was able to ‘understand’ the peo-

ple's algorithm and demands, based on their activity, in the end producing a tailor-made space. If the algorithm recognises a pattern of dancing in the multiple rooms, the system will provide the most comfortable way by, for example, enlarging the living room (dance floor in this case). Due to this creation, the data-driven design can create a comprehensive understanding of everyday experiences and needs. Moreover, Maas stated that designing buildings with numbers can be used in the case of 'extremising scenarios'. Designing by using data lead to frontiers, borders, and ultimately inventions. Rather than the 'classical way' of designing urban outskirts or architectural buildings, the 'data-building' cannot be seen as a design or mix regarding context and relations. The building is described by information; which has no input on prescribed ideology, representation or context. In my opinion, the work of the architect in this project has become mainly valuable on a social yet anthropological level. Since the design was mainly done by computational input, the architect in the case had to change his position towards the social scale. Here it is made clear that preliminary analysis such as conducting survey's and researching typologies has become redundant. The architect can conduct the research at a higher efficiency rate with a top down approach through quantitative data.

### Data as a flaw

Understanding the benefits of big data, I also noticed the contrasts by using this source in architectural practices. This contradiction has been formulated by Professor Jakob Nielsen, who addressed the danger of big data as a lack of framework and transparency; a pool of open to manipulations. More data also offers more possibilities for advertisers and me-

dia companies to track our behaviour, values and desires. One example regarding the misuse of data is in the recent U.S. Presidential Election,. Because of an error unveiling data misuse during the election, it caused many Democrats to stay home. According to the New York Times, this increase of bad data could have been prevented by improving the underlying assumptions of the polls. Examples like this shows that data can be seen as a very vulnerable source that needs to understand its correlations and not causations.

In architectural practice, both Maas and Nielsen stated that data should not fully influence the behaviour of a building. First, data still shows many contradictions due to lack of data or decisions that centre on people. Second, no data or compassion will supplant the way that a designer needs to decide on how to translate data into design. It can be said that intuition likewise plays a fundamental role in decision-making in quickly changing environments. Just like the failure that happened during the U.S. Election, there are still countless cases of misused or misinterpreted data. Also according to Nielsen, relying too much on data will also have terrible effects on our society.

Professor and writer Edward Tenner illustrate these effects in his book of *The Efficiency Paradox*. Although Tenner does not share any architectural relation, he noticed that big data contribute to a more efficient process, but will make us less efficient in the longer time-frame. By removing all the trials and errors, like what is happening in architecture as well during the design process, the platform of efficiency will only limit us to confine within existing patterns. Tenner gave the example of film producers, in which they use data to



find out the most popular genre, which leads to more profit in the film industry. As AI (Artificial Intelligence) already optimised the whole process based on existing data, it does not cater to the needs of the adapting environment and changing taste of the public, resulting in the production of mono-genre movies. For architecture, if we can design on a more extensive and quicker scale, are we willing to sacrifice the enjoyment and the lessons learned from making these mistakes?

### Data as an opportunity

To acknowledging the importance of data-architecture in this era, the fundamental underlying question for all theorists and practitioners relies upon the position of the architect. According to the philosopher Stephen Davies, technology and architecture have been widely discussed by prominent architectural theorists and practitioners, like Le Corbusier, Loos, Venturi, Libeskind, Tschumi and Gehry, who understands the notion of architecture as the foundation for the exploration on the essence of what architecture is. Therefore, they see technological growth also as a study in the quality of architecture.

In 1977, the social critic Ivan Illich argued that the broad influences of digital technology can be understood as the end-of-times for professional class skills such as accountants, lawyers and architects. However, rather than a broad democratisation of the expertise through big data and automation, it enables the architect to “transform the work of human experts”. Architects will no longer be the “gatekeepers” of professional knowledge or judgment. Due to the advantages of working towards the understanding of the human factor, the increasing complexity of building problems will also put more pressure on the position of the architect.

In light of the current 21st century, Richard and Daniel Susskind argued in their book on *The Future Of Professions*, that technological growth will not make architects redundant. In fact, since architects design just a fraction of the total built environment, this trend cannot be seen as harmful for the society. Susskind argued, however, that architects should be aware of this process as it is easy to lose control and influence that will limit our design aspirations to more progressive results. On the other hand, Illich and the Susskinds acknowledges the different influences on architecture, they also noticed great opportunities that can be developed into new opportunities.

#### Results

When analysing the recent theoretical frameworks, I came to understand that conducting big data in architectural research leads to a greater certainty throughout the design process. Where architects like Koolhaas and Maas are acknowledging the benefits of data in architecture, I discovered the constraints like Nielsen addressed. To find the contributing factor of data efficiency in architecture, the answer to the main question is therefore necessary.

#### The good

With the research question in mind, I can see a direct link with Maas' vision on the efficiency rate of big data. Resulting from his vision of the fully-data-based Why Factory project, the data can create an extraordinary benefit for the long term. A timeframe that is continuously trying to fit into the urban envelope. Based on his research of on the most optimal housing block, conducted by an algorithm that can 'read' peoples demands, big data can be re-scaled to define

the new boundaries of the city. Furthermore, Maas' perception goes even beyond a single building. Resulting from the technology that can upgrade the classical approach of defining the boundaries of the city. If for example, there is an understanding that the urban size is equivalent to a maximum of one hour of travelling, new technological developments can be employed to broaden the border of the urban size within its given timeframe. Many years ago, thanks to bicycles, the city development was based on a distance of 20km. However, with the introduction of the automobile, people are able to enlarge this distance up to 80km respectively. Due to quicker mobility, meta-cities, hubs and other data-related urban envelopes, according to Maas, the city can span up to 400km. Peculiarly, the city is able to connect  $400 \times 400 \text{ km} = 160.000.000.000\text{m}^2$ . Although these numbers can be regarded as superficial, it reveals the invisible possibilities, creating much denser and populated cities all around the world.

The results of fully depending on data show that the process can be seen as an efficient source for architects. Even though the best designers in the world are not able to predict human behaviour and interaction, Nielsen noticed a gap in the lack of knowledge between designer and the user. Therefore, Nielsen believes that the research for a targeted audience should be prepared for a range than what is visible. Here, data can be seen as the 'remedy' for designers to reach the most likely demands of the users. Thus, creators can no longer make decisions based on their intuition, and instead meet the user's requirements to apply tailor client experiences.

Therefore, using data in architecture must be seen as a source, not as a role. It allows architects to decide not out

of pure intuition, but based on an empirical foundation for the design. The architect is the synthesiser of information, working with different consultancy. has Architects have entered a new dimension of designing which is nothing different than creating a tangible and visible form.

The bad

When considering Maas' extreme scenario, the results of this development also demonstrates the discrepancy in our society, shown as a quantitative value rather than qualitative. The results of the Why Factory project unveils an interesting finding of intelligent and innovative solutions for ever-changing environments to maximise customisation and adaptation within a building envelope. Although this experiment shows fascinating results of how to optimise space, it also highlights that there are potential dangerous and destructive possibilities of big data, that can subtly (and not subtly), change almost every condition in our modern life. Even though Koolhaas embraces this notion, it can be acknowledged that this development in architecture does not require any historical or typological background. However, I do see the importance of type in architectural practices. Today, a significant part of the people of the world population lives in cities. By 2050, the United Nations expects 2.5 billion more people that will be living in cities. This growth is the result of more choices concerning housing, consumption, transportation, education and employment opportunities, but also to avail different opportunities. Due to technological improvements, migration and globalisation, cities are all starting to look the same. Ironically, writers such as Franklin Foer have denounced this growth of technology in urbanism. The writer sees digitisation as a a global hazard to our humanity.

Although Foer appears to be strongly against technology, he does not advise to change the working environment or to throw away your smartphone. What he advocates is described consent fed by understanding of the agendas of the largest technology industries and what they will do to reach their goal.

### Discussion

It can be said that data is the new oil. Not only in architectural practice, but in almost every profession. From healthcare to retail and logistics. Big data is effective in quantifying the global problem, where there is the need to accommodate thousands maybe millions of people over the coming years. The solution towards optimising living standard has become available. Maas also illustrated the possibilities of big data and other technologies, where the borders of the city may be unlimited. Quantitative numbers are both the consequence and cause of what the world looks like. The more numbers our world will control, as is happening with big data, the more they will change our world. Architects can be seen as the pioneers, and even according to Nielsen, the remedy for big data. Because of the inefficiency in the decision-making process, technological developments can accelerate this process that will skip the errors beforehand.

However, it can be questioned if big data can contribute to the efficiency of the architect's work process. It is still controversial whether data in the long term will make the work of the architect more efficient. Although the architect can use data as a source to get more understanding of the target group, Tenner brings up a strong argument on the missing gratification, resulting in one essential element in architecture; the element of making the mistakes. The trials

and errors in the design process are therefore necessary for the architect to avoid further limitations. “It can be said that success never teaches you anything. Mistakes however, are worth it for plenty of reasons.”

While the municipality of Amsterdam sees data as an opportunity to increase the efficiency to discover the best appropriate buildings possible. Resulting from this research, it can be said data will benefit from a resource we collectively create. The technology helps the architect to set the parameters of possibility ranges. Furthermore, it frames our potential futures, but it is still incapable to select the best option available for us.

For my future project in Havenstad area, I therefore believe data is able to frame our potential futures, but is still incapable to select the best option available for us. Furthermore, I believe changing our habits and interests is a natural yet ordinary for humans to do, due to our evolution of economic, cultural and technological factors - which explains why technology can only be used as a frame or tool for design, but can never replace it completely.

Architects are the synthesiser of information. The society is our resource.

### 4.3 The flowchart towards design

With all the ambitions of the municipality, interviews and essay about data in the architecture, a flowchart diagram (fig 25) has been made about the method of work for the creation of the hub. This diagram shows which input will be available and which phases will occur. Where it was first assumed that big data had to 'design' everything, a conclusion has now been drawn to merge between the data and the 'traditional' method of research by Research by Design. Every part of location, size, function and shape is seen as an iteration process that keeps repeating itself until the 'optimal' hub has been adjusted to my preferences. The following section focuses on the method of research, which is done by research by design research. Here, this method helps to suggest a practice; where design arises from research, search for concordance between the methods of research and form-giving, experimental design practice. Furthermore, it also investigates the research inquiry from the practitioner's methods and acknowledges practise as a mean of gaining new knowledge.

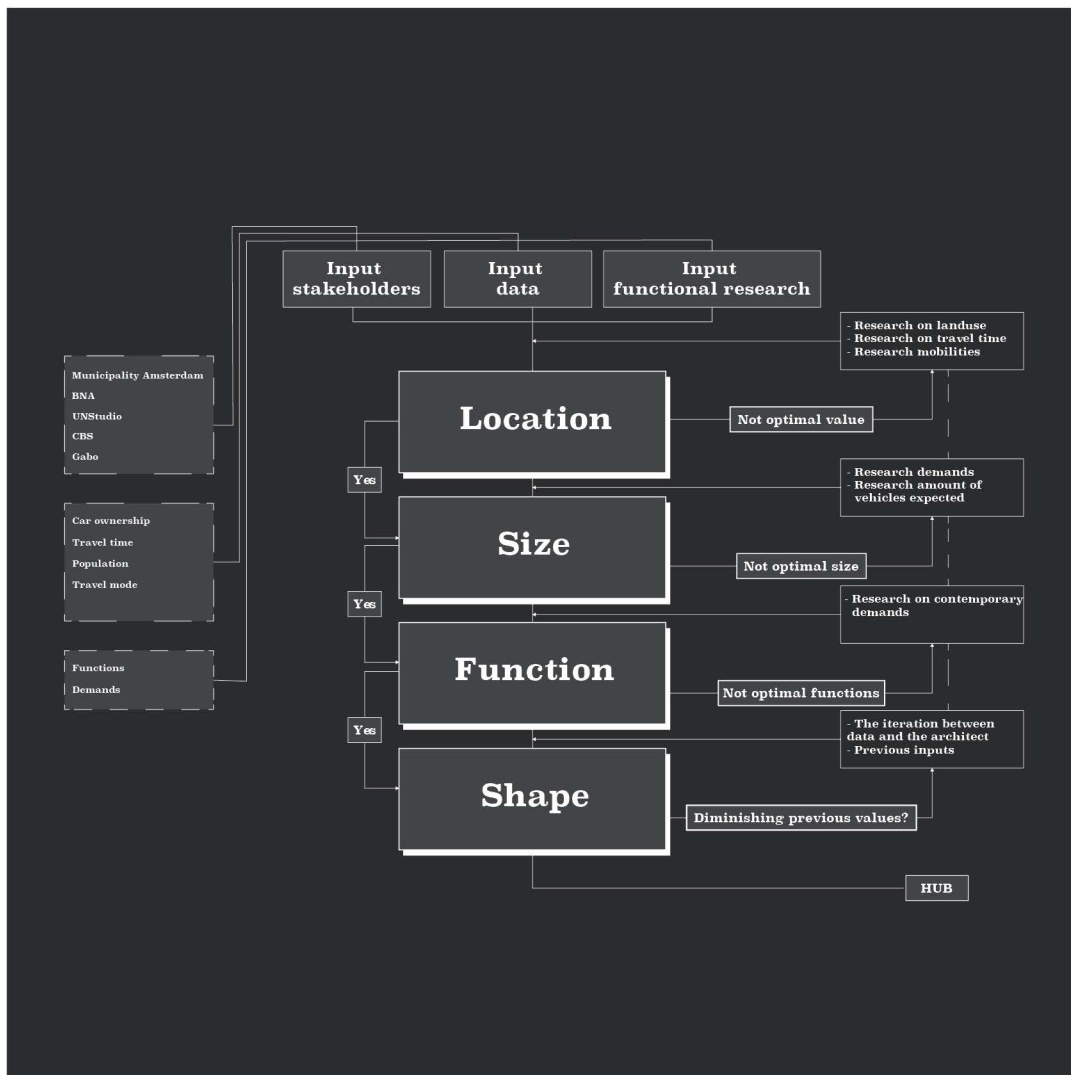
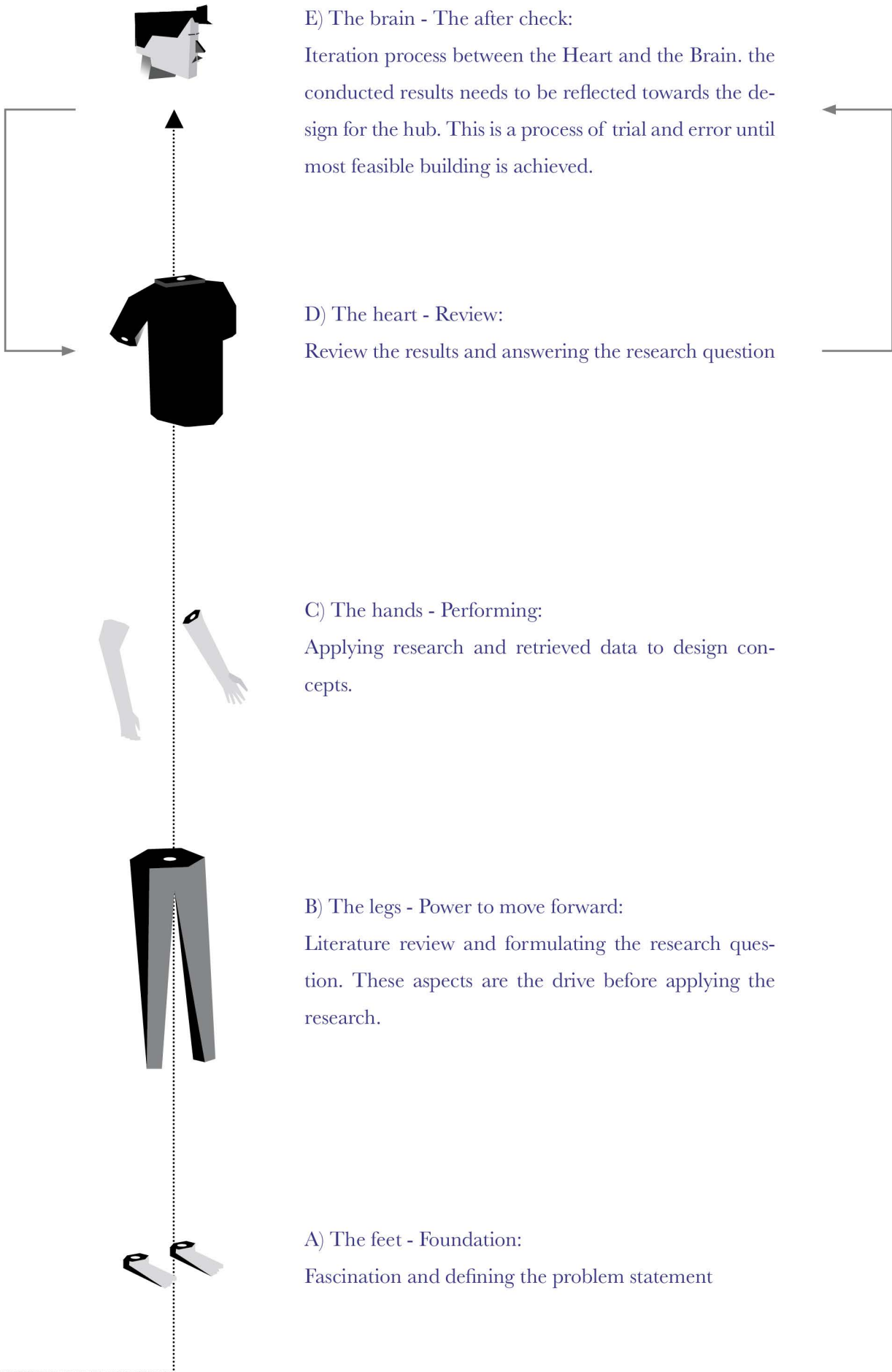

Fig. 25: Flowchart of input and expected output: (Own illustration)



The research method can be understood in a relation of the name of this project; HUMAM, in which the hub focuses on 'giving back' the land to residents. Moreover, the project puts its focus not particularly in the architecture or urbanism field, instead of searching for the possibilities and the impact of the hub. Therefore, human anatomy will reflect the process taken for this project.





## 5.0 Introduction

The following chapter focuses on the three most essential elements for the hub. Here it is crucial to what extent I, as the architect, can contribute to this development. The themes support the general picture of how the hub should behave. They originated from all visions, and information from the previous chapters, and will, therefore, be leading as a design output for this project. This means that the design for the hub must meet these issues at all times. It is important here that consideration is given to the impact of the hub, what it will deliver and what improvements will become visible over the years. With this, the ‘quality’ of the city is redefined, and statements can be made in principle about the operation of such a hub. The hub should offer a new experience for the people, a new qualitative space, new experiences, an eye-opener that the use of the car is not stimulated and sees the benefits of it, which can be seen as a landmark for the city.

CHAPTER  
5  
THE THEMES

- 1. The problem
- 2. The ambition
- 3. The references
- 4. The method
- 5. The themes
- 6. The emergence
- 7. The opportunity
- 8. The results
- A. Bibliography
- B. Appendices

### 5.1 Theme 1: FREEDOM

According to the architectural writer Owen Hopkins (Hopkins, 2014), Architecture is fundamental, a public way of art and the creative mind. At its root, the primary position of the architect is to negotiate the combination between process and design. However, these days, architecture is in thrall to private companies and mainly driven by the desire to reduce the amounts of “risks” in their profession. Hopkins stated that with the emergence of new technological developments, architects tend to express themselves with new possibilities. Our human society always strives for absolute autonomy and freedom in society. Freedom is a precious element that you must continue to cherish and always look for new opportunities to redefine our liberties in times that we long for.

It is now unthinkable to imagine a street or neighbourhood without cars or highways without traffic jams. The impact of a hub in Sloterdijk makes it possible to make the area attractive again and to give people freedom in their area. After the cars within the zone of the hub will disappear, the public spaces around homes and infrastructure can be converted into green spaces and other qualitative spaces such as squares and commercial amenities.



Fig. 27: Theme 1: Freedom drawing: (Own illustration)

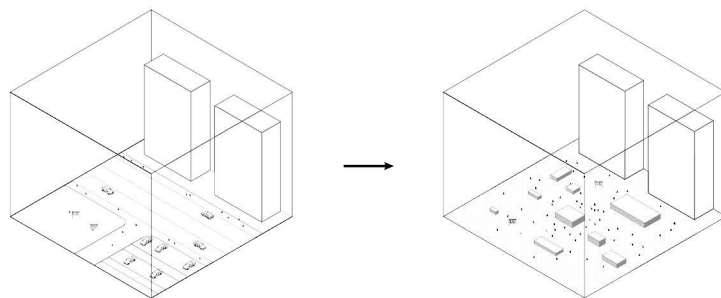

### 5.2 Theme 2: EXPERIENCE & EFFICIENCY

According to the architect Bernard Tschumi, architecture must be critical and revolutionary and must break with all dogmas and traditional rules (Tschumi, 1994). The more experience, the more pleasure there will be, the more “eroticism” the architecture will get. The strange thing is that he does not extend this to the experience of architecture. According to experience eroticism, the pleasure of life is all the greater when there are more and more difficult obstacles to overcome. Tschumi, on the other hand, tries to allow “all” modes of use and all projected meanings. He believes that architecture should be critical and revolutionary and must, therefore, break with all dogmas and traditional rules. The motivation for evolution is always the will for change.

The hub makes new experiences possible. The impact of a building can be the initiation of new methods to create more connections. It shows that Sloterdijk does not connect with other cities, but can express itself in the new experiences that the hub can make possible.

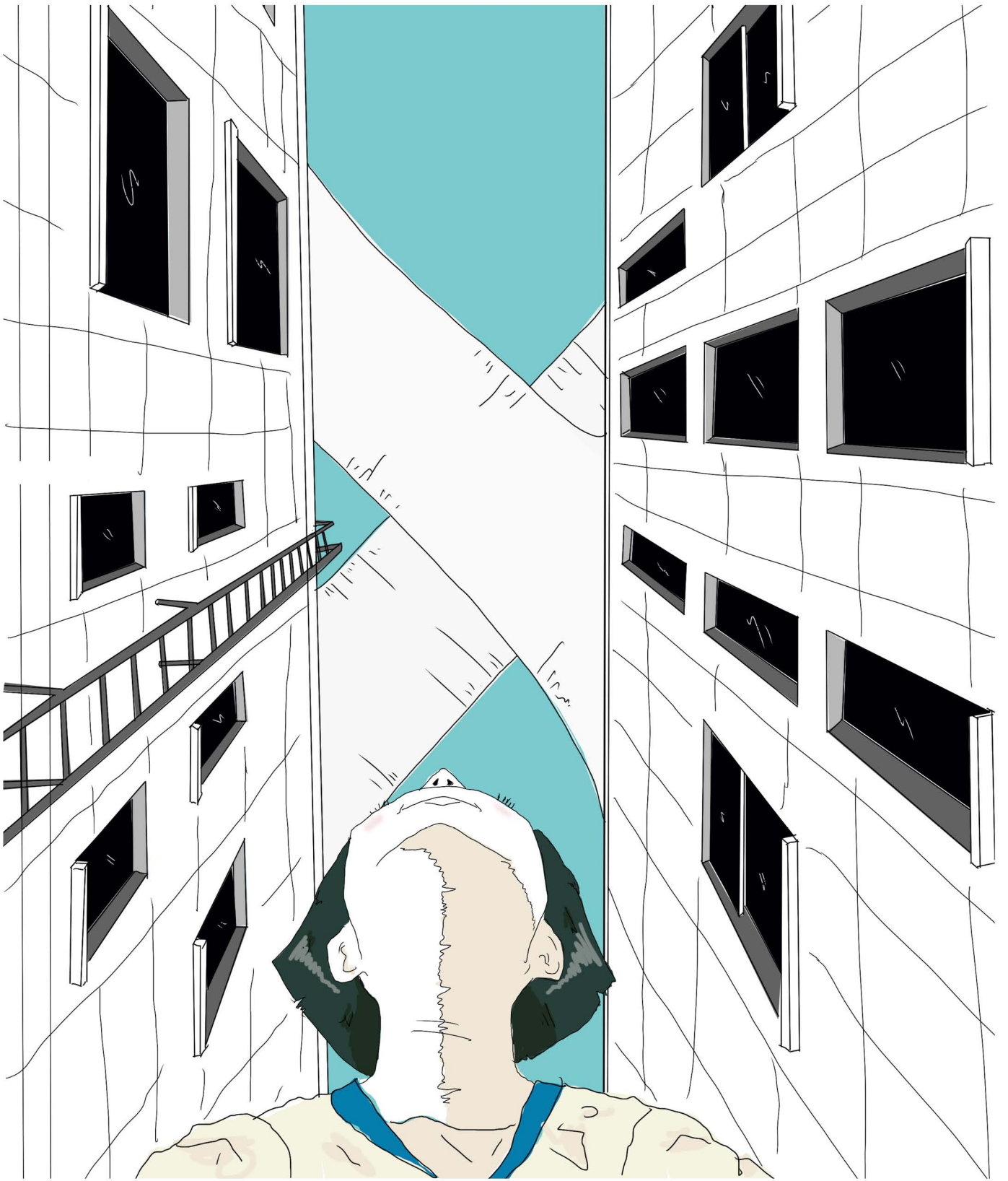
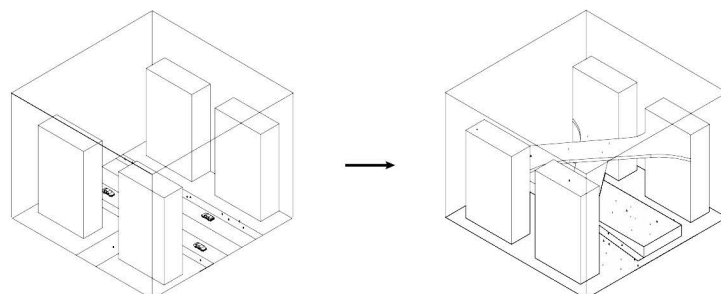

Fig 28: Theme 2: Experience & Efficiency drawing: (Own illustration)





### 5.3 Theme 3: WELL-BEING

People do not notice the cars and highways today because they are not part of the city. People have been grown up with the sense that cars and pollution are just part of our life. People started to notice the upcoming issues of our health and travel efficiency.

Sloterdijk will be one of the first regions to show what advantages a car-free city can have, but will still experience the efficiency of travelling with the self-driving car.



Fig 29: Theme 3: Health & well-being drawing: (Own illustration)

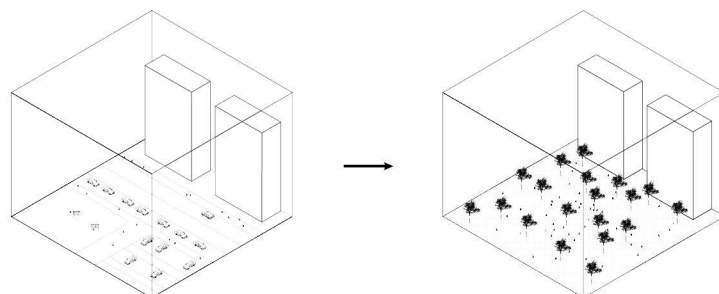

Despite the high ambitions of the Municipality and other architectural firms presenting their project during the BNA event, it is essential to make clear decisions what this will mean to the society; what will it change and therefore what added value it brings? I believe it is therefore vital to understand the architectural contribution that can redefine the way we live our lives.

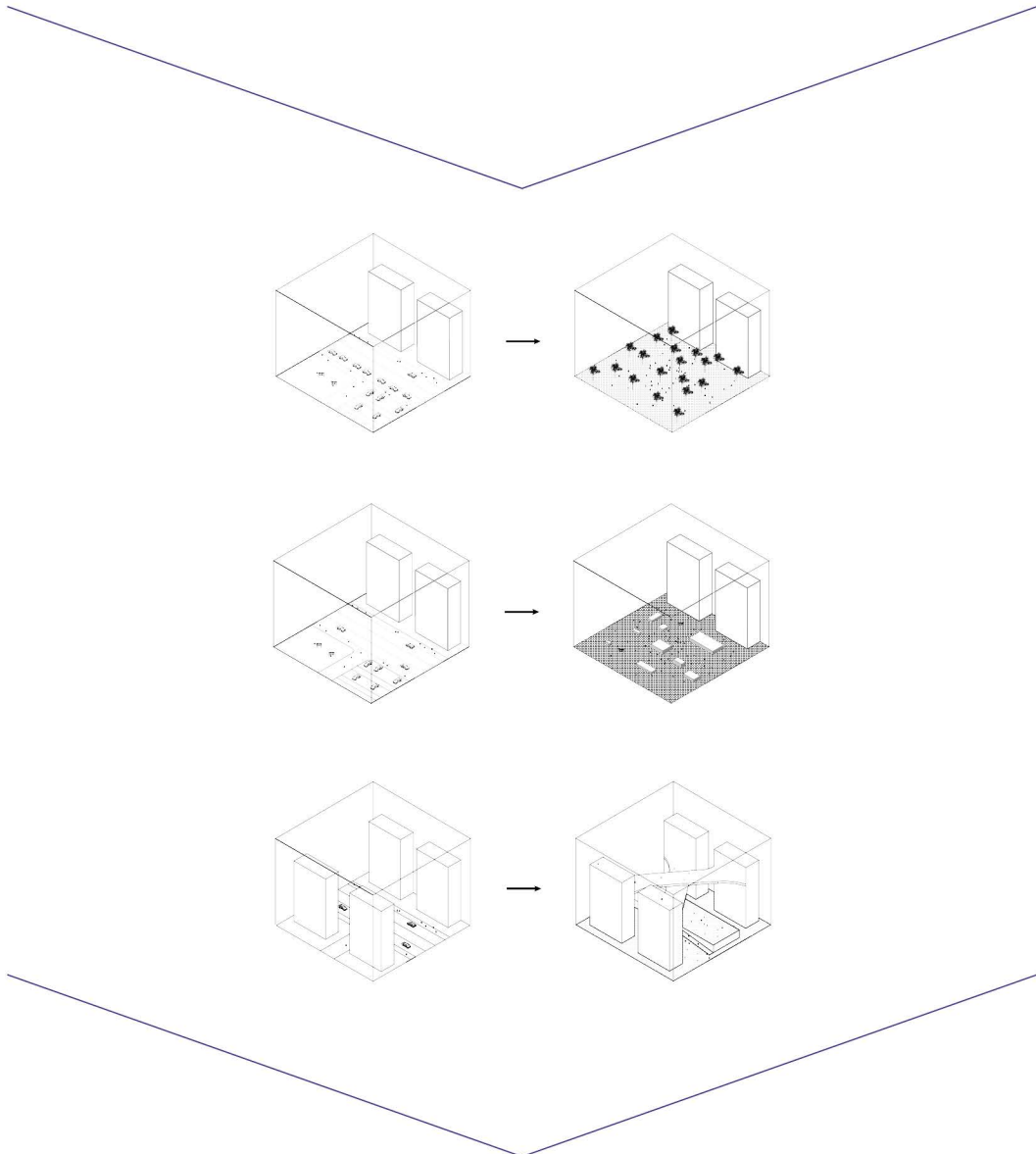
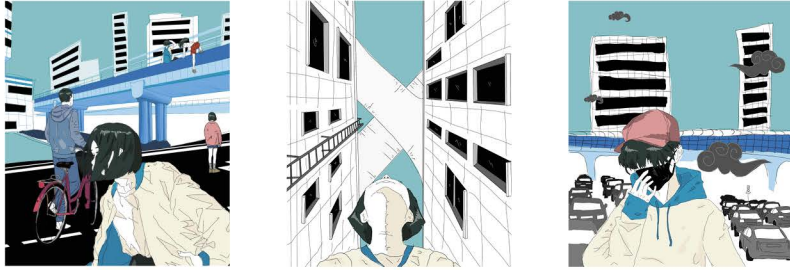

Guideline design process

## **6.0 Introduction**

Contributing to the design of the hub emerges from different aspects in researching what comes close to the earlier mentioned themes, it is vital to understand the conditions what a hub could accommodate.

C  
H  
A  
P  
T  
E  
R

6

THE EMERGENCE

- 1. The problem
- 2. The ambition
- 3. The references
- 4. The method
- 5. The themes
- 6. The emergence
- 7. The opportunity
- 8. The results
- A. Bibliography
- B. Appendices

### 6.1 Location determination based on parameters

In order to discover the best location for a hub, a close companionship with another MSc. Student Gabriel Garcia from TU Delft Geomatics was held to specify the location into a point cloud, given by different parameters. During this research, the program was fed by the following conditions (parameters):

- Within a range of 500m from the main station
- Within a range of 250m from other amenities such as hotels and restaurants
- Adjacent to the primary road

With use of programs such as Rhinoceros and Grasshopper, the system was able to find the shortest paths to travel from different corners of the map (fig 30).

#### 6.1.1 Data as a source for location determination

Another research that has been conducted was the use of data. Thanks to sources of data provided by the municipality and CBS, travel times of 52 residents have been analysed for their daily patterns in Sloterdijk. Figure 31 shows the average times for walking and cycling. The combination of this study and that of the PBL show that the comfortable distance of travelling by bicycle is up to a maximum of 15 minutes. When this limit is exceeded, people tend to use the car or public transport more often.

### 6.2 The radius for the hub

These two types of research both contributed in the best possible location for a hub. Furthermore, to understand how many cars and therefore for how many people one building like a hub should accommodate, it is essential to set up a radius of limitations. These limitations are found based on the information on the earlier findings of the PBL (Netherlands Envi-

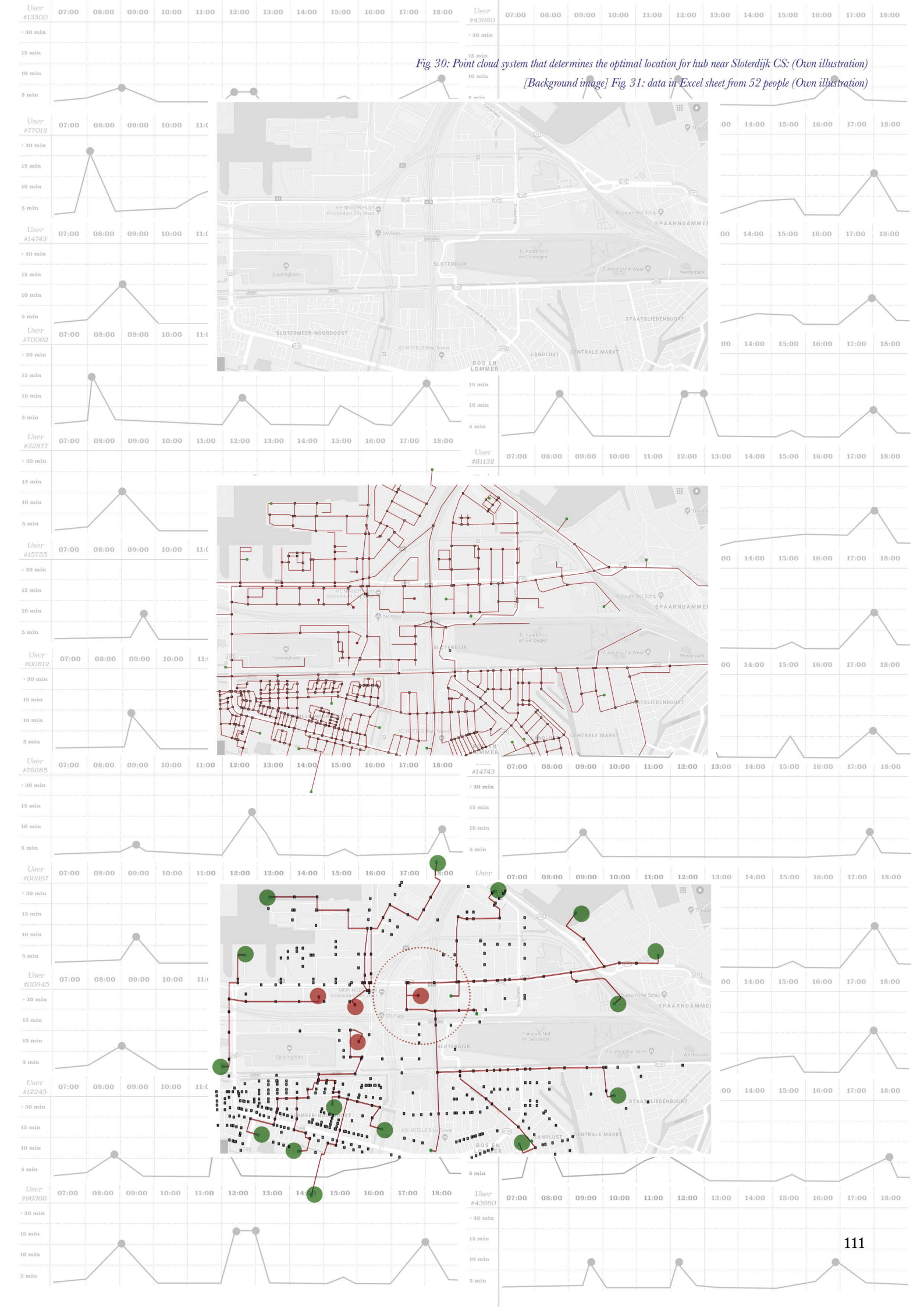



ronmental Assessment Agency). The radius, therefore, determines the conditional border of accessibility and convenience. Thus it is imperative here how many people and transport it can facilitate. This because a too large radius can cause the hub to have too long travel time and people still long for the 'traditional' way of driving within the zone; resulting into a lasting degree of traditional car use. Although penalty factors such as transferring and waiting can be seen as unavoidable, it is therefore important that these factors are implemented smoothly and efficiently. As a result, The bar of 1,5km will be used for this research (Figure 32).

Fig. 32: The study towards the optimal radius a hub should contribute: (Oxen illustration)

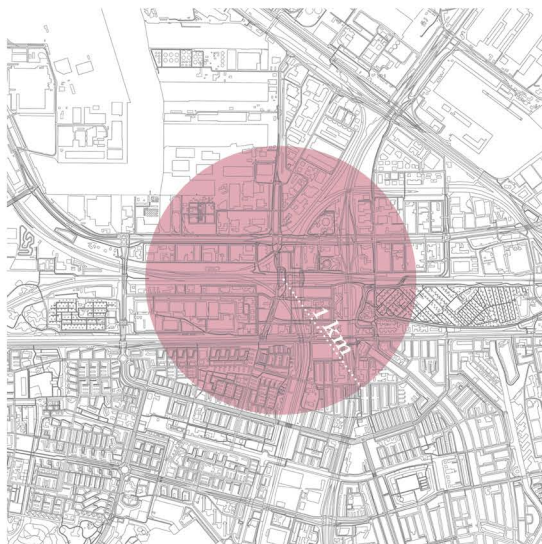
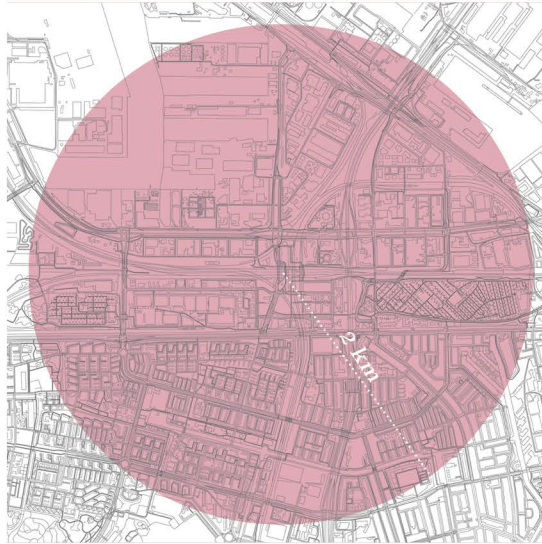

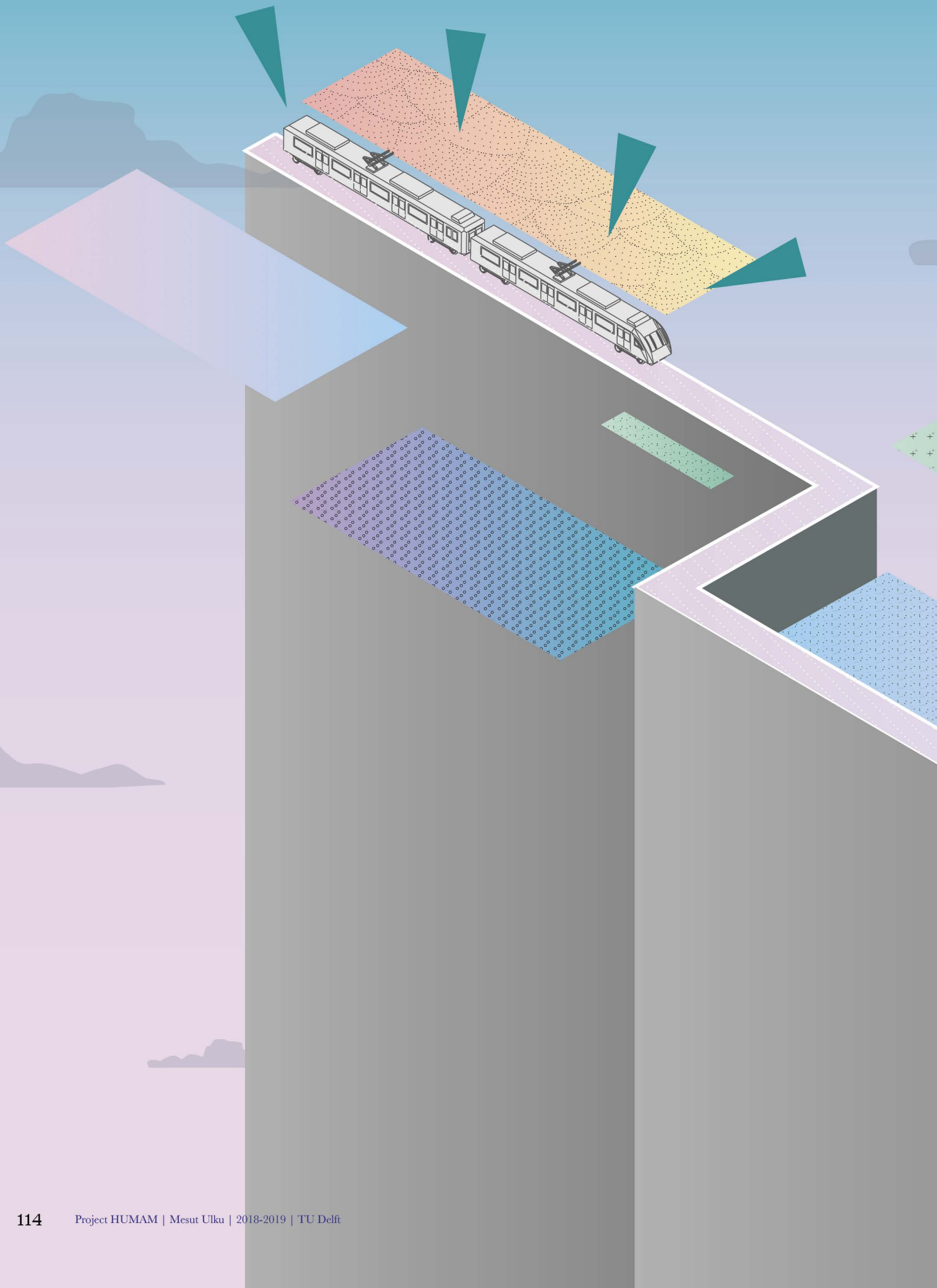

*" A LONGER JOUR -  
NEY WITHOUT  
TRANSFER SEEMS  
SHORTER THAN A  
SHORTER JOURNEY  
WITH TRANSFER "*

*- PBL*

### 6.3 The comfortable travel time-table

The PBL concluded that if the journey is experienced as pleasure, the journey time seems shorter. Even if it is longer than the less pleasant one, to be able to accommodate the maximum number of people in the hub, a maximum possible radius must, therefore, be found. As it is now 15 minutes by bike, this will be increased to 20 minutes, resulting in a radius of 1500m (extreme point to the core). Increasing these 5 minutes is the result of removing the motorways. Giving the user of this space a new experience will make the journey more enjoyable than the 'traditional' way of travelling. A car-free neighbourhood also means less waiting and faster traffic. Increasing the average comfortable travel time can be seen as a logical step for the efficiency of the hub (Figure 33).

The interests for a hub will also differ for specific target groups. For example, residents need more accessibility by personal transport such as the bicycle. The interest in this group is primarily the combination that is made by travelling, such as going to work, school and then going to the supermarket and back home. According to the PBL, the priorities for companies are somewhat different, which focuses more on the economic side; the speed of movements to the station (in this case the hub), and financial value of the company that is within a certain radius of a station.

Making the area car-free also creates more problems for companies within the zone of a hub; because no cars are allowed. Therefore, it is essential that the motorways and rural roads (secondary roads) are still accessible by manual car. The hub will then facilitate zones in combination with self-driving cars within these zones to keep transport efficient, also for emergencies and well-known industries in Sloterdijk.

Fig. 33: Illustration of 'ingredients', the hub needs to take into account: (Own illustration)

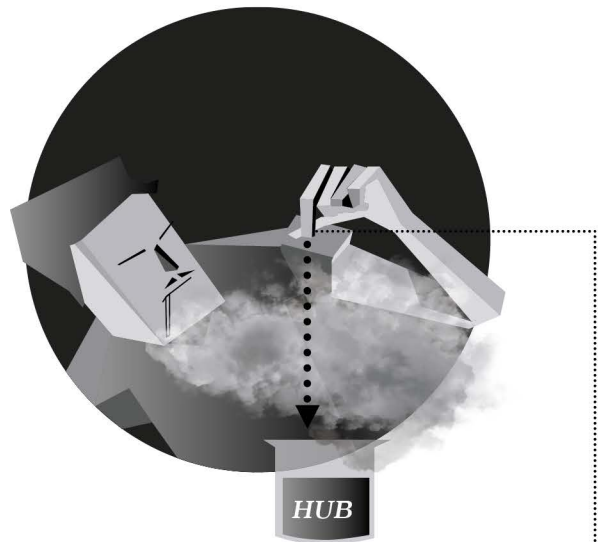

### Residents

Social benefits:

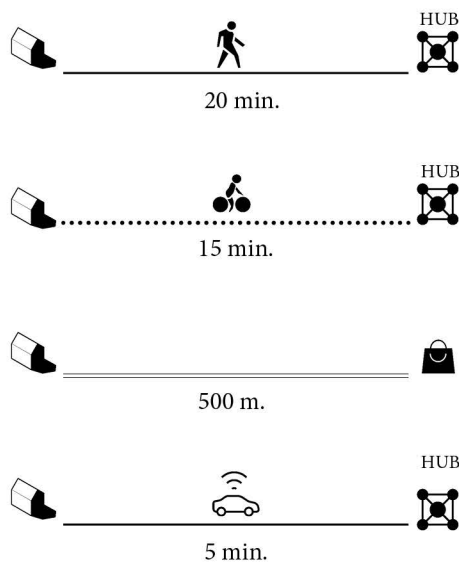

### Employers

Economical benefits:

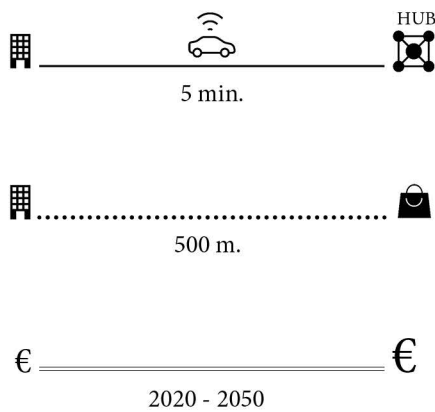

### 6.4 The Baby hub

The large hub (also called Mothership hub) will, therefore, facilitate the central part of Sloterdijk with self-driving cars. The areas such as Isolatorweg, Minervahaven and other surrounding areas will, therefore, be provided with separate hubs, but in a smaller size due to lower density. With future perspective in mind, every 1500m a transportation hub could emerge. However, according to the PBL, creating too many nodes on a relatively short distance can lead to a so-called “node cannibalism”. Therefore, smaller hubs around a Mothership hub would be feasible; these are called Baby Hubs. By providing these Baby hubs with zones with car-free areas, Amsterdam Sloterdijk will take the first steps towards the growth of car-free zones and provide the incentive for self-driving, healthier means of transport.

### 6.5 The Masterplan





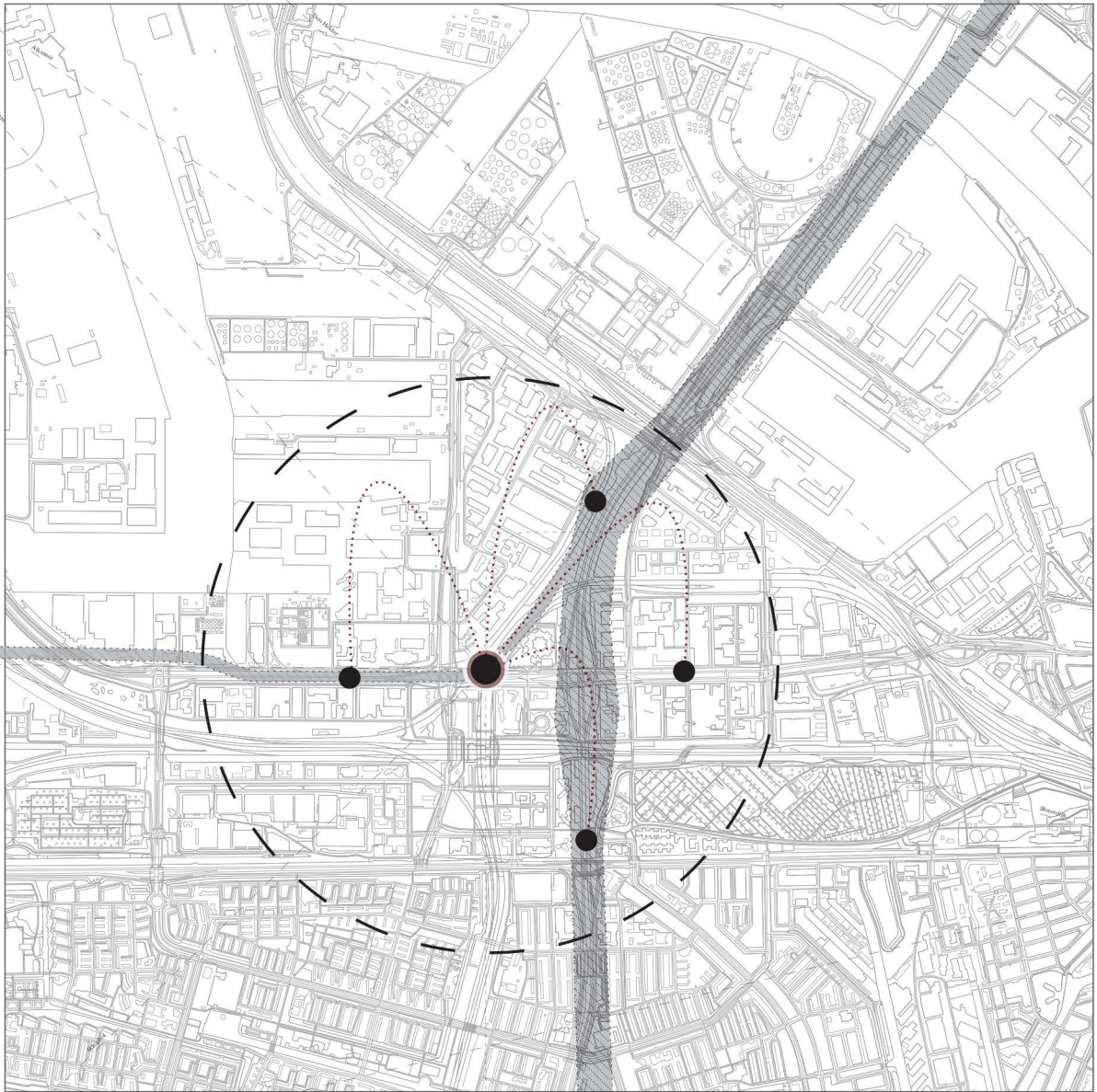

The research of the pointcloud and travel data that determines the position, with followed research of determining the radius and baby hub, resulted in the masterplan shown in fig 34.

Fig 34: Masterplan Sloterdijk: (Own illustration)



# MASTERPLAN

PROJECT HUMAM MESUT ULKU

-  Mothership hub
-  Baby hub
-  A10 + A5 highway
-  Railroad
-  Hub zone 3000 Ø
-  Approx. car-free zone
-  Transport connection



### 6.6 The cell structure

When zooming in into the master plan of figure 35, the area within the circle of a 1,5km is subdivided into different 'cells' (zones). According to the studies of Newman, (Newman et al. 2016), different cells around car-oriented and not-car-oriented zones has to arise in order to maintain the existing road structure and accessibility. The area, therefore, can be seen as a Voronoi of different cells, each provided with a transportation node.

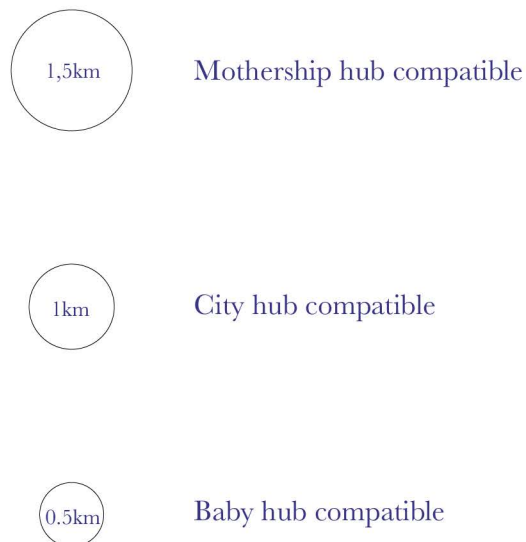

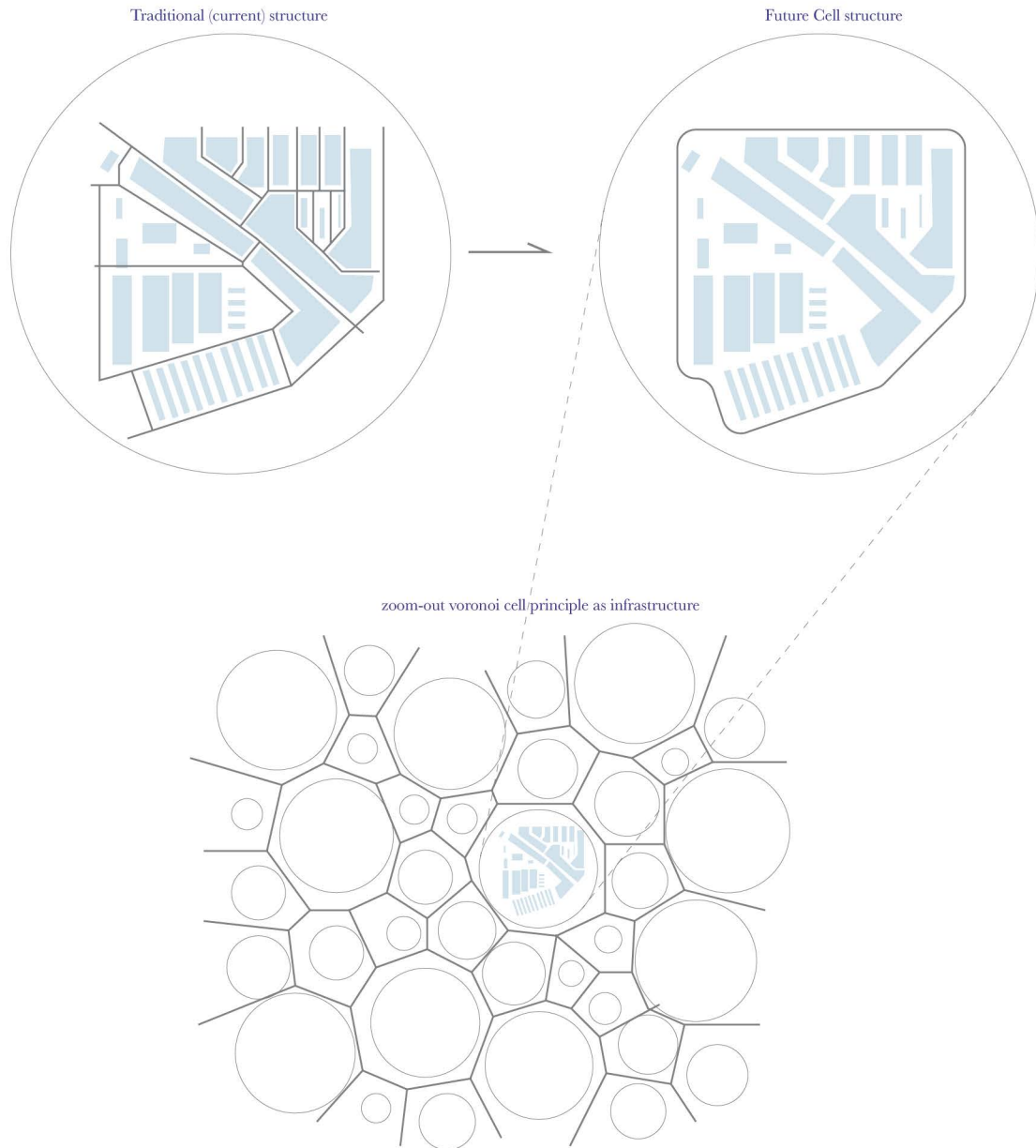

### 6.6.1 Application of the cell structure

As a result of the master plan, figure 36 is showing a detailed visualisation of this cell. In this figure, the purple dotted line is indicating different zones where no manual vehicle is allowed to enter. The self-driving car, however, can drive through the whole area, as if this system can be seen as reliable to blend in with the people, which also is related to one of the earlier mentioned themes of “efficiency”. When entering one of these zones, the roads will be directed towards the Mothership hub. From there, People can park their car and either chose to stay within the hub or drive in one of the determined zones by AV.

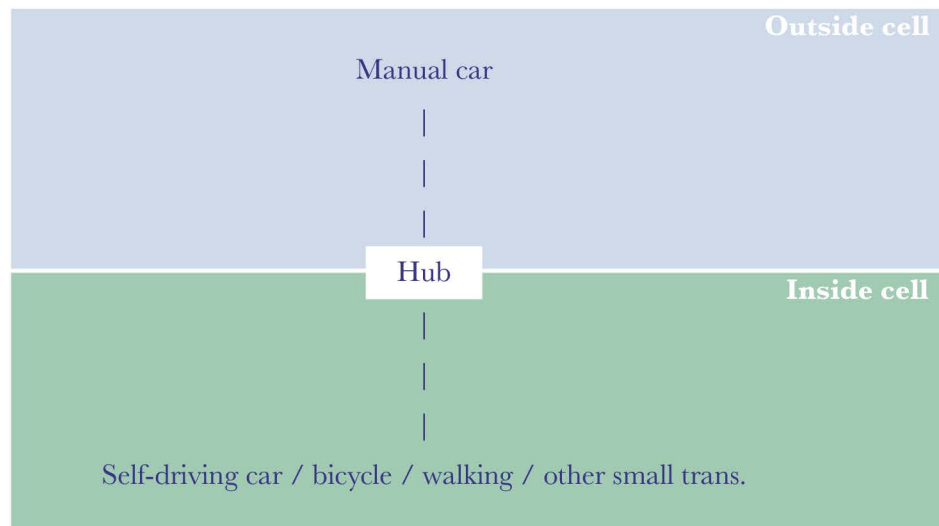

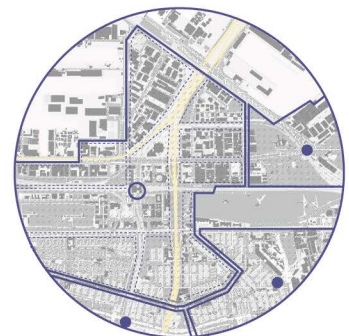
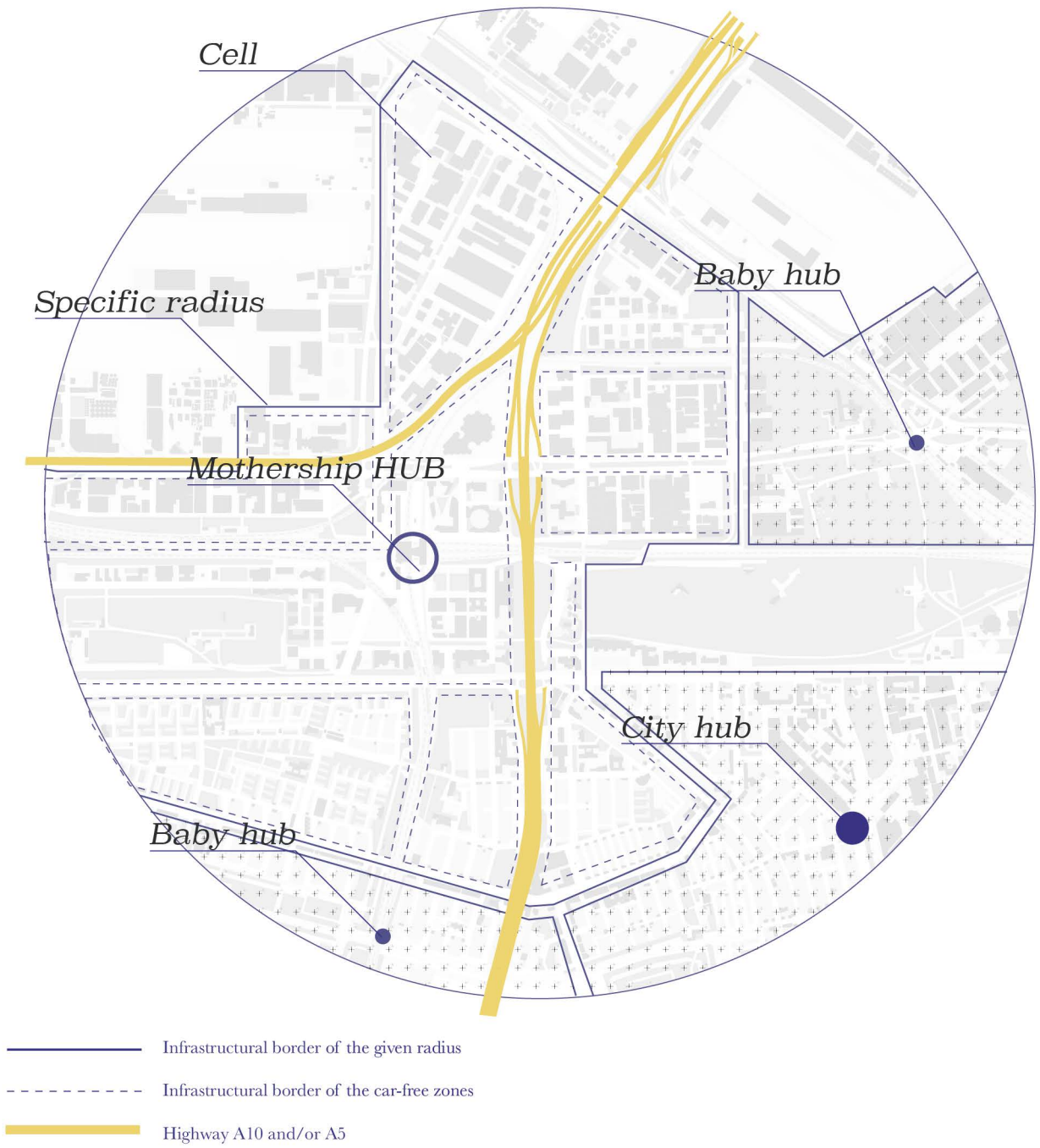

### 6.7 Program of requirements

To make clear what kind of transportation modes a hub should accommodate, a general scheme was created that illustrates the flow of action and destination per mode. Similar to prominent city transit locations, such as the Tokyo Shinjuku station, the focus was to maintain the flow of different situations. Although Shinjuku hub can be seen as the biggest in the world, people still experience transferring as pleasant and comfortable. For this project, it is therefore vital that different modes should not impede the other structure (Figure 37).



*Shinjuku station, Tokyo, Japan. :(www.shinjukustation.com)*

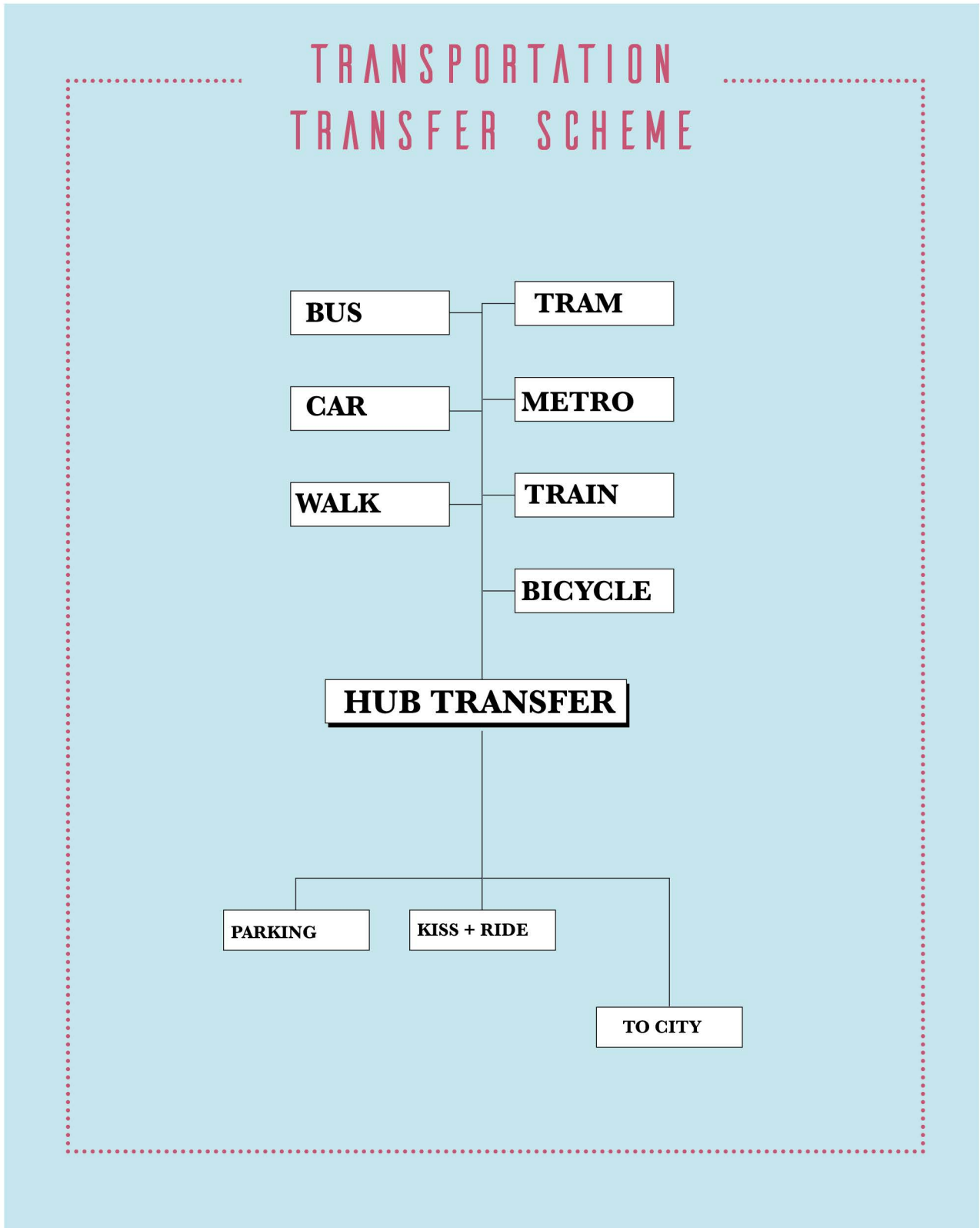





### 6.8 Priority scheme for future changes

According to the research and publication of Stephen Casner (Casner. 2016), there has to be a slow but steady movement of applying driverless cars in cities. Between 2020 and 2030, it is therefore essential to let people be aware of this future technology, where the car can play as an advisor but to let the driver be in charge. Figure 38 illustrates how every ten years this technological development will grow, based on the minimum level of automation. Within every decade, the human interaction of cars will also change from complete separation in 2020 towards complete combination in 2050. According to Casner, the cars, therefore, cannot be seen as a separation rather an implementation to our society. With the understanding of having safe, clean and smart transportation, the purposes of having separate parking garages from other facilities, such as shops and public parks, must be questioned.

In the next chapter, this project will focus on Casners' approach by seeing the hub not only as a node for self-driving cars, but also to redefine our living conditions. For instance, if cars can be seen not as a vehicle but rather as a safe and clean travelable object that can provide you efficiency and electricity, the envelope of having a separate parking place, shops and houses could then maybe merge into each other. Therefore, the next chapter is dedicated to illustrating this added value for Sloterdijk.

# PRIORITY SCHEME

Criteria Year	Minimum level Autom. vehicle*	Parking within hub	Level of Interaction
<b>2020</b>	2: Conducts some parts of driving tasks, such as steering and acceleration.	Separation between combustion-engine cars, electric cars and the people.	
<b>2030</b>	3: Performs most driving functions automatic. May request human driver intervene.	Diminishing space for combustion-engine cars. Priority for Electric and AV's.	
<b>2040</b>	4: Conducts all driving tasks automatic. No steering wheel or pedals required for a person.	No combustion-engine cars. People use cars as energy source. Living with the car.	
<b>2050</b>	5: Conducts all driving functions under all environments without a human driver.	Shared vehicles enrolled. Car can be seen as implementation in society.	

\* 0: No automation  
 1: Driver assistance  
 2: Partial automation  
 3: Conditional automation  
 4: High automation  
 5: Full automation



## **7.0 Introduction**

Besides having a transportation hub for the city that enables people to transfer from manual car to an automated vehicle, it also creates a new definition in living in or near the hub; technology can connect the border between parking and living. Soon, cars will be clean, safe and more efficient. So, why not combining the parking garage with actual living conditions? In my opinion, a first attempt was made by Le Corbusier with its Villa Savoye in Poissy; the car also became an essential element in his design.

The primary purpose of Project HUMAM, of finding the most efficient and flexible system for different travel modes, will also show the effect when unrolling these vehicles in the city; an effect that will redefine our living standards.

C  
H  
A  
P  
T  
E  
R

# 7

THE OPPORTUNITY

- 1. The problem
- 2. The ambition
- 3. The references
- 4. The method
- 5. The themes
- 6. The emergence
- 7. The opportunity
- 8. The results
- A. Bibliography
- B. Appendices

### 7.1 Redefining parking and living

In order to decrease the road capacity, the hub can be seen as the initiator of combining functions like the parking place with commercial, parks and living into one entity. Moreover, yet, despite the ocean of parking garages, visions of a future without cars and having AV's are gaining momentum. The flexibility here lies primarily in the function of the building; if car ownership does indeed drop, the parking garages will turn into empty residual spaces (Figure 39). The architectural value here is the cultural shift from manual driving to ride sharing and AV's that will result in a permanent paradigm shift in urban planning.

Furthermore, Sloterdijk is surrounded by large enterprises and businesses and therefore relies on parking garages and lots. When building new offices that will last 50 years towards the car-less future, the goal of a future-proof building lies in the flexibility. As a result, when the parking demands decrease, future-proof buildings should be designed in a way that could be easily transformed into parks, residential or offices.

### 7.2 Flexible program

Similar opportunities can be learned from existing buildings; it is the architects' social responsibility to design sustainable cities. Over the 50 years, the existing parking garages, therefore, could be transformed into new mixes of parking and living, to minimize environmental impact. However, it might be just a minor intervention but enables the architect to think beyond the present. Flexibility is therefore an important element

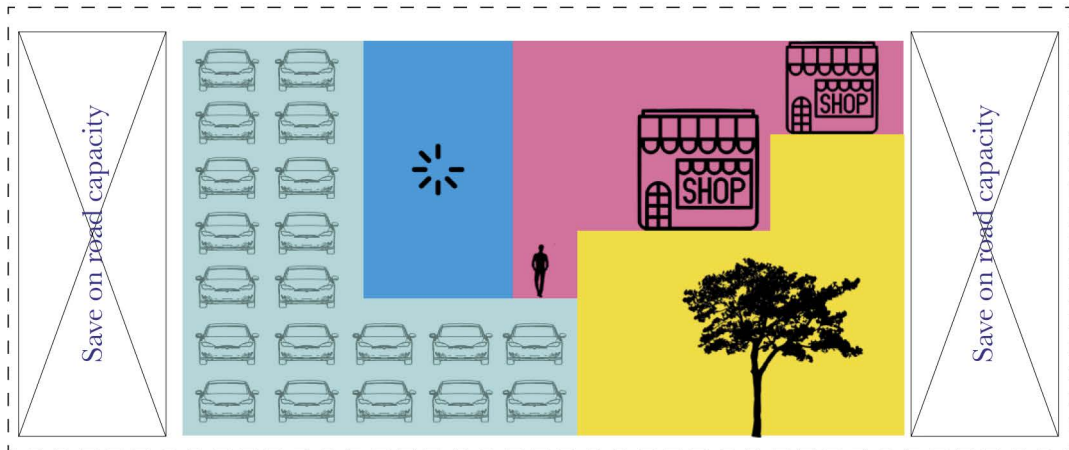
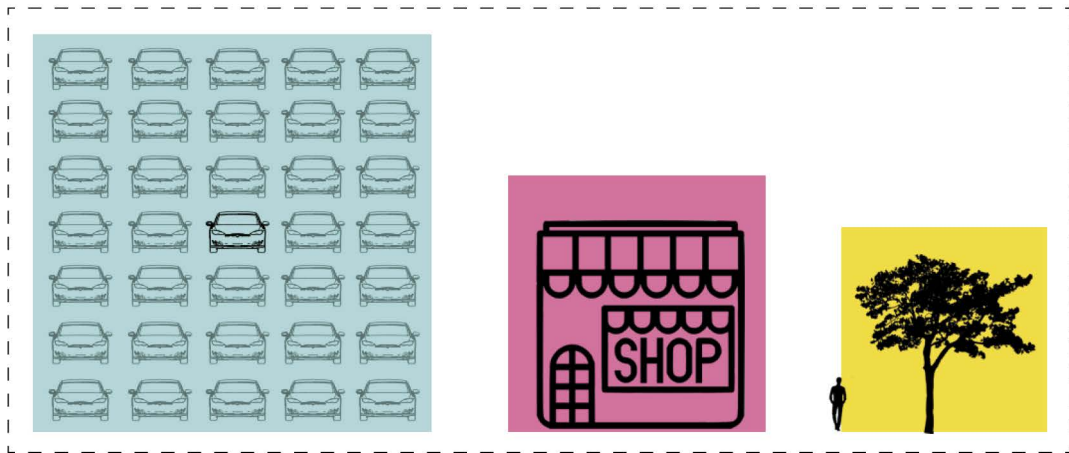

for this building. According to the study in flexibility in architecture done by Robert Kronenburg (Kronenburg 2003), flexible architecture is a necessary design form that enables the building to frequently innovate and express based on contemporary design issues. By showing this flexibility, the value and relevancy shows that social and economic change can be revealed. (Bertolini, 2016)

Therefore, it is interesting to see how human beings can be seen as flexible entities who are mobile, creative and able to work and travel in a broad range of environments. Architecture should adapt more to the human needs, not vice versa.

### 7.3 The car as a possible “P.E.T”

This flexibility in program will therefore be found in this project by redefining the parking and living conditions by merging those together. While cars are getting safer, quieter and cleaner, it gives the opportunity to explore new connections of functions. While the hub can act as the energy source of solar electricity, the cars can be used as a energy source for residents (Fig. 40). Therefore, it will result in a redefinition of parking and living (Kronenburg, 2003). The opportunity of having a flexible program where, over the years, the parking will be diminished into residential while the car is able to live with the people like ‘pets’. (Personal Electronic Transport systems) (Fig. 41). It relates the characteristics of flexible architecture to new building program-principles and explores the effect that such design can have within the different levels in the built environment.

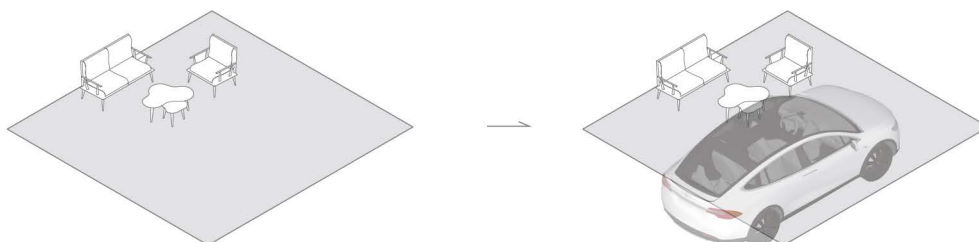

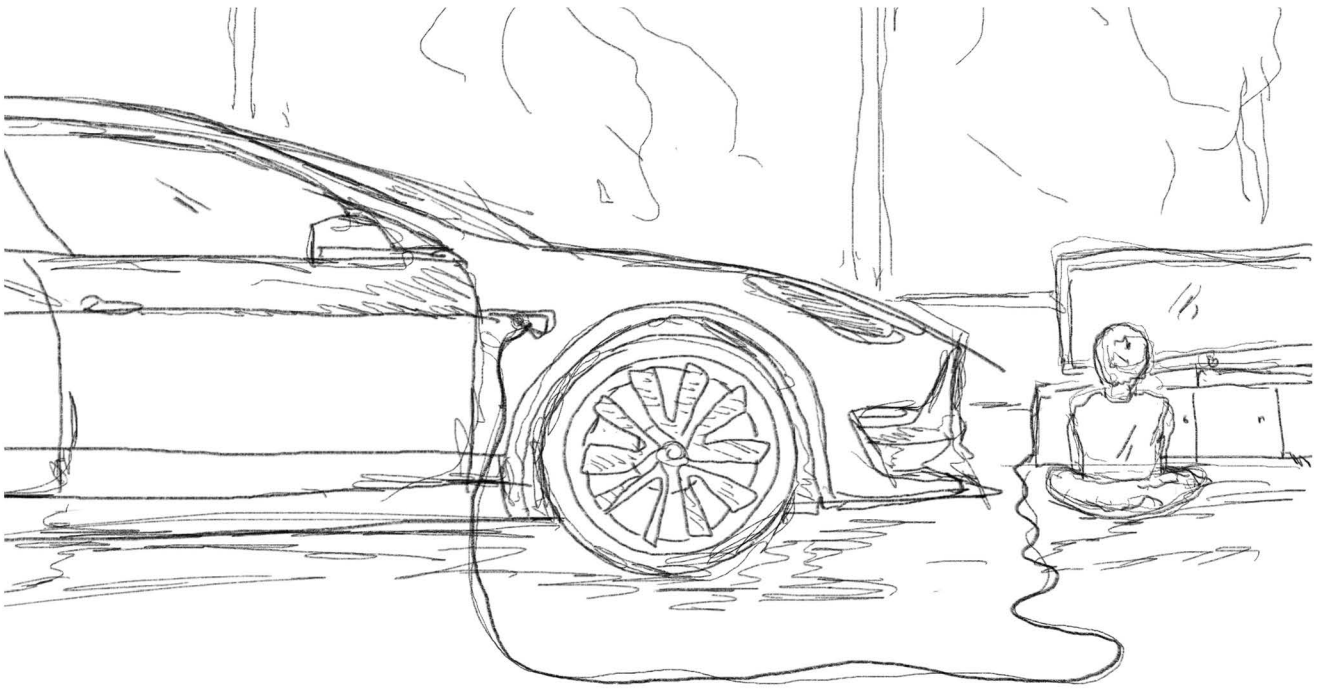

Fig 40: Sketch impressions of a car as energy source: (Own illustration)

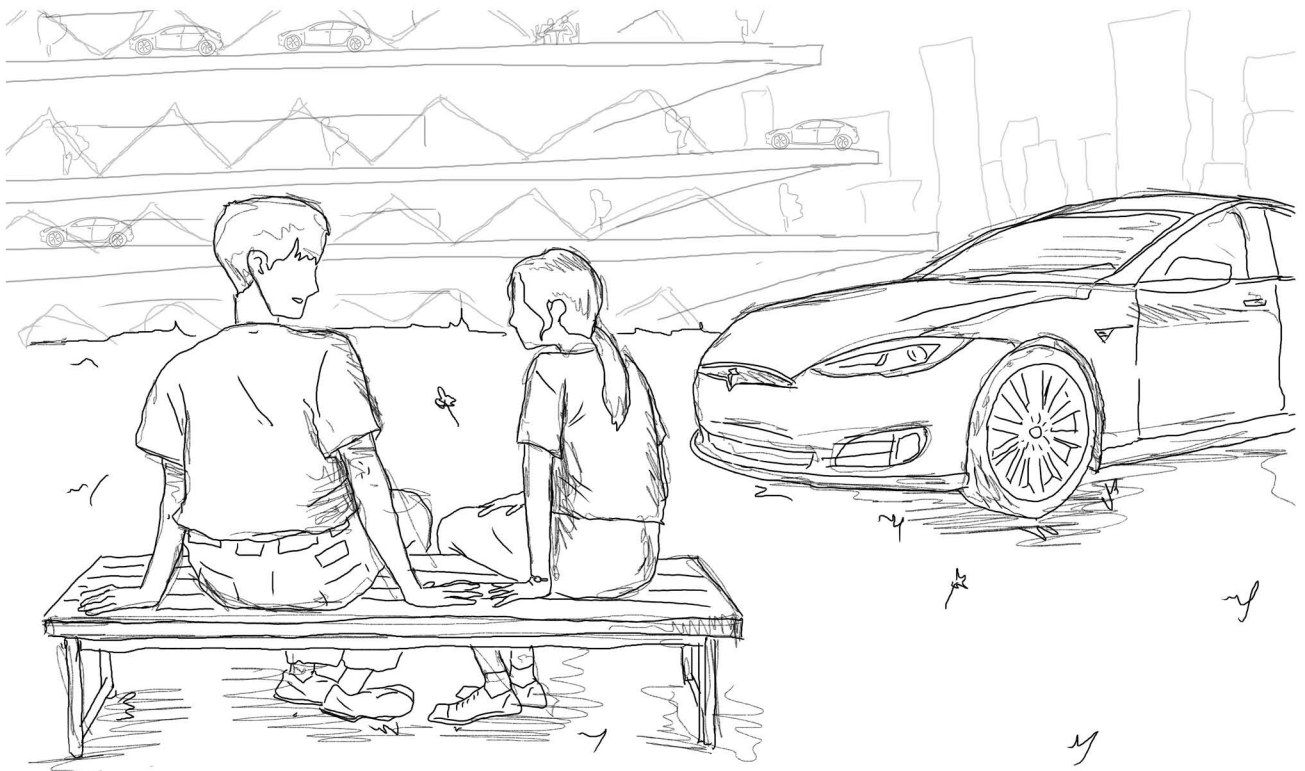

Fig 41: Sketch impressions of parking and leisure: (Own illustration)

## **8.0 Introduction**

The following final chapter shows illustrations of the final result based on earlier analysis of this project. The results are represented in a visual way of all basic components (such as floor plans, elevation and renders). Conclusively, based on the outcomes of research done, recommendations are made in which a potential hub should follow.

C  
H  
A  
P  
T  
E  
R

8

THE RESULTS

- 1. The problem
- 2. The ambition
- 3. The references
- 4. The method
- 5. The themes
- 6. The emergence
- 7. The opportunity
- 8. The results
- A. Bibliography
- B. Appendices



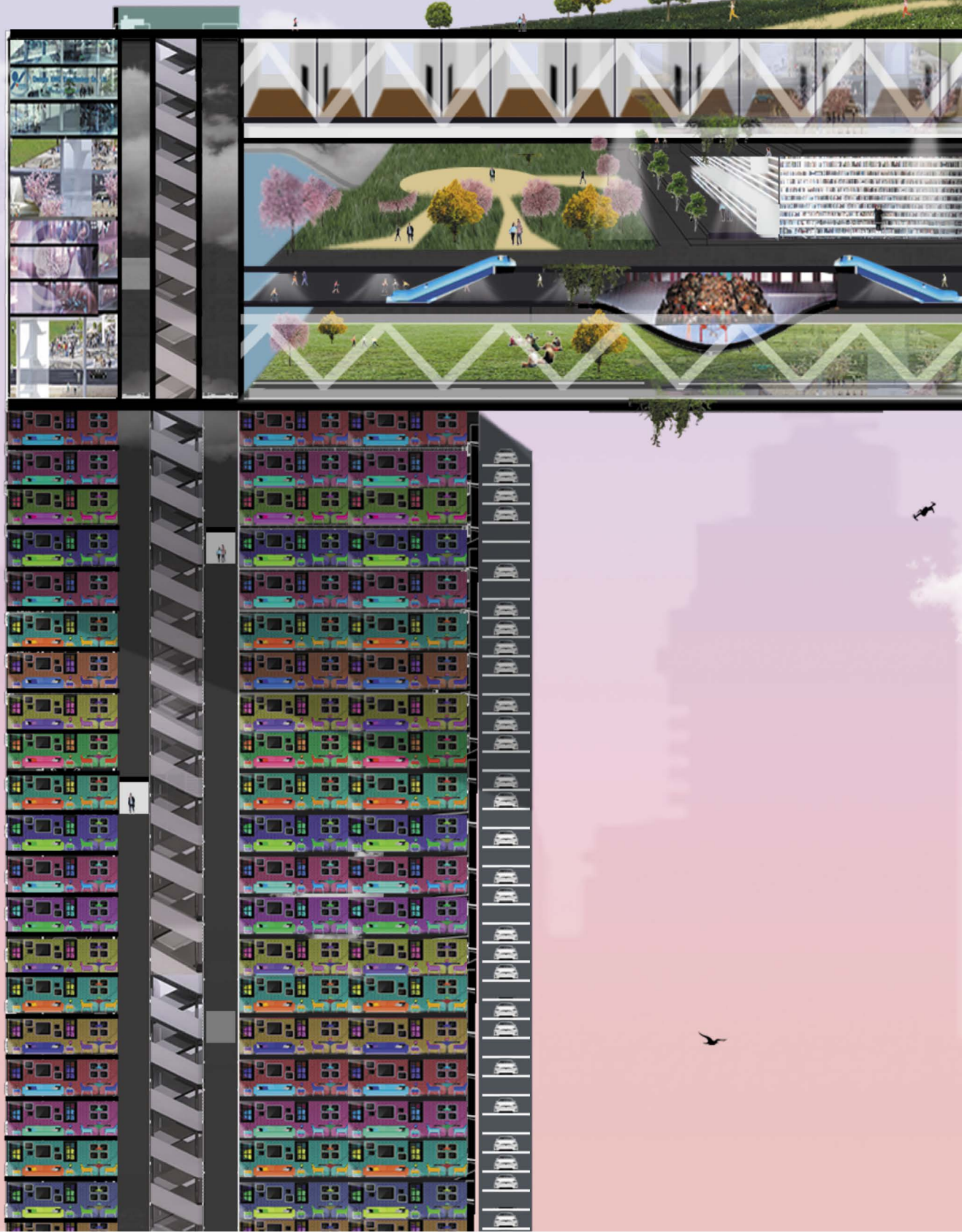

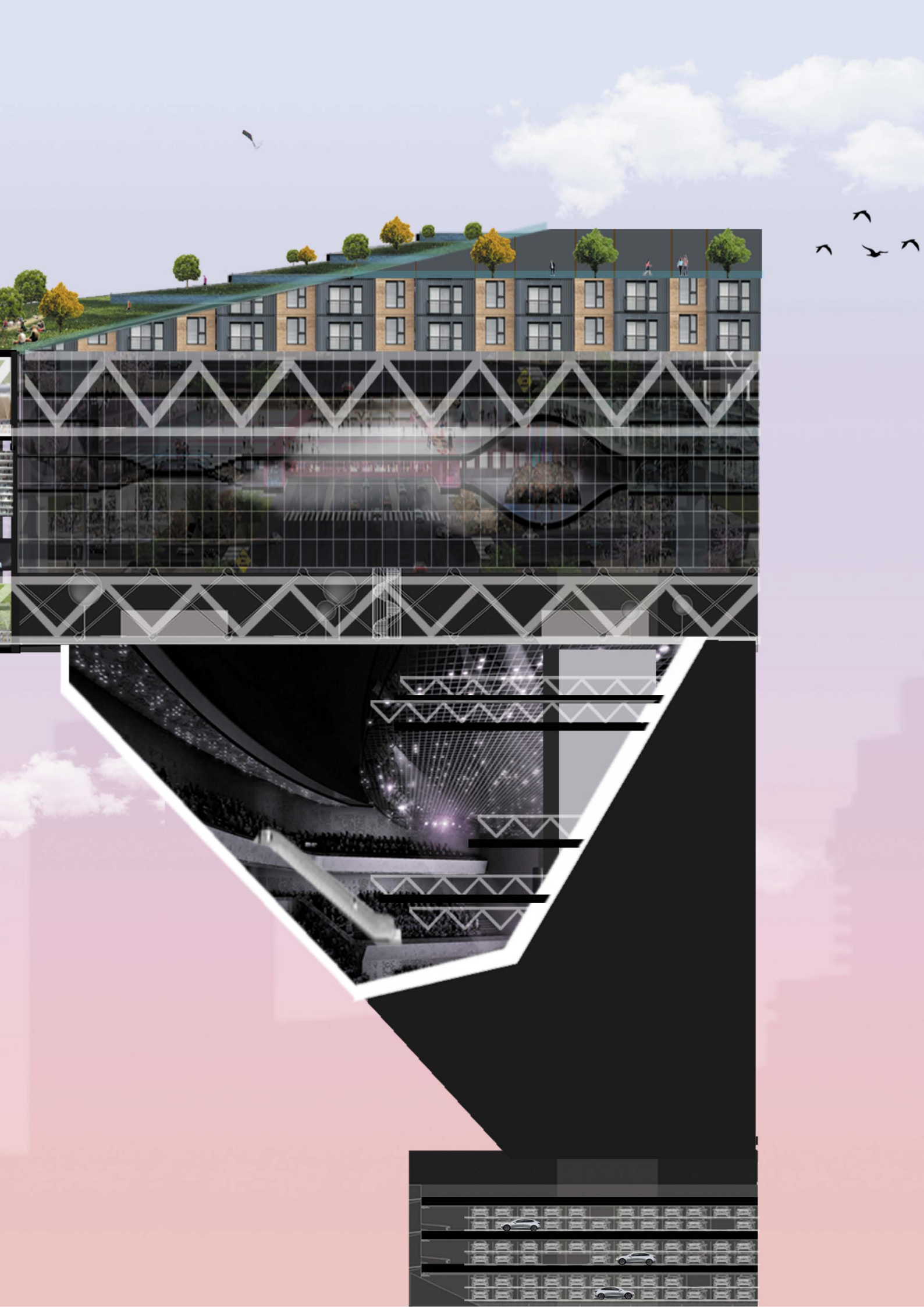

### 8.1

To get a clear understanding of the changes made during this development, the original site on 1:3000 scale is shown in figure 42.

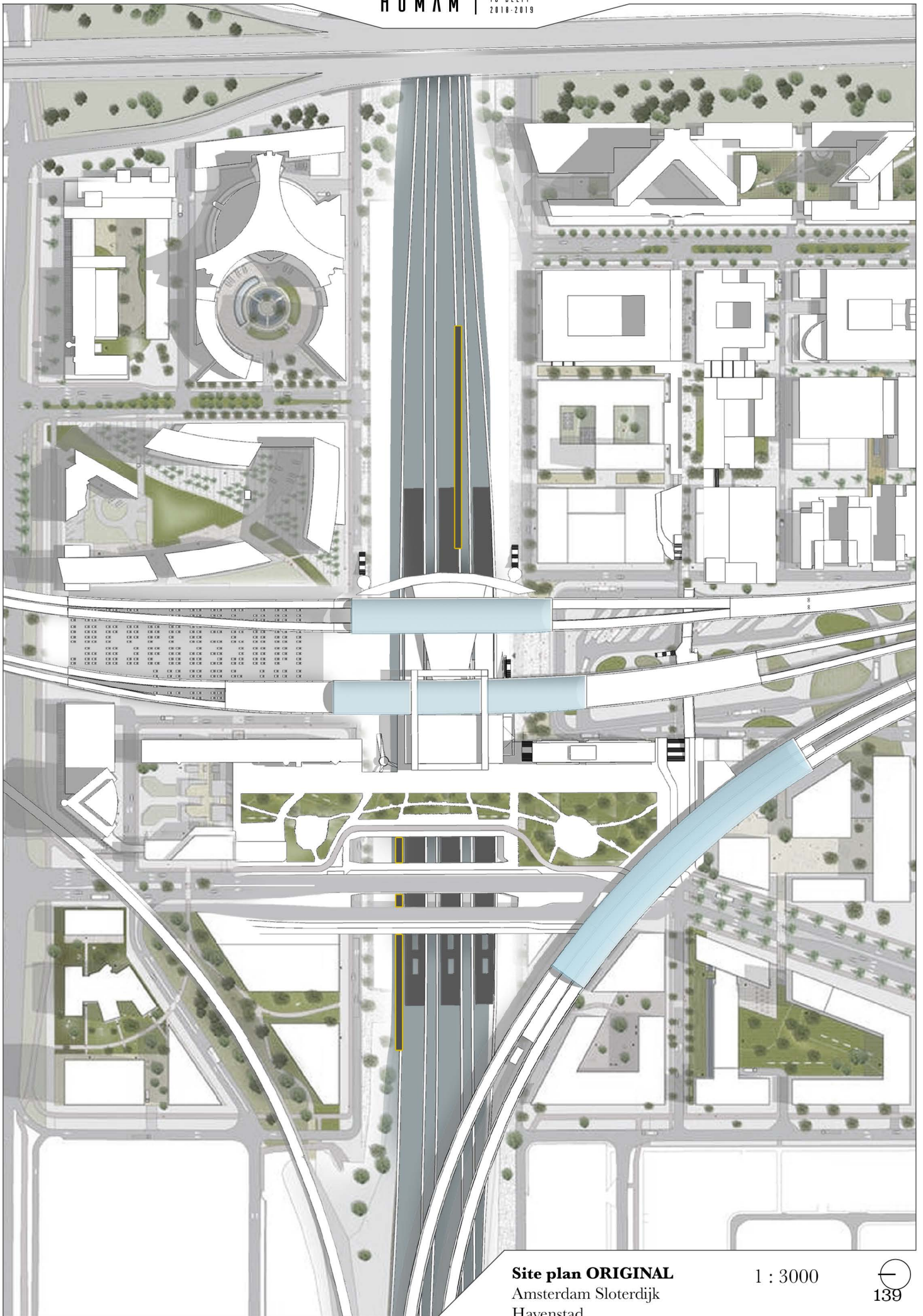

**Site plan ORIGINAL**  
Amsterdam Sloterdijk  
Havenstad

1 : 3000

Fig. 42: Original situation Sloterdijk: (Own illustration)

PLATFORM

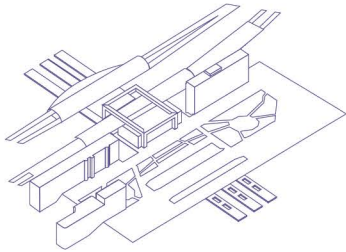

Original station

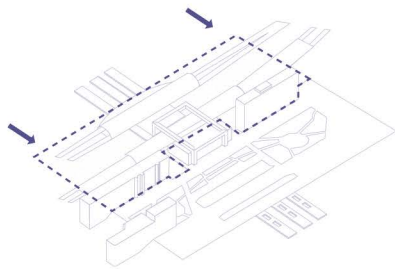

Add platform for AV's

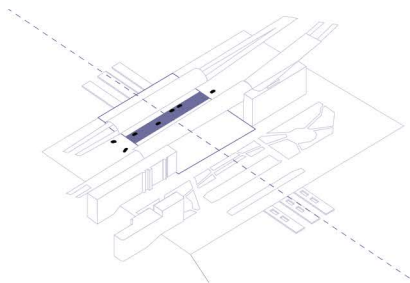

Define corridor as departure

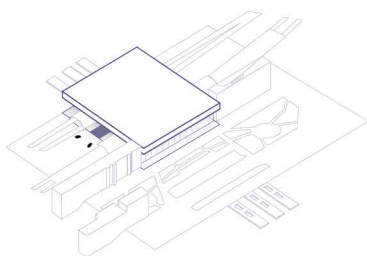

Add program

BUILDING

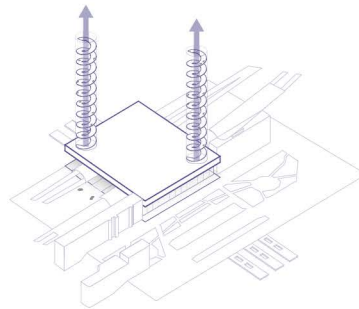

Car recognition

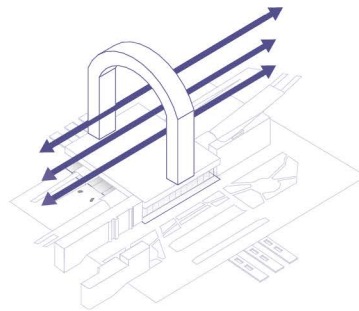

Architectural recognition

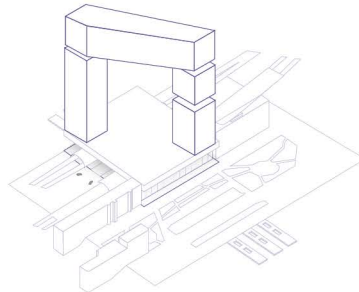

Add program

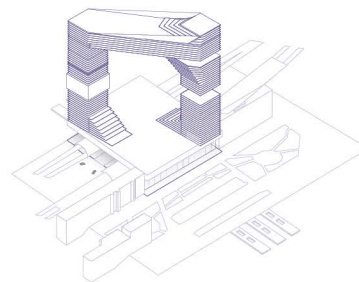

Optimize

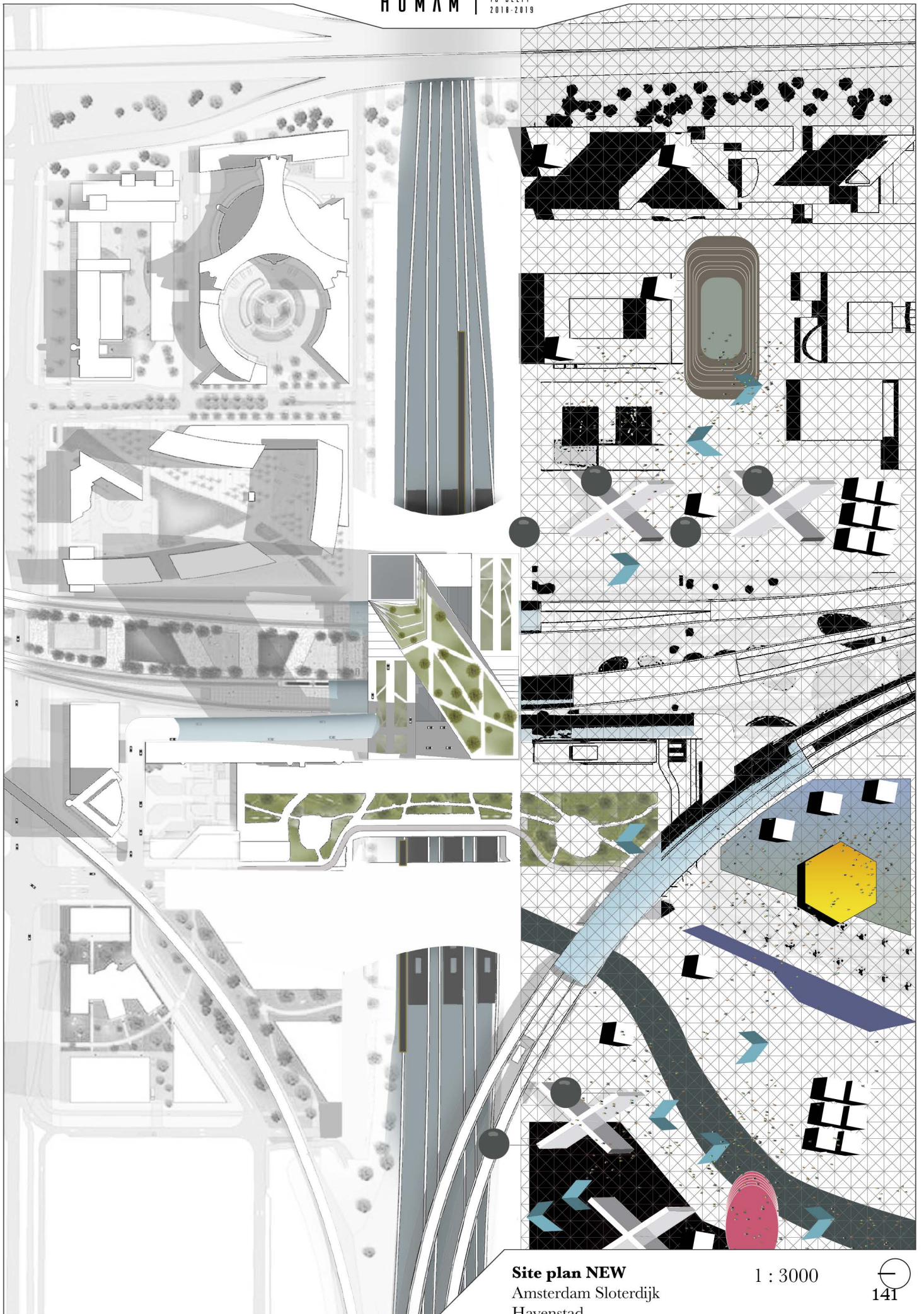

**Site plan NEW**  
Amsterdam Sloterdijk  
Havenstad

1 : 3000

Fig. 43: Proposed situation Sloterdijk: (Own illustration)

### 8.2 Hub sizes

Based on the research of Kronenburg (Kronenburg, 2003) shown in paragraph 7.2, The flexibility in the program also relies on the size. As mentioned earlier in paragraph 6.6, the city can be divided into smaller and larger cells according tot the Voronoi principle. The result shows that different radius's also results in different sizes of the hub. Although some hubs could or could not accommodate a train or bus station, they always need to accommodate parking and accessibility for transferring to a self-driving vehicle.

BABY HUB

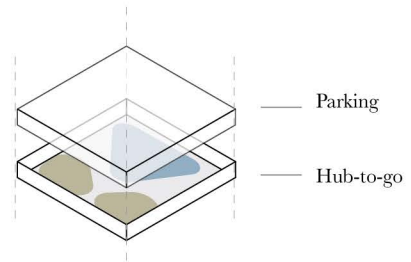
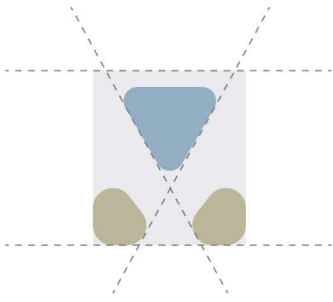

CITY HUB

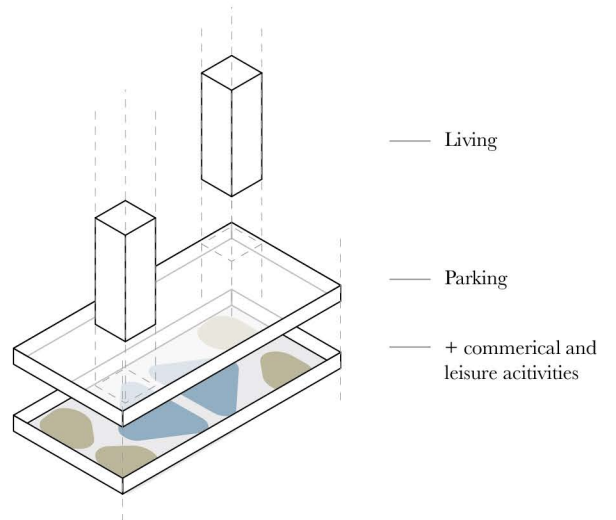
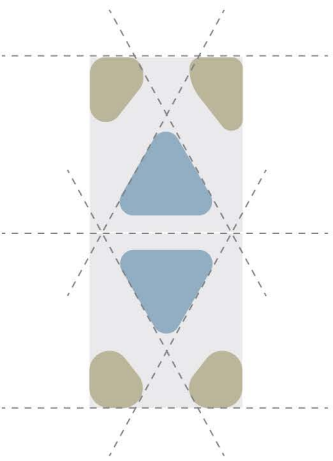

MOTHERSHIP HUB

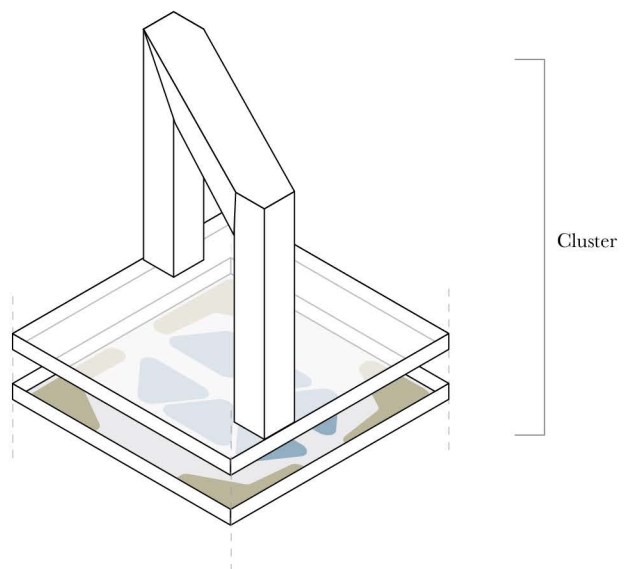
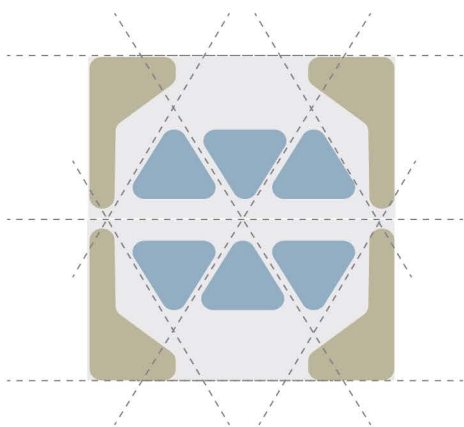



### 8.3 Main programs

The results of paragraph 7.2 and 7.3, shown a mixture of different functions, which representing a redefinition of parking and living. By not accommodating a separate parking place and separate living, the architectural quality arises from the combination. The car that serves as a electricity source for houses, close and easy accessible for the people. (to be continued)

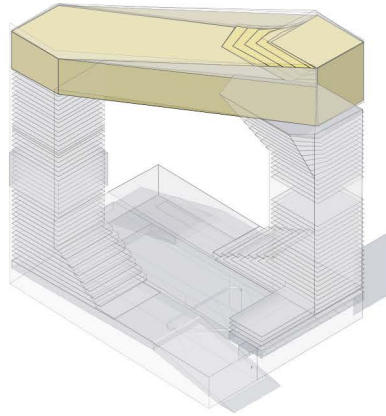

**'Experience deck'**

- Library
- Top floor residentials
- Exposition
- Public park

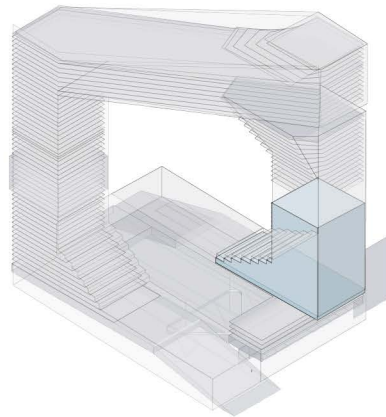

**'Future-proof deck'**

- 2-level car parking

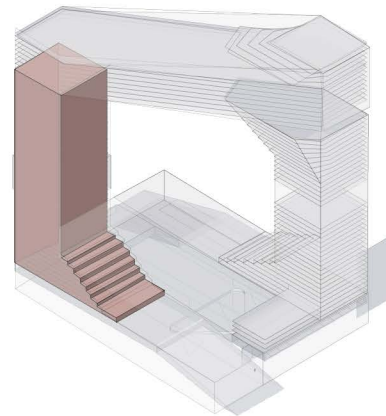

**'Residential deck'**

- 320 units
- Visible car access

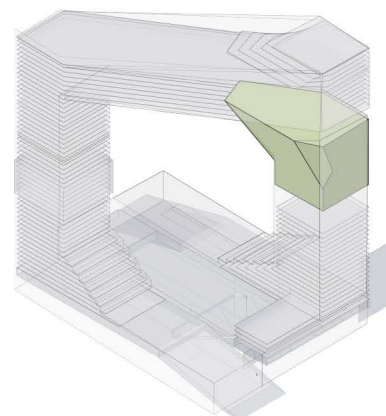

**'Culture deck'**

- Theatre floor

### **8.4 Transportation scheme**

Based on the original transport scheme (figure 46), the main priority was to maintain its flexibility. Therefore, figure 47 illustrates similar outcomes; same train tracks, same metro, bus and tram. This in order to create a minimal intervention while optimizing the station area.

### **8.5 Drawings**

See following pages

Fig. 46: Original transportation scheme towards central station: (Own illustration)

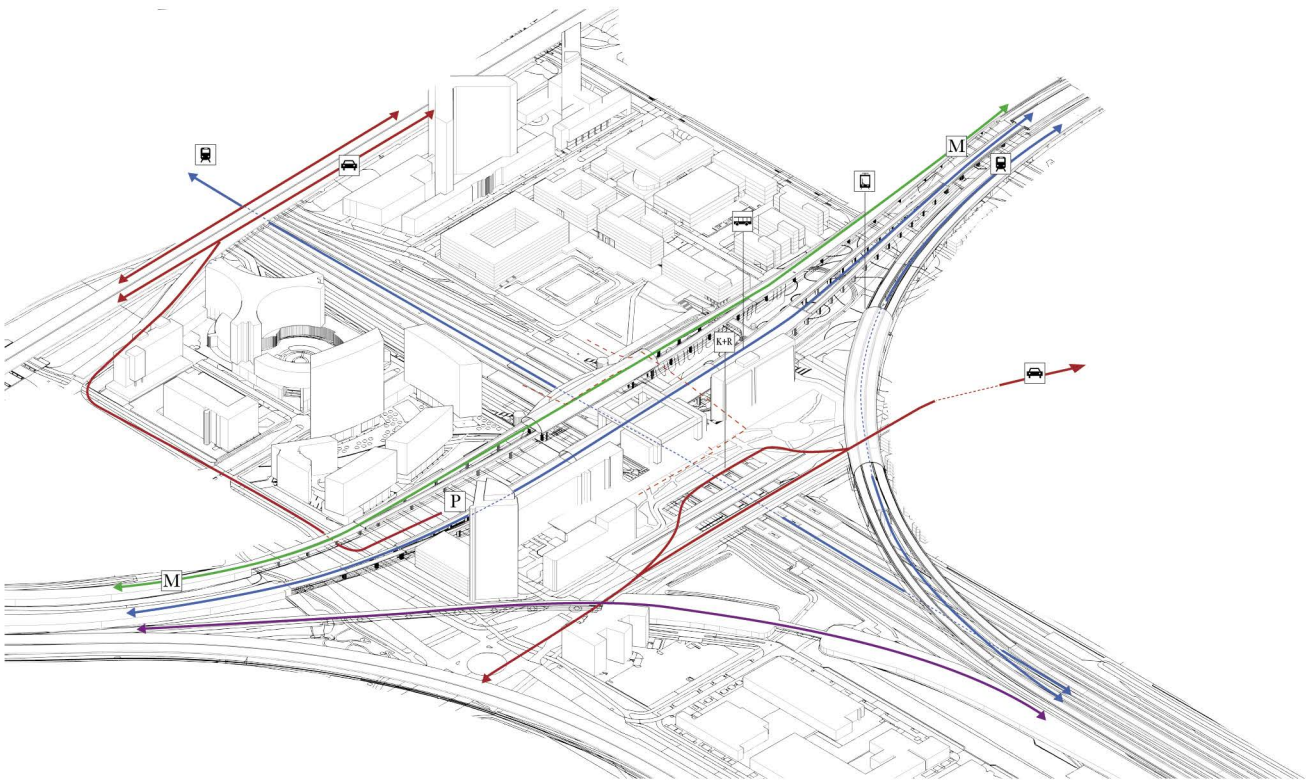
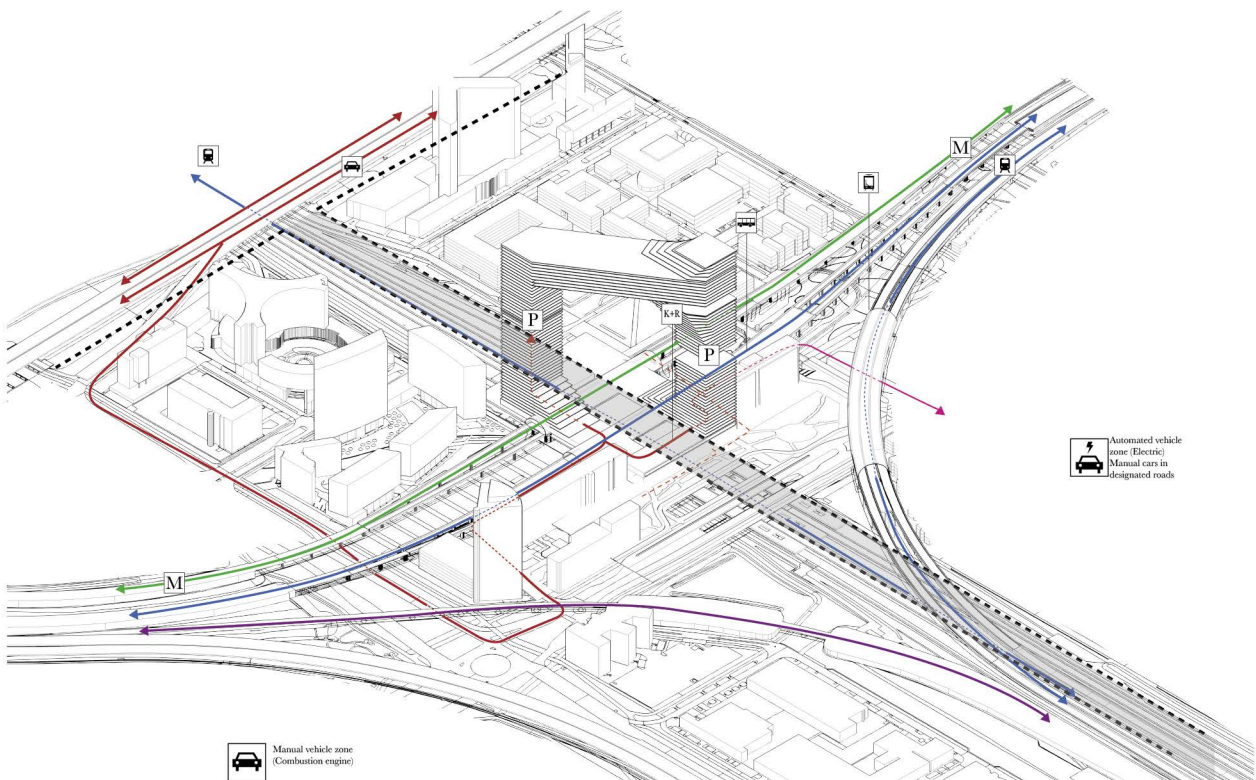
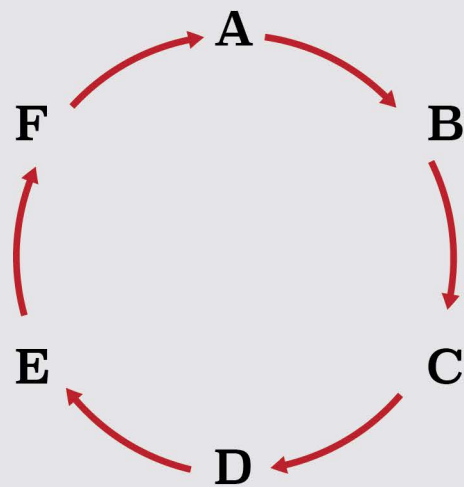
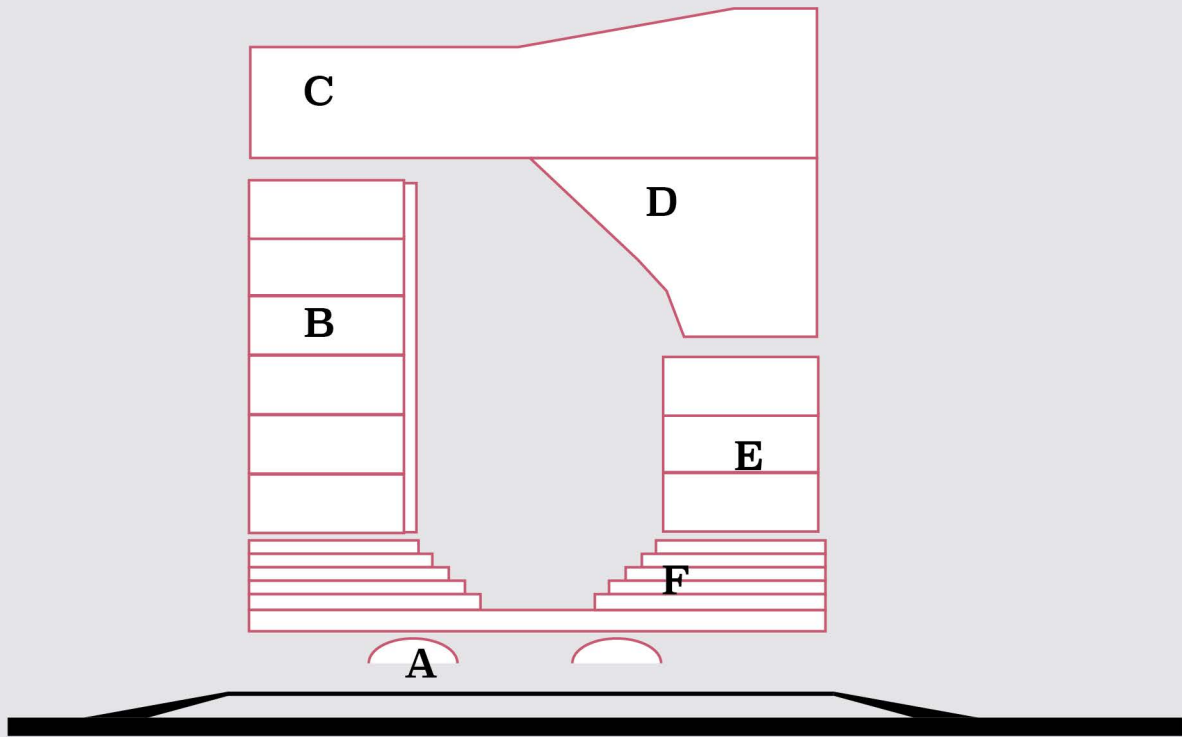

Fig. 47: New transportation scheme towards central station: (Own illustration)



# Complexity



# Simplicity

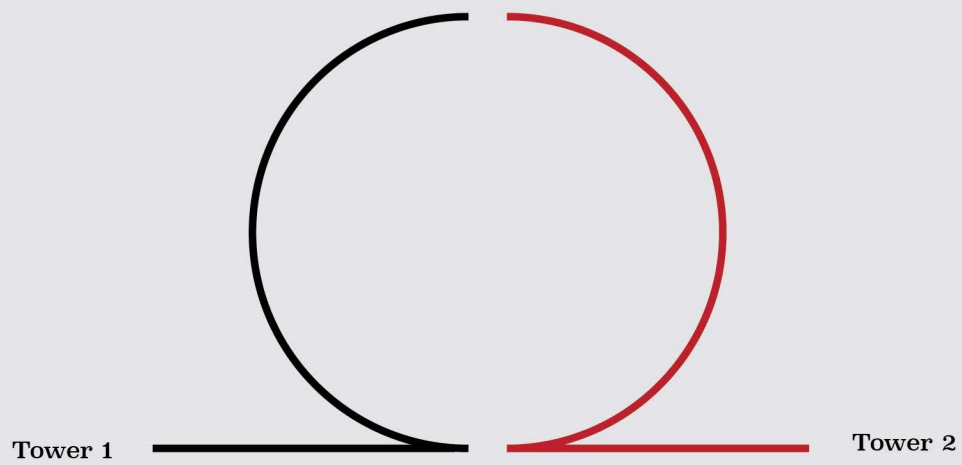
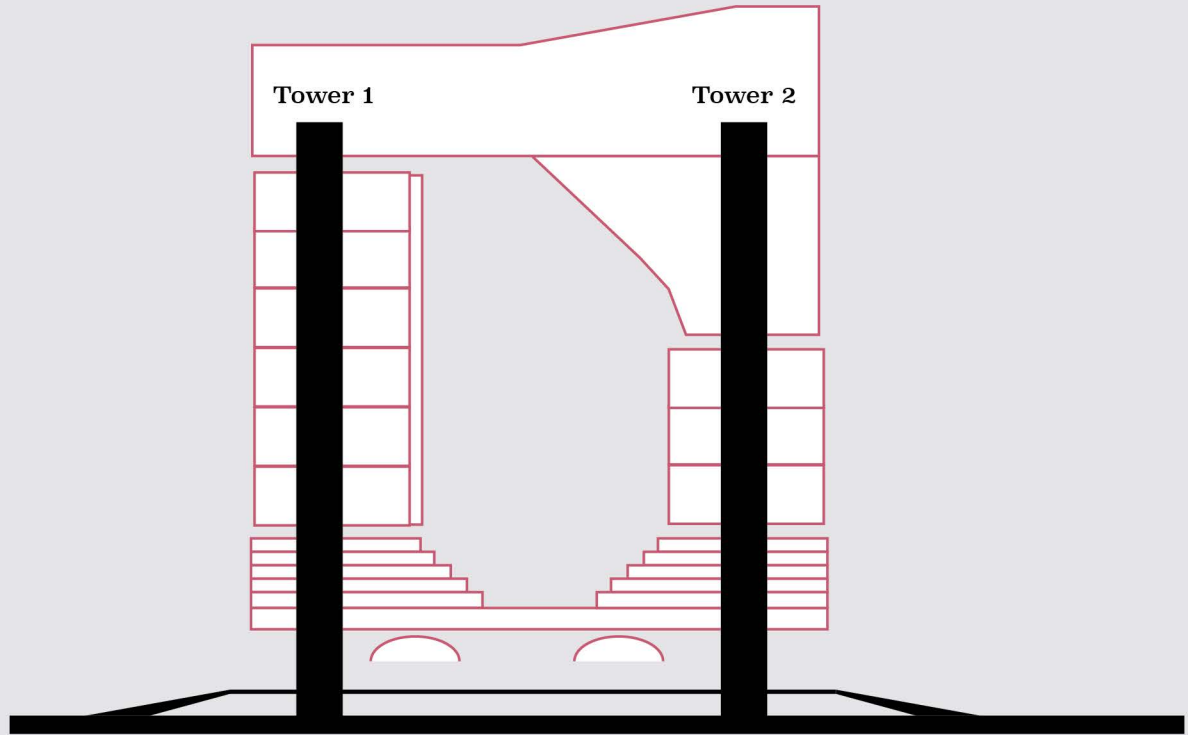

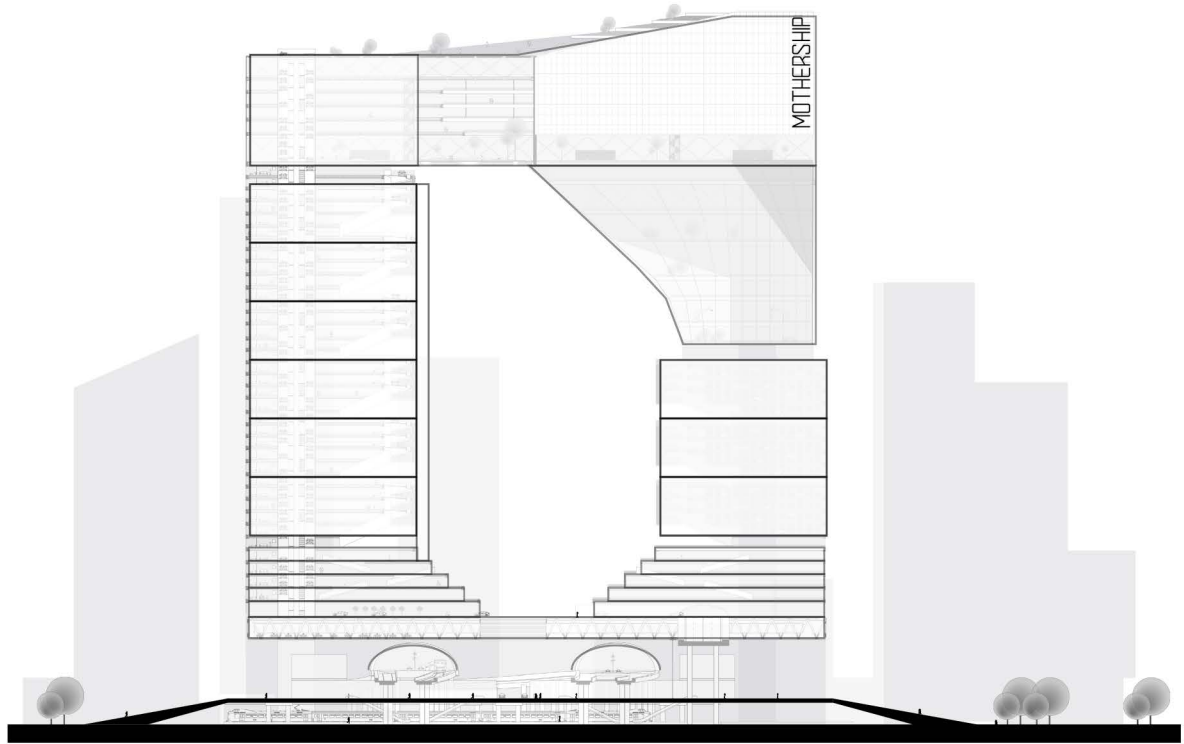

SOUTH VIEW

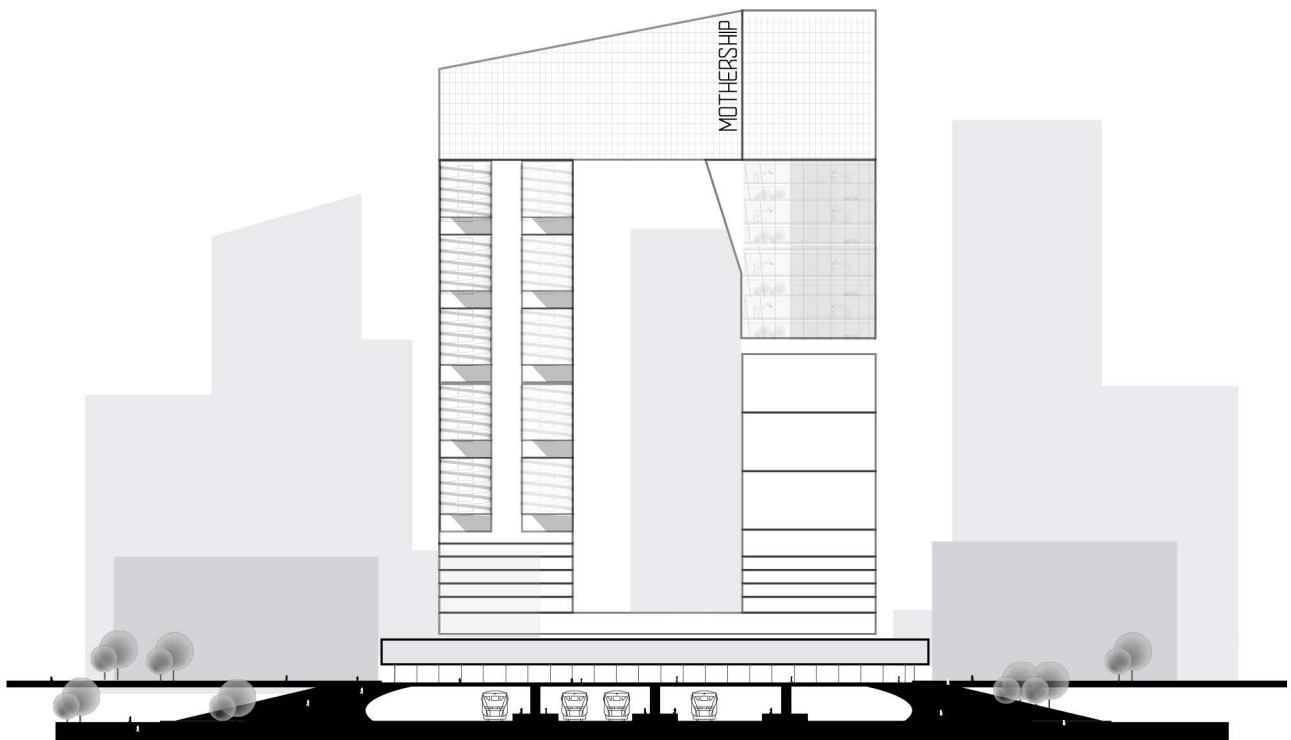

EAST VIEW

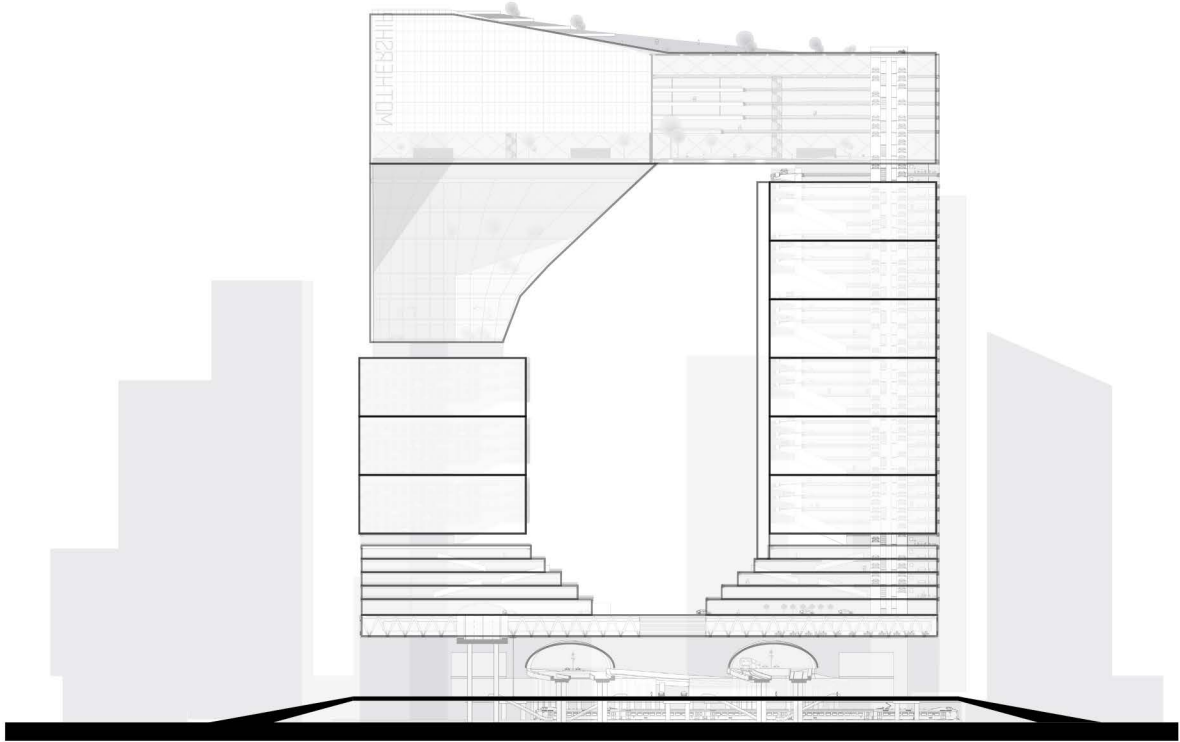

NORTH VIEW

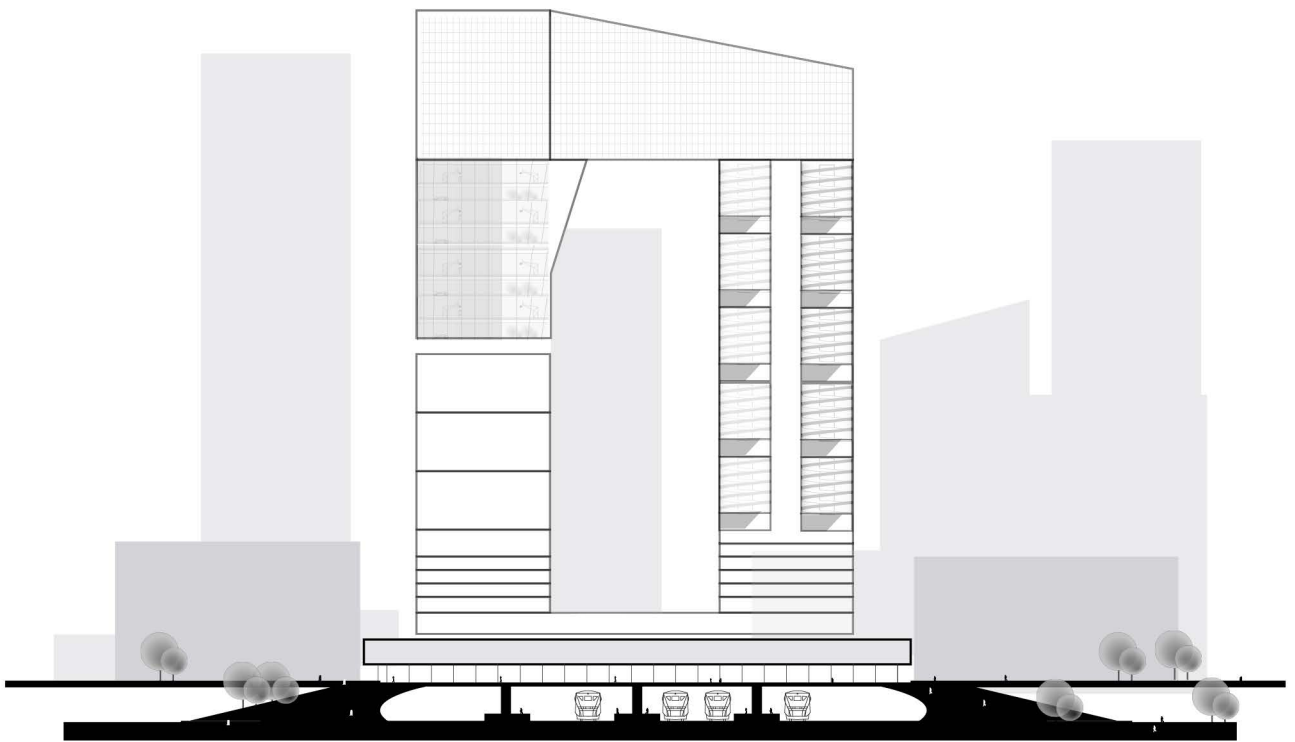

WEST VIEW



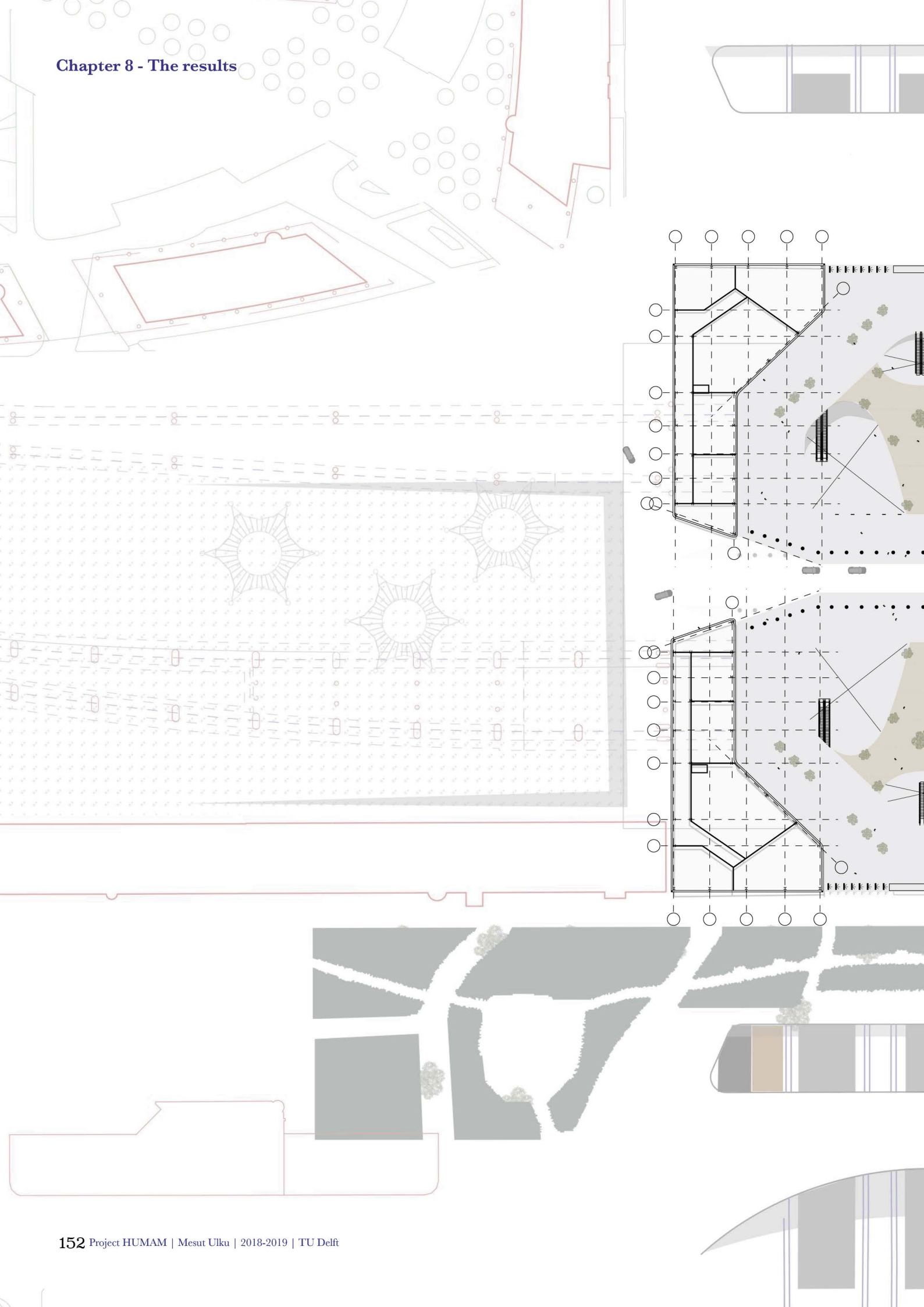
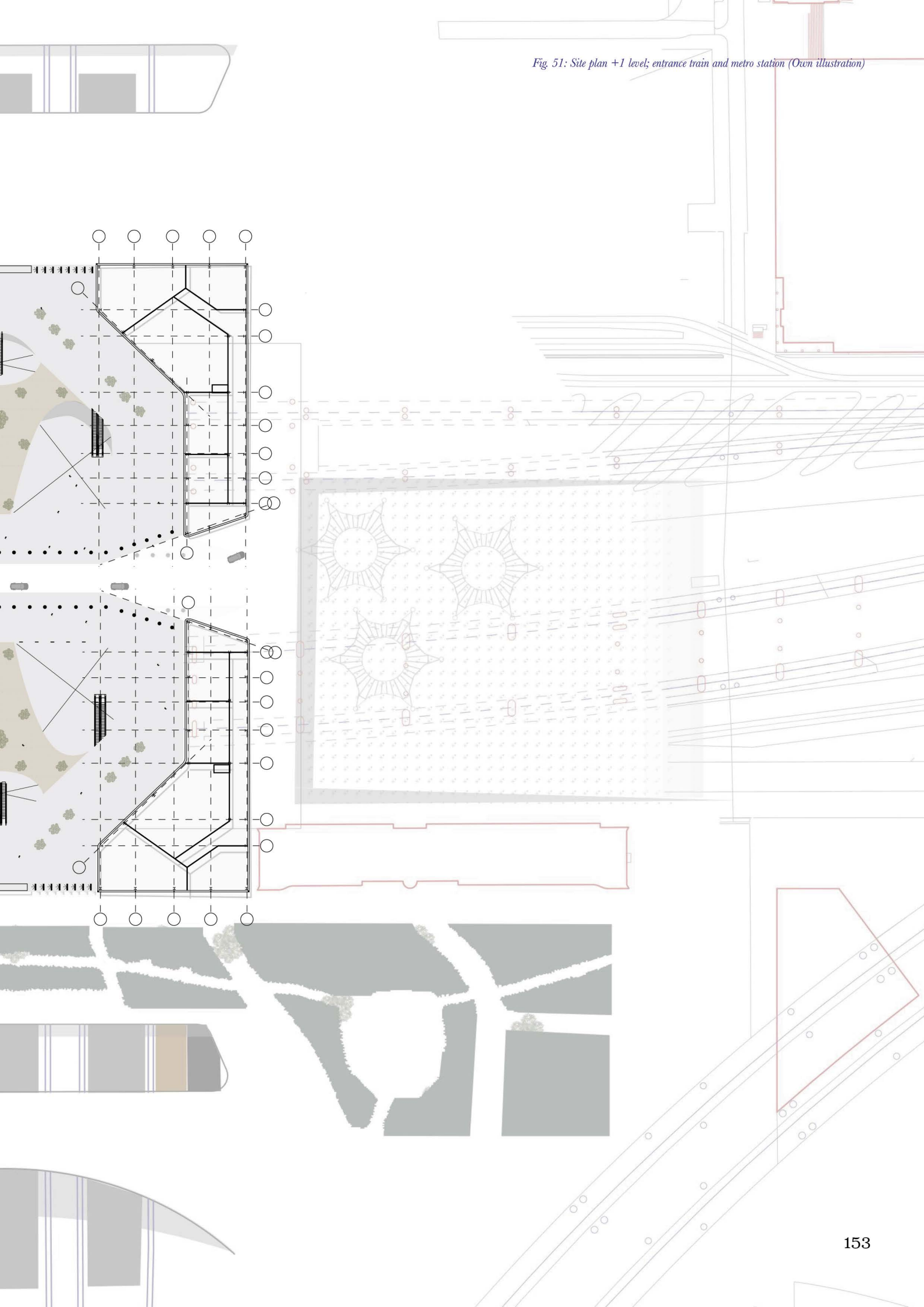

Fig. 51: Site plan +1 level; entrance train and metro station (Oxen illustration)



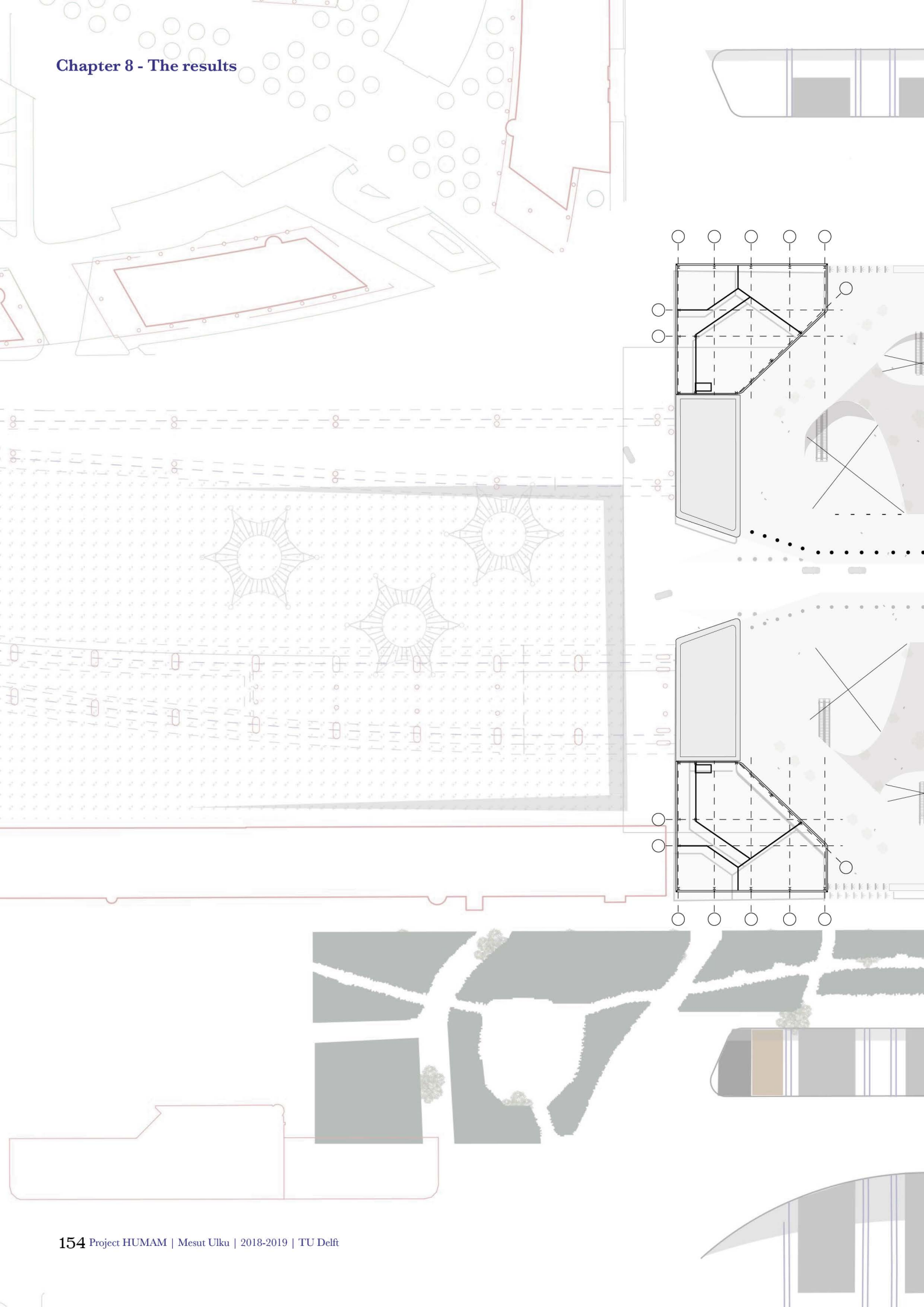
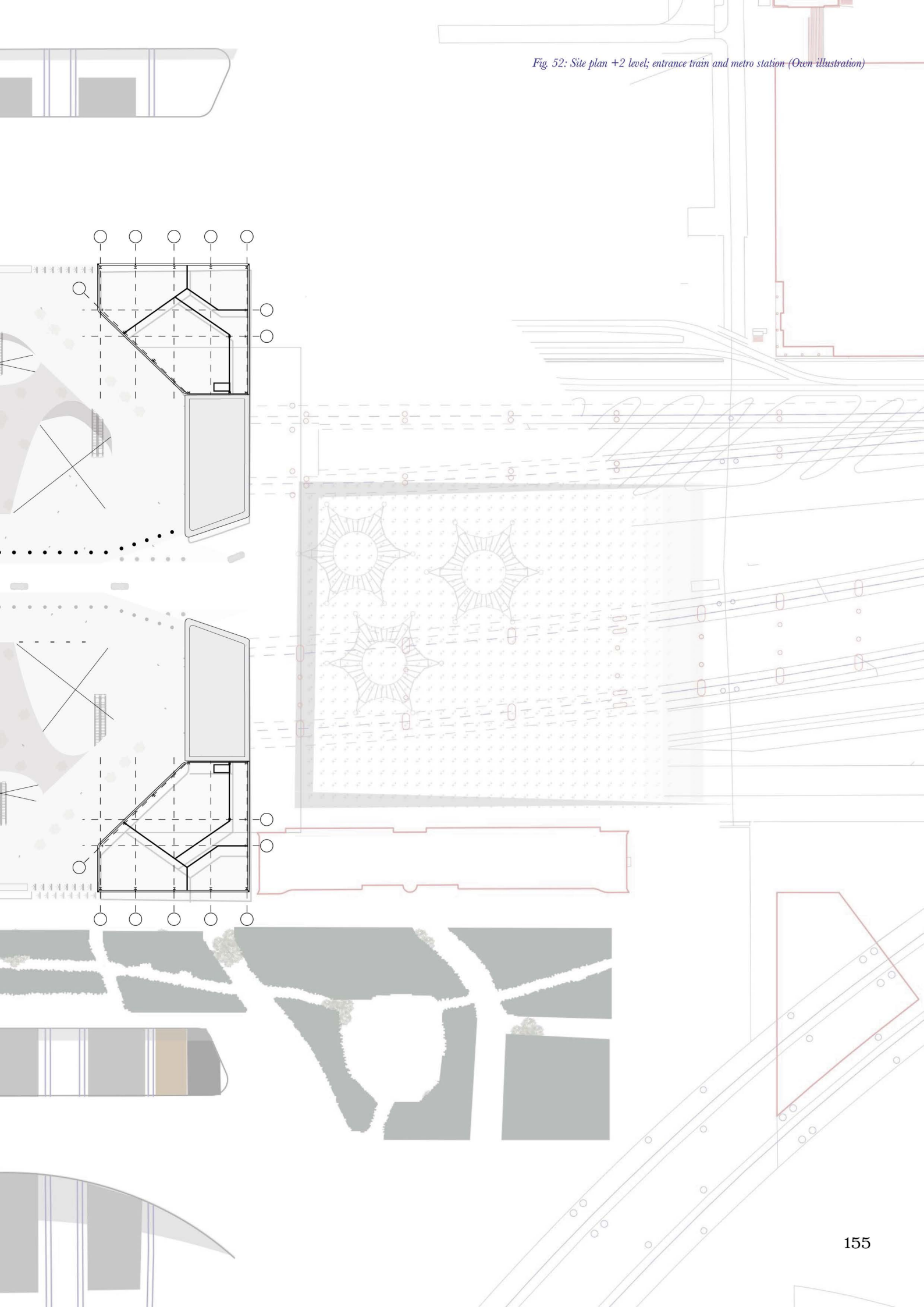
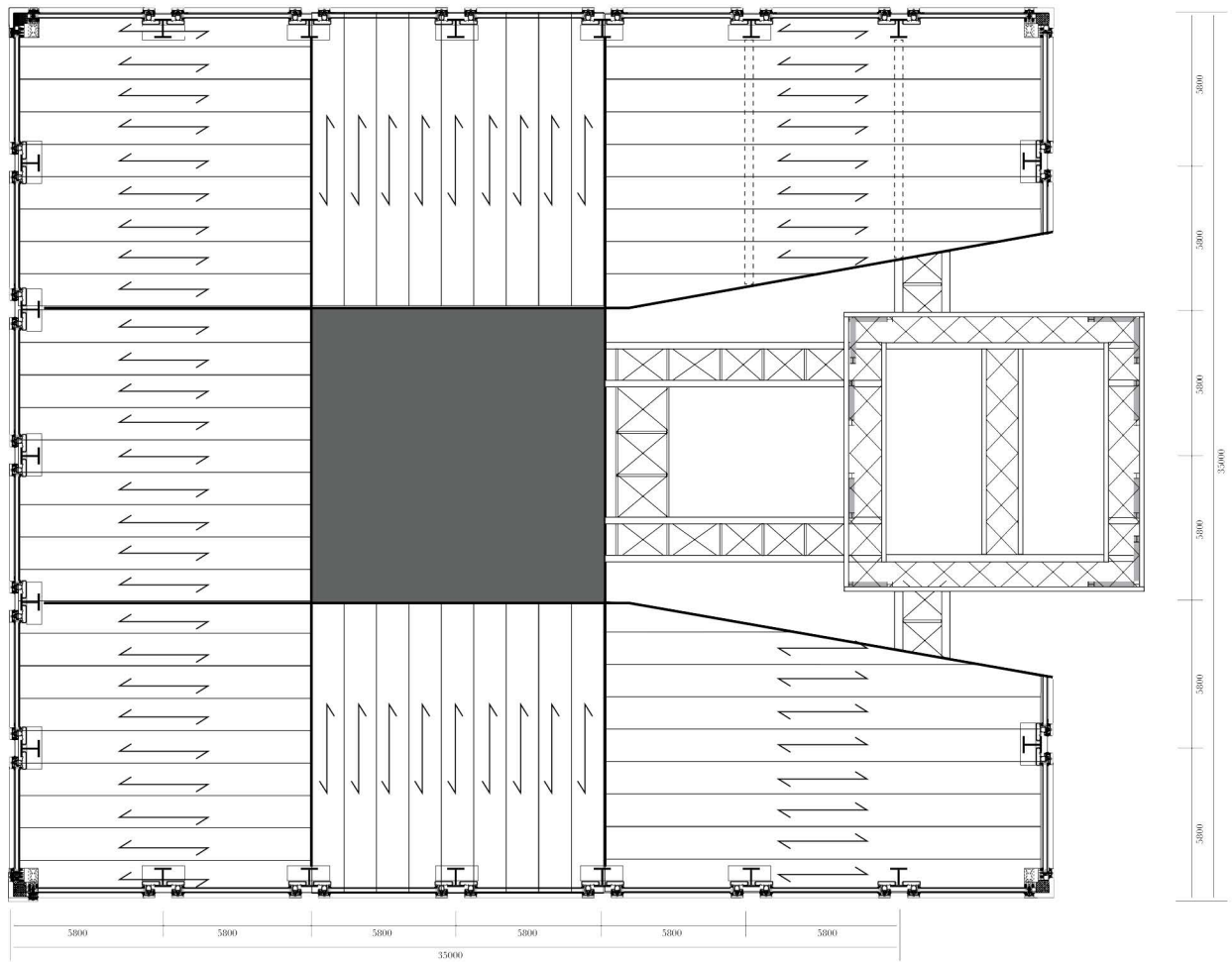
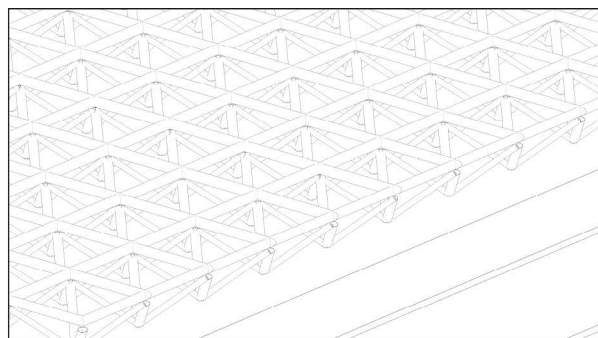
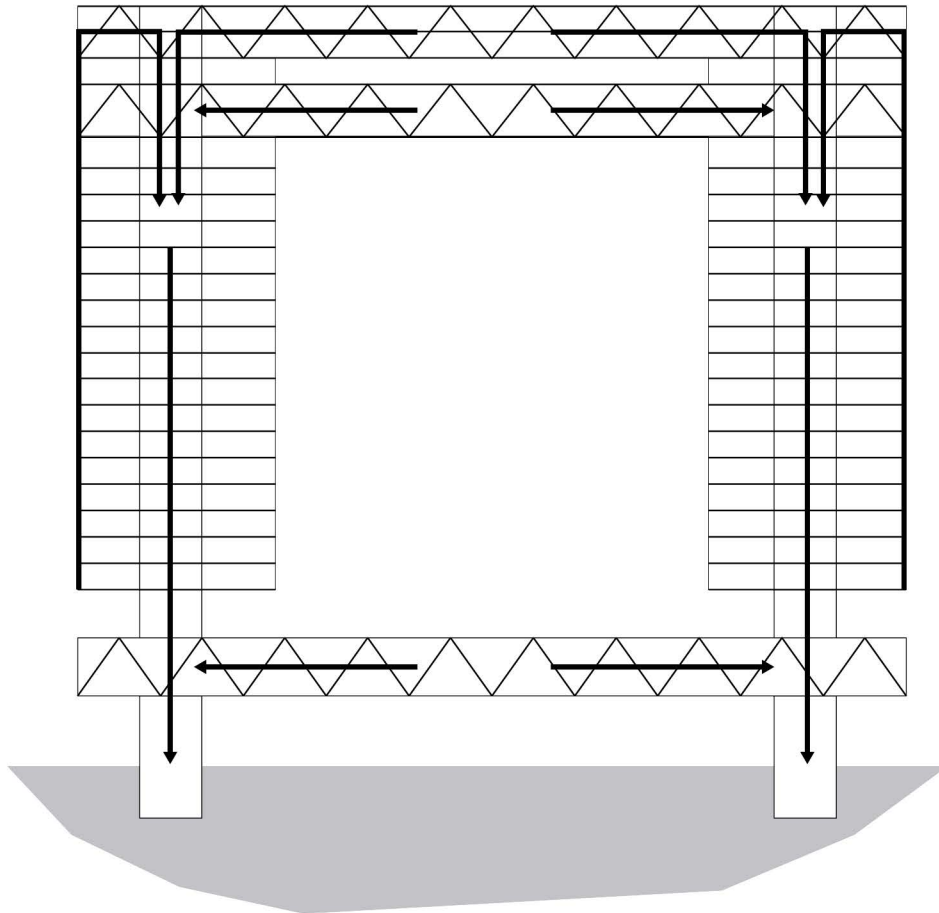
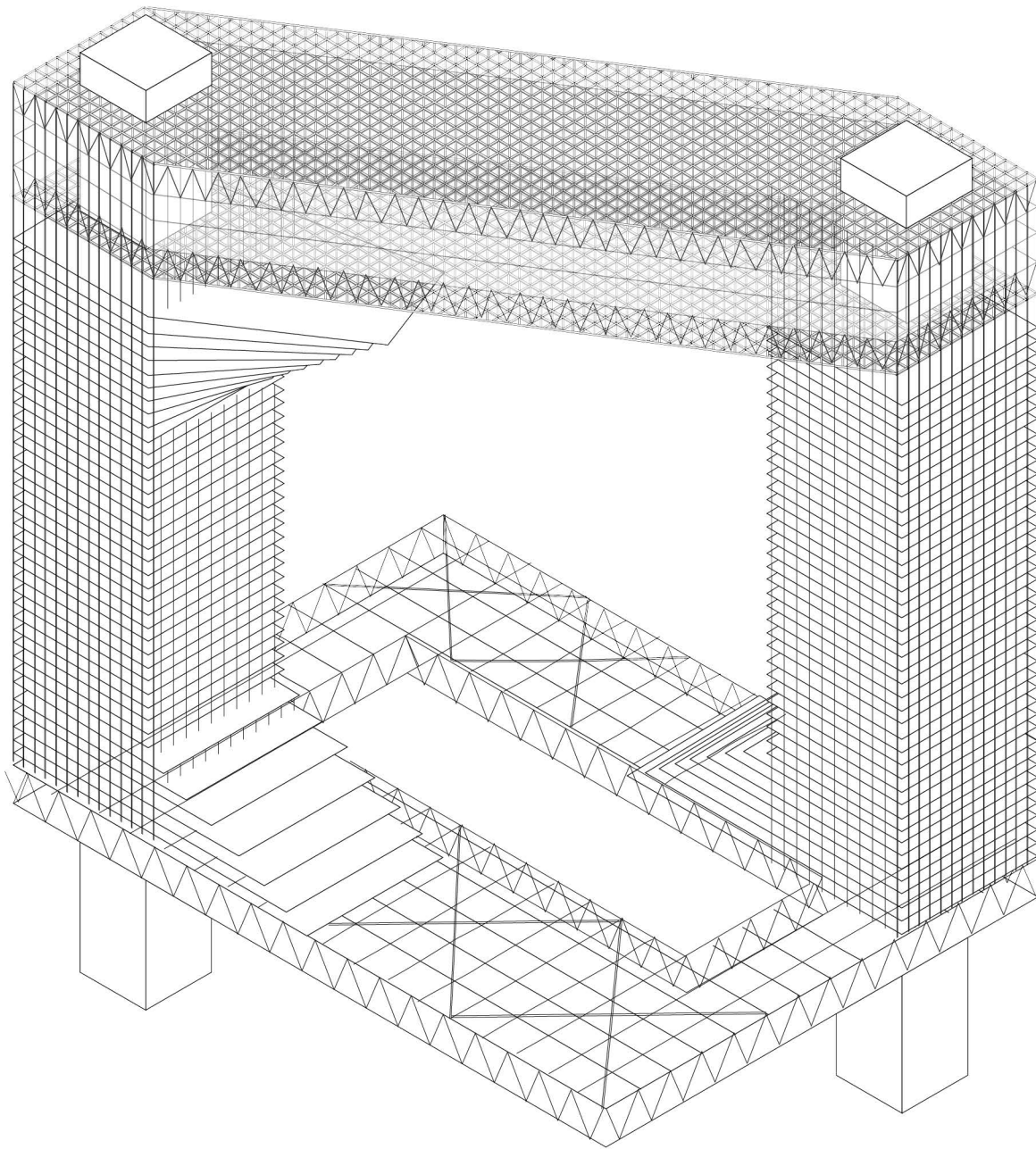

Fig. 52: Site plan +2 level; entrance train and metro station (Oxen illustration)









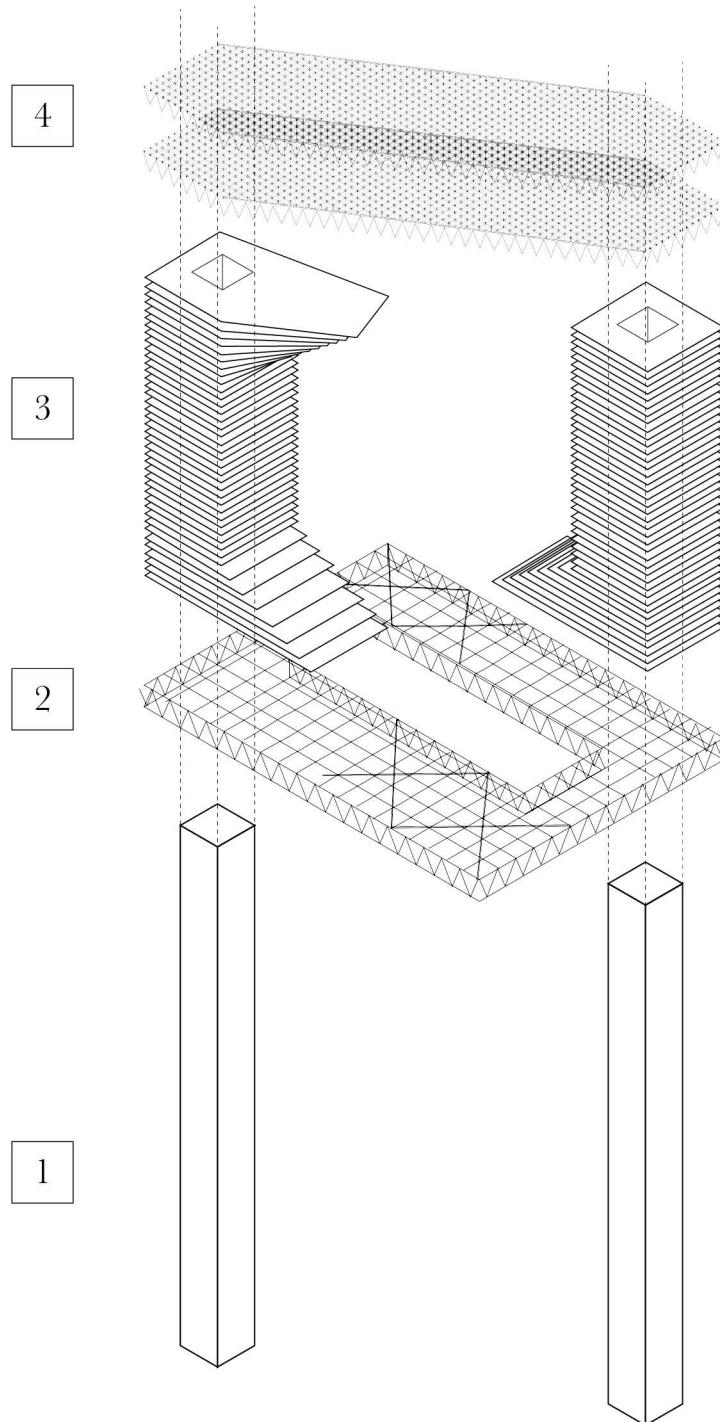

Suspended steel construction method

- 1: X-shaped concrete core
- 2: 3D Spaceframe connecting the cores
- 3: Holcon floorsystem concrete, attached to steel column structure to 3D spaceframe
- 4: 3D spaceframe connecting the cores and provides stability



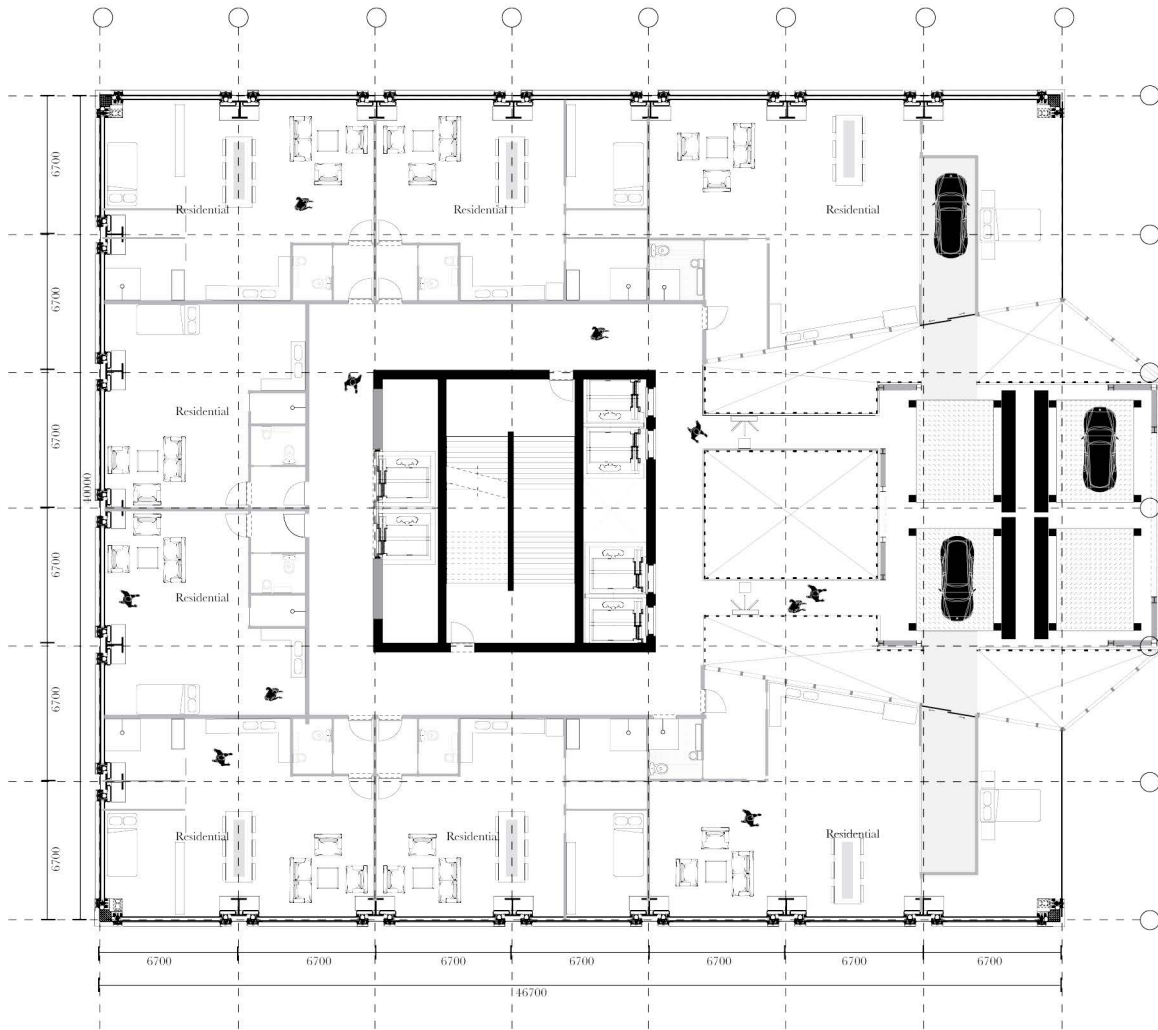
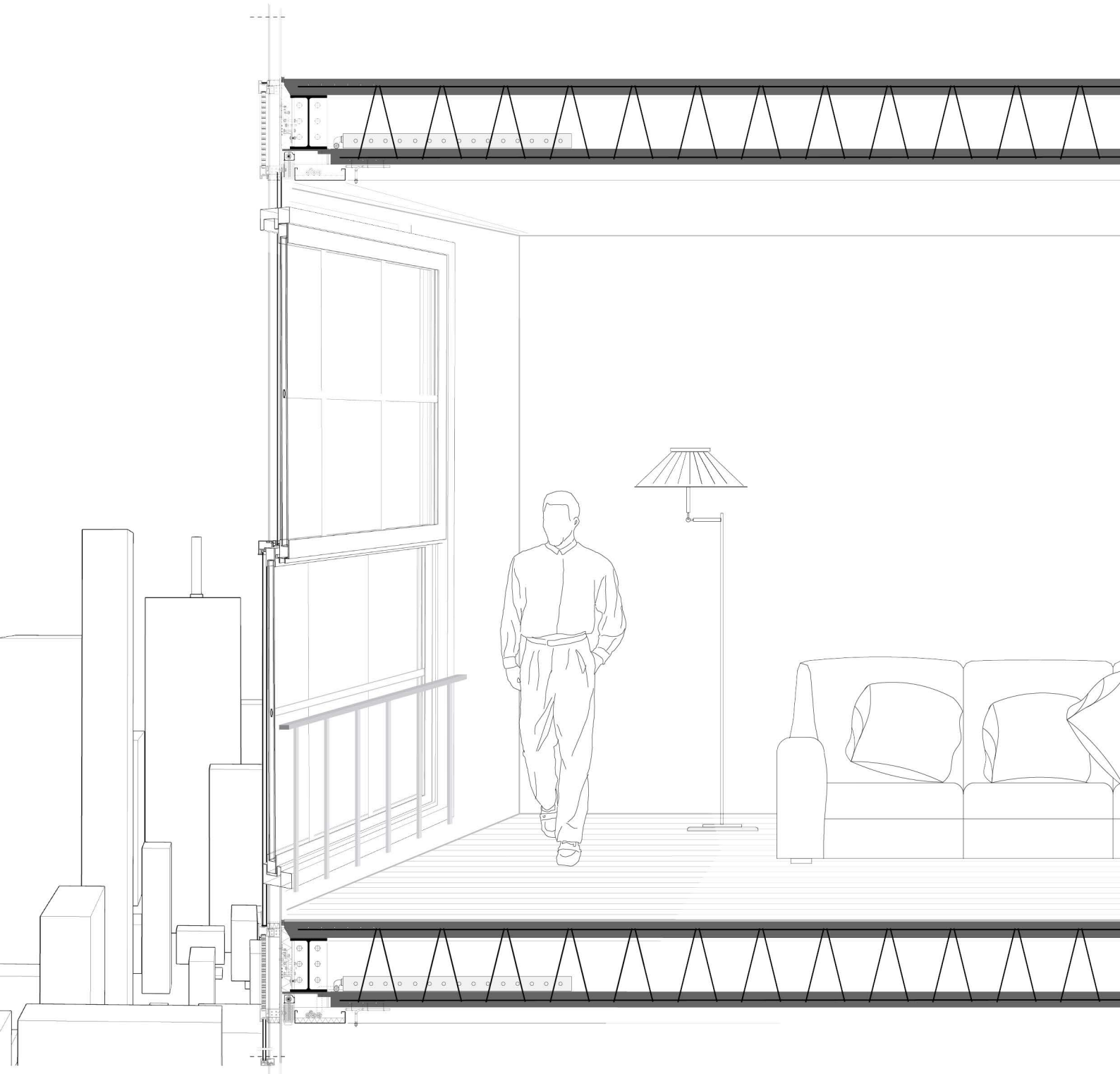

Fig. 58: Room section view residential unit (Own illustration)



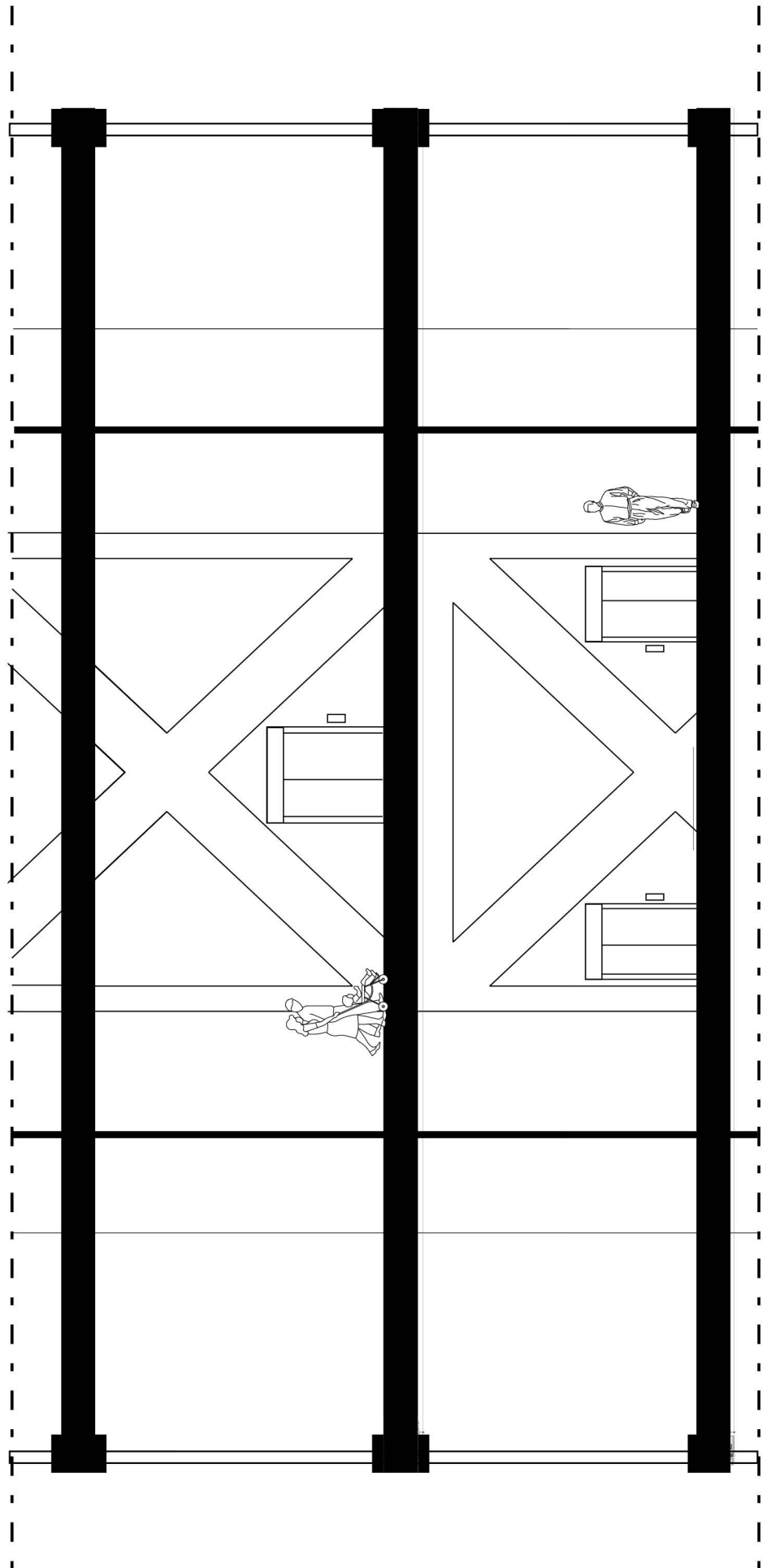
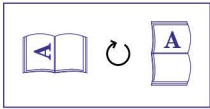

Fig 59: Residential unit plan view + section view (Own illustration)

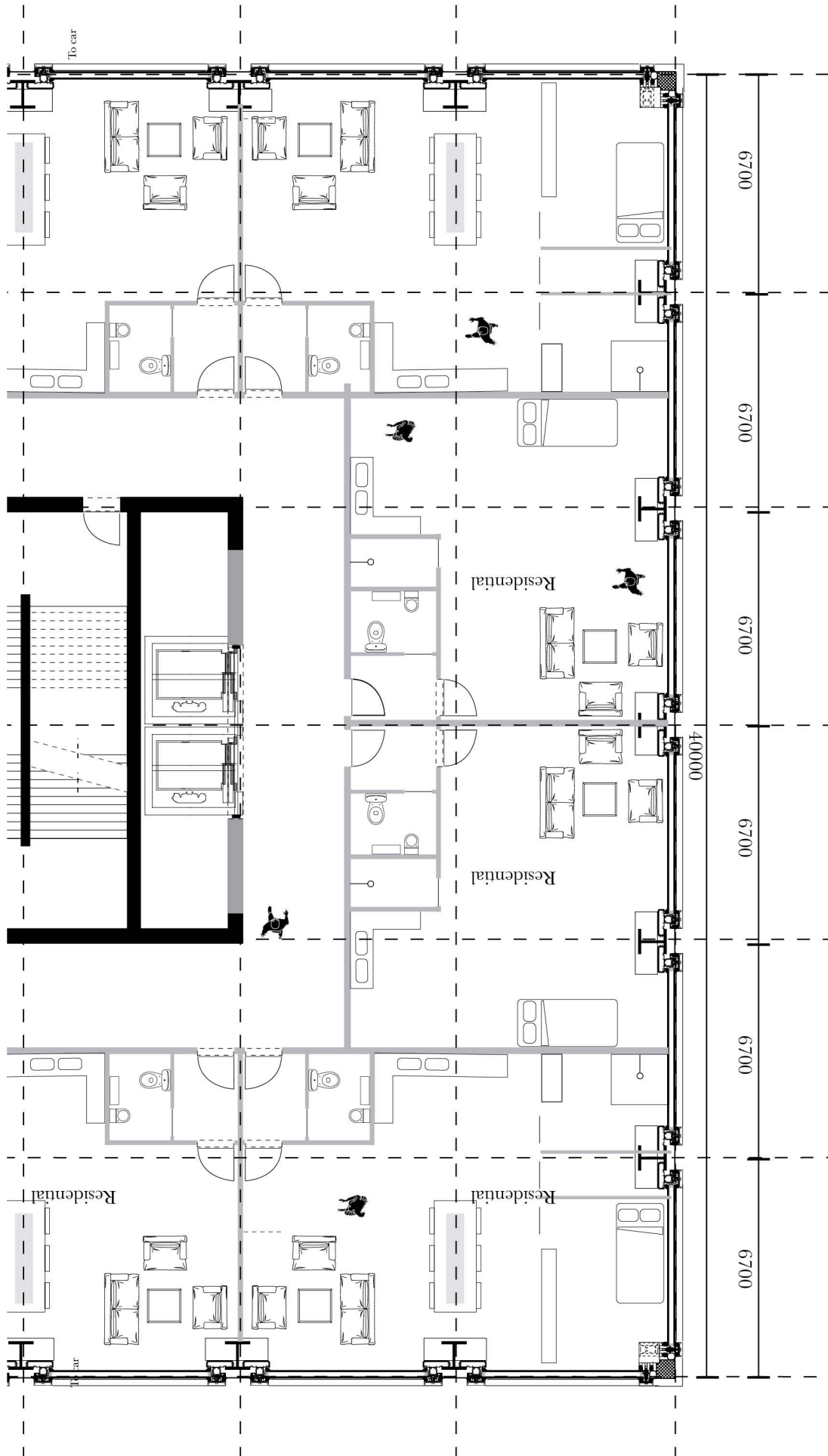

Fig. 60: Detail Holcon floor system (Own illustration)

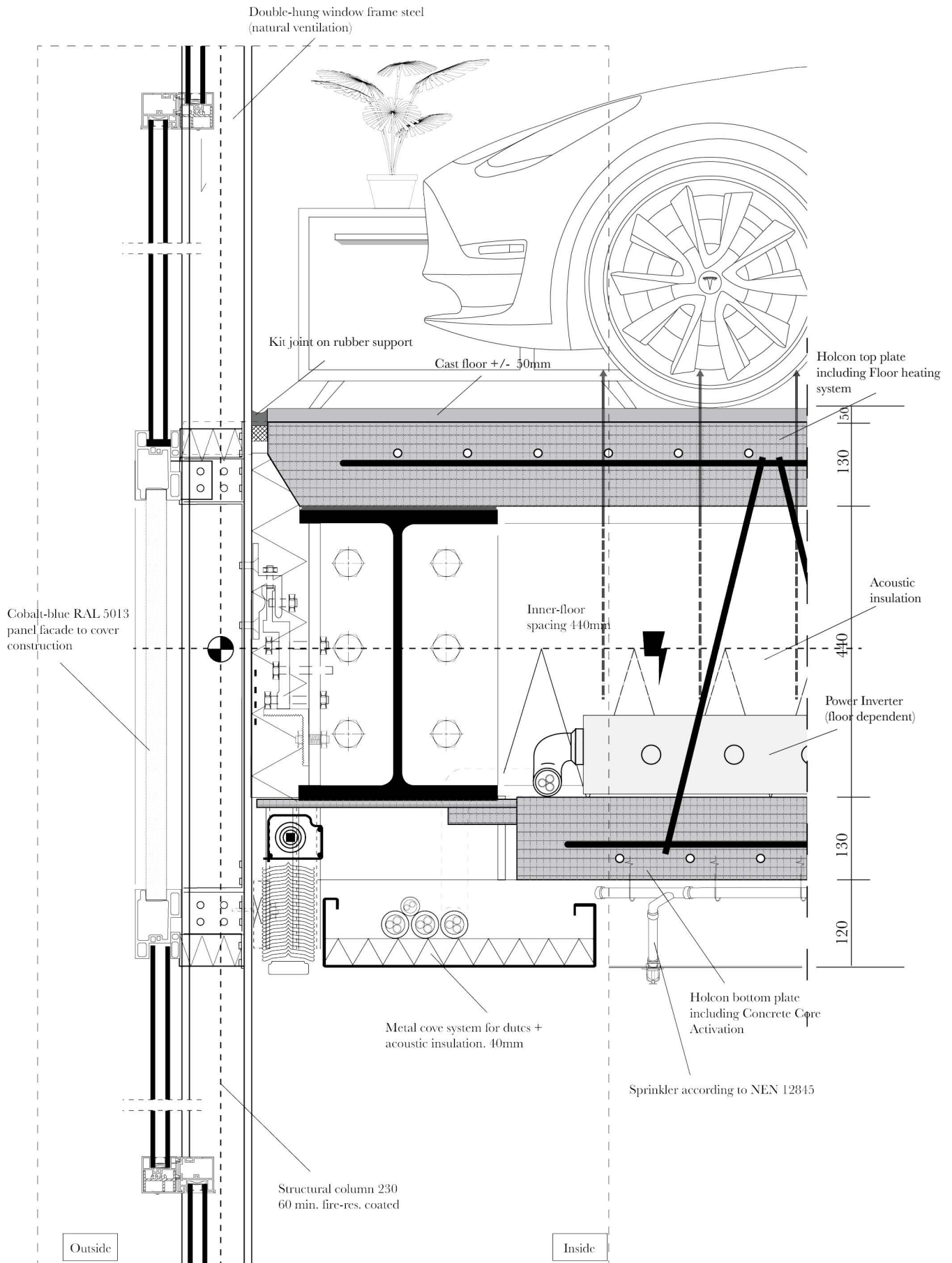

Fig 61: Detail single hung window res. unit (Own illustration)

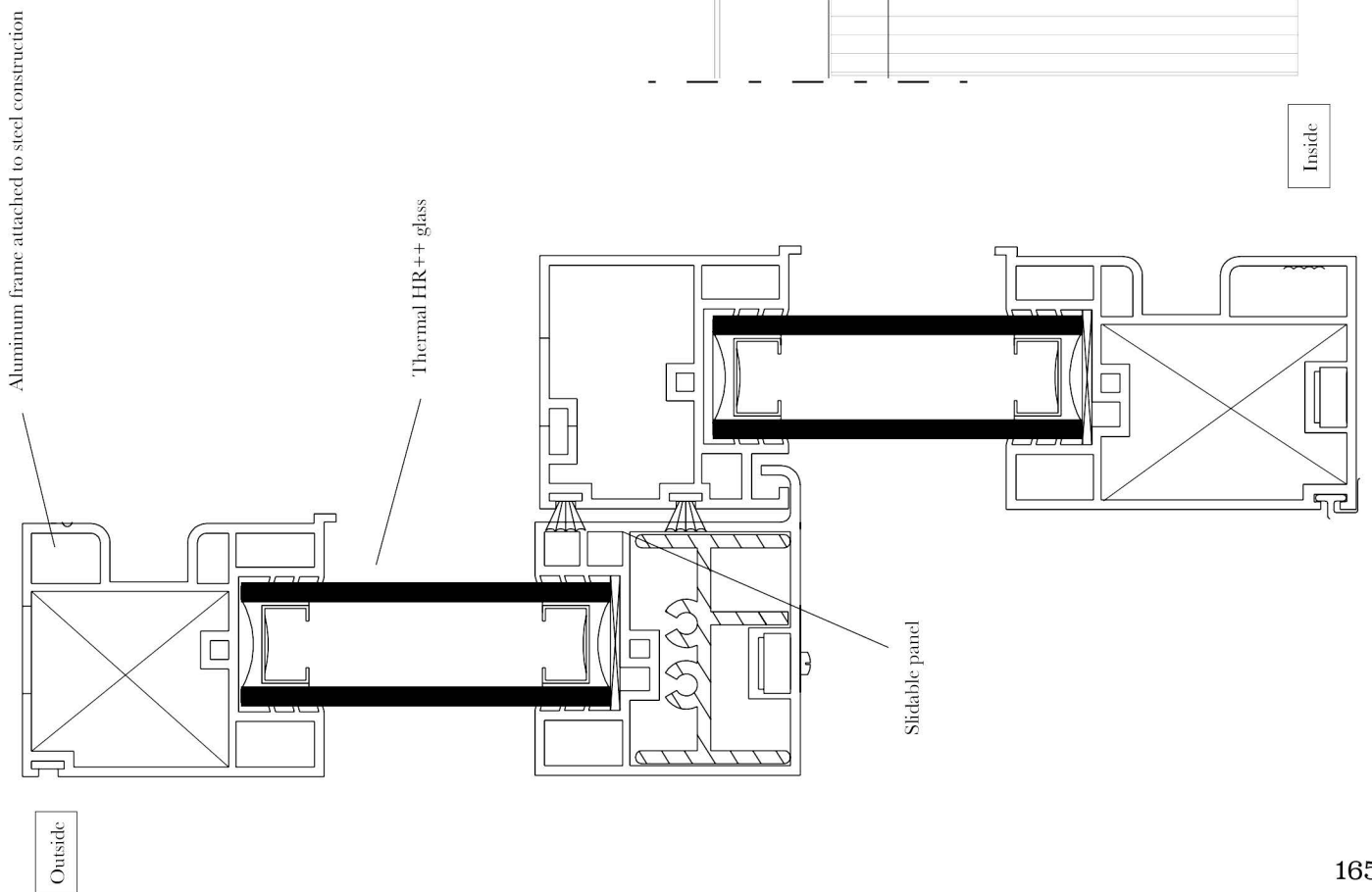



Fig 62: Render car storage (Own illustration)





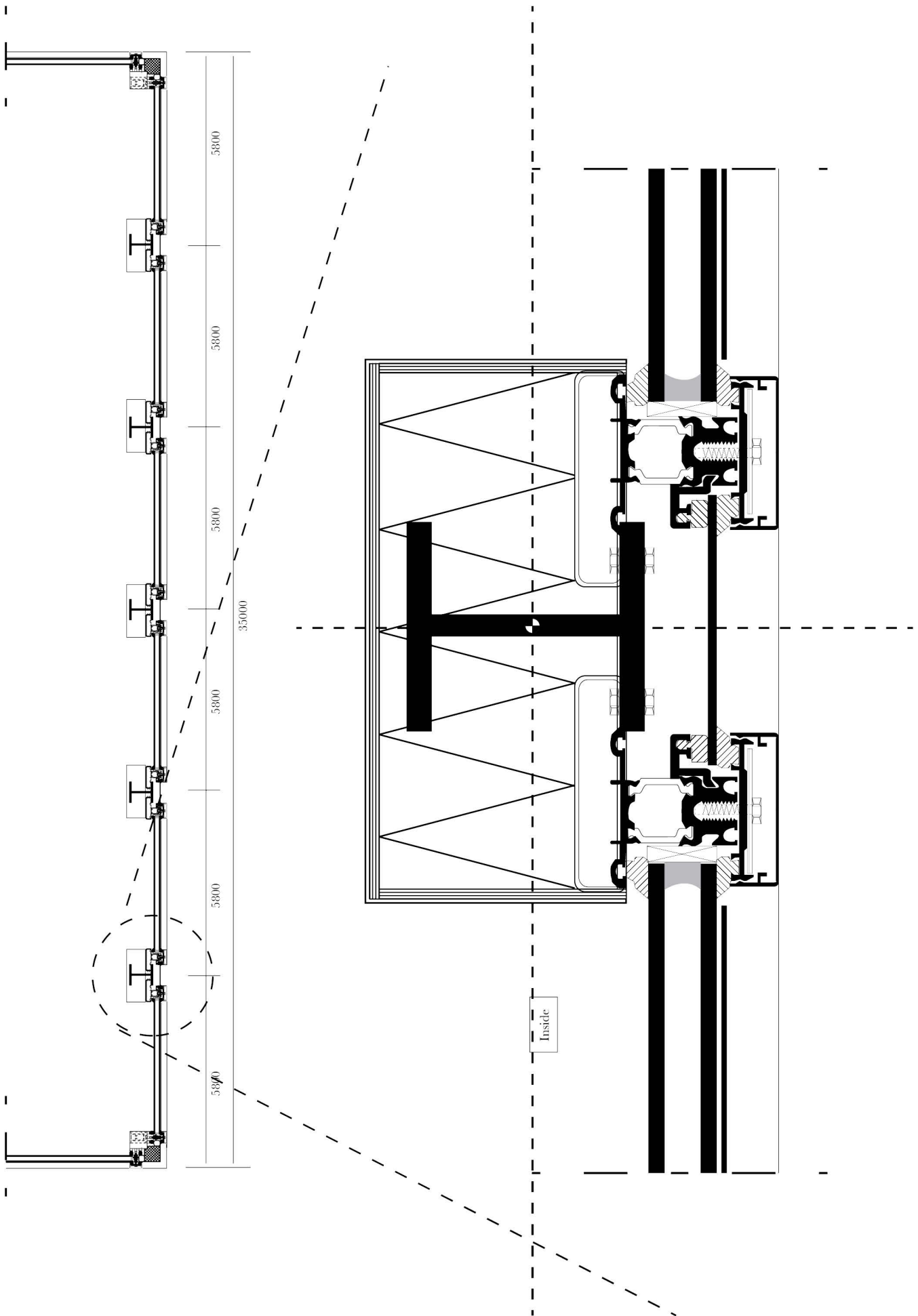

Fig 64: Detail future-proof-modularity facade (Owen illustration)

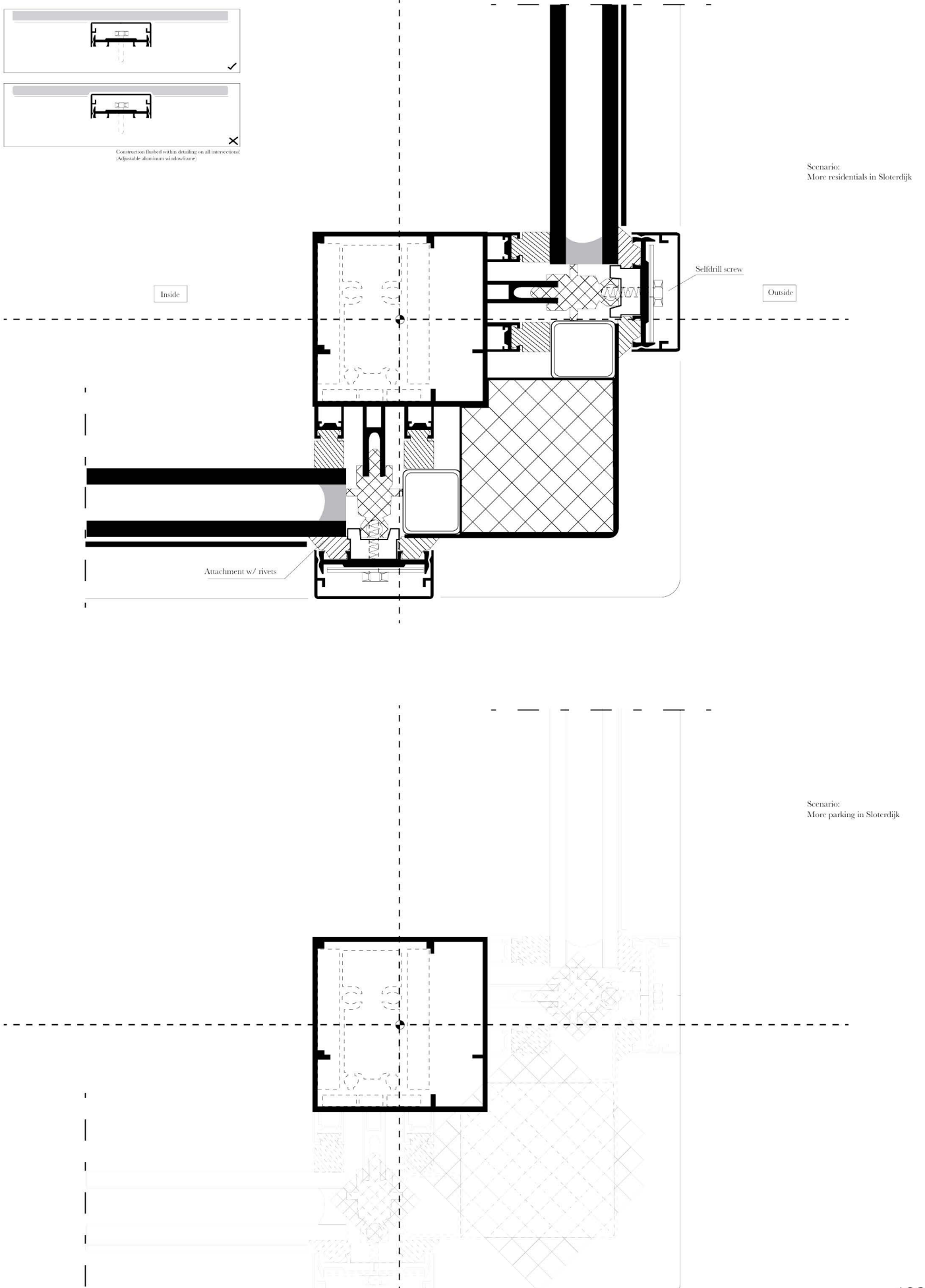

Fig. 65: Detail top green roof (Own illustration)

- Vegetation
- Substrate layer
- Filer layer
- Drainage layer
- Polyethylen film layer
- Hard insulation
- Vapor barrier layer
- Concrete floor structural slab
- Fireproof structural beam (floor dependent)
- Ventilation + sprinkler

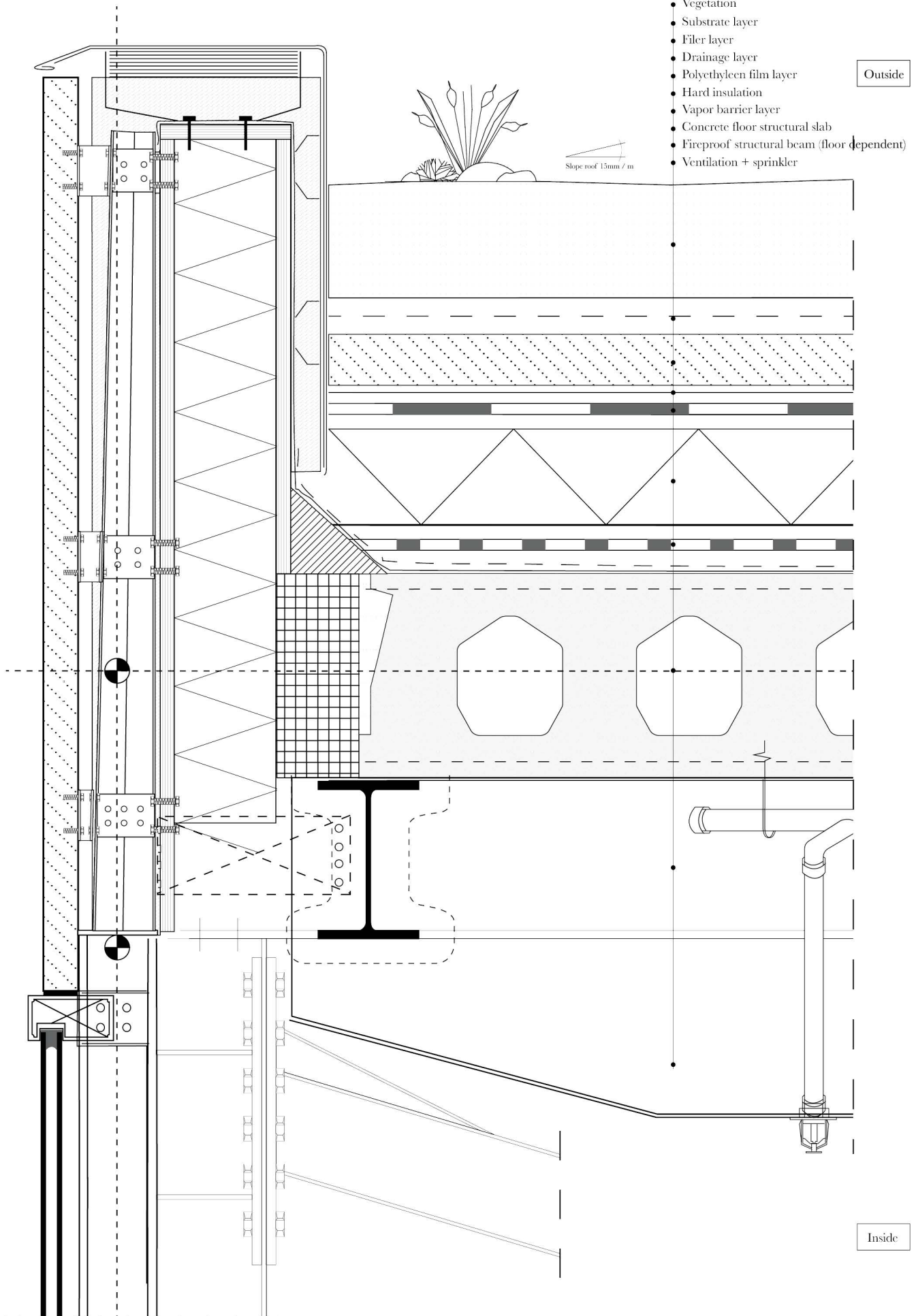

Fig 66: Detail plinth (Own illustration)

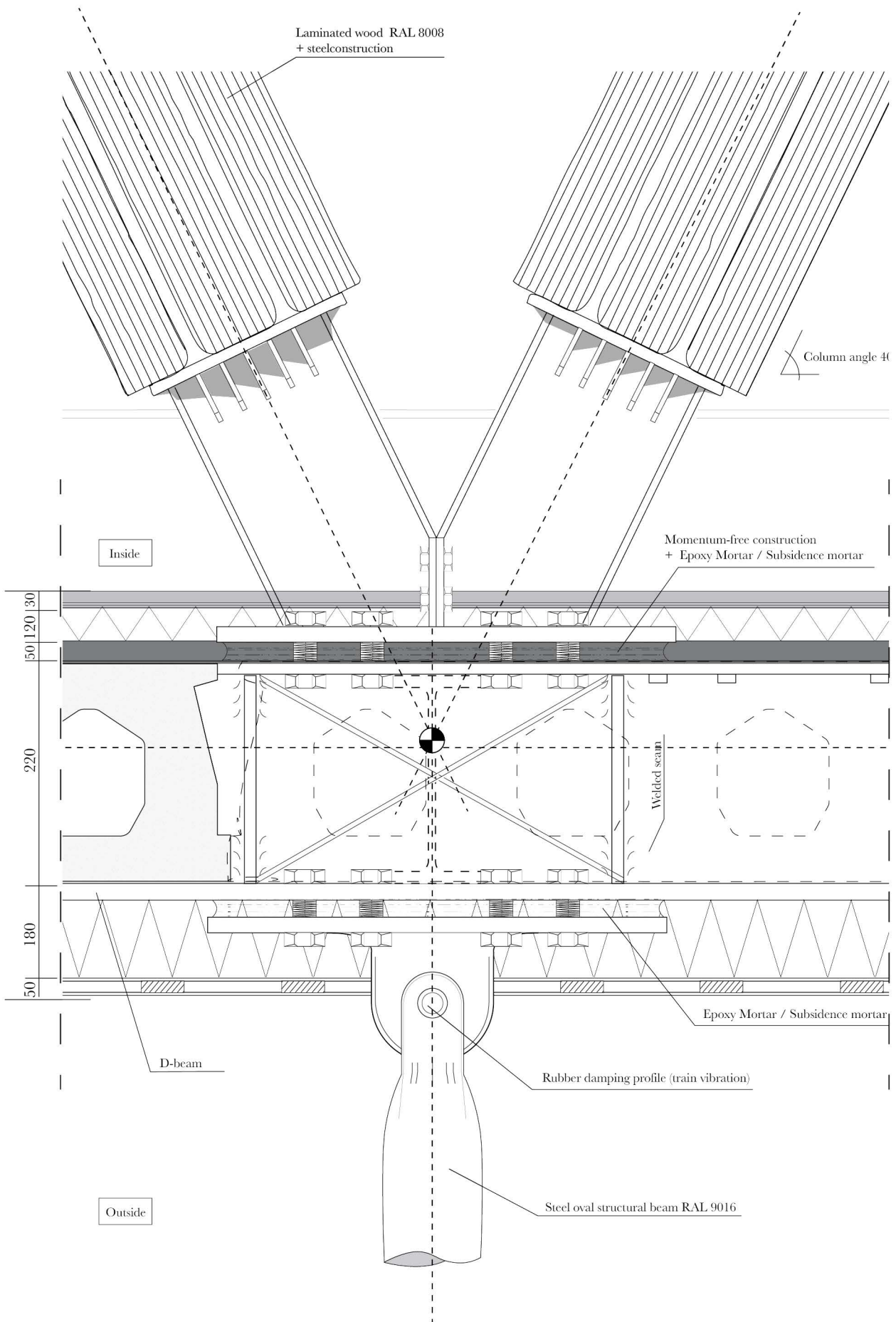
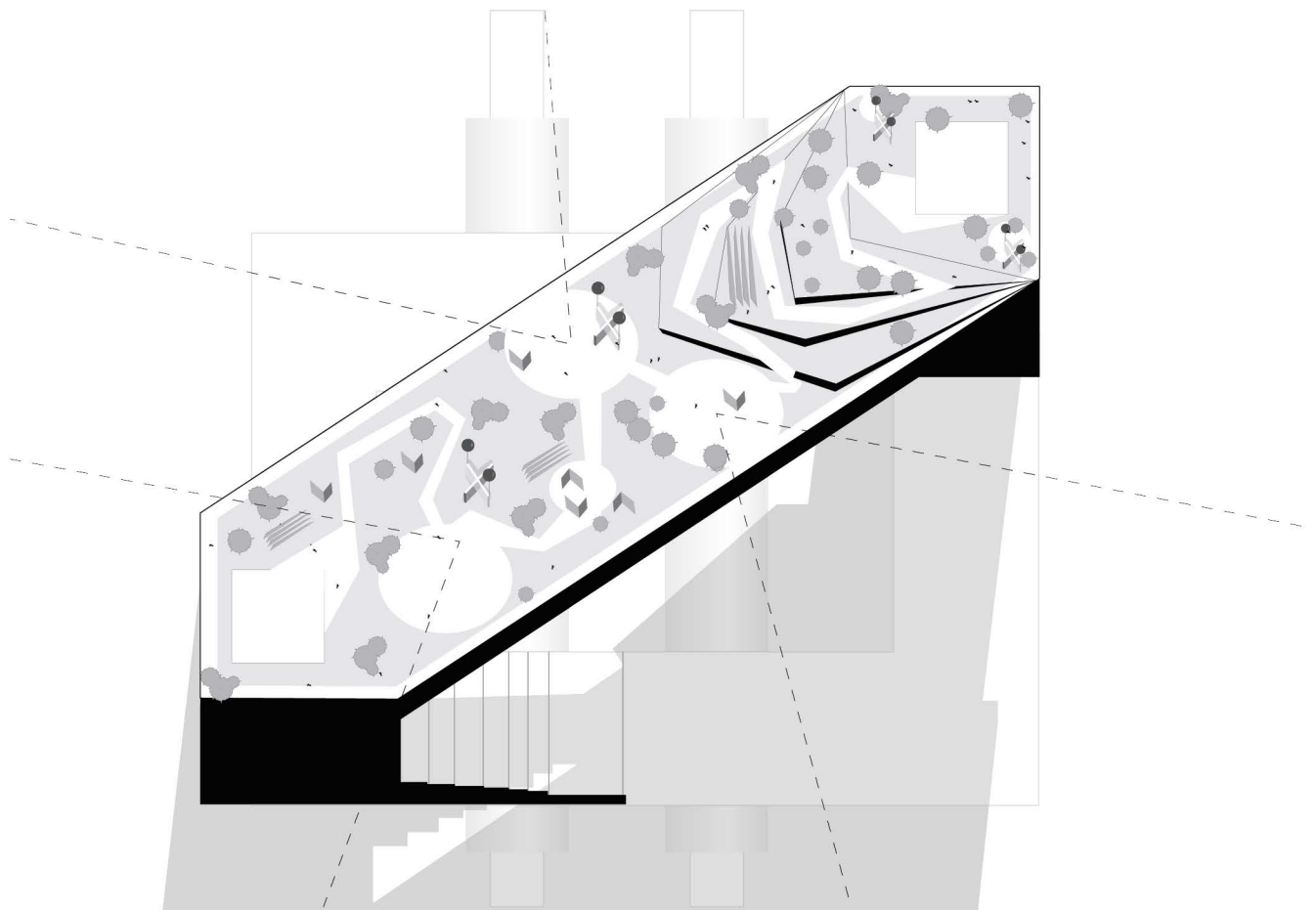
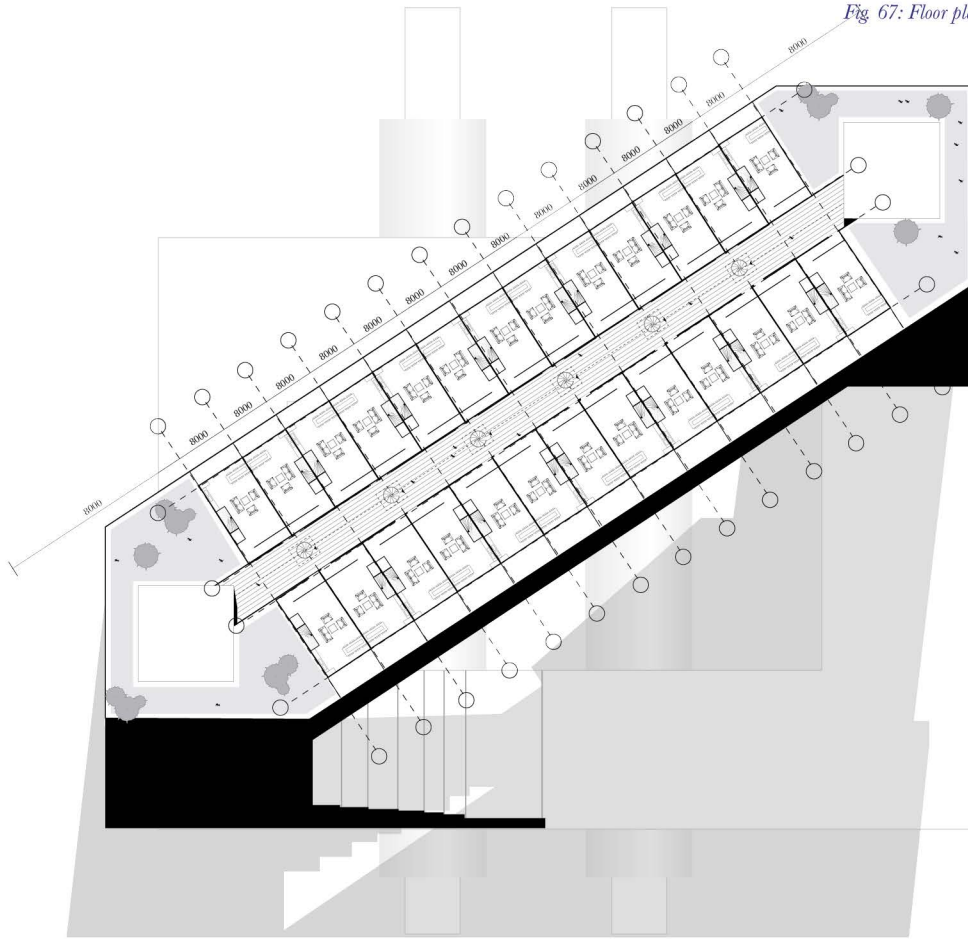

Fig. 67: Floor plan top units (Oven illustration)



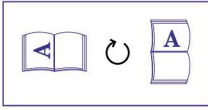

Fig. 68: Section view top units (Own illustration)

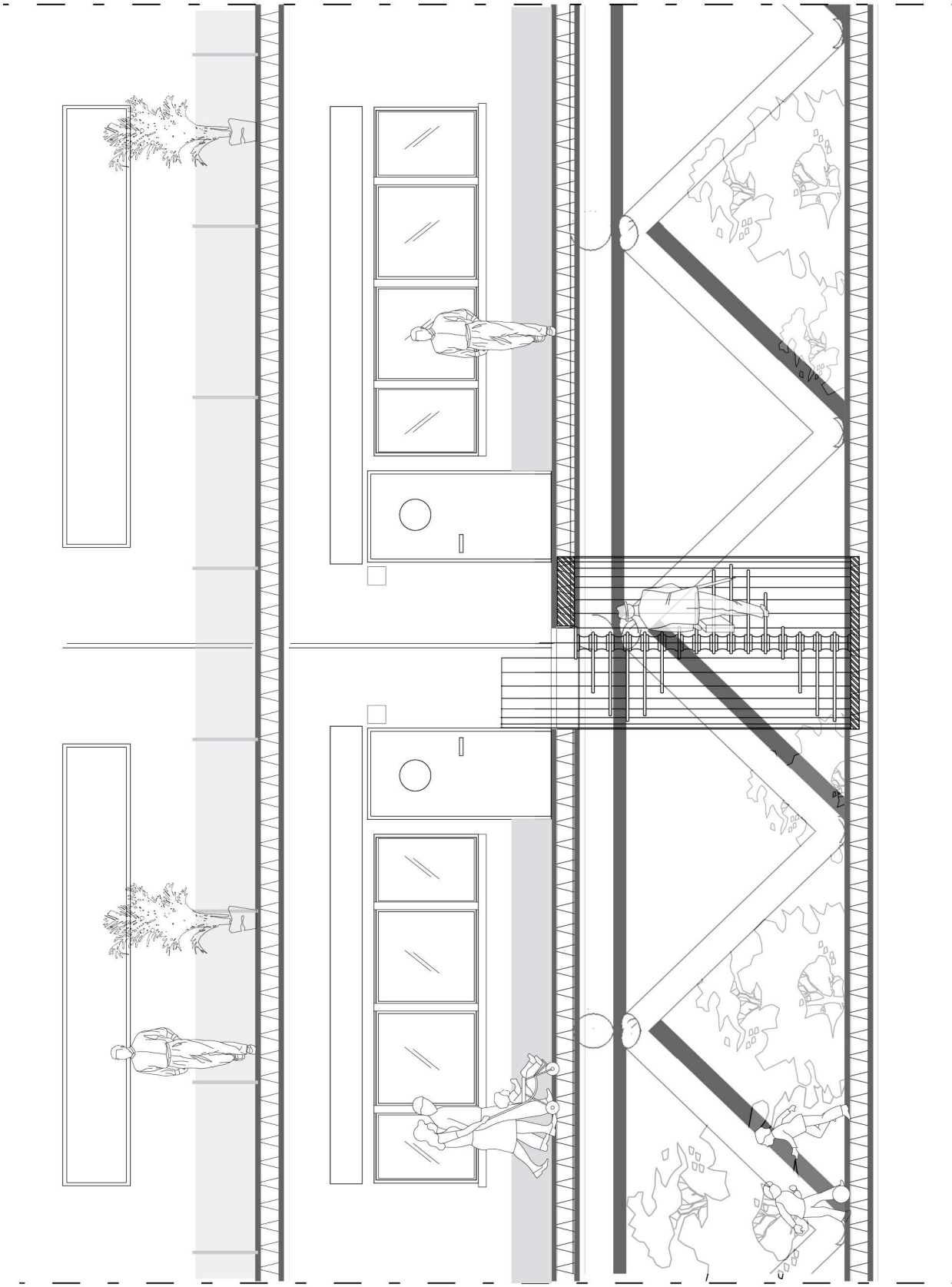

Fig. 69: Detail rubber profile platform level 1 (Own illustration)

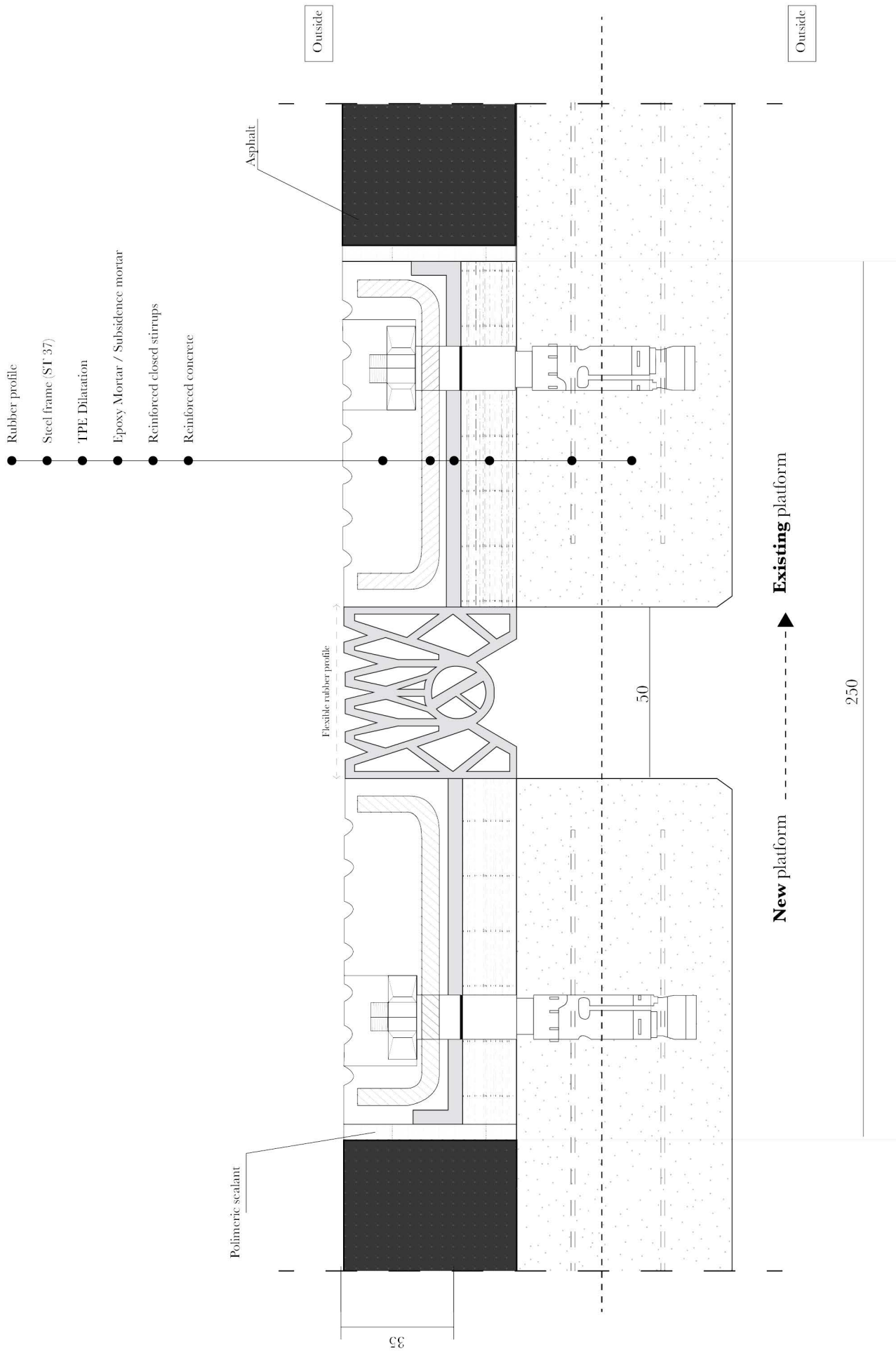

Fig 70: Climate scheme (Owen illustration)

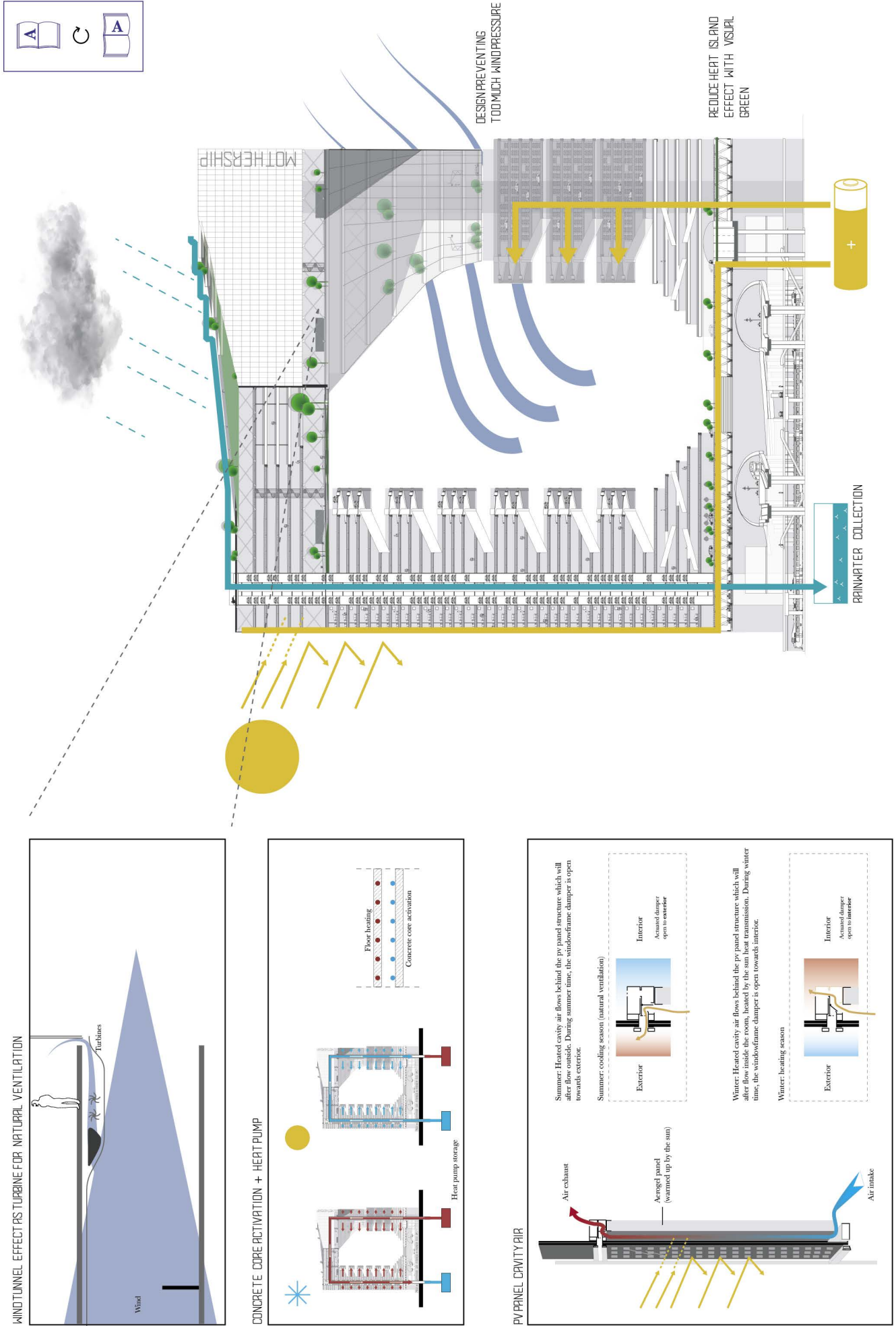
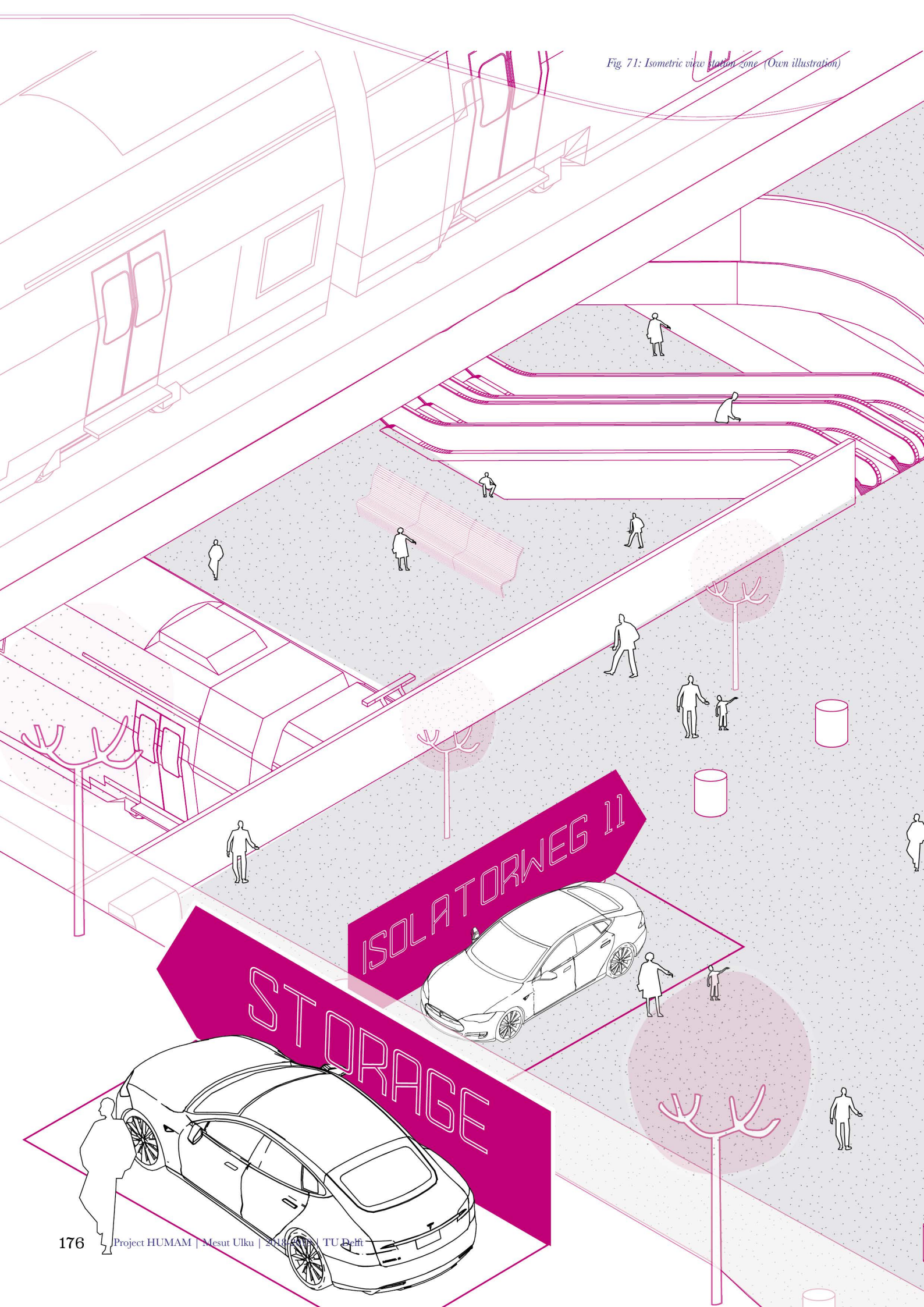
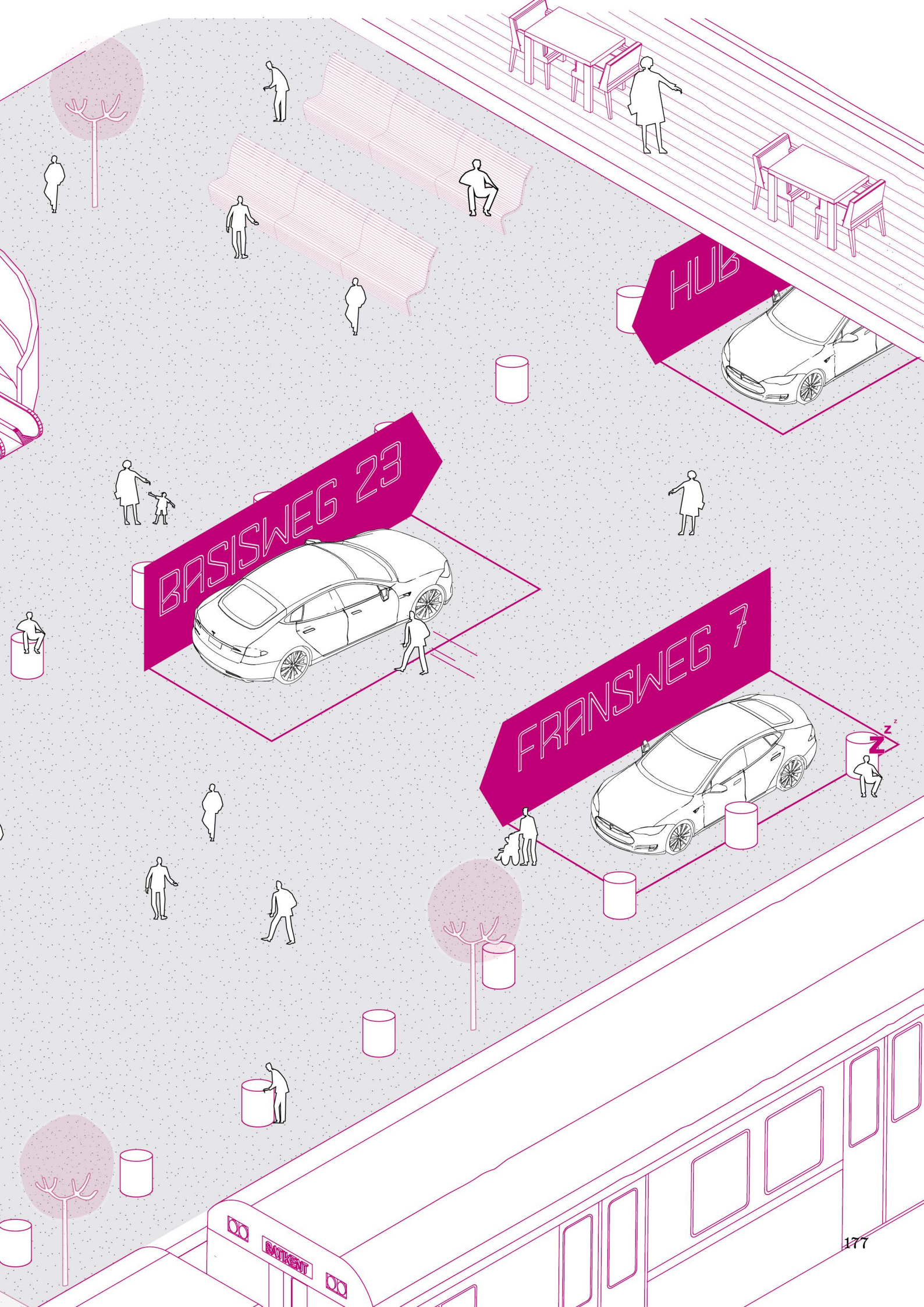



Fig. 71: Isometric view station zone (Own illustration)





BASISWEG 23

FRANSWEG 7

HUB

BATHENT

Fig. 7.2: Isometric view residential units (Own illustration)

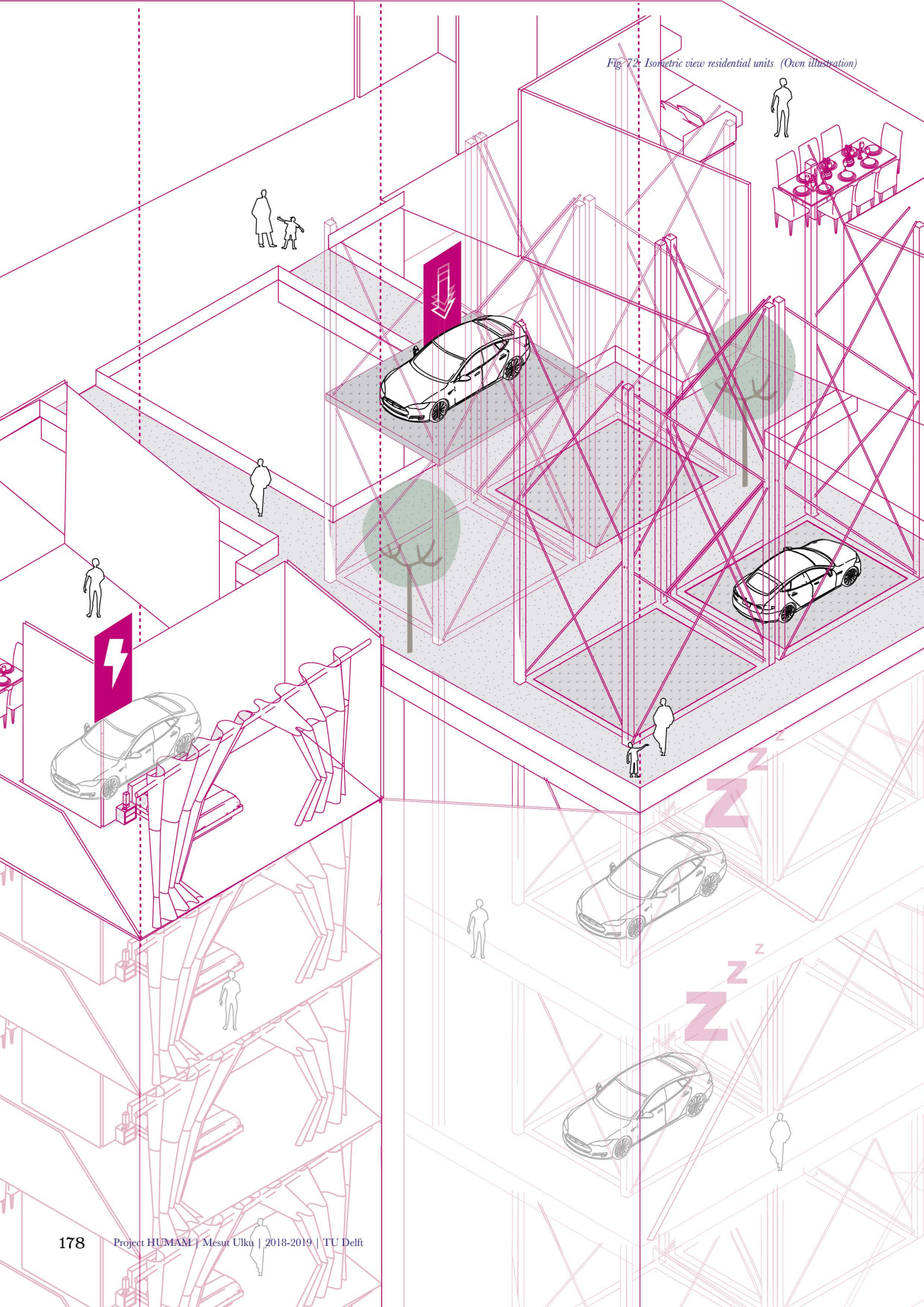

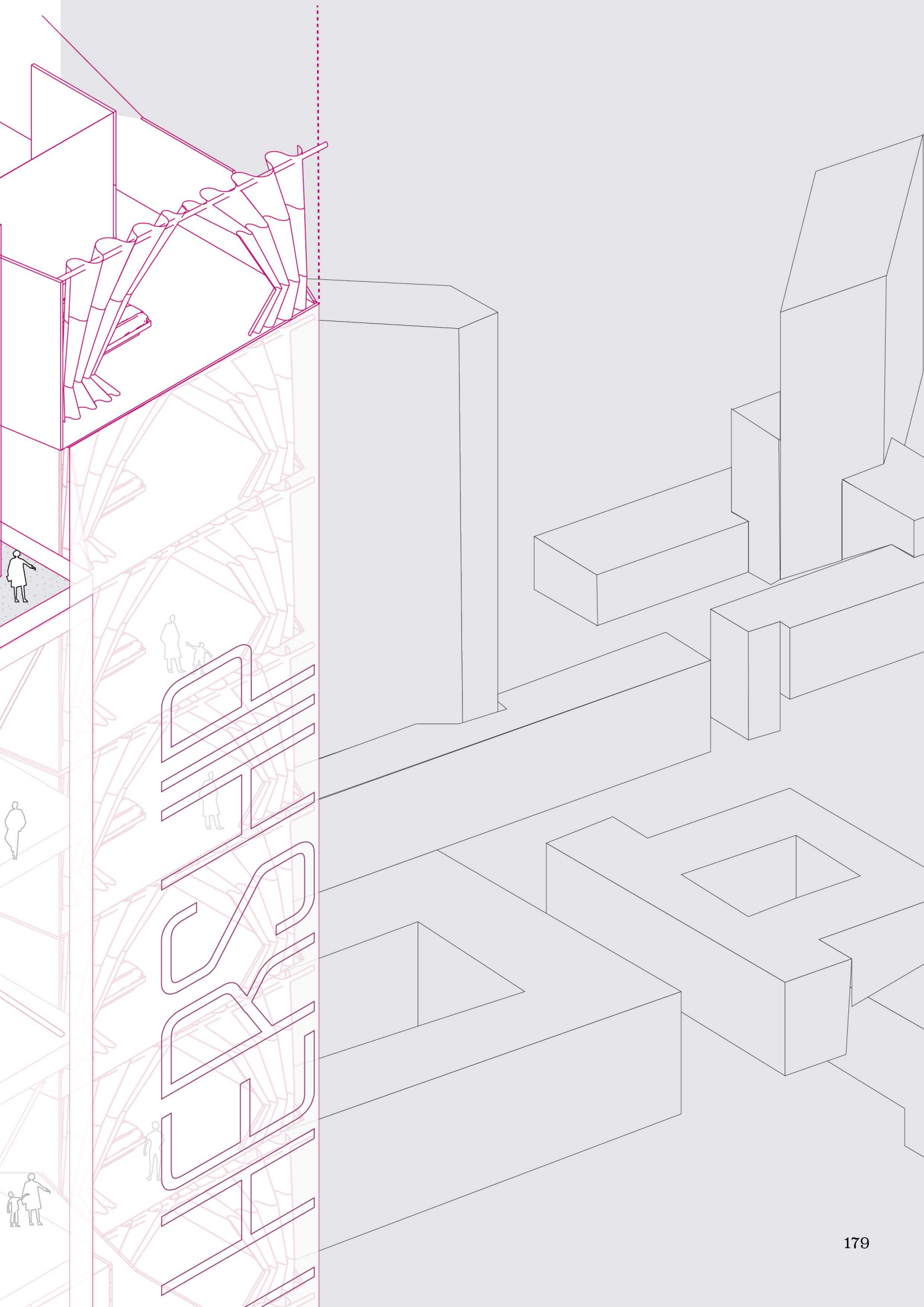
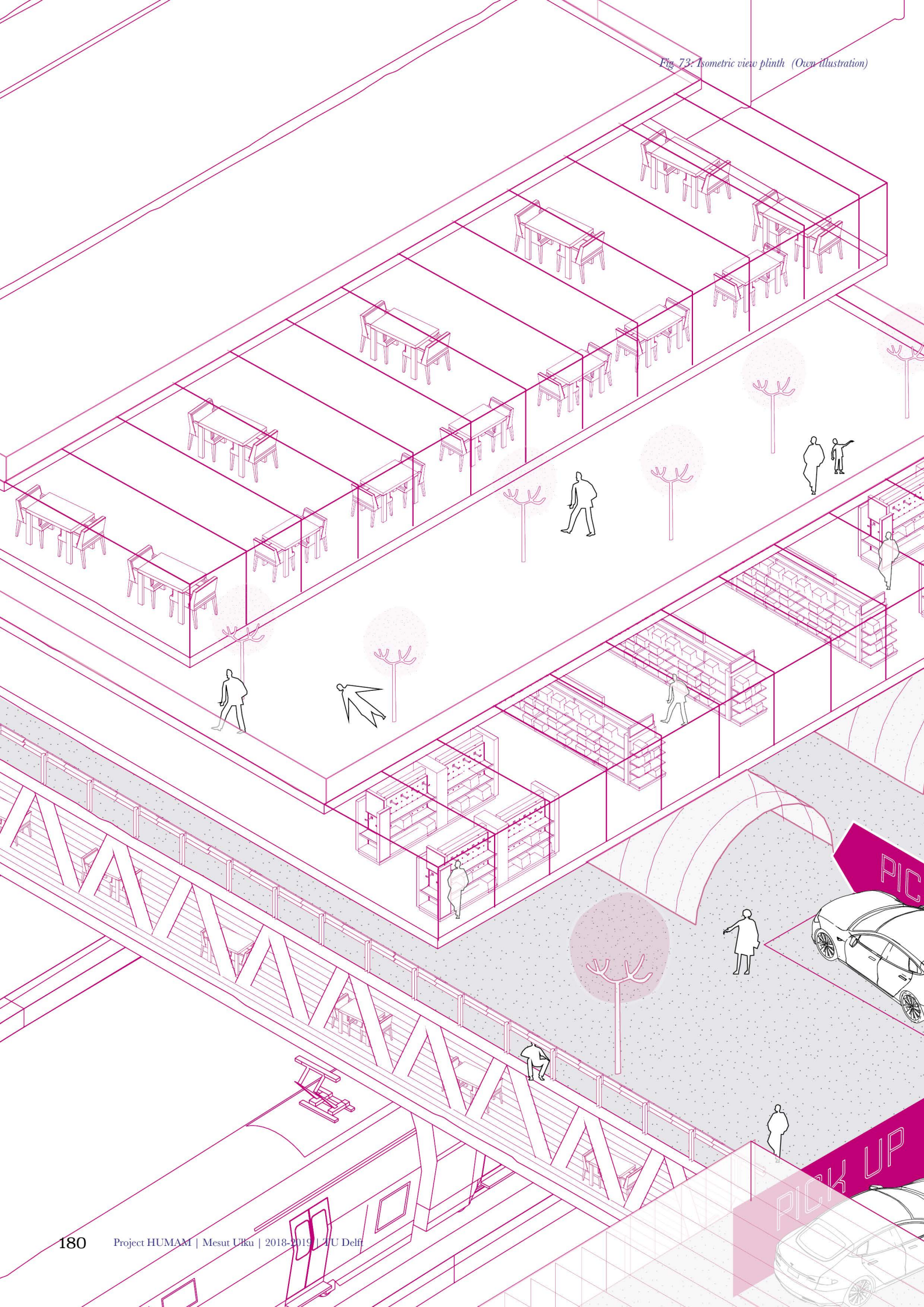
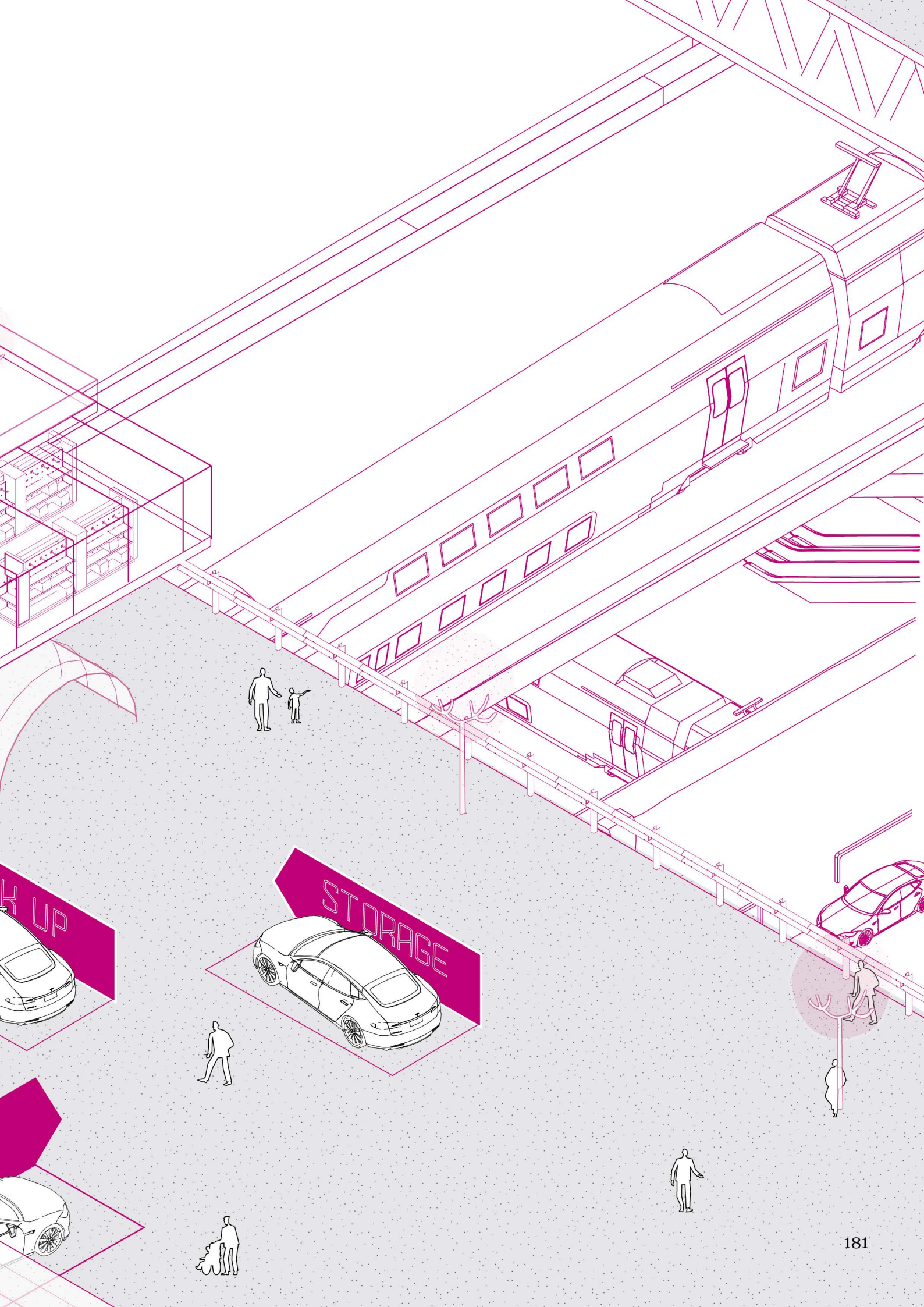

Fig. 73: Isometric view plinth (Open illustration)





## 8.6 Conclusion

While Amsterdam is already expecting thousands of new households in Havenstad area, quick decisions should be made in order to accommodate new residents. The ambition of the city shows the economical benefits as well as the financial benefits for Sloterdijk area, which used to suffer from an identity crisis since the 80's and 90's. However, the Municipalities sees new opportunities to diminish the car-use in Sloterdijk while increasing the number of public spaces and its higher density. Therefore, a mobility hub is necessary to store the cars and will act as the node for the city of transportation.

The results of paragraph 7.2 and 7.3, shown a mixture of different functions, which representing a redefinition of parking and living. By not accommodating a separate parking place and separate living, the architectural quality arises from the combination. The car that serves as a electricity source for houses, close and easy accessible for the people. The result shows a redefinition of living and traveling; the car is not a possession anymore, it is part of the urban infrastructure.

Based on the research done, recommendations has been made that can be seen as the results of this project. These recommendations represent the hub as how it should act in our urban infrastructure. Although the current design of the mobility hub was fairly chosen based on earlier researches, it can be said that these recommendations also represents other less/more radical ideas, infrastructure dependent.

## 8.7 Recommendations

### Architectural context:

Based on research done by PBL and Municipality Amsterdam, every hub needs to be placed in specific radius from each other, to avoid ‘cannibalism’ of capacity. Therefore, based on analyses, a radius of 1500metre can be seen as feasible distance between each hub to stay well connected for all road-users surrounded. Based on the research of Project HUMAM, the most optimal radius relies on the ‘travelable’ distance towards the hub, with maximum of: 20 minutes walking, 15 minutes cycling, 500 metres of commercial space and withing 5 minutes of a self-driving car. Based on the factors of comfort done by the PBL, a potential new hub should follow these guidelines.

### Functional context:

Furthermore, during the study, it appeared to be that the hub should not be seen as a refined parking garage. In fact; with the state of the art in technological transportation, the hub could be seen as a mix of functions regarding the necessity of a potential hub. Which means; functions that are in the demand for a self-driving vehicle (such as residents), could be combined with appartment blocks or commercial places. For this project, the architectural quality of the building was chosen to be a blend of residential units and parking garage. This mix of functions shows the intention of new possibilities in which the hub could be seen as the precursor of innovation. Recognition of a hub was therefore made by visible stacking car storage that can be seen as the ‘gate’ of the hub and car-free zone.

### Transportation context:

Based on the ‘3 themes’ in this project, one of the main priorities became efficiency of transferring to an automated vehicle. According to the PBL, people tend to experience more time penalties when transferring occurs and more energy needs to be taken to arrive at the destination. It can be said that a transportation hub between 2020 and 2050 can not take this problem of transfer-avoidance away. However, the recommendation relies in the efficiency of transferring; to avoid long walks to the automated vehicle, quick and efficient transferring should be possible. Therefore, this project illustrates a car arriving on the plinth of the building, where the user is able to leave its car. At the same moment, an automated vehicle is available to bring the user to its destination without creating too much time penalty.





C  
H  
A  
P  
T  
E  
R

A

THE BIBLIOGRAPHY

- 1. The problem
- 2. The ambition
- 3. The references
- 4. The method
- 5. The themes
- 6. The emergence
- 7. The opportunity
- 8. The results
- A. Bibliography
- B. Appendices

### Books & papers:

- Banham, R. (1976). *Megastructure: Urban features of the recent past*. New York: Harper & Row.
- Banham, P. R., & Herron, R. (1995). *The visions of Ron Herron*. London: Academy Editions.
- Bertolini, L. (2017). *Planning the Mobile Metropolis* (1st ed.). London: Palgrave.
- Boomen, T. V., Hinterleitner, J., & Boer, H. D. (2017). *Snelweg x stad / Highway x city. De toekomst van de stedelijke ringweg / The future of the urban ringroad*. Mechelen: Public Space.
- Chorus, P., & Bertolini, L. (2011). An application of the node place model to explore the spatial development dynamics of station areas in Tokyo. *Journal of Transport and Land Use*, 4(1), 45-58. DOI: 10.5198/jtlu.v4i1.145
- Creswell, J. W., & L., P. C. (2018). *Designing and conducting mixed methods research*. Los Angeles: SAGE.
- Duffhues, J., & Bertolini, L. (2016). From integrated aims to fragmented outcomes: Urban intensification and transportation planning in the Netherlands. *Journal of Transport and Land Use*, 9(3), 15-34. DOI: 10.5198/jtlu.2015.571
- Feddes, F. (2014). *1000 jaar Amsterdam: Ruimtelijke geschiedenis van een wonderbaarlijke stad*. Bussum: Thoth.
- Foer, F. (2018). *World without mind: The existential threat of big tech*. London: Vintage Books.
- Gehl, J. (2010). *Cities for people*. Washington, DC: Island Press.

- Hopkins, O. (2014). *Architectural styles: A visual guide*. London: Laurence King Publishing.
- Illich, I. (n.d.). *Deschooling society: Social questions*. Marion boyars.
  - Koolhaas, R. (2018). *Rem Koolhaas: Elements of architecture / Rem Koolhaas*. Köln: Taschen.
  - Kronenburg, R. 2001. *Spirit of the Machine: Technology as an Inspiration in Architectural Design*. London: Wiley-Academy.
  - Trevor Moore, W. Oregon University, USA. *The impacts on Big Data on Society*
  - Maas, W., Bood, R., & Molenda, A. (2012). *City shock: Planning the unexpected*. Rotterdam: Nai010.
  - Maurer, M., Gerdes, J. C., Lenz, B., & Winner, H. (2016). *Autonomous driving: Technical, legal and social aspects*. Berlin: Springer Open.
  - Mayer-Schönberger, V., & Cukier, K. (2013). *Big Data: A revolution that will transform how we live, work, and think*. Boston, MA: Houghton Mifflin Harcourt
  - Moneo, Rafael (1978). *On Typology*. *Oppositions*, 1978(13) 22-44. Cambridge: MIT Press.
  - Morar, T., & Bertolini, L. (2013). *Planning for pedestrians: a way out of traffic congestion*. *Procedia - Social and Behavioral Sciences*, 81, 600-608. DOI: 10.1016/j.sbspro.2013.06.483
  - Newman, P., Kosonen, L. & Kenworthy, J. 2016. *Theory of urban fabrics: planning the walking, transit/public transport and automobile/motor car cities for reduced car dependency*. *Town Planning Review*, 87, 429-458.
  - Nielsen, J. (2012) *Why You Only Need to Test with 5 Users* Available at: <https://www.nngroup.com/articles/why-you-only-need-to-test-with-5-users/>

## Chapter A - The Bibliography

- Peden, M. (2004). World report on road traffic injury prevention: Information kit. Geneva, Switzerland: World Health Organization.
- Reason, J. (1990). Human error. Cambridge: Cambridge Univ. Press.
- Simon, P. (2015). Too big to ignore: The business case for big data. Hoboken, NJ: Wiley.
- Snellen, D. (2014). Bereikbaarheid verbeeld: 14 infographics over mobiliteit, infrastructuur en de stad. Den Haag: PBL (Planbureau voor de Leefomgeving).
- Soekkha, H. M. (1990). Telematics-transportation and spatial development: Proceedings of an international symposium. Utrecht, the Netherlands: VSP.
- Susskind, R., & Susskind, D. (2017). The future of the professions: How technology will transform the work of human experts. Oxford, United Kingdom: Oxford University Press.
- Van Dooren, E., Boshuizen, E., Van Merriënboer, J., Asselbergs, T., & Van Dorst, M. (2014). Making explicit in design education: generic elements in the design process. *International Journal of Technology and Design Education*, 24( 1), 53-71.
- Toekomstbestendig parkeren: Van parkeercijfers naar parkeernormen. (2018). Ede: CROW.
- Tschumi, B. (1994). The Manhattan transcripts. London: Academy Editions.
- Wiersma, J., Bertolini, L., & Straatemeier, T. (2016). How does the spatial context shape conditions for car dependency? An analysis of the differences between and within regions in the Netherlands. *Journal of Transport and Land Use*, 9(3), 35-55. DOI: 10.5198/jtlu.2015.583

### Websites:

- Business Technology. (n.d.). Retrieved from <https://quizlet.com/gb/205458565/business-technology-flash-cards/>
- Enrique Dans, & Enrique Dans. (2016, March 26). Cities without cars: No longer science

fiction. Retrieved from <https://medium.com/enrique-dans/cities-without-cars-no-longer-science-fiction-889b5ce66a7d>

- (n.d.). Retrieved from <http://www.metrolinx.com/en/regionalplanning/mobilityhubs/default.aspx>

### **Images**

- [www.shinjukustation.com](http://www.shinjukustation.com)

### **Interviews:**

- Hoften, L. V. (2018, October 30). Interview UNStudio, Project HUMAM [Personal interview].

- Krabbenborg, J. (2018, October 18). Interview Municipality Amsterdam, Project HUMAM [Personal interview].

- Binsbergen, A. V. (2018, November 1). Interview RADD TU Delft, Project HUMAM [Personal interview].

### **Others:**

- Notes from lecture TU Delft, course Transport 1 TB141TA about “positionering vervoersmiddelen”.

- Notes from lecture TU Delft, course Transport CIE 5805 about Intelligent Vehicles for Safe and Efficient Traffic, Prof. Dr. B. van Arem.

- Study about Automated Transportation System of Dallas Midtown

- Nota Tweede Structuurschema Verkeer en Vervoer (Transferia)

- Publications from Amsterdam Municipality



C  
H  
A  
P  
T  
E  
R

B

THE APPENDICES

- 1. The problem
- 2. The ambition
- 3. The references
- 4. The method
- 5. The themes
- 6. The emergence
- 7. The opportunity
- 8. The results
- A. Bibliography
- B. Appendices**



## Chapter B - The appendices

### BI: Venice Biennale 2018 - BNA



Short talk about a hub as a potential element in urban environment  
(Own source)



Results after group discussion with Politecnico Milano University + KRFT Architects  
(Own source)



Our team explaining the situation in Amsterdam  
(Own source)

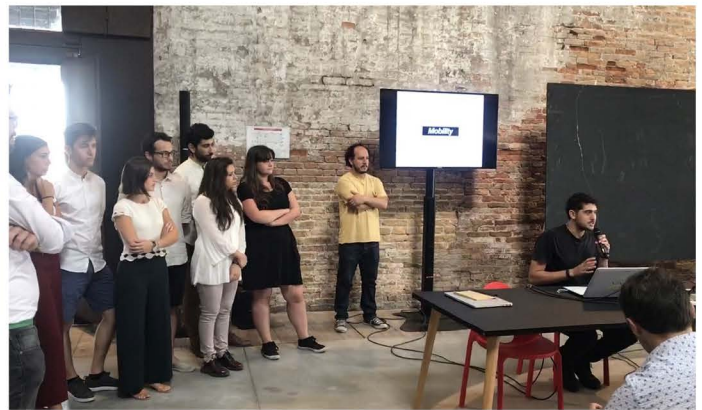

Short talk about mobility as a source of researching  
(Own source)

B2: On-site photography



West view Sloterdijk. Photo taken from entrance train station  
(Owen source)



South view Sloterdijk. Photo taken from Parking place  
(Owen source)



Metro platform view Sloterdijk. (Owen source)



Metro platform view Sloterdijk. (Owen source)



Level 1 to level 0 view, underpass Sloterdijk. (Owen source)



North view Sloterdijk. Photo taken from Parking place. (Owen source)

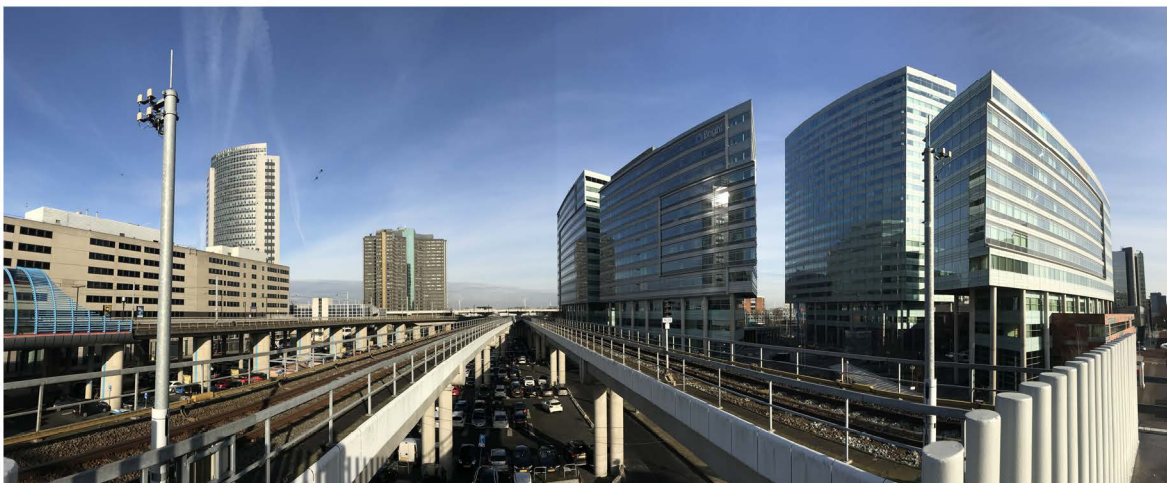

Panorama north-view metro station Sloterdijk. (Owen source)

## Chapter B - The appendices

### B3: Site model

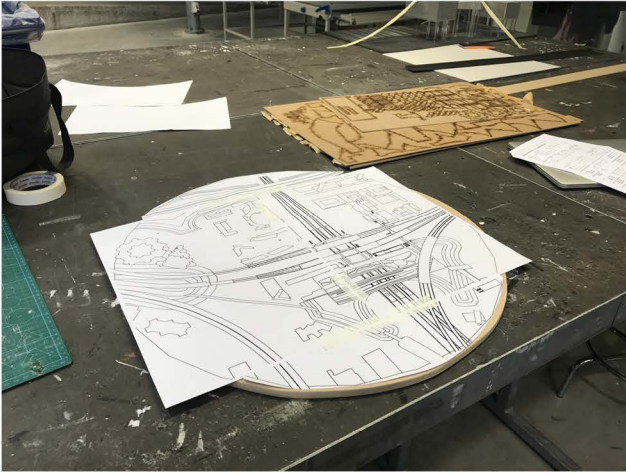

Photo 1; modelmaking. (Own source)



Photo 2; modelmaking. (Own source)

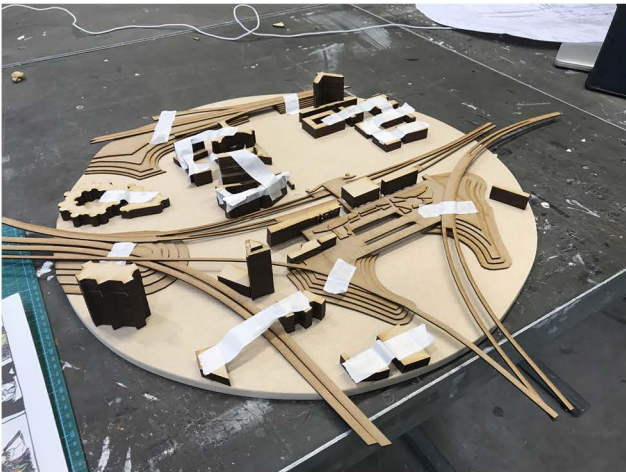

Photo 3; modelmaking. (Own source)



Photo 4; modelmaking. (Own source)



Photo 5; modelmaking. (Own source)



Photo 6; modelmaking. (Own source)

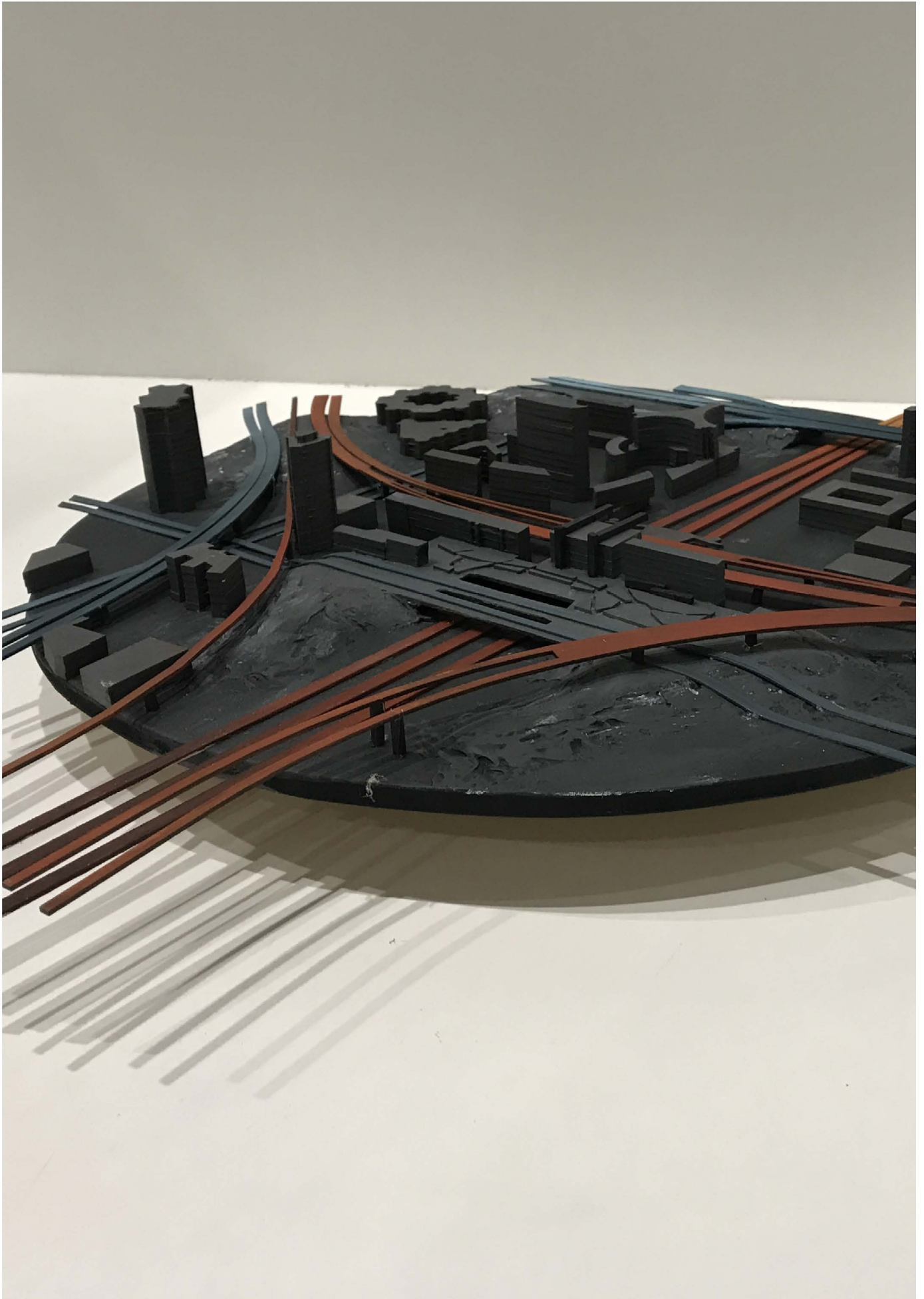
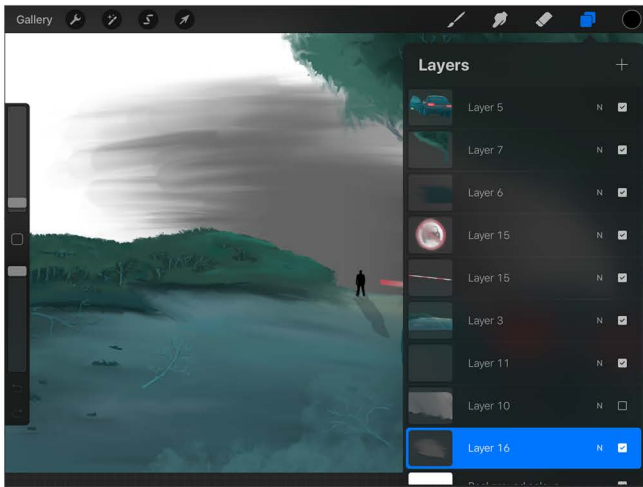
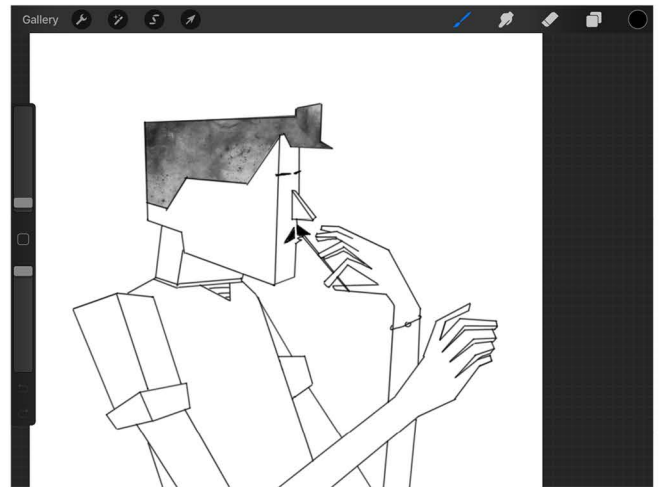

Photo 7; modelmaking (Own source)

B4: Booklet sketches



Booklet sketch 1. (Own source)



Booklet sketch 2. (Own source)

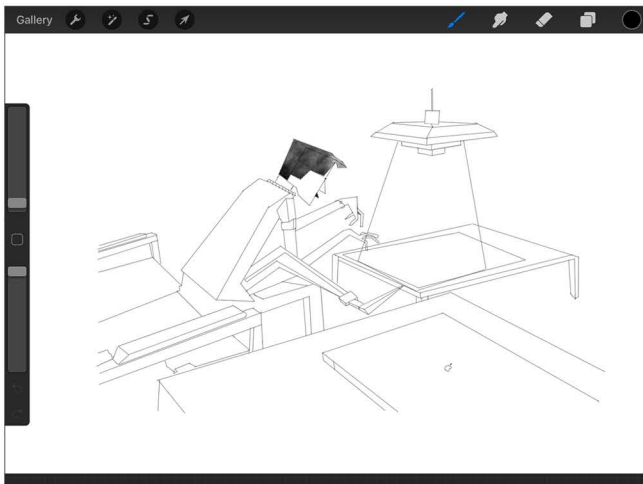

Booklet sketch 3. (Own source)

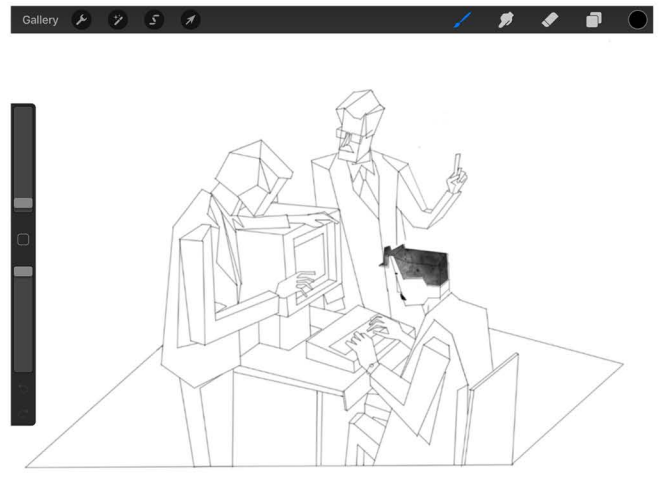

Booklet sketch 4. (Own source)

B5: Conceptual shape analysis

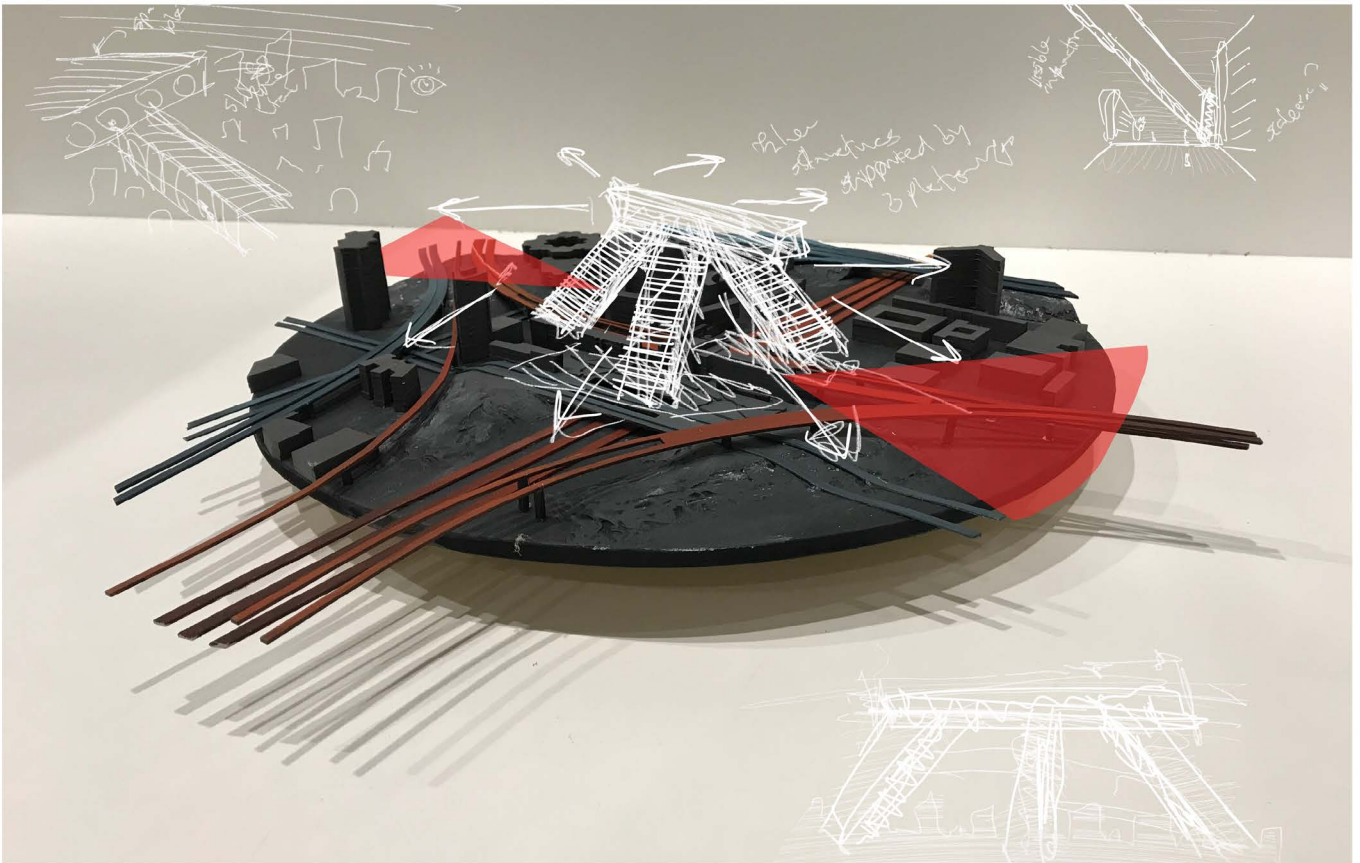

Conceptual shape analysis 1: The stubborn (Own source)

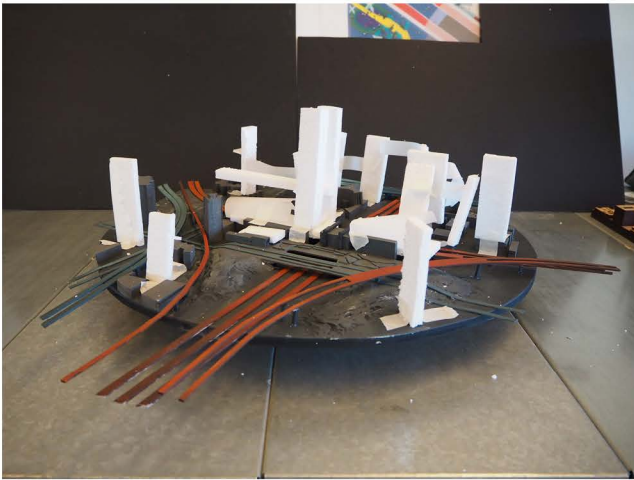

Conceptual shape analysis 2: The rational (Own source)

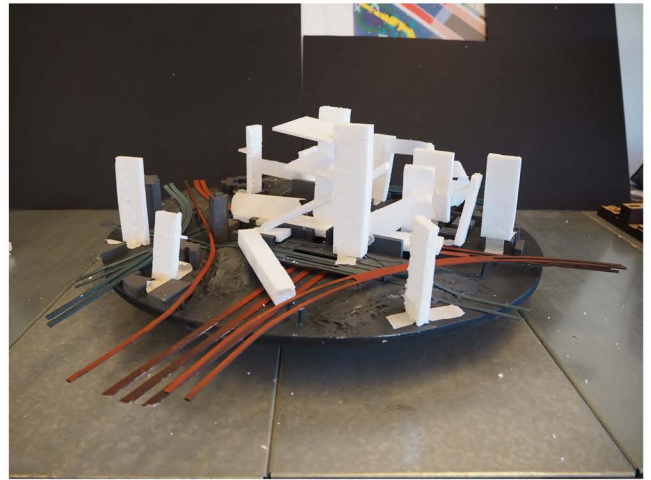

Conceptual shape analysis 2: The stacked (Own source)

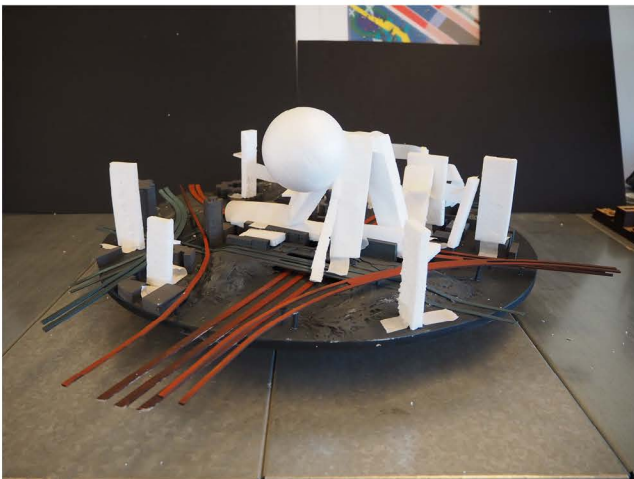

Conceptual shape analysis 3: The progressive (Own source)

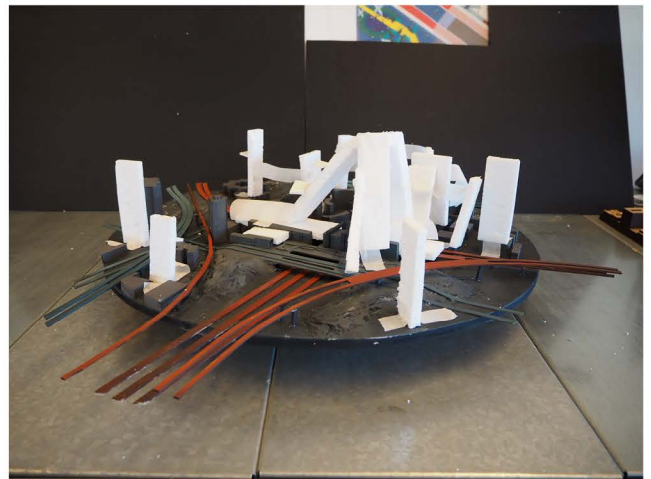

Conceptual shape analysis 3: The modest (Own source)

## Chapter B - The appendices

### B6: Small contribution City of the Future publication



Small contribution in the published BNA City of the Future book; Solving the mobility issue in Amsterdam, MSc 2.  
(Own source)

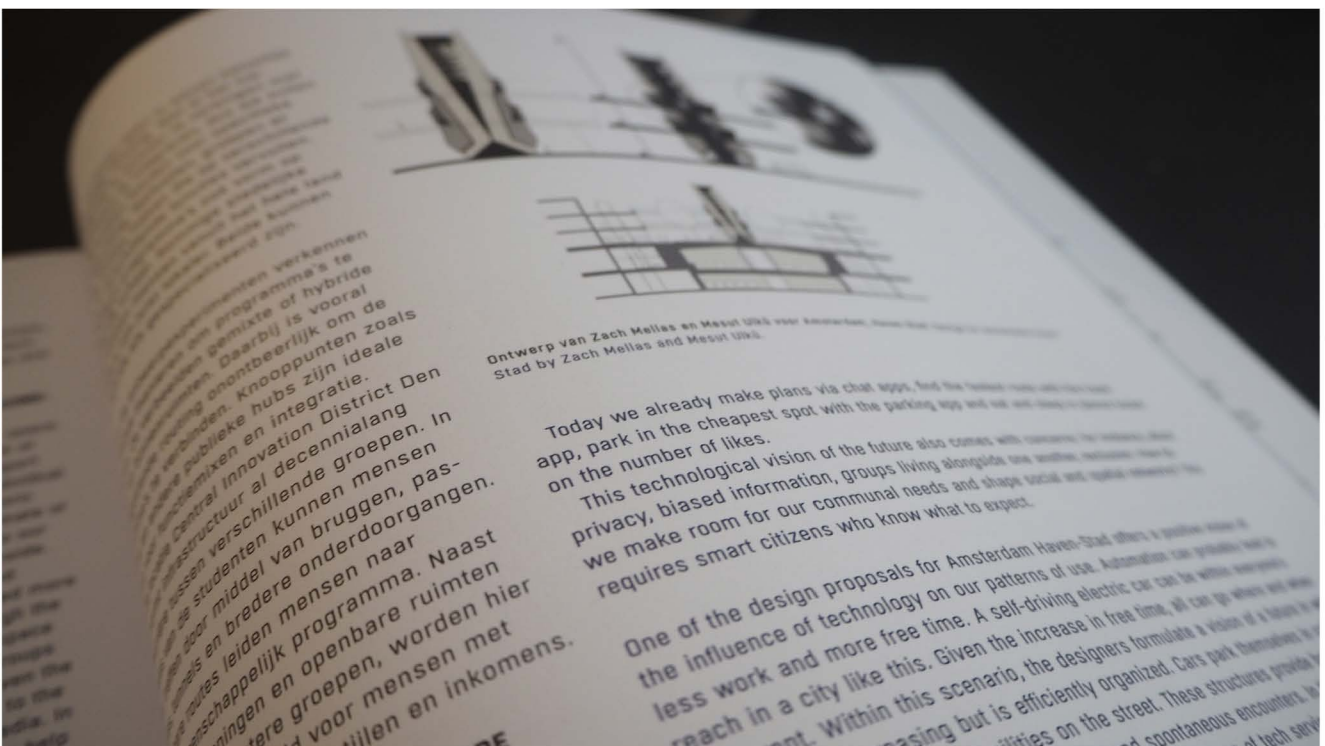

Small contribution in the published BNA City of the Future book; Solving the mobility issue in Amsterdam, MSc 2.  
(Own source)

B7: Design sketches

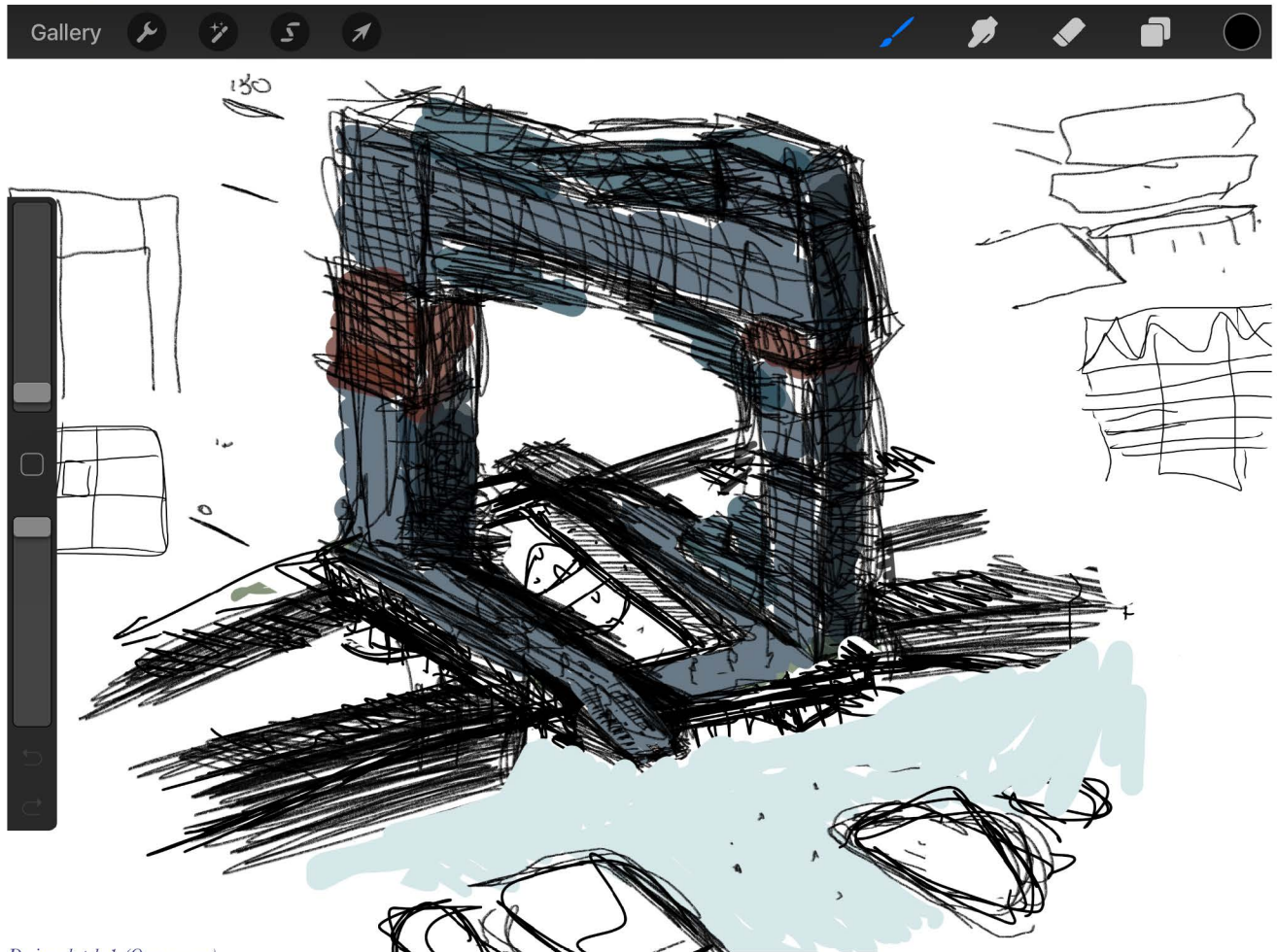

Design sketch 1 (Own source)

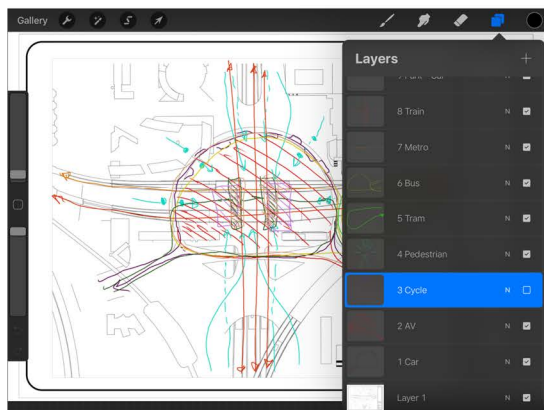

Design sketch 2: Total of 9 kinds of road users (Own source)

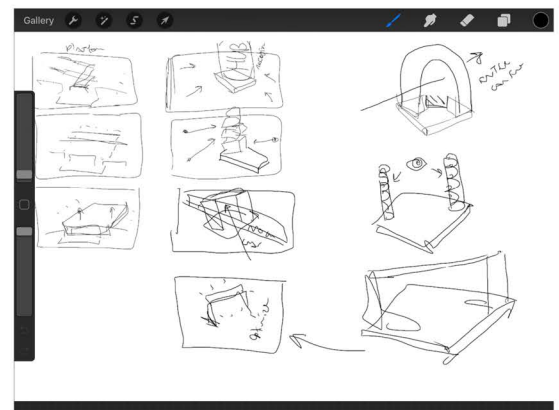

Design sketch 3: Diagrams (Own source)



Design sketch 4: Impression building with people and cars (Own source)

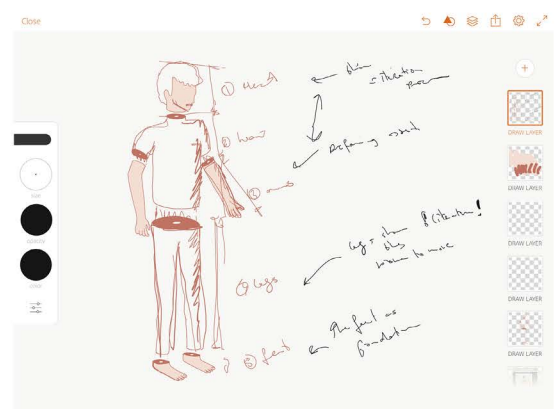

Design sketch 5: Research by design visualisation concept (Own source)















H U M A M