

The Intelligent Built-Environment as Cyber-Physical System

Liu Cheng, Alexander

DOI

[10.7480/abe.2023.24](https://doi.org/10.7480/abe.2023.24)

Publication date

2023

Document Version

Final published version

Citation (APA)

Liu Cheng, A. (2023). *The Intelligent Built-Environment as Cyber-Physical System*. [Dissertation (TU Delft), Delft University of Technology]. A+BE | Architecture and the Built Environment.
<https://doi.org/10.7480/abe.2023.24>

Important note

To cite this publication, please use the final published version (if applicable).
Please check the document version above.

Copyright

Other than for strictly personal use, it is not permitted to download, forward or distribute the text or part of it, without the consent of the author(s) and/or copyright holder(s), unless the work is under an open content license such as Creative Commons.

Takedown policy

Please contact us and provide details if you believe this document breaches copyrights.
We will remove access to the work immediately and investigate your claim.

The Intelligent Built-Environment as Cyber-Physical System

Alexander Liu Cheng



23#24

Design | Sirene Ontwerpers, Véro Crickx

Keywords | Intelligent Built-Environment, Ambient Intelligence, Ambient Assisted Living, Active and Assisted Living, Cyber-Physical Systems, Interactive Architecture, Adaptive Architecture

ISBN 978-94-6366-791-3

ISSN 2212-3202

© 2023 Alexander Liu Cheng

This dissertation is open access at <https://doi.org/10.7480/abe.2023.24>

Attribution 4.0 International (CC BY 4.0)

This is a human-readable summary of (and not a substitute for) the license that you'll find at:
<https://creativecommons.org/licenses/by/4.0/>

You are free to:

Share — copy and redistribute the material in any medium or format

Adapt — remix, transform, and build upon the material

for any purpose, even commercially.

This license is acceptable for Free Cultural Works.

The licensor cannot revoke these freedoms as long as you follow the license terms.

Under the following terms:

Attribution — You must give appropriate credit, provide a link to the license, and indicate if changes were made. You may do so in any reasonable manner, but not in any way that suggests the licensor endorses you or your use.

Unless otherwise specified, all the photographs in this thesis were taken by the author. For the use of illustrations effort has been made to ask permission for the legal owners as far as possible. We apologize for those cases in which we did not succeed. These legal owners are kindly requested to contact the author.

The Intelligent Built-Environment as Cyber-Physical System

Dissertation

for the purpose of obtaining the degree of doctor
at Delft University of Technology
by the authority of the Rector Magnificus, prof.dr.ir. T.H.J.J. van der Hagen
chair of the Board for Doctorates
to be defended publicly on
Friday 22 December 2023 at 12:30 o'clock

by

Alexander LIU CHENG
Master of Science in Advanced Construction and Building Technology,
Technical University of Munich, Germany
born in Quito, Ecuador

This dissertation has been approved by the promotor.

Composition of the doctoral committee:

Rector Magnificus,
Prof.dr. E. Eisemann

chairperson
Delft University of Technology, promotor

Independent members:

Prof.dr.ir. F.A. Kuipers,
Prof.dr.-ing. U. Pottgiesser,
Prof.dr. I. Iordanova,
Prof.dr. D. Ahn,

Dr. A. Ogawa,

Delft University of Technology
Delft University of Technology
Université du Québec, Canada
The City University of New York,
United States of America
Keio University, Japan

אל־תְּהִי צְדִיק הַרְבֵּה וְאַל־תִּתְחַכֵּם יוֹתֵר לְמַעַן תִּשׁוּמָם:

קֹהֶלֶת ז טז

Acknowledgments

Contribution-based Acknowledgments

Chapter 4 and *Chapter 5* detail the development of several functional prototype environments and implementations to various scales and extents. Many developments benefitted from the generous assistance of both students, researchers, professors, and industry professionals from several universities, institutes, and companies in Brazil, Germany, Ecuador, Italy, and the Netherlands. Their contributions are acknowledged more specifically and explicitly as follows:

[Section 4.1.1](#), [Section 5.1](#)

B. C. Aldemir, J. van Lith, S. Kanters, S. van Kempen, I. Slodka, and M. Wieczorkowski, M.Sc. 2 students at *Hyperbody*¹, *Faculty of Architecture and the Built Environment, Delft University of Technology* (TUD), conceived of and developed the *transformable architecture* “Pop Up Apartment” that served as vehicle for the computational interactions described.

[Section 4.1.2](#), [Section 5.2](#)

These sections build on contributions of *Hyperbody* researchers and students involved in the described project, in particular Prof. K. Oosterhuis, B. Kemper, and D. Fischer for the physical development and photographic documentation of the *adaptive stage* showcased in the 2016 *Game Set Match #3* symposium.

[Section 4.1.3](#), [Section 5.3](#)

These sections have profited from the contributions of *Robotic Building* (RB), TUD, researchers, tutors, and students—in particular, C. Du, J. Duan, and F. van Buren, for the conceptual development of a student housing unit as well as its corresponding real-scale fragment and concomitant illustrations.

¹ *Hyperbody* [13] was a research group led by Prof. *emeritus* Kas Oosterhuis from its inception in 2000 until his retirement in 2017.

Section 4.1.4, Section 5.4

These sections build on the contributions of RB, TUD, and *Dessau Institute of Architecture* researchers, tutors, and students—in particular, M. Moharram, H. Hesham, and M. Elmeligy, who developed the student-housing unit as well as its corresponding real-scale fragment and concomitant illustrations.

Section 5.5

An initial implementation of the work detailed in this section was carried out at the *Design-to-Robotic-Operation* workshop at the 2018 *Hiperorgânicos 8 Symposium* [14], [15] in Rio de Janeiro, Brazil. Accordingly, I acknowledge the supporting advice of Dr. H. Bier, Director of RB TUD; and the contributions of M. Sabino, R. Weissenberg, and E. Migueles, members of the *Museum of Tomorrow Laboratory*.

Section 5.6

I acknowledge the assistance that the following people provided during the implementation and trials of the detailed mechanism: S. A. Cevallos, N. B. Solano, and J. G. Díaz.

Section 5.7.1

P. Ordoñez, J. Padilla, P. Romero, A. Toapanta, and A. Villamar, undergraduate students of the *Facultad de Arquitectura y Urbanismo, Universidad Tecnológica Equinoccial* in Quito, Ecuador, assisted with the building of the physical skin-fragments shown in Figure 5.20.

Section 5.7.2

Dr. P. Cruz, Professor at the *Facultad de Ingeniería Eléctrica y Electrónica (FIEE), Escuela Politécnica Nacional (EPN)* in Quito, Ecuador, for his comments and observations with respect to the implementation described.

Section 5.8

This section has benefitted from discussions with RB, TUD researchers, tutors, and students as well as from industry professionals in Quito, Ecuador. More specifically, F. Cevallos and J. Jarrín of *Estudio 685* as well as students (1) V. Monar and J. Galarza, for their assistance in the implementation of the facial identification and expression recognition mechanism; and (2) S. Alvares, G. Herrera, E. Quito, and H. Solís for their assistance in the implementation of the functional building-skin fragment.

Section 5.10

I acknowledge the assistance of the following undergraduate students from FIEE as well as *Facultad de Ingeniería Mecánica* (FIM) at EPN: B. Ayala, J. Balseca, D. Chávez, J. Correa, D. Córdoba, E. Cúñez, A. Herrera, D. Leines, J. Mateus, K. Morejón, F. Poveda, A. Quishpe, J. Quiñónez, B. Sagnay, G. Valencia, S. Vázquez. Moreover, I acknowledge the support by Dr. J. Abad and Ivan Chico, Professors at FIEE, EPN; V. Hidalgo, Professor at FIM, EPN; and N. Carchipulla, Professor at *Facultad de Arquitectura e Ingenierías* (FAI), *Universidad Internacional SEK* (UISEK). Finally, especial thanks to J. Jarrín and F. Cevallos at *Estudio 685* as well as D. Bermeo at FAI, UISEK, for their assistance in coordination and production. Part of the work detailed in this section was made possible by funding provided by EPN's Project *PVS-2018-032* and *PVS-2018-038* as well as UISEK's Project *P111819*.

Section 5.11

C. Amaguaña, J. Balseca, and D. Cabascango, undergraduate students of the FIEE, EPN assisted in the assembly of the physical implementation described. Part of the work detailed was made possible by funding from UISEK's Project No. P111819.

Section 5.12

A. Duarte, D. Duque, J. C. Montero, S. Sangurima, M.Sc. students at FAI, UISEK, contributed to the implementation of the prototypes. Also, I acknowledge J. Balseca, an undergraduate student at FIEE, EPN, who assisted in the test-run programming at initial stages but whose program was not used in the present implementation.

Note

While the article [16] we published and that won *Best Robotics and Automation Systems Paper Award*² was not used *per se* in this thesis, I would still like to acknowledge C. Follini, G. Latorre, and L. Freire for an inspiring collaboration. While C. Follini's light-weight robotic-gripper extends beyond the theme of the present work, the *Voice Identification / Authentication and Control* mechanism developed with G. Latorre and L. Freire was integrated in the solution detailed in *Section 5.10*.

Finally, the icons used to represent the defined parameters in Section 3.2 are from Google's *Material Symbols*³.

² <https://research.tudelft.nl/en/prizes/best-robotics-and-automation-systems-paper-award>

³ <https://fonts.google.com/icons> (CC BY 4.0)

General Acknowledgments

The Talmudic Sage Abbaye interpreted Isaiah 30:18⁴ to mean: “*Blessed are all who wait, [the] 36.*”⁵ That is, blessed are all those who wait for the שכינה, the presence of השם, the צדיקים—*the 36 righteous*—on account of whom (though unbeknownst to them) the world is preserved. While I cannot harbor certainty that the following individuals belong to this group, I incline towards uncertainty that they do not.

Elmar

Your willingness to invest time and effort on my work, with perspicacity, sagacity, and punctiliousness, not only speaks of your commitment to academic excellence but—perhaps more fundamentally—of your generosity. Thank you.

Kas

Your vision—*Hyperbody*—remains an inspiration. Thank you for your support, especially in times of doubt.

Ami, David, Fernando, Ivanka, and Uta

One would be hard-pressed to find a more attentive and affable committee of independent evaluators across *Architecture, Computer Science, and System Design Engineering*. Thank you for enriching the process with your time and expertise.

Keith and Holger

I am grateful for the critical and thoughtful feedback you provided me with during and after my *Go / No Go* evaluation in 2017. Your insights persisted throughout.

Artëm

« ... monegum mægþum, meodosetla ofteah, egsode eorlas. Syððan ærest wearð feascaft funden, he þæs frofre gebad, weox under wolcnum, weorðmyndum þah, oðþæt him æghwylc þara ymbsittendra ofer hronrade hyran scolde, gomban gyldan. þæt wæs god cyning. »⁶

Nathanael

« מְכַלְמֵלֵאכְתּוֹ אֲשֶׁר־בְּרָא אֱלֹהִים לַעֲשׂוֹת: »⁷

4 וְלָכֵן יִתְבַּר יְהוָה לְחַנּוּנֵיכֶם וְלָגוֹן יְרוּם לְרַחֲמֵיכֶם כִּי־אֵלֹהֵי מִשְׁפָּט יְהוָה אֲשֶׁר־יְכַלֵּיחֹבֵי לֹא:

5 *Guggenheimer* 45b:15-18. See also *Sanhedrin* 97b, *Sukkah* 45b.

6 *Beowulf*, lines 5-11; emphasis mine.

7 בְּרֵאשִׁית ב'ג'

Florencia

« ek hefi hjarta / hart í brjósti, / síz mér í æsku / Óðinn framði. »⁸

Οὐδείς

« Haec cum femineo constitit in choro, / unius facies praenitet omnibus. / Sic cum sole perit sidereus decor, / et densi latitant Pleiadam greges, / cum Phoebe solidum lumine non suo / orbem, circuitis cornibus, alligat. »⁹

Camilla, Екатерина, Eloisa, Gabriela, Jonathan, Катя & Λεω, Laura, Luis, and Marcia

The Kiowa tribe were known as the fiercest of Plains warriors. They had vanquished more foe per capita than any other North American tribe. Among this furious clan there were only ten deemed worthy of being part of the *Ka-itsenko*, the “Real Dogs”. Each *Real Dog* owned a sash and a sacred arrow. In battle, he would nail his sash to the earth with his arrow and stand his ground until victory or death¹⁰. Your resilience and tenacity in adversity render you, in my eyes, *Real Dogs*.

Richard

Your instruction and friendship planted in me a love for all things *programming*. Your *recommendation letter* opened doors that have led me to this felicitous point. You have been instrumental—yet what is remarkable is that in spite of your academic impact, it is your humanity that stands salient.

Jerzy

Your encouragement and support of my forays into computational design, however outlandish, enabled me to pursue serious inquiries into the role of computation in conceptualizing the built-environment. This made the rest possible.

Inge and Paul

I cannot thank you enough for your brilliant and patient assistance. You consistently supported me with kindness, integrity, and forbearance. Thank you.

Alex

Quito, November 2023

⁸ A. Le Roy Andrews, Ed., “15,” in *Hálfs saga ok Hálfsrekka*. Halle: Verlag von Max Niemeyer, 1909, p. 119.

⁹ Seneca, *Medea*, Act I, Scene ii, lines 93-98.

¹⁰ W. Davis. *One River: Explorations and Discoveries in the Amazon Rain Forest*. New York, NY: Touchstone, 1997, p. 79.

Contents

Acknowledgments	7
List of Tables	17
List of Figures	18
List of Abbreviations	23
Summary	25
Samenvatting	29

1 Introduction 33

1.1 Background 36

2 State of the Art 39

- 2.1 **Two main branches within the Intelligent Built-Environment discourse** 40
 - 2.1.1 The Architectural branch: Interactive Architecture (IA) and Adaptive Architecture (AA) 42
 - 2.1.2 The Information and Communication Technologies (ICTs) Technical branch: Ambient Intelligence (AmI) and Active and Assisted Living (AAL) 45
- 2.2 **The problem with force-merging branches** 47

3 Theory and Concept 51

- 3.1 **The Intelligent Built-Environment as Cyber-Physical System (CPS)** 52
- 3.2 **Defining Parameters** 54
 - 3.2.1 Indoor Environmental Quality (IEQ) 54
 - 3.2.2 Quality of Life (QoL) 57
- 3.3 **Enabling Technologies** 58
 - 3.3.1 Cyber-Physical Systems (CPSs) 59
 - 3.3.2 Wireless Sensor and Actuator Networks (WSANs / WSNs) 64
 - 3.3.3 Body Area Networks (BANs) 68

3.4	A System Architecture	72
3.4.1	1 st subsystem: Underlying Mechanism, Local system	75
3.4.2	2 nd subsystem: Wearable devices	76
3.4.3	3 rd subsystem: Remote / Cloud Services	77
3.4.4	4 th subsystem: Ad hoc Support devices	77
<hr/>		
4	Demonstrator Environments	79
<hr/>		
4.1	Physical / Tangible / Descript—or Architecture-specific	80
4.1.1	Hyperbody: Transformable Architecture (fragment)	81
4.1.2	Hyperbody: Protospace 4.0 (fragment)	83
4.1.3	Robotic Building: Intelligent Architectural Components (fragment)	85
4.1.4	Robotic Building: Student housing (fragment)	86
4.2	Virtual / Intangible / Non-descript—or Architecture-agnostic	89
4.2.1	The Virtual as placeholder Digital Twin	89
4.2.2	The Non-Descript Environment as indicative of Architecture-independence	90
<hr/>		
5	Demonstrators	91
<hr/>		
5.1	An Extended Ambient Intelligence Implementation for Enhanced Human-Space Interaction	94
5.1.1	Three sensor scenarios	96
5.2	A High-Resolution Intelligence Implementation and its extension based on Design-to-Robotic-Production and -Operation (D2RP&O) strategies	99
5.2.1	1 st development: non-proprietary Human Activity Recognition (HAR)	102
5.2.2	2 nd development: ventilation, voice-control, and notifications	110
5.3	Integration of a Wearable Interface in a Design-to-Robotic-Production and -Operation (D2RP&O) Development	120
5.3.1	Bluetooth Low Energy (BLE) Wearable node	123
5.4	Deep Learning Object-Recognition in a Design-to-Robotic-Production and -Operation (D2RP&O) Implementation	130
5.4.1	Object-Recognition via Deep Learning / Convolutional Neural Networks as a visual component of Design-to-Robotic-Operation (D2RO)	132
5.4.2	Human- and object-centered scenarios	134

5.5	Development of a Smart Sleeve Control Mechanism for Active Assisted Living	138
5.5.1	BAN and WSN aspects	143
5.5.2	Actions: slide a window, swing a door, and regulate the intensity of a light-source	144
5.6	Development of a Light-Tracking and -Redirecting System Actuated by Hand-Gesture Recognition	148
5.6.1	Light-tracking Modules and system	152
5.6.2	Hand-Gesture Recognition Mechanism	154
5.7	Adaptive Building-Skin (Façade / Envelope) Components as Context-Aware Nodes in an Extended Cyber-Physical Network	157
5.7.1	1 st Prototype: Single-layered System	158
5.7.2	2 nd Prototype: Multi-layered System	167
5.8	Actuation Confirmation and Negation via Facial-Identity and -Expression Recognition	178
5.8.1	1 st scenario: Enhancing the precision and sensitivity of an Adaptive and Context-Aware Building-Skin System	182
5.8.2	2 nd scenario: Enhancing the precision and sensitivity of a Fall Detection and Intervention System	186
5.9	Development of an Eye- and Gaze-Tracking Mechanism in an Active and Assisted Living Ecosystem	188
5.9.1	Eye- and Gaze-Tracking for Object Actuation	194
5.9.2	Eye- and Gaze-Tracking for Human Identity Recognition	197
5.10	Development of An Adaptive Staircase System Actuated by Facial-, Object-, and Voice-Recognition	199
5.10.1	Computational component	202
5.10.2	Mechanical component	204
5.10.3	1 st staircase variation (conceptual details)	206
5.10.4	2 nd staircase variation (conceptual details)	208
5.11	Development of an Acoustically Adaptive Modular System for Near Real-Time Clarity-Enhancement	210
5.11.1	Parametric Setup	213
5.11.2	Physical / Mechanical Component: Acoustically Adaptive Modules	218
5.11.3	Computational Component: Evolutionary Solver	221

- 5.12 **Development of an Adaptive Rainwater-Harvesting System for Intelligent Selective Redistribution** [227](#)
- 5.12.1 **Cyber-Physical Setup** [234](#)

6 **Conclusions** [239](#)

- 6.1 **Overview and Outlook** [240](#)
- 6.2 **Limitations** [244](#)

- Appendix [247](#)
- Bibliography [257](#)
- Curriculum Vitae [269](#)
- List of Publications [273](#)

List of Tables

- 2.1 Characteristics of the ICTs vs. Architectural Branch with respect to Intelligent Built-Environments. [40](#)
- 2.2 Overview and Background of Interactive Architecture (table reproduced verbatim from [55]). [42](#)
- 2.3 Overview of basic components and technologies in the area of Ambient Assisted Living (AAL) (table reformatted and reproduced from Figure 3.1 in [84]). [46](#)
- 3.1 A [general] qualitative comparison of MANET, WSN, and CPS (table reproduced from [120]). [63](#)
- 3.2 Differences between WBANs and WSNs (table reproduced from [139]). [69](#)
- 5.1 Demonstrator implementations in relation to (1) Environment (Physical / Virtual) and (2) informing IEQ and QoL parameters (see Section 3.2). IEQ, left-to-right: Thermal Comfort, Interior Air-Quality, Sound / Acoustics, and Light / Illumination. QoL, left-to-right: Health, Independence, Safety / Security, and Activity. [93](#)
- 5.2 Demonstrator 1's summary—environment, parameters, interactions, key results, purpose, and pertinence. [94](#)
- 5.3 Demonstrator 2's summary—environment, parameters, interactions, key results, purpose, and pertinence. [99](#)
- 5.4 Demonstrator 3's summary—environment, parameters, interactions, key results, purpose, and pertinence. [120](#)
- 5.5 Demonstrator 4's summary—environment, parameters, interactions, key results, purpose, and pertinence. [130](#)
- 5.6 Demonstrator 5's summary—environment, parameters, interactions, key results, purpose, and pertinence. [138](#)
- 5.7 Demonstrator 6's summary—environment, parameters, interactions, key results, purpose, and pertinence. [148](#)
- 5.8 Demonstrator 7's summary—environment, parameters, interactions, key results, purpose, and pertinence. [157](#)
- 5.9 Demonstrator 8's summary—environment, parameters, interactions, key results, purpose, and pertinence. [178](#)
- 5.10 Demonstrator 9's summary—environment, parameters, interactions, key results, purpose, and pertinence. [188](#)
- 5.11 Demonstrator 10's summary—environment, parameters, interactions, key results, purpose, and pertinence. [199](#)
- 5.12 Demonstrator 11's summary—environment, parameters, interactions, key results, purpose, and pertinence. [210](#)
- 5.13 Absorption Coefficients (% energy absorbed)—from Pachyderm [256] Material Library. [221](#)
- 5.14 Sample module configurations and resulting C_{50} values and sum averages. [225](#)
- 5.15 Demonstrator 12's summary—environment, parameters, interactions, key results, purpose, and pertinence. [227](#)

List of Figures

- 2.1 Situating the discourse in the Architectural Design Process. 41
- 2.2 Abstraction of overlaps between the ICTs Technical branch and the Architectural branch. 50
- 3.1 How the proposed approach relates to the Architectural Design Process. 53
- 3.2 Figure 5 in Riffelli's Thermal, Indoor Air Comfort (IAQ), Acoustic, and Visual "Percentage weightings in the reviewed research studies" [109] (CC BY 4.0). 55
- 3.3 Cyber-Physical Systems—a Concept Map (figure redrawn from [112]²⁸). 59
- 3.4 The five fundamental WSN technologies which are the bases in CPS designs (figure redrawn from [123]³⁴). 62
- 3.5 Wireless communication standards and their characteristics (figure redrawn from [125], [127]). 64
- 3.6 *Top*: Typical sensing node (figure redrawn from [128]). *Middle*: Structure of a typical Wireless Sensor Network (figure redrawn from [125], [129], [130]). *Bottom*: Typical WSN arrangement (figure redrawn from [128]). 66
- 3.7 Variety of WSN applications (figure redrawn from [125]). 67
- 3.8 *Left*: Typical placement of BAN nodes (figure redrawn from [137]). *Right*: Example of patient-monitoring in a WBAN (figure redrawn from [138]). 68
- 3.9 Various applications of WBASNs (figure redrawn from [139]). 71
- 3.10 BAN node, Generic Architecture (figure redrawn from [137]). 71
- 3.11 Four main subsystems in core System Architecture: *Local System*; *Wearables Subsystem*; *Remote / Cloud Services Subsystem*; and *Ad Hoc Support Subsystem*. 74
- 4.1 Reconfigurable apartment developed with MSc 2 students—B. C. Aldemir, J. van Lith, S. Kanters, S. van Kempen, I. Slodka, and M. Wieczorkowski—and industry partners at Hyperbody, TU Delft (Pop-up Apartment, 2013)[97]. 81
- 4.2 Protospace 4.0, fragment built for GSM3 [161]. 83
- 4.3 *Top*: Single protoCELLs (*Left*); testing Perspex® over LED1 (*Right*). *Bottom*: Generated color gradient (*Left*); Acrylic connections & two LED-strips within the seam of two protoCELLs (*Right*). 84
- 4.4 Robotically fabricated components via material subtraction in D2RP. *Left-to-Right*: Single-layer physical prototype, (1) front-view and (2) side-view; Virtual 3D model, (3) single-layer side-view and (4) double-layer (inner and outer) side-view. Concept by C. Du, J. Duan, and F. van Buren [166]. 85
- 4.5 Schematic design of student housing by M. Moharram, H. Hesham, and M. Elmeligy [164]. 86
- 4.6 Sets of point-clouds corresponding to different types of information. 87
- 4.7 *Left*: Real-scale fragment's multi-layered fabrication / integration logic. Robotically fabricated concrete (*Center*) and EPS (*Right*) fragments. 88

- 5.1 Runtime processes, clustered distribution. 103
- 5.2 *Left-Top*: OSC-data receiving and parsing. *Left-Bottom*: 95.7% prediction success with respect to HAR via SVM (*Left*) vs. 97.85% via k-NN (*Right*). *Right*: Sample MATLAB™-generated ML models with corresponding success rate. 105
- 5.3 Images (1) 3D model with lights off; (2) Pulsating; (3) Activation of discrete components; (4) Leaving a trace; (5) Manual override; (6) individual activity detection correlated with color. 107
- 5.4 *Left*: iOS OSC Applications: TouchOSC (proprietary). *Right*: iOS OSC Applications: Control (open-source). 108
- 5.5 *Top*: Typical node: (1) Air-quality sensors: MQ-3 Alcohol or MQ-4 Methane or MQ-7 Carbon Monoxide or MQ-8 Hydrogen Gas; (2) Temp. & Hum. sensor; (3) USB Mic.; (4) Keyboard / Mouse (only necessary for config.); (5) Speaker; and (6) HDMI Monitor (optional). *Bottom*: Activation of ventilation fans in relation to temperature and relative humidity comfort thresholds (shaded). 111
- 5.6 *Top*: Java Client service initialization. *Bottom*: AVS Java Client interface initialization. 113
- 5.7 *Left*: SMS via Wi-Fi (Twilio®). *Right*: SMS via Siemens T35 GSM module. 114
- 5.8 Runtime decision-tree. 119
- 5.9 BLE Wearable Node as WSN / BAN, Features. 124
- 5.10 Gathered data plotted in real-time in Plotly®. 127
- 5.11 Multiple-object detection via BerryNet®: 'person', 'cup'. 133
- 5.12 Robotic intervention based on object-centered events. *Top*: Rover sent to the location of detected object (circled in red). *Bottom*: Abstracted robotic vision on the rover. 136
- 5.13 System diagram and *Smart Sleeve* description 140
- 5.14 Pointing (*Top*), selecting (*Middle*), and moving (*Bottom*) sliding window. 145
- 5.15 Pointing (*Top*), selecting (*Middle*), and swinging (*Bottom*) hinged door. 146
- 5.16 Pointing and selecting (*Top*), decreasing intensity (*Middle, gesture left*), and increasing intensity (*Bottom, gesture right*) of central illumination device. 147
- 5.17 *Top*: cluster of three nodes. *Second-image-to-bottom*: mirror surface's vertical rotation sequence. 150
- 5.18 *Left-to-Right*: (1) Initial position of light-tracking module; (2) Vertical adaptation of module; (3) Module turning right; (4) Module turning left. 152
- 5.19 *Left-to-Right*: Gesture 1: System Initialization. *Top-right*: Gesture 2: Draw light towards the location of hand-gesture. *Bottom-left*: Gesture 3: Redirect light away from hand-gesture. *Bottom-right*: Gesture 4: System is turned off. 154
- 5.20 *Top*: Components 1-3, skin fragment A (fully open). *Middle*: Components 4-6, skin fragment B (fully shut). *Bottom*: Skin fragment perspective (with differing degrees of component openness). 159
- 5.21 System Architecture (excluding inherited WSN components[153]). 161
- 5.22 *Top*: Components 1-3, Skin fragment A, Light intensity (normalized—0=lower-bound sensor threshold; 1=upper-bound threshold). *Bottom*: Components 4-6, Skin fragment B, Light intensity (normalized). 162

- 5.23 *Top*: Components 4-6, Skin fragment B: Aperture extent (normalized) influenced by interior temperature sensor (equidistant between fragment A and B). Dotted lines: normal (uninfluenced) extent. Solid lines and fill: resulting deviations entailed by temperature fluctuations. *Bottom*: Components 4-6, Skin fragment B: Aperture extent (normalized) influenced by interior temperature sensor (positioned next to fragment B). Dotted lines: normal (uninfluenced) extent. Solid lines and fill: resulting deviations entailed by temperature fluctuations. 164
- 5.24 Components 1-3, Skin fragment A: Aperture extent (normalized) influenced by water sensor (installed in Component 1). Dotted lines: normal (uninfluenced) extent. Solid lines and fill: resulting deviations entailed by detected water. 165
- 5.25 Implementation of sample building-skin fragment, six components. The shading-membrane (in white) is removed from half of the components to show the second actuatable layer below. 168
- 5.26 *Top-Left*: sequence of first-layer aperture (85°, 45°, 0° rotation). *Bottom-Left*: three-module fragment perspective, with first-layer skin removed in two modules to indicate component structure. *Right*: second-layer acrylic panel, 90° rotation (fully opened, axis of rotation in blue). 170
- 5.27 *Top-Left*: user location-specific illumination readings, gauged via a smart-phone held by the user (via OSC, oscHook). *Top-Right*: 2nd new operation mechanism, local assignment of approximate desired-aperture values via Gravity (Gyroscope and Accelerometer derived) data streamed to building-skin system (via OSC, oscHook). *Bottom-Left*: 1st new operation mechanism, local assignment of specific desired-aperture values via slider-based control-override (via OSC, Osc Controller). *Bottom-Right*: 3rd new operation mechanism, remote assignment of specific desired-aperture values in specific building-skin components (identified via keypad) via web-based slider. Moreover, "Off" / "On" web-based buttons enable remote shutdown and activation (both slider and buttons via MQTT, Adafruit IO). 171
- 5.28 *Top*: Exploded isometric description of the first-layer, to regulate illumination. *Middle*: second-layer, to regulate ventilation. *Bottom*: supporting structure. 173
- 5.29 System Architecture. (1) Smart-device with *oscHook* and *Osc Controller* (see Figure 5.27). (2) building-skin fragment composed of six components. (3) Local and built-environment-embedded MCUs, part of the larger WSN ecosystem. (4) Cloud- / Web-services for remote user override. 177
- 5.30 *Left*: real-time Facial Recognition. *Right*: TensorFlow™'s rudimentary "Positive" or "Negative" facial-expression recognition. 181
- 5.31 *Top*: Building-skin fragment reacting differently to agents A and B. *Bottom*: States of module with respect to agents A (fully open) and B (fully closed). 182
- 5.32 New adaptive building-skin module concept; items 1: MDF base, with integration of servo motors and an affordable Raspberry Pi Camera Module V2; 2: MDF pivoting arms; 3: Opaque acrylic sheets. Possible configurations A: Fully extended, closed; B: Semi-open, variation I; C: Semi-open, variation II; D: Semi-open, hybrid of variations I and II; E: Fully retracted, open. 184
- 5.33 *Top Row*: Cloud Vision API's predictions with respect to user B's expressions. *Bottom Row*: instances of equivocation when glasses are worn. 186
- 5.34 Concept and System Architecture of the Eye- and Gaze-Tracking Mechanism. 190
- 5.35 *Top*: Captured-gaze of generic sample built-environment. *Bottom*: Object-boundaries overlaid on top of objects represented. Both generated with PyGame. 191
- 5.36 Pupil detected on object Sofa, with no available actuations. 194
- 5.37 *Top-to-Bottom*: Pupil on object Window (green target/text); Wall-Art (yellow target/text); and Wall-Light (green target/text). 195

- 5.38 Recognition of a familiar face and corresponding output of associated information pertaining to the identified person.⁶¹ 197
- 5.39 Three sample faces used to associate identity with user-type and to enable facial-recognition and corresponding system-actuation. 202
- 5.40 VoiceIt Authentication Success in close-range, as developed elsewhere [16]. 203
- 5.41 *Top-to-Bottom*: variation 1 configured for the 1st user-type (standard-stairs); the 2nd user-type (easy-stairs); and the 3rd user-type (elevating platform). 204
- 5.42 Variation 2 configured for (*Top* and *Middle*) the 1st user-type (standard-stairs); and (*Bottom*) the 3rd user-type (elevating platform). 205
- 5.43 Staircase variation 1 reacting to (1) the first user-type (tread depth: 30 cm; riser height: 17 cm); (2) the second user-type (tread: 42 cm; riser: 8.5 cm); and (3) the third user-type (steps are retracted to enable platform elevation). 207
- 5.44 Staircase variation 2 reacting to (1) the first user-type (with standards-compliant tread-vs.-riser dimensions and proportions); (2) the second user-type—or to users with a variety of disabilities in state of rehabilitation; and (3) the third user-type (the landing platform elevates). 208
- 5.45 Sample arrangement of six acoustically adaptive modules. Present configuration attains ~5.72 dB at a designated point in octave band mid-frequency of 500 Hz. Sound waves are represented in lines up to ten surface-bounces; the line colors are correlated with the sound-energy (i.e., darker to lighter equals more to less energy, respectively). 213
- 5.46 Arrangement of six acoustically adaptive modules. Present configuration attains ~5.72 dB at a designated point in octave band mid-frequency of 500 Hz. 215
- 5.47 *Top-row*: frontal isometric view. *Bottom-row*: posterior elevation view, viewing towards sound-source—N.B.: acoustic foam transparent). *Left-column*: iteration #20, with a C_{50} value of 3.8514 dB—acoustic module configurations (values in mm): A. 132; B. 159; C. 85; D. 112; E.187; F. 189 extension. *Right-column*: iteration #784, with a C_{50} value of 5.715291 dB—acoustic module configurations: A. 256; B. 230; C. 139; D. 213; E.224; F. 206 extension. Note that even small module configuration variations yield vastly different clarity values. 216
- 5.48 *Top*: Module breakdown. *Bottom*: Implemented six-module fragment breakdown. 218
- 5.49 Physical TRL-4 / 5 implementation of the six-module fragment used in laboratory tests. 220
- 5.50 Histogram of C_{50} values across 3,625 iterations generated in the present implementation. 225
- 5.51 *Top*: extension / retraction of each module with respect to each iteration. *Middle*: Corresponding C_{50} values for each genome with respect to each iteration. *Bottom*: Sum averages across all iterations. 226
- 5.52 System layers: (1) collection of rainwater; (2) 1st storage tank; (3) 2nd storage tank, measurement of Ph-levels; (4) 3rd storage tank, measurement of turbidity—if levels exceed 5 NTUs, the water is released to the main, otherwise it is passed through (5) a ceramic filter in the 4th tank (if between 3.5 – 5 NTUs), or sent directly to the (6) 5th and general collection tank (if <3.5 NTUs); (7) Outlet for all releases to the main water system; (8) 6th water tank, representing a toilet-tank; (9) if the toilet-tank is full, contained water in the 5th tank is released for irrigation. 229

- 5.53 Deployment Configurations. *Top-Left*: a single-unit system servicing a single tan. *Top-Right*: a multiple-unit system servicing a single tank. *Bottom-Left*: a single-unit system servicing multiple tanks. *Bottom-Right*: a multiple-unit system servicing multiple tanks. N.B.: ‘~’ symbol indicates location of servovalve & water-flow sensor. 231
- 5.54 System breakdown: (A) rainwater downpipe; (B) water-level switch; (C) 1st container, 1L capacity; (D) servovalve; (E) Ph sensor; (F) water-level switch; (G) 2nd container, 0.5L; (H) manual valve, representing flush-lever / -handle; (I) water-level switch, representing toilet tank-float; (J) 6th container, 5L, representing toilet-tank; (K) water-level switch; (L) turbidity sensor; (M) 3rd container, 0.5L; (N) servovalve (O) servovalve; (P) 4th container, 0.5L; (Q) ceramic filter; (R) servovalve; (S) servovalve; (T) water-level switch; (U) water-pump; (V) 5th container, 10L; water-sensor installed to measure levels; (!) overflow-outlet; (~) outlet to the main, for harmful Ph levels; (=) outlet to the main, for high turbidity levels; (*) intake to toilet water-tank; (^) outlet to irrigation (when toilet water-tank is full). 234
- 5.55 System layers, photograph of one of two implemented prototypes. 235
- 5.56 Plotting by Adafruit IO, one-minute intervals. *Top-Left*: Toilet-tank levels A&B; *Top-Right*: Prioritizing tank A (blue); *Bottom*: Ph- and turbidity-levels, unit A. 237
- 6.1 Interconnected CPS application areas and global application processes (figure reformatted and redrawn from Figure 2.1 in [84]). 242

List of Abbreviations

Abbreviation	Formal Term
AA	Adaptive Architecture
AAL	Ambient Assisted Living / Active and Assisted Living
acatech	Deutsche Akademie der Technikwissenschaften
ADL	Activity of Daily Living
AEC	Architecture, Engineering, and Construction
AI	Artificial Intelligence
AmI	Ambient Intelligence
API	Application Program Interface
AVS	Amazon.com®'s Alexa Voice Service™
BAN	Body Area Network
BBB	BeagleBone Black
BLE	Bluetooth Low Energy
CEN	Comité Européen de Normalisation
CNN	Convolutional Neural Network
CPN	Cyber-Physical Network
CPS	Cyber-Physical System
CV	Computer Vision
D2RO	Design-to-Robotic-Operation
D2RP	Design-to-Robotic-Production
DL	Deep Learning
EPS	Expanded Polystyrene
FADIS	Fall-Detection and -Intervention System
GPIO	General Purpose Input / Output
GPS	Global Positioning System
GSM	Global System for Mobile [Communications]
HAR	Human Activity Recognition
IA	Interactive Architecture
ICT	Information and Communication Technology
IEQ	Indoor Environmental Quality

>>>

Abbreviation	Formal Term
IFTTT	If This Then That®
IoT	Internet of Things
ISM	Industrial, Scientific, and Medical
<i>k</i> -NN	<i>k</i> -Nearest Neighbor
LBB	LightBlue Bean
LDR	Light Dependent Resistor
LED	Light-emmitting Diode
LSR	Light Sensitive Resistor
M2M	Machine-to-Machine
MAC	Medium Access Control
MANET	Mobile Ad Hoc Network
MCU	Microcontroller Unit
ML	Machine Learning
MQTT	Message Queueing Telemetry Transport
MTCNN	Multi-task Cascaded Convolutional Networks
NFC	Near-Field Communication
NGN	Next-Generation Networks
OECD	Organization for Economic Cooperation and Development
OSC	Open Sound Control
PAN	Personal Area Network
QoL	Quality of Life
QoS	Quality of Service
RWH	Rainwater-harvesting
SMS	Short Message Service
SN	Sensor Node
SpO2	Peripheral Capillary Oxygen Saturation
SSH	Secure Shell
SVM	Support Vector Machine
TRL	Technology Readiness Level
UDP	User Datagram Protocol
WBAN	Wireless Body Area Network
WBASN	Wireless Body Area Sensor Network
WHO	World Health Organization
WHOQOL	World Health Organization Quality of Life [assessment]
Wi-Fi	Wireless Local Area Network (WLAN) using IEEE 802.11 standards
WLAN	Wireless Local Area Network
WSAN	Wireless Sensor and Actuator Network
WSN	Wireless Sensor Network—subsuming WSAN, in the present work.

Summary

Discussions of *intelligence in the built-environment* began in the late 1960s and early 1970s [1]–[7]. They belonged to a broader technical and technological discourse, engaged across a variety of domains and disciplines, to explore potential opportunities entailed by the *Information Age*. During this nascent period, and partly due to the novelty of the exploration as well as to the rudimentary state and forbidding costs of *Information and Communication Technologies* (ICTs), said discussions were principally theoretical and/or hypothetical in nature and impartial to defined fields of inquiry. Two main branches developed, one *Technical*¹—stemming from *Information Sciences* and *Engineering* fields—and another *Architectural*.

In the Technical branch, *Ambient Intelligence* (AmI) was coined in the late 90s to describe a cohesive vision of a future *digital living room*, a built-environment whose computing hardware and software technology imbued its dwelling space with serviceable intelligence to the benefit of its occupant(s) [8]. Also salient in this branch was *Ambient Assisted Living*—or *Active and Assisted Living*—(AAL), which framed its inquiry around the promotion of quality of life as well as the prolongation of independence with respect to *Activities of Daily Living* (ADLs) [9] among the elderly via technical assistance [10].

In the Architectural branch, Cedric Price’s pioneering *Generator Project* and corresponding programs by John and Julia Frazer [11] in the late 70s, explored notions of interaction between human and non-human agents in the built-environment. In Price’s project, architecture was conceived as a set of interchangeable sub-systems integrated into a unifying computer system, which enabled a reconfigurability sensitive to function. Price and the Frazers intended for the system to suggest its own reconfigurations, denoting non-human agency.

¹ That is, *technical* with respect to ICTs. After all, the Architectural domain also enjoys a technical craft. However, for simplicity, the distinction made throughout the present work between the Technical and the Architectural seeks to distinguish the ICT-oriented “Technical” from the Architectural Design-oriented “Architectural” qualification.

The promise of solutions yielded by both AmI/AAL and IA/AA is limited by the rigid and increasingly outdated assumptions in their approaches. It is not possible, as they are and as they are currently developing, to combine AmI/AAL and IA/AA to yield a unified and cohesive approach. This is because the sophistication of a system will depend on that of its mutually complementing subsystems; and two or more subsystems may not mutually complement, sustain, and/or support one another properly if their levels of development and sophistication do not correspond [12]. That is: at present, the architectural does not correspond to the technically predominant AmI/AAL, while the technical does not correspond to the architecturally predominant IA/AA. Consequently, a different design-approach is required in order to enable comprehensively and cohesively intelligent built-environments with corresponding levels of technical and architectural sophistication. What could such an approach look like?

In this thesis, an alternative approach that conceives of the intelligent built-environment as a *Cyber-Physical System* (CPS) is presented and demonstrated. Under this approach, ICTs and Architectural considerations *in conjunction* instantiate intelligence *fundamentally*²—i.e., unlike existing AmI/AAL or IA/AA approaches, the present approach subsumes enabling technologies into the very core of the built-environment, where a solution does not exist as such without either of its informational and physical constituents deliberately conceived for each other (if not formally, at least conceptually and operationally with respect to instantiated services).

In this thesis, the general potential and promise of the presented approach is illustrated via its application to a constrained use-case—i.e., that of intelligent built-environments for elderly assistance and care (also informally referred to as *smart homes* or *environments*). Twelve *proof-of-concept* demonstrators (see Chapter 5), each showcasing an intelligent product and/or a service—or combinations and sets thereof—integrated into the built-environment and/or its ecosystem, are developed. Eight established parameters (see Section 3.2)—four pertaining to *Indoor Environmental Quality* (IEQ) and four *Quality of Life* (QoL)—define the purpose and inform the design of each demonstrator’s setup and development within four types of demo environments (see Chapter 4)—two Physical (*Hyperbody* and *Robotic Building*) and two Virtual (*Digital Twin* and *Non-descript*). Each demonstrator, while presented as a discrete *proof-of-concept*, builds on the same core System Architecture, and are intended to be viewed as a collection of systems and services expressed within a same hypothetical environment. That is to say, all come together to represent the intelligent built-environment as CPS.

² That is, from its very conception and foundation. This is to be contrasted with the presently predominant approach where technological services are an *afterthought* to an existing physical structure.

All demonstrators are functionally and physically developed and involve human participation to test and to validate both the feasibility and success of the concept. Success is determined if the developed products and services indeed provide added value to a user and/or occupant of the space—i.e., if they promote and contribute to well-being by assisting, facilitating, or enhancing. Accordingly, the tangible nature of the process and results promote—albeit in a limited scope—the presented approach in very real terms, and—hopefully—situate it as an alternative to existing modes of imbuing intelligence in the built-environment.

Samenvatting

Discussies over intelligentie in de gebouwde omgeving begonnen eind jaren zestig en begin jaren zeventig [1]-[7]. Ze maakten deel uit van een breder technisch en technologisch discours dat in verschillende domeinen en disciplines werd gevoerd om de potentiële mogelijkheden van het informatietijdperk te verkennen. Tijdens deze ontluikende periode, en deels als gevolg van de nieuwheid van het onderzoek en de rudimentaire staat en onbetaalbare kosten van informatie- en communicatietechnologieën (ICT), waren deze discussies voornamelijk theoretisch en/of hypothetisch van aard en onpartijdig ten opzichte van gedefinieerde onderzoeksgebieden. Er ontwikkelden zich twee hoofdtakken, een technische³ – voortkomend uit informatiewetenschappen en ingenieurswetenschappen – en een architecturale.

In de technische tak werd Ambient Intelligence (AmI) eind jaren 90 bedacht om een samenhangende visie te beschrijven van een toekomstige digitale woonkamer, een gebouwde omgeving waarvan de computerhardware en -softwaretechnologie de leefruimte doordrenkt met bruikbare intelligentie ten voordele van de bewoner(s) [8]. Ook belangrijk in deze branche was Ambient Assisted Living of Active and Assisted Living (AAL), dat zijn onderzoek richtte op het bevorderen van de kwaliteit van leven en het verlengen van de onafhankelijkheid met betrekking tot activiteiten van het dagelijks leven (ADL's) [9] onder ouderen door middel van technische assistentie [10].

In de architectuurtak onderzochten Cedric Price's baanbrekende Generator Project en overeenkomstige programma's van John en Julia Frazer [11] aan het eind van de jaren 70 noties van interactie tussen menselijke en niet-menselijke agenten in de gebouwde omgeving. In Price's project werd architectuur opgevat als een verzameling uitwisselbare subsystemen die geïntegreerd waren in een overkoepelend computersysteem dat een herconfigureerbaarheid mogelijk maakte die gevoelig was voor functies. Price en de Frazers wilden dat het systeem zijn eigen herconfiguraties voorstelde, wat duidde op een niet-menselijke agency.

³ Dat wil zeggen, *technisch* met betrekking tot ICT. Het domein Architectuur heeft immers ook een technisch ambacht. Voor de eenvoud wordt in dit werk echter een onderscheid gemaakt tussen het Technische en het Architecturale om de ICT-gerichte "Technische" te onderscheiden van de Ontwerpgerichte "Architecturale" kwalificatie.

De belofte van oplossingen die zowel AmI/AAL als IA/AA opleveren wordt beperkt door de starre en in toenemende mate achterhaalde aannames in hun benaderingen. Het is niet mogelijk om AmI/AAL en IA/AA te combineren tot een verenigde en samenhangende aanpak. Dit komt omdat de geavanceerdheid van een systeem afhangt van die van de subsystemen die elkaar aanvullen; en twee of meer subsystemen kunnen elkaar niet goed aanvullen, ondersteunen en/of ondersteunen als hun niveaus van ontwikkeling en geavanceerdheid niet overeenkomen [12]. Dat wil zeggen: op dit moment komt het architecturale niet overeen met het technisch overheersende AmI/AAL, terwijl het technische niet overeenkomt met het architecturaal overheersende IA/AA. Bijgevolg is er een andere ontwerpbenadering nodig om allesomvattende en samenhangende intelligente gebouwde omgevingen mogelijk te maken met overeenkomstige niveaus van technische en architecturale verfijning. Hoe zou zo'n benadering eruit kunnen zien?

In dit proefschrift wordt een alternatieve benadering gepresenteerd en gedemonstreerd die de intelligente gebouwde omgeving opvat als een Cyber-Physical System (CPS). Bij deze benadering zorgen ICT's en architectonische overwegingen samen voor de fundamentele instantiëring van intelligentie⁴—d.w.z., in tegenstelling tot bestaande AmI/AAL of IA/AA benaderingen, neemt de huidige benadering faciliterende technologieën op in de kern van de gebouwde omgeving, waarbij een oplossing als zodanig niet bestaat zonder dat een van de informatieve en fysieke onderdelen bewust voor elkaar is ontworpen (zo niet formeel, dan tenminste conceptueel en operationeel met betrekking tot instantiëerde diensten).

In dit proefschrift wordt het algemene potentieel en de belofte van de gepresenteerde benadering geïllustreerd via de toepassing ervan op een beperkte use-case, namelijk die van intelligente gebouwde omgevingen voor ouderenhulp en -zorg (ook wel informeel slimme huizen of omgevingen genoemd). Twaalf proof-of-concept demonstrators (zie Hoofdstuk 5), die elk een intelligent product en/of een dienst (of combinaties en sets daarvan) tonen, geïntegreerd in de gebouwde omgeving en/of het ecosysteem daarvan, zijn ontwikkeld. Acht vastgestelde parameters (zie Paragraaf 3.2) – vier met betrekking tot de kwaliteit van het binnenmilieu (IEQ) en vier met betrekking tot de kwaliteit van leven (QoL) – definiëren het doel en informeren het ontwerp van de opzet en ontwikkeling van elke demonstrator binnen vier soorten demo-omgevingen (zie Hoofdstuk 4) – twee fysieke (Hyperbody en Robotgebouw) en twee virtuele (Digital Twin en Non-descript). Elke demonstrator, hoewel gepresenteerd als een discreet proof-of-concept, bouwt

⁴ Dat wil zeggen, vanaf het ontwerp en de oprichting. Dit in tegenstelling tot de huidige overheersende aanpak waarbij technologische diensten een *nabijzaak* zijn bij een bestaande fysieke structuur.

voort op dezelfde systeemarchitectuur en is bedoeld om gezien te worden als een verzameling systemen en diensten binnen dezelfde hypothetische omgeving. Dat wil zeggen, ze komen allemaal samen om de intelligente gebouwde omgeving als CPS te representeren.

Alle demonstrators zijn functioneel en fysiek ontwikkeld en omvatten menselijke participatie om zowel de haalbaarheid als het succes van het concept te testen en te valideren. Het succes wordt bepaald als de ontwikkelde producten en diensten inderdaad toegevoegde waarde bieden aan een gebruiker en/of bewoner van de ruimte – d.w.z. als ze het welzijn bevorderen en er aan bijdragen door te helpen, te faciliteren of te verbeteren. Het tastbare karakter van het proces en de resultaten promoten – zij het in beperkte mate – de gepresenteerde aanpak in zeer reële termen en positioneren deze – hopelijk – als een alternatief voor bestaande manieren om intelligentie in de gebouwde omgeving in te bouwen.

1 Introduction

This thesis reconsiders intelligence in the built-environment. Its objectives are framed with respect to both a general and a specific scope, where resulting consequences to the latter are demonstrative of the promise of the former. In the broader general scope, the thesis aims to develop a theoretical, methodological, and technological approach for the conceptualization of the built-environment as a **Cyber-Physical System** (CPS). As such, the Architecture of the built-environment as well as the intelligence-enabling ICTs seamlessly integrated therein instantiate—in mutually complementing conjunction—the intelligent built-environment. This environment supersedes, in terms of features and services, those resulting from approaches that relegate either Architecture or **Information and Communication Technologies** (ICTs) to auxiliary or secondary roles. In the narrower specific scope, the promise of the presented approach is demonstrated by applying it to the assisted living discourse (see, for example, [17]–[20]), which aims to address the unavoidable and particularly pressing age-related demographic challenge. This demonstration is expressed via twelve devices or solutions, all developed via principles of the promoted approach, that may be instantiated as parts of an open-ended intelligent built-environment that promotes, sustains, and supports well-being among the elderly. The specific scope is therefore a case-study of the general scope, where the benefits yielded by the presented approach extend beyond **Ambient Assisted Living**—or **Active and Assisted Living** in the European Union—(AAL) and **Activities of Daily Living** (ADLs) [9] desiderata.

The *specific* scope of this thesis is concerned with enhancing quality of life for the elderly—a particularly vulnerable segment of society—via unobtrusive, resilient yet robust intelligent systems. In order to sustain a degree of independence with respect to ADLs [21], assistive solutions aim to mitigate the growing dependence incurred by—but not exclusive to—physical and cognitive decline associated with the natural aging process. These solutions generate environments with varying degrees of intelligence, where sensor-actuator modules and robotic agents mitigate and/or compensate for the declining dexterity and diminishing strength of the occupants. Research trends in this field suggest the importance of such robotic and assistive services [22]–[27], especially considering that all emerging industrial nations are undergoing age-related demographic change [28]. At present, there are available robotized and intelligent AAL solutions—e.g., *RoboticRoom* [29], *Wabot-House* [30], *The Aware Home* [31]—as well as ambitious *Ambient Intelligence* (AmI) implementation proposals that make use of sensor networks for intelligent robots [32]. However promising these solutions may be, they are limited by two key considerations: their (a) cost still make them available to a minority of the population, whether the aging, handicapped, and/or the general population; and (b) application of outdated approaches to increasingly sophisticated technologies regardless of the lack of technological complementarity. The focus of this thesis is on presenting an alternative approach in the context of the second consideration, which also bears cost-reduction consequences that mitigate the limitation expressed in the first consideration.

With respect to consideration (a) ⁵: A key reason why present AAL solutions are costly is because the research and industry sectors tend to view them as *complete solutions* [32], “often including overlapping of almost equal or homogeneous sensors [...] leading to an increase of acquisition costs and higher data volume.” [34]—p. 3. Another reason for the high cost is because computation methods require considerable infrastructure to produce a useful dataset from which to draw substantial conclusions. For example, Chiriac & Rosales [35] mention projects such as *SAMDY* [36] and *eHome* [37], where the computation “costs are estimated between 3,500 EUR and 5,000 EUR” [35]—p. 16. Furthermore, AAL solutions require customized planning and installation by experts, which in part cause the “enormous costs of today’s single solutions [...] which are too expensive for private buyers as well as health and care insurance providers.” [38]—p. 350.

⁵ This consideration is also a stated motivation in the *Introduction* chapter of my *Master of Science* thesis [33].

And finally, activity-monitoring in AAL requires the implementation of a system that is able to track the movement and positions of the user. On the whole, indoor tracking solutions, which generally make use of trilateration or triangulation methods, provide a strong and reliable performance. But “these architectures require structured environments and consequently high installation costs” [39]—*p. 1*.

With respect to consideration (*b*): The feasibility of all systems depends on their technological promise as well as their limitations. At the advent of AAL systems in the early 1980s, communication and computation technologies were still at a rudimentary state (in comparison with today’s State of the Art). Their limitations informed the development of certain AAL approaches which became *de facto* guidelines—e.g., high-volume communication was wired; systems were centralized to ease computation costs etc. Decades later, systems are still being tacitly and/or explicitly informed by these outdated guidelines. In the 1980s, early AAL concepts often needed to be scaled back due to costs and services associated with technology. In the 2010s, technology often needs to be scaled back to fit outdated AAL concepts. And still in the early 2020s methods and modes in the intelligent built-environment discourse labor on retrofitting. This is not sustainable or scalable, and a different approach is necessary to better correspond to Milgrom’s fundamental analysis of *complements*, where the economic increase of a variable in a multi-variable system also promotes the economic increase of the complementing variables [12], i.e., where products, organizations, informational assets, and technologies involved in the production of a product conform a mutually complementary system. The intelligent built-environment may be exploited for its full potential if all its constituent subsystems, both in terms of ICTs *as well as* Architectural Design and Technology, are mutually complementary.

1.1 Background⁶

Discussions of *intelligence in the built-environment* began in the late 1960s and early 1970s [1]–[7]. They belonged to a broader technical and technological discourse, engaged across a variety of domains and disciplines, to explore potential opportunities entailed by the *Information Age*. During this nascent period, and partly due to the novelty of the exploration as well as to the rudimentary state and forbidding costs of ICTs, said discussions were principally theoretical and/or hypothetical in nature and impartial to defined fields of inquiry. Over the next two decades, the discourse specialized into subset fields broadly coalescing into the technical on the one hand and the architectural on the other.

With respect to the technical, AmI was coined in the late 90s to describe a cohesive vision of a future *digital living room*, a built-environment whose computing hardware and software technology imbued its dwelling space with serviceable intelligence to the benefit of its occupant(s) [8]. Within AmI a further specialized domain developed, i.e., that of AAL, which framed its inquiry around the promotion of quality of life as well as the prolongation of independence with respect to ADLs among the elderly via technical assistance. By the first decade of the 21st century, AmI and AAL were established and proliferating topics within the fields of Computer Science and related Engineerings [22], [41]–[43], Architectural Engineering [18], [20], [44], and—indirectly—in the Medical Sciences [45].

With respect to the architectural, and beginning with Cedric Price’s pioneering *Generator* project [11] and corresponding programs by John and Julia Frazer [11] in the late 70s, notions of interaction between human and non-human agents in the built-environment began to be explored. For example, in Price’s project, architecture was conceived as a set of interchangeable subsystems integrated into a unifying computer system, which enabled a reconfigurability sensitive to function.

⁶ This section is based on Section 2.2.1 of

 H. Bier, A. Liu Cheng, S. Mostafavi, A. Anton, and S. Bodea, “Robotic Building as Integration of Design-to-Robotic-Production and -Operation,” in *Springer Series in Adaptive Environments*, vol. 1, *Robotic Building*, H. Bier, Ed. 1st ed.: Springer International Publishing AG, 2018. [40]

More importantly, both Price and the Frazers intended for the system itself to suggest its own reconfigurations⁷, denoting non-human agency in the built-environment. Although the *Generator Project* was never realized, it became the *de facto* first instance of a subset field in Architecture concerned with bi-directional communication and interaction between human and non-human agents in the built-environment, viz., *Interactive Architecture* (IA) [13], [48], [49] first and *Adaptive Architecture* (AA) [50]–[52] later, which—like AmI—have also proliferated in the 21st century.

The proliferation of intelligence in the built-environment with respect to AmI/AAL and to IA/AA has differed in sophistication, with the former far surpassing the latter in terms of technical complexity, reliance, and performance. This has been largely due to their differing emphases, with the technical focusing on computing hardware and software technology and the architectural on spatial experience, materiality, and form. That is, the technical proliferated with resources resulting from robust and sustained computational development over decades in ways that the architectural could not, at least not with the same affinity and immediacy. Nevertheless, technical sophistication or lack thereof alone has not necessarily guaranteed or disqualified contributions in the discourse. Indeed, principally technical as well as principally architectural explorations have both independently identified key *effective* as well as *affective* desiderata common to built-environments—intelligent or otherwise—construed as successful with respect to function as well as to spatial experience. This consideration, however, includes a caveat: while both the technical as well as the architectural have yielded independent contributions, these have been otherwise limited by the lack of mutually provided input and/or feedback. For example, AmI/AAL may continue to proliferate as a technical subject even if the physical aspect of its built context remains presupposed and/or static to conventional design and construction approaches.

⁷ Steenson quotes [11] two interesting excerpts from letters exchanged by Price and the Frazers. First, from Price to the Frazers, stating his objective: “The whole intention of the project is to create an architecture sufficiently responsive to the making of a change of mind constructively pleasurable.” [46]. Second, from the Frazers to Price, expressing a desired characteristic: “If you kick a system, the very least that you would expect it to do is kick you back.” [47]

Similarly, IA/AA may also continue to proliferate in its affective and/or qualitative explorations even if the technical aspects of its implementations express modest computational sophistication. However, the promise of solutions yielded by both principally technical AmI/AAL and principally architectural IA/AA explorations will be unwittingly and invariably limited by the rigid and increasingly outdated character of their complementing approaches. This is because the sophistication of a system will depend on that of its mutually complementing subsystems; and two or more subsystems may not mutually complement, sustain, and/or support one another properly if their levels of development and sophistication do not correspond [12]. More succinctly expressed: at present, the architectural does not correspond to the technically predominant AmI/AAL, while the technical does not correspond to the architecturally predominant IA/AA. Consequently, a different design-approach is required in order to enable comprehensively and cohesively intelligent built-environments with corresponding levels of technical and architectural sophistication. This thesis proposes an answer.

2 State of the Art

In his book *Interactive Architecture*, Martin Fox stated that the motivation behind **Interactive Architecture** (IA) was “found in the desire to create spaces and objects that can meet changing needs with respect to evolving individual, social, and environmental demands” [48]—p. 12. Similarly, Eli Zelkha—who, with Simon Birrel, coined **Ambient Intelligence** (AmI)—described such type of spaces as “a digital living room [...] where our environment satisfies our needs, mostly without our having to think about it.”⁸ [8]—p. 4. These descriptions apply to all of the intelligent built-environment discourses, regardless of orientation. However, as detailed in the previous section, their expressions have grown to differ categorically. As salient characteristics within categories, the Architecturally oriented expression differs from its **Information and Communication Technologies** (ICTs)-oriented counterpart in its approach to the built-environment as a protagonist agent in the creation of said spaces and objects. Likewise, the ICTs-oriented expression differs from its Architecturally oriented counterpart in its agnostic position towards non-strictly pragmatic Architectural Design theories and decisions.

⁸ Verbatim from Zelkha’s *Internal Working Draft / Thought-Piece* of his keynote speech for the *Digital Living Room* conference.

2.1 Two main branches within the Intelligent Built-Environment discourse

TABLE 2.1 Characteristics of the ICTs vs. Architectural Branch with respect to Intelligent Built-Environments.

ICTs Branch Ambient Intelligence (AmI) / Active and Assisted Living (AAL)	Architectural Branch Interactive Architecture (IA) / Adaptive Architecture (AA)
Centered around ICTs	Centered around Architecture / Design
Mature Implementations	Experimental Demonstrations
High Technology Readiness Level [53]	Low <i>Technology Readiness Level</i>
Market-release solutions (robust)	Performative prototypes (non-robust)
Arch. Design agnostic	Technology agnostic
Effect dominant (Assistive)	Affect dominant (Performative)
Uses the built-environment as a vehicle to express hi-tech services (often retrofitting)	Uses ICTs as a means to an end, regardless of technical efficiency, cost, etc.

Table 2.1 outlines some salient characteristics of the existing architecture-informed and ICTs-informed branches within the intelligent built-environment discourse. While both aim to instantiate built-environment capable of meaningful—i.e., engaging, enhancing, beneficial, assistive, etc.—interaction, their maturity levels differ drastically. Forcefully put: AmI/AAL-informed solutions (*complete* [32] or as discrete subsystems [19]) are a commercial reality in both healthcare as well as *smart* homes, while no IA/AA-informed counterpart solution exists. AmI/AAL initiatives have been subsumed by national policies (e.g., [54]) yet IA/AA have remained in experimental and/or artistic explorations in Academia. There are various reasons for this, but a salient one is that AmI/AAL tends to be highly resolved and conservative—and therefore *palatable* to conventional construction approaches—while IA/AA tends towards the highly conceptual and provocative. These tendencies proliferate at different stages of the four main stages of the design process (*Conceptual Design*, *Schematic Design*, *Design Development*, and *Construction Documents*) (see Figure 2.1).

Situating the Discourse in the Architectural Design Process

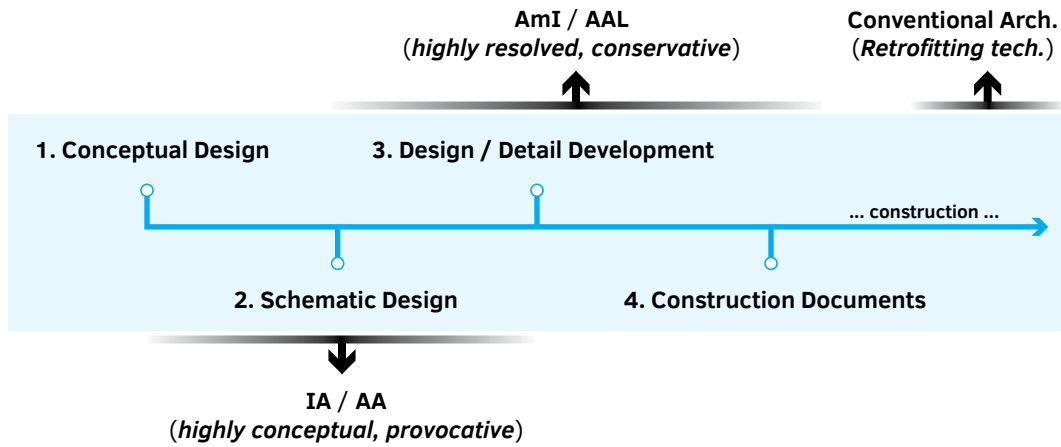

FIG. 2.1 Situating the discourse in the Architectural Design Process.

2.1.1 The Architectural branch: Interactive Architecture (IA) and Adaptive Architecture (AA)

TABLE 2.2 Overview and Background of Interactive Architecture (table reproduced verbatim from [55]).

Years	Effective Events in the Process of the Evolution and Formation of Interactive Architecture
1960s	Formulating existing theories, principles and fields of interactive architecture formulated by Gordon Pask and other cyberneticists. Cedric Price designed the Fun palace Model and presented the concept of anticipatory architecture that was indeterminate, responsive and flexible for people's changing needs and their times.
1970s	Gordon Pask developed Conversational Theory, with emphasise [<i>sic</i>] on the role of users in a soft and flexible way, without specific goals. William Brody proposed the Self-Organisation Intelligence Theory in architecture.
1980s	The Massachusetts Institute of Technology (MIT) Media Lab was founded by Nicholas Negroponte who proposed the "Architectural Machine" idea. Charles Eastman developed the adaptive-conditional architecture model in which architects interpret spaces and users collectively as a feedback system.
1990s	Michael Mozer presented Adaptive House and "intelligence" of the home that predict the behaviour and needs of the inhabitants by having observed them over a period of time. Implementation of wireless networks, embedded computation and technologically and economically flexible sensors. Interactive architecture workshop was launched at Bartlett School of Architecture as a pioneering association for actual architectural projects under the guidance of Stephen Cage.
2000s	Michael Fox established MIT Kinetic Design Group and published interactive architecture books.
2010s	Kas Oosterhuis is teaching and performing interactive architecture projects at the Delft University of Technology and has published the hyperbody Theory.

In the first decade of the 21st century, at around the time of Fox's book, IA—and its subset AA—saw expressions in a wide-range of environments—e.g., living, working, entertainment, healthcare, etc. There was a proliferation of *proof-of-concept* prototypes aimed to illustrate what *could be*. However, what *could be* did not necessarily correspond to demands and/or expectations. That is, mid-range *Technology Readiness Level* (TRL) [53] prototypes work in controlled environments but are not ready for the *real* world. Some such prototypes were not practical enough for the day-to-day—or what is worse: they were not *robust* enough. As IA prototypes were generally developed by university laboratories catering to an academic exploration, long-term sustainability could not be immediately gauged. Consequently, IA expressions grew to center around temporary structures—pavilions, exhibition booths, pods, etc.—that would prove a concept's feasibility yet not focus on pragmatic considerations, and this would restrict its applicability in real-world environments.

Into the second decade of the 21st century, IA and AA are *presently* strongly characterized by performance, experience, and experimentation⁹ centered around the architectural design discourse. While the two have been somewhat reductively grouped within the same branch—i.e., Architecture-focused branch—IA and AA also have their distinct emphases. For example, while IA is performative and its effects often ephemeral, AA views the built-environment as a system capable—at least tentatively—of pragmatic day-to-day utility (not only performance). A salient example of the current state of IA and its interests is expressed in Ruairi Glynn’s *Interactive Architecture Lab* at *University College London*—and its *Masters in Design for Performance & Interaction* program [56]—where the emphasis is situated in performance in the context of art, theater, exhibitions, etc. Likewise, a salient example of the current state of AA and its interests is expressed by Holger Schnädelbach’s work [52], [57]–[60] at the *Mixed Reality Lab* at the *University of Nottingham*, where—among other things—architecture may be *pragmatic* (e.g., regulate its environment via temperature sensors and an adaptive façade), *therapeutic* (e.g., detection of emotive states of users via heart-rate sensors, etc.), and *provocative* (e.g., immersive applications involving art, etc.). However, the common denominator and protagonist of IA and AA remains the Architecture, the Built-Environment.

Urquhart, Schnädelbach, and Jäger [60] identify the following salient *experimental* prototypes that illustrate IA/AA’s *State of the Art*:

- Glynn’s *Reciprocal Space* [61], where a physical space was configured to responds to the actions of its inhabitants via real-time bio-feedback loops;
- Schnädelbach *et al.*’s *ExoBuilding* [58], where abdominal contractions associated with respiratory activity in conjunction with heart-rate and galvanic data caused actuations in the built-environment;
- Khan’s *Open Columns* [62], which correlated CO₂ levels with people-density in a given space by dispersing the latter when the former reached certain predefined levels;
- Jäger *et al.*’s *Reciprocal Control in Adaptive Environments* [63] mechanism, where a system influenced the inhabitant’s breathing automatically and independently of user-control based on real-time physiological data;

⁹ The usage of *presently* is important, as IA and AA have been highly malleable notions. IA, for example, was a broader term for any built-environment capable of any form of dynamic interaction between the user and her built-environment, whether for performance or actual pragmatic utility [48]. But towards the end of the 2010s, IA has increasingly narrowed its expressions down to a performative nature. Likewise, AA was also an umbrella term that oftentimes overlapped with IA projects, but it has set itself apart from the mere performative over the years, attempting to present AA as a more pragmatic agent in the Smart Cities discourse.

- Mozer's *Adaptive House*¹⁰ [64], where air- and water-temperature as well as illumination regulation is correlated with user-behavior;
- Varshney's *Pervasive Healthcare* [65] solutions, where pervasive health-monitoring and as well as data access were made ubiquitous via WLAN, *ad hoc* WSNs, and cellular technology;
- Hecht, Mayer, and Perakslis's *hotel of the future* [66], where pervasive and ubiquitous connectivity enabled architectural reactions personalized to hotel guests; and
- Poulsen, Andersen, and Jensen's *real-scale experiment with interactive urban lighting* [67], where human motion was correlated to illumination regulation in a public square in Aalborg, Denmark, resulting in less energy-consumption.

More recently, projects such as:

- Yablonina *et al.*'s *Soft Office* [68]—where a variety of spatial configurations (in the context of interior commercial spaces) could be instantiated using robotic gantries;
- Wyller *et al.*'s *adaptive kinematic textile architecture* [69], where textiles were kinematically and adaptively shaped via mobile robotic connectors in response to the environment and its inhabitant; and
- Wood *et al.*'s *Cyber Physical Macro Material UAV* [70] reconfigurable system, where aerial robots were used to instantiate an architectural system capable of autonomous rearrangement;

increasingly make use of robotic systems as key enablers of spatial transformations and adaptiveness¹¹. Such projects are compatible with the core thesis of the present work as their very character is inherently *cyber-physical* and they themselves extend beyond conventional *performative* approaches of IA / AA.

¹⁰ This example is also mentioned in the following subsection, as it is also representative of *Ambient Intelligence*. Indeed, to reiterate, the boundaries between different expressions of intelligent built-environments are fuzzy and often overlap.

¹¹ These three projects, all stemming from the *Institute of Computational Design* at the University of Stuttgart and under the overall direction of Achim Menges [71], are indicative of innovative trends in Architectural Robotics.

2.1.2 The Information and Communication Technologies (ICTs) Technical branch: Ambient Intelligence (AmI) and Active and Assisted Living (AAL)

AmI and AAL¹² have *always* been characterized by services—and ones agnostic towards the architectural design discourse. AmI formally predates AAL, and at its onset its discourse was limited to rudimentary monitoring applications on the one hand and to scientific speculation on the other [8]. As ICTs became more powerful and accessible, by the time of AAL’s conception, both AmI and AAL focused on services centered around elderly care [45], [72]–[76]. It is worth noting that even before AAL was coined, notions that would eventually be subsumed under that term already existed in AmI (and before, if we reach into speculative science and even science fiction from the 70s). For example, around the time AmI was coined in the late 90s, an independent yet related discussion [77] on telecare had already identified three generations of technologies that would eventually play roles in AAL projects funded and/or driven by the European Union’s *Active Assisted Living Programme* [54], which was later founded in 2008. The three generations of technologies mentioned were identified as technologies that could support independence with respect to *Activities of Daily Living* (ADLs) [78] in elderly adults and are described as follows¹³:

- 1st Generation: wearable devices, response to an emergency, requires user to initiate alarms, etc.
- 2nd Generation: home sensors, automatic response to emergencies and detection of hazards, may feel intrusive.
- 3rd Generation: integration of home sensors and wearable devices; prevention, monitoring, and assistance; less obtrusive.

There is no consensus on a 4th or even 5th generation, as ICTs and their applications are developing and expanding more rapidly than standardization or consensus can keep up. Moreover, by 2013 Blackman et al. had identified 59 AAL technologies [79] and argued that while first and second generation technologies were already commercially available, most third generation ones were still—at the time of her writing—in development and could benefit from a discussion of theoretical

¹² As of writing, the European Union prefers the term “*Active and Assisted Living*” over the original and awkward “*Ambient Assisted Living*”. However, the former is more common in Gerontology journals that began discussing applications of AAL in the context of elderly care. Throughout the present thesis, AAL subsumes the publications of both terms, as there is no content-wise distinction.

¹³ As summarized by Blackman et al. [79].

underpinnings. This consideration aside, it could be argued that a 4th Generation of AAL technologies began with those enabled more by software than by hardware, i.e.: technologies enabled by *Machine Learning* (ML) and *Artificial Intelligence* (AI) more broadly speaking (see, for example, [80]–[83]). Incidentally, see Table 2.3 for an overview of basic technologies used in AAL as of the first decade of the 21st century.

TABLE 2.3 Overview of basic components and technologies in the area of Ambient Assisted Living (AAL) (table reformatted and reproduced from Figure 3.1 in [84]).¹⁴

Ambient Assisted Living						
Software platforms	Terminologies	Run-time environments	AAL infrastructure	E-Health insurance card and telematics infrastructure	Online medical records	Integration profile
Data formats	For the information technology		For the medical technology	For smart buildings		Character sets
Communication protocols	For the information technology		For the medical technology	For household appliances		Interfaces for smart metering
Networks and bus systems	Cables	Plugs and sockets	Ethernet	Powerline	Smart building field buses	Wireless networks
Devices and sensor	Monitors, Cameras, Smart Devices (e.g., mobile phones, tablets, smart-watches, etc.), Speakers, Microphones, Printers. (etc.)					

As of writing, AmI and AAL are also engaging the Smart Cities¹⁵ discourse from the context of well-being and healthcare [86]—that is, intelligent built-environments from the individual to the society, a *Society Ambient Living* [87]. To highlight a few examples¹⁶:

- Ardito *et al.*'s EFESTO tool [93], which enables users to set rules for smart objects to support elderly adults (with limited physical deterioration) with respect to ADLs;
- Caivano *et al.*'s EUD4SH project [94], which is a model that supports software engineers in evaluating and deploying smart-home solutions that consider the end-user first and foremost;

¹⁴ Geisberger refers the source as M. Eichelberg: *Interoperabilität von AAL-Systemkomponenten Teil 1: Stand der Technik*, VDE-Verlag 2010. [In German], here included as a footnote as it is not directly referenced in the present work.

¹⁵ Although according to a recent review, there is no evidence that AmI- / AAL-based *smart home* technologies contribute to health-related quality of life [85].

¹⁶ For a more extensive list of example projects, please see [88]–[91] For a wholistic survey, please refer to [92].

- Pericu and Licaj’s RESTOQUI [95], a platform that presents the user with all possible design solutions that adapt to their needs;
- Watrinet and Fracasso’s MAESTRO project [96] aims to assist the elderly via a platform for product recommendation based on their needs as well as on profiling / assessment methodologies; and
- Mozer’s ACHE (Adaptive Control of Home Environments) project [64], an actual residence in Boulder, Colorado, is outfitted with 75 sensors and focuses on smart regulation and control of lighting.

2.2 The problem with force-merging branches

While AmI/AAL approaches do have an advantage over IA/AA in terms of practical application / implementation, they are also limited by the conservative context in which they proliferate. That is, as *complete solutions*, they are as rigid as conventional built-environments with a limited set of services that may not be scaled. As discrete subsystems, AmI/AAL systems are Architecture-agnostic, they tend to labor on a retrofitting strategy, where new services and technologies are made to work within a setting whose built typologies were conceived without ICT-integration in mind. Such models are informed by the belief that the costs of retrofitting the new into the old are less than those associated with late-stage design consolidation of intelligent services and their corresponding production¹⁷ [100], [101]. In their 2015 *integrated research agenda on Cyber-Physical Systems* (CPSs), the *German Academy of Science and Engineering* (acatech) stated that CPS technology may be fitted—more correctly: *retrofitted*—into existing buildings¹⁸ to compensate for the decline associated with the natural aging process [84]. Moreover—and

¹⁷ But note that this is true insofar as said design consolidation is *late-stage*. Early-stage design consolidation of intelligent services in conjunction with robotically driven production [97], which considers the changes in the structure and infrastructure of the architecture that must be adopted in order to enable robotic environments suitable for ubiquitous systems and service robots [27], [98], do in fact instigate considerable cost reductions [99].

¹⁸ “An AAL environment might, for example, involve the user’s own home. In order to compensate for the decline in their physical or cognitive abilities as they get older, their home would gradually be fitted with relevant user-controllable CPS equipment which would provide a variety of assistance functions.” [84]—p. 48.

more telling—acatech added that “In the AAL context, the *environment itself thus becomes a smart Cyber-Physical System*” [84]—p. 48, *emphasis mine*. This is telling of what the technical branches of the intelligence in the built-environment discourse consider as necessary components to instantiate a *smart* environment—that is, only ICTs retrofitted into a neutral Architecture. A built-environment retrofitted with CPS-enabling ICTs represents, more precisely, an inactive host to an active CPS¹⁹.

The danger with retrofitting is not immediately clear; after all, it seems like a reasonable and practical approach. While this may be true—i.e., the majority of existing buildings worldwide predate the advent of widely available and accessible wireless technologies—it cannot be a *good* reason to retain the current approach. The danger of considering a retrofitted environment (as such) a *smart* CPS is that the built-environment itself would be a *de facto* subsystem of it, and one at a very different class of *Technology Readiness Level* (TRL) [53] than the remaining ICTs-driven subsystems. One may argue that the built-environment, as represented by any given *tried-and-true* inhabitable building, is a mature technology, and one that reached maturity considerably before any available ICTs did. But the issue is not with the TRL itself, but of its class. That is, rudimentary edification principles and methods are indeed established. But their expression, in relation to concepts informed by economics, geography, politics, and technologies, are in constant evolution. Architectural theory, like any socio-technical theory, changes over time to reflect the strengths, weaknesses, opportunities, and threats of its context (*milieu*). In this sense, it is possible to suggest that there is a compatibility and complementarity spectrum in technological retrofitting into existing buildings²⁰.

¹⁹ But to truly view the inhabited environment as a CPS, both the Architecture and the CPS-enabling ICTs must be construed as active enablers of intelligence in conjunction.

²⁰ For example, retrofitting a given smart-thermostat in Apple Inc.’s corporate headquarters (*Apple Park*, One Apple Park Way, Cupertino, CA 95014, United States. 21st c.) is probably easier than doing so in the *Pantheon* (Piazza della Rotonda, 00186 Roma RM, Italy. 2nd c.). Or a less extreme example: buildings from both the Regency Era (early 19th c.) and the Modernist period (early to mid-20th c.) were built with established and mature technologies, but the latter’s technology class is more compatible than the former’s when retrofitting 21st c. technologies requiring electricity.

Consequently, if a retrofitted environment was considered a CPS itself, it would be one where its built-environment subsystem was not deliberately conceived to complement the TRL—and the class thereof—of the ICTs-driven subsystems. Over time, if the trend of retrofitting significantly faster-evolving ICTs into static-buildings continues, the cost—in terms of time, effort, finances—will become unconscionable²¹.

While both AmI/AAL and IA/AA have differences—and corresponding concomitant limitations—it cannot be denied that they also overlap across a variety of dimensions (e.g., intentions, objectives, enabling technologies, etc.). This *region of overlap*, however, is accidental, contingent, and variable. That is to say, the overlap is not caused by deliberate dialogue between each other but by disciplinarily independent exploration that attained to similar conclusions, motivations, realizations, etc. This, however, makes it difficult to establish a defined relationship between the two branches as the overlap varies by trends and coalesces by chance (see Figure 2.2).

To force merge established lines of inquiry and approaches motivated by different disciplines cannot yield a cohesive line and approach. Conflicting motivations, incompatible methods, non-complementary maturities, etc., would yield an incongruent *chimera* competing, mutually exclusive interests.

²¹ Aside from the context of questioning retrofitting *smart* technologies into existing buildings, retrofitting in general poses economic threats *tout court*. For example, the Berlin-Brandenburg Airport, which inaugurated with an outdated design intended for 27 million passengers per year, is already under-capacity. An expansion retrofitted into the project was estimated to cost an additional €2.3 billion—in fact, €7 billion, as costs currently stand—or the airport's *entire* original budget [102] Admittedly, it may be argued that a legitimate expansion should not be considered retrofitting. Yet cautionary tales on retrofitting may be found within this airport's details. Design flaws and faulty systems were identified across several audits and plans for corresponding renovations and retrofitting were drawn. But newer systems made to fit into outdated designs and requirements proved to be difficult, leading to a lack of coherence and—crucially—reliable functionality. This led to the airport planner at the time, Dieter Faulenbach da Costa, to comment that “[a] stick of dynamite would provide more order than trying to clean it up”—later he explained that what he meant: leave only the shell of the building and “rebuild everything inside. [...] That would have been cheaper, faster, and more successful than trying to renovate the building with the mess it had been made [...]” [103].

ICTs Technical vs. Architectural

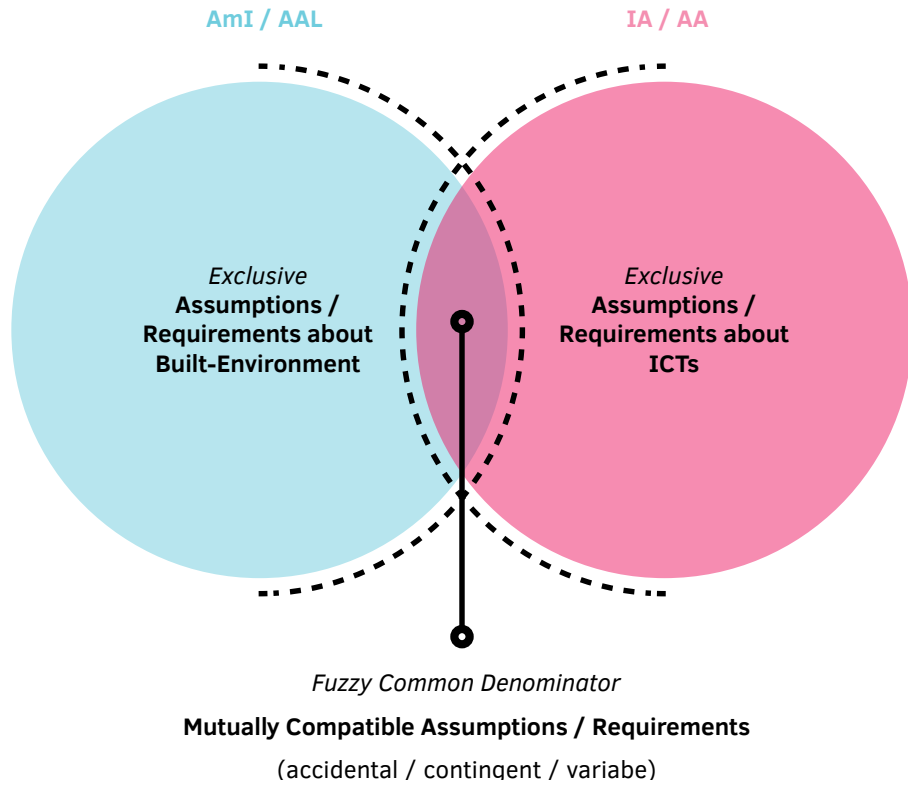

FIG. 2.2 Abstraction of overlaps between the ICTs Technical branch and the Architectural branch.

3 Theory and Concept

Chapter 1 detailed the origins and development of the intelligence in the built-environment discourse into two thematically broad and diverse yet generally identifiable branches, one motivated by Architectural considerations (i.e., **Interactive Architecture (IA) / Adaptive Architecture (AA)**) and another by **Information and Communication Technologies (ICTs)** (i.e., **Ambient Intelligence (AmI) / Active and Assisted Living (AAL)**). Moreover, it highlighted that a simple ad hoc merger of both would not be workable due to their lack of mutual complementarity [12]. In this chapter, and as the general argument of the present work, an alternative approach to intelligent built-environments is presented, one that is capable of instantiating the virtues of architecture-informed and the information-systems-informed intelligent built-environments without being limited by the incongruencies and incompatibilities of a forced and artificial merger. As the application scenarios for and types of end-users of intelligent built-environments are quite broad, the central thesis is demonstrated via a constrained yet specific **proof-of-concept** by focusing on one salient application and type of end-user—that is, the approach is applied to the development of a smart home solution for the elderly and vulnerable (i.e., those suffering from mild to moderate physical disabilities), with a particular emphasis on open-sourced and accessible technologies. The feasibility and potential of the approach, as discussed in the general argument, may be considered and extrapolated to other possible scenarios and end-users. Under said constraint, the proposed intelligent built-environment sets out to ascertain both **Indoor Environmental Quality (IEQ)** as well as **Quality of Life (QoL)** via select established parameters. That is, with respect to IEQ [104]: (1) Thermal Comfort, (2) Light / Illumination, (3) Air-Quality, and (4) Sound / Acoustics are considered (see Section 3.2.1); and with respect to QoL [105]: (1) Health, (2) Independence, (3) Activity, and (4) Safety & Security (see Section 3.2.2). These parameters—in part or in whole—guide the development of a series of prototypes of devices, systems, and services that actively promote comfort and well-being. As the proposed intelligent built-environment approach relies on a decentralized and scalable system architecture (see Section 3.4), these prototypes may serve as stand-alone systems or as parts of a larger whole by sharing gathered data with each other. No formal assessment model of IEQ or QoL is part of the present work. The scope is limited to the immediately observable and tangible effects of the developed prototypes—together instantiated the proposed intelligent built-environment—on the user in the promotion of well-being and comfort.

3.1 The Intelligent Built-Environment as Cyber-Physical System (CPS)

A *Cyber-Physical System* (CPS) (see Section 3.3.1) integrates computation with physical processes such that both the *cyber* and the *physical* parts *in conjunction* define the behavior of the systems [106]—i.e., in *deliberate conjunction*. This is the core concept in the present alternative approach to intelligent built-environments. Whereas it has been argued that the ICTs Technical branch of the intelligent built-environment discourse has viewed Architecture as a neutral vehicle within which to imbue ICTs, the present approach views Architecture as the essential and *deliberate tissue* of the CPS. Whereas it has also been argued that the Architectural branch of the same discourse has viewed ICTs as a means-to-an-end to conceptual / experimental / performative results, the present approach views them as the essential and *deliberate nervous system* of the CPS.

The word *deliberate* is here used to contrast against the accidental, contingent, and variable nature of the incongruous merging of the ICTs Technical and Architectural branches. In the present approach, their relationships between *nervous system* and *tissue* are deliberate²². Accordingly, the designs of one invariably affect the other and vice versa. Under this approach, ICTs do not come second to Architecture nor vice versa. But their systems and relationships are both conceived early in the design process. In contrast to *complete solutions* in AmI/AAL, the present approach enables the built-environment to scale up, and to subsume a variety of technologies to ascertain currency with respect to ICTs. Admittedly, there is no indefinite scaling up with respect to what is actually built as part of the Architecture—but neither is there a requirement for it to do so. The ICTs infrastructure may scale up to meet requirements of evolving technologies or to provide better services or even to accommodate new features pertinent to user-requirements as well as appropriate to available space.²³

²² Admittedly, the analogy between the intelligent built-environment as CPS and the human body (or that of any animal with a nervous system and encompassing tissue) does have its limits. It may be argued that not everything in the human body remains current and deliberate, as it [arguably] possesses vestigial aspects / parts such as goosebumps, wisdom-teeth, tail-bone, appendix, etc. Nevertheless, the analogy still illustrates the intimate interwoven character promoted for the intelligent built-environment to be viewed as CPS.

²³ Modularity in Architecture is an established concept. An intelligent built-environment as CPS may be conceived as a modular building that may physically scale within whatever space is available, within appropriate building-codes and permitting physical laws. At any rate, this discussion is beyond the scope of the present work.

This approach is envisioned to be active at every stage of the main stages of every design process (see Figure 3.1). The twelve demonstrators / proof-of-concept implementations detailed in Chapter 5 aim to illustrate this in a reduced way. From the design and implementation of the ICT-systems to the robotic fabrication of the Architectural components, every step aims to prove its feasibility in *the real world*.

Situating the Proposed Approach in the Architectural Design Process

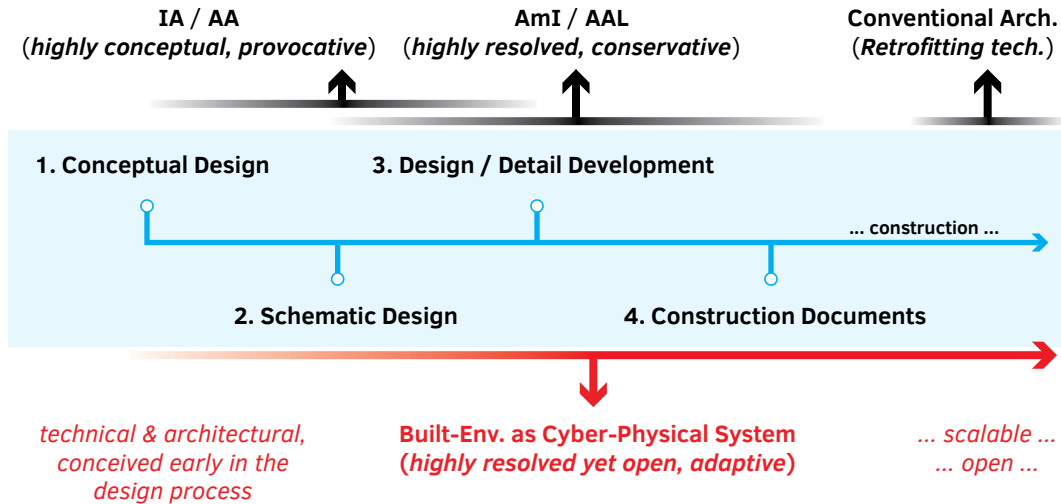

FIG. 3.1 How the proposed approach relates to the Architectural Design Process.

Each demonstrator also aims to do just that—i.e., *demonstrate* the approach at work, and all within the specific context of *smart homes* for the elderly as a proof-of-concept, although the methods, processes, and results may be extrapolated for more general use-cases and audiences. Driving parameters²⁴ were defined (see Section 3.2), enabling technologies detailed (see Section 3.3), a system architecture was conceptualized (see Section 3.4), and demonstrators began to be designed, developed, implemented / built, and tested with real humans (see Chapter 4 - Chapter 5).

²⁴ It is worth noting that different use cases and target-audiences may require different driving parameters but the method and approach remain the same.

3.2 Defining Parameters

3.2.1 Indoor Environmental Quality (IEQ)

At present there is no globally accepted index model, assessment model, nor standardized list of parameters to gauge IEQ [107]. This is partly because—as highlighted by Bluysen et al. almost a decade ago—studies on different habitable built-environments are incomplete and mostly inconclusive when establishing links between occupant-, exposure-, and building-related indicators [108]. Moreover, the subjective nature of sense-perception does not always correspond to physiological realities, and what is perceived as comfortable by one may not be so by another, regardless of what health sciences prescribe as conducive to health and well-being.

Nevertheless, an exhaustive list of parameters is not necessary to pursue practical expressions of IEQ. There are sufficient studies underlying the importance of a number of key parameters (also known as physical stressors) that may instantiate it. A recent survey (see Figure 3.2) that considered several studies with different indicator-weightings and global comfort indices, across a variety of built-environments, found that the following four parameters could be identified as core parameters for user-comfort with respect to IEQ [109]: Thermal Comfort, Air-Quality, Light / Illumination, and Sound / Acoustics.

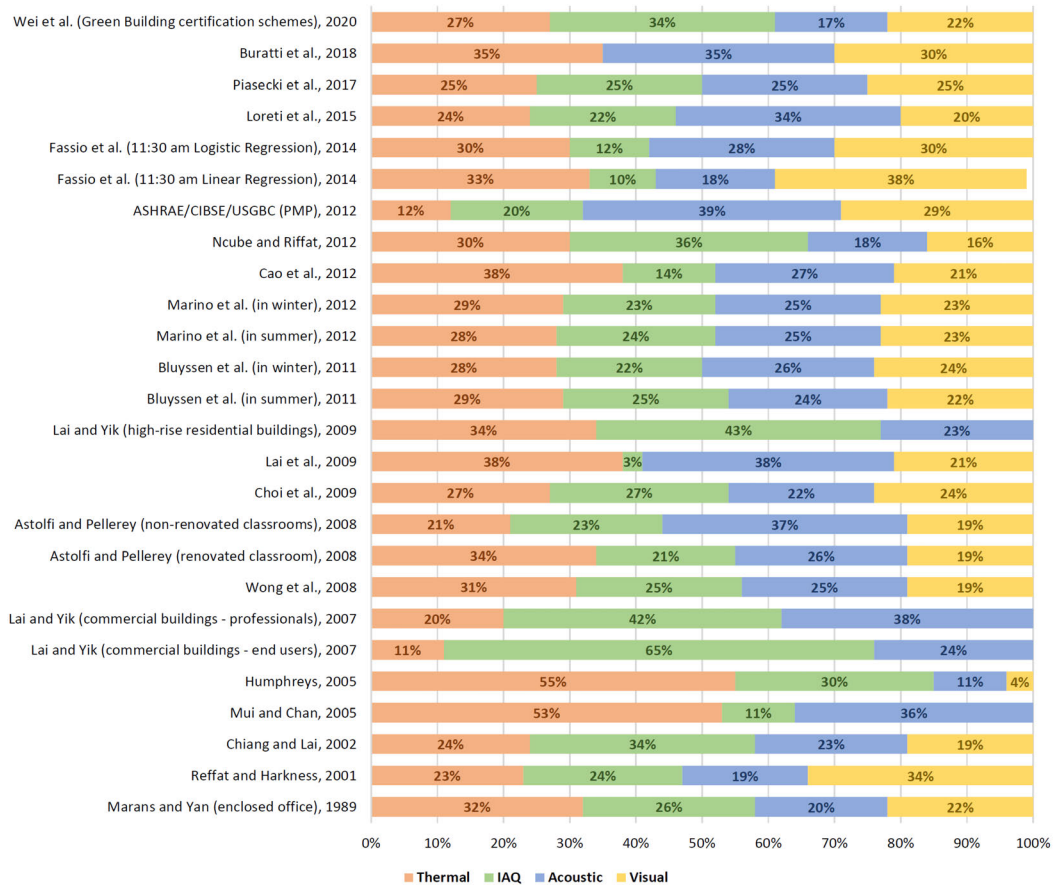

FIG. 3.2 Figure 5 in Riffelli's Thermal, Indoor Air Comfort (IAQ), Acoustic, and Visual "Percentage weightings in the reviewed research studies" [109] (CC BY 4.0).

Since each of these may be understood to encompass slightly different aspects, depending on the context and on the emphasis of their usage, it is worth noting how they are construed in the present work (N.B.: the following uses Bluysen et al.'s general descriptions [104] (in *italics*) and adds particular emphases where applicable):



Thermal Comfort: *moisture, air-velocity and -temperature, etc.*;



Air-Quality²⁵: *comprising odors, indoor air-pollution, fresh air-supply, etc.*; with particular emphasis on natural ventilation over air-conditioning (unless exterior air is polluted) [111];



Sound / Acoustics: *outdoor and indoor noise, vibrations, etc.*; with particular emphasis on acoustic clarity; and



Light / Illumination: *view, illuminance, luminance ratios, etc.*

IEQ parameters will partially inform eight *proof-of-concept* demonstrators / implementations across a variety of physical and virtual environments (see Chapter 4), as detailed in Chapter 5 (specifically, see Section 5.1 - Section 5.3, Section 5.5 - Section 5.8, and Section 5.11). Please refer to Table 5.1 to see how IEQ parameters relate to demonstrator environments.

²⁵ It should be noted that exposure to poor air-quality indoors is more significant (i.e., causes greater impact) than outdoors as people spend the majority of their time indoors [110].

3.2.2 Quality of Life (QoL)

Four key parameters defined by the *World Health Organization Quality of Life* (WHOQOL) assessment instrument [105] are considered²⁶:



Health (WHOQOL's Domain I, facets 1, 2, 4, and 5: (1) Pain and Discomfort, (2) Energy and Fatigue, (4) Sleep and Rest, and (5) Sensory Functions;



Independence (Domain III, facets 11 and 15): (11) Mobility and (15) Communication Capacity;



Safety & Security (Domain V, facets 20, 21, 23, 27): (20) Freedom, physical safety and security, (21) Home environment, (23) Financial resources, and (27) Physical environment (pollution/noise/traffic/climate); and



Activity (Domain III, facets 12 and 16): (12) Activities of Daily Living and (16) Work Capacity;

QoL parameters will partially inform all demonstrators in Chapter 5, also in a variety of physical and virtual environments (see Chapter 4). The core QoL parameter and main motivating parameter of the constrained use-case is *Health*. Accordingly, it is the common-denominating consideration behind all devices, systems, and solutions developed as demonstrators (see Chapter 5). This is followed by *Independence* (see Section 5.1 and Section 5.3 – Section 5.12); *Safety & Security* (see Section 5.3 – Section 5.5, and Section 5.7 – Section 5.10); and *Activity* (see Section 5.3, Section 5.5, and Section 5.10). Please refer to Table 5.1 to see how QoL parameters relate to demonstrator environments.

²⁶ Note that a detailed description of each *domain* and corresponding *facets* is omitted for succinctness. Please refer to the cited instrument for a detailed discussion.

3.3 Enabling Technologies²⁷

While varying types and degrees of *intelligence* in the built-environment may be expressed via a variety of technical and technological ecosystems, configurations, complexities, etc., there is an essential core that defines the *intelligent built-environment* as *Cyber-Physical System*. Broadly speaking, and by definition, this type of built-environment is enabled by a virtual component and a physical one that, *in conjunction*, give rise to systems and services otherwise impossible to instantiate. What is common to all expressions of this type of intelligent built-environment, regardless of scale and scope, is the underlying ICT-infrastructure that receives and processes inputs into outputs (and back, in some form of feedback-loop), where said inputs and outputs may be physical or virtual (or both) as well as local or remote (or both). Within this system, a *Wireless Sensor and Actuator Network* subsystem facilitates communication between said physical (embedded or ambulant) and virtual components. Finally, a *Body Area Network* subsystem may also be present if intended services require precise physical and physiological inputs from the user—if, however, inference (physical gestures / actions via environment-embedded Computer Vision, for example) suffices, this subsystem is optional.

The following subsections describe these core technologies in detail in order to facilitate a finer understanding of the solutions discussed in Chapter 5.

²⁷ Subsection 3.3.1 – Subsection 3.3.3 in this section include figures from and expand on rewritten excerpts of Section 2.1, Chapter 2, of my *Master of Science* thesis [33].

²⁸ From the “Authors and Contributors” note in the source: “This chart began with a taxonomy given by S. Shyam Sunder of NIST at the NIST CPS Workshop on March 13, 2012 in Chicago. Edward A. Lee of UC Berkeley converted the taxonomy to a picture and then started evolving it with input from various people. So far, direct contributions to the current version have been made by: Philip Asare, Bucknell University; Georgios Bakirtzis, University of Virginia; Ray Bernard, Ray Bernard Consulting Services; David Broman, KTH; Edward A. Lee, UC Berkeley; Gerro Prinsloo, Stellenbosch University; Martin Torngren, KTH; S. Shyam Sunder, NIST”.

3.3.1 Cyber-Physical Systems (CPSs)

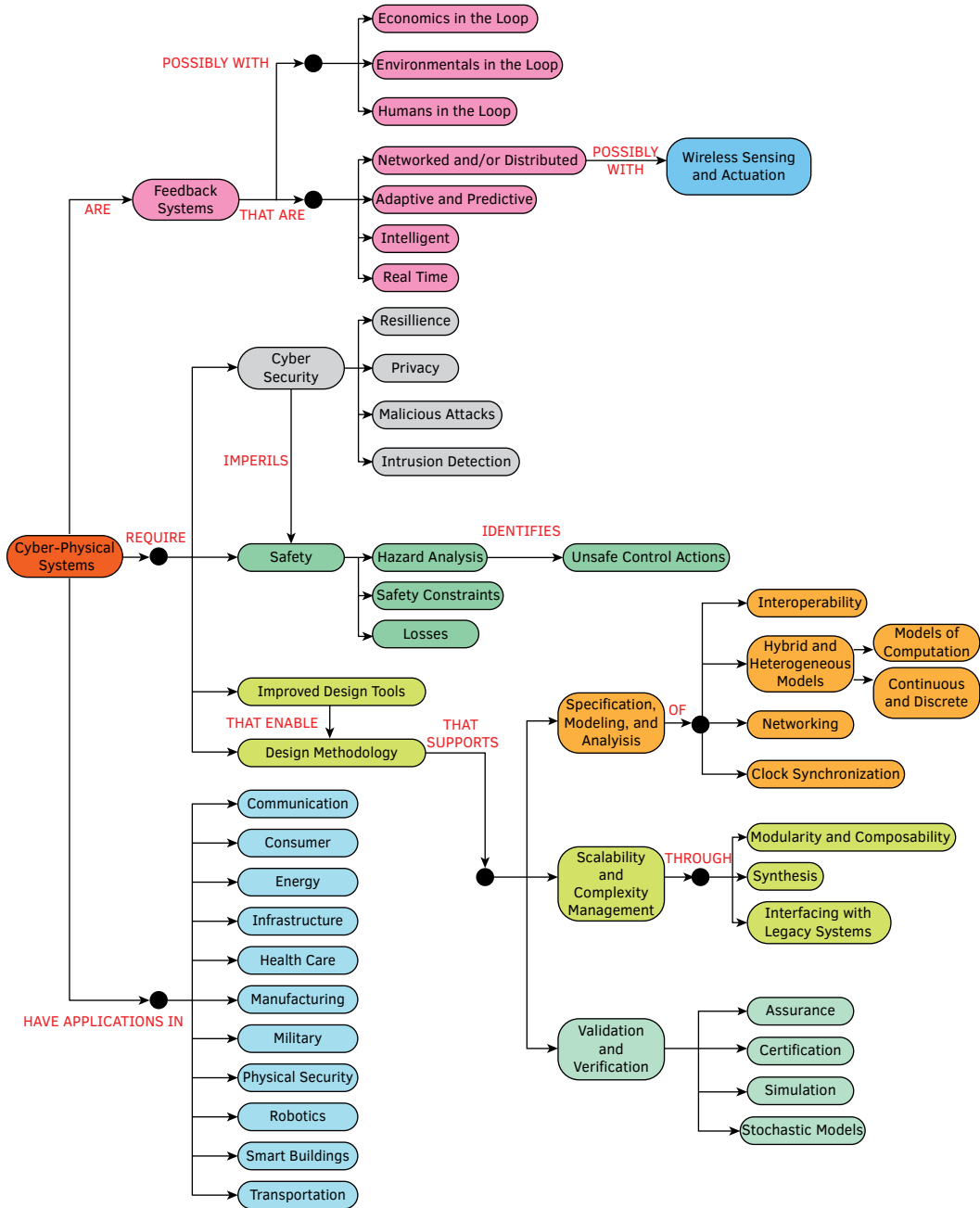

FIG. 3.3 Cyber-Physical Systems—a Concept Map (figure redrawn from [112]²⁸).

CPSs²⁹ integrate computation with physical processes such that both the *cyber* and *physical* parts *in conjunction* define the behavior of the systems³⁰ [106]. As Kopetz notes, CPSs are not mere *conventional data-processing systems*—as represented by, for example, human-machine interfaces that only react to human input and yield a corresponding output. Instead, they are heterogeneous systems—often deployed in time- and safety-critical contexts—consisting of *cyber* and a *physical* subsystems where processes in the latter are observed and regulated by the former, often in a closed-loop and independent of human management [117]. Accordingly, CPSs are particularly well-suited to control, monitor, and/or regulate digital, physical, and hybrid processes in environments where computational systems inform and/or react to physical phenomena and vice versa [118], [119]. This duality requires careful consideration of the joint dynamics involved when designing CPSs, which Lee and Seshia have argued is their salient characteristic [106].

CPSs promise to enrich and/or to enhance *human-to-human*, *human-to-object*, and *object-to-object* interactions in both the virtual and physical worlds [120]. As of writing, they are the core enabling-technologies in (1) *smart* domains including (i) Urban Planning via *Smart Cities*; (ii) Healthcare via *Smart Health*³¹; (iii) Mobility via *Smart Mobility*; (iv) Building Management via *Smart Homes* [84], [118]; (2) *digitalization* in (i) Autonomous systems, (ii) Dynamically connected systems, (iii) Interactive sociotechnical systems, and (iv) Product / service systems [121]; and (3) *Industrie 4.0 / Industry 4.0* [84], [118], *Industrial Internet of Things*, and *Society 5.0* [122].

²⁹ According to Lee and Seshia—and related by Taha *et al.* [113], among others in the literature—the term *Cyber-Physical System* was coined at the *National Science Foundation* in the United States by Helen Gill (around 2006) [106].

³⁰ Definitions vary in descriptiveness and specificity. For example, Krämer cites Sztipanovits as calling CPS research “a new discipline at the intersection of physical, biological, engineering and information sciences” [114]; and goes to add that, by this broad definition, Konrad Zuze is to be considered a pioneer in cyber-physical systems [115] as such—even before Norbert Wiener coined the term “cybernetics” in 1948 [116]. As Krämer expands, soon after Zuze invented his Z3 computation machine in 1941, he went to develop a device that surveyed aircraft wings by (1) reading values from around forty sensors (serving as *analog-to-digital* converters) and (2) processing them as variables in a program [115].

³¹ Indeed, the [German] *National Academy of Science and Engineering* (acatech) states that “AAL”—i.e., *Ambient Assisted Living*—“solutions [...] can only be delivered through Cyber-Physical Systems” [84]—p. 27.

There is no standard architecture for CPSs, being themselves *Systems of Systems* with dynamically adaptive system boundaries [84] (see Figure 3.3 for a “*Concept map*”). They are (1) similar to typical embedded systems—discrete devices—in that they relate physical processes with computations and vice versa; yet (2) dissimilar to said systems in that CPSs consist of various interacting devices and systems, some purely physico-mechanical and some strictly computational [123]. It is not surprising that CPSs bear characteristics of WSNs³², especially considering that the former is built with constituents of the latter. Lin *et al.* state that the following are five important characteristics in WSNs that are used in the design of CPS [123] (see Figure 3.4):

- 1 *Deployment*, which ensures monitoring quality and network connectivity of the *Region of Interest* (ROI);
- 2 *Localization*, which enables the decision-making system to respond accurately with respect to location-specific events and information;
- 3 *Coverage*, which (i) determines whether to adopt fixed or non-fixed sensor deployment and (ii) ensures that there are no blind zones in the coverage of the ROI;
- 4 *Data gathering*, which enables the gathering and transmission of sensed data across a field of sensor-nodes;
- 5 *Communication*, which consists in the design of an appropriate *Medium Access Control* (MAC) that is sensitive to energy-consumption.

In addition to subsuming and being similar to WSNs, there is also some overlap between CPSs and another *ad hoc* network technology represented in *Mobile Ad Hoc Networks* (MANETs)³³. Indeed, CPSs that include MANETs in their ecosystem may be envisioned without difficulty. Nevertheless, please refer to Table 3.1 for a brief comparison of differences and similarities between CPSs, WSNs, and MANETs.

³² *Cyber-Physical Networks* (CPNs), which are formed by interconnecting CPSs, have been considered an extension of WSNs [124].

³³ See Footnote 36 in Section 3.3.2: *Wireless Sensor and Actuator Networks* (WSANs / WSNs).

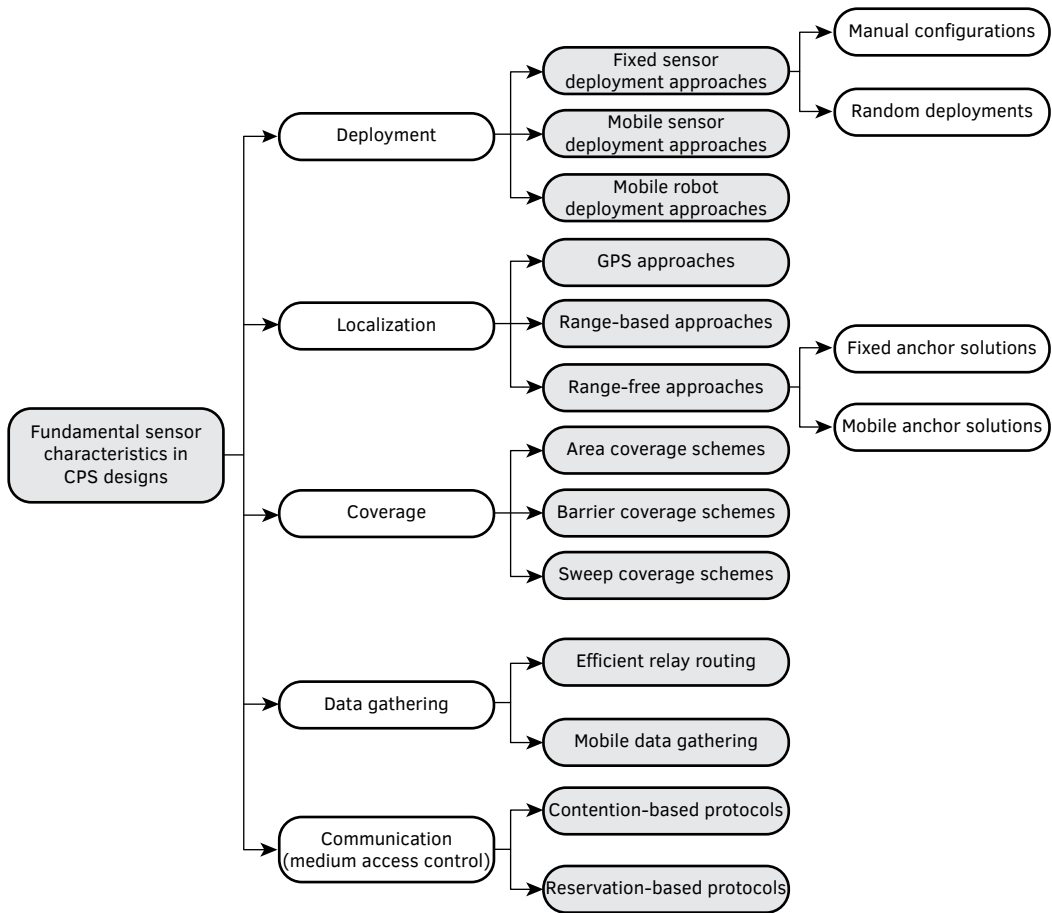

FIG. 3.4 The five fundamental WSN technologies which are the bases in CPS designs (figure redrawn from [123]³⁴).

³⁴ The authors of the source-figure include 66 references for the terminal nodes of the five branches. These references are not included in the bibliography of the present work as they are not direct sources for it. Please refer to the cited reference for a detailed discussion of these branches and their terminal nodes.

TABLE 3.1 A [general] qualitative comparison of MANET, WSN, and CPS (table reproduced from [120]³⁵).

Network	Features	MANET	WSN	CPS
Network formation	Random deployment	■	■	■
	Dynamic topology	■		■
	Internet-supported networking		■	■
	Time-varying deployment			■
	Interconnection among multiple networks			■
Communication pattern	Query-response flows	■	■	■
	Arbitrary communication flows	■		■
	Cross-network communication flows			■
Power management	Opportunistic sleep	■		■
	Multiple sleep modes of nodes			■
	Power management techniques for both sensors and central servers			■
Network connectivity and coverage	Connectivity	■	■	■
	Coverage		■	■
	Heterogeneous coverage and coverage			■
Knowledge mining	Data mining and database management		■	■
	Multi-domain data sources		■	■
	Data privacy and security			■
Quality of services	Networking QoS	■	■	■
	Multiple data resolution		■	■

³⁵ While this comparison was made a decade ago, the general qualitative difference remain consistent. There are exceptions, however, especially with respect to WSNs, given their characteristically heterogeneous architectures.

3.3.2 Wireless Sensor and Actuator Networks (WSANs / WSNs)

Wireless Sensor and Actuator Networks—or, alternatively, *Wireless Sensor and Actor Networks*—(WSANs) are networks that consist of autonomous sensor and actuators that—in deliberate conjunction—(1) monitor, track, and/or control environmental and physical phenomena as well as (2a) transmit corresponding data to a designated *Sink Node / Base Station* and/or (2b) send control-commands to a constituent actuator [125], [126]. For simplicity, WSANs have often been referred to as *Wireless Sensor Networks* (WSNs)³⁶. But while WSANs are indeed a type of WSN, WSNs in their strict original designation are not necessarily WSANs. That is to say, a WSN may consist of sensor-nodes entirely with no requirements for actors or actuators. Consequently, WSANs may be said to be an expansion of WSNs, and as such they are a subset of wireless network applications (see Figure 3.5).

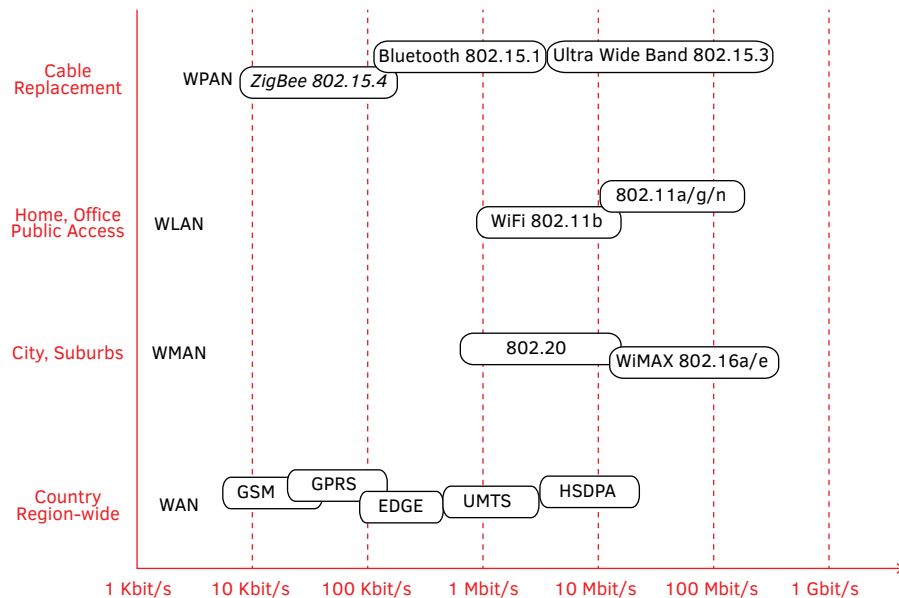

FIG. 3.5 Wireless communication standards and their characteristics (figure redrawn from [125], [127]).

³⁶ Including in the present work—i.e., all occurrences of WSN subsume WSAN.

WSNs contain *sensor nodes* that are typically used for *sensing, relaying, and/or exchanging* data (via *single-hop* or *multi-hop* arrangements). A *sensor node* (SN) consists mainly of a (1) transducer (i.e., some actual sensor), (2) microcontroller, (3) transceiver, (4) power-source (fixed or battery-based), and sometimes (5) external memory [125]. At its most fundamental, a sensor node (i) generates electrical signals—via its transducer—corresponding to a given environmental or physical phenomenon; (ii) processes and stores said signals (raw and/or processed) in the microcontroller and internal / external memory; and (iii) transmits—via its transceiver—said raw and/or processed data to a requesting and/or receiving *sink node / base station* (see Figure 3.6).

Moreover, WSNs use a network protocol stack consisting of five layers: a (1) *physical layer*, where carrier frequencies are generated and signals are modulated / demodulated; (2) *data link layer*, where media is accessed and checked for errors; (3) *network layer*, where routes are discovered and maintained for inter-node communication; (4) *transport layer*, where quality of communication is ensured; and (5) *application layer*, where data is scheduled and distributed based on differing requirements [130]. This five-layer protocol stack has its basis on and is a subset of the *Open Systems Interconnection* seven-layer model proposed by the *International Organization for Standardization* [125].

Furthermore, this stack uses a cross-layer method that includes the following three management platforms that enable nodes to work together with less energy-consumption while still supporting multitasking and resource sharing: (1) an energy management platform that focuses on the network's survival time as well as on the energy-consumption of each protocol layer; (2) a mobile management platform that detects and records node movements while maintaining the path from sensor node to sink node; and (3) a task management platform that coordinates the tasks of nodes in accordance to varying requirements [130].

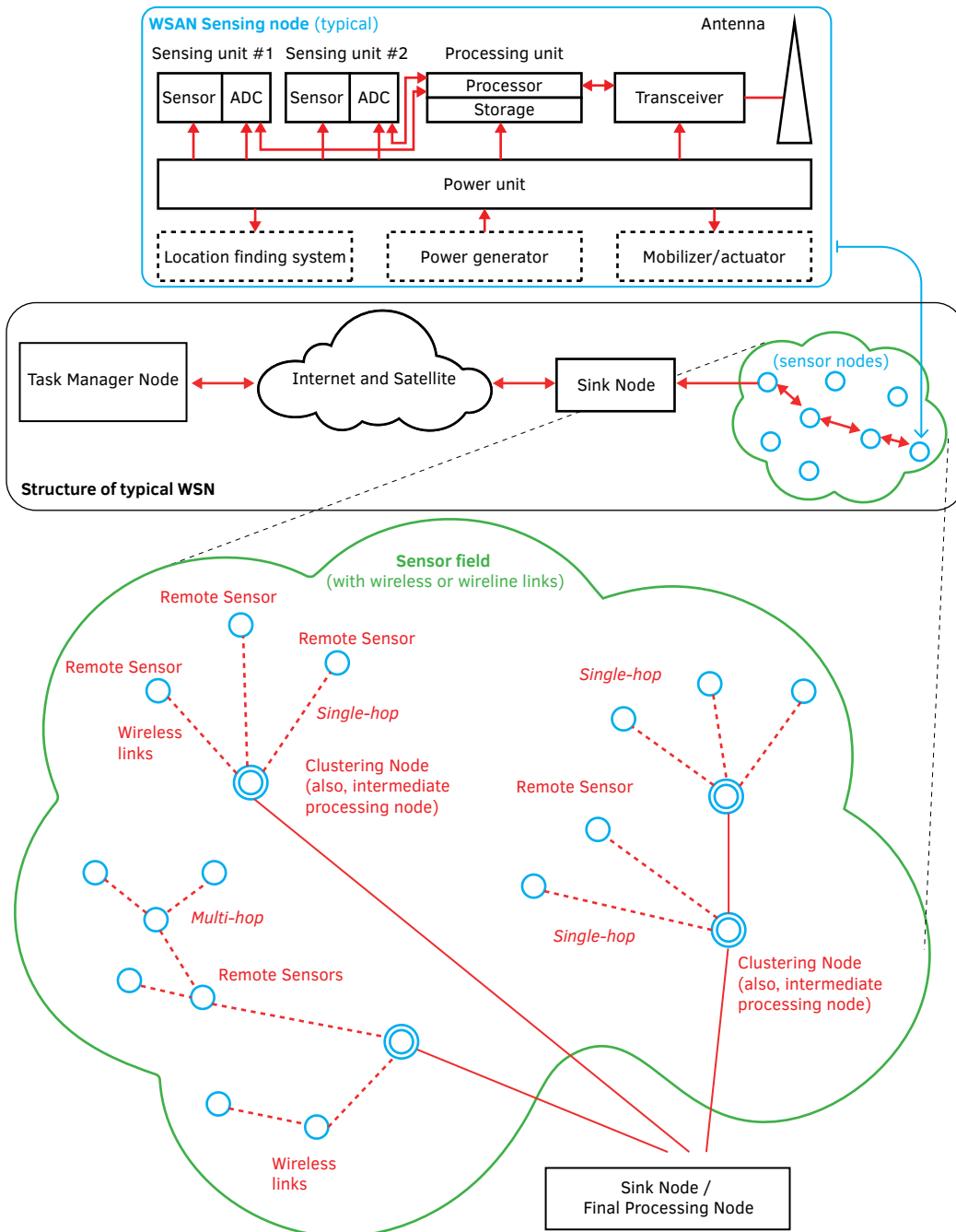

FIG. 3.6 Top: Typical sensing node (figure redrawn from [128]). Middle: Structure of a typical Wireless Sensor Network (figure redrawn from [125], [129], [130]). Bottom: Typical WSN arrangement (figure redrawn from [128]).

While WSNs—as wireless network systems—are not new³⁷, their applications (see Figure 3.7) have considerably proliferated over the last two decades due to advances in ICTs as well as a concomitant reduction of costs, rendering enabling technologies as affordable, accessible, and widely available. A glance over the literature on *smart* domains (e.g., Smart Cities, Smart Healthcare, etc.) in this period show a significant proliferation of WSNs as the default enabling technology³⁸—consider, for example, the increasing number of developments based on WSNs over this period: [22], [131]–[136], to name a few.

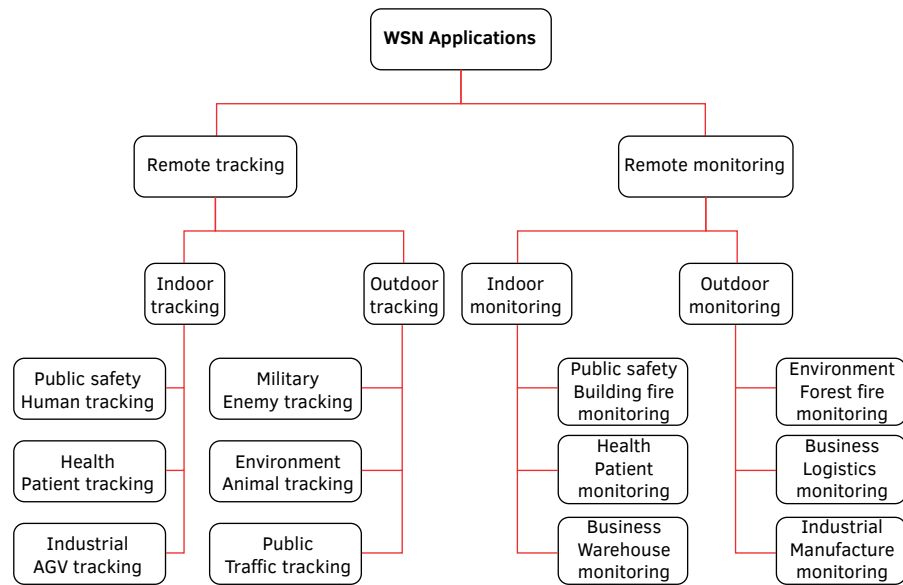

FIG. 3.7 Variety of WSN applications (figure redrawn from [125]).

³⁷ The United States Navy developed the *Sound Surveillance System*, a recognized precursor of WSNs, in the 1950s [130].

³⁸ *Mobile Ad Hoc Networks* (MANETs) are a related and allied enabling technology that, as such, is not discussed in the present work. While WSNs and MANETs are superficially similar (e.g., both contain sensor nodes, include multi-hop communication, depend on energy-efficiency, etc.), their characters are significantly different—just as their intended purpose and application are different. Accordingly, and for example, many communication protocols proposed for generally point-to-point MANET are incompatible with multicast WSNs [128].

3.3.3 Body Area Networks (BANs)

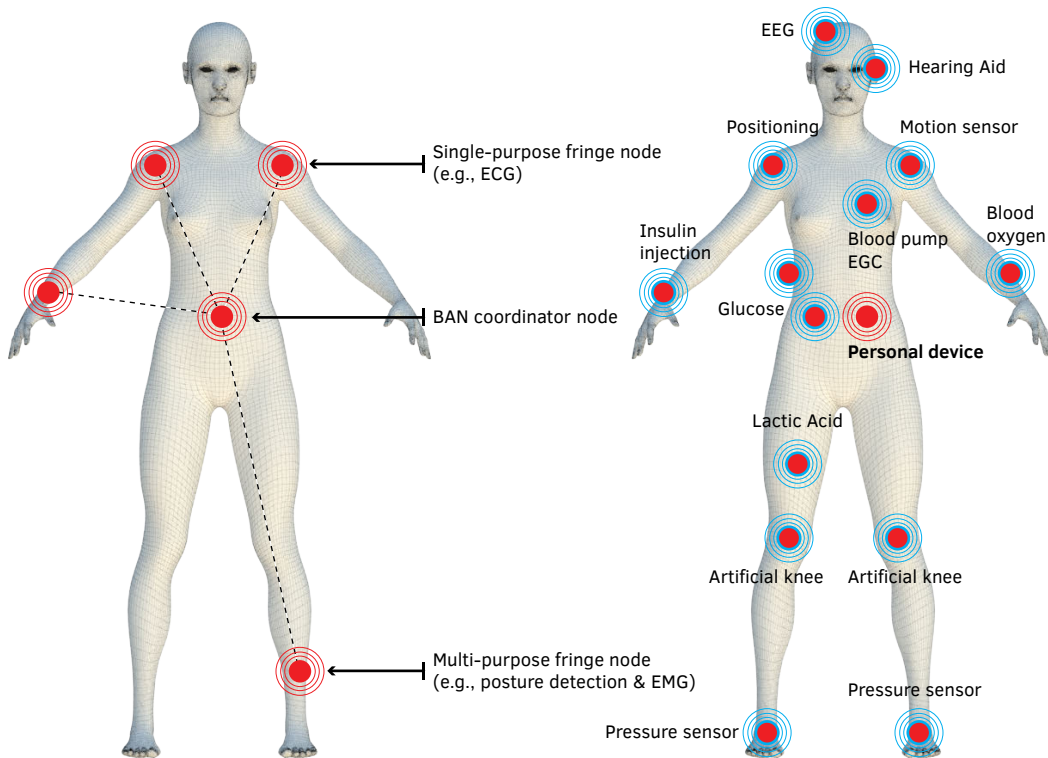

FIG. 3.8 Left: Typical placement of BAN nodes (figure redrawn from [137]). Right: Example of patient-monitoring in a WBAN (figure redrawn from [138]).

Body Area Networks (BANs)—or *Wireless Body Area Networks* (WBANs)—are a specialized subset of WSNs [129], [139]. Accordingly, BANs are also composed of typically heterogeneous *nodes* capable of sensing, actuating, computing, and communicating with one another through a multi-hop wireless channel [140]. One key difference is that BANs center around the human³⁹ body and may be worn or implanted as personalized monitoring devices (see Figure 3.8 and Table 3.2). Whereas WSNs may include nodes with a fixed (wired) source of power, BANs—especially with implanted nodes—rely exclusively on efficient and economic consumption of battery-power.

³⁹ Typically although not exclusively, as BANs have been developed for other animals as well [137].

TABLE 3.2 Differences between WBANs and WSNs (table reproduced from [139]).

Challenges/issues	WBANs	WSNs
Monitoring	Human body physiological parameters	Environment monitoring
Scale	Up to centimeters to a few meters	Meters to kilometers
Channel	Medical channel, ISM (industrial, scientific, medical), body surface	ISM
Number of nodes	Fewer, limited in space	Many nodes are needed so that wide area is covered
Accuracy of result	Through node accuracy and robustness	Through node redundancy
Task of node	Multiple	Dedicated task
Size of node	Small is preferred	Small is preferred, but not important
Network topology	More variable due to body movement	Very likely to be fixed or static
Data rates	Non-homogeneous	Homogeneous
Replacement of nodes	Replacement of implanted nodes difficult	Performed easily, nodes even disposable
Node lifetime	Days/months	Months/years
Power supply	Inaccessible and difficult to replace in an implanted setting	Accessible and likely to be replaced more easily and frequently
Power demand	Lower	Large
Energy scavenging source	Motion (vibration), thermal heat	Wind energy and solar energy
Biocompatibility	Very important	Not important
Security level	Higher, to protect patient information	Lower
Impact of data loss	More significant	Compensated by redundant nodes
Wireless technology	Low-power technology required	Bluetooth, ZigBee, general packet radio service (GPRS), wireless local area network (WLAN)

Moreover, their portable or wearable character imposes greater constraints on formal design requirements as well as specification of highly integrated ICTs. For this reason, their practical application did not begin to proliferate until the early 2000s⁴⁰. In the late 1990s, when portable devices first entered the mainstream, the potential of viewing such devices for monitoring purposes was already envisioned and termed as *Personal Area Networks (PANs)* [139], [141]. PANs gave way to BANs—or WBANs—

⁴⁰ Various sources in the literature cite K. van Dam *et al.* (Van Dam, K., Pitchers, S., Barnard, M. *Body area networks: Towards a wearable future*. In: Proceedings of the wireless world research forum (WWRF) kick off meeting, Munich, 6–7 March 2000) as the first to introduce *wireless body area sensor networks* [139] or to coin the term *Wireless Body Area Network (WBAN)* [138] in 2001. But I have been unable to find the source article cited. For this reason, I have omitted van Dam’s reference in my bibliography and have used other examples of the period to illustrate.

soon after, as portable technology became increasingly affordable, integrated, and increasingly ubiquitous. Now BANs began to be seen as real-life solutions used by the medical practitioners to monitor the physiology of patients without unnecessarily relying on health-services [142]. González-Valenzuela *et al.* [137] highlight three salient examples in this period, which are indicative of developments to come:

- 1 The University of Alabama's *Wearable health monitoring system* (WHMS) [143], where data gathered by BAN sensor nodes was made available on the Internet automatically, thereby enabling care-takers—whether physicians and/or family members—to act on timely anomaly detection.
- 2 Harvard University's *CodeBlue* [144], where ZigBee technology permitted hospitals to host *router* nodes in BANs to enable sensor data transfer to servers accessible by authorized professionals.
- 3 Johns Hopkins University's *Disaster Aid Network* [145], where—like WHMS above—urgent data from mass-casualty events was (1) relayed via WLAN and cellular protocols as well as (2) made available to a variety of devices to promote effective interaction between first-responders via a web-portal.

In addition to the general requirements for WSNs, BANs must also consider bodily comfort and compatibility with respect to wearable devices and implants, especially as their principal and early-adoption application areas lie in *Medicine and Healthcare* [146] (see Figure 3.9). This consideration forces BAN devices to be smaller and less computationally powerful as well as less energy-consuming than WSNs, as said devices serve a specialized purpose and compromise on features already available in general WSNs. This leads to a reduction of overlapping sensors and components, which leads to a reduction of costs as well as that of complexity, enabling some devices or nodes to—say, for example—focus on gathering particular sensor-data while others focus on processing said data, etc.⁴¹

A typical BAN node consists of four main components: (1) Sensor, (2) Memory, (3) *Microcontroller Unit* (MCU), and (4) Radio. These, along other peripherals, are managed by an *Operating System* that generates an abstraction of all available resources. *Application Programming Interfaces* (APIs) enable communication between user applications and lower-level systems, sometimes through *middleware* modules responsible for communication-handling, data-management, *Quality of Service* (QoS), etc. [137] (see Figure 3.10).

⁴¹ As Georgoulas *et al.* showed, systems that aim to reduce complexity of function and costs selectively distribute functions and services along a decentralized ecosystem and not have them centralized in a single system [147].

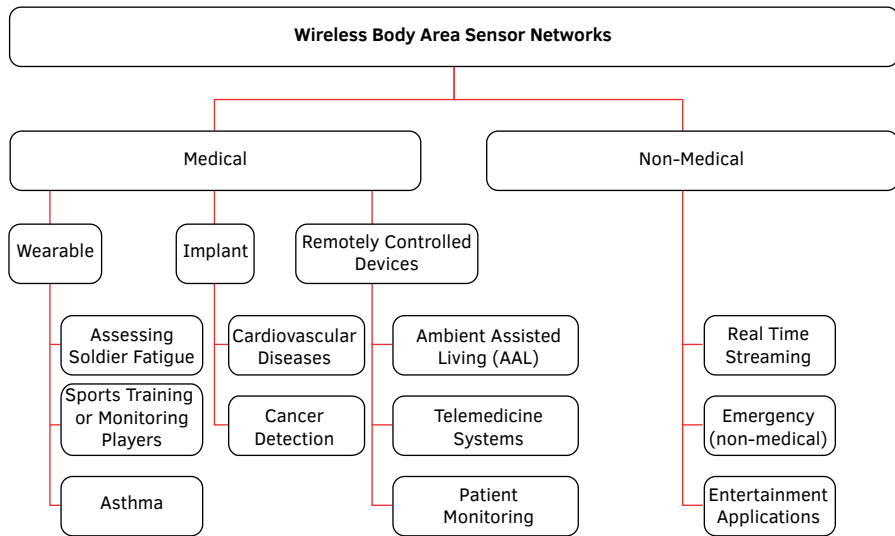

FIG. 3.9 Various applications of WBASNs (figure redrawn from [139]).

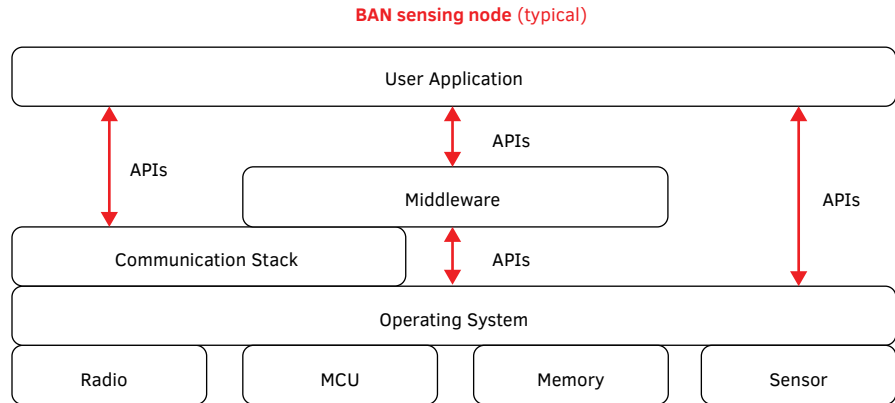

FIG. 3.10 BAN node, Generic Architecture (figure redrawn from [137]).

Current trends suggest that WBANs will become more ubiquitous both in Medicine and Healthcare as well as in the quotidian context due to their capabilities for continuous monitoring and early-detection features [138], [139].

3.4 A System Architecture

As detailed at the beginning of this chapter, the promise of the proposed alternative *intelligence in the built-environment* approach is to be demonstrated in a constrained manner via a salient use-case. This proof-of-concept use-case centers around the promotion of comfort and health among the elderly via assistive devices and solutions developed as integral parts of the inhabited space itself. That is, within this space in the present setup, three categories of solutions may be found with different degrees of physical integration yet all integrated via the same information backbone:

- 1 *Embedded*: systems integrated into the very architectural tissue (e.g., walls, floors, ceiling; general structure, etc.). These are explicitly deliberate and must be planned *as part of the architecture* in the early stages of the design process.
- 2 *Complementary*: systems external to the architectural design yet conceived as compatible (spatially and physically) and complementary add-ons. These may be envisioned yet remain optional depending on the evolving needs of the user across time. That is, with the physical deterioration associated with the natural ageing process, users may require additions and/or modifications to existing services provided by their intelligent built-environments.

Due to their complementary character, these systems retain a certain degree of independence with respect to architectural design. On the one hand, they may be conceived as design-agnostic furnishings that work well in a variety of spaces. On the other hand, if a possible or probably need for them is foreseen early in the design process, spatial requirements as well as supporting structures may already be planned into the design.

- 3 *Ambulant*: systems that may be worn (e.g., Apple® Watch™, Fitbit®, etc.), carried (e.g., smart-devices, etc.), or otherwise free to roam (e.g., the TurtleBot [147], etc.) without a fixed location. These are systems completely independent of the architectural design process that work with the built-environment's informational infrastructure to monitor, gauge, notify, and support the users.

At present such devices—in general—have grown increasingly common in people's lives. However, the type of ambulant systems as well as their degree of integration into the overall intelligence economy of the built-environment envisioned here differ. In the present setup, they exchange and share information directly with the built-environment as any other node, whether integrated or not. That is to say, whereas

consumer wearables require apps to let their users know of particular physiological data, in the envisioned intelligent built-environment such devices share this data as well as receive inputs from the built-environment itself, directly.

The System Architecture that enables the underlying information backbone was expanded progressively with each of the devices and solutions developed as part of the present use-case proof-of-concept. At its onset the System Architecture inherited a *Wireless Sensor Network* (WSN) previously setup for a fall-detection and -intervention system [33] and added three *BeagleBone Black*® [148] (BBB) development platforms, i.e., a (1) *Coordinator*, a (2) *Router*, and an (3) *End Node*; an (4) *Arduino UNO*® [149] MCU coupled with *Libelium*®'s *e-Health Sensor Platform V2.0*® [150] (e-Health kit); (5) three *PunchThrough*®'s *LightBlue Bean*®s [151] (LBBs); and (6) *Fitbit*®'s *Charge HR*™ [152]. By the time of the twelfth and final development in the scope of this dissertation, the System Architecture had four specialized subsystems (see Figure 3.11), each containing a heterogeneity of technologies and protocols: (1) a *Local system* (see Section 3.4.1), which establishes the WSN; (2) a set of *Wearables*, which extend said network's sensing capabilities to include more personal ranges (see Section 3.4.2); (3) *Remote / Cloud Services*, which connect the network with Internet-based services and functions (see Section 3.4.3); and (4) *Ad Hoc Support* interfaces (see Section 3.4.4), which enable direct user-interventions within the network.

The main difference of this architecture from that of typical AmI/AAL—or even IA/AA—solutions is that it is not encapsulated within a local structured environment. Instead, this system is said to be extended in that said local structured environment. IT IS but a subsystem in a larger cyber-physical whole. The system is *extended* in terms of both its sensing as well as its actuation capabilities, both of which may perform beyond the local *structured environment*. For example—and with respect to *sensing*—in the present architecture, the *local system* continues to monitor the user's activity levels even when he/she is outside of the local *structured environment*. That is, the user-activity recorded by an activity tracker (see item 9, Figure 3.11) is downloaded by the *local system* from the tracker's manufacturer's servers via an official API. This enables the local WSN to process user-activity data continuously, which is necessary in order to develop high-fidelity personalization [153]. With respect to *actuating*, in a situation where the user has collapsed and is unresponsive, the system is capable of acting beyond its local *structured environment* by sending free as well as fee-based SMS/email notifications to care-takers and/or family-members for intervention purposes [154].

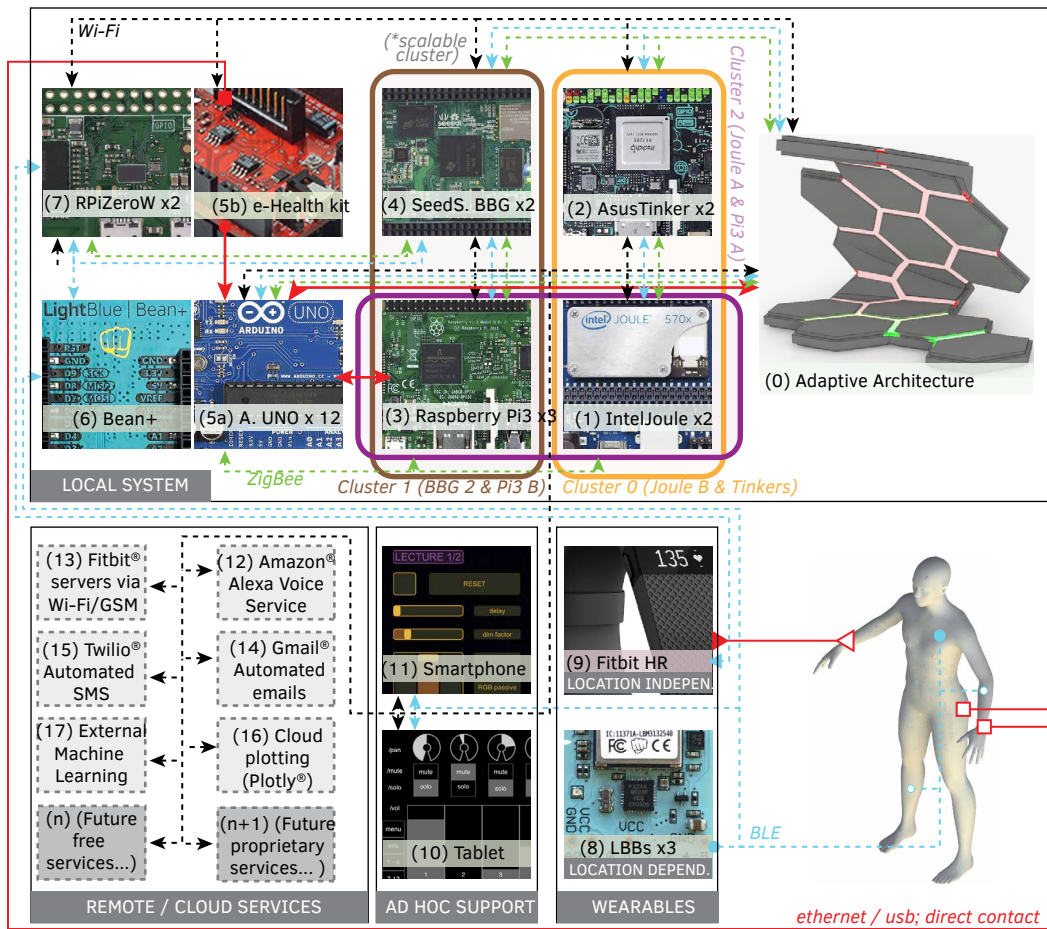

FIG. 3.11 Four main subsystems in core System Architecture: Local System; Wearables Subsystem; Remote / Cloud Services Subsystem; and Ad Hoc Support Subsystem.

Another difference is that the underlying and enabling WSN is designed as highly heterogeneous—in terms of hardware, software, and communication protocols—in order to subsume functional, operational, and economic advantages across technologies (see Figure 3.11). Admittedly, researchers have noted that commercial and/or proprietary solutions are often closed, rendering seamless integration with non-commercial and/or non-proprietary solutions highly cumbersome (at best) or unfeasible (at worst) [155]. This has raised challenges related to interoperability within heterogeneous systems (see [156], for example), which is partly the reason why some AmI solutions have implemented homogeneous products and/or protocols.

Nevertheless, in the last five years manufacturers of proprietary products and services have acted on a vested interest in making their products interoperable with a variety of systems in order to broaden their market. Consequently, an increasing number of proprietary APIs have enabled seamless integration of some proprietary products and services with non-proprietary counterparts.

By virtue of its architecture of subsystems as well as of its heterogeneity, the system is highly scalable and open, capable of growing or shrinking to fit a variety of scales and scopes; and of integrating newer devices and of deprecating outdated ones in order to respond more appropriately to evolving tasks at hand.

3.4.1 1st subsystem: Underlying Mechanism, Local system

A variety of MCUs and development platforms serve as nodes dependent on the local structured environment. Nodes with low-storage and limited information processing capabilities serve as low-energy end devices/routers, and are principally responsible for intermittent sensor-data gathering and relaying⁴². These nodes communicate via *Bluetooth Low Energy* (BLE) in low-range and ZigBee⁴³ in high-range. Nodes with open storage-capacities, medium-performance information processing capabilities gather and store raw sensor data, parse it, and both make it available to any nodes in the network as well as stream it to Plotly[®] via Wi-Fi⁴⁴

Nodes with high-performance information processing capabilities are principally responsible for coordination and computation⁴⁵. These nodes may be clustered to form more powerful nodes depending on the load-requirement and exchange data with one another and with other nodes via Wi-Fi, BLE, or ZigBee depending on the frequency as well as the latency-requirement. In one particular case, wired connections are used between nodes for data exchange (i.e., item 5 with 3, Figure 3.11). If necessary, all Linux-running devices, regardless of individual computational power or predetermined function, may conform a cluster.

⁴² Viz., Arduino[®] UNO[™] as well as PunchThrough[®]'s LightBlue Bean+[™] and LightBlue Bean[™] (LBB)—items 5, 6, and 8, Figure 3.11.

⁴³ ZigBee was developed for *Wireless Sensor Networks* [125].

⁴⁴ Viz., Raspberry[®] Pi Zero W[™] (RPiZW)—item 7, Figure 3.11.

⁴⁵ Viz., Intel[®] Joule[™], Asus[®] Tinkerboard[™], Raspberry[®] Pi 3[™] (RPi3) and SeedStudio[®] BeagleBone Green[™]—items 1-4, Figure 3.11.

The present configuration is one of possible many. The items featured as well as the multiple instances of each serve to represent a typical highly heterogeneous (both in terms of architecture as well as communication protocols and services) and affordable foundation capable of sustaining the growing complexity of subsequent developments and implementations.

3.4.2 **2nd subsystem: Wearable devices**

A set of three LightBlue Bean™s (LBBs) conform the location dependent wearables while a Fitbit® Charge HR™ activity tracker (item 9, Figure 3.11) the location independent wearable. The former detects movement in the upper-body, upper- and lower-extremities and advises the system to listen for *Open Sound Control* (OSC) packets corresponding to accelerometer data sent from a smartphone (see subsystem 3 below). Alternatively, if no smartphone is present, the LBBs broadcast accelerometer data via BLE into the system as well. While the principal function of said LBBs in previous implementations, this alternative is relegated to a contingency measure due to the energy-consumption of constant and sustained data streaming. Both OSC and BLE accelerometer data are used to build and update *Support Vector Machine* (SVM) and *k-Nearest Neighbor* (*k*-NN) classification models and to feed real-time data in the *Machine Learning* (ML) mechanism for *Human Activity Recognition* (HAR).

The principal function of the activity tracker is to gather heart-rate and physical activity (in terms of steps taken and distance covered) data continuously regardless of the location. When the user is inside the structured environment, the LBBs in conjunction with a smartphone also provide user-activity data to the system for HAR. But when the user is outside of said environment, the WSN continues to draw limited data gathered by the activity tracker by downloading it from Fitbit®'s servers (the tracker synchronizes with the servers via mobile data when Wi-Fi is unavailable).

3.4.3 3rd subsystem: Remote / Cloud Services

Six cloud-based services conform this subsystem, three of which were first integrated in the ISARC 2016 conference article [153], and three others newly integrated into the current ecosystem. The inherited three are the following: (I) external ML mechanism via MATLAB® (item 17, Figure 3.11); (II) data exchange with Fitbit®'s servers via its API (item 13, Figure 3.11); and (III) cloud data-storage and -plotting via Plotly®'s API (item 16, Figure 3.11). And the newly integrated three are the following: (IV) Amazon®'s *Alexa Voice Service™* (AVS) (item 12, Figure 3.11); (V) automated SMS notifications, both via Twilio®'s API (item 15, Figure 3.11) as well as via a T35 GSM shield as part of one of the end-device nodes of subsystem 1; and (VI) automated email notifications via Gmail™'s API (item 14, Figure 3.11).

3.4.4 4th subsystem: Ad hoc Support devices

In the last five years, smartphones have become convenient and ubiquitous tools for the tracking of inhabitants across a space [39], fall detection [154], [157], and HAR via ML [158]–[160], which in conjunction with their battery life and rechargeability are the principal reasons why they are the preferred means of accelerometer-data gathering in this development. In addition to this function, a user-interface / configuration mechanism is also enabled via a proprietary (viz., TouchOSC™ by Hexler Limited®) and a free (viz., Control by Charlie Roberts) smartphone application. This mechanism enables the user to override automation by permitting manual input / configuration.

Similarly, a tablet device has also been integrated into the ecosystem in order to provide both another user interface with a more comfortable viewing area as well as a means to modify the behavior of the LBBs and Bean+ devices via BLE. Unlike the Linux-based devices of the ecosystem, the LBBs and Bean+ cannot be accessed wirelessly via *Secure Shell* (SSH). Nevertheless, any necessary modifications to the devices' program or sketch may be effected wirelessly via the tablet. For example, one of the LBBs could be tasked with gathering temperature data on the user for a certain period of time and at varying intervals instead of notifying acceleration events. Both the smartphone and the tablet may access the LBBs and Bean+ devices via BLE, and both are installed with the user-interface / configuration applications to enable parallel modifications should this be necessary.

4 Demonstrator Environments

This chapter presents the types of environments within which the implementations / demonstrations in Chapter 5 were situated. There are two main types of environments, a real and a virtual. Due to their character, requirements, and/or objectives, some implementations required a real physical environment to demonstrate their feasibility, functionality, and promise. Similarly, some others were physical built-environment agnostic, where their feasibility, functionality, and promise could be demonstrated in a virtual context. While all implementations were cyber-physical, their **proof-of-concept** interaction methodologies took place in the following assortment of real and virtual environments. Moreover, it must be noted that these environments serve as deployment contexts within which to unfold systems and services, and that these in themselves may be developed or integrated into a variety of other intelligent built-environment contexts—in particular, to that of **smart** or assistive built-environments for the elderly. Finally, it should be noted that these environments are fragments due, in large part, to funding availability (or unavailability, rather). Nevertheless, as fragmentary minimums, they yet demonstrate the concepts coherently and succinctly—albeit in a constrained scenario, which might deviate from the focus on the elderly, yet it is explained how the presented demonstrators can be mapped to this core focus.

Section 3.2 detailed guiding *Indoor Environmental Quality* (IEQ) and *Quality of Life* (QoL) parameters for the development of *proof-of-concept* demonstrators pertinent to an intelligent built-environment for the elderly⁴⁶. In this Chapter, the environments within which said IEQ- and QoL-informed demonstrators will be deployed are detailed. Two main types of environments, a Physical and a Virtual—with two subtypes each—are represented. This assortment intends to highlight diversity of application-environments and should be interpreted as indicative rather than prescriptive—that is, the envisioned intelligent built-environment need not be exactly as the ones detailed shortly, but rather their features may serve as examples and guideless of a type of environment compatible and complementary to the promoted *cyber-physical* approach.

4.1 Physical / Tangible / Descript—or Architecture-specific

Four demonstrators in Chapter 5 (see Section 5.1 - Section 5.4) are situated within the following respective real / physical fragmentary environments. The first two are dynamic, indicative of transformative / adaptive architectures whose tangible form and/or intangible states act, react, interact with the occupant(s). The latter two are static, indicative of robotically fabricated environments that are deliberately construed and designed to integrate with *Information and Communication Technologies* (ICTs) to formally complement digitally driven services. Their form is geometrically complex—due to optimization as well as ICT requirements—and their constitution require a componential approach as well as material hybridity [40].

With respect to the present use-case emphasis (i.e., *smart homes* for the elderly), the first two “dynamic” (that is, *physically transforming*) environments are conceptually conceived (a) to stimulate activity via physical transformations that discourage a sedentary lifestyle; (b) to compensate for the progressive deterioration of mobility and agility associated with the natural ageing process via transformations that

⁴⁶ Recall that this is a constrained use-case example intended to demonstrate the promise of the design approach promoted in the present work. Both the IEQ and QoL parameters are selected for this particular use-case, and it should be imagined that different audiences—with different challenges and/or limitations—may require a different combination of informing parameters. The approach remains the same.

accommodate to the user's physical limitations; and (c) to ascertain basic comfort with respect to core-indicators of IEQ. Similarly, the latter two “static” (that is, *physically non-transforming*) environments are conceived (a) to monitor the user's well-being via deliberately embedded *invisible*—and therefore unobtrusive—ICTs; (b) to analyze the user's limited physical and physiological data to be compared to prescriptive baselines; and (c) to engage internal services (e.g., ventilation, illumination, heating, etc.) to regulate for comfort as well as external services (e.g., emergency notifications when detecting that the user has collapsed, etc.) to ascertain basic well-being.

4.1.1 Hyperbody: Transformable Architecture (fragment)



FIG. 4.1 Reconfigurable apartment developed with MSc 2 students—B. C. Aldemir, J. van Lith, S. Kanters, S. van Kempen, I. Slodka, and M. Wiczorkowski—and industry partners at Hyperbody, TU Delft (Pop-up Apartment, 2013)[97].

Hyperbody's reconfigurable apartment is an experiment into designing a small apartment of 150 m³ that has all the spatial qualities and functional performances of a standard 300 m³ apartment. The initial assumption was that when a user is in the kitchen or living room, this user does not use the sleeping room at the same time implying that at one moment of the day large sections of the space could cater to only one or two functions. Spatial transformation is exploiting material and geometrical properties in order to easily facilitate continuous change of use. Developed as a compliant mechanism the system transfers input force or displacement through elastic deformation. Consisting of a monolithic (single-piece) or jointless components, this adaptive architecture was envisioned to easily populate empty office buildings, which at the time corresponded to six million square meters and the number is—until now—still growing.

Such a reconfigurable apartment could employ *Wireless Sensor Network / Body Area Network* (WSN/BAN)-enabled high-tech intelligence working in conjunction with architectural components in order to coordinate physical / geometrical rearrangements and/or spatial reconfigurations according to a set of conditions established in order to maximize the welfare of the user(s) (see Figure 4.1 and its implementation in Section 5.1). The reconfigurable apartment is intended to cater to quotidian activities such as sleeping, eating, etc.; and the heterogeneous and decentralized WSN integrated into it is envisioned to continuously gather interior environmental data specific to the respective activities via directly and indirectly attached sensors.

The apartment is envisioned to gradually *learn* that when the user is studying, he/she prefers a more private and intimate space, and accordingly walls, doors, ceiling heights, etc., may be adjusted in conjunction with temperature and illumination settings in order to instantiate just such space. Similarly, if he/she would prefer an open and welcoming space when socializing, the apartment would adapt its physical, geometrical, and spatial properties accordingly. Furthermore, the apartment would encourage the user to adopt a healthier lifestyle by initiating spatial reconfiguration when physical activity is recommended. It would also adjust climate according to monitored needs. Heating, lighting, and ventilation would be distributed and locally deployed when needed and as needed, increasing levels of comfort while at the same time minimizing energy-waste. In this context, sensor-actuated environments are not only customizable in order to provide healthier ambiance, but they may also offer solutions for managing the demands associated with rapid population growth, urban densification, and the contemporary inefficient use of built space by enabling multiple, changing uses within reduced timeframes.

4.1.2 Hyperbody: Protospace 4.0 (fragment)



FIG. 4.2 Protospace 4.0, fragment built for GSM3 [161].

A fragment of *Protospace 4.0* (see Figure 4.2) was repurposed to conform a responsive stage on the occasion of the *GSM3* conference. Sixteen differentiated and function-specific components, viz., *protoCELLs* [162], are assembled to conform said stage while integrating a custom-designed and -built interactive / adaptive LED-based illumination system. The indented borders of each component were lined with LED-strips, which enabled individual color control. In conjunction, these indented borders create a continuous indented seam between all components, which is covered with translucent material in order to enable diffusion of color and intensity. The combination between this translucent cover with two separate individually controlled LED-strips enables the instantiation of multiple color gradients and intensities (see Figure 4.3 and the corresponding demonstrator in Section 5.2).



FIG. 4.3 *Top: Single protoCELLs (Left); testing Perspex® over LED1 (Right). Bottom: Generated color gradient (Left); Acrylic connections & two LED-strips within the seam of two protoCELLs (Right).*

The system-architecture of the interactive / adaptive illumination system involves 12 Arduino® UNO™ microcontroller units (MCUs) that are physically connected to a computer via USB hubs. In the implemented revision, this computer is replaced by an Intel® Joule™, thereby integrating the stage and its responsive illumination into the system-architecture ecosystem of the present implementation. As a stand-alone system, the stage is configured to behave in particular and predetermined patterns. As a subsystem of a more sophisticated system-architecture, it is now imbued with ML capabilities for non-predetermined actions, reactions, and interactions.

While this stage is not, strictly speaking, an abode or place of permanent and/or long-term habitation, the systems and services that are integrated into it (see Section 5.2) as well as the design principles behind it may be extrapolated to suit proper abodes. Accordingly, the implementations within this environment are indicative of solutions that may be conceived for any intelligent built-environment (in general) and for *smart homes* for the elderly (in particular, as the scaled-down deployment context of the present work). For example, while it may not be immediately clear how this stage is relevant to the elderly, it may be imagined that the services it enables—i.e., game-like interaction with panels, visual stimulation via illumination / intensity / color regulation, fatigue-detection and compensatory measures, etc.—may be part of a *playware-enhanced* [163] living-room that encourages the user to remain actively engaged.

4.1.3 Robotic Building: Intelligent Architectural Components (fragment)

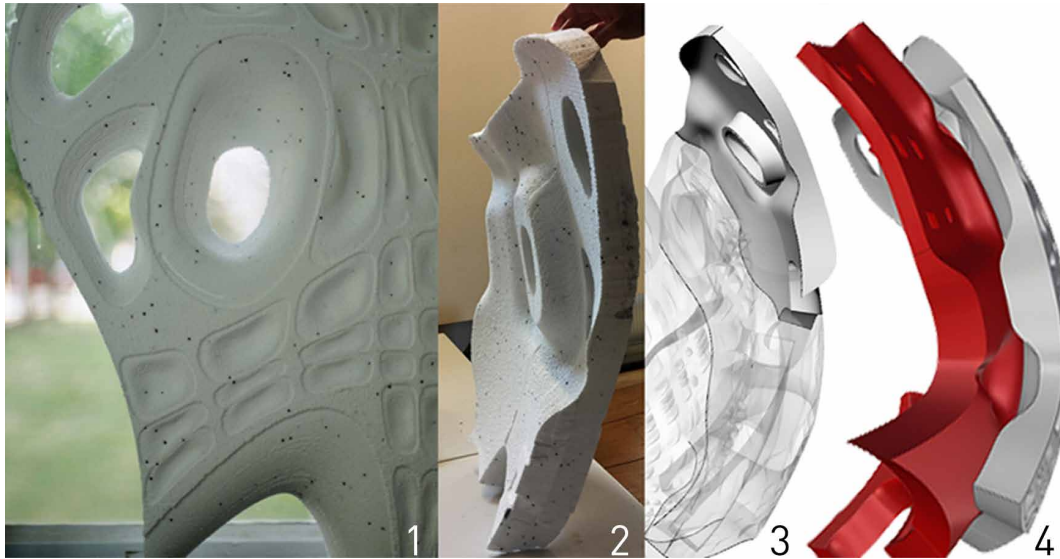

FIG. 4.4 Robotically fabricated components via material subtraction in D2RP. *Left-to-Right*: Single-layer physical prototype, (1) front-view and (2) side-view; Virtual 3D model, (3) single-layer side-view and (4) double-layer (inner and outer) side-view. Concept by C. Du, J. Duan, and F. van Buren [166].

The developed D2RP components are considered from three different perspectives, each pertaining to a different set of functional requirements and scale—i.e., *Macro*, *Meso*, and *Micro*—in order to yield geometries with deliberate densities and porosities (see Figure 4.4). The components are fabricated from Styrofoam blocks via material subtraction with a six-axis KUKA robot [167]. From the *Macro* perspective, human movement is mapped onto an initial geometry with data from human body-posture analysis. The resulting form is optimized via structural analysis, consideration of environmental conditions and loads (e.g., wind direction and loads, etc.), and solar radiation with respect to a specified geographical location. Throughout this process, *componential* principles inform the design, which ensures that differentiated components are deliberately fabricated to conform seamlessly with one another to yield a unified whole. Furthermore, *hybridity* principles enable material heterogeneity within specific components as required by functional considerations. For example, structural analysis identifies areas across the geometry that are subjected to tension, compression, shear, bending, and torsion forces. The components within which these areas are located require deliberate material heterogeneity in order to properly account for said forces while preserving *componential* principles.

From the *Meso* perspective, each component is designed to consist of two irregular yet mutually complementary layers—one external and one internal (see Figure 4.4, *item 4*)—while conforming a middle cavity as a continuous air-channel. Moreover, other cavities across both layers are designed to integrate mechanized cooling, heating, ventilation, and illumination systems, where their operation is controlled by architecture-embedded nodes in the built-environment’s WSN (see its corresponding demonstrator in Section 5.3).

From the *Micro* perspective, variation of densities and porosities at the material level are considered with respect to functional requirements related to natural illumination and ventilation as well as to the potential for particular views.

4.1.4 Robotic Building: Student housing (fragment)

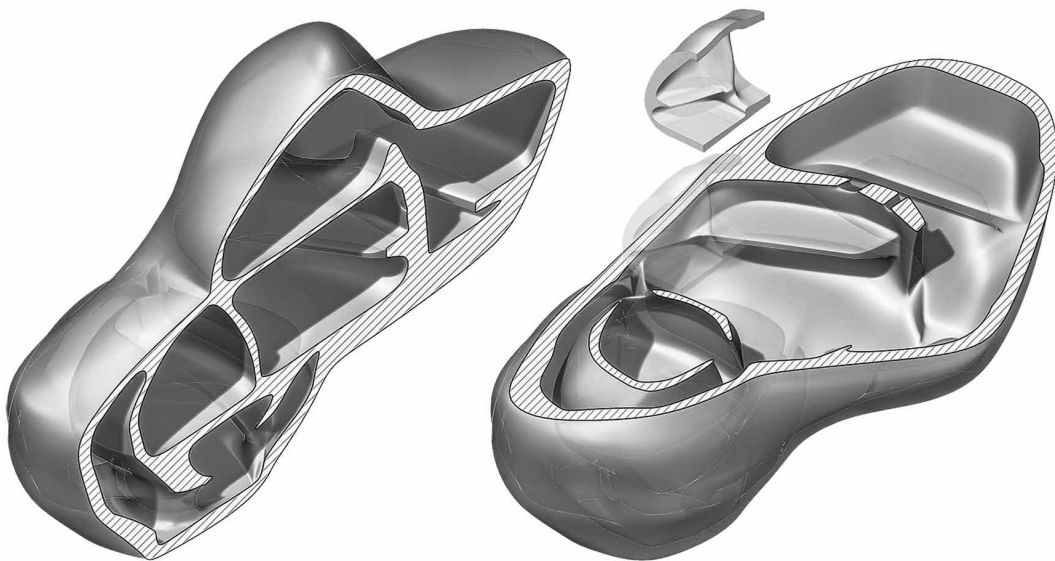

FIG. 4.5 Schematic design of student housing by M. Moharram, H. Hesham, and M. Elmeligy [164].

For the demonstrator in Section 5.4, an integrated single-occupant student housing unit is conceptualized. This unit is formally defined by optimization strategies based on point-clouds, where each point bears both physical and non-physical information about the envisioned space. Various sets of points provide different

types of information—i.e., sets corresponding to spatial definition, structure analysis, heating and cooling, lighting requirements, and the integration of ICT devices (see Figure 4.5 and Figure 4.6). The design-to-production approach is tested by robotically producing the real-scale fragment / prototype as a multi-layered hybrid component consisting of concrete, *Expanded Polystyrene* (EPS), and smart devices. This fragment follows *componentiality* and *hybridity* principles characteristic of *Design-to-Robotic-Production & Operation* (D2RP&O) [40]. That is to say, with respect to *componentiality*, complex geometries are intelligently divided into components following a structural analysis to identify optimal division-seams that do not compromise physical integrity (see Figure 4.7).

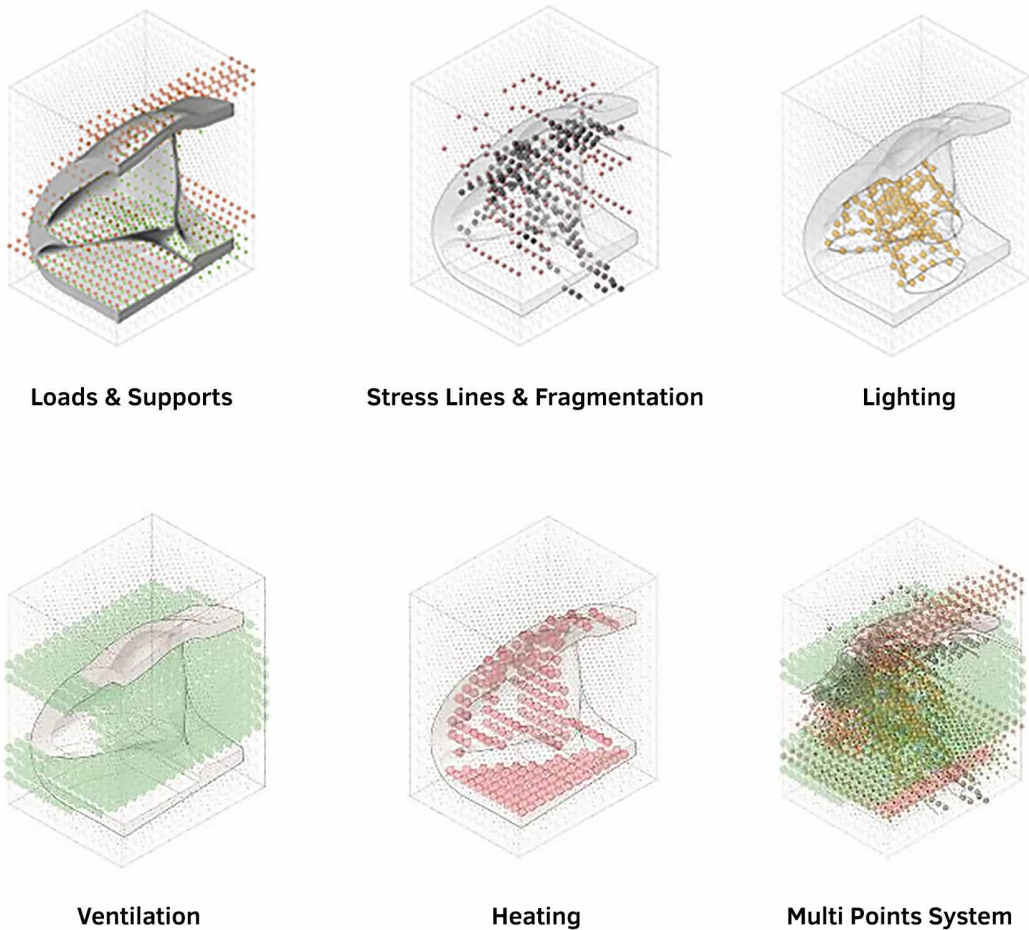

FIG. 4.6 Sets of point-clouds corresponding to different types of information.

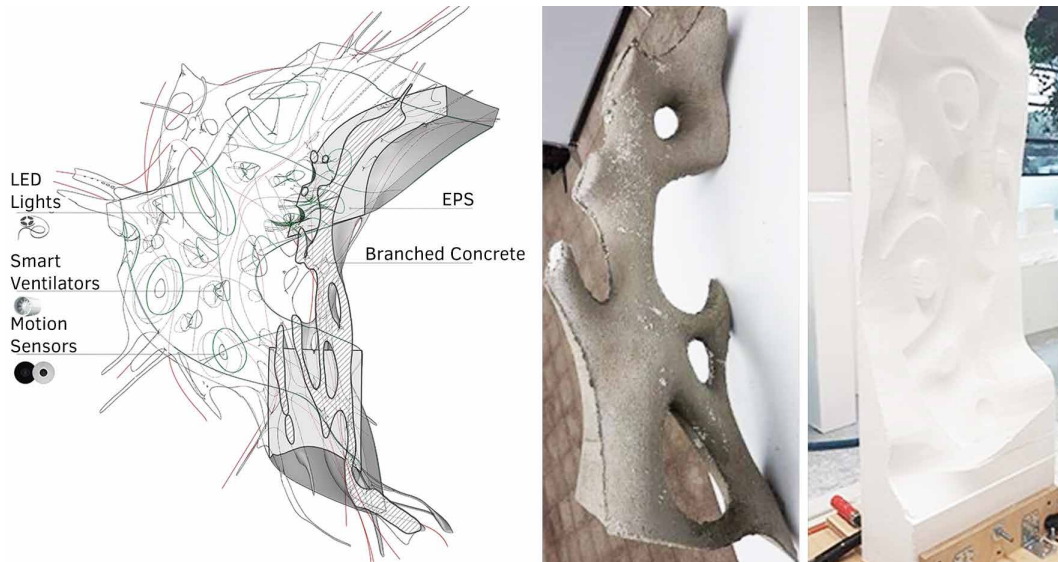

FIG. 4.7 Left: Real-scale fragment's multi-layered fabrication / integration logic. Robotically fabricated concrete (Center) and EPS (Right) fragments.

With respect to *hybridity*, the composition of each component unit consists of the integration of materially heterogeneous layers, each design in direct response to a purpose or a function. For example, the concrete layer is formed following the stress lines extracted from the final element model. Similarly, some of the cavities in the EPS layer are designed with ICT-integration in mind, while others with *Comité Européen de Normalisation* (CEN) Standard EN15251-2007 [165] specified ventilation requirements.

The real-scale fragment representative of the conceptual unit is developed in three main steps. First, structural loads and supports locations are determined based on the configuration of the initial form. By using the resulting geometry and the identified locations of supports and loads, a *finite element* model is created and its corresponding stress lines extracted. These lines are then used to generate the structural elements inside the building component. Second, required lighting is determined based on activities and their corresponding minimum / maximum thresholds of illumination during a typical 24-hour period. This informs the shape and the location of porosities and cavities in the component, enabling the integration of LED-based illumination systems where necessary. Third, heating and cooling requirements inform the orientation of ventilation openings, the integration of intelligent ventilation systems, and the position of required sensors for automated control of said openings to ascertain partial IEQ. Finally, these considerations determined the composition and arrangement of different materials (i.e., concrete and EPS) and identified optimal locations for the integration of ICT devices, which collectively shaped the resulting component.

4.2 Virtual / Intangible / Non-descript—or Architecture-agnostic

4.2.1 The Virtual as placeholder Digital Twin

Three demonstrators in Chapter 5 (see Section 5.5, Section 5.9, and Section 5.11) are situated within virtual environments. That is, the developed devices are indeed real and functional, but their backdrop—or context—within which their interaction methodologies were tested was virtual. While demonstrations within virtual environments may be an affordable approach to prove a concept, the consideration behind the use of the virtual domain in these demonstrators is less frivolous—that is, the virtual world was conceived as a deliberate *digital twin* of some would-be *smart home*. That is to say, while the virtual worlds in the demonstrator setups appear non-descript and generic, they are deliberately so to abstain from bias towards particular architectural designs. This was important to demonstrate that the concept of the developed services and solutions would work across a variety of architectural designs.

Nevertheless, when considered as *real-world* solutions, these virtual worlds would be tailored to mirror specific designs deliberately conceived for specific audiences. Accordingly, while the demonstrators use generic virtual worlds to demonstrate the functionality of the concept, it is worth stressing that the generic would give way to the highly specific in higher *Technology Readiness Levels* (TRLs) [53]. This is because the very functionality of these three demonstrators—in this environment—depends on the very formal / spatial setup of the environment as represented in the virtual world, and functionality would be unreliable if the distances, dimensions, attributes, materials, etc., of the real *smart home* did not correspond to those of its *digital twin*. After all, the *digital twin* serves as the digitized version of the built-environment, and one that serves the demonstrator services and solutions with necessary built-environment (formal and spatial) inputs against which interactions may be gauged, determined, and identified.

In these demonstrators, *Processing* (for Section 5.5), *PyGame* and Google Brain®'s *TensorFlow™* [168] (for Section 5.9), and *Rhinoceros / Grasshopper* (and Section 5.11) were used both to create the virtual setup and to interface the developed devices and solutions with virtual objects / attributes.

4.2.2 The Non-Descript Environment as indicative of Architecture-independence

Five demonstrators in Chapter are situated in deliberately non-descript environments to highlight their independence from particular Architectural inclinations or preconceived theoretical notions of the built-environment. Three demonstrators present devices as multi-façade cladding for an undefined building-envelope (see Section 5.6 - Section 5.8); one presents transformable staircases that may be integrated into interior and exterior built-environments (see Section 5.10); and a final demonstrator presents an intelligent rain-water harvesting system as a stand-alone add-on (see Section 5.12)—as indicative of one of many possible highly portable solutions that may be used to scale up the intelligent built-environment as *Cyber-Physical System* (CPS).

5 Demonstrators

This chapter presents all devices developed as demonstrators of the approach promoted in this thesis. Each device was implemented at different stages of development of the System Architecture and are intended to be considered as both stand-alone solutions as well as modules integrated into a comprehensive whole—i.e., a de facto prototype-expression of the intelligent built-environment as **Cyber-Physical System** (CPS).

Section 3.2 and Chapter 4 detailed both *Indoor Environmental Quality* (IEQ) and *Quality of Life* (QoL) guiding parameters as well as the types of environments within which *proof-of-concept* demonstrators—motivated by said parameters—would be situated. Their relationship and their features are catalogued in Table 5.1.





In total, twelve discrete demonstrators were developed via a progressively complex System Architecture (see Table 5.1). The objective of each development was to instantiate assistive features and services that would enhance a given elderly user's well-being and comfort. And while the specific scope of this thesis has centered around this important end-user and use-case, the assistive promise of these solutions extends beyond it to society in general. That is to say, some of these systems may be envisioned in schools, offices, hospitals, vehicles, and even as part of urban furniture, *all* integrated in one interconnected intelligent system (see, for example, the *German Academy of Science and Engineering's* envisioned global application processes for CPSs in Figure 6.1).

While the main reason different solutions were developed separately and across time had more to do with the availability of research funding (or lack thereof), the approach itself is indeed indicative of how progressive development is envisioned to take place. By considering the built-environment as a CPS from the early stages of the design process, a decentralized and highly scalable System Architecture may be integrated such that additional modules and services may be added across time and as requirements change. Given this embedding of enabling technologies into the very *tissue* of the built-environment, assistive services may be instantiated without the need of expensive architectural alterations or construction retrofitting. Furthermore, upgrades to the underlying information systems may be undertaken over time as well, ensuring the currency and efficiency of assistive services and features.

The solutions presented in this chapter are *proofs-of-concept* developed—on average—to a *Technology Readiness Level* (TRL) [53] of 5-6. Nevertheless, as the principal and overwhelming majority of core services are open-source—or free to use, if proprietary—there is reason to believe that subsequent higher TRL developments would remain affordable and accessible to people from a variety of socio-economic backgrounds.











All the solutions detailed in the following sections—excepting the 2nd prototype of the solution presented in Section 5.7.2—resulted in peer-reviewed articles in conference proceedings and/or journals. They were all developed with the assistance of real human users, who were instrumental reminders of the purposes of the guiding IEQ and QoL parameters.

TABLE 5.1 Demonstrator implementations in relation to (1) Environment (Physical / Virtual) and (2) informing IEQ and QoL parameters (see Section 3.2). IEQ, left-to-right: Thermal Comfort, Interior Air-Quality, Sound / Acoustics, and Light / Illumination. QoL, left-to-right: Health, Independence, Safety / Security, and Activity.

#	Title	Demo Environment	IEQ	QoL
1	An Extended Ambient Intelligence Implementation For Enhanced Human-Space Interaction [153]	 PHYSICAL	HYPERBODY	       
2	A High-Resolution Intelligence Implementation Based On Design-To-Robotic-Production And -Operation Strategies [169]			       
3	Integration Of A Wearable Interface In A Design-To-Robotic-Production And -Operation Development [170]		ROBOTIC BUILDING	       
4	Deep Learning Object-Recognition In A Design-To-Robotic-Production And -Operation Implementation [171]			       
5	Development Of A Smart Sleeve Control Mechanism For Active Assisted Living [172]	 VIRTUAL	DIGITAL TWIN	       
6	Development Of A Light-Tracking And -Redirecting System Actuated By Hand-Gesture Recognition [173]		NON-DESCRIPT	       
7	Adaptive Building-Skin Components As Context-Aware Nodes In An Extended Cyber-Physical Network [174]			       
8	Actuation Confirmation And Negation Via Facial-Identity And -Expression Recognition [175]			       
9	Development Of An Eye- And Gaze-Tracking Mechanism In An Active And Assisted Living Ecosystem [176]		DIGITAL TWIN	       
10	Development Of An Adaptive Staircase System Actuated By Facial-, Object-, And Voice-Recognition [177]		NON-DESCRIPT	       
11	Development Of An Acoustically Adaptive Modular System For Near Real-Time Clarity-Enhancement [178]		DIGITAL TWIN	       
12	Development Of An Adaptive Rainwater-Harvesting System For Intelligent Selective Redistribution [179]		NON-DESCRIPT	       

5.1 An Extended Ambient Intelligence Implementation for Enhanced Human-Space Interaction⁴⁷

TABLE 5.2 Demonstrator 1's summary—environment, parameters, interactions, key results, purpose, and pertinence.

DEMO ENVIRONMENT				IEQ				QoL			
											
HYP	ROB	DT	ND								
INTERACTION METHODS		USER-DRIVEN		Appendix, IEQ Section 1.A				Appendix, QoL Section 1.B			
		SENSOR-DRIVEN				¶ 1 ⁴⁸	¶ 1	¶ 1	¶ 1		
KEY RESULTS		USER-DRIVEN		Appendix, IEQ Section 2.A				Appendix, QoL Section 2.B			
		SENSOR-DRIVEN						¶¶ 1,2,3	¶¶ 1,2		
PURPOSE		<ul style="list-style-type: none"> – An architecture-embedded mechanism that detects prolonged inactivity and engages physical transformations in the built-environment to instigate physical activity. – A wearable <i>Body Area Network</i> (BAN) mechanism, situated within the local structured environment, that detects prolonged static posture and engages physical transformations in the built-environment to encourage the user to exercise. – A mechanism involving a wearable device, compatible yet independent from the local structured environment, that enables activity recorded outside of the smart home to be uploaded and shared with the intelligent built-environment remotely. This enables the built-environment's system to receive activity-related physiological data from the user even when he/she is in external, non-structure environments. 									
PERTINENCE		<ul style="list-style-type: none"> – Physically active elderly adults (>59 years) enjoy reduced risk in cardiovascular diseases, cognitive decline, and depression (among other age-related and/or sedentary-lifestyle diseases) [180]. – Physical transformations in the built-environment may be used to regulate the acoustics of the space as well as the levels of natural and artificial—i.e., to make it direct / indirect—illumination to enhance the quality of the space [109]. 									

⁴⁷ This section is based on

 A. Liu Cheng and H. Bier, "An Extended Ambient Intelligence Implementation for Enhanced Human-Space Interaction," in *Proceedings of the 33rd International Symposium on Automation and Robotics in Construction (ISARC 2016)*, Auburn, Alabama, 2016, pp. 778–786. [153]

⁴⁸ The *Appendix* provides a tabular breakdown—or a catalogue—of the interaction methods present across all Demonstrators. For quick-reference, each demonstrator's *summary card* (e.g., Table 5.2) includes the paragraph reference(s) of its relevant interaction methods. For example, this number specifically refers to the first paragraph of the SOUND / ACOUSTICS section, with respect to IEQ, under USER-DRIVEN ACTION / INTERACTION in said *Appendix*.

Abstract

The proposed solution establishes a justified link between sensed physiological user-data with actuated architectural transformations within the prototype built-environment fragment detailed in Section 4.1.1. It does this via a series of interrelated mechatronic devices and architectural mechanisms that conform the Wireless Sensor Network (WSN). The architectural transformations explored are intended to promote the well-being of the user as well as enhance his/her overall experience of the space. In order to do this, a set of decision-making criteria to justify the link between sensed input and actuated output is defined. In the present scope, a variety of simple actuation events corresponding to particular scenarios are triggered based on a rudimentary decision-making mechanism.

In the first scenario, the user is assumed to be in a seating position, and his/her heart rate, perspiration levels, temperature, and changes in posture are processed to gauge the period and extent of user-inactivity. Based medical baselines, the user is tacitly encouraged to change position, stand and/or walk for a variable period of time by the actuating system's gradual shifting of the desk and seat positions. In the second scenario, the user is assumed to be in a standing position. The system gauges the period in which the user has been inactive in such a position and invites him/her to engage in exercises that are only possible with the appearance of specialized transformable components. Such components would tacitly shift to indicate that the activity levels are sufficient while leaving the user the option to continue through expressed persistence. In these two scenarios, the user's inactivity and static posture trigger the built-environment's transformations to encourage general physical motion and/or exercise. In the third and final scenario, the user is assumed to be absent from the structured environment for the majority of the day. The configuration of the interior environment adjusts itself in preparation for the arrival of its occupant into different combinations depending on the heart rate, and activity averages gathered remotely throughout the day. As a result, the configuration of the space may be more open and ventilated or more enclosed and hermetic.

These basic scenarios are sufficient to demonstrate that transformations in the built-environment are capable of engaging the user in response to his/her physiological state in order to regulate it.

5.1.1 Three sensor scenarios

The WSN developed in this implementation builds on the decentralized architecture implemented in [33]. In addition to three *BeagleBone Black*[®] [148] (BBB) development platforms, *Coordinator*, a (2) *Router*, and an (3) *End Node*; an (4) *Arduino UNO*[®] [149] microcontroller unit (MCU) coupled with *Libelium*[®]'s *e-Health Sensor Platform V2.0*[®] [150] (e-Health kit); (5) three *PunchThrough*[®]'s *LightBlue Bean*[®]s [151] (LBBs); and (6) *Fitbit*[®]'s *Charge HR*[®] [152], have also been integrated into the WSN. Only the *Coordinator* BBB node is used in the present implementation, while the remaining two will be used in subsequent development of the system. Furthermore, in addition to heterogeneity with respect to MCUs, the WSN operates across a variety of communication protocols, i.e., Bluetooth Low Energy (BLE), Wi-Fi, and ZigBee. The present combination of devices serves as a sampler of WSN functionality in exterior, interior, and wearable domains.

The BBB nodes represent the self-healing and meshed backbone of the WSN, while the Arduino UNO and e-Health sensors function as local embedded and principal sensors for the first scenario below; the LBB as the local ambulant and principal sensor corresponding to the second scenario; and the *Charge HR* as a remote ambulant and principal sensor corresponding to the third scenario. Although each scenario has a principal sensor system, it should be noted that all sensor systems play a role in each scenario. In the following subsections a description for each corresponding system is detailed.

1st Scenario: Local embedded sensing:

The e-Health kit is used in conjunction with an Arduino UNO MCU to gather physiological data—i.e., pulse, peripheral capillary oxygen saturation (SpO₂), sweat-levels, temperature—as well as pressure data as measured from a transformable workstation consisting of a desk and a corresponding seat. The galvanic and pulse oximeter sensors are fixed directly unto the fingers of the user while temperature and pressure sensors are placed throughout the seat. These sensors are wired to the MCU. Simultaneously, the LBBs are used to track changes in acceleration, which occur whenever a change in posture takes place. The data gathered is transferred to the MCU via BLE, which is then relayed to the *Coordinator* BBB via ZigBee and made available to all other BBB nodes in case future subsystems require such data. The *Coordinator* node both analyses the data and streams it via Wi-Fi to a cloud-based plotting and analytics service, i.e., *Plotly*[®] [181]. In this manner, long-term daily datasets are stored in *Plotly* and made accessible to any person and/or *Ambient Intelligence* (AmI) system with the proper user-credentials; while short-term datasets

are processed locally to trigger immediate corresponding actuation events. Over time, with the long-term statistical analysis, a personalized baseline may be ascertained. Short-term analysis would be set against this baseline to identify deviations from the user's *normal* state. Naturally, personalized baselines must also take into account prescribe medical baselines according to gender, age, weight range, etc.

According to the *World Health Organization* (WHO), physical inactivity is a leading risk factor for global mortality with approximately 3.2 million deaths each year [182]. In order to prevent, for instance, the formation of decubitus ulcers due to persistent applied pressure to a tissue region or to reduce the development of varicose veins [183] sensor-actuators embedded in the built environment will initiate physical movement or activity. Pressure and temperature datasets relative to time and extent may be sufficient to estimate the probabilities of ulcer formations [184]. With respect to varicose veins, when the user has been sitting on one muscle group and/or has remained inactive for extended periods of time, the *Coordinator* BBB will command the seat and the desk component to shift in different directions to tacitly encourage the user to shift his/her weight and/or to exercise his/her lower extremities. The duration and frequency of this interventive service vary and depend on inactivity levels considered against both short-term data as well as long-term personal statistical baselines.

2nd Scenario: Local ambulant sensing

A series of LBBs is used to provide the user with wearable devices operational within the structured environment. The redundancy in these devices is intended to enhance accuracy and regional coverage—i.e., one LBB represents a wearable attached to the lower extremities, another to the upper extremities, yet another to the core of the upper-body. As in the first scenario, the data is shared across the entire WSN as well as stored and analyzed in *Plotly*. When the extent and frequency of changes in acceleration from these three regions are minimal and scattered far between, the *Coordinator* BBB shifts exercise components towards the region of the user to tacitly invite him/her to increase in activity levels. In the present scope these exercise components are general and hypothetically assumed components, represented as attached to the shifting seat and desk/wall components (see Figure 4.1). At this stage it is not important to define particular types of exercises as long as the user is moving with frequency and consistency.

The principal objectives in this scenario include the second objective of the previous scenario as well as the intention to proactively engage the muscular and circulatory systems. Aside from these considerations, there is also the intention to engage the

user in entertaining tasks, as well-being is not confined strictly to medical concerns. The transformations instantiated in the geometry of the architecture may serve to engage the user in stimulating ways, some of which may have purely physical consequences while others may be both physically and mentally stimulating—for e.g., architecture-embedded *Playware* [185].











3rd Scenario: Remote ambulant sensing

A *Charge HR* activity tracker is used as the system's remote sensor node. This wearable device is designed to sense and record data pertaining to steps taken, heart rate, distance covered, calories burned, and floors climbed. The manufacturer's *Application Programming Interface* (API) provides a means for the proposed WSN to connect to their servers in order to download user-specific datasets pertaining to the listed activities. This API is first installed in the *Coordinator* BBB, which is used in a *Python* script expressly written to fetch such datasets. As with the previous two scenarios, the downloaded time-series data is parsed for local analysis as well as *Plotly* storage and analytics. Inside of the structured environment, the Fitbit® device synchronizes with the *Coordinator* BBB via BLE, and all collected data is subsequently relayed to Fitbit®'s servers via Wi-Fi. Outside of the structured environment, the device synchronizes with a smartphone with Fitbit®'s Application installed, and all collected data may be relayed to corresponding servers via cellular communication technologies (e.g., 3G/4G). It should be noted that in the unlikely event that the *Charge HR*™ should malfunction, Fitbit®'s iOS / Android application is capable of turning the smartphone into an *ad hoc* tracker, thereby providing a level of justified redundancy.

The principal objective in this scenario is to maintain uninterrupted physiological data-tracking with respect to the user even when he/she is outside of the structured environment. While he/she is within it, the Fitbit® device may be used in conjunction with the e-Health kit to refine the heart rate analysis. But when he/she is outside the environment, it is in the interest of the WSN to keep gathering physiological data for the generation of a personalized long-term statistical profile. In addition to this objective, this scenario demonstrates how a remote agent may still be capable to influencing his/her home environment while absent. That is to say, depending on the currency of the gathered data *in absentia*, and relying on GPS-tracking services to ascertain user proximity to the structured environment, the WSN may adjust the built-environment's configuration in order to provide a more suitable welcome to the user. If the measured heart rate has been consistently elevated, and the activity levels have been construed as "intense" (under Fitbit's criteria) within a recent period, the built-environment may reconfigure itself to instantiate a more open and highly ventilated space to help balance the user's physiological status.

5.2 A High-Resolution Intelligence Implementation and its extension based on Design-to-Robotic-Production and -Operation (D2RP&O) strategies⁴⁹

TABLE 5.3 Demonstrator 2's summary—environment, parameters, interactions, key results, purpose, and pertinence.

DEMO ENVIRONMENT				IEQ				QoL			
											
HYP	ROB	DT	ND								
INTERACTION METHODS		USER-DRIVEN		Appendix, IEQ Section 1.A				Appendix, QoL Section 1.B			
				¶ 1	¶ 2	¶ 2, 3	¶ 2				
		SENSOR-DRIVEN		Appendix, IEQ Section 2.A				Appendix, QoL Section 2.B			
				¶ 1		¶¶ 1,2	¶¶ 4,5,6				
KEY RESULTS		<ul style="list-style-type: none"> – A clustered Machine Learning (ML) mechanism capable of generating classification models for Human <i>Activity Recognition</i> (HAR)—i.e., walking, running, sitting, climbing stairs, or standing still. – A responsive integrated LED-lighting mechanism capable of (1) pulsating light-intensities when the user is idle; (2) tracing light-paths depending on user-interaction; (3) correlating colors with body parts of several (up to 6) individuals; (4) mitigating fatigue via lighting regulation / stimulation; and (5) responding to prolonged physical inactivity. – Integration of (1) a global and local ventilation system that ascertains prescriptive optimal temperature and humidity levels; (2) <i>Alexa Voice Service</i> (AVS) to enable recognition of voice-commands that manually instigate or override automatic operation; and of (3) a mobile-data-based as well as web-based SMS and email notification of fatigue-detection events. 									
PURPOSE		<ul style="list-style-type: none"> – To integrate the built-environment with an artificial illumination mechanism that engages the user into physical activity (in a playful and reactive / interactive manner) and/or mitigates fatigue. – To enable localized temperature and humidity regulation for comfort. – To enable the built-environment to send SMS and email notifications—e.g., to family-members and/or caretakers—related to fatigue, etc. 									
PERTINENCE		<ul style="list-style-type: none"> – Physically active elderly adults remain healthier than sedentary counterparts [180]. By integrating <i>playware</i> characteristics into interactive systems in the built-environment, users are more likely to engage and remain engaged [187] 									

⁴⁹ This section is based on

- ▣ A. Liu Cheng, H. Bier, G. Latorre, B. Kemper, and D. Fischer, “A High-Resolution Intelligence Implementation based on Design-to-Robotic-Production and -Operation strategies,” in *Proceedings of the 34th International Symposium on Automation and Robotics in Construction (ISARC 2017)*, Taipei, Taiwan (R.O.C.), 2017. [169]
- ▣ A. Liu Cheng and H. Bier, “Extension of a High-Resolution Intelligence Implementation via Design-to-Robotic-Production and -Operation strategies,” in *Proceedings of the 35th International Symposium on Automation and Robotics in Construction (ISARC) 2018*, Berlin, Germany, 2018, pp. 1005–1012. [186]

Abstract

This implementation continues to build on the adaptive mechanisms and system architecture described in Section 5.1 and is situated within the Protospace 4.0 environment presented in Section 4.1.2. With respect to intelligence in the built-environment, it revisits Protospace 4.0's [162], [188], [189] system of function-specific differentiated components. On the occasion of the international conference Game Set and Match 3 (GSM3) [161] held at the Faculty of Architecture and the Built-Environment, Delft University of Technology (TUD) (9th-11th of November, 2016), a fragment of Protospace 4.0 was rebuilt as a responsive stage, and a purpose-built interactive LED-based illumination system was integrated into its architecture (see Figure 4.2 and Figure 5.3). This illumination system serves as a subsystem of the present system-architecture.

With respect to computational intelligence, a Machine Learning (ML) mechanism is deployed as a subsystem to enable affordable yet robust Human Activity Recognition (HAR) mechanisms via established classifications models—i.e., Support Vector Machine (SVM) and k-Nearest Neighbor (k-NN). A smartphone as well as three LightBlue Beans™ (LBBs) were used to gather gyroscopic and accelerometer data from the user via the Open Sound Control (OSC) protocol. The generated dataset was used to train two SVM and k-NN models, one via local clusters using open-source and purpose-written Python scripts, and another via an external computer—simulating cloud-based analytics services—using third-party proprietary software (see Section 5.2.1, parts 1 and 2). The principal intention was to imbue the proposed system with both localized as well as web-based analysis mechanisms in order to ascertain ML robustness and resilience in case either mechanism failed. A secondary intention was (a) to demonstrate that open-source solutions could be as effective as those rendered by proprietary software while reducing costs; and (b) to illustrate how purpose-written scripts integrated more seamlessly and efficiently (in terms of interoperability) than did proprietary software.

The responsive stage is also imbued with predetermined behavioral patterns such as pulsating when idle, tracing paths, correlating different colors to identified body parts (via Microsoft® Kinect™ V2) of up to six different individuals (see Section 5.2.1, part A). Moreover, the SVM and k-NN mechanisms are trained to identify certain data values as corresponding to a variety of activities, and to use this prediction power to dynamically mitigate fatigue in the user via an active and adaptive regulation of colors and intensities (see Section 5.2.1, part B)

Moreover, as an extension to the above, a voice-enabled mechanism based on Amazon®'s Alexa Voice Service™ (AVS) is integrated into the ecosystem to connect the built-environment with services and resources in the World Wide Web (WWW). Furthermore, a notifications mechanism based on Google®'s Gmail™ API as well as Twilio®'s REST® API enable instances of fatigue to be reported to third-parties. More specifically, the following features and modified scenario are added to the previous solution (see Figure 4.2 and Figure 5.3):

With respect to the built-environment: Proof-of-concept implementation of global and local ventilation systems in order to ascertain both optimal temperature and humidity ranges (as determined by the Comité Européen de Normalisation (CEN) Standard EN15251-2007 [165]; and air-quality via a variety of air pollution (see Section 5.2.2, part 3).

With respect to Remote / cloud-based services: Integration of Amazon®'s AVS [190] into the system (see Section 5.2.2, part 4);

With respect to Remote / cloud-based services: Integration of (a) SMS notification capabilities via Twilio®'s REST® API [191] and Siemens®'s T35 GSM component/shield and standard prepaid SIM-card (see Section 5.2.2, part 5); (b) email notification capabilities via Google®'s Gmail™ API [192].

Furthermore, a new modified deployment scenario is considered, where the adaptive stage invites the user to engage in activity if prolonged physical inactivity is detected (see Section 5.2.2, part C; Figure 5.8, items 21 and 22).

Finally, in the development of this demonstrator, the systems and services in all four scenarios (three Predetermined scenarios and one Non-predetermined scenario in Section 5.2.1—and its modification / extension in Section 5.2.2) were deployed in the context of an Adaptive Stage. Yet it should be noted that while this prototype of Protospace 4.0 was funded by a different resource and for a different purpose, its services—as discussed at the end of Section 4.1.2, where this demonstrator environment is introduced—may be suitably integrated into intelligent solutions for the elderly.

5.2.1 1st development: non-proprietary Human Activity Recognition (HAR)

The development of the detailed implementation consists of three parts: (1) the design and development of a non-proprietary HAR system, which involved the development of (1a) a dynamic *ad hoc* heterogeneous clustering system as well as (1b) data-gathering and -parsing scripts for ML training and testing purposes; (2) the design and installation of the LED-based illumination subsystem and its corresponding electronic setup; (3) the integration of the previous parts into a unified closed-loop system architecture. The first and second parts were developed in parallel and tested as working subsystems before integration.

Due to their evolving and resilient characters, ML classifiers have been implemented in a variety of applications built on *Wireless Sensor Networks* (WSNs) [193]. HAR, as one such application, has successfully exploited said classifiers in the last five years (see, for example, [194]–[196]). However, due to the affordable and low energy-consumption character typical of WSN nodes built on affordable platforms (e.g., Arduino, Raspberry Pi, etc.), computational processing with respect to feature extraction has been considerably limited [197]. To overcome this limitation, the present implementation is capable of instantiating *ad hoc* clusters consisting of a variety of high-performance nodes. Furthermore, several clusters may be instantiated simultaneously in order to enable parallel high-performance information processing activities.

Another way to overcome this limitation is to avoid it altogether by outsourcing all high-performance information processing to cloud-based ML services (e.g., Google® *CloudPlatform*™, Amazon® *Machine Learning*™, Microsoft® *Azure*™, etc.). But there are a number of limitations with this approach. The first, and perhaps the most salient, is the cost incurred by including proprietary services in any proposed intelligent built-environment solution. A second yet no less important limitation may be the impact to the solution's resilience. That is to say, should said built-environment lose access to the Internet, it would be incapable of generating classification models.

The present implementation proposes the integration of both cloud-based as well as localized ML capabilities in order to ascertain robustness and resilience. Whenever possible, ML processes are locally and dynamically executed via *ad hoc* node-clustering. But should this prove impossible either due to failure or unavailability of proper resources, cloud-based ML services are used.

1 Dynamic Clustering mechanism

```
pi@hackem-0:~/cloud $ mpiexec -f machinefile -n 12 python ./hel
This is process 0/12, running on hackem-0.
This is process 1/12, running on hackem-0.
This is process 2/12, running on hackem-0.
This is process 3/12, running on hackem-0.
This is process 9/12, running on hackem-2.
This is process 10/12, running on hackem-2.
This is process 11/12, running on hackem-2.
This is process 8/12, running on hackem-2.
This is process 4/12, running on hackem-1.
This is process 5/12, running on hackem-1.
This is process 6/12, running on hackem-1.
This is process 7/12, running on hackem-1.
pi@hackem-0:~/cloud $
```

Cluster 0

Cluster 2

Cluster 1

FIG. 5.1 Runtime processes, clustered distribution.

The system's clustering mechanism uses the *Message Passing Interface* (MPI) standard via *MPI for Python* (mpi4py) [198] (see Figure 5.1). The system's ecosystem consists of nine types of development platforms, *Microcontroller Units* (MCUs), and proprietary trackers: (1) Intel® *Joule*™, (2) Asus® *Tinkerboard*™, (3) Raspberry® *Pi 3*™ and (4) *Pi Zero W*™, (5) SeedStudio® *BeagleBone Green*™ (BBG), (6) Punch Through® *Bean+*™ and (7) LBB, (8) Fitbit® *Charge HR*™, and (9) Arduino® *UNO*™. Sets of items 1, 2, 3, and 5 may be dynamically clustered *ad hoc* via Wi-Fi for high-performance information processing, and are connected to the rest of the network via Wi-Fi, ZigBee, BLE wireless communication protocols and—in the case of an instance of item 3—Ethernet / USB cables. Items 4, 7, and 9 are considered as low-computation *end devices* meshed into the WSN via ZigBee, with 6 serving as router for 7 via BLE. Since there is a direct relationship between computational power vs. energy-consumption, *end device* and *router* nodes are concerned exclusively with sensor-data gathering and relaying with minimal information processing. Depending on the task, nodes exchange data via pertinent protocols and frequencies.

2 Machine Learning (ML) mechanisms

Two ML mechanisms are integrated into the present implementation: (1) a localized *ad hoc* cluster system based on open-source and purpose-written *Python* scripts, and (2) a simulated cloud-based analytics service using MathWorks® *MATLAB*™. In both mechanisms SVM and *k*-NN classification models are generated. The user's gyroscopic data is used both to train and to predict whether the he/she is engaging in a predefined activity (i.e., walking, running, standing, sitting, and climbing stairs), which (if accurately predicted) enables the system to know how physically active or inactive the person is—this plays a role in subsequent fatigue detection in the *non-predetermined scenario* below.

In the localized mechanism, a script based on *pyOSC* is first written to receive OSC data from any device and application capable of broadcasting in said protocol. While all the Wi-Fi-enabled nodes in the system's WSN have the capacity to receive this data-streaming, only one of the nodes of the cluster instantiated to generate classification models stores it locally and streams it to a cloud-based data visualization service (i.e., *Plotly*™). Should the receiving node fail, another high-performance node will replace it automatically. Since the proposed solution uses a smartphone and three LBBs for data redundancy, resolution, and validation, the script in question proceeds to parse and to reduce the noise in the received multi-sensor data in order to generate a robust and unified dataset. At this point the dataset is processed through two ML scripts based on *scikit-learn* [199], [200], one for SVM and another for *k*-NN classification models (see Figure 5.2, *Left*).

It should be noted that each time a classification model is generated, regardless of whether it is done via open-source or proprietary means, its resulting prediction success rate will vary. For the purposes of the present discussion, the success rate generated in the last sample run is used. That is to say, the success rate of the localized SVM mechanism was 95.7% while that of the *k*-NN mechanism 97.85%. In the proprietary cloud-based mechanism, as simulated by a computer external to the system's WSN and running *MATLAB*™, the same datasets are processed through several *Classification Learners* (see Figure 5.2, *Right*).

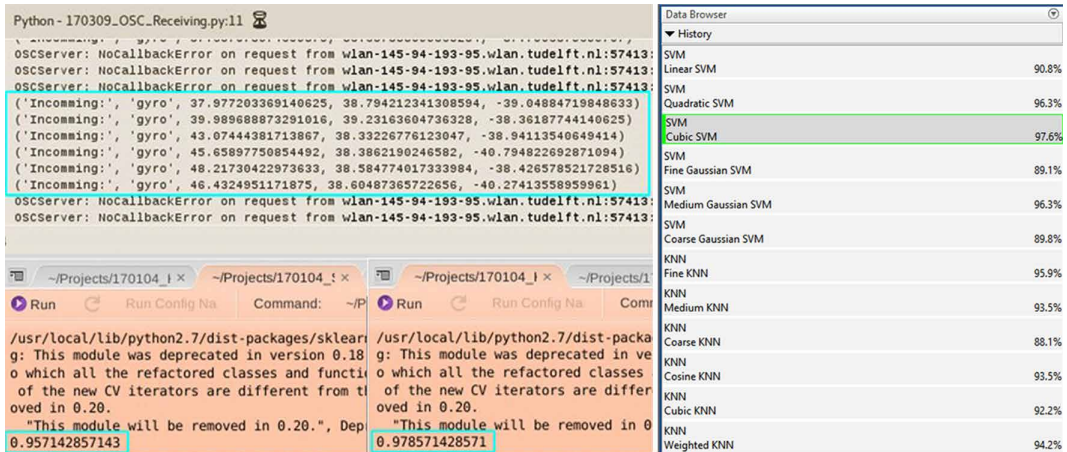

FIG. 5.2 Left-Top: OSC-data receiving and parsing. Left-Bottom: 95.7% prediction success with respect to HAR via SVM (Left) vs. 97.85% via k-NN (Right). Right: Sample MATLAB™-generated ML models with corresponding success rate.

It may be observed that the most successful classification model generated by MATLAB™ is based on *cubic* SVM with a prediction success rate of 97.6%, which is higher than the rate corresponding to the localized and open-source SVM result (i.e., 95.7%). But it may also be noted that the localized and open-source *k*-NN success rate is higher than any of the *k*-NN models generated by MATLAB™ (i.e., 97.8% vs. 95.9%, 93.5%, 88.1%, and 93.5%). It may not be inferred from this that the localized is better than the proprietary, nor vice versa. It may be considered, however, that the localized and open-source mechanism yields comparably robust results as that of the proprietary one within the scope of the present implementation.

Having generated two sets of classification models via localized and cloud-based means, the ones with the most successful prediction rate are used at runtime, with precedence given to the localized mechanism—if and only if said mechanism fails or has unavailable resources are cloud-based ML models be used. The duration of said runtime may be determined by the user, but it should be as brief as practicable in order for the dataset to be updated with new data. For example, the user may decide to schedule the generation of a new updated model every 24 hours and only during sleep periods. This way the user would wake up to updated and relatively more attuned models every day. Furthermore, via this incrementally updating process, classification models may be trained to detect and/or predict new activities or patterns in a gradual manner, thereby enabling the intelligent built-environment to evolve with its user.

A Predetermined Scenarios

There are three predetermined scenarios: (1) Pulsating, (2) Lecture, and (3) Break, all of which are described as follows:

- 1 As soon as the illumination system is powered, the stage slowly pulsates in one color—i.e., oscillates between intensities of a same color. This creates an effect viscerally reminiscent of a beating heart, tacitly suggesting that the stage is “alive”. The intention of this scenario is to instigate interest and curiosity in the users, inviting them to engage with it (see Figure 5.3, *image 2*).
- 2 Two different types of interaction are envisioned during the conference presentations. The first involves the stage’s reaction towards the movements of the speaker, where by stepping on or touching one or multiple components he/she instigates a gradual shift from the initial or *passive* colors to *active* colors for a certain period of time, after which *active* colors would default back to *passive* ones (see Figure 5.3, *images 3, 4*). The second interaction inverts this causal relationship to have the stage influence the speaker—i.e., the speaker knows his/her time is up when the first type of interaction ceases and the stage defaults back to a single color (see Figure 5.3, *image 5*).
- 3 The stage invites interaction from the audience in-between lectures by allowing them to “paint the stage” via body gestures. That is, in this mode, the stage tracks body parts of up to six individuals and instantiates corresponding color changes across the components, hence correlating certain movements or body parts with certain colors (see Figure 5.3, *image 6*).

Finally, it should be noted that in addition to these three automated *cause-and-effect* scenarios, the illumination system is also designed with a manual override control. A proprietary fee-based Apple®’s iOS™ *application*, viz., *TouchOSC™* (by Hexler Limited®) is used to develop customized control screens to provide override capabilities to the illumination system (see Figure 5.4, *Left*).

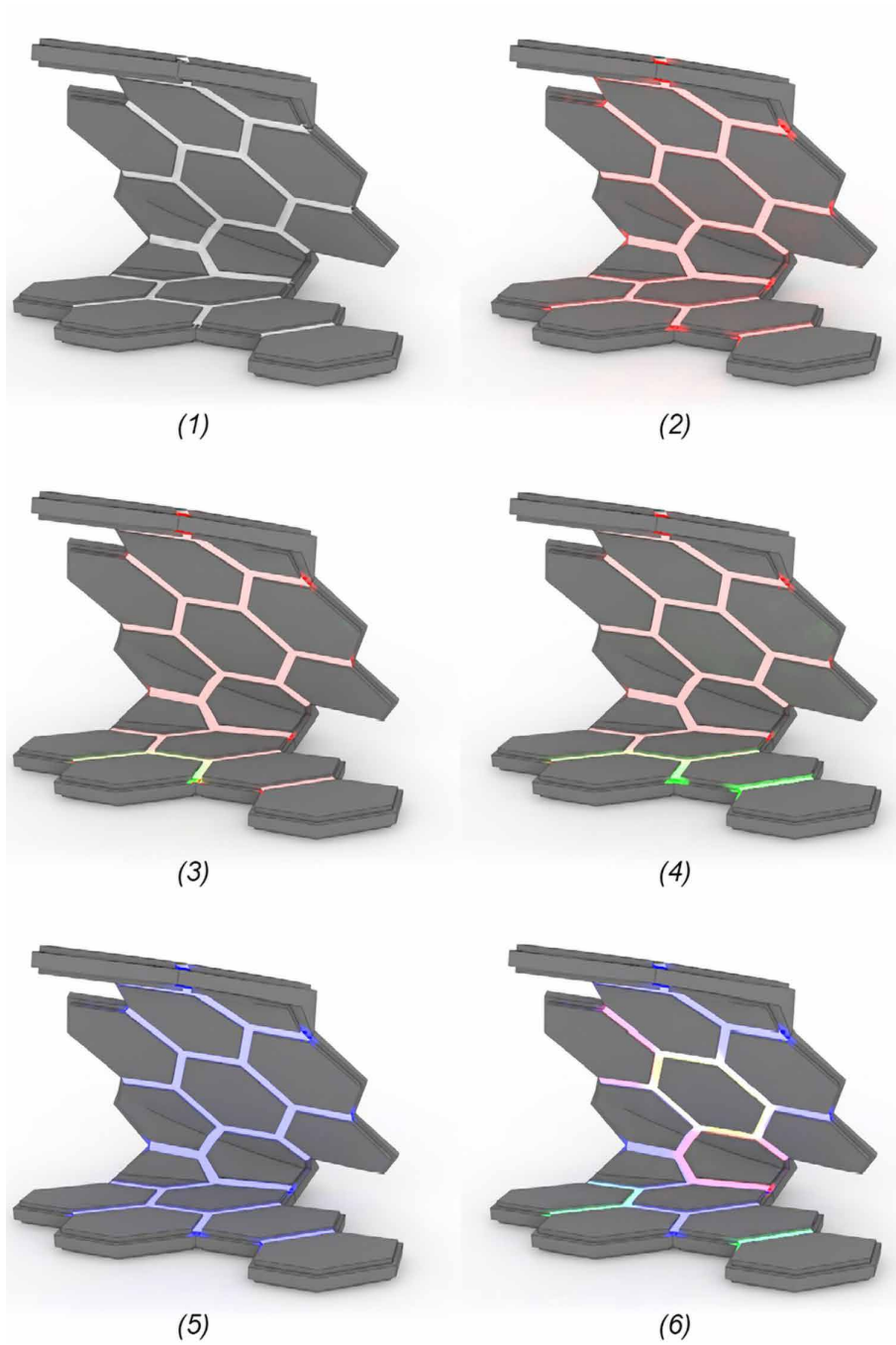

FIG. 5.3 Images (1) 3D model with lights off; (2) Pulsating; (3) Activation of discrete components; (4) Leaving a trace; (5) Manual override; (6) individual activity detection correlated with color.

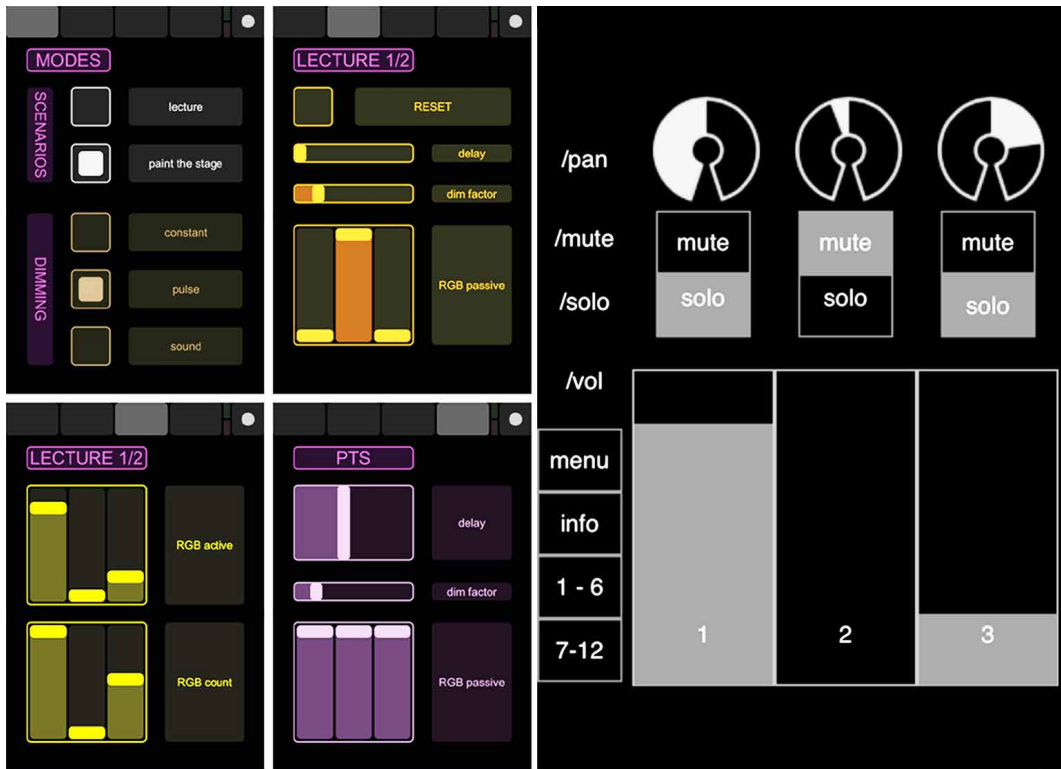

FIG. 5.4 Left: iOS OSC Applications: TouchOSC (proprietary). Right: iOS OSC Applications: Control (open-source).

B Non-predetermined Scenario

The ML-driven HAR mechanism implemented in the present system, in conjunction with an adaptation of the human state estimation mechanism developed by Nakaso *et al.* [201], is used to detect general fatigue in the user. By learning from the user's behavior as a consequence of lighting conditions—both in terms of colors and intensities—the system can learn to identify which combinations of colors and intensities ameliorate or exacerbate the user's fatigue. Having made this identification, the illumination system continuously seeks to improve the state of the user by regulating the experience of the ambiance. Unlike predetermined scenarios, the system is not programmed to associate a given color with a given human state or action—nor vice versa—but rather the ML mechanisms establish such correlations as processed via HAR. More specifically, the localized k -NN classification model is capable of learning to predict which colors and intensities are conducive to mood amelioration / fatigue mitigation and to promote them. Such colors and intensities may change over time, as saturations in the frequency of particular colors and intensities over short periods of time could actually instigate an adverse effect. The ML mechanisms, however, can account for this change as they evolve accordingly.

Like the OSC-enabled manual override provided in the predetermined scenarios, the present scenario also integrates a *correction* mechanism based on human intervention. However, unlike the manual override, the *correction* mechanism is used to provide feedback—i.e., to “teach”—the system when a prediction is inaccurate. This fact is then considered in the next iteration of a new and updated classification model. The *correction* mechanism is implemented via a free and open-source OSC iOS™ application, viz., *Control* (by Charlie Roberts) (see Figure 5.4, *Right*).

3 Global / local ventilation mechanism

This mechanism is first implemented and tested via an abstracted surrogate model equipped with twelve DHT-22 temperature and humidity sensors, twelve air-quality sensors (viz., three of each MQ-3 *Alcohol*, MQ-4 *Methane*, MQ-7 *Carbon Monoxide*, and MQ-8 *Hydrogen Gas*), and twelve small DC-motor fans connected to three RPiZWs and one RPi3 (see Figure 5.5, *Top*). Since the *General-purpose input/output* pins (GPIOs) of these devices are digital while the air-quality sensors are analog, 10-Bit MCP3008 ADCs are used to create a bridge.

As corroborated by the CEN Standard EN15251-2007 [165] as well as the *American Society of Heating, Refrigerating and Air-Conditioning Engineers* Standard 55-2013 and Standard 62.1-2013 [202], the *Thermal Environmental Conditions for Human Occupancy* with respect to comfort should be 67 to 82° F. (~19.5 – 27.8° C.) [203], while relative humidity in occupied spaces be less than 65% in order to discourage microbial. Furthermore, independent of human comfort considerations, frequent and consistent ventilation reduces the concentration of toxins in the air as well as the prevalence of airborne diseases [204].

In this TRL-5 setup, if the collective temperature or humidity levels exceed said recommended limits for comfort, all the fans activate, thereby drawing fresh air into the inhabited space (i.e., Global ventilation concept). If, however, certain areas exceed either or both limits, only those fans within and surrounding them activate (i.e., Local ventilation concept) (see Figure 5.5, *Bottom*). The same concept holds for instances of air-pollution.

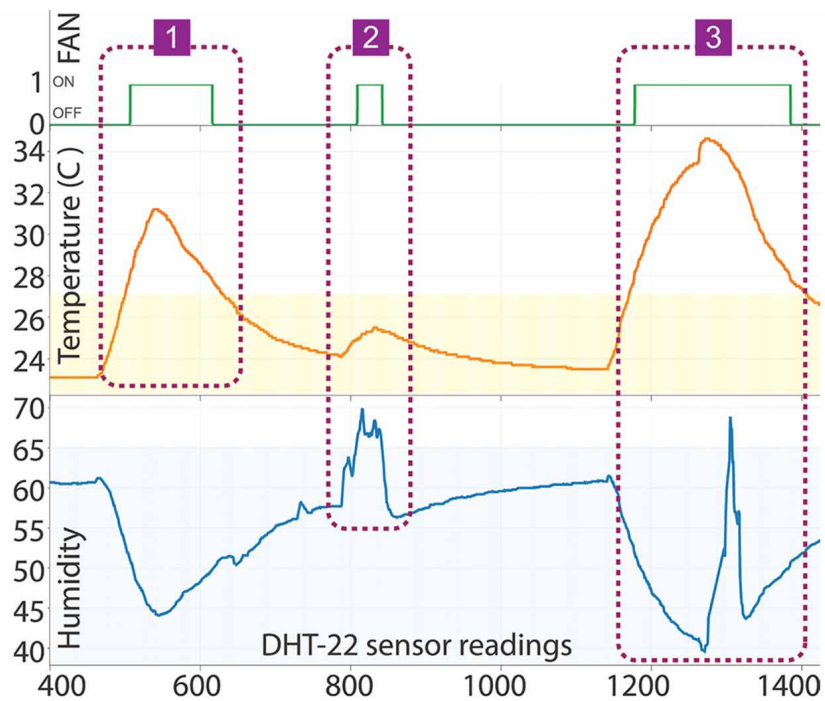
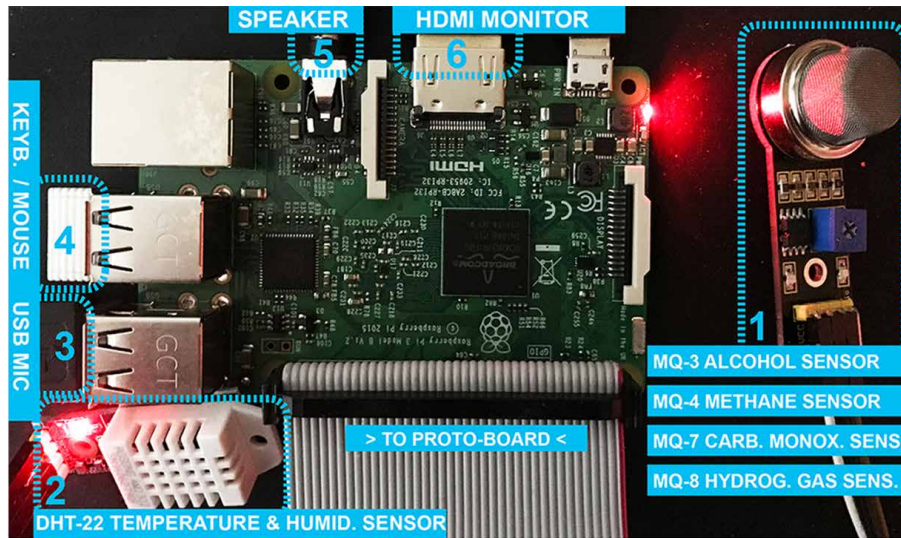

FIG. 5.5 *Top*: Typical node: (1) Air-quality sensors: MQ-3 Alcohol or MQ-4 Methane or MQ-7 Carbon Monoxide or MQ-8 Hydrogen Gas; (2) Temp. & Hum. sensor; (3) USB Mic.; (4) Keyboard / Mouse (only necessary for config.); (5) Speaker; and (6) HDMI Monitor (optional). *Bottom*: Activation of ventilation fans in relation to temperature and relative humidity comfort thresholds (shaded).

4 Voice-control mechanism via Alexa Voice Service (AVS)

This mechanism is implemented and tested (see Figure 5.6) via the same RPi3 mentioned in the previous section, an open-source repository using Amazon®'s API [205], and a generic microphone as well as repurposed speakers. A secondary device is also built based on an RPiZW node both to serve as backup and to instantiate an emphatically low-cost (i.e., USD ~\$15, as of writing) alternative to even the most affordable of Amazon®'s Echo™ product (viz., the Echo Dot™, at USD \$49.99 [206]). The flexibility of developing custom—and more affordable—Alexa-enabled Devices permits virtually any built-environment device, whether deployed in an architectural or an urban context, to capitalize from AVS.

Two main objectives inform the present integration. The first is to enable a powerful and scalable voice-control mechanism within the present development. The second is to demonstrate a cohesive technological heterogeneity between an open-source WSN and a proprietary commercial service without additional cost (with respect to Fitbit® and Gmail™) or with minimum cost (with respect to Twilio®). This latter consideration connects a local intelligent-built environment with vast resources in the WWW, enabling the user to engage in a variety of activities from streaming music to purchasing groceries via devices fundamentally embedded into the built-environment.

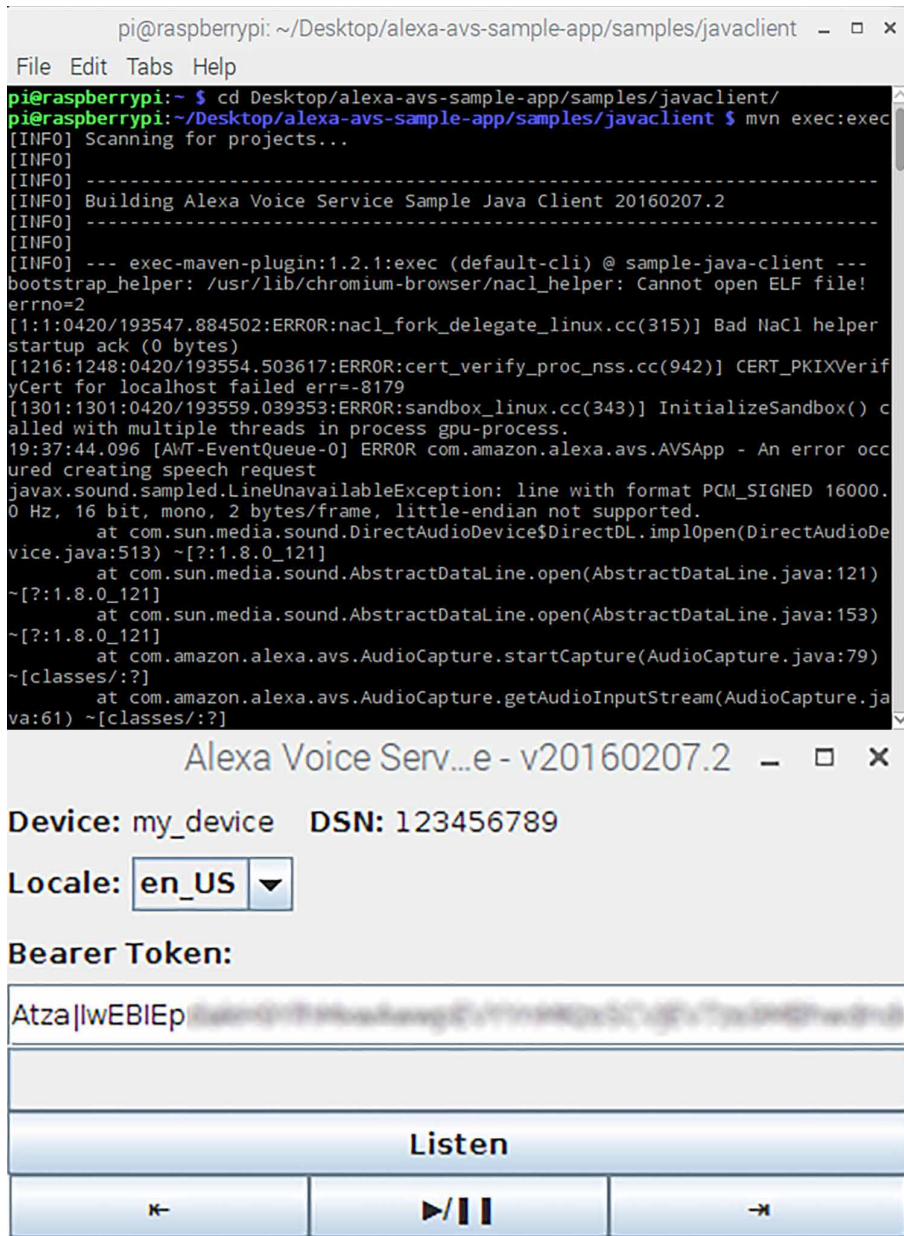

FIG. 5.6 Top: Java Client service initialization. Bottom: AVS Java Client interface initialization.

5 Intervention via SMS and email notification mechanisms

This mechanism, inherited from an earlier implementation [154], is presently implemented and tested via a RPiZW node, a smartphone, and Twilio®'s as well as Gmail™'s APIs. Additionally, a non-web-based contingency device was developed using a Siemens® T35 GSM shield mounted on an Arduino® UNO™. The main objective with this implementation is to setup the foundations of an increasingly comprehensive intervention approach capable of reacting to emergency events, both with respect to the inhabitants of the built-environment and with this environment per se.

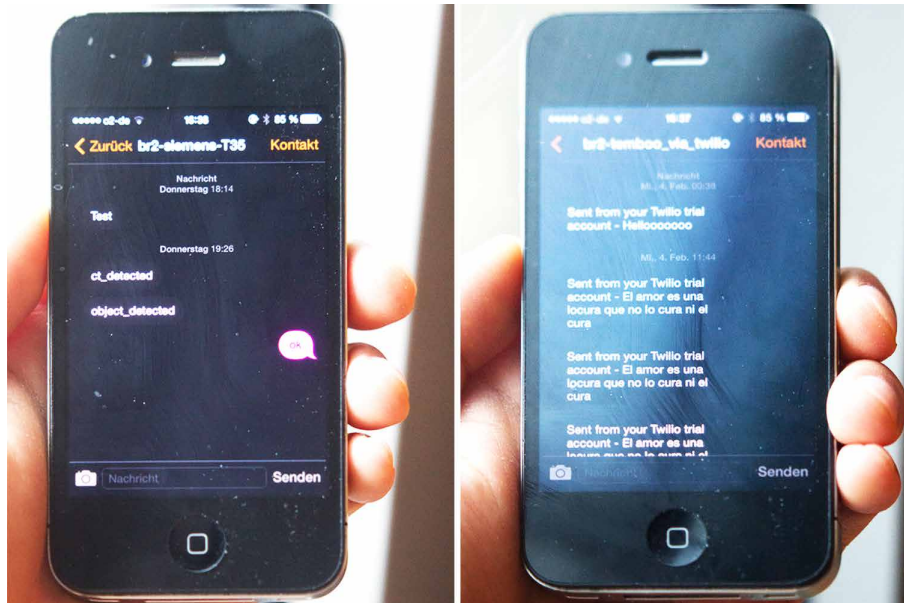

FIG. 5.7 Left: SMS via Wi-Fi (Twilio®). Right: SMS via Siemens T35 GSM module.

The Twilio® implementation represents an affordable SMS service, while the T35 GSM setup represents a standard prepaid SMS service. A scenario may be entertained where the built-environment's Wi-Fi service is unavailable for a period of time, yet the integrity of the WSN's *Local System* remains uncompromised as its constituents remain networked via ZigBee and BLE. In such a scenario, an emergency event may be reported via the T35 GSM setup, as it relies on standard cellular communication. Conversely, another scenario may also be entertained, where cellular services are unavailable due to lack of coverage. In this scenario, emergency events may be reported via Twilio®'s SMS service to any location worldwide.

C Closed-loop Runtime Including New Modified Scenario

In order to describe how the above-detailed mechanisms integrate into the proposed development, a point-by-point runtime description is provided as follows:

- 1 The *Local System*, as the core of the WSN and backbone of the ICT ecosystem, initializes and establishes the network in multiple communication layers (Wi-Fi, BLE, ZigBee). For security reasons, only registered MAC addresses are provided with IP addresses. Once the network is established, all *Linux*-running systems update and upgrade.
- 2 *Wearables* communications initialize. The WSN draws available data from Fitbit®'s servers and begins to listen for LBB notifications as well as to listen and record BLE / OSC accelerometer data.
- 3 *Remote / Cloud-based Services* communications initialize—i.e., *OAuth 2.0* tokens are provided, authentication and authorization are established. Received accelerometer data are streamed to and plotted by Plotly® used for local HAR, if a suitable classification model is present.
- 4 Since the deployment context is that of GSM3, the system checks if the responsive stage is being used by a lecturer.
- 5 If a lecturer is on-stage, the system checks if a suitable ML classification model is available.
- 6 If no ML models are available, local HAR considerations are omitted from subsequent decision-making processes—e.g., whether to activate ventilation systems if the lecturer is assumed to be agitated via Fitbit® data (see points 12 and 13).
- 7 Presupposing the availability of the SVM model mentioned in point 3, the HAR mechanism is initialized—i.e., processed accelerometer data are set against the model and prediction begins in real-time.
- 8 All sensing systems—embedded, ambulant, and location dependent wearable—are initialized and verified.
- 9 Raw data are gathered, cleaned, processed, and made available across the entire network.

- 10 The data from point 9 are written into the (i) local ML and (ii) remote ML datasets (optional) for a subsequent model generation.
- 11 Similarly, said data are streamed, plotted online, and made available for remote monitoring.
- 12 When the system detects the presence of a lecturer on stage, it determines that the lecturer is probably physically agitated if (i) sweat sensors detect perspiration; (ii) temperature and humidity sensors detect an increase in temperature and relative humidity in the overall environment in general, and in user-occupied areas in particular; (iii) the wearable LBBs detect an increase in body temperature; and (iv) the most recent Fitbit® data evidence existing and sustained physical activity.
- 13 Having determined a high probability of physical agitation, all the fans in the ventilation system activate until readings return to CEN recommendations. In the interest of time, this ventilation mechanism is developed and tested via a scaled surrogate setup. The *Information and Communication Technologies* (ICT)-configuration concept presented is asserted to function across a variety of physical forms within human scale.
- 14 After symptoms of agitation cease (e.g., heart-rate normalizes, body temperature falls within recommended levels, and perspiration is not detected), the system continues to check if the temperature and humidity readings of the environment comply with CEN recommendations.
- 15 As a strategy for responsible energy consumption, if the environment's temperature and humidity readings remain too elevated for comfort after a given period of global ventilation (in this runtime: two minutes), the ventilation system switches to ventilate only the areas surrounding the user. If external conditions raise temperatures across the entire environment, it is pointless to condition unoccupied areas.
- 16 In parallel to point 14, the system also checks for air-quality via its MQ-*n* sensors (see Figure 5.5, *Top*) independently of temperature and humidity readings.
- 17 The strategies for mitigating high-concentrations of toxins and reducing the prevalence of airborne diseases differ from the temperature and humidity strategies above in that global ventilation is engaged for the duration of detected poor air-quality. Even across unoccupied spaces, it remains in the occupant's interest to sustain air-quality.

- 18 Following point 14, if the lecturer is not agitated, and if the thermal conditions of the occupied space are optimal, the system begins to watch for potential symptoms of fatigue. The fatigue-detection mechanism used in this development is inherited [169] and is a limited adaptation and modification of the *human state estimation system* developed by Nakaso *et al.* [201].
- 19 The fatigue-detection system relies on a camera—in this case a Microsoft® Kinect™ V2—and a face and eyelid-aperture detection classification model developed in MATLAB. If the lecturer is detected to be probably fatigued—e.g., his/her eyelids droop, activity levels decrease, acceleration in movement decreases—then the following two intervention mechanisms activate:
 - 20 SMS notifications regarding the lecturer’s state, including average heart-rate, temperature, acceleration, steps taken, and distance covered are sent via Twilio® and via T35 GSM. These notifications are shorter than the one sent via Gmail™, where an hour-by-hour overview of activity levels—in some predetermined period of time—are fully detailed. The degree of detail may vary depending on the purpose of the notification. In this development, these SMSs and email are triggered by detection of fatigue, yet these mechanisms serve as indicators of promising application potential.
 - 21 In conjunction with triggering the above passive intervention mechanisms (i.e., such that notify yet do not mitigate or promote), the system considers activity data for the last hour to determine the amount and concentration of inactivity. If the lecturer has continuously stood still for longer than fifteen minutes, the system considers this inactivity as an exacerbating factor in the detected fatigue.
 - 22 Accordingly, the responsive stage triggers four active intervention mechanisms (i.e., such that mitigate and/or promote) sequentially (see Figure 5.8, *item 22*). That is, upon detecting prolonged inactivity, components in the responsive stage fade-on varying colors and intensities to encourage the lecturer to touch them (see Figure 5.8, *item 22, first row*). This, along other scenarios (i.e., Figure 5.8, *items 24, 25, 28, 29, and 26* assisting) turn the stage into *de facto* playware. The second and third active intervention mechanisms (see Figure 5.8, *item 22, second and third rows*) auto-regulate overall illumination intensity and color of the stage’s LEDs in case these be exacerbating factors of the detected fatigue. Finally, the fourth active intervention mechanism triggers local ventilation in case the lecturer’s preferences deviate from recommended thermal conditions, and this be an exacerbating factor of the detected fatigue (see Figure 5.8, *item 22, fourth row*). In order to avoid looping between points 19–22 indefinitely, a reconfigurable time-out mechanism is set in order for the system to move forward, if there are no indications of improvement within twenty minutes.





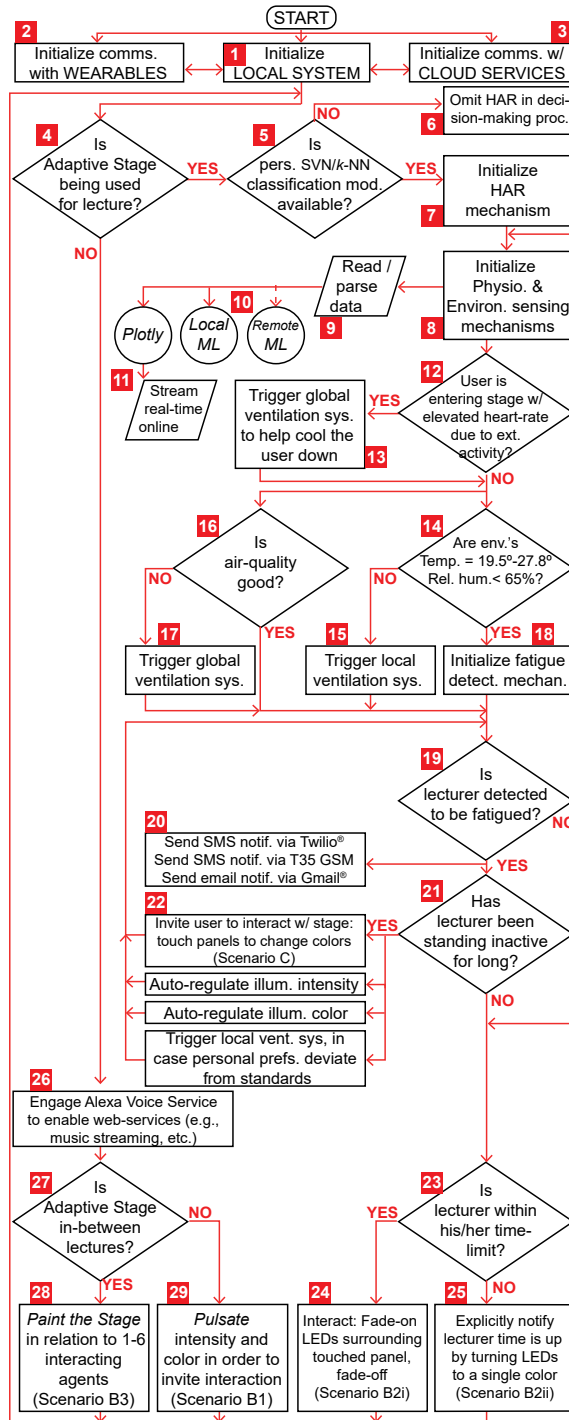





- 23 Assuming a time-out from the previous point, or a lack of fatigue detection from point 19, the system proceeds to check if the lecturer is within his/her allotted time-limit.
- 24 If the lecturer is within this time-limit, the stage enables the lecturer to activate instances of fade-on / fade-off by touching components for visual interaction. This scenario ends when the time-limit is reached.
- 25 If he/she is outside this time-limit, all LEDs turn on to a single color as a visual queue to the lecturer that time is up. This scenario ends when the moderator confirms this via OSC confirmation. Having concluded this or the preceding scenario, the system returns to point 4.
- 26 Returning to point 4, having explored the consequences of the reactive stage being occupied by a lecturer, the consequences of it not being occupied are now detailed. If the stage is empty, then AVS may be engaged for playful and/or entertainment purposes. That is, AVS is habilitated as soon as the WSN is conformed (back in point 3), but in this development, it is only engaged when the stage is empty. In practice, as was carried out in initial sample runs of this point-by-point outline, AVS was engaged in a lecturer scenario.
- 27 At this point the system decides to engage one of two other inherited play / entertainment scenarios depending on whether it is in-between lectures or not. In this development, the state confirmation is provided via OSC confirmation.
- 28 If the stage is in-between lectures, the scenario in item 28, Figure 5.8 activates. In this scenario, the audience is invited to interact with the stage by painting it. That is, depending on the position and movement of identified body-parts of up to six people (via Microsoft® Kinect™ V2), different regions of the stage will change in color and intensity in direct correlation with the articulation of said parts. This scenario ends when a lecturer wearing the LBBs returns to the stage.
- 29 If, however, the stage is simply on a day off, the scenario in item 29, Figure 5.8 activates. In this scenario, the stage pulsates like a beating heart in order to invite interaction from anyone in a passive manner. This scenario ends via OSC confirmation. Having concluded this or the preceding scenario, the system returns to point 4.

FIG. 5.8 Runtime decision-tree.



5.3 Integration of a Wearable Interface in a Design-to-Robotic-Production and -Operation (D2RP&O) Development⁵⁰

TABLE 5.4 Demonstrator 3's summary—environment, parameters, interactions, key results, purpose, and pertinence.

DEMO ENVIRONMENT				IEQ				QoL			
											
HYP	ROB	DT	ND								
INTERACTION METHODS		USER-DRIVEN		Appendix, IEQ Section 1.A				Appendix, QoL Section 1.B			
				¶ 1	¶ 2		¶ 4	¶ 3	¶ 2	¶ 1	¶ 1
		SENSOR-DRIVEN		Appendix, IEQ Section 2.A				Appendix, QoL Section 2.B			
				¶ 1	¶ 2		¶ 3	¶ 7	¶ 3	¶ 1	¶ 1
KEY RESULTS		<ul style="list-style-type: none"> – A wearable device that is integrated with—and, accordingly, is part of—the local structured environment's <i>Information and Communication Technologies</i> (ICTs). – A wearable device capable of gathering the user's real-time physiological data to be shared with Architecture-integrated ICTs. 									
PURPOSE		<ul style="list-style-type: none"> – To provide the local structure environment with accurate and near-real-time physiological data in order to instantiate reactions—in the form of activation of services or of architectural transformations—with greater fidelity and pertinence. – To enable the user to override automatic actuations and/or service operations via a <i>de facto</i> wearable remote control. 									
PERTINENCE		<ul style="list-style-type: none"> – A non-invasive wearable device permits physiological data to be gathered without effort from the user, which in turn enables the built-environment to react with greater accuracy. Moreover, to use said device to instigate or stop actuations or services enables users with limited physical mobility to keep a high-level of engagement with their environment with minimal effort. 									

⁵⁰ This section is based on

▣ A. Liu Cheng, H. Bier, and S. Mostafavi, "Integration of a Wearable Interface in a Design-to-Robotic-Production and -Operation Development," in *Proceedings of the 35th International Symposium on Automation and Robotics in Construction (ISARC) 2018*, Berlin, Germany, 2018, pp. 646–653. [170]

Abstract

This implementation builds on the context of Section 5.2 using the robotically fabricated intelligent architectural components concept detailed in Section 4.1.3. The Internet-of-Things (IoT) wearable device (wearable, henceforth) described develops the Wearables subsystem of said system architecture in order to render the user a de facto context-aware node in its Wireless Sensor Network (WSN), which underlies the Cyber-Physical System (CPS) that is the built-environment with its physical / computational mechanisms and services. Consequently, the built-environment is able to access user-specific physical / environmental data to consider in conjunction with data gathered by architecture-embedded sensors, which together enable the system's decision-making mechanism to yield highly informed actuations sensitive to the user. Similarly, the user is made aware of the status of his/her built-environment and of its interior environmental conditions, enabling direct or wireless intervention. This expression of intelligence in the built-environment supervenes on human and non-human collaboration.

Although the development focuses on a wearable belonging to Design-to-Robotic-Operation (D2RO) [207] systems, its proper operation requires the establishment of a WSN that includes architecture-embedded nodes with which to exchange data and/or to instigate actuations. Such embedded nodes are integrated into architectural components specifically designed via Design-to-Robotic-Production (D2RP) [40] (see its corresponding demonstrator environment in Section 4.1.3) to accommodate them in a seamless and considered manner. In this configuration, the very architecture of the built-environment is able to complement the technical sophistication of the wearable deployed within it. Without the architecture-embedded ICTs, the operability of the wearable would be limited to the services enabled by its own sensors, which would only provide information about the immediate surroundings of the user, leaving him/her unaware of the interior environmental conditions of the remaining surroundings. Moreover, without complementing architecture-embedded ICTs, the wearable would be unable to engage remotely with mechanism inherent in adaptive architectures.

In the present setup, real-scale architectural fragments composed of robotically fabricated components are developed via material subtraction in D2RP in order to meet a variety of environmental, structural, and functional requirements as well as to host said embedded nodes (see Section 4.1.3 and Figure 4.4). That is to say, from the early stages of the design process, the envisioned technological services are taken into consideration along typical architectural considerations. In this manner, the resulting components are deliberately fabricated to sustain adaptive mechanisms in the form of computational services as well as in physical actuations in the built-environment.

With an established complementary infrastructure, four instances of the presented wearable—worn by four different users occupying the same built-environment—are developed and integrated into the WSN via *Bluetooth Low Energy* (BLE). These wearables exchange sensor data and/or actuation commands with two coordinating nodes as well as with six router nodes, which in turn exchange data and/or actuation commands with one another via ZigBee, BLE, and/or Wi-Fi (depending on distance, frequency, and/or latency requirements). This limited setup is intended to demonstrate seamless interoperability with respect to heterogeneous microcontrollers / development platforms as well as to communication protocols within the WSN.

Each wearable is equipped with eight attached sensors, regulators, and LED-bar displays, viz.: (1) an *MQ-4 Air-Quality* sensor to gauge air-quality within the user's personal space; (2) a *DHT-22 Temperature and Humidity* sensor to ascertain the user's thermal comfort; (3) an illumination override rotary as well as (4) a ventilation override rotary to enable the user to deviate from prescribed standards according to preference; (5) a notification confirmation button to acknowledge sent notifications by other WSN nodes; (6) a notification buzzer to enable other WSN nodes to provide audible prompts; (7) a LED-bar indicator of human presence or environmental events (e.g., gas-leaks, etc.) in any of six presently defined regions within the built-environment to notify the user; and (8) a LED-bar indicator of the immediate air-quality to warn the user of personal-space air-contamination levels. Additionally, the *Microcontroller Unit* (MCU) on which the wearable is based is integrated with a *BOSCH BMA250E triaxial accelerometer*, which may be used for gathering spatial displacement data for latter *Human Activity Recognition* (HAR) (see Section 5.3.1).

Finally, the values and states of each mechanism of every wearable-instance are relayed to any of the architecture-embedded nodes for real-time streaming to Plotly® [181] for remote visualization and/or subsequent analysis of gathered datasets (within cloud-service storage limits) (see Figure 5.10).

5.3.1 Bluetooth Low Energy (BLE) Wearable node

The developed D2RO wearable is built with a battery-powered PunchThrough[®] LightBlue Bean+[™] (LBB+) MCU, a corresponding *Groove Expander*, and the eight previously listed mechanisms (see Figure 5.9, *WSN/BAN: BLE Wearable Node*). The four instances of this wearable exchange data (via BLE) with two Raspberry Pi[®] 3 Model B[™] (RPi3) *Single-Board Computer* (SBC) coordinating nodes as well as with six router nodes—i.e., three Asus[®] TinkerBoard[™] SBCs and three Intel[®] Joule[™] system on modules (see Figure 5.9, *WSN: Arch. Embedded Nodes*)—which exchange data via ZigBee, BLE, and Wi-Fi. These six nodes correspond to the six defined regions in the built-environment of this setup. As mentioned earlier, this heterogeneity in systems and communication protocols serves to highlight the effective interoperability between diverse ICTs within the WSN. Nevertheless, these specific ICTs are deliberately included in the WSN for their individual capabilities. For example, all of the presently mentioned coordinating and router nodes may be dynamically clustered together *ad hoc* for *Machine Learning* activities as described in Section 5.2.

In the inherited and presupposed system architecture, a variety of environmental sensors monitor the *Indoor Environmental Quality* (IEQ) [108] of the inhabited space. Whenever sensed-data deviates from prescribed illumination, ventilation, cooling, and heating standards, mechanical systems are activated in order to restore and sustain values within optimal thresholds. The wearable adds another dimension of sensing and aids the built-environment's decision-making mechanisms in accurately gauging the environmental conditions of the inhabited space, while simultaneously raising awareness in the user via its notification / feedback mechanisms.

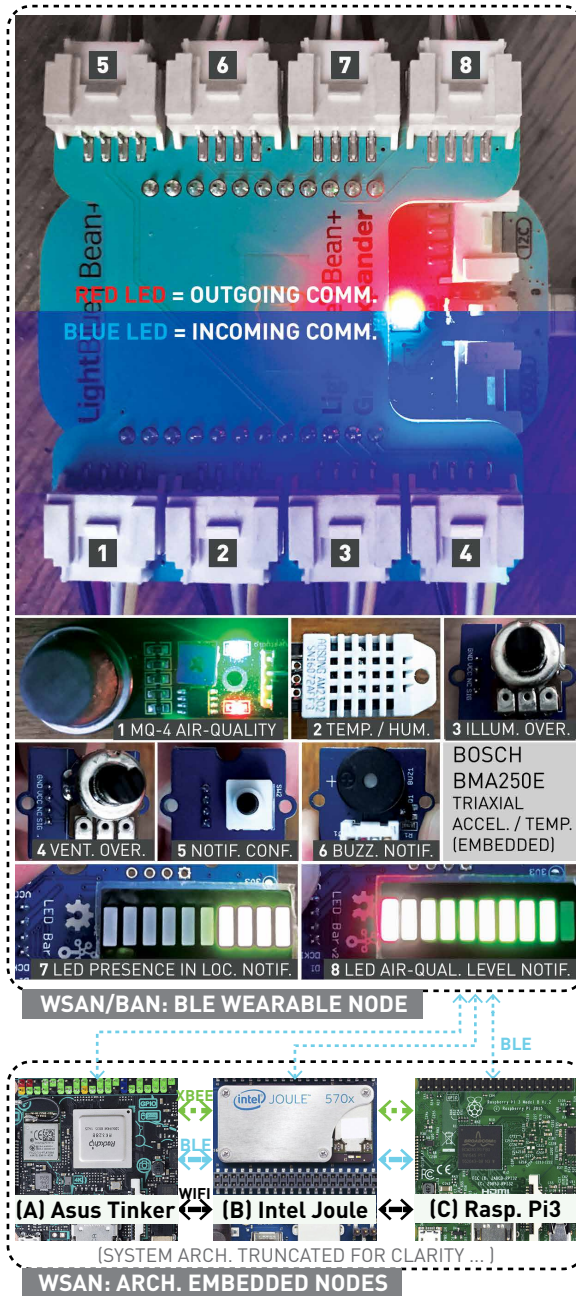

FIG. 5.9 BLE Wearable Node as WSN / BAN, Features.

In order to describe how this wearable does this, the implementation and functionality of each one of its attached and embedded mechanisms is described as follows:

- 1 *MQ-4 Air-Quality sensor*: This sensor has a methane-gas detection range of 300-10,000 *parts-per million* (ppm) [208]. Its purpose on the wearable is to detect the immediate air-quality surrounding the user. Should the built-environment's embedded-sensors fail to perceive contamination, the wearable's air-quality sensor instigates localized ventilation mechanisms nearest to the user to activate. In order to reduce unnecessary energy-consumption, the sensor is programed to take a reading every ten minutes. However, if sudden deterioration of air-quality is detected, the frequency increases to five minutes.
- 2 *DHT-22 Temperature and Humidity sensor*: This sensor detects the temperature and humidity within the user's personal space. Like the previous sensor, if it detects deviations from optimal thresholds (in conjunction with or independently of architecture-embedded counterparts), localized cooling or heating mechanisms activate to sustain user comfort. Since the probabilities of a sudden drop in temperature and humidity within an enclosed environment are low, the sensor is configured to take readings every half hour.
- 3 *Rotary Illumination override*: This rotary mechanism enables the user to override illumination settings automatically determined by the built-environment's decision-making mechanism, should personal preferences deviate from optimal standards. Unlike the previous two sensors, this mechanism does not have a predetermined activation interval, as its activation requires the user's manual rotation.
- 4 *Rotary Ventilation override*: This rotary mechanism performs as the previous one only with respect to ventilation. The IEQ-sustaining mechanisms in the built-environment are configured to maintain conditions within *Comité Européen de Normalisation* (CEN) Standard EN15251-2007 [165] thresholds, but precedence is assigned to human prerogative. Contingency measures limiting this override prevent sustained over-heating or over-cooling detrimental to human well-being.
- 5 *Notification Acknowledgement button*: There may be instances when the built-environment attempts to notify the user of urgent environmental events and/or conditions in particular regions (see item 7). This button serves to acknowledge such notifications.

- 6 *Notification Buzzer*: Two kinds of notification are implemented for this implementation, one using visual cues (see items 7 and 8) and the other using sound. This buzzer is used only for urgent notifications, where a range of tones correspond to varying degrees of urgency. This mechanism works in conjunction with items 7 and 5.
- 7 LED-bar “Presence / Event in Location” notification: This LED-bar represents a visual cue that notifies the user of either human presence in a given regions of the built-environment or environmental events and/or conditions in those regions. For example, with respect to its notification of human presence function, the user may be notified of the presence of other users in any of the six hypothetical regions defined in this setup. It may be observed in Figure 5.10 that this LED-bar indicates that four regions are occupied by other users. With respect to its notification of environmental events and/or conditions function, it may be that a given region has detected a gas-leak, and in this case the LED corresponding to that region would turn red and the buzzer (i.e., item 6) would require acknowledgement via the notification button (i.e., item 5). The architecture-embedded ventilation mechanisms themselves would automatically intervene in such a scenario, but the user is notified to raise awareness of his/her surroundings.
- 8 *LED-bar “Air-Quality in personal space” notification*: This LED-bar works in conjunction with item 1 and serves to inform the user of the air-quality of his immediate surroundings. In order to prevent unnecessary energy-consumption, this visual cue only activates when the user raises his/her arm in a specific gesture—a mechanism adapted from Fitbit® Activity Trackers such as the Charge HR™, which also belongs to the Wearable subsystem of the inherited WSN.

Finally, the embedded *BOSCH triaxial accelerometer* is used for HAR as a secondary data-source, if a primary accelerometer-enabled smart-device is absent from the ecosystem. This is due to the energy-consumption of continuous streaming of accelerometer data. In the inherited system architecture, HAR via smartphones [159]—as developed in Section 5.2.1—is preferred.

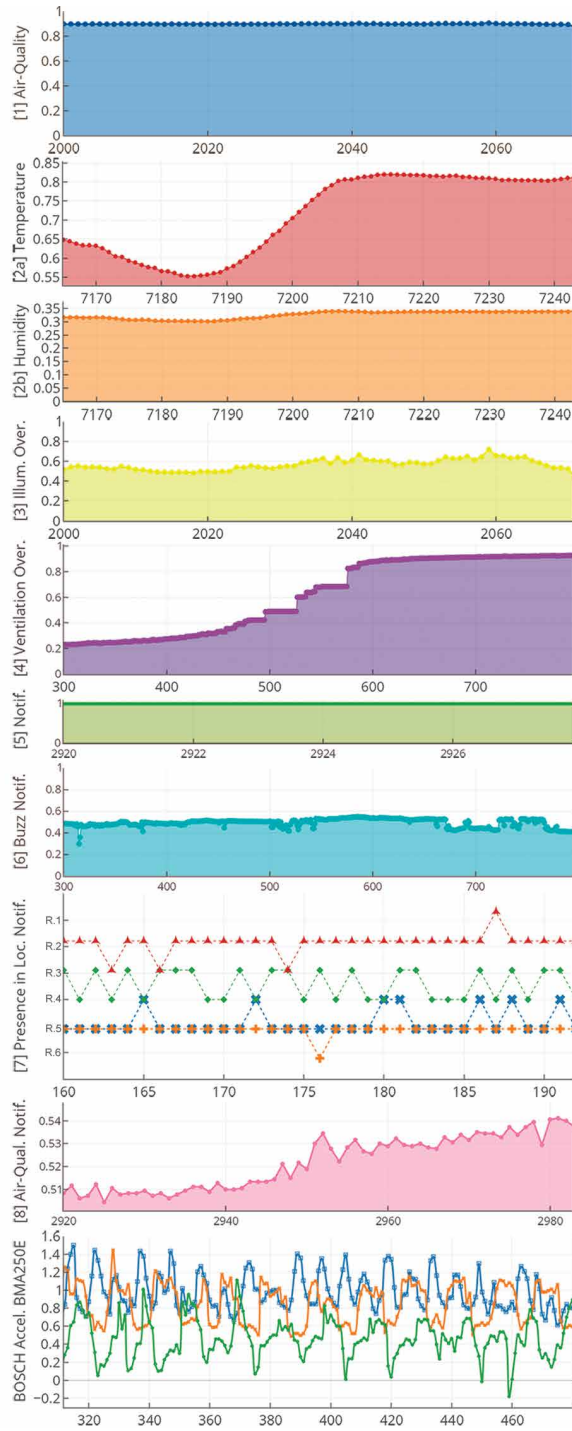

FIG. 5.10 Gathered data plotted in real-time in Plotly®.

As mentioned in earlier sections, in the present setup four instances of the wearable are developed and used in a built-environment containing six defined regions, each one monitored via real-time streaming of the data generated / gathered by its attached and embedded mechanisms to Plotly in different frequencies—for example, accelerometer data frequency, for purposes of HAR, must be higher than that of the Temperature and Humidity sensor. Since the wearables only work with BLE, their generated / gathered data is streamed to any of the architecture-embedded nodes, where each may write directly to data streams pertaining to the attached and embedded mechanisms of any of the wearables. All the data emitted by the wearables include a device identifier which is used to ascertain that each of their corresponding data is fed to the correct Plotly stream. In this section, the Plotly charts corresponding only to one wearable— shown in Figure 5.10—are discussed (from top to bottom).

The first chart in Figure 5.10 shows that in that particular instance of the test-run, the air-quality surrounding the user is consistent, which is expected from a built-environment integrated with self-regulating ventilation devices. The values of the *y-axis* range from 1 to 0, where 1 attains optimal standards. In the test-run interval corresponding to the *temperature* component of the second chart (i.e., chart 2a), the user first manually overrides automatic settings to increase ventilation, resulting in a deviation from the optimal temperature of 22.5° C.—an average of the accepted human-comfort range of 21° C. – 24° C. [209]. That is, it may be observed that between the 7,180th and 7,190th reading the actual sensed temperature dropped to ~55% of 22.5° C.

After this interval, and with no further human override, the temperature climbed steadily to more comfortable temperatures. The *humidity* component of this chart (i.e., chart 2b) indicates a slight decrease in humidity when ventilation systems were manually engaged, which is an expected result of higher air-flow.

The third chart indicates how much of the automatically determined values of illumination intensity is actually permitted to shine. That is to say, the illumination overriding mechanism works as a function of the built-environment determined output. For example, it may be observed in this chart that throughout this test-run interval, the actual illumination was kept between only ~50% to almost ~80% of the prescribed intensity-levels.

In the fourth chart, automatically determined temperature levels were decreased to ~21% of the actual values and gradually increased to ~90%.

The fifth and simplest chart records no instance of notification acknowledgements. The visualization of *pressed* vs. *unpressed* is inverted, where instances of the former are shown as 0 and of the latter as 1. Accordingly, no instance of notification acknowledgement is registered throughout the test-run, which corresponds to no undesirable environmental events being detected in any of the regions of the built-environment.

Urgent notifications result from a function over environmental readings. For example, it is not the case that any air-contamination triggers an urgent prompt, as healthy environments invariably contain degrees of air-contaminants, only within negligible levels. Accordingly, an urgent phenomenon is gauged based on the concentration and duration of undesired contaminants—in the present case, of methane gas, which has a *Threshold Limit Value* (TLV) of 1,000 ppm during an 8-hour period [210]. It is observed from the fifth chart that no notification acknowledgement instances are registered in the test-run's interval, which suggests an absence of urgent environmental events. This, however, does not suggest that the environmental conditions of any of the six regions are optimal. At most, it suggests that no air-contamination levels exceed accepted limits. This may be observed in the sixth chart—corresponding to the *buzzer* notification—where methane levels are detected at ~50% of a the prescribed TLV. Note that there are no instances below ~30%, since the sensor's lower-bound limit is 300 ppm.











The seventh chart maps the presence of the four users (each with a wearable, represented in red, green, blue, and orange) with respect to the six predetermined regions in the built-environment. The present set of charts correspond to the user in red. Unlike the other charts, this one in particular is common to all wearable users, which enables everyone in within the same built-environment to know one another's location.

The eighth chart, which corresponds to the LED-bar Air-Quality notification or indicator, indicates up to which LED is turned on in accordance with the air-quality ascertained (see the first chart). The *y-axis* ranges from 0 – 1, where 0 corresponds to no LEDs being on, 0.5 to five being on, and 1 to all being on.

Finally, the last chart—corresponding to the MCU-embedded triaxial accelerometer—demonstrates that three-dimensional displacement data is accurately logged and plotted by the present setup. It is preferred that accelerometer data-gathering be relegated to another smart-device (e.g., smartphone) due to the energy-consumption involved in high-frequency data transmission. However, if no such alternative is present, the wearable's accelerometer fulfills this task.

5.4 Deep Learning Object-Recognition in a Design-to-Robotic-Production and -Operation (D2RP&O) Implementation⁵¹

TABLE 5.5 Demonstrator 4's summary—environment, parameters, interactions, key results, purpose, and pertinence.

DEMO ENVIRONMENT				IEQ				QoL			
											
HYP	ROB	DT	ND								
INTERACTION METHODS		USER-DRIVEN		Appendix, IEQ Section 1.A				Appendix, QoL Section 1.B			
		SENSOR-DRIVEN		Appendix, IEQ Section 2.A				Appendix, QoL Section 2.B			
								18	14	12	
KEY RESULTS		<ul style="list-style-type: none"> – A <i>Machine Learning</i> (ML)-based object-recognition via <i>Computer Vision</i> (CV) mechanism capable of detecting given objects and people. – Architecture-embedded integration of said object-recognition into an inherited fall-detection and -intervention system [154] 									
PURPOSE		<ul style="list-style-type: none"> – To enhance human-recognition accuracy; and – To enable robotic retrieval of potentially dangerous small—i.e., retrievable by a TurtleBot [147]—objects left on the ground. 									
PERTINENCE		<ul style="list-style-type: none"> – Among elderly adults over 65 years of age, falls are a leading cause of critical injury [211]. Accordingly, an intelligent built-environment must be able to detect falls accurately to trigger a prompt response. – Small objects accidentally and/or haphazardly left on the ground may lead to unintentional falls. Accordingly, a small robot constantly retrieving recognized objects decrease the probability of such events. 									

⁵¹ This section is based on

 A. Liu Cheng, H. Bier, and S. Mostafavi, "Deep Learning Object-Recognition in a Design-to-Robotic-Production and -Operation Implementation," in *Proceedings of the 2nd IEEE Ecuador Technical Chapters Meeting 2017*, Salinas, Ecuador, 2017. [171]

Abstract

In the present implementation, a real-scale fragment of a conceptual student housing unit fabricated as a multi-layered hybrid component consisting of concrete and Expanded Polystyrene (EPS) is used (see Section 4.1.3). Its overall form, distribution of cavities, and densities of porosities are determined by structural optimization, Indoor Environmental Quality (IEQ) [108] considerations, and the integration of anticipated Information and Communication Technologies (ICTs). This implementation expands on the System Architecture detailed in Section 5.2 to include object-recognition via Deep Learning (DL) / Convolutional Neural Networks (CNNs). This vision mechanism is integrated in an inherited Fall-Detection and -Intervention System (FADIS) [154] in order to identify three human-centered (i.e. the image of a person as the detection input of the object-detection mechanism) as well as object-centered (i.e., the image of a given object—in the present case, a cup—as detection input) events and to instantiate automated interventions as output reactions accordingly for the promotion of well-being.

5.4.1 Object-Recognition via Deep Learning / Convolutional Neural Networks as a visual component of Design-to-Robotic-Operation (D2RO)

The object-recognition mechanism is implemented with open-source BerryNet[®] [212], which is built with a classification model (viz., Inception[®] ver. 3 [213]) as well as a detection model (viz., TinyYOLO[®] [214]). The classification model uses CNNs, which are at the forefront of ML research [213]. An advantage of BerryNet[®] is that it is a fully localized DL gateway implementable on a cluster of RPi3s. On an individual RPi3, the inference process is slow, requiring a delay between object-recognition sessions. This situation is ameliorated by the dynamic clustering feature of the WSN (see Figure 5.11). Another benefit-cum-limitation is that BerryNet[®]'s classification and detection models are pretrained, which avoids the need to generate said models locally.

The object-recognition mechanism was intended to be deployed across a variety of cameras in the overall built-environment, and that instances of detection were to be cross-referenced to minimize false positives. In order to implement this setup, each RPi3 node in the *Wireless Sensor Network* (WSN) was equipped with a Raspberry Pi Camera[®] V2.1, then BerryNet[®] was installed in every node and the *inference* mechanism tested individually. The next step was to enable the nodes to share their detection results, which could be done via Wi-Fi. Nevertheless, in order to reduce energy-consumption for every object-detection cross-referencing instance, ZigBee was preferred. In order to enable ZigBee on BerryNet[®]'s *detection_server.py* and *classify_server.py* were modified and made compliant with *python-xbee* [215].



FIG. 5.11 Multiple-object detection via BerryNet®: 'person', 'cup'.

5.4.2 Human- and object-centered scenarios

The newly integrated object-recognition component is intended to enable decentralized detection of three types of events and to instantiate corresponding interventions:

1 Human-centered event: Fall-Detection and -Intervention System, ver. 2.0.

The object-recognition mechanism is integrated with the inherited WSN's FADIS in order to detect a variety of human- and object-centered events and to yield corresponding reactions / interventions to promote well-being. The existing FADIS adopts a *laser-reflectivity* method [216] in order to detect the presence of collapsed objects and their estimated size. If the shape and size of the detected object corresponds to the dimensions of a person, the system gauges the probability of a collapsed person as high. Consequently, large inanimate objects may cause the system to instantiate false-positives.

The object-recognition component represents an added layer of verification that decreases the probabilities of false-positives, as its enabling DL / CNNs mechanism is trained to detect human faces and shapes. In this particular instance, the object-recognition component needs only one camera, integrated into the ceiling of the scanned environment. However, the system architecture intends for multiple cameras be integrated in the same and in various regions across several nodes in the overall built-environment in order to further increase the probabilities of accurate detections by cross-referencing purported detections. That is to say, we may imagine a scenario where lasers have detected a human-size object and its shape has indeed been identified—via that particular space's integrated ceiling-camera—to correspond to that of a human's. Nevertheless, it may still be a false positive.

In order to reduce the probabilities of this scenario, a number of new features—including the discussed object-recognition component—have been added to FADIS ver. 2.0. First, via a wearable (e.g., LBBs and/or Fitbit® activity tracker) and/or smart-device, the presence of the occupant is registered by the WSN (i.e., the WSN is programmed to detect the presence and signal intensity of particular MAC addresses within its structured environment). If the occupant is indeed confirmed to be present, and if he/she is detected—via both lasers and a ceiling-camera—to have collapsed in the bathroom, the WSN will take one final verification step before instantiating appropriate intervention mechanisms (i.e., SMS / email notifications to family-members and/or caretakers).

That is, the WSN requests information from all other nodes controlling the remaining cameras deployed in the overall space in order to detect instances of ambiguities. For example, if the occupant was detected to be in the bathroom as well as in the living-room in the single-occupant unit, then one or more detections may be false-positives. If the occupant has indeed collapsed in the bathroom, then the remaining camera-controlling nodes must not be able to return positive detections.

Hence, and to summarize, if lasers in a given region have detected a collapsed large-object; and if the region's corresponding camera has identified said large-object's shape as that of a human's, and if the wearables / smart-devices associated with the occupant are detected to be within the structured environment; and if no other camera in any other region of the overall unit has detected human-like objects; *then* the built-environment may instantiate aforementioned intervention mechanisms with a high degree of confidence.

This first scenario was verified by having (1) the original FADIS detect a collapsed large-object; (2) a BerryNet[®]-enabled ceiling-integrated RPi3 detect a 'person'; (3) surrounding BerryNet[®]-enabled RPi3 nodes (with corresponding cameras) exchange each other's *inference* results via XBee-antennas; (4) corresponding SMS and email notifications sent.

A caveat pertaining to step 3: while a majority of surrounding RPi3 nodes identified the same object—in varying angles—as likely to be a person, not all of them did. Depending on lighting conditions and body-postures, some inference results read 'car', 'lamp', 'sofa'. In these instances, the probability of the object being a person was simply determined by whether the majority of inferring RPi3 nodes returned 'person' or not. One way to improve the probabilities that the majority of nodes identify a same object accurately would be to train the classification models particularly and further, but even this would not ascertain absolute certainty. A better approach would be to keep adding correlation factors via a variety of sensors in order to identify false-positives.

2 Object-centered event, robotic intervention

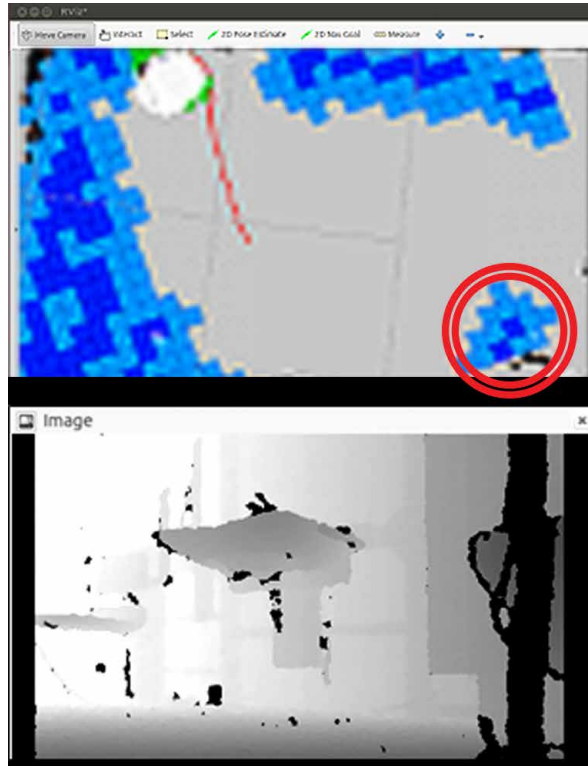

FIG. 5.12 Robotic intervention based on object-centered events. *Top:* Rover sent to the location of detected object (circled in red). *Bottom:* Abstracted robotic vision on the rover.

In this type of events, if FADIS ver. 2.0 detects the unexpected presence of a small object in an otherwise empty region, it engages the object-detection mechanism to attempt to identify it. The identification process is enhanced by cross-referencing the detection via several cameras in whose field of vision the object is found. As may be seen in Figure 5.11, an object may be identified by fragments of it—i.e., in said figure, the object-recognition mechanism detects a “cup” by its overall shape and by its handle. This feature is necessary for the present type of events in questions, as its principal purpose is to detect the presence of broken and/or unexpected idle objects on the floor. In the example of the cup, if from multiple angles (i.e., multiple cameras) a detached handle provides the necessary confidence level for a “cup” to be identified, the WSN engages a robotic agent inherited from FADIS (i.e., a TurtleBot® [18], [154]) in order to retrieve it. Admittedly, there are considerable limitations with this feature stemming from object-recognition via fragments.

In this second scenario functionality was verified by having the object-recognition mechanism accurately detect a cup on the floor, which caused the WSN to relay the XY-coordinates of the object to the TurtleBot® in order for the rover to reach the cup's location (see Figure 5.12). *Rviz* [217] was used to enable the rover to identify the boundaries of its deployment space. In the executed sample runs, the rover was able to arrive at the defined destination while avoiding collision with non-target object on the way. However, at present the TurtleBot® is only able to drag the object away via a rudimentary hook.

Consequently, further development of this system would require the design of a gripper system capable of sensing pressure. Another limitation is that during initial execution, the rover must be placed at its origin position, as defined in the process of generating the environment's map. Over time and inaccuracies of perception, etc., the rover's position and orientation will become uncontrollably inaccurate. This could be ameliorated by the addition of reference touch-sensors or switches in key locations within the environment in order to reset the rover's position and orientation.











3 Object-centered event, visual / aural warning

This type of events is similar to the previous one, except for robotic intervention is replaced with both more passive visual and/or aural interventions as well as palpable vibrations. It may be imagined that an unexpected object, broken or not, may be too large for the TurtleBot® to remove. In such a scenario, visual cues in the form of rapid light-bursts and/or aural warnings in the form of a range of sound-emissions are first instantiated in order to elicit human action. If no response follows, the WSN sends SMS and email notifications to the occupant, who may consequently instruct the system to ignore the object via an SMS response. The intervention mechanisms associated with this type of events may provide an additional assistive service to visually and/or aurally impaired individuals who would otherwise have no means of preemptively learning about unexpected collapsed objects.

The third scenario was verified in tandem with the second. At the detection of the object on the floor, and while the rover was sent to fetch it, a LED and a *buzzer* emitted light and sound, respectively. This was repeated at predetermined intervals, only to stop when a corresponding SMS was sent to the SIM-card installed in the fee-based SMS-sending and -receiving T35 GSM module.

5.5 Development of a Smart Sleeve Control Mechanism for Active Assisted Living⁵²

TABLE 5.6 Demonstrator 5's summary—environment, parameters, interactions, key results, purpose, and pertinence.

DEMO ENVIRONMENT				IEQ				QoL			
											
HYP	ROB	DT	ND								
INTERACTION METHODS		USER-DRIVEN		Appendix, IEQ Section 1.A				Appendix, QoL Section 1.B			
		SENSOR-DRIVEN		¶ 2	¶ 3	¶ 3	¶ 5	¶ 4	¶ 3	¶ 2	¶ 2
		Appendix, IEQ Section 2.A				Appendix, QoL Section 2.B					
KEY RESULTS		<ul style="list-style-type: none"> – A smart-sleeve that enables the user to point at a desired actuatable object in the inhabited built-environment (e.g., doors, windows, lights, etc.) and engage with them via predetermined gestures to open/shut, turn on/off, and/or regulate illumination intensities. 									
PURPOSE		<ul style="list-style-type: none"> – To empower people with limited physical mobility, either due to the natural ageing process or diseases, to engage with their built-environment without physical interaction. 									
PERTINENCE		<ul style="list-style-type: none"> – Mobility becomes increasingly impaired in the natural ageing process—e.g., 35% of people over 70 years of age versus the majority of those over 85 years [218]. This impairment may cause simple and rudimentary interactions in the built-environment to become increasingly cumbersome, often leading to dependence or reliance on third-parties. This smart-sleeve aims to empower users to retain their independence with respect to simple interactions with their built-environment. 									

Abstract

This implementation develops a Smart Sleeve control mechanism for assisted living. The Smart Sleeve is a physically worn sleeve that extends the user's control capability within his/her intelligent built-environment by enabling (1) direct actuation and/or (2) teleoperation via a virtual interface. With respect to the first, the user may point his/her sleeve-wearing arm towards a door or a window and actuate an opening or a shutting; or towards a light and effect its turning on and off as well as regulating its intensity; or even towards a particular region to initiate ventilation of it.

⁵² This section is based on

 A. Liu Cheng, C. Santos, P. Santos, and N. Llorca Vega, "Development of a Smart Sleeve Control Mechanism for Active Assisted Living," in *Proceedings of the IEEE 5th World Forum on Internet of Things 2019*, Piscataway, NJ, USA: IEEE, 2019, pp. 847–851. [172]

With respect to the second, the user may engage actuations in systems beyond his/her field of vision by interacting with a virtual representation of the intelligent built-environment projected on any screen or surface. For example, the user is able to shut the kitchen's door from his/her bedroom by extending the Smart Sleeve towards the door of a virtual representation of the kitchen projected (via a standard projector and/or television monitor) on the bedroom's wall. In both cases, the Smart Sleeve recognizes the object which the user wishes to engage with—whether in the real or the virtual worlds—(a) by detecting the orientation of the extended arm via an Accelerometer / Gyroscope / Magnetometer sensor; and (b) by detecting a specific forearm muscle contraction via Electromyography caused by the closing and opening of the fist, which serves to select the object. Once the object is identified and selected with said muscle contraction, subsequent arm gestures effect a variety of possible actuations for a given. In cases of ambiguous selections, the user may use voice-commands to explicitly identify the desired object of selection. Furthermore, due to this voice-based recognition mechanism, which recognizes both spoken commands as well the identity of the speakers, different rights to actuation may be assigned to different users.

This demonstrator was developed in a virtual environment, which is a placeholder representation of a de facto Digital Twin of the real / physical space inhabited by the user. An important question arises: how does the virtual representation relate to the physical one with respect to interactions? That is, does the viewpoint of the user in the virtual world change according to that of the real world to retain one-to-one correspondence between objects viewed and interacted with in both the virtual and physical worlds? In this implementation, the virtual world is intended to be viewed as a reduced representation of a future Augmented Reality setup, and so correspondence is ascertained by making the viewport of the virtual dependent on the viewport of the real. The door pointed towards with the smart sleeve in the virtual world corresponds directly to a real and physical door in the same viewport location⁵³.

⁵³ This may be contrasted with an approach where the virtual and physical worlds are decoupled from each other, where the virtual world may be viewed as an independent and navigable environment that corresponds to the objects of the real world but the viewport does not. In this setup the user could be physically fixed in one location—say, the bedroom—and navigate to other spaces virtually for the purpose of controlling any actuable mechanism in the environment—e.g., opening the front door from a distant bedroom by pointing the smart-sleeve at the virtual object (either on screen or with Virtual Reality goggles) and engaging it to open. This setup may be more appropriate for people with severely limited mobility, and a separate mechanism to navigate through this virtual environment would have to be developed.

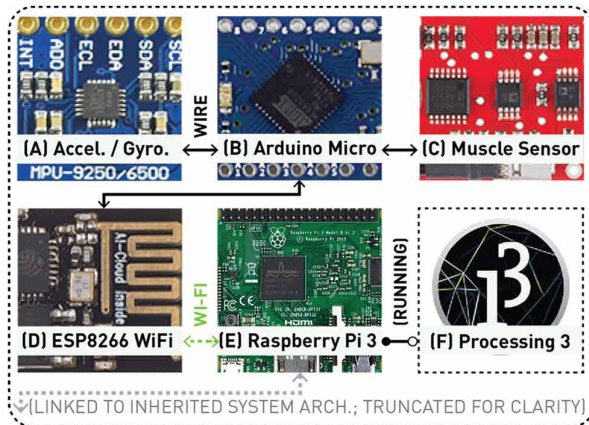
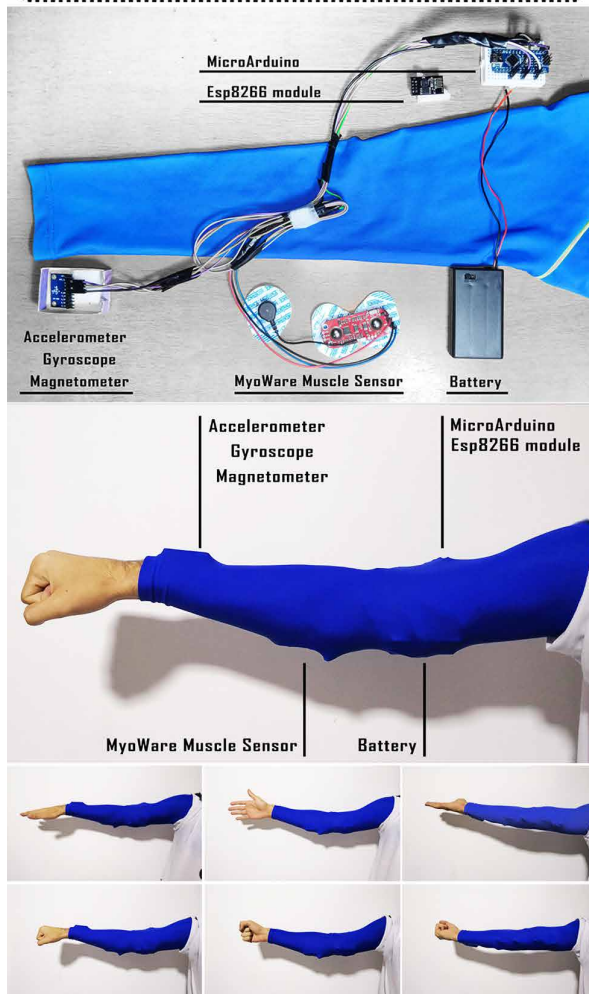

FIG. 5.13 System diagram and Smart Sleeve description



The *Smart Sleeve* enables the user's arm to work as a pointer. The user selects / deselects objects and/or actuating systems in his/her built-environment by pointing towards them and contracting the forearm's muscles (via the opening and closing of the fist). Once an object / actuating system is selected, subsequent arm movements / gestures are translated into actuation commands acting on said object / actuating system. Some commands are binary (e.g., open or shut the door) while others graduate in degrees (e.g., increase or decrease illumination intensity). The selection of objects may be direct (inside the user's field of vision) by pointing at the actual object or indirect (outside the user's field of vision) by pointing at its virtual representation. Regardless of whether the engagement is direct or indirect, a virtual representation of the built-environment may be projected any time. This representation is optional when the engagement is direct but necessary when it is indirect. In this representation, the user's arm is illustrated as a black line with one end anchored at the center of the virtual world and the other moving with the orientation of the arm's pointing.

By virtue of the Accelerometer / Gyroscope / Magnetometer sensor integrated in the Smart Sleeve (see Figure 5.13), the orientation of the user's arm relative to the built-environment is consistently tracked and represented in the virtual world. When the user is engaging directly with an object, he/she simply points, closes and opens his/her fist to select it, and then waves up or down, left or right, depending on what such gestures are configured to mean for the object. However, when the user is engaging indirectly with an object, the control sequence is more elaborate. For example, imagine that the user is lying in bed in his/her bedroom and that he/she forgot to shut the kitchen's door. He/she would request the built-environment to show its virtual world, either on a monitor or via a projector, and the user would first indicate which region of the built-environment he/she would like to engage with.

Upon selecting a particular space, the virtual world would show this space as if viewed from the center of a wall. That is, the representation of the space in the virtual world would not rotate to match the orientation of the user's arm while lying in bed—perhaps this orientation would be an awkward one with respect to the kitchen. Instead, this neutral point of view (see Figure 5.14, Figure 5.15, and Figure 5.16) enables the user to correlate his arm's physical orientation—at the time of beckoning the projection of the virtual world—with a centered orientation in the virtual kitchen. That is to say, if the user's arm parallel to the floor and pointing North at the time of beckoning the virtual world, then that orientation is the neutral orientation. This neutral orientation would always be perpendicular to the user's view of the virtual space in question. If the user does not move his/her pointing arm, then this pointer would look like a dot in the virtual world (a line perpendicular to the viewer would have both its start- and end-points aligned). But as soon as he/she moved his/her pointing arm, the start-point would remain in the center of the virtual world while

the end-point would displace in the direction and magnitude corresponding to the physical arm's direction and magnitude—i.e., from this point onward, any motion left / right, up / down, etc. would be represented faithfully in the virtual world. To summarize on this distinction: when engaging with objects directly, the arm's pointing is absolute, while when engaging with objects indirectly, its pointing is relative. But in both cases, spatial displacement of the arm / pointer is accurately represented.

When an object is selected and engaged with, whether directly or indirectly, the corresponding arm gestures that can elicit an actuation are determined in a way that reflects how the arm would move if and when engaging physically with that same object. For example, a user swings a physical door open, therefore the swinging motion is a gesture that the built-environment's underlying system would construe as applicable to the door. Conversely, a punching motion would not be one that effects any actuation on the door, as it is normally uncommon to punch a physical door open. Nevertheless, an array of motions and gestures may be configured to effect a variety of actuations upon all actuating systems, depending on the user's preference. In the present implementation, the user may lift / lower a sliding window (see Figure 5.14) and swing a door open / shut (see Figure 5.15). The only configured arm motion that does not correspond to a physical one that is commonly effected upon an object is the turning of an illumination fixture on and off, and of its corresponding regulation of intensity. In the physical world, these would be caused by hand gestures / motions (e.g., pressing a switch, twisting a knob), and the present Smart Sleeve relies only on arm gestures. Accordingly, at present, the light fixture turns on and off when selecting and deselecting it, respectively. When on, moving the pointing arm towards the left reduces its intensity, while moving it towards the right increases it (see Figure 5.16).

As indicated earlier, the main objective of this *proof-of-concept* implementation is to demonstrate the feasibility and functionality of the Smart Sleeve as an aid in interacting with the intelligent built-environment, in particular for users with limited mobility (e.g., the elderly, people recovering from illnesses and/or accidents, et al.) and/or reach (e.g., children, expecting mothers, et al.). Finally, the Smart Sleeve, being a mechanism within a larger technical ecosystem, is also integrated with a previously developed—yet not presented as a demonstrator project *per se*—*Speech and Voice-Command Recognition* mechanism [219]. Accordingly, the user may verbally specify a selection in situations where there is ambiguity. For example, imagine that the user points at the door directly, but at that angle a desk actionable lamp is also in the line of sight. In such a case the user may explicitly speak the name / identifier of the object he/she wishes to select in order to disambiguate. Furthermore, via this voice-based recognition mechanism's ability to recognize both the spoken command and the identity of the speaker, different actuation rights may be assigned to different users.

For example, a user may have the right to open all windows and doors, while another may be assigned accessibility rights to specific ones only. This feature addresses potential safety concerns, especially where children are involved.

5.5.1 BAN and WSN aspects

The *client* side of the Smart Sleeve mechanism is controlled by an Arduino / Genuino Micro connected with an MPU-9250 Accelerometer / Gyroscope / Magnetometer and a MyoWare Muscle sensor. The MyoWare muscle sensor uses *Electromyography* to detect forearm muscle contraction / release, which is correlated with the selection and deselection feature of the Smart Sleeve. The MPU-9250 sensor is used to detect the movement, velocity, and orientation of the Smart Sleeve-wearing arm. The incoming data is cleaned, processed (in a way based on [158]), and sent to the *server* side of the Smart Sleeve mechanism via an ESP8266 Wi-Fi module. On the *server* side, a Raspberry Pi 3 Model B (RPI3) that is part of the inherited System Architecture receives the data via the *Open Sound Control* (OSC) protocol and makes the stream available to a script in Processing 3.3 (see Figure 5.13)—it is this script that also generates the virtualization of the intelligent built-environment (i.e., the virtual world). In a previous development, instead of the ESP8266 module and the OSC protocol, a 433MHz RF transmitter and corresponding receiver were used. However, the range of such a setup was too limited for the *client*-side of the Smart Sleeve mechanism to interact with its *server*-side at large distances.

Since the RPi3 *server* node is part of the larger System Architecture, it has access to all the ICT-based service mechanisms in the ecosystem. It is in this manner that the Smart Sleeve integrates with the *Speech and Voice-Command Recognition* mechanism developed via Google Cloud Platform™’s Cloud Speech-to-Text API [220]. As described elsewhere [219], this mechanism is capable of translating spoken speech to *String* text that can be used as triggering input for actuations. In this implementation, the user uses this mechanism by referring to the object it wants to select in cases of ambiguity. In order to do this, the service-triggering keyword (to initiate the service) must first be spoken to inform the system to translate what follows to *String* text. The user then must indicate that the commands that follow are directed to the Smart Sleeve mechanism (e.g., “For Smart Sleeve”). Finally, after receiving audio feedback that the specification is understood, the user proceeds to speak directed to the Smart Sleeve. For example, in the situation considered earlier, where the user points directly at the door yet encounters a desk lamp in the line of sight, the user must tell the system which of the available objects in the line of sight he/she wants to select (e.g., “the lamp”, “the door”). Accordingly, the identified object is selected—and this selection is

indicated in the virtual world by a change of color of the object in question; and in the real world via audio feedback. In order for this to work, the library of recognized words / commands in the Speech and Voice-Control Recognition mechanism must be current to include the catalog of actuating systems within the intelligent built-environment. It should be noted that for clarity, the built-environment within which the Smart Sleeve was implemented and tested was kept architecturally simple. The elements created include a basic door, sliding window, sliding floormat, central illumination, and a spherical geometry representing a non-descript piece of furniture.

5.5.2 **Actions: slide a window, swing a door, and regulate the intensity of a light-source**

The simplified built-environment is a rectangular room that contains a basic door, sliding window, sliding floormat, central illumination, and a spherical geometry representing a non-descript piece of furniture. All of these elements are actionable, and in the present implementation all of them were engaged with several times to gauge precision, performance, and functionality. However, in this implementation, figures corresponding to only three of these elements are illustrated. In the case of the window, the Smart Sleeve is pointed towards it, selects it, and an upwards movement is effected once the object is locked (see Figure 5.14). Similarly, the case of the door, it is pointed at, selected, and swung open with the same gesture that is typically used to open hinged doors (see Figure 5.15). Finally, in the case of the central light fixture, it is pointed at, selected, and gradually turned brighter or darker depending on whether the Smart Sleeve is oriented towards the right or left side of the room (see Figure 5.16).

In all trials the Smart Sleeve performed successfully, which is promising yet unsurprising due to the controlled environment within which it was tested. Although the components of the Smart Sleeve are at a *Technology Readiness Level* (TRLs) [53] of 9, the solution itself must be crafted in a more intuitive and non-intrusive way before it may be considered as a feasible and comfortable device. Furthermore, cases of ambiguity were only tested with two overlapping objects (e.g., the door and the desk lamp in the same line of sight). Consequently, further tests with more complex scenarios must be tested in order to gauge the actual feasibility and TRL of the device. As the Smart Sleeve is optimized and further polished, it may be integrated with other existing mechanisms supervening on the inherited System Architecture. For example, further work is being conducted to integrate likewise developed *Object-* as well as *Facial-Identity and -Expression Recognition* mechanisms (see Section 5.4 and Section 5.8, respectively) based on *TensorFlow*[™] [168] and Google Cloud Platform[™]'s Cloud Vision API [221] with the Smart Sleeve's functionality.

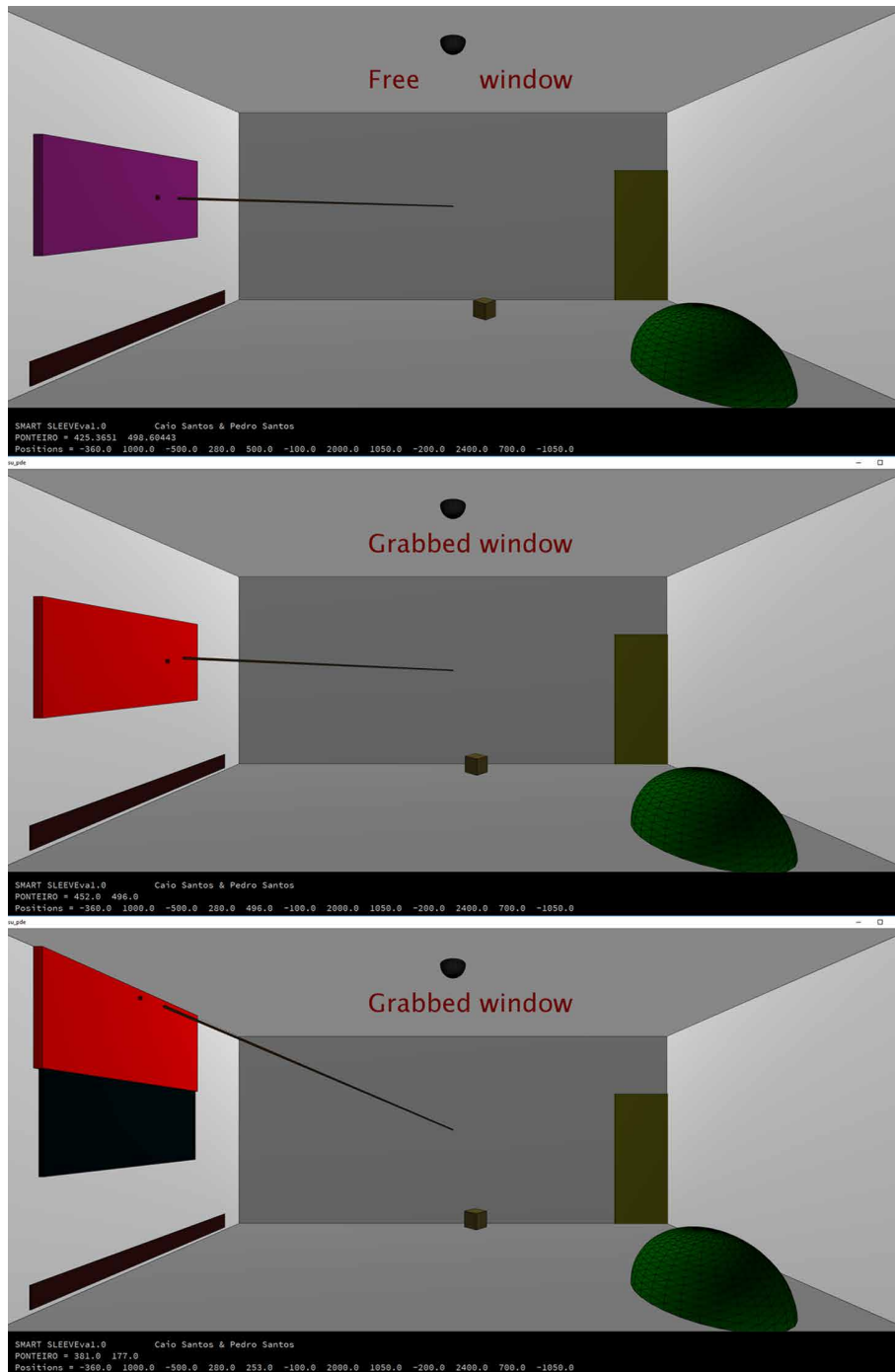

FIG. 5.14 Pointing (Top), selecting (Middle), and moving (Bottom) sliding window.

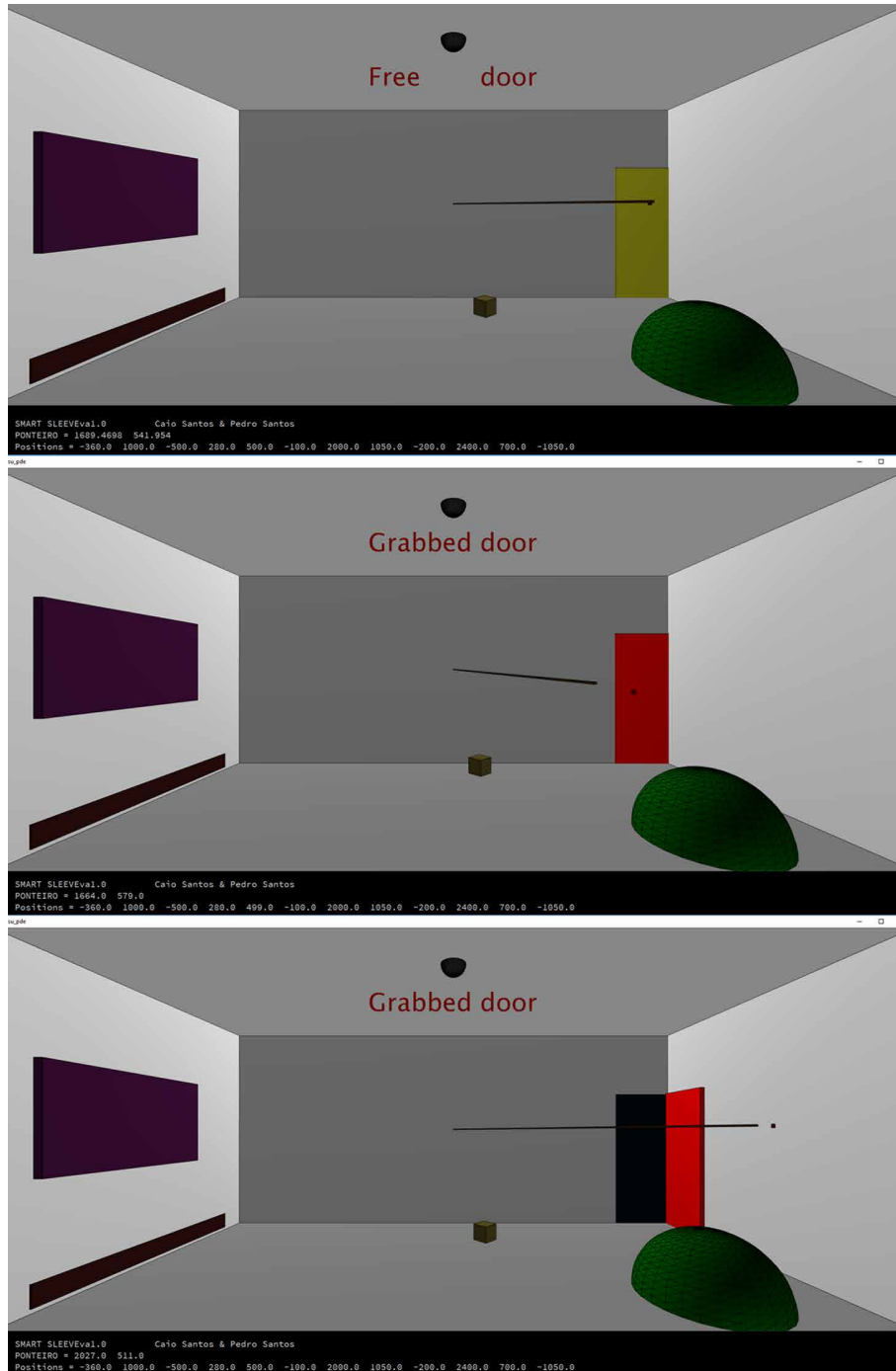

FIG. 5.15 Pointing (Top), selecting (Middle), and swinging (Bottom) hinged door.

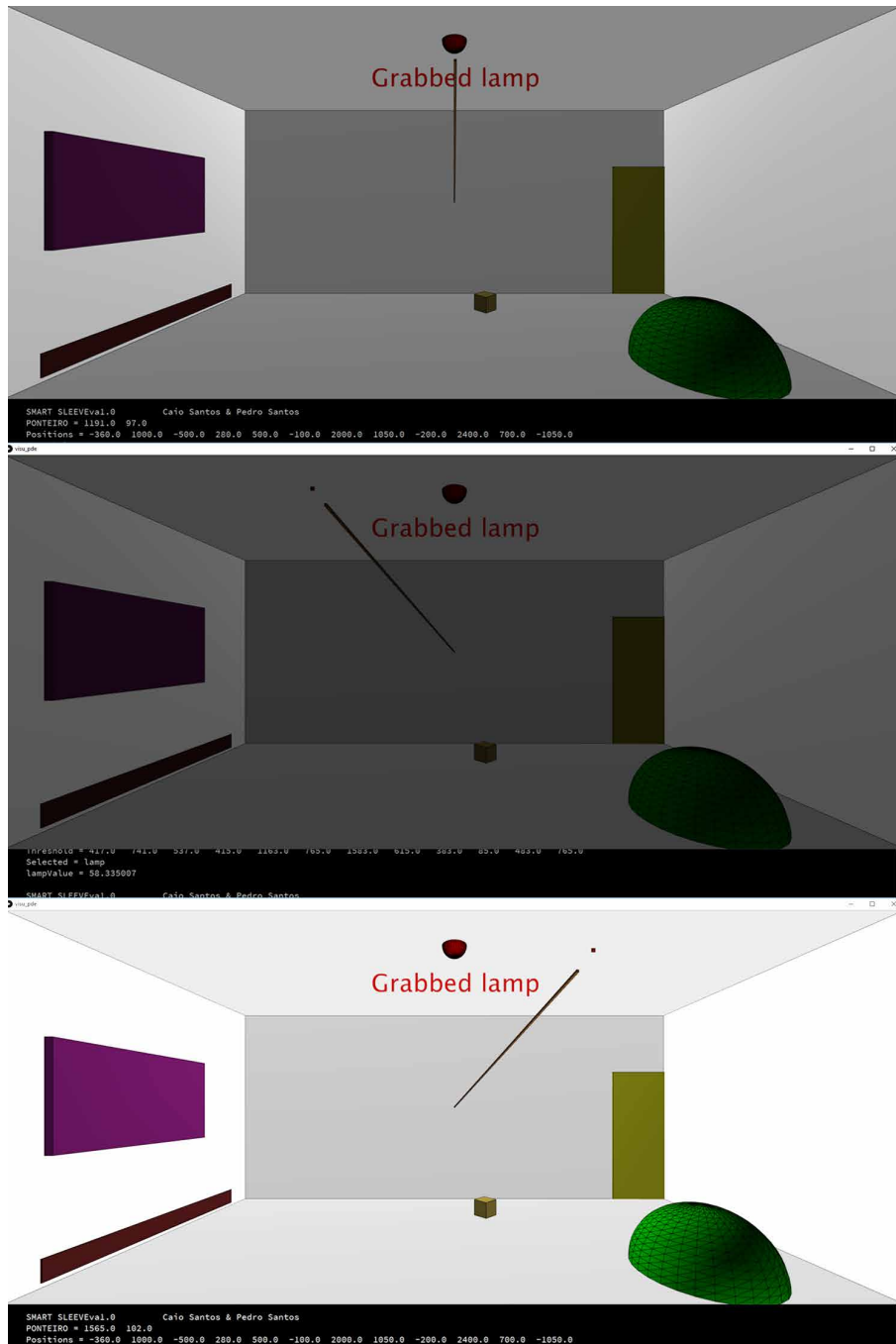













FIG. 5.16 Pointing and selecting (Top), decreasing intensity (Middle, gesture left), and increasing intensity (Bottom, gesture right) of central illumination device.

5.6 Development of a Light-Tracking and -Redirecting System Actuated by Hand-Gesture Recognition⁵⁴

TABLE 5.7 Demonstrator 6's summary—environment, parameters, interactions, key results, purpose, and pertinence.

DEMO ENVIRONMENT				IEQ				QoL			
											
HYP	ROB	DT	ND								
INTERACTION METHODS		USER-DRIVEN		Appendix, IEQ Section 1.A				Appendix, QoL Section 1.B			
		SENSOR-DRIVEN									
KEY RESULTS		<ul style="list-style-type: none"> – A light-tracking module capable of redirecting light away from / towards specific locations based on recognized hand-gestures. – A system consisting of said modules capable of interfacing with the local structured environments <i>Information and Communication Technologies</i> (ICTs), where Architecture-embedded integrated cameras are used to relay commands associated with recognized hand-gestures. – The modular system is compatible and complementary to the modular façade systems outlined in Section 5.7 and Section 5.8, and accordingly may be conceived as a façade system itself. 									
PURPOSE		– To enable the user to draw natural illumination away from / towards his/her specific location.									
PERTINENCE		– Natural illumination, as a subset of general illumination, is one of four <i>de facto</i> core parameters in <i>Indoor Environmental Quality</i> (IEQ) [109] (see Figure 3.2). With minimal effort, elderly users may actuate these light-tracking modules to draw light away from / towards them as desired.									

⁵⁴ This section is based on

 A. Liu Cheng, N. Llorca Vega, G. Latorre, and D. Coba, "Development of a Light-Tracking and -Redirecting System Actuated by Hand-Gesture Recognition," in *Proceedings of the IEEE 5th World Forum on Internet of Things 2019*, Piscataway, NJ, USA: IEEE, 2019, pp. 702–706. [173]

Abstract

The detailed system consists of individual nodes that are strategically installed across regions of a building-envelope, which enables this latter to draw or deflect direct natural light into or away from specific locations within the built-environment as requested by the user(s) via recognized hand-gestures. Each node is capable of sending and receiving sensed-data continuously via ZigBee with one another as well as with microcontrollers embedded within the interior built-environment. Said microcontrollers are equipped with cameras via which four hand-gestures may be recognized. The first or initializing hand-gesture engages the system and enables it to recognize any of the remaining hand-gestures. The second redirects light towards the position of the detected hand-gesture, while the third redirects it away from said position. Finally, the fourth gesture turns the light-tracking and -redirecting system off.

The objective of the system is to enable the user(s) to draw or deflect direct natural light into or away from his/her inhabited space in a way that enhances its quality⁵⁵. This notion of quality labors on subjective considerations such as human preference as well as objective ones such as measurable health benefits associated with exposure to direct natural light. For example, humans prefer direct natural light over artificial counterparts (especially fluorescent) as they associate it with higher levels of concentration, health, aesthetic quality [223]. Additionally, daylight is associated with fatigue mitigation as well as vitality, which is a psychological metric for mental well-being [224], [225]. Artificial lighting, especially in the workplace and in the pervasive form of fluorescent lights, is associated with fatigue and degraded cognitive performance [226]. Furthermore, lack of exposure to direct natural light is correlated with depression and even to the perception of sleep quality, where insufficient exposure to direct natural light is strongly correlated with the perception of insufficient sleep [227]. This system is conceived as a support layer for a class of dynamic building-envelopes—capable of reacting to a particular set of environment-related conditions—such as Jean Nouvel's dilating façade components in his Institut du Monde Arabe [228], Aedas®'s Al Bahar Towers [229], ETH Zürich's Adaptive solar façade [230], and the adaptive and context-aware building-envelope nodes previously developed (see Section 5.7) to name a few. The present system is conceived and construed as an active protagonist in the continuous promotion of the user(s)'s well-being and spatial experience, and it is considered as part of an intelligent built-environment ecosystem centered on Internet of Things and People, or what Oosterhuis has called a Society of Home [231] in describing the future dwelling space.

⁵⁵ For examples of notable built-environments enhanced by direct natural lighting considerations, see [222].



FIG. 5.17 Top: cluster of three nodes. Second-image-to-bottom: mirror surface's vertical rotation sequence.

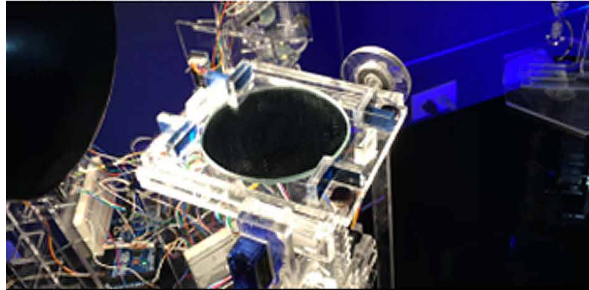
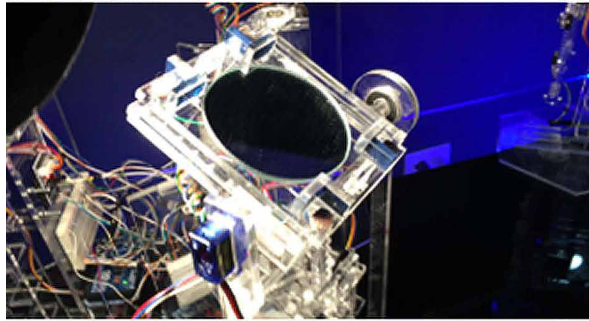
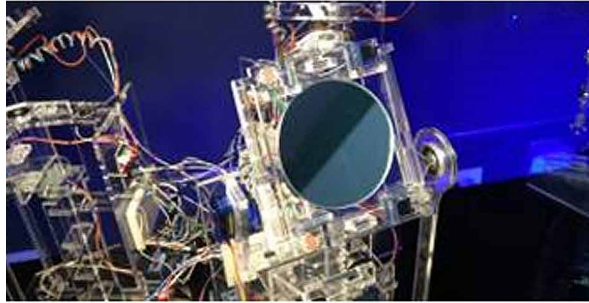

This system enables the user(s) to draw or deflect direct natural light via a series of discrete nodes equipped with concave mirrors whose position reconfigures horizontally and vertically (see Figure 5.18). These nodes are intended to be integrated in specific regions of the building envelope, depending on the orientation of daylight sources given the particular geographic location on which the built-environment is situated. It is not necessary to populate the entire building-envelope with these nodes given that certain latitudes do not receive direct natural light on certain facades throughout the year. Said nodes continuously send and receive information with *microcontrollers* (MCUs) embedded in the interior space that serve a variety of other service features inherited from previous work. Some of these MCUs, which are strategically installed in specific locations within the interior space, are equipped with a *Raspberry Pi Camera v2* capable of engaging in computer vision functions such as facial-recognition [175] as well as gesture-recognition. A user in the interior of a built-environment covered by the service range of a given set of nodes (again, depending on where the nodes are strategically installed considering the building's geolocation) engages the light-tracking and -redirecting system by effecting an initializing hand-gesture (viz., Figure 5.19, *Gesture 1*). Due to the position of the cameras installed across said space, the general position of the recognized hand-gesture may be ascertained. It is in this manner that the nodes may reconfigure to redirect their received direct natural light towards the general position of a detected specific hand-gesture whenever this is recognized (viz., Figure 5.19, *Gesture 2*). It should be noted that if the nodes that service the interior space in question are not receiving direct natural light and are therefore unable to redirect it, a sound-notification is emitted to inform the user. In addition to drawing direct natural light, the nodes may also deflect it from a hand-gesture location when another specific hand-gesture is recognized (viz., Figure 5.19, *Gesture 3*) and if its concave mirror's vertical and horizontal range is within the direct natural light's direction. Since each discrete node is integrated with four *Light-Dependent Resistors* (LDRs), it is capable of ascertaining whether it is in the path of direct natural light. If after being engaged by gesture 3 none of the nodes servicing a given interior space detects the presence of direct natural light within its vertical and horizontal displacement—and can therefore not engage in deflection / redirection—a sound-notification is emitted to inform the user. Finally, when gesture 4 (see Figure 5.19, *Gesture 4*) is recognized, the light-tracking and -redirecting system is instructed to stop listening to gestures 2 and 3. As the cameras in the built-environment are continuously engaging in object, facial-identity and -expression, and hand-gesture recognition, this last gesture is implemented in order to prevent the false engagement of the nodes via gestures 2 and 3.

The light-tracking and -redirecting system consists of two main components: (1) a set of discrete light-tracking and -redirecting nodes, and (2) a hand-gesture mechanism that commands them. Although these are integrated to work as a single system, the present section discusses the implementation of each component separately.

5.6.1 Light-tracking Modules and system

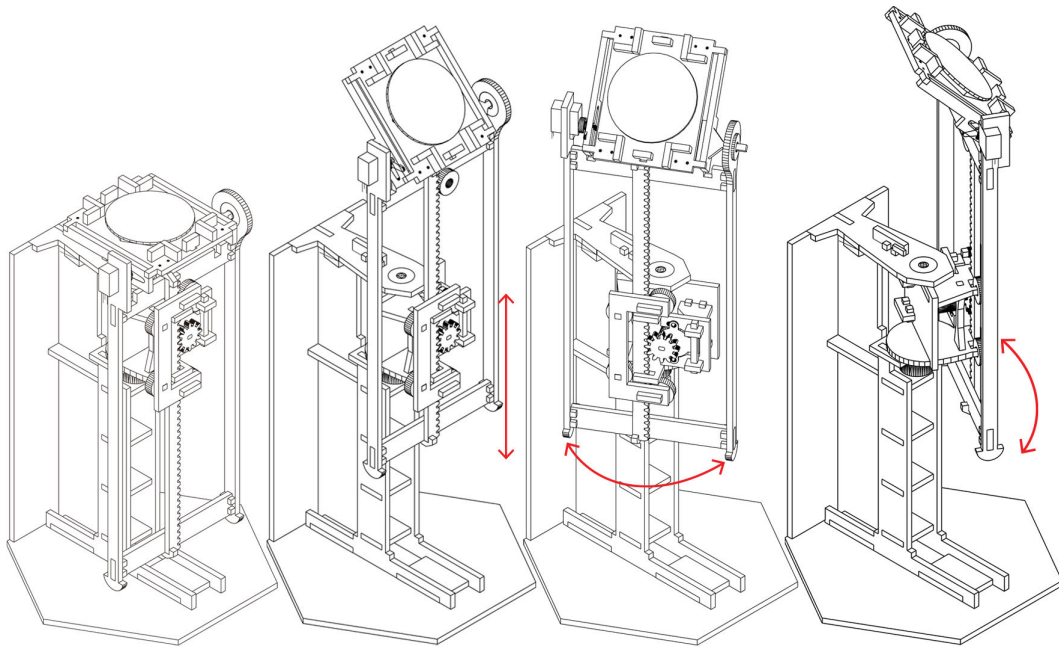

FIG. 5.18 *Left-to-Right:* (1) Initial position of light-tracking module; (2) Vertical adaptation of module; (3) Module turning right; (4) Module turning left.

Although each node is its own discrete mechanism, the present setup has one MCU for every set of three nodes, which occupy all of the MCU's analog and digital GPIOs. A single *XBee Series 2 antenna* services each MCU. Nevertheless, the individual sensor data of each node may be identified via software. That is, the perceived light-intensity data of each node is stored in an array, and the source node of a given data stream may be identified via the index values of this array. In this manner any node from within any cluster of three (see Figure 5.17, *Top*) may access the sensed-data of any other node within any other cluster of three. There are scenarios where such interconnectivity is not necessary in the present setup. For example, in order to orient a particular node's mirror a particular location, the node only needs to receive the instructions from its MCU. Nevertheless, envisioned future scenarios and services require the nodes to be capable of swarm-like behavior, which is effectively only possible within the context of a meshed topology.

Each node consists of two stepper motors for vertical displacement and horizontal rotation as well as one servo motor for the vertical rotation of the concave mirror (see Figure 5.17). The surface that supports the concave mirror is integrated with four LDRs, and the direction of said surface's displacement is determined by which LDR or combination of LDRs is receiving the most intensity of direct natural light. Based on this information, the MCU in conjunction with the camera data sent to it by the camera-integrated interior MCUs computes the horizontal and vertical displacements as well as vertical rotation necessary to redirect sensed direct natural light towards a specific location within the built-environment (as guided by gesture 2). A similar but opposite computation takes place in order to deflect detected direct natural light from a given space. In the present setup the nodes are configured to deflect to any direction that requires the least amount of physical displacement as long as no direct light is detected at the location of the hand effecting gesture 3. In subsequent implementations a default location may be identified for mirrors to focus on while deflecting light from a given location. But in the present *proof-of-concept*, the least amount of physical displacement is informed by energy-efficiency considerations.

In order to preserve energy, the MCU controlling each cluster sets each of its nodes on standby and the XBee antenna to sleep-mode when no direct natural light is detected.

5.6.2 Hand-Gesture Recognition Mechanism

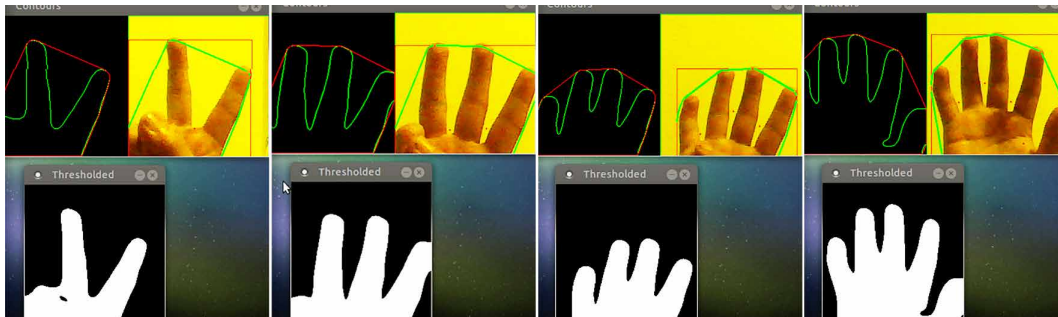

FIG. 5.19 Left-to-Right: Gesture 1: System Initialization. Top-right: Gesture 2: Draw light towards the location of hand-gesture. Bottom-left: Gesture 3: Redirect light away from hand-gesture. Bottom-right: Gesture 4: System is turned off.

As previously mentioned, the present implementation inherits and builds upon an open-ended System Architecture (see Section 3.4 and Figure 3.11: Four main subsystems in core System Architecture: Local System; Wearables Subsystem; Remote / Cloud Services Subsystem; and Ad Hoc Support Subsystem.). In particular, (1) a visual gesture-detection mechanism is built next to an inherited object-recognition mechanism (see Section 5.4.1) in order to enable the intelligent built-environment to be capable of hand-based gesture-recognition; and (2) an extension of an inherited *Human Activity Recognition* (HAR) mechanism (see Section 5.2.1) is used to make inferences about motion and basic posture with respect to the user. This same mechanism has previously been used to trigger actuation events such as ventilation, illumination, etc., within the built-environment. Nevertheless, the present discussion is limited to the light-tracking and -redirecting system in question. The visual gesture-detection mechanism relies primarily on architecture-embedded ICTs while the HAR mechanism—and therefore the motion and basic posture recognition components thereof—relies primarily on smart-devices and wearables (which transmit body-specific accelerometer and gyroscopic data) and secondarily on embedded ICTs (which receive and process said data).













The instantiated feature in question enables the user to trigger physical and computational events by a combination of recognized hand-gestures in relation to recognized posture and/or motion associated with specific activities. In order to provide a technical breakdown of the mechanisms that enable the feature in question, this section details the implementation of the hand-gesture mechanism first and the extension of the HAR mechanism second, culminating with a description of how their outputs are used in conjunction to trigger events. The inherited object-

recognition mechanism (see Section 5.4) is built with BerryNet® [212], which in turn is built with Inception® ver. 3 [213] for a classification model and TinyYOLO® [214] for a detection model. A salient advantage of BerryNet is that it is a fully localized gateway implementable on a cluster of Raspberry Pi 3s (RPI3s), which are the principal computational nodes of the inherited System Architecture. On an individual RPI3, the inference process is slow, requiring a delay between object-recognition sessions, which is ameliorated by the dynamic clustering feature of the inherited *Wireless Sensor Network* (WSN) that supervenes on said System Architecture. Incidentally, it is worth noting that due to their evolving and resilient characters, *Machine Learning* (ML) classifiers are aptly implemented in a wide-range of applications built on WSNs [193]. Another benefit-cum-limitation is that BerryNet®'s classification and detection models are pretrained, which avoids the need to generate said models locally, but which also restricts its range of detection. However, for the present implementation this is more a benefit than a limitation, since the object-detection mechanism is used to recognize general objects (e.g., cars, chairs, people, dogs, etc.) but not to discern between variations or specifics. Within the intelligent built-environment, a number of cameras and corresponding RPI3s embedded within deliberately purpose-fabricated cavities are used via the object-recognition mechanism to recognize whether a person is within a given area of the built-environment. The hand-gesture mechanism is executed only when a person is detected with a fair degree of confidence (i.e., confidence-level greater than 75% in BerryNet's inference results). This is informed by efficiency considerations, as there is no need recognize for hand-gestures where there is an absence of hands. In addition to saving energy and computation resources, this consideration also decreases the number of false positives in improbable-yet-possible scenarios. For example, a computer screen in a given space may display an image of a hand in a recognizable gesture, which could trigger the hand-gesture mechanism to construe a detected instance when there is none. Also, there may be a physical model of a hand bearing a particular gesture—e.g., a mannequin's hand—which may also fool the hand-gesture mechanism. These two scenarios, however improbable, are wholly avoided by enabling the object-recognition mechanism to allow the hand-gesture recognition mechanism to consider only those instances where a person's presence has already been confirmed. A caveat: there are measures that could be implemented to discard displayed hands or physical representations of hands such as using sensors to gauge the heat-signature and -distribution of the object, but even with such measures there would be a question of how efficient it would be to run both object-recognition and hand-gesture recognition mechanisms simultaneously. To be sure, there may be instances where such operation is justified, but such considerations exceed the scope of the present implementation.

The hand-gesture mechanism is built with *OpenCV* [232]. Unlike the object-recognition mechanism, it is deployed locally in its entirety due to its relatively modest consumption of computational resources. In this setup, the mechanism first generates a silhouette corresponding to the person detected by the object-recognition mechanism. It then identifies the regions where the hands should be and centers on capturing images of those regions. A rough rectangular region is drawn around the object captured in said images and its contours are identified via segmentation techniques based on the thresholding of images in grayscale. This results in a boundary line representative of the captured object (see Figure 5.19). Note that at this point the object may not actually be a hand. There may have been errors in the process of detecting the regions where hands are typically found, especially in non-controlled setups. Accordingly, further steps are taken to ascertain whether it is a hand bearing any one of the three considered gestures. The first is to identify the tips of the objects that may or may not be fingers as well as the concavities between them. From these points angles are calculated, and if they are within specified limits, then a high-probability of it being a hand via identification of fingers is construed. In this same step the number of fingers is identified and recognized as any of the three considered gestures. It should be noted that segmentation techniques presently employed will not work in all scenarios, especially in when illumination and composition are not controlled. In such cases other segmentation techniques may be applied—for example, Soffritti uses skin tone as a threshold to binarize images [233].

5.7 Adaptive Building-Skin (Façade / Envelope) Components as Context-Aware Nodes in an Extended Cyber-Physical Network⁵⁶

TABLE 5.8 Demonstrator 7’s summary—environment, parameters, interactions, key results, purpose, and pertinence.

DEMO ENVIRONMENT				IEQ				QoL					
													
HYP	ROB	DT	ND										
INTERACTION METHODS		USER-DRIVEN		Appendix, IEQ Section 1.A				Appendix, QoL Section 1.B					
				¶ 3	¶ 4		¶ 7	¶ 6	¶ 5	¶ 3			
		SENSOR-DRIVEN		Appendix, IEQ Section 2.A				Appendix, QoL Section 2.B					
				¶ 2	¶ 3		¶ 4	¶ 9	¶ 5	¶ 3			
KEY RESULTS		<ul style="list-style-type: none"> – Two variations of an adaptive building-façade module, a single-layer version that regulates ventilation and natural illumination, and a double-layer version with dedicated ventilation and natural illumination regulation. Both versions also react in the presence of water, preventing infiltration. – A system composed of said modules that integrates with the built-environment’s <i>Information and Communication Technologies</i> (ICTs) to exchange environmental data over which reactions actuate. – A local structured environment that enables remote control / override of automatic functions of the façade system. This control may take place by a user within the environment itself or from a remote location. 											
PURPOSE		<ul style="list-style-type: none"> – To develop a building-façade—or envelope—capable of automatic regulation of ventilation and natural light intake that continuously ascertains optimal (i.e., prescriptive) temperature levels and air-quality as well as a user’s preferred minimum illumination level. – To develop a building-façade system capable of detecting hazardous conditions and of overriding automatic operation to respond—e.g., natural air-ventilation takes precedence over comfort with respect to temperature in situations with detrimental or dangerous air-quality (e.g., gas-leaks, smoke, etc.). 											
PERTINENCE		<ul style="list-style-type: none"> – An environment capable of self-regulating temperature, air-quality, illumination levels can guarantee that an elderly occupant is living in appropriate conditions with minimal effort from their part. It is reasonable to consider that, given memory loss or loss of sensorial acuity associated with the natural ageing process, an elderly user may forget to shut a window in wintertime, turn-off a stove, etc. Especially if the user is unconscious (e.g., asleep), hazardous air-quality or dangerously low temperatures may be deadly. This automatic adaptive façade would respond independently of user intervention. 											

⁵⁶ This section is based on

 A. Liu Cheng and H. Bier, “Adaptive Building-Skin Components as Context-Aware Nodes in an Extended Cyber-Physical Network,” in *Proceedings of the 3rd IEEE World Forum on Internet of Things: IEEE*, 2016, pp. 257–262. [174]

Note that two prototypes are presented, the second building in complexity on the first, in order to highlight single-layered (simple) and multi-layered (complex) functionalities in the same adaptive building-skin concept. Indeed, increasingly complex variations may be envisioned, but the present serves to illustrate the solution's feasibility in a variety of expressions.

5.7.1 1st Prototype: Single-layered System

Abstract

Two IoT-ready skin fragments (A and B, see Figure 5.20) containing three components each (1-3 for A, 4-6 for B) are developed as part of the proof-of-concept. These components are formally similar to ones installed on Aedas®'s Al Bahar Towers [229]. A variety of other skin components were also considered, but this one was chosen for its functional and aesthetic qualities. The architectural skin fragments are to be considered parts of a larger and unified whole, which will eventually be expressed in the form of a building-envelope. For the scope of this section, it is not relevant to detail the design considerations behind the form of the overall structure; what is relevant is that the nodes behave in a swarm-like manner with respect to each other and to the interior environment's nodes within a distributed, decentralized, yet unified solution.

The two demonstrations arranged in order to test the entangled functionality of the skin system specifically, and of the overall Cyber-Physical System (CPS) generally, involve real-time sensed data and corresponding actuated reactions. One thousand sensor-state and actuator-state readings were taken per sample run. The experimental set-up involved installing fragment A as part of a skin facing North-East (NE), while fragment B as part of one facing South-West (SW), at 5:11 p.m. in the month of May in Quito, Ecuador. This meant that fragment B faced the late-afternoon sun while fragment A was exposed to diffused illumination characteristic of the late-afternoon sky. As the relationship between normalized Light-Dependent Resistor (LDR) values and the aperture extent was inversely proportional, the components in skin fragment A were more open than those of skin fragment B, since the latter received more sun than the former. Figure 5.22 represents the experiment's baseline from which the force of external influencing factors was gauged.

In addition to this initial arrangement, the gathered data by each fragment's node and the corresponding extents of actuation in both demonstrations were live-streamed to a cloud-based data plotting and analytics service, thereby establishing the possibility of future Internet-of-Things (IoT) expansion and Machine-to-Machine (M2M) exchange within and without the CPS.

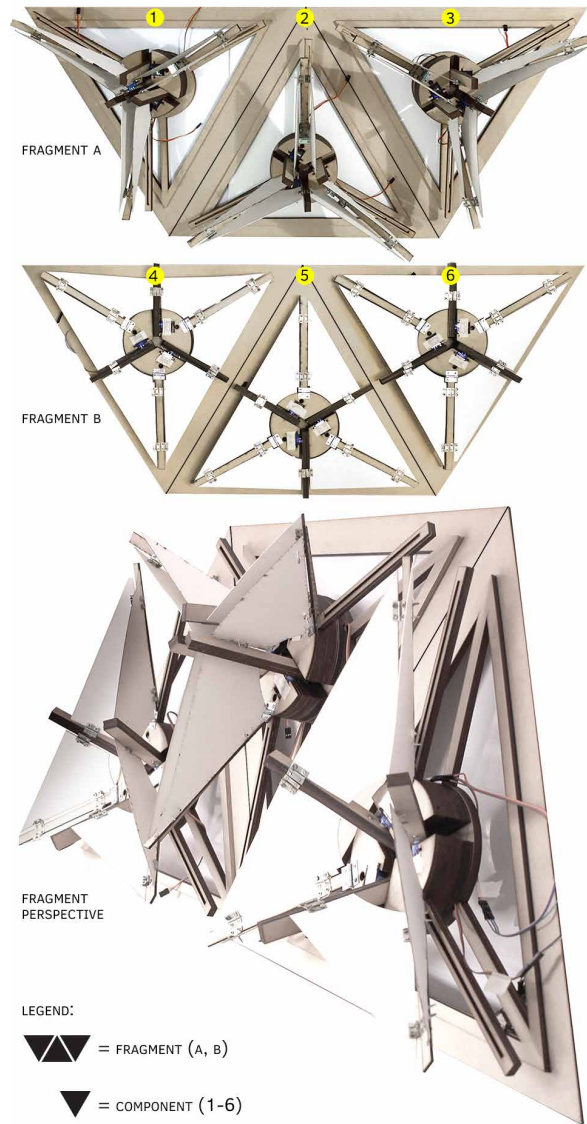

FIG. 5.20 Top: Components 1-3, skin fragment A (fully open). Middle: Components 4-6, skin fragment B (fully shut). Bottom: Skin fragment perspective (with differing degrees of component openness).

In addition to their ability to operate as distributed systems, swarms are particularly pertinent to architectural applications due to their failure tolerances via self-healing mechanisms. Furthermore, while individual nodes may be quite simple, the emergent behavior of swarms grows increasingly complex, where local interactions between nodes lead to the emergence of a global behavior. In this context, local cooling and heating, ventilating and / or shading / illuminating responds to indoor-outdoor conditions and users' needs by establishing changing global indoor climates.

This prototype expands the inherited ecosystem by adding another *BeagleBone Black* (BBB) with a corresponding XBee cape, and two UNO MCUs with corresponding XBee shields. The new BBB serves as the *Router* node that links the new MCUs to the original *Coordinator* node via *ZigBee*-enabled *XBee Pro Series 2B* antennae. Although the MCUs could directly communicate with the *Coordinator* node, this setup was selected in order to extend the communication range between *Coordinator* and the skin nodes, which are controlled by the MCUs. Each MCU is connected to three skin nodes corresponding to each fragment of the skin. These fragments do not share a physical connection with each other, nor with any other node in the interior environment—Fragment A was installed facing North-East and Fragment B South-West (opposing faces) (see Figure 5.21).

Under this wireless ecosystem, whenever any skin node is affected by an environmental condition or a user-correlated action, the effects will propagate across all other skin nodes (in both fragments) as well as all interior-environment nodes. The distribution of the propagation's magnitude across the entire (*Wireless Sensor Network*) WSN will be correlated with the proximity as well as the relationship between the detecting skin node and its neighbors. For example, if a given interior environment sensor node is moved closer to either skin fragments, the immediacy and extent of the sensor readings' influence upon the behavior of corresponding components will vary. Similarly, if a skin fragment's component (e.g., Component 1 in fragment A) includes a moisture sensor that detects the presence of water, the extent to which the immediate neighbors (i.e., Components 2 and 3 in fragment A) react in an event of rain is more pronounced and immediate than that of more distant neighbors (i.e., Components 4, 5, and 6 in fragment B).

All the nodes are equipped with individual LDRs in order to correlate light intensities to degrees of dilation / aperture (see Figure 5.22). For simplicity, the normalized light intensity is inversely proportional to the normalized aperture extent. The setup is intended to illustrate that though all skin nodes are sensitive to exterior lighting conditions, some nodes may be specialized to account for other environmental conditions as well as user-dependent actions. This serves to enrich the capabilities of the skin as a unified system, as the specialized data sensed by one node is accessible by all others and vice versa.

Since each skin component possessed its own LDR, this entailed that every component aperture would be different—however slightly or emphatically—from one another (Figure 5.22, *Left* and Figure 5.22, *Right*).

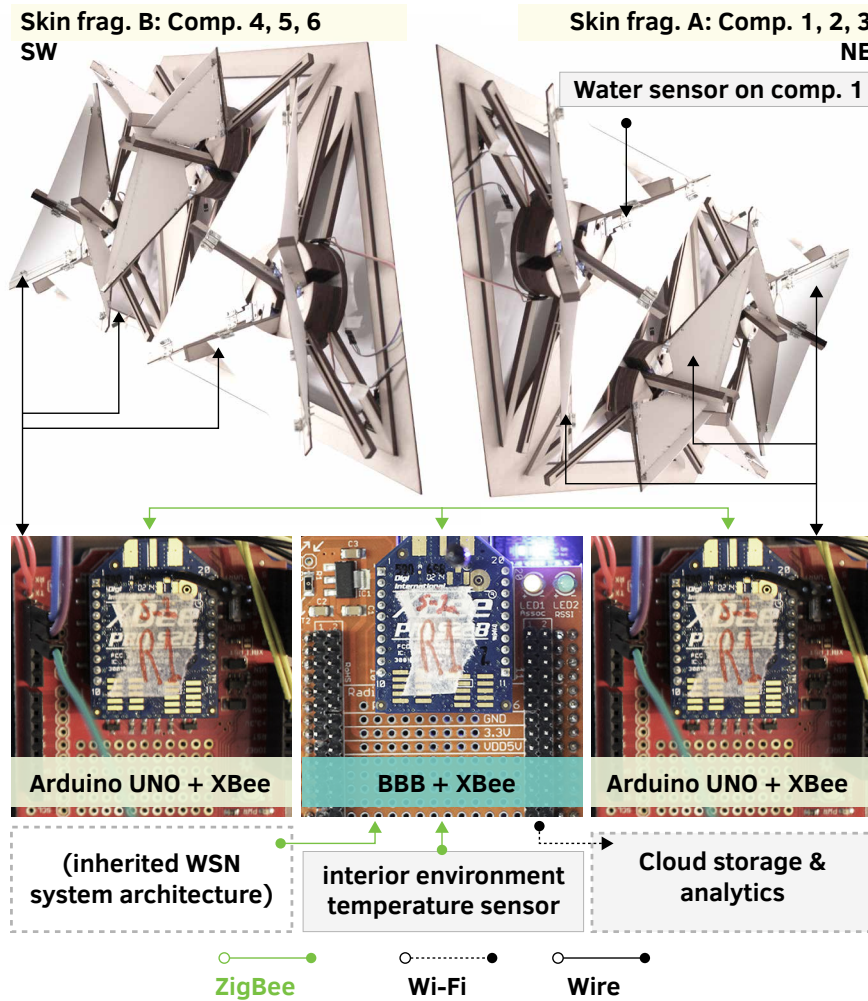

FIG. 5.21 System Architecture (excluding inherited WSN components[153]).

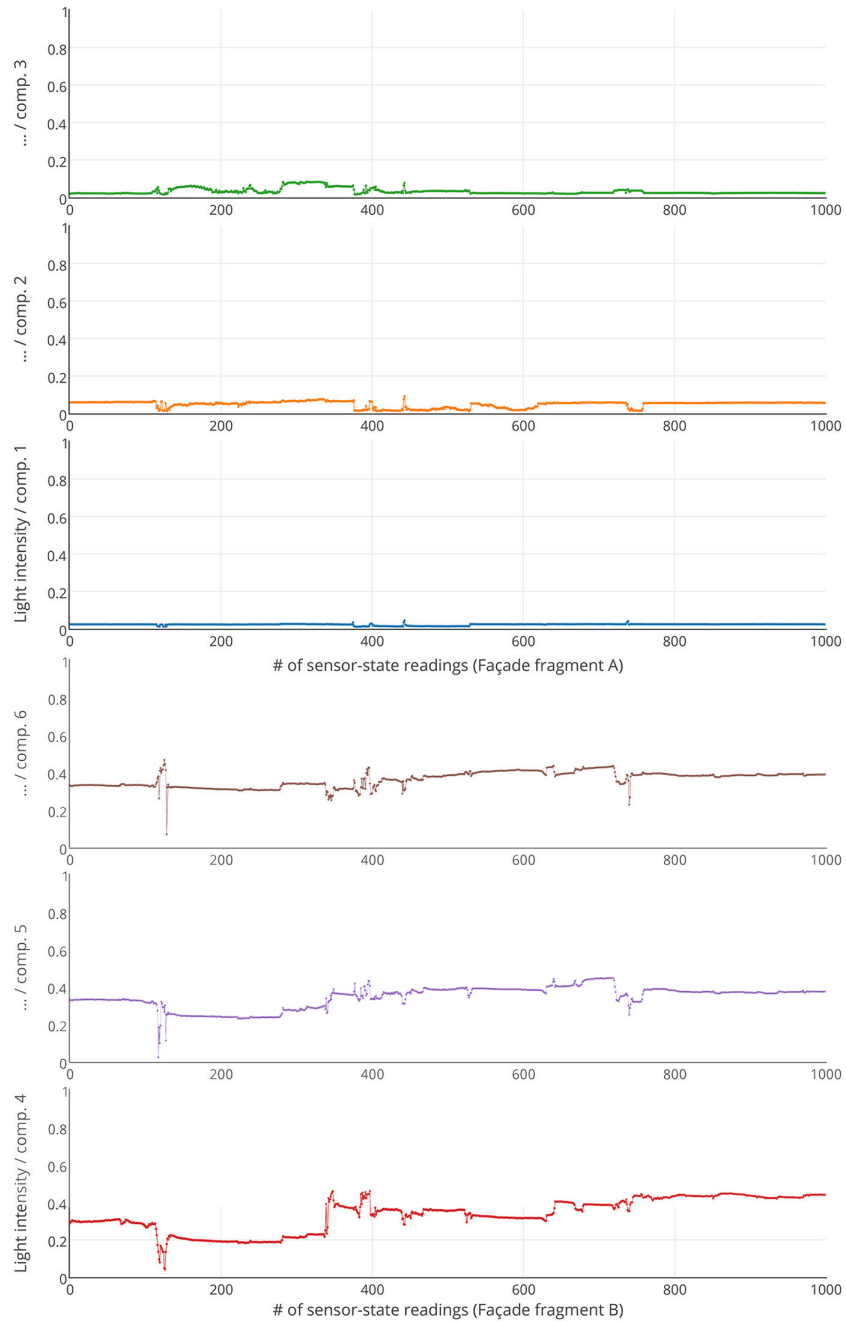

FIG. 5.22 *Top*: Components 1-3, Skin fragment A, Light intensity (normalized—0=lower-bound sensor threshold; 1=upper-bound threshold). *Bottom*: Components 4-6, Skin fragment B, Light intensity (normalized).

The two demonstration-concepts and corresponding results are as follows:

First demonstration: Skin fragments A and B (and corresponding components) reacting to a temperature sensor situated in the interior environment

In this demonstration, a temperature sensor was used to represent the class of sensors deployed in the interior environment. In the first sample run, the position of the sensor was set to an equidistant distance with respect to both skin fragments A and B. In the second sample run, the position was moved to be immediately next to fragment B, which is the sun-facing set of skin components. In this manner, it would be possible to gauge if all the nodes within the CPS's underlying WSN were indeed taking relationship and proximity between acting nodes into consideration, as the varying of the sensor's position would output different extents of influence and skin behavior variation.

For this demonstration, the *ideal temperature* constant was set to 22.5° C.—an average of the accepted human-comfort range of 21° C. – 24° C. [209]. If the sensed temperature exceeded this constant, skin fragment A was programmed to increase its aperture while fragment B to decrease it. That is, since fragment B received direct sunlight, if the interior temperature exceeded comfortable levels, the components in fragment B would reduce solar heat-gains by decreasing their aperture. Simultaneously, the components in fragment A would increase their aperture to contribute to the ventilation of the interior space. Alternatively, if the sensed temperature was below the ideal constant, skin fragment A was programmed to decrease its aperture while fragment B to increase it.

As evidenced by the real-time data collected in the first run of this demonstration, where the position of the temperature sensor was equidistant to both skin fragments A and B, the demonstration corresponded with the anticipated results. It may be observed in Figure 5.23, *Top*, that the influence deviation was greater as the temperature increased. It was also observed that the change in fragment A⁵⁷ was less pronounced than that of fragment B. This was principally due to our baseline's experimental set-up, where the relationship between light intensity and aperture extent was inversely proportional.

⁵⁷ The corresponding figures for façade A in the first demonstration, and for façade B in the second, are omitted for brevity.

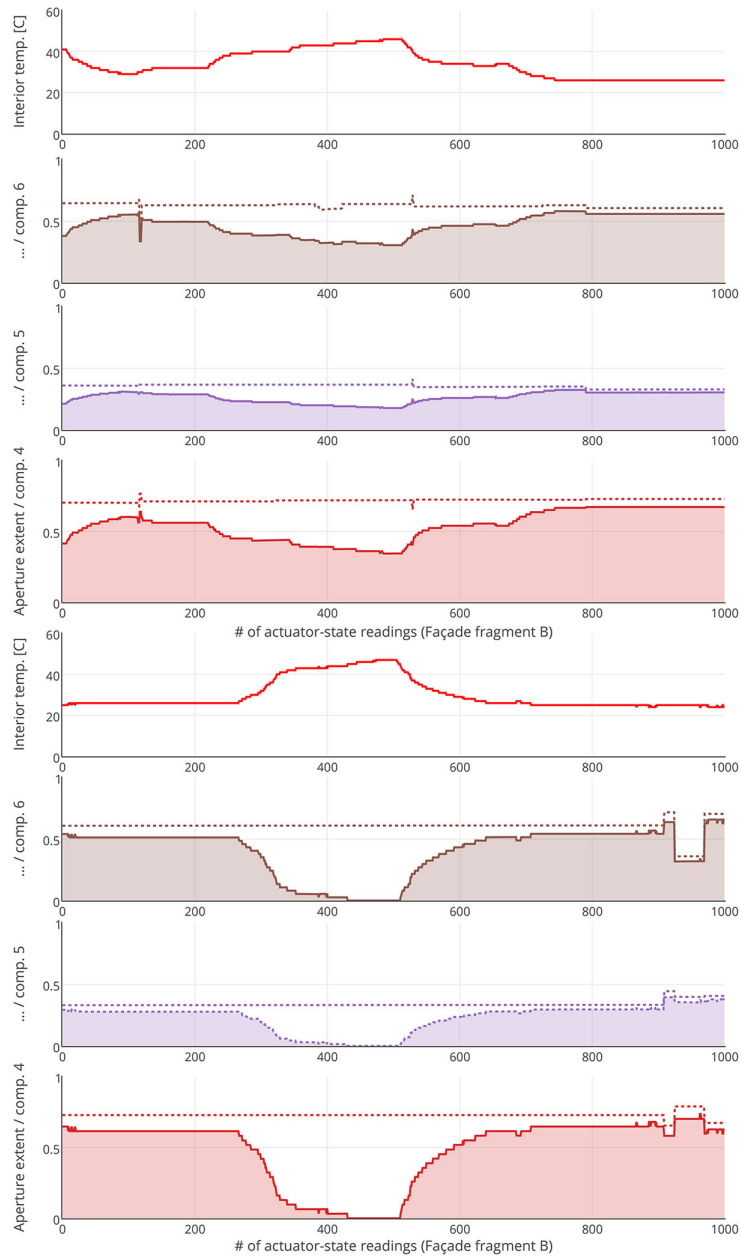

FIG. 5.23 *Top:* Components 4-6, Skin fragment B: Aperture extent (normalized) influenced by interior temperature sensor (equidistant between fragment A and B). Dotted lines: normal (uninfluenced) extent. Solid lines and fill: resulting deviations entailed by temperature fluctuations. *Bottom:* Components 4-6, Skin fragment B: Aperture extent (normalized) influenced by interior temperature sensor (positioned next to fragment B). Dotted lines: normal (uninfluenced) extent. Solid lines and fill: resulting deviations entailed by temperature fluctuations.

In the second run of the first demonstration, the temperature sensor was placed immediately next to fragment B's skin components. This informed the CPS whether the temperatures in the region immediately next to fragment B deviated from the established comfort range. Accordingly, and due to the proximity of the temperature sensor, the deviation affecting fragment B's components became more pronounced than before (see Figure 5.23, *Bottom*).

Second demonstration: A water sensor attached to component 1 in skin fragment A affecting immediate neighboring components 2 and 3 as well as distant components 4, 5, and 6 in skin fragment B in a graduated manner

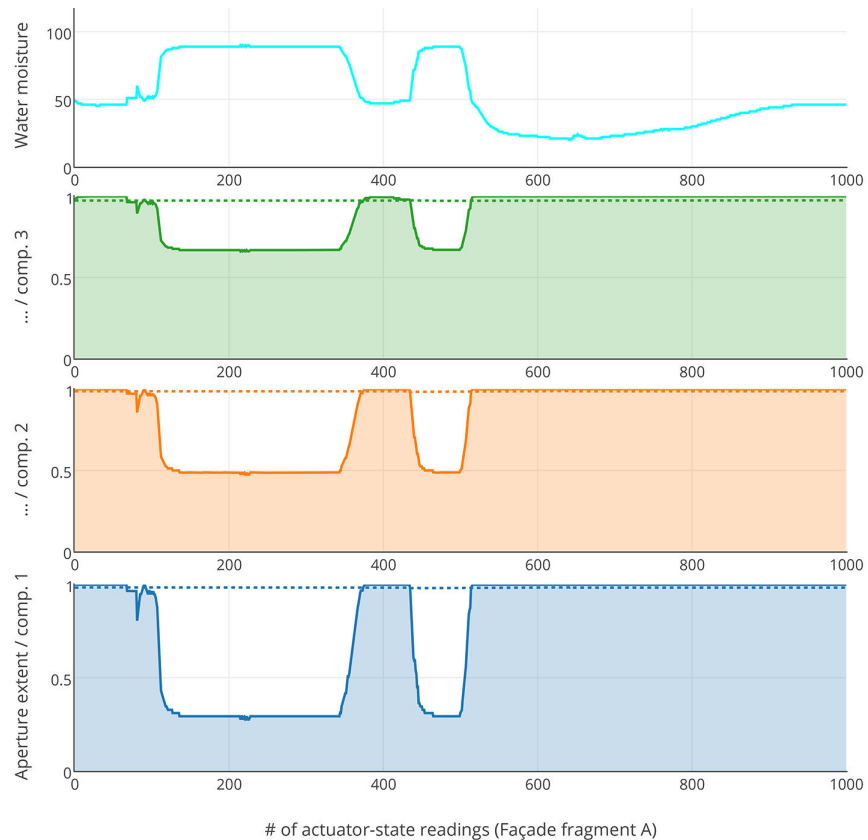

FIG. 5.24 Components 1-3, Skin fragment A: Aperture extent (normalized) influenced by water sensor (installed in Component 1). Dotted lines: normal (uninfluenced) extent. Solid lines and fill: resulting deviations entailed by detected water.

In this demonstration, skin fragment A's Component 1 was equipped with a water / moisture detection sensor in addition to the standard-issue LDR. Any detection of water in particular, and liquids in general, would affect the behavior of Components 2 and 3 explicitly, and of skin fragment B's Components 4, 5, and 6 tacitly. Even within the broad influence of the moisture sensor across both skin fragments, the set-up would differentiate between the immediacy and extent of influence among components. For example, Component 1, being the node within which the moisture sensor is deployed, would trigger the most immediate and intense reaction to the possible event of rain. Similarly, Component 2, being closest to Component 1, would trigger a reaction more immediate and intense than would Component 3. This graduated influence would be subsequently experienced by more distant components with less immediacy and intensity. In the results of this demonstration, it was observed that the moisture content detected by fragment A's Component 1 influenced the behavior of the components in both fragments. However, the important phenomenon to highlight is that the extent of this influence was intelligently graduated. When the detected water / moisture levels were high, the deviation affecting Component 1 was more pronounced than that which affected Component 2, which in turn was also more pronounced than that which affected Component 3 (see Figure 5.24).

It may likewise be observed that when the water / moisture content was high, the extent of aperture in the components in skin fragment B were affected by an increasing deviation, which sought to account for the loss of ventilation resulting from the reduction of aperture extents in fragment A. However, this deviation was considerably mild since the water / moisture sensor was far from the components in fragment B.

Abstract

This prototype subsumes and extends the inherited services and capabilities—both mechanical and computational—of the previous system as follows. With respect to the mechanical: a second actuatable layer is integrated along the inherited first layer, which enables ventilation and natural-light intake to be determined independently via separate automatic or manual aperture controls. With respect to the computational: both local and remote, human and non-human multi-modal control / operation is integrated. More specifically, the following three new operation mechanisms are added along the inherited local sensor-based automatic mode: a local manual control-override based on (1) specific desired-aperture values (via a graphical slider) or (2) approximate desired-aperture values (via gyroscopic sensing) both based on Open Sound Control (OSC); and (3) a remote manual and/or automatic control-override based on Message Queuing Telemetry Transport (MQTT). The first two mechanisms involve local user interaction via a smart-device, and the third mechanism involves remote human and/or non-human interaction via if-this-then-that (IFTTT) and/or Adafruit IO cloud services. The objective of the enhanced adaptive building-skin system remains the intelligent interfacing between interior and exterior environments in a way that is conducive to user comfort, well-being, and environmental safety. Accordingly, the system is conceived as part of the intelligent built-environment discourse that implies the technical / technological basis of typical Ambient Intelligence (AmI) / Active and Assisted Living (AAL) advances while remaining informed by Architectural considerations.

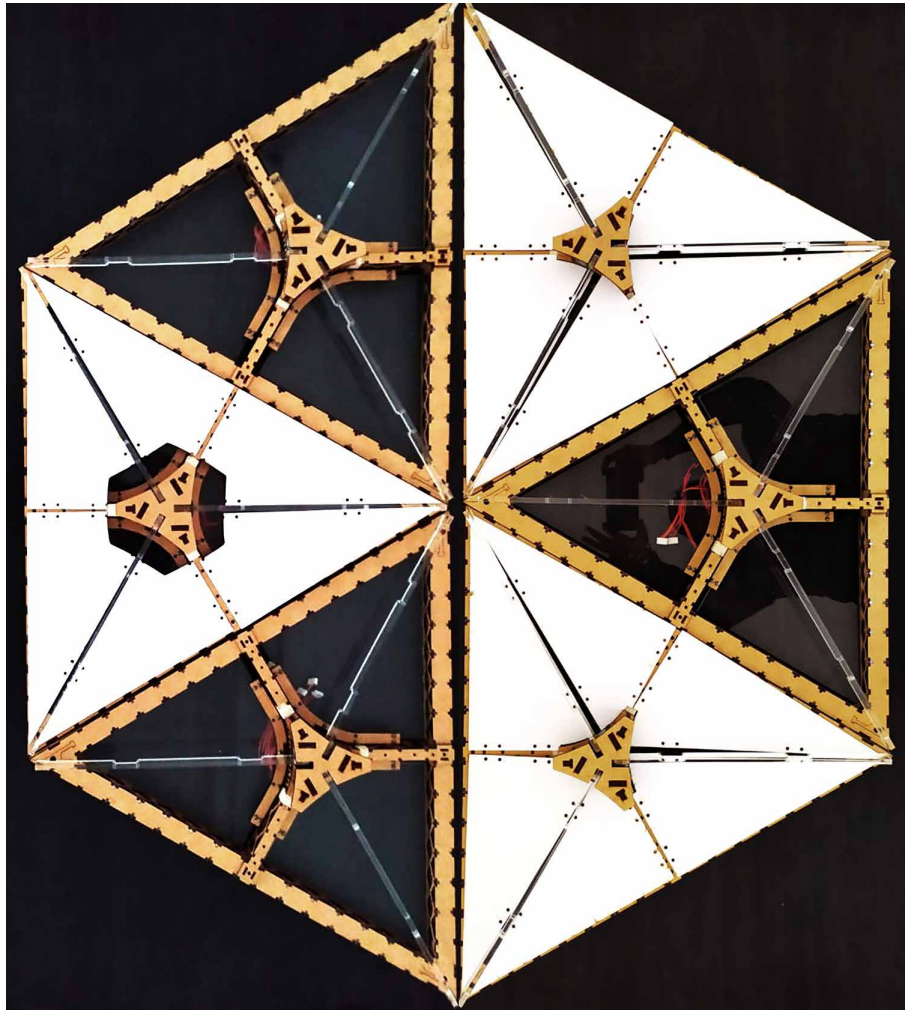

FIG. 5.25 Implementation of sample building-skin fragment, six components. The shading-membrane (in white) is removed from half of the components to show the second actuatable layer below.

The building-skin system is composed of triangular context-aware components that consists of two actuatable layers (see Figure 5.25). The first layer (shown in white) is principally concerned with illumination while the second with ventilation. The degree of aperture of the first layer is directly correlated to the intake of natural illumination. This layer consists of three legs that rotate vertically from 0 to 85 degrees (see Figure 5.28, *Top*). A shading membrane conformed of six right triangles linked to each other and to said legs represents the skin of the layer. The second layer consist of three trianguloid acrylic panes that rotate horizontally from 0 to 90 degrees

with respect to the axes formed by connecting the triangle's center-point and each corner (see Figure 5.28, *Middle*). These panes are transparent to enable light to pass regardless of aperture degree, as this layer's principal concern is to enable or to restrict ventilation. Due to the component's design and overlaid nature of the layers, the actuation extent of the first layer is independent of the second while the second layer's functional rotation maximum is limited by the first layer—that is, the second layer's rotation clearance is determined by the aperture extent of the first layer. Due to the distance between the layers, the second may nevertheless actuate and open its panes to a maximum of five degrees while the first remains shut (i.e., remains at zero degrees). This permits a controlled degree of air-flow even while the first layer is non-hermetically shut to the external environment.

Each component is equipped with an LDR as well as a temperature and humidity sensor integrated to the first layer to enable it to gauge exterior illumination levels as well as temperature and humidity levels, respectively. Moreover, each component is also made aware of the interior space's illumination as well as temperature and humidity levels via architecture-embedded sensors. The decision-making mechanism of the automatic operation of the system depends on data gathered from both the exterior as well as the interior environment. If, for example, the interior temperature exceeds acceptable levels as specified by the *Comité Européen de Normalisation* (CEN) [165] (i.e., $>27^{\circ}$), the building-skin actuates to ventilate the space if the exterior temperature is lower than the interior (the present set-up does not consider wind-factor). However, if the exterior temperature exceeds this level, no ventilation actuation is engaged. A limited number of contingency exceptions to such conditional operation is integrated into the default operation. For example, while the building-skin may not actuate to ventilate a space if the exterior temperature is greater than the interior's, but it would indeed do so in situations where the air-quality is detrimental to the occupant (e.g., detected gas-leaks, etc.), regardless of temperature levels. Similar considerations apply to illumination. For example, given a user's preferred minimum illumination in a space when he/she is present, the system does not actuate if artificial illumination levels meet said minimum. More specifically, the computational component of the system calculates whether the measured external illumination levels would contribute positively or negatively to the user's predetermined minimum in relation to the actual state of illumination in the interior space. Naturally, the user may prefer natural light over artificial light [223] when available. In such a case, the user could turn off artificial lighting to cause the interior illumination levels to drop below the preferred minimum, which would cause the system to actuate and permit natural light in. In this subsection, a discussion on the inherited features of the automatic / default operation of the previous iteration of the building-skin system is limited to the previous examples in order to focus on the following enhancements.

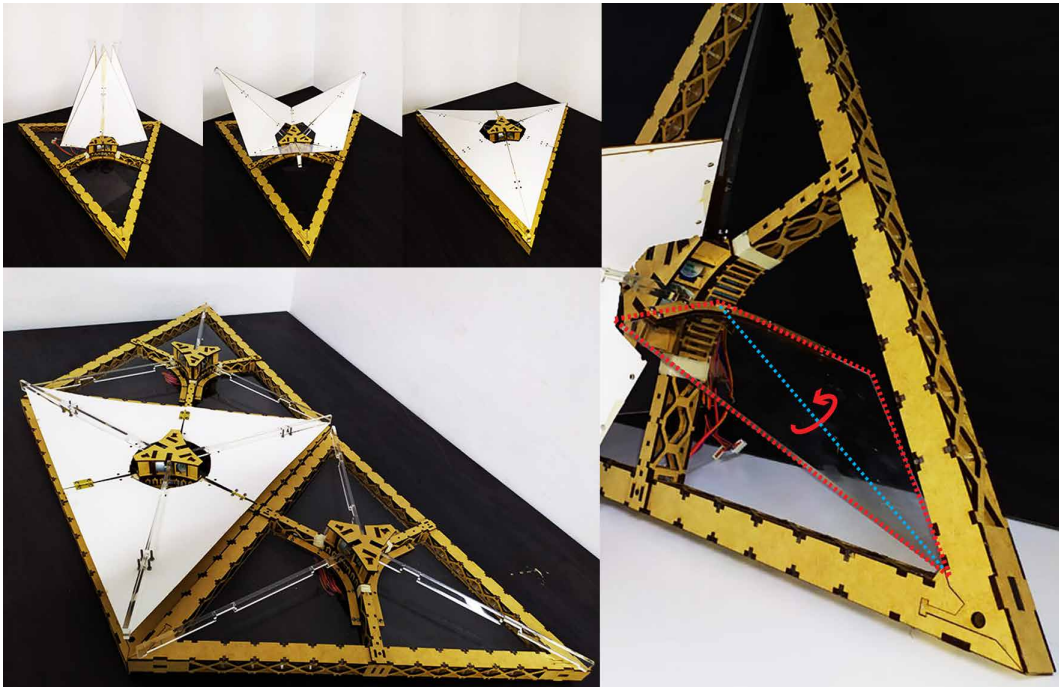

FIG. 5.26 *Top-Left:* sequence of first-layer aperture (85°, 45°, 0° rotation). *Bottom-Left:* three-module fragment perspective, with first-layer skin removed in two modules to indicate component structure. *Right:* second-layer acrylic panel, 90° rotation (fully opened, axis of rotation in blue).

1 System-wide awareness of location-specific illumination—Local transmission of light-sensor data from smart-device to building-skin system via OSC

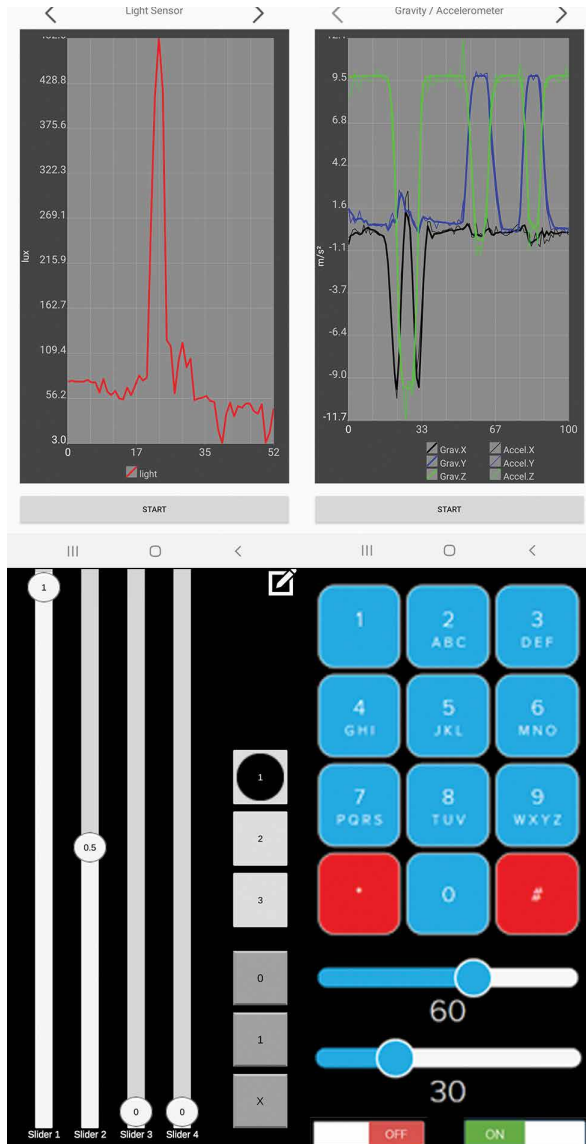

FIG. 5.27 *Top-Left:* user location-specific illumination readings, gauged via a smart-phone held by the user (via OSC, oscHook). *Top-Right:* 2nd new operation mechanism, local assignment of approximate desired-aperture values via Gravity (Gyroscope and Accelerometer derived) data streamed to building-skin system (via OSC, oscHook). *Bottom-Left:* 1st new operation mechanism, local assignment of specific desired-aperture values via slider-based control-override (via OSC, Osc Controller). *Bottom-Right:* 3rd new operation mechanism, remote assignment of specific desired-aperture values in specific building-skin components (identified via keypad) via web-based slider. Moreover, “Off” / “On” web-based buttons enable remote shutdown and activation (both slider and buttons via MQTT, Adafruit IO).

The previous iteration of the building-skin system depended on interior architecture-embedded LDRs to gauge the amount of interior illumination. These LDRs were strategically integrated at intervals creating a Cartesian grid of sensors upon the floor. This, however, sacrificed precision for practicality. In the present set-up, the light-sensor embedded in smart-devices is used to measure the amount of illumination within the user's personal space (see Figure 5.27, *Top-Left*). This data is made available to all components via OSC. Assuming the smart-device is hand-held, the amount of light gauged by said sensor is more precise than that gauged by architecture-embedded LDRs approximate to the user. Accordingly, if a user-predetermined minimum of illumination is not met in a given location where he/she is present, the components of the building-skin system closest to him/her actuate to enable natural-light intake. The device-to-device proximity is gauged via signal strength (in decibels), where the shorter the distance between the smart--device and given components correlates with a stronger signal. Caveat: signal-strength difference is negligible under some distances.

The application *osCHook* [234] is used for the implementation of this mechanism. It is capable of accessing the readings of the light sensor embedded in the smart-device and of streaming said readings—once every 250 milliseconds—to a supervising *microcontroller* (MCU) via its static IP address (see Figure 5.29 and Figure 5.27, *Top-Left*). (N.B.: The static MCU is part of the inherited System Architecture and is one of many capable of assuming a supervisorial role with respect to the building-skin system. This redundancy is deliberate in order to ascertain service robustness and resilience.) The supervisor MCU makes the received light-readings available to the entire network, which enables all the components in the building-skin system to be aware of the amount of illumination received by the user. The present set-up presupposes the device to be hand-held, which enables a more accurate gauging of illumination levels within the user's personal space by virtue of its proximity. Although the smart-device is not streaming directly to each component's MCU but to a supervising MCU, each component is still able to gauge its proximity to the smart-device via Bluetooth's *Received Signal Strength Indication* (RSSI) [235]. Admittedly, RSSI estimation is inexact. However, high-precision with respect to proximity is unnecessary in the present set-up, as an estimation is sufficient to demonstrate the behavior of some components actuating their first layer more than others when proximity is perceived.

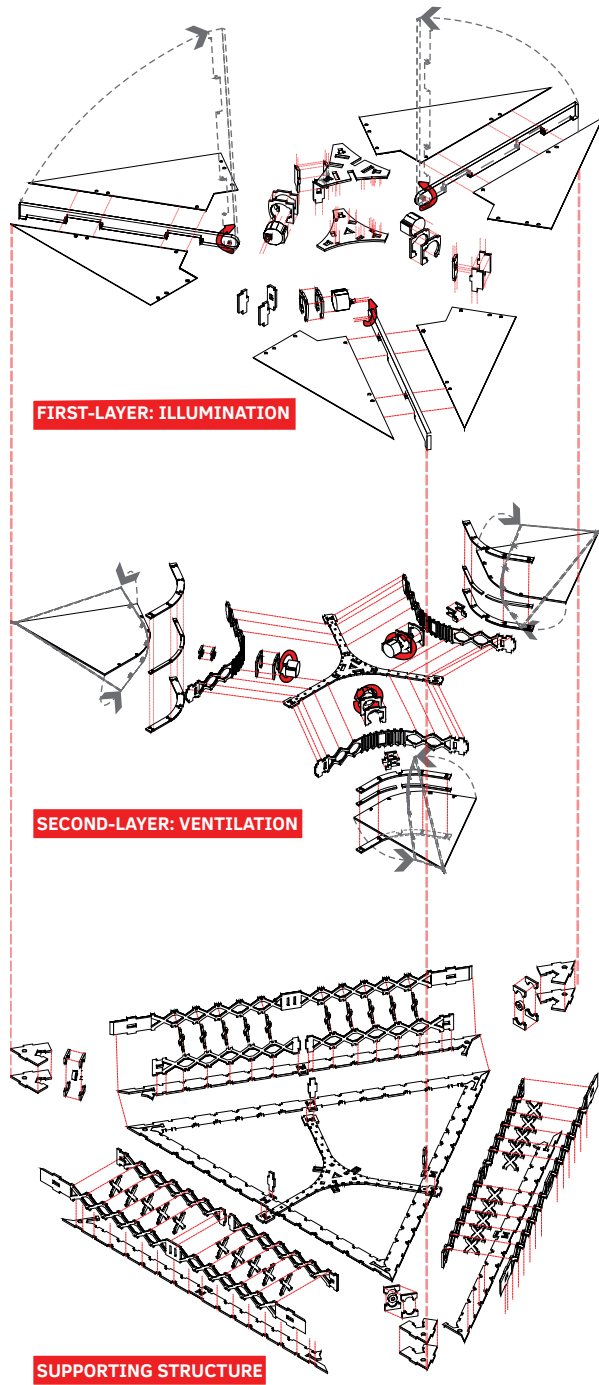

FIG. 5.28 *Top:* Exploded isometric description of the first-layer, to regulate illumination. *Middle:* second-layer, to regulate ventilation. *Bottom:* supporting structure.

2 Local transmission of specific aperture-levels from smart-device to specific building-skin component via OSC

The first of three new override-operation mechanisms enables the user to manually control and *precisely* specify the aperture levels of both actuatable layers (individually) of each component in the building-skin system. A slider in a graphical interface enables the user to specify aperture levels via normalized values (i.e., 0 – 1) (see Figure 5.27, *Bottom-Left*). This mechanism provides a means of complete and precise control over all actuations to the user.

The present implementation consists of a six-component fragment representative of a larger building-skin system. Unlike the mechanism described in the previous subsection, the present *specific* override-operation mechanism streams OSC data specifically to one of the six implemented components' MCU—not the supervisor MCU—via its static IP address. The application *OSC Controller* [236] is used to stream specific normalized values to the first and second layers of a particular component via a graphical slider.

The default slider interface has four sliders, three buttons, and three toggles whose ranges (particular to the case of the sliders) and values may be configured. In the present setup, only sliders 1 and 2 are used to correspond to a component's first and second layers. Moreover, the buttons are configured with values '0', '1', and 'X'. Buttons '0' and '1' enable the user to input the binary ID of the component he/she wishes to control. Button 'X' serves as a reset button in case a mistake occurs in the ID input. Only toggle 1 is used in the present setup. Its activation serves to inform the system that specific override-control is and remains engaged as long as it is activated. Once toggle one is released / deactivated, the building-skin system defaults to its preset automatic operation (see Figure 5.27, *Bottom-Left*).

Since the component's second layer's functional clearance is limited by the first layer's rotation, slider 2 is delimited by slider 1. That is, it is impossible for the second layer to rotate 90 degrees if the first layer rests at 0 degrees. The second layer may rotate a maximum of five degrees when the first layer is at zero degrees. Accordingly, at software level, the component's MCU delimits slider 2's streamed values to prevent collision with the first layer. This entails that the lowering of slider 1 values also lowers slider 2 values until slider 1 reaches '0' and slider 2 reaches '.056'—N.B.: this value multiplied by the second layer's maximum rotation of 90 degrees results in the five-degree rotation clearance allowed when the first layer rests at zero degrees.

3 Local transmission of approximate aperture-levels from smart-device to specific building-skin component via OSC

The second override-operation mechanism enables the user to manually control and *approximately* specify the aperture levels of both actuatable layers (individually) of each component in the system. Gyroscopic data streamed from a smart-device is used to correlate its roll extent (0° - 180°) with aperture levels of the first layer (see Figure 5.28, *Top*) and its pitch (0° - 180°) with aperture levels of the second layer (see Figure 5.28, *Middle* and Figure 5.27, *Top-Right*). This mechanism represents a tangible way of controlling aperture levels without the need of assigning specific input values.

This *approximate* override-mechanism uses *oscHook*'s Gravity / Accelerometer gauging to generate *roll* and *pitch* readings (see Figure 5.27, *Top-Right*) that are streamed to a specific component's MCU via its static address. It is noted that both the "light-sensor" and "Gravity / Accelerometer" functions may be used simultaneously, as the application reads sensed-data from all the available sensors in the smart-device and streams all or a predetermined selection thereof to a designated building-skin component. At a software level in this component's MCU, the incoming OSC data is prefixed with an identifying string of text that indicates what type of reading the value corresponds to—for example, a roll or pitch value is prefixed with "/accelerometer/gravity/x" or "/accelerometer/gravity/y". Based on this string, the data is parsed to correspond to first layer aperture (in case of roll) or second layer aperture (in case of pitch). The limitation of the actuation extent of the second layer stated at the end of the previous subsection is inherited. That is, the component's MCU will artificially delimit the maximum value of pitch readings in order to avoid collisions between the first and second layers. The advantage of this *approximate* override-control mechanism over its *specific* counterpart lies in its intuitive and tangible simultaneous control of both first and second layers in a given component. However, the *specific* override-mechanism enables greater individual layer control.

4 Remote manual and/or automatic control-override via MQTT

The final override-operation mechanism enables a remote user (1) to supervise the state of aperture of the components conforming the building-skin system; and (2) to control aperture levels of both layers of each component via cloud- / web-services. Moreover, it also enables said user to activate or to shut-down individual components entirely. Interaction is engaged via Adafruit IO's [237] website and controls—i.e., a keypad (to specify a component ID), a slider, “ON” / “OFF” toggle (see Figure 5.27, *Bottom-Right*). A machine notification sent via IFTTT [238] informs the remote user when his/her remote control causes illumination and temperature / humidity levels to exceed desired thresholds.

Adafruit IO enables (1) remote monitoring of streamed data gathered from the LDRs and temperature / humidity sensors embedded in each building-skin component; and (2) remote operation of local systems via a set of web-based controls (see Figure 5.27, *Bottom-Right*). The bidirectional communication between the local system and Adafruit IO is enabled by MQTT. Since it is unfeasible to create individual sets of controls corresponding to individual building-skin components, the present setup uses a keypad to enable the identification of the component to be controlled. After a component has been specified, moving the two web-based sliders controls the first and second layers of said component—in Figure 5.27, the slider with value of “30” corresponds to the component's first layer and the slider with the value of “60” to the second layer. Whenever remote control is engaged, the machine notification service previously mentioned is also engaged to message the user across his/her registered smart-devices via IFTTT that such control of aperture levels has dropped below or climbed above CEN-prescribed illumination and temperature / humidity thresholds. This machine-based service does not, however, interfere with the user's control. Finally, and in addition to such control, the user may also shut-down said specific component remotely.

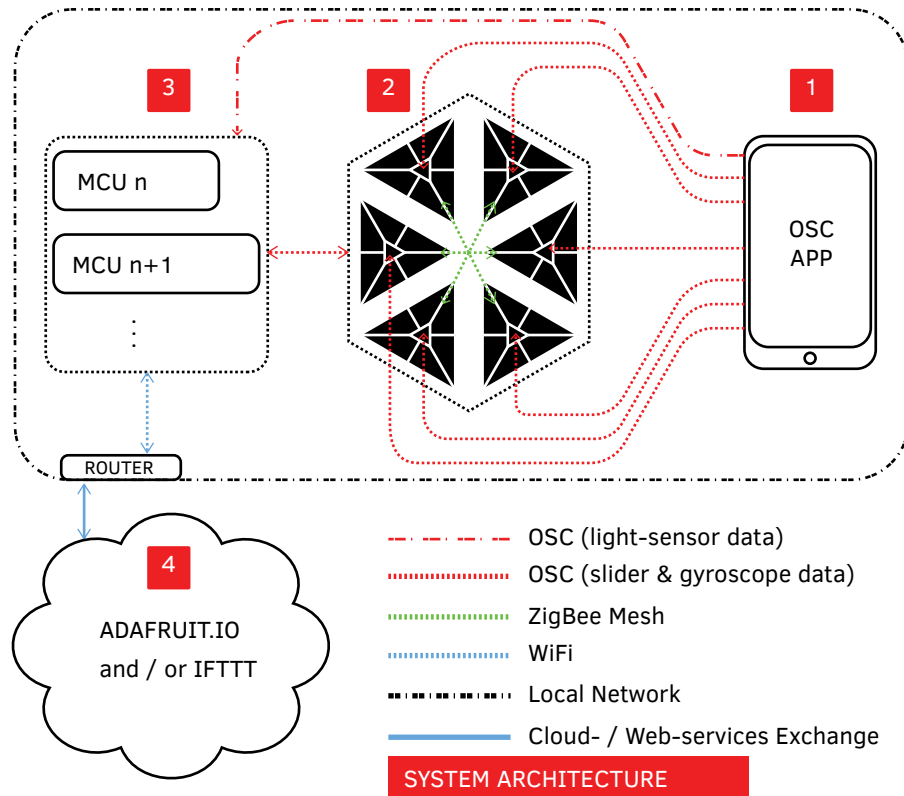











FIG. 5.29 System Architecture. (1) Smart-device with *oscHook* and *Osc Controller* (see Figure 5.27). (2) building-skin fragment composed of six components. (3) Local and built-environment-embedded MCUs, part of the larger WSN ecosystem. (4) Cloud- / Web-services for remote user override.

5.8 Actuation Confirmation and Negation via Facial-Identity and -Expression Recognition⁵⁸

TABLE 5.9 Demonstrator 8's summary—environment, parameters, interactions, key results, purpose, and pertinence.

DEMO ENVIRONMENT				IEQ				QoL			
											
HYP	ROB	DT	ND								
INTERACTION METHODS		USER-DRIVEN		Appendix, IEQ Section 1.A				Appendix, QoL Section 1.B			
				¶ 5			¶ 7	¶ 6	¶ 4		
		SENSOR-DRIVEN		Appendix, IEQ Section 2.A				Appendix, QoL Section 2.B			
				¶ 4			¶¶ 10,11		¶¶ 4,5		
KEY RESULTS		<ul style="list-style-type: none"> – An intuitive way of canceling or confirming automatic reactions from façade modules via facial-identity and -expression recognition. In this setup, a new façade-module design—other than the ones presented in Section 5.7—is used, one capable of more physical configurations to correlate with a variety of emotions recognized. – As with Section 5.4, the present demonstrator also adds to the fall-detection and -intervention system referenced [154] as the precursor to all the demonstrators outlined in this work. The system added recognizes the facial expression of a detected collapsed person, and whether this expression is of pain, sorrow, etc. 									
PURPOSE		<ul style="list-style-type: none"> – To enable the user to interact with automated operations by confirming or negating events via displaying pleasure or displeasure. In this manner, the system's pursuit of optimal interior-environment conditions would be sensitive to the user, and not removed from considerations of personal preference. – To further enhance the accuracy of detecting fall-related emergency events (as opposed to intentional, non-emergency events such as a person playing with a pet or a child on the floor). 									

>>>

⁵⁸ This section is based on

 A. Liu Cheng, H. Bier, and G. Latorre, "Actuation Confirmation and Negation via Facial-Identity and -Expression Recognition," in *Proceedings of the 3rd IEEE Ecuador Technical Chapters Meeting (ETCM) 2018*, 2018. [175]

TABLE 5.9 Demonstrator 8's summary—environment, parameters, interactions, key results, purpose, and pertinence.

DEMO ENVIRONMENT	IEQ	QoL
PERTINENCE	<ul style="list-style-type: none"> – This demonstrator presents a facial-identity and -expression mechanism that contributes to two distinct services or features. That is, it adds to the façade-envelop system detailed in Section 5.7 and accordingly inherits its pertinence on ascertaining a certain interior-environment quality independent of user intervention. Similarly, it adds to the object recognition mechanism in Section 5.4—and its inherited fall-detection and -intervention system—and accordingly inherits its section's use-case pertinence. In both cases, facial expressions enable the built-environment to be sensitive to perceived / recognized emotions often correlated with states of pleasure, displeasure, pain, etc. – As its own discrete demonstrator, however, it expresses a pertinence to the elderly use-case scenario by adding a consideration of personal preference over automatic / pre-calculated directives. Personal preference, as an expression of Independence (a crucial <i>Quality of Life</i> parameter), must be able to negate an automatic operation deemed to be optimal for the user, and this may be done via the features developed in this demonstrator with minimal user effort. 	

Abstract

This implementation develops a facial-identity and -expression recognition mechanism that confirms or negates physical and/or computational actuations in an intelligent built-environment. Said mechanism is built via Google Brain®'s TensorFlow™ [168] (as regards facial identity recognition) and Google Cloud Platform™'s Cloud Vision API [221] (as regards facial gesture recognition).

The present work is validated via two scenarios (physical and computational). In the first scenario—and building on an inherited adaptive mechanism—if building-skin components perceive a rise in interior temperature levels, natural ventilation is promoted by increasing degrees of aperture. This measure is presently confirmed or negated by a corresponding facial expression on the part of the user in response to said reaction, which serves as an intuitive override / feedback mechanism to the intelligent building-skin mechanism's decision-making process.

In the second scenario—and building on another inherited mechanism—if an accidental fall is detected and the user remains consciously or unconsciously collapsed, a series of automated emergency notifications (e.g., SMS, email, etc.) are sent to family and/or care-takers by particular mechanisms in the intelligent built-environment. The precision of this measure and its execution are presently confirmed by (a) identity detection of the victim, and (b) recognition of a reflexive facial gesture of pain and/or displeasure.

The present work inherits a previously developed system architecture [186] whose *Wireless Sensor Network* (WSN) enables the two mechanisms presently expanded. While it is not pertinent to describe this system architecture in detail here, in the following subsections a summary of the mechanisms in question is provided, followed by an explanation of the role of facial-identity and -expression recognition in their enhanced functionality. Incidentally, it may be noted that facial identification and recognition mechanisms have been implemented in intelligent built-environments for a variety of purposes (e.g., [239]). But one overarching innovation of the present implementation is that an instance of such mechanisms is used to confirm or negate actuations in the built-environment in an intuitive and nuanced manner, thereby enhancing the way the user(s) interact with their intelligent built-environment.

Furthermore, and with respect to technical and technological innovation, the present implementation adopts a modular and distributed approach where the facial identification component is independent of yet interrelated with the facial expression recognition component, with the former being driven by limited and affordable local resources and the latter by powerful and proprietary cloud-based resources. That is, the approach attempts to allocate and distribute adequate resources for the demands of each component in a way that the successful performance of one does not interfere with that of the other, even as they are executed in parallel. This is an important point, as in both scenarios of expansion of inherited mechanisms involve both facial recognition components running in tandem in order to yield personalized reactions.

The facial-identity and -expression recognition mechanism is implemented via two independent yet interrelated components. The first—the facial identity recognition component—is implemented locally via Google Brain®'s *TensorFlow™* [168] (see Figure 5.30): while the second—the facial expression recognition component—is implemented via Google Cloud Platform™'s *Cloud Vision API* (see Figure 5.33). Additionally, the first component is capable of rudimentary facial expression recognition as well, a feature that is used as a back-up measure in case the second component fails. The second component, however, is incapable of subsuming the function of the first because Cloud Vision API does not support facial identity recognition due to privacy concerns (although it *can* detect human faces). In the implementation of the facial identity recognition component (i.e., the first component), TensorFlow™ is installed on a Linux (Ubuntu) virtual environment and executed in Python.

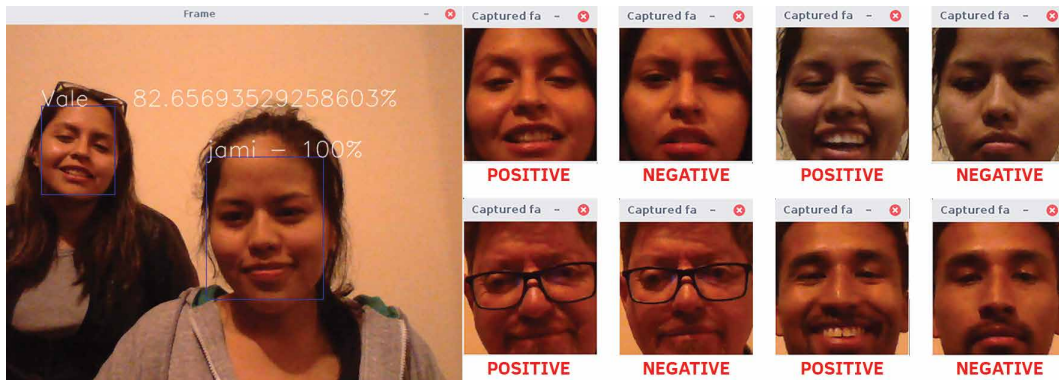

FIG. 5.30 *Left:* real-time Facial Recognition. *Right:* TensorFlow™’s rudimentary “Positive” or “Negative” facial-expression recognition.

During execution of its *Multi-task Cascaded Convolutional Networks* (MTCNN) face detection model, TensorFlow™ requests the user—and, consequently, every individual who is to be subsequently recognized by the system—to let the camera capture his/her face from a variety of positions, orientations, and angles. After completing this phase, facial identity recognition is successfully tested real-time (see Figure 5.30, *Left*). As previously mentioned, TensorFlow™ may also be used for basic facial expression recognition, which serves as a functional back-up in case the component implemented with Cloud Vision API fails. This back-up component is capable of recognizing two broad types of expression: “positive” and “negative” (see Figure 5.30, *Right*). In the implementation of the facial expression recognition component (i.e., the second component), Python is used to integrate the services of Cloud Vision API into the inherited WSN. The same visual input is fed to both components to yield a correlated recognition of an identity as well as of a facial expression. This is important, as it is the way that the system knows *who* the recognized facial expression corresponds to (recall that Cloud Vision API does not support facial identity recognition and consequently its returned output by itself is anonymous).

5.8.1 1st scenario: Enhancing the precision and sensitivity of an Adaptive and Context-Aware Building-Skin System

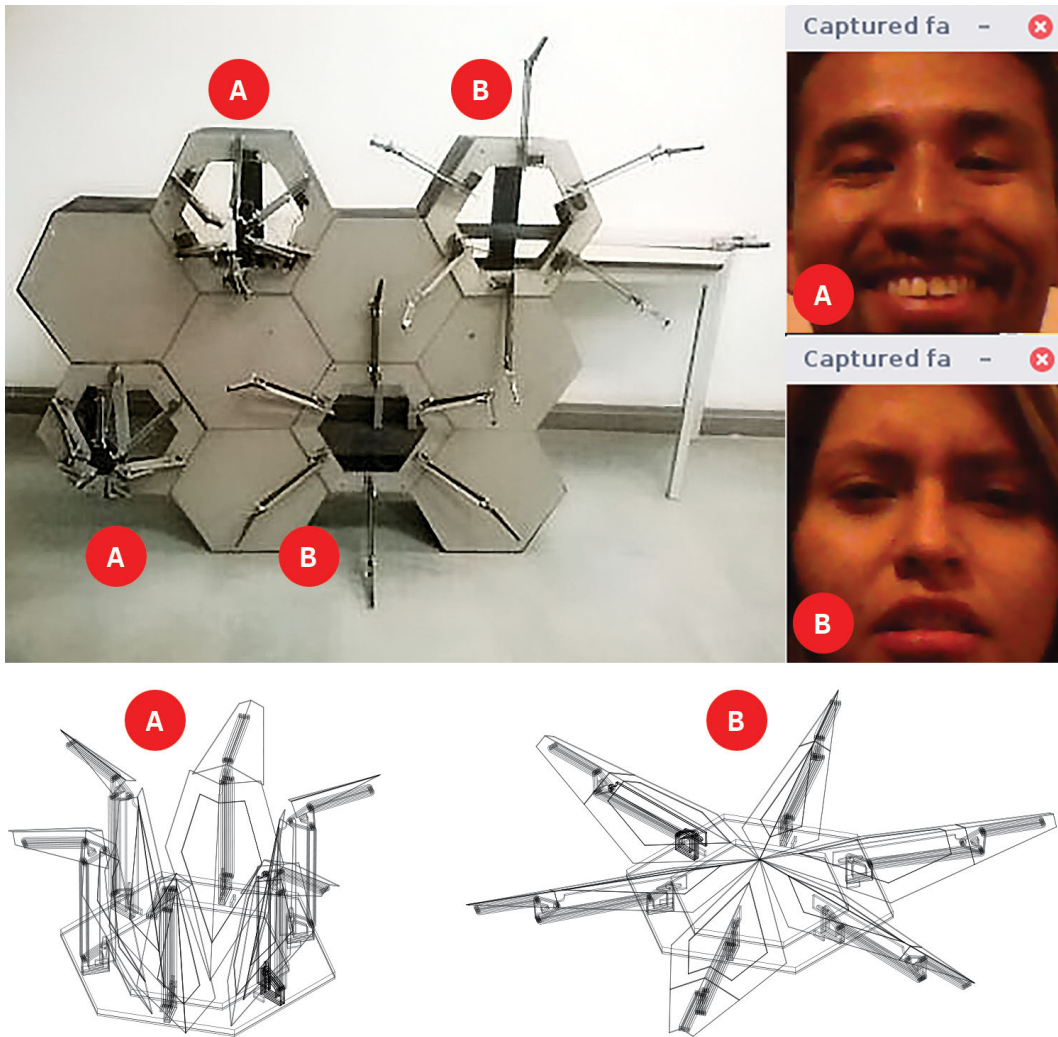

FIG. 5.31 Top: Building-skin fragment reacting differently to agents A and B. Bottom: States of module with respect to agents A (fully open) and B (fully closed).

This scenario expands on the setup and context of a previous demonstrator of an adaptive building-envelope (see Section 5.7). Each of its components acts as individual, context-aware, sensor-actuator nodes capable of differentiated—yet correlated—actions, reactions, and interactions. Accordingly, as the sensed data of any device is accessible across all devices in a topology of meshed nodes, the computationally processed behavior of any node is potentially informed by and informing of the status of individual and/or sets of other nodes. In this manner, the building-skin is not construed as a mere envelope, but rather as a system comprised of agents that actively and continuously promote user-comfort [174]. In the present implementation, new building-skin nodes are developed and built (see Figure 5.32). The mechanism that drives their functionality remains the same, but the new design enables a larger variety of configurations and degrees of aperture / closure than the original design used in the first implementation of the system.

In this scenario, embedded sensors within the built-environment feed the WSN with temperature and humidity data. When these exceed limits prescribed by heating and cooling requirements defined by CEN Standard EN15251-2007 [165], the building-skin nodes begin to react in a way as to ascertain optimal temperature and humidity data. This reaction is diffused and graduated, both in terms of time of initial execution, duration, and extent of actuation. More explicitly, those nodes closest to identified areas of high-temperature are first to react, engage for a longer period, and actuate to degrees of maximum aperture to enable optimal ventilation. Those nodes farther away react in proportion to their proximity to the high-temperature areas in question, and to their estimated efficacy to support cooling / ventilation efforts by establishing an intake-outturn air-flow pathway. This automated behavior is now influenced by feedback received via the facial-identity and -expression recognition mechanism, feedback that may serve to confirm or negate the automatically effected actuation. More specifically, when during the moment of reaction to a high-temperature condition the facial-identity and -expression recognition mechanism detects—to a high-degree of probability (>80%)—that sole user A (see Figure 5.31, *face A*) reacts approvingly to the effected actuation, then said actuation is confirmed and proceeds normally.

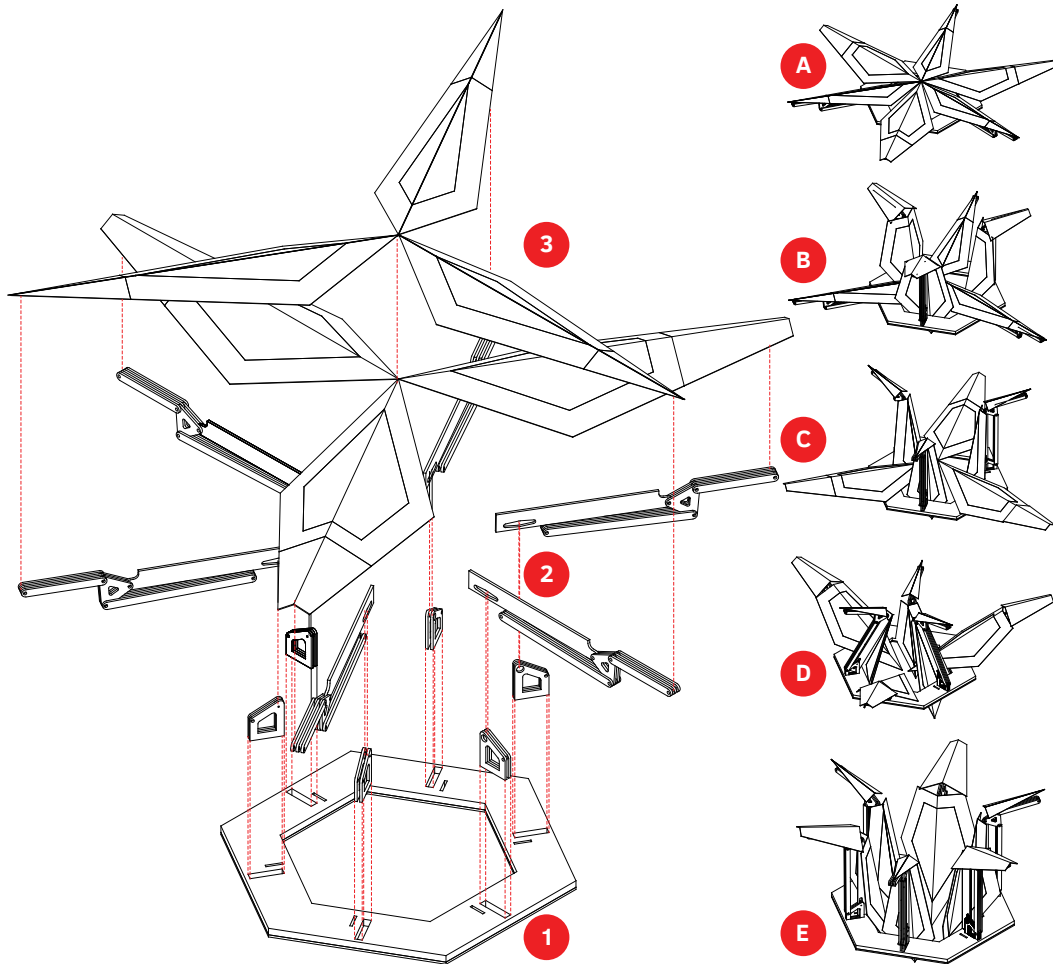

FIG. 5.32 New adaptive building-skin module concept; items 1: MDF base, with integration of servo motors and an affordable Raspberry Pi Camera Module V2; 2: MDF pivoting arms; 3: Opaque acrylic sheets. Possible configurations A: Fully extended, closed; B: Semi-open, variation I; C: Semi-open, variation II; D: Semi-open, hybrid of variations I and II; E: Fully retracted, open.

Alternatively, when said facial recognition mechanism detects that sole user B (see Figure 5.31, *face B*) reacts adversely to the actuation, then it is negated. In situations with more than one user in the built-environment, the decision to confirm or negate a routine actuation comes to a proportional compromise depending on the proximity and reaction of all detected users. That is, suppose the following scenario: Given a region of high-temperature, a set of closest building-skin nodes begins to actuate to maximum degrees of aperture to encourage high-volume ventilation. Users A and B are both in the high-temperature area in question. Accordingly, the facial

identification and expression recognition mechanism, via the cameras embedded in the building-skin nodes being maximally actuated, begins to ascertain a probable reaction (e.g., joy, sorrow, anger, surprise, etc.) for each user. This probable reaction is given by a straightforward average of the probabilities gathered via each maximally actuating node's embedded camera's data—N.B.: only those probabilities with greater than 80% confidence-level are considered. If user A's reaction is identified as “joy” and user B's reaction as that of “sorrow”, then the extent of maximal actuation is mitigated in proportion to the proximity of users A and B to any given building-skin node in maximal actuation. If with respect to a given actuating building-skin node both users are at the same distance, then the actuation will compromise halfway with respect to both—that is, if user A approved of 100% aperture and user B of 0%, then the building-skin node will actuate to 50% aperture. If with respect to another given actuating building-skin node user A is 25% closer than user B, then user A's perceived preference is assigned 25% more weight than that of user B's, and so forth and so on.

With respect to the testing and validation of scenario 1, two users—already introduced in previous sections as A and B—with conflicting facial expressions (i.e., user A: joy; B: sorrow), are asked to stand—always aligned to the building-skin fragment's center—(1) next to each other and equidistantly close to the fragment; (2) far from each other and equidistantly close to the fragment; and (3) close to each other and equidistantly far to the fragment, with a simulated high-temperature area around where they stand across all configurations. In the first configuration, all four building-skin modules default to a neutral aperture configuration—i.e., item C in Figure 5.32. In the second configuration (see Figure 5.31), those modules closest to user A open maximally as the statutory actuation [to open the node] is confirmed by the user's expression; and those modules closest to user B remain shut as the statutory actuation is negated by the user's expression. In the third configuration, due to the large distance between the users and the fragment—and, consequently, between the users and the cameras belonging to the nodes within the fragment—the mechanism is unable to ascertain a high probability favoring a particular facial expression and therefore this consideration is ignored. That is to say, the nodes behave as they would without user feedback. Due to their interesting results, the above three position configurations for users A and B with respect to the fragment are the most salient ones among the other configurations sampled. To some extent, they are also indicative of the most common or anticipated results among the tested configurations. That is to say, more frequently than not—and under the present set-up conditions—the fragment defaults to a negotiated average with respect to aperture extent; or to a fair distribution of nodes that satisfy user A and those that satisfy user B; or to a situation where user input / feedback is ignored. These results are more indicative of the experiment's setup—and its limitations—than of the programmed behavior of the building-skin module. Nevertheless, such results are sufficient for a modestly successful proof-of-concept implementation.

5.8.2 2nd scenario: Enhancing the precision and sensitivity of a Fall Detection and Intervention System

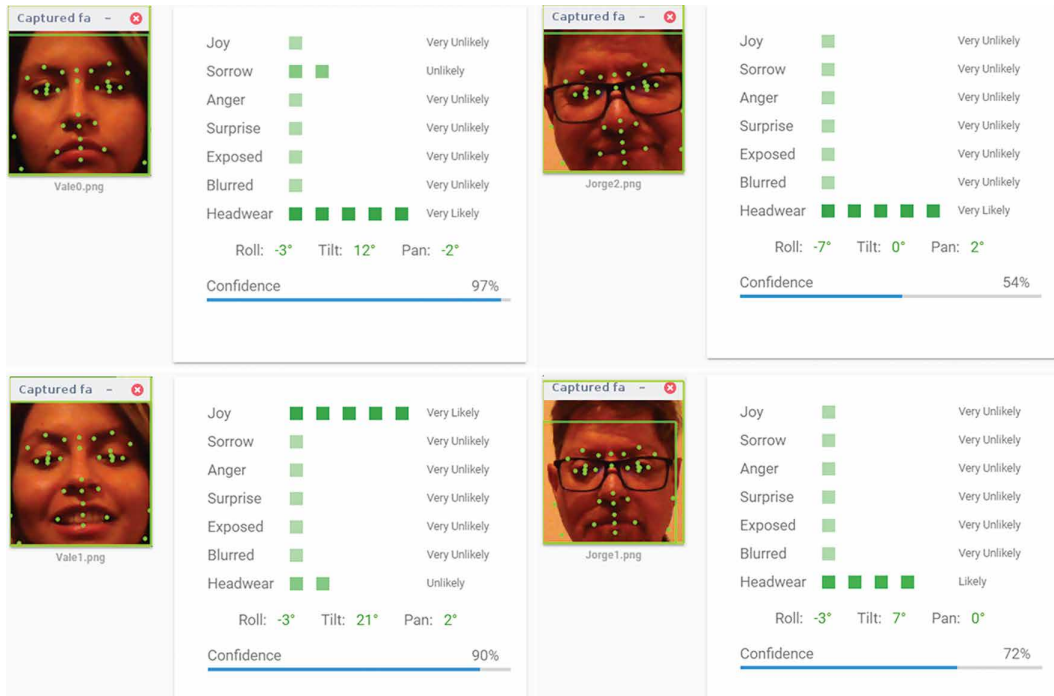

FIG. 5.33 Top Row: Cloud Vision API's predictions with respect to user B's expressions. Bottom Row: instances of equivocation when glasses are worn.











This scenario expands on a fall detection and intervention system developed as a fully operational, real-scale solution [154] that uses two Class 2M 10° line lasers in conjunction with a number of *Light Dependent Resistors* (LDRs) to gauge the probabilities of an emergency-event based on the estimated dimensions of the collapsed object. If the solution construes the probabilities of an emergency event as high, a TurtleBot [147] is sent to the location of the collapsed person and automated notifications are sent to emergency-personnel, care-takers, and/or family via both wireless and cellular technologies. From the previous expansion of this system [171], an object-recognition mechanism is implemented via BerryNet® [212] (built with Inception® ver. 3 [213] for a classification model as well as with TinyYOLO® [214] for a detection model).

In this implementation, the facial-identity and -expression recognition mechanism is deployed to complement the functions of the object-detection mechanism. That is to say, while this latter is used to detect kinds of objects (e.g., person, car, cup, book, etc.), the former is used exclusively within the domain of human and probable human-state recognition. In the present expansion, the fall detection and intervention system is integrated with a mechanism capable of detecting *who* the collapsed person is, and *what* facial expression is on his/her face via the same embedded cameras mentioned in the first scenario. Depending on the input of these variables, the urgency and repetition frequency of the system's original intervention mechanisms vary. For example, if the system detects that a known user has fallen and remains collapsed, and that his/her facial expression is construed as "sorrow", "anger", or "surprise" (see Figure 5.33), then SMS and email notifications expressing a corresponding urgency-level are sent repeatedly until no object is detected.

With respect to the testing and validation of scenario 2, for all instances of successfully detected collapsed people in the original implementation and first expansion of the fall detection and intervention system, a corresponding enacted fall event is produced, where the identity and facial expression of the actor are identified. In this experimental setup, the emphasis of the testing is on the efficacy of the facial-identity and -expression recognition mechanism. In the trial runs, the first mechanism performs successfully by consistently identifying the user and his/her facial expression most of the time (>90%). Instances of false positives occur when hats, glasses, and other accessories are worn (see Figure 5.33, *Bottom Row*).

5.9 Development of an Eye- and Gaze-Tracking Mechanism in an Active and Assisted Living Ecosystem⁵⁹

TABLE 5.10 Demonstrator 9’s summary—environment, parameters, interactions, key results, purpose, and pertinence.

DEMO ENVIRONMENT				IEQ				QoL			
											
HYP	ROB	DT	ND								
INTERACTION METHODS		USER-DRIVEN		Appendix, IEQ Section 1.A				Appendix, QoL Section 1.B			
		SENSOR-DRIVEN						18	17	15	
KEY RESULTS		USER-DRIVEN		Appendix, IEQ Section 2.A				Appendix, QoL Section 2.B			
		SENSOR-DRIVEN						16	16		
PURPOSE		<ul style="list-style-type: none"> – A prototype of eye- and gaze-tracking glasses capable of (1) identifying objects, (2) displaying actuations associated with those objects; and of (3) recognizing predetermined people and of (4) displaying their relationship to the wearer. – A local structured environment capable of interfacing with said glasses—i.e., to interpret recognized blinking by the glass as commands to open, shut, regulate intensities, etc., in the built-environment. 									
PERTINENCE		<ul style="list-style-type: none"> – To empower people with severe limitations of physical mobility (e.g., quadriplegics, survivors of multi-limb amputations, et al.) to engage with actuatable or feature-rich objects in their built-environment (e.g., windows, lights, wall-art, etc.). – To help people with memory loss to recognized familiar individuals with access to the inhabited space. 									

Abstract

This implementation consists of an open-source eye- and gaze-tracking mechanism compatible with open, scalable, and decentralized intelligent built-environment ecosystems designed on Wireless Sensor Networks (WSNs). Said mechanism is

⁵⁹ This section is based on

 A. Liu Cheng, N. Llorca Vega, and G. Latorre, “Development of an Eye- and Gaze-Tracking Mechanism in an Active and Assisted Living Ecosystem,” in *Proceedings of the 36th International Symposium on Automation and Robotics in Construction (ISARC) 2019*, Banff, AB, Canada: IAARC, 2019, pp. 749–755. [176]

deliberately conceived as yet another service-feature in an on-going implementation of an extended intelligent built-environment approach, one motivated and informed by both Information and Communication Technologies (ICTs) as well as by emerging Architecture, Engineering, and Construction (AEC) considerations. The eye- and gaze-tracking mechanism enables the user, via two separate algorithms, (1) to engage (i.e., open, shut, slide, turn-on/-off, etc.) with a variety of actuatable objects and systems deployed within an intelligent built-environment via sight-enabled identification, selection, and confirmation; and (2) to extract and display personal identity information from recognized familiar faces viewed by the user.

The first feature is intended principally (although not exclusively) for users with limited mobility, with the intention to support independence with respect to the control of remotely actuatable mechanisms within the built-environment.

The second feature is intended to compensate for loss of memory and/or visual acuity associated principally (although not exclusively) with the natural aging process. As with previously developed service-features, the present mechanism intends to increase the quality of life of its user(s) in an affordable, intuitive, and highly intelligent manner.

These two features, which run as separate services, serve as extensions of the user's physical and mental capabilities (with respect to the described contexts and scopes) in a way that enables the user to retain a degree of independence otherwise impossible without technical and technological assistance. This is in line with current trends where Computer Vision (CV) is integrated into assistive services and solutions (see, for example, [240]).

Note: as with the virtual environment of the previous section, the present one is a reduced representation of a Digital Twin envisioned for Augmented Reality. That is, whenever the user is said to look at actuatable objects in this implementation, he/she is to be understood to be looking at a real object that bears correspondence to a virtual counterpart. Indeed, the mechanism recognizes that the user is looking at a given real object by identifying what virtual object (or its corresponding defined region, more specifically) the pupil—the right-eye's, in this setup—is hovering over⁶⁰.

⁶⁰ As added in footnote 51, a virtual/physical *decoupled* setup—where the virtual does not overlay the physical—may be more appropriate for users with severe limited mobility. In such a setup, the user would be able to navigate the virtual environment without moving in the real one. Accordingly, he/she would be able to virtually 'look' at virtual objects and engage with them. But this setup would not work with the human identity recognition part of this implementation (see Section 5.9.2), as it requires looking directly at a real person. Modifications could be made to the *decoupled* setup to instantiate virtual representations of people navigating in the same virtual environment, but in such a case their identity may be ascertained by virtue of whose owner said avatar is. Accordingly, no actual *looking at a face* would be needed to ascertain identity.

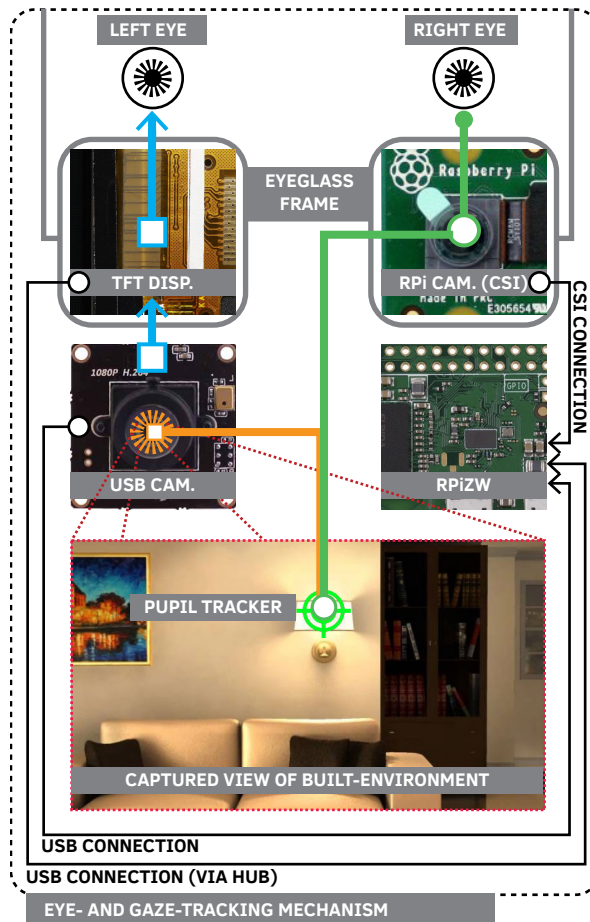

FIG. 5.34 Concept and System Architecture of the Eye- and Gaze-Tracking Mechanism.

The eye- and gaze-tracking mechanism integrates the following hardware components into a generic eyeglass frame: a (i) Raspberry Pi Zero W (RPIZW); (ii) generic USB TFT Display; (iii) generic USB Camera (USBCam); (iv) and a CSI Raspberry Pi Camera v. 2.1. (RPiCam). The RPiCam is used to track the movement of the pupil corresponding to the right eye, while the USBCam captures the environment viewed and projects this scene back to the left eye via the TFT Display with a real-time update frequency. The position of the pupil is mapped on top of the captured scene, and gaze-tracking is enabled by analyzing the position of the pupil—and its movements—in relation with recognizable objects captured in the scene (see Figure 5.34). The following recognizable objects are presently defined: a (1) sofa, (2) wall-light, (3) window, (4) ceiling-light, (5) bookcase, (6) lamp, (7) wall-art, and (8) a dining table (see Figure 5.35, *Bottom*). This represents a generic sampling of objects contained in a given built-environment, where some actuate and others do not.

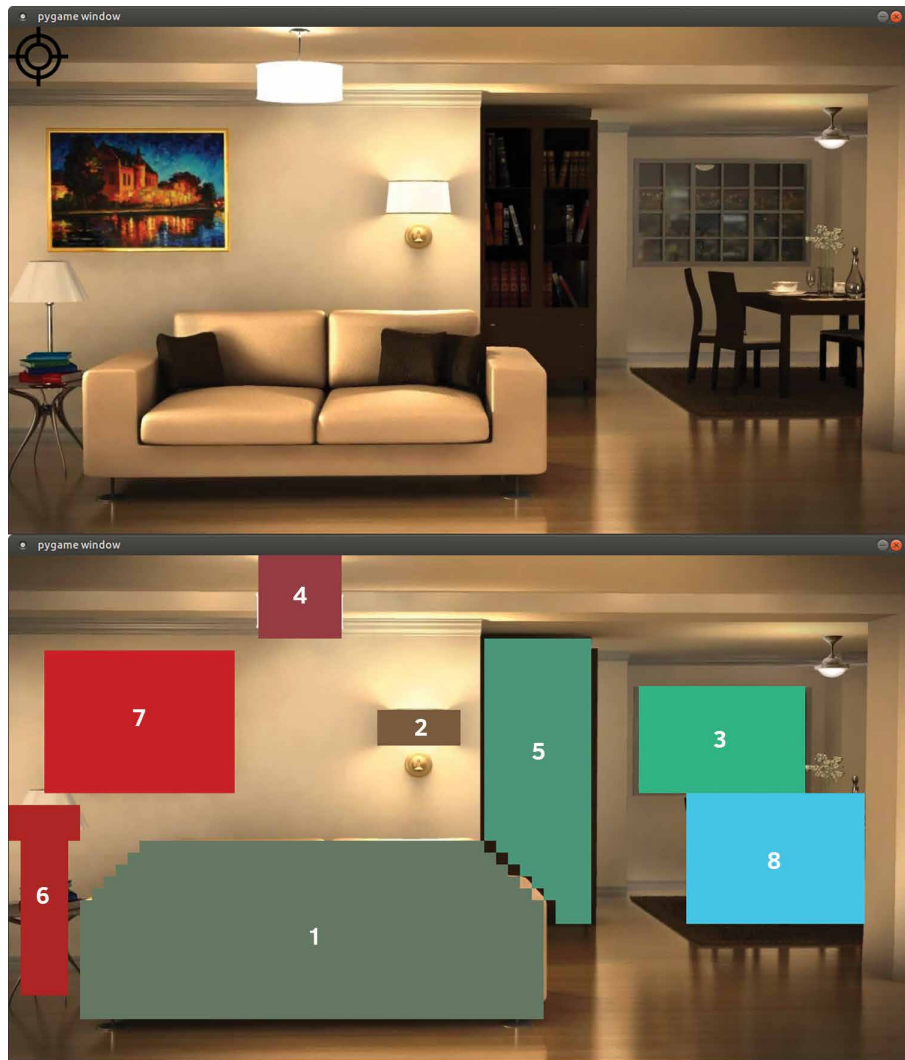

FIG. 5.35 *Top*: Captured-gaze of generic sample built-environment. *Bottom*: Object-boundaries overlaid on top of objects represented. Both generated with PyGame.

In this implementation, the engagement with actuable objects and systems (e.g., doors, windows, lights, etc.) is limited to their generic virtual representation (see Figure 5.35, *Top*). That is, while previous implementations have required the building of physical representations in real-scale, the present development only requires confirmation of engagement at a software level to ascertain its functionality. Accordingly, a black-box approach is adopted with respect to the other subsystems

of the inherited WSN. In this manner, the present mechanism is said to actuate a window, a door; or to turn on/off a light, etc., if the user is detected to be engaging with a given object and the eye- and gaze-tracking mechanism does indeed respond by sending a signal to actuate or to turn on/off.

A caveat on the architecture / built-environment used as the captured scenes in this implementation: the type of architecture displayed intends to represent an average contemporary built-environment. As such, it is meant as a neutral representation, and not as an illustration of the type of environments to be generated by considering both ICTs and emerging AEC features. Nevertheless, as simple and reduced as representation as it may be, it does serve to illustrate the functionality of the present mechanism in a variety of existing assisted living built-environments.

As mentioned at the beginning of this section, the position of the tracked pupil is overlaid with frequently updated captured scenes. When the eye-target symbol representing the location of said pupil lands on a non-defined region, its color remains black and no actuation options appear on the display (see Figure 5.35, *Top*). The eye-target symbol changes color whenever the system detects that it has entered any of the eight defined regions. N.B.: entering a region occurs when the overlap between the eye-target symbol's area and a given object's defined region is greater than 50% of the symbol's overall area—that is, when the majority of the symbol representing the eye is inside a given object's region.

If the eye-target symbol's color turns red (see Figure 5.36), the console outputs confirmation of recognition of viewed object while warning that no actuations are associated with said object—as Kolarevic points out, an adaptive environment is more appropriately conceived as one containing both high-tech. and low-tech. objects [51], where the former are actuatable while the latter are fixed. If, however, the eye-target symbol's color turns green (see Figure 5.37, *Wall* and *Wall-Light*), the console confirms object recognition and provides a list of actuation options associated with said object. The user is able to select any of the available actuation options by looking at it (i.e., by moving the eye-target symbol to sit on top of the preferred option) and then blinking twice to confirm selection and trigger actuation execution (i.e., sending a confirmation signal to the responsible node via which the actuatable object is controlled). Finally, if the eye-target symbol's color turns yellow (see Figure 5.37, *Wall-Art*) the console confirms object recognition and outputs a series of options pertaining not to physical actuation but to other kinds of engagement, namely information finding about the object, etc.—for example, in Figure 5.37, *Wall-Art*, which represents the user looking at a generic instance of wall-art, options to find information about said art on the web or to take, store, and share a picture of it are outputted by the console.

This first feature concerns the recognition of actuatable and static objects and systems within the built-environment. In addition to this feature, the mechanism is equipped with a second feature that concerns the extraction of information corresponding to recognized familiar faces. In this second feature, recognized human faces—that is, faces that have already undergone ML-based training for identity recognition for a given user—are also a *de facto* defined region. If the eye-target symbol enters this region, the console outputs previously stored information about the recognized person (see Figure 5.38). Since this region is not of the same class as the previously listed eight regions corresponding to the actuatable / static objects in the present generic built-environment, the eye-target symbol disappears to give way to a rectangular boundary that contains the recognized face. This change of representation explicitly distinguishes identified and viewed non-human and human objects. As illustrated in Figure 5.38, the probability of recognition of a face is overlaid on top of the captured scene. Accordingly, in this particular figure, the user is informed that the viewed person is “Alejandra” with a 77.98% probability—for simplicity, any probability higher than 75% is accepted as accurate in this implementation.

Figure 5.38 shows multiple console outputs, each of which represents the processing of a new instance of a captured scene. In this particular figure, it may be appreciated how the prediction probability fluctuates depending on lighting conditions, distance, etc. Nevertheless, all shown instances correctly and strongly indicate that the person viewed is “Alejandra”. Furthermore, in addition to successful prediction probabilities, the console also outputs other useful and pertinent information in order to compensate for loss of memory and/or visual acuity.

5.9.1 Eye- and Gaze-Tracking for Object Actuation

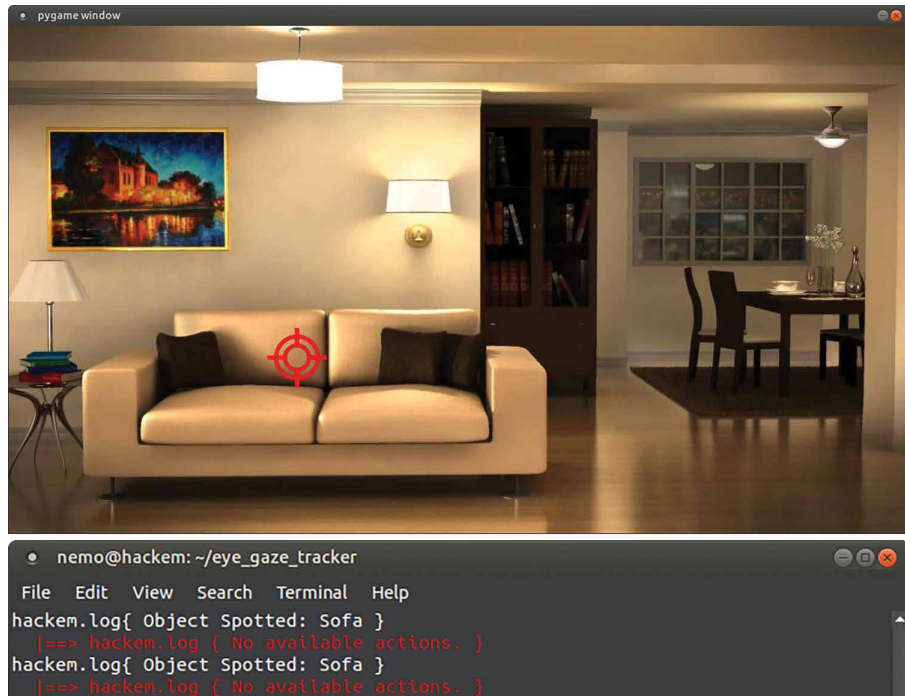

FIG. 5.36 Pupil detected on object Sofa, with no available actuations.

The eye- and gaze-tracking mechanism as a means to engage actuable objects / systems is implemented via two Python programs: (1) *main_eye_detector.py* and (2) *pygame_window.py*. The first (built with *OpenCV* and *Numpy*) is responsible for identifying and tracking the pupil; while the second (built with *Sys* and *PyGame*) is responsible for generating and/or displaying the representation of a given captured built-environment scene. It is in this latter that the regions corresponding to the eight actuable / static objects are defined; and where the overlapping between eye-target symbol and the defined objects' boundary is calculated.

With respect to the object actuation feature, three volunteers (with varying ages) (see *Acknowledgements*) tested its functionality and performance via the following five steps:

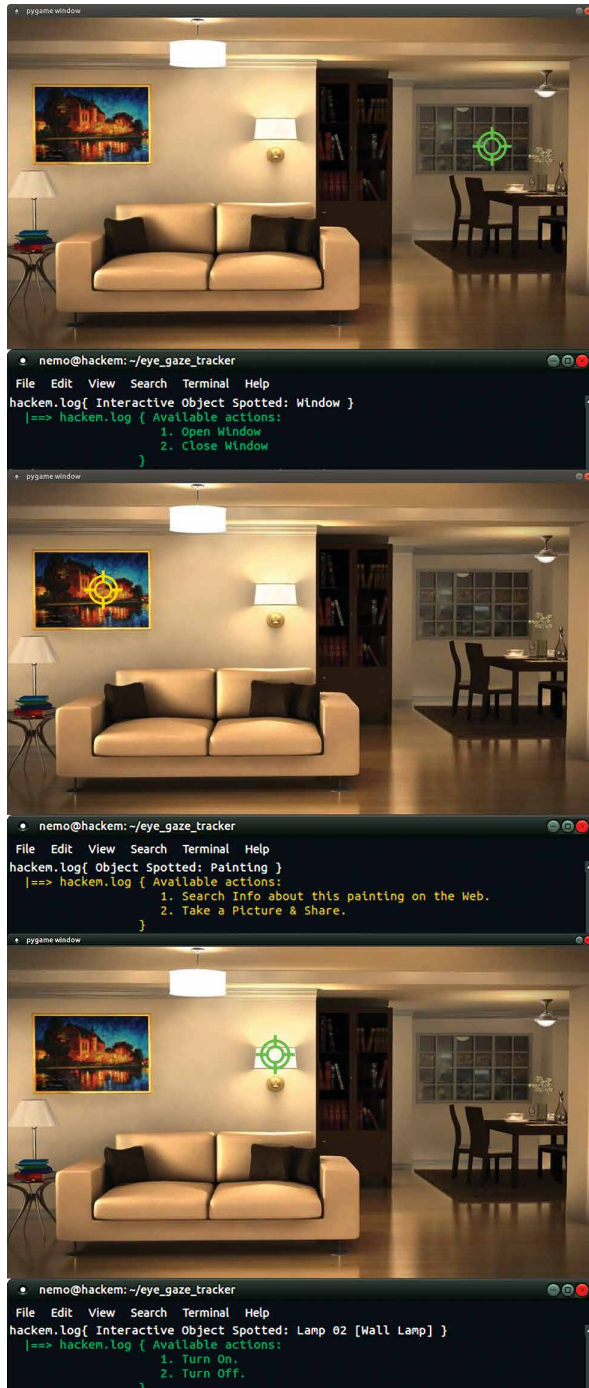

FIG. 5.37 Top-to-Bottom: Pupil on object Window (green target/text); Wall-Art (yellow target/text); and Wall-Light (green target/text).

- 1 At initialization of *PyGame*'s represented captured-scene, the eye-target symbol first appears in the upper-left corner. The user then moves her/his pupil in question (i.e., right-eye's pupil) and blinks twice over defined objects in order to first calibrate the eye-tracking component.
- 2 Once the eye-tracking component is calibrated the user is directed to look at the *window*, at which point the eye-target symbol changes colors to green, and the console first recognizes the actuatable object and the outputs the available actuation options: *open* or *close* (see Figure 5.37, *Window*). The user selects *open* and a confirmation of a corresponding execution signal sent is ascertained—the same, *mutatis mutandis*, for *close*.
- 3 The user is then instructed to look at the *sofa*, which is a non-actuating / fixed object that is nevertheless recognized. At this point the eye-target symbol turns red to indicate that no available actuation options exist for this object (see Figure 5.36).
- 4 The user's attention is turned to the *wall-art*, which is a non-actuatable object yet is nevertheless an object associated with non-physical actions. That is, after the eye-target symbol turns yellow (to indicate that the object in question is neither actuatable or fixed with no available options), the user is given the choice *to search for more information on the art online* or *to take, store, and share a picture of the art* (see Figure 5.37, *Wall-Art*). The user is instructed to engage in both, and a corresponding confirmation signal is ascertained.
- 5 Finally, the user is instructed to look at any of the light fixtures (see Figure 5.37, *Wall-Light*). Any of these fixtures present the user with two options: *turn on* or *turn off*. The user is instructed to engage in both, sequentially, and corresponding confirmation signals are ascertained.

The present setup has its actuations act on virtual representations of generic objects found in an average built-environment. For the scope of the present implementation, it is only necessary to ascertain that a confirmation signal is sent to a respective enabling-node (enabling of the window, the lights, etc.) in order to demonstrate the successful functionality of the present *proof-of-concept*. In all of the above five steps mentioned, corresponding confirmation signals were indeed ascertained.

In this setup, only three types of responses / options have been considered: (1) actuatable object (green eye-target); (2) static object (red eye-target); and (3) static object associated with non-physical actions (yellow eye-target). However, other possible responses / options may be envisioned for subsequent iterations of this feature of the mechanism.

5.9.2 Eye- and Gaze-Tracking for Human Identity Recognition

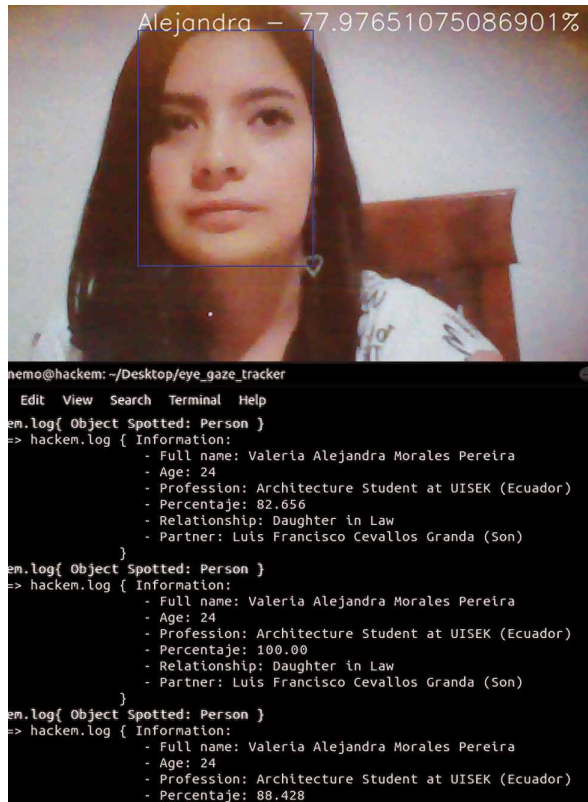

FIG. 5.38 Recognition of a familiar face and corresponding output of associated information pertaining to the identified person.⁶¹

The component of the eye- and gaze-tracking mechanism responsible for human identity recognition depends on the inherited facial-identity and -expression mechanism previously developed in Section 5.8. In the previous work as with the present, the facial identity recognition component is implemented in the local network via Google Brain[®]'s *TensorFlow*[™] [168]. That is, TensorFlow[™] is installed

⁶¹ In this figure, the mechanism informs the user that this is "Alejandra", and that she is: "24 years old"; an "Architecture student"; the user's "daughter-in-law"; and the wife of "Luis Francisco", who may be presumed to be the user's son. All this information pertaining to this familiar face are previously stored for the user and will naturally differ from user to user. In the present setup, only a small set of data (i.e., Full name, Age, Profession, etc.) is provided to illustrate the mechanism's functionality. However, the amount and type of data may be added or removed depending on the user's preference and/or need. The principal purpose of this second feature is to enable to user to always recognize the people in her/his immediate surroundings.











in the RPiZW's *Raspbian* operating system and its cloud-based services are implemented via Python. The implementation of this service has two phases. In the first phase, and during execution of its *Multi-task Cascaded Convolutional Networks* (MTCNN) face detection model, the camera captures a given subject's face from different positions, orientations, and angles. All the people to be added to the eye- and gaze-tracking mechanism's users circle of familiar faces must undergo this phase. The second phase is the actual real-time execution of facial recognition, following the successful acquisition of analyzed and stored faces from the first phase.

With respect to the human identity recognition feature of the present mechanism, a database of recognizable faces was first established, followed by a sequence of trials by the same volunteers to gauge the feature's human identity recognition capabilities. The feature performed as expected, where the prediction accuracy probabilities were consistently above 70%.

In this section an eye- and gaze-tracking mechanism has been presented. Said mechanism enables the user (1) to engage (i.e., open, shut, slide, turn-on/-off, etc.) with a variety of actuatable objects and systems deployed within an intelligent built-environment via sight-enabled identification, selection, and confirmation; and (2) to extract and display personal identity information from recognized familiar faces viewed by the user. As with previously developed service-features, the present mechanism intends to increase the quality of life of its user(s) in an affordable, intuitive, and highly intelligent manner. Although the present setup is limited and not yet ready for widespread adoption (being in a *Technology Readiness Level* (TRL) [53] of 5), the detailed *proof-of-concept* implementation's validated functionality and performance indicates further potential for development, which is presently being undertaken.

5.10 Development of An Adaptive Staircase System Actuated by Facial-, Object-, and Voice-Recognition⁶²

TABLE 5.11 Demonstrator 10's summary—environment, parameters, interactions, key results, purpose, and pertinence.

DEMO ENVIRONMENT				IEQ				QoL			
											
HYP	ROB	DT	ND								
INTERACTION METHODS		USER-DRIVEN		Appendix, IEQ Section 1.A				Appendix, QoL Section 1.B			
		SENSOR-DRIVEN		Appendix, IEQ Section 2.A				Appendix, QoL Section 2.B			
								1 12	1 7	1 7	1 2
KEY RESULTS		<ul style="list-style-type: none"> Two variations of a transformable staircase system capable of recognizing—via <i>Machine Learning</i> (ML)-based facial-identity recognition—and reacting to three types of users: those (1) walking normally; (2) walking with assisting devices (e.g., walking-cane); and (3) on wheelchairs. In the present setup, the identities of given users were correlated with these user-profiles. Accordingly, facial-identity recognition alone sufficed to trigger physical transformations in the staircases to accommodate each profile's requirements. 									
PURPOSE		<ul style="list-style-type: none"> To develop a staircase solution capable of accommodating user-limitations in terms of vertical mobility. To develop a solution that may be used to assist in rehabilitation of people with limited walking capabilities. To enable users with limited—or completely absent—walking capabilities to move across different levels independently and at their own pace. 									
PERTINENCE		<ul style="list-style-type: none"> Accessibility remains a constant challenge in the built-environment. Given the possibility of transformable systems, staircases need not be considered via a “one-size-fits-all” approach. Staircase systems capable of accommodating to elderly users' physical limitations empower them to retain a certain degree of independence with respect to mobility. 									

⁶² This section is based on

 A. Liu Cheng et al, “Development of An Adaptive Staircase System Actuated by Facial-, Object-, and Voice-Recognition,” in *Proceedings of the 21st IEEE International Conference on E-Health Networking, Application & Services (Healthcom) 2019*, 2019. [177]

Abstract

This implementation consists in the development of an adaptive staircase system-type capable of user-specific mechanical reconfigurations actuated by facial-, object-, and voice-recognition. The system is described via two variation-prototypes—developed at Technology Readiness Level (TRL) [53] 4—as instances of the same system-type. Accordingly, each prototype is informed by the same use-case considerations and requirements. Nevertheless, by means of their mechanical particulars, advantages and disadvantages specific to each variation are identified and explored. The present adaptive staircase system-type consists of two main components, one computational and the other mechanical. More specifically, the computational component uses Google’s TensorFlow™ [168] for facial-recognition (see Section 5.8); BerryNet® [212] for multi-object detection (see Section 5.4); and VoiceIt [241] for voice-recognition (see [16]). These three cloud-compatible, -based, or -dependent recognition mechanisms are used to ascertain the identity three user-types: (1) a person without perceivable physical disabilities; (2) a person reliant on a walking-cane; and (3) a person on a wheelchair. With the exception of the first case, the computational component proceeds to actuate mechanical transformations pertinent to each variety of disabilities depending on which user-type is identified. The objective of this implementations is to present an intuitive and automated vertical mobility solution capable of supporting users with varying degrees of reduced mobility.

Two variations of this system-type are developed, with both able to recognize any of the following three user-types: (i) a person without perceivable physical disabilities; (ii) a person reliant on a walking-cane; and (iii) a person on a wheelchair. The first user-type does not instigate actuation; it is deliberately considered to account for the system’s ability to recognize the absence of explicit physical disabilities. The second user-type instigates physical changes in the dimensions of the stair’s tread and/or riser to facilitate more effortless stair-climbing. The third user-type instigates the transformation of the staircase into an elevating platform, which dismisses stair-climbing entirely. Both staircase variations have the same reaction to the first and third user-types. With respect to reactions to the second user-type, the first staircase variation adjusts the dimensions of both its tread and riser (see Figure 5.41 and Figure 5.43) while the second variation can only adjust its riser (see Figure 5.42 and Figure 5.44). Nevertheless, due to its mechanical design, the second variation enables the second user-type to choose to engage in partial stair-climbing or to avoid it entirely; whereas the first variation requires stair-climbing. Both variations aim to empower users with varying physical disabilities to ascertain a degree of independence with respect to mobility, which promotes dignity and quality of life.

Note: These variations of the same transformable staircase concept may be envisioned in built-environments rich in physical transformations—e.g., the transformable apartment (Section 4.1.1) used in the first demonstrator (Section 5.1).

The prototypes of both staircase-variations are built at 1:2.5 scale and at TRL 4. Each prototype is driven by a *microcontroller unit* (MCU) attached to a variety of sensors, actuators, and emitters. In the present implementations, all sensors and emitters respond to user-safety considerations by either preventing actuation or by providing notifications via sound as well as light emission. Such safety measures ensure that actuation does not take place while the user is climbing steps (while in stairs-mode), nor while the user is outside of the bounds of the elevating platform (while in elevator-mode). Each variation's MCU communicates with a coordinating single-board computer used to operate the facial-, object-, and voice-recognition mechanisms. In the present setup, the single-board computers are already trained to recognize a variety of faces (see Figure 5.39) and associated voices (see Figure 5.40) as corresponding to particular user-types. Similarly, the object-recognition mechanism is already pre-trained to recognize wheelchairs as well as other assistive devices. In both variations, facial-recognition is first engaged to detect faces who approach the system to within a meter. If the identity of the person is ascertained to a confidence level greater than 70%, the system actuates to its corresponding configuration. If, however, the confidence level is low, the user is prompted to utter a predetermined phrase. The voice-recognition mechanism detects both the phrase as well as the identity of the person uttering it. Actuation is engaged by correlating both the facial- and voice-recognition output. Finally, if both the facial- and voice-recognition mechanisms failed to ascertain the identity of a user, the remaining object-recognition mechanism attempts to recognize a wheelchair, walking-cane, etc., and actuates accordingly.

The staircase system-type consists of two main components, one computational and the other mechanical. The computational consists of three mechanisms, each concerned with facial-, object-, and voice-recognition. The mechanical consists of the physical parts that instantiate the reconfiguration modes particular to each user-type. Each of the computational mechanisms inherits and/or builds upon previous developments via *Application Programming Interfaces* (APIs)—with respect to facial- (see Section 5.8), object- (see Section 5.4.1), and voice-recognition [16].

5.10.1 Computational component

With respect to the computational mechanisms, the facial-recognition mechanism is developed via Google's free and open-source *TensorFlow*[™]. Its functionality is implemented in Python on the single-board computer, which enables it—with the assistance of a *Raspberry Pi Camera Module V2*—to recognize faces via cloud-based ML. The face of each of the test-individuals is captured in various positions and used to generate a profile (see Figure 5.39). In this implementation, each profile is associated with a user-type. The object-recognition mechanism is inherited from Section 5.4 and serves as a localized *Deep Learning* gateway implementable on a single-board computer, although its performance—as well as that of *TensorFlow*[™]'s implementation—benefit from a cluster of said computers rather than in a single instance.

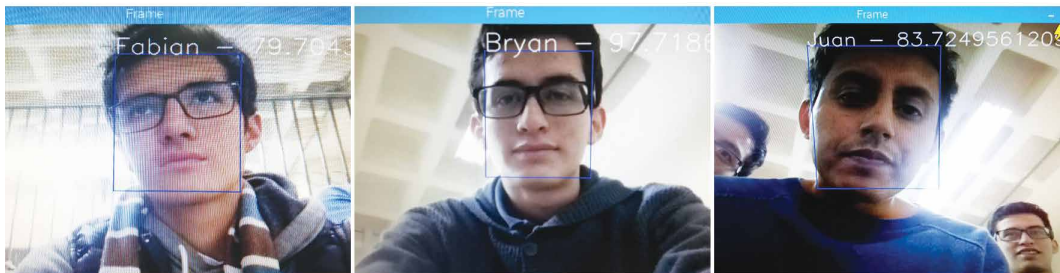

FIG. 5.39 Three sample faces used to associate identity with user-type and to enable facial-recognition and corresponding system-actuation.

The voice-recognition mechanism is built via *VoiceIt*'s [241] API in Python. User-profiles are created for each test-subject associated with a user-type. In this process, a minimum of three voice samples are required to *enroll* each subject. Following successful enrollment, the identity of each subject may be ascertained via his/her voice (see Figure 5.40). This mechanism is capable of recognizing both the utterance as well as the identity of the utterer. In the present implementation only the identity of the utterer is used.

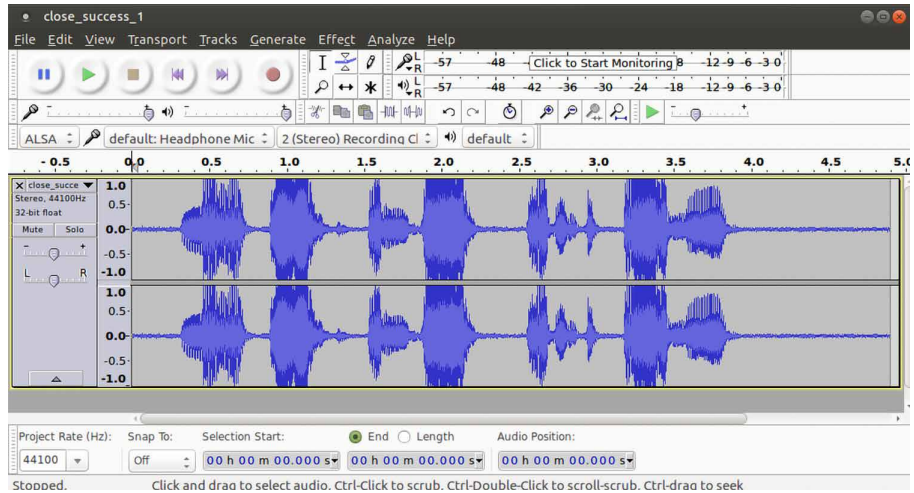

FIG. 5.40 VoiceIt Authentication Success in close-range, as developed elsewhere [16].

The above three ML-based recognition mechanisms are implemented in order to correlate their outputs to increase the accuracy of identity-detection. In instances where the camera's visibility is unhindered and recognition confidence is greater than 90%, the facial-recognition mechanism takes precedence. In instances where the facial-recognition confidence is greater than 70% yet lesser than 90%, the identity of the user is ascertained via a correlation of the facial-recognition mechanism's and voice-recognition mechanism's output. In cases where facial-recognition confidence is below 70%, the voice-recognition mechanism takes precedence. Finally, in cases where both facial- and voice-recognition failed, the object-recognition mechanism takes precedence—that is, perhaps the user is someone whose profile is not yet stored in the system but is nevertheless recognized to be on a wheelchair or using a rollator, walker, etc.

5.10.2 Mechanical component

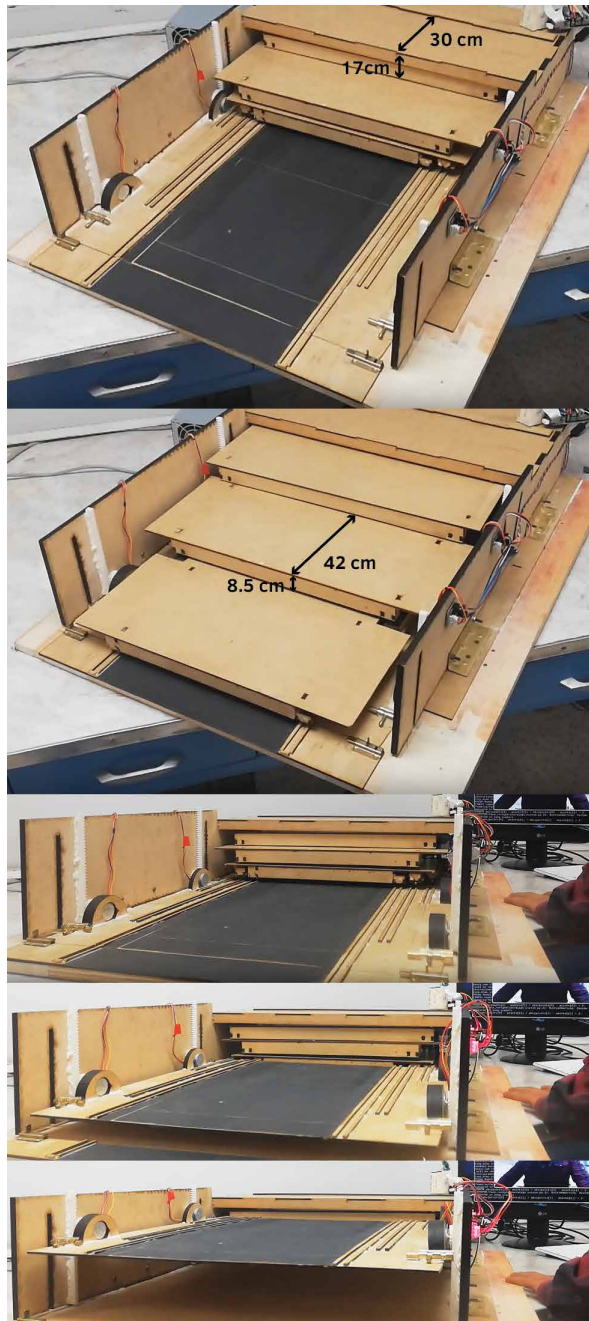

FIG. 5.41 *Top-to-Bottom:* variation 1 configured for the 1st user-type (standard-stairs); the 2nd user-type (easy-stairs); and the 3rd user-type (elevating platform).



FIG. 5.42 Variation 2 configured for (*Top and Middle*) the 1st user-type (standard-stairs); and (*Bottom*) the 3rd user-type (elevating platform).

With respect to the mechanical component, the first staircase variation is built with MDF. Its retracting / extending function is driven by two stepper motors (see Figure 5.41, top two images), while its platform's elevating function is driven by four stepper motors (with corresponding drivers) (see Figure 5.41, bottom three images). The second staircase variation is built with aluminum parts. Its mechanical transformation is enabled by two stepper motors (with corresponding drivers) built into the support rails (see Figure 5.42). As both variations are built at 1:2.5, the motors that actuate the system are not rated for real-scale use, but are appropriate for the present *proof-of-concept* implementations. Moreover, in both cases the camera is detached from the actual prototype and is situated adjacent to it for practicality during tests and trials.

5.10.3 1st staircase variation (conceptual details)

The first variation features three mechanical modes / configurations (see Figure 5.43) corresponding to each of the three user-types. The first mode represents a staircase that is compliant with both the *Ecuadorian Service for Standardization (INEN)* prescriptions [242] as well as with the American *Occupational Safety and Health Administration (OSHA)* standards [243]. That is, the staircase's steps are dimensioned with 30 cm treads and 17 cm risers, which may be comfortably climbed by users without physical disabilities. The second mode represents a staircase that is designed for people with mild to moderate physical disabilities with respect to mobility. That is to say, the step's tread width expands to 42 cm while its riser height decreases to 8.5 cm. This second mode is intended for the elderly as well as for pregnant women / nursing parents whose mobility may be reduced. The third and final mode represents an elevating platform that eliminates the need to climb steps entirely. This mode is designed for people dependent on wheelchairs and/or on other mobility support-devices such as rollators, walkers, etc.—i.e., for people whose physical ability to climb steps is either impossible or unduly difficult.

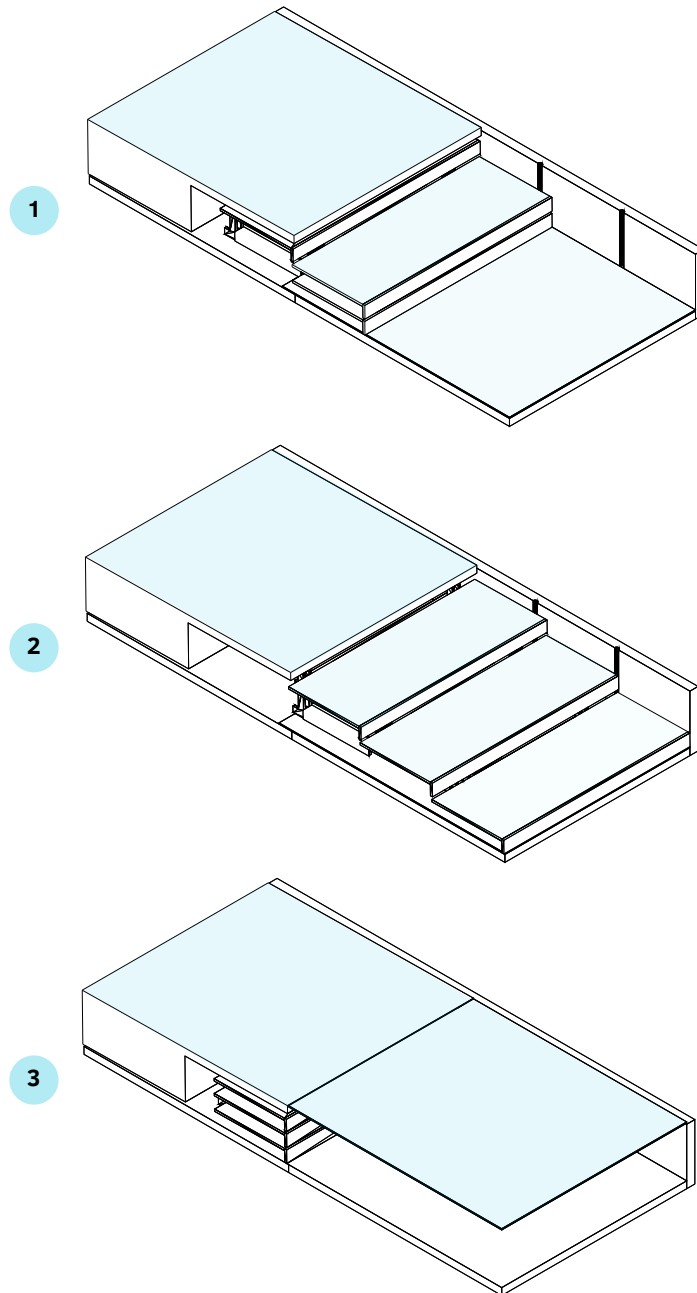

FIG. 5.43 Staircase variation 1 reacting to (1) the first user-type (tread depth: 30 cm; riser height: 17 cm); (2) the second user-type (tread: 42 cm; riser: 8.5 cm); and (3) the third user-type (steps are retracted to enable platform elevation).

5.10.4 2nd staircase variation (conceptual details)

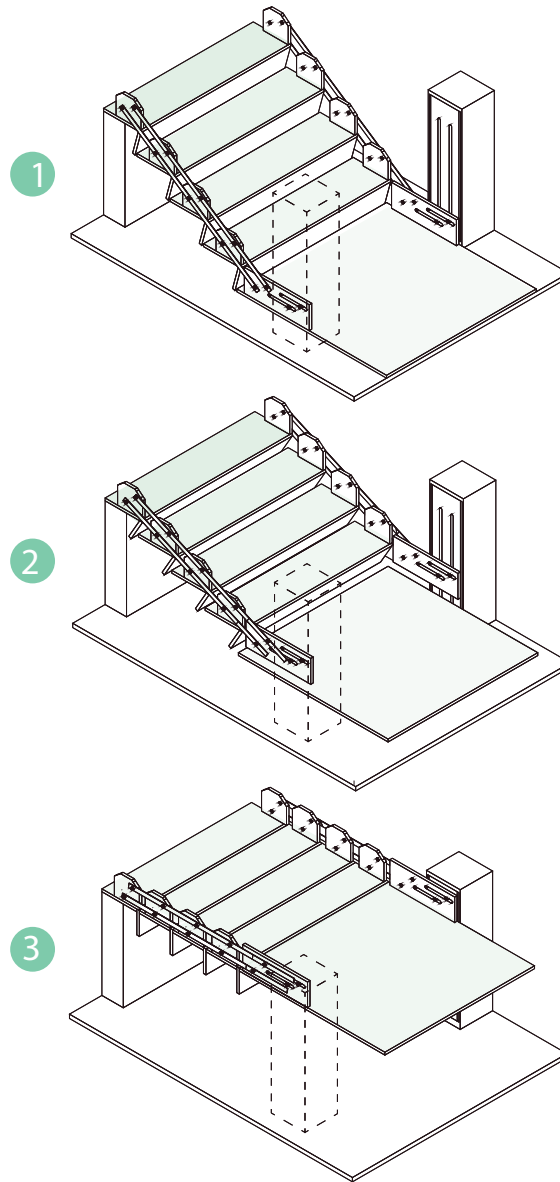











FIG. 5.44 Staircase variation 2 reacting to (1) the first user-type (with standards-compliant tread-vs.-riser dimensions and proportions); (2) the second user-type—or to users with a variety of disabilities in state of rehabilitation; and (3) the third user-type (the landing platform elevates).

The second variation also features three mechanical modes / configurations (see Figure 5.44). The first mode, as in staircase variation 1's first mode, represents an INEN / OSHA compliant staircase. The second mode is capable of instantiating multiple riser heights, which may be used in cases of rehabilitation, where the user is encouraged to walk or to train in a variety of climbing heights. In this mode, a user undergoing rehabilitation may use the system to gradually increase her stair-climbing ability over time.

The third mode turns the staircase's landing into an elevating platform. In this variation, the first mode caters to the first user-type (user without physical disabilities), while the third mode to the second and third user-types (users dependent on canes, walkers, rollators, or wheelchairs). The second mode principally caters to users in rehabilitation.

5.11 Development of an Acoustically Adaptive Modular System for Near Real-Time Clarity-Enhancement⁶³

TABLE 5.12 Demonstrator 11's summary—environment, parameters, interactions, key results, purpose, and pertinence.

DEMO ENVIRONMENT				IEQ				QoL			
											
HYP	ROB	DT	ND								
INTERACTION METHODS		USER-DRIVEN		Appendix, IEQ Section 1.A				Appendix, QoL Section 1.B			
		SENSOR-DRIVEN		Appendix, IEQ Section 2.A				Appendix, QoL Section 2.B			
						11		113	18		
KEY RESULTS		<ul style="list-style-type: none"> Adaptive modules capable of physical transformations that impact the acoustics of a space. An adaptive modular system consisting of the above modules that together with an evolutionary solver physically reconfigures to ascertain C_{50} speech clarity index in specific locations in a given space. 									
PURPOSE		<ul style="list-style-type: none"> To enable the intelligent-built environment to seek optimal acoustics for speech clarity. To provide the user with an adaptive mechanism that continuously seeks to enhance the acoustics (i.e., with respect to speech clarity) of a space without conscious intervention. 									
PERTINENCE		<ul style="list-style-type: none"> Hearing-loss is a common phenomenon within the natural ageing process. This makes it difficult to communicate without additional effort. The system developed in this demonstrator attempts to reduce this effort by helping to ascertain optimal acoustics automatically and continuously with respect to the user's location. 									

⁶³ This section is based on

 A. Liu Cheng, P. Cruz, N. Llorca Vega, and A. Mena, "Development of an Acoustically Adaptive Modular System for Near Real-Time Clarity-Enhancement," in *Lecture Notes in Computer Science*, vol. 11912, *Ambient Intelligence (AmI 2019)*, I. Chatzigiannakis, B. de Ruyter, and I. Mavrommati, Eds., Springer International Publishing, 2019, pp. 170–185. [178]

Abstract

This implementation details the development of an acoustically adaptive modular system capable of enhancing Speech Clarity (C_{50} Clarity Index) in specific locations within a space in near real-time. The mechanical component of the system consists of quadrilateral, truncated pyramidal modules that extend or retract perpendicularly to their base. This enables said modules (1) to change in the steepness of the sides of their frustum, which changes the way incoming sound waves are deflected / reflected / diffused by the surfaces of the pyramid; and (2) to reveal or to hide the absorbent material under each module, which enables a portion of incoming sound waves to be absorbed / dissipated in a controlled manner. The present setup considers a fragmentary implementation of six modules. The behavior of these modules is determined by two steps in the computational component of the system. First, the initial position of the modules is set via a model previously generated by an evolutionary solver, which identifies the optimal extension / retraction extent of each of the six modules to select for individual configurations that collectively ascertain the highest clarity in said specific locations. Second, a simulated receiver at the location in question measures the actual clarity attained and updates the model's database with respect to the configuration's corresponding clarity-value. Since the nature of acoustics is not exact, if the attained measurement is lower than the model's prediction for said location under the best module-configuration, but higher than the second-best configuration for the same location, the modules remain at the initial configuration. However, if the attained values are lower, this step reconfigures the modules to instantiate the second—or third-, fourth-, etc.—best configuration and updates the model's database with respect to the new optimal module-configuration value. These steps repeat each time the user moves to another specific location. The objective of the system is to contribute to the intelligent and intuitive Speech Clarity regulation of an inhabited space. This contributes to its Indoor Environmental Quality (IEQ), which promotes well-being and quality of life.

This implementation details the development of an acoustically adaptive modular system capable of enhancing Speech Clarity (C_{50} Clarity Index) in specific locations within a space in near real-time. It is designed and implemented as a sub-system within an open-ended and on-going development of an intelligent built-environment approach informed by both technical and architectural considerations. With respect to the technical, the present work is situated within the broad intelligent built-environment discourse (e.g., *Ambient Intelligence* (AmI) [244], [245] / *Ambient Assisted Living* [10]—or *Active and Assisted Living* [246], [247]—(AAL)). With respect to the architectural, it is informed by the *Interactive Architecture* [248] and *Architectural Robotics* [249] discourses. The consideration of both aspects is central to the development of mutually complementary interoperability between physical and computational components within the built-environment.

The acoustically adaptive modular system is designed to improve the acoustic ambience via said enhancement of Speech Clarity and a concomitant noise-reduction in predetermined locations via mutually informing Physical / Mechanical and Computational components. Since sound is a potential environmental stressor associated with a variety of negative physiological, psychological, and cognitive responses [250], acoustic ambience is an important indicator of IEQ [251], which is strongly correlated with well-being and sustained quality of life [108]. The impact extends to a variety of programmatic functions as well as to specific spaces and audiences, not all partial to the context or character of AmI / AAL. For example, with respect to classrooms and children: Speech Clarity is strongly correlated with reading development among elementary school—i.e., second-grade—pupils [252]; and with respect to offices and adults: it is strongly correlated with intelligibility even in teleconference systems at the workplace [253], etc.

Although the scope of the detailed implementation consists of maximal C_{50} value-selection at octave band mid-frequency of 500 Hz, the same method and system may be used to select for C_{80} —Music Performance Clarity Index—or other acoustic features such as *Reverberation Time*, *Definition* (D_{50}), *Early Decay Time*, etc., at a variety of frequencies (e.g., 1000 Hz – 8000 Hz). Accordingly, the present work is an instance-implementation of a method-type capable of enhancing acoustic ambience with respect to multiple acoustical parameters (in individual maximization or collective optimization). As with other sub-system developments belonging to the same open-ended intelligent built-environment approach, the present system is intended to operate intuitively, intelligently, and automatically in a closed-loop via inattentive or passive user-interaction yet without his/her intervention.

5.11.1 Parametric Setup

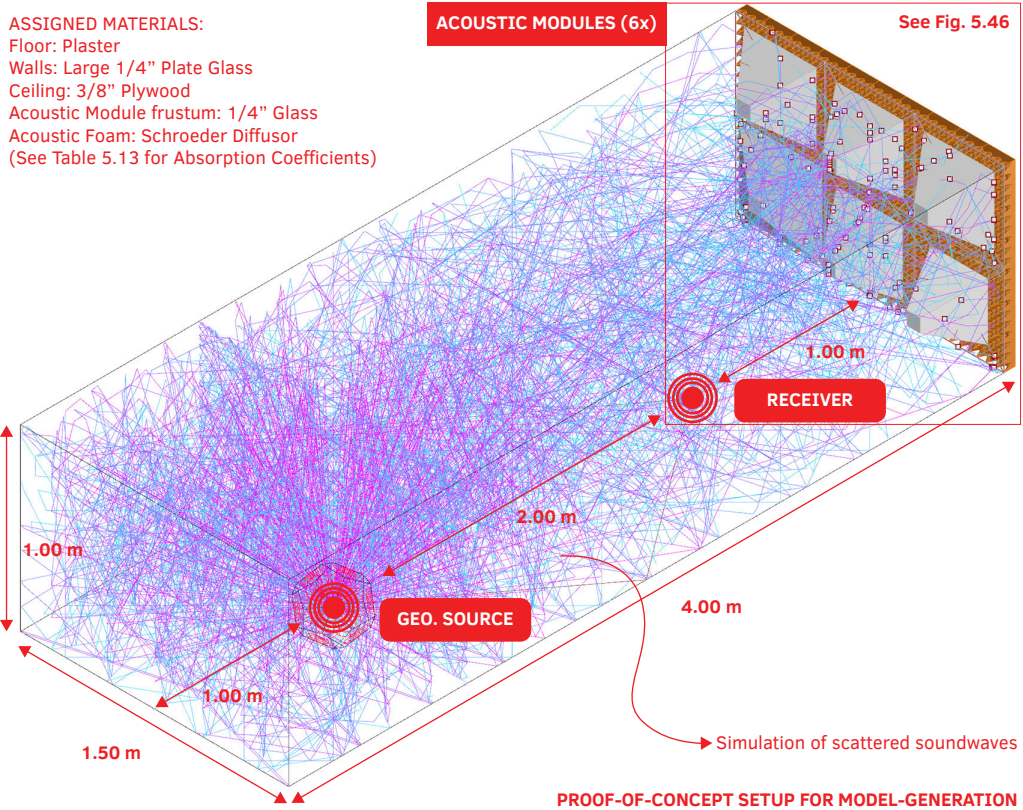

FIG. 5.45 Sample arrangement of six acoustically adaptive modules. Present configuration attains ~ 5.72 dB at a designated point in octave band mid-frequency of 500 Hz. Sound waves are represented in lines up to ten surface-bounces; the line colors are correlated with the sound-energy (i.e., darker to lighter equals more to less energy, respectively).

The present setup considers a virtual space of 4 meters in length, 1.5 in width, and 1 in height—N.B.: the width and height correspond to the dimensions of the six-module fragment, and represent minimal dimensions for trials in the present setup. In this volume, the simulated sound-source is placed 3 meters from the acoustical six-module fragment along the center-axis of the volume's length. The simulated receiver, and therefore the particular location where maximal C_{50} value is being selected for, is placed at 1 meter from the module fragment along the same axis. The virtual and physical acoustic modules measure 0.5 x 0.5 meters (see Figure 5.45—and Table 5.13 for *Absorption Coefficients*). The physical modules instantiate extension / retraction configurations corresponding to C_{50} calculations from this virtual space.

The adaptive modular system is conceived as a *Cyber-Physical System* (CPS) [122], [254]. Its physical / mechanical component (see Section 5.11.2) consists of quadrilateral, truncated pyramidal modules that extend or retract perpendicularly to their base (see Figure 5.46 and Figure 5.48). This enables said modules (1) to change in the steepness of the sides of their frustum, which changes the way incoming sound waves are deflected / reflected / diffused by the surfaces of the pyramid; and (2) to reveal or to hide the absorbent material under each module, which enables a portion of incoming sound waves to be absorbed / dissipated in a controlled manner. The extension / retraction of each module—ranging from 70 mm to 270 mm in height—is controlled by the computational component of the system (see Section 5.11.3), which consists of two steps.

In the first, the initial extension / retraction of each module is determined by a generated model based on an evolutionary solver—viz., *Galapagos* [255]—selecting for maximal C_{50} values ascertained via an acoustical simulation software—viz., *Pachyderm* [256]—both running on Grasshopper [257]. In the second step, a simulated receiver at the location in question measures the clarity attained and updates the model's database with respect to the configuration's corresponding clarity-value. Since the nature of acoustics is not always exact, if the attained measurement is lower than the model's prediction for said location under the best module-configuration, but higher than the second-best configuration for the same location, the modules remain at the initial configuration. However, if the attained values are lower, this step reconfigures the modules to instantiate the second—or third-, fourth-, etc.—best configuration and updates the model's database with respect to the new optimal module-configuration value (see Figure 5.47). These steps repeat each time the user moves to another location.

The computational model is an open-ended and closed-loop mechanism that is generated before any actual operation of the physical / mechanical component. It is open-ended in that, via its evolutionary solver (see Section 5.11.3), it continues to compute selected module extension / retraction configurations without a specific value as its selected target. It therefore continues to build its database of C_{50} values with respect to module extension / retraction configurations indefinitely. A caveat: the solver may be configured to end either after a particular period of time or when the difference between maximal values found becomes smaller than some designated threshold. Moreover, in cases where the *Fitness Landscape* or *Volume* (i.e., every fitness value resulting from the inter-combination of different variables or *genes*—see Rutten's discussion [258]) does have an actual optimum (either maximal or minimal value), the solver would end after having found it. However, this is not the case in the present system, as due to its complexity, there may be several equally satisfactory values whose difference is negligible (again, e.g., values with differences after ten decimal points).

Octave band mid-frequency: 500Hz (... now selecting for highest C50)

A-Weighted Sound Pressure Level: 123.384464

C50, dB: 5.715291

C80, dB: 9.746634

Reverb. time: 0.597964

D50: 78.851451

Early Decay Time: 0.485165

Initial Time Delay Gap: 0.0

F	E	D
206.0	224.0	213.0
139.0	230.0	256.0
C	B	A

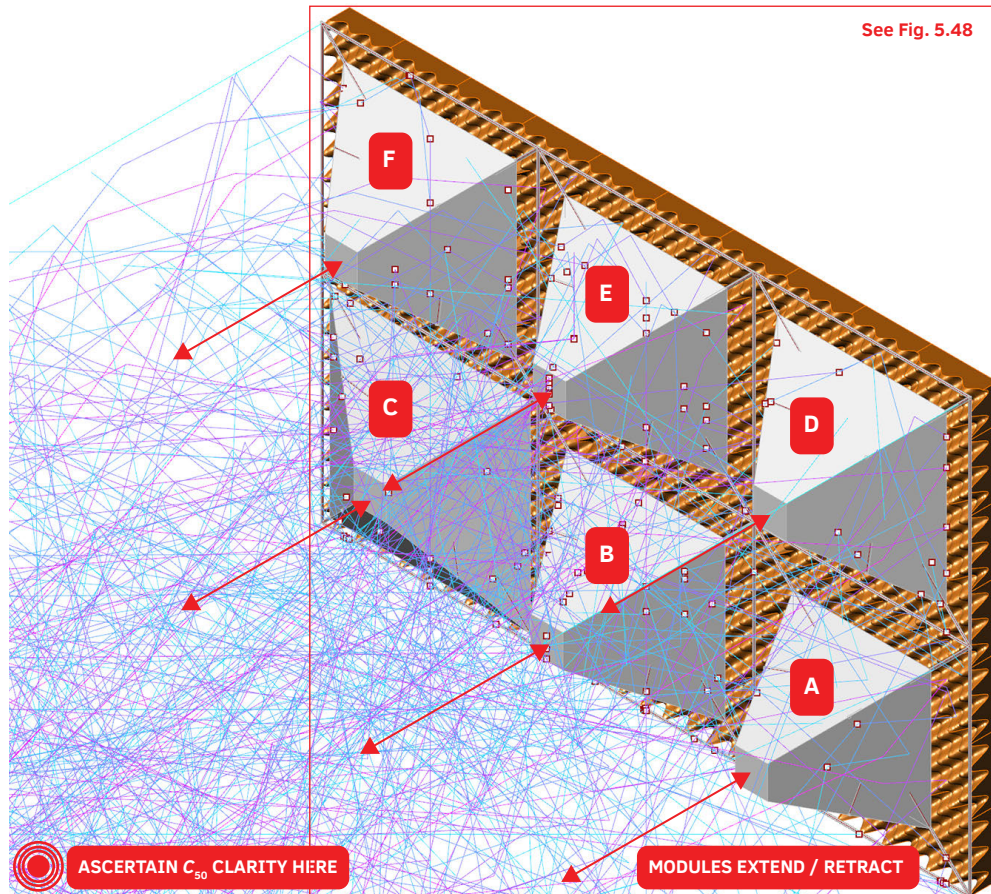

FIG. 5.46 Arrangement of six acoustically adaptive modules. Present configuration attains ~5.72 dB at a designated point in octave band mid-frequency of 500 Hz.

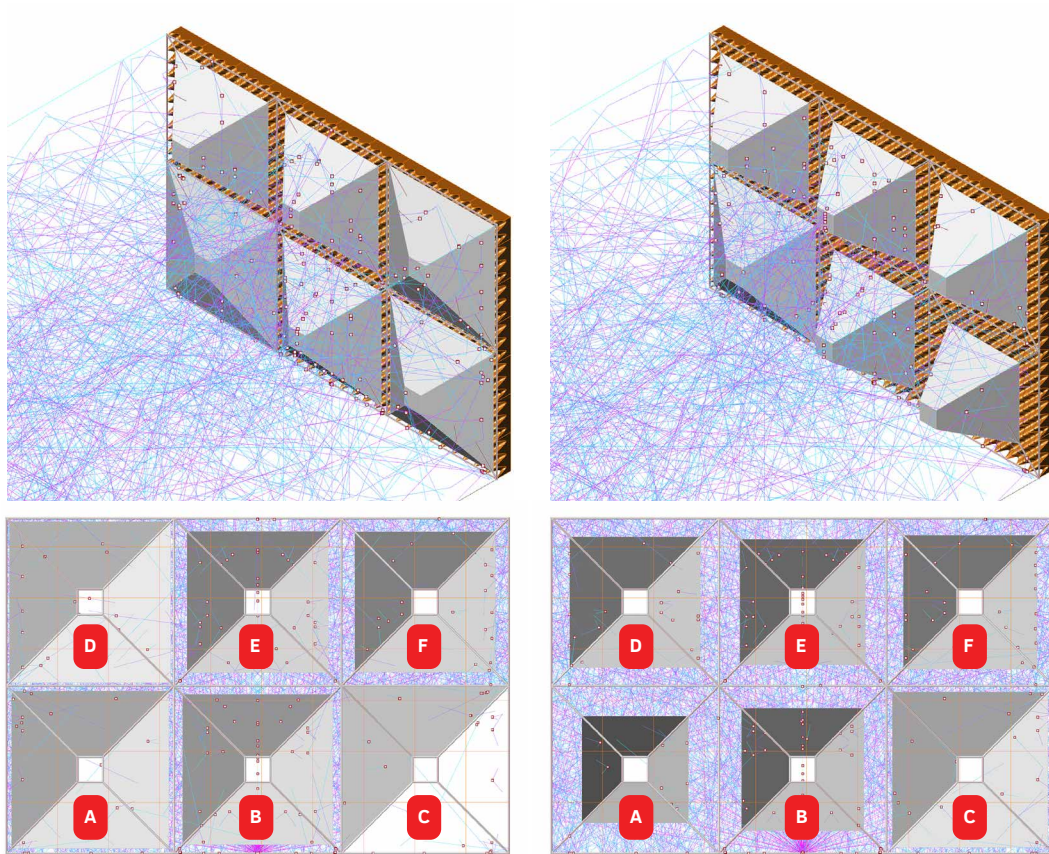

FIG. 5.47 *Top-row:* frontal isometric view. *Bottom-row:* posterior elevation view, viewing towards sound-source—N.B.: acoustic foam transparent). *Left-column:* iteration #20, with a C_{50} value of 3.8514 dB—acoustic module configurations (values in mm): A. 132; B. 159; C. 85; D. 112; E.187; F. 189 extension. *Right-column:* iteration #784, with a C_{50} value of 5.715291 dB—acoustic module configurations: A. 256; B. 230; C. 139; D. 213; E.224; F. 206 extension. Note that even small module configuration variations yield vastly different clarity values.

The model is also closed-loop in that it updates its database from received feedback. That is, while the solver computes values from module extension / retraction configurations and ranks them from highest (most optimal) to lower (least optimal) indefinitely, the feedback mechanism updates the model's ranked database to reflect actual states of affairs—i.e., the actual supersedes the predicted / generated). In this manner, the model is constantly and continuously ascertaining the latest values and ranking them for use, which enables the physical / mechanical component to operate as soon as the model's database has at least one predicted / generated value. This is why a model extension / retraction configuration is said to be the most optimal with respect to maximizing C_{50} only up until the most recent iteration. Of course, an arguable minimum number of iterations (and therefore stored C_{50} values) is required in order to yield non-trivial module extension / retraction configuration suggestions—that is, to say that a particular module extension / retraction configuration is the optimal because there is only one generated / measured C_{50} value is to say nothing at all. While this setup risks yielding trivial results when the model's database is small, it also enables the system to potentially improve over time with increasingly higher C_{50} values found in a more comprehensive database (for example, see Figure 5.50 for a *Histogram* corresponding to presently computed C_{50} values).

The behavior of the physical acoustic modules with respect to their extension / retraction extents is determined by data gathered from the virtual space. Although the ascertained module configurations are expressed in the physical world, the real space is not correlated with the virtual one. That is to say, in the scope of the present implementation, the principal purpose is to demonstrate that a model configuration found via a virtual space may be instantiated in the real-world; and that feedback corresponding to the real-world may be used to update the model's database. The particulars of both physical and computational components are detailed in the following sub-sections.

5.11.2 Physical / Mechanical Component: Acoustically Adaptive Modules

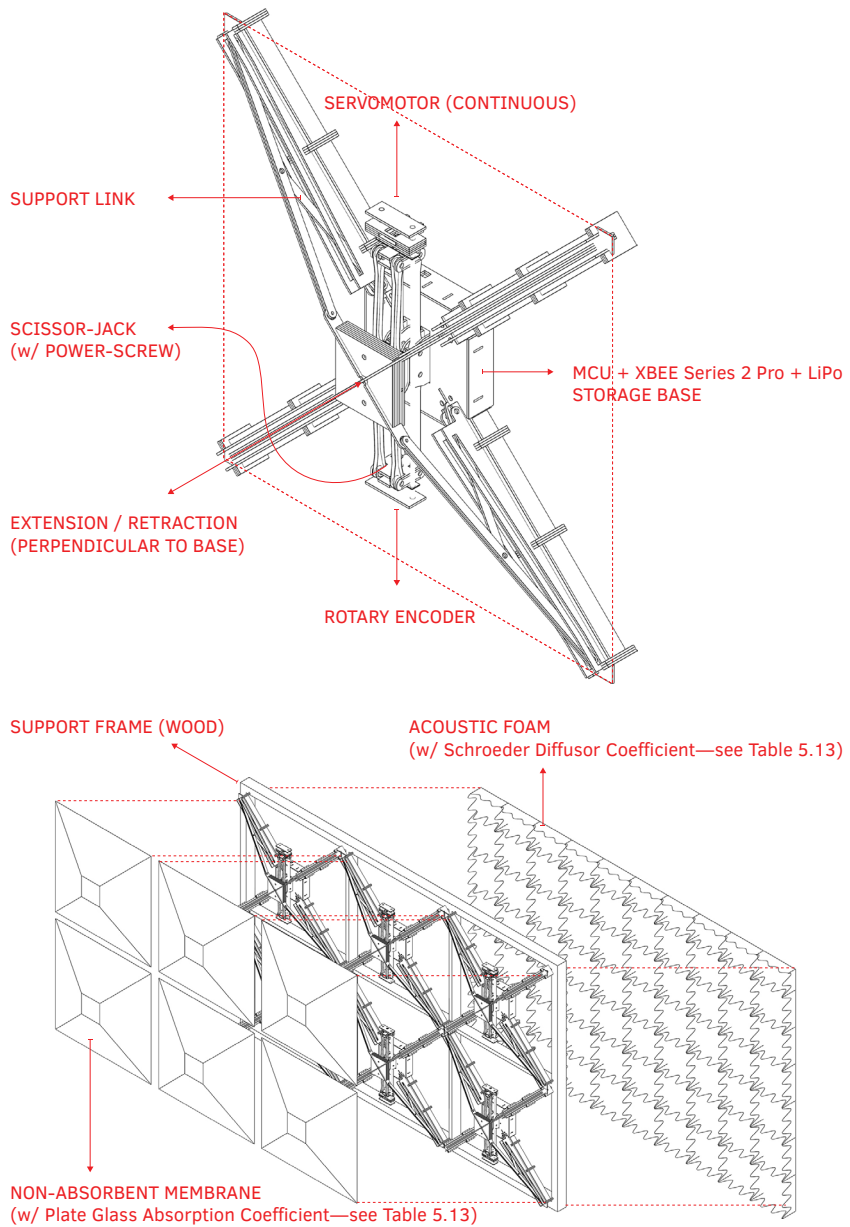

FIG. 5.48 Top: Module breakdown. Bottom: Implemented six-module fragment breakdown.

In terms of the physical build, each instance of the acoustically adaptive module is built with medium-density fiberboards, a steel tie-rod or power-screw, an acrylic scissor-jack as well as a variety of other metallic accessories such as ball-bearings, bolts, nuts, etc. These modules were designed as proof-of-concept instances appropriate to a *Technology Readiness Level* (TRL) [53] of 4-5 (see Figure 5.49).

In terms of *Information and Communication Technologies* (ICTs), each module is equipped with a continuous servomotor (with 15 KG of torque) correlated with a rotary encoder to keep track of the rotation of the power-screw. The motor and encoder are connected to a *Microcontroller Unit* (MCU) attached at the base of the module. An XBee Series 2 Pro antenna as well as a LiPo battery are attached to the MCU—N.B.: While the modules depend on the main power supply to function, batteries are integrated as a contingency measure in case of power-outage. Each module serves as a node in an inherited and expanded self-healing and meshed *Wireless Sensor Network* (WSN) (see Section 3.4). Each node sends and receives data to and from any one of several coordinating devices built with *Raspberry Pi Zero Ws* (RPIZWs). The computational model stores calculated C_{50} data in a shared database that the RPIZWs access via ZigBee in order to read module extension / retraction extents corresponding to each C_{50} value, which are then relayed—also in ZigBee—to each adaptive acoustic module for configuration instantiation. The present setup considers three coordinating RPIZWs as representative of a larger multitude in an intelligent built-environment's WSN. This redundancy ensures system resilience, as operation would not be interrupted if one or two coordinating nodes were to fail. Moreover, even if the selected communication protocol (i.e., ZigBee, for reduced energy-consumption) between the nodes were to fail, the sending and receiving of data and instructions would default to *User Datagram Protocol* (UDP) over Wi-Fi. Redundancy of computational resources as well as communication protocols is essential to instantiate unobtrusive, intuitive, and independent data-driven intelligence. Finally, the LiPo battery is included as a secondary source of power, as the present implementation presupposes uninterrupted power availability from the main power supply.

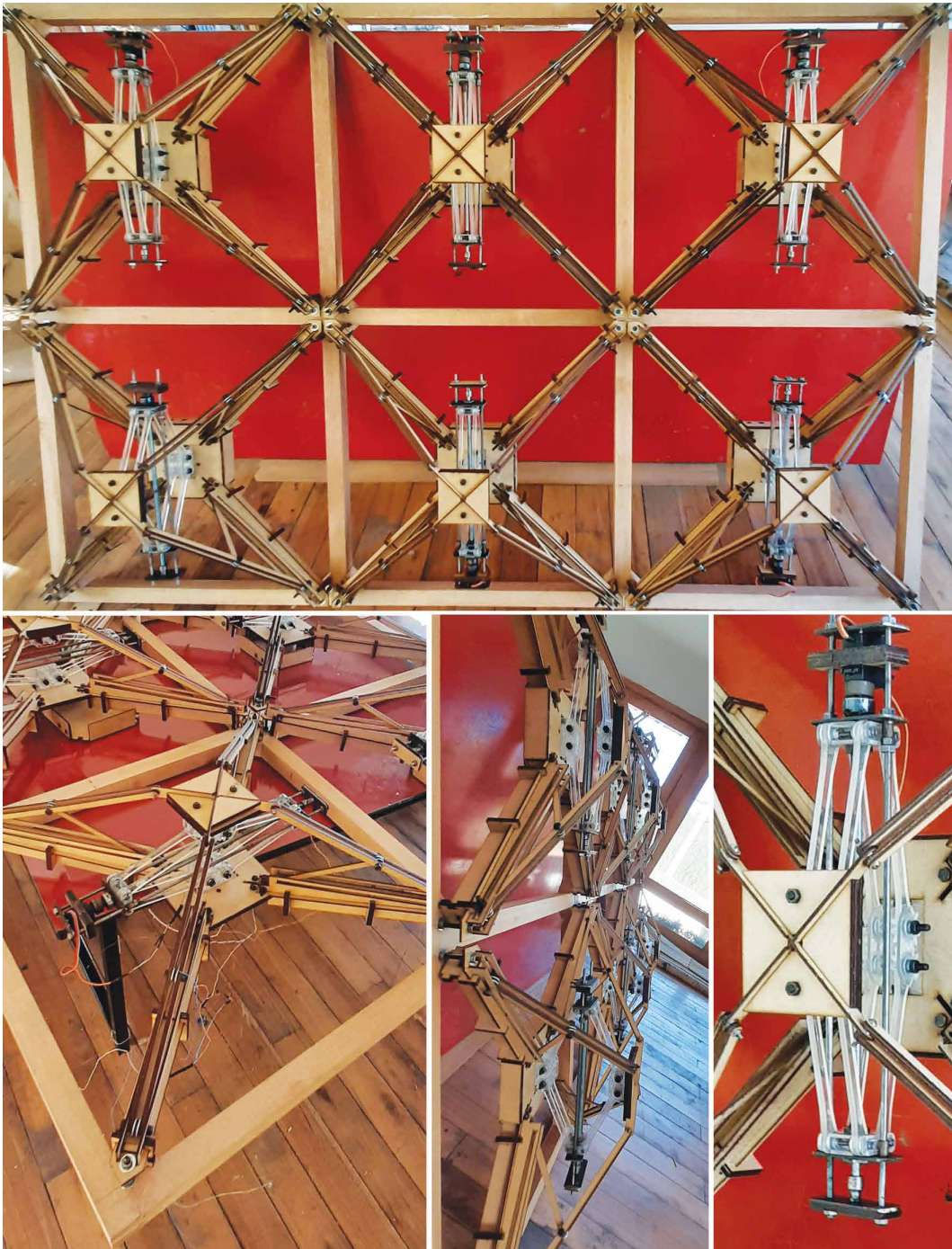

FIG. 5.49 Physical TRL-4 / 5 implementation of the six-module fragment used in laboratory tests.

5.11.3 Computational Component: Evolutionary Solver

TABLE 5.13 Absorption Coefficients (% energy absorbed)—from Pachyderm [256] Material Library.

Hz	Plaster – rough on lath (Floor)	Large ¼” Plate Glass (Pyramid Surfaces, Walls)	¾” Plywood Wall (Ceiling)	Schroeder Diffusor (Acous. Absorber)
62.5	2	25	32	18
125	2	18	28	22
250	3	6	22	24
500	4	4	17	32
1000	5	3	9	23
2000	4	2	10	19
4000	3	2	11	19
8000	2	2	13	19

As stated earlier, the computational component has two steps, where the first instructs physical modules to instantiate a particular extension / retraction configuration; and the second receives feedback and updates the model’s database. Both steps are described in greater detail below. But it is worth emphasizing first that prior to either step, the spatial and material attributes and conditions of the virtual space must be assigned and/or determined. That is, the virtual space’s (see Figure 5.45) walls, ceiling, floor, etc., must be assigned material absorption attributes (see Table 5.13). Likewise, the sound-source and -receiver must also be explicitly specified and identified. From this, the acoustic simulation software—viz., Pachyderm [256]—may be used to compute a corresponding *Energy-Time Curve* (ETC) from which a variety of acoustical parameters may be ascertained. In the present case, C_{50} is the parameter of interest, which is an objective measure of Speech Clarity (vis-à-vis C_{80} , a measure of Music Performance Clarity) measured in *decibels* (dB). C_{50} , as a Clarity Index, reflects the fact that late sound-reflections degrade the intelligibility of speech due to the merging speech sounds. Similarly, very early sound-reflections, while not detrimental *per se*, will invariably contribute to intelligibility. The time-limit before sound-reflections become detrimental is agreed to be approximately 50 milliseconds. C_{50} is calculated accordingly:

$$C_{50} = 10 \log_{10} \frac{\int_0^{50} p^2(t) dt}{\int_{50}^{\infty} p^2(t) dt} \quad (1)$$

where $p(t)$ is the impulse-response sound-pressure at time t measured from direct-sound arrival [253]. The present implementation ascertains the highest C_{50} value possible in one octave band frequency: 500 Hz—although the same methods work for other bands.

In the first step of the computational component, the evolutionary solver—i.e., Galapagos [255]—instantiates an initial set of random module extension / retraction configuration in the virtual space and their corresponding C_{50} values are derived via the calculated ETC in Pachyderm [256]. The extension / retraction extents corresponding to the highest C_{50} gathered in this random set are relayed to the MCU of each corresponding module—respectively—and instantiated in the real world. While the physical instantiation takes place, the evolutionary solver continues to gather more C_{50} values from different configurations and ranks them from highest (most optimal) to lowest (least optimal). Only when a recent value is higher than the previously instantiated are new module extension / retraction extents relayed for physical instantiation. This means that given a specific location within a space, the module configurations will continue to update almost in real time, always instantiating the most optimal value found thus far for that location. Since it is not the case that each iteration in the virtual space yields a progressively higher value, the module configuration will not be changing at each iteration. Instead, the most optimal module configuration thus far for that location will be instantiated automatically and in near real-time whenever the user steps in that location without the need of calculation—i.e., calculation takes place continuously in the background, at every iteration, but there is always a most optimal stored value corresponding to said location for fast physical instantiation.

As previously stated, the first set of module configurations is random. However, from that point onwards the extension / retraction extent of each module proceeds with evolutionary principles from information gathered from said random configurations. That is, each configuration contains an extension / retraction extent value for each module A, B, C, D, E, and F (see Figure 5.46). This set or array of values per each configuration is called a *genome*. The *fitness*—in the present case: the C_{50} value—is determined for each *genome*, and the *Fitness Volume* is populated with these values. The fittest *genomes* are bred with one another to create a subsequent iteration or generation. As Rutten [258] points out, this breeding among the fittest *genomes* is necessary as it is unlikely that the initial randomized set instantiates the most optimal solution. Prior to the breeding process, those *genomes* deemed to be unfit—via a configuration option—are discarded and only the set of best performing pass their genes to the next generation. The offspring of the first randomized generation will have *genomes* whose *fitness* is distributed somewhere between that of their parents. A caveat cum limitation: in simpler systems—say,

those with only two variables—it may be reasonable to assume that the offspring of fit parents will enjoy a relatively similar degree of fitness. However, this is not necessarily the case in the present six-variable system, where any one variable may have a negative impact over the positive selection of the whole. This *Fitness Volume* may be deemed chaotic due to its unpredictability. However, despite the individual chaos, rhyme and reason may still be derived when considering the sum average of all attained C_{50} values. That is, the *genomes* from each iteration / generation may yield *fitness* values not conforming to a discernible pattern, but the system may be said to be evolving positively if the sum average of said *fitness* values is said to be on the overall increase. In other words, the system is still evolving positively if, on average, subsequent generations are fitter than previous ones, which is the case in the present implementation (see Figure 5.51) for an expansion on this caveat with respect to limitations. Despite such potential limitations, evolutionary solvers are still considerably useful in problems that select for maximization or minimization of values. They are, for example, markedly more effective than trying all possible variable combinations in this six-variable system, which would require 64,000,000,000,000 calculations (i.e., the extension / retraction range of 200 mm of each module to the power of 6 modules).

In the second step of the computational component, after having physically instantiated a highest C_{50} value, an independent simulated receiver (also implemented with Pachyderm [256], yields a “measured” C_{50} value to compare with the model-computed value. Since the nature of acoustics is not always exact, simulated receivers may yield different C_{50} values under the same conditions. (N.B.: Even the same simulated receiver may yield a different C_{50} value if measured multiple times (see, for example, iterations # 1 and 2 in Table 5.14, where with the same module extension / retraction configurations yielded 4.67 dB vs. 4.36 dB, respectively). But said values will also not be substantially different from each other. That is to say, the nature of acoustics is compatible with margins and tolerances.) If the independent receiver’s C_{50} value is higher than that of the model’s for that particular module configuration, the model’s database is updated to reflect this independently measured value and the physical module configuration remains unchanged. If, however, the independent receiver’s value is lower than the model’s (i.e., lower than expected), then the system updates the model’s database and proceeds to look for another module configuration that is expected to be higher than the independently measured value. That is to say, suppose that a given module configuration that corresponds to the highest ranked C_{50} value is expected to ascertain 5.00 dB at a given location but instead is independently measured to yield only 4.5 dB. At this point, the 5.00 dB in the model’s database is replaced by 4.5 dB, and the system finds the second highest ranked C_{50} value and compares it to the 4.5 dB. If the second highest ranked C_{50} value is higher—say, 4.75 dB—then the

system first proceeds to instantiate the module extension / retraction configuration that corresponds it and then to classify it as the new highest ranked C_{50} value. Hence what used to be the highest ranked C_{50} value is now the second (4.5 dB) and what used to be the second is now the first (4.75 dB). If, however, the second highest ranked C_{50} value is lower than the measured 4.5 dB value—say, 4.25 dB—then 4.5 dB and its corresponding module configuration remain highest ranked and 4.24 dB remains second highest. By virtue of the ranking mechanism, it is impossible for the third highest ranked to be higher than 4.25 dB, 4.5 dB, or 4.75 dB in this example. In other words, the second step of the computational component ensures that the independently measured C_{50} values are integrated back into the model's database always in a ranked manner, where the highest ranked is always the best module extension / retraction configuration to yield the highest C_{50} value for a specific location. This two-step process repeats at every configuration instantiation that yields a C_{50} value that is higher than the previous highest ranked value.

The computation component of the system executed 3,625 iterations in the present implementation. During this cycle, a maximum C_{50} value of ~ 5.72 dB (at iteration # 784, see Table 5.14) and minimum of ~ 3.66 dB are ascertained, with the sum average of all iterations being ~ 4.58 dB. The difference between maximum and minimum is ~ 2.05 dB.

The majority of module extension / retraction configurations yielded C_{50} values between ~ 4.40 dB and ~ 4.48 dB (see Figure 5.50). This illustrates a salient advantage of implementing adaptive intelligence in the present system, as random manual operation would likely yield results in that range, which is lower than ~ 5.72 dB. At 3,625 iterations it may be observed how each variable becomes increasingly attuned to a particular extension / retraction range (see Figure 5.51, *Top*). However, as indicated by Figure 5.51, *Middle*, it is difficult to see a pattern or correlation between this attunement and the resulting C_{50} values, which seemingly seem random. Nevertheless, as indicated by Figure 5.51, *Bottom*, over time the sum average of the C_{50} values tend to increase, indicating that while individual *genomes* do not evidence positive evolution at each generation, the average of the collective does show important progress over time.

The physical modules shown in Figure 5.49 instantiated highest ranked module extension / retraction configurations as expected, only instantiating a new configuration whenever a higher C_{50} value is found or when the user moves to another specific location in the real world as accounted for in the virtual space.

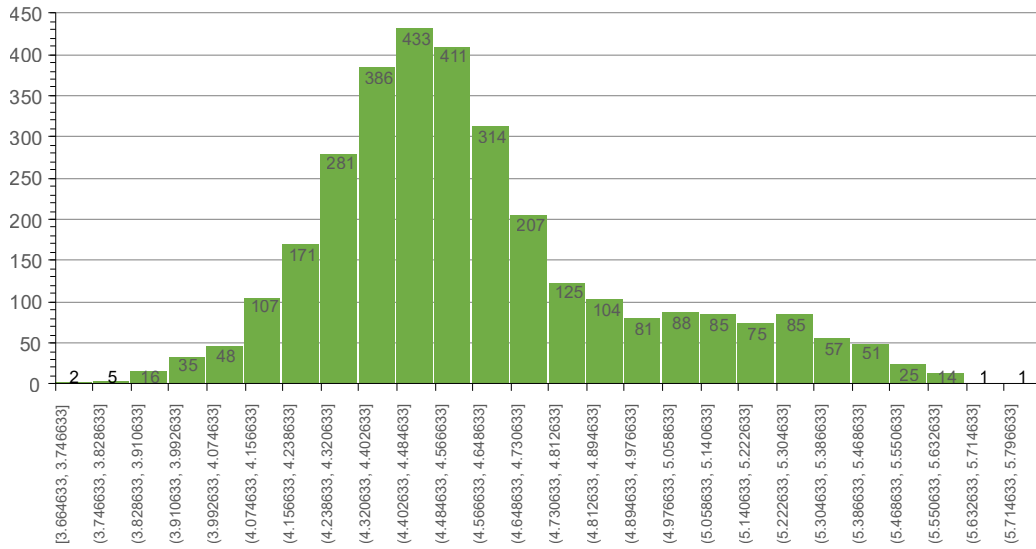

FIG. 5.50 Histogram of C_{50} values across 3,625 iterations generated in the present implementation.

TABLE 5.14 Sample module configurations and resulting C_{50} values and sum averages.

Iter.	Mod. A (mm)	Mod. B (mm)	Mod. C (mm)	Mod. D (mm)	Mod. E (mm)	Mod. F (mm)	Output C_{50} (dB)	Σ Average (dB)
1	112	259	193	135	255	246	4.670331	4.670331
2	112	259	193	135	255	246	4.362115	4.516223
-	-	-	-	-	-	-	-	-
20	132	159	85	112	187	189	3.8514	4.396181
-	-	-	-	-	-	-	-	-
784	256	230	139	213	224	206	5.715291	4.455165
-	-	-	-	-	-	-	-	-
3625	239	218	129	203	213	195	4.563596	4.581994

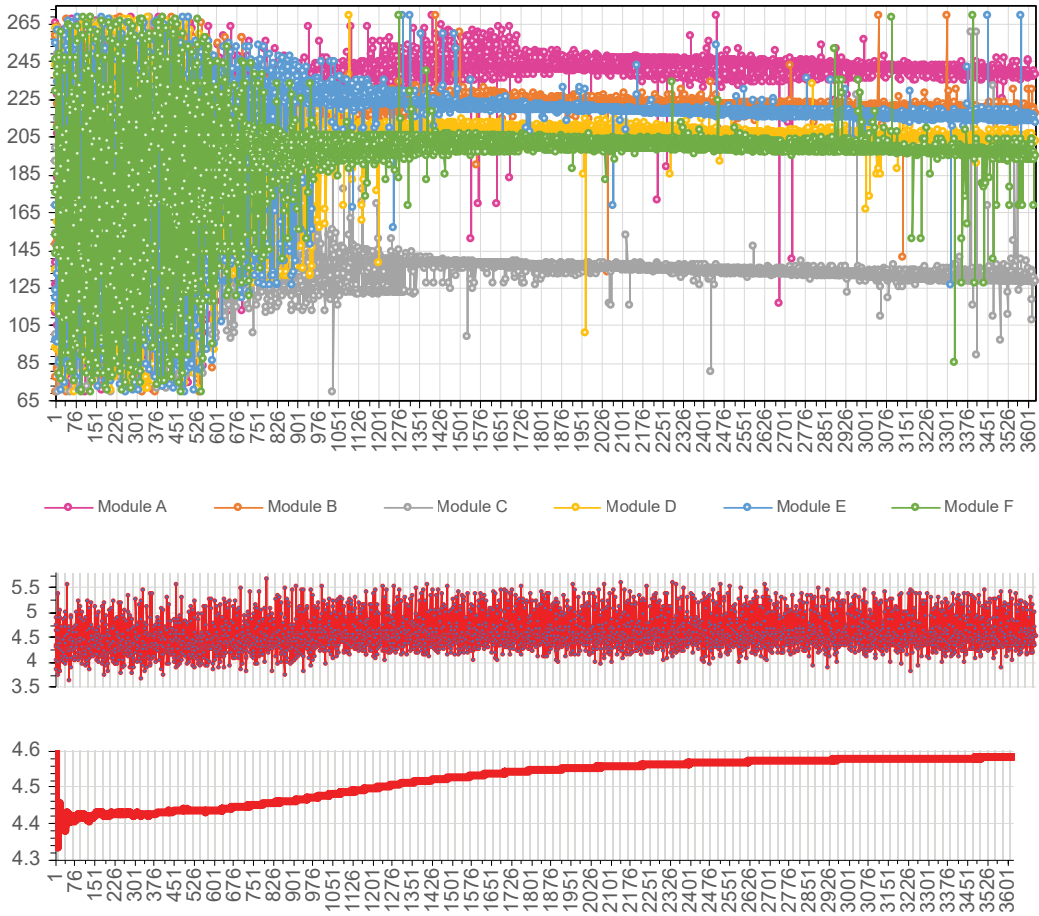













FIG. 5.51 *Top:* extension / retraction of each module with respect to each iteration. *Middle:* Corresponding C_{50} values for each genome with respect to each iteration. *Bottom:* Sum averages across all iterations.

5.12 Development of an Adaptive Rainwater-Harvesting System for Intelligent Selective Redistribution⁶⁴

TABLE 5.15 Demonstrator 12’s summary—environment, parameters, interactions, key results, purpose, and pertinence.

DEMO ENVIRONMENT				IEQ				QoL			
											
HYP	ROB	DT	ND								
INTERACTION METHODS		USER-DRIVEN		Appendix, IEQ Section 1.A				Appendix, QoL Section 1.B			
		SENSOR-DRIVEN		Appendix, IEQ Section 2.A				Appendix, QoL Section 2.B			
								19		18	
								114		19	
KEY RESULTS		<ul style="list-style-type: none"> – A <i>rainwater-harvesting</i> (RWH) system capable of automated controlled grey-water redistribution. – Integration with the local structured environment to enable remote control inside and outside of said environment. 									
PURPOSE		<ul style="list-style-type: none"> – To provide the user with an environmentally sensitive means to collect and distribute grey-water and thereby spare costs associated with non-rainwater-based water supply. 									
PERTINENCE		<ul style="list-style-type: none"> – The developed RWH system is intended to be integrated into bathrooms, irrigation systems, and general grey-water-appropriate usage. In this manner, a user need not spend potable water needlessly, nor worry about its waste in toilet functions. 									

⁶⁴ This section is based on

 A. Liu Cheng, L. Moran Silva, M. Real Buenaño, and N. Llorca Vega, “Development of an Adaptive Rainwater-Harvesting System for Intelligent Selective Redistribution,” in *Proceedings of the 4th IEEE Ecuador Technical Chapters Meeting (ETCM) 2019*, 2019. [179]

Abstract

This section presents an adaptive rainwater-harvesting (RWH) system based on a rainwater-collecting unit that (1) ascertains baseline water-quality in its collected rainwater via Ph- and turbidity sensors, and (2) redistributes it to designated toilet-tanks and/or irrigation points. Each unit is integrated with an XBee S2B antenna to enable affordable and energy-efficient mesh capabilities for inter-unit communication when two or more units conform the system. Moreover, each unit is also an Internet-of-Things (IoT) device that transmits water-tank levels and sensor-data to a local supervising microcontroller (MCU) via Open Sound Control (OSC). This MCU is, in turn, capable of communication with a cloud-based data plotting / storing and remote-control platform—viz., Adafruit IO—via Message Queueing Telemetry Transport (MQTT). The interface with Adafruit IO enables a remote administrator (a) to monitor water-tank levels and sensor readings, and (b) to execute manual overrides in the system—for example, any or all of the units may be shut-down remotely. When only one unit conforms the system, its water-tank services the toilet-tanks and/or irrigation points connected to the unit. When two or more units conform the system, their water-tank outputs are physically linked, enabling any unit to contribute to the servicing of a variety of connected toilet-tanks and/or irrigation points. In both single or multi-unit configurations, water redistribution is impartial to any end-point at initialization, yet over time the system identifies which end-point(s) require(s) water with a higher frequency and selectively prioritizes servicing to it/them to guarantee prompt refill / supply.

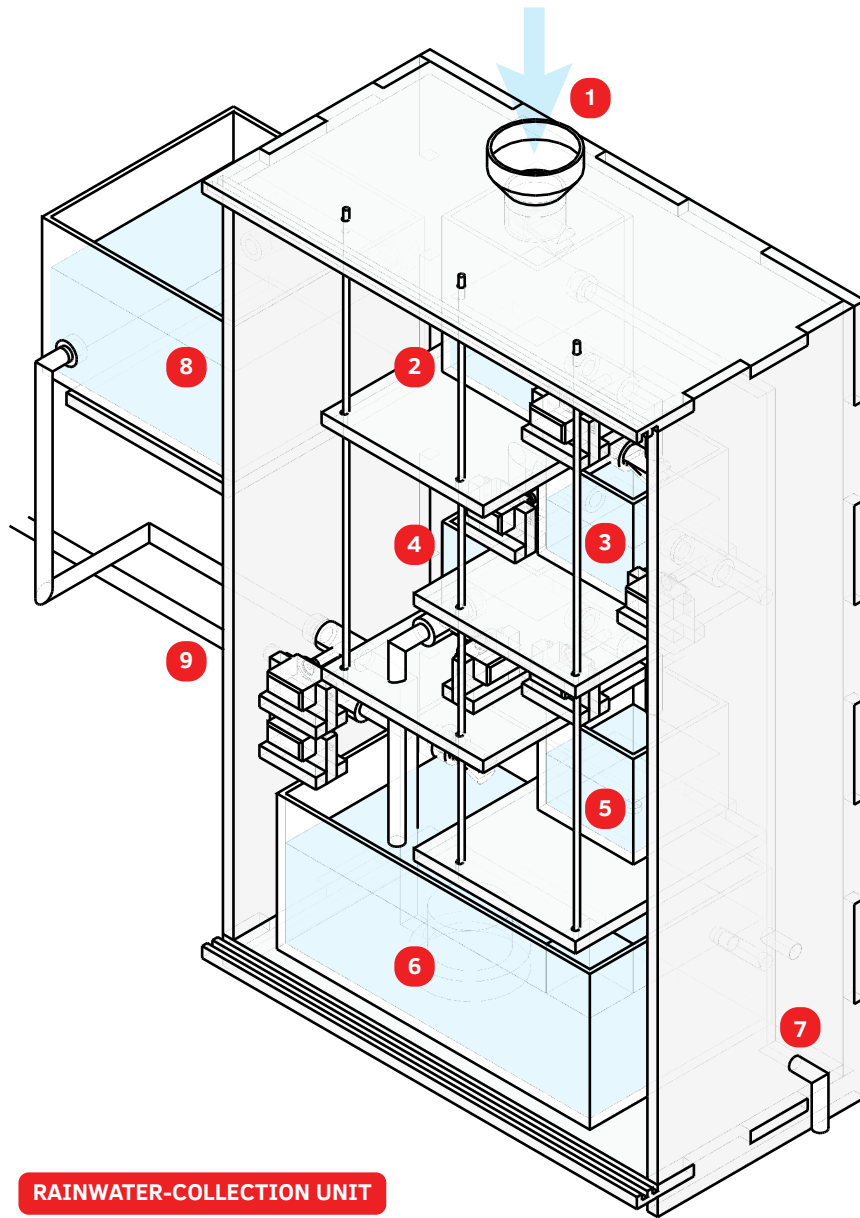

FIG. 5.52 System layers: (1) collection of rainwater; (2) 1st storage tank; (3) 2nd storage tank, measurement of Ph-levels; (4) 3rd storage tank, measurement of turbidity—if levels exceed 5 NTUs, the water is released to the main, otherwise it is passed through (5) a ceramic filter in the 4th tank (if between 3.5 – 5 NTUs), or sent directly to the (6) 5th and general collection tank (if <3.5 NTUs); (7) Outlet for all releases to the main water system; (8) 6th water tank, representing a toilet-tank; (9) if the toilet-tank is full, contained water in the 5th tank is released for irrigation.

Rainwater-harvesting (RWH) systems can play an important role in providing limited alternatives to sources dependent on conventional water treatment to meet present water requirements [259]. Their versatile character enables them to be implemented in a variety of application domains including: cleaning services [260], farming and agriculture [261], [262], and—to a limited extent—healthcare [263], etc. Incidentally, although most of its uses are non-potable, some users have explored their potable potential—for example, 25% of respondents in a survey conducted on members of the *American Rainwater Catchment Systems Association* reported to use rainwater for potable purposes [264].

The present implementation situates RWH systems within the intelligent built-environment discourse. The detailed RWH system is presented as an open-ended and highly scalable system for the intelligent selective redistribution of collected-water (with tolerable Ph and turbidity levels) to toilet-tanks and/or limited irrigation points based on the frequency of requirement. The system is a *Cyber-Physical System* (CPS) [254] composed of one or more rainwater-collecting units designed as *Internet-of-Things* (IoT) devices capable of communicating with one another (when consisting of two or more units) and with a cloud service (viz., Adafruit IO [237]) via a supervising *Microcontroller Unit* (MCU). Data pertaining to water-tank levels as well as sensor-readings from each module is streamed to said cloud service, which also enables override interventions in the system's local operation. The physical / mechanical resolution of the system is developed to a *Technology Readiness Level* (TRL) [53] of 4, while its informational / computational resolution—which is based on established *Information and Communication Technologies* (ICTs)—is developed to a TRL of 9. The RWH system represents a highly technological (in terms of ICTs) type of RWH systems, one capable of open-ended scalability; and of employing ICTs to enhance its serviceability and performance over time.

The operation of each rainwater-collecting unit in the RWH system consists of nine layers (see Figure 5.55). In the first layer, rainwater is collected via a funnel—equipped with a meshed filter to exclude visible particulates—installed directly below designated water-draining points (typically on the roof and/or on regions of walls immediately below the roof). Alternatively, and instead of the funnel, a drain-pipe connected to a protected water-catchment point may be directly connected to the unit. The water is collected into the storage tank of the second layer, which holds collected water until a minimum of one liter is obtained. In the third layer, the Ph-levels of the water are gauged, and if it is either hazardously acidic or basic, it is immediately released to the main water system. If, however, the Ph-levels are within 6 to 8.5, the water is passed to the storage tank of the next layer. In the fourth layer, the water's turbidity levels are gauged. If the water exceeds 5 *Nephelometric Turbidity Units* (NTUs), it is released to the main water system.

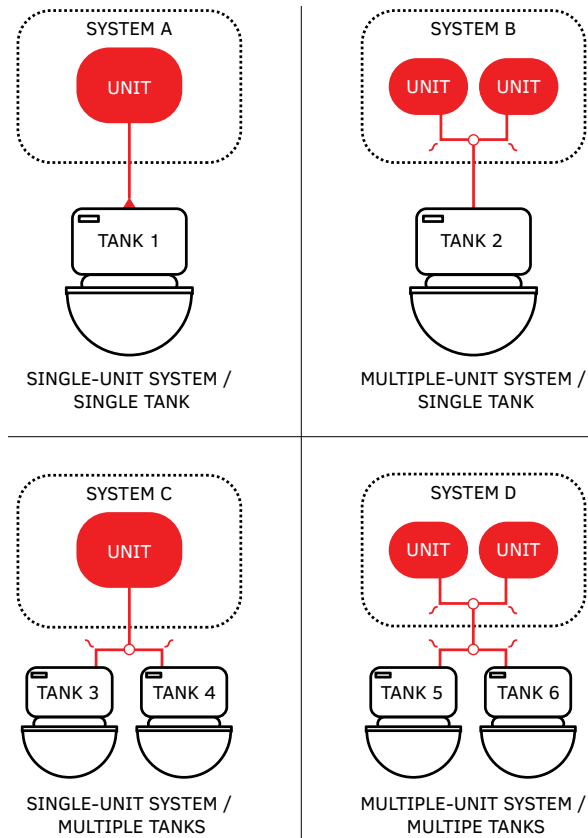

FIG. 5.53 Deployment Configurations. *Top-Left:* a single-unit system servicing a single tank. *Top-Right:* a multiple-unit system servicing a single tank. *Bottom-Left:* a single-unit system servicing multiple tanks. *Bottom-Right:* a multiple-unit system servicing multiple tanks. N.B.: ‘~’ symbol indicates location of servovalve & water-flow sensor.

If, however, it is between 3.5 to 5 NTUs, the water is passed to the fifth layer for filtering. And if turbidity levels are below 3.5 NTUs, it is passed directly to the sixth layer, bypassing the need for filtering. All collected water with non-hazardous Ph- and turbidity-levels is stored in the tank of the sixth layer, which has a maximum capacity of ten liters. A water-sensor is attached near the rim of the water tank, which informs all previous tanks to withhold passing water until levels are reduced. The tank in the sixth layer itself cannot overflow, as an outlet connected to the main water system is installed near the rim. The seventh layer is where all the connections to the main water system meet into a single outlet. The eighth layer represents the toilet-tank, although it may also represent a reserve tank additional to the toilet-tank depending on the requirements of the user. Finally, the ninth layer represents the irrigation outlet, which is optionally engaged—likewise by means of servovalves—as a release mechanism when the tanks are at full capacity.

When the system is conformed by a single unit or multiple units servicing only one toilet-tank (see Figure 5.53, *Top-Left* and *Top-Right*), no reconfiguration of parameters is required in the unit's program or electronics. In the case of a single-unit system servicing multiple toilet-tanks (see Figure 5.53, *Bottom-Left*), the outlet pipe of the ten-liter tank furcates to correspond to and connect with each toilet-tank. Immediately past the point of furcation, corresponding servovalves and water-flow sensors are attached at the root of each diverging pipe. Minor modifications to the unit's program and addition of the servomotors to the MCU must be undertaken to meet the physical configuration demands. N.B.: In the present TRL-4 physical design, each unit is capable of servicing a maximum of two ultra-low-flow toilet-tanks (~six liters per flush) in situations of simultaneous flush, provided that the storage tanks across all operation layers are full. In Figure 5.53, *Bottom-Left*, the output of the ten-liter tank of system C's unit bifurcates to connect to toilet-tanks 3 and 4, with a servovalves and water-flow sensor integrated at each furcation. The flushing of either toilet-tanks 3 or 4 (or both) is detected by the water-flow sensor—i.e., as the toilet-tank empties, a pressure differential draws water from the system. If toilet-tank 3 is to be prioritized due to a detected higher frequency of usage, then the servovalve controlling the flow to toilet-tank 4 is restricted. In the case of a multi-unit system servicing multiple toilet-tanks (see Figure 5.53, *Bottom-Right*), the ten-liter tank outlets of all units are linked into one outlet in order to instantiate a single source of collected rainwater. As in the case of a single-unit system servicing multiple toilet-tanks, the single-source outlet furcates to correspond to and connect with each toilet tank, where a servovalve and a water-flow sensor is attached at the root of each furcation. This setup also requires minor reconfigurations to the program and electronics of each unit. The same selective restriction by servovalves at the furcation of pipes enables a selective prioritization of service to a given toilet-tank.

As the RWH system is a CPS, in parallel to the above-mentioned activities, a corresponding set of activities taking place informationally / computationally are also taking place in tandem correspondence. All sensed data and water-tank levels are transmitted by each unit to a supervising MCU. Moreover, the states of all servovalves and water-flow sensors (in cases of a single-unit system or a multiple-unit system servicing multiple toilet-tanks) is also communicated to said MCU. This MCU first verifies if malfunctions have occurred—i.e., if the unit or units have deviated from expected states and ranges. If it has, the MCU shuts the system down automatically. Regardless of malfunction, all received sensor and actuator data across the system (i.e., across all units in the network) are streamed to a cloud-based data plotting / storing and remote-control platform, viz., Adafruit IO via MQTT (see Figure 5.56 for sample streamed-data plots). A remote administrator—say, the owner or care-taker of the building—is able to view the states of all sensors and actuators across all units in the deployed system. He/she can also intervene with

a manual override via MQTT to the local system. For example, suppose tank 3 in Figure 5.53, *Bottom-Left* is being selectively prioritized by the local system due to a detected high frequency of use. In such a case, the remote administrator could override this to prioritize tank 4 or to reset all priority weights to instantiate an initial state of impartial distribution. Furthermore, the setup enables the remote administrator to shut-down all units across a system during a dry period. The ability to interact with the system remotely is one of the salient characteristics of the present system, and one that may be expanded to include non-human control. For example, instead of a remote administrator deciding that a period is dry, this may be objectively determined via Dark Sky [265], which works with Adafruit IO.

5.12.1 Cyber-Physical Setup

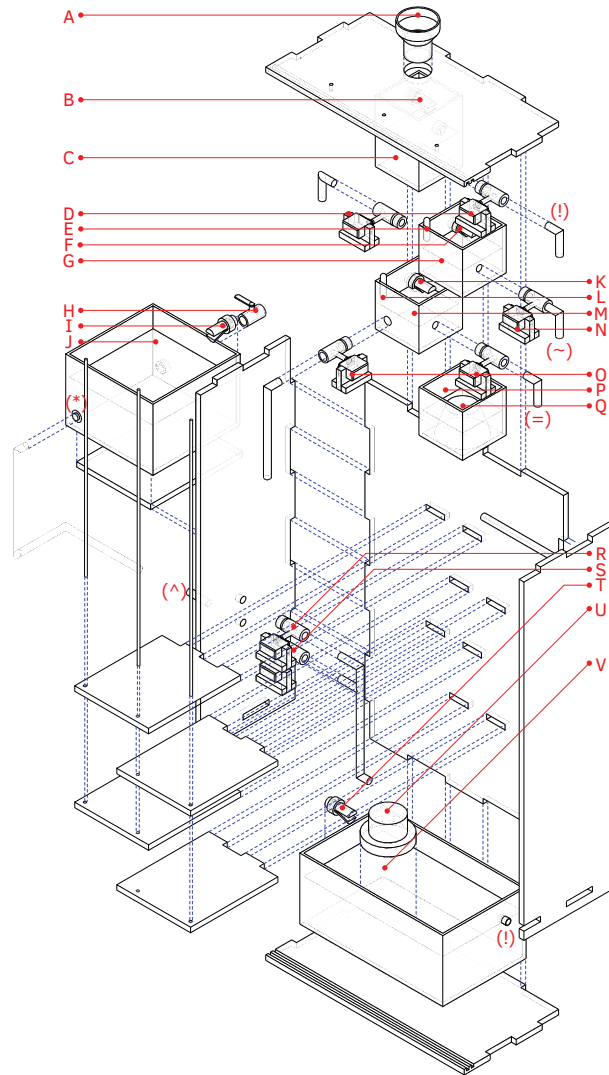

FIG. 5.54 System breakdown: (A) rainwater downpipe; (B) water-level switch; (C) 1st container, 1L capacity; (D) servovalve; (E) Ph sensor; (F) water-level switch; (G) 2nd container, 0.5L; (H) manual valve, representing flush-lever / -handle; (I) water-level switch, representing toilet tank-float; (J) 6th container, 5L, representing toilet-tank; (K) water-level switch; (L) turbidity sensor; (M) 3rd container, 0.5L; (N) servovalve (O) servovalve; (P) 4th container, 0.5L; (Q) ceramic filter; (R) servovalve; (S) servovalve; (T) water-level switch; (U) water-pump; (V) 5th container, 10L; water-sensor installed to measure levels; (!) overflow-outlet; (~) outlet to the main, for harmful Ph levels; (=) outlet to the main, for high turbidity levels; (*) intake to toilet water-tank; (^) outlet to irrigation (when toilet water-tank is full).

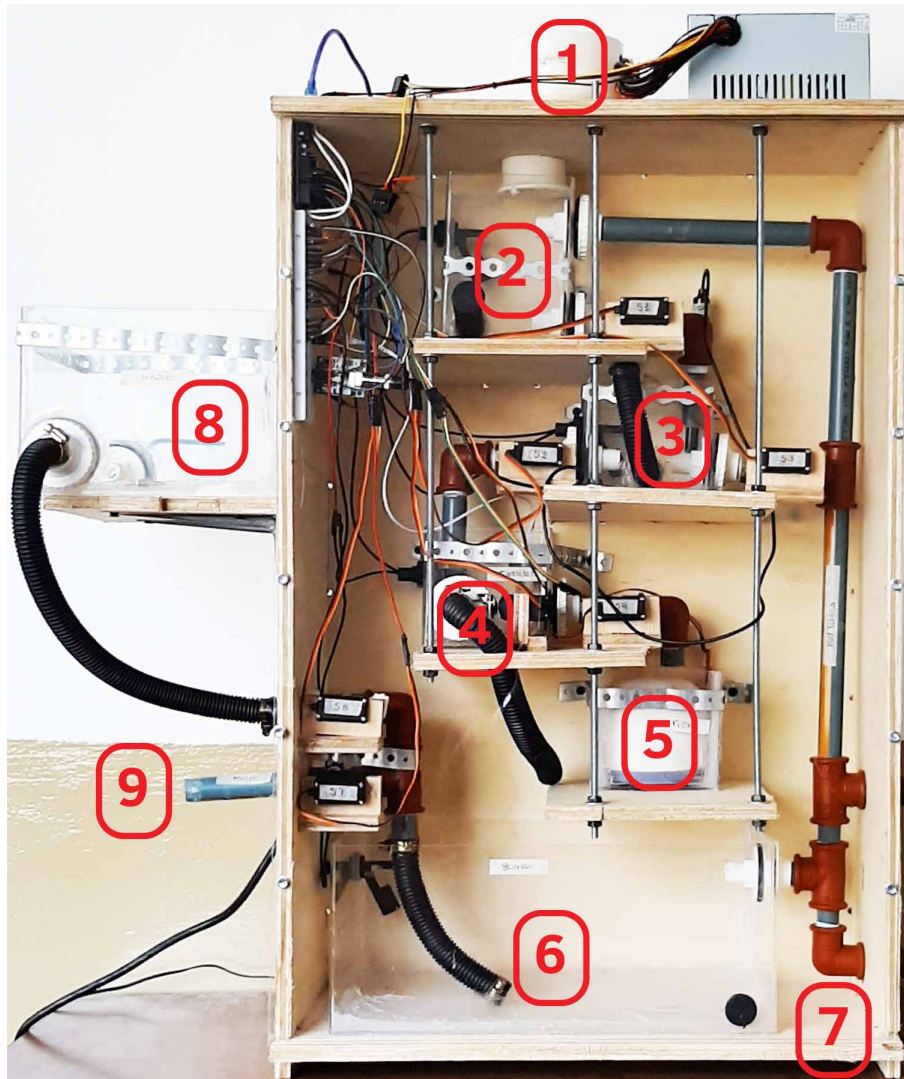

FIG. 5.55 System layers, photograph of one of two implemented prototypes.

The physical / electronic part of the system is built with three 1/4" tie-rods, six acrylic water-tight tanks, a ceramic water-filter (particular to dissolved solids), a 2" funnel, threaded hoses, and triplex wood (see Figure 5.54 and Figure 5.55).

With respect to the ICTs: each unit is integrated with an XBee S2B antenna via a shield on its MCU to enable affordable and energy-efficient mesh capabilities for inter-unit communication when two or more units conform the system. Each unit is designed as an IoT device that transmits water-tank levels, Ph- and turbidity sensor-data, servovalve states, and water-flow sensor-data to a local supervising MCU built with a WiPy 3.0 board on a PySense shield. This local transmission takes place via OSC. The supervising MCU, in turn, streams gathered data every minute to Adafruit IO via MQTT. The communication between the supervising MCU and Adafruit IO is programmed with Adafruit IO's API in MicroPython.

Once one prototype was successfully built and tested, a second instance is built in order to simulate a two-unit system servicing two toilet-tanks (see Figure 5.53, *Bottom-Right*). To undertake functionality tests, the toilet tanks are simulated virtually to gauge the behavior of the prototypes in a simpler manner. All other systems are implemented fully and functionally using commercial and/or open-source TRL-9 ICTs. Nevertheless, since the TRL of a system is determined by the TRL of the least-mature sub-system or component, the present overall implementation is at TRL 4.

The prototypes were tested in several configurations and scenarios continuously for a period of 24 hours. During this time, the local supervising MCU disconnected from Adafruit IO twice due to an exceeding of streaming frequency rates for free-accounts. This was resolved by slowing the streaming to once every minute. During this period, negligible leakage was observed in a number of servovalves, which was resolved via software by reconfiguring rotation values. Also, the ceramic filter's rate of filtration was measured to be unacceptably slow for a higher TRL development, and hence a new filter was purchased. Nevertheless, the physical / electronic part of the system performed as expected. As may be gathered by the first and top image of Figure 5.56, the transmission of sensor-data from rainwater-collecting units A and B to the supervising MCU, and then from this latter to Adafruit IO was successful. Also, as shown in the second image of the same figure, selective prioritization of toilet-tank A's levels (plotted in blue) was verified in a simulated synchronized flushing of both tanks, as toilet-tank A refills more rapidly and to a higher level than toilet-tank B. Finally, the two bottom images in Figure 5.56 show successful tracking of Ph- and turbidity sensor-values transmitted from unit A.

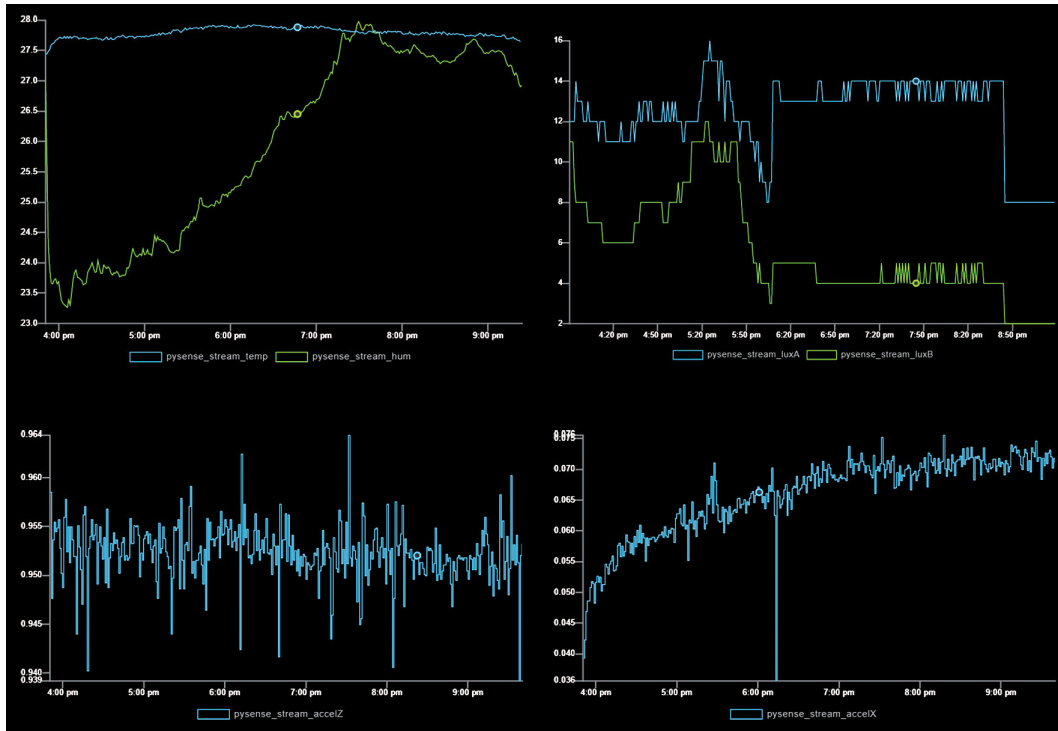

FIG. 5.56 Plotting by Adafruit IO, one-minute intervals. *Top-Left:* Toilet-tank levels A&B; *Top-Right:* Prioritizing tank A (blue); *Bottom:* Ph- and turbidity-levels, unit A.

6 Conclusions

The lack of mutual-complementarity, with respect to enabling technologies both in terms of **Information and Communication Technologies** (ICTs) as well as Architecture technologies, **within** the ICTs Technical branch and the Architectural branch prevents each from becoming a robust approach for effective intelligent built-environments. Furthermore, the lack of mutual-complementarity **between** branches prevents a cohesive merging and results in incongruent and competing intentions, objectives, enabling technologies, etc. That is to say, lack of mutual-complementarity affects these branches in an **intra** and **inter** manner. Accordingly, an alternative approach with intra-cohesion between ICTs and Architecture technologies was presented, promoted, and demonstrated via limited **proof-of-concepts**. But were the questions posed at the beginning of the thesis answered? How did the hypotheses fare? And what are the next steps? What is the outlook?

6.1 Overview and Outlook

This thesis began with a central argument: that the existing (1) *Information and Communications Technologies* (ICTs) Technical branch and (2) Architectural branch of the intelligent built-environment discourse lacked *intra*—i.e., within each branch itself—and *inter*—i.e., between branches—mutual-complementarity and hence a new approach for intelligence in the built-environment was necessary.

The first branch was broadly represented by *Ambient Intelligence* (AmI) and *Ambient Assisted Living*—or, also, *Active and Assisted Living* (AAL). AmI/AAL solutions either express themselves as *complete solutions* [32] or as discrete subsystems [19]. It was detailed that as *complete solutions* they were costly and often unnecessarily redundant, not to mention reliant on *localized* and often centralized structured environments only. Moreover, it was argued that due to their agnostic stance on architecture itself, AmI/AAL discrete solutions relied on an *effective* retrofitting strategy, where increasingly sophisticated technology was made to fit outdated methods and/or conventional architectures not made for this purpose. Hence the lack of complementarity within this branch itself. The second branch was broadly represented by *Interactive Architecture* (IA) and *Adaptive Architecture* (AA). IA/AA solutions tend to be highly experimental and/or performative in nature. It was argued—among other things—that because their main drive stems from spatial and/or experiential Architectural *affective* explorations, their ICTs tended to serve a *means-to-an-end* secondary role, often lacking in technical sophistication. Hence the lack of complementarity within this branch itself as well. It was then argued that though a first intuition would be to merge the Technically predominant AmI/AAL with the Architecturally predominant IA/AA, that such an endeavor would be misguided because they would not complement each other but rather yield an incongruent approach—a *chimera* with competing intentions, objectives, enabling technologies, etc.

Forced-merging would not do. Instead, a new approach was proposed, and one that conceived of the built-environment as a highly integrated and deliberate *Cyber-Physical System* (CPS), where the *cyber* and *physical* parts *in conjunction* defined the behavior of the systems [106]. That is to say, the *cyber* would not be secondary to the *physical*, nor the *physical* secondary to the *cyber*. This required a consideration of both parts from the early stages of the Architectural Design process (see Figure 3.1), which would enable an intimate interweaving of both parts when considering the types of services and features to be instantiated.

To demonstrate the feasibility of the presented approach, a series of demonstrator implementations were developed for a specific use-case and target-audience—i.e., smart homes for the elderly. This was a *proof-of-concept* application of the approach whose results would be indicative of its potential for other use-cases and target-audiences. That is, the development of smart assistive solutions—as indicative of solutions that may be expected in a smart home for the elderly—was part of the specific scope of the thesis, and one whose results would speak of its potential—in the broader general scope—as a robust alternative in the intelligent built-environment discourse. Twelve demonstrators were designed, developed, and tested (see Chapter 5) within an open and scalable CPS ecosystem (see Chapter 3). Each—with the exception of the second prototype of the solution presented in Section 5.7.2—were presented in peer-reviewed Conference Proceedings, Journals, and/or Book Chapters, to demonstrate and to validate the feasibility and promise of the presented approach.

The robust development of intelligent built-environments is a pressing matter. From a societal point-of-view, public and private healthcare providers would be alleviated from unnecessary and premature cases of patients whose ailments were exacerbated by sedentary lifestyles. For example, according to Espinoza, the *Organization for Economic Cooperation and Development* (OECD) predicts that the health expenditure in the EU alone is expected to rise by 350% by the year 2050 compared to an economic expansion of only 180% [266]. This reality alone, even without considerations at the individual level, is sufficient to motivate the discourse. While intelligent built-environments bear potential benefits for all age-groups, foreseeable early adopters in the near future are likely to include people with early symptoms related to metabolic syndrome, which—if left untreated—may lead to more serious secondary diseases [267] such as heart attacks, cognitive impairment [268], and even vascular dementia [269]. These diseases are more common among the elderly, which represent the most vulnerable segment of society and, as such, were the target-audience of the proof-of-concept demonstrators in this thesis.

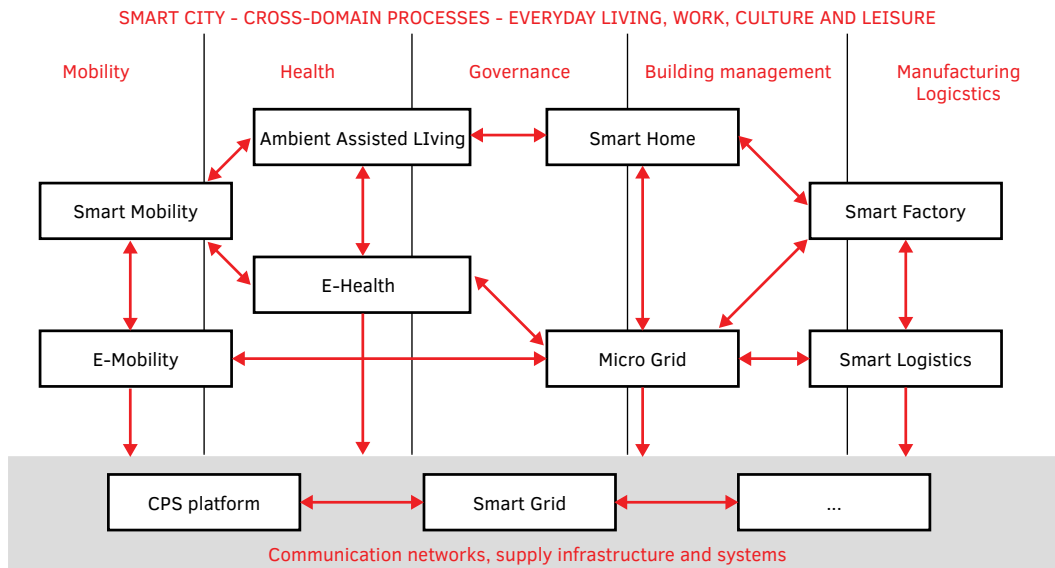

FIG. 6.1 Interconnected CPS application areas and global application processes (figure reformatted and redrawn from Figure 2.1 in [84]).

The solutions presented as applications of the promoted approach were conceived, designed, and implemented in such a way as to sustain a new kind of artificial ecosystem, where the environment's components are self-sustaining, and where their development, adaptation, and evolution occur in symbiosis with their corresponding users [270]. In more sophisticated demonstrators of the present approach, architectural components could begin to demonstrate basic yet explicit forms of agency based on and in response to processed user as well as environmental data [271]. The fundamentally and analytically intelligent built-environment effortlessly facilitates an immediate and intimate version of what Oosterhuis has described as a *Society of Building Components*, where the environment's components act and react computationally (i.e., exchange data) and physically (i.e., change forms, within limits) towards one another and towards the users [231]. A caveat: it should be noted that Architecture under this approach need not involve, necessarily, complex physical geometries and transformations. As Kolarevic notes, an architecture that adapts may not necessarily involve highly sophisticated technology only, as a judicious balance between “low-tech” and “hi-tech” may prove more effective [51]. This consideration motivates the pursuit of simpler physical designs, where the same services may be instantiated with fewer mechanical components. This does not limit the computational features of the system but rather emphasizes the requirement of rendering them more seamless and intuitive, where user-engagement and -participation is effortless.

Viewed as CPSs, intelligent built-environments enter fertile context. The [German] *National Academy of Science and Engineering (Deutsche Akademie der Technikwissenschaften*, i.e., acatech)'s 2015 study on the national interest in *Cyber-Physical Systems* (CPSs) identified CPSs as enablers of “system landscapes and socio—technical systems with applications are not only innovative but genuinely revolutionary” [84]—*p. 13*. This study envisions future applications as well as use-case scenarios as no longer developing in isolation but rather within a global context of interactions, interconnections, and interdependencies. “These interactions will be so extensive that a lack of certain developments in one scenario could result in neighboring scenarios being unable to create the conditions needed for them to maximize their potential” [84]—*p. 33*.

This means that intelligent built-environments as CPSs have the potential to become a system within a system in a larger interconnected network, which promises to deliver potential new services and features capable of enhancing our well-being and quality of life.

6.2 Limitations

The demonstrators presented in Chapter are, admittedly, a seemingly varied set. They are only twelve of *many* possible expressions of systems and services reasonably anticipated to be present in *intelligent built-environments* as *Cyber-Physical Systems*. Nevertheless, they are twelve possible expressions joined by common motivations and threads—i.e., *Indoor Environmental Quality* (IEQ) and *Quality-of-Life* (QoL) core considerations—and which, in conjunction, demonstrate the feasibility and advantage of the approach promoted in this thesis. Their resolution is kept prototypical and limited to their self-contained scopes and scales, yet their expressed services cohere—though sometimes even overlap—one another's. While they—in their fragmentary physical implementation—are not intended to be discrete parts of a larger physical whole, their expressed services may indeed be taken as part of a single whole. This thought deserves expansion:

Twelve demonstrators are implemented across two main types of environments, one physical (with four expressions—see Section 4.1) and one virtual (with two expressions—see Section 4.2). These environments do not add up to a single whole, being different in nature across types (i.e., physical vs. virtual) as well as in the character within types (e.g., Physical: *dynamic* transformable architecture vs. *static* robotically fabricated, ICTs-embedded, components). Unless otherwise noted, there is no intentional physico-spatial relationship or continuity between the environments within which each demonstrator is expressed, as their fragmentary nature intends to illustrate feasibility and variety of deployment environments. As noted throughout this thesis, the fragmentary character is an invariable necessity given limited funding and other material resources. Accordingly, fragments are developed to a scale and scope necessary to prove a set of concepts. Nevertheless, these concepts—and their expressed systems and services—are compatible and may be construed as part of a single hypothetical whole. For example, while it is evidently the case that the transformable staircase in Section 5.10 is architecturally different from the robotically fabricated and ICTs-embedded components in Section 5.4, it is yet not difficult to imagine both solutions instantiated in some other architecturally redesigned whole. The same applies to, say, the acoustically adaptive modules in Section 5.11 and the rainwater-harvesting system in Section 5.12. That is, the rainwater-harvesting system as expressed here is architecture-design-agnostic, while the acoustically adaptive modules do have a modular design-language (i.e., pyramidal, extruding and/or collapsing perpendicular to its base).

Yet it may be conceived that in a more considered—and less budgetarily constrained—expression, both solutions may be instantiated in the same building-structure. As all systems and services are motivated by the same IEQ and QoL core considerations, they are compatible and combinable as a single set of coherent solutions that promote well-being and ascertain a baseline quality of life.

The systems and services presented (via however limited demonstrators)—all presently enabled via promoted methods such as robotic fabrication, modular componentiality, etc.—meet the envisioned *desiderata* for intelligent built-environments as anticipated by theoretical precursors such as Zelkha et al.'s *digital living room* [8], Price's *Generator* project [11], and the Frazer's interactive systems [46], [47] (see *Introduction* chapter, Section 1.1). That is to say, the *intelligent built-environment* as CPS provides an alternative answer and approach to both the ICTs-technical and Architectural branches of the intelligence discourse *without* force-merging them.

Appendix

Demonstrator Interaction Methodologies

This appendix details the **Interaction Methodologies** of the developed solutions presented in Chapter 5 and that unfold within the environments presented in Chapter 4. Actions, reactions, and interactions mediate the relationship between the occupant(s) and the intelligent built-environment. They may be initiated and/or sustained by the user or/and the built-environment as both a preemptive or **post-hoc** response to environmental phenomena as well as physical events.

In this work four *Indoor Environmental Quality* (IEQ) (see Section 3.2.1)—Thermal Comfort, Light / Illumination, Air-Quality, and Sound / Acoustics—and four *Quality of Life* (QoL) (see Section 3.2.2) parameters—Health, Independence, Activity, and Safety & Security—informed the design of the systems subsumed by a prototype-expression of the intelligent built-environment as *Cyber-Physical System* (CPS). These systems and their services were deliberately conceived to act towards, react to, and interact with the user(s) of said built-environment in a way that would instantiate what Oosterhuis called a *Society of Home*, where human and non-human objects / products endowed with a fair degree of sophisticated intelligence communicate with one another—thereby instantiating a home of *Internet of Things and People* as well as a *Society of Building Components*, where the environment's components act and react informationally and physically towards one another and towards the users [231].

Two basic forms of interaction may be found in such a home: (1) User-driven Interaction and a (2) Sensor- / System-driven Interaction, which are discussed in relation to IEQ and QoL parameters in the following sections. The brief descriptions are intended as a descriptive catalogue of actions in relation to motivating parameters.

1 User-driven Action/Interaction (Manual Intervention)

A With respect to IEQ

The occupant of the intelligent built-environment may ...

THERMAL COMFORT



- 1 **Control** ventilation regulation by overriding automatic operation via a custom-made wearable device. (See Section 5.3 for a corresponding demonstrator.)
- 2 **Open** or **shut** windows and doors via a wearable smart-sleeve mechanism by pointing towards the window in question and gesturing the desired action by a swing (i.e., up/down for windows; right/left for doors). (See Section 5.5.)
- 3 **Control** natural ventilation by (1) directly specifying aperture values (via an app's graphical slider on a smart-device); (2) approximate aperture values gauged by gyroscopic information by tilting or rotating the same smart-device; and (3) remote controlling said aperture values online via Message Queuing Telemetry Transport (MQTT) and a third-party service such as Adafruit IO. (See Section 5.7.)

AIR-QUALITY

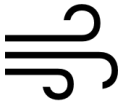

- 1 **Engage** artificial ventilation by overriding automatic operation. (See Section 5.2.)
- 2 **Override** automatic ventilation regulation via a custom wearable device. (See Section 5.3.)
- 3 **Open** or **shut** windows by pointing towards specific ones with a wearable smart-sleeve, clenching the corresponding fist to confirm selection, and gesturing a slide up or down to open or shut, respectively. (See Section 5.5.)
- 4 **Control** façade apertures designed to regulate natural ventilation (see Figure 5.28, *Middle*) (1) via an app in a smart-device; or (2) by approximating aperture extents as gauged by gyroscopic information gathered by the same smart-device; or (3) through remote intervention via MQTT. (See Section 5.7.)
- 5 **Confirm** or **override** an increase or decrease in aperture-levels for increased ventilation in façade modules via facial-expression-based reaction-recognition (Section 5.8, scenario 1.)

SOUND / ACOUSTICS



- 1 **Override** architectural transformations that may adversely change acoustic qualities of the space. (See Section 5.1, peripheral consequence of scenario 1.)
- 2 **Engage** with via Amazon®'s Alexa Voice Service™ (AVS) to play music, change illumination and/or ventilation preferences via voice-commands. (See Section 5.2.)
- 3 **Change** the acoustic quality of the space by pointing towards architecture-embedded transformable systems or furniture via a wearable smart-sleeve, clenching the corresponding fist to confirm selection, and gesturing for a given transformation.⁶⁵ (See Section 5.5.)

>>>

⁶⁵ While the demonstrator in Section 5.5 only details how the smart-sleeve may be used to open/shut windows and doors; increase/decrease artificial illumination levels, the actual implementation included a simulation of moving furniture (notice the green 'bean-bag' on the floor in Figure 5.14 - Figure 5.16). The principle was the same: use the smart-sleeve to point, select, and actuate, and it may be imagined that other physical transformations that affect the acoustical quality of the space may be instantiated as well. Even excluding possible architecture-embedded transformable systems or furniture, the mere opening of doors and windows will affect the acoustics of the space.



- 1 **Override** architectural transformations that may block sources of illumination. (See Section 5.1, peripheral consequence of scenario 1.⁶⁶)
- 2 **Activate** artificial illumination via tactile interaction of wall / ceiling / floor modules (see Figure 4.2 and Figure 5.3) or by overriding automatic operation via smart-device applications (see Figure 5.4). (See Section 5.2, predetermined scenarios.)
- 3 **Correct** an automatically regulated illumination level—an act that becomes a “correction” input fed back into the mechanism’s training-model. (See Section 5.2, non-predetermined scenario.)
- 4 **Override** automatic illumination regulation via a custom-made wearable device. (See Section 5.3.)
- 5 **Increase** or **decrease** the intensity of artificial illumination by pointing towards specific sources with a wearable smart-sleeve, clenching the corresponding fist to confirm selection, and gesturing left or right to decrease or increase intensity respectively. (See Section 5.5.)
- 6 **Direct** façade modules to draw natural light towards or away from a given location as configured via hand-gesture recognition (See Section 5.6.)
- 7 **Control** façade apertures designed to regulate natural illumination (see Figure 5.28, *Top*) (1) via an app in a smart-device; or (2) by approximating aperture extents as gauged by gyroscopic information gathered by the same smart-device; or (3) through remote intervention via MQTT. (See Section 5.7.)

⁶⁶ In the first scenario of Section 5.1’s development, the user is tacitly encouraged to change posture by a slight shifting by the architecture-embedded desk and seat. However, and as a consequence of the design of the transformable prototype (see Figure 4.1), this shifting would gradually block a source of natural illumination. To avoid this, the user may override the shifting by simply resisting it.

B With respect to QoL

The occupant of the intelligent built-environment may ...

HEALTH



- 1 **Engage** with architecture-enabled exercise components. Some exercises may be designed for physical stimulation while others for mental and yet while others for both. While the instantiation of said 'exercise' components is automated, the duration of their use may be extended by the will of the user (See Section 5.1, scenario 2.)
- 2 **Command** desired artificial ventilation-levels via voice-control. Ventilation in the adaptive stage may also be engaged with for comfort via AVS. (See Section 5.2.)
- 3 **Set** ventilation and illumination levels via a wearable. The wearable detects the air-quality of a user's personal space and enables him/her to engage architecture-embedded ventilation systems. Moreover, depending on temperature and humidity levels, the user may similarly engage ventilation. Finally, automatic illumination may also be overridden to user-preferences. (See Section 5.3.)
- 4 **Control** actuable objects and lights via simply pointing and gesturing. Via a wearable such as a smart-sleeve, a user may engage actuators in its built-environment by pointing and gesturing. For example, a user may point at a door, contract his/her fist to confirm selection, and then make a swing open/shut gesture to cause the physical door to actually open or shut. The same principle, only with a different physical gesture, may be used to indicate a desire to increase or decrease illumination. (See Section 5.5.)
- 5 **Draw** light to or away from specific locations via hand-gestures. (See Section 5.6.)
- 6 **Determine** preferred levels of natural illumination and ventilation. The user may engage façade apertures designed to regulate natural illumination and ventilation (see Figure 5.28, *Top and Middle*). (See Section 5.7.)
- 7 **Confirm** or **negate** desired / undesired façade actuators. Facial identity and expression recognition may be used to confirm or negate reactions in the built-environment, enabling the user to engage his/her built-environment in a more tacit manner. For example, if the user shows signs of displeasure in response to some automated actuation (e.g., increase in aperture for increased ventilation in the façade modules), said actuation may be mitigated / cancelled. (See Section 5.8, scenario 1.)
- 8 **Engage** with objects with a glance, and get assistance with people-recognition. Eye- and gaze-tracking is used to actuate / activate objects (i.e., open, shut, slide, turn on or off) as well as to extract information from faces viewed by the user (See Section 5.9.)
- 9 **Control** where grey-water from rainwater-harvesting-units is allocated. Each IoT-unit may be monitored and controlled remotely via MQTT. (See Section 5.12.)

INDEPENDENCE



- 1 **Exercise** with architecture-integrated components to promote physical health. (See Section 5.1, scenario 2.)
- 2 **Regulate** ventilation and illumination levels via a wearable. (See Section 5.3.)
- 3 **Control** actuable objects and lights via simply pointing and gesturing. (See Section 5.5.)
- 4 **Draw** light to or away from specific locations via hand-gestures. (See Section 5.6.)
- 5 **Decide** how a space is ventilated and/or illuminated (1) via a graphical slider on app in some smart-device; (2) by approximating aperture values gauged by gyroscopic information; or (3) through a remote interface. (See Section 5.7.)
- 6 **Confirm** or **override** desired / undesired façade actuators. (See Section 5.8, scenario 1.)
- 7 **Engage** with objects with a glance, and get assistance with people-recognition. (See Section 5.9.)
- 8 **Control** where grey-water from rainwater-harvesting-units is allocated. (See Section 5.12.)

>>>

SAFETY / SECURITY



- 1 **Set** ventilation and illumination levels via a wearable. (See Section 5.3.)
- 2 **Actuate** objects and lights via simply pointing and gesturing. (See Section 5.5.)
- 3 **Determine** preferred levels of natural illumination and ventilation. (See Section 5.7.)
- 4 **Confirm** or override desired / undesired façade actuations. (See Section 5.8, scenario 1.)
- 5 **Engage** with objects with a glance, and get assistance with people-recognition. (See Section 5.9.)

ACTIVITY



- 1 **Set** ventilation and illumination levels via a wearable. (See Section 5.3.)
- 2 **Actuate** objects and lights via simply pointing and gesturing. (See Section 5.5.)

2 Sensor- / System-driven Action/Interaction (Automatic Operation)

A With respect to IEQ

The intelligent built-environment automatically and continuously ...

THERMAL COMFORT



- 1 **Regulates** cooling, heating, and general artificial ventilation according to established comfort standards. (See Section 5.3.)
- 2 **Regulates** natural ventilation to ascertain comfortable interior temperatures as well as air-quality. (See Section 5.7.)

AIR-QUALITY



- 1 **Regulates** a local and global ventilation system. (See Section 5.2.)
- 2 **Regulates** cooling, heating, and general artificial ventilation according to established comfort standards. (See Section 5.3.)
- 3 **Maintains** optimal ventilation via building-skin components capable of controlling apertures. (See Section 5.7.)
- 4 **Regulates** automated actuations to increase ventilation via the façade modules. (See Section 5.8, scenario 1.)

SOUND / ACOUSTICS



- 1 **Ascertains** speech clarity—with respect to the C_{50} Clarity Index—in a given location in a predetermined space. The acoustic qualities of an environment rely on the physical geometries of the space. By making these geometries adaptable, a mechanism based on genetic algorithms learns to adjust to proper configurations. (See Section 5.11.)

LIGHT / ILLUMINATION



- 1 **Recognizes** what kinds of activities the user is engaging in via a Machine-Learning-based Human Activity Recognition (ML-based HAR) mechanism. In the demonstrator's adaptive stage, the physical activities of the user may trigger changes in illumination on the one hand, but also vice versa on the other hand—for example to let the user know his speaking time is almost up. (See Section 5.2, predetermined scenarios.)
- 2 **Detects** and **mitigates** fatigue by correlating HAR with eye-aperture levels [201]. The ML mechanism ascertains correlations between illumination (colors and their intensities) with mood and fatigue and to regulate the former in order to mitigate the latter. As with the predetermined scenario, a manual override may be used to explicitly 'correct' an automatically regulated illumination level, and this correction may be used by the mechanism's training-model. (See Section 5.2, non-predetermined scenario.)
- 3 **Regulates** general illumination (inherited mechanism) according to established comfort standards. (See Section 5.3.)
- 4 **Maintains** optimal illumination via building-skin components capable of controlling apertures. (See Section 5.7.)

B With respect to QoL

The intelligent built-environment automatically and continuously ...



- 1 **Mitigates** physical inactivity via transformations in the built-environment (including intelligent furniture) that encourage the user to shift their weight and/or to exercise their lower extremities. (See Section 5.1, scenario 1.)
- 2 **Engages** the user with architecture-enabled exercising components. (See Section 5.1, scenario 2.)
- 3 **Maintains** physiological data-tracking outside of the structured environment via a wearable device (Fitbit®'s Charge HR™). This information is uploaded to the cloud by the wearable and accessed by the home environment's devices. In this manner, the home environment is aware of activity levels taking place outside it. This information in conjunction with location-tracking services such as GPS may be used to regulate the home environment's IEQ ahead of the user's arrival. So, for instance, if the user is detected to be arriving to the home with elevated heart-rate and body temperature, home systems may configure to instantiate a highly ventilated environment, etc. (See Section 5.1, Scenario 3.)
- 4 **Engages** in playful activity. The "cells" in the adaptive stage demonstrator shift colors and intensities via tactile interaction (by the presenter on-stage) as well as body-gestures (by the audience during intermissions). Both phenomena encourage physical activity through playfulness. (See Section 5.2, predetermined scenario.)
- 5 **Detects** and mitigates fatigue by correlating HAR with eye-aperture levels and regulating artificial illumination (colors and their intensities) to improve general mood. (See Section 5.2, non-predetermined scenario.)
- 6 **Regulates** local and global ventilation according to prescribed comfort and air-quality standards. (See Section 5.2.2.)
- 7 **Regulates** cooling, heating, and general artificial ventilation as well as natural illumination. (See Section 5.3.)
- 8 **Detects** and intervenes in events of accidental falls via object-recognition based on *Convolutional Neural Networks* (CNNs). The size of the collapsed object in a given space is correlated with data gathered by cameras integrated in other spaces, the user's wearables, and other associated smart-devices to increase the event's detection's confidence level. (See Section 5.4, human-centered event.) Similarly, the same cameras used in object-recognition may also be used to detect non-human objects and (a) to send a robotic agent to retrieve it (if within a certain size) and/or (b) to trigger visual / aural notifications to make the user aware of this object. In this second case, SMS and email notifications are also sent if the potentially hazardous object is not retrieved. In cases of the visually and/or aurally impaired, vibrations in specific locations may be instantiated as the means of notification. (See Section 5.4, object-centered events.)
- 9 **Maintains** optimal illumination and ventilation via building-skin components capable of controlling apertures. (See Section 5.7.)
- 10 **Regulates** ventilation and illumination apertures, which may be overridden via recognized facial-expressions from the user(s). (See Section 5.8, scenario 1.)
- 11 **Detects** person-specific fall-detection events and notifies particular parties accordingly. The identity of the fallen person is ascertained as well as his/her general state inferred from facial expressions of pain and/or displeasure via integrated cameras. SMS and email notifications may be sent to specific family-members or care-takers. (See Section 5.8, scenario 2.)
- 12 **Adjusts** transforming staircases to accommodate (1) a person without perceivable physical disabilities, (2) one reliant on a walking-cane, and (3) another on a wheelchair. This accommodation is triggered by facial-, object-, and voice-recognition to instantiate appropriate adaptations as needed. (See Section 5.10.)
- 13 **Ascertains** speech clarity—with respect to the C_{50} Clarity Index—in a given location in a predetermined space. (See Section 5.11.)
- 14 **Determines** baseline rainwater-quality (via Ph- and turbidity-levels) as well as collects and redistributes it to toilet-tanks and/or irrigation points. Several units in conjunction may work to prioritize toilet-tanks that go through more frequent flushes. (See Section 5.12.)

>>>

INDEPENDENCE



- 1 **Mitigates** physical inactivity to prevent (1) decubitus ulcers and to control the appearance and/or exacerbation of (2) varicose veins via physical transformations in the built-environment (including intelligent furniture). (See Section 5.1, scenario 1.)
- 2 **Engages** the user with architecture-enabled exercising components. (See Section 5.1, scenario 2.)
- 3 **Regulates** cooling, heating, and general artificial ventilation as well as natural illumination. (See Section 5.3.)
- 4 **Detects** and intervenes in events of accidental falls via object-recognition based on CNNs. (See Section 5.4, human-centered event.)
- 5 **Maintains** optimal illumination and ventilation via building-skin components capable of controlling apertures. (See Section 5.7.)
- 6 **Recognizes** and displays identity information to smart glasses to assist the wearer in recognizing the viewed individual. (See Section 5.9.)
- 7 **Adjusts** transforming staircases to accommodate (1) a person without perceivable physical disabilities, (2) one reliant on a walking-cage, and (3) another on a wheelchair. (See Section 5.10.)
- 8 **Ascertains** speech clarity—with respect to the C_{50} Clarity Index—in a given location in a predetermined space. (See Section 5.11.)
- 9 **Determines** baseline rainwater-quality (via Ph- and turbidity-levels) as well as collects and redistributes it to toilet-tanks and/or irrigation points. (See Section 5.12.)

SAFETY / SECURITY



- 1 **Regulates** cooling, heating, and ventilation as well as natural illumination. (See Section 5.3.)
- 2 **Detects** and **intervenes** in events of accidental falls via object-recognition based on CNNs. Similarly, the same cameras used in object-recognition may also be used to detect non-human objects and (a) to send a robotic agent to retrieve it (if within a certain size) and/or (b) to trigger visual / aural notifications to make the user aware of this object. (See Section 5.4.)
- 3 **Maintains** optimal illumination and ventilation via building-skin components capable of controlling apertures. (See Section 5.7.)
- 4 **Regulates** ventilation and illumination apertures, which may be overridden via recognized facial-expressions from the user(s). (See Section 5.8, scenario 1.)
- 5 **Detects** person-specific fall-detection events and notifies particular parties accordingly. SMS and email notifications may be sent to specific family-members or care-takers. (See Section 5.8, scenario 2.)
- 6 **Recognizes** and **displays** identity information to smart glasses to assist the wearer in recognizing the viewed individual. (See Section 5.9.)
- 7 **Adjusts** transforming staircases to accommodate people with limited walking capabilities as well as those in wheelchairs. (See Section 5.10.)

ACTIVITY



- 1 **Regulates** cooling, heating, and ventilation as well as natural illumination. (See Section 5.3.)
- 2 **Adjusts** transforming staircases to encourage people with limited walking capabilities to climb stairs independently by transforming into low-rise, wide-run stairs. This may be used for rehabilitation purposes as well. (See Section 5.10.)

Bibliography

- [1] P. Cook, *Experimental architecture*. New York: Universe Books, 1970.
- [2] P. Cook, *Archigram*. London: Studio Vista, 1972.
- [3] C. M. Eastman, *Adaptive conditional architecture*. Pittsburgh: Institute of Physical Planning, School of Urban and Public Affairs, Carnegie-Mellon University, 1972.
- [4] G. Pask, *Conversation, cognition and learning: A cybernetic theory and methodology*. Amsterdam, New York: Elsevier, 1975.
- [5] G. Pask, *The cybernetics of human learning and performance: A guide to theory and research*. London: Hutchinson Educational, 1975.
- [6] N. Negroponte, "Toward a Theory of Architecture Machines," *Journal of Architectural Education (1947-1974)*, vol. 23, no. 2, p. 9, 1969.
- [7] N. Negroponte, "The architecture machine," *Computer-Aided Design*, vol. 7, no. 3, pp. 190–195, 1975.
- [8] E. Zekha, B. Epstein, S. Birrell, and C. Dodsworth, "From Devices to 'Ambient Intelligence': The Transformation of Consumer Electronics (Conference Keynote)," in *Digital Living Room Conference*, 1998.
- [9] S. Katz, "Assessing self-maintenance: activities of daily living, mobility, and instrumental activities of daily living," (eng), *Journal of the American Geriatrics Society*, vol. 31, no. 12, pp. 721–727, 1983.
- [10] D. Calvaresi et al, "Exploring the ambient assisted living domain: A systematic review," *Journal of Ambient Intelligence and Humanized Computing*, vol. 8, no. 2, pp. 239–257, 2017.
- [11] M. W. Steenson, *Architectures of information: Christopher Alexander, Cedric Price, and Nicholas Negroponte and MIT's Architecture Machine Group*, 2014.
- [12] P. R. Milgrom, "The economics of modern manufacturing: technology, strategy, and organization," *The American Economic Review*, vol. 80, no. 3, pp. 511–528, 1990.
- [13] K. Oosterhuis, *Hyperbody: First decade of interactive architecture*. Heijningen: Jap Sam Books, 2012.
- [14] *Hiperorgânicos - Simpósio Internacional de Pesquisa em Arte, Hibridização, Biotelemática e Transculturalismo*. [Online] Available: <http://www.nano.eba.ufrj.br/hiper8/>. Accessed on: May 30 2018.
- [15] H. H. Bier and A. Liu Cheng, "Ancestorfuturist explorations within a design-to-robotic-operation framework," *Hiperorganicos*, 2021.
- [16] C. Follini, A. Liu Cheng, G. Latorre, and L. Freire Amores, "Design and Development of a Novel Robotic Gripper for Automated Scaffolding Assembly," in *Proceedings of the 3rd IEEE Ecuador Technical Chapters Meeting (ETCM) 2018*, 2018.
- [17] A. Liu Cheng, C. Georgoulas, and T. Bock, "Design And Implementation Of A Novel Cost-effective Fall Detection And Intervention System For Independent Living Based On Wireless Sensor Network Technologies," in *Proceedings of the 32nd International Symposium on Automation and Robotics in Construction (ISARC 2015)*, Oulu, Finland, 2015.
- [18] C. Georgoulas, A. Raza, J. Güttler, T. Linner, and T. Bock, "Home Environment Interaction via Service Robots and the Leap Motion Controller," in *Proceedings of the 31st International Symposium on Automation and Robotics in Construction (ISARC 2014)*, Sydney, Australia, 2014.
- [19] T. Linner, J. Güttler, T. Bock, and C. Georgoulas, "Assistive robotic micro-rooms for independent living," *Automation in Construction*, vol. 51, pp. 8–22, 2015.
- [20] T. Linner, C. Georgoulas, and T. Bock, "Advanced building engineering: Deploying mechatronics and robotics in architecture," *Gerontechnology*, vol. 11, no. 2, p. 380, 2012.
- [21] S. S. Intille, "A New Research Challenge: Persuasive Technology to Motivate Healthy Aging," *IEEE Trans. Inform. Technol. Biomed*, vol. 8, no. 3, pp. 235–237, 2004.
- [22] J.C. Augusto, P. Novais, J.M. Corchado, and C. Analide, Eds, *Ambient Intelligence and Future Trends: International Symposium on Ambient Intelligence (ISAmI 2010). Advances in Intelligent and Soft Computing 72*. DE: Springer Verlag, 2010.

- [23] R. Wichert and B. Eberhardt, Eds, *Ambient Assisted Living 4. AAL-Kongress 2011 Berlin, Germany, January 25-26, 2011*. New York: Springer, 2011.
- [24] R. Wichert and H. Klausning, Eds, *Ambient Assisted Living 6. AAL-Kongress 2013 Berlin, Germany, January 22-23, 2013*. Berlin/Heidelberg, Germany: Springer Berlin Heidelberg, 2013.
- [25] R. Wichert and H. Klausning, Eds, *Ambient Assisted Living 8. AAL-Kongress 2015 Frankfurt/Main, Germany, April 29-30, 2015*. Berlin/Heidelberg, Germany: Springer Berlin Heidelberg, 2015.
- [26] R. Wichert and H. Klausning, *Ambient Assisted Living*. Berlin, Heidelberg: Springer Berlin Heidelberg, 2014.
- [27] H. Bier, "Robotic environments," in *Proceedings of the 28th international symposium on automation and robotics in construction*, 2011, pp. 863–868.
- [28] H. Maier, *Supercentenarians*. Heidelberg [Germany], New York: Springer: Springer, 2010.
- [29] T. Sato, T. Harada, and T. Mori, "Environment-type robot system "RoboticRoom" featured by behavior media, behavior contents, and behavior adaptation," *IEEE/ASME Transactions on Mechatronics*, vol. 1; 9, no. 3, pp. 529–534, 2004.
- [30] S. Sugano, Y. Shirai, and S. Chae, "Environment Design for Human-Robot Symbiosis: Introduction of WABOT-HOUSE Project," in *Proceedings of the 23rd International Symposium on Automation and Robotics in Construction*, Tokyo, Japan, 2006, pp. 152–157.
- [31] C. D. Kidd *et al*, "The Aware Home: A Living Laboratory for Ubiquitous Computing Research," in *Proceedings of the Second International Workshop on Cooperative Buildings, Integrating Information, Organization, and Architecture*, London, UK: Springer Verlag, 1999.
- [32] K. Murakami, T. Hasegawa, R. Kurazume, and Y. Kimuro, "A structured environment with sensor networks for intelligent robots," in *Sensors, 2008 IEEE*, 2008, pp. 705–708.
- [33] A. Liu Cheng, "Design and Implementation of a Novel Cost-effective Fall-Detection and -Intervention System for Independent Living based on Wireless Sensor Network Technologies," Master of Science thesis, Lehrstuhl für Baurealisierung und Baurobotik, Technische Universität München, Munich, Germany, 2015.
- [34] G. F. Sit, C. Shen, H. Stort, and C. Hofmann, "Application-Oriented Fusion and Aggregation of Sensor Data," in *Ambient Assisted Living 5. AAL-Kongress 2012 Berlin, Germany, January 24-25, 2012*, R. Wichert and B. Eberhardt, Eds, Heidelberg, New York: Springer, 2012, pp. 3–13.
- [35] S. Chiriac and B. Rosales, "An Ambient Assisted Living Monitoring System for Activity Recognition -- Results from the First Evaluation Stages," in *Ambient Assisted Living 5. AAL-Kongress 2012 Berlin, Germany, January 24-25, 2012*, R. Wichert and B. Eberhardt, Eds, Heidelberg, New York: Springer, 2012, pp. 15–28.
- [36] U. Gaden *et al*, "SAMDY – Ein sensorbasiertes adaptives Monitoringsystem für die Verhaltensanalyse von Senioren," in *Proceedings of the 4th German AAL Congress*, Berlin, Germany, 2011.
- [37] P. Mayer, M. Rauhala, and P. Panek, "Field test of the eHome system," in *Proceedings of the 4th German AAL Congress*, Berlin, Germany, 2011.
- [38] R. Wichert, F. Furfari, A. Kung, and M. R. Tazari, "How to Overcome the Market Entrance Barrier and Achieve the Market Breakthrough in AAL," in *Ambient Assisted Living 5. AAL-Kongress 2012 Berlin, Germany, January 24-25, 2012*, R. Wichert and B. Eberhardt, Eds, Heidelberg, New York: Springer, 2012, pp. 349–358.
- [39] B. Andò, S. Baglio, C. O. Lombardo, and V. Marletta, "An advanced tracking solution fully based on native sensing features of smartphone," in *2014 IEEE Sensors Applications Symposium (SAS)*, 2014, pp. 141–144.
- [40] H. Bier, A. Liu Cheng, S. Mostafavi, A. Anton, and S. Bodea, "Robotic Building as Integration of Design-to-Robotic-Production and -Operation," in *Springer Series in Adaptive Environments*, vol. 1, *Robotic Building*, H. Bier, Ed. 1st ed.: Springer International Publishing AG, 2018.
- [41] J. Esch, "A Survey on Ambient Intelligence in Healthcare," *Proc. IEEE*, vol. 101, no. 12, pp. 2467–2469, 2013.
- [42] D. J. Cook, J. C. Augusto, and V. R. Jakkula, "Ambient intelligence: Technologies, applications, and opportunities," *Pervasive and Mobile Computing*, vol. 5, no. 4, pp. 277–298, 2009.
- [43] H. Nakashima, H.K. Aghajan, and J.C. Augusto, Eds, *Handbook of ambient intelligence and smart environments*. New York: Springer, 2010.
- [44] T. Bock, J. Güttler, C. Georgoulas, and T. Linner, "The Development of Intra-House Mobility, Logistics and Transfer Solutions in PASSAge," *JRM*, vol. 27, no. 1, p. 108, 2015.
- [45] G. Acampora, D. J. Cook, P. Rashidi, and A. V. Vasilakos, "A Survey on Ambient Intelligence in Healthcare," *Proc. IEEE*, vol. 101, no. 12, pp. 2470–2494, 2013.
- [46] C. Price, "Letter To John Frazer", Dec. 1978, Box 4, Generator document folio, DR1995:0280:65, 4/5, CPA.
- [47] J. Frazer and J. Frazer, "Letter To Cedric Price", Jan. 1979, Box 5, Generator document folio, DR1995:0280:65 5/5, CPA.
- [48] M. Fox and M. Kemp, *Interactive architecture*, 1st ed. New York: Princeton Architectural Press, 2009.

- [49] M. Fox, "Catching up with the Past: A Small Contribution to a Long History of Interactive Environments," *FOOTPRINT*, no. 6, pp. 5–18, 2010.
- [50] T. Jaskiewicz, "Towards a Methodology for Complex Adaptive Interactive Architecture," PhD Dissertation, Delft University of Technology, Faculty of Architecture and the Built-Environment, Delft, The Netherlands, 2013.
- [51] B. Kolarevic, "Outlook: Adaptive Architecture: Low-Tech, High-Tech, or Both?," in *Applied Virtuality Book Series*, v.8, *ALIVE: Advancements in adaptive architecture*, M. Kretzer and L. Hovestadt, Eds, Basel/Berlin/Boston: Birkhäuser, 2014, pp. 148–157.
- [52] H. Schnädelbach, "Adaptive Architecture-A Conceptual Framework," *Proceedings of Media City*, 2010.
- [53] European Association of Research and Technology Organisations (EARTO), *The TRL Scale as a Research & Innovation Policy TOOL: EARTO Recommendations*. [Online] Available: http://www.earto.eu/fileadmin/content/03_Publications/The_TRL_Scale_as_a_R_I_Policy_Tool_-_EARTO_Recommendations_-_Final.pdf. Accessed on: Jan. 07 2015.
- [54] AAL Association, *Ageing Well in the Digital World*. [Online] Available: <http://www.aal-europe.eu/country/germany/>. Accessed on: Nov. 05 2022.
- [55] M. Amini, M. Mahdavinejad, and M. Bemanian, "Future of Interactive Architecture in Developing Countries: Challenges and Opportunities in Case of Tehran," *JCDC*, vol. 24, no. 1, pp. 163–184, 2019.
- [56] R. Glynn, "Designing futures of performance and interaction," (en), 2021.
- [57] H. Schnädelbach, "Adaptive architecture," *interactions*, vol. 23, no. 2, pp. 62–65, 2016.
- [58] H. Schnädelbach, A. Irune, D. Kirk, K. Glover, and P. Brundell, "ExoBuilding," *ACM Trans. Comput.-Hum. Interact.*, vol. 19, no. 4, pp. 1–22, 2012.
- [59] H. Schnädelbach, P. Slovák, G. Fitzpatrick, and N. Jäger, "The immersive effect of adaptive architecture," *Pervasive and Mobile Computing*, vol. 25, pp. 143–152, 2016.
- [60] L. Urquhart, H. Schnädelbach, and N. Jäger, "Adaptive Architecture: regulating human building interaction," *International Review of Law, Computers & Technology*, vol. 33, no. 1, pp. 3–33, 2019.
- [61] R. Glynn, *Reciprocal Space*. [Online] Available: <http://www.interactivearchitecture.org/reciprocal-space-ruairi-glynn.html>.
- [62] O. Khan, "Open columns," in *CHI '10 Extended Abstracts on Human Factors in Computing Systems*, New York, NY: ACM, 2010, pp. 4789–4792.
- [63] N. Jäger, H. Schnädelbach, J. Hale, D. Kirk, and K. Glover, "Reciprocal Control in Adaptive Environments," *Interact. Comput.*, 2017.
- [64] M. C. Mozer, "Lessons from an Adaptive Home," in *Smart environments: Technologies, protocols, and applications*, D. J. Cook and S. K. Das, Eds, Hoboken, NJ: John Wiley, 2005, pp. 271–294.
- [65] U. Varshney, "Pervasive Healthcare and Wireless Health Monitoring," *Mobile Netw Appl*, vol. 12, no. 2-3, pp. 113–127, 2007.
- [66] H. Hecht, M. Mayier, and C. Perakslis, "Pervasive connectivity: The thriving hotel of the future," in *2014 IEEE International Conference on Pervasive Computing and Communications Workshops (PERCOM Workshops)*, Piscataway, NJ: IEEE, 2014, pp. 357–363.
- [67] E. S. Poulsen, H. J. Andersen, and O. B. Jensen, "Full Scale Experiment with Interactive Urban Lighting," (English), *Workshop on Designing Interactive Lighting*, <https://vbn.aau.dk/en/publications/full-scale-experiment-with-interactive-urban-lighting>, 2012.
- [68] M. Yablonina, B. Ringley, G. Brugnaro, and A. Menges, "Soft Office: a human–robot collaborative system for adaptive spatial configuration," *Constr Robot*, vol. 5, no. 1, pp. 23–33, <https://link.springer.com/article/10.1007/s41693-021-00056-x>, 2021.
- [69] M. Wyller, M. Yablonina, M. Alvarez, and A. Menges, "Adaptive kinematic textile architecture," *Constr Robot*, vol. 4, no. 3-4, pp. 227–237, <https://link.springer.com/article/10.1007/s41693-020-00046-5>, 2020.
- [70] D. Wood *et al*, "Cyber Physical Macro Material as a UAV [re]Configurable Architectural System," in : Springer, Cham, 2019, pp. 320–335.
- [71] A. Menges, "The New Cyber-Physical Making in Architecture: Computational Construction," *Archit. Design*, vol. 85, no. 5, pp. 28–33, 2015.
- [72] K. Connelly, M. Mokhtari, T. H. Falk, and others, "Approaches to understanding the impact of technologies for aging in place: a mini-review," *Gerontology*, vol. 60, no. 3, pp. 282–288, 2013.
- [73] J. Guttler, C. Georgoulas, T. Linner, and T. Bock, "Towards a future robotic home environment: a survey," (eng), *Gerontology*, vol. 61, no. 3, pp. 268–280, 2015.
- [74] S. T. M. Peek *et al*, "Older Adults' Reasons for Using Technology while Aging in Place," (eng), *Gerontology*, vol. 62, no. 2, pp. 226–237, 2016.

- [75] M. J. Rantz *et al.*, "A New Paradigm of Technology-Enabled 'Vital Signs' for Early Detection of Health Change for Older Adults," (eng), *Gerontology*, vol. 61, no. 3, pp. 281–290, 2015.
- [76] R. Schulz *et al.*, "Advancing the Aging and Technology Agenda in Gerontology," (eng), *The Gerontologist*, vol. 55, no. 5, pp. 724–734, 2015.
- [77] K. Doughty, K. Cameron, and P. Garner, "Three generations of telecare of the elderly," (eng), *J. Telemed. Telecare*, vol. 2, no. 2, pp. 71–80, 1996.
- [78] J. M. Wiener, R. J. Hanley, R. Clark, and J. F. van Nostrand, "Measuring the activities of daily living: comparisons across national surveys," *Journal of Gerontology*, vol. 45, no. 6, pp. S229, 1990.
- [79] S. Blackman *et al.*, "Ambient Assisted Living Technologies for Aging Well: A Scoping Review," *Journal of Intelligent Systems*, vol. 25, no. 1, pp. 55–69, 2016.
- [80] A. Aztiria, J.C. Augusto, and A. Orlandini, Eds, *State of the art in AI applied to ambient intelligence*. Amsterdam, Berlin, Washington, DC: IOS Press, 2017.
- [81] M. Dragone *et al.*, "A cognitive robotic ecology approach to self-configuring and evolving AAL systems," *Eng Appl Artif Intell*, vol. 45, pp. 269–280, 2015.
- [82] M. Gams, I. Y.-H. Gu, A. Härmä, A. Muñoz, and V. Tam, "Artificial intelligence and ambient intelligence," *AIS*, vol. 11, no. 1, pp. 71–86, 2019.
- [83] P. Novais and D. Carneiro, "The role of non-intrusive approaches in the development of people-aware systems," *Progress in Artificial Intelligence*, vol. 5, no. 3, pp. 215–220, 2016.
- [84] E. Geisberger and M. Broy, Eds, *Living in a networked world: Integrated research agenda, cyber-physical systems (agendaCPS)*. München: Acatech, National Academy of Science and Engineering; Herbert Utz Verlag GmbH, 2015.
- [85] L. Liu, E. Stroulia, I. Nikolaidis, A. Miguel-Cruz, and A. Rios Rincon, "Smart homes and home health monitoring technologies for older adults: A systematic review," (eng), *International journal of medical informatics*, vol. 91, pp. 44–59, 2016.
- [86] L. Burzagli, "Smart Cities: A New Relationship Between People and Technologies," in vol. 725, *Ambient Assisted Living*, A. Monteriù, A. Freddi, and S. Longhi, Eds, Cham: Springer International Publishing, 2021, pp. 161–166.
- [87] L. Burzagli, P. L. Emiliani, and S. Naldini, "From Ambient Assisted Living to Society Ambient Living," in vol. 544, *Ambient Assisted Living*, A. Leone, A. Caroppo, G. Rescio, G. Diraco, and P. Siciliano, Eds, Cham: Springer International Publishing, 2019, pp. 35–45.
- [88] F. Shafiqat, M. N. A. Khan, and S. Shafiqat, "SmartHealth: IoT-Enabled Context-Aware 5G Ambient Cloud Platform," in *IoT in Healthcare and Ambient Assisted Living*: Springer, Singapore, 2021, pp. 43–67.
- [89] D. Spoladore, S. Arlati, V. Colombo, G. Modoni, and M. Sacco, "A Semantic-Enabled Smart Home for AAL and Continuity of Care," in *IoT in Healthcare and Ambient Assisted Living*: Springer, Singapore, 2021, pp. 343–371.
- [90] M. S. Perera, M. N. Halgamuge, R. Samarakody, and A. Mohammad, "Internet of Things in Healthcare: A Survey of Telemedicine Systems Used for Elderly People," in *IoT in Healthcare and Ambient Assisted Living*: Springer, Singapore, 2021, pp. 69–88.
- [91] G. Marques, A.K. Bhoi, V.H.C. de Albuquerque, and K.S. Hareesha, Eds, *IoT in healthcare and ambient assisted living*. Singapore: Springer, 2021.
- [92] R. Dunne, T. Morris, and S. Harper, "A Survey of Ambient Intelligence," *ACM Computing Surveys*, vol. 54, no. 4, pp. 1–27, 2021.
- [93] C. Ardito *et al.*, "Enabling End Users to Define the Behavior of Smart Objects in AAL Environments," in vol. 544, *Ambient Assisted Living*, A. Leone, A. Caroppo, G. Rescio, G. Diraco, and P. Siciliano, Eds, Cham: Springer International Publishing, 2019, pp. 95–103.
- [94] D. Caivano, F. Cassano, D. Fogli, and A. Piccinno, "EUD4SH: A EUD Model for the Smart Home," in pp. 86–93.
- [95] S. Pericu and A. Licaj, "RESTOQUI: A Platform to Live at Home All Your Life," in *Lecture Notes in Electrical Engineering, Ambient Assisted Living*, N. Casiddu, C. Porfirione, A. Monteriù, and F. Cavallo, Eds, Cham: Springer International Publishing, 2019, pp. 39–51.
- [96] M.-L. Watrinet and F. Fracasso, "MAESTRO, an Integrated Quality Assurance Framework for Seniors," in vol. 725, *Ambient Assisted Living*, A. Monteriù, A. Freddi, and S. Longhi, Eds, Cham: Springer International Publishing, 2021, pp. 287–293.
- [97] H. Bier, "Robotically Driven Architectural Production," *Archidoct*, vol. 2, no. 1, pp. 11–16, 2014.
- [98] J. Forlizzi and C. DiSalvo, "Service robots in the domestic environment: a study of the roomba vacuum in the home," in *Proceedings of the 1st ACM SIGCHI/SIGART conference on human-robot interaction*: ACM, 2006.

- [99] T. Bock and T. Linner, *Robot-oriented design: Design and management tools for the deployment of automation and robotics in construction*. New York, NY: Cambridge University Press, 2015.
- [100] N. Blismas and R. Wakefield, "Drivers, constraints and the future of offsite manufacture in Australia," *Construction Innovation*, vol. 9, no. 1, pp. 72–83, 2009.
- [101] C. M. Tam, V. Tam, S. X. Zeng, and W. Ng, "Towards adoption of prefabrication in construction," *Building and Environment*, vol. 42, no. 10, pp. 3642–3654, 2007.
- [102] W. N. Glucroft, *Berlin's new airport: A story of failure and embarrassment*. [Online] Available: <https://www.dw.com/en/berlins-new-airport-finally-opens-a-story-of-failure-and-embarrassment/a-55446329>.
- [103] Euronews, <https://www.euronews.com/2020/10/31/berlin-airport-opens-10-years-late-and-three-times-over-budget>. [Online] Available: <https://www.euronews.com/2020/10/31/berlin-airport-opens-10-years-late-and-three-times-over-budget>.
- [104] P. M. Bluyssen, *The indoor environment handbook: How to make buildings healthy and comfortable*. London, Sterling, Va.: Earthscan, 2009.
- [105] World Health Organization®, *The World Health Organization Quality of Life (WHOQOL)*. [Online] Available: <https://www.who.int/publications/i/item/WHO-HIS-HSI-Rev.2012.03>. Accessed on: Sep. 10 2022.
- [106] E. A. Lee and S. A. Seshia, *Introduction to Embedded Systems, Second Edition: A Cyber-Physical Systems Approach*. [s.l.]: The MIT Press Open, 2016.
- [107] V. V. Sakhare and R. V. Ralegaonkar, "Indoor environmental quality: Review of parameters and assessment models," *Architectural Science Review*, vol. 57, no. 2, pp. 147–154, 2014.
- [108] P. M. Bluyssen, *The Healthy Indoor Environment: How to Assess Occupants' Wellbeing in Buildings*. London, New York: Routledge/Taylor & Francis Group, 2014.
- [109] S. Riffelli, "Global Comfort Indices in Indoor Environments: A Survey," *Sustainability*, vol. 13, no. 22, p. 12784, 2021.
- [110] L. Chatzidiakou, A. Pathan, A. Summerfield, and D. Mumovic, "Environmental and Behavioral Factors Affecting Residential Air Conditioning Use in Athens and London," in *Springer optimization and its applications*, v. 56, *Sustainable environmental design in architecture: Impacts on health*, S. T. Rassia and P. M. Pardalos, Eds, New York, NY: Springer, 2012, pp. 109–141.
- [111] Y. Al Horr et al, "Impact of indoor environmental quality on occupant well-being and comfort: A review of the literature," *International Journal of Sustainable Built Environment*, vol. 5, no. 1, pp. 1–11, 2016.
- [112] E. A. Lee, *Cyber-Physical Systems—a Concept Map*. [Online] Available: <https://ptolemy.berkeley.edu/projects/cps/>. Accessed on: Oct. 08 2022.
- [113] W. Taha, A.-E. M. Taha, and J. Thunberg, *Cyber-physical systems: A model-based approach*. Cham, Switzerland: Springer, 2021.
- [114] J. Sztipanovits, "Composition of Cyber-Physical Systems," in *Raising expectations of computer-based systems: Proceedings ; 14th Annual IEEE International Conference and Workshops on the Engineering of Computer-Based Systems ; ECBS 2007 ; March 26-29, 2007, Tucson, Arizona ; [ECBS Model-Based System Development Workshop]*, Los Alamitos, Calif.: IEEE Computer Society, 2007, pp. 3–6.
- [115] B. J. Krämer, "Evolution of Cyber-Physical Systems: A Brief Review," in *Applied cyber-physical systems*, S. C. Suh, Ed, New York: Springer Science, 2014, pp. 1–3.
- [116] N. Wiener, *Cybernetics or Control and Communication in the Animal and the Machine: Or Control and communication in the animal and the machine*, 1961st ed. Cambridge: MIT Press, 2019.
- [117] H. Kopetz, "Cyber-Physical Systems Are Different," in *Simplicity is Complex*, H. Kopetz, Ed, Cham: Springer International Publishing, 2019, pp. 69–75.
- [118] S. J. Oks et al, "Cyber-Physical Systems in the Context of Industry 4.0: A Review, Categorization and Outlook," *Information Systems Frontiers*, pp. 1–42, <https://link.springer.com/article/10.1007/s10796-022-10252-x>, 2022.
- [119] Y. Jiang, S. Yin, and O. Kaynak, "Data-Driven Monitoring and Safety Control of Industrial Cyber-Physical Systems: Basics and Beyond," *IEEE Access*, vol. 6, pp. 47374–47384, 2018.
- [120] F.-J. Wu, Y.-F. Kao, and Y.-C. Tseng, "From wireless sensor networks towards cyber physical systems," *Pervasive and Mobile Computing*, vol. 7, no. 4, pp. 397–413, 2011.
- [121] W.-G. Drossel, S. Ihlenfeldt, T. Langer, and R. Dumitrescu, "Cyber-Physical Systems: Research for the digital factory," in *Digital Transformation*, R. Neugebauer, Ed, Berlin, Heidelberg: Springer Berlin / Heidelberg, 2019, pp. 189–213.
- [122] D. Serpanos, "The Cyber-Physical Systems Revolution," *Computer*, vol. 51, no. 3, pp. 70–73, 2018.

- [123] C.-Y. Lin, S. Zeadally, T.-S. Chen, and C.-Y. Chang, "Enabling Cyber Physical Systems with Wireless Sensor Networking Technologies," *International Journal of Distributed Sensor Networks*, vol. 8, no. 5, p. 489794, 2012.
- [124] A. Badi and I. Mahgoub, "Emerging Concepts in Collective Sensing," in *Springer Series on Chemical Sensors and Biosensors (Series Editor: G. Urban)*, vol. 13, *Autonomous Sensor Networks: Collective Sensing Strategies for Analytical Purposes*, D. Filippini, Ed, Berlin/Heidelberg: Springer-Verlag, 2013, pp. 395–423.
- [125] S.-H. Yang, *Wireless sensor networks: Principles, design and applications*. London: London; Springer, 2014.
- [126] S.-H. Yang and Y. Cao, "Networked control systems and wireless sensor networks: theories and applications," *Int.J.Syst.Sci*, vol. 39, no. 11, pp. 1041–1044, 2008.
- [127] L. Benini, E. Farella, and C. Guiducci, "Wireless sensor networks: Enabling technology for ambient intelligence," *Microelectron.J*, vol. 37, no. 12, pp. 1639–1649, 2006.
- [128] K. Sohraby, D. Minoli, and T. Znati, *Wireless sensor networks :technology, protocols, and applications*. Hoboken, N.J.: John Wiley & Sons, 2007.
- [129] I. Akyildiz, W. Su, Y. Sankarasubramaniam, and E. Cayirci, "Wireless sensor networks: a survey," *Computer Networks*, vol. 38, no. 4, pp. 393–422, 2002.
- [130] S. Chai, Z. Wang, B. Zhang, L. Cui, and R. Chai, *Wireless sensor networks*. Singapore: Springer, 2020.
- [131] D.J. Cook and S.K. Das, Eds, *Smart environments: Technologies, protocols, and applications*. Hoboken, NJ: John Wiley, 2005.
- [132] D. J. Cook and S. K. Das, "How smart are our environments? An updated look at the state of the art," *Pervasive and Mobile Computing*, vol. 3, no. 2, pp. 53–73, 2007.
- [133] G. Acampora, D. J. Cook, P. Rashidi, and A. V. Vasilakos, "A Survey on Ambient Intelligence in Health Care," (eng), *Proc. IEEE*, vol. 101, no. 12, pp. 2470–2494, 2013.
- [134] A. Braun, R. Wichert, and A. Maña, Eds, *Ambient Intelligence*. Cham: Springer International Publishing, 2017.
- [135] D. Bacciu *et al*, "An ambient intelligence approach for learning in smart robotic environments," (en), *Computational Intelligence*, vol. 35, no. 4, pp. 1060–1087, <https://onlinelibrary-wiley-com.tudelft.idm.oclc.org/doi/full/10.1111/coin.12233?sid=worldcat.org>, 2019.
- [136] B. Kantarci and S. Oktug, Eds, *Wireless Sensor and Actuator Networks for Smart Cities*. [Erscheinungsort nicht ermittelbar]: MDPI - Multidisciplinary Digital Publishing Institute, 2019.
- [137] S. González-Valenzuela, X. Liang, H. Cao, M. Chen, and V. C. Leung, "Body Area Network," in *Springer Series on Chemical Sensors and Biosensors (Series Editor: G. Urban)*, vol. 13, *Autonomous Sensor Networks: Collective Sensing Strategies for Analytical Purposes*, D. Filippini, Ed, Berlin/Heidelberg: Springer-Verlag, 2013, pp. 17–38.
- [138] B. Latré, B. Braem, I. Moerman, C. Blondia, and P. Demeester, "A survey on wireless body area networks," *Wireless Networks*, vol. 17, no. 1, pp. 1–18, 2011.
- [139] R. A. Khan and A.-S. K. Pathan, "The state-of-the-art wireless body area sensor networks: A survey," *International Journal of Distributed Sensor Networks*, vol. 14, no. 4, 155014771876899, 2018.
- [140] S. K. S. Gupta, *Body area networks: Safety, security, and sustainability*. Cambridge: Cambridge University Press, 2013.
- [141] T. G. Zimmerman, "Personal Area Networks: Near-field intrabody communication," *IBM Syst. J*, vol. 35, no. 3.4, pp. 609–617, 1996.
- [142] S. González-Valenzuela, M. Chen, and V. C. M. Leung, "Mobility Support for Health Monitoring at Home Using Wearable Sensors," *IEEE Transactions on Information Technology in Biomedicine*, vol. 15, no. 4, pp. 539–549, 2011.
- [143] A. Milenković, C. Otto, and E. Jovanov, "Wireless sensor networks for personal health monitoring: Issues and an implementation," *Comput.Commun*, vol. 29, no. 13, pp. 2521–2533, 2006.
- [144] K. Lorincz *et al*, "Sensor networks for emergency response: challenges and opportunities," *IEEE Pervasive Computing*, vol. 3, no. 4, pp. 16–23, 2004.
- [145] T. Gao *et al*, "The Advanced Health and Disaster Aid Network: A Light-Weight Wireless Medical System for Triage," *IEEE Transactions on Biomedical Circuits and Systems*, vol. 1, no. 3, pp. 203–216, 2007.
- [146] G. M. Weiss and M. Z. A. Bhuiyan, "An Overview of Wearable Computing," in *Studies in Systems, Decision and Control*, vol. 164, *Mission-Oriented Sensor Networks and Systems: Art and Science: Volume 2: Advances*, H. M. Ammari, Ed. 1st ed, Cham: Springer International Publishing; Springer, 2019, pp. 313–349.
- [147] C. Georgoulas, T. Linner, A. Kasatkin, and T. Bock, "An AmI Environment Implementation: Embedding TurtleBot into a novel Robotic Service Wall," in *Proceedings of the 7th German Conference on Robotics*, Munich, Germany: VDE Verlag, 2012.

- [148] BeagleBoard®, *BeagleBone Black*. [Online] Available: <http://beagleboard.org/black>. Accessed on: Jun. 10 2015.
- [149] Arduino®, *Arduino UNO & Genuino UNO*. [Online] Available: <https://www.arduino.cc/en/Main/ArduinoBoardUno>. Accessed on: Mar. 06 2016.
- [150] Libelium®, *e-Health Sensor Platform Complete Kit V2.0 for Arduino, Raspberry Pi and Intel Galileo [Biometric / Medical Applications]*. [Online] Available: <https://www.cooking-hacks.com/ehealth-sensors-complete-kit-biometric-medical-arduino-raspberry-pi>. Accessed on: Mar. 06 2016.
- [151] PunchThrough®, *The LightBlue Family: Bean and Bean+: BLE dev boards for the mobile age*. [Online] Available: <https://punchthrough.com/bean>. Accessed on: Mar. 06 2016.
- [152] Fitbit®, *Take your place in the future of fitness: Develop Your App With The Fitbit API*. [Online] Available: <https://dev.fitbit.com/>. Accessed on: Mar. 06 2016.
- [153] A. Liu Cheng and H. Bier, "An Extended Ambient Intelligence Implementation for Enhanced Human-Space Interaction," in *Proceedings of the 33rd International Symposium on Automation and Robotics in Construction (ISARC 2016)*, Auburn, Alabama, 2016, pp. 778–786.
- [154] A. Liu Cheng, C. Georgoulas, and T. Bock, "Fall Detection and Intervention based on Wireless Sensor Network Technologies," *Automation in Construction*, 2016.
- [155] B. L. Harrison, S. Consolvo, and T. Choudhury, "Using Multi-modal Sensing for Human Activity Modeling in the Real World," in *Handbook of ambient intelligence and smart environments*, H. Nakashima, H. K. Aghajan, and J. C. Augusto, Eds, New York: Springer, 2010, pp. 463–478.
- [156] S. Jiménez-Fernández, P. de Toledo, and F. del Pozo, "Usability and Interoperability in Wireless Sensor Networks for Patient Telemonitoring in Chronic Disease Management," (eng), *IEEE transactions on bio-medical engineering*, vol. 60, no. 12, pp. 3331–3339, 2013.
- [157] S. Abbate et al, "A smartphone-based fall detection system," *Pervasive and Mobile Computing*, vol. 8, no. 6, pp. 883–899, 2012.
- [158] D. Anguita, A. Ghio, L. Oneto, X. Parra, and J. L. Reyes-Ortiz, "A Public Domain Dataset for Human Activity Recognition Using Smartphones," in *Proceedings of the 21th European Symposium on Artificial Neural Networks, Computational Intelligence and Machine Learning, ESANN 2013*, 2013.
- [159] J. L. R. Ortiz, *Smartphone-based human activity recognition*. Cham: Springer, 2015.
- [160] D. Micucci, M. Mobilio, P. Napolitano, and F. Tisato, "Falls as anomalies?: An experimental evaluation using smartphone accelerometer data," *Journal of Ambient Intelligence and Humanized Computing*, vol. 8, no. 1, pp. 87–99, 2017.
- [161] Hyperbody®, *GSM3: Game Set and Match: International Symposium & Exhibition*. [Online] Available: <http://gsm3.hyperbody.nl/>. Accessed on: Nov. 09 2016.
- [162] K. Oosterhuis, *004 | ProtoCELL*. [Online] Available: <http://www.oosterhuis.nl/?p=23>. Accessed on: Mar. 29 2017.
- [163] C. B. Nielsen and H. H. Lund, "Adapting playware to rehabilitation practices," *International Journal of Computer Science in Sport*, vol. 11, no. 1, 2012.
- [164] M. Moharram, H. Elbrashi, and M. Meligy, *DIA Group 2: Topological Hybridity*. [Online] Available: <http://ip.hyperbody.nl/index.php/Msc2G8:Group>. Accessed on: Jul. 01 2017.
- [165] Comité Européen de Normalisation® (CEN), *Standard EN 15251–2007: Indoor environmental input parameters for design and assessment of energy performance of buildings addressing indoor air quality, thermal environment, lighting and acoustics*. Accessed on: 16/07/07.
- [166] C. Du, J. Duan, and F. van Buren, *MSc2, Group 2, Student Housing Unit*. [Online] Available: <http://ip.hyperbody.nl/index.php/Msc2G2:Page4>. Accessed on: Jul. 01 2017.
- [167] C. Du, J. Duan, and F. van Buren, *Interactive Prototyping, MSc 2 Spring Semester 2017: GROUP 2: Components Production*. [Online] Available: <http://ip.hyperbody.nl/index.php/Msc2G2:Page4>. Accessed on: Jul. 10 2017.
- [168] TensorFlow™, *An open source machine learning framework for everyone*. [Online] Available: <https://www.tensorflow.org/>. Accessed on: Apr. 20 2018.
- [169] A. Liu Cheng, H. Bier, G. Latorre, B. Kemper, and D. Fischer, "A High-Resolution Intelligence Implementation based on Design-to-Robotic-Production and -Operation strategies," in *Proceedings of the 34th International Symposium on Automation and Robotics in Construction (ISARC 2017)*, Taipei, Taiwan (R.O.C.), 2017.
- [170] A. Liu Cheng, H. Bier, and S. Mostafavi, "Integration of a Wearable Interface in a Design-to-Robotic-Production and -Operation Development," in *Proceedings of the 35th International Symposium on Automation and Robotics in Construction (ISARC) 2018*, Berlin, Germany, 2018, pp. 646–653.

- [171] A. Liu Cheng, H. Bier, and S. Mostafavi, "Deep Learning Object-Recognition in a Design-to-Robotic-Production and -Operation Implementation," in *Proceedings of the 2nd IEEE Ecuador Technical Chapters Meeting 2017*, Salinas, Ecuador, 2017.
- [172] A. Liu Cheng, C. Santos, P. Santos, and N. Llorca Vega, "Development of a Smart Sleeve Control Mechanism for Active Assisted Living," in *Proceedings of the IEEE 5th World Forum on Internet of Things 2019*, Piscataway, NJ, USA: IEEE, 2019, pp. 847–851.
- [173] A. Liu Cheng, N. Llorca Vega, G. Latorre, and D. Coba, "Development of a Light-Tracking and -Redirecting System Actuated by Hand-Gesture Recognition," in *Proceedings of the IEEE 5th World Forum on Internet of Things 2019*, Piscataway, NJ, USA: IEEE, 2019, pp. 702–706.
- [174] A. Liu Cheng and H. Bier, "Adaptive Building-Skin Components as Context-Aware Nodes in an Extended Cyber-Physical Network," in *Proceedings of the 3rd IEEE World Forum on Internet of Things: IEEE*, 2016, pp. 257–262.
- [175] A. Liu Cheng, H. Bier, and G. Latorre, "Actuation Confirmation and Negation via Facial-Identity and -Expression Recognition," in *Proceedings of the 3rd IEEE Ecuador Technical Chapters Meeting (ETCM) 2018*, 2018.
- [176] A. Liu Cheng, N. Llorca Vega, and G. Latorre, "Development of an Eye- and Gaze-Tracking Mechanism in an Active and Assisted Living Ecosystem," in *Proceedings of the 36th International Symposium on Automation and Robotics in Construction (ISARC) 2019*, Banff, AB, Canada: IAARC, 2019, pp. 749–755.
- [177] A. Liu Cheng et al, "Development of An Adaptive Staircase System Actuated by Facial-, Object-, and Voice-Recognition," in *Proceedings of the 21st IEEE International Conference on E-Health Networking, Application & Services (Healthcom) 2019*, 2019.
- [178] A. Liu Cheng, P. Cruz, N. Llorca Vega, and A. Mena, "Development of an Acoustically Adaptive Modular System for Near Real-Time Clarity-Enhancement," in *Lecture Notes in Computer Science*, vol. 11912, *Ambient Intelligence (AmI 2019)*, I. Chatzigiannakis, B. de Ruyter, and I. Mavrommati, Eds., Springer International Publishing, 2019, pp. 170–185.
- [179] A. Liu Cheng, L. Moran Silva, M. Real Buenaño, and N. Llorca Vega, "Development of an Adaptive Rainwater-Harvesting System for Intelligent Selective Redistribution," in *Proceedings of the 4th IEEE Ecuador Technical Chapters Meeting (ETCM) 2019*, 2019.
- [180] C. Cunningham, R. O' Sullivan, P. Caserotti, and M. A. Tully, "Consequences of physical inactivity in older adults: A systematic review of reviews and meta-analyses," (eng), *Scandinavian journal of medicine & science in sports*, vol. 30, no. 5, pp. 816–827, 2020.
- [181] Plotly®, *API Settings*. [Online] Available: <https://plot.ly/settings/api>. Accessed on: Feb. 15 2015.
- [182] World Health Organization®, *Health topics: Physical activity*. [Online] Available: http://www.who.int/topics/physical_activity/en/. Accessed on: Mar. 11 2016.
- [183] G. Milio et al, "Superficial venous thrombosis: Prevalence of common genetic risk factors and their role on spreading to deep veins," *Thrombosis Research*, vol. 123, no. 2, pp. 194–199, 2008.
- [184] I. K. Angelidis, D. Lidman, F. Sjöberg, and J. Thorfinn, "Decubitus ulcer development: Pressure alone increases tissue temperature," *Eur J Plast Surg*, vol. 32, no. 5, pp. 241–244, 2009.
- [185] H. H. Lund and P. Marti, "Designing modular robotic playware," in *Robot and Human Interactive Communication, 2009. RO-MAN 2009. The 18th IEEE International Symposium on*, 2009, pp. 115–121.
- [186] A. Liu Cheng and H. Bier, "Extension of a High-Resolution Intelligence Implementation via Design-to-Robotic-Production and -Operation strategies," in *Proceedings of the 35th International Symposium on Automation and Robotics in Construction (ISARC) 2018*, Berlin, Germany, 2018, pp. 1005–1012.
- [187] H. H. Lund, "Play for the Elderly - Effect Studies of Playful Technology," in *Lecture Notes in Computer Science Ser. v.9194, Human Aspects of IT for the Aged Population. Design for Everyday Life: First International Conference, ITAP 2015, Held As Part of HCI International 2015, Los Angeles, CA, USA, August 2-7, 2015. Proceedings, Part II*, J. Zhou and G. Salvendy, Eds, Cham: Springer International Publishing, 2015, pp. 500–511.
- [188] H. Bier, "Robotic building(s)," *Next Generation Building*, no. 1, 2014.
- [189] H. Bier and S. Mostafavi, "Robotic Building as Physically Built Robotic Environments and Robotically Supported Building Processes," in *Human-computer interaction series, Architecture and interaction: Human computer interaction in space and place*, N. S. Dalton, H. Schnädelbach, M. Wiberg, and T. Varoudis, Eds, Switzerland: Springer International Publishing, 2016, pp. 253–271.

- [190] Amazon®, *Alexa Voice Service: Bring Alexa to your connected products with Amazon's intelligent cloud-based voice service*. [Online] Available: <https://developer.amazon.com/alexa-voice-service>. Accessed on: Apr. 19 2017.
- [191] Twilio®, *REST API: Sending SMS or MMS*. [Online] Available: <https://www.twilio.com/docs/api/rest/sending-messages>. Accessed on: Apr. 01 2017.
- [192] Alphabet®, *Google Gmail > API: Flexible, RESTful access to the user's inbox*. Accessed on: Apr. 20 2017.
- [193] M. A. Alsheikh, S. Lin, D. Niyato, and H.-P. Tan, "Machine Learning in Wireless Sensor Networks: Algorithms, Strategies, and Applications," *IEEE Commun. Surv. Tutorials*, vol. 16, no. 4, pp. 1996–2018, 2014.
- [194] W. Xiao and Y. Lu, "Daily Human Physical Activity Recognition Based on Kernel Discriminant Analysis and Extreme Learning Machine," *Mathematical Problems in Engineering*, vol. 2015, no. 1, pp. 1–8, 2015.
- [195] A. E. Villa, *Artificial neural networks and machine learning-- ICANN 2012: 22nd International Conference on Artificial Neural Networks, Lausanne, Switzerland, September 11-14, 2012, Proceedings*. Berlin, New York: Springer, 2012.
- [196] J. Andreu and P. Angelov, "An evolving machine learning method for human activity recognition systems," *Journal of Ambient Intelligence and Humanized Computing*, vol. 4, no. 2, pp. 195–206, <https://link.springer.com.ezproxy.library.ubc.ca/content/pdf/10.1007%2Fs12652-011-0068-9.pdf>, 2013.
- [197] E. L. Salomons, P. J. M. Havinga, and H. van Leeuwen, "Inferring Human Activity Recognition with Ambient Sound on Wireless Sensor Nodes," (ENG), *Sensors (Basel, Switzerland)*, vol. 16, no. 10, 2016.
- [198] L. D. Dalcin, R. R. Paz, P. A. Kler, and A. Cosimo, "Parallel distributed computing using Python," *Advances in Water Resources*, vol. 34, no. 9, pp. 1124–1139, 2011.
- [199] F. Pedregosa et al., "Scikit-learn: Machine Learning in Python," *Journal of Machine Learning Research* (, <https://arxiv.org/pdf/1201.0490>, 2011.
- [200] L. Buitinck et al., "API design for machine learning software: experiences from the scikit-learn project," *European Conference on Machine Learning and Principles and Practices of Knowledge Discovery in Databases* (, <https://arxiv.org/pdf/1309.0238>, 2013.
- [201] S. Nakaso, J. Güttler, A. Mita, and T. Bock, "Human state estimation system implemented in an Office Deployable Getaway based on multiple bio information," in *Proceedings of the 33rd International Symposium on Automation and Robotics in Construction (ISARC 2016)*, Auburn, Alabama, 2016.
- [202] ASHRAE® *Standard 62.1-2013*, 2013.
- [203] ASHRAE® *Standard 55-2013*, 2013.
- [204] Olli Seppänen and Jarek Kurnitski, "Moisture control and ventilation," in *WHO Guidelines for Indoor Air Quality: Dampness and Mould*, O. Seppänen and J. Kurnitski, Eds.: World Health Organization, 2009.
- [205] GitHub, Inc.®, *alexa-avs-sample-app*. [Online] Available: <https://github.com/alexa/alexa-avs-sample-app>. Accessed on: Apr. 01 2017.
- [206] Amazon®, *Echo Dot (2nd Generation)*. [Online] Available: https://www.amazon.com/dp/B01DFKC2SO/ref=fs_ods_fs_aucc_bt. Accessed on: Apr. 15 2017.
- [207] A. Liu Cheng, "Design-to-Robotic-Operation Principles and Strategies as Drivers of Interior Environmental Quality: (Extended Abstract)," *Next Generation Building*, no. 3, 2016.
- [208] Zhengzhou Winsen Electronics Technology Co, Ltd, *Flammable Gas Sensor (Model: MQ-4): Manual version: 1.3, 2014-05-01*. [Online] Available: <https://cdn.sparkfun.com/datasheets/Sensors/Biometric/MQ-4%20Ver1.3%20-%20Manual.pdf>. Accessed on: Jun. 05 2017.
- [209] A. Hartley, "Fuel poverty," *West Midlands Public Health Observatory. Birmingham, UK: West Midlands Public Health Observatory (1 March 2006)*, p. 3, 2006.
- [210] The National Institute for Occupational Safety and Health (NIOSH), *International Chemical Safety Cards (ICSC): Methane*. [Online] Available: <https://www.cdc.gov/niosh/ipcsneng/neng0291.html>. Accessed on: Jul. 10 2017.
- [211] R. Gelbard et al, "Falls in the elderly: a modern look at an old problem," (eng), *American journal of surgery*, vol. 208, no. 2, pp. 249–253, 2014.
- [212] DT42®, Ltd, *BerryNet®: Deep learning gateway on Raspberry Pi*. [Online] Available: <https://github.com/DT42/BerryNet>. Accessed on: Jun. 21 2017.
- [213] C. Szegedy, V. Vanhoucke, S. Ioffe, J. Shlens, and Z. Wojna, "Rethinking the Inception Architecture for Computer Vision," in *2016 IEEE Conference on Computer Vision and Pattern Recognition (CVPR 2016): Las Vegas, Nevada, USA, 27-30 June 2016*, Piscataway, NJ: IEEE, 2016, pp. 2818–2826.
- [214] J. Redmon and A. Farhadi, "YOLO9000: Better, Faster, Stronger," in *30th IEEE Conference on Computer Vision and Pattern Recognition (CVPR)*, Los Alamitos, California: IEEE, 2017.

- [215] n.io Innovation®, LLC, *python-xbee: Python tools for working with XBee radios*. [Online] Available: <https://github.com/nioinnovation/python-xbee>. Accessed on: Jun. 01 2017.
- [216] Y. Pyo, T. Hasegawa, T. Tsuji, R. Kurazume, and K. Morooka, "Floor sensing system using laser reflectivity for localizing everyday objects and robot," *Sensors (Basel, Switzerland)*, vol. 14, no. 4, pp. 7524–7540, 2014.
- [217] ROS.org®, *ros-visualization: rviz is a 3D visualizer for the Robot Operating System (ROS) framework*. [Online] Available: <https://github.com/ros-visualization/rviz>. Accessed on: Jul. 16 2015.
- [218] E. Freiburger, C. C. Sieber, and R. Kob, "Mobility in Older Community-Dwelling Persons: A Narrative Review," (eng), *Frontiers in physiology*, vol. 11, p. 881, 2020.
- [219] A. Liu Cheng, "Machine Learning as enabler of Design-to-Robotic-Operation," *Archidoct*, vol. 6, no. 1, pp. 37–49, 2018.
- [220] Google Cloud Platform™, *Cloud Speech-to-Text: Speech to text conversion powered by machine learning and available for short or long-form audio*. [Online] Available: <https://cloud.google.com/speech-to-text/>. Accessed on: Apr. 25 2018.
- [221] Google Cloud Platform™, *Cloud Vision API: Derive insight from images with our powerful Cloud Vision API*. [Online] Available: <https://cloud.google.com/vision/>. Accessed on: Apr. 20 2018.
- [222] M. A. Steane, *The Architecture of Light: Recent Approaches to Designing with Natural Light*. Hoboken: Taylor and Francis, 2012.
- [223] A. Haans, "The natural preference in people's appraisal of light," *Journal of Environmental Psychology*, vol. 39, pp. 51–61, 2014.
- [224] K. C. Smolders and Y. A. de Kort, "Bright light and mental fatigue: Effects on alertness, vitality, performance and physiological arousal," *Journal of Environmental Psychology*, vol. 39, pp. 77–91, 2014.
- [225] K. Smolders, Y. de Kort, and S. M. van den Berg, "Daytime light exposure and feelings of vitality: Results of a field study during regular weekdays," *Journal of Environmental Psychology*, vol. 36, pp. 270–279, 2013.
- [226] B. K. Hawes, T. T. Brunyé, C. R. Mahoney, J. M. Sullivan, and C. D. Aall, "Effects of four workplace lighting technologies on perception, cognition and affective state," *International Journal of Industrial Ergonomics*, vol. 42, no. 1, pp. 122–128, 2012.
- [227] E. C. Marqueze *et al*, "Natural light exposure, sleep and depression among day workers and shiftworkers at arctic and equatorial latitudes," (eng), *PLoS one*, vol. 10, no. 4, e0122078, 2015.
- [228] E. Pasquini, "L'Institut du Monde Arabe—a "Must See" On a Visit to Paris," *The Washington report on Middle East affairs*, vol. 29, no. 2, p. 61, 2010.
- [229] Council on Tall Buildings and Urban Habitat, *Al Bahar Towers—External Automated Shading System: CTBUH Innovation Award Winner*, 2012.
- [230] A. Schlüter, *Soft robotics for adaptive building facades*. Accessed on: Apr. 20 2016.
- [231] K. Oosterhuis, "Caught in the Act," in *Applied Virtuality Book Series*, v.8, *ALIVE: Advancements in adaptive architecture*, M. Kretzer and L. Hovestadt, Eds, Basel/Berlin/Boston: Birkhäuser, 2014, pp. 114–119.
- [232] OpenCV, *OpenCV: Open Source Computer Vision Library*. [Online] Available: <https://opencv.org/>.
- [233] P. Soffritti, *Hand detection software written in C++ using OpenCV*. [Online] Available: <https://github.com/PierfrancescoSoffritti/Handy>. Accessed on: Jun. 18 2018.
- [234] hollyhook®, *oscHook: oscHook plots device sensor measurements and sends them in form of OSC messages*. [Online] Available: <https://play.google.com/store/apps/details?id=com.hollyhook.oscHook&hl=en>. Accessed on: Aug. 01 2018.
- [235] J. Jung, D. Kang, and C. Bae, "Peer to peer signal strength characteristic between IoT devices for distance estimation," in *2014 IEEE World Forum on Internet of Things (WF-IoT)*, Piscataway, NJ: IEEE, 2014, pp. 208–211.
- [236] A. Katz, *OSC Controller: Controls to send Open Sound Control messages over a network*. [Online] Available: <https://play.google.com/store/apps/details?id=com.ffsmultimedia.osccontroller&hl=en>. Accessed on: Aug. 01 2019.
- [237] Adafruit®, *Adafruit IO*. [Online] Available: <https://io.adafruit.com/>. Accessed on: Aug. 14 2019.
- [238] IFTTT®, *IFTTT: Everyt thing works better together*. [Online] Available: <https://ifttt.com/>. Accessed on: Aug. 01 2019.
- [239] L. Y. Mano *et al*, "Exploiting IoT technologies for enhancing Health Smart Homes through patient identification and emotion recognition," *Comput. Commun.*, vol. 89-90, pp. 178–190, 2016.
- [240] M. Leo and G.M. Farinella, Eds, *Computer Vision for Assistive Healthcare*: Elsevier, 2018.
- [241] VoiceIt®, *Your Voice Is Key®: Cloud Based Biometrics Service*. [Online] Available: <https://voiceit.io/>. Accessed on: May 30 2018.

- [242] NTE INEN 2249: *Accesibilidad de las personas al medio físico. Circulaciones Verticales. Escaleras. Requisitos*, 2249, 2016.
- [243] *United States Department of Labor, Occupational Safety and Health Administration, Part 1910: Stairways*, 1910.25.
- [244] A. Kameas and K. Stathis, Eds, *Ambient Intelligence: 14th European Conference, AmI 2018, Larnaca, Cyprus, November 12-14, 2018. Proceedings*, 1st ed. Cham: Springer International Publishing; Springer, 2018.
- [245] J. F. d. Paz Santana, V. Julian, G. Villarrubia, G. Marreiros, and P. Novais, *Ambient intelligence: Software and applications : 8th International Symposium on Ambient Intelligence (ISAmI 2017)*. Cham, Switzerland: Springer, 2017.
- [246] M. Grzegorzek, A. Gertych, G. Aumayr, and E. Piętka, "Trends in Active and Assisted Living - Open hardware architecture, Human Data Interpretation, intervention and assistance," (eng), *Computers in biology and medicine*, vol. 95, pp. 234–235, 2018.
- [247] F. Flórez-Revuelta and A.A. Chaaraoui, Eds, *Active and Assisted Living: Technologies and Applications*. Stevenage, UK: The Institution of Engineering and Technology, 2016.
- [248] M. Fox, *Interactive architecture: Adaptive world*. New York: Princeton Architectural Press, 2016.
- [249] K. E. Green, *Architectural Robotics: Ecosystems of bits, bytes, and biology*. Cambridge, Massachusetts: The MIT Press, 2016.
- [250] E. A. Edelman and E. Macagno, "Form Follows Function: Bridging Neuroscience and Architecture," in *Springer optimization and its applications*, v. 56, *Sustainable environmental design in architecture: Impacts on health*, S. T. Rassia and P. M. Pardalos, Eds, New York, NY: Springer, 2012, pp. 27–42.
- [251] C.-A. Roulet, P. M. Bluysen, B. Müller, and E. de Oliveira Fernandes, "Design of Healthy, Comfortable, and Energy-Efficient Buildings," in *Springer optimization and its applications*, v. 56, *Sustainable environmental design in architecture: Impacts on health*, S. T. Rassia and P. M. Pardalos, Eds, New York, NY: Springer, 2012, pp. 83–108.
- [252] G. E. Puglisi, A. Prato, T. Sacco, and A. Astolfi, "Influence of classroom acoustics on the reading speed: A case study on Italian second-graders," (eng), *The Journal of the Acoustical Society of America*, vol. 144, no. 2, EL144, 2018.
- [253] T. Shimizu and H. Onaga, "Study on acoustic improvements by sound-absorbing panels and acoustical quality assessment of teleconference systems," *Applied Acoustics*, vol. 139, pp. 101–112, <https://www-sciencedirect-com.tudelft.idm.oclc.org/science/article/pii/S0003682X17310654/pdf?md5=a7f1d7c153c346b90757600463508584&pid=1-s2.0-S0003682X17310654-main.pdf>, 2018.
- [254] S. Ochoa, G. Fortino, and G. Di Fatta, "Cyber-physical systems, internet of things and big data," *Future Generation Computer Systems*, vol. 75, pp. 82–84, <https://www-sciencedirect-com.tudelft.idm.oclc.org/science/article/pii/S0167739X17311196/pdf?md5=67689f695d26ac87b30f1765c457e09f&pid=1-s2.0-S0167739X17311196-main.pdf>, 2017.
- [255] D. Rutten, "Galapagos: On the Logic and Limitations of Generic Solvers," *Archit Design*, vol. 83, no. 2, pp. 132–135, 2013.
- [256] A. van der Harten, "Pachyderm Acoustical Simulation: Towards Open-Source Sound Analysis," *Archit. Design*, vol. 83, no. 2, pp. 138–139, 2013.
- [257] Grasshopper®, *About Grasshopper*. [Online] Available: <http://www.grasshopper3d.com/>. Accessed on: Feb. 14 2015.
- [258] D. Rutten, "Evolutionary Principles Applied to Problem Solving," Vienna, Austria, Sep. 21 2010.
- [259] M. V. Vargas-Parra, M. R. Rovira-Val, X. Gabarrell, and G. Villalba, "Rainwater harvesting systems reduce detergent use," *Int J Life Cycle Assess*, vol. 24, no. 5, pp. 809–823, 2019.
- [260] Sanches Fernandes, Luís F, Terêncio, Daniela P.S, Pacheco, Fernando A.L, "Rainwater harvesting systems for low demanding applications," *Science of The Total Environment*, vol. 529, pp. 91–100, 2015.
- [261] M. A. Macias-Corral and I. Sanchez-Cohen, "Rainwater harvesting for multiple uses: A farm-scale case study," (en), *Int. J. Environ. Sci. Technol*, pp. 1–10, <https://link-springer-com.tudelft.idm.oclc.org/content/pdf/10.1007%2Fs13762-018-02200-7.pdf>.
- [262] J. F. Velasco-Muñoz, J. A. Aznar-Sánchez, A. Batlles-delaFuente, and M. D. Fidelibus, "Rainwater Harvesting for Agricultural Irrigation: An Analysis of Global Research," *Water*, vol. 11, no. 7, p. 1320, 2019.
- [263] K. W. Koenig, "Rainwater harvesting: Vortex filters make cost savings at German hospital," *Filtration + Separation*, vol. 51, no. 1, pp. 36–38, 2014.
- [264] R. B. Thomas, M. J. Kirisits, D. J. Lye, and K. A. Kinney, "Rainwater harvesting in the United States: A survey of common system practices," *Journal of Cleaner Production*, vol. 75, pp. 166–173, 2014.

- [265] The Dark Sky Company, LLC, *About Us*. [Online] Available: <https://darksky.net/about>.
- [266] J. Espinoza, *Europe's Failing Health*. [Online] Available: <http://www.wsj.com/articles/SB10001424052748704893604576200724221948728>. Accessed on: Apr. 15 2015.
- [267] A. M. McNeill *et al*, "The Metabolic Syndrome and 11-Year Risk of Incident Cardiovascular Disease in the Atherosclerosis Risk in Communities Study," *Diabetes Care*, vol. 28, no. 2, pp. 385–390, 2005.
- [268] J. K. Ninomiya *et al*, "Association of the metabolic syndrome with history of myocardial infarction and stroke in the Third National Health and Nutrition Examination Survey," *Circulation*, vol. 109, no. 1, pp. 42–46, 2003.
- [269] C. Raffaitin *et al*, "Metabolic syndrome and risk for incident Alzheimer's disease or vascular dementia: the Three-City Study," *Diabetes Care*, vol. 32, no. 1, pp. 169–174, 2009.
- [270] T. Jaskiewicz, "Approaching Distributed Architectural Ecosystems," in *Applied Virtuality Book Series*, v.8, *ALIVE: Advancements in adaptive architecture*, M. Kretzer and L. Hovestadt, Eds, Basel/Berlin/Boston: Birkhäuser, 2014, pp. 133–139.
- [271] J. Sanchez, "Polyomino: The Missing Topology Mechanic," in *Applied Virtuality Book Series*, v.8, *ALIVE: Advancements in adaptive architecture*, M. Kretzer and L. Hovestadt, Eds, Basel/Berlin/Boston: Birkhäuser, 2014, pp. 125–128.

Curriculum Vitae

Alexander Liu Cheng

19.07.1981

Date of birth in Quito, Ecuador

Education

02.2016 – 12.2023

Ph.D. Student / Candidate

Thesis: The Intelligent Built-Environment as Cyber-Physical System

Promotor: Prof. Dr. Elmar Eisemann

Delft University of Technology

Delft, The Netherlands

09.2013 – 08. 2015

M.Sc. Advanced Construction and Building Technology—

Automation, Robotics, Services

Thesis: Design and Implementation of a Novel Cost-effective Fall-Detection and -Intervention System for Independent Living based on Wireless Sensor Network Technologies

Score: 1.0 (with high distinction / mit auszeichnung bestanden)

Technische Universität München

Munich, Germany

08.2006 – 09.2009

M.Arch. Architecture, 1st Professional

Thesis: Algorithmic Architecture in La Ciudad Feliz

Score: A (with Best Thesis Prize)

The University of British Columbia

Vancouver, British Columbia, Canada

08.2002 – 05.2005

B.S. Computer Science

Thesis: A New Encryption Algorithm based on RSA and Diffie-Hellman

Score: A (with Honors)

New York Institute of Technology

New York, New York, USA,

09.1997 – 05.2000

American Highschool Diploma,

Alliance Academy

Quito, Ecuador

Professional Experience

03.2020 – 12.2023

Senior Engineer / Data Analytics Lead

KEWAZO GmbH

Munich, Germany

05.2018 – 01.2020

Docente Titular Agregado

02.2012 – 03.2013

Docente Titular de Talleres Avanzados

Universidad Internacional SEK

Quito, Ecuador

09.2017 – 01.2018

Architekt / Computational Designer

09.2010 – 11.2011

Architectural Designer / Computational Designer

GRAFT GmbH

Berlin, Germany | Beijing, China

04.2016 – 02.2017

Docente Investigador

04.2013 – 08.2013

Coordinador de Talleres Avanzados
Universidad Tecnológica Equinoccial
Quito, Ecuador

03.2014 – 07.2015

Wissenschaftliche Hilfskraft
Technische Universität München
Munich, Germany

02.2012 – 10.2012

Docente Auxiliar
Universidad Central del Ecuador
Quito, Ecuador

Awards & Recognition

2018

Outstanding Researcher Award (Category: Scopus Publications)
Universidad Internacional SEK
Quito, Ecuador

2018

Best Robotics and Automation Systems (RAS) Paper Award
3rd IEEE Ecuador Technical Chapters Meeting 2018
Cuenca, Ecuador

2017

Top 15% Selected Invitation for “Special Issue”
Journal of Automation in Construcion

2016

Best Poster Award
33rd International Symposium on Automation and Robotics in Construction 2016
Auburn, Alabama, USA

2015

Top 10% “Best Papers”

32nd International Symposium on Automation and Robotics in Construction 2015

Oulu, Finland

2013.10 - 2015.08

“Universidades de Excelencia” Full Scholarship

Secretaría de Educación Superior, Ciencia, Tecnología e Innovación de Ecuador

Quito, Ecuador

2009

Master of Architecture Thesis Prize

2008

Junior Fellow, St. John’s College

2007

Student Contribution Award

2006 / 2007

Junior Fellow / Fellow, Green College

2006

Bryce Rositch Award

The University of British Columbia

Vancouver, British Columbia, Canada

List of Publications

- 24. H. Bier and A. Liu Cheng, “Ancestorfuturist explorations within a design-to-robotic-operation framework,” (English), *Hiperorganicos : Vol. 3 - Art, Consciousness and Nature / Create, Cultivate, Connect*, <https://research.tudelft.nl/en/publications/ancestorfuturist-explorations-within-a-design-to-robotic-operatio>, 2021.
- + 23. A. Liu Cheng, L. Moran Silva, M. Real Buenaño, and N. Llorca Vega, “Development of an Adaptive Rainwater-Harvesting System for Intelligent Selective Redistribution,” in *Proceedings of the 4th IEEE Ecuador Technical Chapters Meeting (ETCM) 2019*, 2019.
- + 22. A. Liu Cheng, P. Cruz, N. Llorca Vega, and A. Mena, “Development of an Acoustically Adaptive Modular System for Near Real-Time Clarity-Enhancement,” in *Lecture Notes in Computer Science*, vol. 11912, *Ambient Intelligence (AmI 2019)*, I. Chatzigiannakis, B. de Ruyter, and I. Mavrommati, Eds., Springer International Publishing, 2019, pp. 170–185.
- + 21. A. Liu Cheng et al, “Development of An Adaptive Staircase System Actuated by Facial-, Object-, and Voice-Recognition,” in *Proceedings of the 21st IEEE International Conference on E-Health Networking, Application & Services (Healthcom) 2019*, 2019.
- + 20. A. Liu Cheng, N. Llorca Vega, and G. Latorre, “Development of an Eye- and Gaze-Tracking Mechanism in an Active and Assisted Living Ecosystem,” in *Proceedings of the 36th International Symposium on Automation and Robotics in Construction (ISARC) 2019*, Banff, AB, Canada: IAARC, 2019, pp. 749–755.
- + 19. A. Liu Cheng, N. Llorca Vega, G. Latorre, and D. Coba, “Development of a Light-Tracking and -Redirecting System Actuated by Hand-Gesture Recognition,” in *Proceedings of the IEEE 5th World Forum on Internet of Things 2019*, Piscataway, NJ, USA: IEEE, 2019, pp. 702–706.
- + 18. A. Liu Cheng, C. Santos, P. Santos, and N. Llorca Vega, “Development of a Smart Sleeve Control Mechanism for Active Assisted Living,” in *Proceedings of the IEEE 5th World Forum on Internet of Things 2019*, Piscataway, NJ, USA: IEEE, 2019, pp. 847–851.

- + 17. A. Liu Cheng, H. Bier, and G. Latorre, "Actuation Confirmation and Negation via Facial-Identity and -Expression Recognition," in *Proceedings of the 3rd IEEE Ecuador Technical Chapters Meeting (ETCM) 2018*, 2018.
- 16. C. Follini, A. Liu Cheng, G. Latorre, and L. Freire Amores, "Design and Development of a Novel Robotic Gripper for Automated Scaffolding Assembly," in *Proceedings of the 3rd IEEE Ecuador Technical Chapters Meeting (ETCM) 2018*, 2018.
- 15. A. Liu Cheng, "Machine Learning as enabler of Design-to-Robotic-Operation," *Archidoct*, vol. 6, no. 1, pp. 37–49, 2018.
- + 14. H. Bier, A. Liu Cheng, S. Mostafavi, A. Anton, and S. Bodea, "Robotic Building as Integration of Design-to-Robotic-Production and -Operation," in *Springer Series in Adaptive Environments*, vol. 1, *Robotic Building*, H. Bier, Ed. 1st ed.: Springer International Publishing AG, 2018.
- + 13. A. Liu Cheng, H. Bier, and S. Mostafavi, "Integration of a Wearable Interface in a Design-to-Robotic-Production and -Operation Development," in *Proceedings of the 35th International Symposium on Automation and Robotics in Construction (ISARC) 2018*, Berlin, Germany, 2018, pp. 646–653.
- + 12. A. Liu Cheng and H. Bier, "Extension of a High-Resolution Intelligence Implementation via Design-to-Robotic-Production and -Operation strategies," in *Proceedings of the 35th International Symposium on Automation and Robotics in Construction (ISARC) 2018*, Berlin, Germany, 2018, pp. 1005–1012.
- + 11. A. Liu Cheng, H. Bier, and S. Mostafavi, "Deep Learning Object-Recognition in a Design-to-Robotic-Production and -Operation Implementation," in *Proceedings of the 2nd IEEE Ecuador Technical Chapters Meeting 2017*, Salinas, Ecuador, 2017.
- + 10. A. Liu Cheng, H. Bier, G. Latorre, B. Kemper, and D. Fischer, "A High-Resolution Intelligence Implementation based on Design-to-Robotic-Production and -Operation strategies," in *Proceedings of the 34th International Symposium on Automation and Robotics in Construction (ISARC 2017)*, Taipei, Taiwan (R.O.C.), 2017.
- 9. A. Liu Cheng, "Design-to-Robotic-Operation Principles and Strategies as Drivers of Interior Environmental Quality (Extended Abstract)," *Next Generation Building*, no. 3, 2016.

- + 8. A. Liu Cheng and H. Bier, "Adaptive Building-Skin Components as Context-Aware Nodes in an Extended Cyber-Physical Network," in *Proceedings of the 3rd IEEE World Forum on Internet of Things*: IEEE, 2016, pp. 257–262.
- + 7. A. Liu Cheng and H. Bier, "An Extended Ambient Intelligence Implementation for Enhanced Human-Space Interaction," in *Proceedings of the 33rd International Symposium on Automation and Robotics in Construction (ISARC 2016)*, Auburn, Alabama, 2016, pp. 778–786.
- 6. A. Liu Cheng, "Towards embedding high-resolution intelligence into the built-environment," *Archidoct*, vol. 4(1), no. 7, pp. 29–40, http://www.enhsa.net/archidoct/Issues/ArchiDoct_vol4_iss1.pdf, 2016
- 5. A. Liu Cheng, C. Georgoulas, and T. Bock, "Fall Detection and Intervention based on Wireless Sensor Network Technologies," *Automation in Construction*, 2016.
- 4.* A. Liu Cheng, C. Georgoulas, and T. Bock, "Design And Implementation Of A Novel Cost-effective Fall Detection And Intervention System For Independent Living Based On Wireless Sensor Network Technologies," in *Proceedings of the 32nd International Symposium on Automation and Robotics in Construction (ISARC 2015)*, Oulu, Finland, 2015.
- 3.* A. Liu Cheng, "InTUItive Robot Teleoperation within Ambient Assisted Living Environments via Grasshopper, Firefly, and gHowl," in *Proceedings of the CIB IAARC W119 CIC 2014 Workshop*, Munich, Germany: Lehrstuhl für Baurealisierung und Baurobotik (BR²), Technische Universität München, 2014, pp. 33–38.
- 2.* A. Liu Cheng, "Post-Disaster Reconstruction Efforts Informed by Swarm Intelligence via Data Mining of Social Networks," in *Proceedings of the CIB IAARC W119 CIC 2014 Workshop*, Munich, Germany: Lehrstuhl für Baurealisierung und Baurobotik (BR²), Technische Universität München, 2014, pp. 28–32.
- 1.* A. Liu Cheng, P. Skrzypczyk, and B. Toornstra, "REST (Relief from Emergency for Survival Treatment): An alternative approach to Tsunami / Post-Tsunami Life-Support Systems," in *Proceedings of the CIB IAARC W119 CIC 2014 Workshop*, Munich, Germany: Lehrstuhl für Baurealisierung und Baurobotik (BR²), Technische Universität München, 2014, pp. 1–6.

+ Included in this thesis

● Awarded Prize

* Publications 1–4 were published during my Master of Science studies at Technische Universität München.

The Intelligent Built-Environment as Cyber-Physical System

Alexander Liu Cheng

This thesis presents an alternative approach to *intelligence in the built-environment*, departing from the two established yet divergent branches in the discourse: the *Technical*, centered around *Information and Communication Technologies (ICTs)*, and represented by *Ambient Intelligence (AmI)* and *Ambient Assisted Living (AAL)*; and the *Architectural*, centered around architectural / spatial experiences and considerations, and represented by *Interactive Architecture* and *Adaptive Architecture*.

The promise of both AmI/AAL and IA/AA is constrained by rigid and increasingly outdated assumptions in their approaches—i.e., AmI's / AAL's approach to the built-environment, and IA's / AA's approach to ICTs. Moreover, it is impossible to combine them to yield a cohesive system due to disparity in their typical *Technology Readiness Levels*. That is, the sophistication of a system depends on that of its mutually complementing subsystems; and two or more subsystems may not mutually complement, sustain, and/or support one another if their levels of development do not correspond.

Consequently, the presented alternative conceives the intelligent built-environment as a *Cyber-Physical System*. Under this approach, ICTs and Architectural considerations *in conjunction* instantiate intelligence fundamentally. The presented approach's promise is illustrated via its application to a constrained use-case focused on the elderly. Twelve *proof-of-concept* demonstrators are developed based on key parameters pertaining to *Indoor Environmental Quality* and *Quality of Life*. While each demonstrator is presented as a discrete *proof-of-concept*, all build on the same core System Architecture and technological ecosystem, and are intended to be viewed as a collection of systems and services expressed within a same hypothetical environment.

A+BE | Architecture and the Built Environment | TU Delft BK