

Digital design workflow using fabrication-aware configurators

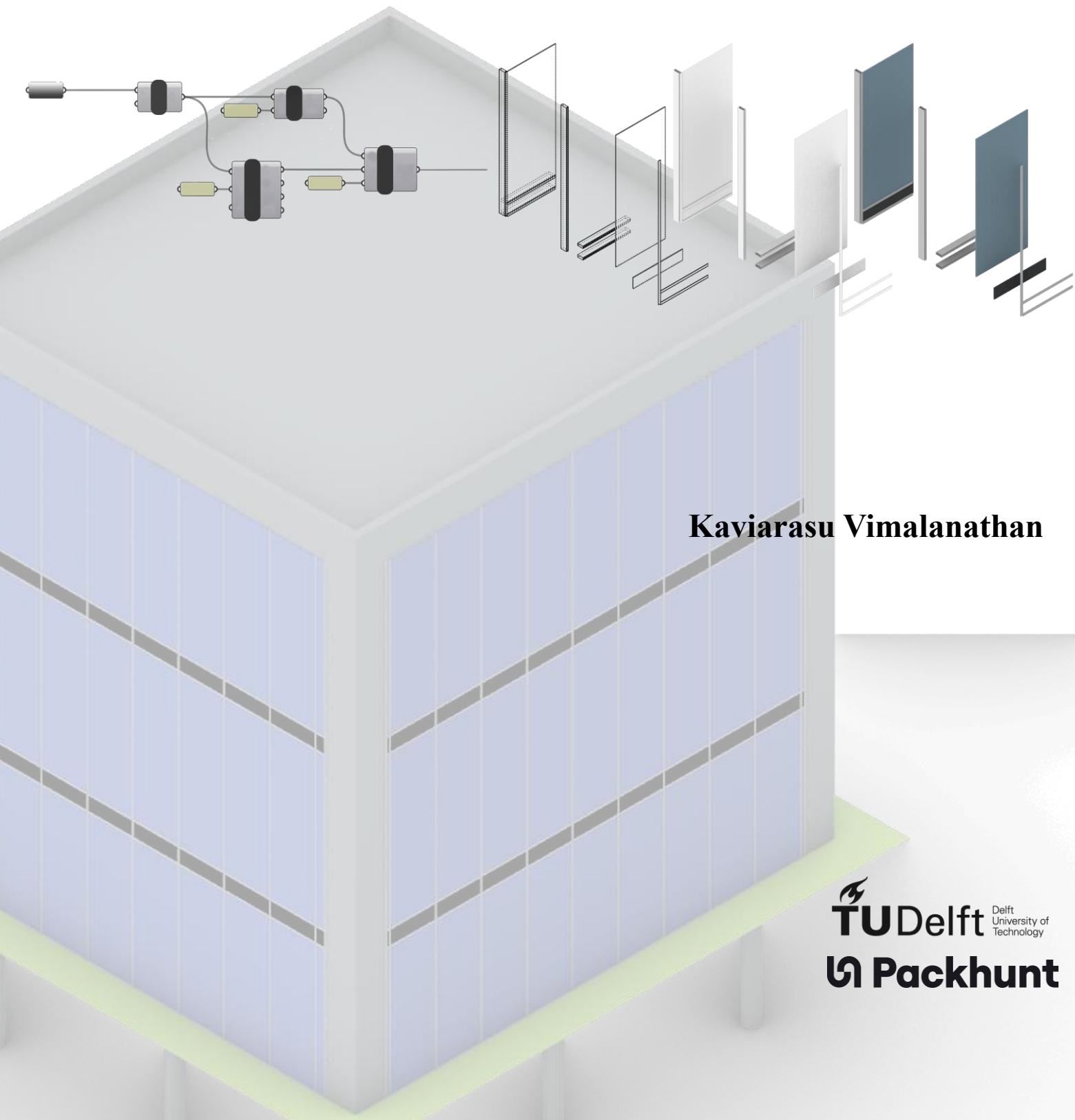

Kaviarasu Vimalanathan

Digital design workflow using fabrication-aware configurators

by

Kaviarasu Vimalanathan

Master thesis submitted to the Delft University of Technology
in partial fulfilment of the requirements for the degree of

Master of Science

in Civil Engineering

Faculty of Civil Engineering and Geosciences

in coordination with White Lioness technologies
to be publicly defended on 31st October 2023

Student number: 5466652

Thesis committee: Dr.ir. H.R. (Roel) Schipper TU Delft
Dr.ir. Sander van Nederveen TU Delft
Dr. P. Janssen White Lioness technologies
Dr.ir. J.L. Coenders White Lioness technologies

Acknowledgements

I wish to convey my profound gratitude and appreciation to everyone who granted me the opportunity to finalize this endeavour. The realization of such a project results from the invaluable contributions of numerous individuals who generously offered their time, expertise, and resources.

Firstly, I wish to express my gratitude to Roel Schipper, Patrick Janssen, Jeroen Coenders and Sander van Nederveen for their priceless insights, constructive critiques, and engaging feedback during the evolution of this academic work. Their viewpoints and suggestions were instrumental in refining this project. My deepest thanks go to my two mentors, Roel and Patrick, whose knowledge, compassion, and endurance have significantly enriched my graduate journey. Special thanks to Jeroen for allowing me to collaborate with Packhunt and use their industry-leading configurator. Thanks to Sander for his valuable insights during the final phase of the thesis. I value all my committee members's extensive proficiency and capabilities in the construction industry and adjacent fields and their persistent inspiration and encouragement throughout my study.

I am immensely grateful to my professional leads, Anke Rolvink and Leah Dierker Viik, for their encouragement and for managing my internship work with my academic research, which allowed me to understand the configurator role and finalize this project.

I also wish to extend my appreciation to professionals from various industries who supported this research journey. I am beholden to all and aspire to validate their contribution through the calibre of my work.

Last but not least, my family and friends deserve my deepest gratitude for their endless love, backing, and sacrifices throughout my life and during my master's. Their confidence in my potential and pride in my achievements have been my constant strength.

In conclusion, I acknowledge that the support of many made this research possible, and any unintentional omission of acknowledgement is regretted. My heartfelt gratitude goes to everyone who participated in this journey, and I dedicate my endeavour to all those who accompanied me.

Kaviarasu Vimalanathan

Amsterdam, October 2023

Abstract

The construction industry has undergone a profound transformation in recent years, driven mainly by integrating advanced digital tools. One such tool is configurators, advanced digital platforms that enable the integration of diverse knowledge domains, allowing architects, designers, fabricators, contractors, and engineers to explore many design variations and assess them against various parameters such as sustainability, cost, and manufacturability. However, Building Information Modelling (BIM) stands out as a game-changer, revolutionising how stakeholders collaborate and execute projects. Generally, a building configurator is made for product-specific criteria involving only one stakeholder. As to developing a multi-party configurator, this research delves into the transformative role of configurators in streamlining design workflows and enhancing collaboration among stakeholders in the construction sector.

The Design-Bid-Build (DBB) system, a predominant project delivery method in construction, operates under a linear workflow where the design and construction phases are distinct and sequential. During the bidding phase of this system, once the design is finalized and approved, it is put out to bid, inviting contractors to submit their proposals. To formulate their bid, contractors review the design documents and calculate the overall cost, considering labour, materials, overhead, and profit. This phase is characterized by competitive bidding, where multiple contractors vie to offer the most cost-effective solution to secure the project. This method allows owners to select a contractor that best aligns with the project's budgetary and quality requirements.

In a conventional design workflow, the conceptual design undergoes numerous iterations of design and detailing before advancing to the fabrication phase. This iterative cycle, albeit integral to building planning, is notably time-intensive. Given this context, integrating manufacturing insights early in the design phases has been contemplated to expedite the overall design workflow.

Given the considerations above, the project's proposal was focused on creating a prototype tool capable of executing the competitive bidding process involving contractors and subcontractors. It also translates the manufacturer's expertise into a digital model. The example of the curtain wall system as a prototype was chosen and modelled as a solution to the proposed workflow. As an assumption, Two curtain wall systems, stick and unitised, are built by two fabricators. This proof of concept would enable the design of a curtain wall façade to be ready for the schematic phase after the bidding.

The foundational knowledge and information for developing this tool were sourced from the literature survey. The tool entered the modelling phase after the initial study of design workflow and façade elements. The configurator aimed to highlight the tool's user and developer and their impact during the modelling. The initial step involved setting the input parameters, using the knowledge from the manufacturer needed for the bidding, enabling the designer to create a model that aligns with the manufacturer's capabilities. Two bidding fabrication-aware configurators were formulated based on the tool's back end.

Following the development of the two configurators, the project advances to the validation phase, structured into two distinct processes. Initially, the process was tested for its feasibility and workability of the configurator by various iterations of the input parameters. The outcomes of this process ensure the critical support requirements for the proof of concept.

Subsequently, the emphasis shifts to the professional validation of the configurator, a crucial step in the practicality of the solution. Four key validations were analysed in this step with professional feedback from the demonstration. The derived results offer insights into various aspects of the design's effectiveness, productivity, functionality and market viability, providing pivotal information that can significantly influence the refinement and finalization of the project. The validation results are instrumental in making informed adjustments and optimizations, ensuring the proposed design workflow meets the intended objectives and specifications.

Adopting configurators in the construction industry is instrumental in addressing the challenges of increasing design complexities and the demand for sustainable, high-performance buildings. By providing a platform for real-time feedback and multidisciplinary collaboration, configurators allow for informed decision-making, optimizing designs for human comfort, environmental impact, and structural integrity. The exploration of configurators in this paper underscores their significance in advancing digital design workflows and highlights their potential in shaping the future of construction, marked by innovation, sustainability, and enhanced interoperability.

Table of Contents

Acknowledgements.....	iii
Abstract.....	iv
Table of Contents.....	vi
List of Figures	viii
List of tables	xi
List of abbreviations.....	xii
1 Introduction	1
1.1 Background Information.....	1
1.2 Design Bid Build Workflow.....	3
1.3 Problem Statement.....	4
1.4 Research Hypothesis.....	5
2 Literature Review.....	6
2.1 Current Building Workflow and its Practices	6
2.2 Design Solutions.....	7
2.3 Facades.....	8
3 Methodology.....	11
3.1 Proof of concept.....	12
3.2 Digital Design Workflow.....	12
4 Development of Configurator	14
4.1 Packhunt Configurator	14
4.2 Curtain Wall Facade Modelling.....	16
4.2.1 Initial Setup – Preliminary Design	18
4.2.2 Governing Parametric Inputs	20
4.2.3 Level of Detail (LOD)	24
4.2.4 Packhunt Plugin and Set of Rules.....	25
4.2.5 Façade Section and Build-up.....	27
4.2.6 Panelisation and Assembly	33
4.2.7 Generating the cost of the facade	35
4.2.8 Output for the Configurator.....	36
4.3 Self Service Interface (SSI).....	38
5 Results.....	41
5.1 Results from Curtain Wall Modelling and Configuration.....	41

5.2	Validation of the Proof of Concept	49
5.2.1	Feedbacks.....	50
5.3	Validation Aspects.....	52
5.4	Limitations.....	53
6	Discussions	55
6.1	Reflection on the Façade Configurator	55
6.2	Hypothesis Testing and Impact of the Design Workflow.....	56
7	Conclusions and Recommendations	58
7.1	Conclusions	58
7.2	Recommendations and Future Scope	59
	References	61
A	Parametric Modelling.....	A-1
A.1	Common Grasshopper scripts.....	A-1
A.2	Stick CWS Configurator	A-4
A.3	Unitised CWS Configurator	A-5
B	Façade Sections.....	B-1
B.1	Drawings and sketches.....	B-1
C	Workflow and Data Exchange.....	C-1
C.1	Workflow.....	C-1
D	Professional Feedback	D-1
D.1	Interviews.....	D-1

List of Figures

Figure 1.1. Product configurator with the design details of the electric car (Tesla, 2023)	3
Figure 1.2. Schematic representation of the proof of concept.....	5
Figure 2.1. The conventional design process for façade systems (Boswell, 2013).....	9
Figure 2.2. Stick system (left) and Unitised system (right) (Herzog et al., 2017)	10
Figure 3.1. The sequence of events in the research from start to finish	11
Figure 3.2. Packhunt configurator layout denoting the three primary entities.	12
Figure 3.3. Conventional Design-Bid-Build (left) without the tool vs Proposed Design-Bid-Build (right) – with the configurator	13
Figure 4.1. Layout of Packhunt configurator – 1. Visualisation tool (left) and 2. User interface (right)14	
Figure 4.2. Process of events in Packhunt’s configurator workflow	15
Figure 4.3. Isometric view of rendered Curtain Wall System (CWS) and its components	17
Figure 4.4. Initial design workflow – surface with ‘n’ degree of freedom (left), panelisation and optimisation of the surface for grid points (middle) and final design solution for a given surface (right)	18
Figure 4.5. Corner curtain wall (top) (METRIK, 2018) and Equal length of the panel (bottom) (Anonymous, 2021).....	19
Figure 4.6. Connection of Packhunt’s input component with the number slider.	20
Figure 4.7. Skeletal of the 3D model.....	21
Figure 4.8. Panel spread around the canvas for the initialisation of static inputs	23
Figure 4.9. Illustration of factored input and conditional input.....	24
Figure 4.10. Level of Detail (LOD) of split Mullion considered for modelling	25
Figure 4.11. Vertical section of stick system connecting two glass panels - high level of detail (left) and minimum level of detail (right)	25
Figure 4.12. Packhunt plugin components used in the façade configurator	26
Figure 4.13. Simple GH canvas showing standards and principles	27
Figure 4.14. Representation of mullion section on Rhino XY-plane – Breadth is 50 mm for a length of 100 mm (left), and breadth is 55mm for a length of 170 mm (right)	28
Figure 4.15. Drafted sections in the modelling of two curtain wall systems	29
Figure 4.16. The 3-D modelling process of a single unit of stick panel (left) and unitised panel (right)	31
Figure 4.17. Three types of Stick CWS panels – Regular (Left), Corner (Middle) and Edge (Right)	32

Figure 4.18. General stick system façade elements for side one (top explode tree) and two (bottom explode tree).....	33
Figure 4.19. Grid system and reference points generation (YZ plane) for corner wall condition (left) and no corner wall condition (right)	34
Figure 4.20. Lengthwise façade components moved to respective reference points	34
Figure 4.21. Assembly of the final façade elements	35
Figure 4.22. Algorithm of the calculation of the area of the panel.....	36
Figure 4.23. Material allocation and Output of the Configurator	37
Figure 4.24. Definition of “Text Output” component	38
Figure 4.25. Working methodology of Packhunt’s Self-Service Interface (SSI)	39
Figure 4.26. The layout of assigning material names and colours	39
Figure 5.1. Check for the equal dimension of the panel’s length and the corner façade’s length.....	42
Figure 5.2. A – Exploded regular stick system, B – Connection detail of glass panel with the mullion, C – Connection detail of glass panel and spandrel panel with the transom and D - Cross-section of the transom	43
Figure 5.3. A – Exploded corner stick façade system, B - Corner Stick System, C – Connection detail of glass panel and corner fin with the corner mullion and D - Cross-section of the corner mullion section	44
Figure 5.4. A - Left split-mullion, B – Exploded view of the unitised system, C – Right split mullion, D - Cross-section of the spandrel transom and split transom and E - Connection detail of glass panel and split transom with split mullion	46
Figure 5.5. A - Exploded view of the corner unitised system, B – Corner unitised system, C – Connection detail of glass panel with a top corner split mullion and D – Connection detail of the spandrel fin transom, corner fin mullion with glass and spandrel panel.....	47
Figure 5.6. Single floor condition for a unitised façade system (left) and Stick system with a corner wall condition is toggled	48
Figure 5.7. Modelling when fit panel to its length is turned off (left) and turned on (right)	48
Figure 5.8. The stick system configurator deployed in the Packhunt server	49
Figure A.1. Overview of the script structure for both configurators.....	A-1
Figure A.2. Fit panel logic to adjust the new length and breadth of the floor.....	A-1
Figure A.3. Fit panel logic when the corner wall is turned on	A-2
Figure A.4. Structure logic for floor, foundation and columns.....	A-2
Figure A.5. Structural logic for roof and parapet	A-2
Figure A.6. Corner wall logic for the structural component	A-2
Figure A.7. Overview of the panelisation and reference points generation canvas	A-3

Figure A.8. Logic for three types of fin section	A-3
Figure A.9. Logic for generation of the stick section.....	A-3
Figure A.10. Logic for the assembly for all the floors except the ground floor.....	A-4
Figure A.11. Overview of the stick system model and its assembly canvas.....	A-4
Figure A.12. Overview of the corner stick system logic and its assembly canvas.....	A-5
Figure A.13. Overview of the unitised system model and its assembly canvas.....	A-5
Figure A.14. Overview of corner unitised system logic and its assembly canvas	A-5
Figure B.1. Stick system sections considered for the modelling – Part 1.....	B-1
Figure B.2. Stick system sections considered for the modelling - Part 2.....	B-2
Figure B.3. Unitised system sections considered for the modelling – Part 1.....	B-2
Figure B.4. Unitised system sections considered for the modelling – Part 2	B-3
Figure C.1. Schematic representation of construction supply chain management in the construction industry (Vrijhoef & De Ridder, 2014)	C-1

List of tables

Table 4.1. Structural Components Inputs.....	21
Table 4.2. Façade Components Inputs	22
Table 4.3. Cost Components Inputs	22
Table 4.4. Cost calculation of both façade systems.....	35
Table 4.5. Description and Details of the Output Components	37
Table 4.6. Modifiable input fields in the setting panel of SSI.....	40
Table 5.1. Validation aspects and feedback questions regarding the assessment.....	50
Table D.1. Interview answers and recommendations – Personnel 2	D-1
Table D.2. Interview answers and recommendations – Personnel 1	D-2
Table D.3. Interview answers and recommendations – Personnel 3	D-3
Table D.4. Interview answers and recommendations – Personnel 4	D-4
Table D.5. Interview answers and recommendations – Personnel 5	D-5

List of abbreviations

2D	2 Dimensional
3D	3 Dimensional
AEC	Architectural Engineering and Construction
BIM	Building Information Modeling
BOQ	Bill of Quantities
CAD	Computer Aided Design
CWS	Curtain Wall Systems
DBB	Design Bid Build
DfMA	Design for Manufacture and Assembly
GC	General Contractor
GH	Grasshopper
ICT	Information and Communications Technology
IPD	Integrated Project Delivery
LOD	Level of Detail
mm	Millimetres
NURBS	Non Uniform Rational B-Splines
PoC	Proof of Concept
RFA	Real-time Fabrication analysis
SSI	Self-Service Interface
SubD	Subdivision
UI	User-Interface
URL	Uniform Resource Locator

1

Introduction

This chapter briefly explains construction practices in the construction firm and how various stakeholders participate. It further outlines the significance of automated processes between the stakeholders and how configurators work in the industry. The research analyses the problem in the current practices and develops a research question. The research hypothesis is discussed on how to overcome the problem statement.

1.1 Background Information

Today's construction practices have evolved significantly, with contractors playing a pivotal role in ensuring project success. Modern contractors are not just builders but project managers, coordinating various trades, ensuring safety standards, and integrating technology into their workflows. Digital tools, like Building Information Modelling (BIM) and project management software, have become indispensable, allowing for real-time collaboration, efficient resource allocation, and predictive analytics. Sustainability is also a key focus, with contractors adopting green building techniques and materials to reduce environmental impact. Additionally, with the rise of modular and prefabricated construction, contractors are leveraging off-site production for faster, more efficient builds. This holistic approach ensures timely, cost-effective, quality outcomes in contemporary construction.

The background process of the current workflow has involved lots of information flow between parties and seems repetitive until the final design is developed. Apart from the major parties, many sub-divisions and groups of stakeholders are involved in the process and cannot hinder the progress (Jin et al., 2017). There are many proposed solutions from the stakeholders or service providers to overcome the tedious procedure; some are practised now.

One such early design solution is that designers have rationalised and optimised the design to simplify an end-design product. The early design process in construction is often referred to as design rationalisation. Design rationalisation strives to improve building performance regarding material resource consumption, manufacturing time, and labour costs (Dritsas, 2012). It also controls quality from detailed design to the construction phase. The rationalised design of the building component undergoes multiple selections and testing before it is sent to factories for manufacturing. However, in a rationalisation strategy, a third party translates the architect's original design model to a different computational medium to better

suit its fabrication setup (Austern et al., 2018). This process is performed either by the fabricator himself or a fabrication specialist, such as design to production. However, the impact of design rationalisation is not notable in the typical design of the buildings.

Secondly, contractors have incorporated BIM and its technology in the building to have a smoother workflow. BIM allows contractors to visualise the entire project, detect clashes, and make informed decisions. The entire project team benefits from an accurate building model. It lessens the possibility of mistakes and disagreements and enables a smoother, better-planned construction process. Contractors nowadays also use prefabrication techniques to assemble components off-site, ensuring timely and quality project completion. Enshassi et al (2019) discovered that a significant shift in organisational culture was necessary, but there was a lack of senior management support, little understanding of how to adopt BIM, little staff expertise, and a need to change work processes.

To create a better workflow and design solution, fabricators or subcontractors, the third main party, use specialised software tailored to their trade. For instance, a carpentry subcontractor might use software specially designed for wood systems. This software can help with design, material estimation, and scheduling, ensuring that suitable materials are available when needed and reducing wastage. Like General Contractors (GC), subcontractors use prefabrication techniques for quick installations and hassle-free project delivery.

Overall, every stakeholder has adapted to a faster and more efficient way in the construction industry. The common practice between all three parties is BIM and its tools. BIM software allows users to create custom elements, modify existing ones, and adapt the modelling environment to suit specific project needs or preferences. Users can develop custom scripts, plugins, or applications to automate routine tasks, enabling a more tailored approach to modelling and project management. For example, software like Autodesk Revit allows users to create custom parametric components and tailor them to meet specific design requirements. Additionally, users can leverage programming languages to automate workflows. Sacks et al (2018) also say the customisable functions for generating model displays that are coloured according to various data are highly beneficial.

One such tool is a configurator, developed for a specific purpose and comprises a catalogue of predefined products. A configurator is a very effective platform for entering and visualising management information, particularly for erectors and general contractor staff outside the developer organisation. Configurators are commonly used in various industries, including manufacturing, e-commerce, construction, and automotive. A simple example of an automobile configurator from Tesla is shown in Figure 1.1. The automotive configuration is a product-specific configuration that can initiate the material selection of seat, engine type, motor performance, et cetera. The design tool also provides the customer with a 3D rendering of the e-vehicle, cost and delivery time. The rendering of the material is subjective to the user's definition.

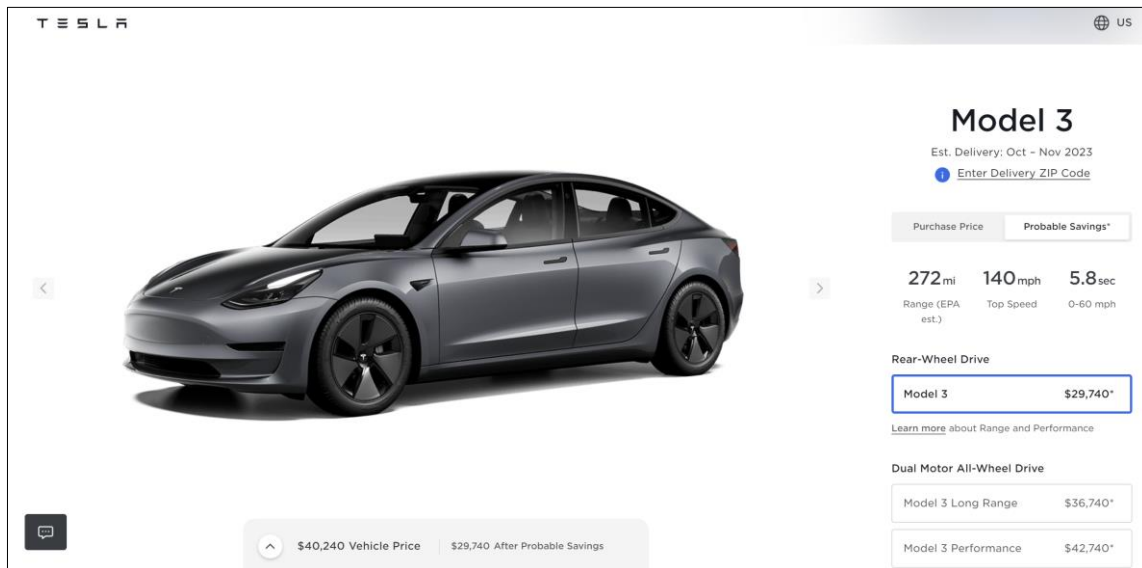

Figure 1.1. Product configurator with the design details of the electric car (Tesla, 2023)

1.2 Design Bid Build Workflow

Design-Bid-Build (DBB) is a widely adopted project delivery method in the construction industry. The bidding phase in the DBB system unfolds as a structured, competitive process once the design phase is concluded. When making these required designs into reality, designers often need customised products to be created by fabricators. These products can be any part of the building, like facades, roofs, stairs, and many other components. Such customised products are typically based on a system of components that can be configured according to rules. For example, a staircase in a BIM model is not just a static representation; it is a parametric object that can have attributes like height, width, material, colour, and more. By adjusting these parameters, the appearance and properties of the staircase can change, but it remains fundamentally a staircase.

The following step is transferring the document for the bid invitation to the contractor by the owner or the architect. Upon receiving the bid invitation, interested contractors meticulously review the provided design documents to comprehend the project's scope, scale, and complexities. The attributes are nothing but the reflection of various fabrication constraints. The constraint leads to changes and sometimes leads to complete product change. So, to get the best design solution, contractors must consult multiple fabricators and compare the various solutions offered against the project's requirements.

Contractors submit their proposals by a predetermined deadline, and the owner, alongside any consultants, scrutinizes the received bids, evaluating them predominantly based on the proposed cost and considering factors such as contractors' experience, past performance, and availability. Segerstedt & Olofsson (2010) conveys that past performance is generally seen as a foundation for forming a well-established supply chain in manufacturing industries. A

quick and visualised solution for product design is helpful for every contractor to submit the best bid and give details to the subcontractors. However, currently, most of the product configurators do not have technical pieces of information. The design tool should consider the technical and engineering details rather than the architect's imagination.

The last step is the awarding phase, where the contract is typically awarded to the lowest responsive and responsible bidder, provided they meet all the stipulated criteria and requirements. This entire bidding process in the DBB model is characterized by open competition and clear separation of design and construction responsibilities, aiming to secure favourable pricing and high-quality execution for the owner.

1.3 Problem Statement

Creating a smooth workflow between various parties is always a task in every project. For creating the unbarring workflow, the design's technical aspects should be well-known and shared between the parties. For example, a structural engineer should know the specifications of the steel supplier. The case is simple in most cases, but there might be a few exceptions when an on-field survey is done, and small values can play a vital role in design alteration. Engineers from the supplier must collaborate well with structural people at the start of the project to ensure a robust foundation design.

Likely, contractors consult multiple subcontractors to assess the architect's designed systems' constructability. These systems are then executed in real life. The contractor concludes by submitting the best bids from the fabricators. The process is time-consuming and lacks clarity in the design phase. On the other hand, the fabricator has a one-off product developed based on aesthetics, costs, and performance. For example, the façade system proposed by the fabricator will have a different design from the architect's glazing preferences, the glass colour and structural connection systems. The fabricator will try implicating their solution instead of the designer's goal. This construction process transfers much information from one party to another, and in the end, too much paperwork is executed.

However, there is a lack of design tools for the bidding process, which can be pivotal in the early design phase. Automating the workflow is the need of the hour, which can be developed using various design tools. The configurator, being one, would address standardisation, consistency, and data accuracy. The challenges associated with the configurator are resistance to change, compatibility and lack of development. Moreover, it is necessary to investigate the viability and efficacy of employing a configurator to automate processes in the building business to solve these difficulties. This problem and situation bring us to the research question,

“How can design workflow and early design solutions be improved using fabrication-aware product configurators?”

1.4 Research Hypothesis

Various workflows exist in the construction industry, and numerous stakeholders participate. All the workflows can be configured differently and meant for different purposes. However, this research limits the broad scope of the proposed workflow with the test case. So, the research develops a design tool to show the implementation of the digital design workflow using a configurator. Hence, to automate the construction process with the digital design workflow with the configurator,

- A fabrication-aware configurator would be a proof of concept for the proposed digital design workflow.
- The working nature of the configurator follows the Design-Bid-Build (DBB) project delivery method involving contractors and fabricators, as illustrated in Figure 1.2.
- An example curtain wall façade configurator from two different manufacturers will be developed.
- The façade configurator will be validated using various aspects, proving its role in the digital design workflow.

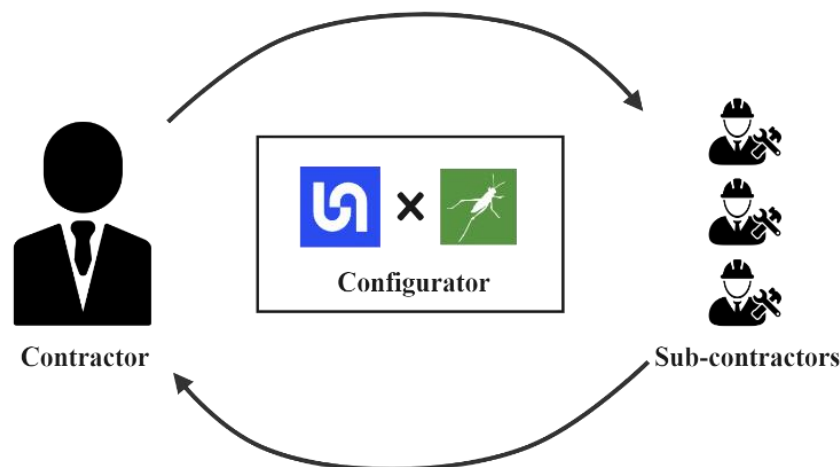

Figure 1.2. Schematic representation of the proof of concept

2

Literature Review

This chapter reviews the existing works on the current practice of the construction process and how the process is executed. It supports the need to develop a digital design workflow. Additionally, the chapter explains the current solutions developed in the construction industry and their impact. Details about the façade types and design are also explained.

2.1 Current Building Workflow and its Practices

Construction supply chains are unstable, fragmented, and make-to-order, with little repetition, apart from minor exceptions. However, to smoothen the integration process, one company depends on the same supply chain for benefits. The relationship between the parties often leads to more projects and establishments. Implementing multi-project strategies within integrated supply chains and establishing enduring relationships between closely related parties are intended to provide competitive edge benefits over rival companies (Vrijhoef & De Ridder, 2014; Vrijhoef & Koskela, 2000). This supply chain creates healthy competition between stakeholders in selling a product. To implement the need for competitiveness, selling a product is a typical example of a fabricator's role. Hence, the fabricator is one of the key stakeholders in the building industry and is considered for the research.

The research concentrates further on the most common building engineering practice, the traditional Design-bid-build project delivery method. Kubba (2012) states that DBB is a linear process where one task follows the completion of another with no overlap. The method has three main steps—the design, tender/bidding, and construction phases. The proof of concept targets the bidding phase and two parties involved in the DBB – the contractor and the sub-contractor. DBB also clearly distinguishes between the roles of the architect and the contractor, limiting conflicts between domains (Boswell, 2013). This statement ensures that the conflicts are lessened for the PoC and can be validated with fewer contradictions, considering that the architect's input is vital for a façade's design.

Piroozfar et al (2019) developed a platform design to enable the modularisation of façades elements to show customisable façade systems. The research studies BIM as a platform to implement Mass customisation and personalisation. Their research concludes that the AEC industry has not fully adopted Mass customisation and personalisation strategies. This

negligence is due to several reasons, such as the nature of the AEC industry, divisions in its supply chain, resistance to change, and lack of support to adopt cutting-edge technologies.

However, the construction industry follows BIM as its ultimate solution, and the research's Proof of concept (PoC) is a division of workflow solutions. Jang et al (2019) state that Integrated project delivery (IPD) is the best contractual approach for BIM-based solutions, but DBB has remained the most popular contracting approach due to IPD's complexity and local regulations. Through the value engineering process, BIM-based design coordination under DBB can successfully eliminate design errors. As a result, the DBB system was chosen as the proper workflow to implement in the proposed design solution to reduce the complexity of the current workflow.

2.2 Design Solutions

Alreshidi, Mourshed and Rezgui (2018) have studied extensively how the construction industry has adapted to the current collaboration method to manage current practices. In their study, they studied the BIM-based solutions currently available in the industry and conducted a survey. The authors mention that BIM does not have appropriate mechanisms for effectively managing collaboration, accessing, and storing data. The potential solution to this problem is cloud-based BIM governance tools. Despite this, there is a lack of comprehension regarding the construction industry's ICT practices.

From the fabricator's point of view, the design for manufacture and assembly (DfMA) method is one of the best approaches to solving building component complications. Involving manufacturers in the early design process will make the fabrication work easier and contribute to manufacturability (Chen & Lu, 2018). The design of a façade always complies with the limitations of the manufacturer. The final geometrical aspect of facade design is subject to change due to the fabrication parameters. Fabricators will make the design come into physical reality. Thus, a façade configurator eliminates the problems faced by the fabricator and helps to attain DfMA.

In support of the DfMA, Austern et al (2022) have developed a computational tool called Real-time Fabrication analysis (RFA), which evaluates the fabrication parameters of complex geometries. Their research provides real-time feedback for designers, helping them minimise fabrication resources early in the design process. The research presented aims to streamline concrete geometry to adhere to the limitations of its moulds during the fabrication process. The method was implemented in the Grasshopper script, which takes in NURBS objects as inputs. RFA was developed as a tool for architects and designers. However, it was also helpful for fabricators, helping them to fine-tune fabrication parameters and decrease the time and materials used to make moulds without sacrificing their quality. The construction workflow can be vital in an early design when considering fabrication parameters. The research considers both these aspects for its research validation.

A 3D building model viewer is a very effective platform for entering and visualising management information, particularly for general contractor staff outside the fabricator's organisation. Customisable functions for generating model displays that are coloured according to various production status data are highly beneficial. Utilising cloud technology when creating platforms may be able to solve several issues with the enormous volume of created data (Austern et al., 2018). To integrate contractual, organisational, and informational factors, web-based technology has progressively become a standard practice in the management of building projects. An integrated framework is needed in this technology, which takes in all the stakeholders in the industry. The platform should be multifunctional to support the design, manufacturing, and assembly (Cao & Hall, 2019).

2.3 Facades

Parametric technology has helped designers explore various features and unique designs in the façade world. The design process of the façade system is critical to developing the façade design. In addition to the design process, Kulcke & Lorenz (2022) say that online product configurators are more than being able to choose your favourite colour; it is about determining what will indeed be your favourite colour for a particular product, purpose, and context. The façade configurator should know all the technical and prove its purpose. Hence, one should know the current design process and the stakeholders involved. These participants and the design process are the keys to constructing a successful façade.

According to Boswell (2013), there are six main steps for constructing the façade. These six steps have been developed considering the various façade construction worldwide. The author also considers the different project delivery types and their impact on constructing façade. The process is long and time-consuming for the final design to be developed. He further explains that the participants in developing a facade include.

- Owner
- Architect
- Engineers
- Design Team Resources
- Builders

The author explains how the façade construction influences DBB. The principles were considered for choosing the correct user of the configurator and where the configurator plays an important role. The conventional design process developed by Boswell is described below in Figure 2.1.

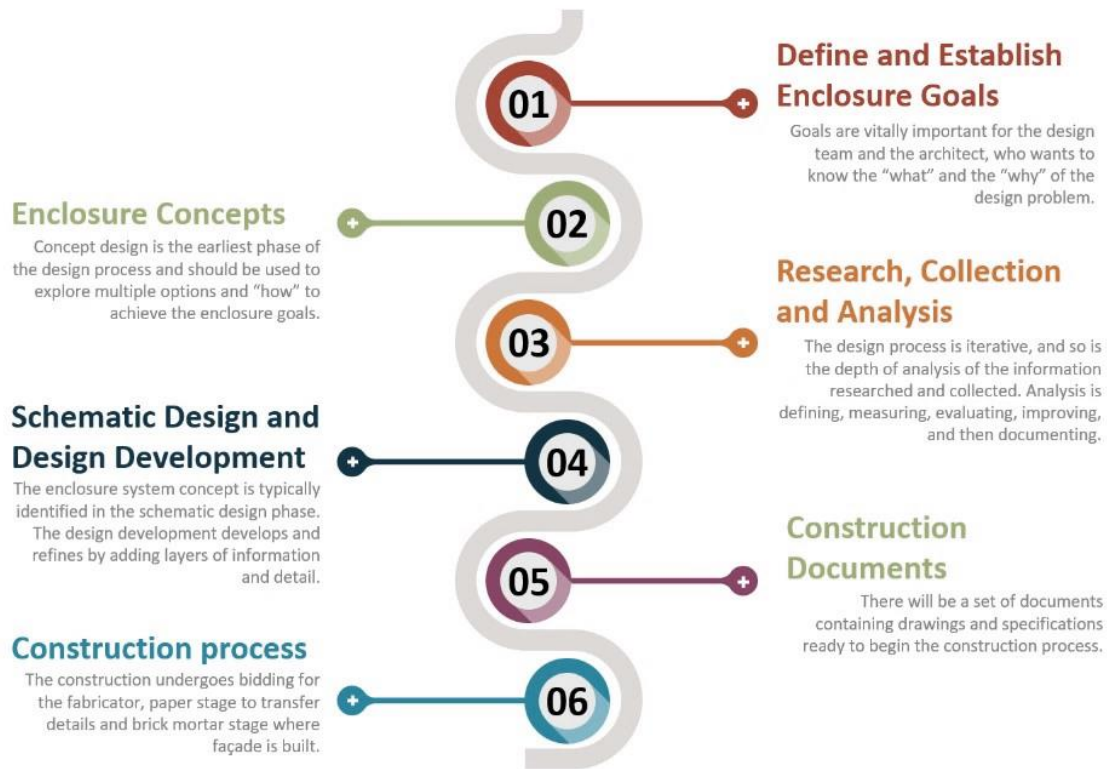

Figure 2.1. The conventional design process for façade systems (Boswell, 2013)

The research develops the prototype design solution for step 3 of the façade construction process. Various curtain wall systems are considered for the modelling and are studied for the design and limitations to develop a façade configurator. The modelling is an example of proof of concept and validating digital design workflow. The design of CWS is complex, and the fabrication limitations are even higher. The panelisation of CWS is executed using required boundary conditions, loading conditions, fabrication conditions, and façade sections.

Wilson Zhou (2002) indicates that the curtain wall design is considered self-weight, wind load and imposed load. With these loads, the curtain wall is designed for its mullion and transom dimensions by structural calculations. He also highlights the importance of providing a movement joint in the curtain wall system. In his book, the author further delves into the design of curtain wall components using numerical calculations. Generally, mock-ups of these curtain walls are made for testing. The curtain wall should be tested for because of its variable design from project to project. The various parts of the information used in the modelling were implemented in the research to show the level of detail of the modelling. However, all the numerical implementation was constrained to assumptions in the proof of concept.

Generally, two major curtain wall systems are present and classified according to their construction procedure. Figure 2.2. describes the difference between two curtain wall systems: 1) Stick system – built in the construction site and 2) Unitised system – prefabricated and placed as panels on site.

Watts (2014) explains the definition of both panels. According to him, unitized panels are fabricated and glazed at the production site. When brought on-site, they are secured using brackets connected to the floor slab and are arranged side by side, with the installation usually commencing from the bottom of the building and ascending. These panels are crafted to sit adjacent to each other, enabling the replacement of the whole panel in case of unexpected damage, or they may be designed to be semi-interlocking, allowing the glass to be replaced without the need to remove the panel. Similarly, he states that stick systems provide extensive flexibility in module dimensions and facade styling. There is no necessity for continuous mullions and transoms; the glazing bars' arrangement can be in varied, staggered grids and conveniently altered from finer to broader grid dimensions. Sophisticated geometric configurations are more seamlessly integrated using stick systems instead of unitized systems. Stick systems tend to be the selected option for structures that are not tall.

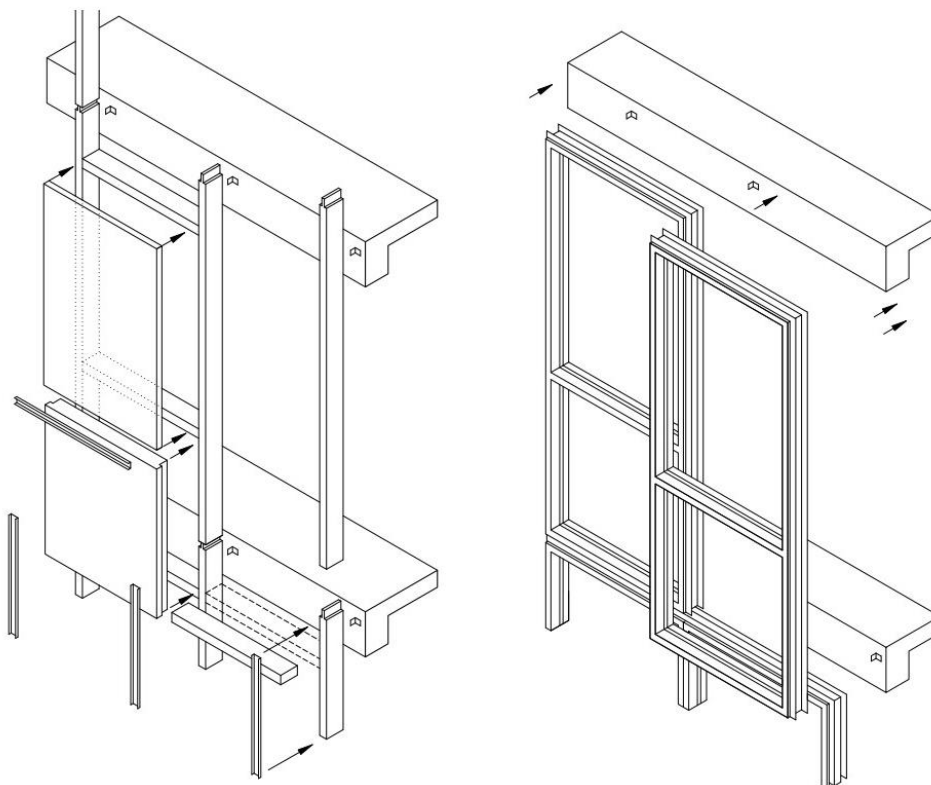

Figure 2.2. Stick system (left) and Unitised system (right) (Herzog et al., 2017)

3

Methodology

This chapter explains the methodology by which the problem statement is validated. It explains how the proof of concept is developed and shows us the workflow of the events in the research. The section also explains the key aspects of the proposed digital design workflow.

The present research methodology aims to validate the proof-of-concept based on the digital design construction workflow. The first phase saw a detailed analysis of the construction process's current mode, which was covered in the literature survey. The study concentrated on the construction practices between fabricators and contractors, mainly for façade systems. The literature survey was extended into curtain wall façade and construction configurators. A study on present configurators integrating facade design was analysed. In the second phase, the research developed the configurator for two curtain wall façade systems – stick and unitized. The configurators were assumed to be developed by two companies to compare themselves to real life.

The last and most crucial phase was validating the proposed digital workflow. The model was evaluated based on six key aspects supporting the configurator role in the construction industry. The validation was carried out in two steps – testing and professional feedback. The configurator was tested with various test case scenarios supporting two key aspects. The fully functional configurator was then demonstrated to industry professionals to support the other aspects. The sequence of the research method followed in this research can be seen in Figure 3.1.

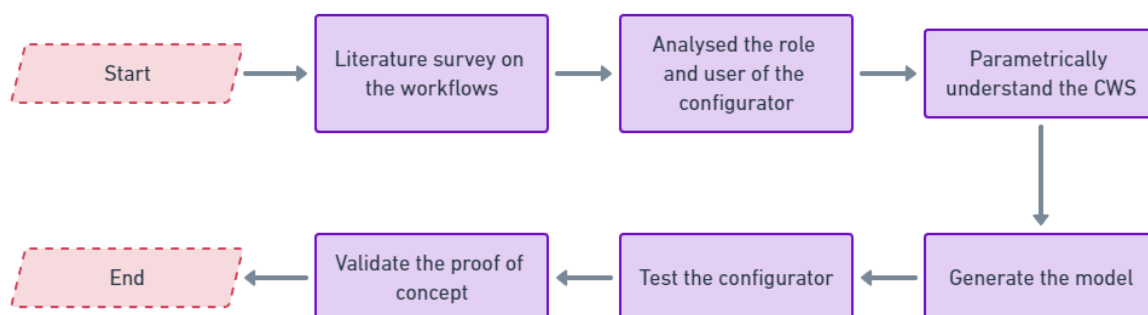

Figure 3.1. The sequence of events in the research from start to finish

3.1 Proof of concept

The configurator tool is developed in Grasshopper combined with Rhinoceros 3D. Grasshopper (GH) is a visual programming language that allows designers and developers to create complex geometries and parametric models quickly, and Rhino/Rhinoceros 3D is a modelling software used in various industries. Grasshopper with Rhino helps to create and manipulate the models and data by node interface. Many plugins inside Grasshopper help to automate and improve the performance evaluation of the building. In the research, Grasshopper graphs act as a background programming platform where it is scripted so the user gives the inputs and results are generated as a model. The Grasshopper helps to create the configurator system for the contractors.

Only the background activities are created in Grasshopper, further connected to an online user platform. The platform used for the digital workflow is Packhunt, which is a cloud-native platform offering digital services like a web-based Grasshopper. The platform's primary purpose is modelling and configuration, mainly within the building industry. The Packhunt platform provides a digital experience with the power of visual programming by Grasshopper, Visual Basic and Python. The simple representation explaining the working of the Packhunt configurator is shown in Figure 3.2.

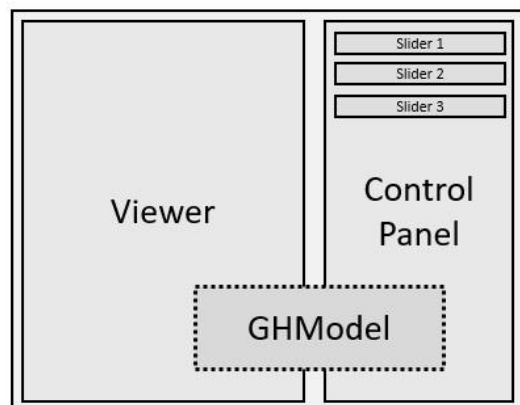

Figure 3.2. Packhunt configurator layout denoting the three primary entities.

3.2 Digital Design Workflow

The tool and platform for developing a configurator were set, but there was a problem with the configurator's purpose, user and developer. The answers to these questions define the project's scope, boundary restrictions and goal.

Purpose of the configurator

The proposed digital design workflow incorporates the configurator between the stakeholders of the traditional construction process. Design-Bid-Build project delivery method is taken and studied. It follows a bidding and construction phase where the workflow can be

built in a configurator. The purpose of the two configurators is to benefit the bidding process in the traditional workflow.

The user of the configurator

The user of the configurator was the crucial question to answer, and eventually, the contractor was defined as the role and user. Although the configurator has a 3D visual panel that can be eye-catching for clients and architects, the project restricted the user of the configurator to contractors. The user's definition helped the project contemplate key parameters in modelling two curtain walls.

Developer of the configurator

The role of the configurator was to validate the research statement; hence, for having the technical inputs and showing the details of the configurator, the developer was chosen as fabricator/sub-contractor. In this case, two fabrication companies produce sticks and unitised systems.

Type of the configurator

Two configurators are built separately, showing two types of curtain wall façade manufacturers. The input and output of two configurators are assumed to be the same to develop the competitiveness of the digital workflow. A simple comparison of integrating Design Bid Build with and without the configurator is seen in Figure 3.3.

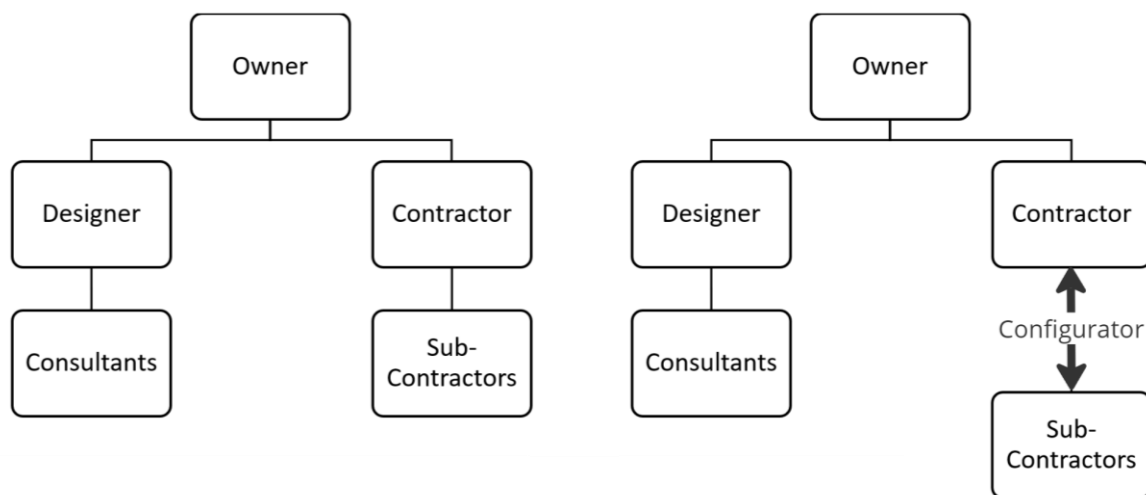

Figure 3.3. Conventional Design-Bid-Build (left) without the tool vs Proposed Design-Bid-Build (right) – with the configurator

4

Development of Configurator

This chapter explains the proof of concept developed using the Packhunt configurator and its visualisation engine. It also shows us how the modelling phases are executed. The configurator modelling is discussed step-by-step for both the façade systems. It further explains Packhunt's Self-Service Interface (SSI) and how the configurator will work.

4.1 Packhunt Configurator

Packhunt is a web-based configurator that enables users to customise and personalise products by selecting predefined options and features, tailoring the final offering to their specific needs and preferences. It simplifies creating unique configurations while ensuring compatibility and often includes pricing and visualisation features.

The critical part of a configurator is its User Interface (UI) and visualisation engine. Figure 4.1 represents the two sections – 1) Visualisation area (left) and 2) User Interface (right). In this image, the surface as the 3D model is visualised and the slider and information text are seen in the user interface.

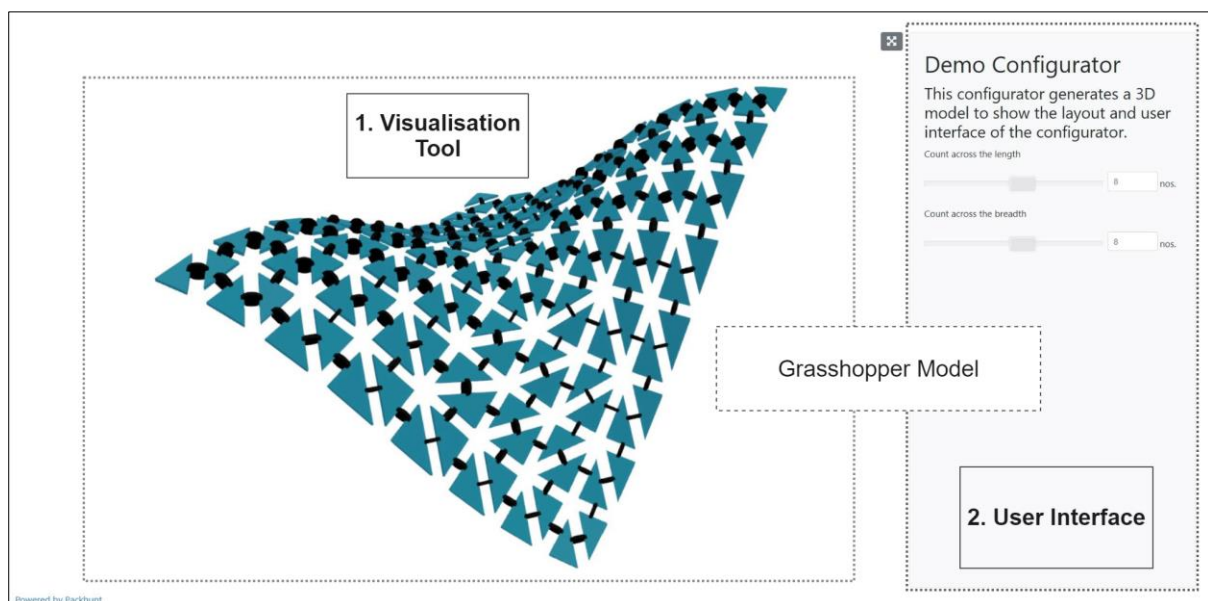

Figure 4.1. Layout of Packhunt configurator – 1. Visualisation tool (left) and 2. User interface (right)

A configurator user interface (UI) is a critical software tool or application element that allows users to customise and configure products or services according to their specific needs and preferences. The configurator user interacts with selection menus, checkboxes, sliders, or other input elements to make choices. These choices affect the configuration of the product or service. The UI often guides users through a step-by-step configuration process. Hence, the UI is refreshed and updated regularly based on the user input. Each step typically focuses on a specific product or service aspect, such as features, specifications, or design elements. A visual representation or preview of the configured item includes 2D or 3D models, diagrams, or images that update in real-time as users make selections. The user interface of a facade configurator is crucial for providing an intuitive and user-friendly experience.

A visualisation engine is a software component or system that generates visual representations of data, designs, or concepts. It is crucial in various fields, including computer graphics, data analysis, architectural design, engineering, and more. Visualisation engines transform raw data or abstract concepts into visual forms easier for humans to understand and interpret. Grasshopper for Rhino is one popular tool for creating parametric visualisations, especially in architecture and design. Grasshopper is a visual programming language and graphical algorithm editor for the Packhunt configurator. It is well-suited for creating parametric and generative designs and can be a powerful visualisation engine. Figure 4.2 shows the configurator workflow of Packhunt, which is used in the research.

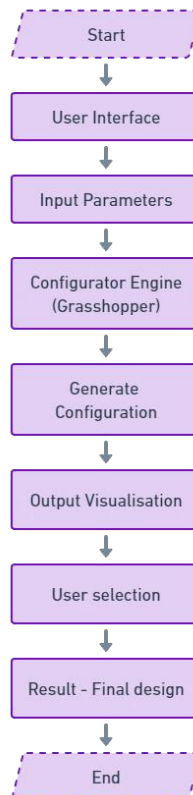

Figure 4.2. Process of events in Packhunt's configurator workflow

The facade configurator developed in the research executes real-time visualisations in the Packhunt, allowing users to instantly see how their design choices affect the building's envelope. This iterative and interactive approach allows for experimentation and fine-tuning until the desired facade design is achieved from a contractor's and fabricator's point of view. Once the configuration is complete, the contractor can generate the best bid and renderings directly from the configurator, streamlining the bidding process. This design tool uses the Packhunt configurator as a workflow for the proof of concept.

4.2 Curtain Wall Facade Modelling

A curtain wall system is an outer building envelope that protects a structure, allowing transparency and natural light to enter its internal rooms. It is made of lightweight materials like composite panels, glass, aluminium, or steel. Contrary to conventional load-bearing walls, curtain walls primarily serve aesthetic and environmental purposes and are suspended from or fastened to a building's structural frame. They also permit freedom and architectural inventiveness in building design. Careful engineering and attention to detail are crucial for its design and construction to be successful.

The Curtain Wall System (CWS) has critical elements for modelling – Grid generation, Panelization, Mullion and transoms, and Connection detail. The modelling considered all these aspects for the configuration.

- Grid generation - This grid will determine the placement and size of the panels, mullions, and transoms.
- Panelization – The panel comprises various materials and functionalities. The glass and spandrel are the main components for a panel and are taken in the modelling.
- Mullion and Transom - Vertical and horizontal supports are Mullion and Transom, respectively. They ensure that the panel is held in its place.
- Connection Detail – These are the junctions/joints between mullions, transoms, panels, and floor slabs.

The modelling comprises the design of two curtain wall systems to ensure two types of façades manufacturers. For the validating step, the situation is considered a real-life scenario; hence, each façade type represents a different fabricator. The research has implemented Company A to produce stick CWS, and Company B produces unitised CWS.

Stick system (Company A) - It derives its name from the assembly method, where individual components, or “sticks” and “mullions,” are installed piece by piece on-site, allowing for precise customisation. Hence, the configurator was developed to incorporate the installation and involves meticulous craftsmanship, ensuring the alignment of components and

the correct fitting of glazing materials. The configurator considers stick CWS versatility and dynamic choice for achieving functional and aesthetic goals in architectural design.

Unitised system (Company B) is prefabricated, modular units manufactured and assembled in a controlled factory environment before being transported and installed on-site. The built design tool of unitised CWS consists of individual panels or units, including the glazing and the framing elements, mullions and transoms. Two separate configurations for both fabricators were built: stick and unitised CWS. The sequence of the modelling of both configurators is explained in upcoming sections. A detailed view of CWS is shown in Figure 4.3.

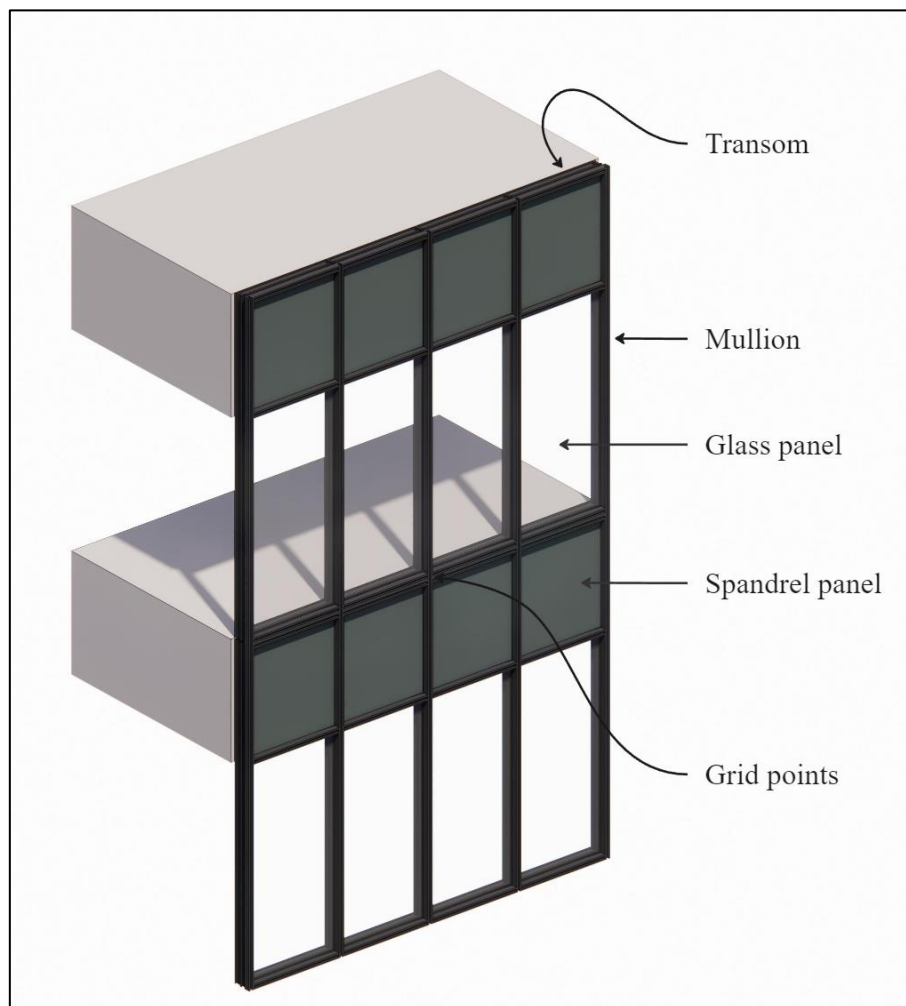

Figure 4.3. Isometric view of rendered Curtain Wall System (CWS) and its components

Although the stick and unitised CWS differ in the 3D detail, both configurations follow a similar approach in the modelling and have many similarities. The model's inputs were similar for both configurations to generate a 3D design and cost output. The modelling process was executed in a step-by-step process. The sequence of the process is explained in the following sections.

4.2.1 Initial Setup – Preliminary Design

At first, the input for the configurator was discussed as a surface. The surface drawn in the Rhino interface is taken into Grasshopper and initialised to the surface component. The surface can be with any degree of freedom and have multiple dimensions. Inside the Grasshopper, the surface component further undergoes panelization and checks for the grid points. After which, the final facade design is developed. The workflow of the system is shown in Figure 4.4.

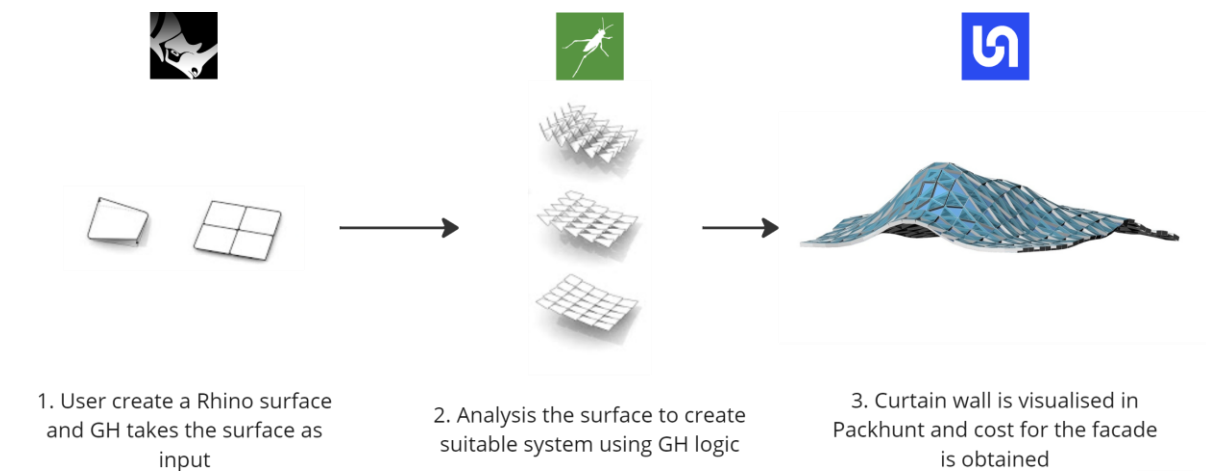

Figure 4.4. Initial design workflow – surface with ‘n’ degree of freedom (left), panelisation and optimisation of the surface for grid points (middle) and final design solution for a given surface (right)

Due to the complexity of the design of the façade system and lack of data, the idea of curved glazing was avoided. When a curved facade surface is designed, the panels are often one-off and less likely to have similar panels. The more curves on the surface, the more the number of unique panels. The unique panels are not manufactured on a day-to-day basis and are executed only in specific situations. The complexity was also noted in manufacturing these unique panels, leading to high costs. The cost, the central part of selecting the bid, will not be affected if the project is a one-off. One-off projects have a trusted relationship between contractors and sub-contractors, and the competition is minimised. The purpose of the configurator is to fasten the process and give a quotation from the competition between sub-contractors.

Hence, a Rhino surface as the input was nullified, and other types of inputs were considered. The most used design method by architects and contractors bidding on the façade design process is considered. Generally, the architects give a design with the technical details that the sub-contractors can understand and manufacture. For a CWS, the standard inputs based on numerical or as a list were considered. The façade manufacturability and fabricators’ feasibility are considered for these numerical data. The user of the configurator, the contractor, has an idea about the critical elements for a CWS to be built, and they can understand the design details of the architect. Hence, the Rhino inputs like surface were avoided, and only Grasshopper inputs were taken, which are used by contractors.

Secondly, the visualisation in the configurator was taken as a foundation stone for the modelling. Visualisation is vital for any configurator; hence, the model should have realistic parts of the building apart from the primary model. For a façade configurator, although the superstructure behind the façade is covered, the geometry of the building's structural components is incorporated for the 3D visualisation. The structural components were modelled with essential inputs that directly influence the façade of the building. No external inputs were given, which only governs structural components. Overall, the CWS is modelled using parametric inputs with required LOD, visualised with the given material and displayed the cost of the façade.

Considering the visualisation aspects, it was discussed what shall be the features of both the company's configurators. It was assumed that to increase the competitiveness of the two fabricators and the complexity of the model, it had unique conditions in a particular case. Various cases were considered for the visualisation. Examples of these conditions are the corner curtain wall (top) and the symmetrical panel condition (right), as shown in Figure 4.5.

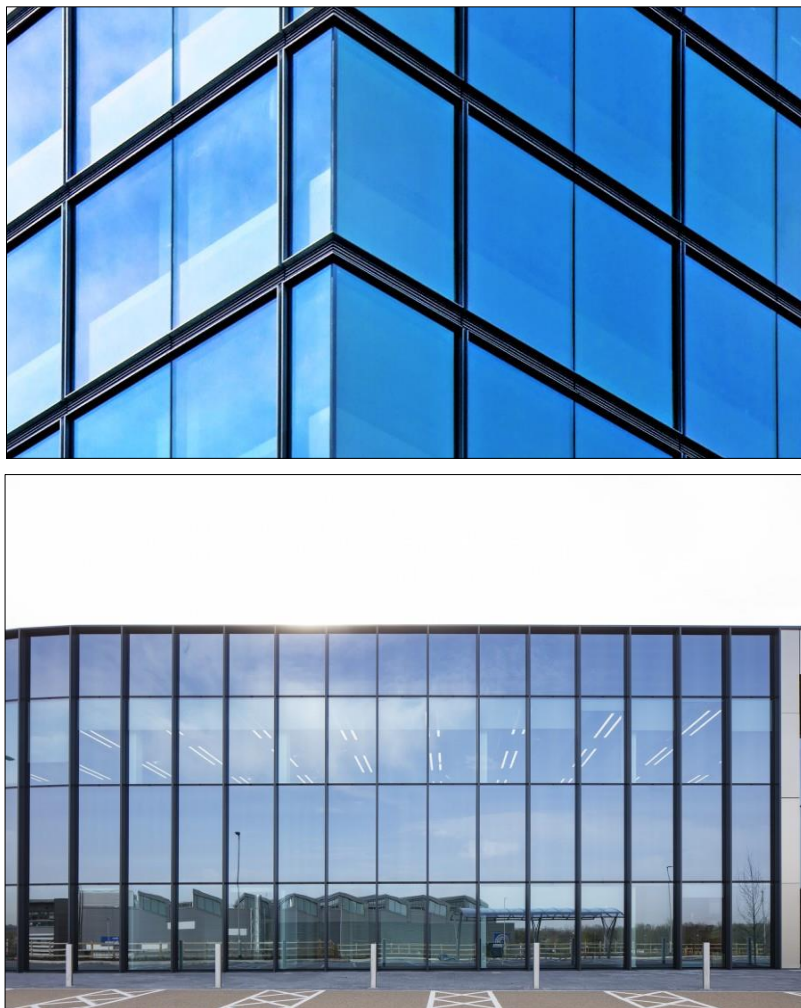

Figure 4.5. Corner curtain wall (top) (METRIK, 2018) and Equal length of the panel (bottom) (Anonymous, 2021)

4.2.2 Governing Parametric Inputs

The input was decided based on the visualisation of the 3D model and cost aspects. The main criterion was to reduce the number of inputs so that the configurator could generate the bid with the minimal information provided. The modelling inputs are broadly classified in terms of function and definitions.

Packhunt inputs

Packhunt inputs are defined in the GH canvas's input section, which governs the input panel of the configurator. These inputs are configurator inputs and the main parameters that govern the modelling. The inputs are connected to the Packhunt plugin's input component, as seen in Figure 4.6. All the Packhunt inputs were the same for both configurators. The Packhunt input component sends the information to the backend of the configuration layout. The inputs are divided into three components: 1) Structural components, 2) Facade components and 3) Cost components.

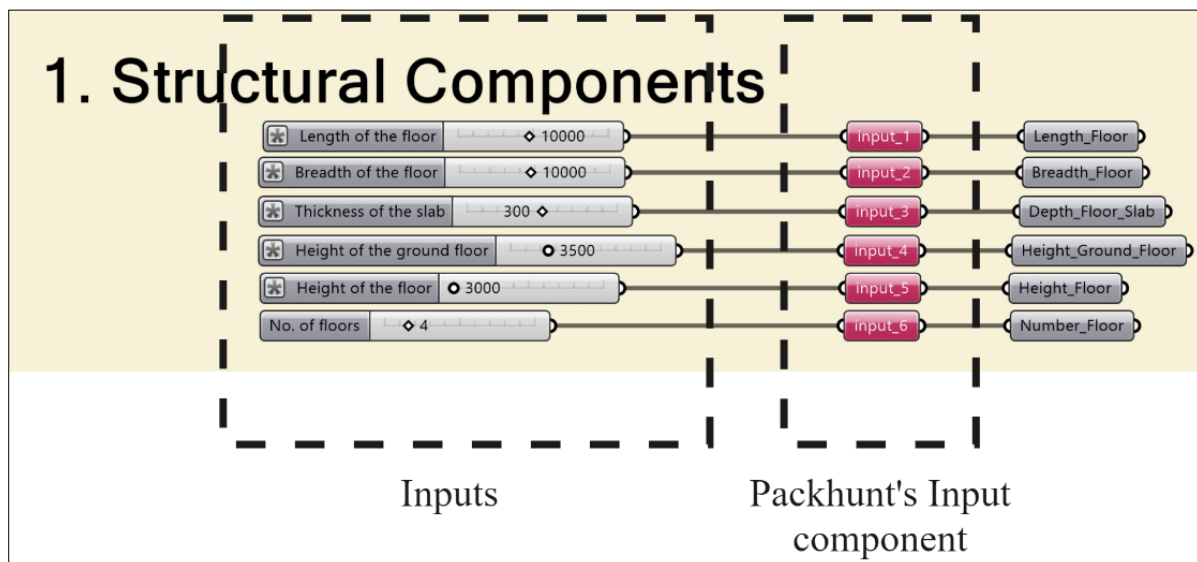

Figure 4.6. Connection of Packhunt's input component with the number slider.

The structural components are inputs that directly influence the structural parts of the building and also influence the façade of the building. Structural components are vital to the performance and integrity of curtain wall facades, which are non-structural glass-based building exteriors. Structural components, like floor slabs and columns, carry the curtain wall's dead load. Anchorage and attachment points secure the curtain wall to the building's structural frame, preventing detachment due to wind or seismic forces. These attachment points form the base for panelisation and reference points. The structural component inputs are responsible for the generation of these grid points. Transoms and mullions in these reference points form the curtain wall's grid-like framework, supporting glass panels and transferring wind loads. The input for these structural components is given in Table 4.1, which is required to generate the reference points for structural connection.

Table 4.1. Structural Components Inputs

S. No	Input	GH Component Type	Range	Incremental Value
1	Length of the floor	Number Slider	5000-20000	100
2	Breadth of the floor	Number Slider	5000-20000	100
3	Thickness of the floor	Number Slider	200-400	10
4	Height of the ground floor	Number Slider	3000-5000	100
5	Height of the floor	Number Slider	3000-5000	100
6	No. of floors	Number Slider	1-15	1

Logical and standard ranges and conditions were taken for the inputs. The 3D model of the structural components consists of a floor slab, columns, a foundation, and a roof with a parapet. The ground is also visualised along the ground floor slab. Figure 4.7. shows the building's skeletal structural components along with the grid points of the façade. The chosen example is for a 5000 mm x 5000 mm floor with a panel length of 600 mm. 8 grid points are generated along the edge, and the two corner panel length is determined to be 100 each.

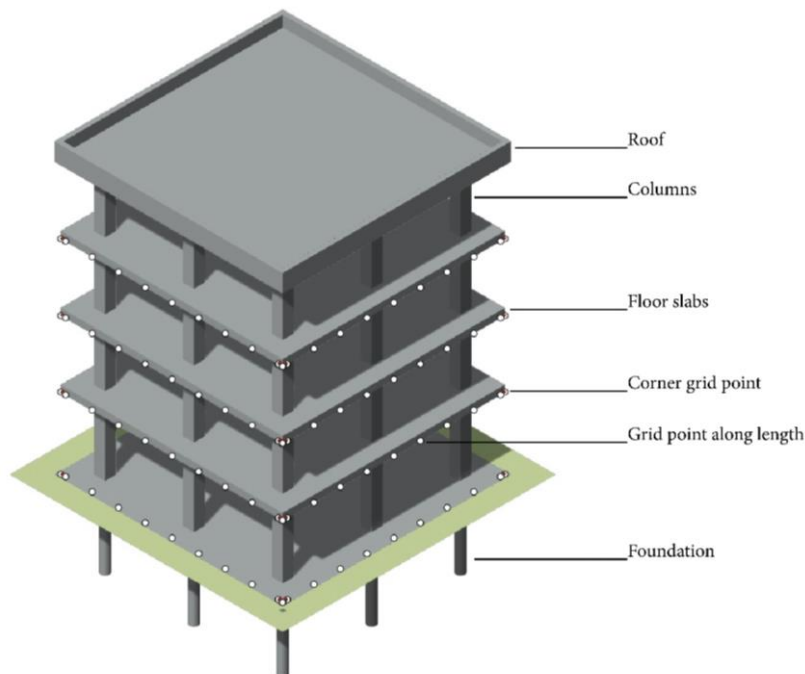

Figure 4.7. Skeletal of the 3D model

Façade inputs govern the modelling of façade components of the building. These components are connected to the Packhunt's input component, like the structural component. The structural inputs are also involved in developing the façade. These inputs mainly define the dimensions of the mullion and transoms. The single-panel model is developed based on the inputs and later attached to the reference point (Figure 4.7). The façade component has corner wall condition, developing a corner façade at every corner integrated into the structural system. This input avoids a corner section of the façade and executes the end/side panel of the façade. The fifth input of the façade component is "Fit the panels to the dimension", which takes in yes or no to execute the similarity between the corner/end panels and regular panels. All the façade components are also responsible for the cost of the façade. The Table 4.2. shows the inputs for façade components.

Table 4.2. Façade Components Inputs

S. No	Input	GH Component Type	Range	Incremental Value
1	Length of single panel	Value List	600-4800	-
2	Mullion/Transom thickness	Number Slider	90-300	10
3	Corner wall	Value list	-	-
4	Corner wall length	Number Slider	500-2000	100
5	Fit the panels to the dimension	Value list	-	-
6	Fin options	Value list	-	-

Cost inputs did not affect the 3D model in the viewer but showed an estimation of the façade design in the user interface. The cost components are defined solely for cost calculation. The cost components inputs are seen in Table 4.3.

Table 4.3. Cost Components Inputs

S. No	Input	GH Component Type
1	Structural connection	Value list
2	Glazing	Value list
3	Spandrel insulation	Value list

Static inputs

Apart from the primary inputs, static inputs were defined inside the modelling to ensure the final model was generated. Static inputs are user-based inputs that stay the same for any change in parametric input. Static input is also termed as constant values based on typical assumptions. Assumptions are made on general thought, which does affect the model in the 3D viewer but will not affect the model's scope. Example: The chosen model has cantilevered slabs; in the case of columns definition, the number of columns will not affect the façade of the building (no columns in the edge). In this case, the value 3×3 was assumed for any configuration change; hence, the number of columns is 9 for any design.

The primary static input was for a dimension of the façade cross-section. Generally, the thickness of the frame is based on the loading conditions. However, the inputs were given as static values to ease configuration and minimise the data exchange. The thickness of the mullion section was taken as 4 mm. Generally, the static inputs are initiated with “panel”, which takes in custom notes and text values and is shown in Figure 4.8.

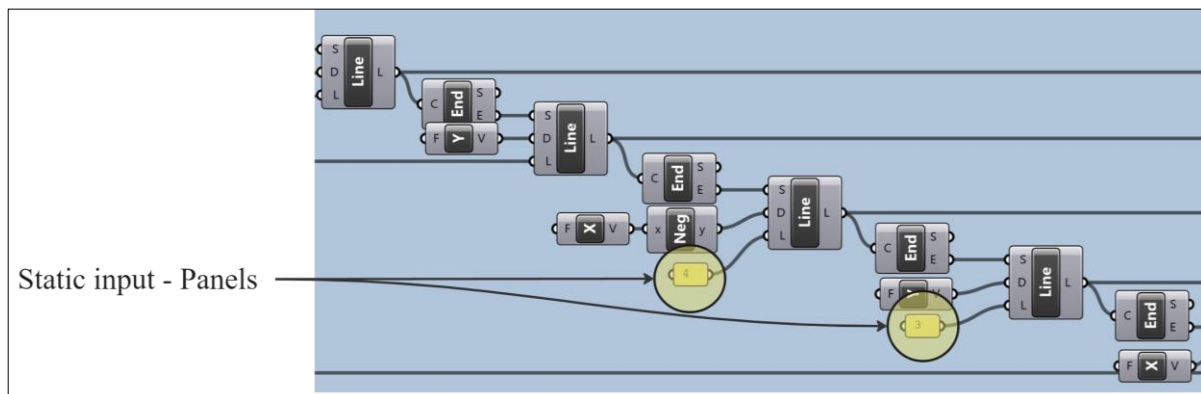

Figure 4.8. Panel spread around the canvas for the initialisation of static inputs

Conditional inputs

Conditional inputs are based on a given condition. For example, the façade manufacturer produces a panel size of 600 mm, which is standard. Hence, the user would be unable to give values other than predefined ones. The conditional inputs are given in some cases where the result is not valid anymore. Another example of conditional input is that when the length of the panel is greater than the length of the floor, the building model is out of logic. Hence, the condition has been given for minimum floor length, which is always over the single length of the panel. There are also predefined values in the input group like the floor length takes only increments of 100.

Factored inputs

Factored inputs are a division of conditional and parametric inputs which are not predefined. These values change proportionally to the parametric inputs. The depth of the mullion is directly dependent on the length of the mullion. A rule-of-thumb is followed based

on the literature survey for these factors. The factored inputs are also given in panels. The Figure 4.9. shows the difference between conditional and factorial inputs.

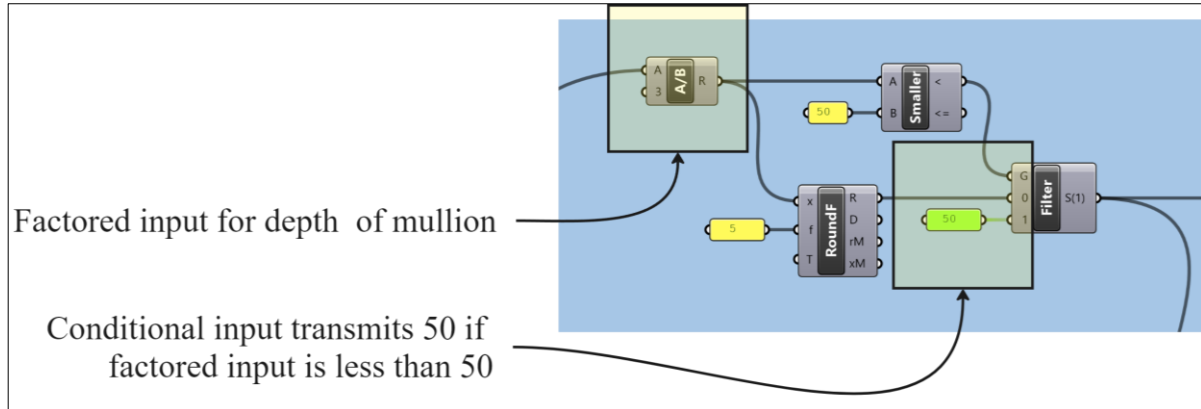

Figure 4.9. Illustration of factored input and conditional input

4.2.3 Level of Detail (LOD)

The modelling's Level of Detail (LOD) was based on the architect's design and real-life scenario. The level of detail in the architect's facade design submission is a critical factor in ensuring that subcontractors can accurately assess the scope and complexity of the work. While less detailed submissions might expedite the early design phases, they can lead to misunderstandings, change orders, and budget overruns during construction. The trusted relationship confirms that minimum information is provided to draft a competitive bid (Boswell, 2013). The necessary levels of detail in the design development phase empower subcontractors to provide competitive quotes based on a clear understanding of the project, reducing uncertainty and potential disputes.

Initially, the section detail was set to incorporate more modelling details and produce detailed results. The modelling was set to include most parts of curtain wall systems like rubber gaskets, sealants, and insulation. The more objects, the more time it takes for the model to execute in real-time. Hence, due to the constraint of the configuration time, the section detail was optimised in such a way to execute efficiently. The various LODs that were considered during modelling are shown in Figure 4.10.

The LOD was set to a minimum in the research, but the section details are well distinguished to show the different types of façade. The façade sections showed only the representation of the mullion and transom, avoiding any curves in the system. The high LOD was drafted in AutoCAD and then reduced to its minimum representations. The chosen LOD was later modelled in Grasshopper by giving parametric inputs. The High LOD and representation of the façade section that was considered for the drafting are shown in Figure 4.11.

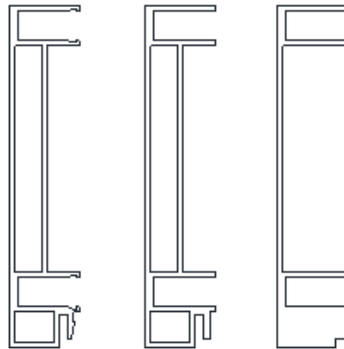

Figure 4.10. Level of Detail (LOD) of split Mullion considered for modelling

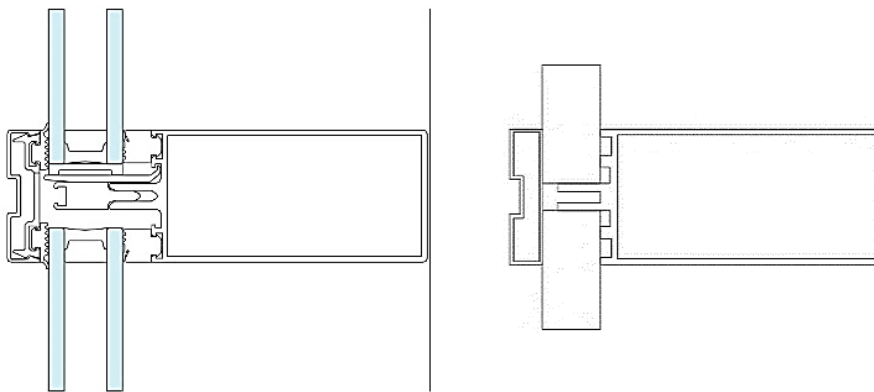

Figure 4.11. Vertical section of stick system connecting two glass panels - high level of detail (left) and minimum level of detail (right)

4.2.4 Packhunt Plugin and Set of Rules

The Grasshopper has a Packhunt plugin that helps deploy the GH definition in the cloud. The Packhunt plugin has built-in components connected to the logic, ensuring the graph runs and is visualised in the Packhunt configurator. The Grasshopper logic runs in the background as the tool for the visualisation engine. These Packhunt components are predefined and link the configurator UI, visualisation tool and the Grasshopper graph. Some of the plugins are listed below in Figure 4.12. The key Packhunt components used in the research are:

- Input (params) – It gets the input from the user as a slider, dropdown list, or static number. It is connected to the input from the user, which is seen in the configurator UI. The naming of the generative input is always the following: “input_count”. The count is increasing for every input added. The naming of the input guarantees that the Packhunt configurator recognises it.
- Output (params) – This shows the final model from the logic and transmits it to the background activities. The final model is shown in the configurator visualisation panel. The name can be used according to the user logic to which the component is connected.

- Assign material (display) – This component gets two inputs – object and material and assigns the defined material to the object for final visualisation. The material colour is later given while the file is uploaded to Packhunt.
- Text output (params) – It displays a message like the panel cost and the volume of each façade component on the user interface of Packhunt.

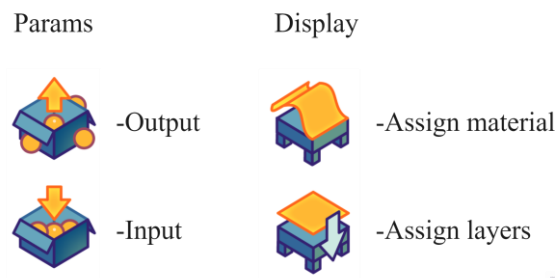

Figure 4.12. Packhunt plugin components used in the façade configurator

There are regulations and principles while scripting in Grasshopper to ensure the graph is understandable and clean. Packhunt follows a set of rules to be applied while modelling. This set of rules was also followed during the modelling. The general structure consists of inputs located at the left of the canvas, the body in the middle and output to the right. The logic of the graph is split into smaller sections and groups. Each group has input and output from Grasshopper's 'params' tab to show each section's clarity and working nature. Each group is labelled to contain the specific logic of the modelling. The Grasshopper also follows a colour code specific to these groups for efficient segregation. All the wires were hidden at the components directly connected to the input, and some components which required much connection were also hidden for better readability. The curved connecting wires are straightened using a relay component before connecting two components. There are no cross-over wire connections (connecting the wire to the left component of the canvas), and it always follows the logic sequence to the right.

The mentioned set of rules was followed in the modelling, and geometry followed a sequence to ensure effective profiler timing. Profiler timing is a diagnostic tool that helps users analyse the computational performance of their definitions. It measures the amount of time each component in the definition takes to compute, allowing users to identify which parts of their definitions are most time-consuming and potentially optimise them for better performance. The research streamlined and simplified geometry to maintain low profiler timing values, minimised data tree complexity, and strategically used the "Stream" component to control data flow and avert unnecessary calculations. Additionally, the script avoided non-essential components and calculations, optimising iterative processes by minimising iterations.

The script also utilised native Grasshopper and Rhinoceros components due to their optimised nature. However, the Pufferfish component for rounding off mathematical numerical

values was used to speed up the execution. Pufferfish is a plugin for Grasshopper, known for its versatile set of components that enable users to perform various geometric operations and manipulations. It extends Grasshopper's ability to tween, morph, and complex transformations, allowing for more advanced and intricate designs. Packhunt supported the Pufferfish component, and the plugin was implemented in the modelling.

The preview was turned off for components, especially those involving heavy geometry, which significantly reduced computational load and enhanced the efficiency and responsiveness of the Grasshopper interface, allowing for the management of more intricate and computationally demanding design scenarios. Simple Grasshopper logic and set rules applied are shown in Figure 4.13. Here, the image describes the clean modelling, group segregation and wire management.

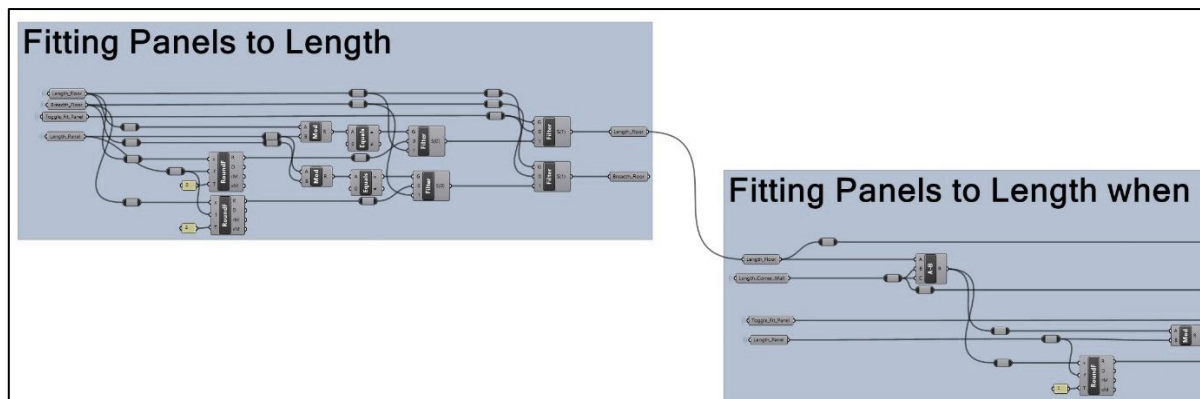

Figure 4.13. Simple GH canvas showing standards and principles

4.2.5 Façade Section and Build-up

The façade is built by panel by panel and then placed onto the envelope of the structural system. Like structural systems, the script follows basic geometric operations and algorithms to develop a panel. These panels are modelled according to the user's specifications. The build-up develops the entire 3D of the panels, taking in all the regular and special conditions. The build-up follows five critical steps in the process.

Step 1: Creation of Section

After the inputs, the façade modelling started by developing a mullion section. As the curtain wall has basic details, the mullion section is the same as the transom in the proof of concept. A study was conducted to develop an optimal section. Various façade sections of different LODs were taken into consideration for the build-up.

Initially, two to three types of sections were considered as internalised data. Internalised data refers to storing external data, like geometry or values, directly within a component, eliminating the need for a constant link to the source. In this research case, a façade section curve is drawn in Rhino and referenced in Grasshopper, internalised as curve data within the Grasshopper component. These sections were retrieved from 2-D CAD drawings and exported

as curves in Rhino. The internalised curves were connected to a scale component using control points. Control points are the vertices or nodes that influence the shape and geometry of a curve. They are not necessarily on the curve but are used to control the curve's path. The curves are scaled in the respective direction for their length and breadth. However, the scaled curve was not practical due to its variable thickness. The frame's thickness is subject to change for every change in length or breadth. There were non-uniform measurements in the section as a result.

Secondly, the sections were split into four parts to keep the thickness constant after scaling. The internalised section was divided with a 2-section plane vertically perpendicular to each other at its centre. The first vertical plane was defined along the Y-axis, which governs the length of the section frame. The second plane was defined along the X-axis, which governs the section's breadth. This section definition can be achieved for all the sections, keeping the thickness of the frame constant. Although the method is feasible for most of the façade sections, it involves more components and algorithms. Using a section plane at the start also increased the compiler time. Hence, the section-splitting method was not executed.

As a solution to the above two methods, it was decided that the section should not be internalised and manually created using inputs. Ultimately, the section was created based on lines and points defined inside the Grasshopper script. The script in this section used only basic arithmetic operations and logic for the design. However, to constrain the number of inputs, there were a lot of static and conditional inputs for the development.

The primary conditional input in developing the sections was the mullion depth. The depth was directly proportional to 0.33 times the length of the mullion. If the factored value is less than 50, the minimum depth is defined as a default dimension of 50 mm. Both example cases are shown in Figure 4.14. below when the length of the mullion is 100 mm and 170 mm.

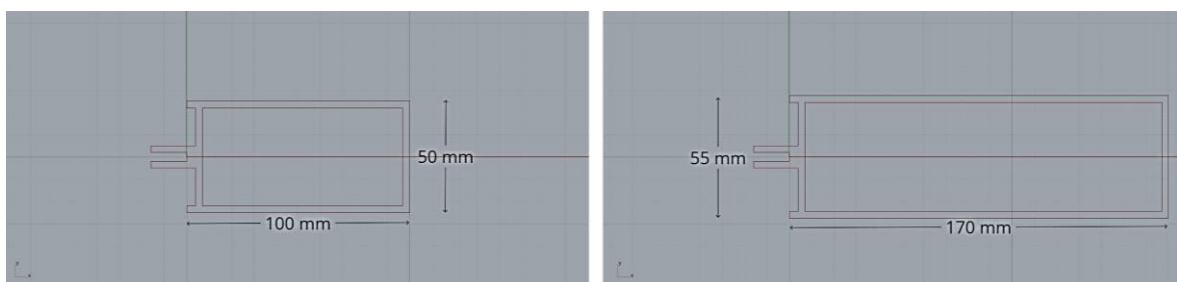

Figure 4.14. Representation of mullion section on Rhino XY-plane – Breadth is 50 mm for a length of 100 mm (left), and breadth is 55mm for a length of 170 mm (right)

The minimal LOD and data collection resulted in the drafting of 6 sections for the façade. Of these, 2 are regular frame sections, 1 is a corner frame section, and 3 are fin sections. The seven details of the two configurators are shown in Figure 4.15. For the representation of the façade section, the length of the mullion input was 150 in all the cases illustrated below.

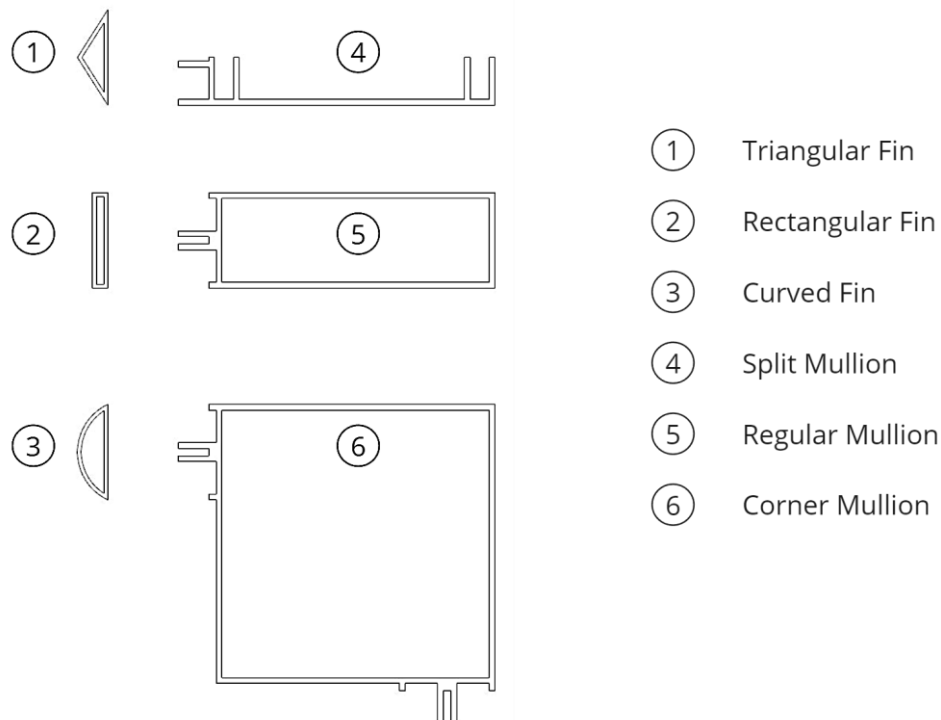

Figure 4.15. Drafted sections in the modelling of two curtain wall systems

The sections represented are developed using line, point, basic mathematical operations, and input panels. The inputs and operations ensured that the mullion's thickness was maintained at 4 mm for all the sections. Also, the protruding part of the façade was given a constant dimension of 16 mm as a standard. In the case of the corner mullion section, the dimensions were fixed for its glass and spandrel panel locations, and the dimensions changed for the rest of the frame based on the user inputs. The corner panel modelling will be briefly discussed in step 5 of the build-up.

The components are separated into groups according to the façade section built. In this modelling phase, there are a total of 6 groups, with three groups in each configurator. The 3-stick CWS configurator group develops 1) Regular mullions, 2) all the fin sections, and 3) corner mullions. Unlike the stick configurator, the unitised system has no special corner section, and a split mullion group replaces the corner mullion group. Most sections avoided curved lines except the curved fin, developed by the arc component. All the sections are referenced to the origin (0,0,0), and stream filters were used in the case of the stick system when there is a toggle for corner wall presence. At the end of step 1, all the façade sections are developed and are ready to be extruded or lofted to make a 3D model.

Step 2: Positioning according to the reference points

Generally, a model is extruded along a direction to create a 3D geometry. However, forming a 3D object by brep was efficient in this case. Breps are boundary representations and

mathematical representations of a 3D object. The 3D object is defined by its boundary surfaces, edges, and vertices. For example, a glass panel (cuboid) is a Brep that has six faces (the boundary surfaces), twelve edges, and eight vertices (corners), and all these elements together define the shape, structure, and space it occupies.

In step 2, the façade sections developed are moved to the respective locations to form a brep. When two section curves are parallel and in a straight line, the two curves can be lofted to form a brep. The positioning of the sections varies depending on the type of configurator. For example, to form a transom of a stick configurator, the referenced mullion section is rotated about 90 degrees and moved to the height of the slab. The reposition curve is further moved to the length of the panel. These two curves are positioned to create a brep transom.

Similarly, a corner mullion of a unitised panel gets two split mullion sections and moves at the edge of the panel along the y-axis and x-axis. This positioned curve is further moved to the height of the floor to get the floor height corner mullion. The procedure is executed for all the cases except the ground floor and corner wall conditions. The same concept of positioning is executed in the case of the ground floor but with the absence of the spandrel transom and different heights. Regarding corner wall conditions, the edge panel has a different model than the regular panel. A rectangle is created with a thickness of 16 mm for both spandrel and glass panels. These spandrel and glass rectangles as curves are positioned for respective slab and floor heights. All the curves are positioned at respective positions and scripted in the groups, followed by the section groups. Step 2 shares their algorithm in the same group with extrusion to form a 3D model of respective elements.

Step 3: Extrusion of Mullion and Transom

Steps 3, 4, and 5 follow a similar process of loft and are executed simultaneously. The façade curve sections are positioned and merged as pairs to form a lofted brep. In both configurators, two groups target general mullion/transom extrusion and corner mullion/transom. The mullion and transoms are lofted for their respective boundaries.

Step 4: Panel Extrusion

The pane consists of 2 parts – glass and spandrel. A particular case is seen in the case of the corner section. The curves are of different dimensions to the regular panel. Each configurator has two separate groups for the panel 3D model. The first group output is to form regular panel elements, and the second group forms corner panel elements.

Step 5: Fin Extrusion

Fin is the final 3D model of the script and refers to vertical or horizontal elements attached to the façade of the building, primarily serving as architectural enhancements, shading devices, or structural reinforcements. In this case, it serves both architectural and structural aspects and impacts the cost of the façade based on the chosen option type.

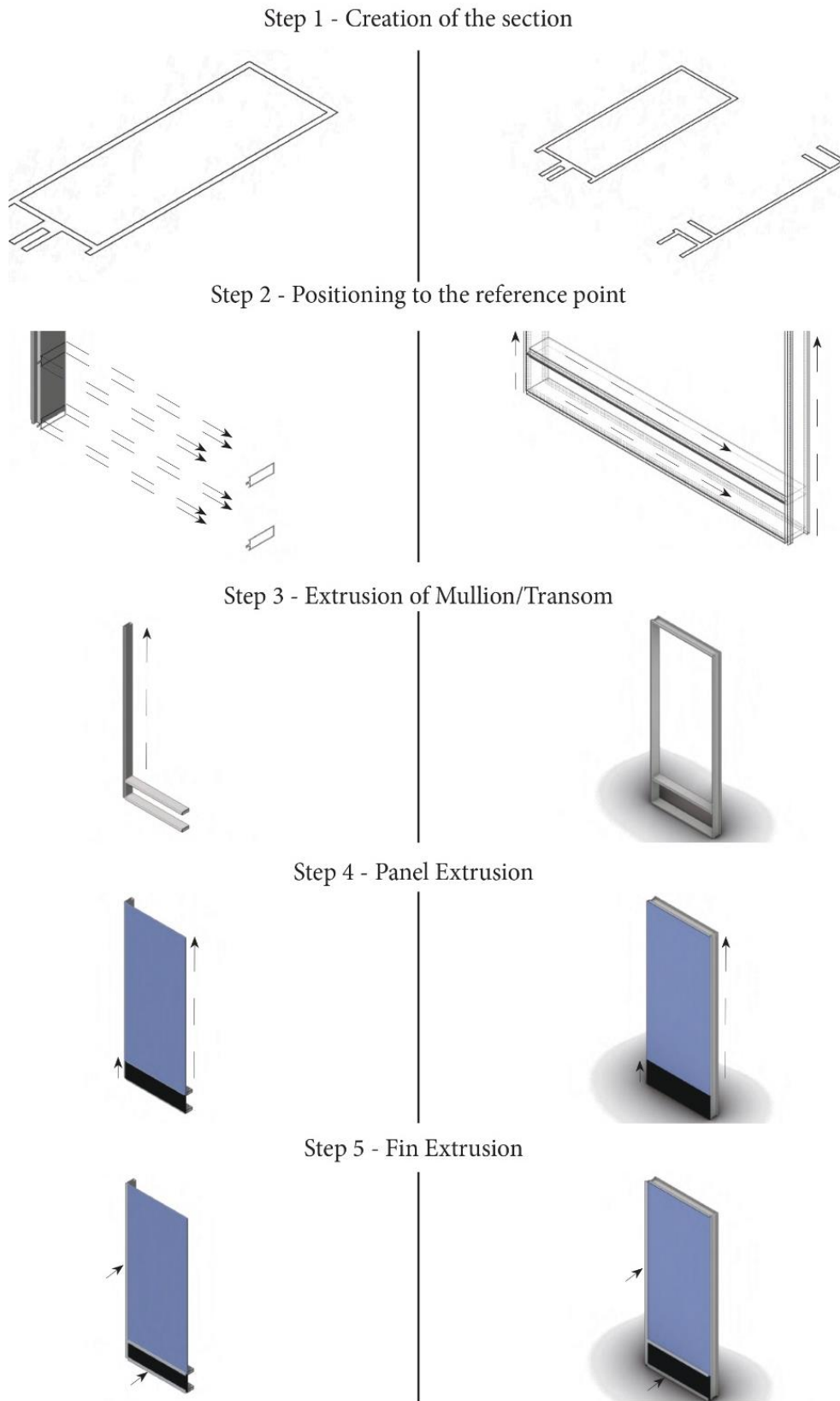

Figure 4.16. The 3-D modelling process of a single unit of stick panel (left) and unitised panel (right)

The models of all the required panels were developed for both the configurators. The total types of panels developed are regular, corner and edge panels.

Regular panels are the most predominant panels in both configurators. They consist of around 80 – 90% of the façade. The panels are at the centre of the façade system and are permanently joined with corner/edge from the sides. Corner panels are the corner of the façade and join two faces of the building. It is always joined to a regular panel and count to 4 around each floor. The corner panels are only present when the corner wall condition is false.

Contrary to the corner panel, the edge panels are only present when the corner wall is turned true. This edge panel is the junction between the wall and a regular panel, counting to 8 on each floor. The edge panel also lacks a mullion section, which was later achieved during the assembly. The three variations are applicable for both façade configurators, and the three-panel variations are shown below in Figure 4.17.

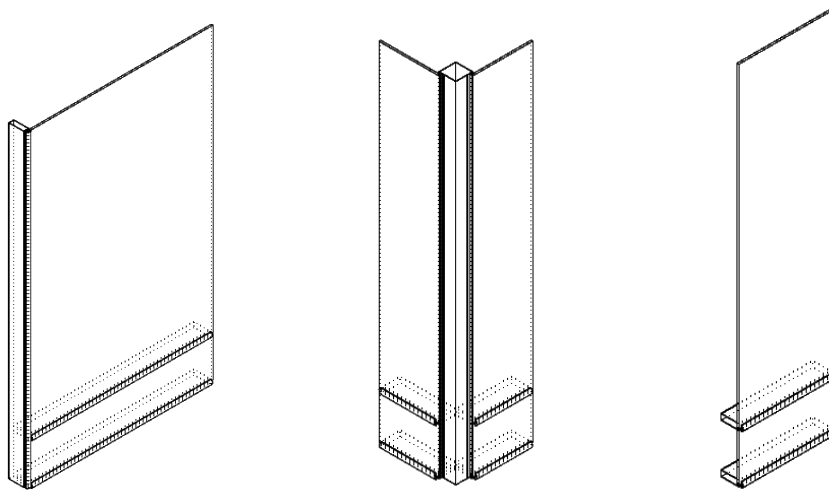

Figure 4.17. Three types of Stick CWS panels – Regular (Left), Corner (Middle) and Edge (Right)

Now, the models were rotated and aligned to reference points. For this, two critical aspects of the should be taken into account. The panelisation is executed only on two sides of the building since it will have a mirrored façade on the other two sides. Hence, after the entire assembly of the two sides, the model can be rotated to create the envelope for the other two sides. This process avoided repeated computation algorithms.

The modelled panels were split into two parts – models along lengthwise and models along the breadthwise. The same two conditions are repeated for regular, corner and edge panel conditions. In Figure 4.18, the exploding tree retrieves separate data after transforming from brep to mesh for a regular panel. The top explode tree component is for the lengthwise façade panels, and the bottom represents the breadthwise regular panels. The bottom panel is rotated along its reference point to align with the breadth-facing view. These outputs are ready for assembly, which is explained in the next section.

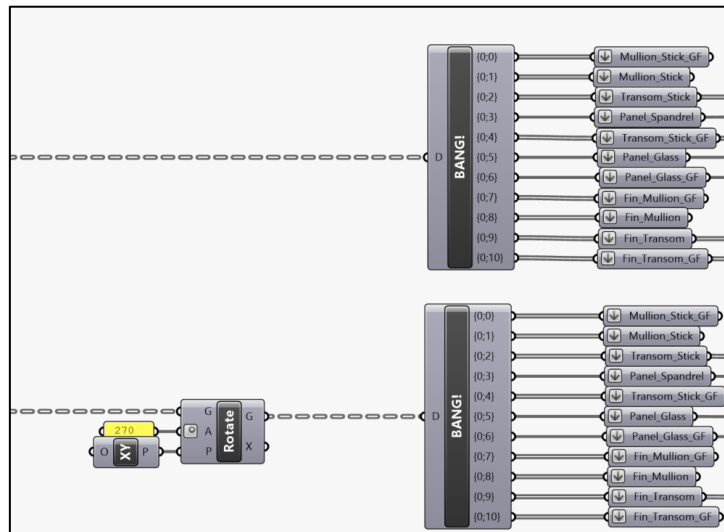

Figure 4.18. General stick system façade elements for side one (top explode tree) and two (bottom explode tree)

4.2.6 Panelisation and Assembly

The crucial process in terms of façade modelling is panelisation and assembly. Panelization of a curtain wall system refers to assembling sections of curtain walls in panels either on-site or off-site, depending on the type of configurator used.

Panelisation

In a panelised stick curtain wall system, sections of the wall, including mullions, transoms, and glazing, are pre-assembled into panels in a factory setting before being transported to the site. Likewise, the configurator has separated the 3D model with the required specifications. In a unitised system, this method is a part of prefabrication techniques, where each panel is designed and fabricated in a controlled factory environment, ensuring precision and quality control. The panels typically include framing, glazing, and other façade elements, and they are designed to meet the project's specific requirements, including aesthetic preferences, performance criteria, and structural loads. This research panelization optimises the construction process, reduces on-site labour and waste, and minimises construction time and disruptions.

The first step in the assembly is the precision in grid generation, as it is a paramount influential factor of the panelization, fabrication, and installation processes, ensuring that each component aligns accurately with the overall design specifications. Grid points are the foundational layout of the entire façade system. This research created systematic lines and symmetrically divided to get the vertices. Later, it followed a vertical pattern that defined the placement of various façade components such as panels, mullions, and transoms. These vertices generate a grid. The grid points are generated individually for the regular, edge, and corner panels and are present at the edges of each floor slab. An example of a grid system, when a corner wall is present, is shown in Figure 4.19.

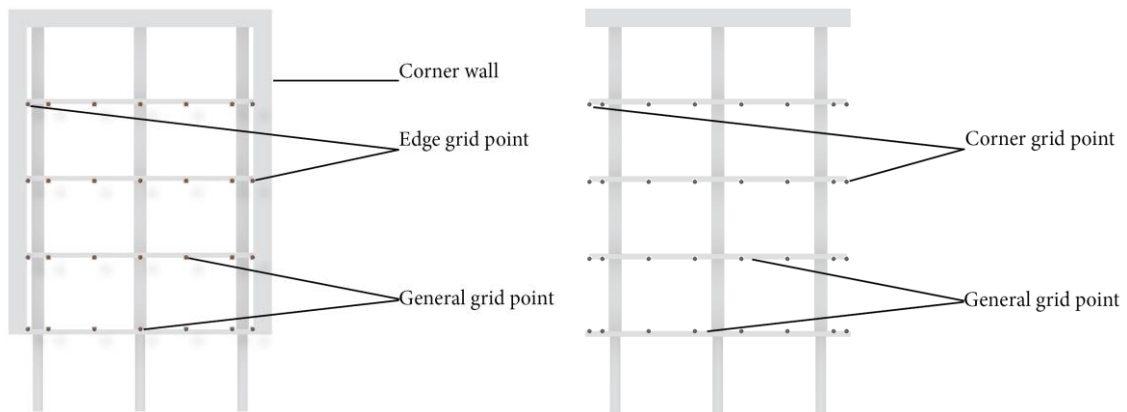

Figure 4.19. Grid system and reference points generation (YZ plane) for corner wall condition (left) and no corner wall condition (right)

Assembly

After the grid point generation, the respective façade elements were moved to these points to assemble the final model. Figure 4.20. shows the assembly of all floors except the ground floor. The script shows that the spandrel panel, glass panel, transom, mullion and fin developed from the previous section are moved to the panelisation grid points. The assembly is across the length of the building, and a similar approach is followed on the breadth of the floor. In this assembly, the mullion and fin are also assembled in an extra location, which is the last grid point in the length; that is, the point where the corner of the edge panel meets the regular panel. The absence of Mullion in the edge panel is satisfied by this assembly.

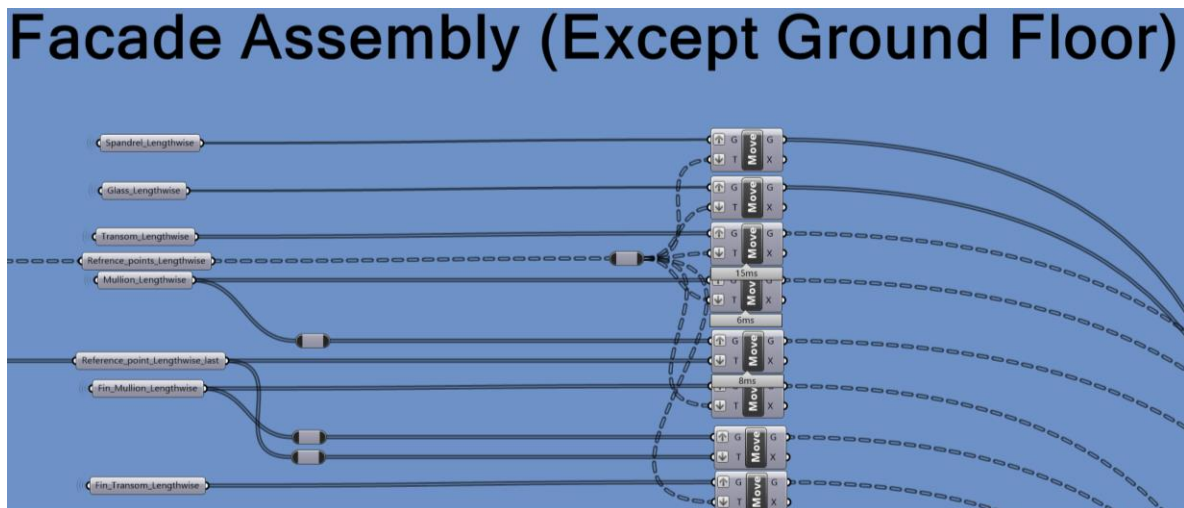

Figure 4.20. Lengthwise façade components moved to respective reference points

After the assembly along length and breadthwise, the model is rotated to the other two sides and with precision modelling, the model is one complete curtain wall façade envelope. Figure 4.21. shows the rotation of the façade components to complete the entire façade modelling.

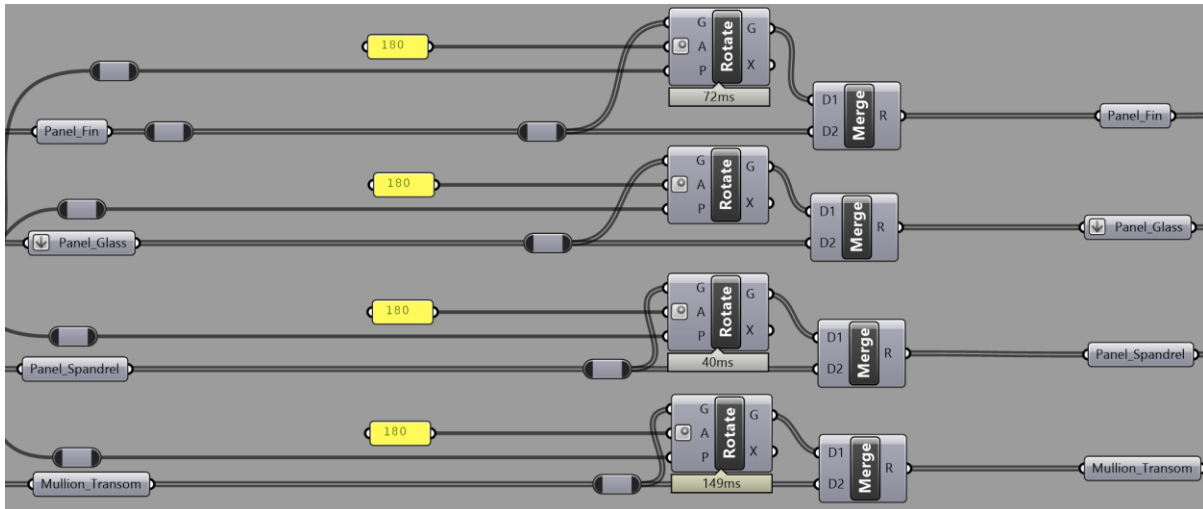

Figure 4.21. Assembly of the final façade elements

4.2.7 Generating the cost of the façade

The cost of the façade is the final algorithm in the canvas, followed by the panel assembly. The total cost of the façade was calculated based on the area, length and type. The factors are shown in Table 4.4. were used to determine the total cost. Two main factors are considered: factor 1 is always a Packhunt input, and factor 2 is the value retrieved from the GH for the respective unit of the cost.

Table 4.4. Cost calculation of both façade systems

S.No	Factor 1	Factor 2	Cost/Unit	Cost
1	Fin options (Input)	Length of Frames	EUR/m	C1
2	Glazing (Input)	Area of glass panel	EUR/Sq.m	C2
3	Spandrel insulation (Input)	Area of spandrel panel	EUR/Sq.m	C3
4	Structural Connection (Input)	-	EUR	C4
5	-	Length of Frames	EUR/m	C5
Total cost			EUR	

The total cost of the façade is calculated by the total sum of the product of factors 1 and 2 with the respective cost per unit. For example, C1 is calculated based on the fin option type given, like rectangular fin type, as a factor multiplied by the total length of the frames. This

result gives the total length of the material used, further multiplied by the cost per unit, giving the total cost for fin construction. Similarly, the area of the glass panel and the spandrel panel is found by finding the total volume of the panels divided by factor 16, which is the thickness of the panel in the proof of concept. The result shows the respective panels' area as seen in Figure 4.22. When multiplied by the glazing or insulation type and cost per unit, this result gives the total cost of the glass panel (C2) and spandrel panel (C3).

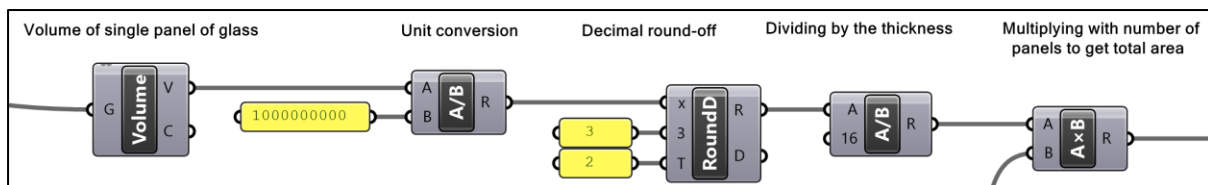

Figure 4.22. Algorithm of the calculation of the area of the panel

Particular calculations are seen in the case of C4 and C5, which have only one factor. C4 has only three types of input (top, middle and bottom), which have defined values and are added to the calculation as conditional input. In the case of C5, the length of the frame is calculated by the model of mullion and transom, which is multiplied further by cost per metre to give the total cost of the aluminium frame. The cost per unit is given as conditional input in all the cases as it varies based on the user selection.

The cost calculation algorithm is similar for both configurators, but the final output differs as material consumption differs. The length of the frames is calculated around the frame for four sides in the case of the unitised system and two sides for the stick system. However, the total cost of the façade is calculated based on the above algorithm and is executed in the same method for both systems. The cost is calculated in GH as a separate group, which takes inputs from the panel model. The end output of the group is the total cost and is connected to the Packhunt plugin's text component to show it on the configurator. It is displayed on the configurator's user interface at the end. However, the final value of the cost is calculated based on the assumption in the current Netherlands market. It is subject to change as the material cost differs from manufacturer to manufacturer.

4.2.8 Output for the Configurator

The output for the configurator is the last group and the final step in modelling. It is on the rightmost side of the canvas, containing all the output components of the Packhunt plugin. The final group consists mainly of two sections – material assigning and final output, as shown in Figure 4.23.

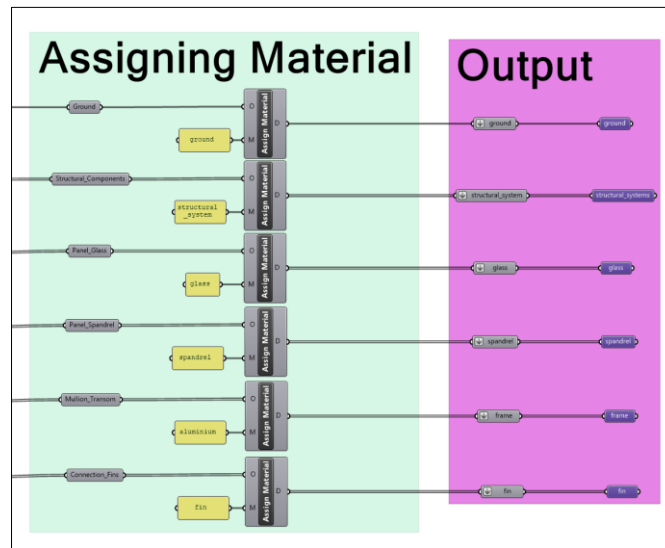

Figure 4.23. Material allocation and Output of the Configurator

There are seven outputs from the modelling in the two sections. The seven outputs of the modelling and the respective data type are listed in Table 4.5. All seven outputs are the same for both configurators. The façade model from the assembly group is assigned to their particular material using the “Assign material” component from Packhunt. The final model from the assembly group - mesh, is given a material using a unique name. These unique names are defined using the “Panel” component of the GH. After assigning the material, the output is connected to the “Data Output” component, ensuring the model can display itself in the configurator using Packhunt’s material colour.

Table 4.5. Description and Details of the Output Components

S. No	Name of the Output	Description	Packhunt Component Type	Data Type
1	ground	Ground surface	Data Output	Mesh
2	structural_systems	Structural components model	Data Output	Mesh
3	glass	Glass panel elements	Data Output	Mesh
4	spandrel	Spandrel panel elements	Data Output	Mesh
5	frame	Mullion and Transom	Data Output	Mesh
6	fin	Fin across the mullion and transom	Data Output	Mesh
7	cost	Total cost of the facade	Text Output	Text

The “Data Output” component is always connected to the result after assigning the material for the façade model. This output component accepts all the geometry types except SubD. Shepherd and Richens (2009) state that SubD modelling is a recursive process that creates a set of new child vertices for each original vertice in a mesh. This type of modelling creates more data and hence increases the runtime of the configurator. Hence, as a rule, the modelling avoided SubD surfaces, and all the outputs were in the mesh geometry. The “Data Output” cannot accept a mesh which does not have its material assigned. The model result is displayed in the visualisation engine part of the configurator.

On the other hand, the “Text Output” component shows the total cost of the façade and is connected to the “text join” component. The text join component gets static user input “Total Cost of the Façade: EUR”, which will be displayed before the cost output. These “Text Outputs” can only accept string values. However, there are no specific rules for the “Text Output” Component, and it accepts all the text that the GH supports. The “Text Output” is defined with the text join component and is shown in Figure 4.24. The result is displayed at the end of the user interface of the configurator.

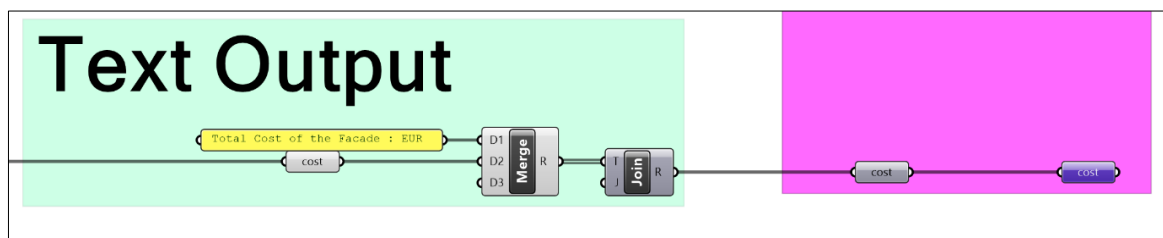

Figure 4.24. Definition of “Text Output” component

4.3 Self Service Interface (SSI)

There are various methods for executing the Grasshopper file in Packhunt. One such way is using the Self-Service Interface platform. The term “Self-Service Interface” (SSI) refers to the user interface or Packhunt platform that allows customers or users to perform tasks without direct assistance from service providers. SSI is used to upload the Grasshopper model to the Packhunt platform, allowing the user to test the solution. The workflow of the SSI is given in Figure 4.25.

After the modelling, the scripts were saved in the compatible format as (.gh, .ghx) files. These files are checked for any scripting error and corrected for Grasshopper standards. All the user inputs and output are connected to Packhunt’s Input and output components, respectively. The model is then uploaded to Packhunt for initialising the information.

The first step is creating a project for both configurators under a unique project slug name. A “project slug” typically refers to a simplified, URL-friendly version of a configurator project name. It is used to create clean and user-friendly URLs or as a unique identifier for a project within a system. After defining the project slug, the template is selected. Templates are

a type of configurator with predefined configurator layouts and ideas. Three templates are available in Packhunt, and the basic template was chosen for this proof of concept.

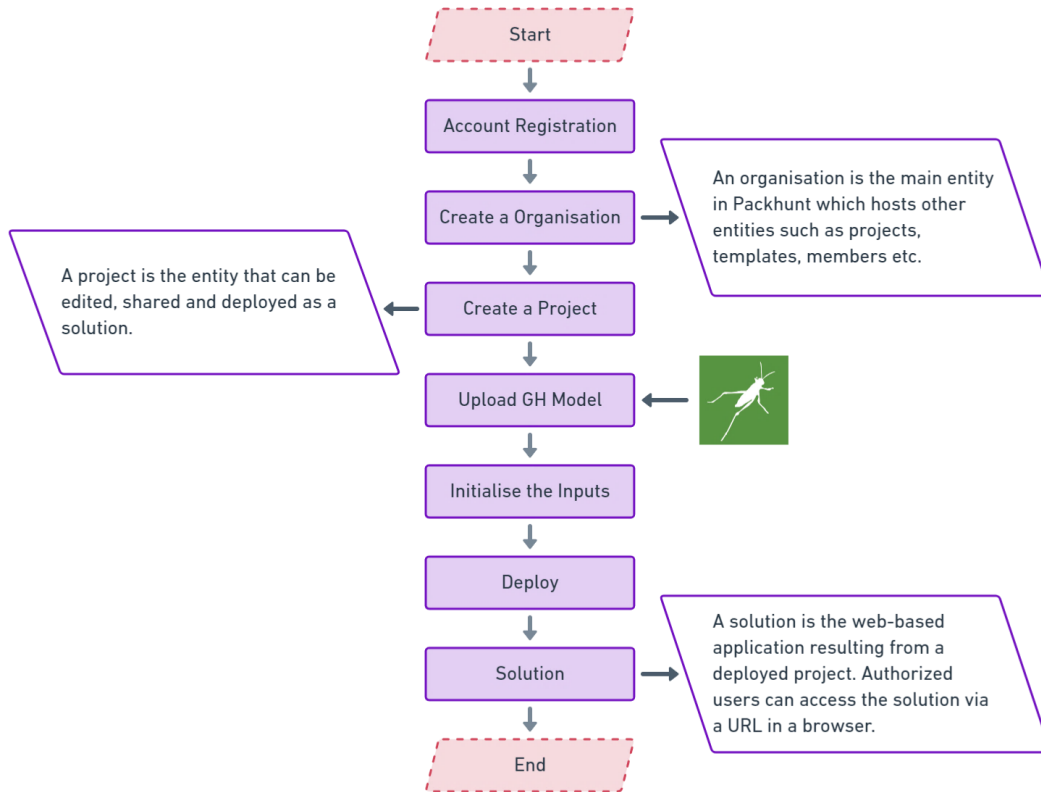

Figure 4.25. Working methodology of Packhunt’s Self-Service Interface (SSI)

The Packhunt’s inputs are defined in the initialisation panel of the basic template, along with necessary texts and heading. At first, the material of the outputs is determined using the colour with hex code and material name, as seen in Figure 4.26. The material name should be the same as the panel input for the “assign material” component. The user can choose any colour according to the user’s specifications. A typical example of the material definition for glass and spandrel, along with their respective colour, is shown below.

	<input type="text" value="#5BCAD7FF"/>	<input type="text" value="glass"/>	<input type="button" value="X"/>
Material name*			
	<input type="text" value="#000000FF"/>	<input type="text" value="spandrel"/>	<input type="button" value="X"/>
Material name*			

Figure 4.26. The layout of assigning material names and colours

The second section of the initialisation is the geometry model. Here, the graph is uploaded and checked for its feasibility. When the Grasshopper is uploaded successfully, the

user inputs are defined and can be edited. However, if the model has any error, the uploading will fail and denote the necessary mistakes executed in the Grasshopper. Some text add-ons are proposed for the understandability of the configurator, and the user can edit these texts and place them according to the location. The input is edited and redefined in the Packhunt for all three types of information– structural, façade and cost. Various fields can be adjusted except for the kind of input given. The input types used in this research are slider and dropdown, defined in the Grasshopper. For both types of inputs, the editable fields which can be changed when initialising are shown in Table 4.6.

Table 4.6. Modifiable input fields in the setting panel of SSI

Input Type	Editable fields	Description
Slider	Label above slider	The name of the input
	Unit	Gets a text/number from the user
	Min value	Gets the minimum value of the slider
	Max value	Gets the maximum value of the slider
	Default value	A default value from the min-max range
	Precision	Gets the number of decimals for precision
Dropdown	Label above dropdown	The name of the input
	Value	Gets a value for the respective label
	Label	Gets a text/ number
	Select default value	A default value for the dropdown
	Add choices	More labels and values can be created.

The inputs are defined, and the last process is deploying as a solution. The stick configurator from company A and the unitised curtain wall from company B, as two separate configurators, were deployed as a solution online using a unique project slug. This solution was tested for their efficiency and compiling time in the Grasshopper. Alterations were made whenever necessary and when there was substantial compiling time. After the changes and correction, the solution was again tested for efficiency. The process was executed to check the correctness of the solution. At last, the end solution from two companies was developed using the Packhunt SSI and was available for validation.

5

Results

The chapter explores the final design details of the curtain wall modelling in Grasshopper and Pakchunt. This section briefly discusses professional feedback for validating the proof of concept using the façade configurator.

In Chapter 4, the research explored how the Packhunt configurator is a helpful tool in creating the proof of concept using curtain wall facades. This chapter broke down the complex process of building facades into more straightforward steps, showing how different parts and pieces come together in the modelling phase. The previous section ends with how it was deployed into a solution in the Packhunt configurator. The deployed solution was tested for its merits and demerits.

5.1 Results from Curtain Wall Modelling and Configuration

As a proof of concept to be validated, it should also address efficiency, productivity and usability. For this, the configurator must be working with no failure conditions. Hence, after the development of the model, the configuration must be tested for its working nature. The configurator is generally checked in the project slug URL, but it was decided to be tested in the Grasshopper file. The configurator's compiling time was slightly higher than the Grasshopper's. The primary reason to avoid configurator testing was the luxury of open sources of Packhunt. The GH file can be tested in simple steps using Packhunt's SSI.

Testing

In Grasshopper, the script was tested for various parametric inputs and conditions and checked for its breakability. The conditions were drawn in Rhino using the rhino preview component for various colours. When a single component fails in the script, it often leads to breaking the final model. For example, when an input is given as below,

- Length of the floor: 7000 mm
- Breadth of the floor: 10800 mm
- Length of the single panel: 3600 mm
- Corner wall: No
- Configurator Type: Stick CWS (Company A)

This situation indicates that only one regular panel can be drawn in the given length and breadth of the building. The corner modelling tends to have a panel length of 1700 mm and 3600 mm breadth. Initially, this condition failed since the corner panel was the same as the length of the panel. However, the model was rectified using this test case by checking whether the floor's breadth was modulus to the panel's length. The value is checked if it is "0" and then transmits the required breadth of the floor and further forms the corner panel, as shown in Figure 5.1.

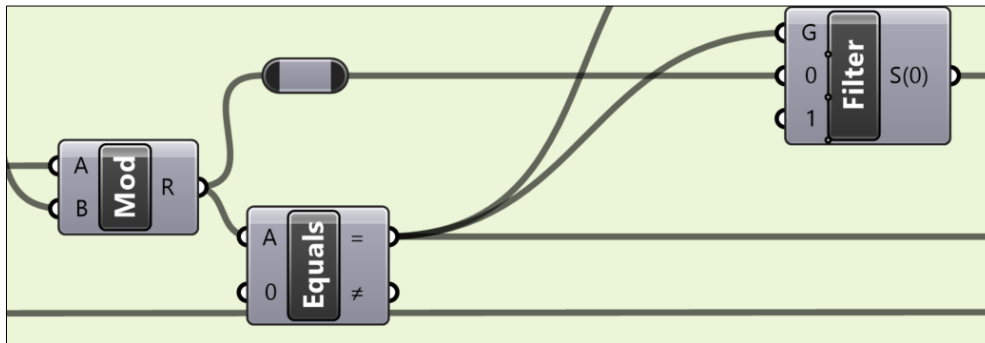

Figure 5.1. Check for the equal dimension of the panel's length and the corner façade's length

Likewise, various minor details were adjusted for the corner condition to get efficient compiler time. The panel model was developed using Brep and later converted into mesh for faster compilation. This conversion ensured the component ran 5-10 seconds faster than the initial compiling time. The Grasshopper was simplified, and the algorithms were optimized to reduce unnecessary computations. The testing was for efficient data structures and algorithms. The script also minimises the data processed by culling and simplifying geometry. Culling resulted in the deleting the null values from the list. The optimised script was developed using a well-structured data tree.

The testing was concluded once the model could be drawn with all the varying inputs and conditions. The test also showed less execution time, and data are always managed in a tree. The two configurators' ran successfully with the optimised scripts. The two test results provided an efficient LOD in the model.

Stick system

The stick system is modelled with more façade sections than the unitised system but has fewer 3D-modelled data elements. Eight elements were modelled in the regular panel, 4 for the edge panel and 14 for the corner panel. The corner panel has variable dimensions across its length and breadth, making it suitable for all conditions. The edge panel and corner panel are adjusted to the length of the regular panel when the fit condition is given in the configurator. All the modelled parts are developed as mesh. Figures 5.2 and 5.3 represent the regular and corner stick systems. The essential element in the modelling was the gap provision for the

rubber/sealants, which are crucial for the thermal barrier. These were incorporated into the static values modelling to show the practicality of these stick systems.

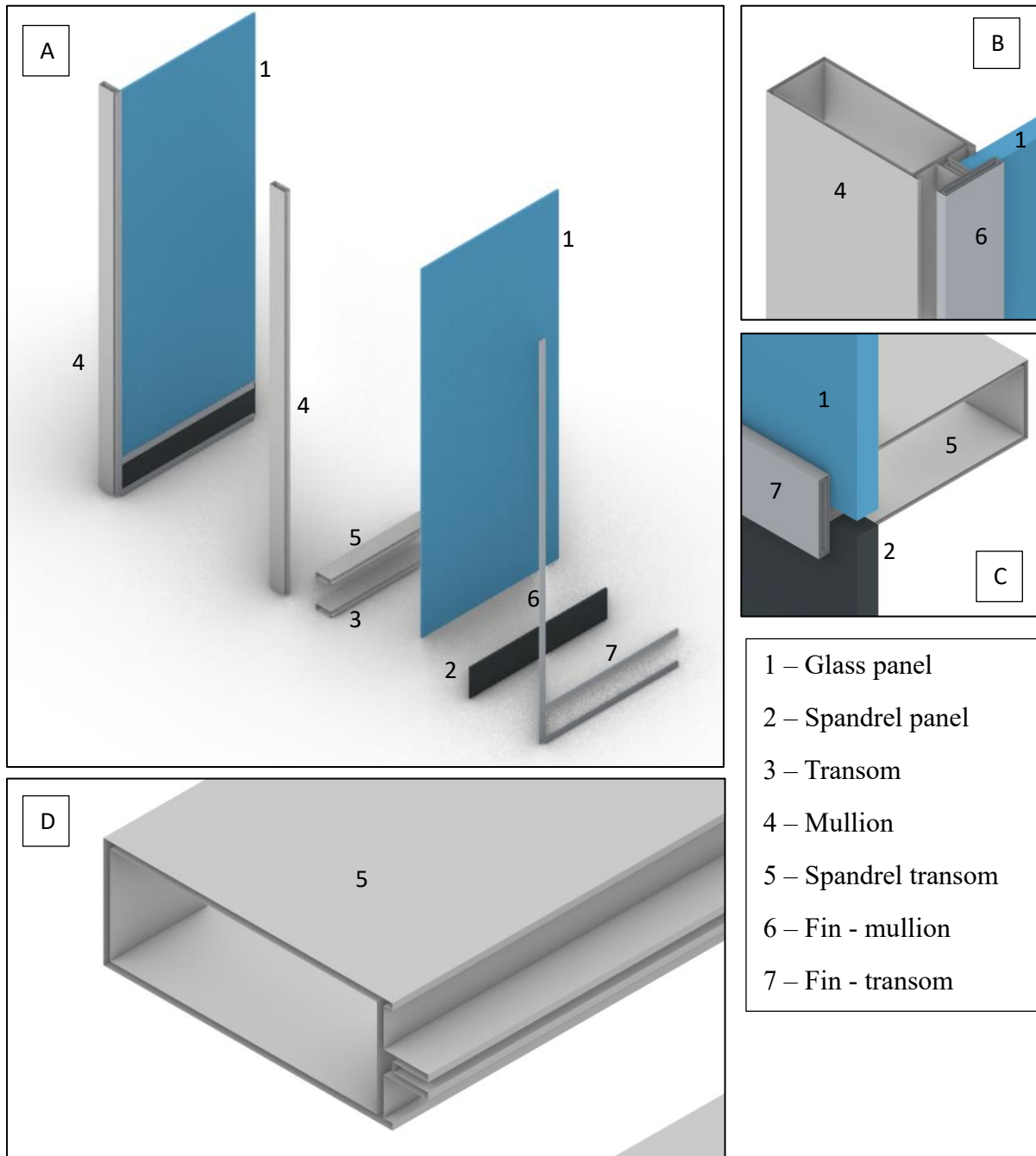

Figure 5.2. A – Exploded regular stick system, B – Connection detail of glass panel with the mullion, C – Connection detail of glass panel and spandrel panel with the transom and D - Cross-section of the transom

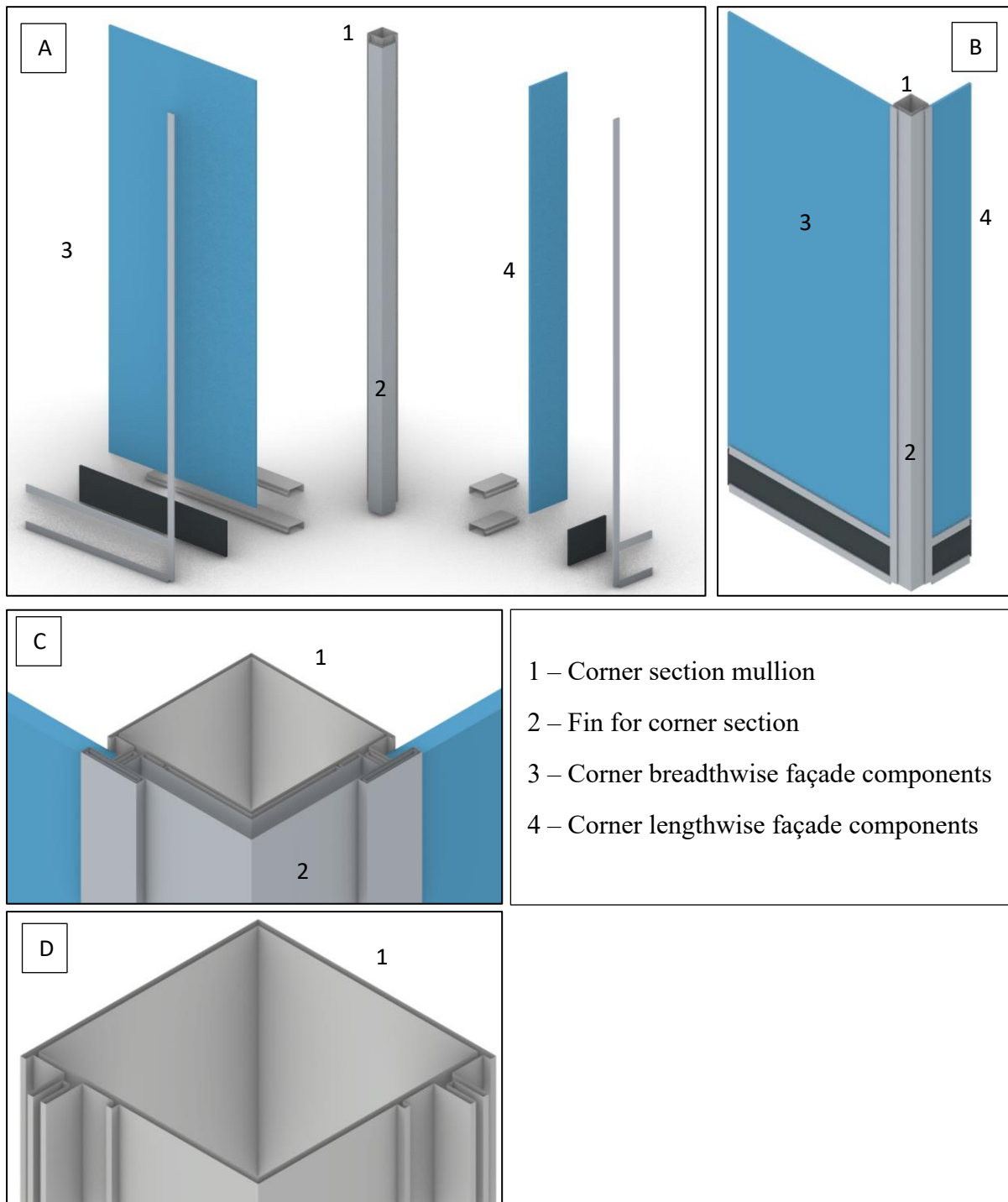

Figure 5.3. A – Exploded corner stick façade system, B - Corner Stick System, C – Connection detail of glass panel and corner fin with the corner mullion and D - Cross-section of the corner mullion section

Unitised system

Similar to the unitised system, the modelling of the unitised system was developed considering the real-life applications. The unitised system generally has more models than unitised but uses only one significant section of split mullion. The core frame of the entire model of the unitised system was developed from one split mullion. This feature was unique for this configurator, and it executes computationally faster. However, the more the elements, the more the elements for assembly; hence, the overall computation time was slower. The results of the regular unitised system are shown in Figure 5.4, and the corner unitised system in Figure 5.5. These renderings are developed from the Rhino preview component by assigning colours similar to the Packhunt “Assign material”.

Differences in the configurator

Although both share a similar approach in the modelling, there are notable differences between the two configurators. The most notable differences are as follows:

- In a regular panel, only one transom is developed (at the bottom) in the case of a stick, whereas all four sides have a split mullion enclosed in a regular unitised panel.
- Systematically, the numerical values of referencing the panels are different from each other.
- Due to the split mullion condition, all the depth of façade sections was reduced to half for the feasibility of the configurators. In the stick system, the depth of the mullion was taken to be complete in most cases.
- The corner panel of both configurators is entirely built differently. The stick system follows a corner section at the corner point of the floor, while the unitised system corner panel is connected with a split mullion of the last panel from both sides.
- The edge panel has an extra split mullion in the case of the unitised system. This extra mullion is to finish the connection system and to have a water-tight façade system.
- The assembly of these panels follow a similar approach but has numerical values depending on the configurator type.
- The spandrel transom of the unitised system is developed from the façade section of the stick system. However, both systems use 5 of six defined sections for the modelling.
- The cost of both the facades is different due to their difference in the modelling, unlike real life.

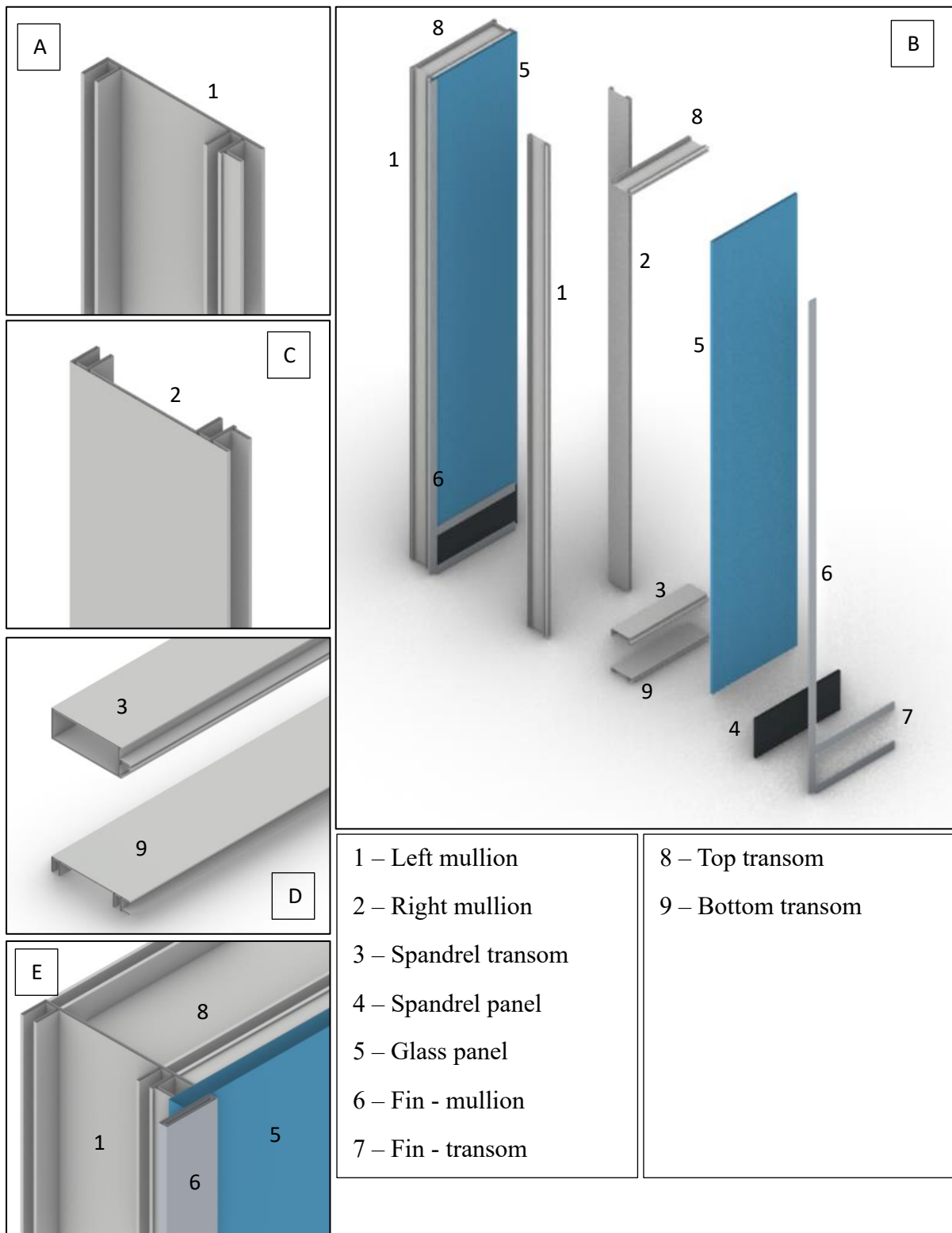

Figure 5.4. A - Left split-mullion, B – Exploded view of the unitised system, C – Right split mullion, D - Cross-section of the spandrel transom and split transom and E - Connection detail of glass panel and split transom with split mullion

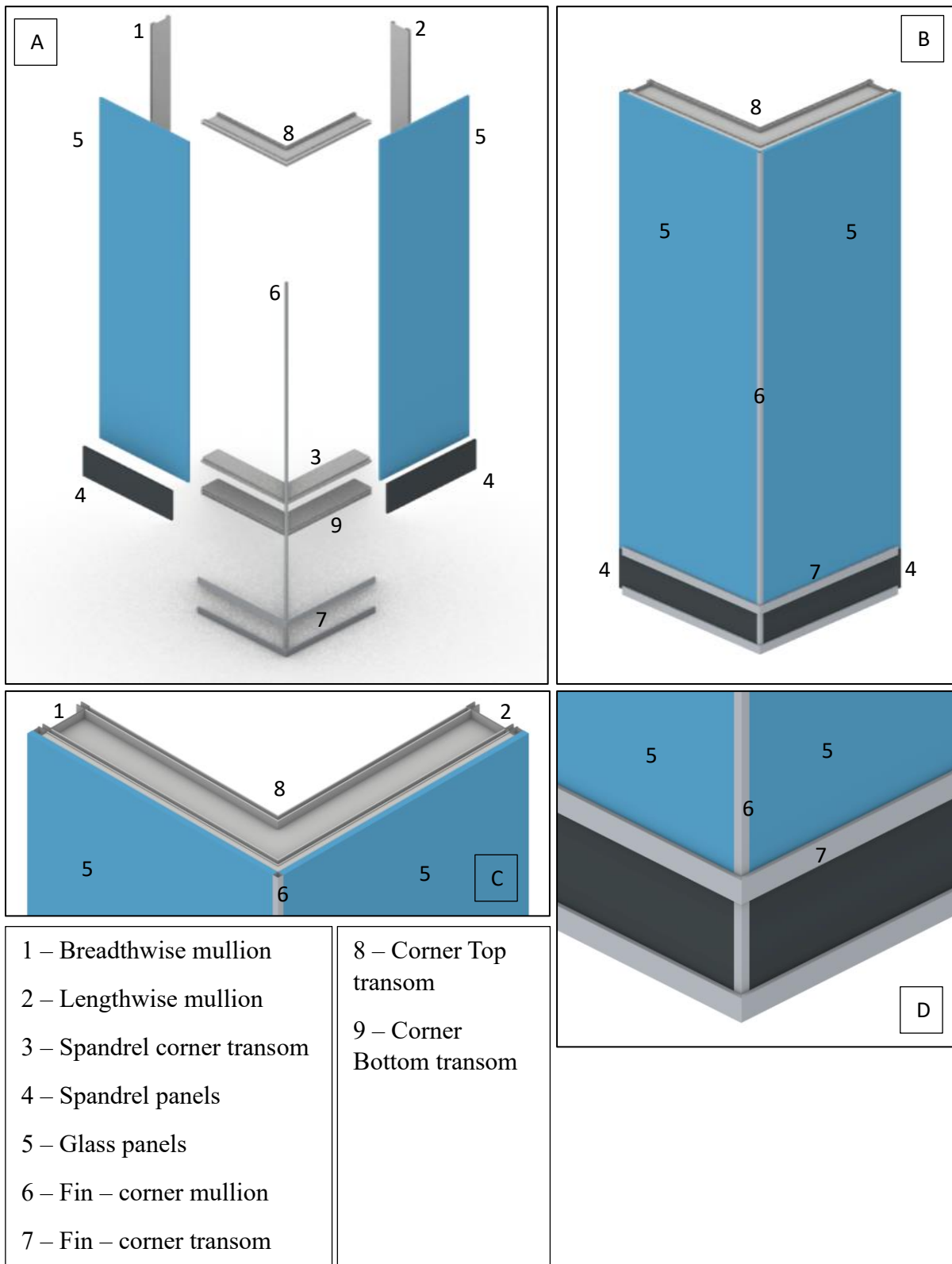

Figure 5.5. A - Exploded view of the corner unitised system, B – Corner unitised system, C – Connection detail of glass panel with a top corner split mullion and D – Connection detail of the spandrel fin transom, corner fin mullion with glass and spandrel panel

Special cases

Apart from the regular and corner panels, there are exceptional cases: roof and ground floor panels. In the ground floor panel, there is an absence of a spandrel panel. Thus, there is no spandrel transom. Where the number of floors is given as one, the following façade models are executed as shown in Figure 5.6.

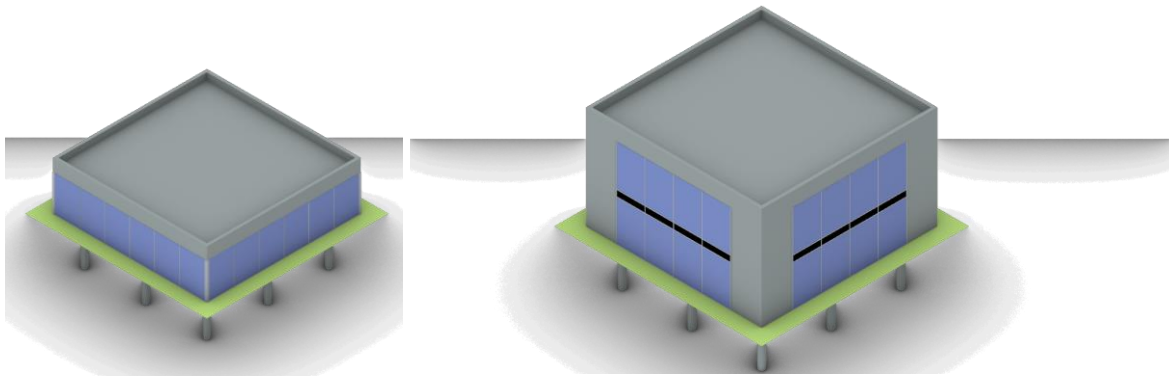

Figure 5.6. Single floor condition for a unitised façade system (left) and Stick system with a corner wall condition is toggled

The next feature of both configurations is the corner wall condition. A corner wall is developed when this is turned on, and the façade panels are arranged to the given boundary conditions. If the user also defines yes to fit the panels along its length, they are fitted to its dimensions within the corner wall, making it appealing. So, it forms four iterations for a single configurator. These iterations happen:

- When both the corner wall and fit panels are turned on (Figure 5.6)
- When the corner wall is turned on, the fit panel is turned off
- When the fit panel is turned on and the corner wall is turned off (Figure 5.7)
- When both the inputs are turned off (Figure 5.7)

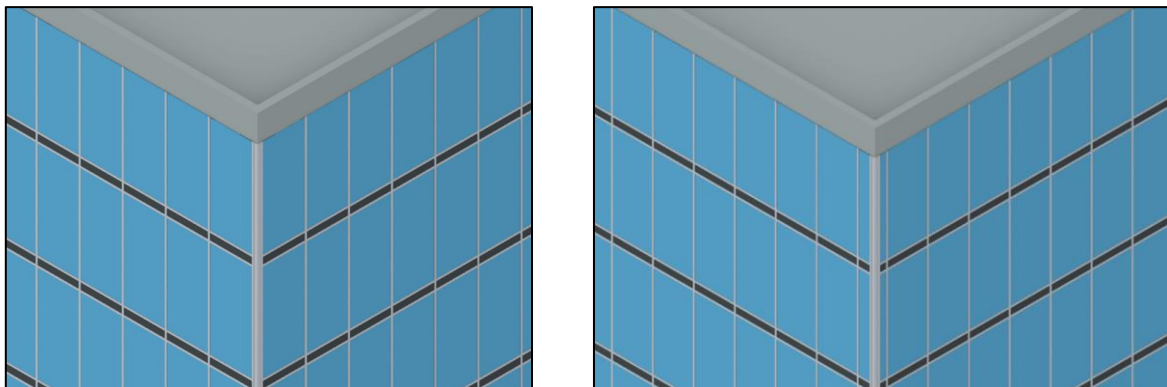

Figure 5.7. Modelling when fit panel to its length is turned off (left) and turned on (right)

The SSI solution for both configurators was developed by uploading the optimised script. The Figure 5.8. illustrates Company A- stick system configurator. In this image, the 3D visualisation and UI are seen.

The UI gets all the user inputs defined in the Grasshopper, and the model previewed in the Rhino interface is represented in the visualisation engine. The initialised settings like precision, default value, unit and texts can be seen in the UI. On the other hand, the engine shows the chosen colour of the material defined in the settings of the solution. The resultant model can be used parametrically for various design solutions and quotations. In the 3D engine, the user can rotate and zoom in to see facade details with a closer look. The four-sided arrow icon represents the zoom to fit the entire model.

The end product is configured, and the proposed design solution is developed and needs to be validated. The Rhino preview demonstrated a faster compiling process than the web tool for this validation. However, both the configurators are running with a similar compiling time, though their logic is different.

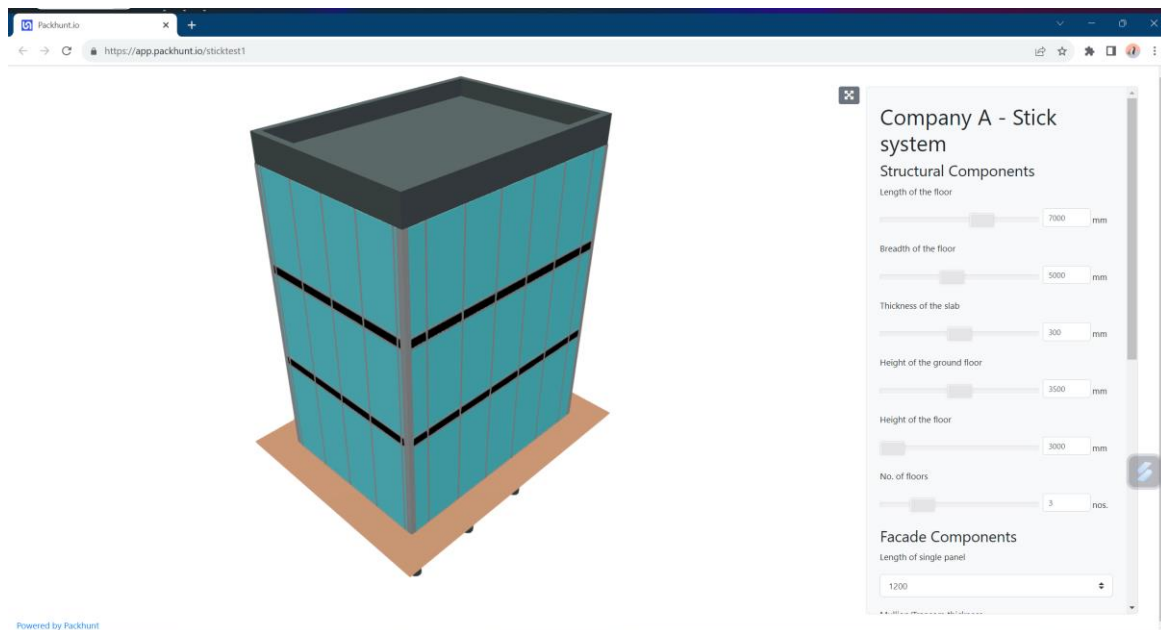

Figure 5.8. The stick system configurator deployed in the Packhunt server

5.2 Validation of the Proof of Concept

The results from the configurator are briefly discussed in the above section. However, a proof of concept needs validation to understand its working nature. As a result, the configurator was presented to various professionals from the construction industry for their feedback. The validation targetted four significant aspects: effectiveness, productivity, functionality and market viability. As a result, four questions were formulated and asked the professionals for their thoughts, represented in Table 5.1.

Table 5.1. Validation aspects and feedback questions regarding the assessment

S. No	Validation aspect	Question
1	Effectiveness	From what you understand of this configurator, could you see it as an effective improvement of future interaction between fabricators and contractors?
2	Productivity	In general, do you expect end users to be more productive with this new digital design workflow?
3	Functionality	From a contractor/fabricator/stakeholder point of view, what functionalities would you see most helpful in these configurators?
4	Market Viability	Is there a need or business case for this type of configurator in the supply chain of curtain wall facades?

5.2.1 Feedbacks

The questions were asked to various industry people from the façade engineering domain. The company's professional feedback is as follows.

Feedback 1

Personnel 1 is the leader in building physics on the façade at an engineering company producing architectural envelopes. They state that the configurator is very effective for small companies. Usually, big companies tend to have custom production of facades, and fabricators have their software for these kinds of fabrication. They say the configurator is handy in the early design stage, where architects can visualise multiple options but suppress their design capacity. However, architects can know about the Level of Detail, like corner sections, which are often problematic. In this case, the contractor can know the rough estimation of the façade. They mention that the users of this type of configurator are not the contractors or the architects but the developers. A developer is a person who develops a conceptual design into a schematic design. The expectation of the configurator is targeted mainly for its Bill of Quantities (BOQ). Regarding building physics functionality, the person expects extra LOD, units and a database for predefined mullion sections. Overall, the configurators are built by one stakeholder and have lost limitations for designers but are very useful for small-scale projects.

Feedback 2

Personnel 2 is the director of a wooden façade manufacturing company. They state that these configurators are a massive addition to the construction industry and are very effective. The users are all the stakeholders in their opinion, and the design developer can have multiple options. The fabrication constraints are reducing the scope of the configurator as it cannot provide any modular sections defined in the configurator. In their feedback, the digital workflow is the next revolution that minimises data exchange between parties. For the digital

workflow, configurators are the solutions all parties should use. Overall, the limitations are not in the configurators but in the fabricator's incapability to produce these configured modular systems.

Feedback 3

Personnel 3 is the lead designer at a façade company, leading global curtain wall and advanced façade technologies. They have a very critical point of view of a configurator in general. The configurator developed in this thesis is very flat and minimalistic and could not answer the bigger question of the workflow. They say that the developed workflow is a black-box approach, and generally, the manufacturers do not give the data to other stakeholders of their limitations and constraints. In this case, the configurator that the fabricator develops is not practically possible for other stakeholders to use it. The seeking functionalities of the personnel are to have a finish option for the façade system, cost-optimal solutions and a lot of data prebuilt in the database. They also briefly discussed how the configurator could be improved with details of the existing framings and sections incorporated into the configurator. The user can benefit from these data as they can know the practical conditions and suggestions. These improvements can make the configurator directly get a work order when the fabricators develop it. They strongly contradicted the need for these configurators at the current state but see a vision for it if the configurators are set to boundary conditions and improved.

Feedback 4

Personnel 4 is a computational designer from an architectural company specialising in complex 3D-formed steel constructions. They state that the configurator is very effective as it can aid the bidding process, but in theory, there are façade suppliers who make the sections and façade companies who make the installation and engineering. The personnel see the result time as the paramount productivity. The database of façade sections from the suppliers has a vast potential that can be a significant functionality. They also recommend using a skylight façade system and window options. Overall, the personnel, being a computational designer, sees the proposed workflow as a very effective tool but needs much refining before implementation.

Feedback 5

Personnel 5 is a construction company's co-owner concentrating on the engineering and manufacturing of steel frames, curtain walls and siding. They say that the proposed workflow concentrates on the contractor being the user, but this is not the case, and the contractor does not care about the architect's design. The owner and clients are the fundamental factors for the decisions. They say that façade are very complex systems with many components that must be considered, but the current concept is a significant progress for an initial design. They further say there is a scope for these configurators in the early design phase, which needs to be a step further in structural calculations and building physics. The current state is an excellent system in terms of its configuration time, and they were optimistic about the impact on the current workflow. However, they see the configurator can impact more in a Design and Build contract

system where contractors are the key for any decision. They see the end users of these configurators as designers and see the positives of the broad approach of the proposed workflow for prefabricated materials.

5.3 Validation Aspects

The feedback results were concluded and compiled into the six criteria based on configurator performance and professional feedback. The concluded results are as follows:

Feasibility

Feasibility is a criterion that can be validated if the product is conveniently done. The feasibility was proved by testing various design inputs and cases. Validating a PoC for its feasibility is a multifaceted process involving testing and iterative refinement. It is crucial to approach this process systematically to make informed decisions about the concept's potential for real-world application. The iterative refining using various test cases after the development has meticulously developed the feasibility. The solution is deployed once all these refinements have been solved. This process ensured that the configurator was ready for the on-stage applications.

Workability

Workability refers to the ease of designing and flexible modifications. The logic of the algorithms was established as very basic and understandable scripting to be validated by this aspect. The script was adjusted easily in the respective groups after each test and case condition if anything failed. In a particular example, the contractors will consider the thickness or breadth of the mullion in a real-life condition. Although it is not present in the current configurator, it can be explored in the future by changing very few components. These features can be achieved by changing the static and conditional inputs and changing algorithms related to these inputs. The model has hassle-free wires, and a person with technical knowledge of the software could work around the GH for future scope.

Effectiveness

The façade configurator allows users to visualise different façade designs, materials, and configurations in real-time, enhancing the overall design process. This configurator allows users to generate real-time adjustments, enabling immediate feedback, which can be particularly beneficial in addressing any concerns or changes arising during the design process. A higher level of customisation can lead to more client satisfaction and result in buildings that align with the end-user's needs and preferences. The exploration can lead to innovative design solutions and help achieve the optimal balance between aesthetics and functionality. Enhanced collaboration of two stakeholders has led to more cohesive and well-rounded design solutions and helped identify and address potential issues early in the design process.

Productivity

Configurators facilitate rapid generation and modification of façade designs, allowing designers to explore multiple options and variations in less time. The current PoC offers precise material calculations and cost estimations, enabling optimal resource allocation and budget management. The current façade configurator automates the generation of detailed models, specifications, and bid values, reducing manual effort and errors. One can be more productive if they have the solution at their fingertips. The proposed workflow is attributed to the productive nature of the human.

Functionality

The main functionality recommended by professionals was the high-quality, interactive 3D visualisation of designs, allowing for detailed examination and modifications. The configurator has only two predefined databases that can be automated and accurately calculate material requirements and associated costs based on the configurations chosen. However, the configurators should also be flexible with designs and reduce the limitations of the ideas. More functionality like variable and customisable parts must be added, like different spandrel panel dimensions rather than depending on the height of the slab.

Market viability

Façade configurators contribute to sustainability by optimising material usage, reducing waste, and facilitating the design of energy-efficient buildings. The ability of façade configurators to integrate with other software and systems increases their usability and adaptability, making them more viable in diverse project environments. This results in streamlined data exchange in the construction process. The configurators also offer companies a way to differentiate themselves by enabling the creation of groundbreaking designs and ensuring client engagement in the design process, thus enhancing their market position.

5.4 Limitations

The developed configurator has various limitations that were considered critical points for the practicality of the workflow. The professional feedback also mentioned the limitations, who recommended it as the future scope of the project. The significant design restrictions and limitations of the configurator are listed below.

- **Structural Calculations:** The model considers only a few aspects of the structural calculations in designing the façade. The practical condition of the wind load and material design were neglected to limit the scope. All the thicknesses were static input, which is not considered in the practical scenario. The facade configurators account for limited technical constraints and requirements but do not consider building codes, structural limitations, and safety regulations.

- **Level of detail:** The direct impact of the structural calculations is reflected in the detail of the façade sections. The assumption is made by considering the existing reference objects, which are still in the minimal considerations. Other façade sections are absent, which can directly impact the design. The professionals' feedback highly recommended using pre-defined details and façade sections to develop the configurator.
- **Cost Calculations:** While the facade configurators allow users to visualize the design, they provide tentative cost estimates for the chosen configuration. The current facade configurators offer a predefined selection of materials, finishes, and textures. The contractor may not authorise different materials, which can impact the cost.
- **Data sets:** The current configurator only takes into account five sections. However, there are many sections which should be considered in the modelling. All the data in the current system are developed from the input, which the pre-built data sets can replace. The data sets should consist of the façade sections currently in use.

6

Discussions

The concluding thoughts of this thesis project are offered in the subsequent chapter and further delve into hypothesis testing. The steps of the procedure are discussed, as well as the outcomes. The discussion focuses on the acceptance of the proof of concept.

The initial goal of this thesis project was to create a design workflow that could encapsulate a manufacturer's knowledge and allow users to create virtually finished façade systems. This broad approach was restricted throughout the research, concluding that a proof-of-concept proposal must be addressed to validate the objective. Hence, the proof of concept targets two primary stakeholders in the current workflow - contractors and subcontractors, and the tool aims to configure the process between contractors and subcontractors. The design tool is developed by fabricators, who can draft a bid that is helpful for the contractors in the bidding process.

The literature survey provides a comprehensive overview of the construction industry's challenges and potential solutions, focusing on data exchange, collaboration, and fabrication feasibility. The insights gained from this literature review are foundational for understanding the complexities and challenges in the construction industry and set the stage for the subsequent chapters, where the report introduces innovative solutions and a proof of concept to address these challenges. The emphasis on the need for more streamlined and standardized approaches and the integration of advanced digital tools are pivotal points.

The research then continued to develop the configurator's scope and identify its merits and demerits. After brief discussions, it was concluded that the configurator's user was a contractor and the configurator's developer was a sub-contractor. The level of detail for modelling the configurator was established based on the current façade details in the data exchanges. The trends and expectations of the user were the crucial criteria for this study.

6.1 Reflection on the Façade Configurator

The information and knowledge gathered from the literature survey were initially sorted, and the Rhino surface was introduced as input parameters. Later, due to the project's scope, it was restricted to the numerical input. These inputs were not considered due to a lack of competitiveness with two configurators. The three input components – structural façade and cost were the governing inputs of the entire façade parametric process. However, these

governing inputs were responsible for many other governing values. Once again, the LOD was discussed for fastening the compilation process. The configurator's workability was tested when considering a higher level of detail. Unlike the first time, this reduced level of detail was seen as a limiting factor for the overall goal since it considered the fabrication factors.

The Packhunt configurator and its background process were briefly discussed, and it also mentions the rules and standards for the GH script. The rules ensured the workability further and dived into the façade development. Based on the input, the façade modelling was developed for many cases. Despite the LOD and input generation difficulties, the model was prioritised in the section development. Prioritizing the already built façade types and drafting the solution was comparatively easy with the pre-built data solutions. The fact that the developed design tool is a complex scenario suggests that it can be incorporated into buildings like office spaces and classrooms.

The outputs of the façade configurator were obtained after many iterations. This iteration means that the results were not determined using one case. They generally produce versatile solutions based on user inputs. More iterations and LOD might increase the probability of reaching the best solution. However, the broad idea was restricted due to the project's timeline. Overall, the PoC proved to work and function as it was executed in fabrication-aware scenarios. The detailed results of the provided configurator can also guarantee the accuracy of the results. Finally, the developed configurator as a PoC is sent to be validated.

6.2 Hypothesis Testing and Impact of the Design Workflow

As the configurator is developed as a proof of concept, it must be provided with validity for its acceptance. The acceptance can be executed considering a lot of critical aspects. However, these key aspects should be validated with a strong case and professional perspective. Hence, the proposed hypothesis was validated using testing and professional feedback. The testing of the configurator was executed internally using various test conditions. This type of validation governs the feasibility and workability of the configurator. The external demonstration targeted four configurator aspects, validating the proof of concept.

- The configurator was conveniently done using the necessary components; no external criteria were required. The modelling satisfied all the project deliverables in terms of bid evaluation.
- The script was organised, and ethical standards were followed for its canvas, allowing the scope of workability on the current model. Apart from the continuity, the digital workflow also enhances the collaboration of stakeholders by high workability.

- The effectiveness of configurators in this context is evident in the enhanced efficiency, reduced errors, improved quality, and streamlined compliance they bring to the construction and fabrication process.
- The façade configurators significantly enhance productivity for general contractors and fabricators by enhancing project management, optimising material usage, and rework. The precise and detailed information provided in the configurators ensures accuracy in fabrication and construction, leading to less time and cost.
- The integration of innovative functionalities has ensured that the configurator serves as an effective tool in bridging the gap between contractors and fabricators.
- Configurators align well with the evolving needs and preferences of the construction and architectural industry, making them an asset in the contemporary building environment.

With the opinion of professionals from different roles, integrating a curtain wall façade configurator in the traditional Design-Bid-Build (DBB) system can bring about transformative changes, impacting various facets of construction projects. However, these changes are not accepted by all the personnel. The fact that construction systems often tend not to practice unconventional methods creates an incompatibility between the two stakeholders. This misinterpretation probably explains why the tool is still in the PoC phase and has not been practised worldwide, even though similar technologies have been prevalent for years. Nevertheless, apart from resistance to adoption, the configurator acts as a digital tool for efficient automated design workflow.

7

Conclusions and Recommendations

7.1 Conclusions

The research successfully developed a prototype tool to execute the competitive bidding process involving contractors and subcontractors, translating the manufacturer's expertise into a digital model. The tool was developed focusing on curtain wall systems, specifically stick and unitised systems, built by two fabricators, serving as a practical example to illustrate the proposed workflow. This prototype tool is a significant stride in demonstrating the feasibility of integrating manufacturing insights early in the design phases, thereby expediting the overall design workflow.

The prototype underwent rigorous validation phases, ensuring its feasibility and workability. The initial testing involved various iterations of input parameters, confirming the tool's support requirements and alignment with the proof of concept. The professional validation provided critical insights into the practicality of the solution, with feedback from demonstrations contributing to the analysis of the tool's effectiveness, productivity, functionality, and market viability.

The results indicated that the configurator substantially impacted the design workflow. The tool allowed for integrating the manufacturer's knowledge early in the design phase, enabling the creation of models that sync with the manufacturer's capabilities. This integration is pivotal in reducing the time-intensive iterative cycle traditionally involved in building planning, allowing for a more streamlined and efficient design process.

The configurator served as a platform for multidisciplinary collaboration, allowing for real-time feedback and informed decision-making. The results highlighted the tool's potential in optimizing designs for various parameters such as human comfort, environmental impact, and structural integrity, addressing the increasing demand for sustainable, high-performance buildings.

The professional feedback and validation results were instrumental in assessing the market viability of the configurator. The insights derived from the validations offered pivotal information, guiding the refinement and finalization of the project. The adjustments and optimizations made based on the results ensured that the proposed design workflow met the

intended objectives and specifications, aligning with the practical needs and demands of the construction industry.

Overall, the research results underscore the transformative potential of adopting configurators in the construction industry. The developed prototype tool demonstrated significant promise in streamlining design workflows, enhancing collaboration, and optimizing designs for sustainability and performance. The rigorous validation and professional feedback provided valuable insights into the practicality and market viability of the configurator, paving the way for further refinements and advancements in integrating advanced digital tools in the construction sector. The exploration and development of the configurator in this research highlight its significance in shaping the future of construction, marked by innovation, sustainability, and enhanced interoperability.

7.2 Recommendations and Future Scope

Given the promising results of the prototype tool, it is recommended to continue its development and refinement. Addressing any limitations or areas of improvement identified during the validation phases will be crucial in enhancing the tool's effectiveness, functionality, and user-friendliness. The research focused on curtain wall systems as a practical example. It is recommended to expand the scope of the tool's application to other construction elements and systems, allowing for a broader range of use and increasing its relevance and applicability in the construction industry.

Given the tool's potential to foster multidisciplinary collaboration, efforts should be made to enhance this aspect further. Integrating features that facilitate seamless communication, real-time feedback, and collaborative decision-making among various stakeholders will be pivotal. Engage with construction firms, architects, designers, fabricators, contractors, and engineers to promote the benefits of integrating such tools into their workflows, emphasizing the potential in optimizing designs and enhancing collaboration.

Conduct extensive market research to understand the evolving needs and demands of the construction industry and gather user feedback continuously to make informed enhancements to the tool, ensuring its alignment with industry trends and user requirements. Ensure the tool and its applications align with the prevailing construction regulations and standards. Engage with regulatory bodies to understand the compliance requirements and make necessary adjustments to the tool to meet these requirements.

Implement the tool in pilot projects to test its real-world application and gather practical insights and feedback, which can be instrumental in refining the tool for broader applications. Promote public awareness regarding the benefits of using advanced digital tools in construction and educate the industry stakeholders about the transformative potential of such tools in shaping the future of construction. Maintain comprehensive documentation of the tool's development, application, and refinements and encourage knowledge sharing within the

industry to foster collective learning and advancement. Encourage investment in research and development to explore innovative features and capabilities that can be integrated into the tool, keeping it at the forefront of technological advancements in the construction industry.

By implementing these recommendations, the construction industry can leverage the transformative potential of configurators to the fullest, paving the way for a future.

References

- Alreshidi, E., Mourshed, M., & Rezgui, Y. (2018). Requirements for cloud-based BIM governance solutions to facilitate team collaboration in construction projects. *Requirements Engineering*, 23(1), 1–31. <https://doi.org/10.1007/s00766-016-0254-6>
- Anonymous. (2021, May 11). SUSTAINABLE CURTAIN WALL DRIVES FAÇADE DESIGN FOR NEW £70M AUTOMOTIVE R&I HUB. *Specification Online*. <https://specificationonline.co.uk/articles/2021-05-11/technal/sustainable-curtain-wall-drives-fa-ade-design-for-new-70m-automotive-r-i-hub>
- Austern, G., Capeluto, I. G., & Grobman, Y. J. (2018). Rationalization methods in computer aided fabrication: A critical review. *Automation in Construction*, 90, 281–293. <https://doi.org/10.1016/j.autcon.2017.12.027>
- Austern, G., Capeluto, I. G., & Grobman, Y. J. (2022). Real-time fabrication analysis: a method for evaluating fabrication constraints of complex concrete shapes. *Architectural Science Review*, 65(6), 421–435. <https://doi.org/10.1080/00038628.2022.2107992>
- Boswell, C. K. (2013). *Exterior Building Enclosures Design Process and Composition for Innovative Facades*.
- Cao, J., & Hall, D. (2019). An overview of configurations for industrialized construction: typologies, customer requirements, and technical approaches. *Proceedings of the 2019 European Conference on Computing in Construction*, 1, 295–303. <https://doi.org/10.35490/ec3.2019.145>
- Chen, K., & Lu, W. (2018). Design for manufacture and assembly oriented design approach to a curtain wall system: A case study of a commercial building in Wuhan, China. *Sustainability (Switzerland)*, 10(7). <https://doi.org/10.3390/su10072211>
- Dritsas, S. (2012). *Rationalisation of complex building envelopes*. 7–16. <https://doi.org/10.52842/conf.caadria.2012.007>
- Enshassi, M. A., Al Hallaq, K. A., & Tayeh, B. A. (2019). Limitation Factors of Building Information Modeling (BIM) Implementation. *The Open Construction & Building Technology Journal*, 13(1), 189–196. <https://doi.org/10.2174/1874836801913010189>
- Herzog, T., Krippner, R., & Lang, W. (2017). *Facade Construction Manual*. DETAIL. <https://doi.org/10.11129/9783955533700>
- Jang, S., Jeong, Y., Lee, G., & Kang, Y. (2019). Enhancing Subcontractors' Participation in BIM-Based Design Coordination under a DBB Contract. *Journal of Management in Engineering*, 35(6). [https://doi.org/10.1061/\(asce\)me.1943-5479.0000714](https://doi.org/10.1061/(asce)me.1943-5479.0000714)
- Jin, X., Zhang, G., Liu, J., Feng, Y., & Zuo, J. (2017). Major Participants in the Construction Industry and Their Approaches to Risks: A Theoretical Framework. *Procedia Engineering*, 182, 314–320. <https://doi.org/10.1016/j.proeng.2017.03.100>
- Kubba, S. (2012). Types of Building Contract Agreements. In *Handbook of Green Building Design and Construction* (pp. 633–676). Elsevier. <https://doi.org/10.1016/B978-0-12-385128-4.00014-7>

- Kulcke, M., & Lorenz, W. E. (2022). *Multilayered Complexity Evaluation within Configurators for Design Responsible collaborative systems for architectural and product design*.
https://papers.cumincad.org/cgi-bin/works/paper/ecaade2022_109
- METRIK. (2018, January 25). *Aluminum Classical Facade Systems*.
<https://www.metrikyapi.com/Aluminum-Curtain-Wall-Systems/aluminum-classical-facade-systems?culture=en-US>
- Piroozfar, P., Farr, E. R. P., Hvam, L., Robinson, D., & Shafiee, S. (2019). Configuration platform for customisation of design, manufacturing and assembly processes of building façade systems: A building information modelling perspective. *Automation in Construction*, 106.
<https://doi.org/10.1016/j.autcon.2019.102914>
- Sacks, R., Eastman, C., Lee, G., & Teicholz, P. (2018). *BIM Handbook*. Wiley.
<https://doi.org/10.1002/9781119287568>
- Segerstedt, A., & Olofsson, T. (2010). Supply chains in the construction industry. In *Supply Chain Management: An International Journal* (Vol. 15, Issue 5, pp. 347–353).
<https://doi.org/10.1108/13598541011068260>
- Shepherd, P., & Richens, P. (2009). *Evolution and Trends in Design, Analysis and Construction of Shell and Spatial Structures Subdivision surface modeling for architecture*.
- Tesla. (2023, March 14). *Tesla Model 3 Configurator*.
<https://www.tesla.com/model3/design#overview>
- Vrijhoef, R., & De Ridder, H. (2014). *Applying systems thinking to supply chain integration in construction Interreg REDUCES circular business model View project Lean Project Preparation Toolbox View project Applying systems thinking to supply chain integration in construction*.
<https://www.researchgate.net/publication/239920661>
- Vrijhoef, R., & Koskela, L. (2000). The four roles of supply chain management in construction. In *European Journal of Purchasing & Supply Management* (Vol. 6).
<https://reader.elsevier.com/reader/sd/pii/S0969701200000137?token=C057B4CF3732A7424350BC63C490B4607EFC888F6F8B8720A5B09431B9178944A56E7275DC478E38EB80F514DC0437E0&originRegion=eu-west-1&originCreation=20230423074131>
- Watts, A. (2014). *Modern Construction Envelopes*. Ambra Verlag.
<https://doi.org/doi:10.1515/9783990436042>
- Wilson Zhou. (2002). *An Introduction to The Design of Curtain Walls, Aluminum Windows, Glass Walls, Skylights and Canopies* (W. Zhou, Ed.). Wilson Curtain Wall Consultant (HK) Limited.

A

Parametric Modelling

A.1 Common Grasshopper scripts

The parametric logic is shown in the following appendix. The structure of the general script is shown in Figure A.1. The following figures show the standard logic between the two configurators.

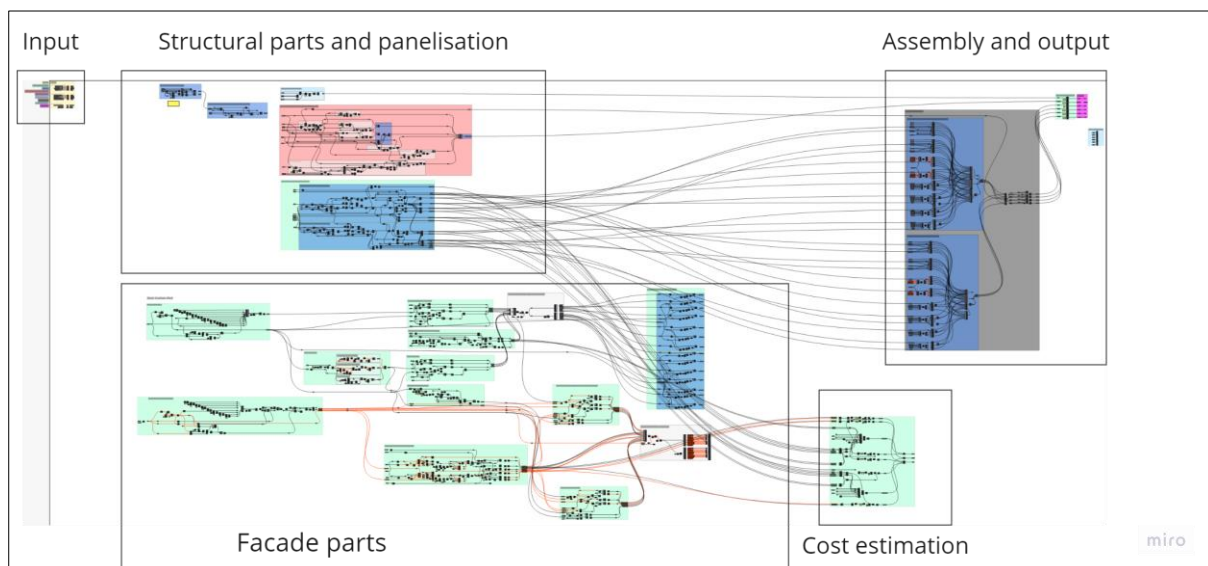

Figure A.1. Overview of the script structure for both configurators

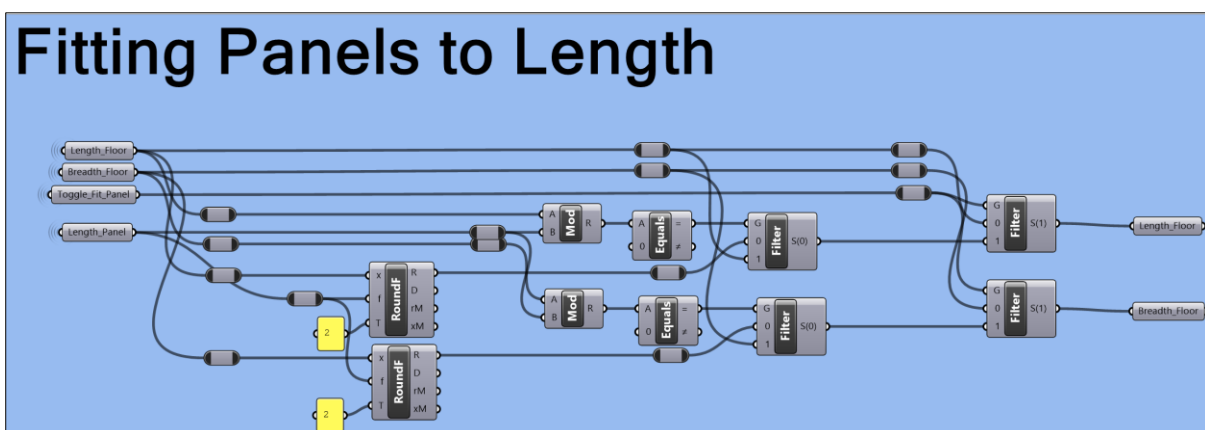

Figure A.2. Fit panel logic to adjust the new length and breadth of the floor

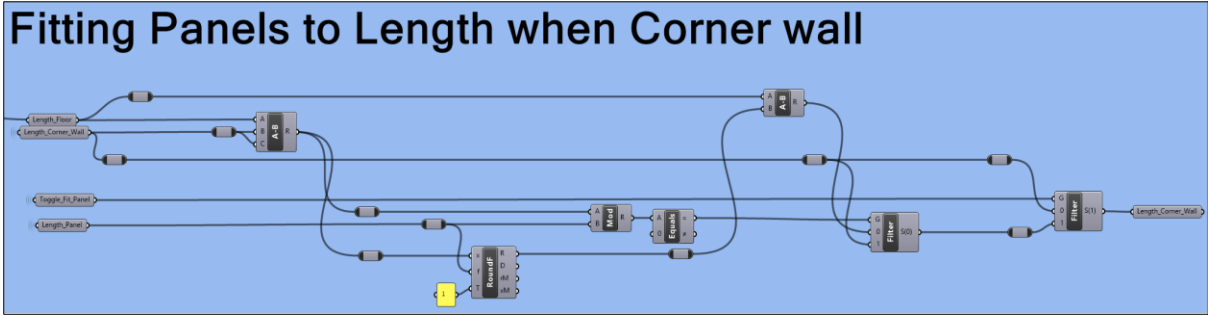

Figure A.3. Fit panel logic when the corner wall is turned on

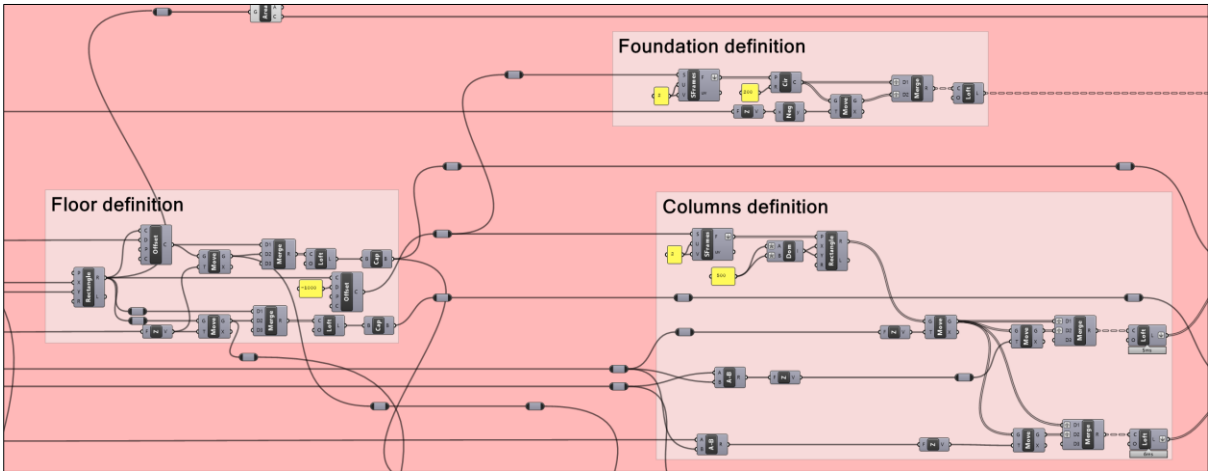

Figure A.4. Structure logic for floor, foundation and columns

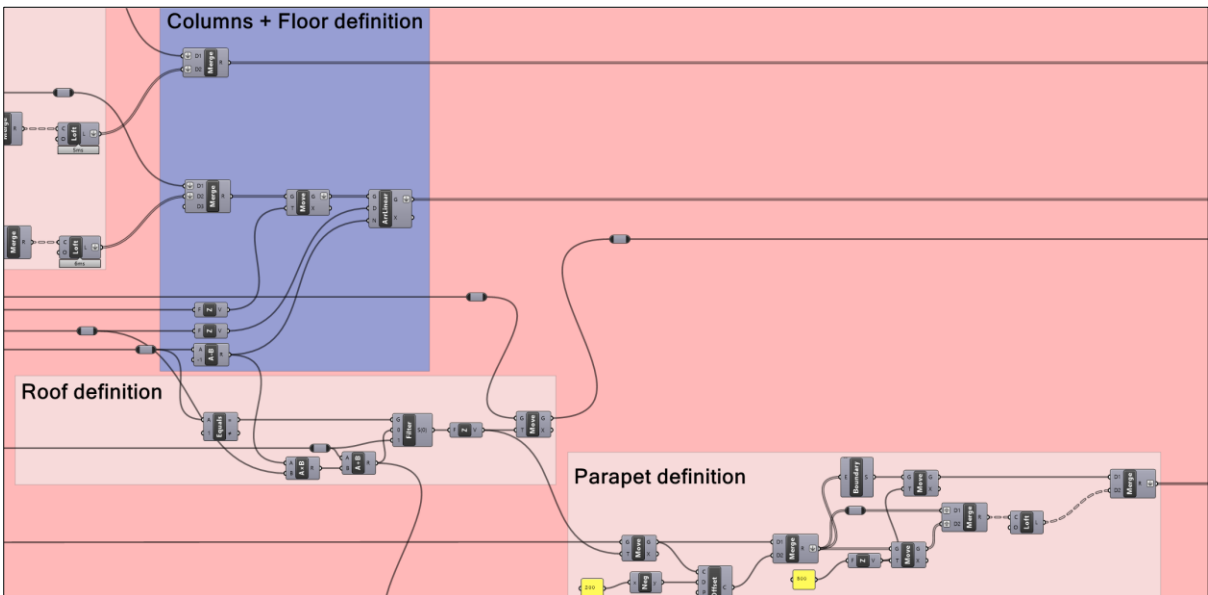

Figure A.5. Structural logic for roof and parapet

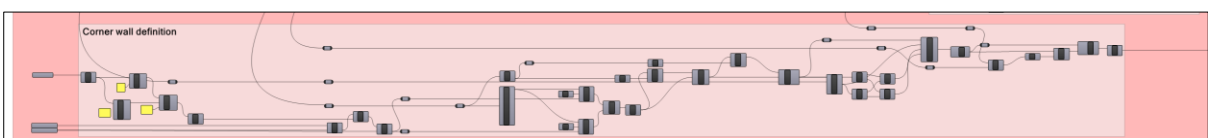

Figure A.6. Corner wall logic for the structural component

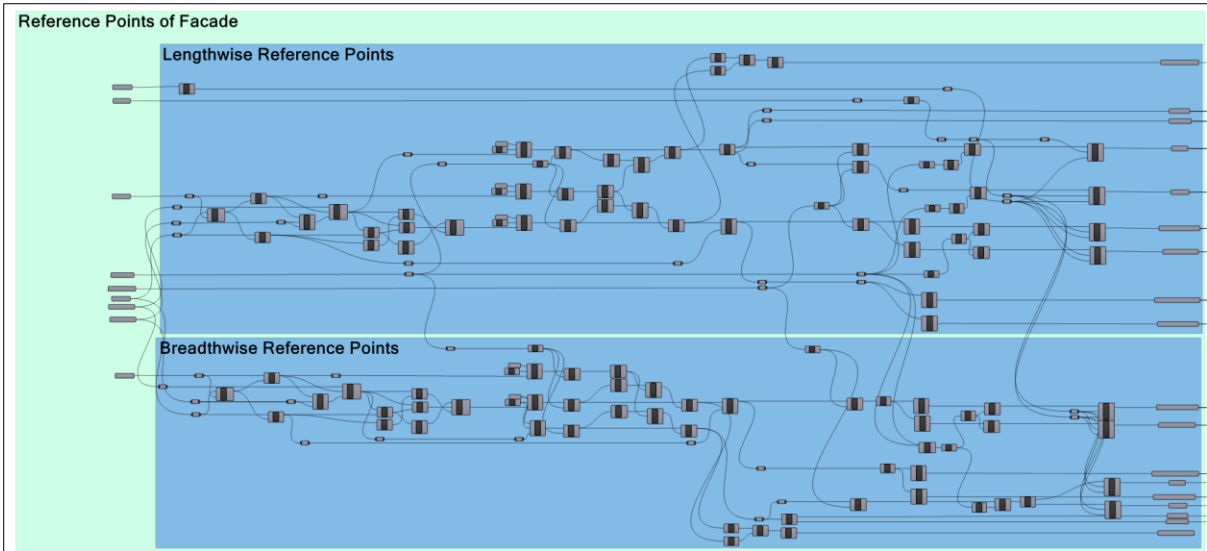

Figure A.7. Overview of the panelisation and reference points generation canvas

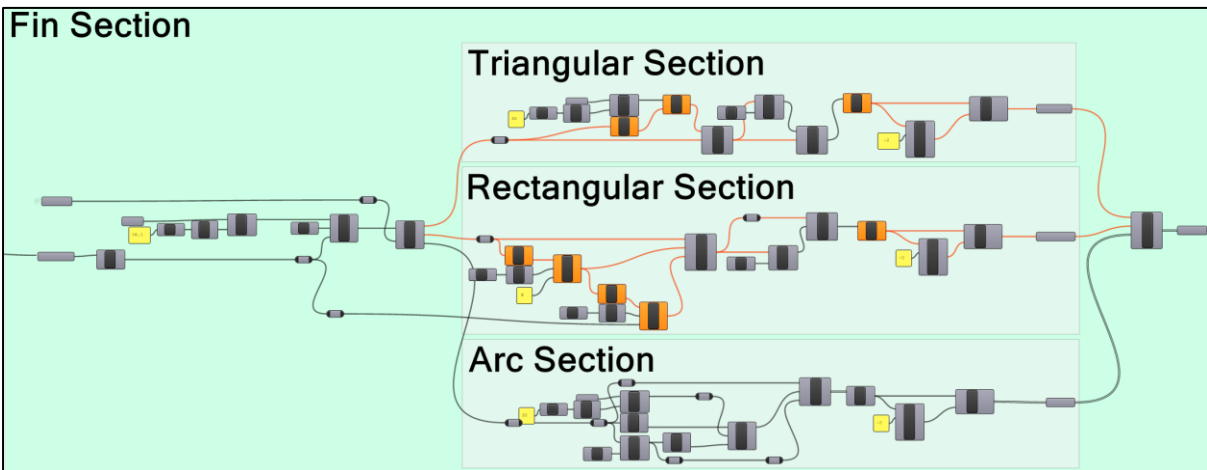

Figure A.8. Logic for three types of fin section

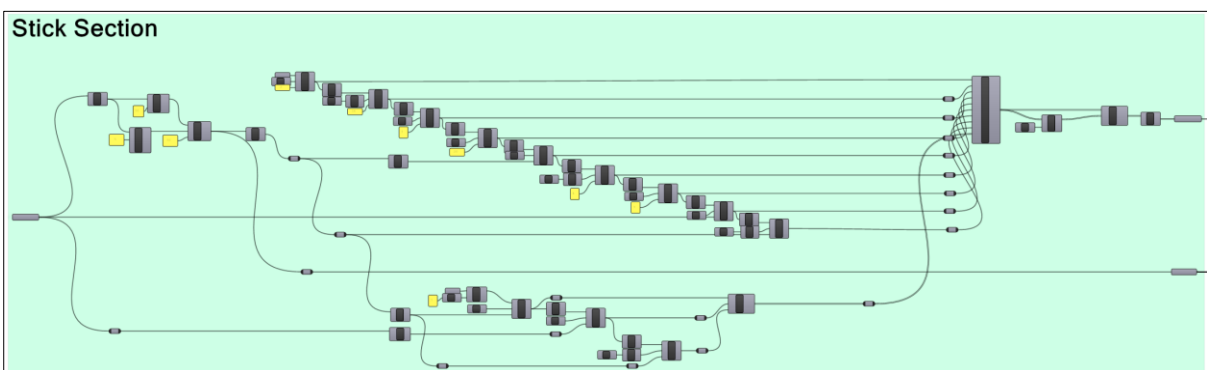

Figure A.9. Logic for generation of the stick section

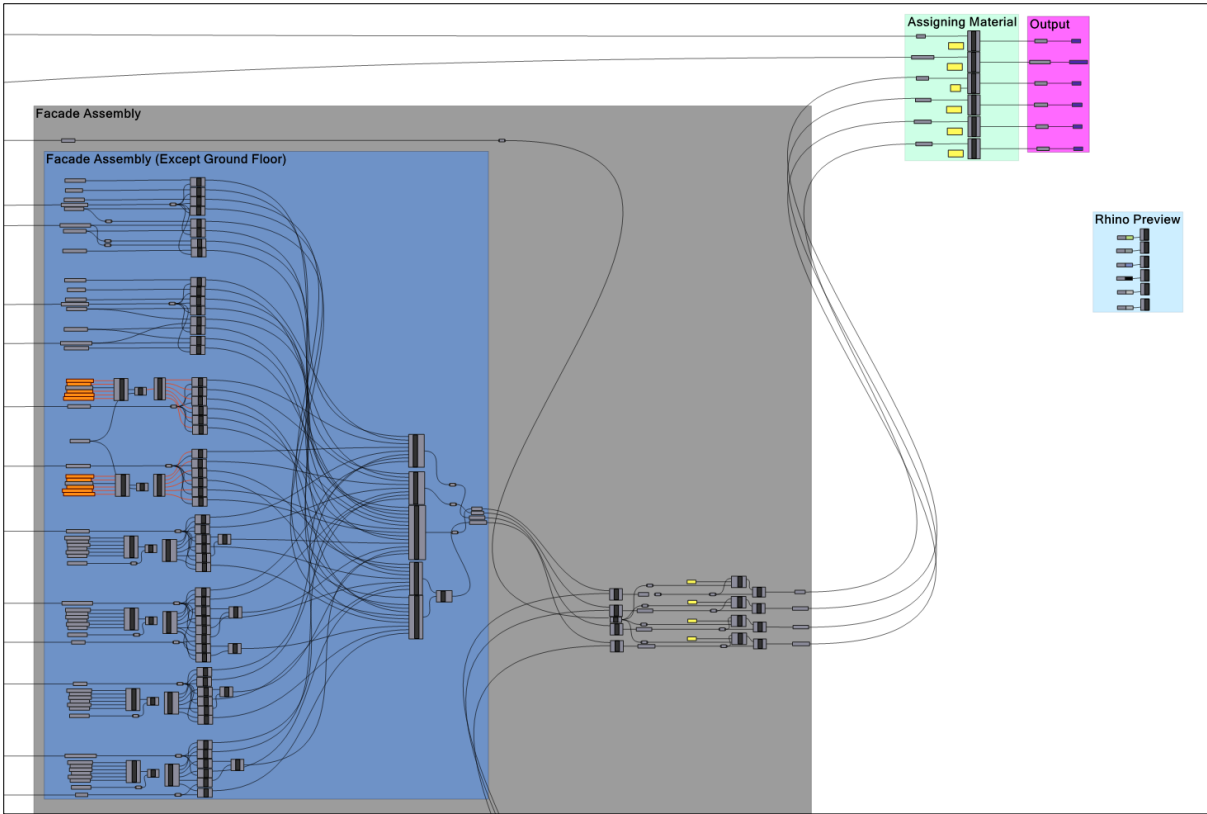

Figure A.10. Logic for the assembly for all the floors except the ground floor

A.2 Stick CWS Configurator

The logic is different in the façade part of the canvas. The section shows the logic for the stick configurator. Figure A.11 shows the regular panel model of the stick system along its length and breadth. Figure A.12 shows the corner stick model and its placements.

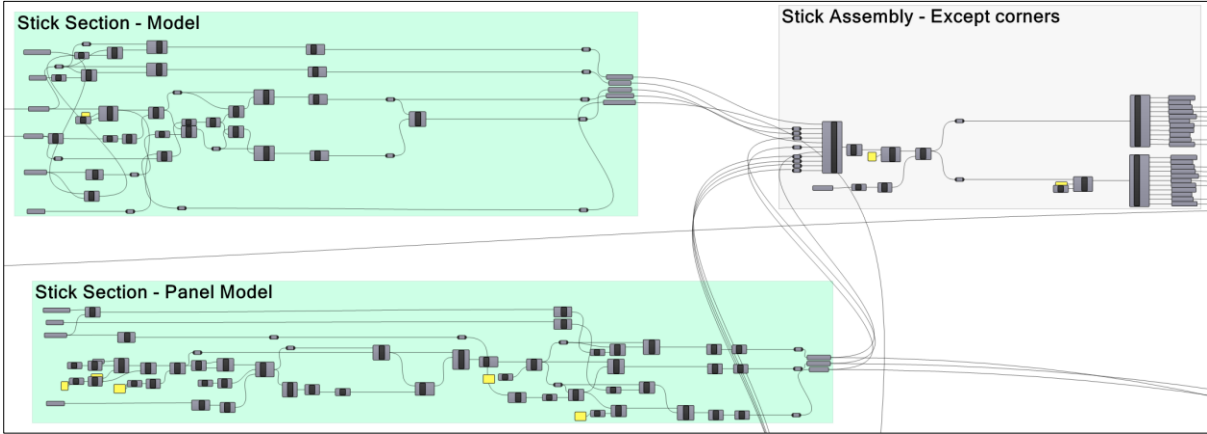

Figure A.11. Overview of the stick system model and its assembly canvas

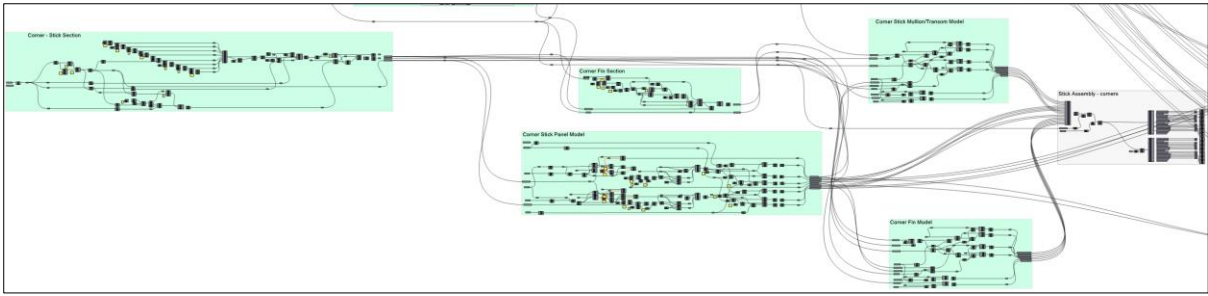

Figure A.12. Overview of the corner stick system logic and its assembly canvas

A.3 Unitised CWS Configurator

The section shows the logic for the unitised configurator. Figure A.13 shows the regular panel model of the unitised system along its length and breadth. Figure A.14 shows the corner unitised model and its placements.

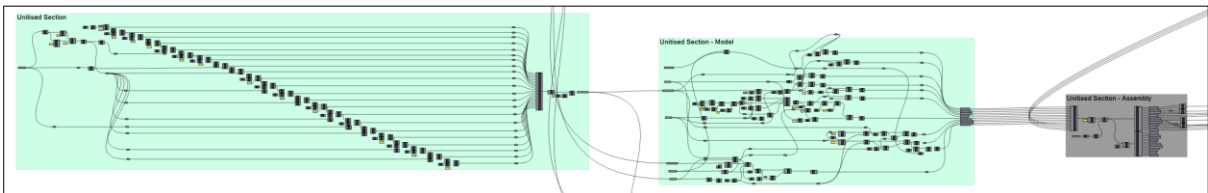

Figure A.13. Overview of the unitised system model and its assembly canvas

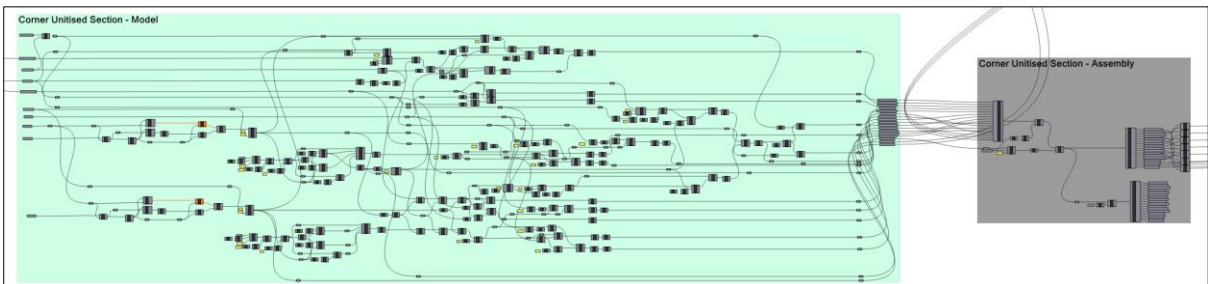

Figure A.14. Overview of corner unitised system logic and its assembly canvas

B

Façade Sections

B.1 Drawings and sketches

Various documents were referred to for the development of sections. The critical sections were developed in AutoCAD, referenced from the curtain wall section by the author Watts (2014). This section of the appendix shows the High LOD considered for both systems. The following Figures represent the façade section taken for reference.

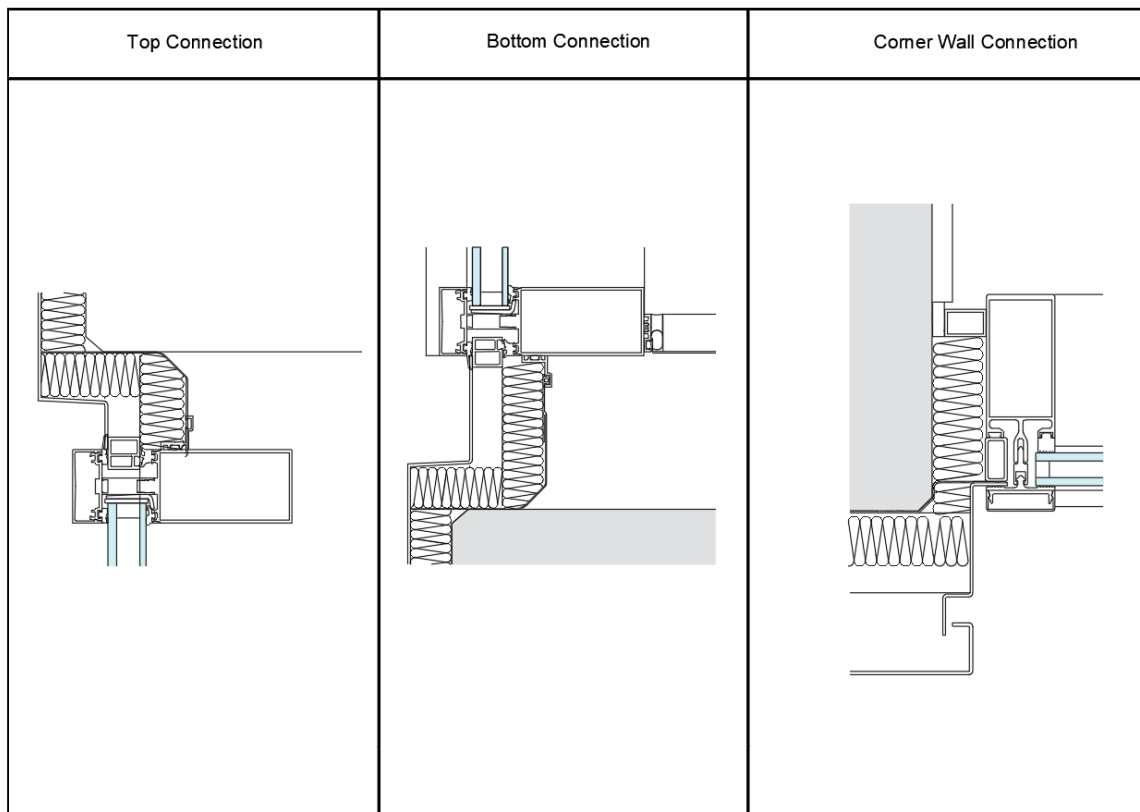

Figure B.1. Stick system sections considered for the modelling – Part 1

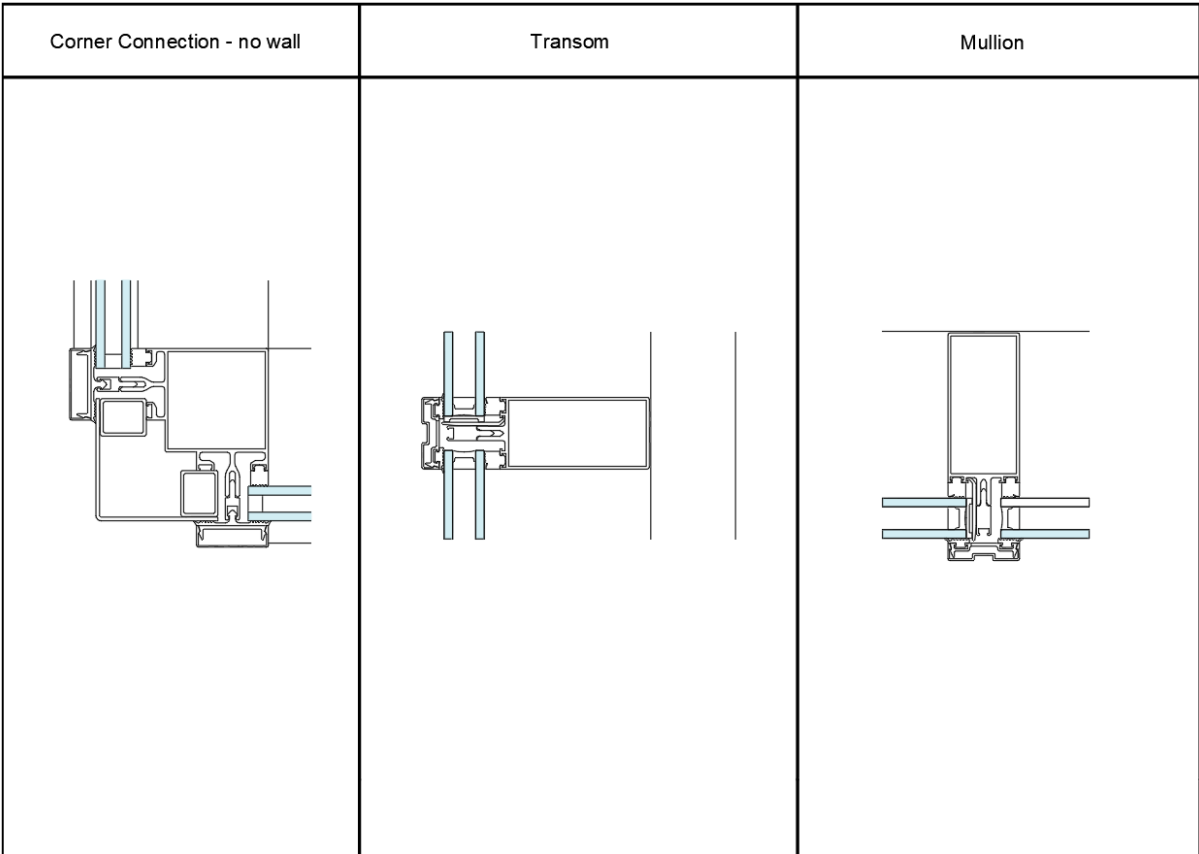

Figure B.2. Stick system sections considered for the modelling - Part 2

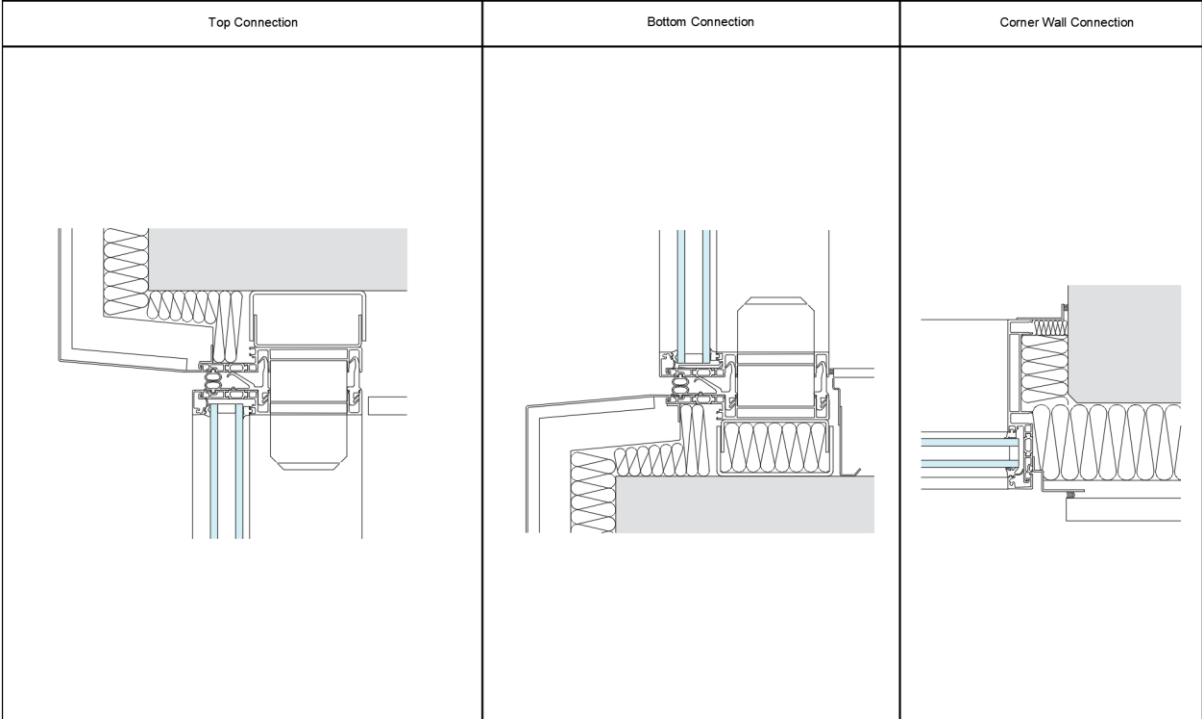

Figure B.3. Unitised system sections considered for the modelling – Part 1

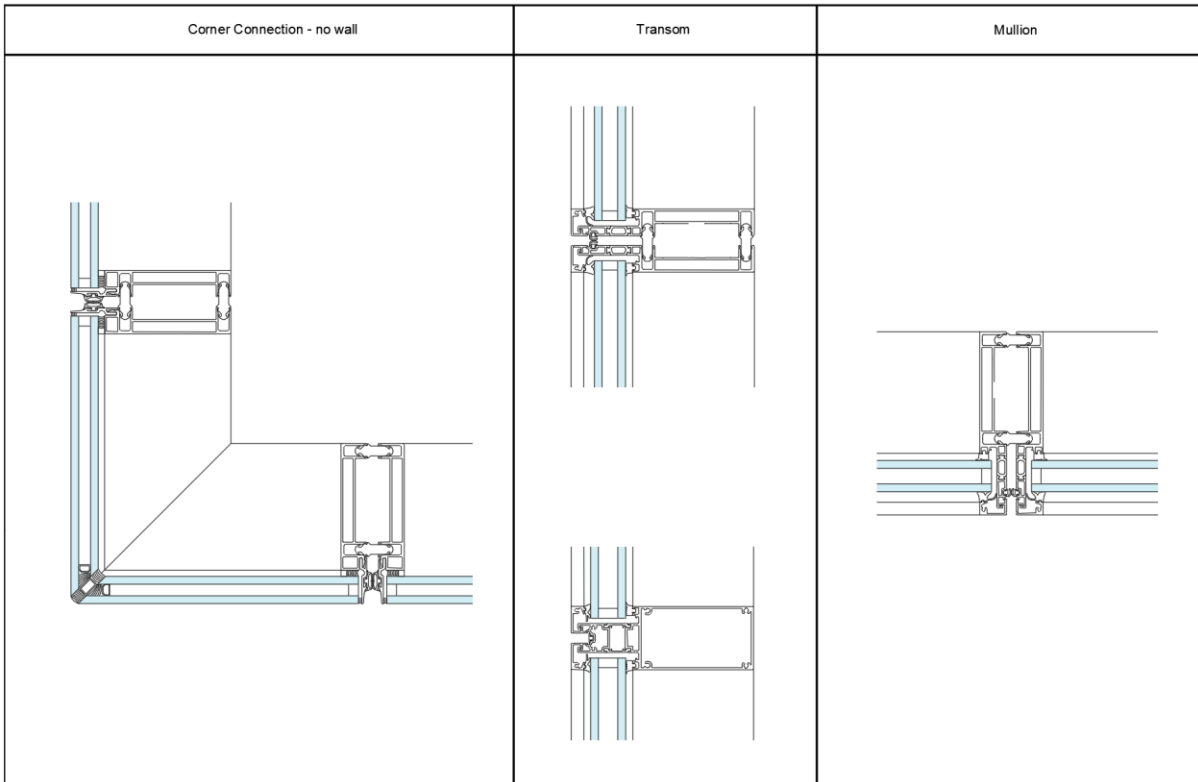

Figure B.4. Unitised system sections considered for the modelling – Part 2

C

Workflow and Data Exchange

C.1 Workflow

The current information and material workflow described by the authors Vrijhoef and De Ridder (2014) is shown in Figure C.1.

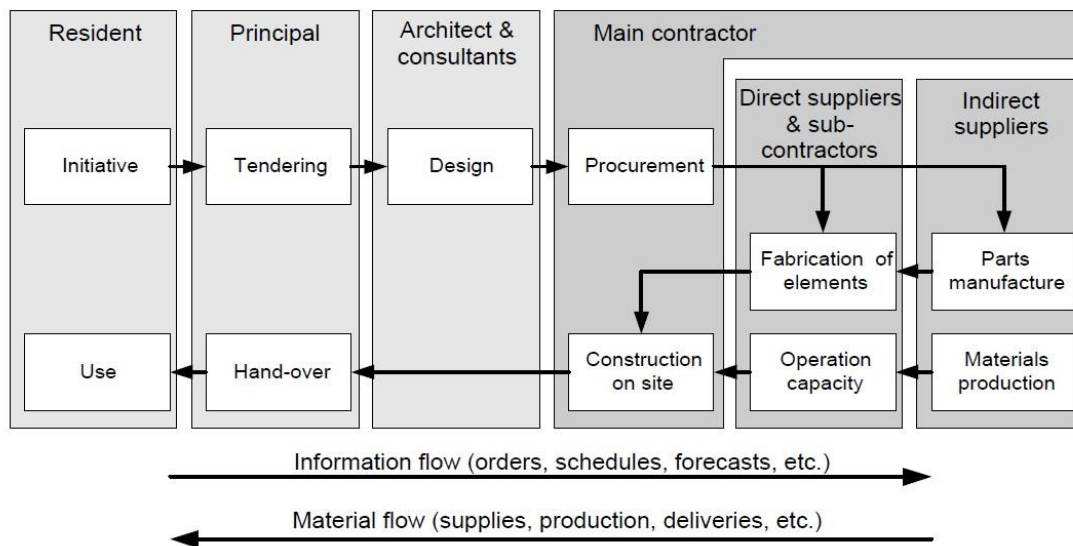

Figure C.1. Schematic representation of construction supply chain management in the construction industry (Vrijhoef & De Ridder, 2014)

The traditional workflow of contractors working with subcontractors in the construction industry is a highly organised process involving various phases, from project initiation to closeout, where each party plays a distinct role. Project initiation begins with the client hiring a general contractor (GC) to oversee the project. The GC assesses the project's scope, budget, and timeline. Subcontractor selection is a meticulous process where the GC identifies specialised subcontractors for specific trades and negotiates contracts that outline the scope of work and project details.

Architect gives contractors a set of specified plans for construction projects. The details are subjective to be changed during the early design phase, where the details are refined and developed. The documents also include the scope of the project, bill of quantities and quality of work required. These documents are studied, and then contractors submit their respective bids. This approach is the most common building engineering practice and is called Design-

bid-build. Design bid build is a traditional and standard project delivery method frequently used in construction projects, also known as the conventional method.

After the successful procurement, a list of documents is exchanged to fabricate the required product. Many data exchange happens after the procurement of the tender. The exchanged documents contain the following:

- Detailed dimensions of every component in the building are transferred to manufacture the right product
- Tolerance factors like designing the envelope and structure of the core building
- Schedules of construction, material delivery and payments
- Shop drawings for product designs

Some other exchange documents include fabrication methods, quality control and maintenance plans. Generally, the architect ensures that the fabricators have all the necessary information to build a high-quality, durable building that satisfies the functional requirement. Though there are all the necessary details, some designs are not practically possible, found only during the fabrication stage. and data exchange between parties.

Many data exchange formats are used in the abovementioned construction, and different contractual procedures are currently followed. In addition to the multi-party exchange, there is a lack of standardisation and consistency in data exchange. To counterattack the inconsistent data format and avoid noisy data in the construction industry, a supply chain is often created between trusted fabricators and contractors who prefer established relationships over going for new connections. Hence, the owner, with the assistance of the design professional, evaluates the bids. They will consider factors like price, contractor's experience, proposed schedule, and other relevant criteria outlined in the bid documents. The contractor's main aim is to ensure the owner's satisfaction by completing the project within budget and on time.

D

Professional Feedback

D.1 Interviews

The survey conducted with various professionals and the respective feedback from the individuals are listed in tables.

Table D.1. Interview answers and recommendations – Personnel 2

Question	Personnel 2 response
Question 1 Effectivity	<ul style="list-style-type: none">• Yes, this is a very effective tool for the industry.• The effectiveness of the configurator is high when the user is a developer or a designer, as they know the values and standards.• It is beneficial for generating the modular system.
Question 2 Productivity	<ul style="list-style-type: none">• Yes, the productivity of the configurator increases, and there are BIM data drawings that undergo checking and are then digitalised for the data exchange.• This configurator could be a massive step in the technology aspect as it can be vital in the process.• In their factory, they develop wooden facades from the technology they use and their knowledge, which has limitations and constraints. The production can be configured if these tools are used.
Question 3 Functionality	<ul style="list-style-type: none">• Define the boundary of the system and design the modular systems depending on the constraints.• More glass and solid parts dimensions make the system with many variants.
Question 4 Market Viability	<ul style="list-style-type: none">• It is not far from being a great tool in the industry and has no limitations.• It needs to be implicated and used by all parties soon for the BIM process's betterment.

Table D.2. Interview answers and recommendations – Personnel 1

Question	Personnel 1 response
Question 1 Effectivity	<ul style="list-style-type: none"> • Configurator targets small companies; Big companies go from concept design to existing constraints. • Custom contractors are used in the current scenario, and people prefer the existing contractor’s relationship. • It might be effective if used by small companies.
Question 2 Productivity	<ul style="list-style-type: none"> • It is only productive when parametricism is used at the beginning of the design process. • Generally, a wireframe is used from the architect's model to develop a facade. So, a configurator of the façade can help to understand the corner details as shown in the current configurator. • It also constrains people's design using a configurator and is recommended for small designers.
Question 3 Functionality	<ul style="list-style-type: none"> • The user must get the Bill of Quantities from the configurator, which can satisfy sustainability and other important parameters used in the construction. • The thickness of the slab is not the only thing that governs spandrel thickness. • Regarding building physics, the incorporation of pre-build mullion sections, a database of used panels, glass area construction and precise with the units.
Question 4 Market Viability	<ul style="list-style-type: none"> • Different stakeholders are present, and their insights are needed to develop the configurator. There is a developer for these configurators, and they are already present in the market. • It is needed for the stakeholders who need cost generation for pre-baked products. In simple words, the configurator is needed only in specific ecosystems.

Table D.3. Interview answers and recommendations – Personnel 3

Question	Personnel 3 response
Question 1 Effectivity	<ul style="list-style-type: none"> • The effectivity depends on the usage and function of the configurator. • Big companies cannot use it as the projects are always complex and one-off. It applies only to smaller companies with minimal and basic design. • It also can be effective if there is a standard product catalogue.
Question 2 Productivity	<ul style="list-style-type: none"> • Currently, the project is a black box with minimal inputs. • The productivity aspect is nullified as it targets the designer, and for this configurator, data from the supplier is generally required. However, a confidentiality agreement does not allow the company to give data. • The configurator is productive if it can directly get orders to the company and gives a green light to the production parts.
Question 3 Functionality	<ul style="list-style-type: none"> • Cost calculation should be optimised and consider all factors, like supplier-provider, structural glazing of the façade, material cost, and fabrication cost. • The 3D viewer is a must and is already present, and interaction within the 3D viewer is highly recommended for the future. The interaction should have the option to change the finish options. • The configurator should consider pre-built items as data input, which can benefit the user in predicting the value.
Question 4 Market Viability	<ul style="list-style-type: none"> • The market viability is low for the current configurator, and with the proper boundary conditions, the configurator can be reached to the market.

Table D.4. Interview answers and recommendations – Personnel 4

Question	Personnel 4 response
Question 1 Effectivity	<ul style="list-style-type: none"> • In theory, some suppliers provide the sections of the facade and subcontractors who build the façade. The personnel worked in a steel hollow section façade company where they got the façade section details from a supplier and developed the façade based on supplier input. • It is practical and valuable if the user considers the sections from the suppliers and is not user-friendly. In other words, the configurator is practical when the sections of the supplier are pre-built.
Question 2 Productivity	<ul style="list-style-type: none"> • The configurator is generally handy; considering the particular case, it is beneficial for the contractors who draft a bid using the configurator. • Productivity directly impacts time, which is highly beneficial when the user uses the configurator.
Question 3 Functionality	<ul style="list-style-type: none"> • A list of databases should be attached, considering all the standard sections in the industry. • Unique features like glass roofs can be incorporated into the current configurator, which can sell a lot. • Windows and openings can also be very effective when selecting a façade supplier. • Incorporation of the structural calculation is a must-added function and future scope.
Question 4 Market Viability	<ul style="list-style-type: none"> • Yes, the current configurator is needed and highly recommended for the designers. • Further developments will make the configurator cutting-edge technology.

Table D.5. Interview answers and recommendations – Personnel 5

Question	Personnel 5 response
Question 1 Effectivity	<ul style="list-style-type: none"> • General contractors do not care about the design provided by the architect. The configurator is the starting point of the design process and is effective in the initial stage of the design. • Most suitable for the design and built system type of contract. • It can increase the production value as the material can be optimised and recommended to the configurator user.
Question 2 Productivity	<ul style="list-style-type: none"> • The current configurator is on its way to help the contractor at the initial stage of the design. • Designing the curtain wall façade is complex, and configuring it is much more difficult. Hence, it will help the user if it is tuned. • Similar to personnel 4, they also mentioned that a supplier distributes the sections, and a separate person builds the façade.
Question 3 Functionality	<ul style="list-style-type: none"> • Structural optimisation is needed for the design process and is a significant factor. The wind load and dead load factor affect the mullion dimensions. • Must be able to help the architect’s design process with high LOD. Including building physics is recommended but very hard to establish in a broad environment. • The configurator can be developed one component at a time, simplifying the process.
Question 4 Market Viability	<ul style="list-style-type: none"> • The solution has potential in the market with further developments. • It is recommended for the designers and not the contractors, and these configurators' developers maintain the background operations. • Prefabricated parts and fabrications are suitable for these types of configurators.