

Fault diagnosis using spatial and temporal information with application to railway track circuits

Verbert, K.; De Schutter, B.; Babuska, R.

DOI

[10.1016/j.engappai.2016.08.016](https://doi.org/10.1016/j.engappai.2016.08.016)

Publication date

2016

Document Version

Accepted author manuscript

Published in

Engineering Applications of Artificial Intelligence

Citation (APA)

Verbert, K., De Schutter, B., & Babuska, R. (2016). Fault diagnosis using spatial and temporal information with application to railway track circuits. *Engineering Applications of Artificial Intelligence*, 56, 200-211. <https://doi.org/10.1016/j.engappai.2016.08.016>

Important note

To cite this publication, please use the final published version (if applicable). Please check the document version above.

Copyright

Other than for strictly personal use, it is not permitted to download, forward or distribute the text or part of it, without the consent of the author(s) and/or copyright holder(s), unless the work is under an open content license such as Creative Commons.

Takedown policy

Please contact us and provide details if you believe this document breaches copyrights. We will remove access to the work immediately and investigate your claim.

Fault Diagnosis Using Spatial and Temporal Information with Application to Railway Track Circuits

K. Verbert^{a,*}, B. De Schutter^a, R. Babuška^a

^a*Delft Center for Systems and Control (DCSC), Delft University of Technology, Mekelweg 2, 2628 CD Delft, The Netherlands*

Abstract

Adequate fault diagnosis requires actual system data to discriminate between healthy behavior and various types of faulty behavior. Especially in large networks, it is often impracticable to monitor a large number of variables for each subsystem. This results in a need for fault diagnosis methods that can work with a limited set of monitoring signals. In this paper, we propose such an approach for fault diagnosis in networks. This approach is knowledge based and uses the temporal, spatial, and spatio-temporal network dependencies as diagnostic features. These features can be derived from the existing monitoring signals; so no additional sensors are required. Besides that the proposed approach requires only a few monitoring devices, it is, thanks to the use of the spatial dependencies, robust with respect to environmental disturbances. For a railway track circuit example, we show that, without the temporal, spatial, and spatio-temporal features, it is not possible to identify the cause of a detected fault. Including the additional features allows potential causes to be identified. For the track circuit case, based on one signal, we can distinguish between six fault classes.

Keywords: System monitoring; Fault detection; Fault diagnosis; Railway systems; Reasoning systems.

1. Introduction

In this paper, we propose an approach to fault diagnosis in networks in the presence of environmental disturbances. Because it is often not feasible to monitor a large number of variables for each subsystem in the network, we particularly look into diagnosis strategies that require only a few monitored variables.

With respect to the diagnosis strategy, a choice needs to be made between a model-based, a model-free, or a hybrid approach (see Figure 1). *Model-based* approaches [1–6] rely on a qualitative or quantitative description of the relations between the monitoring data and system health, while *model-free* approaches [7, 8] use historical data and techniques from machine learning or pattern recognition. Finally, *hybrid* approaches [9–11] use a combination of the aforementioned strategies. The difficulty with model-free approaches, and to a lesser extent also with hybrid approaches, is that a representative amount of labeled historical data is required, which is in general difficult to obtain [8]. Furthermore, due to preventive maintenance activities, usually only few data samples are available that are characteristic of the natural degradation behavior. For these reasons, we will not further consider model-free and hybrid approaches in this work.

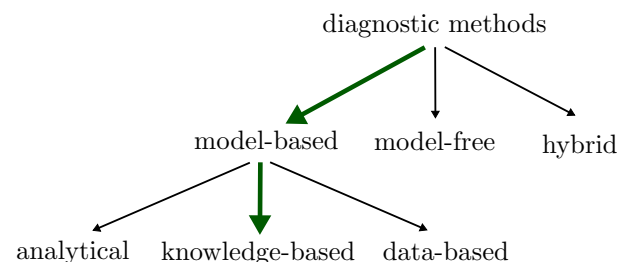

Figure 1: Classification of the different fault diagnosis methods.

Model-based approaches can be further divided according to the way the model is created [12] (see Figure 1). *Analytical* approaches [1–3] are based on a quantitative model derived from first principles, *knowledge-based* approaches [4, 5] use expert knowledge to define a qualitative model of the system, while *data-based* approaches [6] use historical data to learn this model. As we consider applications where data are scarce, and detailed system insight is often difficult to obtain because of system complexity and uncertain environmental disturbances, in this work, a knowledge-based approach is proposed.

The main contribution of this paper is the introduction of a new approach to fault diagnosis in general networks. Key features of this approach are that it relies on the availability of only a limited number of monitoring signals and that it is robust with respect to environmental disturbances. To ensure an adequate diagnosis performance, the following diagnostic features are taken into account:

*Corresponding author

Email addresses: k.a.j.verbert@tudelft.nl (K. Verbert),
b.deschutter@tudelft.nl (B. De Schutter),
r.babuska@tudelft.nl (R. Babuška)

1. Temporal dependencies in the considered subsystem;
2. Spatial dependencies within the network;
3. Spatio-temporal dependencies within the network.

The *temporal dependencies* are valuable for diagnosis because different faults develop in different ways. Knowing the temporal system behavior provides insight into possible fault causes. Similarly, the *spatial dependencies* are useful because they are different for different types of system faults, i.e. some faults only influence one subsystem, whereas other faults influence multiple subsystems. Finally, the *spatio-temporal dependencies* become of interest when objects move through the network. In this case, faulty behavior can be caused by the network itself or by an object moving through the network. Since object faults manifest themselves differently in place and time than network faults, spatio-temporal network dependencies are a suitable feature to discriminate between the two fault categories. The temporal, spatial, and spatio-temporal dependencies can be determined from the available monitoring signals, meaning that they do not require the installation of additional monitoring devices. To the authors' best knowledge, the use of spatial and spatio-temporal dependencies has not been previously proposed for fault diagnosis in networks.

Figure 2 gives a schematic overview of the proposed diagnosis approach. The proposed method can be used to monitor all kinds of networks where temporal and spatial knowledge is available, e.g., drinking water distribution networks, building infrastructures, and highways. In this work, the applicability of the proposed method is illustrated based on a track circuit diagnosis task.

Railway track circuits are used for train detection. Fault diagnosis for railway track circuits has already been dealt with, e.g. in [7–10, 13, 14]. A distinction can be made regarding the way the monitoring data are obtained, e.g. using a measurement train [7, 8, 13, 14] or using track-side monitoring devices [9, 10]. In the current paper, track-side monitoring devices are considered because they continuously monitor the system state and are therefore suitable for the early detection and diagnosis of faults. The main difference compared to the approaches in [9, 10] is that in those works multiple monitoring signals are used, while in this paper, for each track circuit, only one measurement signal is available. Although the availability of a wide variety of measured quantities can be beneficial for model-based fault diagnosis [2], it is not realistic to assume that this will be realized for the whole rail infrastructure, as the related installation and monitoring costs are high. Therefore, we restrict ourselves to one monitoring signal, the current measured at the track circuit receiver.

Note that this paper is an improved and extended version of our conference paper [15]. In particular, the current paper adds the following elements: a general framework for fault diagnosis in networks, inclusion of the spatio-temporal dependencies, and a more extensive example.

The paper consists of three parts: 1. a part regarding

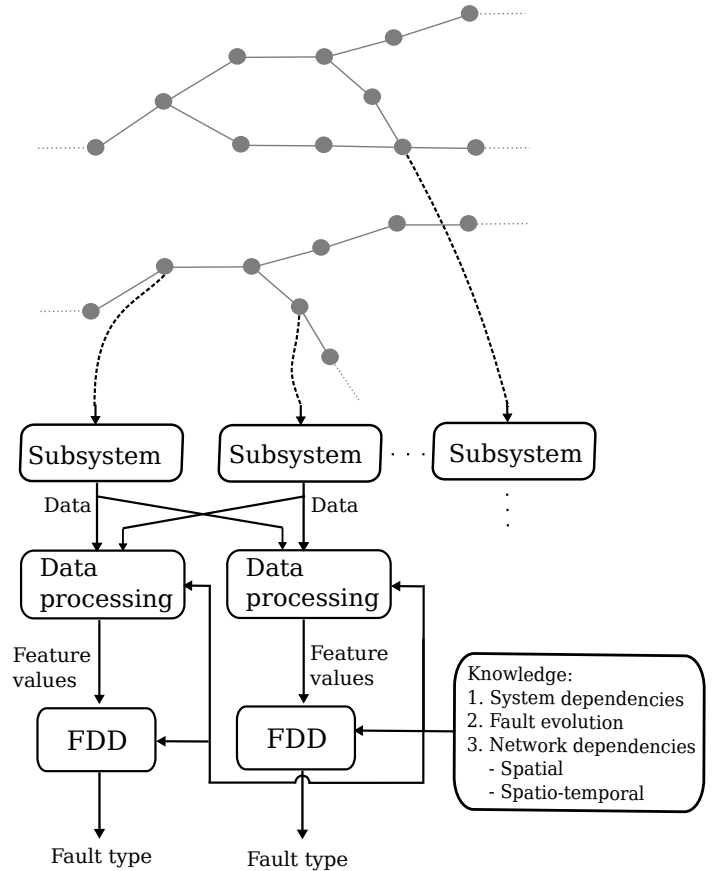

Figure 2: Overview of the proposed diagnosis approach.

fault diagnosis in general networks (Section 2), 2. a part covering fault diagnosis in railway track circuit networks (Section 3 and 4), and 3. a specific track circuit diagnosis example (Section 5).

2. Fault diagnosis in networks

In this section, we propose a knowledge-based approach to fault diagnosis in networks. Figure 3 gives a schematic overview of the proposed approach. In brief, we collect monitoring signals from the subsystems in the network, correct them for the effect of environmental disturbances (Section 2.3), and extract diagnostic features from the corrected signals. Based on the extracted features (see Section 2.2) and knowledge of the system states (see Section 2.1), we infer the system health. In the remainder, the different steps are worked out in more detail.

2.1. Diagnosis setup

Consider a network consisting of n subsystems¹ that can be graphically represented by a, possibly disconnected, graph (see e.g. the graph in Figure 2). In this graph, the black dots represent the subsystems and the edges represent connections between the different subsystems. Here, we consider fault diagnosis of an arbitrary subsystem i in the network. We assume that each subsystem i has one healthy mode f_0 and ℓ faulty modes f_1 till f_ℓ . For clarity of presentation and without loss of generality, in the theory part of this paper we consider only single fault scenarios, i.e. the system health² F_i of each subsystem i takes one value in the set $\Theta_F = \{f_0, f_1, \dots, f_\ell\}$. Furthermore, it is assumed that for each subsystem i in the network a monitoring signal (vector) M_i is available that characterizes system behavior. From these monitoring signals, we extract the following diagnostic features (see Figure 3):

- system dependencies K_i ,
- temporal dependencies T_i ,
- spatial dependencies S_i ,
- spatio-temporal dependencies G_i ,

which we will elaborate on in Section 2.2.

Generally, the state X_i of each subsystem i can take a finite number $m \geq 1$ of possible values x_1 till x_m . For example, for a railway switch, the state X_i can take the values:

x_1 : at rest

x_2 : moving from the normal position to the reverse position

x_3 : moving from the reverse position to the normal position

In general, the monitoring signal (vector) M_i and the extracted features can take different values. The interpretation of these values can be different for different state values. Therefore, for a system with more than one state value, i.e. $m > 1$, it is only guaranteed that system health can be inferred from the extracted features if we know the current system state X_i . In this work, the following basic assumption is adopted

Basic assumption A₀: The state X_i is known for each subsystem i in the network at all times.

The state X_i can e.g. be determined from additional analyses or sensors measurements.

2.2. Diagnostic Inference

To determine the system health of a subsystem in the network, a representative set of diagnostic features is extracted from all the available monitoring signals (see Figure 3). Based on subsystem and network knowledge, these diagnostic features are then linked to the subsystem health. In the remainder of this section, we introduce the rule-based system we use to capture the diagnostic model³. Next, we propose four diagnostic features (see Figure 3) and discuss the knowledge required to link these features to the system health. Note that in this work the number of available monitoring signals is assumed to be fixed. Generally, the diagnostic performance improves when more data become available [2]. Therefore, a straightforward way to improve diagnosis is to place additional sensors. As this is, especially in large-scale networks, often not feasible for economic reasons, in this work, the possibility of adding extra sensors is excluded.

For sake of brevity, in the sequel we omit the subscript i when the explicit reference to a particular subsystem i is not necessary.

2.2.1. Diagnostic model

To describe the relations between the features and the system health, we use a rule-based system. Consider that we have z features C_1 till C_z and that each feature C_k is n_k -valued, i.e. C_k takes values in the set $\{v_{k,1}, v_{k,2}, \dots, v_{k,n_k}\}$. Each feature C_k is linked to the system health F by the following, state-dependent set of rules:

³A diagnostic model is a set of static or dynamic relations that link specific input variables – the feature values – to specific output variables – the faults [16].

¹For clarity, in the remainder we assume that all subsystems are identical. The proposed method can however be easily extended to networks with different types of subsystems.

²In the theory part of this paper, we use capital letters to denote variables and small letters to denote possible values of these variables.

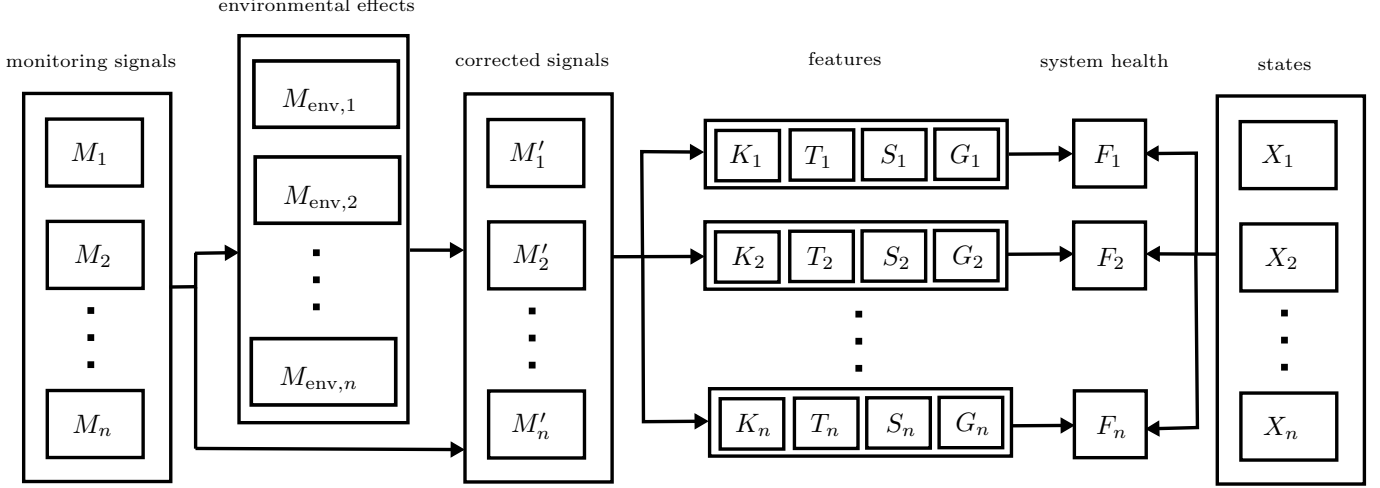

Figure 3: Schematic overview of the proposed knowledge-based fault diagnosis approach.

if $X = x_\zeta$ then

$$\text{if } C_k = v_{k,1} \text{ then } W_{C_k}^{(\zeta)} = w_{k,\zeta,1} \quad (1a)$$

$$\text{elseif } C_k = v_{k,2} \text{ then } W_{C_k}^{(\zeta)} = w_{k,\zeta,2} \quad (1b)$$

\vdots

$$\text{elseif } C_k = v_{k,n_k-1} \text{ then } W_{C_k}^{(\zeta)} = w_{k,\zeta,n_k-1} \quad (1c)$$

$$\text{else } W_{C_k}^{(\zeta)} = w_{k,\zeta,n_k} \quad (1d)$$

and

$$F \in W_{C_k} \quad (2)$$

$$W_{C_k} = W_{C_k}^{(1)} \cap W_{C_k}^{(2)} \cap \dots \cap W_{C_k}^{(m)} \quad (3)$$

with each $w_{k,\zeta,\beta} \subseteq \{f_0, f_1, \dots, f_\ell\}$ and W_{C_k} the set of possible fault causes given C_k in all operating states. When we have m operating states and z features C_k that are n_k -valued, we end up with $m \sum_{k=1}^z n_k$ rules. In the ideal case, given the value of each feature C_k in each operating state, we can determine the fault case, i.e. we know the value of F . This is guaranteed to be the case if each observed combination of feature values corresponds to one possible fault cause, i.e. if:

$$|W| = |W_{C_1} \cap W_{C_2} \cap \dots \cap W_{C_z}| = 1 \quad (4)$$

for all possible valid assignments of values for W_{C_1} till W_{C_z} . When $\ell+1 > |W| > 1$, it is not possible to determine the fault cause, but it is possible to exclude some of the fault causes.

2.2.2. Diagnostic features

In this section, we propose four diagnostic features for fault diagnosis in networks. First, we propose two features that are applicable to individual systems, namely the system dependencies and the temporal dependencies. Next, we propose two features that become of interest when the

system is part of a network consisting of multiple monitored systems, namely the spatial dependencies and the spatio-temporal dependencies.

System dependencies K_i . System knowledge is generally considered as a first source for feature generation in model-based diagnosis strategies. System knowledge is used to generate a qualitative description of the nominal, i.e. fault-free, system behavior. Based on system insight, useful features K_i are extracted from the monitoring signal vector M_i . Comparing the value of the feature K_i derived from the measurement data with the value of K_i derived from the system model, provides information about the system health [2].

Temporal dependencies T_i . Although, in general, a fault may develop in a complex way and an exact quantitative description of the fault evolution cannot be provided, often information is available regarding its qualitative time behavior. For example, it may be known whether the time evolution of a particular fault is intermittent or approximately linear. This information can be used to distinguish between the different faults. Based on the available fault and system knowledge, the expected temporal behavior T_i of the monitoring signal vector M_i as a consequence of a particular fault in subsystem i can be determined. Conversely, based on the observed temporal behavior of M_i , possible underlying fault evolution behaviors can be recovered. So, based on the temporal behavior of M_i , we can infer possible fault evolution behaviors and subsequently the associated fault types. With respect to the fault evolution behavior, a distinction can be made between a wide range of time behaviors. For the purpose of fault diagnosis, faults are often divided, according to their evolution over time, into the following three groups [2]: abrupt, intermittent, and incipient (e.g. linear or exponential). Depending on the, application-specific, fault evolution knowledge, a further refinement of the different groups can be made,

e.g. for crack growth, detailed evolution characteristics are available [17, 18] whereas for other faults only rough descriptions may be available.

Spatial dependencies S_i . When the system i to be diagnosed is part of a network, the monitoring data of other subsystems in the network may contain valuable information regarding the health of subsystem i . Valuable information is contained in these data if there exist dependencies between the different subsystems that vary for different fault types. In this case, the cross-correlations between the monitoring signals of the different subsystems provide information about the possible fault causes. So, faults can be classified according to their impact region. For example, a distinction can be made between faults that are specific to one subsystem and faults that affect all interconnected subsystems.

Spatio-temporal dependencies G_i . In the case that objects move through the network, faulty behavior can be caused by the network itself or by an object moving through the network. To easily distinguish between a fault in subsystem i and an object fault, we propose to use the spatio-temporal dependencies G_i in the network. In the situation that the faulty behavior is caused by an object o moving through the network, it is expected that this behavior is only observed during the time that the object is in the considered subsystem i and that time-shifted versions of the faulty behavior are visible in the monitoring signal of each other subsystem lying on the path \mathcal{P}_o of the moving object o . In the case of a fault in one or more of the subsystems themselves, the faulty behavior is observed regardless of the object moving through the subsystem. Note that in this paper the main focus is on the fault diagnosis of the network and not on diagnosing objects passing through the network. Therefore, only a distinction is made between faults that are object-specific and faults that are not object-specific, i.e. G_i is a variable that can take on two values only. This distinction is made to prevent that object faults are incorrectly diagnosed as network faults.

Note that to determine the proposed features, standard techniques from signal analysis and/or pattern recognition [19, 20] can be used. The exact procedure to determine these dependencies is application-specific and a further elaboration is beyond the scope of this paper. Section 5 briefly explains the determination of the feature values for a track circuit diagnosis task.

2.3. Correction for environmental disturbances

An important property of the proposed approach is that it is robust with respect to environmental disturbances. To achieve adequate diagnosis performance in the presence of environmental disturbances, the monitoring signals are corrected for environmental disturbances before proceeding with the fault diagnosis. To correct for

environmental disturbances, we again use the spatial dependencies, i.e. the correlations between the monitoring signals of the different subsystems in the network.

Environmental disturbances generally affect all subsystems in a close neighborhood (independent of the network structure) in a similar way. Therefore, if we observe a particular faulty behavior in all nearby subsystems (even in subsystems that are not connected from the network point of view), we can attribute the common part of the faulty behavior to environmental disturbances. Note that in the case that environmental disturbances may hamper the proper execution of the system task, environmental disturbances should be treated as a potential fault cause. So, besides for the diagnosis itself, the spatial dependencies are useful to identify the environmental disturbances.

The contribution of environmental disturbances to M_i , denoted as $M_{\text{env},i}$, can be determined from the monitoring signals of the subsystems in the immediate neighborhood \mathcal{N}_i , assuming that a sufficient number of the subsystems in \mathcal{N}_i is healthy (apart from environmental disturbances). In this work, the following basic assumption is adopted:

Basic assumption A₁: In each local neighborhood \mathcal{N}_i , the number of healthy subsystems is sufficient to determine $M_{\text{env},i}$.

To determine the effect of environmental disturbances based on the monitoring data, standard signal analysis techniques, e.g. correlation analyses, can be used (see e.g. [19, 20]). The optimal size of the neighborhood set \mathcal{N}_i needed to appropriately determine $M_{\text{env},i}$ is application-specific and dependent on the specific environmental disturbances. However, two factors play a role in general:

1. The behavior of the subsystems in neighborhood \mathcal{N}_i should be representative for subsystem i . In general, the closer a subsystem is located to i , the more representative its behavior is. So this requirement asks for a small neighborhood.
2. The diagnosis result should be insensitive to possible faults in the considered nearby subsystems. In general, the more subsystems are considered, the less sensitive the diagnostic result is to possible faults. So, this requirement asks for a large neighborhood.

So, for each diagnosis task, a trade-off between these two requirements needs to be made. Optionally, additional information, e.g. weather reports, can be taken into account to determine the environmental disturbances. Next, based on $M_{\text{env},i}$, monitoring signal M_i is corrected. The corrected monitoring signals M'_j for $j \in \mathcal{N}_i \cup \{i\}$ are then used for the diagnosis of subsystem i , with M'_j the monitoring signal of subsystem j corrected for environmental disturbances.

2.4. Diagnostic procedure

Procedure 2 outlines the proposed approach for online fault diagnosis in networks, with the local neighbor-

hoods \mathcal{N}_i , \mathcal{L}_i , and \mathcal{M}_i defined in Procedure 1. Procedure 2 is executed at all diagnosis instants, while Procedure 1 is executed only at startup and when the network topology or knowledge have been changed. In Procedure 2, τ is used to denote time. In $S_{i,\tau}$ (step 3 of Procedure 2) we collect the behavior corresponding to different objects passing through subsystem i . By analyzing $S_{i,\tau}$, the spatio-temporal dependencies $G_{i,\tau}$ can be determined, i.e. it can be inferred whether the problem is object-specific (if the problem is also observed for other subsystems on the path) or system-specific (if the problem is observed independently of the object). The function $\text{corr}(\cdot)$ in step 6 corrects the monitoring signal $M_{i,\tau}$ for the effect of environmental disturbances $M_{\text{env},i,\tau}$ as determined in step 5. An example of how to determine and correct for environmental disturbances can be found in Section 5.

Procedure 1 Defining the local neighborhoods

Input: Graph of the network, definition of a close neighborhood

- 1: **for** $i = 1, \dots, n$ **do**
 {Selection of subsystems relevant for diagnosis of subsystem i }
- 2: Collect in the neighborhood set \mathcal{N}_i the subsystems that are in a close neighborhood of subsystem i
- 3: Split \mathcal{N}_i into two sets: \mathcal{L}_i , containing subsystems connected with i , and \mathcal{M}_i containing the unconnected subsystems.
- 4: **end for**

3. Track circuits

To illustrate the applicability of the method proposed in Section 2, in the remainder of this paper, we consider the fault diagnosis of track circuits within a railway network. In this section, track circuits are described and modeled and possible system faults are discussed. Double-rail, 75 Hz AC track circuits, as used in the Netherlands, are considered. However, it is important to note that the methods proposed in this paper can be easily applied to other track circuit variants.

3.1. Working principle

Throughout the world, track circuits are the most commonly used devices for train detection [9]. For the purpose of train detection, the railway track is divided into electrically separated sections, each having its own track circuit, see Figure 4. In this figure, V_{rail} represents the voltage applied between the two rails at the side of the transmitter and I_c represents the signaling current measured at the receiver. The insulated joints prevent current flow via the rails to the neighboring sections. The impedance bonds allow direct traction currents to flow to adjacent sections, while blocking the alternating currents used for train detection.

Procedure 2 Diagnosis approach at time τ

Input: Neighborhoods \mathcal{N}_i , \mathcal{L}_i , and \mathcal{M}_i and monitoring signal M_i for each subsystem $i = 1, \dots, n$ in the network, path \mathcal{P}_o of all objects o passing through the network, time window length δ

- 1: **for** $i = 1, \dots, n$ **do**
 {Selection of subsystems relevant for diagnosis of subsystem i at time τ }
- 2: **for all** objects o passing through i in $[\tau - \delta, \tau]$ **do**
- 3: Add local path $\mathcal{P}_{o,i,\tau}$ to $S_{i,\tau}$, with $\mathcal{P}_{o,i,\tau}$ containing all subsystems $j \in \mathcal{N}_i \cap \mathcal{P}_{o,\tau}$
- 4: **end for**
 {Determination and correction of environmental disturbances}
- 5: Determine $M_{\text{env},i,\tau}$ using $M_{j,\tau} \forall j \in \mathcal{N}_i \cup \{i\}$
- 6: Correct monitoring signal $M_{i,\tau}$ for environmental disturbances:

$$M'_{i,\tau} = \text{corr}(M_{i,\tau}, M_{\text{env},i,\tau})$$

- 7: **end for**
- 8: **for** $i = 1, \dots, n$ **do**
 {Feature extraction, fault detection, and diagnosis}
- 9: Determine the features $K_{i,\tau}$, $T_{i,\tau}$, $S_{i,\tau}$, and $G_{i,\tau}$ in all states using $M'_{j,\tau}$ for all $j \in \mathcal{N}_i \cup \{i\}$ and the spatio-temporal network knowledge collected in \mathcal{L}_i , \mathcal{M}_i , and $\mathcal{S}_{i,\tau}$
- 10: Use (1)-(3) to determine $W_{K,i,\tau}$, $W_{T,i,\tau}$, $W_{S,i,\tau}$, and $W_{G,i,\tau}$
- 11: $W_{i,\tau} = W_{K,i,\tau} \cap W_{T,i,\tau} \cap W_{S,i,\tau} \cap W_{G,i,\tau}$
- 12: **end for**

Output: Set of possible faults $W_{i,\tau}$ for all subsystems $i = 1, \dots, n$ at the current time τ .

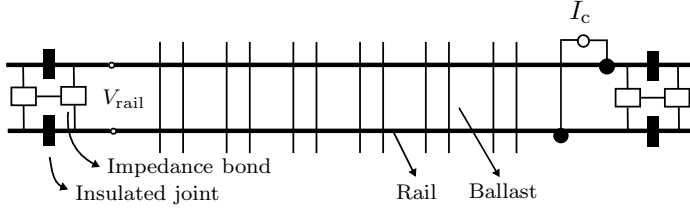

Figure 4: Overview of a railway section and the corresponding track circuit.

Track circuits operate by transmitting electric current to a receiver via the two rails. When a section is free, the transmitted signal reaches the far end of the section. When the section is occupied by a train, the circuit is short-circuited by the wheel sets and the current does not reach the receiver (see Figure 5). More specifically, the track circuit working can be described as follows: Under healthy conditions, the current is above a certain threshold α_2 when the section is free and below a threshold α_1 when the section is occupied by a train. The track circuit is tuned such that even in the case of small current deviations, the presence and absence of a train are correctly reported, i.e.

if $I_{c,i} > \gamma_2$ **then** section i is reported as free,

if $I_{c,i} < \gamma_1$ **then** section i is reported as occupied,

with^{4,5} $\alpha_2 > \gamma_2 > \gamma_1 > \alpha_1$. So, α_1 and α_2 serve to define system health, whereas γ_1 and γ_2 are settings of the train detection system. For a free section, this means: When $I_{c,i} > \alpha_2$, the track circuit in section i is healthy and is correctly reported as free. When $I_{c,i} < \alpha_2$, the current is too low. However, when $\gamma_2 < I_{c,i} < \alpha_2$ section i is still correctly reported as free and the corresponding system behavior is classified as faulty. Only when $I_{c,i} < \gamma_2$, this fault may result in a *false positive* (FP) train detection result. In this case, we no longer talk about a fault, but about a failure. In the same way, for an occupied section i , it holds that when $I_{c,i} < \alpha_1$, the track circuit is healthy; when $\alpha_1 < I_{c,i} < \gamma_1$, circuit i is faulty (no train detection error); and when $I_{c,i} > \gamma_1$, the circuit fails, i.e. we have a *false negative* (FN) train detection result.

3.2. System modeling

To get insight into the system behavior and possible fault causes, a track circuit model will be derived hereafter. To model the relation between the input voltage V_{rail} and the output current I_c , a good understanding of the electrical properties of the rails, ballast, and train shunts is required.

⁴In general, $\alpha_1, \alpha_2, \gamma_1$, and γ_2 may vary for different sections.

⁵When the current is between γ_1 and γ_2 , the detection result is not uniquely defined by $I_{c,i}$ and depends on the previous level of the current.

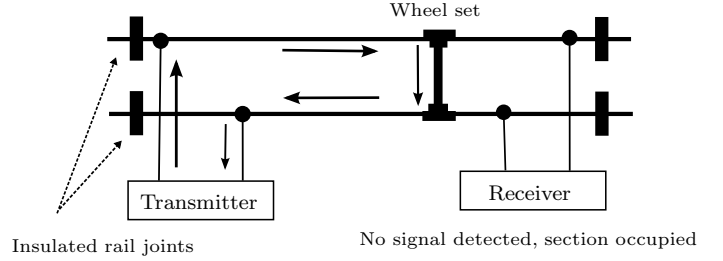

Figure 5: Current flow in a track circuit.

3.2.1. Rail and ballast impedance

The rail bars are made of iron, having a low resistance for DC currents and an increasing resistance for AC currents as frequency increases. Here, we are interested in the resistance (Ω/km) that 75 Hz current encounters when flowing in the longitudinal direction of the rail bars. The ballast impedance is a measure of how easily current can flow between the two rails of a track circuit and it consists of the leakage between the rail fixings, sleepers, and earth [21].

To model the rail impedance Z_R and ballast impedance Z_B , the two-line transmission line model [9] is often used. This model assumes that the rail and ballast impedance are evenly distributed over the length of the track. For practical purposes, lumped parameter models, consisting of a finite number of (identical) cascaded subsections, are often considered to approximate the transmission line behavior. The number of subsections determines the accuracy of the model considered. In Figure 6, a model with one subdivision is shown. A connection to an adjacent section is included to model insulated joint defects (see Section 3.3.2).

3.2.2. Train shunt

When a train is present in a section, the wheels and axles create low-impedance connections between the two rails. Such a connection can be modeled by the shunt impedance Z_S between the two rails, parallel to the ballast impedance Z_B . Resistor Z_S is only connected when there is a train in the section (switch s closed).

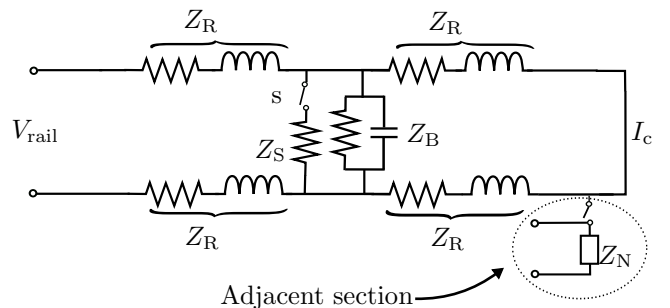

Figure 6: Model of a track circuit.

Table 1: Fault characteristics for track circuits. The relationships between features and faults are defined based on system knowledge and information extracted from historical data. FN = False Negative, FP = False Positive, L = Linear, E = Exponential, A = Abrupt, I = Intermittent, NC = No Correlation, CCS = Correlation with Connected Sections, CAS = Correlation with All Sections, TS = Train-Specific, NTS = Not Train-Specific.

(a) fault characteristics				(b) features				
Health (F)	Problem	Cause	Potential error	System knowledge(K)		Temporal (T)	Spatial (S)	Spatio-temporal (G)
				section free	section occupied			
f_0	-	Healthy state	-	high	low	-	-	-
f_1 f_2	Train shunt imperfection	Rail contamination Lightweight trains	FN FN	high high	medium \vee high medium \vee high	- -	- -	NTS TS
f_3 f_4	Insulation imperfection	Insulated joint defect Conductive objects	FP FP	low \vee medium low \vee medium	low low	L \vee E A	NC NC	NTS NTS
f_5 f_6	Rail conductance impairment	Mechanical defect Electrical disturbances	FP FP	low \vee medium low \vee medium	low low	E I \vee A	NC CCS	NTS TS \vee NTS
f_7 f_8	Ballast condition	Ballast degradation Ballast variation	FP FP	low \vee medium low \vee medium \vee high	low low	L \vee E A \vee L \vee E \vee I	CAS \vee CCS CAS	NTS NTS

3.3. Fault causes

Due to several causes, a track circuit can behave in an undesired way. For instance, due to an increased resistance of the rails (e.g. as a consequence of a broken rail), the current level at the receiver may be too low. In the worst case, this hinders the execution of the system task (train detection), resulting in a functional failure. To prevent functional failures, it is important to recognize system faults as early as possible. Therefore, in the sequel, different types of system faults, the related causes, and their effect on the system behavior are investigated. Table 1(a) gives an overview of the faults considered.

3.3.1. Train shunt imperfection

The proper functioning of a track circuit requires that every train short-circuits the section, meaning that the path “rail-wheels-axles-wheels-rail” should have a sufficiently low resistance for 75 Hz AC currents. A good train shunt can be hampered by different causes; the two most important ones are: 1. contamination between the rail surface and the wheels, and 2. lightweight trains. Contamination between the rails and the wheels (e.g., rust films, sand, and leaf residue) acts as a semi-conductor, in the sense that it exhibits high resistance until the voltage exceeds a threshold [21]. When the contamination level is too high, the voltage between the rails and the train is too low to realize a good train shunt. In addition, lightweight trains may suffer from shunting problems because they can be too light to make good contact and to clean the rails. In the case of a bad train shunt, the resistance of Z_S is relatively high, meaning that the path via the train is electrically less attractive and more current flows to the receiver.

3.3.2. Insulation imperfection

Insulated joints are used to prevent that 75 Hz AC currents leak to neighboring sections. Problems occur when insulated joints degrade or when conductive objects lie over the joints. Insulated joints are implemented in a way that they are fail-safe. This is achieved by using phase-shifted currents in adjacent sections, so that a current sig-

nal of one section cannot energize the relay of an adjacent section. Insulated joint defects can be modeled by a connection to another circuit (see Figure 6). The impedance of this circuit determines the amount of current flowing to the adjacent section. In the case of an insulation problem, the circuit leaks current and consequently, the current I_c is too low.

3.3.3. Rail conductance impairment

The proper functioning of a track circuit relies on the conductance properties of the rails. The rail conductance is influenced by the quality of the rails themselves (e.g., damaged rail, broken rail), the quality of the bonds in jointed track, and electrical influences of disturbance currents (e.g. saturated track due to high traction currents). In the track circuit model, the quality of the rails is modeled by the value of the impedance Z_R . Problems occur when this resistance is too high; in that case, the path via the ballast Z_B becomes more attractive and the current level at the receiver decreases.

3.3.4. Ballast condition

The condition of the ballast determines the resistance that currents encounter when flowing from one rail to the other rail or to the ground. Because the effect of a decreasing ballast resistance is similar to that of a train shunt, it is important that the ballast resistance is sufficiently high and constant. Due to environmental disturbances (mainly weather) and aging, the ballast resistance will fluctuate over time. Some degree of fluctuation is acceptable, but when the ballast resistance becomes too low, the section will be reported as occupied, even if there is actually no train present.

3.3.5. Circuit-related faults

Although track circuits have a high reliability, their components (e.g., relays, cables, and power supply) can break. In this paper, circuit-related faults are not treated further and it is assumed that the circuit itself functions

properly. However, the proposed approach can be extended so that also circuit-related faults can be handled.

4. Fault diagnosis of railway track circuits

In this section, we apply the diagnosis approach introduced in Section 2 to the track circuit diagnosis case discussed in Section 3. First, the diagnosis problem is specified and assumptions are given. Next, we elaborate on the application-specific knowledge that is required to interpret the values of the diagnostic features introduced in Section 2.2. Finally, the diagnosis algorithm is worked out for the track circuit diagnosis example.

4.1. Diagnosis setup

According to the approach proposed in Section 2, a track circuit (i.e. section) can be considered as a system for which the state X_i of each section i can take two possible values:

- x_1 : Free section,
- x_2 : Occupied section.

Furthermore, $M_i \equiv I_{c,i}$ and each section i in the network may suffer from the system faults f_1 till f_8 listed in Table 1.

For the track circuit case, we only focus on faults and not on failures⁶. This means that the actual system state X_i can be inferred from $I_{c,i}$, so X_i is known at each moment. This means that basic assumption A_0 (see Section 2) is satisfied. Please note that we do not assume that the detection system cannot be broken. We assume that fault diagnosis is preceded by a failure detection mechanism. Failure detection can e.g. be done using redundant measurement equipment, based on train schedules, or by verifying the spatio-temporal dependencies in the network. A further elaboration of it is beyond the scope of this paper.

The following assumptions are adopted:

Assumption A₂: Ballast variations (f_8) are caused by environmental disturbances, which are present in all sections (see Section 2.3);

Assumption A₃: At most one of the faults f_3 till f_7 and one of the faults f_1 and f_2 are present in the considered section;

Assumption A₄: We have a closed world, i.e. Table 1 is complete.

⁶A fault is defined as a deviation in the system operation that does not hinder the execution of the system task (train detection), whereas a failure indicates that the system task can no longer be executed properly.

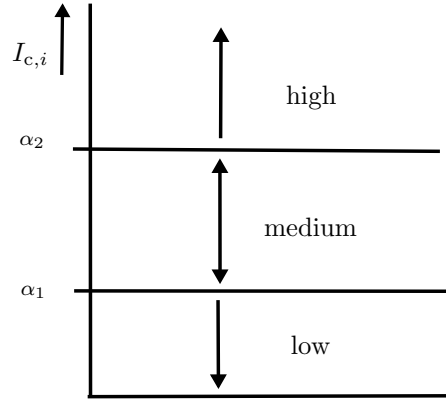

Figure 7: Definition of the feature values of K_i for the track circuit case.

So, ballast variations are considered as environmental disturbances, and our aim is to detect and diagnose other faults (f_1 till f_7) in the presence of this natural variation.

Since some faults are allowed to be simultaneously present (e.g. faults f_1 and f_4), we consider two fault variables $F_{o,i} \in \{f_{o,0}, f_1, f_2\}$ and $F_{f,i} \in \{f_{f,0}, f_3, f_4, f_5, f_6, f_7\}$. The overall system health F_i equals $F_{o,i} \cup F_{f,i}$, with the system being healthy (i.e. $F_i = f_0$) if $F_{o,i} = f_{o,0}$ and $F_{f,i} = f_{f,0}$. The set of values $F_{o,i}$ can take given feature C_k is denoted as $W_{o,C_k,i}$ and the set of values $F_{f,i}$ can take given feature C_k is denoted as $W_{f,C_k,i}$. The associated sets $W_{o,i}$ and $W_{f,i}$ (see Section 2.2.1) can be computed according to Procedure 2.

4.2. Feature extraction

This section focuses on feature extraction for the fault diagnosis of railway track circuits. As the goal of fault diagnosis is the identification of the root cause(s) of faulty behavior, the feature set should be chosen such that, given the values of the features, the cause can be determined or at least some potential causes can be excluded. We first show that, for the track circuit example, system knowledge in combination with the only available monitoring signal $I_{c,i}$ is not sufficient to adequately distinguish between the different faults listed in Table 1. To improve diagnostic performance, we consider the diagnostic features proposed in Section 2.2, i.e. temporal dependencies, spatial dependencies, and spatio-temporal dependencies.

4.2.1. System dependencies

The actual system knowledge of section i is represented in the form of a single-input single-output system with as (unknown and uncontrollable) input the voltage across the two rails $V_{rail,i}$ and as measured output the current $I_{c,i}$. Based on the measured signal $I_{c,i}$ and our system knowledge (see Section 3), we define the feature K_i as the qualitative behavior of $I_{c,i}$, where K_i takes values in the set {low, medium, high} (see Figure 7), with:

low: $I_{c,i} < \alpha_1$;

medium: $\alpha_1 \leq I_{c,i} \leq \alpha_2$;

high: $I_{c,i} > \alpha_2$.

Note that a finer distinction in current values can be made by using both the thresholds α_1 and α_2 and the thresholds γ_1 and γ_2 . However, since for the purpose of fault diagnosis, a finer discretization does not add additional information, K_i is defined as a three-valued feature. In Table 1(b) the value of K_i is given for each of the considered faults. Based on K_i only, it is not possible to distinguish between the different faults. Indeed, it is observed that different types of faults have a similar effect on $I_{c,i}$ (e.g. both ballast degradation, rail conductance impairment, and insulation imperfection result in a low value of $I_{c,i}$). Given the system state X_i (occupied or free), the value of K_i only tells us whether section i is healthy or not, i.e. we can detect faults, but we cannot diagnose them. The system knowledge (see Table 1) is represented by the following set of rules:

- if $K_i = \text{high}$ for $X_i = \text{free}$ then $W_{f,K,i} = \{f_{f,0}\}$
- if $K_i \neq \text{high}$ for $X_i = \text{free}$ then $W_{f,K,i} = \{f_3, f_4, f_5, f_6, f_7, f_8\}$
- if $K_i = \text{low}$ for $X_i = \text{occupied}$ then $W_{o,K,i} = \{f_{o,0}\}$
- if $K_i \neq \text{low}$ for $X_i = \text{occupied}$ then $W_{o,K,i} = \{f_1, f_2\}$

where f_1, \dots, f_8 refer to the faults given in Table 1.

4.2.2. Temporal dependencies

For most faults, a qualitative description of their evolution over time is available and this information can be used for fault diagnosis. In Table 1, for each of the faults, a characterization of the time evolution T_i of $I_{c,i}$ as a consequence of a fault in section i is given. Hereby we have restricted ourselves to the four types of time behavior T_i shown in Figure 8, i.e.:

- A: Abrupt;
- L: Linear;
- E: Exponential;
- I: Intermittent.

The results are included in Table 1(b). Note that the temporal dependency T_i is only a relevant feature for the diagnosis of a free section, i.e. $X_i = \text{free}$. Furthermore, all behaviors that are possible according to the available knowledge are listed⁷. Taking this additional information into account, our knowledge base can be extended with the following rules:

⁷We did not choose one particular type of behavior T if the knowledge to do so was lacking, i.e. for an insulated joint defect (f_3), both $T = L$ and $T = E$ are assumed to be possible.

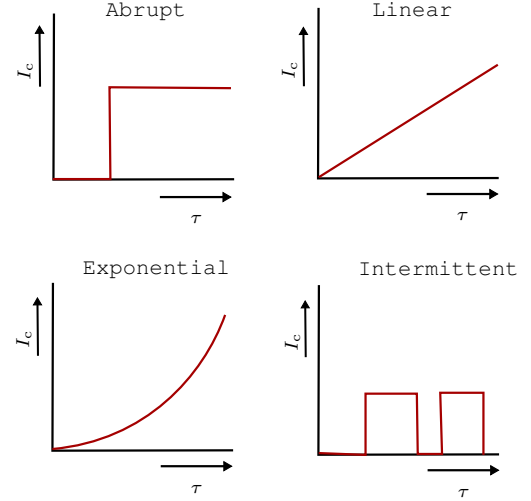

Figure 8: Temporal behaviors.

- if $T_i = L$ for $X_i = \text{free}$ then $W_{f,T,i} = \{f_{f,0}, f_3, f_7, f_8\}$
- if $T_i = E$ for $X_i = \text{free}$ then $W_{f,T,i} = \{f_{f,0}, f_3, f_5, f_7, f_8\}$
- if $T_i = A$ for $X_i = \text{free}$ then $W_{f,T,i} = \{f_{f,0}, f_4, f_6, f_8\}$
- if $T_i = I$ for $X_i = \text{free}$ then $W_{f,T,i} = \{f_{f,0}, f_6, f_8\}$
- $W_{o,T,i} = \{f_{o,0}, f_1, f_2\}$

The last rule states that the temporal dependencies do not contain information to distinguish between faults $f_{o,0}$, f_1 , and f_2 .

4.2.3. Spatial dependencies

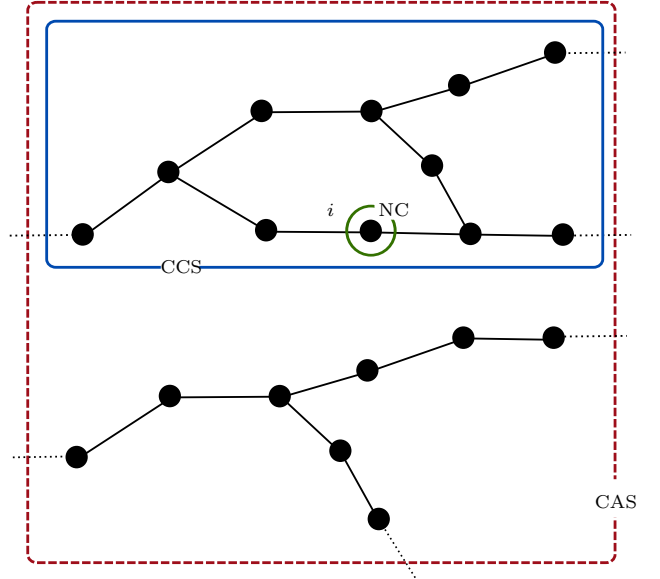

Figure 9: Division of the subsystems (track circuits) in a railway network system for the fault diagnosis of subsystem i .

For each section i , only one monitoring signal ($I_{c,i}$) is available. However, this signal is measured for all sections in the network. It is interesting to investigate whether the

monitoring signals of other sections in the network can provide additional information about the health of section i . Additional information is contained in these data thanks to the dependencies between the signals of neighboring sections that vary for different types of faults. Some faults are likely to influence all sections in a small neighborhood (e.g. ballast variation), other faults only influence sections of the same track (e.g. electrical disturbances), while still other faults are specific to one section (e.g. mechanical rail defects). So, the presence of a fault introduces dependencies between (some of) the sections in a local neighborhood. These dependencies introduce correlations between the monitoring signals of the different sections, which can be used for fault diagnosis. An overview of the correlations introduced by the different faults can be found in Table 1(b), where the correlations are defined as:

NC: No correlation of $I_{c,i}$ with the monitoring signals of other sections;

CCS: Correlation of $I_{c,i}$ with the monitoring signal of connected sections, i.e. sections on the same track;

CAS: Correlation of $I_{c,i}$ with the monitoring signal of all nearby sections.

In Figure 9, a graphical overview is given of the affected sections corresponding to the spatial dependencies NC, CCS, and CAS.

Accordingly we extend our knowledge based with the following set of rules:

if $S_i = \text{NC}$ for $X_i = \text{free}$ **then** $W_{f,S,i} = \{f_{f,0}, f_3, f_4, f_5, f_7\}$
if $S_i = \text{CCS}$ for $X_i = \text{free}$ **then** $W_{f,S,i} = \{f_{f,0}, f_6, f_7\}$
if $S_i = \text{CAS}$ for $X_i = \text{free}$ **then** $W_{f,S,i} = \{f_{f,0}, f_8\}$
 $W_{o,S,i} = \{f_{o,0}, f_1, f_2\}$

4.2.4. Spatio-temporal dependencies

For the track circuit diagnosis task, a distinction can be made between faults that are caused by a train and so are train-specific (e.g. train shunt imperfection due to a lightweight train) and faults that are related to the section itself (e.g. rail contamination). Therefore, we make a distinction between the following two types of faulty spatio-temporal behavior G_i :

TS: Train-specific faulty behavior

NTS: Faulty behavior that is not train related

Taking this additional information into account, the following rules can be added to our knowledge base:

if $G_i = \text{NTS}$ for $X_i = \text{occupied}$ **then** $W_{o,G,i} = \{f_{o,0}, f_1\}$
if $G_i = \text{TS}$ for $X_i = \text{occupied}$ **then** $W_{o,G,i} = \{f_{o,0}, f_2\}$
if $G_i = \text{TS}$ for $X_i = \text{free}$ **then** $W_{f,G,i} = \{f_{f,0}, f_6\}$
if $G_i = \text{NTS}$ for $X_i = \text{free}$ **then** $W_{f,G,i} = \{f_{f,0}, f_3, f_4, f_5, f_6, f_7, f_8\}$

Considering Table 1, it can be concluded that the temporal, spatial, and spatio-temporal dependencies are valuable diagnostic features for fault diagnosis in a railway track circuit network. Without these additional features, faults can only be detected, whereas when taking these features into account, also possible fault causes can be determined.

4.3. Diagnosis approach

In this section, the diagnosis approach proposed in Section 2 is elaborated for the track circuit case. The diagnosis of section i in a monitored track circuit network can be split into the following tasks:

1. Select the sections that are relevant for the diagnosis according to Procedure 1.
2. Infer the system state X_i from $I_{c,i}$:
if $I_{c,i} > \gamma_2$ **then** $X_i = \text{free}$
if $I_{c,i} < \gamma_1$ **then** $X_i = \text{occupied}$
3. Determine current fluctuations due to environmental disturbances (ballast variations) based on the free section behavior of the sections selected in step 1 (step 5 of Procedure 2).
4. If $X_i = \text{free}$, correct the currents $I_{c,j}$ for all $j \in \mathcal{N}_i \cup \{i\}$ for ballast variations (step 6 of Procedure 2)
5. Check for faulty behavior:
if $X_i = \text{free}$ **then** ($K_i \neq \text{“high”} \implies F_i \neq f_0$)
if $X_i = \text{occupied}$ **then** ($K_i \neq \text{“low”} \implies F_i \neq f_0$)
6. If a fault is detected, determine the spatial dependencies S_i , the temporal dependencies T_i , and the spatio-temporal dependencies G_i and diagnose section i (steps 9 – 11 of Procedure 2).

Below, the determination of the ballast variation over time (tasks 3 and 4) and the fault detection and diagnosis (tasks 5 and 6) are worked out for both free and occupied sections.

Determination of the ballast variation over time

Based on the behavior of section i and the behavior of the sections in a close neighborhood \mathcal{N}_i , the current fluctuations due to ballast variation $I_{\text{bal},i}$ need to be determined. These fluctuations can be easily determined from the monitoring signals of healthy sections. One possible way to do this is to compute the current fluctuations due to ballast variations $I_{\text{bal},i}$ as a filtered (weighted) average of the current fluctuations of the considered sections:

$$I_{\text{bal},i}(\tau) = \text{filter} \left(\sum_{j \in \mathcal{K}_i} \frac{I_{c,j}(\tau) - \bar{I}_{c,j}(\tau)}{|\mathcal{K}_i(\tau)|} \right) \quad (5)$$

with $\mathcal{K}_i \subseteq \mathcal{N}_i$ the set of sections in a close neighborhood of section i that are expected to be healthy, i.e. that are

not known to be faulty⁸, and $\bar{I}_{c,j}$ the nominal value (i.e. long-term average) of $I_{c,j}$. Note that for the determination of these variations, only the measurements corresponding to a free track are considered. When a train is present in the section, generally, the track circuit is short-circuited and the current measured at the receiver is approximately zero, independent of the ballast condition.

Fault detection and diagnosis of a free section

The current measurements corresponding to a free section are first corrected for ballast variation based on the previously determined behavior of $I_{\text{bal},i}(\tau)$. The corrected current measurements $I'_{c,i}$ can e.g. be defined as:

$$I'_{c,i}(\tau) = I_{c,i}(\tau) - I_{\text{bal},i}(\tau) \quad (6)$$

The corrected current signals $I'_{c,i}$ are then used for the fault diagnosis of section i . When a fault is detected in section i (i.e. $K_i \neq \text{“high”}$), the corresponding temporal (T_i), spatial (S_i), and spatio-temporal (G_i) dependencies are determined. To determine the spatial dependencies S_i , the monitoring signals of neighboring sections lying on the same track as section i are analyzed. Based on T_i , S_i , and G_i the cause (or a set of possible causes) for the faulty behavior can be inferred from Table 1.

Fault detection and diagnosis of an occupied section

When a section is occupied, ballast variations play no significant role, so we can directly proceed with the detection of faulty behavior. When a fault is detected, i.e. $K_i \neq \text{“low”}$, diagnosis is required. Then, it is verified whether the problem is train-specific or not. For this purpose, the monitoring signals of sections lying on the train routes of several passing trains are analyzed. If the problem is train-specific, the faulty behavior is caused by a lightweight train and not due to rail contamination (i.e. fault f_2 is present and fault f_1 is absent). If the problem is not train-specific, rail contamination (among others) causes the faulty behavior, i.e. fault f_1 is present. When rail contamination is present, problems with lightweight trains are no longer guaranteed to be identified in section i . However, defective trains will be detected in any other section on the train path without rail contamination.

5. Illustrative example

In this section, we consider the fault diagnosis of a railway section in a small network. First, we introduce the diagnosis setup together with the adopted assumptions. Next, we consider how to determine and correct for ballast variations and finally, the fault detection and diagnosis is performed.

⁸Sections that are diagnosed to be faulty, but are still not repaired are excluded from \mathcal{K}_i .

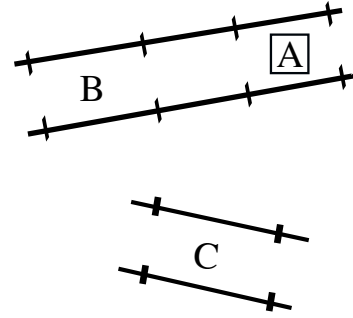

Figure 10: Sections considered in the diagnosis example.

5.1. Diagnosis setup

Consider that we aim to diagnose section A and we have the monitoring signals $I_{c,A}$, $I_{c,B}$, and $I_{c,C}$ of the three sections A, B, and C as depicted in Figure 10 available for the diagnosis of section A, with:

- A: the section to be diagnosed;
- B: a nearby preceding section;
- C: a nearby section located on another track.

So for this example, we have:

$$\begin{aligned} \mathcal{N}_A &= \{B, C\} \\ \mathcal{L}_A &= \{B\} \\ \mathcal{M}_A &= \{C\} \end{aligned}$$

Furthermore, basic assumption A_1 is specified as:

Assumption A'_1 : Sections B and C do not suffer from section-specific faults (i.e. faults for which $S = \text{NC}$) and section C does not suffer from track-specific faults (i.e. faults for which $S = \text{CCS}$).

Assumption A'_1 is adopted here because (for simplicity) only two neighboring sections are considered. In the case that more sections are considered, the redundant information contained in these signals can be used to detect (and correct for) possible faults in neighboring sections.

5.2. Determination and correction for ballast variation

To determine the part of the current signal $I_{c,A}$ that can be attributed to ballast variations (i.e. environmental disturbances), we consider the long-term behavior of the signals $I_{c,A}$, $I_{c,B}$, and $I_{c,C}$ for a free track. In Figure 11, samples of these signals are given. From this figure, it can be observed that all the current signals exhibit a similar type of variation over time. However, it can also be observed that there is a systematic difference between the current values of the three section, e.g. the current of section C is generally higher than the current of section A. Furthermore, it can be observed that the measurements are disturbed by noise and quantization. To determine the current fluctuation due to ballast variation $I_{\text{bal},A}$, we first

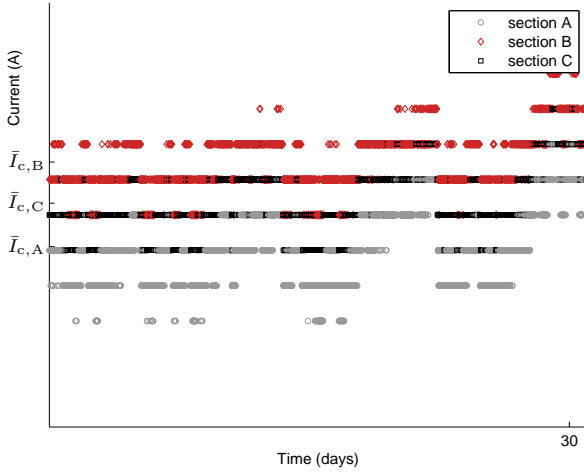

Figure 11: The current signals of the three considered sections A , B , and C when the section is free.

normalize the current signals by subtracting their nominal (i.e. mean) value from the measurements (see (5)). In Figure 12, the normalized current signals are given. As we know that section C is healthy, apart from ballast variation, the resulting signal can basically be attributed to ballast variations. To reduce the effect of the noise and quantization, we first fit a twelfth-degree polynomial model⁹ through the data (filter operation in (5)) and use the resulting model $I_{\text{bal},A}$ (black solid line in Figure 12) to correct the current signals for the effect of ballast variation. Note that because only this local neighborhood of three sections is available, we assume $I_{\text{bal},A} = I_{\text{bal},B} = I_{\text{bal},C}$. The corrected current signals are given in Figure 13. The remaining variation can mainly be attributed to noise and quantization.

5.3. Feature extraction, fault detection, and diagnosis

For the fault diagnosis, we focus on a short time interval, including several train passages. The associated corrected monitoring signals are shown in Figure 14, with the gray areas indicating the time intervals during which the section is occupied by a train. As expected, after correction for ballast variation (see Section 5.2), the free track behavior of section C is as desired; the current $I_{c,C}$ is above the threshold α_2 (i.e. $K_C = \text{“high”}$) when the section is free and below the threshold α_1 (i.e. $K_C = \text{“low”}$) when the section is occupied. To diagnose section A , first the behavior of K_A is analyzed. We conclude that till time $\tau = \tau_1$, $K_A = \text{“high”}$ when the section is free and $K_A = \text{“low”}$ when the section is occupied, i.e. the system is healthy (see Section 4). At time τ_1 , the current level drops as a consequence of a train passage, but the current does not decrease below the threshold value α_1 (i.e. $K_A \neq \text{“low”}$),

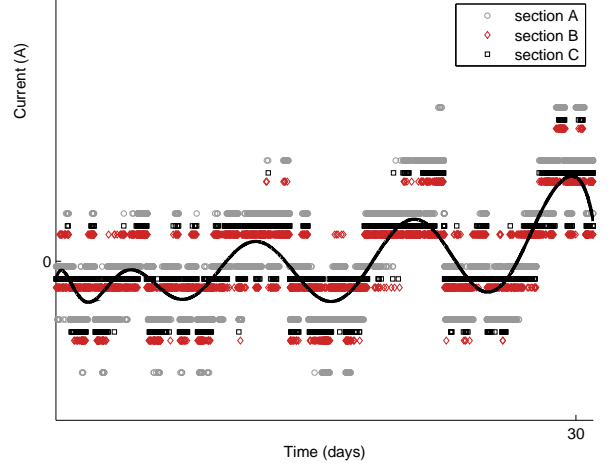

Figure 12: Normalized current measurements of sections A , B , and C together with a polynomial fit (black solid line) through the measurement data of healthy section C .

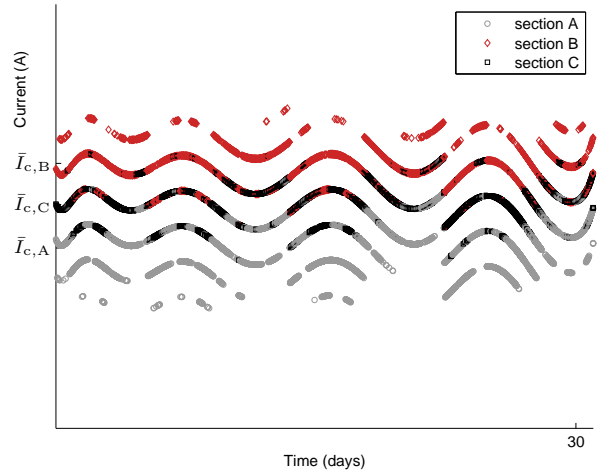

Figure 13: The current signals corrected for ballast variation.

⁹The degree of the polynomial has been tuned manually.

indicating that faults f_1 and/or f_2 are present (see Table 1). To determine which fault is present, feature G_A is used¹⁰, i.e. we verify whether the problem is train-specific (see Section 4.2.4). This is done by checking whether the same problem occurred for other train passages. This is not the case ($G_A = \text{TS}$), indicating that the fault is caused by a lightweight train (see Table 1). This conclusion is validated by the monitoring signal $I'_{c,B}$ of preceding section B. Also from this monitoring signal, it is concluded that one particular train suffered from shunt problems.

After the train passage at time $\tau = \tau_1$ the behavior is normal again till $\tau = \tau_2$. Then, after $\tau = \tau_2$ some deviating behavior is observed: In some time intervals, the current level is below α_2 (i.e. $K_A \neq \text{“high”}$) while the track is free, indicating the presence of one of the faults $f_3 - f_7$. To further specify which fault is present, we first consider feature S_A , i.e. we verify whether there is a correlation with neighboring sections. Considering the monitoring signals $I'_{c,B}$ and $I'_{c,C}$, we observe a similar faulty behavior in section B, but no deviating behavior in section C, from which we conclude that the disturbance is track-specific, i.e. $S_A = \text{CCS}$. So far, it can be concluded that $F_A = f_6$ or $F_A = f_7$. To make a further distinction, the time evolution of $I'_{c,A}$ is studied, i.e. we consider feature T_A . Based on the available part of the time signal, we conclude that the time behavior of $I'_{c,A}$ is intermittent, i.e. $T_A = \text{I}$. Then it follows that $F_A = f_6$.

In summary, from the signals in Figure 14, we can conclude that around $\tau = \tau_1$ a “defective” train passes through sections A and B and after $\tau = \tau_2$, sections A and B suffer from electrical disturbances.

6. Conclusions

In this work, a knowledge-based approach to fault diagnosis in networks has been proposed. Next to system dependencies, the temporal, spatial, and spatio-temporal dependencies in the network are used as diagnostic features. Two main advantages of this method compared to existing diagnosis methods are that 1. fewer monitoring devices are required and 2. the method is robust with respect to environmental disturbances. The applicability of the method has been demonstrated on a railway track circuit diagnosis case. It has been shown that the proposed method is able to adequately detect and diagnose track circuit faults, even in the presence of environmental disturbances. Compared to the current practice of threshold checking, the proposed approach provides more timely insight into faulty behavior and a characterization of the

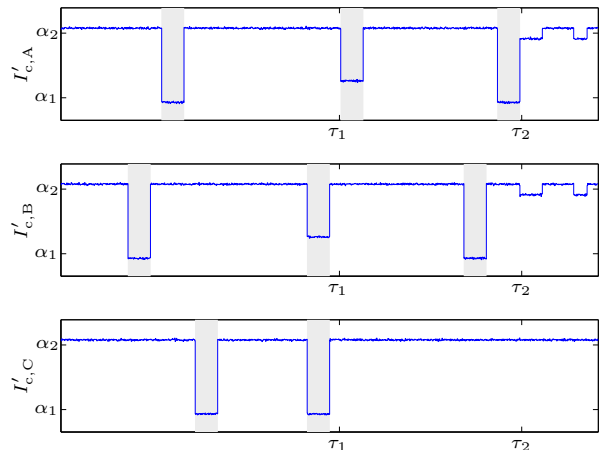

Figure 14: Monitoring signals of sections A, B, and C.

type of fault present. This additional information is important for creating an effective condition-based maintenance schedule.

Maintenance planning based on fault diagnosis and prognosis results will be a topic of further research. Moreover, we plan to extend the method to a probabilistic setting, taking uncertainties into account. In a probabilistic setting, it would be interesting to investigate whether and when it is beneficial to explicitly include predictive information, e.g. regarding usage, previous maintenance activities, and system dependencies, in the diagnostic model.

For the track circuit case, topics for future work include the development of systematic methods to determine the feature values as well as the incorporation of extra or more refined features to further improve diagnostic performance and to allow for more multiple fault scenarios.

Acknowledgment

We thank Inspectation (VolkerRail) for the provision of track circuit monitoring data. This research is supported by ProRail and the Dutch Technology Foundation STW, which is part of the Netherlands Organization for Scientific Research (NWO), and which is partly funded by the Ministry of Economic Affairs. The research leading to these results has received funding from the People Programme (Marie Curie Actions) of the European Union’s Seventh Framework Programme (FP7/2007-2013) under REA grant agreement nr 324432.

References

- [1] J. Chen, R. J. Patton, Robust Model-Based Fault Diagnosis for Dynamic Systems, Springer Publishing Company, 2012.
- [2] R. Isermann, Model-based fault-detection and diagnosis: status and applications, Annual Reviews in Control 29 (1) (2005) 71–85.

¹⁰Remember that for an occupied section, features T_i and S_i do not provide information about the fault cause (see Section 4.2.2 and Section 4.2.3). It is therefore sufficient to only consider features K_i and G_i here. In other words, features T_i and S_i do not put any constraints on the set of possible faults, so $W_{o,K,i} \cap W_{o,G,i} = W_{o,K,i} \cap W_{o,T,i} \cap W_{o,S,i} \cap W_{o,G,i}$.

- [3] I. Hwang, S. Kim, Y. Kim, C. E. Seah, A survey of fault detection, isolation, and reconfiguration methods, *IEEE Transactions on Control Systems Technology* 18 (3) (2010) 636–653.
- [4] C. Nan, F. Khan, M. T. Iqbal, Real-time fault diagnosis using knowledge-based expert system, *Process Safety and Environmental Protection* 86 (1) (2008) 55–71.
- [5] J. Kukal, K. Macek, J. Rojicek, J. Trojanová, From symptoms to faults: Temporal reasoning methods, in: *Proceedings of the International Conference on Adaptive and Intelligent Systems*, Klagenfurt, Austria, 2009, pp. 155–159.
- [6] A. Fekih, H. Xu, F. N. Chowdhury, Neural networks based system identification techniques for model based fault detection of nonlinear systems, *International Journal of Innovative Computing, Information and Control* 3 (5) (2007) 1073–1085.
- [7] L. Oukhellou, A. Debiolles, T. Denoeux, P. Aknin, Fault diagnosis in railway track circuits using Dempster-Shafer classifier fusion, *Engineering Applications of Artificial Intelligence* 23 (1) (2010) 117–128.
- [8] Z. Cherfi, L. Oukhellou, E. Côme, T. Denoeux, P. Aknin, Partially supervised independent factor analysis using soft labels elicited from multiple experts: application to railway track circuit diagnosis, *Soft Computing* 16 (5) (2012) 741–754.
- [9] J. Chen, C. Roberts, P. Weston, Fault detection and diagnosis for railway track circuits using neuro-fuzzy systems, *Control Engineering Practice* 16 (5) (2008) 585–596.
- [10] M. Sandidzadeh, M. Dehghani, Intelligent condition monitoring of railway signaling in train detection subsystems, *Journal of Intelligent and Fuzzy Systems* 24 (4) (2013) 859–869.
- [11] S. Narasimhan, I. Roychoudhury, E. Balaban, A. Saxena, Combining model-based and feature-driven diagnosis approaches—a case study on electromechanical actuators, in: *Proceedings of the 21st International Workshop on the Principles of Diagnosis*, Portland, OR, 2010.
- [12] P. Frank, E. A. Garcia, B. Köppen-Seliger, Modelling for fault detection and isolation versus modelling for control, *Mathematics and Computers in Simulation* 53 (4) (2000) 259–271.
- [13] S. Sun, H. Zhao, Fault diagnosis in railway track circuits using support vector machines, in: *Proceedings of the 12th International Conference on Machine Learning and Applications*, Vol. 2, Miami, FL, 2013, pp. 345–350.
- [14] Z. Lin-Hai, W. Jian-Ping, R. Yi-Kui, Fault diagnosis for track circuit using AOK-TFRs and AGA, *Control Engineering Practice* 20 (12) (2012) 1270–1280.
- [15] K. Verbert, B. De Schutter, R. Babuška, Exploiting spatial and temporal dependencies to enhance fault diagnosis: Application to railway track circuits, in: *Proceedings of the 14th European Control Conference*, Linz, Austria, 2015, pp. 3052–3057.
- [16] R. Isermann, *Fault-Diagnosis Applications: Model-Based Condition Monitoring: Actuators, Drives, Machinery, Plants, Sensors, and Fault-Tolerant Systems*, Springer Science & Business Media, 2011.
- [17] P. Paris, F. Erdogan, A critical analysis of crack propagation laws, *Journal of Fluids Engineering* 85 (4) (1963) 528–533.
- [18] C. H. Oppenheimer, K. A. Loparo, Physically based diagnosis and prognosis of cracked rotor shafts, in: *AeroSense*, 2002, pp. 122–132.
- [19] A. Papoulis, *Signal Analysis*, McGraw-Hill New York, 1978.
- [20] A. Meyer-Baese, V. J. Schmid, *Pattern Recognition and Signal Analysis in Medical Imaging*, Elsevier, 2014.
- [21] R. Spoors, *General Information on Track Circuits*, Railroad PLC, London, UK (1998).