

SAVing the Internet

Measuring the adoption of Source Address Validation (SAV) by network providers

Lone, Q.B.

DOI

[10.4233/uuid:cfed8540-76cf-4d35-b528-b03230ef98e0](https://doi.org/10.4233/uuid:cfed8540-76cf-4d35-b528-b03230ef98e0)

Publication date

2022

Document Version

Final published version

Citation (APA)

Lone, Q. B. (2022). *SAVing the Internet: Measuring the adoption of Source Address Validation (SAV) by network providers*. [Dissertation (TU Delft), Delft University of Technology].
<https://doi.org/10.4233/uuid:cfed8540-76cf-4d35-b528-b03230ef98e0>

Important note

To cite this publication, please use the final published version (if applicable).
Please check the document version above.

Copyright

Other than for strictly personal use, it is not permitted to download, forward or distribute the text or part of it, without the consent of the author(s) and/or copyright holder(s), unless the work is under an open content license such as Creative Commons.

Takedown policy

Please contact us and provide details if you believe this document breaches copyrights.
We will remove access to the work immediately and investigate your claim.

SAVING THE INTERNET

**MEASURING THE ADOPTION OF SOURCE ADDRESS
VALIDATION (SAV) BY NETWORK PROVIDERS**

SAVING THE INTERNET

**MEASURING THE ADOPTION OF SOURCE ADDRESS
VALIDATION (SAV) BY NETWORK PROVIDERS**

Dissertation

for the purpose of obtaining the degree of doctor
at Delft University of Technology,
by the authority of the Rector Magnificus prof.dr.ir. T.H.J.J. van der Hagen,
chair of the Board for Doctorates
to be defended publicly on
Monday 28 March 2022 at 17:30 o'clock

by

Qasim Bilal LONE

Master of Science in Computer Networking,
North Carolina State University, NC, USA,
born in Karachi, Pakistan.

This dissertation has been approved by the promotor:

Prof. dr. M.J.G. van Eeten
Dr.ir. C. Hernandez Gañán

Composition of the doctoral committee:

Rector Magnificus,	Chairperson
Prof. dr. M.J.G. van Eeten,	Delft University of Technology, Promotor
Dr.ir. C. Hernandez Gañán,	Delft University of Technology, Co-promotor

Independent members:

Prof. dr. J.A. (Hans) de Bruijn	Delft University of Technology
Prof. dr. G. Smaragdakis	Delft University of Technology
Prof. dr. ir. A. Pras	University of Twente
Prof. dr. A. Duda	University of Grenoble Alpes
Prof. dr. K.C. Claffy	University of California, San Diego

Keywords: Source Address Validation, SAV, BCP38, BCP84, DDoS, cybersecurity, incentives, vulnerability scan, data analysis, statistical models, metrics, notifications

Printed by: Gildeprint

Cover design: Usama Alam

ISBN 978-94-6419-468-5

An electronic version of this dissertation is available at
<http://repository.tudelft.nl/>.

To my parents

ACKNOWLEDGEMENTS

A Ph.D. is a long journey with a mixed bag of happiness, chaos, and achievements. Now that I am near completion, I can look back and reflect on some of the memorable moments. I remember getting my manuscript accepted or finally solving a problem after months would make me feel like being at the top of the world. However, those feelings did not stay for long, as the next challenge was usually around the corner.

In this long journey of ups and downs, I was fortunate to receive support from some amazing people, and I would like to thank them. First and foremost, I would like to thank my promoter and supervisor, Michel van Eeten for his unwavering trust in my abilities. I wouldn't have finished without his support. His supervision not only helped me learn the requisite research skills but also boosted my confidence to stand my ground as an independent researcher. Thank you for being a wonderful mentor and a supervisor.

Next, I want to thank my supervisors, Carlos, Maciej, and Giovane. I am deeply grateful to them for their countless hours of brainstorming sessions, which have helped me gain critical insights into scientific methods and Internet measurements. I am also thankful to them for giving me the freedom to bring new ideas to the table and their kind help conceptualizing those ideas into a complete manuscript.

I like to express my gratitude to my external collaborators, Matthew Luckie, Alisa Frik, and Mobin Javed. I really enjoyed their passion for research, which also served as a motivation for me. I am thankful to my collaborators for their valuable insights, helping me with new ideas, and for improving the overall manuscript. Specifically, I have had a chance to collaborate with Matthew Luckie on several manuscripts, and I am grateful that despite the significant time difference, Matthew was always available for a quick meeting to discuss specific agenda. I learnt a lot from these collaborations, and I hope we can continue our cooperation in the future.

Ph.D. studies at O&G gave me a chance to meet many amazing people and make friends. For this, I want to thank my wonderful colleagues, Samaneh, Arman, Orcun, Rolf, Elsa, Matthew, Maria, Natalia, Kate, Xander, Arwa, Radu, Ugur, and all of my fantastic new colleagues who have recently joined the team. I have thoroughly enjoyed our discussions and coffee breaks. The daily discussions provided a welcome distraction from Ph.D. work and also made me realize that everybody is going through the same challenges, and I am not alone in this journey.

I was fortunate to find a passionate community of long-term friends outside work. I want to thank Neil, Sarah, Saad, Hussam, Irfan, Imran, Shakeel, Aftab, Mohsan, Tabish, Nauman, Mubariz, Samad, Hassan, Rehan, Haris, Haider, and Osama for providing family-like support in my difficult times when my own family was miles away. I thoroughly enjoyed our meetups on the weekend, along with delicious food and late-night discussions on every possible topic. Given that I am terrible at cooking but fond of traditional Pakistani food, fantastic food was always a great motivation to not miss any gathering.

My father's passion and trust of my mother were always a major push to pursue my dreams and never settle without fulfilling them. My father encouraged me to take on this journey and trained me to face difficult situations with a smile. I wish my father was here to see my success. I lost my father in 2017, and at that time, it seemed impossible to continue and complete my studies. I am thankful to my mother for her unrelenting emotional support and for always standing by me when I needed it the most. Besides, I am deeply grateful to my brother and sister for their encouragement throughout the journey. Last but not least, I am thankful to my loving wife, who supported me in every way possible and brought so much joy and happiness to my life.

SUMMARY

IP spoofing is the act of forging source IP addresses assigned to a host machine. Spoofing provides users the ability to hide their identity and impersonate another machine. Malicious users use spoofing to invoke a variety of attacks. Examples are Distributed Denial of Service (DDoS) attacks, policy evasion and a range of application-level attacks.

Despite source IP address spoofing being a known vulnerability for at least 25 years, and despite many efforts to shed light on the problem, spoofing remains a popular attack method for redirection, amplification and anonymity. Defeating these attacks requires operators to ensure that their networks filter packets with spoofed source IP addresses. This is a Best Current Practice (BCP), known as Source Address Validation (SAV).

Yet, widespread SAV adoption is hindered by a misalignment of incentives: networks that adopt SAV incur the cost of deployment, while the security benefits diffuse to all other networks. The challenges posed by SAV adoption exemplify the failure of traditional governance models to provide solutions in the Internet ecosystem. Policy interventions usually require transparency in measurements to quantify and assess the vulnerability landscape. However, measuring SAV requires a vantage point inside the network or in the upstream provider of the network. Once a packet with a spoofed source address leaves the upstream network provider, it is almost impossible to ascertain its origin.

Furthermore, various stakeholders have different aggregation and precision requirements for measurement results. For instance, policymakers need SAV compliance and remediation to be measured at the organizational level. However, current methodologies report noncompliance at the network level – i.e., counting noncompliant IP address space, aggregating noncompliant /24 prefixes or Border Gateway Protocol (BGP) prefix announcements – or at the Autonomous Systems (ASes) level.

A more pressing question is how can more operators be moved to adopt SAV. Multiple studies show varying degrees of success in use of notifications to stimulate remediation of vulnerable or compromised devices. Improving SAV adoption is made more challenging by the aforementioned misaligned incentives. The Spoofer Project reported that notifying operators boosted remediation rates by about 50%. However, its findings were based only on observational data. In the absence of a control group, we cannot establish whether interventions in fact had significant impact on SAV compliance.

Therefore, for the adoption of SAV, we require not only representative data points, but also a better understanding of the current landscape of SAV deployment. We also need to introduce relevant interventions for network operators to adopt SAV. This leads to the main question of the current research:

How can we measure and improve the adoption of Source Address Validation (SAV) by network operators?

The following chapters explore multiple research topics. Collectively, chapters 2, 3, 4 and 5 answer the main research question. These chapters form the core of the thesis and have been individually published in separate peer-reviewed venues.

Chapter 2 sets out to expand the coverage of the existing Spoofer tool for measuring SAV compliance using crowdsourcing platforms. In six weeks, we recruited 1,519 workers from 91 countries and 784 unique ASes, at a cost of approximately €2,000. Some 342 of these ASes were not previously covered, representing a 15% increase in ASes over the prior 12 months. We draw the following conclusions from our work. First, commercially crowdsourced vantage points are relatively costly, especially for longer-term studies. If longitudinal measurements are required, workers can be compensated with smaller bonuses per week or month to keep the tool running. Second, if a study seeks a specific set of vantage points outside its current coverage, then accurately screening workers can make crowdsourcing quite cost-effective – offering an almost ‘no cure, no pay’ approach. Third, crowdsourcing can be seen as a way to acquire ground truth data for researchers to validate conclusions based on other, cheaper network measurements. Fourth, there appears to be potential to retain some of the workers as volunteers. Within our study, we found that more than one in four workers kept the tool running and submitted follow-up tests unpaid.

Chapter 3 introduces a new methodology to measure SAV noncompliance among upstream providers. We used routing loops appearing in traceroute data to infer inadequate SAV at the transit provider edge. Our method utilizes a router misconfiguration, which functions as a vantage point to observe the absence of SAV between the customer and the transit provider. In other words, our methodology does not require a vantage point within the customer network. We found 703 provider ASes that did not implement ingress filtering on at least one of their links for 1,780 customer ASes.

Chapter 4 investigates the impact of various incentives on SAV adoption. It combines two independent datasets (misconfigured open resolvers and Spoofer) with observations on the absence of SAV to statistically model causal drivers for non compliance. In this study, our analysis focused on a critical population with a rather homogeneous composition: Internet Service Providers (ISPs), here defined as the businesses that offer Internet access to end-users. Given that they provide Internet access to billions of users, ISPs are a critical control point for adopting SAV and for blocking potential miscreants from IP spoofing. Nonetheless, we found evidence of the absence of SAV for certain prefixes of 250 ISPs. We then set out to explain what proportion of an ISP’s address space allowed spoofing based on four causal factors – network complexity, security effort, ISP characteristics and institutional environment. These were measured via 12 indicators. In sum, evidence suggests that larger ISPs have a larger proportion of noncompliant IP space. ISP security efforts, most notably adoption of Resource Public Key Infrastructure (RPKI) and hygiene of the network, such as the number of amplifiers, were positively correlated with SAV. Finally, we found that ISPs in countries with more developed ICT infrastructures were more likely to adopt SAV.

Chapter 5 explores various interventions to improve SAV adoption. It presents a first-ever randomized control experiment to measure the effectiveness of various notification mechanisms on SAV deployment. Psychology and behavioral science literature suggest that nudges and minor changes in message framing may lead to higher compliance with

a recommendation. We used behavioral nudges in notification messages to test their effect on SAV compliance. We also sent notifications to a public operator forum (Network Operator Group). Finally, we tested the impact of a notification treatment directly administered by a national computer emergency response team (CERT). Nic.br, a leading Brazilian CERT, sent the notification on our behalf and followed up on questions from operators. This allowed us to test the impact of direct CERT notifications on remediation. Our rigorous design reveals a painful reality that contrasts with earlier observational studies: none of the notification treatments significantly improved SAV deployment compared to the control group. We explore the reasons for these findings and report on a survey among operators to identify ways forward. A proportion of the operators indicated that they did plan to deploy SAV and asked for better notification mechanisms, training and support materials for SAV implementation.

Finally, Chapter 6 synthesizes our findings and discusses their implications for governance. Lessons learned are presented with respect to collecting and analyzing SAV compliance data, and the implications of our findings are examined in light of four canonical governance models. We propose future directions of research to measure and improve SAV.

CONTENTS

Acknowledgements	vii
Summary	ix
1 Introduction	1
1.1 The trust-based nature of the internet	1
1.1.1 The threat landscape	1
1.2 Source Address Validation to the rescue	3
1.3 Factors affecting noncompliance	4
1.4 Research gaps	4
1.4.1 Measuring SAV adoption	5
1.4.2 Drivers of adoption of SAV	6
1.4.3 Interventions to improve SAV adoption	6
1.5 Research aims and questions	7
1.5.1 Study 1:Improving the coverage of existing methodology	7
1.5.2 Study 2:Proposing a new methodology to identify noncompliant networks	8
1.5.3 Study 3:Understanding factors responsible for noncompliance	8
1.5.4 Study 4: Improving SAV compliance	8
1.6 Dissertation outline	9
2 Using Crowdsourcing Marketplaces for Network Measurements: The Case of Spoofer	11
2.1 Introduction	11
2.2 Related Work	13
2.3 Background on the Spoofer Project	14
2.4 Crowdsourcing Platforms	15
2.5 Infrastructure Design	16
2.5.1 Measurement Goal	16
2.5.2 Measurement Infrastructure	16
2.5.3 Measurement Campaigns	17
2.5.4 Ethical considerations	18
2.5.5 Interaction with workers	19
2.5.6 Follow up tests	19
2.6 Evaluation of design	20
2.7 Analysis of platforms	21
2.8 Contributions to Spoofer	22
2.9 Conclusion	24

3	Using Loops Observed in Traceroute to Infer Ability to Spoof	25
3.1	Introduction	25
3.2	Background on Ingress Filtering	26
3.3	Related Work	27
3.4	Motivation of Ingress ACLs	27
3.5	Inferring Absence of Filtering using Traceroute	28
3.5.1	Input Data	29
3.5.2	Construction of Topology	29
3.5.3	Algorithm to Infer Absence of Ingress Filtering from Loops	30
3.5.4	Finding Needles in a Haystack	31
3.5.5	Persistence of Loops	32
3.6	Validation by Network Providers	32
3.7	Results	33
3.8	Conclusion	35
4	SAVING the Internet: Explaining the Adoption of Source Address Validation by Internet Service Providers	37
4.1	Introduction	37
4.2	Background and Literature Review	39
4.2.1	SAV – Source Address Validation	39
4.2.2	Inferring SAV Deployment	39
4.2.3	Modeling Security Performance	40
4.3	Theoretical Framework	41
4.3.1	Incentives	41
4.3.2	Explanatory Factors for SAV Compliance	42
4.4	Data Collection	44
4.4.1	Mapping observations to ISPs	45
4.4.2	Data on IP Spoofing	45
4.4.3	Network Properties Data	50
4.4.4	Security Effort Data	51
4.4.5	ISP Characteristics Data	53
4.4.6	Institutional Environment Data	53
4.5	Statistical Model for Non-Compliance	53
4.5.1	Model Specification	54
4.5.2	Discussion of Results	54
4.6	Challenges in the Adoption of SAV	59
4.6.1	Reducing the cost of adoption	59
4.6.2	Reducing Information Asymmetry	61
4.6.3	Internalizing Externalities	61
4.6.4	Community Action to Reduce Weak Links	61
4.7	Conclusions	62
5	Deployment of Source Address Validation by Network Operators: A Randomized Control Trial	63
5.1	Introduction	63

5.2	Related Work	65
5.2.1	Methods to Infer the Adoption of SAV	65
5.2.2	Security Notification Experiments	66
5.2.3	Behavioral Nudges	67
5.3	Methodology	67
5.3.1	Vulnerability Discovery	68
5.3.2	Experimental Design	69
5.3.3	Notification Procedure	73
5.3.4	Post-Experiment Survey Design	73
5.3.5	Ethics	74
5.4	Results	75
5.4.1	Organization-Level Remediation	75
5.4.2	Partial Remediation	76
5.4.3	Main Experimental Effects	77
5.4.4	Comparison with Spoofer	79
5.5	Factors affecting remediation rates	80
5.6	Survey Results	83
5.7	Discussion & Conclusions	85
5.7.1	Treatment Effects	85
5.7.2	Remediation in the Control Group	85
5.7.3	Comparison with Previous Studies	85
5.7.4	Reasons for Non-Remediation	86
5.7.5	Moving Forward: Recommendations	87
6	Conclusion	89
6.1	Contribution to the research gaps	90
6.1.1	Transparency of Measurements	90
6.1.2	Incentives	93
6.1.3	Interventions	94
6.2	Moving forward	96
6.2.1	Improving transparency	96
6.2.2	New Interventions	97
6.3	Closing Thoughts	100
A	APPENDIX A	115
A.1	Notification Text	115
A.1.1	Direct Notifications – Baseline	115
A.1.2	Direct Notification – Social Nudge	115
A.1.3	Direct Notification – Reciprocity	116
A.1.4	CERT Notification – Baseline	116
A.1.5	CERT Notification–Social Nudge	117
A.1.6	CERT Notification–Reciprocity	118
A.1.7	NOG Notification	118
A.2	Questionnaire	119
A.3	Screen shot of Website	121

1

INTRODUCTION

1.1. THE TRUST-BASED NATURE OF THE INTERNET

The Internet can be defined as a global system of interconnected computer networks that links multiple devices to exchange digital information [1]. The architecture of the Internet was kept simple on purpose so that it can accommodate various services with minimal intervention [1], [2]. In essence, any device that wants to communicate over the Internet divides the information into equal chunks of data, or ‘packets’. In the header of the packet, it then adds its own address, known as the *source Internet Protocol (IP) address* and the address of the recipient the (*destination IP address*). The core of the Internet consists of routers that maintain a map of all connected devices (IP addresses) in a routing table. Each router determines the IP address of the next ‘hop’ (next closest router) based on the destination address, and forwards the packet to it. The packets are processed at each hop, with the next hop determined until the packet reaches its desired destination.

The destination device uses the source IP address of the incoming packet to establish the connection and reply to requests from the sender. Users are oblivious of source and destination IP addresses, since applications usually fill in this information for the IP packet. However, users can override the IP header and customize the source or destination address. Unlike in the real world, where official documents like driving licenses and passports are used to authenticate people and information sources, the Internet lacks validation of source addresses in IP packets. Network operators and hardware manufacturers are not obligated to validate a device’s IP address before routing a packet on the global Internet. Senders can therefore ‘spoof’ or falsify the source IP address of a packet. This constitutes a critical flaw in the design of the Internet.

1.1.1. THE THREAT LANDSCAPE

Malicious actors use this flaw to their advantage. It provides them with anonymity, as receivers are unable to trace the origin of malevolent communications. Moreover, users can evade liability for impersonating another machine or user, since it is difficult to trace

packets back to their actual sender. Many types of malicious attack rely on IP spoofing. This section describes some of the more common ones, from congesting a victim's network or device to redirecting users to compromised domains using DNS (Domain Name System) cache manipulation.

BANDWIDTH CONGESTION ATTACKS

In a bandwidth congestion attack, an attacker directs a high volume of traffic toward the target's network, congesting the victim's network and resulting in a Denial of Service (DoS). Such an attack relies on open services like DNS, NTP (Network Time Protocol) and memcached reflection and amplification. Exploiting these open protocols, the attacker finds services that result in an amplified response. For instance, an attacker might find a large TXT record in a DNS system, then send spoofed DNS packets to the open DNS servers requesting the TXT record with the victim's source address. The public resolvers then send the replies to the spoofed address, i.e., that of the victim. Hence, each small query to the DNS generates an amplified response. An attacker can also launch a Distributed Denial of Service (DDoS) attack by exploiting botnets and sending millions of packets with a spoofed source address to open resolvers from various networks, devices and geographic locations. This effectively chokes the victim's bandwidth.

Bandwidth congestion DDoS attacks can affect multiple users sharing the same network. In a recent survey [3], network operators named DDoS attacks as one of the most significant threats to their network operations. The victims of DDoS attacks span access networks, governmental networks, educational networks, gaming servers and influential domains. Figure 1.1 presents a timeline of the biggest DDoS attacks between 2013 and 2020. Among the targets of these attacks were an organization that reports on malicious activities (SpamHaus) and well-known websites providing a range of entertainment, financial and productivity services. Outages caused by DDoS attacks result in significant monetary losses. Recently, a Voice over IP (VoIP) service provider (bandwidth.com) reported a loss of nearly US \$12 million because of customers leaving their services due to DDoS attacks [4]. In another instance, a ransomware group (REvil) demanded \$4.5 million from VoIP.ms to end a week-long attack [4].

TCP/IP-BASED TARGETED ATTACKS

Attackers can also exploit other protocols to launch non-bandwidth attacks. One such example is to exploit the 'three-way handshake' of the Transmission Control Protocol/Internet Protocol (TCP/IP). TCP/IP provides for reliability in data transmission over the Internet. The 'handshake' is a three-step process performed by the client and the server before they start transmitting data. The steps are as follows:

1. The client sends a synchronization (SYN) packet to the server, indicating that it wants to initiate data transfer.
2. The server replies to the client with a SYN and acknowledgment (ACK) of the SYN packet sent by the server.
3. The client responds to the SYN packet of the server with an ACK.

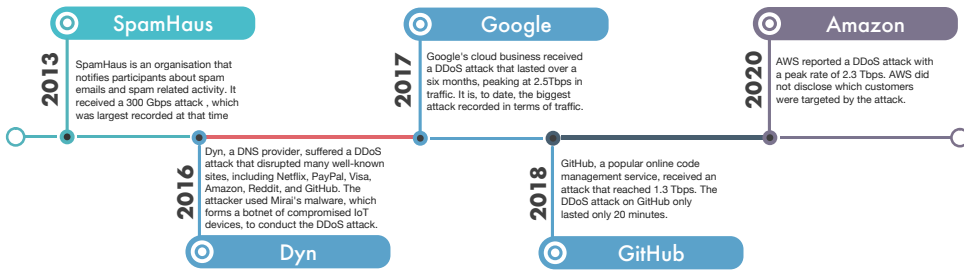

Figure 1.1: Examples of particularly significant DDoS attacks (2013-2020)

An attacker can exploit the three-way handshake process by sending the server a spoofed packet with the source IP address of the victim. The server then responds with the SYN-ACK packet to the victim. Since the victim did not initiate the connection, it drops these packets. The server keeps resending the SYN-ACK, assuming the packets were lost due to network issues. An attacker can launch a coordinated attack in which multiple servers send a burst of high packet per second (PPS) SYN-ACK traffic to the victim. While this attack is low bandwidth, it nonetheless congests the network equipment or machine of the victim. Akamai reported that several of its customers had been targets of a SYN-ACK attack [5].

DNS-BASED ATTACKS

The Domain Name System (DNS) forms the backbone of our Internet. Every website we visit gets the translation of the IP address hosting it from a DNS resolver. In a DNS-based attack, the attacker sends a request for resolution to the local DNS resolver. If the local resolver does not have the record, it requests an answer from the upstream authoritative server. However, the attacker attempts to send a rogue response with a spoofed IP address for the authoritative server before arrival of the legitimate response. If the attacker's response arrives before the legitimate reply, the local resolver accepts the answer and keeps it in the cache. When the victim queries for the website, it is redirected to the compromised machine controlled by the attacker. Since the discovery of this vulnerability in 2008, several patches have been released to circumvent such attack. A recent study [6], however, indicates that DNS-based attacks may still succeed.

In summary, numerous types of attacks are made feasible by IP spoofing. The scourge of IP spoofing led Internet Hall of Fame technologist Paul Vixie [7] to observe, "Nowhere in the basic architecture of the Internet is there a more hideous flaw than in the lack of enforcement of simple source-address validation (SAV) by most gateways."

1.2. SOURCE ADDRESS VALIDATION TO THE RESCUE

To mitigate cyber-attacks, the operator of the victim's network usually needs two sets of information: the source of the attack and a methodology to drop traffic from this point of origin. However, IP spoofing makes it almost impossible to identify the source IP address, and attacks can originate from various networks. So operators cannot block the malicious communications without dropping legitimate traffic.

A simpler solution is for the majority of network operators to verify the source address of packets originating from their own networks and drop illegitimate packets. This would curtail attackers' ability to send spoofed packets in the first place. Defeating amplification attacks and other threats based on IP spoofing requires that providers filter out any incoming packets with spoofed source IP addresses. In other words, they must implement BCP 38 [8], the Best Current Practice also known as Source Address Validation (SAV).

The Spoofer Project [9], which measures SAV compliance, reported that as of November 2021 some 24% of networks still allowed users to send packets with a false source address. Thus, despite source IP address spoofing being a known vulnerability for at least 25 years, and despite much effort to shed light on the problem, spoofing remains a viable method for redirection, amplification and anonymity of attackers.

1.3. FACTORS AFFECTING NONCOMPLIANCE

Numerous community-driven programs have encouraged operators to implement the best practice. However, many networks are still observed to be noncompliant, discovered through various methodologies. The question that arises is why do we still find operators without SAV, despite all the efforts made to implement SAV and despite DDoS attacks being one of the most significant challenges facing network operators?

The most-used argument in favor of noncompliance is borrowed from the economics literature and known as the *tragedy of the commons*. In simple terms, it depicts a situation where an individual user with access to a shared resource acts selfishly in their own interest, to the detriment of the common interest of all users. This results in depletion of the resource and losses to others. Translated to network operators' non-implementation of SAV, the Internet is the shared resource and those network providers that have implemented SAV are the ones who experience the loss. This is because they incur the cost of hardware, training and time to keep the hardware updated. However, their adoption of SAV does not protect their own network from attacks involving IP spoofing; it only prevents their networks from being used by attackers.

In short, adoption of SAV is hindered by a clear misalignment of incentives: the cost is borne by the networks that implement it, while the benefits go to the rest of the Internet. Noncompliance can therefore be termed a negative externality (a cost incurred by a third party for the actions of other parties). Seen in this light, it is actually remarkable that a sizeable proportion of all networks are in fact SAV compliant.

There are other reasons for noncompliance, including technical issues, economic drivers and network complexity. These are briefly touched upon in the discussion of the research gaps below, and detailed further in Chapter 4.

1.4. RESEARCH GAPS

Various authors have examined SAV compliance among network providers. This section presents an overview of efforts to measure and understand SAV compliance, and some limitations in the current state of the art.

1.4.1. MEASURING SAV ADOPTION

A wealth of tools has been developed to collect data on network policies and practices across the Internet – e.g., for quality, security and transparency purposes. Many measurements rely on a distributed set of vantage points to capture representative data. Having adequate vantage points is particularly critical for tools that must be run from *within* a network to enable accurate inferences. SAV measurements, too, require vantage points within networks, in order to measure whether the network allows IP packets with a spoofed source address or blocks these before the packet leaves the network.

One way to gain the needed vantage points is by recruiting volunteers to deploy a vantage point within their network to measure compliance. This is a solution offered by the Spoofer Project. However, it brings several challenges. Particularly, (1) it is not easy to find volunteers willing to install the spoofer client software, (2) the participants need to be in diverse networks to get appropriate coverage and (3) the tool needs to conduct longitudinal tests to assess whether noncompliant networks have gone on to deploy SAV.

Another approach to measure compliance is by collaborating with Internet Exchange Points (IXP). IXPs provide connectivity to Internet service providers and as such are at the core of the Internet. Previous studies [10], [11] have compared the source IP addresses of incoming packets from Internet providers with the IP ranges allocated to them to infer whether the network operator had deployed SAV. However, a significant challenge in using this methodology is non-availability of data, as IXPs don't publicly share their data. Moreover, many network providers are multiple hops away from an IXP, which renders this method ineffective for measuring SAV compliance. In addition, IXPs receive packets in the order of petabytes, which can be challenging to store and process for ongoing measurements.

Finally, a previous study [12] exploited a misconfiguration in home routers to infer noncompliance. When probed, the misconfigured devices acted as vantage points and responded with incorrect source IP addresses to a specially crafted DNS request. However, this methodology depends on the misconfigured devices and only reveals noncompliant networks that host these devices. Moreover, the authors did not run longitudinal analysis using the methodology.

Finally, a previous study [12] had used a misconfiguration in home routers to infer non-compliance. When probed, the misconfigured devices act as a vantage point and send packets with incorrect source IP addresses. Their methodology depends on the misconfigured devices and only reveals noncompliant networks that host these devices. Moreover, the authors did not run any longitudinal analysis using this methodology.

In summary, there is no reliable metric to estimate the current status of SAV deployment. Multiple methodologies reveal noncompliant networks. However, no datasets are publicly available, except for those of the Spoofer Project, which has only partial coverage. This results in information asymmetry. Which network operators have implemented SAV is seldom visible to customers, providers and outside observers. Neither is this information readily available to the public or to other providers, which might use it in peering decisions. Thus, while adopting SAV is a good practice, it does not result in a better reputation. Conversely, non-compliance does not generate a clear negative reputational impact.

1.4.2. DRIVERS OF ADOPTION OF SAV

We know little about why certain operators do not implement SAV in their network. Lichtblau and colleagues surveyed 84 network providers in early 2017 [11]. The operators raised several reasons for noncompliance, including technical difficulties and the time and knowledge required to deploy SAV. Moreover, many respondents reported a lack of motivation to implement SAV, stating that spoofed traffic was only a fraction of their total traffic volume. While providing some insight into obstacles to SAV deployment, the sample in this research was biased toward a small set of operators that already understood the implications of noncompliance and might already have deployed some network filtering measures.

No research has yet systematically scrutinized the underlying causes of non-adoption. Is it the size of the network or general complexity that drives network operators away from compliance? Can compliance be explained by economic drivers? For instance, is SAV adoption more widespread in countries with better Internet infrastructure and resources? Or, are providers simply unconcerned with network hygiene in general? Similarly, little has been done to develop empirical models to quantify the impact of different causal drivers of noncompliance.

1.4.3. INTERVENTIONS TO IMPROVE SAV ADOPTION

A stream of studies has examined the effectiveness of notifications to network operators to remediate vulnerabilities. However, substantially less effort has gone into improving SAV adoption among operators. A global initiative called Mutually Agreed Norms for Routing Security (MANRS) is leading the effort to improve routing security [13]. One of its main action items is providing knowledge, awareness and technical assistance to network operators to implement SAV in their networks. MANRS recommends that all of its member organizations be fully compliant with SAV. It provides technical documents for different routers, and conducts workshops and seminars to educate operators on best practices. Despite leading the effort, as of February 2022 MANRS has only 809 Autonomous Systems (ASes) as participants [14], out of a total of more than 70,000 ASes advertised in Border Gateway Protocol (BGP). Participants were, furthermore, concentrated in developed countries. The MANRS initiative promotes its objectives through attendance at network operator conferences and via social media. While its observatory has information about noncompliant providers, it does not actively send notifications.

Regarding notifications, multiple channels are available to reach noncompliant network operators. We can reach them using the abuse contact provided in the WHOIS database. Or, we can use public databases, like peeringDB, to find an email address to contact the providers. Another way to contact noncompliant operators is via an intermediary, like a national computer emergency response team (CERT). Finally, we can use public forums, like social media and network operator lists, to reach the providers. The Spoofer Project disseminates the data that it collects only on the network operators' mailing list. The project sends monthly reports of networks that are noncompliant and those that have remediated. Despite the importance of an effective means of approaching providers, no study provides information on what is the best channel to reach them. We are similarly in the dark about whether providers contacted through Network Operator Group (NOG) lists have enough knowledge and sufficient motivation to implement

SAV in their networks.

In summary, we observe three main gaps in current research. First, the multiple methodologies currently available afford only a partial view of noncompliance, while efforts to assess compliance, as yet, either lack coverage or do not make their data publicly available. Second, we lack information about causal drivers that explain non-adoption by providers. Finally, limited work has been done examining interventions and the methods that work best to improve SAV adoption.

1.5. RESEARCH AIMS AND QUESTIONS

SAV adoption requires policy interventions that differ from traditional remediation approaches. Unlike other network policies, there is no way to measure adoption of SAV from outside a network. Whether a network operator is compliant with SAV is seldom visible to customers, providers and outside observers. Neither is the information readily available to the public or to other providers, which might use it in peering decisions. Thus, while adopting SAV is a good practice, it does not result in a better reputation. Conversely, noncompliance does not generate a clear negative reputational impact. In the current research, we set out to improve the visibility and coverage of SAV noncompliance by network providers. We estimated the impact of various incentives on SAV adoption and statistically modelled causal drivers for the absence of SAV. To understand how to improve compliance, we conducted a randomized control experiment with several interventions and a comparison of channels for notifying operators. The main research question is the following:

- *How can we measure and improve the adoption of Source Address Validation (SAV) by network operators?*

To answer this question, we conducted four studies, presented in chapters 2-5 of this thesis. We briefly introduce these studies below.

1.5.1. STUDY 1: IMPROVING THE COVERAGE OF EXISTING METHODOLOGY

In the first study, we explored ways to improve the coverage of the volunteer-based Spoofer Project tool. Crowdsourcing marketplaces can potentially recruit workers to run tools from networks not covered by the current volunteer pool. We designed an infrastructure to collect and synchronize measurements from five crowdsourcing platforms, and used that infrastructure to collect data on network SAV policies for CAIDA's Spoofer Project. In six weeks, we increased the coverage of Spoofer measurements. The study recruited 1,519 workers from 91 countries and 784 unique ASes, at a cost of approximately €2,000. The project did not have a vantage point for some 342 of these ASes in the 12 months prior to our study, representing a 15% increase. We compiled lessons learned in recruiting and remunerating workers, particularly regarding strategies to address worker behavior when workers are screened because of overlap in the volunteer pool. In short, this study aimed to answer the following question:

- *How can we acquire additional vantage points using crowdsourcing platforms to improve visibility of SAV adoption?*

1.5.2. STUDY 2: PROPOSING A NEW METHODOLOGY TO IDENTIFY NONCOMPLIANT NETWORKS

With our second study, we introduced a new method to identify networks in which SAV has not been implemented. We used routing loops appearing in traceroute data to infer inadequate SAV at the transit provider edge, where a provider did not filter traffic that could not have come from the customer. This method does not require a vantage point within the customer network. We present and validate an algorithm that identifies at Internet scale which loops imply a lack of ingress filtering by providers. We found 703 provider ASes that did not implement ingress filtering on at least one of their links for 1,780 customer ASes. Most of our observations were unique compared to those gained by the existing methods of the Spoofer and Open Resolver projects. By increasing the visibility of the networks that allow spoofing, we aim to strengthen the incentives for SAV adoption. The main goal of this study was to answer the following question:

Most of these observations are unique compared to the existing methods of the Spoofer and Open Resolver projects. By increasing the visibility of the networks that allow spoofing, we aim to strengthen the incentives for the adoption of SAV. The main goal of this study was to explore the following research question.

- *How can we leverage traceroute loops to improve the visibility of SAV non-compliance, and what additional coverage does it provide?*

1.5.3. STUDY 3: UNDERSTANDING FACTORS RESPONSIBLE FOR NONCOMPLIANCE

In the third study, we estimated the impact of various incentives on SAV adoption. This is the first-ever study to combine two independent datasets with observations on the absence of SAV and to statistically model causal drivers for noncompliance. We mapped these observations to a population of 334 ISPs that controlled the bulk of the Internet access market in 61 countries. We found evidence of the absence of SAV for certain prefixes of 250 ISPs. We then set out to explain what portion of an ISP's address space allowed spoofing based on four causal factors – network complexity, security effort, ISP characteristics and institutional environment. These were measured using 12 indicators. The study answered the following research question:

- *What incentives explain operator noncompliance with SAV, and how do network characteristics, intermediaries and market forces impact these incentives?*

We found evidence that larger Internet Service Providers (ISPs) had a higher proportion of noncompliant IP space. ISP security efforts, most notably adoption of RPKI and the number of amplifiers, were positively correlated with SAV. Subscription prices and ISP revenue had no significant impact. Finally, we found that ISPs in countries with more developed ICT infrastructure were more likely to have wider adoption of SAV. We reflect on these findings and discuss potential ways forward for SAV.

1.5.4. STUDY 4: IMPROVING SAV COMPLIANCE

Various interventions have been tried to combat spoofing and increase adoption of SAV among network operators. In this study, we conducted the first-ever randomized control

experiment to measure the effectiveness of various notification mechanisms on SAV deployment. Specifically, we tested different nudges and notification channels. We also ran a survey among operators to identify ways forward. A portion of the operators indicated that they did plan to deploy SAV and welcomed better notification mechanisms, training and support materials for SAV implementation. In addition to exploring how more operators might be moved to adopt SAV, we zoomed in on the effectiveness of particular incentives and notifications, asking the following:

- *What intervention offers the strongest incentives for network operators to implement SAV, and how can we improve SAV notifications to make them most effective for network operators?*

This study revealed a painful and disappointing reality: there was no evidence of any remediation driven by any of the treatments compared to the control group. All in all, our findings are sobering but important if we are to correct our understanding of these interventions and move forward on this critical issue. Our survey among operators helps us identify how.

1.6. DISSERTATION OUTLINE

The remainder of this dissertation is organized as follows. Chapters 2 through 5 present the studies introduced above. Chapter 6 presents conclusions and proposals for future work. The four main chapters (2-5) were originally published separately as peer-reviewed articles in distinguished outlets. Table 1.1 provides an overview of these. During the course of this dissertation, I was fortunate to collaborate with some of the great researchers, whose contributions I gratefully acknowledge at the end of the dissertation.

Chapter	Publication
2	Qasim Lone, Matthew Luckie, Maciej Korczyński, Hadi Asghari, Mobin Javed, and Michel Van Eeten. "Using crowdsourcing marketplaces for network measurements: The case of spoofer." In 2018 Network Traffic Measurement and Analysis Conference (TMA), pp. 1-8. IEEE, 2018.
3	Qasim Lone, Matthew Luckie, Maciej Korczyński, and Michel Van Eeten. "Using loops observed in traceroute to infer the ability to spoof." In International Conference on Passive and Active Network Measurement, pp. 229-241. Springer, Cham, 2017.
4	Qasim Lone, Maciej Korczyński, Carlos Gañán, and Michel van Eeten. "SAVing the Internet: Explaining the Adoption of Source Address Validation by Internet Service Providers." In Workshop on the Economics of Information Security. 2020.
5	Qasim Lone, Alisa Frik, Matthew Luckie, Maciej Korczyński, Michel van Eeten, Carlos Gañán. "Deployment of Source Address Validation by Network Operators: A Randomized Control Trial." To appear in the IEEE Symposium on Security & Privacy, May 2022

Table 1.1: Overview of dissertation chapters

2

USING CROWDSOURCING MARKETPLACES FOR NETWORK MEASUREMENTS: THE CASE OF SPOOFER

Internet measurement tools are used to make inferences about network policies and practices across the Internet, such as censorship, traffic manipulation, bandwidth, and security measures. Some tools must be run from vantage points within individual networks, so are dependent on volunteer recruitment. A small pool of volunteers limits the impact of these tools. Crowdsourcing marketplaces can potentially recruit workers to run tools from networks not covered by the volunteer pool.

We design an infrastructure to collect and synchronize measurements from five crowdsourcing platforms, and use that infrastructure to collect data on network source address validation policies for CAIDA's Spoofer project. In six weeks we increased the coverage of Spoofer measurements by recruiting 1519 workers from within 91 countries and 784 unique ASes for 2,000 Euro; 342 of these ASes were not previously covered, and represent a 15% increase in ASes over the prior 12 months. We describe lessons learned in recruiting and remunerating workers; in particular, strategies to address worker behavior when workers are screened because of overlap in the volunteer pool.

2.1. INTRODUCTION

A wealth of tools have been developed to collect data on network policies and practices across the Internet – e.g., for quality, security, and transparency purposes. Many measurements rely on a distributed set of vantage points to capture representative data. This is even more critical for tools that need to be run from *within* a network to enable correct inferences, such as censorship measurement [15], network performance debug-

ging [16]–[19], or detecting security policies such as deployment of Source Address Validation (SAV) [20].

A common challenge is acquiring an adequate set of vantage points. A conventional approach is recruiting volunteers via conferences, mailing lists, and other channels to deploy a tool or hardware probe [21]. Another approach is to use established distributed measurement platforms with a substantial number of vantage points, such as RIPE Atlas [21] and SamKnows [22]. As of October 2017, RIPE Atlas has 10,113 connected vantage points within 3,596 ASes routing IPv4 prefixes. However, these platforms only allow a limited set of measurement tools under their user agreements. For example, while there is demand among RIPE Atlas probe hosts for SAV testing (the case we examine in this study), and operators of 117 probes within 83 IPv4 ASes have voluntarily tagged their probes asking for this testing, SAV testing on Atlas is unlikely to be supported, at least in the near future [23]. Other platforms, like PlanetLab [24], have most of their vantage points in educational networks, or have few vantage points to begin with. Project Bismark [25], for example, has only 57 active vantage points. Such limitations greatly reduce the types of networks that can be included in a study, especially for measurements that need to be conducted from within networks.

Crowdsourcing marketplaces offer an attractive complementary option for recruiting vantage points, as payment makes studies less reliant on volunteer recruitment. These platforms offer workers small monetary benefits for carrying out micro jobs that usually do not require extensive knowledge and can be completed within few minutes, and attract workers with diverse backgrounds and geographical locations.

In this study, we explore how effective crowdsourcing marketplaces are in extending, within a limited budget, the coverage of vantage points for network measurements, compared to the volunteer-based approaches commonly used in network measurements. We design and test a system to conduct parallel measurements across five marketplaces, each with a different geographical reach, and assess the improvement in network coverage. We collect data for CAIDA's Spoofer project [20]. The client tests whether the network in which the vantage point is located filters packets with spoofed source IP addresses, a best practice known as SAV [8]. More comprehensive visibility into SAV compliance is important to incentivize network operators combat IP spoofing and mitigate the associated threats, most notably large-scale distributed denial of service attacks [26], [27].

Spoofers provides a very informative case study, as it is dependent on the coverage of vantage points inside networks. It is well known and has been recruiting volunteers for over a decade. To extend its reach, it cannot turn to platforms like RIPE Atlas, which currently does not allow spoofing measurements [23]. These factors make marketplaces valuable, but the tool also poses hurdles, as workers must be willing to install and run an executable, and such a task must be permitted within the Terms of Service of the platform.

To summarize, our main contributions are as follows:

1. We design an infrastructure to collect and synchronize parallel measurements via multiple marketplaces. Our infrastructure prevents invalid submissions, and can be extended to any measurement tool which reports a proof of completion.

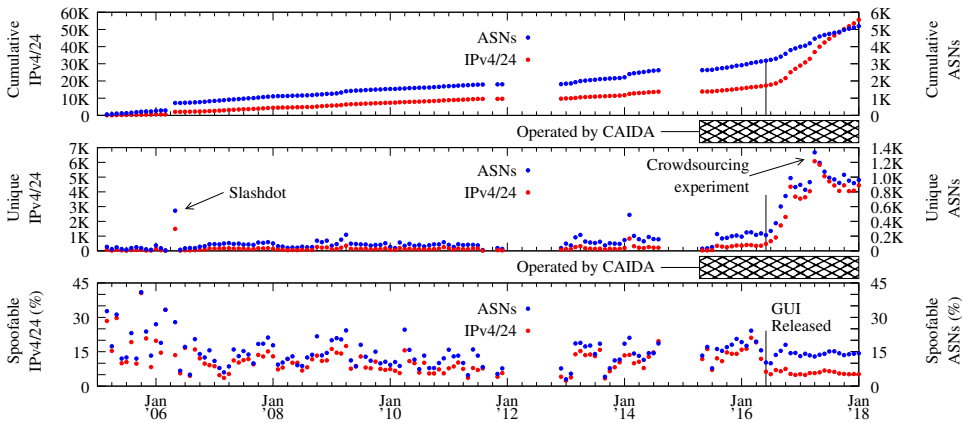

Figure 2.1: Overview of Spoofer project data collection over time, aggregated per month. The gaps are due to hardware failures. Between November 2016 and December 2017, the range of spoofable IPv4 prefixes is 4.9% – 6.8%, and the range of spoofable ASNs is 13.1% – 14.5%. The two data collection peaks in April and May 2017 are due to the crowdsourcing experiments in this study, and those results are qualitatively similar to those collected between November 2016 and December 2017.

2. We present experiences of how this design interacts with the marketplace platforms during measurement studies.
3. We assess the geographical diversity of the workers willing and able to complete the test, both between and within the platforms. We measure the effect of price elasticity (higher compensation) on the recruitment of additional workers. In total, we acquired vantage points from 91 countries and 784 unique Autonomous Systems (AS) and 1519 IP addresses at a price of approximately 2,000 Euro on platform fees and worker compensation.
4. We show that in six weeks, we increased the coverage of Spoofer by 342 unique ASes and 1470 /24's, a 15% increase of ASes over the prior 12 months.
5. We make our code available to the community[28].

2.2. RELATED WORK

Numerous papers used crowdsourcing platforms from diverse fields such as behavioral sciences, automation [29], [30], and computer vision [31], [32]. Researchers have also explored the dynamics of microjob platforms, and estimated the worker demographics and geographical dispersion [33]. Furthermore, studies have looked at increasing experiment efficiency in terms of price or new users [34]–[36].

Closer to our work, there is a handful of studies in the area of information security. Christin *et al.* were able to hire 965 workers to execute their program for an hour [37]. The program collected the Windows version, the list of active processes, and detected whether the application was running in a virtual machine. The goal was to test if raising the price has an impact on participants willingness to execute potentially malicious applications. They observed that significantly more people downloaded the program when

the price was raised to \$0.50 and then \$1.00. In another study, researchers were able to identify 85% of browsers running plug-ins with known vulnerabilities using JavaScript [38]. They concluded that for a mere \$52, 1,000 machines could be compromised.

Huz *et al.* conducted two Internet measurements on the MTurk platform, acquiring additional vantage points for broadband speed tests and the state of IPv6 adoption [39]. They found that participants from the US and India constituted 89% of completed tasks. The campaigns were shorter than ours and only on MTurk. Their exploration of pricing effects had inconclusive results. They were also unable to conduct tests using an executable, as this was against the terms of service at the time. Similarly, Varvello *et al.* studied page load times recruiting 1000 paid participants [40]. This study accepted all workers and did not control for, nor optimize, the distribution of vantage points over networks.

Some experiments require workers to conduct subjective assessments, relying on the worker actively participating in the experiment. Mok *et al.* proposed a method to detect low-quality workers that reduce experiment quality in a Quality of Experience context [41]. We do not face the same challenges in this work; the spoofer system automatically evaluates the reliability of the host for conducting SAV measurements.

We build on prior work, most notably [39], by designing an infrastructure to control and optimizing network coverage across platforms, by comparing platforms with different geographical coverage, by running measurements using an executable, and by more systematically observing the impact of job pricing.

2.3. BACKGROUND ON THE SPOOFER PROJECT

Determining if a given network blocks packets with spoofed source addresses requires a system within that network try sending packets with spoofed source addresses. The Spoofer project began in March 2005 as an effort by Beverly *et al.* to understand the prevalence of SAV deployment in the Internet using crowd-sourced measurements. They built a client/server system that allows the client to test whether or not packets with spoofed source addresses are discarded before they reach the server. For their initial study [20], they solicited volunteers through the North American Network Operators Group (NANOG) and dhsield security mailing lists to install and run the client. They received 459 client reports from unique IP addresses within 302 different prefixes; the server received packets with spoofed source addresses from 24.2% of these prefixes [20].

Between 2005 and 2009, the client-server system was updated to include a simple GUI for MacOS, IPv6 probing for UNIX systems, multiple destination support and traceroute probing to provide for tomography on paths where SAV is not deployed [42], and tracefilter to find where SAV is deployed [43]. However, there were three key issues limiting volunteer adoption and use of the system: (1) the lack of a user interface to the client software, (2) the user had to manually run the client software, and (3) the results were not made public so ISPs were not incentivized to deploy filtering. Figure 2.1 summarizes the data collection and project results over time; the peak in May 2006 coincides with a post to Slashdot seeking volunteers to run measurements [44].

In May 2015, CAIDA took over stewardship of the spoofer project, and in May 2016 released a new system that included a GUI and feature parity across all supported platforms (MacOS, Windows, and UNIX). The client operates in the background, testing

Platform	Claimed Coverage	Claimed Population	Min Amount	Payment
MTurk	US, IN	500,000	No min	Credit Card
ProA	GB, US, EU	56,556	\$7.50 USD/hr	Paypal
RW	IN, BD, US	N/A	\$0.01 USD	Skrill, Paypal
Jobboy	US, BD	152,000	\$0.01 USD	Paypal, Payza
Minijobz	BD, IN	N/A	\$0.01 USD	Paypal, Payza

Table 2.1: Crowdsourcing marketplaces we used in this study. The source of these demographics is various blog posts and platform websites, discussed in section 2.4. US: United States, IN: India, EU: Europe, GB: Great Britain, BD: Bangladesh.

networks as the volunteer's computer is attached to them, and once a week thereafter. CAIDA built a public reporting engine providing an anonymized view of results, allowing affected IPv4 /24 and IPv6 /40 blocks to be identified, reported with the origin AS of the block and IP geolocation. Raw IPv4 and IPv6 addresses of the tester are kept in a database, and are only disclosed to the affected network if the user consents to the raw IP addresses being shared for remediation, and the operator requires them to remediate. The client software deliberately does not include any tracking capability that would allow CAIDA to determine if tests conducted in different networks are from the same volunteer.

The crowdsourcing measurements we report in this dissertation contributed to the current peak volume of measurements received by the spoofer project in a single month (middle panel of figure 2.1). The measurements are, in spoofability, qualitatively similar to other measurements collected between November 2016 and December 2017, i.e. these measurements are no more biased in that dimension than other measurements collected during this period (bottom panel of figure 2.1).

2.4. CROWDSOURCING PLATFORMS

We compiled a list of 15 crowdsourcing platforms from prior research and blog posts [45]–[47]. First, we selected platforms that allowed tasks which require workers to install and run an executable on their machine, ruling out platforms like CrowdFlower [48]. We also excluded platforms where language barriers prevented us from determining whether running executables were allowed (e.g., `zbx.com` and `crowdworks.jp`). Second, the marketplace should support micro jobs. Platforms like CloudFactory [49] and Upwork [50] only support more complex jobs and impose higher minimum compensation levels.

Based on these requirements, we selected the following five platforms: Amazon Mechanical Turk (MTurk) [51], Prolific Academic (ProA) [52], RapidWorkers (RW) [53], Jobboy (JB) [54], and Minijobz (MJ) [55]. Table 2.1 lists features of the selected platforms. They provide diversity of coverage across Europe, the United States, and South Asia (India and Bangladesh), are flexible in setting compensation levels, and offer secure payment methods.

Platform	Job Posting	Worker proof our website	Worker proof Job website	View Submission	Payment
MTurk	iframe	-	URL	API	API
ProA	iframe	URL + ID	-	CSV	CSV
RW	link	URL	Validation code	Web UI	Manual
MJ	link	URL	Validation code	Web UI	Manual
JB	link	URL	Validation code	Web UI	Manual

Table 2.2: Interactions between the microjob platforms and our infrastructure.

2.5. INFRASTRUCTURE DESIGN

Using marketplaces for network measurements is not trivial, as these platforms were not envisioned to support this use case. Screening of workers is based on worker demographics rather than properties of the network or client machines. Furthermore, tasks are generally integrated into the platform. Support for tracking completion of external tasks (e.g., running tools) is not directly available. In this section, we discuss how we tackle these challenges and design a measurement infrastructure to collect network measurement data.

2.5.1. MEASUREMENT GOAL

We articulate our measurement goal as follows: given a limited budget of 2,000 euro, maximize the coverage of vantage points (workers) over networks. After estimating worker payouts, platform overhead, and unforeseen costs at 2 euro per worker, we estimated we could acquire data from 1,000 vantage points (VPs). In total, we obtained data from 1,519 VPs, which we discuss in §2.7 and §2.8.

Next, we consider how to distribute these points across the IP address space to optimize diversity across networks. One starting point is to seek one data point per Autonomous System. This might be too restrictive for very large ASes, which may have substantial internal heterogeneity. For large ASes, we allow one measurement per each /11 subnet. We chose the granularity of /11 based on two observations: (1) we expect most workers on the platforms to be located in broadband networks, and (2) we know these networks collectively represent around 2.4 billion addresses [56]). When distributing 1,000 vantage points across this space, the closest block aggregation is /11. Note that this granularity can be changed based on a study's budget and objectives.

2.5.2. MEASUREMENT INFRASTRUCTURE

Researchers may need to screen out workers from network blocks where they already have a vantage point. We therefore determined the eligibility of workers interested in our task and selected them accordingly. We discuss our measurement infrastructure and how we integrate this design consideration.

(i) *Job posting*: All platforms allow linking to an external website in the job posting. For MTurk and ProA, our website was rendered as an `iframe` inside the platform site. We redirected workers for the other platforms to our website with platform name in the URL arguments to record which platform they participated from.

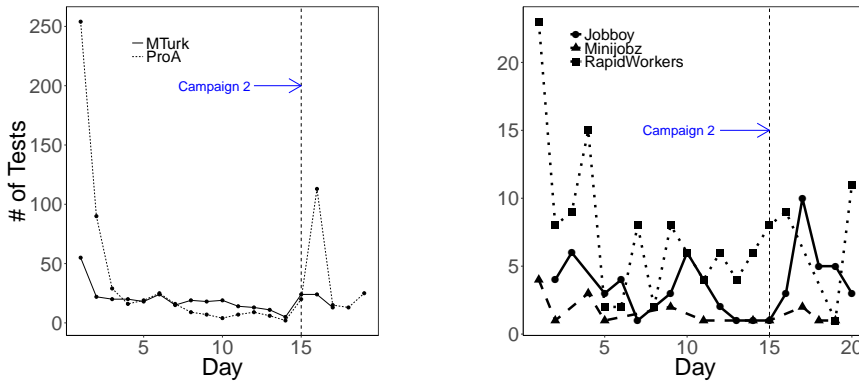

Figure 2.2: Job completion for bigger (left) and smaller (right) platforms. When we increased compensation (campaign 2) we attracted additional workers on all platforms.

(ii) *Screening*: When a potential worker visits our website, we check whether we already have a test result for the corresponding network block they connected from. If so, the potential worker is told that they are ineligible. Otherwise, they are presented with instructions and a form to submit the result from running the Spoofer tool.

(iii) *Proof of completion and payment*: Upon completion, the Spoofer tool generates a URL with a unique session ID. We ask the workers to submit this URL as a proof of completion. For Mturk, the completion URL must be submitted to Mturk instead of our website, because the terms of service require that all worker-submitted data be stored on Amazon servers first. We set up a cron job to download these URLs and the corresponding Mturker IDs to our centralized database. This allowed us to automate payments on Mturk using the provided payment API. For ProA, we requested workers to submit the worker ID and completion URL to our website. For bulk payments, we uploaded the CSV with worker IDs to the platform. For RapidWorkers, Jobboy, and Minijobz, we asked workers to submit the completion URL to the platform, as there is no easy way to extract a worker ID from these platforms, which is necessary for payments. Further, these platforms do not provide an automatic payment method, and we had to manually approve payment for each successful submission.

(iv) *Centralized data collection*: A centralized database is required to synchronize the results collected from different crowdsourcing platforms in order to screen workers. Because MTurk required us to store data on Amazon servers, and there is a delay before we subsequently copied the data to our centralized database, we might be too late to screen out subsequent submissions from the same worker on MTurk. To avoid this, we used MTurk's qualification criteria: when a given worker accepts our task, we set a qualification criteria on the worker ID that disqualifies them for accepting it again. We reset this flag in new campaigns, so that workers can participate from a different network block, if eligible.

2.5.3. MEASUREMENT CAMPAIGNS

We ran three subsequent campaigns to evaluate the effectiveness in recruiting vantage points across different networks and to measure price elasticity.

Campaign 1: 50 cents per test. The first campaign lasted two weeks on all platforms.

On average, it takes around 4 minutes to download, install, and run the client and to report the completion code to the platform. Offering 50 cents for this time is roughly equivalent to the minimum wage in the Netherlands [57]. Further, Christin *et al.* found that when workers need to install software, raising the compensation to 50 cents caused a dramatic increase in workers [37].

The goals of this experiment were to test our setup and exhaust the pool of workers willing to do the job for 50 cents. We ran this campaign for two weeks, and the completion rate from each platform decreased per day. The last five days brought in only 10% of the results. In total, we received completed submissions from 1,155 workers in 85 countries.

Campaign 2: \$1 per test. When few new workers were selecting the job, we increased compensation to \$1 to assess price elasticity – i.e., whether higher payment attracted additional workers. The higher compensation was set at the start of day 15. Figure 2.2 shows that all platforms had an increase in potential workers and completed tasks. RapidWorkers had an outage after we raised the price, so the increase occurred on day 19, when the platform was back online.

We were able to get 364 new submissions from 63 countries after the price increase. Some of these workers will have seen, but not taken up, the task during campaign 1. Of the 364 new submissions, 63 were from IP addresses from which we saw workers viewing, but not selecting, the task during campaign 1. This undercounts the fraction of users who responded directly to the price increase. Workers can see the title and the compensation level on the task list of the platform, without visiting our page. In other words, a portion of the workers from new IP addresses have also seen the task during campaign 1 and are now responding to the higher price, though we cannot estimate what portion. Combined with the fact that the higher price also brought in more new users than during the last period of campaign 1, we can safely conclude that the price level makes a significant difference in recruiting additional vantage points.

Campaign 3: 10 cent job plus 90 cent bonus. In the final phase, we changed the compensation structure. We ran this campaign as a proof of concept and to resolve the problem of ProA and MTurk worker complaints about compensations (more in section 2.6). We offered 10 cents to workers for just reading our task. We offered an extra “bonus” to workers who were eligible, to be paid after completing the test. The campaign ran for two days on ProA. 1243 workers participated from which 43 received bonuses. On MTurk, we ran the campaign for a week, 12 workers from a total of 211 participants received bonuses. The low ratio of eligible workers (4-6% compared to 38% for campaigns 1 and 2) combined reflects that eligibility rate goes down over time as more address blocks are already covered. That also makes this pricing structure less efficient, since an increasing fraction of spending will be on workers testing their eligibility rather than actual tests. In our analysis we did not use results from this campaign (§2.7,2.8) because it was limited to two platforms (ProA, Amazon) and lasted only for 2 and 7 days respectively.

2.5.4. ETHICAL CONSIDERATIONS

Ethical considerations informed the design of our study. The first was fair compensation. One could argue that since microjob platforms are markets, workers can refuse low

payouts. Still, due to personal convictions, we did not want to go below the approximate equivalent of the Dutch minimum wage, the location of the majority of this dissertation's authors. The second consideration was that the measurement tool should not harm worker machines. The Spoofer tool is from a trusted source, does not slow down the machine or the network, is open-source, and can be easily un-installed. Third, we needed to work within the terms of service of the platforms. We only ran our measurements on platforms which allowed software to be downloaded and executed on user machines. Note that previously, Huz *et al.* was not allowed to run the Spoofer tool on MTurk [39], but the terms have since been relaxed to only prohibit software that can be harmful to users. Finally, for privacy considerations we did not ask workers for personal information, which is also forbidden on many platforms. We saved the minimum data necessary to ensure measurement validity: the worker's IP address and user-agent. We saved the worker's IP address to ensure the IP address recorded by the Spoofer project (§ 5.4.4) corresponded to the IP address used by the worker when selecting our task. Last, to ensure informed consent, we provided clear information about the study.

2.5.5. INTERACTION WITH WORKERS

ProA and MTurk provide an option to allow communication between workers and job posters; we resolved all worker questions and complaints. There were only two questions regarding the legitimacy of the Spoofer tool and data being collected. We sent them the prior paper on Spoofer and an example of the data being collected. One user proceeded to test the tool, while the other one did not respond. The breakdown of the rest of the messages received is summarized in Table 2.3.

The majority of comments were about the screening process. Potential workers wanted to know if they would be allowed to run the test in the future and also showed their interest in conducting our study. A few workers demanded to be paid for reading the ineligibility message.

Some workers requested additional help for installing the software. We improved the description of our task based on the feedback we received. A few workers were still unable to run the application, which was mostly due to an incompatible operating system, old hardware, or firewall preventing the installation. We compensated them for their time and effort.

We also received a few messages where workers, after successfully running Spoofer, were not able to upload the results due to some temporary failure of crowdsourcing platform or our server. After verifying their test, we manually entered the result in our database and paid them for the task.

Finally, there were some workers who requested early acceptance of their submissions. We changed our payment process from one time per week to every three days for successful submissions.

2.5.6. FOLLOW UP TESTS

The task description included instructions on how to un-install the Spoofer tool after submitting the unique result identifier. Still, the Spoofer project received at least one or more follow-up tests from 433 of the 1519 (28.5%) IP addresses that the workers tested.

Classification	MTurk	ProA	Total
Screening	32	118	150
Unclear instruction	5	22	27
Application error	0	32	32
Platform error	4	68	72
Request early payment	9	20	29
Total	50	260	310

Table 2.3: Interaction with workers from the ProA and MTurk platforms. Despite having similar numbers of potential workers (Table 2.4) we had much more interaction with ProA workers, particularly on screening.

2.6. EVALUATION OF DESIGN

Our infrastructure met the requirements outlined in section 2.5.2. However, we did encounter several complications along the way, all related to worker behavior.

First, crowdsourcing platforms are designed for screening human subjects, not vantage points. In other words, the platforms offer screening in terms of subject demographics. We had to implement our own automated screening mechanisms, the result of which then had to be returned to the platform in a platform-specific way for handling task selection and completion. This limitation caused problems on ProA in particular, as the platform allowed participants to mark the task as complete, even if we screened them as not eligible. We ended up with a large number of users who submitted invalid completed tasks. We could have rejected their entries, but cancelling would result in negative scores for these workers. We discussed this issue with ProA staff and ProA cancelled these submissions.

A second issue is that some participants behaved strategically. Some workers on ProA ignored instructions, seemingly consciously, and reported a task as complete, perhaps to see if they would get paid anyway. Due to our requirement that the worker submits a URL with a unique session key that only they can know upon completion of the test, these workers were easily detected. Some workers who were not eligible also sent complaints, arguing that they should be compensated for reading the message that they were not eligible. Interestingly, complaints increased with the higher price of campaign 2. Some workers also complained directly to the platform operator, which led MTurk to suspend one campaign. The automated message cited a violation of their terms of use by collecting Personally Identifiable Information (PII). We think this is because the complaint form on MTurk only offered two options: report a broken task or a privacy violation. In response, campaign 3 tested the compensation model of small payout plus larger bonus, which prevented further complaints.

The final complication is that we could not clearly identify why certain eligible participants did not complete the test. There could be a number of reasons. First, the price of the job might be too low for some workers. Second, they might not like running executables. Third, some workers were using mobile devices for which there is no Spoofer client. Fourth, language barriers may have discouraged some workers. Further research is required on how to improve task uptake.

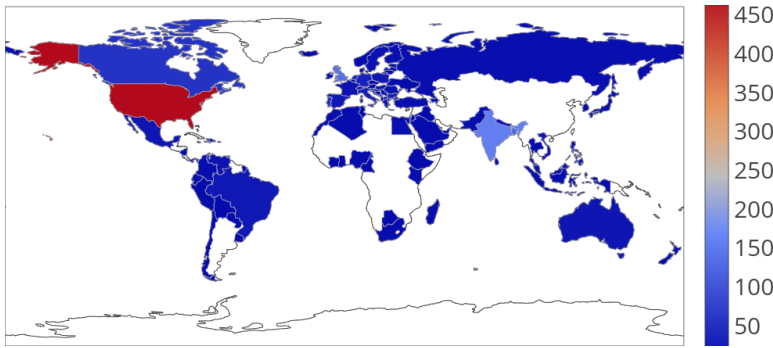

Figure 2.3: Location of workers which completed the task. The majority were located in the US and India.

MTurk		ProA		RW		JB		MJ	
CC	Number	CC	Number	CC	Number	CC	Number	CC	Number
US	4226 (49.7%)	GB	3615 (47.0%)	IN	719 (40.6%)	BD	634 (65.1%)	BD	67 (20.4%)
IN	2925 (34.4%)	US	2238 (29.1%)	BD	495 (28.0%)	US	80 (8.2%)	IN	53 (16.2%)
VE	110 (1.3%)	PT	231 (3.0%)	US	133 (7.5%)	IN	40 (4.1%)	MA	37 (11.3%)
CA	102 (1.2%)	CA	194 (2.5%)	NP	86 (4.9%)	NP	26 (2.7%)	US	29 (8.9%)
GB	78 (0.9%)	IT	177 (2.3%)	LK	29 (1.6%)	EG	12 (1.2%)	DZ	14 (4.3%)
Other	1161 (13.7%)	Other	1231 (16.01%)	Other	307 (17.35%)	Other	182 (18.7%)	Other	127 (38.9%)
Total	8500 (100%)	Total	7686 (100%)	Total	1769 (100%)	Total	974 (100%)	Total	327 (100%)

Table 2.4: Number of potential workers interested in performing the study by country code. We report the top 5. US: United States, IN: India, VE: Venezuela, CA: Canada, GB: Great Britain, PT: Portugal, IT: Italy, BD: Bangladesh, NP: Nepal, LK: Sri Lanka, EG: Egypt, MA: Morocco, DZ: Algeria.

2.7. ANALYSIS OF PLATFORMS

Coverage of platforms. Our website was visited from 1,978 unique ASes in 142 countries. Even though there is a diversity of networks and countries, we observed that 10 ASes of all potential workers account for 90% of the unique IP addresses. This highlights the need for screening of workers to obtain an effective distribution of vantage points across networks.

Table 2.4 shows the distribution of potential workers for the largest five countries per platform, by unique IP address. The majority of potential workers for MTurk were based in US (49.7%) and India (34.4%), whereas 47% and 29.1% of potential workers in ProA were from UK and US, respectively. RapidWorkers, Jobboy, and Minijobz were more dominant in Bangladesh, India and US.

In terms of the added value of each platform, 29 countries were unique to MTurk, five to only ProA, another five to RapidWorkers, two to Minijobz, and one to Jobboy.

Furthermore, the overlap of ASes between platforms from which workers were interested in completing the task was significant. In the case of smaller platforms (Jobboy, Rapidworkers and Minijobz) the overlap was 75%, 77% and 85%, respectively, when compared to all ASes from which workers visited our website. It was 42% for MTurk and 46% for ProA. However, the overlap in terms of unique /24 networks is relatively small, indicating the significance of choosing prefixes that can be tested by adding multiple platforms. Table 2.7 illustrates pairwise crowdsourcing platform intersections as a matrix, with unique /24 networks from which workers were interested in completing the

Platform	Tests	ASes	Countries
MTurk	424 (27.9%)	255	51
ProA	806 (53.1%)	423	69
RW	165 (10.9%)	134	36
JB	92 (6.1%)	85	24
MJ	32 (2.1%)	24	18
Total(Unique)	1519	784	91

Table 2.5: Distribution of workers which completed the Spoofer task. The majority of tasks were completed on the ProA platform.

OS	Crowdsourced	Volunteer
Linux	1.2 % (0.14)	8.1%
MacOS	10.6% (0.52)	20.4%
Windows	88.2% (1.24)	71.1%

Table 2.6: Spoofer client OSes of crowdsourced workers compared to volunteers. The portion of MacOS and Linux users in the crowdsourced population is much less than the volunteer (0.52 and 0.14) population.

task. The rightmost column indicates the percentage and absolute number of /24 networks that the platform has in common with all other platforms combined. In the case of ProA we find only 3% of such /24 networks, while it was only 6% for MTurk when compared to all other platforms.

Fluctuations over time. Figure 2.2 shows the number of new potential workers per day for MTurk stabilized after the initial peak. The number of potential workers from RapidWorkers fluctuates over different days of the week. The number of potential workers increases for Jobboy over time while the pool decreases for ProA.

Completion per platform. Since our design accepts one observation per address block, only 38% of potential workers were eligible to complete the task. Figure 2.3 shows the countries of the workers who completed the task and ran the Spoofer tool; while we have submissions from 91 countries, the majority of submissions are from US and India.

Table 2.5 shows the tests contributed by each platform from respective ASes and countries. The three smaller platforms (RapidWorkers, Minijobz, and Jobboy) added results from 7 countries which were absent from the results from MTurk and ProA. MTurk and ProA added measurements from 12 and 14 countries absent from other platforms, respectively.

Table 2.6 shows the OS distribution of participants of the study along with overall users of spoofer tool. Crowdsourcing platform users seem to be closer to global OS market share **statcounter** when compared to volunteer spoofer users.

2.8. CONTRIBUTIONS TO SPOOFER

What is the added value of the crowdsourcing marketplaces compared to the volunteer pool of Spoofer? Within the study period, we collected data from 1,519 vantage points.

	MJ	MTurk	RW	ProA	JB	TOT
MJ		12%,38	24%,74	1%,6	16%,52	34%,105
MTurk	0%,38		3%,275	3%,228	0%,43	6%,518
RW	5%,74	20%,275		3%,46	14%,198	36%,489
ProA	0%,6	3%,228	0%,46		0%,15	3%,259
JB	8%,52	7%,43	33%,198	2%,15		39%,231

Table 2.7: Pairwise overlap of /24 networks of potential workers of crowdsourcing platforms.

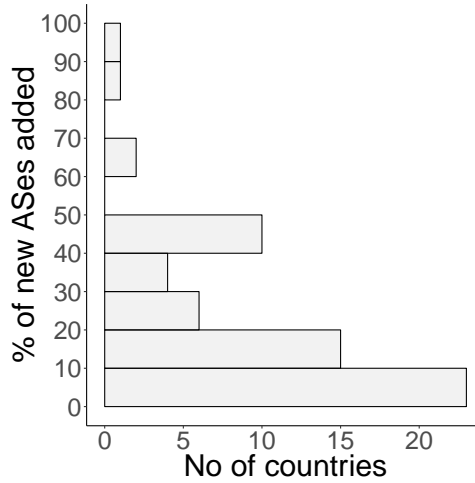

Figure 2.4: Percentage of new ASes per country added in Spoofer.

While we only allowed eligible workers to complete the task, we did not screen out workers from running the tool from networks that were already present in the volunteer-based Spoofer dataset. The reason is that we wanted to assess the general distribution of workers across networks and how they compared to the volunteer pool that the project has recruited over many years. During our campaigns, on average 12% of daily Spoofer tests came from crowdsourcing platforms. We found 6% overlap in /24 subnets between crowdsourced and volunteer tests.

Table 2.8 compares one year of Spoofer volunteer measurements with our 6 weeks of data collection using crowdsourcing platforms. The crowdsourced tests added one country that was missing from a year of Spoofer data: Ivory Coast. One network was found to allow spoofing. For all other countries, the crowdsourced tests increases the coverage of ASes. Figure 2.4 shows the percentage of additional vantage points we gathered. For instance, in the US, one year of Spoofer measurements collected data from 778 unique ASes, while our much shorter study added tests from 97 additional ASes, 48 of which allowed IP spoofing. Importantly, crowdsourced tests had minimal overlap with the volunteer tests at the level of /24 blocks: only 49 out of 1519 /24 overlapped.

CAIDA notifies operators of networks that do not filter packets with spoofed source addresses. One of the 69 affected networks discovered by our crowdsourcing platform has remediated.

	Mar (2016,-2017)		(25 Mar-4 May 2017)		Unique	
	Spoofing Tool		CS Platform		CS Platform	
	Total	Spoofable	Total	Spoofable	Total	Spoofable
Countries	143	-	91	-	1	-
ASes	2,237	294	784	66	342	48
/24 blocks	13,081	583	1519	69	1470	69

Table 2.8: Comparison of spoofing vantage points with crowdsourcing platforms.

2.9. CONCLUSION

We have presented the first systematic study to deploy multiple crowdsourcing marketplaces to acquire vantage points for Internet measurements. We designed and tested an infrastructure that was able to control the distribution of vantage points. We provide the code of our infrastructure [28].

Using CAIDA’s Spoofing tool as a case study, we found that with a limited budget of 2,000 euro, we were able to acquire vantage points in 91 countries and 784 ASNs, 342 of which did not have a vantage point in the 12 months before our study. The measurements are, in spoofability, qualitatively similar to volunteer-based measurements and they do not introduce additional bias. We find evidence that measurement tasks are quite price sensitive and that higher compensation is likely to recruit even more vantage points.

Crowdsourcing marketplaces provide a realistic and valuable option for recruiting vantage points for Internet measurements. Whether it is the right option for a specific project, depends on several considerations. First, commercially crowdsourced vantage points are relatively costly, especially for longer-term studies. Prolific and Amazon do allow giving bonuses based on worker ID’s. If longitudinal measurements are required, workers can be compensated with smaller bonuses per week or month to keep the tool running. Second, if a study seeks a specific set of vantage points outside of its current coverage, then accurately screening workers can make crowdsourcing quite cost effective – almost offering a ‘no cure, no pay’ approach. Third, one could also see crowdsourcing as a way to acquire ground truth data for researchers to validate conclusions based on other, cheaper network measurements. Fourth, and final, there seems to be a potential to retain some of the workers as volunteers. Within our study, we found that over one in four workers kept the tool running and submitted unpaid follow-up tests. A project can motivate workers to contribute. For example, the GalaxyZoo project had great success, where 150,000 people participated in a year because they enjoyed the task and they wanted to help advance astronomy.

While crowdsourcing vantage points cost money, important policy efforts, such as the adoption of SAV, should not be wholly dependent on volunteers. Being able to compensate participants in an easy and scalable way is a valuable option to improve our visibility into issues in security, privacy, censorship, and other areas, and designers of measurement systems should consider including built-in payment mechanisms.

3

USING LOOPS OBSERVED IN TRACEROUTE TO INFER ABILITY TO SPOOF

Despite source IP address spoofing being a known vulnerability for at least 25 years, and despite many efforts to shed light on the problem, spoofing remains a popular attack method for redirection, amplification, and anonymity. To defeat these attacks requires operators to ensure their networks filter packets with spoofed source IP addresses, known as source address validation (SAV), best deployed at the edge of the network where traffic originates. In this dissertation, we present a new method using routing loops appearing in traceroute data to infer inadequate SAV at the transit provider edge, where a provider does not filter traffic that should not have come from the customer. Our method does not require a vantage point within the customer network. We present and validate an algorithm that identifies at Internet scale which loops imply a lack of ingress filtering by providers. We found 703 provider ASes that do not implement ingress filtering on at least one of their links for 1,780 customer ASes. Most of these observations are unique compared to the existing methods of the Spoofer and Open Resolver projects. By increasing the visibility of the networks that allow spoofing, we aim to strengthen the incentives for the adoption of SAV.

3.1. INTRODUCTION

Despite source IP address spoofing being a known vulnerability for at least 25 years [58], and despite many efforts to shed light on the problem (e.g. [59]–[61]), spoofing remains a viable attack method for redirection, amplification, and anonymity, as evidenced in February 2014 during a 400 Gbps DDoS attack against Cloudflare [62]. That particular attack used an amplification vector in some implementations of NTP [62]; a previous attack against Spamhaus [26] in March 2013 achieved 300+ Gbps using an amplification vector in DNS. While some application-layer patches can mitigate these attacks [63], attackers continuously search for new vectors.

Defeating amplification attacks, and other threats based on IP spoofing, requires providers to filter incoming packets with spoofed source IP addresses [8] – in other words, to implement BCP 38, a Best Current Practice also known as source address validation (SAV). SAV suffers from misaligned incentives: a network that adopts SAV incurs the cost of deployment, while the security benefits diffuse to all other networks. That being said, SAV is a widely supported norm in the community. Increasing the visibility of which networks have or have not adopted SAV reduces the incentive problem by leveraging reputation effects and the pressure of other providers and stakeholders. These factors put a premium on our ability to measure SAV adoption.

In this dissertation, we report on the efficacy of a new measurement technique that is based on an idea of Jared Mauch. It allows an external observer to use traceroute to infer the absence of filtering by a provider AS at a provider-customer interconnect. This study makes the following five contributions: (1) We show that it is generally feasible for providers to deploy static ingress ACLs, as their customers rarely change address space. (2) We describe a scalable algorithm for accurately inferring the absence of ingress filtering from specific patterns in traceroute data. (3) We validate the algorithm's correctness using ground truth from 7 network operators. (4) We demonstrate the utility of the algorithm by analyzing Internet-scale inferences we made. (5) We build a public website showing the provider-customer edges that we inferred to imply the absence of filtering, combined with actionable data that operators can use to deploy filtering.

3.2. BACKGROUND ON INGRESS FILTERING

The canonical documents describing the use of ingress filtering methods for SAV are RFCs 2827 [8] and 3704 [64], known in the network operations and research communities as BCPs 38 and 84. BCP 38 describes the basic idea: the source address of packets should be checked at the periphery of the Internet against a set of permitted addresses. For an access network, this check could be at the point of interconnection with a single customer; for an enterprise, this could be on their edge routers to their neighbors; and for a transit provider, this could be on the provider-edge router where a customer connects. For single-homed customers, a transit provider can discard packets that have a source address outside the set of prefixes the customer announces to the transit provider, using Strict or Feasible Reverse Path Forwarding (RPF). A router using Strict RPF will drop a packet if it arrived on a different interface than the router would choose when forwarding a packet to the packet's source address; a router using Feasible RPF will consider all paths it could use to reach the source address, not just the best path.

BCP 84 discusses challenges in deploying ingress filtering on multi-homed networks. Both Strict and Feasible RPF are not always feasible if a customer is multi-homed and does not announce all of its prefixes to each neighbor router, as it might do for traffic engineering purposes. Instead, an operator might define a set of prefixes covering source addresses in packets the router will forward, known as an Ingress Access List, or Ingress ACL. BCP 84 states that while ingress ACLs require manual maintenance if a neighbor acquires additional address space, they are “the most bulletproof solution when done properly”, and the “best fit ... when the configuration is not too dynamic, .. if the number of used prefixes is low.”

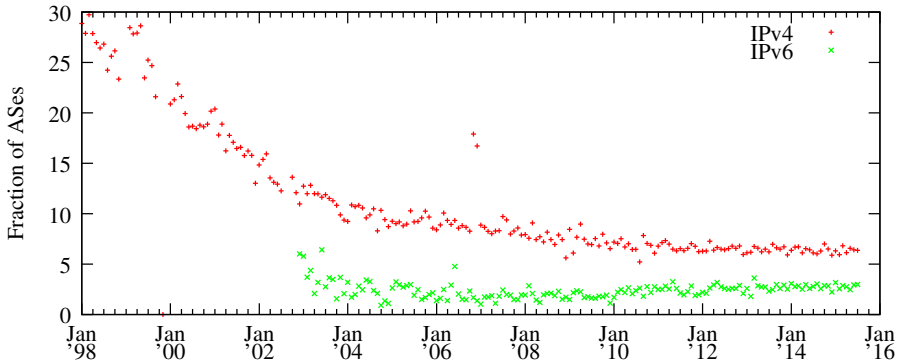

Figure 3.1: Fraction of ASes whose prefix announcements changed month-to-month.

3.3. RELATED WORK

Testing a network's SAV compliance requires a measurement vantage point inside (or adjacent to) the network, because the origin network of arbitrary spoofed packets cannot be determined [64]. The approach of the Spoofer project [59] is to allow volunteers to test their network's SAV compliance with a custom client-server system, where the client sends spoofed packets in coordination with the server, and the server infers that the client can spoof if the server receives these spoofed packets. However, the Spoofer project requires volunteer support to run the client to obtain a view from a given network. In May 2016, CAIDA released an updated client [65] that operates in the background, automatically testing attached networks once per week, and whenever the system attaches to a network it has not tested in the previous week. The number of prefixes tested per month has increased from ≈ 400 in May 2016 to ≈ 6000 in December 2016 [65].

Jared Mauch deployed the first technique to infer if a network had inadequate SAV without requiring a custom client-server system. As a product of the Open Resolver Project [66], he observed DNS resolvers embedded in home routers forwarding DNS queries from his system with IP_X to other resolvers, without rewriting the source IP address of the packet. These other resolvers returned the subsequent answer directly to IP_X , rather than to the DNS resolver in the home router as they should have.

We emphasize that these methods are complementary, and that no one technique is able to test deployment of SAV for all networks.

3.4. MOTIVATION OF INGRESS ACLS

As described in §3.2, the best place to deploy filtering is at the edge. However, not all edge networks have the technical ability or motivation to filter their own traffic. A transit provider, however, is often managed by skilled network operators who may already deploy defenses to prevent their customers from announcing inappropriate routes. The provider-customer interconnect for an edge network represents the other straightforward place to deploy ingress filtering.

Figure 3.1 quantifies the dynamism of address space announced by stub ASes over time. Using BGP data collected by Routeviews and RIPE RIS with the method described in §3.5.1, we aggregated the prefixes each stub AS originated in BGP into the minimum

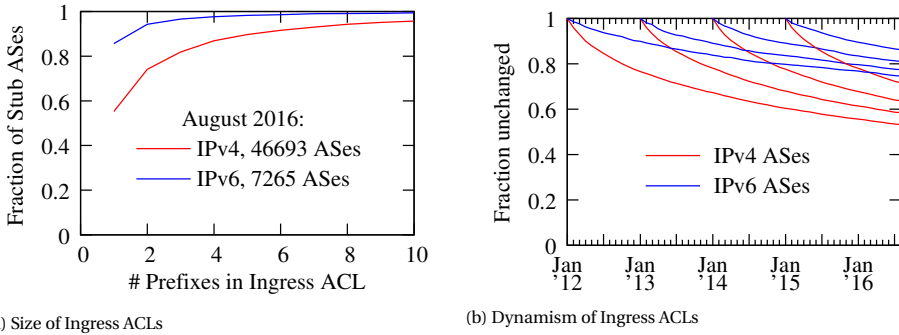

Figure 3.2: Size and dynamism of ACLs to filter traffic from stub ASes.

prefix set, and examined month-to-month changes in the set. Perhaps a consequence of IPv4 address exhaustion, we see a trend toward stable announcement patterns. This trend may improve the practicality of static ingress ACLs: in May 2000, $\approx 15\%$ of stub ASes would have required deployment of a different IPv4 ingress ACL month-to-month, but in 2015, less than 5% of ASes would have required the same.

As BCP 84 states that because ingress ACLs require manual maintenance they are best suited “when the configuration is not too dynamic” and “if the number of used prefixes is low”, figure 3.2 examines the size and dynamism of ingress ACLs required for stub ASes in August 2016. Figure 3.2a shows that 88.9% of stub ASes would require an IPv4 ACL of no more than 4 prefixes, and 85.6% of stub ASes would require an IPv6 ACL of a single prefix. Figure 3.2b shows the dynamism of these ACLs over time, based on ACLs that could have been defined for all stub ASes in January 2012, 2013, 2014, and 2015. For stub ASes for these times, at least 77.4% of IPv4 ACLs would not have had to change over the course of one year; for those defined in January 2012, 54.4% of the inferred ACLs would not have required change even up to August 2016. Further, required IPv6 ACLs would be even less dynamic: more than 74.6% of IPv6 ACLs would not have needed to change over the course of 4.5 years until August 2016. We believe the observed number of prefixes and dynamism over time imply that ingress ACLs are feasible in the modern Internet.

3.5. INFERRING ABSENCE OF FILTERING USING TRACEROUTE

The key idea of our approach is that traceroute can show absence of ingress filtering by providers of stub ASes when a traceroute path reaches the stub AS and then exits out of the stub, as the traceroute packets contain a source address belonging to the vantage point (VP) launching the traceroute. If the provider’s border router is performing SAV, it should filter the traceroute packet when it arrives from the stub AS, as the packet has a source address not belonging to the stub AS. If the provider’s router does not perform SAV, it will forward the packet, and the traceroute will show an apparent IP-level forwarding loop as the provider’s router returns subsequent packets to the stub AS.

Xia *et al.* found that 50% of persistent loops were caused by a border router missing a “pull-up route” covering address space not internally routed by the customer [67]. However, a forwarding loop does not imply absence of SAV at the edge: a loop resulting

from a transient misconfiguration or routing update can occur anywhere in the network. The key challenge in this work is inferring the provider-customer boundary in traceroute [68], [69]. In this chapter, we superimpose millions of traceroutes towards random IP addresses in /24 prefixes to build a topology graph, and use a small set of heuristics to infer provider-customer edges for stub ASes in the graph. §3.5.1 describes the Internet topology datasets that we used, and §3.5.3 describes the algorithm we used to filter the loops that imply the absence of ingress filtering by the provider – in other words, the lack of compliance with BCP 38.

3.5.1. INPUT DATA

CAIDA IPv4 routed /24 topology datasets: We used CAIDA's ongoing traceroute measurements towards every routed /24 prefix in the Internet. CAIDA's probing of all routed /24s is especially useful here, as the goal is to find unrouted space that can result in a forwarding loop. CAIDA's traceroute data is collected with scamper [70] using Paris traceroute which avoids spurious loops by keeping the ICMP checksum value the same for any given traceroute [71]. As of August 2016, CAIDA probes every routed /24 using 138 Vantage Points (VPs) organized into three teams; each team probes the address space independently. Each team takes roughly 1.5 days to probe every routed /24.

CAIDA IPv4 AS relationships: We used CAIDA's ongoing BGP-based AS relationship inferences [72] to identify customer-provider interconnections in traceroute paths. The relationship files were inferred by CAIDA using public BGP data collected by Routeviews and RIPE RIS, using RIB files recorded on the 1-5 of each month. We also used the same BGP data to identify the origin AS announcing each prefix measured with traceroute.

CAIDA Sibling Inferences: We used CAIDA's ongoing WHOIS-based AS-to-organization inference file [73] to identify ASes that belong to the same underlying organization (are siblings). The sibling files were inferred by CAIDA using textual analysis on WHOIS databases obtained from Regional Internet Registries (RIRs) at 3-month intervals. We used sibling inferences to avoid mis-classifying a loop that occurs within a single organization using multiple ASes as one that occurs between distinct provider and customer ASes.

3.5.2. CONSTRUCTION OF TOPOLOGY

Our first goal is to correctly identify the provider-customer boundaries towards stub ASes with high precision. Because the customer usually uses address space provided by the provider to number their interface on their router involved in the interconnection, the customer-edge router usually appears in traceroute using an IP address routed by the provider. Therefore, one of our goals is to accurately identify customer routers using provider address space without incorrectly inferring that a provider's backbone router belongs to a customer.

We assemble all traceroutes collected for a single cycle by a single team that do not contain loops, and label each interface with (1) the origin AS of the longest matching prefix for the interface address, and (2) the set of destination ASes the interface address is in the path towards. If an address is in the path towards multiple ASes, the address could not be configured on a customer router of a stub AS.

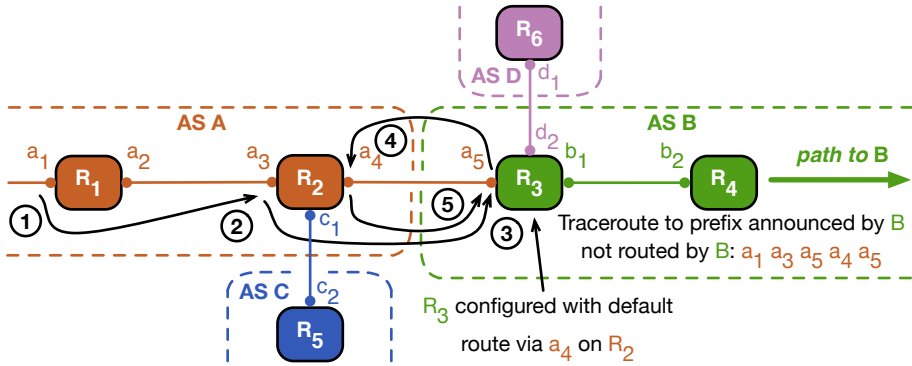

Figure 3.3: A simple loop between AS A and its customer B implying absence of filtering by A at R_2 . R_2 should discard packet 4 because it arrives with a source address outside of B's network, rather than send it back to B (5).

3.5.3. ALGORITHM TO INFER ABSENCE OF INGRESS FILTERING FROM LOOPS

Our algorithm considers two different ways a traceroute path may enter a stub AS and exit through a provider AS: (1) a simple point-to-point loop between a single provider-edge router and a single customer-edge router, (2) a loop from a customer-edge router that exits using a different provider.

Simple point-to-point loops: Figure 3.3 illustrates the first case, where R_3 is a customer-edge router belonging to AS B configured with a default route via R_2 . If the operator of B announces address space in BGP but does not have an internal route for a portion of that address space, and does not have a “pull-up route” covering the unused portion on R_3 , then R_3 forwards the packet back to R_2 using the default route [67]. R_2 will then forward the packet back to R_3 , the loop sequence will likely be a_5 (customer-edge router), a_4 (provider-edge router), and a_5 (customer-edge router), with a_4 and a_5 assigned from the same IPv4 /30 or /31 prefix the routers use to form the point-to-point link. Therefore, our criteria are: (1) that the addresses in the loop are assigned from a single /30 or /31 prefix, (2) that the AS originating the longest matching prefix is an inferred provider of the stub AS and not a sibling of the stub AS, (3) that the assumed customer router only appears in traceroute paths towards the stub AS, (4) that there is at least one other address originated by the provider in the traceroute path towards the stub. Criteria #3 avoids incorrectly inferring a provider-operated router as a customer-edge router when a loop occurs before the stub AS (e.g. $a_1 a_3 a_2 a_3$) as a_3 appears in traceroute paths towards both B and C. Criteria #4 avoids incorrectly inferring which router in a traceroute path is the customer-edge router when the customer-edge router is multi-homed and the traceroute path enters via a second provider AS D (e.g., $d_2 a_4 a_5 a_4$).

Two-provider loops: Figure 3.4 illustrates the second case, where R_3 and R_4 are customer-edge routers belonging to AS B, with default routes configured on R_3 and R_4 . The underlying routing configuration issues are the same as a point-to-point loop, except the default route is via a different AS than the AS the traceroute entered the network. Figure 3.4 shows the traceroute visiting two routers operated by AS B; however, it is possible that the traceroute will never contain an IP address mapped to B, depending

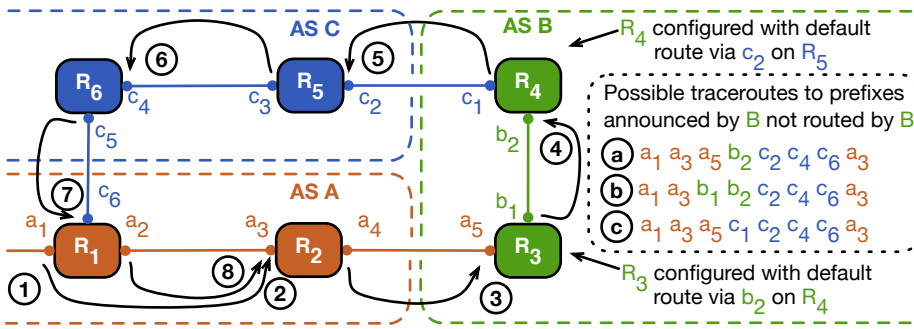

Figure 3.4: A two-provider loop between ASes A and C and their customer B implying absence of filtering by C at R_5 . R_5 should discard packet 5 because it arrives with a source address outside of B, rather than forward the packet to R_6 .

on how many routers in B the traceroute visits, and how the routers respond to traceroute probes. Therefore, our criteria are: (1) that the assumed customer router where the traceroute exits appears only in paths towards the stub AS, (2) that both the ingress and egress AS in the traceroute path are inferred providers of the stub AS and not a sibling of the stub AS, (3) that there is no unresponsive traceroute hop in the traceroute path where a customer router could be located, (4) that at least two consecutive IP addresses mapped to the same egress AS appear in the loop. Criteria #2 does not require different provider ASes: if the stub AS is multi-homed to the same provider with different routers, our method will still infer an absence of filtering. Criteria #3 ensures that we do not misinfer where the customer router is located in the path, and thus incorrectly infer the AS that has not deployed ingress filtering. Finally, criteria #4 reduces the chance that a loop inside the customer network is mis-classified as crossing into a provider network if the customer router responds with a third-party IP address.

3.5.4. FINDING NEEDLES IN A HAYSTACK

As discussed in §3.5.1, CAIDA uses three teams of Ark VPs to probe a random address in every routed /24 prefix. In this section, we report on the characteristics of cycle 4947 conducted by team 3. The characteristics of data conducted by other teams and for other cycles is quantitatively similar. In total, cycle 4947 contains 10,711,132 traceroutes, and 163,916 (1.5%) of these contain a loop. 105,685 (64.5%) of the traceroutes with loops were not towards a stub network.

Of the remaining 58,231 traceroutes with loops towards stub ASes, we inferred 31,023 (53.3%) had a loop within the stub network, i.e. the addresses in the loop were announced in BGP by the stub, or involved the customer-edge router. A further 11,352 traceroutes (19.5%) contained a loop with an unresponsive IP address, and 1,373 traceroutes (2.4%) contained an unrouted IP address that prevented us from inferring if the loop occurred at a provider-customer interconnect. 610 traceroutes (1.0%) had a loop that we disqualified as occurring at a customer-provider boundary, as the loop occurred at a router that also appeared in paths towards multiple destination ASes, and 494 traceroutes (0.8%) contained an IP address that could have been a third party address on a customer router, rather than a router operated by a provider. In total, only 2,530 traceroutes

with loops (4.3%) contained simple point-to-point loops, and only 93 (0.2%) contained more complex two-provider loops.

3.5.5. PERSISTENCE OF LOOPS

Given that we are looking for needles in haystacks, how reliably can we find them? Ideally, we would be able to consistently reproduce the loops that imply absence of ingress filtering, and discard observations caused by transient events. Unfortunately, there is currently no straightforward way of doing so.

The data we used was collected by CAIDA using traceroutes conducted by a distributed set of VPs towards a random IP address in each routed /24 prefix. This approach adds efficiency by reducing the number of probes, at the cost of potentially missing loops that occur for smaller prefixes. It also means that when such a loop is in fact discovered, the next probe might miss it again by selecting a random address outside the smaller prefix. In other words, the traceroute data itself does not tell us much about the persistence of loops.

To better understand the impact of random address selection and the persistence of loops, we collected traceroutes towards the same addresses that revealed the loops. We first applied the algorithm outlined in §3.5.3 to the traceroute data for August 2016 and found 2,500 unique loops between 703 provider and 1,780 customer ASes. In October 2016, we collected traceroutes towards the same IP addresses that revealed the loops, using two different vantage points. We were able to reproduce 1,240 of the loops between 461 provider and 1,026 customer ASes. Next, we repeated this procedure for over a year of traceroute data: August 2015-August 2016. We found 7,784 unique loops between 1,286 provider and 3,993 customer ASes. In October 2016, we were able to reproduce 1,542 unique loops between 505 provider and 1,176 customer ASes. In other words, the additional data identified 342 loops that persisted.

A significant portion of all loops could not be reproduced and the longer the time lag, the higher the odds of failure, for four reasons. First, the loop might have been transient, i.e., it only occurred during routing protocol convergence [74] or temporary misconfiguration [67]. Second, it might depend on the vantage point of the probe, e.g., because of multi-homed routers. Third, the provider might have fixed the routing issue that caused the loop. Fourth, and most relevant, the provider has implemented ingress filtering.

Future work is needed to untangle these causes. We know from our validation effort (§3.6) that even loops that appeared only once can correctly signal absence of ingress filtering. Some of the loops that we could not reproduce had already been validated by the provider as true positives. In the remainder of the chapter, we will work with the full set of loops as identified by our algorithm.

3.6. VALIDATION BY NETWORK PROVIDERS

In order to validate our results and obtain ground truth, we contacted providers in two rounds: September 2015 and September 2016. We got feedback from one hosting provider, four ISPs, two national research and education networks, and two Tier 1 networks. We contacted some providers only in one round, some in both, depending on whether we inferred absence of ingress filtering for links involving their network at both times, and

our ability to reach the right specialist in the organization. We gave all providers a formal assurance that their names would not be included in the study.

Feedback from the providers during the first round resulted in improvements in our methodology. We applied the final methodology to both the August 2015 and August 2016 data. We then compared the final results to the feedback that we received from the providers in both rounds. We talked to 6 providers in round 1 and 7 in round 2, and 4 providers participated in both rounds.

We defined a result as a true positive if we identified a provider-to-customer link where the provider does not perform ingress filtering and an operator at the provider confirms this. That is, we correctly inferred the absence of SAV as well as the boundary between provider and customer. A false positive occurred when we either incorrectly detected the boundary or the provider is actually performing SAV at the boundary. Our methodology correctly identified the absence of ingress filtering on the provider boundary in 95 out of 97 IP links between provider and customer ASes (45 of 47 links in round 1, and 50 of 50 links in round 2).

The two false positives had different causes. One of them occurred because of route aggregation. Providers perform route aggregation by consolidating multiple routes in a single, more general route. This practice can lead to problems with our border router detection. Imagine this scenario: a provider is assigned a /16 prefix X by the Regional Internet Registry (RIR). The provider allocates a /24 subnet Y from prefix X to a customer, and the customer assigns addresses from Y to its routers. The customer also has its own prefix Z allocated by an RIR. If the provider aggregates Y into a single /16 advertisement for X, we would infer that customer routers with addresses in Y belong to the provider AS. Our methodology would then categorize a loop between provider prefix X and customer prefix Z as signaling the absence of SAV, when the loop was actually within the customer network.

For the second false positive, the provider informed us that the traceroute data suggested that the loop had occurred inside their network rather than on the boundary. However, they could not reproduce it anymore and blamed it on a transient event. Note that in the second round, we found 2 loops for the same provider and they were both true positives.

One additional piece of feedback that we received was that some of the providers, while confirming the validity of our inference that they were not doing ingress filtering on their boundary, objected to the implication that they *should* be filtering. They saw their services as offering transit and contracted them as such, which meant no filtering on the provider's side. In the view of these providers, the downstream customer AS should perform SAV at their border router. The customer ASes were business entities like ISPs, hosting providers or large enterprises. Evaluating whether this interpretation of BCP 38 [8] is merited falls outside the scope of this dissertation and is for the community to address. For this dissertation, the key point is that the proposed method performed accurately.

3.7. RESULTS

We first summarize the results in terms of the number of networks that do not implement SAV. We then compare our method to the two alternatives: the Spoofer and the

Open Resolver projects. Like those methods, our approach only observes a subset of the networks without SAV. In the absence of loops, we cannot tell anything about the presence of ingress filtering.

Using one month of CAIDA's traceroute data from August 2016, our approach identified 2,500 unique loops involving 703 provider ASes as lacking SAV on one or more of their customer-facing links and 1,780 customer ASes. These represent approximately 1.3% and 3.2% of all advertised ASes, respectively. Moreover, when compared to all advertised stub ASes and their providers [72], we found 9.0% of provider ASes without ingress filtering involving 3.8% of all stub ASes.

As discussed in §3.6, some providers argued that customer ASes should be responsible for SAV within their networks or at their borders. However, we found that about 63% of the involved customer ASes advertise /20 or smaller prefix lengths. It is unlikely that such small entities have the resources and incentives to implement SAV in their networks. On the other hand, such small prefixes should allow the providers to implement static ACLs.

We now compare our results to the data from the Spoofer and Open Resolver projects (see §3.3 for details). Our method only detects the lack of ingress filtering for provider networks, which means that their customer ASes might be able to spoof. We compared those customer ASes with the Spoofer data from February to August 2016 [65]. Of 54 overlapping ASes, 38 of the Spoofer tests were only conducted from behind a Network Address Translation (NAT) device that likely prevented spoofing. Of the systems not behind a NAT, 10 of the 16 stub ASes allowed spoofing, i.e., more than half of these ASes had not deployed SAV, suggesting the provider's expectation for their customers to deploy filtering is not being met, and supporting the case for transit providers to filter their customers. This means that the connected provider ASes do not implement ingress filtering, which is consistent with our results. Packets with spoofed source addresses from Spoofer tests in the 6 remaining customer ASes were not received, suggesting that filtering took place in the customer AS. The overlap between both methods contains only a small sample, but it does indicate that the majority of the overlapping customer networks were not doing SAV – a finding that reinforces the point that providers should not expect their customer ASes to be willing and able to do SAV, even if they are not that small.

Kührer *et al.* used the Open Resolver data in 2014 by to identify 2,692 unique ASes from within which spoofing was possible [12]. Following the same approach, we analyzed the August 2016 data from the Open Resolver project, generously provided to us by Jared Mauch, and found a total of 3,015 unique ASes that were able to spoof. We compared these to the customer ASes that our method identified as allowing spoofing – i.e., those connected to the providers which lack ingress filtering. We found only a modest overlap: 244 ASes.

In sum: these findings show that our method can add unique data points to both existing methods, and improve visibility of networks lacking SAV. In terms of the volume of observations, it resides between Spoofer and Open Resolver. The three methods are complementary and provide views into the problem, contributing to improved overall visibility of SAV adoption.

3.8. CONCLUSION

In this chapter we implemented and validated an algorithm that uses traceroute data to infer a lack of SAV between a stub and provider network. We inferred 703 providers that do not implement ingress filtering on at least one of their links facing 1,780 customer ASes. We also built a public website showing the provider-customer edges that we inferred as lacking ingress filtering: <https://spoofer.caida.org/>. Providers can use the data to deploy filtering, which would not only stop attackers from sending packets with spoofed addresses from the customer's network, but also block attempts to attack the provider-customer link by sending packets to addresses that enter the forwarding loop [67].

To improve the reliability of the method, future work is needed on border detection and on untangling the different factors that prevent loops from being reproduced, to separate the implementation of ingress filtering from the other causes. A completely different direction for future work is to experimentally test the strength of reputation effects among providers and network operators. The networks that allow spoofing could be made public in varying ways, to see which mechanism best incentivizes providers into taking action.

For the community of network operators, the results support efforts such as the Routing Resilience Manifesto [75] and other community initiatives to improve network security. By complementing the Spoofer and Open Resolver data, our method increases visibility into the adoption of SAV. Public visibility of spoofing-enabled networks is a critical step in incentivizing providers to deploy ingress filtering in their networks. The dataset is also useful for the national CERTs who want to push BCP 38 compliance in their countries. The problems caused by IP spoofing have been recognized for years [58], and the task to reduce its role in attacks is becoming increasingly urgent.

4

SAVING THE INTERNET: EXPLAINING THE ADOPTION OF SOURCE ADDRESS VALIDATION BY INTERNET SERVICE PROVIDERS

Spoofed Internet traffic is used by miscreants, most visibly for amplification DDoS attacks. Source Address Validation (SAV) by network operators is a security best practice to stop spoofed traffic from leaving their network. Its adoption is hampered by incentive misalignment: the cost is borne by the operator, while the benefits go to the rest of the Internet. This chapter estimates the impact of various incentives on SAV adoption. It is the first study that combines two independent datasets with observations for the absence of SAV and that statistically models its causal drivers. We map these observations to a population of 334 ISPs that control the bulk of the market share for Internet access in 61 countries. We find evidence for the absence of SAV for certain prefixes of 250 ISPs. Next, we try to explain what portion of an ISP's address space allows spoofing from four causal factors – network complexity, security effort, ISP characteristics and institutional environment – as measured via 12 indicators. We find evidence larger ISPs have a higher proportion of non-compliant IP space. ISP security efforts, most notably the adoption of RPKI and the number of amplifiers, are positively related to SAV. Subscription prices and ISP revenue have no significant impact. Finally, we find that ISPs in countries with more developed ICT infrastructures are also more likely to have a wider adoption of SAV. We reflect on these findings and discuss potential ways forward for SAV

4.1. INTRODUCTION

Spoofed Internet traffic—crudely put, IP packets with forged source IP addresses—has been a persistent security problem for decades. Used in a variety of attacker practices, its

most visible consequence has been the problem of Distributed Denial-of-Service (DDoS) attacks based on amplification. This has led Internet Hall of Fame technologist Paul Vixie to conclude: ‘Nowhere in the basic architecture of the Internet is there a more hideous flaw than in the lack of enforcement of simple SAV (source-address validation) by most gateways’ [7].

The way attackers abuse spoofed traffic in amplification DDoS attacks is by sending queries with a forged source IP to a multitude of servers running amplification protocols, such as open DNS resolvers or Memcached servers. The spoofed packets set the victim’s IP address as the source IP address. As a result, the victim receives a large number of server responses that congest its network or system, making it unavailable for incoming and outgoing traffic. This attack is hard to mitigate by the victim’s network. However, if network operators would verify the source address of the packets originating from their own networks, and drop illegitimate packets, it would curtail the ability of the attacker to successfully send spoof packets in the first place. This practice is commonly known as Source Address Validation (SAV), most notably documented in BCP38. The idea of BCP38 is that a network operator checks the source address of every outgoing packet before it leaves its network against a set of allocated addresses. They should drop the packet if the source address is outside the range of IPs assigned to them.

Even though for years now there has been a push for the implementation of BCP38 across operators, we still observe 22% of all observed ASes being non-compliant in the Spoofer dataset [9]. The adoption of BCP38 suffers from a clear misalignment of incentives: the cost is borne by the network that adopts it, while the benefits go to the rest of the Internet. Non-compliance can therefore be seen as causing a negative externality. Seen in this light, it is actually remarkable that a sizeable portion of all networks *are* in fact compliant.

This chapter presents the first study that measures the current state of SAV using two independent measurement techniques and that identifies causal factors for non-compliance. We use the terms compliance and adoption interchangeably. The underlying causal mechanisms are likely to be different, if not outright incomparable, across the enormous heterogeneity of operators behind the more than 60,000 Autonomous Systems (AS) that currently make up the Internet. For this reason, we focus our analysis on a critical population with a more homogeneous composition: Internet Service Providers (ISPs), here defined as the businesses that offer Internet access to end users. Given that these networks offer access to billions of users, they are also a critical control point for adopting SAV and block potential miscreants from IP spoofing. What is also important here is that the BCP38 unambiguously applies to such so-called ‘stub’ networks that ISPs operate, as opposed to the more complicated case of transit networks [76]. The underlying problem for transit providers is that they might have customers that are not announcing routes to them, due to traffic engineering. If the non-stub network drops these IP packets, they are losing legitimate traffic destined towards its downstream customers. BCP84 introduced several improvements to BCP38 and proposed filtering using static Access Control Lists (ACLs) or Reverse Path Forwarding (RPF) [77]. It also suggests that in the case of asymmetric routing, network operators should only drop packets with “martian addresses” or currently not routed IP addresses. This will limit the problem, but the routable IP space can still be spoofed. Since our dataset only deals with ISPs,

there are very few transit networks. Some of these transit ASes can also be siblings of stub ASes, belonging to the same organization where routing information can be shared.

The research question that we set out to answer is: What factors explain the extent in which Internet Service Providers are not compliant with BCP38? We will be looking at factors like network complexity, security effort and the institutional environment of the country where the ISP is located.

After we discuss the related work, we will unpack various economic factors that shape the incentives for compliance. We then explain how BCP38 non-compliance was measured across our study population of 250 ISPs in 61 countries. We collect various indicators for our theoretical framework and then estimate an OLS regression model to explain non-compliance. Finally, we discuss our findings in light of current industry proposals on how to increase the adoption of BCP38.

4.2. BACKGROUND AND LITERATURE REVIEW

4.2.1. SAV – SOURCE ADDRESS VALIDATION

Best Current Practice 38, also referred to as Source Address Validation (SAV), was proposed in RFC 2827 almost 20 years ago to respond to a growing problem of DoS attacks [78]. The RFC describes the straightforward idea of ingress filtering, which assumes that source IP addresses should be checked against a set of allowed addresses and discarded if they are not following filtering rules. If a network provider is aggregating routing announcements for its single-homed client networks, it should strictly prohibit traffic which claims to have originated from outside of these networks. RFC 3704 proposed different ways to implement ingress filtering using static Access Control Lists (ACLs) or Reverse Path Forwarding (RPF) [77].

Adversaries take advantage of the absence of SAV to launch DDoS attacks by exploiting public services vulnerable to reflection. In a typical scenario, end-user machines send requests from networks that allow spoofing to public services by forging source IP addresses of the victim [79]. The victim is then overloaded with the traffic coming from the public services rather than from the compromised machines. Therefore, the origin of the attack is not traceable.

4.2.2. INFERRING SAV DEPLOYMENT

Numerous papers proposed methods to infer SAV deployment [10], [11], [76], [80]–[85]. The approach of the Spoofer project [80] is to enable volunteers and “workers” remunerated through five crowdsourcing platforms in a pilot study [83] to test SAV compliance of their networks with a custom client-server system. The client sends spoofed and non-spoofed traffic to the server periodically or when it detects a different network. The server infers if SAV is deployed in a tested network. Even though the Spoofer project provides the most confident picture of the deployment of SAV, those that are unfamiliar with the problem or do not implement BCP38 are less likely to run the Spoofer client on their networks.

Another approach proposed by Mauch [85] and implemented by Kühner et al. [82] leverage the misconfiguration of DNS resolvers. DNS servers perform resolutions of human-readable domain names to IP addresses interpretable by machines. Local DNS

resolvers can be configured to *forward* requests to other DNS servers that perform resolutions on their behalf. When a misbehaving *open DNS resolver* receives a request from an external client, it may forward the request to another DNS resolver located outside its network without changing the packet source IP address to its address. If SAV is not deployed at the network edge, the client will receive the request resolution from the IP address of another resolver. The method is more practical than the Spoofer because the measurement can be performed remotely and does not require volunteers inside the tested networks.

Lone et al. [76] proposed another technique using routing loops appearing in traceroute data to infer inadequate SAV at the transit provider edge. When packets are sent to a customer network with an address that is routable but not allocated, and the default route is set to provider, the packets will be forwarded back to the provider's router without changing the packet source. If the router does not perform SAV, the traceroute will show a forwarding loop as the provider's router will again return subsequent packets to the customer's network.

Lichtblau et al. [11] and Müller et al. [10] have passively analyzed traffic at Internet Exchange Points (IXPs) to infer which source addresses should legitimately appear across IXP parts by leveraging Autonomous System (AS) topology extracted from Border Gateway Protocol (BGP) data. Even though the proposed detection method does not depend on volunteers running any custom software or existing misconfigurations, it requires privileged access to the traffic exchange points and cannot be easily replicated without special access to the data.

Luckie et al. [84] analyzed Spoofer dataset and ran remediation campaigns. They found at least a quarter of ASes did not filter packets for the year ending Aug 2019. They also found networks behind Network Address Translation (NAT) not always perform SAV. Finally, they analyzed remediations and found that 21% of networks remain unremediated for more than six months.

While the above-proposed methods infer SAV deployment for outbound traffic (i.e., coming from inside the customer network to the outside), Korczyński et al. proposed a new technique to identify networks not filtering *inbound* traffic to the customer network [81], [86], [87]. It consists of identifying open and closed DNS resolvers handling requests coming from the outside of the network with the spoofed source address from the range assigned inside the network under the test. This method covers roughly 50% of all ASes and provides the most complete picture of the status of inbound SAV deployment at network providers.

This dissertation presents the first study to combine two independent measurement techniques (based on Spoofer and DNS Resolvers) to identify the lack of outbound SAV, as well as the first to statistically model causal factors for SAV non-compliance at the ISP level.

4.2.3. MODELING SECURITY PERFORMANCE

A few studies have explored concentrations of abuse events across different types of Internet intermediaries, with the intent to explain what factors correlate with abuse levels. Tajalizadehkhooob et al. [88] and Noroozian et al. [89] explored analytical models to estimate the security performance of the hosting providers. By building generalized lin-

ear models (GLM) for phishing abuse counts, they demonstrated that hosting providers' structural properties, such as domain names space size or IP space size, but also factors reflecting security performance can predict a large amount of the variance in abuse incident counts.

Other studies have explored factors driving domain abuse of operators of Top-Level Domains (TLD) [90], [91]. They concluded that apart from structural properties of the operators, security efforts such as strict policies of domain names registration significantly reduce the number of domains used in phishing and malware attacks.

Our work is closely related to [92] in which Zhang et al. systematically explored the relationship between the mismanagement of networks using Internet-scale measurements of BGP routers, SMTP, HTTP and DNS servers, and malicious activities. They found a statistically significant correlation between networks that are mismanaged and networks that are responsible for distributing spam, malware, or phishing attacks. In this work, we collect various indicators reflecting network properties, security efforts, institutional factors and characteristics of ISPs to explain the absence of SAV using the data from the Spoofer project and measurements of misbehaving open DNS resolvers.

4.3. THEORETICAL FRAMEWORK

Several economic concepts help understand the incentives of network operators to adopt or ignore best security practices like SAV. We first discuss these concepts and then present the causal framework that is the basis for our empirical study.

4.3.1. INCENTIVES

COST OF ADOPTION:

First, the most obvious incentive against adoption is the demand for resources, including technical expertise, time, and hardware requirements for the implementation of SAV. The two well-known methods to deploy SAV are Access Control Lists (ACLs), which requires manually maintaining a list of all the prefixes announced by the AS, and Universal Reverse Path Filtering (uRPF), where the router checks if a source address exists in its routing table before forwarding it. Other than the requirements for implementing SAV, organizations also face ongoing maintenance costs, e.g., engineering time needed for keeping the ACL-based filtering up to date or hardware requirements for uRPF to maintain good throughput rates.

EXTERNALITIES:

An externality can be defined as the cost or benefit that affects a third party without this being reflected in the market price. SAV adoption suffers from externalities because the cost of adoption is borne by the operator, while the benefits go to others, e.g., the victims of amplification DDoS attacks. Simply put, operators do not see a direct economic benefit to implementing SAV in their networks. While one could argue that the cost of delivering spoofed traffic also implies a cost to the operator where it originates [93], this effect is seen to be very small. In a survey on SAV adoption, the majority of respondents said that spoofed traffic constitutes only a small fraction of all traffic in terms of total volume [11].

INFORMATION ASYMMETRY:

Whether a network operator is compliant with SAV is often not visible to customers, other providers or outside observers. Adopting this good practice, therefore, doesn't generate a benefit in terms of a better reputation, as the information is not readily available to the public or to other providers who might use it in peering decisions. Conversely, non-compliance doesn't generate a clear negative reputation impact.

WEAKEST LINK:

Finally, SAV suffers from being a weakest-link problem. If there are even a handful of non-compliant networks, the attack will remain possible. It would be difficult to trace it back to the offending network where it originates. Innovators and early adopters can definitely help the cause by reducing the number of vantage points from where an attack can be launched. However, it would not be possible to eradicate the attack vector until all of the operators are compliant. Since SAV adoption is a good practice, and there are no regulations or fines, it is unlikely all the operators will become fully compliant.

4.3.2. EXPLANATORY FACTORS FOR SAV COMPLIANCE

In light of the above-mentioned incentives, we are developing a causal model that hypothesizes the cost of adoption to impact adoption. We approximate this cost in two ways. First, the more complex and dynamic the operator network is, the more costly SAV adoption will be. We include this variable as 'network complexity'. Second, if an operator has a large customer base, it will have economies of scale and be more likely to have expertise in network engineering, making it less costly to implement SAV adoption. This factor is included as 'ISP characteristics'.

The impact of the cost of adoption is moderated by other factors. First, the willingness of the operator to incur costs for security efforts. Second, by the overall development level and wealth of the country in which it operators ('institutional environment')—in other words, the extent to which they can pass these costs on to their customers.

For each of these four factors, we identified several indicators that can be empirically observed. Figure 4.1, shows an overview of variables and the indicators to understand non-compliance of SAV. The dependent variable is defined as non-compliance because of the way compliance is measured. As we will discuss in Section 4.4, the two measurement techniques are able to observe the lack of compliance, rather than its complement.

NETWORK COMPLEXITY:

We hypothesize that the more complex and dynamic a network is, the more costly it will be to implement SAV safely; thus, the more likely it is that the operator will not be compliant. We measure network complexity from several observable network properties. One of the important indicators is the amount of IPv4 address space advertised by ISPs. It gives us a proxy of the size of the ISP. If the operator is announcing a large number of IPs, it is more likely that they have a more complex network. They might also be running various network policies for different IP ranges, which would mean they are required to apply SAV at multiple points in the network.

Similarly, we calculated the stability of ASes based on the number of prefixes that are changing over time. The more prefixes there are, the more costly it will be to maintain

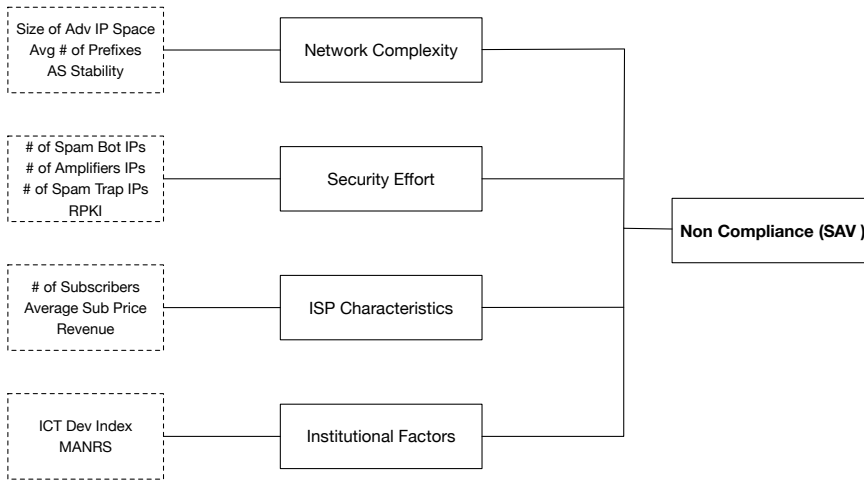

Figure 4.1: Causal Model for Non-Compliance with Source Address Validation

the ACLs needed to implement SAV. We calculated the total number of prefixes advertised per week by ASes for April-Sept, 2019. The more the prefixes change, this will also increase the cost of adoption. We calculated the ones that remain consistent throughout the year. If advertisements are constantly changing, it would mean that it is difficult for ASes to implement ACL-based BCP38 implementation.

SECURITY EFFORT:

We used network hygiene to understand how well the networks are maintained. The idea behind network hygiene is to measure proxies for how much effort operators put into keeping their networks secure. We use two factors to calculate the hygiene of the networks. First, the presence of amplifiers in the network. Services like Open Resolvers, Memcached servers, and Chargen are constantly used by attackers to redirect and amplify a DDoS attack. There has been a consistent effort in the operator community to get operators to reduce the number of such amplifiers in their network. We calculated the number of amplifiers per ASN and used it as an indicator that the network operators with a higher count of amplifiers are less likely to have SAV in place.

Second, we calculated abuse in the network in the form of the number of bots and the number of spam-sending IPs. We hypothesize that the network operators who perform poorly on keeping their networks clean are less likely to care about SAV.

Finally, we checked if operators have signed one or more of their prefixes using Resource Public Key Infrastructure (RPKI). We assigned a binary value for adoption. RPKI is a framework that allows service providers to sign the prefixes allocated to them. It allows other ASNs to validate the ownership of the advertised prefix.

Since RPKI is a relatively new framework, and it is an opt-in service, we hypothesize that the operators that sign one or more prefix are security-aware and are more likely to adopt SAV for their networks.

ISP CHARACTERISTICS:

We define ISP characteristics as a function of the number of subscribers and available funds of ISPs. These characteristics give us a different picture compared to network properties. For instance, IPv4 allocation is not evenly distributed. It has a limited pool and was assigned based on a first-come, first-serve basis. As a result, we have many ISPs with a large customer base and fewer IP addresses.

We use subscriber numbers from Telegeography data [94] and manually map company names to ASes. Moreover, we use an average subscription price as a proxy to their earnings for available funds. We hypothesize that ISP with a large number of subscribers will face difficulties for the implementation of SAV. However, ISPs with a higher subscription price will have more funds to invest in good security practices like SAV.

INSTITUTIONAL FACTORS:

Additionally, we measure the impact of institutional characteristics on ISPs for the implementation of BCP38. We expect ISPs in countries with more mature ICT development more likely to be compliant as there will be more resources, more mature networks, and more initiatives for better security. For this, we use the U.N.'s ICT Development Index [95].

Similarly, we test whether ISPs are a signatory of Mutually Agreed Norms for Routing Security regulations (MANRS). MANRS initiative recommends best practices for ISPs to reduce the most common routing threats. It requires SAV for single-homed ISPs or for those whose customer network is owned by the ISP. There are currently 209 member ISPs. We expect that these ISPs are likely to be more compliant compared to non-members.

In sum, the basic idea is that the cost and benefit of SAV adoption are highly asymmetrically distributed, making adoption much less likely. We want to estimate the impact of various causal factors on adoption. First, network complexity (via various indicators), where we assume this would increase the cost of adoption and thus lower the probability of adoption. Second, security effort, where we assume this reflects the willingness of network operators to invest in security measures that also, or even primarily, benefits third parties. We assume this increases the likelihood of adoption. Third, institutional factors, where we assume that more operators in more wealthy countries and with more mature networks and regulatory environments are more likely to accept the cost of adoption as a 'cost of doing business', thus increasing the likelihood of adoption.

4.4. DATA COLLECTION

In this section, we describe the sources for various datasets that we use to estimate the model. As explained before, we focus our analysis on ISPs to have a somewhat homogeneous study population, but also because the majority of the user devices are in an ISP network. They form a critical control point because they are closer to the origin of the traffic and can not only detect but also block spoofed traffic.

Several of our datasets of the independent and dependent variables are based on IP addresses and Autonomous System Numbers (ASNs). The relationship between ASes and ISPs is not that simple. Yes, many ISPs have a single AS, but a fraction of ISPs have multiple ASNs, some ISPs share a single ASN. We first explain how we mapped ASNs to ISPs, followed by an explanation of how we collected data on IP addresses that were ob-

served to facilitate spoofed traffic. Finally, we explain our methodology to obtain and analyze the datasets for network complexity, security effort, and institutional environment.

4.4.1. MAPPING OBSERVATIONS TO ISPs

We define an ISP as a company that provides access services, typically in residential broadband markets. To map to ISPs our indicators and our observations of compliance, we need to identify their network address space.

We start our identification of the network space of ISPs with market analysis data from Telegeography: the GlobalComms database [94]. The database contains a highly reliable overview of the main broadband ISPs in each country, drawn from annual reports and market filings. We focused on the ISPs in 64 countries who together possess a broadband market share of over 85% in those countries [96]. This gives us a total population of 334 ISPs.

In the next step, we used CAIDA's AS ranking dataset [97]. It provides an approximate map of the organization name based on AS, the number of IP addresses announced, the country from which AS originate and the AS number. We then manually mapped the ASNs that belong to these ISPs by matching their names and the registration information to ASes that reside (at least partially) in that country.

In some cases, due to mergers, acquisitions, or branding changes, the AS name information might be outdated and no longer consistent with the current ISP name. The TeleGeography data also contains historical information about the ISPs. We search for historical names and updated mappings if we find evidence that an AS belongs to one of the ISPs in our dataset.

Finally, we look at the description of prefix announcements from the Hurricane Electric dataset [98] and exclude ASes that appear to be used primarily for other purposes like hosting, cellular data, IPTV, etc. There is a possibility that an ISP might provide multiple services from the same AS. In such a scenario, the identified AS might include some services like hosting infrastructure inside an access network. For our purposes, however, it still falls within the category of providing access services and should be included in the mapping of ISP network space.

We then map the IP addresses belonging to each AS number using BGP data from the Routeviews project [99]. Via the AS, we can then connect the IP address to the ISPs and country. Now, as some ASes span multiple countries, we geo-locate all IP addresses using the MaxMind GeoIP2 database [100]. For each ISP, we map only the portion of the AS that geo-locates to the country in which the ISP resides. This way, multi-country ASes get split up over the subsidiaries of the ISP in the various countries.

4.4.2. DATA ON IP SPOOFING

To measure whether networks allow outbound spoofing to their upstream networks, we analyze data from the Spoofer project and from our Internet-wide scans of misbehaving open DNS resolvers. We merge these two sources into a variable that indicates non-compliance at the /24 prefix level. In this section, we first give an overview of the two techniques, followed by why and how of the data aggregation methodology.

SPOOFER PROJECT:

The Spoofer project is the most known and used source to collect data on BCP38 compliance. The Spoofer tool is a client-server application. The client application is run by volunteers. It generates packets with spoofed and non-spoofed source addresses and then sends them to the Spoofer project server periodically and when it detects a new network. Based on the reception of these packets, the server infers whether the network blocks spoofed traffic or not. The benefit of these measurements is that it not only reveals networks that allow spoofed traffic to upstream networks, but it can also detect the opposite: networks that are compliant. However, data collection is based on volunteers to run the application from within the network, which limits the visibility of the tool across all ISP networks. This introduces some selection bias, where ISPs with more users as such and especially more users in the western countries, where the Spoofer project is more known, have higher odds of being included in the measurements. In this chapter, we used data from the Spoofer tool collected over a period of 6 months (April-September 2019). The dataset contains tests collected from within 66 ISP networks in 31 countries. It is 26% of the total ISP population we have in our dataset.

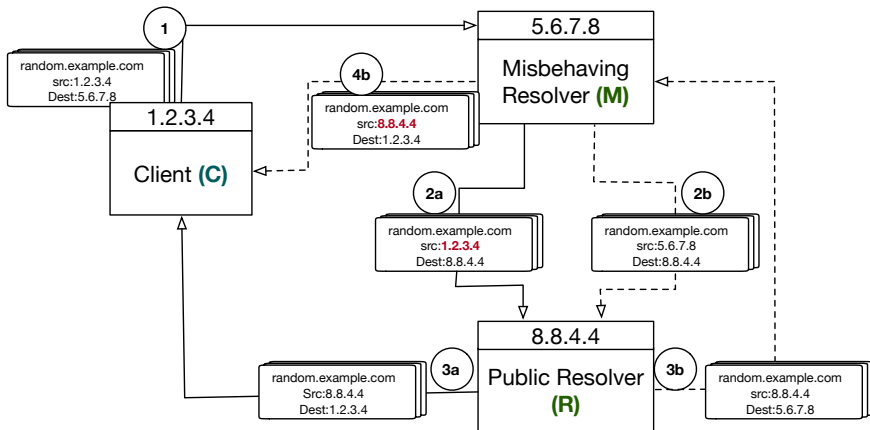

Figure 4.2: Detecting spoofing ASes from misconfigured openresolvers.

MISBEHAVING OPEN DNS RESOLVERS:

Jared Mauch first mentioned the idea to detect non-compliant networks using misconfigured open DNS resolvers on the NANOG mailing list [85]. Subsequently, Kührer et al. scanned the IPv4 address space for misconfigured DNS resolvers [82] and found 2,692 ASes that allow spoofing.

It is important to note here that we are only interested in a very specific subset of open resolvers, namely CPE (customer-premise equipment) devices with a specific configuration error, which can function as a vantage point to observe the absence of SAV in parts of the network. In other words, these specific devices provide a de facto measurement platform for networks that lack SAV, since these devices respond with spoofed traffic in response to a specially crafted DNS request. In that sense, these misconfigured devices are similar to the spoofer client.

A previous study [82] has fingerprinted these misconfigured open resolvers and found the majority of them were running on home routers. These open resolvers have a very specific configuration error that makes them act as a forwarder for incoming packets. They probably have either misconfigured NAT rules or erroneous DNS proxy implementations [82]. We use these devices basically as vantage points. If we receive a response, this tells us two things: first, that there are no edge controls in place and, second, that there is no SAV at the network level, i.e., on border routers. In other words, there is no compliance with BCP38. In short, the misconfigured resolvers are a means for us to measure that anti-spoofing measures are not in place within the ISP's network.

Figure 4.2 illustrates how the proposed misconfiguration works. A client (C) with an IP 1.2.3.4 sends a DNS request to an IP address 5.6.7.8 to resolve `random.example.com` in step 1. If it reaches a misbehaving DNS resolver (M), it may forward the DNS request to another DNS resolver (R) to resolve the request in step 2a (in the example it is Google's open public resolver with an IP address 8.8.4.4). However, a misbehaving resolver M may not change the source IP address of the original request to its own before forwarding it to R (step 2a). If SAV is not deployed at the network edge of the tested network, the forwarded query will reach R , which will perform the resolution and will send the response directly to the client in step 3a, revealing the lack of SAV in the tested network. In a second scenario, the misbehaving resolver M may correctly forward the query to R by replacing the client's IP with its own in step 2b. After performing a recursive query resolution, R may send the response back to M , in step 3b. However, M may forward the DNS response to the client C without changing the source IP address of R to its own in step 4b, thus again revealing a non-compliant network.

To collect the data on networks without SAV using the method explained above, we extended the implementation of the myDig software [101]. We generated a list of unique subdomains for each routable IPv4 address and sent DNS requests from our server. Each time we get the response, we compare the destination IP address we sent the request to with the IP address that replied. We conclude that spoofing is feasible if the IP address from the response belongs to a different AS than we initially queried. We have repeated the scan for a period of 6 months from April till September 2019 on a weekly basis. With this technique, we observed IP addresses that can send spoofed packets in 240 ISPs and 60 countries.

FROM MEASUREMENTS TO NETWORKS:

The Spoofer and Open Resolver measurements observe individual IP addresses where sending spoofing traffic was feasible. A key methodological issue is how to infer, from these individual IP addresses, what overall portion of an ISP's network is non-compliant. In order to estimate the amount of IP space that allows spoofing, we need to aggregate the tested IP to the prefix level. SAV compliance requires configurations of the routers; hence it is more likely that either the entire prefix is compliant or not. It is, however, challenging to infer how the ISP has segmented its network in different prefixes, since it is operator dependent and is not reported publicly.

In principle, we could aggregate the non-compliant space at three different levels. First, we could classify the entire AS as spoofable if we find measurements showing that IPs can spoof in either of our two datasets. However, if policies are implemented on a

prefix level, it will mean we would overcount the amount of addresses space that is non-compliant. Moreover, some large ASes operate across different countries, containing multiple ISPs (country-level subsidiaries of a multi-national ISP). Parts of the same AS might therefore be under the control of different organizations, which might result in varying SAV policies within that AS.

The second and more realistic approach would be to deduce policies from BGP inter-domain routing tables. The BGP table contains reachability information, which is shared amongst the ASes. We can map the IPs observed in our two datasets to the longest matching prefix from the BGP routing table and count that prefix as being non-compliant. These counts are better than assigning the entire space of ASN based on a few measurements. However, it still suffers from overcounting due to IP space aggregation by ISPs for efficient routing.

In this study, we have chosen a more conservative third approach. If we find one or more IPs that allow spoofing within a /24 prefix (256 addresses), we classify the entire /24 prefix as non-compliant. We also check BGP routing data and if an AS is announcing a prefix that is less than /24, we chose the smaller prefix as the more conservative estimate.

In [84], Luckie et al. show that in about 30% of the remediated cases in Spoofer, the client can still spoof address space outside the /24 prefix. This confirms that our approach is conservative and likely to underestimate the portion of an ISP's IP space that allows spoofed traffic to leave the network.

In Figure 4.3, we show the distribution of non-compliant IP space per ISP. It can be seen that 40% of ISP have a non-compliant address space of less than 1000 IP addresses, while around 86% percent has 10,000 or fewer IPs that can potentially send spoofed packets. In terms of /24 prefixes, we observe that around 16% ISPs have only one prefix, while around 37% of ISPs we have measurements from two /24 prefixes.

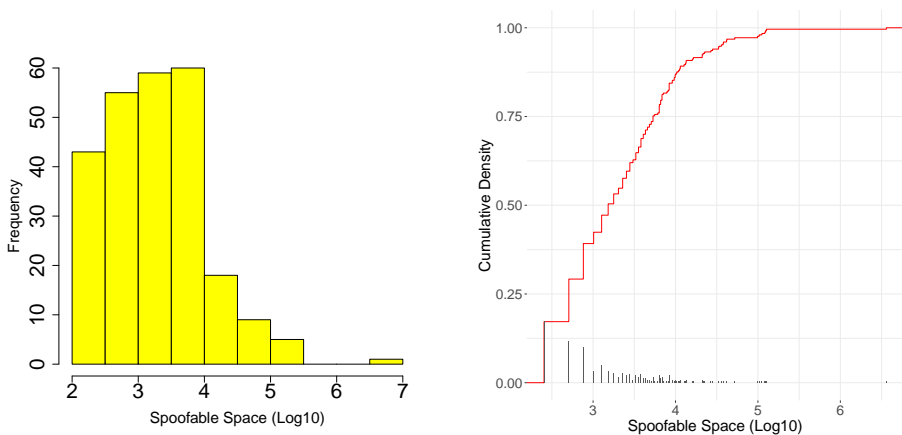

Figure 4.3: Distribution of Amount of Non-Compliant Address Space of ISPs

COMPARISON OF DATASETS:

The Spoofer client not only detects when a network allows a host to send spoofed traffic, but when it is blocked. The latter can be because the network has implemented BCP38

or because the client IP addresses are behind a NAT. We excluded the observations that detect a NAT, as it is unclear whether BCP38 is implemented at the network level or not. Prior work already found some networks with NAT not to be compliant when using IPv6 measurements [84]. We categorized IPs as “Spoofer Blocked”, for which Spoofer infers the presence of BCP38.

OR Spoofable	21332		
Spoofer Blocked	19	3775	
Spoofer Spoofable	2	6	287
	OR Spoofable	Spoofer Blocked	Spoofer Spoofable

Figure 4.4: Overlap among datasets at /24 level. Each number represents the number /24 prefixes where two datasets both have at least one observations. As a point of reference, we also include the overlap of each dataset with itself – i.e., the total number of prefixes for which that dataset has observations

In Figure 4.4, we summarize the overlap between Spoofer and Open Resolver datasets at the /24 prefix level – in other words, the number of /24 prefixes where we have observations from both datasets. There are only two /24 prefixes where the Open Resolver data has an observation and the Spoofer dataset contains an observation that an IP address in that prefix allows spoofing (Spoofer Spoofable). We can attribute this tiny overlap to the lower coverage of the Spoofer tool compared to the Open Resolver dataset. Moreover, within the same /24 prefixes, we also find mixed results: 6 prefixes where Spoofer observes both spoofable and unspoofable traffic and 19 prefixes where Open Resolver observes spoofing is possible, but Spoofer finds it is blocked. Compared to the total dataset, this fraction of inconsistent results is negligible. They might result from differences in timing, where the prefix allowed spoofing during one observation and not during a subsequent one. Or they might result from the fact that SAV is implemented at a smaller prefix level than /24. As we discussed above, [84] found that in 90% of the cases, operators implement SAV at the /24 level or larger. That still leaves 10% where operators implement it at smaller prefixes, which might result in different SAV policies in the same /24. We do not observe any contradictory test results for the same IP address.

Again, these inconsistencies occur in a tiny fraction of our overall observations. Even

OR Spoofable	245		
Spoofed Blocked	144	182	
Spoofed Spoofable	65	57	70
	OR Spoofable	Spoofed Blocked	Spoofed Spoofable

Figure 4.5: Overlap among datasets at ISP level. Each number represents the number of ISPs both datasets have at least one observation. As a point of reference, we also include the overlap of each dataset with itself – i.e., the total number of ISPs for which that dataset has observations

in these cases, we have proof that spoofing is allowed from a least a portion of the /24. For this reason, we consider this fraction of prefixes also to be non-compliant. In the rest of the chapter, we only consider the non-compliant address space.

Figure 4.5 shows where we have observations for the same ISP in two datasets. ISPs typically operate their address space as multiple networks, sometimes even multiple ASes. This explains why a large number of ISPs where we detected spoofing also had other parts of their network where SAV was implemented. It is important to note that, on average, we find 10.5 more non-compliant addresses than compliant addresses in these ISPs. In any case, as explained earlier, even if there are a few addresses that allow spoofing, the possibility of a DDoS attack remains intact. From our overall population of 343 ISPs, we have observations that indicate non-compliance for 250 of them (73%). For 182 ISPs (53%), we also have test results indicating that they did deploy SAV on some prefixes. We have no test results whatsoever for 51 (15%) of ISPs. For 149 of all ISPs (43%), we have mixed results: hosts can send spoofed packets from some prefixes and while spoofed traffic is filtered in other prefixes.

4.4.3. NETWORK PROPERTIES DATA

TOTAL SIZE OF ADVERTISED IP SPACE:

We used routing data collected by Routeviews project [99] to estimate the number of IPs per ISP. We analyzed weekly BGP routing data for the period of April-September 2019. We used the pyasn library [102] to determine the prefixes announced for the ASNs, which are then mapped to ISPs in our dataset. We then aggregated the total number of IPs for each

of the ASNs per ISP. Finally, we took the average number of IPs from the weekly data per ISP.

AVERAGE NUMBER OF PREFIXES:

IP space is announced in BGP tables in the form of prefixes. An IP prefix represents the number of bits, which is used to identify a network and determine the total number of hosts. Network operators usually aggregate the total advertised space to the maximum prefix announcement possible for efficient routing and lower number of advertisements, which is useful routing tables. However, in some cases, due to routing policies or their usage, they advertise multiple prefixes for the same range. Once a week, we calculated the **number of prefixes** announced per ISP between Apr-September 2019. We then took an average of these counts.

STABILITY OF PREFIX ANNOUNCEMENTS:

Moreover, using the BGP data and `pyasn`, we determined the **stability** of the announced prefixes by calculating the percentage of prefixes per operator that remained unchanged compared to the total set of prefixes that were announced at some point during the measurement period (Apr-Sep, 2019).

4.4.4. SECURITY EFFORT DATA

RPKI:

Internet operators use BGP to exchange routing data. It contains prefixes and the number of hops they are away from the AS announcing the information. Routing information is constantly changing and BGP is flexible enough to converge for these route changes. However, BGP lacks a mechanism to validate if the prefixes being announced actually belong to the entity announcing them. To verify the authenticity of the announcement, Internet Engineering Task Force (IETF) developed a mechanism known as Resource Public Key Infrastructure (RPKI) [103]. Internet operators can now use a cryptographic system of public/private keys to sign prefixes, thereby authenticating that they are authorized to announce them. The Regional Internet Registries (RIRs) maintain public key certificates. The operators can detect announcements with an invalid route origin. It is important to note that RPKI doesn't secure the path. It is, however, the first step towards BGP route security.

We interpret the adoption of RPKI as an indicator of security effort by the ISP. We used `Nlnetlabs Routinator`, an RPKI validator tool [104], to download prefixes that were signed by their respective ISPs. We then mapped these ASNs, where we observed signed prefixes to ISPs from our dataset. We assigned a binary value of 1 to the ISPs that had signed one or more prefixes, and 0 to the ISPs that had no signed prefixes.

SPAM BOTS:

Like the lack of SAV compliance, infected end-user machines in an ISP network are a widely recognized security externality [105]. While ISPs have been involved in mitigating botnets, many of the benefits of mitigation go to the third parties that are attacked by botnets. Contrary to SAV, though, the ISP might suffer some cost via blacklisting when

it does not mitigate outbound spam. We interpret the relative number of bots is an indicator of the security effort ISPs are willing to undertake in light of significant external effects.

We measured the number of bots in the ISP networks using multiple data feeds. First, we used the Composite Blocking List (CBL) of SpamHaus [26]. The dataset contains IPs of spam bots, including Cutwail, Rustock, Lethic, Kelihos, and Necurs. We receive a daily report from SpamHaus and map the IPs in the feed to their respective ISPs. We have to control for DHCP churn, which would lead to serious overcounting for ISPs with very dynamic IP address allocation, as the same infected machine would show up under multiple IP addresses. [106]. In order to compensate for this churn, we count the number of unique IPs observed each day and then calculate the average of all daily counts over our measurement period. The downside of this methodology could be that we are undercounting. However, due to our long time-frame, the averages would bring the estimated count closer to the actual number of infected machines.

A second indicator on bots is based on a spam trap operated by Dave Rand of Trend-Micro. We follow the same approach as with Spamhaus CBL: extract the IP addresses, map them to the ISPs and calculate the daily average number of unique IPs seen over the measurement period.

AMPLIFIERS:

Finally, we look at the presence of so-called amplifiers in the networks of ISPs. Amplifiers are legitimate services that can be abused in amplification attacks with spoofed traffic, exactly as was explained at the start of this chapter. Again, this is an example of a security externality for the ISP, thus providing us with an indicator for measuring security effort related to threats with significant external effects.

We downloaded Rapid7 data containing IP addresses of UDP amplifiers in ISPs' network [107]. Rapid7 scans for various protocols are publicly available every month. In our study, we used IP addresses for Chargen, DNS resolvers, Memcached, Netbios, Ntpmonlist, Portmap and Qotd.

We have decided to combine the observations of amplifiers into a single proxy. Our goal is to capture a signal on overall network hygiene, not the ISP response to a specific type of amplifier. The protocols that we have included in our study have been identified as potential attack vectors by US CERT advisory [108]. Network operators should either take down the amplifiers or at least deny access to the services over the Internet. They can also deploy Response Rate Limiting (RRL) to reduce the rate at which replies are sent and thus limiting the impact of amplification. By combining the amplifier observations, we also get much better coverage of observations across the ISP population, further improving the statistical behavior of the proxy. (To telegraph ahead to the statistical analysis: when we include each amplifier type as a separate predictor in the model, the signal gets too weak and we no longer find any significant relationships.) A high correlation between non-compliant networks and the presence of a large number of amplifiers would indicate operators' inaction for DDoS problem. We mapped the reported IP addresses to each ISP. Finally, to mitigate the effect of churn, we calculated daily averages of the number of observed amplifiers using the methodology explained above.

4.4.5. ISP CHARACTERISTICS DATA

NUMBER OF SUBSCRIBERS:

We used the total number of subscribers as a proxy to determine the size of ISPs. Telegeography database reports the total number of subscribers per quarter, and we selected quarter two of 2019, as it matches the closest to the spoofing datasets.

AVERAGE SUBSCRIPTION PRICE AND REVENUE:

Telegeography reports revenue and average subscription price per company. However, they do not have data for all Internet providers. We mapped revenue and subscription prices to our dataset. We are missing 68 ISPs and do not have any reliable estimates to fill in missing values.

4.4.6. INSTITUTIONAL ENVIRONMENT DATA

Finally, we collected indicators for the institutional environment of the ISPs. The first one is at the level of countries, the second at the level of the provider community, i.e., whether the ISP is part of a group of industry peer committing themselves to adopt good security practices for routing, among which is SAV.

ICT DEVELOPMENT INDEX:

We also used the ICT development index, which is an indicator representing ICT development per country. The dataset is provided by ITU (United Nations International Telecommunication Union). It assigns values from 1 to 10, with a higher number representing a higher level of development based on various ICT indicators.

MANRS DATASET:

MANRS initiative requires best practices for ISPs to reduce the most common routing threats. We downloaded member ASNs of MANRS from their website and mapped it to ISPs in our dataset [13].

4.5. STATISTICAL MODEL FOR NON-COMPLIANCE

In this section, we first explain the transformations we did for some of the indicators, followed by basic statistics of the dataset. Next, we estimate a linear model and discuss the results and interpretations.

The number of non-compliant IP addresses per ISP has a correlation of 0.52 with the total number of IP addresses being announced by that ISP. ISPs with a larger number of IP addresses have a higher chance of having tests and are hence more likely to have non-compliant address space being observed. For this reason, we first transform the dependent variable into a relative metric: the ratio of the non-compliant address space to the whole address space being announced by the ISP. In Figure 4.6 (a), we show the distribution of this normalized variable. One of the concerns is that the distribution is left-skewed, partially because of the fact that we adopted a conservative approach to estimate the amount of non-compliance address space, likely undercounting it. This distribution would violate the assumptions of linear regression. We perform a natural log transformation to resolve this issue. Figure 4.6(b) shows that the transformed distribution is much closer to normal. We used this transformed variable as the dependent

variable in our model. For the same reasons, we also log-transform some of our independent indicators, namely the number of subscribers and the security effort indicators for bots and amplifiers. Table 4.1 summarizes the indicators that are used in the model.

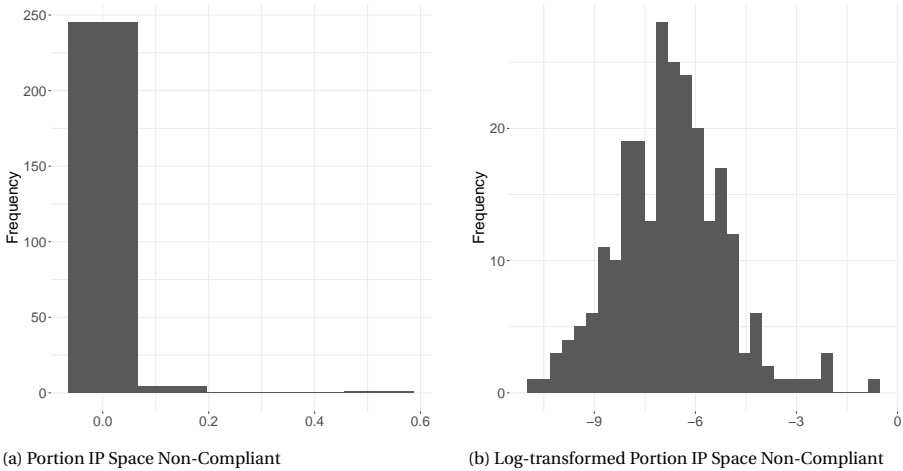

Figure 4.6: Distribution of Transformed Spoofable IPs per ISP

4.5.1. MODEL SPECIFICATION

To reiterate: we measure SAV compliance as the number of IP addresses in all /24 blocks where one or more IP addresses were observed as being non-compliant in our Spoofer or Open Resolver datasets. Our response variable is a normalized count of non-compliant addresses divided by the total number of IP addresses announced by the operator. We define our response variable Y_i as the log of the normalized size of non-compliant address space by ISP_i for $i = 1, \dots, n$, where n is the total number of ISPs for which we have our tests. To estimate the impact of network properties, security effort, ISP characteristics and institutional factors on non-compliant address space, we use a linear regression, which takes the following form:

$$\ln(Y_i) = \beta_0 + \sum_{j=1}^k \beta_j x_{ij} + x_{ij} * y_{ij} + \epsilon_i$$

where β_0 is the intercept and x_{ij} , $j = 1, \dots, k$, are the indicators for network complexity, security efforts, ISP characteristics and institutional environment and $x_{ij} * y_{ij}$ is the interaction terms for the model. Our error term ϵ_i is normally distributed with mean 0 and the variance sigma squared.

4.5.2. DISCUSSION OF RESULTS

We construct models following step-wise inclusions for the various indicators. A summary of four models is presented in Table 4.2. Our goal is to understand the relationship of various indicators and improve the goodness of fit for these models. The Adjusted-R-

Variables	N	Min	Mean	Median	Max
Portion of adv. IP space non-compliant	250	0.00002	0.006	0.0012	0.522
Total size of adv. IP space	250	6,617	6M	1,4M	124M
Avg # of prefixes	250	3.61	204.0	88.15	2,668
AS stability (percentage)	250	4.03.	79.75	86.38	100
Avg # of bots Spamhaus	250	18.3	29,772	4,264	1,1M
Avg # of amplifiers	250	86.3	13,979	2,703	0,51M
Avg # of bots spam trap	250	1.06	43.25	14.36	1,681
RPKI	250	0	n/a	1	1
# Subscribers	250	5,500	3M	0,7M	174M
Avg sub price (USD)	182	4.5	47.02	41.04	883
Revenue (USD)	182	12	2,302	533.7	46,377
ICT Dev Index	250	2.42	6.68	7.04	8.98
MANRS	250	0	n/a	0	1

Table 4.1: Summary of indicators used in the model

squared value increases from 0 in the model (1) to 0.47 in the model (3), which means we were able to explain 47% of variance by adding the indicators for network complexity, security effort, and institutional environment. Moreover, the signs of coefficients do not change from the model (2) to model (4). Note that we had to drop 68 ISPs in the model (4) due to missing information on revenue and subscription prices. Since these two indicators do not add any explanatory power, nor affect the other variables, we omit them and select model (3) as our final model. It performs the best in terms of explained variance.

In the final model, we also include interaction terms to understand the effect of advertised IP space in combination with subscribers and prefixes. Note that the distribution of IPv4 address space is asymmetric: early adopters were able to acquire a large number of addresses, while more recent market entrants got smaller allocations for the same number of users – due to the shrinking pool of address space held by RIRs – and they therefore have to rely more on NAT. Furthermore, IPs are allocated to ISPs in terms of prefixes. The early adopters were able to acquire bigger ranges. Later on, ISPs were allocated smaller prefixes, as IPv4 started running out. This presents an interesting interaction effect: ISPs with a large number of IP addresses and a small number of prefixes would have a relative advantage in SAV adoption because routes would be easier to configure and maintain. We included the interaction of total IP space advertised with the number of prefixes to test this hypothesis.

The indicators that measure the size of the ISP, in terms of address space and in terms of subscribers, are significant and have a negative sign. However, we need to be careful with their interpretations due to interaction effects. We explain this in more detail later in the section, but to telegraph ahead: we observe that the signs change for both the number of advertised IPs and the number of subscribers when the number of announced IPs get past the 450,000 mark (see intersecting point Figure 6). From our dataset, a large majority (76%) of ISPs advertise more than 450K IP addresses. We can therefore state that, by and large, larger ISPs have a higher proportion of non-compliant IP space.

	Response Variable: Portion of adv. IP space non-compliant (ln)			
	(1)	(2)	(3)	(4)
# Advertised IPs (ln)		-1.782*** (0.342)	-2.080*** (0.382)	-1.844** (0.617)
Avg # prefixes			0.011** (0.003)	0.016*** (0.004)
AS stability (percentage)			0.001 (0.004)	0.002 (0.004)
RPKI			-0.313* (0.156)	-0.207 (0.187)
Avg # amplifiers (ln)			0.368*** (0.075)	0.283*** (0.080)
Avg # bots SH.(ln)			0.099 (0.077)	0.071 (0.090)
Avg # bots ST.(ln)			-0.068 (0.090)	0.027 (0.099)
# Subscribers (ln)		-0.842* (0.353)	-1.257** (0.410)	-0.936 (0.642)
Average subs price				0.001 (0.001)
Revenue				0.00001 (0.00003)
ICT Dev Index			-0.164* (0.065)	-0.236** (0.081)
Adv. IPs(ln):# subs(ln)		0.077** (0.024)	0.094*** (0.028)	0.079 (0.045)
Adv.IPs(ln):Avg# prefixes			-0.001** (0.0002)	-0.001*** (0.0003)
Constant	-6.725*** (0.101)	15.000** (4.736)	18.924*** (5.205)	14.959 (8.555)
Observations	250	250	250	182
R ²	0.000	0.333	0.495	0.463
Adjusted R ²	0.000	0.325	0.472	0.421
Residual Std. Error	1.601 (df = 249)	1.315 (df = 246)	1.163 (df = 238)	1.134 (df = 168)
F Statistic		40.929*** (df = 3; 246)	21.209*** (df = 11; 238)	11.131*** (df = 13; 168)

Note:

*p<0.05; **p<0.01; ***p<0.001

Table 4.2: Linear regression model

In the case of BCP38, size plays an essential role in the implementation of SAV. ISPs with larger address space are more likely to peer with a higher number of upstream providers, to avoid a single point of failure. To be compliant, they would then have to implement BCP38 on multiple edge routers. This would be more costly. However, a counteracting effect of size, especially when measured in terms of the number of customers, is that larger ISPs have more resources and expertise than smaller operators. Furthermore, there are likely economies of scale in implementing BCP38. The model suggests these cost-reducing effects of size are smaller than the cost increases because of the increased network complexity. In the case of the number of prefixes, we observe for around 96% of ISPs increasing the number of prefixes would also lead to an increase in non-compliant IP space. We give a detail explanation in the latter part of the section. We did not find the stability of prefixes significant in our model.

Next, we look at the impact of ISP security efforts. We have used the signing of BGP prefixes (RPKI), as a positive indicator of effort, i.e., the willingness to invest in security issues with significant externalities. The number of DDoS amplifiers and spambots in the network is a negative indicator of this willingness. The model finds a weak but significant relationship with RPKI. Operators that sign their prefixes are more likely to implement SAV in their networks. From our results, holding all variables constant, an ISP that signs its prefixes with RPKI will have a 31.3% lower portion of non-compliant space compared to ISPs that don't sign their prefixes. We find the indicator for the number of amplifiers per ISP has a significant positive impact. In other words, for a 1% increase in the number of amplifiers, there is an increase of 0.36% of the portion of non-compliant address space, holding all other variables constant. Please note that when we treat each amplification protocol independently in the model, the relationships are no longer significant. However, by combining these observations, we can approximate overall hygiene, as observed by the fact of whether operators reduce amplifiers across the board.

The two indicators for spambots are not significant. There could be several reasons for this. Contrary to RPKI and the number of amplifiers, the number of spambots is influenced by attacker behavior. This could confound the indicator in terms of measuring provider effort. Also, ISPs have another incentive than security for dealing with spambots: they might get blacklisted. This, in turn, might impact the service quality for their customers (e.g., legitimate email might also get blocked). In other words, this indicator might also include effects that are not capturing the provider's willingness to invest in security issues with serious externalities.

When looking at the ISP characteristics, we find that the number of subscribers has an impact. We discuss this below, where we interpret the interaction effects. The other two indicators, average subscription price and revenue of the ISP, were included in the model (4). Both of these variables are non-significant and have a small coefficient. This might be partially due to missing data, since we have no information for about 27% (68) of ISPs. Future work is needed to collect data on the financials of ISPs to understand these relationships.

Next, we measure the impact of the institutional environment. The model shows a weak but significant effect for the ICT development index. ISPs that operate in countries with lower ICT development have a higher percentage of non-compliant address space. In other words, for a 1% increase in ICT index, there is a decrease of 16.4% of the portion

of non-compliant address space, holding all other variables constant. We did not regress our model against the MANRS indicator since we only found 16 ISPs out of 250 MANRS signatories in our data on non-compliance. This makes sense, as we are only looking at ISPs that have been observed as allowing spoofed traffic to leave their networks. MANRS signatories explicitly commit to adopting BCP38. It seems that this self-commitment does have an effect, but we would need more test results from compliant networks to confirm this. Here, all we can say is that most ISPs that signed MANRS are not observed as allowing spoofing.

We interpret the impact of the number of subscribers and prefixes in more detail. As these variables are influenced by the amount of announced IP space, we included 2 interaction terms in the model. The coefficient of the interactive term (Adv. IPs(ln):# subs(ln)) is positive and statistically significant at .001 level. On the other hand, the interactive term (Adv. IPs(ln):Avg # prefixes) is negative but also statistically significant at .01 level. This tells us that the coefficient of announced IPs depends on the value of subscribers and prefixes and vice versa; these estimated coefficients are conditional. It does not indicate anything, however, about the magnitude or statistical significance of these conditional coefficients. To help understand the effects of this marginal coefficient, we plot in Figure 4.7 the relationship between the variables involved in both interaction terms.

4

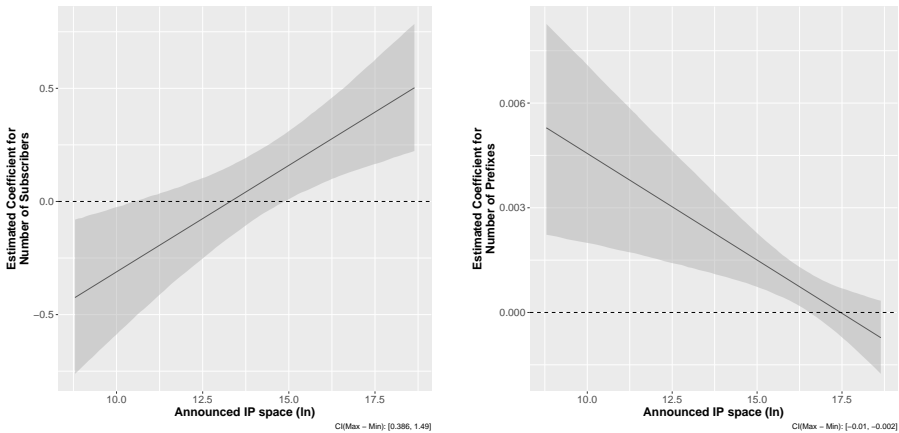

Figure 4.7: Interaction of Subscribers and Prefixes with the total number of IP addresses Announced by ISPs

The left plot in Figure 4.7 clearly shows that with increasing the announced IP space, the magnitude of the coefficient of the number of subscribers also increases, ranging from a -0.42 for the minimum number of announced IPs to 0.50 for the maximum number of announced IPs. This means that when the number of IPs is lower than 450k (see the intersecting point), an increase in the number of subscribers will lead to a decrease in the portion of non-compliant IP space. On the contrary, for those ISPs with more than 450k advertised IPs, an increase in the number of subscribers would lead to an increase of the portion of non-compliant IP space. For instance, for the ISP with the largest number of advertised IP addressed, a 1% increase in the number of subscribers will increase

the portion of spoofable IPs by 0.5%. The confidence intervals (see caption at the right bottom corner of Figure 4.7) of the difference between the conditioned effects of the announced IP space at the minimum and maximum values of the subscribers.

The second interaction term shows a negative relationship between conditional coefficient of the announced IP space and the number of prefixes, i.e., increasing the announced IP space, the magnitude of the coefficient of the number of prefixes decreases, ranging from a 0.05 for the minimum number of announced IPs to -0.0007 for the maximum number of announced IPs. This means that when the number of IPs is larger than 39 million, an increase in the number of prefixes will lead to a decrease of the portion of non-compliant IP space. On the contrary, for those ISPs with less than 39 million advertised IPs, an increase in the number of prefixes will lead to an increase of the portion of non-compliant IP space. For instance, for the ISP with the largest number of advertised IP addressed, a 1% increase in the number of prefixes will increase the portion of spoofable IPs by 5%. From our dataset, we have 242(96%) of ISPs that advertise less than 39 million IPs.

In summary, we observe that network complexity plays a significant role in non-compliant IP space. Our interaction terms for the number of IPs announced with subscribers, and prefixes give us insights on the variability of policies for significantly large ISPs. From our security effort indicators, we found the number of amplifiers significant, which shows us that non-compliant ISPs are also part of the bigger ecosystem of DDoS attacks since amplifiers are commonly used to redirect and amplify the spoofed IP packets. Other than the number of subscribers, we did not find the rest of the ISP characteristics significant.

Comparing this with institutional factors, ISPs that are in countries with better ICT infrastructure are more compliant. We observe very few ISPs within MANRS, which is a positive sign. However, future work is needed to understand the role of MANRS for compliance.

4.6. CHALLENGES IN THE ADOPTION OF SAV

Lack of SAV by network operators has been a concern for many years now. In a recent survey by RIPE NCC, the RIR for Europe, West Asia and the former USSR, 4,161 operators responded that DDoS was the most significant security problem for them [3]. Even though ISPs acknowledge that DDoS is a considerable challenge, we still find evidence of non-compliance in part of the networks of 250 ISPs (73%). A key reason is the cost associated with the adoption and maintenance of SAV, while at the same time providing very limited benefits for ISPs. Moving forward, we need to re-align the incentive structure if we want to see any uptick in compliance. In this section, we review some of the available options and the role various actors can play to improve SAV compliance and reduce the number of hosts that can successfully send spoofed traffic and launch amplification DDoS attacks.

4.6.1. REDUCING THE COST OF ADOPTION

One of the ways to persuade operators to comply is by reducing the cost of SAV adoption. Our empirical findings emphasize the importance of cost incentives for smaller

providers. They have, on average, higher rates of non-compliant address space. Larger providers benefit from the resources, non-compliance in their network can largely be attributed to limited incentives. However, it is challenging for smaller ISPs to configure SAV correctly for their network.

In the RIPE survey, 36% of the respondents suggested the best way RIPE can help them is by providing security-specific training programs. It is important to note here that RIPE attracts participants from various businesses, including ISPs, hosting providers, educational networks, etc. The security issues they require help with do not necessarily all apply to ISPs. In another survey among 84 network operators, a vast majority of respondents reported that SAV is out of reach for them in terms of knowledge, planning, and time need to maintain up-to-date access control lists (ACLs) for the implementation of SAV [11].

There are multiple ways network operators can get support to implement SAV, including training engineers via industry communities like RIPE and Network Operators' Groups (NOGs). Another option is getting router vendors to providing SAV compliance as the default option [84]. Other areas in security have shown that better tools can also reduce the cost of adoption of new solutions. Notable examples include an RPKI prefix signing tool by RIPE. It provides a simple web-based or API based interface for providers to sign prefixes [109]. Similarly, Let's Encrypt, a non-profit certificate authority, has played a significant role in improving HTTPS adoption after major browsers started flagging HTTP sites as insecure. It is currently serving over 180 million websites [110]. One of the key reasons for this success is open-source, free software with clear and concise documentation that requires few clicks or commands to configure a TLS certificate to serve HTTPS traffic.

A usable open-source tool for SAV implementation would have to accommodate the dynamic nature of Internet routing. Building such software is a challenging task, due to complex routing policies based on the various needs and contractual relationships of ISPs. Moreover, the tool would be required to keep updated information about customers and network allocations to feed automated systems. Any mishap potentially disruptive and cause downtime for customers. Unless thoroughly tested and backed by major players, it is highly unlikely that ISPs would use a tool that affects the backbone of their business.

Some other suggestions include decentralizing the BGP routing [111] or offloading it to cloud where SAV implementation could benefit from economies of scale [112]. Recently, the University of Massachusetts Amherst has received a \$1.2 million grant to develop and test "logically centralized interdomain routing architecture." [112]. It is yet to be seen how this solution will pan out and if Internet providers would trust cloud networks to route their traffic. Another new direction is the emergence of reconfigurable networks [113]. The P4 programming language, in combination with supported hardware, would enable network operators to change the configuration of the connected switches without any downtime. It is still in its early days, and it is hard to predict if operators will end up adopting it.

All in all, some options to reduce cost are within reach, such as training via industry associations, but substantial cost reductions would require some form of automation. This still seems infeasible in the short term.

4.6.2. REDUCING INFORMATION ASYMMETRY

Another way to re-align the incentives is to reduce information asymmetry. In a recent development, Cloudflare launched a website isbgpsafeyet.com to reduce information asymmetry on RPKI deployment. Participants can run a test to check if their ISP would accept a legitimate route with an invalid announcement. If the test fails, it means the ISP would likely accept a leaked or a hijacked route. The users are encouraged to tweet the results to increase awareness, which might result in increasing pressure on ISPs to implement RPKI.

CAIDA's Spoofer project has been publishing lists of non-compliant and remediated prefixes and ASes on its website. It sends updates to various network operators mailing lists making transparent which networks are not compliant and which networks remediated. However, they do not present results at the level of ISPs, but at the level of ASes and prefixes, i.e., technical identifiers rather than actors. AS names might not even match ISP names in some cases. Furthermore, these results do not rank networks in terms of compliance. If there is a reputation effect or social proof nudge to be gained from making non-compliance and remediation more visible, then it would likely be more effective at the level of the ISP, since that is the actor who needs to be incentivized to remediate. Similarly, ISPs that remediate non-compliant address space could be incentivized by receiving recognition in the industry.

Moreover, after the launch of the 'Is BGP safe yet' website, network operator groups (NOGs) (e.g., [114]) are already discussing to add a social nudge to www.bcp38.info. It is important to note that residential IP space provides an easily accessible vantage point for attackers to send spoof packets. If subscribers request their ISPs to be compliant, it will offer them an incentive to deploy SAV. We propose creating a more visible list of ISPs and their degrees of compliance to be shared not only on the operator mailing list but also with the users and on the website of the RIRs and perhaps with national CERTS.

4.6.3. INTERNALIZING EXTERNALITIES

A third option would be to internalize some of the external costs of non-compliance to the ISP. One study suggested regulating government procurement to require all government-contracted network providers to adopt SAV [84]. Another route might be pressure from other providers. They could, for example, require SAV to be implemented before entering into a peering agreement. Upstream providers, commonly known as tier 1 or tier 2 providers, hold a strong vantage point to observe SAV compliance, since they give connectivity to many ISPs. They can detect if ISPs are not filtering traffic, especially when they are the only provider of that ISP [76]. There have been examples where upstream providers have leveraged their position to achieve security improvements in BGP routing. Hurricane Electric and Portugal's IPTelecom joined forces to cut off Bitcanal from the global Internet, after it had consistently observed to conduct BGP route hijacking [115]. The organization was later also removed by German Internet exchange DE-CIX and others in the routing ecosystem.

4.6.4. COMMUNITY ACTION TO REDUCE WEAK LINKS

We see no path towards overcoming the weakest-link problem, i.e., the fact that a single non-compliant provider would mean amplification DDoS attacks are still possible.

Miscreants who want to conduct such attacks need only to rent hosts in these non-compliant networks. From there, they can reach all amplifiers with their spoofed packets. That being said, the community of ISPs might reduce the number of such networks via collective action. MANRS is a good example of this. We could not include MANRS in the regression model precisely because operators that signed MANRS are unlikely to be observed in the tests of Spoofer and Open Resolver used in our study. In other words, participating in such an initiative does seem strongly correlated with SAV adoption. However, we did observe a small number of member ISPs (16 out of 250) with one or more prefix being non-compliant. While MANRS promotes best-practices and helps with running a healthy BGP environment, operators are not legally bound to implement any of the promoted policies.

Moreover, some pressure can be exerted by National CERTs and RIRs on ISPs to behave more in line with community norms. We recently saw an example of the American Registry for Internet Number (ARIN) banning Cogent, a large ISP, from accessing its WHOIS database for 6 months, after several ISPs complained that they had received unsolicited marketing calls from the Cogent's sales team [116].

4.7. CONCLUSIONS

We have presented the first study to combine two independent techniques to measure the state of SAV across networks. We used these measurements to estimate the extent to which the population of 334 ISPs in 61 countries is not compliant with BCP38. A large portion of them, 73% to be precise, has at least one prefix that allows IP spoofing. What portion of its IP address space is not compliant is influenced by network complexity, security efforts, ISP characteristics and the institutional environment. As SAV adoption suffers from misaligned incentives, the main route forward seems to be to either reduce the cost of compliance for the providers or to increase the cost of non-compliance. Some of these forces seem to be at play, already, as a significant portion of the ISP population has in fact adopted SAV for all, or at least most, of its address space. Our study only looked at ISPs with at least one prefix that allows spoofing. We did not study the factors that explain why some ISPs are, in fact, fully compliant. Future work might look at that glass-half-full part of the picture and find factors apparently overrode the incentive misalignment that has plagued SAV adoption for a long time now.

5

DEPLOYMENT OF SOURCE ADDRESS VALIDATION BY NETWORK OPERATORS: A RANDOMIZED CONTROL TRIAL

IP spoofing, sending IP packets with a false source IP address, continues to be a primary attack vector for large-scale Denial of Service attacks. To combat spoofing, various interventions have been tried to increase the adoption of source address validation (SAV) among network operators. How can SAV deployment be increased? In this work, we conduct the first randomized control trial to measure the effectiveness of various notification mechanisms on SAV deployment.

We include new treatments using nudges and channels, previously untested in notification experiments. Our design reveals a painful reality that contrasts with earlier observational studies: none of the notification treatments significantly improved SAV deployment compared to the control group. We explore the reasons for these findings and report on a survey among operators to identify ways forward. A portion of the operators indicate that they do plan to deploy SAV and ask for better notification mechanisms, training, and support materials for SAV implementation.

5.1. INTRODUCTION

Distributed Denial of Service (DDoS) attacks remain a significant challenge for network operators. In a 2019 survey by RIPE NCC of more than 4,000 participants, operators identified DDoS as the most critical security problem [3]. Attacks keep increasing in size. In February 2020, Amazon web services received the largest DDoS attack observed to date, which peaked at approximately 2.3 Tbps and lasted three days [117]. IP spoofing—sending Internet Protocol (IP) packets with a false source IP address—continues to serve

as a primary attack vector for large-scale DDoS attacks [118]. It is used in amplification attacks, where an attacker forges the victim's IP address in requests sent to systems that act as amplifiers, such as DNS or Memcached servers. These systems reply with larger responses than the request sent by the attacker, thereby congesting victim's network or server. IP spoofing is also used in SYN flood attacks, to obscure the origin of the attack traffic.

The scourge of IP spoofing has Internet Hall of Fame technologist Paul Vixie [7] to observe: 'Nowhere in the basic architecture of the Internet is there a more hideous flaw than in the lack of enforcement of simple source-address validation (SAV) by most gateways.' Over the last decade, a movement of sorts has emerged around a manifesto on routing security [13]. It aims to remediate this problem by encouraging network operators to adopt a best current practice referred to as BCP38 [77]. BCP38—also more generally referred to as SAV—defines a method for routers to validate the source address of every outgoing packet. A router should drop packets if the source address is not valid for the attachment point. Around 25-32% of the Autonomous Systems (ASes) tested by volunteers of the Spoofer project are reported to have problematic or wholly lacking SAV adoption [84].

This brings us to our main question: How can more operators be moved to adopt SAV? Earlier work on other security issues found that operators do act on notifications that report vulnerabilities or abuse in their networks, albeit to varying degrees [119]–[122]. Specifically for SAV, researchers at the Spoofer project recently reported that notifying operators boosted remediation rates by about 50% [84]. Their findings were based only on observational data. The authors argued that “ideally” one would undertake A/B testing to more reliably measure the effect of various interventions on remediation.

In this paper, we present the first randomized control trial (RCT, also called 'A/B test') for measuring the impact of notifications sent to 2,320 network operators on SAV remediation rates. This population is much larger than in any prior study on SAV. It is possible because we use misconfigured open resolvers as vantage points [79], [123]—a different technique to observe the lack of SAV adoption than the volunteer-based Spoofer project [9]. We include a control group in the design, which no earlier study on SAV did and which yields a crucial insight that puts the earlier findings in a different light: the improvements that [84] observed might be incorrectly attributed to the interventions.

Our study is novel in other aspects as well. We contribute to the research on notification mechanisms by conducting the first test of social and reciprocity nudges in the message design. In terms of channels, we test private messages to operators versus notifying national CERTs versus using geographically-organized Network Operator Group (NOG) mailing lists. Sending notifications to a public forum (NOG) has not before been tested in an experiment. Finally, we partnered with NIC.br, a leading Brazilian CERT, to have them deliver the treatment first-hand. CERTs are a trusted partner in the operator community and a critical player in the security notification ecosystem, yet it has not been measured if their notifications have more impact than those of researchers or security companies. We complement our experiment by a survey among operators, to help us interpret the findings and identify ways forward. In short: we conduct the largest and most rigorous study on improving SAV adoption to date, as well as advance the knowledge on notification mechanisms.

Our study reveals a painful and disappointing reality: there is no evidence of any remediation driven by any of the treatments, compared to the control group. This includes treatments that prior work has thought to be effective. Even for the notifications from the Brazilian CERT, the trusted entity, we found no effect compared to the control group. Importantly, we did observe some remediation across all groups, including the control group. It might explain why [84] did report an impact of their notifications. Since they had no control group, they could not see that the remediation they measured was not actually driven by the intervention. All in all, our findings are sobering but important, if we are to correct our understanding of these interventions and move forward on this critical issue. Our survey among operators helps us identify how. In sum, we make the following contributions:

- We present the first rigorous notification experiment with a control group that focused on network operators as the primary population to be incentivized to adopt more secure practices.
- We perform the first large-scale notification experiment to measure the impact of social and reciprocity nudges in the notification messages, the use of a public forum (NOG mailing lists), and a national CERT sending out the notifications. None of the treatments performed better than the control.
- We use a Cox mixed-effects model `therneau2000cox` to quantify the impact of network complexity factors and socio-technical country level effects on the deployment of SAV. Our results show that smaller networks with fewer edge routers are likely to implement SAV faster than larger networks.
- Our survey confirmed that notifying contacts registered in WHOIS does, in fact, mostly reach the operator staff responsible for implementing SAV. The reasons they give for not implementing it are a lack of time and technical expertise. About half of respondents do indicate that they plan to implement SAV in the future. To improve SAV adoption, the operators recommend better notification systems, training on SAV implementation and better supporting resources like software and technical documentation.

5.2. RELATED WORK

In this section we review the existing methods to infer the adoption of SAV among network operators, prior experiments that tested the effectiveness of security notifications, and literature on nudging.

5.2.1. METHODS TO INFER THE ADOPTION OF SAV

Previous work [9]–[11], [76], [80]–[82], [84], [124], [125] have proposed methods to detect networks that do or do not implement the SAV standard. They differ with respect to the direction of filtering, whether they infer the presence or absence of SAV, and whether the measurements can be performed remotely or from inside the network under test.

The Spoofer project [9], [80], [84], [125] develops and supports a client-server system based on volunteers that run the client software from inside their networks. The client

periodically sends and receives packets with spoofed source IP addresses to test if the SAV is deployed for both inbound and outbound traffic.

Lone et al. [76] described a remote method that relies on traceroute loops. When a packet is sent to a destination network with a routable but unallocated IP address space, it is forwarded back to the provider router, thus resulting in a loop. Such a packet should be dropped by the provider router as the source IP does not belong to the customer network. The main limitation is that it relies on a routing misconfiguration, and therefore coverage of the method is relatively small.

Müller et al. [10] and Lichtblau et al. [11] passively analyzed inter-domain traffic at large inter-connection points (IXPs) to detect networks not deploying SAV. However, the proposed methods need to overcome several challenges to be effective, such as analyzing noisy BGP data sources, AS relationship inference, and require collaboration with IXPs.

To detect the lack of SAV for outbound traffic, we implement a different method that does not require volunteers for vantage points inside the tested network and that enabled us to include a larger sample of operators in our study than prior work.

5.2.2. SECURITY NOTIFICATION EXPERIMENTS

There has been a rich stream of studies on the effectiveness of notifications to operators of networks, websites and DNS infrastructure. Cetin et al. [126] described how ISPs notified and quarantined customers who were running devices that were vulnerable to being abused in amplification DDoS attacks. They reported the quarantined users achieved very high remediation rates, around 87%, even though these devices did not pose a risk to the users themselves and the users could easily exit the quarantine.

In another study, Kühner et al. [82] sent notifications to the network operators about open resolvers, which provide amplification and redirection for DDoS attacks in their network. They were able to remediate 92% of the open NTP servers which supported `monlist`. They used various intermediaries, including national CERTs, Network Operation Centers (NOCs), and notifications using the open NTP project. They, however, did not compare the effectiveness of these channels.

Luckie et al. notified network operators who had not implemented SAV in their networks [84]. They initially contacted them directly using email addresses listed in the WHOIS. Subsequently, they sent monthly emails to NOGs identifying ASes in a given region with apparent gaps in SAV deployment. They observed around 48.2% of remediation took at least 1 month to deploy. Furthermore, they reported NOG was twice as effective as private notifications.

Our work comes closest to the study by Luckie et al. [84], since we also notify network operators who have not implemented SAV in their networks. However, their analysis of the impact of their interventions was based on observational data, not a randomized control trial. The lack of randomization and a control group makes causal inferences about the impact of notification on SAV deployment less reliable. Moreover, we also tested the significance of interventions using nudges and the impact of sending notifications through national CERTs on remediations. Another difference is that our study is based on a much larger sample [79], [123]. Our technique to detect SAV via open resolvers has two advantages over Spoofer data [84]: we find 10 times more providers that

are not compliant (Oct 2020–Feb 2021) and we are not dependent on volunteers, so we can reliably re-check the identified networks for remediation.

In summary, we present the first study using randomized control trial to measure effectiveness of notifications on SAV remediations. We also tested the impact of social and reciprocity nudges on compliance.

Notification Channels Previous studies have utilized various channels for reaching out to the network operators: the “abuse email” listed in the WHOIS database [127], physical letters [119], [128], and manually collected email addresses, postal addresses, phone numbers, and social media contacts [128]. Other studies used the authorized intermediaries, such as national CERTs [79], [122], [129], or clearinghouses, to deliver the notifications.

Max et al. [119] more than doubled the remediation rates for non-GDPR compliant websites (from 33.9% to 76.3%) by sending using physical letters instead of emails. Despite the effectiveness, sending notifications via post costs time and money: Maass et al. [119] spent around 5,000 Euros on postage alone to notify 3,997 non GDPR compliant websites. On the other hand, sending email using WHOIS record also presents challenges. Previous studies have experienced a bounce rate of over 50% in some cases [130], [131]. In our paper we prioritize contacts from peeringDB over WHOIS, where available. We explain this further in the methodology section.

5.2.3. BEHAVIORAL NUDGES

Behavioral science literature suggests that nudges and minor changes in the framing of a message may lead to a higher compliance with a recommendation and drive the behavior change [132]–[134]. For example, in the security domain, previous studies have found that nudges are effective in motivating users to choose stronger passwords [135], update software [136], and make better online privacy and security choices [137]. Some common nudges utilize social comparison, authority, and reciprocity mechanisms to influence behavior. Specifically, *social comparison* raises normative behavioral expectations by contrasting target individual’s behavior with the behavior of other people in their social group [138], [139]. Making a request on behalf of *authority* is another persuasion technique leading to higher level of compliance than requests made by someone without authoritarian power [140]–[142]. Finally, in social psychology, *reciprocity* indicates a social norm that encourages people to respond to a positive or kind action with another positive or kind action [143]–[146]. For example, in the ‘repeated helping game’ participants were more likely to provide costly help to other participants if they had received such help from them in previous rounds [147], [148].

In our study, we leveraged social comparison, authority, and reciprocity mechanisms in attempt to improve the effectiveness of notifications and nudge network operators to deploy SAV.

5.3. METHODOLOGY

We first explain the forwarders-based method for identifying operators who did not implement SAV. We then describe the experimental treatments and random assignment

method. Finally, we discuss the design of the post-RCT survey.

5.3.1. VULNERABILITY DISCOVERY

To identify networks that do not implement BCP38, we leverage a technique that uses misbehaving forwarding open resolvers as vantage points. It was proposed by Mauch [85] and later implemented by Kührer et al. [82] and Lone et al. [123]. Figure 5.1 illustrates the idea of the method. A Scanner (controlled by us) with IP 192.0.2.32 sends a DNS query to a misbehaving DNS Forwarder (with IP 203.0.113.54) to resolve the randomly generated `random.example.com` subdomain (Figure 5.1a). When the Forwarder receives the DNS query, it does not rewrite the source IP with its IP before forwarding it to a Recursive Resolver (e.g., 8.8.8.8) located outside the network under test. If the network hosting the vantage point has not deployed SAV, the forwarded query will reach the Recursive Resolver (Figure 5.1a: 2nd packet). The recursive resolver will perform a query resolution and return the query response directly to the Scanner under our control. Another possibility is that when the Forwarder receives a DNS query, it correctly rewrites the source IP address with its IP address and then passes it to the Recursive Resolver (Figure 5.1b). However, the forwarder sends the response from the recursive resolver to our scanner without rewriting the source address (Figure 5.1b: 4th packet). If the network does not implement SAV at the network edge, it will arrive at our Scanner with a spoofed IP address belonging to the Recursive Resolver.

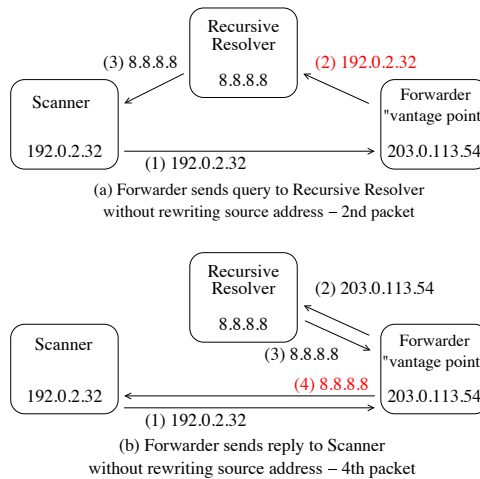

Figure 5.1: Methodology to infer absence of SAV using forwarding resolvers.

We performed Internet-wide forwarders-based scans of IPv4 space weekly between September 2020 and February 2021 to identify misbehaving DNS resolvers in each routable network. We mapped their IP addresses to their ASNs and inferred 2,433 ASes operated by 2,320 providers in 118 countries had not at least partially deployed SAV for outbound spoofing. We also used the Maxmind GeoIP database [100] to map the IP address of misconfigured forwarders to their respective countries. Finally, we extracted contact addresses of the ASes using `peer.ingDB` [149] and WHOIS [127]. We also identified the rele-

vant national CERT for each country using the APIs from FIRST [150] and SEI [151] and via manual search. The Spoofer project already sends notifications to NOG mailing lists. We utilized Spoofer's NOG lists to map IP addresses in each country to the relevant NOG mailing list, if one was available.

The study population is network operators where we observed a lack of SAV with the technique explained above, which we operationalized as ASes with unique WHOIS contact email addresses. If two ASes had the same contact email address, we would assume they belong to the same operator and collate them. So to put it differently: the study population consists of 2320 unique WHOIS email addresses representing that number of operators.

Limitations of remediation tracking Our data set that observes IP spoofing via misconfigured forwarders presents a few challenges to infer remediation. If a vantage point no longer shows up in our scan, this could mean the operator implemented SAV, but it could also mean the vantage point (temporarily) disappeared for other reasons. There could be DHCP churn [152], which means the forwarder's IP address changed, though this will be to another address in the operator's IP space. The user of the device could also switch it off. Or the operator could fix the misconfiguration, thereby making the device no longer send spoofed packets.

These factors mean that observations of spoofed traffic will appear and disappear also when there is no change in the adoption of SAV. If we have multiple vantage points for a network, then the impact of these measurement issues will be limited. Averaged across all weekly measurement cycles, we have more than one vantage point in 73% of all ASes. More importantly, the random assignment of our RCT design controls for this measurement problem. It will affect treatment groups and the control group more or less equally, meaning we can still reliably observe the impact of the treatments on remediation by looking at the difference among those groups.

To corroborate our findings on the presence or absence of SAV, we also included advice in the notification to run the Spoofer client, which can more directly observe SAV. However, only a small number of operators appeared to have done so (see Section 5.4.4). While Spoofer is more reliable, it requires volunteers to run the test and has lower coverage of networks than the open resolver-based method.

5.3.2. EXPERIMENTAL DESIGN

To explore the effectiveness of notifications, we designed a large-scale randomized control trial (RCT) experiment. In an RCT, the subjects are randomly assigned to control and treatment groups. The effectiveness of the treatments are then assessed based on the comparison of the remediation rate in each treatment group with the control group. If the treatment is significantly different than the control group, researchers can confidently conclude that the intervention was successful.

We designed eight experimental treatments along two dimensions: delivery channels and message content. Figure 5.2 illustrates our experimental treatments, which we will now describe in more detail.

In every treatment group, using the communications channel associated with that treatment (see 5.3.2), we sent notifications about the discovered vulnerability and pro-

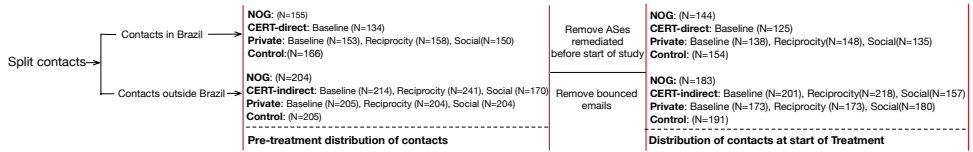

Figure 5.2: Random assignment process and experimental treatments. The number of operators assigned to each treatment is included in parentheses

vided recommendations to deploy SAV, along with a link to the test that revealed the vulnerability and additional resources about remediation strategies. Beyond this baseline, in the nudging conditions, we added additional short nudging sentences (see 5.3.2). We also shortened the version of the baseline text for the NOG mailing list, to be consistent with the Spoofer notifications.

One of the requirements of randomized control trial experiments is to prevent contamination between the treatment and control groups. To fulfill this requirement, we built a public-facing website with private links for each operator with information only about their own network.

5

Notification Channel Treatments

We used three channels to deliver our notifications: (i) direct emails to the operators; (ii) emails to the national CERT, with the request to notify the non-compliant operators in their country, including Brazilian NIC; and (iii) emails to NOG mailing lists. In Brazil, we were fortunate to be able to partner with NIC.br, a trusted institution in a similar position as the national CERT. While NIC.br assured us to send the notifications to Brazilian operators assigned to the CERT treatment, we did not receive such assurance from CERTs in other countries. Therefore, NIC.br presents a special case within the CERT treatment group.

Direct Emails The operators assigned to this treatment received the notification via a direct email. To find the contact addresses for ASes in our data set, we use the following process. We first check if there is a technical contact in either `peeringDB` [149] or `WHOIS` [127]. If both of them have an address and it is different, we prioritize the email address from `peeringDB`. We preferred `peeringDB` because it has been used in previous studies [153], [154] and they found the database up-to-date. If there are no technical addresses, we would use the listed abuse contact addresses, where we again prioritize the address from `peeringDB`. We preferred using the technical contact address, where possible, because we assumed that the odds would be higher to reach network engineering staff via that address rather than via the abuse address, which is managed by abuse handling departments. Implementing SAV requires reconfiguration of routers. This is better suited for the role of network administrators.

Notifications to CERTs In the second treatment group, we sent the notifications to national CERTs and requested they forward the notifications to the operators. We asked CERTs to use the text of notification that we designed for the operators, to preserve the

consistency of the notifications across groups (see Appendix A.1). Since this channel is indirect, it requires the cooperation of CERTs to forward our message to the relevant network operators. We have no way of ensuring that the messages were actually forwarded. This treatment leverages the CERT's role and reputation (or *authority*, as discussed in Section 5.2.3), so we can empirically measure whether they fulfill this role. We hypothesize that operators are more likely to take action if they receive a notification from CERT compared to an email from university researchers.

Notifications Directly from CERT As we explained earlier, we partnered with NIC.br, a trusted CERT entity in the Brazilian operator community that routinely sends notifications about vulnerabilities to operators. This allowed us to set up a separate treatment where the CERT itself would issue the notifications. In contrast to the CERT treatment outside Brazil, the messages in the Brazilian CERT treatment would be directly sent by NIC.br, in Portuguese, and from their official email address. We hypothesized that the notifications are more likely to have impact if they come from an entity trusted by the network operator community. This allowed us to perform the first experimental test whether messages from CERTs, a critical player in the security ecosystem, have more impact than those of researchers. (An earlier study [129] also sent notifications to CERTs, but these were meant to be forwarded by the CERTs to the final recipients, the same as in our 'notifications to CERT' channel (b). The researchers could not ascertain if the CERTs actually forwarded the notifications.) To limit the effort required from NIC.br, we asked them to conduct only one treatment. This is consistent with how we approached all other CERTs: each received only a single treatment and a single message to forward to operators. Different CERTs were assigned to different treatments.

Notifications to NOGs In the third group, we bundled our notification with the Spoofer notifications sent by the NOG lists. The Spoofer project measures the absence of SAV using a client-server application [84]. The project has been sending monthly emails since Dec 2018. The operators are used to these messages and already know that it is about missing SAV. In terms of what operators are covered by either data set, the Spoofer data has minimal overlap with our open-resolver data. We discuss the comparison in more detail in the section 5.4.4.

The advantage of bundling the notifications and combining the measurements is that it saves network operators from receiving multiple emails about the same problem. Moreover, we hypothesize that publicly identifying the ASes on NOG mailing list would encourage them to deploy SAV more than when they receive this message through a private channel.

Nudging Treatments

In the CERT and private-email treatment groups, we differentiated our messages by incorporating specific nudges aiming at further motivating network operators to implement SAV. We created three conditions in each group: (i) the baseline message, which only contained the guidelines for the operators to understand the issue and how to fix it; (ii) the baseline message plus a social nudge; and (iii) the baseline message plus a reciprocity nudge. The full text of notifications is included in Appendix A.1.

In the social nudge condition, we urged the operators to deploy SAV and pointed out that most providers have already done so. To this purpose, we added following text to the content of the notification: “Note that 75% of network operators in the world already deploy BCP38 in their networks. Deploy BCP38 in your network to become one of them.”

In the reciprocity condition, we asked the providers to return the favor to operators who did implement SAV, thus reducing the attacks on everyone else, including the recipient. We added the following text to the baseline message: “Note that your network is receiving fewer DDoS attacks because other networks have deployed BCP38. Return the favor - deploy BCP38 in your network to make the Internet more secure.”

We chose encouraging (positive) framing of the nudges to the providers, rather than ‘naming and shaming’ (negative), because positive framing has been shown more effective in driving behavior change than negative framing [155]–[157].

Treatment Group Assignment

We use the data on the operators who lack SAV from October 2020 and randomly assign them—or more precisely, the unique WHOIS contact addresses for the ASes—to the experimental groups. We first separate the population in Brazilian and non-Brazilian operators (Figure 5.2). The special Brazilian CERT treatment meant we needed to randomly assign the Brazilian operators separately from the rest of the world. Then in both branches, we randomly assigned each operator to a treatment or control group. We had five treatment groups and one control group for the Brazilian sample, and seven treatment groups and one control group outside of Brazil. The treatments are the same, except for the CERT group, which outside of Brazil includes two additional treatments for the social nudges. In total, we apply eight different treatments.

We had to modify the assignment process since CERT and NOG treatments operate at country-level: instead of assigning the operator contacts, we assign a country to a treatment group. The process becomes complicated since we want to have a balanced population across treatments, and the number of operators in each country is not the same. We designed our solution based on a best-effort algorithm to distribute contacts among different groups. We run the algorithm separately for contacts in Brazil and contacts in other countries. In each assignment, our random algorithm first validates if it can assign the contact to the treatment group. This is not always the case for the CERT or for a NOG treatments. For a few countries we have no contact point for a national CERT or for a NOG mailing list. If, for a specific operator, we have no CERT or NOG mailing list in our data set, the algorithm randomly selects another operator.

Under some conditions, the randomization could lead to unbalanced assignments. Stratification would then be used to ensure balanced treatment groups. However, methodological studies [158] have shown that in moderate and large samples, like ours, random assignment and stratification achieve similar variances. Furthermore, we checked various network and economic factors after the assignment to determine if the groups were in fact balanced. We statistically tested the group differences using ANOVA for: average AS size (i.e., number of IPv4 addresses calculated using longest matching prefixes in BGP announcement per AS), number of misconfigured forwarders, number of countries, number of stub ASes, membership of MANRS, Gross Domestic Product, and ICT Development Index assigned to each group. We found no statistical difference between the groups, which means they were similar for these variables.

Preventing Treatment Spillover

We designed the study to prevent contamination between the treatments. We built a website with an interface to the data on the non-compliant IP addresses and ASes. It also includes a detailed explanation of our methodology to infer the lack of SAV aided by dynamically generated diagrams containing misconfigured IP addresses and information on how to reproduce the result.

The website segments the information for different groups and recipients and does not contain any information for the control groups. We created separate sub-domains for CERT, NOG, and privately communicated treatments. We then generated unique URLs for each subject in the treatment. To prevent contamination within the private group, we sent individual links in our notification. The URLs only gave them access to the misconfigured IP addresses mapped to their ASes.

Similarly, we drafted a message for the CERT to forward to the ASes assigned to them. We instructed CERTs to append the AS number at the end of the URL to create a unique link for the operator they are contacting. Operators notified by CERT could potentially tinker with the URL to find information about other operators assigned to the CERT group. However, they cannot find information about other treatment groups since a different sub-domain segregates them.

The notification to the NOG contains all the ASes and IP addresses assigned to the notified NOG. They cannot view operators assigned to other NOGs, since they are segregated via unique URLs. NOG treatment was likely to be seen by some operators in other treatments, but the NOG message had no information on operators in those other treatments. The website had no data on the control group.

5.3.3. NOTIFICATION PROCEDURE

We launched our first campaign on Oct 8, 2020 and sent notifications to 2,563 operators, and continued to conduct weekly scans to observe the remediation of IP spoofing. For operators that did not remediate, we sent a second message on Dec 8, 2020. We analyzed the remediation data until Feb 28, 2021. This meant that operators had about four months to implement SAV since our first notification.

Of all our emails, 102 (4%) bounced. In those cases, we retried with an alternate email address where possible, and reached additional 30 contacts. Eventually, we removed 72 contacts which we could not reach. Around 97% of our emails reached the recipients, which shows our approach to prioritize peeringDB and technical contacts gave improved reachability compared to previous studies, where in some cases the bounce rate was over 50% [130], [131]. In most cases, we got an automated reply that confirmed they had received the email and a ticket has been opened or someone would follow up. The German CERT copied us in cc in the forwarded notifications to the operators.

5.3.4. POST-EXPERIMENT SURVEY DESIGN

To further understand the challenges in deploying SAV and contextualize the interpretations of our experimental findings, we designed a short survey aiming at collecting feedback from the operators. The survey has four main objectives. First, to understand the security challenges faced by network operators and what role SAV and DDoS play among them. Second, to understand if the notification has reached the correct contact

person and preferable method for providers to receive similar notifications. Third, to understand the challenges in implementing SAV and whether the content of our notifications and referenced resources were sufficient for operators to deploy SAV in their network. Finally, we wanted to solicit suggestions on how to improve the notification process in general. Our survey was partially inspired by Lichtblau et al. [11], who in 2017 surveyed network operators about the impact of spoofing on their network, their filtering strategies, and challenges in the adoption of SAV.

In the survey, we asked participants about four main topics: 1) what security issues they believe their networks have, and how they discover them; 2) whether they have implemented or have planned to implement SAV and a subsequent question on their chosen methodology to deploy filtering from operators with SAV 3) who is responsible for implementing SAV in their organization, and whether the issue was escalated to the responsible entity; 4) whether MANRS guidelines provide sufficient information on how to implement SAV, what other strategies can help achieve better compliance, and how would network operators prefer to be notified about IP spoofing issues. The full questionnaire is included in Appendix A.2. As compensation for their valuable time and comments, we offered all respondents a 50 Euro gift card through a raffle with a 1:15 chance of winning. Participants were offered an option to stay anonymous and let us donate the prize to a charity.

5

5.3.5. ETHICS

We had a detailed discussion with the university's IRB and received clearance to conduct the notification experiment and the survey. Our study followed all the active monitoring guidelines for ethical network measurement research [159], including creating a web page running at the IP address of the scanner, communicating with Internet response teams, and providing an opt-out option for operators.

We conducted our own scans since there is no existing public dataset that reveals non-compliance for SAV using our methodology. It is important to note that our scans are different from scans that aim to detect open resolvers, since we track responses that arrive from a different source IP address than the probed address. This means we cannot use existing data from open resolver scans conducted by Shadowserver and others. We randomly distributed our queries across the IPv4 address space, so the scanner does not consistently query the same AS before moving on to the next one. Furthermore, in line with the Menlo report [160], we considered that the marginal negative impacts of these measurements are outweighed by the beneficence of improved SAV adoption and reduced spoofed attack traffic.

We only received two requests to opt-out and we immediately removed their IP ranges from the study. The content of the notification has a positive framing as we wanted to encourage the providers to deploy SAV. So even in public notifications (NOG), we did not 'shame' them for not implementing SAV.

Finally, we asked for consent from providers at the start of the survey and explained to them that we will anonymize their responses before publishing them. We offered compensation in the form of a lottery with gift cards. If they did not want to receive gift cards due to the nature of the job or for any other reason, we gave them an option to donate the amount to a charity and stay anonymous.

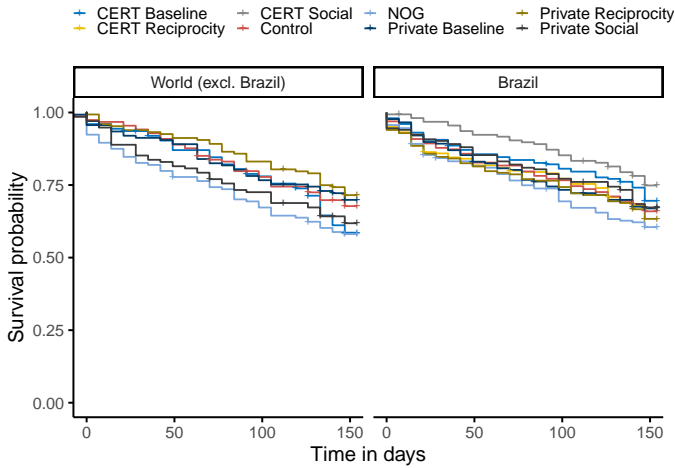

Figure 5.3: Contact remediation survival plots for organizations in World excl. Brazil (left) and in Brazil (right).

5.4. RESULTS

In this section, we analyze the impact of our notifications on remediation rates across different treatment groups. We start by examining remediation at three different levels: organization, AS, and prefix level. Then, we compare the remediation rates between CERTs and NOGs.

5.4.1. ORGANIZATION-LEVEL REMEDIATION

We start the analysis at the organizational level. Organizations can operate multiple ASes and while the SAV compliance can differ per AS, the decision to implement SAV can be driven by organizational policies. Therefore, we bundled the ASes with the same contact email address together as they are most likely sibling ASes under the same administrative domain. Thus our unit of analysis is contact email addresses for the ASes. Our data set contains 200 (8.6%) contacts with more than one AS registered in WHOIS.

We only consider remediation as successful if all ASes under the contact email address do not appear in our scans after we have notified them. It is a high bar to pass since it might miss partial compliance, where providers might be remediating some ASes in their network or just a part of their AS.

To understand the differences across the groups, we compute the Kaplan-Meier survival curves per group as shown in Figure 5.3. On the y-axis, we have the probability of an organization deploying SAV t days after they received the notification (x-axis). This is estimated taking into account the number of organizations that had deployed SAV at time t divided by the total number of organizations that had not deployed SAV at time t . Overall, the survival curves show the same downwards trend for all the groups including the control. In Brazil, the NOG and Private Social groups do slightly better: they remediated 10% and 6% more than the control group, respectively. In the rest of the countries, networks in the NOG group remediated 5% more than in the control group.

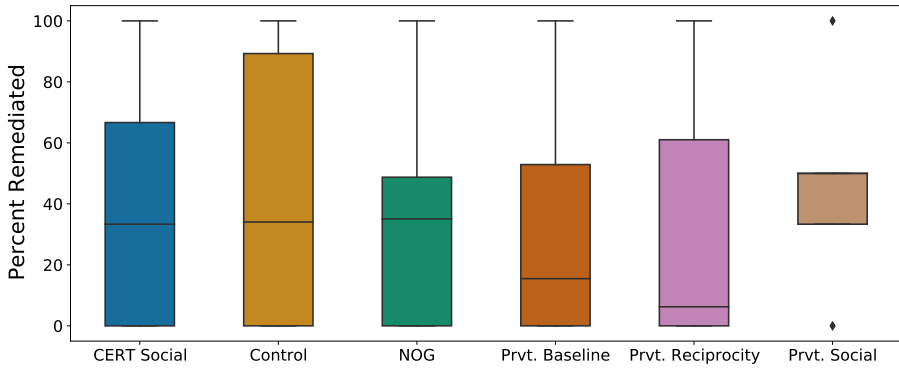

Figure 5.4: Remediation per treatment group for countries that also received a notification in CERT Social group.

5

To check whether these differences in remediation rates are statistically significant, we ran the log-rank test comparing the survival curves of the control group with the treatments. It tests the null hypothesis $H_0 : S_1(t) = S_2(t)$ for all t where the two exposures have survival functions $S_1(t)$ and $S_2(t)$. We consider (≤ 0.05) as statistically significant. Confirming our initial visual observations, most of the groups did not have significantly different remediation rates. Only the result for the NOG group in Brazil is weakly statistically significant ($p = 0.049$). However, in light of how many treatments we tested, a 1 in 20 probability of this outcome being due to chance, is actually quite plausible. So we do not see this as enough evidence of an impact of that treatment group.

For all countries except Brazil, we also observed the CERT Social group remediated slightly slower ($p = 0.043$) than the control group. To understand why the CERT Social group remediated slower than the control group, we investigated the distribution of organizations at the start of our analysis in Figure 5.2. There are 34 (17.8%) fewer contacts in the CERT Social group than in the control. Hence, the baseline probability of remediation is also lower. Some network operators might have upgraded their routers or policies, which we count as baseline, or natural, remediation. In Figure 5.4, we compare remediation in the CERT Social group with other groups. We observe that remediation for contacts in the CERT Social group is similar to the control, NOG, and Private Social groups. Moreover, the average remediation in the CERT Social group is around 54%, while the average is only slightly higher for the rest of the countries (58%). In short, we can conclude that remediation in the CERT Social group is worse than in the control group mainly due to sampling differences.

5.4.2. PARTIAL REMEDIATION

An organization can choose to implement SAV for a few ASes but not for all the ASes they operate. Multiple ASes could also be managed by different teams, especially if these are located in different countries. Similarly, due to technical reasons like ASes not being stub or multihomed networks, operators might not be able to implement SAV in their entire network. To further investigate this, we analyzed partial remediation measured as the

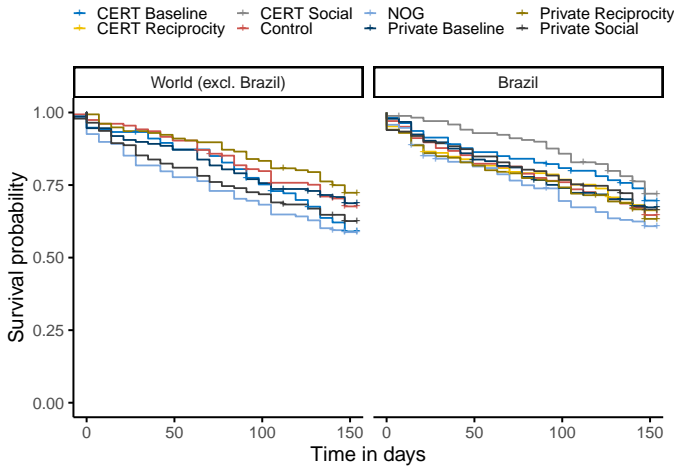

Figure 5.5: AS remediation survival plots for ASes in the World excluding Brazil (left) and in Brazil (right).

number of ASes and prefixes within an organization that implemented SAV within the study period.

AS-level remediation: Figure 5.5 shows the survival curves using ASes as unit of analysis. The results are almost identical to the organization-level results. The global remediation rates are not significantly different between the treatments and the control group. Only the ASes in NOG group in Brazil remediate significantly faster than the control group ($p = 0.05$).

Prefix-level remediation: Remediation can also occur at the prefix level, having both SAV compliant and non-compliant prefixes within the same AS. Figure 5.6 shows the survival curves of remediation using BGP prefixes as unit of analysis. Similar to both the organization- and AS-level remediation, we observe no significant difference between the groups. Again, the only exception is the NOG group which remediated slightly faster than the rest of the groups.

5.4.3. MAIN EXPERIMENTAL EFFECTS

In this section, we analyze the differences in remediation rates across different experimental groups. We use relative risk ratio (RR) as a descriptive statistic to measure the probability of deploying SAV in one group compared to the probability of deploying SAV in the other group.

IMPACT OF THE CERTS GROUPS

We further compared the remediation across the CERT groups. Our motivation was to explore if there are significant differences between national CERTs. We calculate relative risk ratio between each pair of CERTs. In simple terms, this ratio produces a factor by which one CERT is different from the other in terms of remediation rate.

Figure 5.7 only displays the countries for which risk ratios—the differences in remediation—were significant. We determine the significance by looking at the confidence intervals

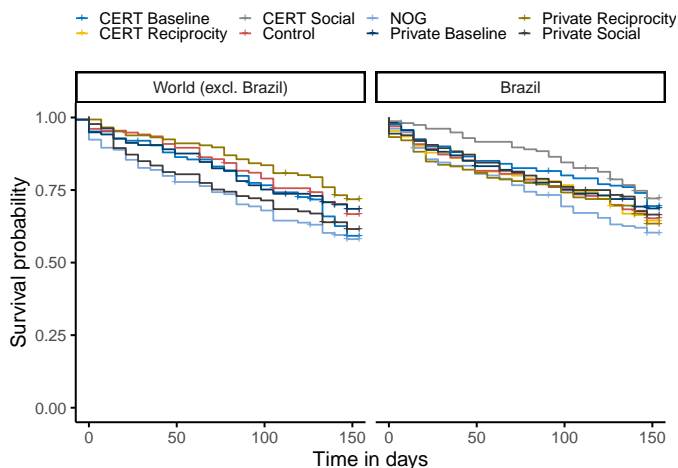

Figure 5.6: Prefix remediation survival plots for World excluding Brazil (left) and in Brazil (right).

5

(CI). If the CI includes the value 1, the RR is not statistically significant. If CI contain 1, it would mean that the relative remediations have no difference [161]. We interpret the figure row-wise for each national CERT. For instance, France had 4.2 times higher remediation rate than Argentina. In our sample, only networks in France, Iran, Iraq, and the Netherlands assigned to the CERT group were more likely to remediate than the other countries.

IMPACT OF THE NOG GROUP

We also calculated the relative risk ratios between the countries assigned to a NOG experimental group. Figure 5.8 only shows the countries that significant differ in remediation. We used the confidence intervals to determine the significance as explained earlier. Germany, France and Lebanon NOG's were more likely to remediate than other countries outside of Brazil in our sample. The RR for Brazilian NOG did not have any significant value, which in other words means that ASes in Brazilian NOG did not remediate more than other countries.

IMPACT OF NUDGES ON REMEDIATION

We explore the effectiveness of adding social and reciprocity nudges to the baseline text of notifications on remediation rates. We aggregate data for each of the nudging conditions (baseline, social, and reciprocity) from the different treatment groups and compare them against the control group. In Table 5.1, we show the relative risk of remediation with reference to the control group. All of the nudges have a relative risk of around one compared to the control, which shows the nudges did not significantly impact remediation. In other words, operators that received the notification with a nudge were as likely to remediate as operators in the control group.

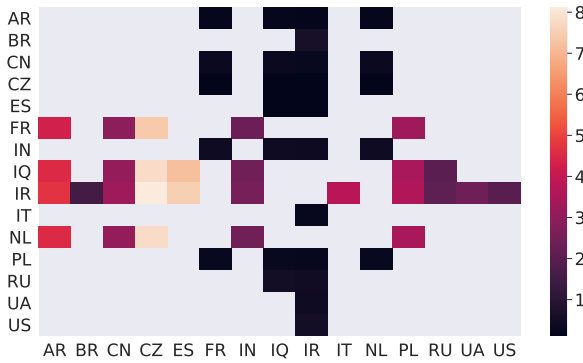

Figure 5.7: Relative risk ratios among countries in the CERT group. Only the countries with significant risk ratios are displayed.

Table 5.1: Risk Ratios for nudging conditions compared to the control group

Group	Remediated	Exposed	RR	CI
Control	112	345	-	-
Baseline (no nudge)	206	637	0.99	0.82-1.2
Reciprocity nudge	175	539	1	0.82-1.22
Social nudge	150	472	0.97	0.80-1.19

5.4.4. COMPARISON WITH SPOOFER

We requested operators to run the Spoofer tool [84] to validate if they have correctly deployed SAV. A total of 1,670 ASes submitted tests using the Spoofer tool in the study period (Oct 2019 - Feb 2021). While we cannot know if our request caused the operators to use Spoofer tool, the overlap between the ASes from the Spoofer tool and our methodology is around 12% (296 ASes). It signifies that our experiment did not get contaminated because of the Spoofer project. Note that the Spoofer project sends monthly notifications to NOG lists and often gets presented at conferences. MANRS also recommends using the Spoofer tool to test SAV deployment [162].

We also analyzed the remediations reported by the Spoofer tool [84]. In total across all Spoofer measurements, 98 ASes in Spoofer data implemented SAV in their network during our study period (Oct 2020 - Feb 2021). Of these, 22 ASes overlap with our measurements and 5 of them are in the control group. Since we did not send notifications to the control group, this clearly demonstrates that there is some natural remediation occurring. It is important to note that we sent notifications to 2,563 ASes which had not deployed SAV, while during the study period, the Spoofer dataset revealed only 248 ASes without SAV.

We can conclude from these results that there is limited evidence that operators acted upon our notifications. Moreover, positive remediation rates in the control group signals that factors other than our interventions influenced SAV as well.

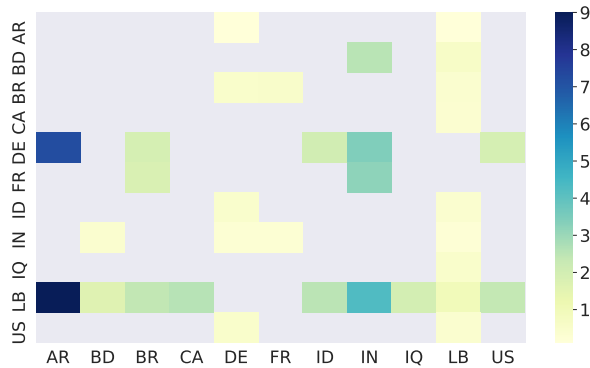

Figure 5.8: Relative risk ratios among countries in the NOG group.

5

5.5. FACTORS AFFECTING REMEDIATION RATES

Multiple factors could have affected remediation rates. Such factors could range from the size and complexity of the network, to the lack of budget and/or expertise. In this section we first identify potential factors that might have an impact on SAV implementation rates, and then quantify this impact through regression analysis.

In response to our notifications, three operators requested additional guidance or information. For instance, one operator claimed that his network was fully compliant. However, in further discussion, with the evidence from the measurements, he acknowledged that part of his network was recently upgraded and was not compliant. The operator subsequently implemented SAV in the network and did not reappear in our measurements. Other operators showed signs they lacked SAV knowledge. For example, two operators did not fully understand our measurement methodology and thought that we were notifying them about open-resolvers in their networks. We responded with a detailed explanation of our methodology. We did not receive further responses.

This anecdotal evidence suggests that lack of information or knowledge could have influenced the operators' decisions to not implement SAV in their networks. There could also be socio-technical reasons for non-compliance, such as operators in countries with low GDP based on Purchasing Power Parity (PPP), lower Internet penetration, and limited learning opportunities. To further understand the impact of these factors, we built a Cox proportional hazards model with mixed effects. At the multivariate level of analysis, we performed a two-level Cox proportional regression analysis to examine the effects of AS- and country-level characteristics on SAV implementation rate, and to determine the extent to which characteristics at the AS and country levels explain variations in SAV implementation rates. The multi-level Cox proportional hazards model allowed us to account for the hierarchical structure of the data. We hypothesize that ASes are nested within countries with different socio-economic characteristics. This suggests that ASes with similar characteristics can have different SAV implementation rates when operating in countries with different characteristics.

Using the multi-level Cox proportional hazards model, the probability of implement-

ing SAV after receiving the notification was regarded as the hazard. We assessed the assumption of proportional hazard using visual inspections of graphs and statistical tests based on weighted Schoenfeld residuals. Two-sided p-values (≤ 0.05) indicated statistical significance. As explanatory variables we used socio-technical factors and a set of factors derived from the operators' email responses, including the following:

CERT: boolean variable. True if the notification was sent to the national CERT, False otherwise.

NOG: boolean variable. True if the notification was sent to the NOG, False otherwise.

Private: boolean variable. True if the notification was sent to the technical contact email address of the AS, False otherwise.

AS size: numerical variable. We estimated the size of an AS by counting the number of advertised IPv4 addresses. We calculated the size using BGP data from Routeviews project [99]. We used weekly data for Oct 2020 and calculated the average IP space advertised by the ASes in our data set.

ISP: boolean variable. True if the AS belonged to an Internet Service Provider, False otherwise. To check whether an AS is used by an ISP we leveraged Telegeography: the GlobalComms database [94]. The database contains a highly reliable overview of the main broadband ISPs in each country, drawn from annual reports and market filings. The database contains details of major ISPs in 84 countries.

Edge Rtr: numerical variable. This variable is calculated by counting the number of edge routers of an AS. We used CAIDA's Internet Topology Data Kit (ITDK) for March 2021 [163] to count the number of border routers per AS. The ITDK consists of routers and links observed in traceroute data collected from multiple vantage points, alias resolution to identify which IP addresses belong to the same router [164], and a mapping from router to AS heuristically inferred using bdrmapIT [165]. We counted the number of border routers for ASes in our dataset connected to other ASes.

Stub: boolean variable. True if the AS is stub, False otherwise. We used Caida's AS relationship data [166] to determine if the ASes in our data set are stub or not.

IDI: numerical variable. This variable represents the ICT Development Index (IDI) which is provided by ITU (United Nations International Telecommunication Union) and represents ICT development per country [95]. It assigns values from 1 to 10 to each country, with a higher value representing a higher level of development based on various ICT indicators.

In Table 5.2, we present the results from the Cox model. The parameter estimates reported in the *est* column are log-hazard ratios. Their exponentiation produces hazard ratios. P-values indicate the statistical significance of each factor.

The notification channels did not impact significantly the implementation of SAV. Interestingly, only the NOG group has a positive coefficient which indicates that ASes that received a notification via this channel have higher probability of remediating than those in the control group. In particular, the hazard ratio for the NOG group is $\exp(0.23) = 1.25$. Therefore, notifying operators via NOG increases the probability of remediation by 1.25 times compared to ASes that received no notification.

Regarding the impact of AS size on SAV deployment, the argument can be made on both sides. For instance, bigger networks are more likely to have more resources to im-

Table 5.2: Cox mixed-effects model with random effects for countries.

Parameter	Est	Std.err	P-value	CI
<i>Fixed effects</i>				
CERT	-0.06	0.12	0.60	[-0.29; 0.16]
NOG	0.23	0.13	0.07	[-0.02; 0.48]
Private	-0.02	0.11	0.85	[-0.23; 0.19]
ASsize(ln)	-0.06	0.03	0.02	[-0.11; -0.01]
ISP	0.12	0.17	0.48	[-0.21; 0.44]
Edge Rtr(ln)	-0.05	0.02	0.00	[-0.08; -0.01]
Stubs	0.33	0.10	0.00	[0.13; 0.54]
IDI	-0.05	0.03	0.15	[-0.11; 0.02]
<i>Random effects</i>				
Group	Variable	Std Dev	Variance	
Countries	Intercept	0.217	0.04	

plement SAV. On the other hand, smaller networks are likely to have less complex networks and hence require relatively simpler configurations to implement SAV. In our results, we observe that smaller ASes were more likely to implement SAV in their networks. In particular, a 10% increase in the size of an AS, holding all other variables constant, was associated with a 5.82% decrease in the probability of SAV deployment.

The number of edge routers also decreases the probability of remediation. Network operators use multiple links to load-balance the traffic and avoid a single point of failure. To remediate, operators have to implement filtering policies near all edge routers. We found that networks with fewer edge routers were more likely to remediate after being notified. In particular, a 10% increase in the number of edge routers in an AS, holding all other variables constant, was associated with a 4.87% decrease in the probability of SAV deployment.

There could be technical reasons preventing network operators from implementing SAV in their network. One factor could be having a non-stub or a transit AS. A customer of non-stub AS might not announce all routes to a provider because the AS is a customer of other providers as well. Hence, it is not technically feasible for provider ASes to apply strict filtering policies on their network [77]. We find that stub networks have 1.4 times higher remediation rate than the control group (holding all other variables constant). The country-level effect, an estimated intercept (excess risk) for each country, has a standard deviation of 0.21. This means that countries that are 1 standard deviation or more above the mean SAV remediation rate will have 1.24 times faster remediation rate than the norm, a modestly small country-level effect.

The other factors we considered did not significantly impact the remediation. One could hypothesize that ISPs would be more likely to implement SAV in their network since most end users are behind their networks and can be abused for an attack. While the hazard ratio sign indicates such relationship, we did not find statistically significant difference in remediation rate for networks that are ISPs compared to the control group. Finally, socio-economic factors defined by the ICT Development Index (IDI) did not influence the remediation, suggesting that the economic situation of a country has no im-

pact on the remediation hazard.

In summary, we can conclude that network complexity plays an important role in remediation, i.e., the networks that are smaller in size and have fewer edge routers are likely to remediate faster. Similarly, stub networks are more likely to implement SAV faster in their network compared to non-stub.

5.6. SURVEY RESULTS

To gain additional insights and feedback from the participants, we sent out the survey one month after our final notification. We sent a reminder to participate in the survey to non-responders after waiting for a month. We received responses from 32 network operators (less than 2%). While sample size does not allow us to make statistical comparisons between treatment groups, we believe that survey responses provide useful clarifications for interpreting our results.

Vulnerability Awareness Ninety percent of survey respondents knew they had not deployed SAV, either because of the Spoofer tool test (30%), notifications from security researchers (20%), from NOGs (20%), from CERTs(10%), or based on their prior knowledge (10%). The remaining 10% were not sure if their networks deployed SAV.

SAV Implementation Although 90% of respondents were aware that their network lacked SAV, more than half (52.7%) of the respondents reported that they have no filtering in place. Another 17% reported only partial implementation on some segments of the networks. Only 26% have implemented SAV throughout their network, and 4% were not sure.

More than half of respondents (53%) filtered out packets with a source IP address within private address space (RFC1918), so that only packets with a source address from routable IP space leave their network. It is important to note that filtering RFC1918 is simple as it has static address space and the filtering mechanisms are widely available. Lichtblau et al. [11] reported 70% of participants in their survey filtered RFC1918 addresses.

Moreover, 30% of respondents deployed SAV on routers that were customer-facing, 11% on their stub ASes, and 6% deployed SAV towards peering/IXP interfaces as well. In other words, they have deployed SAV in user space and those IPs cannot be abused to send spoofed traffic.

When we asked participants if they planned to deploy SAV in the future, we received mixed responses. Around 42% said that they were planning to deploy SAV, 33% had no plan, and 25% were not sure. One provider also sent us an email in response to our notification, saying that he acknowledges the issue and will get back to it after implementing another security practice (RPKI) in his network. Given that non-compliance is not an active “battleground,” it is likely that some providers assign SAV deployment to a lower priority compared to other network issues, but they might return to it later. However, we still think that 4 months we gave to the participants provided sufficient time to plan and remediate the issue, yet, we did not observe a significant impact on the outcome.

Notification Targets It is possible that despite awareness, the respondents did not implement SAV, simply because they are not responsible for it. We wanted to confirm whether we reached the operator staff responsible for implementing SAV. There could be multiple reasons for not reaching the operator staff responsible for implementing SAV. For instance, 83% of the contacts we notified only had the address of the abuse mailbox. The abuse team is generally responsible for threats like spam, malware, and phishing campaigns from or towards the network. In cases where operators are not responsible, they may have another team performing network configurations.

However, a large majority (67%) of respondents said that they were responsible for implementing SAV. Only 13% said that they were not responsible, and 20% did not know what SAV is. Subsequently, respondents that believed they were not responsible for SAV said they did not escalate the issue to the responsible contact.

Reasons for Non-Compliance We also asked operators why they had not implemented SAV in their networks. 30% of the respondents lacked the technical knowledge on how to perform filtering, and 30% lacked time to implement SAV. Another 18% were concerned that implementation may cause downtime or other performance issues. 12% mentioned technical reasons (multi-homed network, non-stub network) for not implementing SAV. Finally, 6% of the respondents thought that SAV is ineffective in addressing the attacks that use spoofed source addresses.

We can conclude from the survey results that the main reasons for non-compliance are driven by misaligned incentives and lack of knowledge, which are relatively easy to improve, compared to the concerns related to downtime, performance, or technical limitations.

Respondents' Suggestions for Improvements In the final section of the survey, we asked participants for suggestions about possible improvements in the notification process. We sent MANRS guidelines [167] as part of our notification. About 73% of the respondents said that MANRS had sufficient information explaining how to implement SAV. However, 23% were not sure, and 4% said that MANRS does not provide sufficient details. They explained that the guide currently provides configurations only for CISCO and Juniper routers, and needs to cover configurations for other brands of routers as well. For example, one of our respondents said they used a Mikrotik router, which is not covered in MANRS.

One respondent suggested to create a dedicated channel for SAV notifications, where operators can also discuss technical difficulties in implementing SAV. 64% of the respondents requested more community-driven seminars that discuss SAV implementation. Finally, 36% of respondents suggested that routers should provide user friendly configurations to implement SAV.

While the sample size of our survey does not allow us to extensively generalize the results, it still provides valuable insights. We provide recommendations for improving the notification process and policies for SAV compliance in section 5.7.

5.7. DISCUSSION & CONCLUSIONS

In this section, we interpret our results, discuss issues that might have played a role in low remediation, and present future avenues for improving both notifications and SAV adoption.

5.7.1. TREATMENT EFFECTS

Except for the Brazilian NOG group, there are no significant differences when comparing remediation between the treatments and the control group. There can be multiple reasons why the Brazilian NOG group had higher remediation rates than the control group. First, operators that have subscribed to a NOG show their willingness to understand and discuss network challenges. Second, it creates peer pressure because the names of ASes are publicly available, while they can ignore the private communication. Finally, operators might trust the NOG channel, since the communication was part of the already known Spoofer project [84].

5.7.2. REMEDIATION IN THE CONTROL GROUP

We also observed remediation in the control group, where we did not send any notifications. There could be several reasons for that. First, some network operators might have upgraded their routers or policies, which we count as a natural remediation.

Second, some operators might have read articles or attended conference talks or seminars about current routing issues, which could have urged the operators to adopt SAV. For instance, in the RIPE meeting in Oct 2020, with more than 1200 participants, MANRS presented their initiatives about routing security, including available resources to deploy SAV [168]. SAV is also discussed in various network operator conferences and channels, which might have further encouraged the adoption [169]–[171].

Finally, the MANRS program, which encourages members to be SAV compliant, has been very active in the recent years. They provide resources in the form of documentation, tutorials, and seminars to help network operators deploy best security practices. They reported that their members doubled in 2020, reaching 588 by the end of December 2020 [172].

While there can be many factors driving natural remediation, they affect all treatment and control groups equally. So we can still have confidence in our conclusions about the null effect of the treatments. This is the essence of the random assignment process: it neutralizes the impact of confounding factors.

5.7.3. COMPARISON WITH PREVIOUS STUDIES

Even though previous studies showed some success with large-scale notifications, our results show little to no impact. We attribute these to the following factors.

Complexity: Complexity can play a vital role in the success of notification studies. SAV requires significant time and expertise and can cause downtime if not correctly implemented. Previous studies ([129], [173], [174]) notified hosting providers and users about compromised websites which usually requires fixing the access privileges or removing malicious files. Similarly, other experiments [175], [176] notified web admins about misconfigurations or best practices for their domains. To properly configure their

web server, the domain owners usually have to follow a set of simple steps in the notification. In comparison, SAV requires a thorough understanding of the network. The configurations and types of routers make it difficult to provide a similar guide. Finally, the recipients of the notification might need to escalate the issue to senior network operators since it requires downtime, and misconfiguration can cause major disruptions.

Target Audience: Multiple studies notified network operators about routing and security issues [82], [84]. However, none of these had a control group, which is required to reliably assess the effectiveness of remediation. Our study is the first one that focuses on network operators and performs a randomized control trial. Previous studies using RCTs either sent notifications to the domain owners [129], [173], [174] or to the network operator about compromised user devices [126]. In those cases, the operators are only asked to forward the message. They do not incur the main cost, as they rely on their users to remediate the problem.

Liability and incentives: The incentives of treatment subjects in our experiment is different from most operators of vulnerable or compromised resources. The benefits of implementing SAV flow to the rest of the Internet, not the operators themselves. The network implementing SAV is still vulnerable to DDoS attacks from other networks. In terms of liability, a prior study had found higher remediation rates because of legal consequences [119]. However, there is no liability on operators prevent spoofed traffic from leaving their network.

Language of Notification: We sent out our treatments in English, except for those administered by the Brazilian CERT, which were in Portuguese. Notifications in network operators' native language could have improved the effectiveness of interventions. However, our study found no impact of the language difference. This is consistent with earlier work where more languages were included in a notification experiment, which also found no impact on remediation [122].

Awareness of Vulnerability: There has been a significant effort by the security community to deploy SAV over the last several years [84], [162], [177]. It is possible that some network operators already know through notifications from the Spoofer project that their network is non-compliant and have either ignored prior notifications or cannot deploy SAV due to technical limitations. That said, it is important to note that our dataset is very different from that used in the Spoofer-based campaigns, the main notification effort in this area. This dataset has not been used in previous notification campaigns.

5.7.4. REASONS FOR NON-REMEDICATION

Our survey results found that 57% of respondents did not follow the recommendation to implement SAV, even though they confirmed we reached the right recipient in most cases. It contradicts previous work [11], where only 24% of the operators mentioned that they did not implement SAV in their networks. One possible explanation is that Lichtblau et al. [11] contacted only NOG members. The operators who have subscribed to the list are likely more aware of security challenges and willing to adopt best practices.

Our survey results revealed several reasons for non-compliance. Perhaps surprisingly, awareness about IP spoofing and the absence of responsibility for router configurations are not the prominent reasons. The majority of our survey respondents said that they were aware of the issue and were responsible for its remediation. Yet, many partic-

ipants acknowledged that they were not familiar with how to perform filtering. Thus, as we discuss in Section 5.7.5, educating network operators about security vulnerabilities and remedies, further improving notification systems, and making sure the notifications reach the target person responsible for remediation (including proper escalation of the issues by network operators) are important steps in improving the overall compliance.

A large proportion of participants also mentioned that they lack time for implementing SAV, or that it is not their top priority. Finally, some respondents acknowledged concerns about performance issues or technical limitations deferring them from implementing SAV in their networks. While understanding relative impact of those reasons on remediation requires future work, our research and previous studies [3], [11] conclude that there is a need for community-driven efforts in aligning operators' incentives and providing better resources for addressing technical challenges with SAV implementation. We further discuss the recommendations for improving SAV adoption in the next section.

5.7.5. MOVING FORWARD: RECOMMENDATIONS

Although notifications did not dramatically increase SAV adoption, we propose a number of steps that can help improve the adoption of routing and security vulnerability remediation.

Improving Notification Channels: Our survey response indicate that most of our notifications reached the recipients. However, to make sure they reach the team responsible for security and routing, we propose that providers should be encouraged by RIRs to fill in and keep up-to-date the technical team's contact details, in addition to abuse-email contacts.

Improving Resources: MANRS provides guidelines to network providers that describe how to implement SAV in their network, in English. To increase SAV adoption, it should be available in other languages, and it should cover other popular brands of routers in addition to CISCO and Juniper.

Improving Incentives: The main issue with routing security is that the remediation entails financial costs and requires human resources, while benefits would be mostly absorbed by the rest of the Internet. To align the incentives, the Internet community can play its part. Most of the providers with stub networks get connectivity through upstream providers. They hold a unique vantage point where they can detect if the incoming packets have a spoofed source [11], [76], [84]. If they exercise their position of power and peer with compliant networks, the overall compliance could increase significantly. There are examples where network providers leveraged their power to achieve compliance. For instance, a provider dropped invalid prefixes from its customer ASes [178]. The owners of the prefixes took corrective action and updated their Route Origin Authorizations (ROA) to fix the issue. Similarly, after observing a consistent BGP hijack from Bitcanal, Hurricane Electric and Portugal's IP Telecom were able to cut them off from the Internet [179]. Thus, the network community needs to take corrective actions. This could be supported by legislation that makes the providers liable for network attacks. Interestingly, two countries—Albania and the Philippines—consider avoiding correcting security flaws as administrative and criminal offenses [180]. Both inside and outside the network community, actions are possible to improve the incentives for SAV adoption.

6

CONCLUSION

This chapter summarizes the main findings of the thesis and connects these to our central question: How can we measure and improve the adoption of Source Address Validation (SAV) by network operators? It also discusses the current state of the art and paths forward in future work. The presented research focused on three major themes: measurement of SAV, the incentives structure for SAV deployment, and interventions required to improve incentives for and adoption of SAV. Four empirical studies were presented as separate research papers, answering the following sub-questions:

1. How can we acquire additional vantage points using crowdsourcing platforms to improve the visibility of SAV adoption?
2. How can we leverage traceroute loops to improve the visibility of SAV non-compliance, and what additional coverage does it provide?
3. What incentives explain operator noncompliance with SAV, and how do network characteristics, intermediaries and market forces impact these incentives?
4. What intervention offers the strongest incentives for network operators to implement SAV, and how can we improve SAV notifications to make them most effective for network operators?

Section 6.1 returns to the research gaps identified in Chapter 1 and summarizes the contributions of the current research towards reducing those gaps. Contributions from chapters 2 and 3 center on improving SAV measurements. Those of Chapter 4 concern the landscape of noncompliance and incentives affecting compliance. Contributions of Chapter 5 relate to our understanding of what interventions improve compliance in practice. Section 6.2 reflects on our findings and discusses next steps to improve the transparency of SAV measurements. Actionable conclusions are presented for policy-makers, intermediaries and problem owners. Section 6.3 concludes the thesis with some final thoughts on the future work required to improve SAV measurement and compliance.

6.1. CONTRIBUTION TO THE RESEARCH GAPS

This section explores the research findings and contributions with respect to transparency in measurements, incentives and policy interventions.

6.1.1. TRANSPARENCY OF MEASUREMENTS

We defined transparency as the ability to observe the current state of SAV deployment by network operators and the impact of various interventions on remediation. In essence, we found a need for actionable measurements of SAV deployment. For instance, for policymakers, metrics need to summarize the state of deployment at the organization or country level. In contrast, for network engineers, a more fine-grained measurement is required, enabling them to assess and remediate the prefixes from which spoofing is possible.

We identified various challenges in collecting and analyzing network measurements. One of these concerns the flexible and scalable nature of the Internet, as networks can join and leave the wider Internet without much intervention. This introduces uncertainty in measurements, as paths and links are in constant flux. It also poses an aggregation challenge, which hampers analysts' ability to make inferences from SAV measurements. Nonetheless, security researchers rely on these measurements to draw conclusions about network hygiene, based on various network policies and Internet provider practices.

Another challenge in accurately measuring the constantly changing Internet is the limited availability and circumscribed global distribution of vantage points from which to observe and measure network policies at the required level of granularity. We classified Internet measurements into two broad categories: data collected from outside the network and data collected from inside the network. The first type of data is obtained by sending specially crafted probes from any Internet-connected machine to the network that we want to measure. Examples are sending Internet Control Message Protocol (ICMP) echo requests to determine the reachability of machines, and sending traceroute probes to determine the network path to the destination. For the second category, probes are leveraged within the network to send packets to a measurement server. These types of measurements are required to assess the outbound policies of Internet providers and can be used, for example, to study web censorship imposed by countries [25], security policies or the general network configuration of ISPs, such as their NAT (Network Address Translation) or DHCP (Dynamic Host Configuration Protocol) [181].

To measure SAV policies, we must rely on the second category – i.e., we need a vantage point from inside the network to send spoofed packets to measure compliance. Because security researchers are unlikely to capture the network policies of all connected networks, they must make inferences based on a limited set of observations per network. Moreover, inaccuracies can arise due to measurement errors stemming from different policies for a subset of a network, different policies for upstream network providers and contradictory results caused by changes in paths to a destination. The current research explored various methodologies to obtain adequate vantage points to measure SAV compliance and create metrics for improved transparency.

Acquiring vantage points from inside the network: Chapter 2 presented a framework and an experiment to capture additional vantage points inside a network using the Spoofer tool. The study provides a first-of-its-kind design that employs multiple crowdsourced platforms to acquire vantage points. Our design collects and synchronizes parallel measurements via multiple crowdsourcing marketplaces. We demonstrated the effects of price elasticity (higher compensation) on the hiring of additional vantage points. The primary benefit of combining various platforms was to achieve greater geographical diversity and better network coverage in the results. In total, we acquired vantage points in 91 countries, 784 unique Autonomous Systems (ASes) and 1,519 IP addresses, at a cost of approximately €2,000 for platform fees and worker compensation. In a six-week measurement period, we increased the coverage of the Spoofer tool by 342 unique ASes and 1,470 /24s, a 15% increase over the prior 12 months.

Acquiring vantage points from outside the network: Chapter 3 presented the efficacy of a new measurement technique for SAV compliance. Here we implemented and validated an algorithm that uses traceroute data to infer the absence of filtering by a provider AS at a provider-customer interconnect. Specifically, routing loops appearing in traceroute data were used to infer inadequate SAV at the transit provider edge, where a provider did not filter traffic that could not have come from the customer. We showed that it is generally feasible for providers to deploy static ingress Access Control Lists (ACLs), as customers rarely change address space. We found 703 provider ASes that did not implement ingress filtering on at least one of their links for 1,780 customer ASes. We validated the algorithm's correctness using ground truth provided by seven network operators.

Chapter 4 presented a methodology – and its implementation – to acquire vantage points based on a vulnerability in an open resolver. We scanned for a very specific subset of open resolvers, namely Customer-Premise Equipment (CPE) devices with a particular configuration error. These provided a vantage point to observe the absence of SAV in parts of the network. Even though we scanned the Internet from outside the network, the misconfigured devices forwarded a packet with the wrong source IP address. In other words, these specific devices provided a de facto measurement platform for networks that lacked SAV, since they unintentionally responded to a specially crafted DNS request with spoofed traffic. In that sense, the misconfigured devices functioned similarly to the Spoofer client software.

In summary, using inferences from the traceroute data enabled us to improve the visibility of SAV compliance. We also collected longitudinal data about SAV noncompliance by exploiting misconfigured open resolvers. An advantage of these methodologies was that the datasets had minimal overlap; each thus increased the visibility of SAV compliance across the Internet. We mapped the IP addresses in our datasets (Spoofer and open resolver) to their respective ASes and then mapped those ASes to ISPs. We defined an ISP as a company that provides access services, typically in residential broadband markets. The relationship between ASes and ISPs is complicated. Many ISPs have a single AS, but a fraction of ISPs has multiple ASNs (Autonomous System Numbers), and some ISPs share a single ASN.

We started our identification of the network space of ISPs with market analysis data

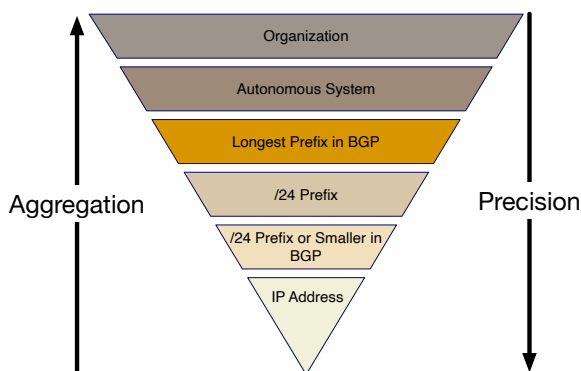

Figure 6.1: Aggregation levels used in metrics for SAV

from the TeleGeography GlobalComms database [94]. It offers a highly reliable overview of the main broadband ISPs in each country, drawn from annual reports and market filings. We focused on ISPs in 64 countries. Together, these held a broadband market share of over 85% in those countries [96]. This provided us a total population of 334 ISPs, with our dataset containing a number of these ISPs' subscribers as well. From our overall population, we had 250 observations of noncompliance (73%). Only 65 ISPs (26%) were present in both Spoofer and open resolver datasets. While the Spoofer and open resolver datasets revealed noncompliant ISPs (customers), the traceroute-loop data revealed inadequate SAV among the transit providers.

6

From measurements to metrics: SAV measurements suffer from selection bias and false positives. As such, a key issue is how to measure SAV adoption correctly. If we only consider IP addresses that allow spoofing in the measurements, we would likely be undercounting the problem since network policies are usually applied on prefixes. Similarly, if we consider only a few data points to determine whether an entire AS or organization is compliant, our inferences might be inaccurate, as results for the unmeasured space might be contradictory. AS or organization level results are more actionable, since we can introduce interventions for noncompliant network providers and incentivize compliant networks.

Figure 6.1 presents various aggregation levels used in previous analyses. The highest reported level of aggregation is the AS level. In Chapter 4, we presented the first-ever study to report results at the organization level. We also normalized the spoofable IP space with reference to the total advertised IP space, which allowed us to perform comparative analysis. We compared the organizations based on the percentage of address space that was noncompliant. Yet, in so doing we had to compromise on precision since we counted the entire /24 or smaller Border Gateway Protocol (BGP) advertised prefix as spoofable for each IP address in our datasets.

The key takeaway from this work is that there is no single correct answer for the right level of precision or aggregation; it depends on the purpose of the measurements. Moreover, it is important to understand that compromises are required in reporting SAV com-

pliance data. For instance, Regional Internet Registries (RIRs) and governments will be interested primarily in the proportion of networks that are largely noncompliant, so they can improve compliance in their jurisdiction. Network operators, researchers and intermediaries, however, need more precise data so that they can reproduce results and implement SAV on the reported prefixes.

6.1.2. INCENTIVES

In economic terms, SAV deployment suffers from a negative externality: the network operators that allow spoofing save themselves the time and effort of deploying the SAV, while other operators incur the cost of this laxity in the form of attacks emanating from the noncompliant networks.

Chapter 4 empirically investigated the impact of different incentives on SAV deployment. It also presented a theoretical framework which provided the basis for our empirical study. It identifies four key economic factors thought to shape incentives for SAV deployment: the cost of adoption, externalities, information asymmetry and the weakest-link property of antispoofing security. Furthermore, we built a statistical model to explain the proportion of an ISP's address space that allows spoofing, based on four causal factors – network complexity, security effort, ISP characteristics and the institutional environment. These were measured using 12 indicators. We found evidence that complex networks were more prone to a larger proportion of noncompliant IP space.

To measure network complexity we used multiple proxy variables, including network size, number of subscribers, number of prefixes and stability of BGP prefix announcements. An argument can be made that larger and more complex networks have multiple points of failure. However, these network operators might also have more experience, knowledge and time available to deploy SAV. We found that more complex ISPs – i.e., those with a larger advertised IP space, more subscribers and a larger number of advertised prefixes – had a larger proportion of noncompliant IP space. Though there are likely to be economies of scale in SAV implementation, our model suggests that the cost-reducing effects of network size are smaller than the cost-increasing effects of greater network complexity.

We defined the hygiene of a network using security practices, like the signing of RPKI (Resource Public Key Infrastructure), the number of amplifiers and the number of bots in the network. We used the signing of BGP prefixes (RPKI) as an indicator of a more hygienic network – i.e., operator willingness to invest in resolving security issues with significant externalities. The number of DDoS amplifiers and bots in a network was taken as a negative indicator, expressing an operator's unwillingness to do so. In short, we found that operators with one or more RPKI-signed prefixes had a smaller proportion of noncompliant space, compared to ISPs that did not sign their prefixes. Similarly, we found that the number of amplifiers per ISP had a significant positive impact. In other words, ISPs with a larger number of amplifiers also had a larger proportion of noncompliant address space. We found no statistically significant effect of the number of bots in a network on noncompliant address space.

Finally, we tested economic factors under which these ISPs operated. Our results indicate a weak but significant effect of the ICT development index. That is, ISPs operating in countries with lower ICT development had a larger proportion of noncompliant

address space.

Reflections on Incentives: For two decades now, we have had a Request for Comments (RFC) on Best Current Practice for SAV (BCP 38) [8], alongside numerous research articles and ongoing discussions in operator communities. Yet, we still observe significant SAV noncompliance. Previous work attributes such noncompliance primarily to misaligned incentives [11], [84], [123].

Nonetheless, there are dissenting views on operator incentives. For instance, MANRS published an article arguing that operators benefit from maintaining a clean network [93]. The cost of SAV implementation is decreasing as well, and almost all new network equipment supports Unicast Reverse Path Forwarding (uRPF), a well-known feature to implement SAV. Similarly, RIPE NCC, published a draft business case for operator compliance [182]. It emphasized that BCP 38 implementation is a source of good publicity for operators, while also limiting attacks within the own network as well as those of other providers.

We found that many operators had in fact implemented SAV. Spoofer tests show that some 20% of the ASes in their dataset had either fully or partially implemented SAV in their networks. Yet, they could not test the majority of ASes (58%) due to NAT. Recent tests (Sept. 2020–Sept. 2021) found only 23% of ASes to be not fully compliant [183]. Similarly, 179 previously noncompliant ASes were found to have implemented SAV in the last year. This brings a different question to mind: what factors influence network providers to implement SAV? We speculated that operators could be influenced to adopt SAV by unobserved incentives, or factors we might not characterize as incentives – such as social norms. Such norms might determine how expectations defined by society feed through to individual behavior. For instance, the operators attending Network Operator Group (NOG) and RIR meetings were self-motivated and informed about attacks on networks operated by their peers due to noncompliance. Their decision to deploy SAV was likely driven by more than economic incentives, being shaped by community expectations as well. Disentangling these norms through examination of encouragement, community involvement and communication can enable us to better understand incentives and improve SAV compliance.

Though primarily anecdotal, our interactions with operators indicate that moral factors have had considerable influence in driving adoption, notwithstanding economic incentives. Moreover, all factors considered, operators in developed countries were more likely to be compliant, as they had the resources required to fulfill the basic requirements to run their networks. This is in line with our results from Chapter 4, which found that operators in countries with better ICT infrastructure were more compliant. However, further work is required to fully understand the effects of moral and social norms on operators' implementation of best practices.

6.1.3. INTERVENTIONS

Chapter 5 investigated interventions that might help us improve SAV compliance. Previous studies on other security issues found that operators did act on notifications of vulnerabilities and reports of abuse in their networks, albeit to varying degrees [119]–[122]. This brings us to our final sub-question: how can more operators be moved to

adopt SAV? To shed light on this issue, we performed the first-ever randomized control experiment to measure the impact of notifications sent to 2,320 network operators on SAV remediation rates. This population is much larger than in any prior study on SAV. We included a control group in the design, which no earlier study on SAV has done. This yielded a crucial insight that puts earlier findings in a different light. Specifically, the improvements observed by Luckie et al. [84] might have been incorrectly attributed to their interventions.

Unlike previous work, our study focused on network operators as the primary population to be incentivized to adopt more secure practices. We also experimented with framings, testing social and reciprocity nudges in message design. In terms of channels, we tested private messages to operators versus notifying national computer emergency response teams (CERTs) versus using geographically organized NOG mailing lists. Sending notifications to a public forum (NOG) had not previously been tested using an experimental design. Finally, we partnered with NIC.br, a leading Brazilian CERT, to have them deliver the treatment directly. CERTs are a trusted partner in the operator community and a critical player in the security notification ecosystem. Yet, no previous study on SAV has measured whether CERT notifications have more impact than those of researchers or security companies. Our findings, however, revealed a disappointing reality: there was no evidence of remediation driven by any of the treatments compared to the control group. Importantly, we did observe some remediation across all groups, including the control group. This might explain why a prior study [84] reported an impact of notifications. Since that study had no control group, it could not ascertain whether the remediations were in fact driven by their intervention.

Reflections on interventions: Multiple factors likely influenced the null results, including providers' reachability, their understanding of our notifications and their SAV knowledge. Below, we reflect on the intervention process and lessons learned in our notification study from Chapter 5.

Once network vulnerability is determined, a first step toward remediation is to determine a methodology required to reach the operators. Our methods included obtaining abuse mailbox details of operators from peeringDB and WHOIS records. While previous studies experienced a bounce rate of over 50% [130], [131], the large majority of our emails (97%) did reach the operators' mailboxes. This better success rate can be attributed to our having network operators rather than hosting providers as our target group, as RIR anti-abuse groups monitor the presence of functional mailboxes for these [184]. We recommend using the technical contact from WHOIS or peeringDB to reach operators about routing issues, since our survey confirmed that we reached the right contact to notify noncompliance.

Once reached, however, we experienced very little interaction with network providers. Only three operators requested additional guidance or information in response to our notifications. There could be multiple reasons for providers' minimal engagement. It is possible that they missed our notification due to an excess of email in their mailboxes. Or, providers might simply ignore most abuse reporting and focus only on selected issues. It is also possible that they did not understand the content or were not in the habit of replying to notification emails. Further work is needed to understand the reasons for

the providers' lack of interaction.

The third step in the cycle is having incentives and knowledge to remediate. As explained, operators have limited incentive to implement SAV in their networks. Nonetheless, we do observe networks adopting SAV. Other than the moral and ethical factors discussed earlier, community actions also appear to influence adoption. During our notification campaigns, one of the operators informed us that they had prioritized implementation of RPKI (another routing security protocol) in their network. The current status of RPKI had been a topic of discussion at all recent NOG and RIR meetings. Though anecdotal, this seems indicative of the community's role in advancing moral and ethical incentives to implement best current security practices.

In sum, multiple steps are required for a successful intervention. Although we did not find a significant remediation group, our study outlines lessons learned and necessary steps to move forward. We discuss these further below.

6.2. MOVING FORWARD

This section examines the implications of our findings for governance. It first sets out lessons learned from our studies that may be useful to the measurement community. It then presents interventions that could improve SAV compliance.

6

6.2.1. IMPROVING TRANSPARENCY

The measurement community has been focused on the reliability of Internet measurements. Previous work has used the results from the Spoofer tool to discuss the landscape of SAV deployment [84]. The benefit of Spoofer is that it gives precise results for the IP that is tested by the software. However, if we only consider the noncompliant address space based on IP addresses, we lack adequate coverage to analyze the overall SAV deployment landscape. We proposed additional measurement methodologies to extend coverage of the noncompliant address space. However, these come at the cost of accuracy. It will be up to policymakers to decide what level of granularity and accuracy of results is required. For instance, network providers require the IP addresses shown in the measurements to identify the routers that need to be reconfigured to implement SAV. However, for the network operator community, such as members of NOGs, national CERTs and RIRs, granularity at the prefix level is needed, so they can estimate the size of the network from which spoofed traffic can originate. Similarly, governments might need only to know the number of providers that have not deployed SAV. They can then provide incentives for compliant operators, while nudging noncompliant operators to adopt SAV.

Furthermore, to improve transparency a responsible and sufficiently visible organization is needed to host and notify operators that are not SAV compliant. Currently, the Center for Applied Internet Data Analysis (CAIDA) is the only organization hosting both the Spoofer tool and data on network operator compliance. Even though the project is well maintained, its visibility is still limited. Network operators are unlikely to visit the Spoofer page without an intervention or notification about their noncompliance. More visibility could be brought to the issue if RIR portals displayed information on the SAV compliance status of their operators, as network operators know about these portals

and visit them to update their organization's information and to request resources like IP addresses. Furthermore, RIRs could notify noncompliant operators and display non-compliant prefixes on operator dashboards. There are multiple other methodologies to detect networks that allow IP spoofing [10], [11], [76], [86], [123]. However, as in most academic research, these have remained mostly in the proof of concept stage. There have been scant follow-up studies and a lack of data collected longitudinally. Central authorities like the RIRs and community-driven initiatives like MANRS need to implement these methodologies to increase their visibility and influence organizations to adopt SAV. In this regard, we must conclude that collective action by the community is needed if we hope to increase SAV compliance in the coming years.

6.2.2. NEW INTERVENTIONS

Network operators are geographically distributed, operating under different social norms and with varying degrees of technical knowledge. At the same time, there is little formal regulation and limited governance mechanisms to improve network provider security. To effectively overcome problems related to network security in general, and SAV in particular, a collaboration of different actors is required. This section examines the roles that multiple actors can play to improve the deployment of SAV, using the four canonical governance models of market, hierarchy, network and community [185], [186].

Market: The market can be understood as a self-regulated form of governance based on contracts, prices, property rights and competition. There are a number of means by which market forces can drive increased SAV compliance. The self-regulatory function can be performed by various forums in which the network operator community participates. For instance, a hosting provider community in the Netherlands created a code of conduct prioritizing removal of child sex and abuse material [187]. Among its recommendations are automated removal of abuse content and establishment of trust channels with the Bureau for Internet Fraud of the Dutch police to expedite immediate removal of such content. Similarly, Australian ISPs signed a code of conduct to share abuse information and established standardized steps to remediate malware from their networks [188]. There is a need for global and country-level consortiums for SAV implementation as well. These would incentivize the ISPs that have implemented SAV in their networks and provide a platform for information sharing and training opportunities for noncompliant operators struggling to implement SAV due, for example, to lack of resources.

Another market player with a role in SAV deployment is router manufacturers. One of the findings from our survey in Chapter 5, in line with a previous study [11] of non-deployment of SAV, concerns the time and knowledge required to adopt SAV. If the major players introduce more user-friendly configurations to implement SAV, more providers are likely to implement SAV in their networks. Implementing SAV as a default policy in routers would further add to compliance. Luckie et al. [84] found that single-homed stub ASes are on the rise, with around 38% of ASes falling into this category. Network providers of these ASes can run strict unicast Reverse Path Forwarding (uRPF), a well-known methodology for implementing SAV without impacting packet forwarding or dropping legitimate traffic. The main question then is why don't router manufacturers pro-

vide easy-to-use functionality or SAV as the default in their operating systems. The answer lies somewhere between incentives and demand. Market parties can play a part in improving demand and providing easy-to-use solutions. For instance, if a government mandates that it will only do business with compliant operators, network administrators are more likely to choose hardware that provides easy-to-use configurations. SAV as a default option on routers would also help increase network providers' compliance. Currently, five router providers – Cisco, Huawei, HPE, Nokia and Juniper – hold more than 75% of the market [189], with Cisco having the most significant share, of around 56%. This market concentration shows that it is difficult for new entrants. However, if incentives are realigned among the more prominent manufacturers, SAV non-deployment can be improved.

Similarly, the ISP market can leverage transparency to implement SAV if it can be encouraged to use security as a differentiator. For instance, RPKI, another routing security practice, has gained attention within the operator community due to BGP route hijacking. Cloudflare started the initiative isbgpsafeyet.com to reduce information asymmetry on RPKI deployment. Participants can run a test to check if their ISP has implemented RPKI. Users are encouraged to tweet the results to increase awareness, which puts pressure on ISPs to implement RPKI.

6

Hierarchy: Hierarchy is the form of governance in which authorities regulate the market. One of the most significant issues in introducing new regulations is differences between the laws of different countries. Regulations can be either national or international. For instance, Portugal and Thailand have government bodies that audit the cybersecurity of organizations within the country and can penalize companies with inadequate measures to protect their networks [180]. There are global initiatives too, like the International Telecommunication Union (ITU), which has broader reach but must accommodate more differences between countries. Governments can either use global initiatives or nudge providers within their own jurisdiction by introducing criminal laws, reward programs and awareness campaigns. Examples of these instruments with reference to SAV are examined below.

(i) *Regulation:* Governments can use regulating bodies to introduce penalties for noncompliance among network providers and network equipment manufacturers. For instance, the US Federal Trade Commission (FTC) sued a network equipment manufacturer (D-Link) for failing to secure its routers and IP cameras. To settle the lawsuit, D-Link agreed to implement a comprehensive security program including third-party assessment of its software and security for ten years [190]. Since it is difficult to track the origin of DDoS attacks because of spoofed packets, governments or regulatory bodies can introduce fines for network equipment manufacturers or noncompliant providers. This, however, requires legislation. A previous study of 156 countries found that only 2 (Albania and The Philippines) had cybercrime legislation assigning liability to vulnerable resource owners [180]. Furthermore, the EU's Network and Information Systems (NIS) Directive [191] mandates operators of essential services (OES) and digital service providers (DSPs) to ensure service availability within the EU and minimize the impact of security incidents. It also provides liability clauses invoking financial penalties for noncompliant organizations.

(ii) *Reward Programs*: Government can also introduce reward programs for Internet companies that adhere to best security practices, including implementing SAV in their networks. For instance, the companies that report SAV compliance might receive tax benefits. This would encourage network operators to implement SAV. Similarly, they can run programs like Bug Bounty, encouraging Internet company subscribers to identify noncompliant networks for a small reward. This would increase transparency while providing an incentive for network operators to implement SAV. Finally, governments could issue directives to procure network services only from providers that are BCP 38 compliant.

(iii) *Awareness Campaigns*: Awareness campaigns are another means available to governments to incentivize compliance. For example, lists of compliant and noncompliant providers can be published on various public forums. Public “naming and shaming” can be a useful tool to motivate noncompliant networks to implement SAV, while providing incentives to compliant operators. Government organizations can either conduct these measurements and notifications themselves, or delegate the job to a trusted third party. For instance, in Japan, the National Institute of Information and Communication Technology (NICT) surveyed Internet of Things (IoT) devices for known vulnerabilities and notified the network operators that had vulnerable customers [192]. Government organizations could run a similar initiative for SAV compliance, to enhance transparency while providing incentives for the compliant operators.

Network: Governments have a role in supporting network governance too. For example, they can provide funding for peer groups, offer technical and logistical assistance and publish reports from neutral third parties on SAV implementation in the various participating organizations. The Netherlands, for example, has several initiatives to combat abuse and DDoS. One of these is the Dutch Abuse Information Exchange Center (Abuse-Hub), in which multiple organizations formed a consortium to receive feeds on various types of abuse originating from their networks. Members meet on a regular basis to exchange information regarding their ongoing efforts to deal with abuse, and the government publishes reports of independent third-party researchers [193]. Similarly, an initiative to curtail DDoS attacks was set up by the Dutch Continuity Board (DCB). This is a consortium of leading network operators in the Netherlands to share information and cooperate to improve network resilience among member organizations, specifically against DDoS attacks [194].

The most significant example of network governance for SAV implementation is the MANRS initiative. It recommends that member organizations implement SAV in their networks. It also provides technical help to member operators via tutorials on its website and by organizing seminars and talks. Even though the initiative grew from 200 to more than 500 members last year (2021), it still has a way to go, with more than 70,000 ASes, many of which still allow spoofing.

Moreover, national CERTs and RIRs can leverage their positions vis-à-vis ISPs to stimulate them to behave more in line with community norms. For instance, the American Registry for Internet Numbers (ARIN) banned Cogent, a large ISP, from accessing its WHOIS database for 6 months, after several ISPs complained that they had received unsolicited marketing calls from Cogent’s sales team [116]. There have also been examples

where upstream providers leveraged their position to achieve security improvements in BGP routing. Hurricane Electric and Portugal's IPTelecom joined forces to cut off Bitcanal from the global Internet after it was consistently observed to conduct BGP route hijacking [115]. The organization was later also removed by the German Internet exchange DE-CIX and others in the routing ecosystem.

Community: Community is the form of governance in which peers come together for a common cause. The difference between network and community is that personal connections are not required in this governance model. For instance, RIRs can create working groups in which providers share ideas and experiences in implementing SAV. Moreover, RIRs and NOGs have regular meetups where participants give talks and tutorials on various network issues. Operators often use these meetups to discuss BCP 38 implementation and experiences.

Security researchers can play a part as a community too. Currently, the Spoofer Project disseminates a monthly report on the NOG mailing list about vulnerable and recently remediated networks. This is a good first step, but not all network operators and countries are on these mailing lists, and many operators likely miss these notifications. CERTs and local and global initiatives should also regularly notify networks within their jurisdictions to extend the reach of these notifications. They can also use other datasets (open resolver, traceroute, IXP) to notify operators of noncompliance. Similarly, security researchers can advance solutions in the form of RFCs and software to implement SAV. In our survey, noncompliant operators noted that manuals for less popular routers, like MicroTik routers, were missing from MANRS documentation. We recommend that security researchers develop a more comprehensive guide with easy-to-use software as a way forward to improve compliance.

6.3. CLOSING THOUGHTS

This research investigated various methods to measure and analyze the SAV compliance landscape. We found limited incentives for network operators to comply. However, the community and service providers continue to suffer on a daily basis due to ever-increasing DDoS attacks. A joint effort is needed among stakeholders to improve compliance and limit the vantage points that malicious actors can exploit to launch attacks. We discussed several initiatives, including MANRS, which is at the forefront of improving the transparency of SAV adoption measurements. In addition to these, we need major players, like RIRs, IXPs and influential network equipment manufacturers, to take a lead in improving SAV compliance. We hope that this research provides a stepping stone, helping policymakers and network providers understand the current landscape of SAV adoption and advancing compliance.

AUTHORSHIP CONTRIBUTION

The core of this dissertation is formed by four peer-reviewed publications, which were conceptualized and published with the help of various co-authors. While I led all of the studies, I was fortunate to receive valuable contributions and feedback from my co-authors. Below I summarize their respective contributions per study.

In the first study (Chapter 2), I developed the website and methodology to collect and analyze the data from the crowdsourcing platforms. Matthew Luckie analyzed the additional vantage points collected through the crowdsourcing platform and drafted background on the Spoofer Project. Mobin Javed, Maciej Korczyński, Hadi Asghari and Michel van Eeten helped with argumentation, proofreading the paper, and improving the draft.

For the second study (Chapter 3), I conducted the data analysis for the persistence of traceroute loops, drafted the text and helped develop and validate the algorithm. Matthew Luckie implemented the algorithm to collect the data on traceroute loops and did most of the analysis. Maciej Korczyński helped in reaching out to the operators to validate the findings. Michel van Eeten helped with the structure of the text of the paper as well as the argumentation. All the co-authors contributed significantly to improving the text.

For the third study (Chapter 4), I handled most of the data collection process, modeling, analysis and writing. Maciej Korczyński wrote the scanner to collect data and helped in setting it up. Carlos Gañán helped with the modeling and interpretation of the results. Michel van Eeten helped in the conceptualization of the main idea and incentive structure for the operators. All co-authors helped improve the text and sharpen the argumentation.

In the fourth study (Chapter 5), I collected the data, implemented the algorithm for random distribution of subjects in the treatment and control group, and did most of the writing and analysis. Alisa Frik helped in the development of the overall methodology and, more specifically, in designing and writing behavioral nudges and the survey. Matthew Luckie developed the website and sent notifications to the NOG lists. Carlos Ganan and Maciej Korczyński helped with the statistical model and writing of the paper. All the co-authors contributed greatly to writing the text and improving the argumentation.

BIBLIOGRAPHY

- [1] B. M. Leiner, V. G. Cerf, D. D. Clark, *et al.*, “A brief history of the internet,” *ACM SIGCOMM Computer Communication Review*, vol. 39, no. 5, pp. 22–31, 2009.
- [2] S. Keshav, “Paradoxes of internet architecture,” *IEEE Internet Computing*, vol. 22, no. 1, pp. 96–102, 2018.
- [3] R. NCC, *Survey Results*, <https://ripe79.ripe.net/presentations/89-RIPE-NCC-Survey-2019-Report-Presentation.pdf>, 2019.
- [4] <https://www.zdnet.com/article/ddos-attack-cost-bandwidth-com-nearly-12-million/>.
- [5] <https://www.akamai.com/blog/security/anatomy-of-a-syn-ack-attack>.
- [6] K. Man, Z. Qian, Z. Wang, X. Zheng, Y. Huang, and H. Duan, “Dns cache poisoning attack reloaded: Revolutions with side channels,” in *Proceedings of the 2020 ACM SIGSAC Conference on Computer and Communications Security*, 2020, pp. 1337–1350.
- [7] P. Vixie, “Rate-limiting state,” *Communications of the ACM*, vol. 57, no. 4, pp. 40–43, 2014.
- [8] P. Ferguson and D. Senie, “Network ingress filtering: Defeating denial of service attacks which employ IP source address spoofing,” RFC 2827.
- [9] CAIDA, *The Spoofer Project*, <https://www.caida.org/projects/spoofers/>, 2020.
- [10] L. F. Müller, M. J. Luckie, B. Huffaker, kc claffy, and M. P. Barcellos, “Challenges in inferring spoofed traffic at IXPs,” in *ACM Conference on Emerging Networking Experiments And Technologies (CoNEXT)*, 2019, pp. 96–109.
- [11] F. Lichtblau, F. Streibelt, T. Krüger, P. Richter, and A. Feldmann, “Detection, Classification, and Analysis of Inter-domain Traffic with Spoofed Source IP Addresses,” in *Internet Measurement Conference*, ACM, 2017.
- [12] M. Kühner, T. Hupperich, C. Rossow, and T. Holz, “Exit from hell? reducing the impact of amplification ddos attacks,” in *USENIX Security Symposium*, 2014.
- [13] MANRS, <https://www.manrs.org/isps/participants/>, 2020.
- [14] MANRS, *Network Operator Participants*, <https://www.manrs.org/isps/participants/>, 2020.
- [15] A. Filasto and J. Appelbaum, “Ooni: Open observatory of network interference,” in *FOCI*, 2012.

- [16] A. Tirumala, F. Qin, J. Dugan, J. Ferguson, and K. Gibbs, "Iperf: The tcp/udp bandwidth measurement tool," 2005.
- [17] W. Matthews and L. Cottrell, "The pinger project: Active internet performance monitoring for the hlep community," *IEEE Comm. Magazine*, vol. 38, no. 5, 2000.
- [18] *NDT*, www.measurementlab.net/tools/ndt/.
- [19] R. Hiran, N. Carlsson, and N. Shahmehri, "Crowd-based detection of routing anomalies on the internet," in *Communications and Network Security (CNS), 2015 IEEE Conference on*, IEEE, 2015, pp. 388–396.
- [20] R. Beverly and S. Bauer, "The Spoofer project: Inferring the extent of source address filtering on the Internet," in *Usenix Sruti*, 2005.
- [21] *RIPE Atlas*, <https://atlas.ripe.net/>.
- [22] *Samknows*, <https://www.samknows.com/>.
- [23] D. Karrenberg, [atlas] "Spoofing" tests, <https://www.ripe.net/ripe/mail/archives/ripe-atlas/2013-September/001026.html>.
- [24] *Planet Lab*, <https://www.planet-lab.org/>.
- [25] S. Sundaresan, S. Burnett, N. Feamster, and W. De Donato, "Bismark: A testbed for deploying measurements and applications in broadband access networks.," in *USENIX ATC*, 2014.
- [26] SpamHaus, 2020. [Online]. Available: [%5Curl%7Bhttps://www.spamhaus.org/%7D](https://www.spamhaus.org/).
- [27] M. Prince, *Technical details behind a 400Gbps NTP amplification DDoS attack*, <http://blog.cloudflare.com/>, Feb. 2014.
- [28] *Crowdsourcing Tools*, <https://github.com/qblone/crowdsourcingTools>.
- [29] W. Mason and S. Suri, "Conducting behavioral research on amazon's mechanical turk," *Behavior research methods*, vol. 44, no. 1, 2012.
- [30] M. Restivo and A. van de Rijt, "No praise without effort: Experimental evidence on how rewards affect wikipedia's contributor community," *ICS*, vol. 17, no. 4, 2014.
- [31] A. Sorokin and D. Forsyth, "Utility data annotation with amazon mechanical turk," in *CVPRW'08*, IEEE, 2008.
- [32] S. Branson, C. Wah, F. Schroff, *et al.*, "Visual recognition with humans in the loop," *ECCV*, 2010.
- [33] J. Ross, L. Irani, M. Silberman, A. Zaldivar, and B. Tomlinson, "Who are the crowd-workers?: Shifting demographics in mechanical turk," in *CHI'10*.
- [34] A. Kittur, E. H. Chi, and B. Suh, "Crowdsourcing user studies with mechanical turk," in *ACM SIGCHI*, 2008.
- [35] P. Dai, Mausam, and D. S. Weld, "Decision-theoretic control of crowd-sourced workflows," in *AAAI-10*, Atlanta, Georgia, pp. 1168–1174. [Online]. Available: <http://dl.acm.org/citation.cfm?id=2898607.2898793>.

- [36] J. J. Horton and L. B. Chilton, "The labor economics of paid crowdsourcing," in *ACM EC*, ACM, 2010.
- [37] N. Christin, S. Egelman, T. Vidas, and J. Grossklags, "It's all about the benjamins: An empirical study on incentivizing users to ignore security advice," in *FC'11*.
- [38] C. Kanich, S. Checkoway, and K. Mowery, "Putting out a hit: Crowdsourcing malware installs.," in *WOOT*, 2011.
- [39] G. Huz, S. Bauer, R. Beverly, *et al.*, "Experience in using mturk for network measurement," in *SIGCOMM C2B(I)D Workshop*, 2015.
- [40] M. Varvello, J. Blackburn, D. Naylor, and K. Papagiannaki, "Eyeorg: A platform for crowdsourcing web quality of experience measurements," in *CoNEXT'16*.
- [41] R. K. P. Mok, R. K. C. Chang, and W. Li, "Detecting low-quality workers in QoE crowdtesting: A worker behavior-based approach," *IEEE Transactions on Multimedia*, vol. 19, 3.
- [42] R. Beverly, A. Berger, Y. Hyun, and k. claffy k, "Understanding the efficacy of deployed Internet source address validation filtering," ser. IMC '09.
- [43] R. Beverly and S. Bauer, "Tracefilter: A tool for locating network source address validation filters," in *USENIX Security Poster*, 2007.
- [44] *Slashdot: Can you spoof IP packets?* <https://slashdot.org/story/06/05/02/1729257/can-you-spoof-ip-packets>.
- [45] www.behind-the-enemy-lines.com/2010/10/explosion-of-micro-crowdsourcing.html.
- [46] E. Peer, S. Samat, L. Brandimarte, and A. Acquisti, "Beyond the turk: An empirical comparison of alternative platforms for crowdsourcing online behavioral research,"
- [47] D. Vakharia and M. Lease, "Beyond mechanical turk: An analysis of paid crowd work platforms," in *iConference*, 2015.
- [48] *Crowd Flower*, <http://www.crowdfLOWER.com/>.
- [49] *Cloudfactory*, <https://www.cloudfactory.com/>.
- [50] *upwork*, <https://www.upwork.com/>.
- [51] *Amazon Mechanical Turk*, <https://www.mturk.com/>.
- [52] *Prolific*, <https://www.prolific.ac/>.
- [53] *Rapidworkers*, <http://rapidworkers.com/>.
- [54] *JobBoy*, <http://www.jobboy.com/>.
- [55] *Minijobz*, <https://minijobz.com/>.
- [56] H. Asghari, "Cybersecurity via intermediaries: Analyzing security measurements to understand intermediary incentives and inform public policy," in 2016, ch. 3.
- [57] *Amount of the minimum wage*, www.government.nl/topics/minimum-wage/contents/amount-of-the-minimum-wage.

- [58] S. Bellovin, "Security problems in the TCP/IP protocol suite," *CCR*, vol. 19, no. 2, pp. 32–48, 1989.
- [59] R. Beverly and S. Bauer, "The spoofer project: Inferring the extent of source address filtering on the Internet," in *Proceedings of USENIX SRUTI*, Jul. 2005.
- [60] R. Beverly, A. Berger, Y. Hyun, and k claffy, "Understanding the efficacy of deployed Internet source address validation," in *IMC*, Nov. 2009, pp. 356–369.
- [61] R. Beverly, R. Koga, and kc claffy, *Initial longitudinal analysis of IP source spoofing capability on the Internet*, <http://www.internetsociety.org/>, Jul. 2013.
- [62] M. Prince, *Technical details behind a 400Gbps NTP amplification DDoS attack*, <http://blog.cloudflare.com/>, Feb. 2014.
- [63] P. Vixie, "Rate-limiting state: The edge of the Internet is an unruly place," *ACM Queue*, vol. 12, no. 2, pp. 1–5, Feb. 2014.
- [64] F. Baker and P. Savola, "Ingress filtering for multihomed networks," RFC 3704, Mar. 2004, IETF BCP84.
- [65] *Spoofers*, <https://www.caida.org/projects/spoofers/>.
- [66] *Open Resolver Project*. [Online]. Available: <http://openresolverproject.org/>.
- [67] J. Xia, L. Gao, and T. Fei, "A measurement study of persistent forwarding loops on the internet," *Computer Networks*, vol. 51, no. 17, pp. 4780–4796, 2007.
- [68] M. Luckie, A. Dhamdhere, B. Huffaker, D. Clark, and k claffy, "Bdrmap: Inference of borders between IP networks," in *IMC*, Nov. 2016. [Online]. Available: <https://www.caida.org/~mjl/pubs/bdrmap.pdf>.
- [69] A. Marder and J. M. Smith, "MAP-IT: Multipass accurate passive inferences from traceroute," in *IMC*, Nov. 2016.
- [70] M. Luckie, "Scamper: A scalable and extensible packet prober for active measurement of the Internet," in *IMC*, Nov. 2010, pp. 239–245.
- [71] B. Augustin, X. Cuvellier, B. Orgogozo, *et al.*, "Avoiding traceroute anomalies with Paris traceroute," in *IMC*, Oct. 2006, pp. 153–158.
- [72] M. Luckie, B. Huffaker, A. Dhamdhere, V. Giotsas, and k claffy, "AS relationships, customer cones, and validation," in *IMC*, Oct. 2013, pp. 243–256.
- [73] B. Huffaker, K. Keys, R. Koga, and kc claffy, *CAIDA inferred AS to organization mapping dataset*, <https://www.caida.org/data/as-organizations/>.
- [74] P. Francois and O. Bonaventure, "Avoiding transient loops during igp convergence in ip networks," in *INFOCOM*, Mar 2005, pp. 237–247.
- [75] *Mutually Agreed Norms for Routing Security (MANRS)*. [Online]. Available: <https://www.routingmanifesto.org/manrs/>.
- [76] Q. Lone, M. Luckie, M. Korczyński, and M. van Eeten, "Using Loops Observed in Traceroute to Infer the Ability to Spoof," in *Passive and Active Measurement Conference*, 2017.

- [77] F. Baker and P. Savola, *Rfc3704: Ingress filtering for multihomed networks*, 2004.
- [78] D. Senie and P. Ferguson, *Network Ingress Filtering: Defeating Denial of Service Attacks which employ IP Source Address Spoofing*, RFC 2827, May 2000. [Online]. Available: <https://rfc-editor.org/rfc/rfc2827.txt>.
- [79] C. Rossow, “Amplification Hell: Revisiting Network Protocols for DDoS Abuse,” in *NDSS*, 2014.
- [80] R. Beverly and S. Bauer, “The Spoofer Project: Inferring the Extent of Source Address Filtering on the Internet,” in *USENIX Steps to Reducing Unwanted Traffic on the Internet (SRUTI) Workshop*, Jul. 2005.
- [81] M. Korczyński, Y. Nosyk, Q. Lone, M. Skwarek, B. Jonglez, and A. Duda, “Don’t Forget to Lock the Front Door! Inferring the Deployment of Source Address Validation of Inbound Traffic,” in *Passive and Active Measurement Conference (PAM)*, 2020.
- [82] M. Kühner, T. Hupperich, C. Rossow, and T. Holz, “Exit from Hell? Reducing the Impact of Amplification DDoS Attacks,” in *23th USENIX Security Symposium (USENIX Security 14)*, 2014.
- [83] Q. Lone, M. Luckie, M. Korczyński, H. Asghari, M. Javed, and M. van Eeten, “Using Crowdsourcing Marketplaces for Network Measurements: The Case of Spoofer,” in *Traffic Monitoring and Analysis Conference*, 2018.
- [84] M. Luckie, R. Beverly, R. Koga, K. Keys, J. A. Kroll, and k. claffy k, “Network hygiene, incentives, and regulation: Deployment of source address validation in the internet,” in *Proceedings of the 2019 ACM SIGSAC Conference on Computer and Communications Security*, 2019, pp. 465–480.
- [85] J. Mauch, *Spoofing ASNs*, <http://seclists.org/nanog/2013/Aug/132>, 2013.
- [86] *The Closed Resolver Project*, <https://closedresolver.com>.
- [87] M. Korczyński, Y. Nosyk, Q. Lone, M. Skwarek, B. Jonglez, and A. Duda, “Inferring the Deployment of Inbound Source Address Validation Using DNS Resolvers,” in *The Applied Networking Research Workshop 2020 (ANRW)*, 2020.
- [88] S. Tajalizadehkhoob, R. Böhme, C. Gañán, M. Korczyński, and M. van Eeten, “Rotten Apples or Bad Harvest? What We Are Measuring When We Are Measuring Abuse,” *ACM Trans. Internet Techn.*, vol. 18, no. 4, 49:1–49:25, 2018.
- [89] A. Noroozian, M. Ciere, M. Korczyński, S. Tajalizadehkhoob, and M. van Eeten, “Inferring security performance of providers from noisy and heterogenous abuse datasets,” in *WEIS*, 2017.
- [90] M. Korczyński, S. Tajalizadehkhoob, A. Noroozian, M. Wullink, C. Hesselman, and M. van Eeten, “Reputation Metrics Design to Improve Intermediary Incentives for Security of TLDs,” in *2017 IEEE European Symposium on Security and Privacy, EuroS&P*, 2017, pp. 579–594.
- [91] M. Korczyński, M. Wullink, S. Tajalizadehkhoob, *et al.*, “Cybercrime after the sunrise: A statistical analysis of DNS abuse in new gtlds,” in *Proceedings of the 2018 on Asia Conference on Computer and Communications Security, (AsiaCCS 2018)*, 2018, pp. 609–623.

- [92] J. Zhang, Z. Durumeric, M. Bailey, M. Liu, and M. Karir, "On the mismanagement and maliciousness of networks," in *Network and Distributed System Security Symposium (NDSS)*, The Internet Society, 2014.
- [93] A. McConachie, *Anti-Spoofing, BCP 38, and the Tragedy of the Commons*. [Online]. Available: [%5Curl%7Bhttps://www.internetsociety.org/blog/2014/07/anti-spoofing-bcp-38-and-the-tragedy-of-the-commons/%7D](https://www.internetsociety.org/blog/2014/07/anti-spoofing-bcp-38-and-the-tragedy-of-the-commons/).
- [94] TeleGeography, <https://www.telegeography.com/products/globalcomms/>, 2020.
- [95] ITU, <http://www.itu.int/net4/ITU-D/idi/2017/index.html>, 2020.
- [96] M. Van Eeten, J. M. Bauer, H. Asghari, S. Tabatabaie, and D. Rand, "The role of internet service providers in botnet mitigation an empirical analysis based on spam data," TPRC, 2010.
- [97] CAIDA, *AS Rank IPv4*, 2020. [Online]. Available: [%5Curl%7Bhttps://asrank.caida.org/%7D](https://asrank.caida.org/).
- [98] *Hurricane Electric Toolkit*, 2020. [Online]. Available: [%5Curl%7Bhttps://bgp.he.net/%7D](https://bgp.he.net/).
- [99] *University of Oregon Route Views Project*, <http://www.routeviews.org/routeviews/>, 2020.
- [100] M. LLC, *Maxmind geoip*, 2020. [Online]. Available: <https://www.maxmind.com/en/geoip2-databases>.
- [101] M. Skwarek, M. Korczynski, W. Mazurczyk, and A. Duda, "Characterizing vulnerability of DNS AXFR transfers with global-scale scanning," in *2019 IEEE Security and Privacy Workshops*, 2019, pp. 193–198.
- [102] H. Asghari, "pyasn–Python IP address to autonomous system number lookup module," URL: <https://github.com/hadiasghari/pyasn>,
- [103] R. Bush, "Origin Validation Operation Based on the Resource Public Key Infrastructure (RPKI)," *IETF RFC7115 (January 2014)*, 2014.
- [104] *Routinator 3000*, 2020. [Online]. Available: [%5Curl%7Bhttps://www.nlnetlabs.nl/projects/rpki/routinator/%7D](https://www.nlnetlabs.nl/projects/rpki/routinator/).
- [105] J. M. Bauer and M. J. Van Eeten, "Cybersecurity: Stakeholder incentives, externalities, and policy options," *Telecommunications Policy*, vol. 33, no. 10-11, pp. 706–719, 2009.
- [106] R. Padmanabhan, A. Dhamdhere, E. Aben, k. claffy kc., and N. Spring, "Reasons Dynamic Addresses Change," in *Internet Measurement Conference*, ACM, Nov. 2016.
- [107] Rapid7, 2020. [Online]. Available: [%5Curl%7Bhttps://opendata.rapid7.com/sonar.udp/%7D](https://opendata.rapid7.com/sonar.udp/).
- [108] *UDP-Based Amplification Attacks*, 2020. [Online]. Available: [%5Curl%7Bhttps://www.us-cert.gov/ncas/alerts/TA14-017A%7D](https://www.us-cert.gov/ncas/alerts/TA14-017A).

- [109] *Resource Public Key Infrastructure (RPKI)*, 2020. [Online]. Available: <https://www.ripe.net/manage-ips-and-asns/resource-management/certification/resource-certification-roa-management%7D>.
- [110] *Let's Encrypt*, 2020. [Online]. Available: <https://letsencrypt.org/%7D>.
- [111] *Using Cloud Resources to Dramatically Improve Internet Routing*. [Online]. Available: <https://www.umass.edu/newsoffice/article/using-cloud-resources-dramatically-improve%7D>.
- [112] *NOIA Network*, 2020. [Online]. Available: <https://noia.network/technology%7D>.
- [113] P. Bosshart, D. Daly, G. Gibb, *et al.*, "P4: Programming protocol-independent packet processors," *ACM SIGCOMM Computer Communication Review*, vol. 44, no. 3, pp. 87–95, 2014.
- [114] *NANOG 2020*, 2020. [Online]. Available: <https://mailman.nanog.org/pipermail/nanog/2020-April/107356.html%7D>.
- [115] *BGP hijacker booted off the Internet's backbone*. [Online]. Available: https://www.theregister.co.uk/2018/07/11/bgp%5C_hijacker%5C_booted%5C_off%5C_the%5C_internets%5C_backbone%7D.
- [116] *Cogent cut off from ARIN Whois*. [Online]. Available: https://www.theregister.co.uk/2020/01/09/arin%5C_boots%5C_cogent%7D.
- [117] *Amazon 'thwarts largest ever DDoS cyber-attack'*, <https://www.bbc.com/news/technology-53093611>, 2020.
- [118] *NET SCOUT THREAT INTELLIGENCE REPORT*, https://www.netscout.com/sites/default/files/2020-02/SECR_001_EN-2001_Web.pdf, 2020.
- [119] M. Maass, A. Stöver, H. Pridöhl, *et al.*, "Effective notification campaigns on the web: A matter of trust, framing, and support," in *30th {USENIX} Security Symposium ({USENIX} Security 21)*, 2021.
- [120] M. Carvalho, J. DeMott, R. Ford, and D. A. Wheeler, "Heartbleed 101," *IEEE Security & Privacy*, vol. 12, no. 4, pp. 63–67, 2014.
- [121] Z. Durumeric, F. Li, J. Kasten, *et al.*, "The matter of heartbleed," in *Proceedings of the 2014 conference on internet measurement conference*, 2014, pp. 475–488.
- [122] F. Li, Z. Durumeric, J. Czyz, *et al.*, "You've got vulnerability: Exploring effective vulnerability notifications," in *25th USENIX Security Symposium (USENIX Security 16)*, 2016, pp. 1033–1050.
- [123] Q. Lone, M. Korczyński, C. Gañán, and M. van Eeten, "Saving the internet: Explaining the adoption of source address validation by internet service providers," in *Workshop on the Economics of Information Security*, 2020.
- [124] M. Korczyński, Y. Nosyk, Q. Lone, M. Skwarek, B. Jonglez, and A. Duda, "Inferring the deployment of inbound source address validation using dns resolvers," in *Proceedings of the Applied Networking Research Workshop*, 2020, pp. 9–11.

- [125] R. Beverly, A. Berger, Y. Hyun, and k. claffy k., “Understanding the Efficacy of Deployed Internet Source Address Validation Filtering,” in *Internet Measurement Conference*, ACM, 2009.
- [126] O. Cetin, C. Ganán, L. Altena, S. Tajalizadehkhoo, and M. van Eeten, “Tell me you fixed it: Evaluating vulnerability notifications via quarantine networks,” in *2019 IEEE European Symposium on Security and Privacy (EuroS&P)*, IEEE, 2019, pp. 326–339.
- [127] R. Client, <https://about.rdap.org/>, 2020.
- [128] B. Stock, G. Pellegrino, F. Li, M. Backes, and C. Rossow, “Didn’t you hear me?—towards more successful web vulnerability notifications,” 2018.
- [129] B. Stock, G. Pellegrino, C. Rossow, M. Johns, and M. Backes, “Hey, you have a problem: On the feasibility of large-scale web vulnerability notification,” in *25th USENIX Security Symposium (USENIX Security 16)*, 2016, pp. 1015–1032.
- [130] O. Cetin, M. Hanif Jhaveri, C. Gañán, M. van Eeten, and T. Moore, “Understanding the role of sender reputation in abuse reporting and cleanup,” *Journal of Cybersecurity*, vol. 2, no. 1, pp. 83–98, 2016.
- [131] O. Cetin, C. Ganan, M. Korczynski, and M. van Eeten, “Make notifications great again: Learning how to notify in the age of large-scale vulnerability scanning,” in *Workshop on the Economics of Information Security (WEIS)*, 2017.
- [132] R. H. Thaler and C. R. Sunstein, “Libertarian paternalism,” *American economic review*, vol. 93, no. 2, pp. 175–179, 2003.
- [133] Thaler, Richard H and Sunstein, Cass R, *Nudge: Improving decisions about health, wealth, and happiness*. Penguin, 2009.
- [134] C. R. Sunstein, “Nudging: A very short guide,” in *The Handbook of Privacy Studies*, Amsterdam University Press, 2018, pp. 173–180.
- [135] E. Peer, S. Egelman, M. Harbach, N. Malkin, A. Mathur, and A. Frik, “Nudge me right: Personalizing online security nudges to people’s decision-making styles,” *Computers in Human Behavior*, vol. 109, p. 106347, 2020.
- [136] A. Frik, N. Malkin, M. Harbach, E. Peer, and S. Egelman, “A promise is a promise: The effect of commitment devices on computer security intentions,” in *Proceedings of the 2019 CHI Conference on Human Factors in Computing Systems*, 2019, pp. 1–12.
- [137] A. Acquisti, I. Adjerid, R. Balebako, *et al.*, “Nudges for privacy and security: Understanding and assisting users’ choices online,” *ACM Computing Surveys (CSUR)*, vol. 50, no. 3, pp. 1–41, 2017.
- [138] M. Nagatsu, “Social nudges: Their mechanisms and justification,” *Review of Philosophy and Psychology*, vol. 6, no. 3, pp. 481–494, 2015.
- [139] A. Brandon, P. J. Ferraro, J. A. List, R. D. Metcalfe, M. K. Price, and F. Rundhammer, “Do the effects of social nudges persist? theory and evidence from 38 natural field experiments,” National Bureau of Economic Research, Tech. Rep., 2017.

- [140] H. C. Kelman and V. L. Hamilton, *Crimes of obedience: Toward a social psychology of authority and responsibility*. Yale University Press, 1989.
- [141] R. B. Cialdini, "The psychology of persuasion," *New York*, 1993.
- [142] Cialdini, Robert B, "The science of persuasion," *Scientific American*, vol. 284, no. 2, pp. 76–81, 2001.
- [143] A. Falk and U. Fischbacher, "A theory of reciprocity," *Games and economic behavior*, vol. 54, no. 2, pp. 293–315, 2006.
- [144] A. W. Gouldner, "The norm of reciprocity: A preliminary statement," *American sociological review*, pp. 161–178, 1960.
- [145] J. Berg, J. Dickhaut, and K. McCabe, "Trust, reciprocity, and social history," *Games and economic behavior*, vol. 10, no. 1, pp. 122–142, 1995.
- [146] E. Fehr and S. Gächter, "Fairness and retaliation: The economics of reciprocity," *Journal of economic perspectives*, vol. 14, no. 3, pp. 159–181, 2000.
- [147] M. A. Nowak and K. Sigmund, "Evolution of indirect reciprocity," *Nature*, vol. 437, no. 7063, pp. 1291–1298, 2005.
- [148] I. Seinen and A. Schram, "Social status and group norms: Indirect reciprocity in a repeated helping experiment," *European economic review*, vol. 50, no. 3, pp. 581–602, 2006.
- [149] *PeeringDB*, <https://www.peeringdb.com>, 2020.
- [150] F. of Incident Response and S. Teams, <https://www.first.org/>, 2020.
- [151] S. E. Institute, <https://www.sei.cmu.edu/our-work/cybersecurity-center-development/national-csirts/>, 2020.
- [152] M. Kührer, T. Hupperich, J. Bushart, C. Rossow, and T. Holz, "Going Wild: Large-Scale Classification of Open DNS Resolvers," in *Internet Measurement Conference*, ACM, 2015.
- [153] A. Lodhi, N. Larson, A. Dhamdhere, C. Dovrolis, and K. Claffy, "Using peeringdb to understand the peering ecosystem," *ACM SIGCOMM Computer Communication Review*, vol. 44, no. 2, pp. 20–27, 2014.
- [154] T. Böttger, F. Cuadrado, and S. Uhlig, "Looking for hypergiants in peeringdb," *ACM SIGCOMM Computer Communication Review*, vol. 48, no. 3, pp. 13–19, 2018.
- [155] A. Kühberger, "The framing of decisions: A new look at old problems," *Organizational Behavior and Human Decision Processes*, vol. 62, no. 2, pp. 230–240, 1995.
- [156] R. J. Donovan and G. Jalleh, "Positive versus negative framing of a hypothetical infant immunization: The influence of involvement," *Health Education & Behavior*, vol. 27, no. 1, pp. 82–95, 2000.
- [157] D. H. Rosenblatt, S. Bode, H. Dixon, *et al.*, "Health warnings promote healthier dietary decision making: Effects of positive versus negative message framing and graphic versus text-based warnings," *Appetite*, vol. 127, pp. 280–288, 2018.
- [158] J. E. Grizzle, "A note on stratifying versus complete random assignment in clinical trials," *Controlled clinical trials*, vol. 3, no. 4, pp. 365–368, 1982.

- [159] J. Van Der Ham, "Ethics and internet measurements," in *2017 IEEE Security and Privacy Workshops (SPW)*, IEEE, 2017, pp. 247–251.
- [160] E. Kenneally and D. Dittrich, "The Menlo Report: Ethical Principles Guiding Information and Communication Technology Research," en, *SSRN Electronic Journal*, 2012, ISSN: 1556-5068. DOI: [10.2139/ssrn.2445102](https://doi.org/10.2139/ssrn.2445102). (visited on 12/08/2021).
- [161] O. R. Understanding Relative Risk and R. Terms, <https://www.pitt.edu/~bertsch/risk.pdf>, 2020.
- [162] M. for Network Operators, <https://www.manrs.org/isps/>, 2021.
- [163] CAIDA, *Macroscopic Internet Topology Data Kit (ITDK)*, <https://www.caida.org/data/internet-topology-data-kit/>, 2020.
- [164] K. Keys, Y. Hyun, M. Luckie, and K. Claffy, "Internet-scale ipv4 alias resolution with midar," *IEEE/ACM Transactions on Networking*, vol. 21, no. 2, pp. 383–399, 2012.
- [165] A. Marder, M. Luckie, A. Dhamdhere, B. Huffaker, K. Claffy, and J. M. Smith, "Pushing the boundaries with bdrmapit: Mapping router ownership at internet scale," in *Proceedings of the Internet Measurement Conference 2018*, 2018, pp. 56–69.
- [166] X. Dimitropoulos, D. Krioukov, M. Fomenkov, B. Huffaker, Y. Hyun, G. Riley, *et al.*, "AS relationships: Inference and Validation," *ACM SIGCOMM Computer Communication Review*, vol. 37, no. 1, pp. 29–40, 2007.
- [167] *MANRS Implementation Guide*, <https://www.manrs.org/isps/guide/antispoofing/>, 2020.
- [168] *RIPE 81*, <https://ripe81.ripe.net/archives/video/420/>, 2020.
- [169] *RIPE Roundtable*, <https://www.ripe.net/participate/meetings/roundtable/january-2017/presentations/security-and-the-ripe-community>, 2020.
- [170] *NANOG 2018*, https://pc.nanog.org/static/published/meetings/NANOG2019/1838/20180921_Wittkop_Routing_Security_Ddos_v1.pdf, 2020.
- [171] *NANOG75*, https://pc.nanog.org/static/published/meetings/NANOG75/1887/20190219_Compton_Ebgp_Flowspec_Peering_v1.pdf, 2020.
- [172] *NANOG 2018*, <https://www.internetsociety.org/issues/manrs/>, 2020.
- [173] M. Vasek and T. Moore, "Do malware reports expedite cleanup? an experimental study.," in *CSET*, 2012.
- [174] M. Vasek, M. Weeden, and T. Moore, "Measuring the impact of sharing abuse data with web hosting providers," in *Proceedings of the 2016 ACM on Workshop on Information Sharing and Collaborative Security*, 2016, pp. 71–80.
- [175] W. Soussi, M. Korczynski, S. Maroofi, and A. Duda, "Feasibility of large-scale vulnerability notifications after gdpr," in *2020 IEEE European Symposium on Security and Privacy Workshops (EuroS&PW)*, IEEE, 2020, pp. 532–537.

- [176] E. Zeng, F. Li, E. Stark, A. P. Felt, and P. Tabriz, “Fixing https misconfigurations at scale: An experiment with security notifications,” 2019.
- [177] *RIPE IP Anti-Spoofing Task Force*, <https://www.ripe.net/participate/ripe/tf/anti-spoofing>, 2021.
- [178] *NANOG75*, https://pc.nanog.org/static/published/meetings/NANOG75/1956/20190219_Levy_Lightning_Talk_Dropping_v1.pdf, 2020.
- [179] *BGP hijacker booted off the Internet’s backbone*, https://www.theregister.com/2018/07/11/bgp_hijacker_booted_off_the_internets_backbone, 2020.
- [180] S. M. Diop, J. D. Ndibwile, D. Fall, S. Kashihara, and Y. Kadobayashi, “To coerce or not to coerce? a quantitative investigation on cybersecurity and cybercrime legislations towards large-scale vulnerability notifications,” in *2019 IEEE International Symposium on Software Reliability Engineering Workshops (ISSREW)*, IEEE, 2019, pp. 282–287.
- [181] G. C. Moura, C. Ganán, Q. Lone, P. Poursaied, H. Asghari, and M. van Eeten, “How dynamic is the isps address space? towards internet-wide dhcp churn estimation,” in *2015 IFIP Networking Conference (IFIP Networking)*, IEEE, 2015, pp. 1–9.
- [182] *Network hygiene pays off - the business case for ip source address verification*, <https://www.ripe.net/publications/docs/ripe-432>.
- [183] CAIDA, *The Spoofer Project*, <https://spoofer.caida.org/summary.php>.
- [184] RIPE NCC, *Abuse Contact Management in the RIPE Database*, <https://www.ripe.net/publications/docs/ripe-705>, 2020.
- [185] T. Tenbenschel, “Multiple modes of governance: Disentangling the alternatives to hierarchies and markets,” *Public Management Review*, vol. 7, no. 2, pp. 267–288, 2005.
- [186] W. W. Powell *et al.*, “Neither market nor hierarchy: Network forms of organization,” *ThFr91*, pp. 265–276, 1991.
- [187] *Stichting DINL*, <https://www.dinl.nl/nieuws/samenwerking-bestrijding-online-content-kindermisbruik/>, 2021.
- [188] *OECD*, <https://www.oecd.org/sti/ieconomy/45509366.pdf>, 2021.
- [189] *ENTERPRISE ROUTERS MARKET GROWTH, TRENDS, COVID-19 IMPACT, AND FORECASTS*, <https://www.mordorintelligence.com/industry-reports/enterprise-routers-market>.
- [190] *FTC*, <https://www.ftc.gov/enforcement/cases-proceedings/132-3157/d-link>.
- [191] <https://www.itgovernance.eu/nl-nl/nis-directive-nl>.
- [192] *The NOTICE Project to Survey IoT Devices and to Alert Users*, <https://www.nict.go.jp/en/press/2019/02/01-1.html>.

-
- [193] M. van Eeten, Q. Lone, G. Moura, H. Asghari, and M. Korczyński, “Evaluating the impact of AbuseHUB on Botnet mitigation,” *arXiv preprint arXiv:1612.03101*, 2016.
- [194] *Dutch Continuity Board*, <https://www.dcboard.nl/about-us>.

A

APPENDIX A

A.1. NOTIFICATION TEXT

A.1.1. DIRECT NOTIFICATIONS – BASELINE

Subject : Possible IP spoofing from AS X

We are security researchers from Delft University of Technology (TU Delft). We have conducted a test to detect potential IP spoofing.

DETECTED ISSUE: We have observed that your network may be allowing IP spoofing. You can check the test results at: [LINK]

WHAT TO DO: We encourage you to deploy Source Address Validation (BCP38) in your network today: <https://www.manrs.org/isps/guide/antispoofing/>

HOW TO VALIDATE: Please run the Spoofer tool to validate if BCP38 was implemented correctly: <https://www.caida.org/projects/spoofier/#software>

CONTACT: If you have any questions, concerns, issues, or comments, please send an email to infospoofing@tudelft.nl

A.1.2. DIRECT NOTIFICATION – SOCIAL NUDGE

Subject : Possible IP spoofing from AS X

We are security researchers from Delft University of Technology (TU Delft). We have conducted a test to detect potential IP spoofing.

DETECTED ISSUE: We have observed that your network may be allowing IP spoofing. You can check the test results at: [LINK]

WHAT TO DO: We encourage you to deploy Source Address Validation (BCP38) in your network today: <https://www.manrs.org/isps/guide/antispoofing/>.

Note that 75% of network operators in the world already deploy BCP38 in their networks. Deploy BCP38 in your network to become one of them.

HOW TO VALIDATE: Please run the Spoofer tool to validate if BCP38 was implemented correctly: <https://www.caida.org/projects/spoofer/#software>

CONTACT: If you have any questions, concerns, issues, or comments, please send an email to infospoofing@tudelft.nl

A.1.3. DIRECT NOTIFICATION – RECIPROCITY

Subject : Possible IP spoofing from AS X

We are security researchers from Delft University of Technology (TU Delft). We have conducted a test to detect potential IP spoofing.

DETECTED ISSUE: We have observed that your network may be allowing IP spoofing. You can check the test results at: [LINK]

WHAT TO DO: We encourage you to deploy Source Address Validation (BCP38) in your network today: <https://www.manrs.org/isps/guide/antispoofing/>.

Note that your network is receiving fewer DDoS attacks because other networks have deployed BCP38. Return the favor - deploy BCP38 in your network to make the Internet more secure.

HOW TO VALIDATE: Please run the Spoofer tool to validate if BCP38 was implemented correctly: <https://www.caida.org/projects/spoofer/#software>

CONTACT: If you have any questions, concerns, issues, or comments, please send an email to infospoofing@tudelft.nl

A.1.4. CERT NOTIFICATION – BASELINE

Subject : Possible IP Spoofing from ASes in COUNTRY

We are security researchers from Delft University of Technology (TU Delft). We have conducted a test to detect potential IP spoofing.

We have observed that certain network operators in your country may be allowing IP spoofing. You can check the test results at: [LINK]

We encourage you to recommend those operators to deploy Source Address Validation (BCP38) in their network.

For your convenience, we tailored a draft of the notification for the network operators. This draft has been tested for clarity and comprehension and has been validated by the experts. We highly recommend you including this draft in your notification to the network operators.

DRAFT OF THE NOTIFICATION: Security researchers from Delft University of Technology (TU Delft) have conducted a test to detect potential IP spoofing.

DETECTED ISSUE: They have observed that your network may be allowing IP spoofing. You can check the test results at: [LINK] (NOTE: Before sending out the notification, please insert the appropriate AS NUMBER)

WHAT TO DO: We encourage you to deploy Source Address Validation (BCP38) in your network today: <https://www.manrs.org/isps/guide/antispoofing/>

HOW TO VALIDATE: Please run the Spoofer tool to validate if BCP38 was implemented correctly: <https://spoofer.caida.org/projects/spoofer/#software>

CONTACT: If you have any questions, concerns, issues, or comments, please send an email to infospoofing@tudelft.nl

A.1.5. CERT NOTIFICATION–SOCIAL NUDGE

Subject : Possible IP Spoofing from ASes in COUNTRY

We are security researchers from Delft University of Technology (TU Delft). We have conducted a test to detect potential IP spoofing.

We have observed that certain network operators in your country may be allowing IP spoofing. You can check the test results at: [LINK]

We encourage you to recommend those operators to deploy Source Address Validation (BCP38) in their network.

For your convenience, we tailored a draft of the notification for the network operators. This draft has been tested for clarity and comprehension and has been validated by the experts. We highly recommend you including this draft in your notification to the network operators.

DRAFT OF THE NOTIFICATION: Security researchers from Delft University of Technology (TU Delft) have conducted a test to detect potential IP spoofing.

DETECTED ISSUE: They have observed that your network may be allowing IP spoofing. You can check the test results at: [LINK] (NOTE: Before sending out the notification, please insert the appropriate AS NUMBER)

WHAT TO DO: We encourage you to deploy Source Address Validation (BCP38) in your network today: <https://www.manrs.org/isps/guide/antispoofing/>

Note that 75% of network operators in the world already deploy BCP38 in their networks. Deploy BCP38 in your network to become one of them.

HOW TO VALIDATE: Please run the Spoofer tool to validate if BCP38 was implemented correctly: <https://www.caida.org/projects/spoofer/#software>

CONTACT: If you have any questions, concerns, issues, or comments, please send an email to infospoofing@tudelft.nl

A.1.6. CERT NOTIFICATION—RECIPROCITY

Subject : Possible IP Spoofing from ASes in COUNTRY

We are security researchers from Delft University of Technology (TU Delft). We have conducted a test to detect potential IP spoofing.

We have observed that certain network operators in your country may be allowing IP spoofing. You can check the test results at: [LINK]

We encourage you to recommend those operators to deploy Source Address Validation (BCP38) in their network.

For your convenience, we tailored a draft of the notification for the network operators. This draft has been tested for clarity and comprehension and has been validated by the experts. We highly recommend you including this draft in your notification to the network operators.

DRAFT OF THE NOTIFICATION: Security researchers from Delft University of Technology (TU Delft) have conducted a test to detect potential IP spoofing.

DETECTED ISSUE: They have observed that your network may be allowing IP spoofing. You can check the test results at: [LINK] (NOTE: Before sending out the notification, please insert the appropriate AS NUMBER)

WHAT TO DO: We encourage you to deploy Source Address Validation (BCP38) in your network today: <https://www.manrs.org/isps/guide/antispoofing/>

Note that your network is receiving fewer DDoS attacks because other networks have deployed BCP38. Return the favor - deploy BCP38 in your network to make the Internet more secure.

HOW TO VALIDATE: Please run the Spoofer tool to validate if BCP38 was implemented correctly: <https://www.caida.org/projects/spoofers/#software>

CONTACT: If you have any questions, concerns, issues, or comments, please send an email to infospoofing@tudelft.nl

A.1.7. NOG NOTIFICATION

CAIDA's source address validation measurement project (<https://spoofers.caida.org>) is automatically generating monthly reports of ASes originating prefixes in BGP for systems from which we received packets with a spoofed source address.

We are publishing these reports to network and security operations lists in order to ensure this information reaches operational contacts in these ASes. This report summarises tests conducted within *COUNTRY*.

Inferred improvements during $\langle DATE \rangle$:

ASN	Name	Fixed by
ASN X	ASN NAME	DATE

Further information for the inferred remediation is available at: <https://spoofer.caida.org/remedy.php>

Source Address Validation issues inferred using Spoofer tool during $\langle DATE \rangle$:

ASN	Name	First-Spoofed	Last-Spoofed
ASN X	ASN NAME	DATE	DATE

Further information for these tests where we received spoofed packets using spoofer is available at: https://spoofer.caida.org/recent_tests.php?country_include=ccc,ccc&no_block=1

Source Address Validation issues inferred using misconfigured open resolvers during $\langle DATE \rangle$:

ASN	Name	First-Spoofed	Last-Spoofed
ASN X	ASN NAME	DATE	DATE

Further information for these tests where we received spoofed packets using open resolver is available at:

Please send any feedback or suggestions to spoofer-info@caida.org

A.2. QUESTIONNAIRE

Q1: In your opinion, does your network have any of the following security issues? Choose all that apply

1. Susceptible to Route/Prefix Hijack
2. Does not prevent IP spoofing
3. Susceptible to DDoS
4. None of the above
5. I'm not sure

Q2: How did you discover the issue with IP spoofing? Choose all that apply.

1. I ran a Spoofer test

2. I received a notification from NOG (Network Operator Group)
3. I received a notification from CERT (Computer Emergency Response Team)
4. I received a notification from security researchers
5. Other (please specify)

Q3: Are you the person responsible for the implementation of Source Address Validation (SAV), which is also referred to as BCP38?

1. Yes
2. No
3. I'm not sure
4. I don't know what SAV means

Q4: Have you escalated the issue with IP spoofing to the person/team responsible for SAV implementation?

1. Yes
2. No
3. I'm not sure

Q5: Have you implemented SAV in your network?

1. Yes, on the entire network
2. Yes, but only in the segment of our network
3. No, we haven't implemented SAV in our network at all
4. I'm not sure

Q6: What kind of filtering of origin IPs do you perform ? Choose all that apply

1. Filter private address space (RFC 1918)
2. Perform SAV on customer facing interfaces
3. Perform SAV on stub AS
4. Other (please specify)

Q7: Why didn't you implement SAV in your network? Choose all that apply.

1. I lack technical knowledge to implement SAV
2. I am concerned that SAV implementation may cause network downtime/performance
3. I don't have time to implement SAV at the moment

4. I don't think IP spoofing is an important issue
5. I don't think DDoS (Distributed Denial of Service Attack) is an important issue
6. I don't think SAV is effective in addressing IP spoofing issues
7. We are running a non-stub network
8. We are running a multi-homed network
9. Other (please specify)

Q8: Are you planning to implement SAV in your network?

1. Yes
2. No
3. I'm not sure

Q9: MANRS provides the following guidelines for implementing SAV: <https://www.manrs.org/isps/guide/antispoofing/>. Please review the guidelines and tell us your opinion: Do you think the MANRS guidelines provide sufficient information on how to implement SAV in your network?

1. Yes
2. No
3. I'm not sure

Q10: What information, necessary for implementing SAV, is missing in MANRS guidelines? Please, provide as much details as you can.

A.3. SCREEN SHOT OF WEBSITE

Below is an example for website linked to the notification to AS137612

This page contains evidence that a network may not have deployed Source Address Validation (SAV) to block packets with source addresses that are invalid given the attachment point.

Our method to detect a possible lack of SAV is based on querying Open Resolvers. When we queried the Open Resolver resolver IP address listed, we received a response to the query from the listed Recursive Resolver IP that maps to a different ASN, which is likely not a valid source address for that network attachment point.

Each row contains a link to a report with further details of how we observed a possible lack of SAV for that Open Resolver.

Id	Timestamp (UTC)	Open Resolver IP	Open Resolver ASN	Country	Recursive Resolver IP	Recursive Resolver ASN
5566796	2020-12-05 03:48:05	103.117.38.214	137612 (CDCN-AS-IN)	ind	8.8.8.8	15169 (GOOGLE)
5566784	2020-12-05 03:47:42	103.117.39.236	137612 (CDCN-AS-IN)	ind	8.8.8.8	15169 (GOOGLE)
5566359	2020-12-05 03:28:58	103.117.38.227	137612 (CDCN-AS-IN)	ind	8.8.8.8	15169 (GOOGLE)

Figure A.1: Main page with individual reports per IP address for AS137612

Description:

This page describes the outcome of probing the open resolver with IP address 103.117.38.214 in AS 137612. When we sent that open resolver a DNS query with a domain name under our authoritative control, we received a response from 8.8.8.8. We present two possible explanations for the behavior that indicate the network hosting the open resolver has not deploying source address validation.

You may be able to reproduce these results using the dig command, as follows:

```
$ dig www.example.net @103.117.38.214
;; reply from unexpected source: 8.8.8.8#53, expected 103.117.38.214
```

Summary:

Timestamp: 2020-12-05 03:48:05
 Open Resolver IP: 103.117.38.214
 Open Resolver ASN: 137612
 Open Resolver Country: ind
 Recursive Resolver IP: 8.8.8.8
 Recursive Resolver ASN: 15169

Figure A.2: Details about our methodology and steps to reproduce the results

First case: Open Resolver forwards query to Recursive Resolver without rewriting Source Address

In the first case, (1) the open resolver forwards the query directly to its configured recursive resolver without rewriting the source IP address from the Vantage Point (VP) we sent the query from, and (2) we subsequently receive the response to our query directly from the recursive resolver. Because the source IP address is not valid at the network attachment point hosting the open resolver, the query should be filtered if the network hosting the open resolver has configured source address validation.

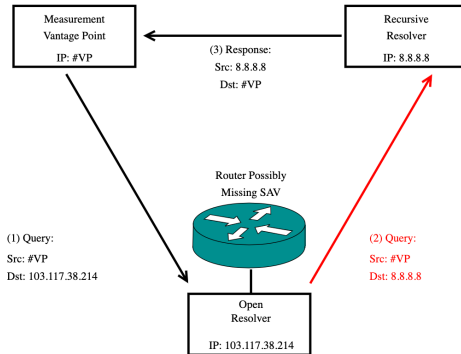

Figure A.3: Explanation of the first case with dynamic IP addresses for the figures

Second case: Open Resolver forwards response to our Vantage Point without rewriting Source Address

In the second case, the open resolver forwards the query and receives the response from its configured recursive resolver. However, the open resolver then forwards the response back to our vantage point, without rewriting the source address of the reply from the recursive resolver. Because the IP address of the recursive resolver is not a valid source IP address at the network attachment point hosting the open resolver, the response should be filtered if the network hosting the open resolver has configured source address validation.

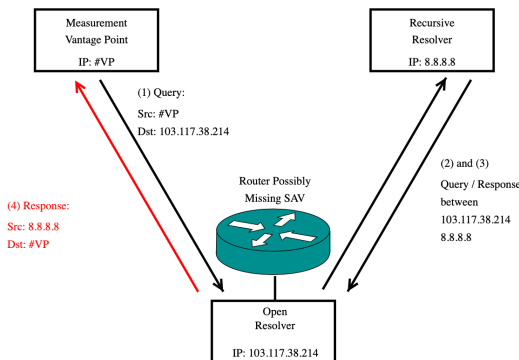

Figure A.4: Explanation of the second case with dynamic IP addresses for the figures