

# Zeeland Earthworks

Re-composition of an Altered Landscape

Research Report  
Zoe Panayi 4747062

Mentors: Stefano Milani, Sjap Holst, Taneha Bacchin  
Board of Examiners Delegate: Dan Vitner

Transitional Territories Studio  
Department of Architecture  
Faculty of Architecture and Building Sciences  
TU Delft



## Index

Abstract	1
1 Territorial Analysis: North Sea	3
1.1 Flood risk at 5m of sea level rise	4
1.2 Areas of biodiversity under stress from industry	6
2 Territorial Analysis: Scheldt Estuary, The Netherlands	8
2.1 Land-Sea Borders	10
2.2 Economic Factors	12
2.3 Urban Borders	14
2.4 Ecological Impact	16
2.5 Cultural Impact	18
2.6 Summary	20
3 Territorial Analysis: Scenario	23
3.1 Scenario Framework	24
3.2 Scenario 1: Strengthened Dikes	26
3.3 Scenario 2: Depolderisation	28
3.4 Scenario 3: Controlled Inflow of Elements	30
4 Urban Analysis : Borssele Polder, Zeeland	33
4.1 Test Case: Borssele Polder, Zeeland	34
4.2 Geometry	36
4.3 Geology	38
4.4 Urban character	40
4.5 Polder system	42
4.6 Summary	44
4.7 Problem Statement	46
5 Strategy: Material Analysis	49
5.1 Material flows	50
5.2 Material composition	52
5.3 Material [re]composition	54
5.4 Sediment settlement and processing	56
5.5 Brief development and temporality	58
5.6 Summary	60
6 Composition: A Performative Landscape	63
6.1 Polder system as a performative landscape	64
6.2 Wall typology	66
6.3 Construction and materiality	68
6.4 Landscape elements	70
7 [Re]Composition: An Altered Landscape	107
7.2 Current Condition	110
7.3 Proposed Condition	112
7.4 Future Condition	114
8 Project Reflection	117



## Abstract

This project takes the increasingly polluted and flood prone coast line of the Scheldt estuary as the basis for a new coastal condition, centred on the re-composition of the sediment of the river. As a third option between dike raising and depoldering the coastline of Zeeland, a design for a new line of defence is developed which controls the inflow of storm water, and collects sand, silt and clay. The collected clay is processed in a ceramics factory capturing heavy metal pollutants and preventing them from reaching the polder system.

The primacy of material transformation through landscape is the key concern of the project, where the daily flows of sediment and water of the Scheldt are performed as architectural rhythms, cuts and insertions in a new boundary edge. Through this research, the existing design parameters of the coastline are questioned and expanded to include multiple actors, varying future conditions and an aesthetic and atmospheric dimension.

*Key words: flood control, sediment flows, performative landscape, architectural membrane*

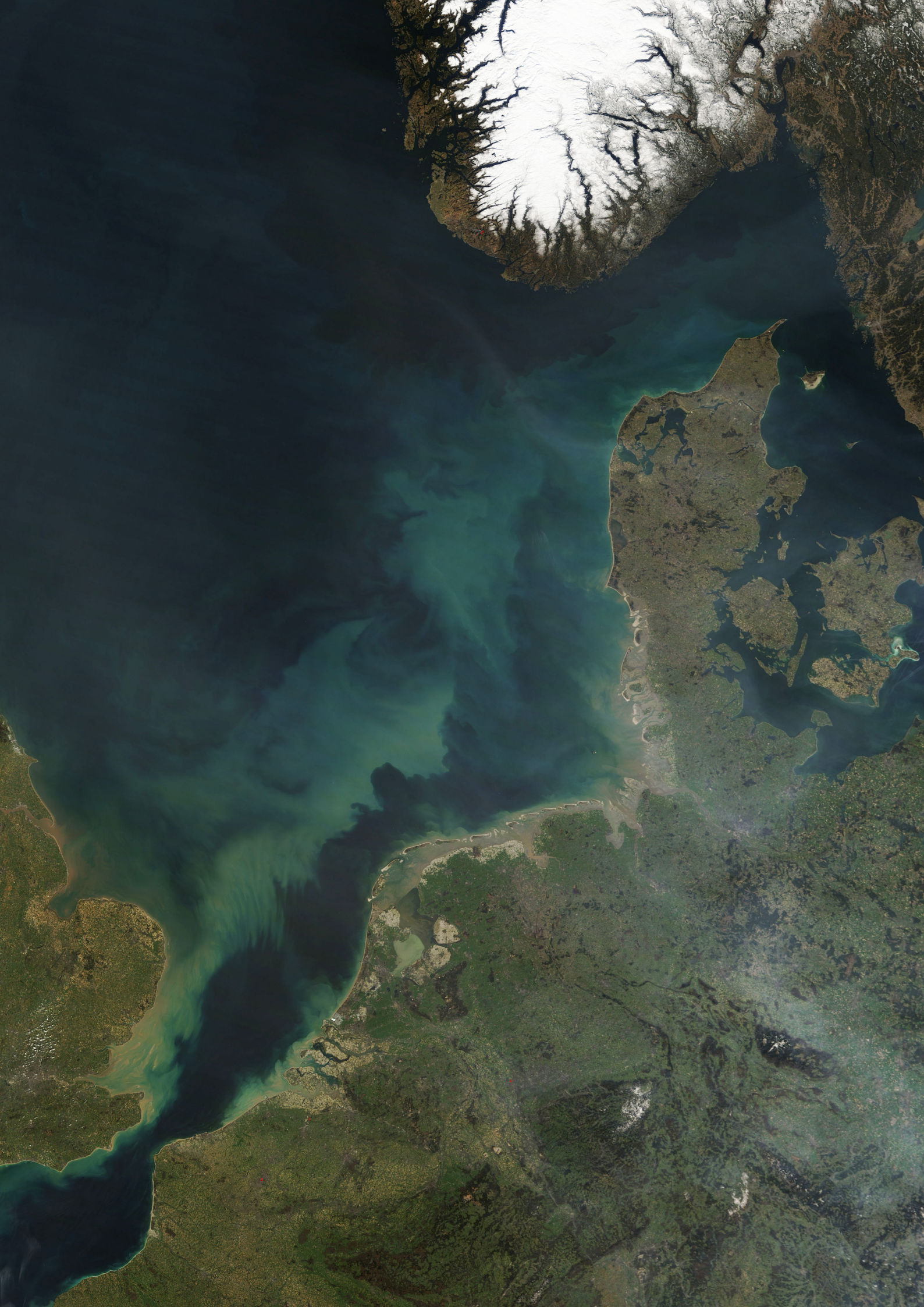

As a fluid body the sea brings to our attention the externalities of industrial systems of extraction, manufacture, logistics, and consumption. In a subversion of its cultural role as hinterland, as a transport mechanism, effluent disposal device and resource carrier, the sea brings back what we have expelled in the form of unprecedented pollutant and debris concentrations, unpredictable storm patterns and climate change related sea level rise. In this way, the study of the North Sea becomes a study of the flows between coastlines, and the continuous re-composition of elements which happens along the way.

The North Sea's long use by the first industrialised economies has made it a highly trafficked, heavily fished and severely polluted cultural landscape. Its fluid ecosystem of currents, marine life, and industrial infrastructure are constantly in flux as they put reciprocal pressures on each other.

## 1 Territorial Analysis North Sea

## 1.1 Flood risk at 5m of sea level rise

Today, the combined pressures of sea level rise, storm surges and increased winter precipitation leading to higher discharge rates in the flood basins of the rivers threaten coastal settlements with inundation and put North Sea coastlines at the forefront of a shift in urbanisation patterns as we adapt to rising tides.

- Urban concentration
- Coastal inundation in the event of 5m of relative sea-level rise
- Fluvial flooding



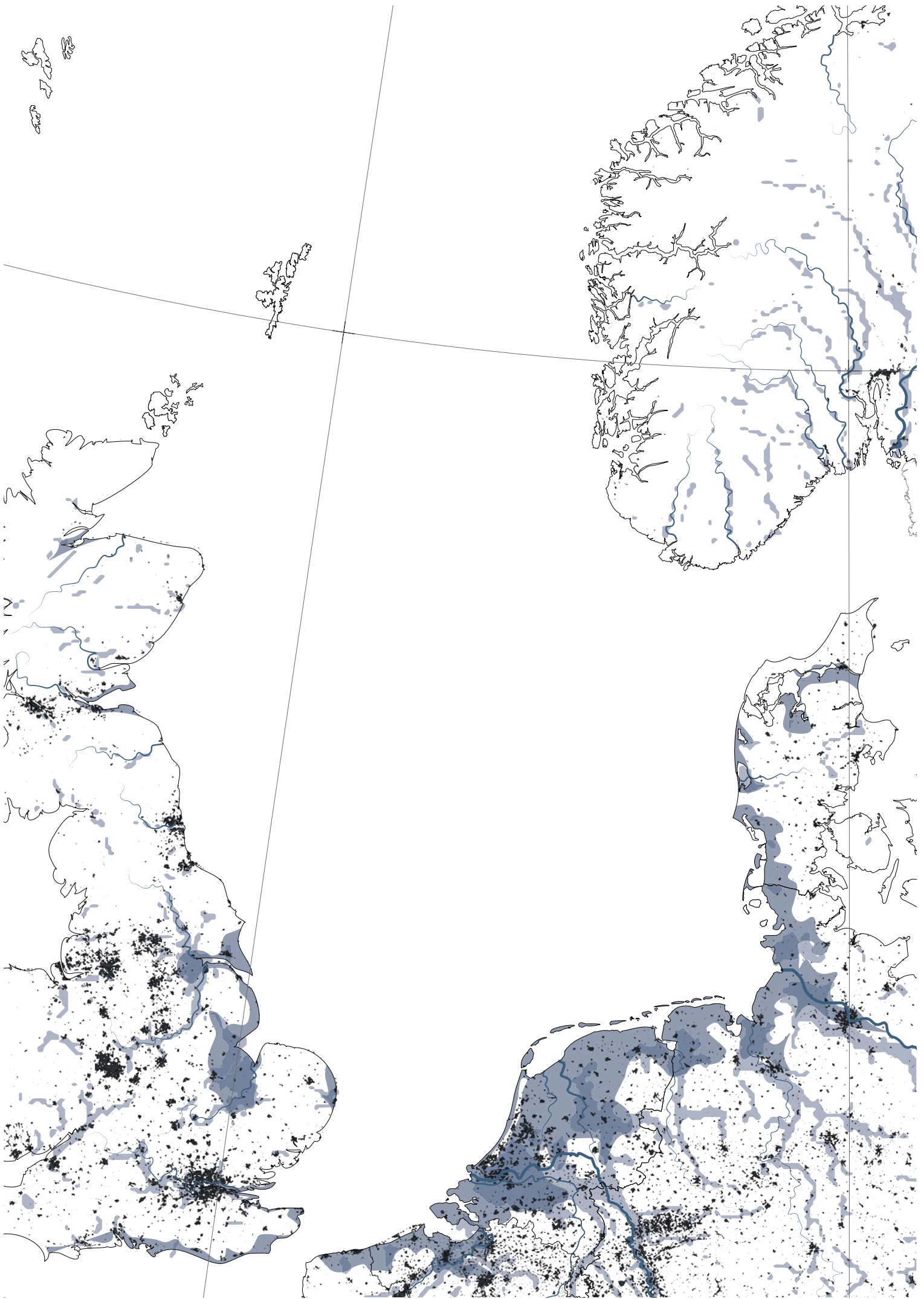

## 1.2 Areas of biodiversity under stress from industry

A second key driver of change in the North Sea is the impact of industry and urbanisation on biodiversity. The North Sea has a long history of industrial development concentrated at the shoreline. This has always been in conflict with the shore's key role in marine life breeding habitats. Today's exponential growth of both urbanisation and industrialisation are causing rapid biodiversity loss throughout the North Sea. The problem is especially acute in river systems and deltaic areas which stand out as particularly vulnerable and precious. The Netherlands Environmental Assessment Agency predict the disappearance of over 200 species

- Forest
- Cropland
- Sea-grass
- Biodiversity Area (IUCN 2016)
- Environmental Degradation Area \*
- ⊗ Area Under Environmental Pressure \*

\* (Netherlands Environmental Assessment Agency)

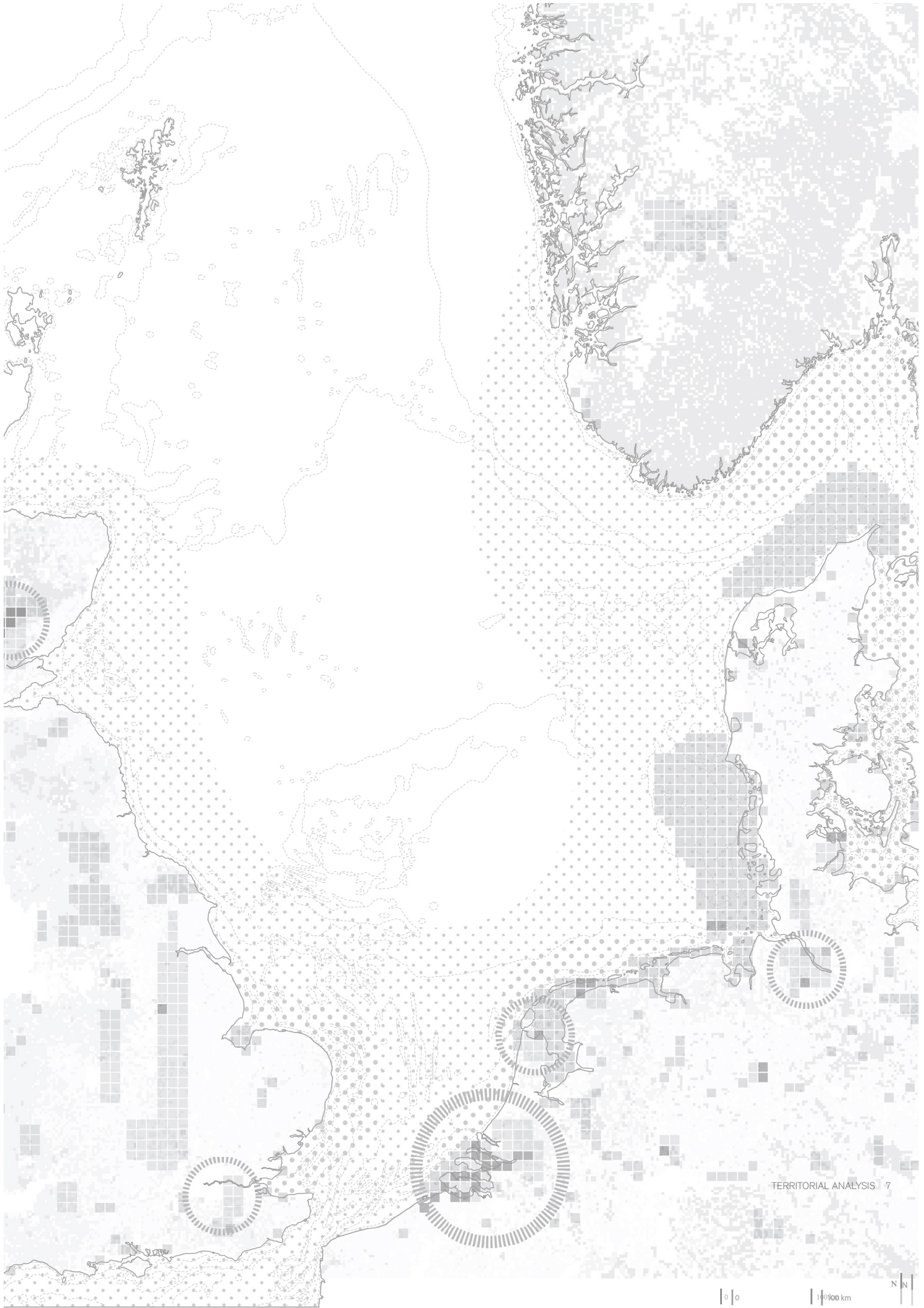



The Scheldt is chosen as an area of research as it stands out as particularly vulnerable and precious at the scale of the North Sea. Estuaries, where fresh water meets salt water at a tidal inlet to the land are key breeding grounds and nurseries for marine life. They are also particularly valuable to industry as they are the site of global ports, allowing for cheap material sourcing and distribution and allow industrial waste to be cheaply diluted and carried away. The Scheldt is the only open estuary system in the Netherlands, and serves the Port of Antwerp. As a result it is both highly polluted and especially fragile in terms of its resilience to increased storm surges and a higher sea level.

## 2 Territorial Analysis Scheldt Estuary, The Netherlands

## 2.1 Land-Sea Borders

The combined pressures of sea level rise, storm surges and increased winter precipitation leading to higher discharge rates in the flood basins of the rivers threaten coastal settlements with inundation.

In the Netherlands, where these processes pose the biggest threat to the low lying land, sea level rise is predicted to be between 0.65 to 1.3m by 2100 and 2 to 4m by 2200, combining with the subsidence of drained land the elevational disparity between land and sea will continue to increase.

Longer periods of drought in the summer months when the need to retain water will change the logic of immediate drainage currently at the core of the polder landscape. The reduction in drainage will lead to an increased threat of salination of groundwater as freshwater is in constant demand to keep salt water from penetrating under the dikes.

As the only tidal inlet in the Southwest Delta the Western Scheldt is the most exposed to storm surges and sea level rise. If the primary dikes and dunes were to suddenly fail 90% of the land along the Western Scheldt would flood.

Flood depth in the event of a dike breach



Source: <https://overstroomik.nl/>

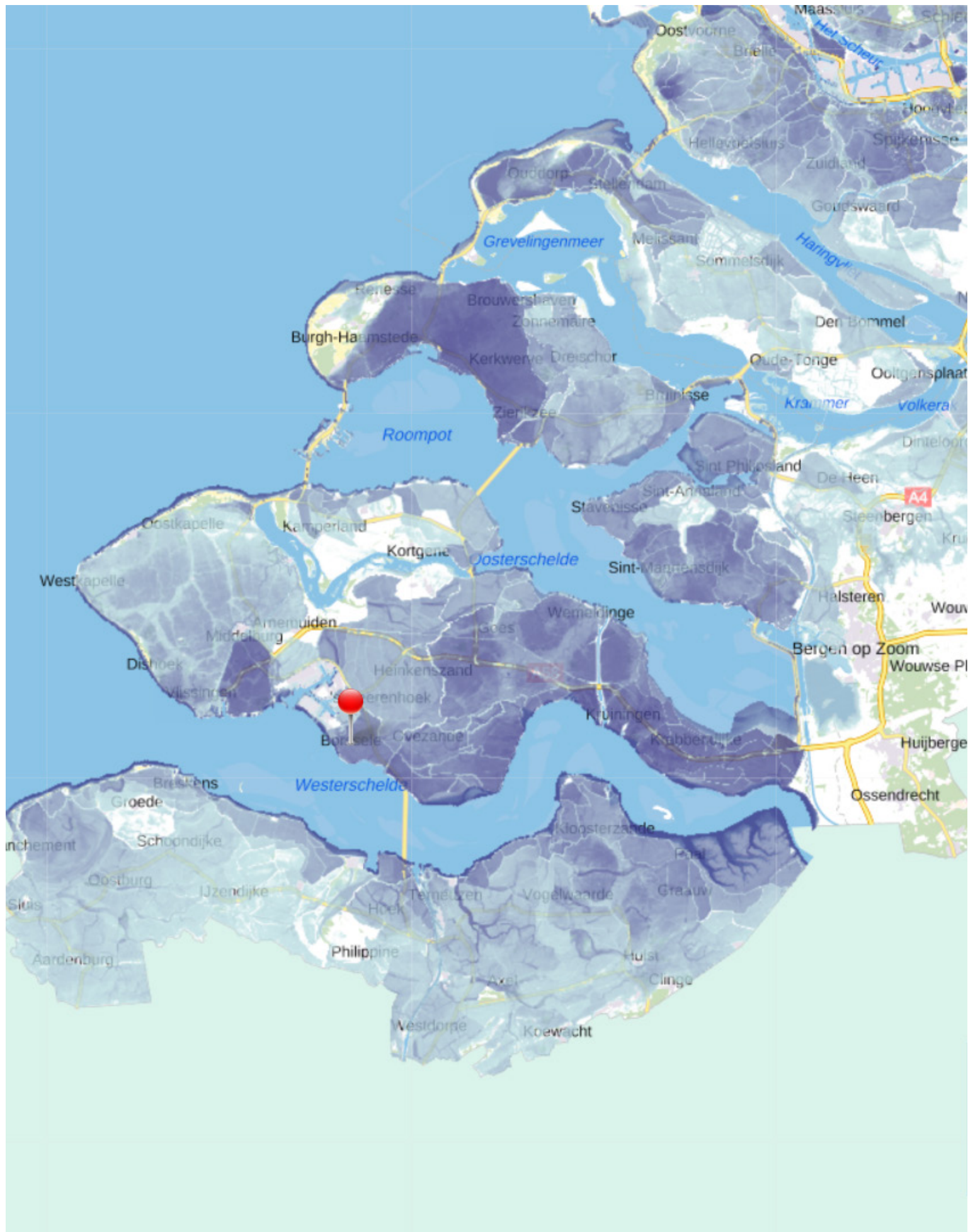

*"Every Euro can only be spent once, so investments are the most effective if they are targeted at the weakest flood defence structures that protect large population centres."*

Rijkswaterstaat, *Dutch Safety Map* (2014)

## 2.2 Economic Factors

The impact of an increased flood risk will be augmented by a set of economic pressures laid out by an OECD report from 2014. Namely, globalisation of industry and manufacturing, an aging labour force, and the need to limit government spending, continuing a trend for the reduction of the budget of the Delta Fund and increasingly targeted coastal intervention characterised by cost benefit analysis on the basis of economic productivity. In Zeeland, the sand flats at the estuary of the Scheldt are at the forefront of coastal flooding and at risk from pluvial flooding. On the land behind the dikes agricultural consolidation and depopulation have led to large areas of low value agricultural land providing only 2% of national GDP.

Thus, according to the economic logic of the Rijkswaterstaat, fewer assets are at risk but an increasingly fortified and inflexible infrastructure is required to protect them. As a result it is my hypothesis that as pressure on coastal defence across the country increases the Netherlands' least densely populated province will experience some loss of land to the sea.



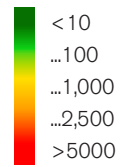
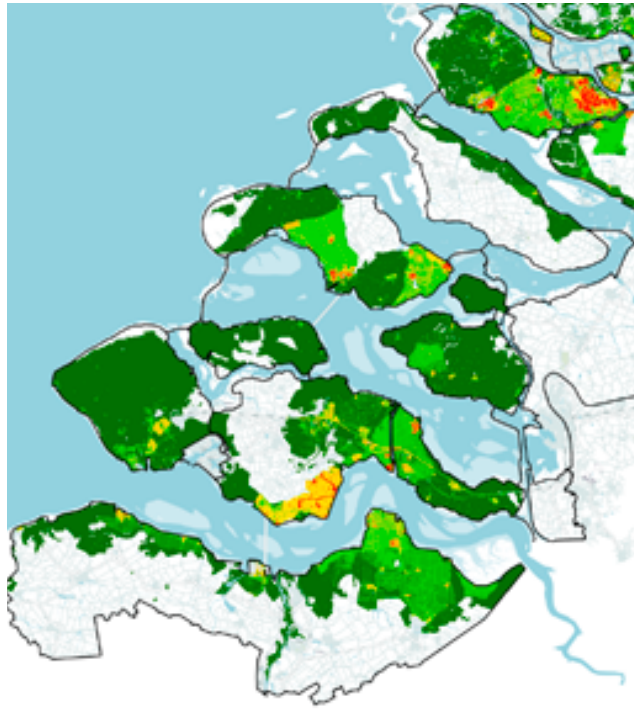

Economic risk (€/ha/year)  
 Rijkswaterstaat VNK Project Office  
*The National Flood Risk Analysis for the Netherlands (2014)*

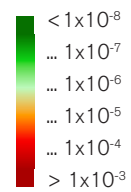
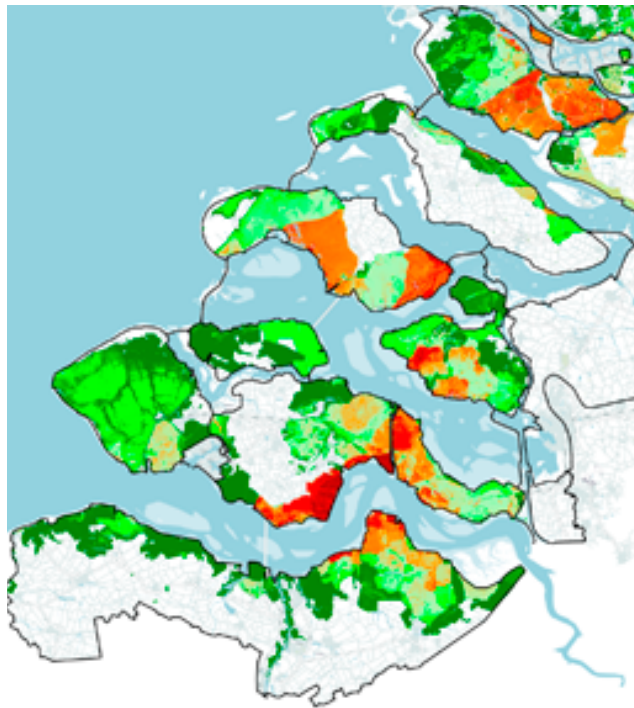

Annual individual loss-of-life risk  
 Rijkswaterstaat VNK Project Office  
*The National Flood Risk Analysis for the Netherlands (2014)*

## 2.3 Urban Borders

The Scheldt is made up of three key interrelated systems; a natural system of plants and animals living in the brackish waters and intertidal habitats, an industrial system defined by the cargo and oil ports of Antwerp and Ghent as well as chemical and concrete manufacturers, and finally an urban system of inhabitation defined by small port cities and agricultural polderland. These systems are in conflict as they have very different demands on the space, largely leading to hardening borders of demarcated ownership. This is expressed in the polder borders, land ownership boundaries, regulations on water quality discharges into the river and sea, and protected nature reserves in the form of Natura 2000 zones. The 1886 Scheldt Treaty is a key example of conflicting national systems hardening into spatial practice.

### Locations of Industry on the Scheldt

- Catchment basin
- /// Urban concentrations
- ⋆ Natura 2000 network



#### Copper contamination of the Scheldt



Source: Wijdeveld, Arjan & Schipper, Cor. (2017). Predicting the impact of seasonal fluctuations on the potential ecotoxicological risk of multiple contaminants in the River Scheldt discharge into the Western Scheldt estuary. CATENA. 149. 131-139. 10.1016/j.catena.2016.09.006.

## 2.4 Ecological Impact

The reclamation of land from the sea since 1200AD, initially with a system of mounds and later using walls and dikes to permanently enclose areas of sedimentation. The morphology of the river is now entirely artificial, centuries of dredging channels, straightening watercourses and digging canals have made continued navigation of the channel possible, against the natural process of sedimentation by the river.

As ship draughts have increased since the 1970s dredging volumes in the Scheldt have been escalating. However, because the mud does not meet environmental specification it cannot be dumped further out in the estuary. As a result excavated mud and sand from the main channel are redeposited in the shallows of the same stretch, quickly being carried back by the current.

The estuary is an important breeding ground for much marine life as it has fresh, brackish and salt water, as well as inter tidal habitats, making it one of the most biologically productive and important sites in the North Sea. However, these habitats are damaged by the loss of salt and fresh water marshes and intertidal foreshores to land reclamation and agriculture. In addition dredging has steepened the slopes of the sand banks meaning they do not emerge from the low water at high tide, the heavy dredging also makes the water unnaturally turbid affecting marine health. Finally, heavy metals, fertilisers and oil as well as debris in the water make it toxic to most marine life.

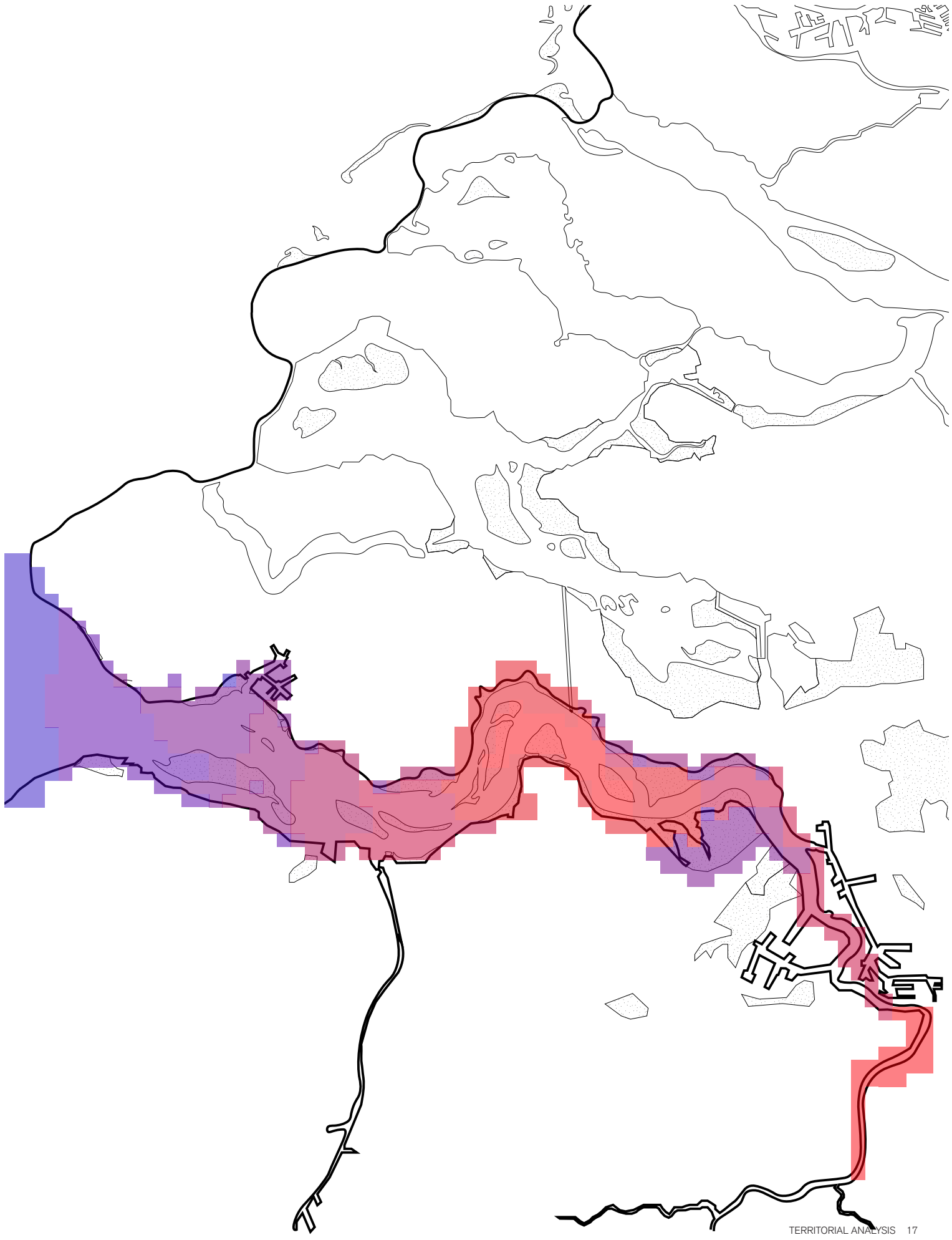

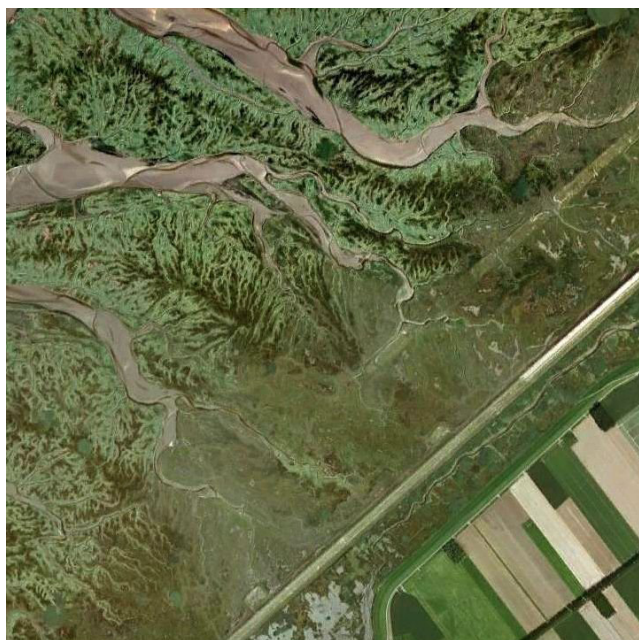

## 2.5 Cultural Impact

According to the Statute of the Western Scheldt dating from 1839, the Netherlands guarantees the necessary works to maintain access to the port, including continued dredging to give access to ever-larger ships. Port expansion at Antwerp has already led to the controversial depoldering of Hedwigepolder in January 2018. This depolderisation was put into motion by the dual motivations of the Sigma Plan, a series of interventions along the Scheldt designed to mitigate flood damage to Flemish territory, and the legal requirement to compensate for ecological damage caused by the expansion.

### Cross Border Depolderisation

-  Depoldered wetland
-  Dutch - Belgian Border



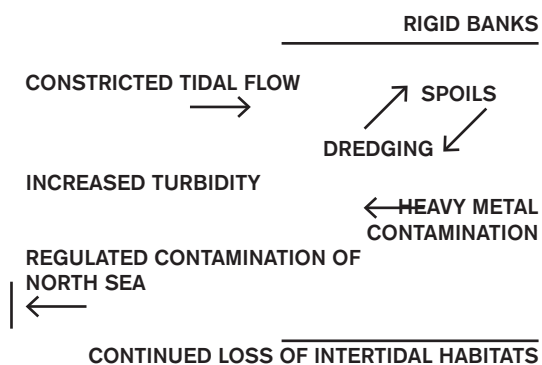

## 2.6 Summary

The Scheldt is made up of three key interrelated systems; a natural system of plants and animals living in the brackish waters and intertidal habitats, an industrial system defined by the cargo and oil ports of Antwerp and Ghent as well as chemical and concrete manufacturers, and finally an urban system of inhabitation defined by small port cities and agricultural polderland. These systems are in conflict as they have very different demands on the space, largely leading to hardening borders of demarcated ownership. This is expressed in the polder borders, land ownership boundaries, regulations on water quality discharges into the river and sea, and protected nature reserves in the form of Natura 2000 zones. The 1886 Scheldt Treaty is a key example of conflicting national systems hardening into spatial practice.



**URBAN**

Viessengen

Middleburg

Ghent

Terneuzen

Goes

Bergen op Zoom

Antwerp



Hooge Platen Sandbanks

Oosterschelde  
Dammed 1986

Saeftinghe  
Depoldered 1584

Hedwigepolder  
Depoldered 2012

**LANDSCAPE**

Naval  
stip/yard

Nuclear  
power  
substation

Concrete  
manufacture

Oil  
storage

Oil  
terminal

Oil  
terminal

Chemical  
works

Chemical  
works

Chemical  
works

Chemical  
works

Chemical  
works

Chemical  
works

Chemical  
works

Chemical  
works

Chemical  
works

Chemical  
works

Chemical  
works

**INDUSTRY**

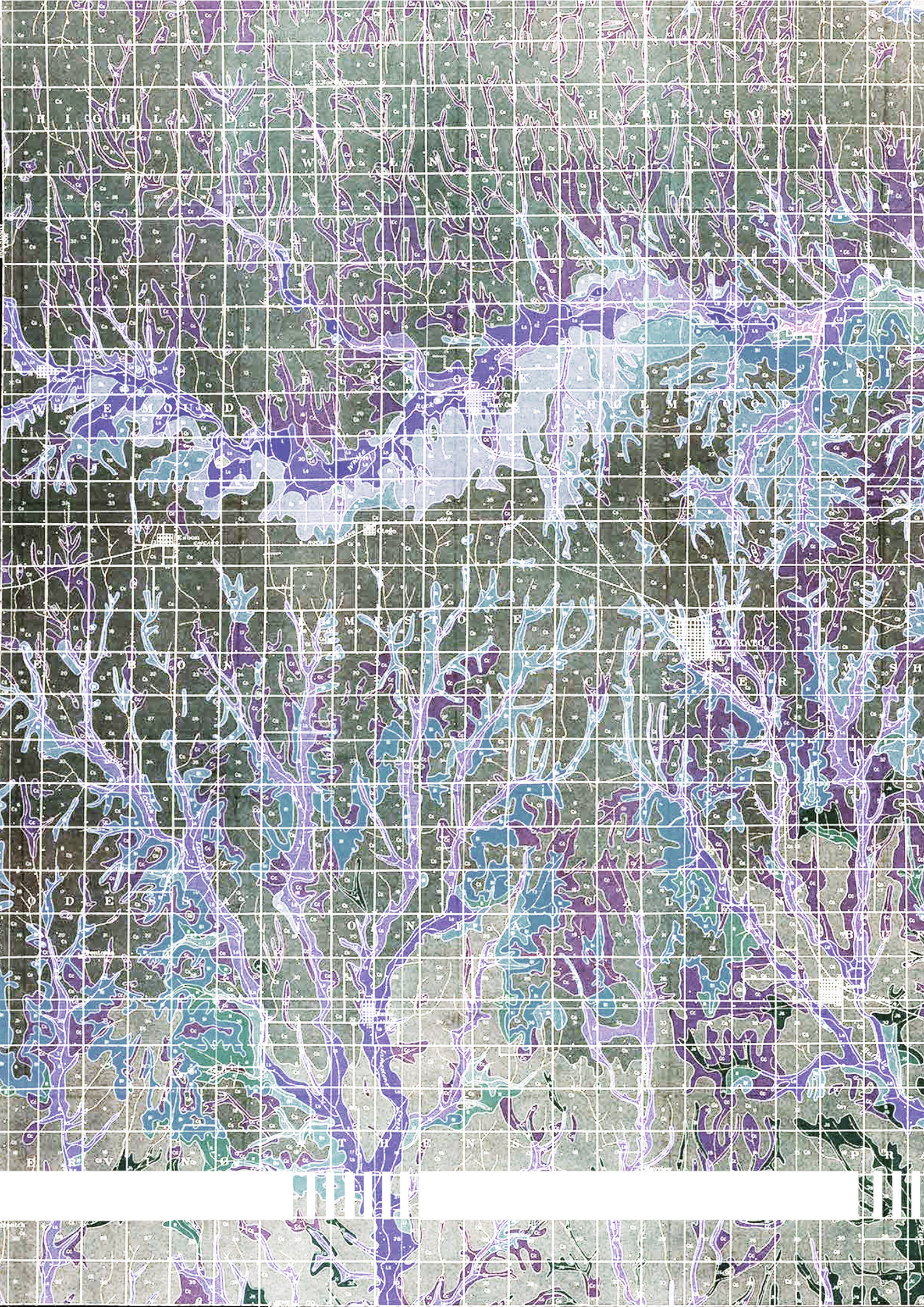

The dominant actor in the Scheldt Estuary, the Port of Antwerp continues to expand. According to the Statute of the Western Scheldt dating from 1839, the Netherlands guarantees the necessary works to maintain access to the port, including continued dredging to give access to ever-larger ships.

The port continues to compensate for ecological damage by pushing for the depolderisation of land bordering the Western Scheldt, often in Dutch territory, arguing along three lines; flood defence (through a decrease in tidal height variation at Antwerp); increased intertidal habitats and the reduction in dredging as a result of increased tidal velocities.

### 3 Territorial Analysis Scenario

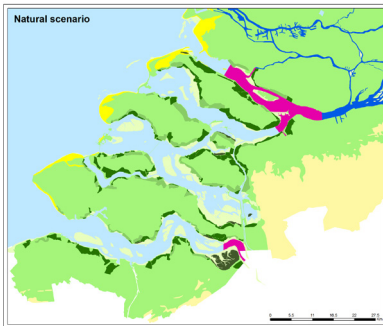

Natural Scenario

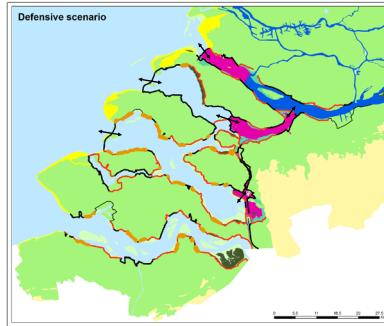

Defensive Scenario

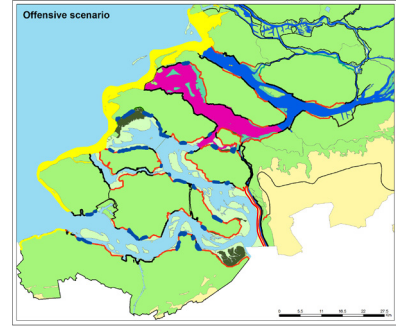

Offensive Scenario

### 3.1 Scenario Framework

I employed a scenario based approach to developing the various spatial strategies which could be employed in the South West Delta in order to consider new variables. As my hypothesis led me to an open system of flood defence I considered active and passive defences. These were framed in reference to a recent study by Deltares and Wageningen University which considered different applications and scales for 'building with nature' which aims to create hydraulic infrastructure utilizing the dynamics of the natural system.

The open/passive response is defined by an extended foreshore and nourished sand banks, in line with the logic of the depolderisation of Hedwigepolder. The closed/defensive scenario leaves the Delta as it is but applies currently used building with nature measures on a larger scale. The close/active scenario reshapes the Delta into a manageable but safe design, defined by secondary dikes which create electricity by tidal movement. An open/active system suggests this type of harvesting of available resources leading me to a scenario where the materials of the invading water are taken full advantage of by a productive landscape.

The same process was applied to the movement of sediment by dredging based on research on existing practices, described by the Rijkswaterstaat and the Port of Antwerp. The open/active response in this case is to utilise the dredged material inland for construction or land elevation.

This scenario signifies a break with contemporary logic of containing and separating water, but has precedents in a more distant past when materials for flood defence had to be found in the immediate surroundings. This approach would make relevant again the health of the river to its residents.

Sources:

Rijkswaterstaat, *Dutch Safety Map* (2014)

Rijkswaterstaat Tidal Waters Division, *Prospects for the Scheldt Estuary* (1992)

A. Wiersma, *Sustainable Scenarios for the South West Delta based on Building with Nature Strategies* (2014)

Port of Antwerp, *Sustainability Report* (2017)

Water Control

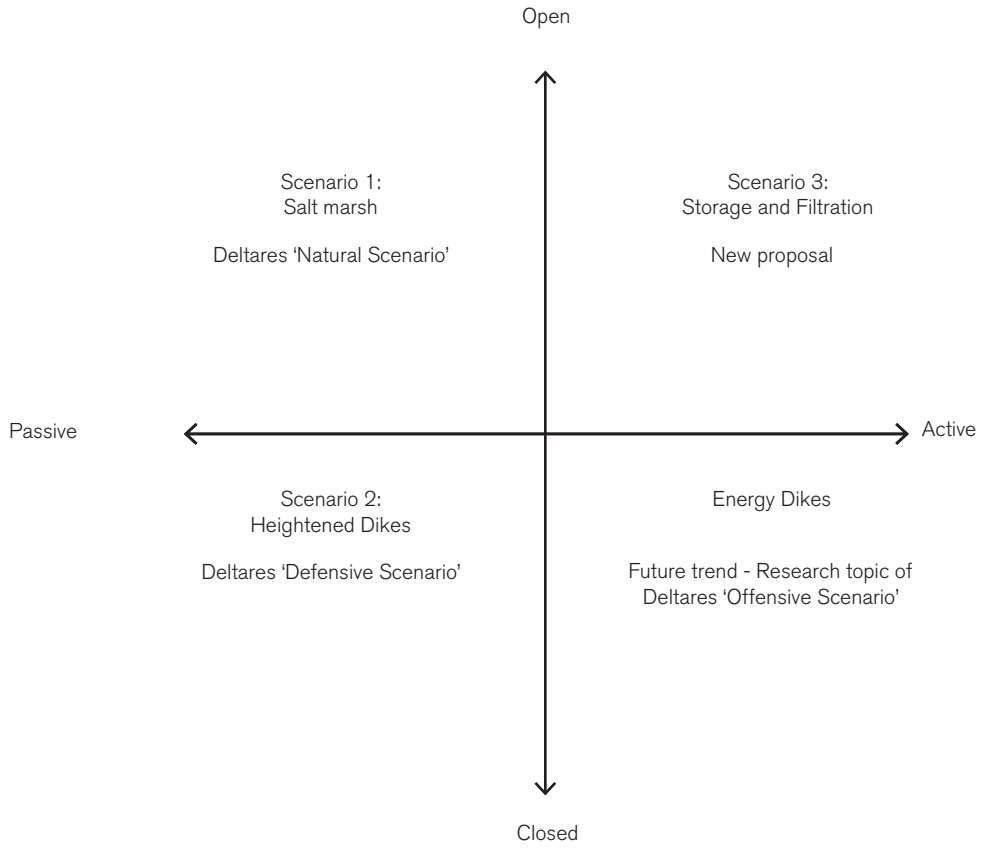

Sediment Control

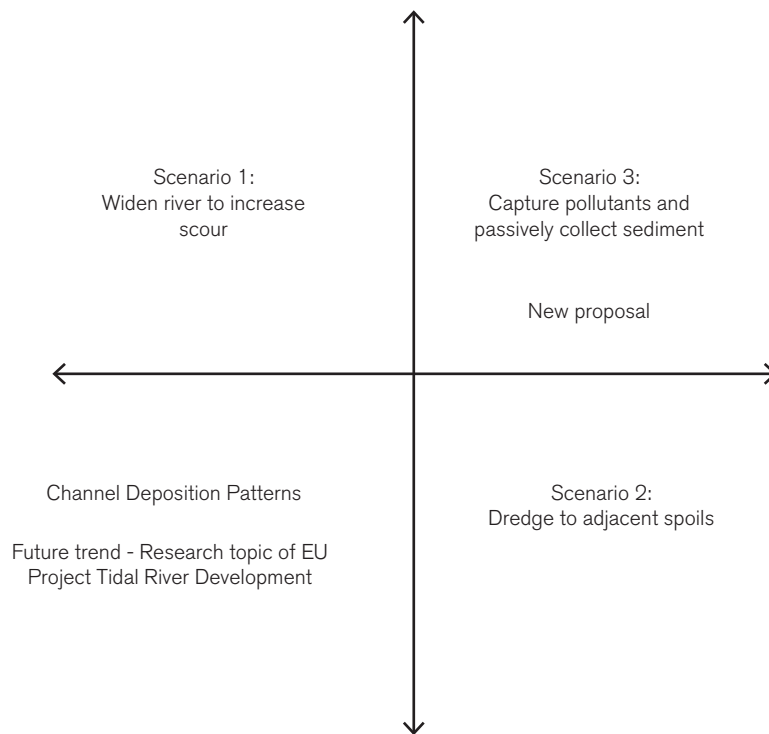

## RISK OF SUDDEN ECOLOGICAL

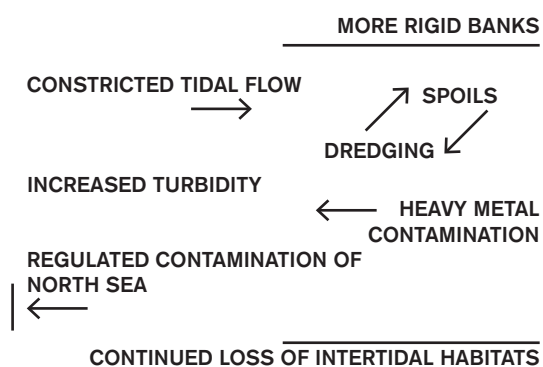

### 3.2 Scenario 1: Strengthened Dikes

If the spatial logic of today continues into the future we can expect the coastline of the Netherlands to become increasingly fortified with dikes raised along the coast. This represents a high investment in construction and maintenance but would be widely accepted as a means to combat increased storm surges and high sea levels. From a cultural point of view this represents business as normal. Spaces for marine life would continue to be minimised and the continued need for dredging and spoils within the estuary system would continue to damage the biodiversity of the shoreline. Rigid banks continue to constrict tidal flow and in the event of a storm surge put the Port of Antwerp at risk of inundation as there is little to slow the flow of water before reaching the expanding port. This could represent an ecological disaster in the form of an oil chemical spill requiring increased monitoring and warning systems.

Overall this scenario risks long term ecological damage in order to maintain the status-quo.



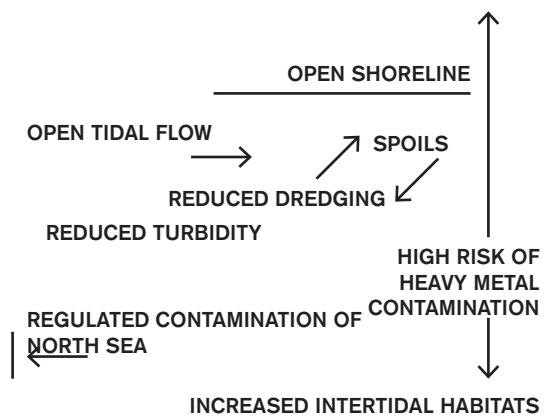

### 3.3 Scenario 2: Depolderisation

An alternative scenario to heightening the dikes is to enlarge the estuary, allowing more water to enter on each tide, using a system of double dikes or by further depoldering parts of Zeeland. This was the recommendation of a 1992 study carried out by Rijkswaterstaat's Tidal Waters Division but would face strong resistance by local inhabitants at the loss of their land. This would greatly benefit the Port of Antwerp as tidal variation would be reduced before reaching Antwerp, reducing the mean high water level. Furthermore the increased ebb and flow velocities would maintain channel depth partly by natural scour, reducing the need for dredging. Ecologically this scenario would also be beneficial as a wider foreshore would give space for more complex biotopes and reduced dredging would improve the turbidity of the water. However, the continued pollution of the water would affect ecological sites further inland and could mean that complex ecosystems never develop. The heavy metal pollution also threatens local inhabitants who would be further exposed, and the entry of salt water into the polder system would make land non-arable.





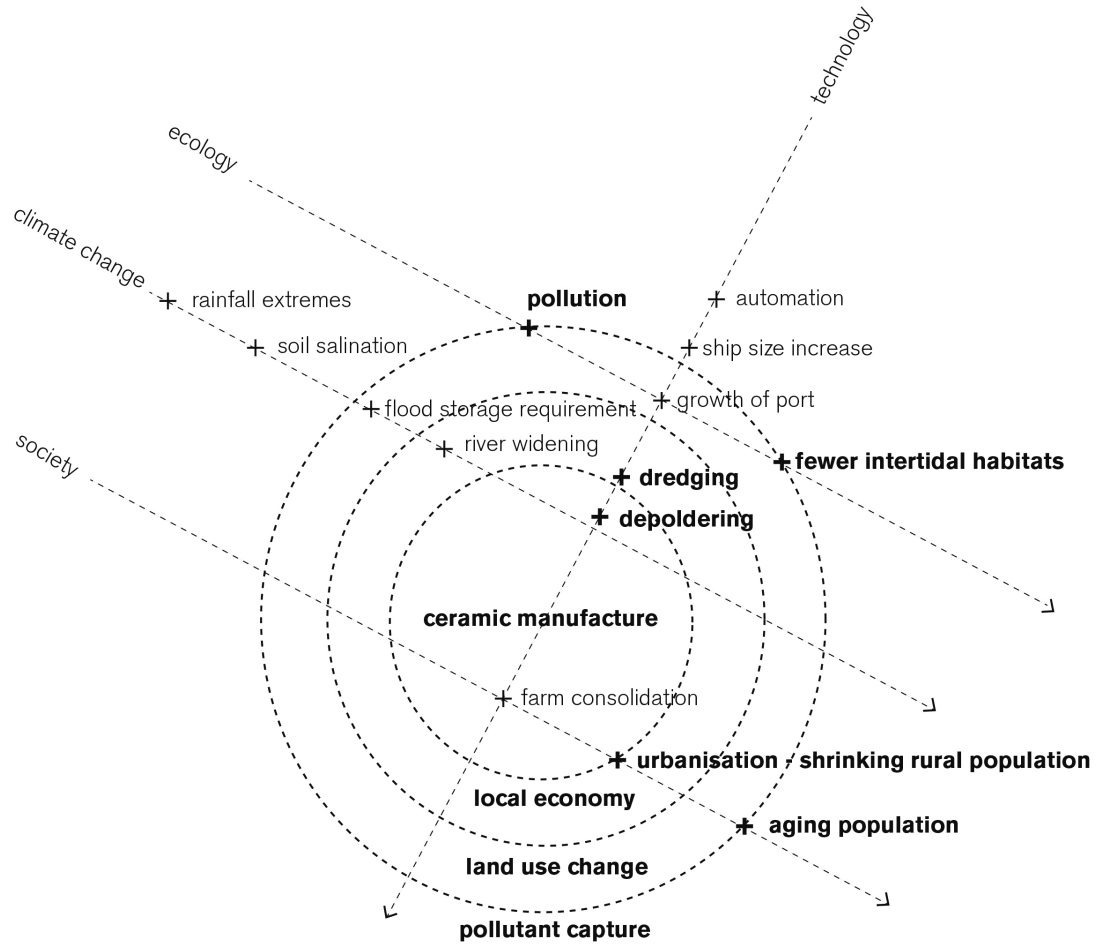

### 3.4 Scenario 3: Controlled Inflow of Elements

My proposed scenario seeks to combine the benefits of both systems by creating a system of gradual, controlled depolderisation while providing a new economy for heavy metal capturing clay products. In a departure from the current model, a compensation fund from the Port of Antwerp is imagined to be locally managed by individual communities where they sustain some loss of farmland for their own protection and benefit through a site specific adaptation of the existing dike and polder system.

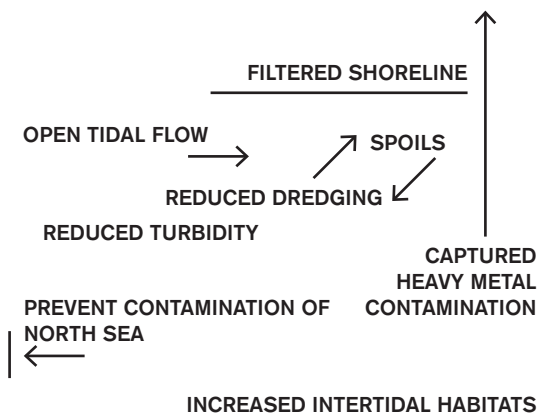





4 Urban Analysis  
Borssele Polder, Zeeland

#### 4.1 Test Case: Borssele Polder, Zeeland

The areas which are most beneficial for increasing the velocity of the river are the sand points as a straighter channel runs faster. A study of areas most a risk of flooding by the Rijkswaterstaat in 2014 also shows that these sand bats are the most vulnerable areas to flooding. The Borssele polder is chosen as my site as it represents a likely area to be depoldered in the future.

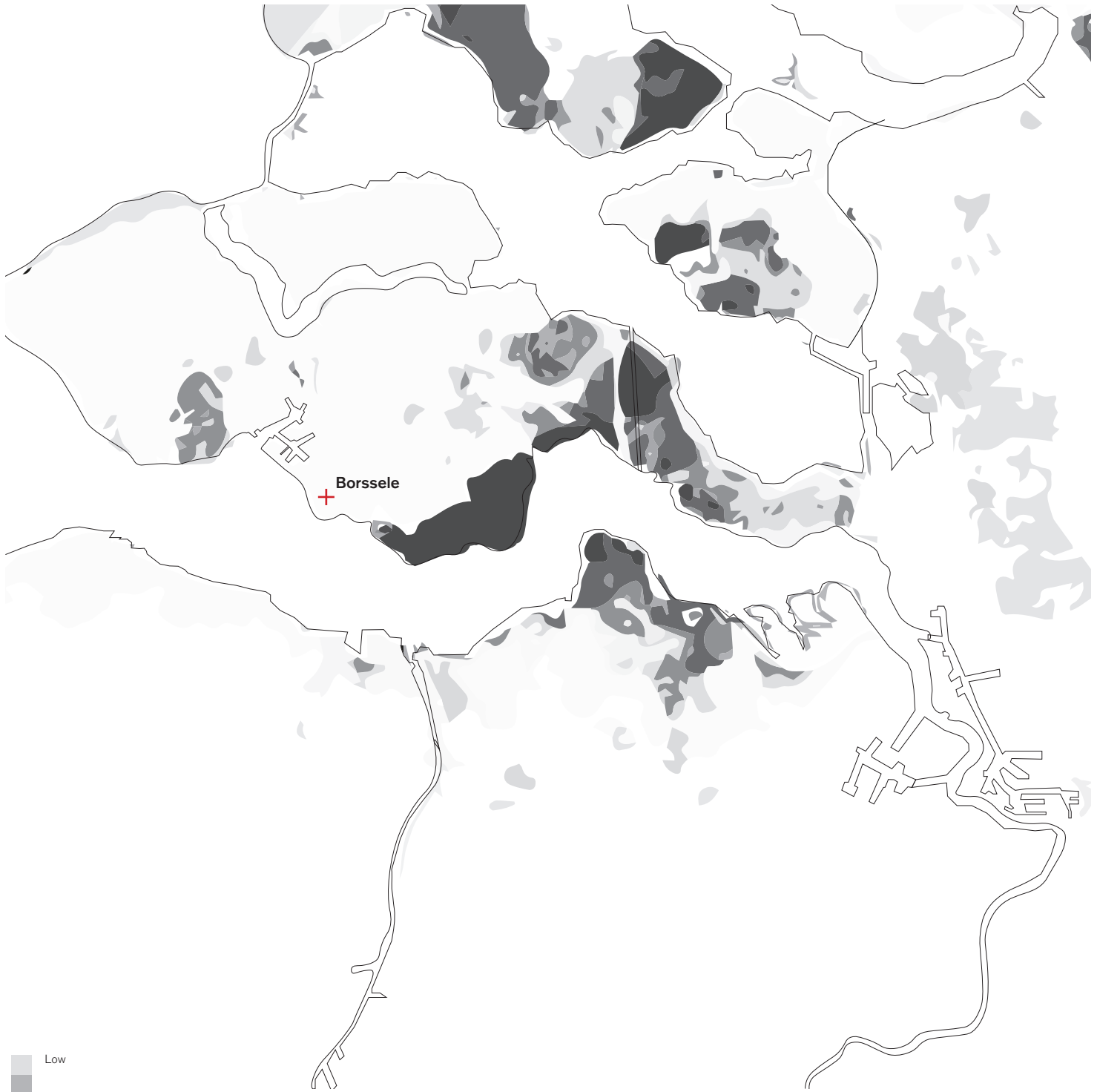

Annual individual loss-of-life risk  
Rijkswaterstaat, *Dutch Safety Map* (2014)



## 4.2 Geometry

The axis of the polder reflect its continuous recapture from the water. Borssele was initially enclosed from the estuary in the 14th century and the rational layout of the town reflects Renaissance ideals about beauty and nature. The first dikes weren't strong enough and it was re-flooded soon after, leaving behind only the castle motte. This created a system of tidal creek-beds in the landscape which now form the polder drainage creeks. When it was re-enclosed in 1616 the axis of the polder land was shifted about 10° meaning the combined effect is unusually complex.









### 4.3 Geology

The town has a long history, mentioned as Brumsale in 976 when it was an estuarine island. Its enclosure was from the deposits which built up outside the dikes, meaning that the geology of the ground is largely marine clay. Tidal creeks, created during its re-flooding deposited clay onto the clay land, and led to a heightened topography along their banks as sand is less prone to subsidence. Today clay deposits build up on the Eastern edge of the dikes, brought by the flow of river clay from the mouth of the Scheldt, while the Western coastline is deep and heavily dredged to accommodate the shipping lane which passes close by.

-  Water
-  Dike ring
-  Creek
-  Clay deposits
-  Sand deposits

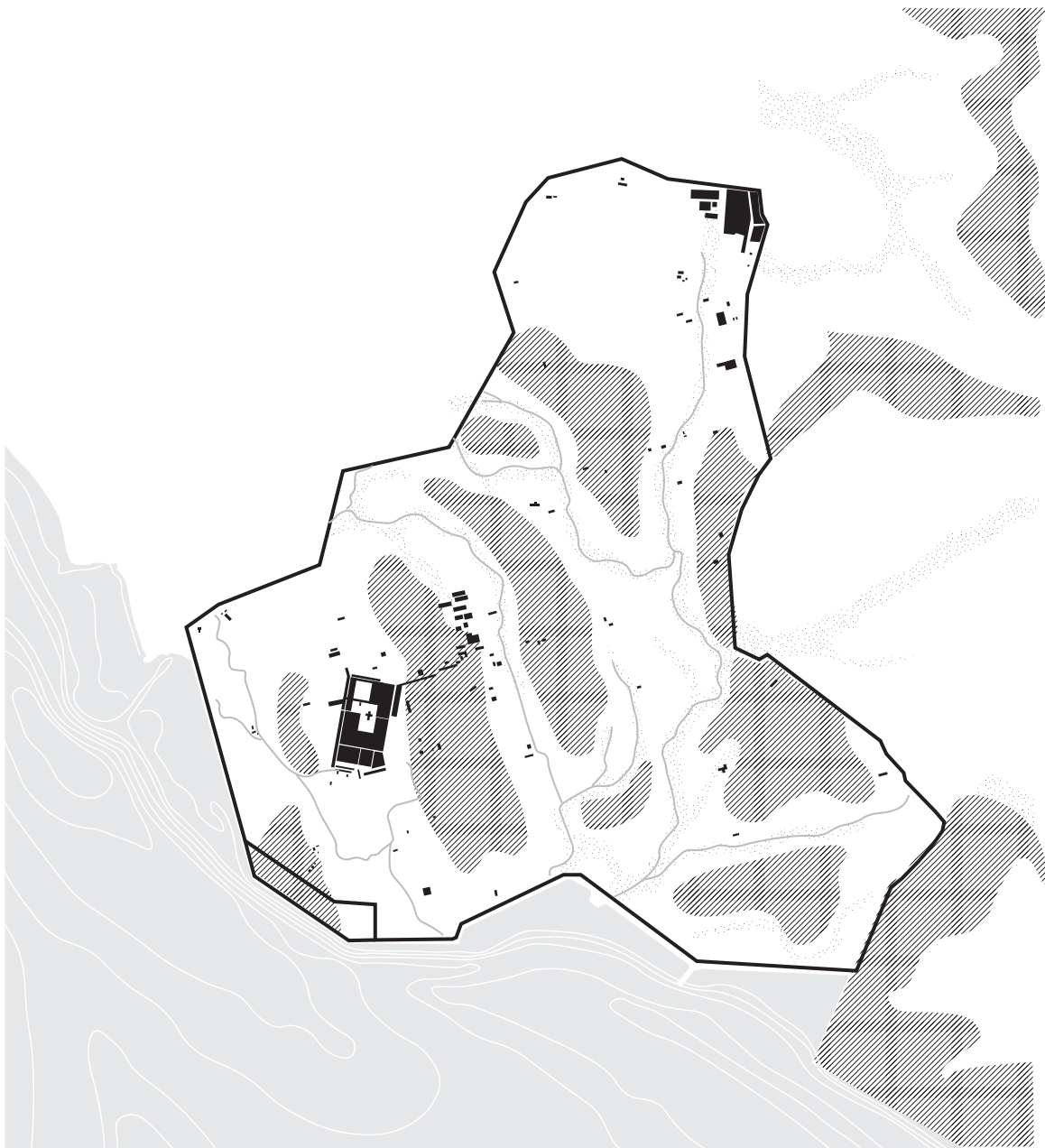



#### 4.4 Urban character

Within the polder the land is agricultural and residential, with a town made up of about 400 houses and a small industrial area. There are a concentration of nationally protected monuments in the town centre, including the Dutch Reformist church and the ancient motte. The town of Borssele is separated from the rest of the polder by the Westerscheldtunnelweg, a road built in 2003 to connect Zeeland to Zeeland-Flanders at Terneuzen. Directly adjacent to the West of the polder is of the Netherlands' only nuclear power plant and an electrical transformer station run by Tennet. In 2020 this will be the connection site to the Borssele wind farm, 94 turbines in the North Sea projected to supply 1484MW of energy. These nationally important assets are protected from flooding by ground elevation of 5.5m.





- Water
- Dike ring
- Agricultural land use
- Industrial land use
- Open spaces





#### 4.5 Polder system

The water from inland drains through Borssele into the Scheldt, controlled by a series of pump houses which maintain a consistent water level all year round, designed to be optimal for agricultural production. This occurs in a rationalised canal system, whereas the secondary system of canals which drain the water captured within the polder itself reflect a combination of the tidal creek beds and the rational plot divisions.

-  Water
-  Ditches
-  Canal
-  Pumping station

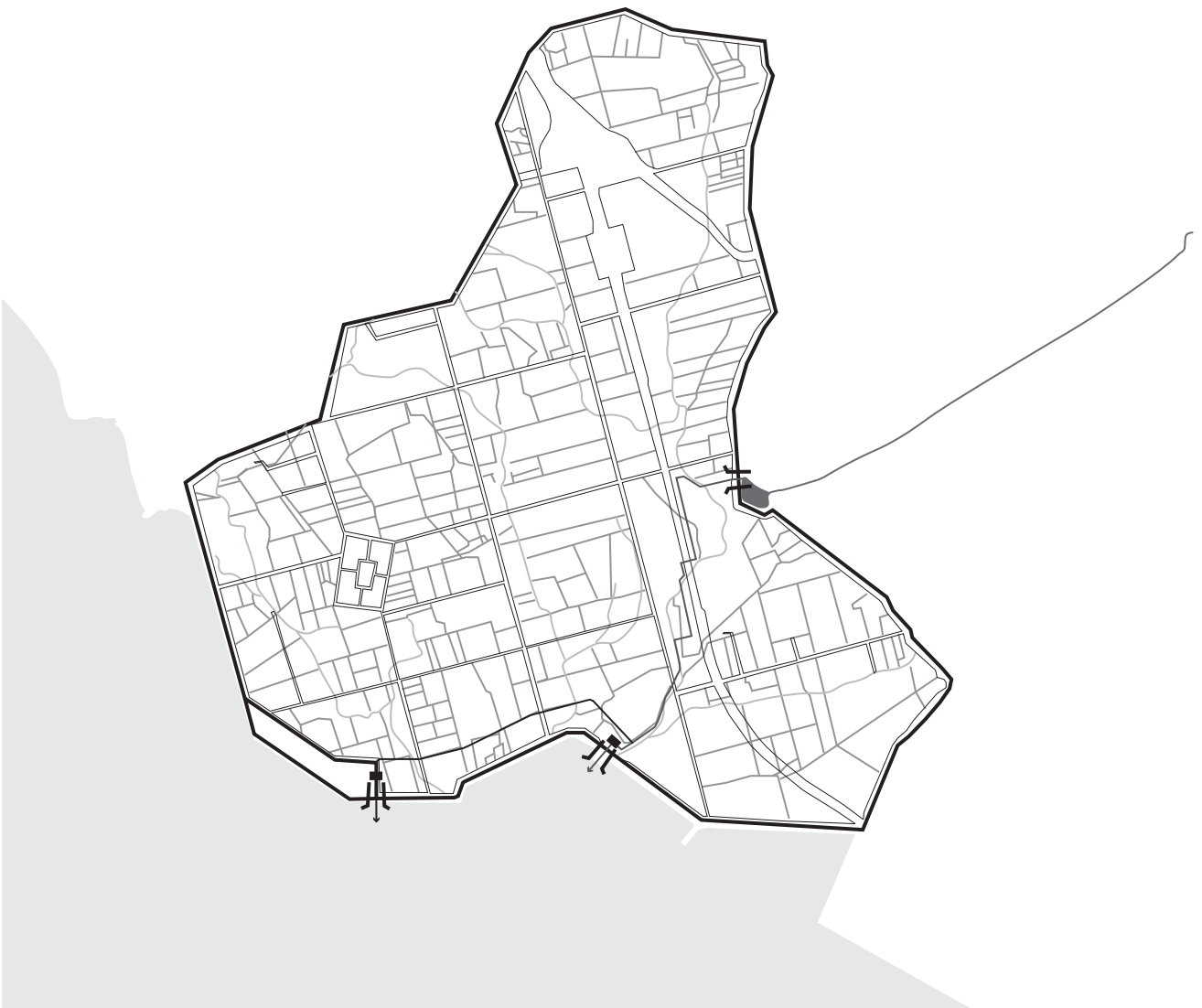

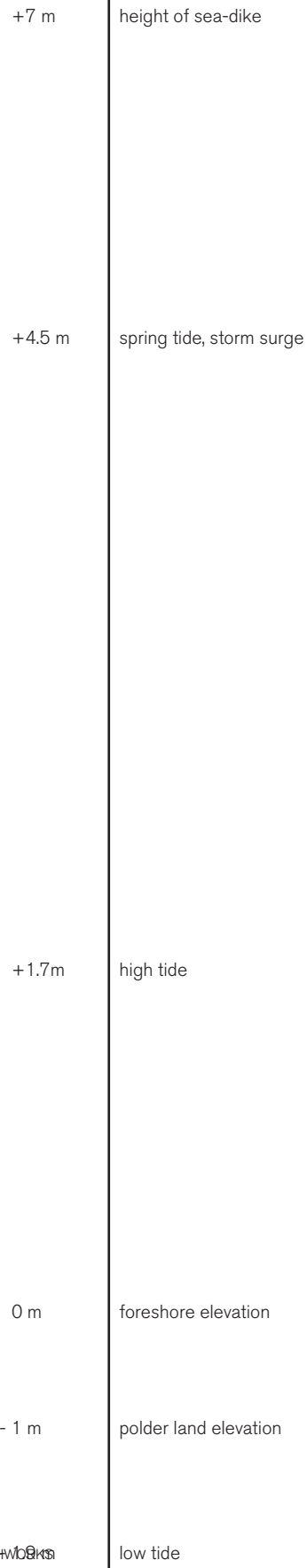

#### 4.6 Summary

Borssele represents an island of land surrounded by larger neighbours, with important cultural, infrastructural and elevational relationships which would have to be maintained and managed in an open flood defence system. This makes it a contained but also challenging testing ground to design a new site specific system of defence in response to.







#### Research question

How can an architecturally altered polder system control the new material elements resultant from an open system of flood defence?

#### Sub-questions

What are the new material elements resultant from an open system of flood defence?

What are the built elements required to control and manage an open system?

How does a system of control reflect the current and possible future conditions of Borssele?

### 4.7 Problem Statement

By considering an open system of flood defence my project questions the physical and cultural norms established by the polder system. If applied to Borssele depoldering tactics will have clear material consequences through the introduction of salt, silt and sand. Taking these as the material characteristics of a new cultural identity for the depoldered landscape the project proposes a new system of control based on adaptation to and benefit from the altered industrial wasteland condition of the Western Scheldt estuary.

Currently Borssele acts as an island, cut off from its surroundings by its industrial neighbours, the Westerscheldtunnelweg and the sea dike. It is at risk of flooding from sea level rise and from river discharge and its location as part of a sand point makes it an opportune location for river widening schemes. Its landscapes are defined by an agricultural character but an increasing proportion of its residents commute outside of the island for work in other industries. It is home to a concentration of nationally protected monuments, symbols of the cultural landscape.

As a microcosm for Dutch life, threatened by inundation, this site is taken as the testing ground for a new relationship with its surroundings, one defined by inclusion and collection of new elements rather than exclusion and dispersal. It will require a new lexicon of spatial forms, related to the existing system but augmenting it to provide new cultural relationships to land and water.





By taking matter as a primary agent of change my research into the estuary prioritised its material qualities and flows. The movement of earth is a tangible measure of the power of different actors on the Scheldt, evident in the construction of dikes for farming, the elevation of land to protect industrial assets and the dredging of the riverbed for the access of cargo ships to the port. Thus, a new set of power relations is also imagined performed in material terms, where the movement of earth to create a new line of defence a new set of secondary consequences, shifting the power relations on the estuary through the transformation of clay into tile and heavy metals into glaze.

## 5 Strategy Material Analysis

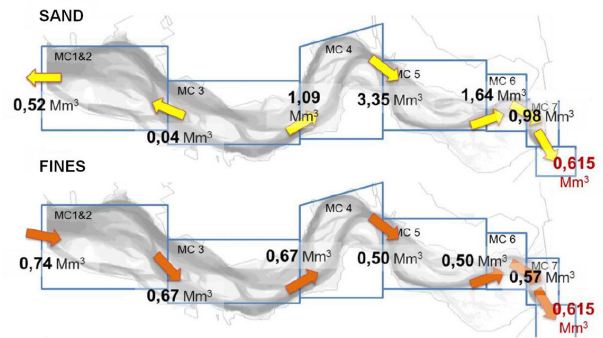





Annual sand and sludge transports over the edges of the Westerschelde macrocells, calculated over the 1994-2000 period based on the sand and silt balance (Cleveringa, 2013)

## 5.1 Material flows

The Scheldt is a complex system of flow patterns that broadly create a chain of natural erosion and deposition sites, which are then augmented by the dredging of the access channel to the port and the associated spoils grounds. The flood tide brings mostly sand and a smaller proportion of marine clay from the North Sea. The ebb tide draws riverine clay and silt from the mouth of the river in Belgium.

Dredged material is currently dumped in spoils grounds as it is too heavily polluted to be dumped into the North Sea where it would pose an ecological threat. This speeds up the process of erosion and increases the turbidity of the water. The on-shore dumps and underwater compartments currently used for the disposing of maintenance dredging spoil are slowly coming to their capacity limits. As a result in 2006, the Flemish Region decided to tackle the problem in a new and sustainable manner by building a mechanical de-watering installation and storing the de-watered sludge on shore in the Port of Antwerp itself. It is estimated that 500,000 tonnes of dry matter will have to be treated and stored every year.

-  Water
-  Clay Deposits
-  Dredged Shipping Routes
-  Dredge Spoils

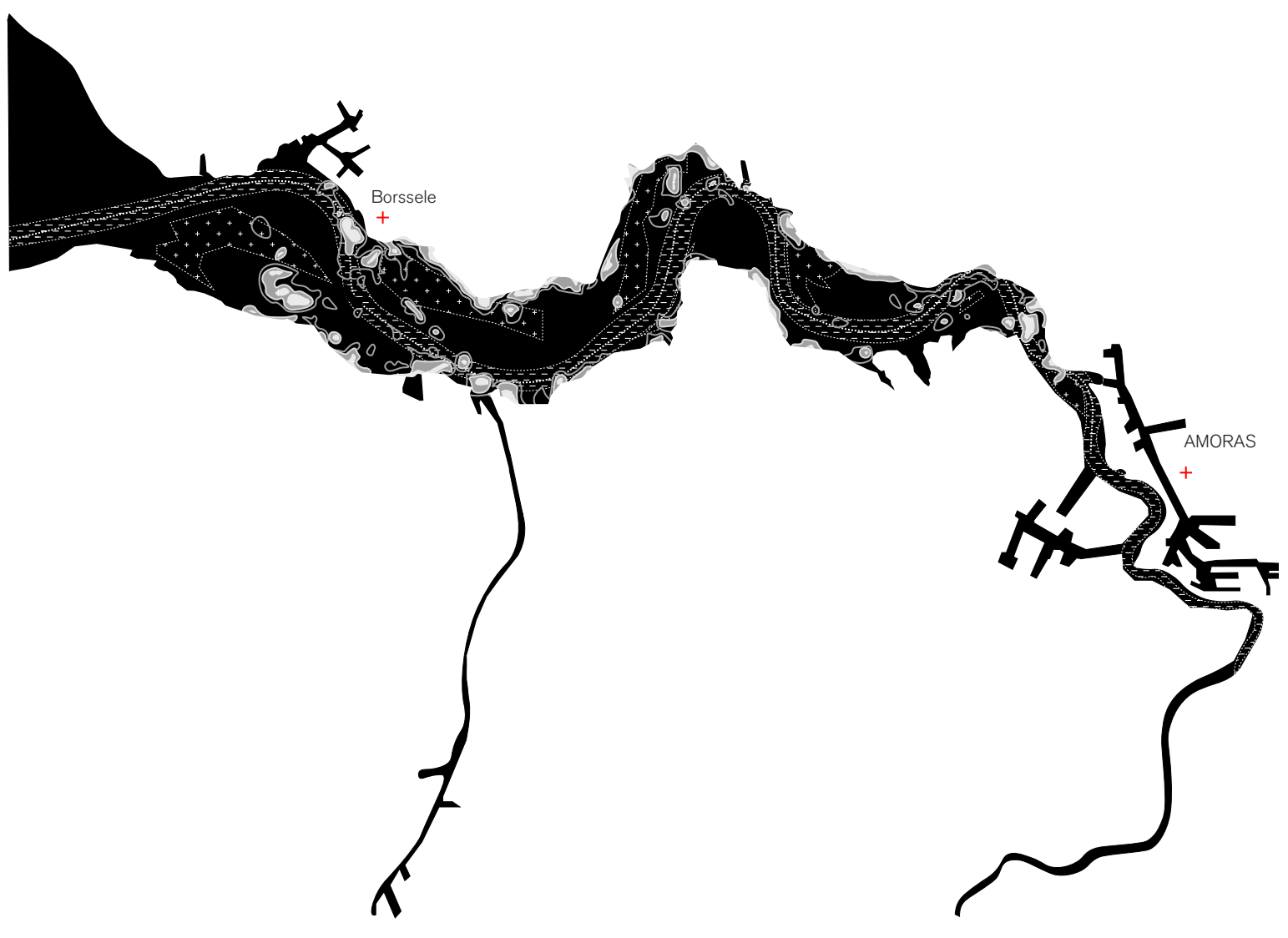

Borssele  
+

AMORAS  
+

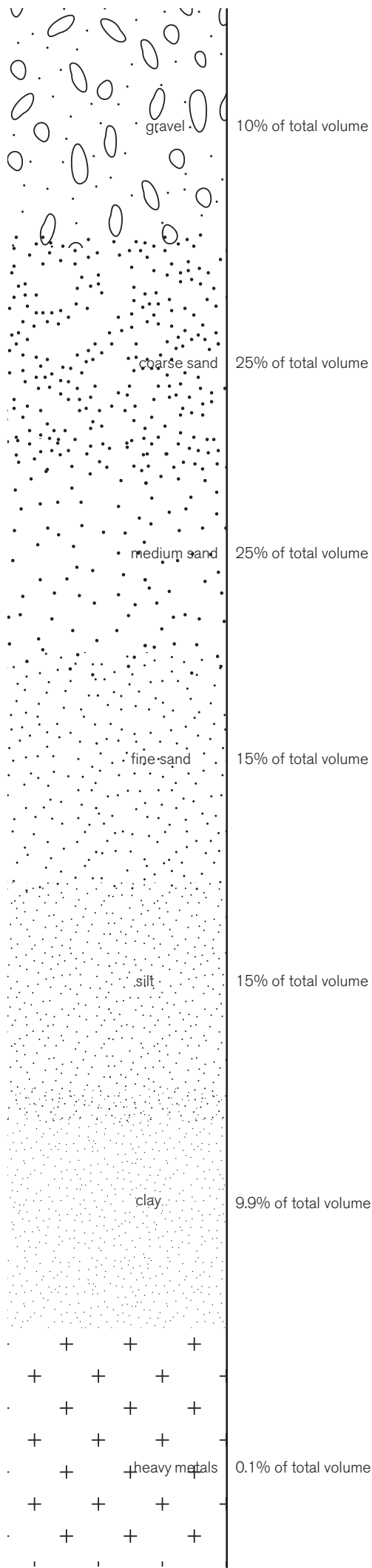

- water**
- sand**
- riverine + sea clay**
- debris**
- salt
- organic matter
- crude oil
- zinc
- copper
- chromium
- lead
- nickel





Relative importance of emission sources of heavy metals in the Antwerp port area  
Port of Antwerp, *Sustainability Report* (2017)

## 5.2 Material composition

As a resource collector the landscape becomes closely connected to the health of the river, the output being the physical record of the environment. Research showed that the Scheldt's lithology is clay, both sea and riverine, as well as high amounts of sand. This also showed that the water of the Scheldt is contaminated by heavy metals. The main contaminants are copper, mostly from the hulls of seagoing ships, zinc, mostly from anodes used in hydraulic engineering projects and shipping and cadmium, mostly from hydraulic engineering structures and atmospheric deposition. Other contaminants include crude oil and plastic debris. The water by the site is salty or brackish depending on rainfall.

By understanding the material makeup of the Scheldt its threat to and opportunities for an open system of flood defence become clear.

Soil composition Western Scheldt Estuary  
Source: [scheldtmonitor.be/geomonitor](http://scheldtmonitor.be/geomonitor)

-  Buildings
-  Water
-  Gravel
-  Clay
-  Sand





10km

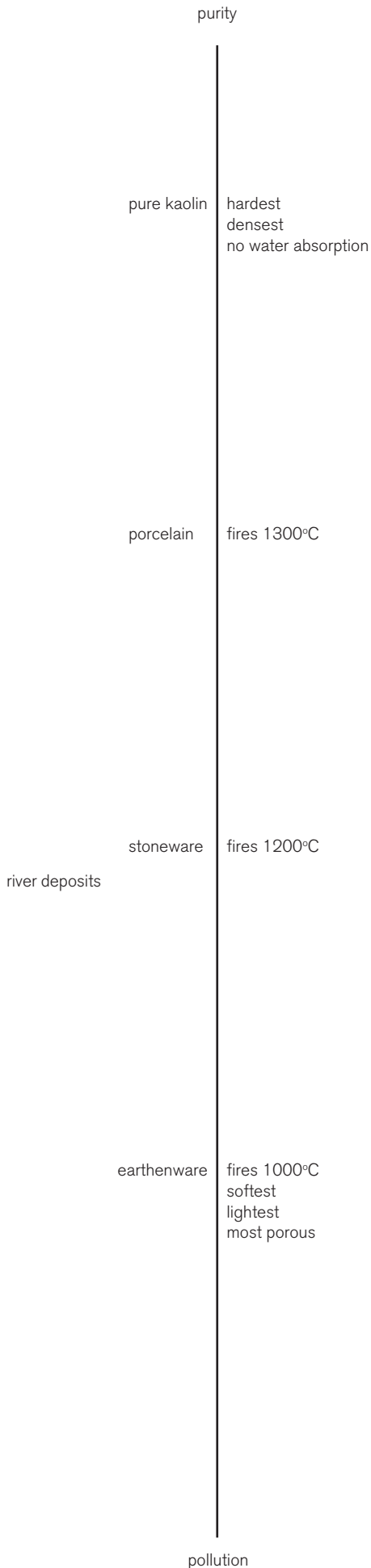

A. Kucerenkaite, *Ignorance is Bliss* (2016) agne-k.com

### 5.3 Material [re]composition

The materials analysed above give an ingredients list for recomposing the material elements of the Scheldt inland. As a natural absorber of chemicals, including heavy metals and salt, clay has a history of use in medicine. Recent research in environmental engineering assesses its use for soil desalination, but its traditional use as ceramics also has the potential to incorporate toxic heavy metals into a solid form resistant to chemical degradation and leaching. In its inert form the pollutants of the Scheldt become both visible and a part of a new local economy, creating a functional landscape which accepts an altered condition.

An artist from the Design Academy of Eindhoven, Agne Kucerenkaite, uses industrial waste as the colourant for ceramic design ware, making visible the local chemistry of specific locations. This inspired a design for a ceramics factory utilising local materials extracted from the Scheldt as both an economic driver for the area but also a manifestation of the changing ecology of the river.

Sources:  
 E. Helios-Rybicka, *Clays and Clay Minerals as the Natural Barriers for Heavy Metals in Pollution Mechanisms* (1990)  
 J. Kujawa, *Hydrophobic Ceramic Membranes for Water Desalination* (2017)  
 Agne Kucerenkaite, *Ignorance is Bliss* (2016) agne-k.com



Agne Kucerenaite, *Ignorance is Bliss* (2016)

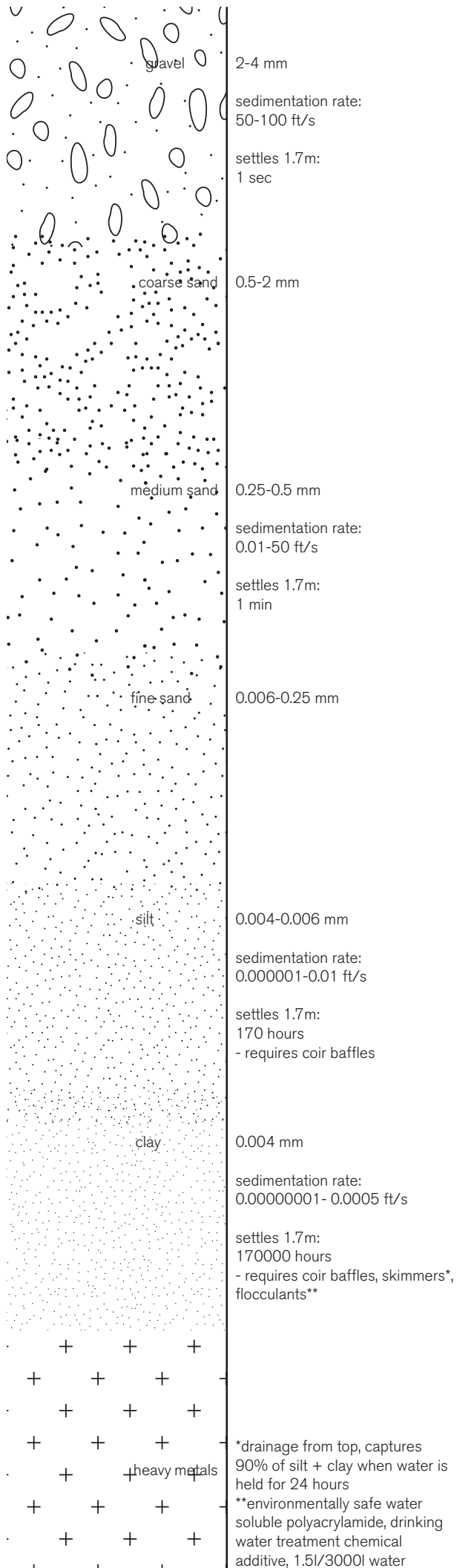

**sediment budget**

area of basins: 500,000m<sup>2</sup>  
 water depth: 1.7m  
 volume water inflow: 850,000,000l  
 approx 350mg suspended sediment /l  
 sediment volume: 300m<sup>3</sup>  
 approx clay composition 10%  
**clay volume: 30m<sup>3</sup>**  
 clay weight: 30 tonnes

silo 5x6x6m volume:180m<sup>3</sup>  
 clay curing 2 months  
**9 silos for storage of clay**

**5.4 Sediment settlement and processing**

The collection of clay defines the scale and nature of the design proposal. The landscape intervention precedes the architectural one, where the volume of clay defined by the scale of the settlement basins and the suspended sediment load of the Scheldt combine to create the potential for a ceramic factory.

A set of basins is designed based on the relative volumes and settlement rates of the sand, silt and clay found suspended in the water of the Scheldt. My proposal is for a set of basins through which the sediment can be sorted and collected using coir baffles to speed up the process in order for it to occur within one tidal cycle of 6 hours.

At the end of the system the finest particles of clay are allowed to settle until the clear water is drained through a system of sluice gates into a canal and then to the river. At times of high tides this water is channelled into the polder scape. Next, the slurry of clay and water is pumped into holding tanks in the active facade of the building ready to be processed.

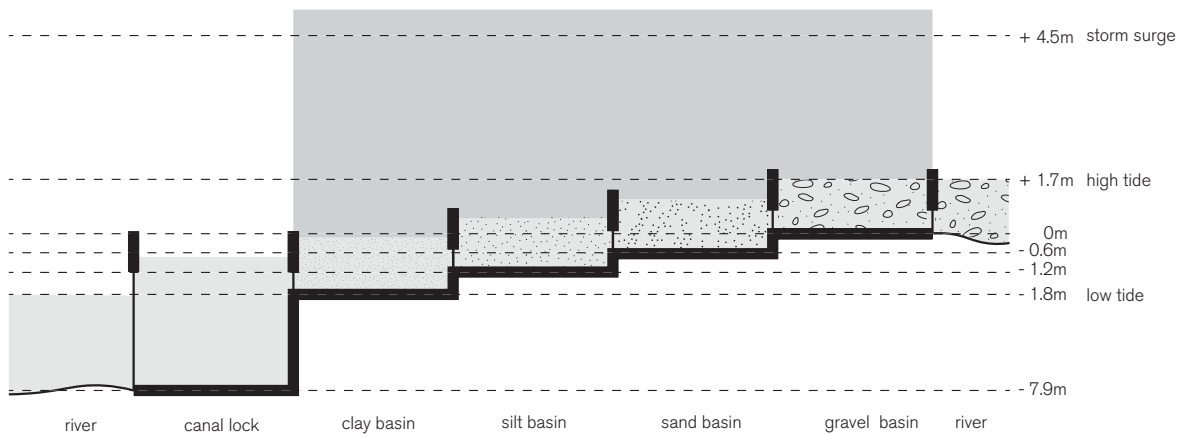
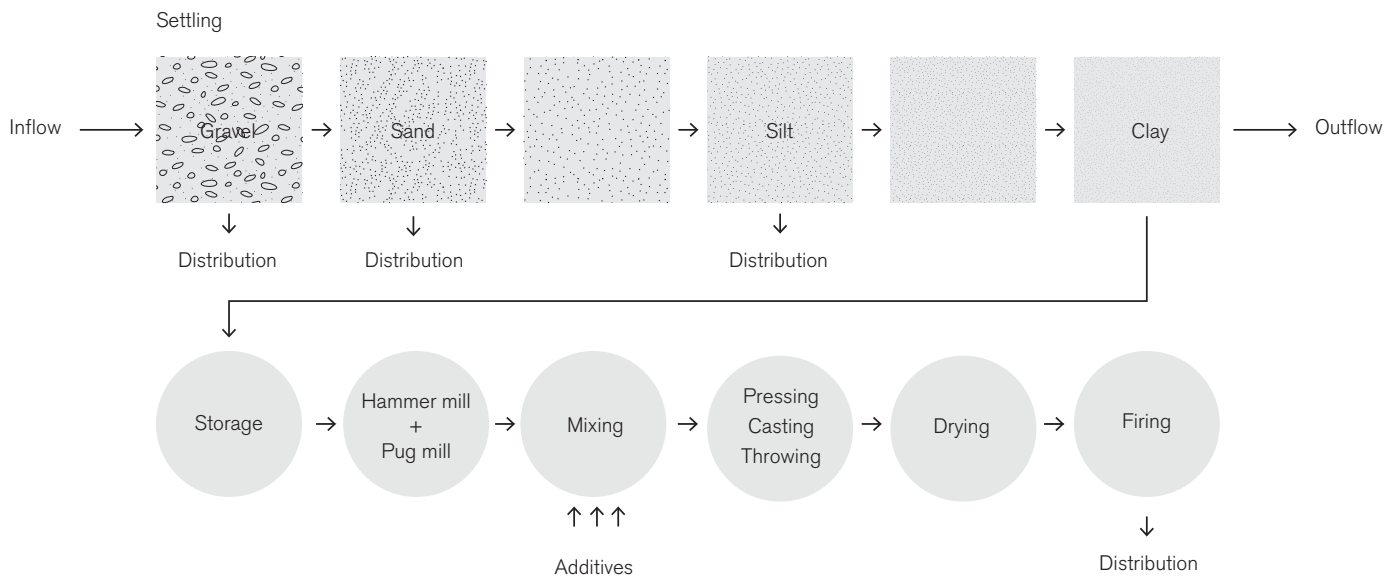

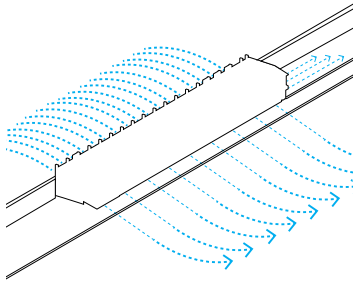

water flows  
wetland creation

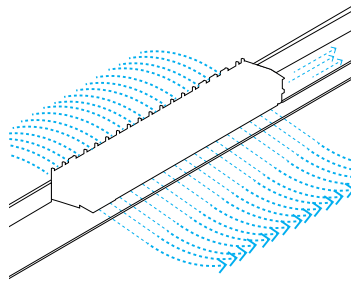

water flows  
storm surge storage

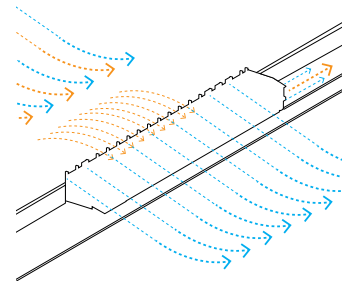

material flows  
clay collection, transformation,  
distribution

## 5.5 Brief development and temporality

A table of requirements is drawn up based on three temporal cycles. The first is the yearly harvesting of phytoremediation crops for the production of heavy metal glazes. The second is the daily rhythm of workers and visitors to the ceramic factory. The third is the tidal cycle of sediment settlement and collection. Future conditions are adapted to in the way the system is design to allow water to pass into the polderscape in times of flood.

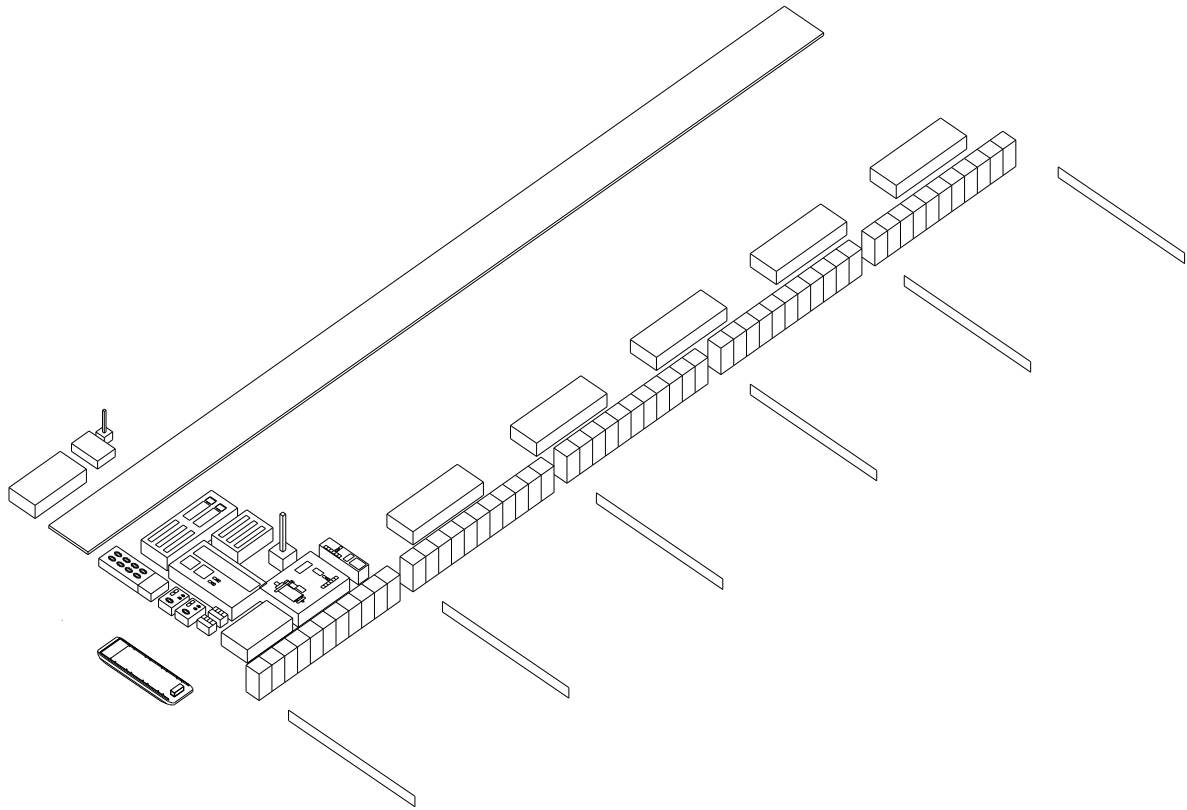

A Biomass storage  
3 Gardeners  
Tools, vehicle storage

B Glaze production lab  
1 Soil researcher, artist

C Biomass burner

D Phytoremediation gardens

E Storage silos  
125m<sup>3</sup>

F Clay milling  
5 Controllers

G Clay mixing  
3 Controllers

H Extrusion and printing

I Drying space

J Kiln  
2 Controllers

K Storage and distribution  
5 Drivers

L Exhibition  
3 Artists in residence, 1 curator

MWCs

N Print design labs  
2 Permanent technicians

O Distribution by barge  
1 Hydrologist, 2 crew

23 Permanent staff

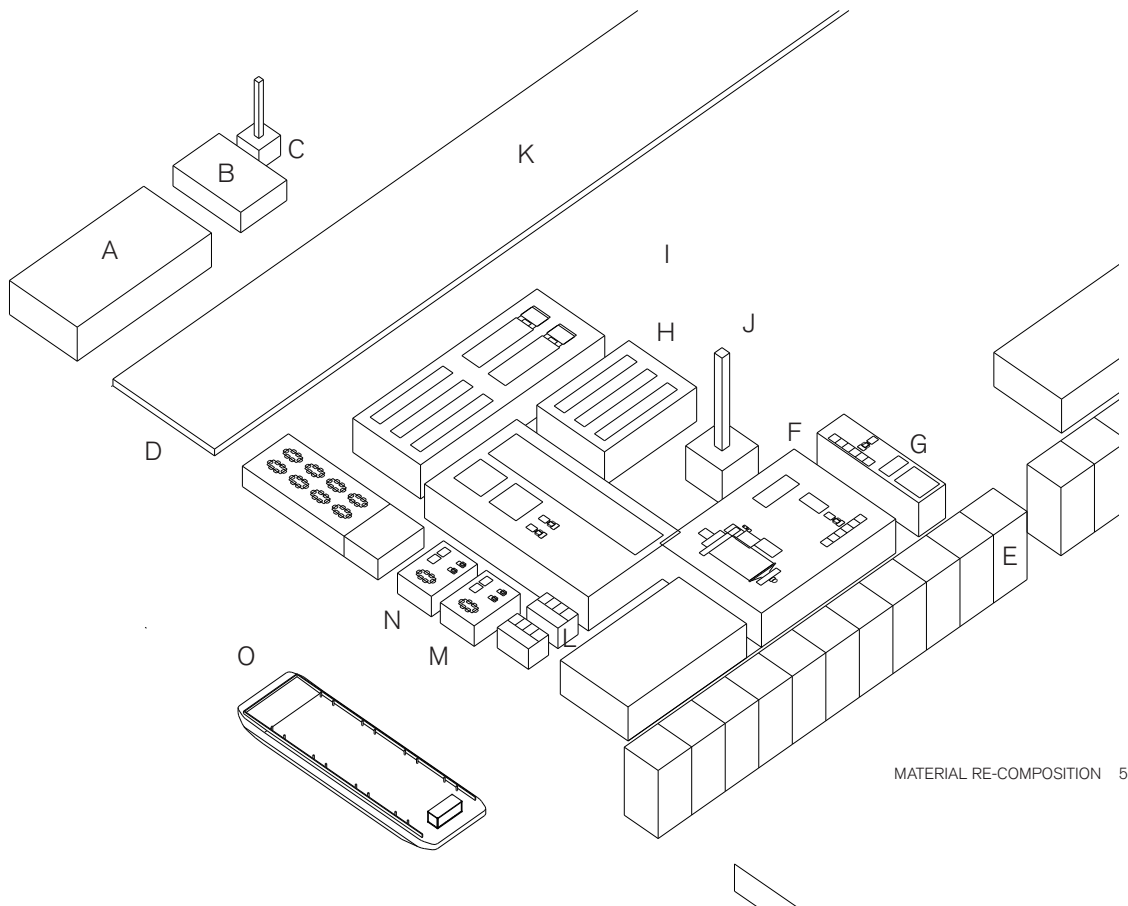

## 5.6 Summary

The landscape of Borssele Polder is transformed by the addition of a united productive element, a long inner dike which manages the flow of sediments and water inland. All of the processes of sedimentation happen passively and in relation to the local sediment budget and tidal variation. At the culmination of this landscape system is a ceramics factory which recomposes the elements of the Scheldt into cultural objects inherent with a local and sustainable development logic.



URBAN

Town centre protected

Vital infrastructure protected

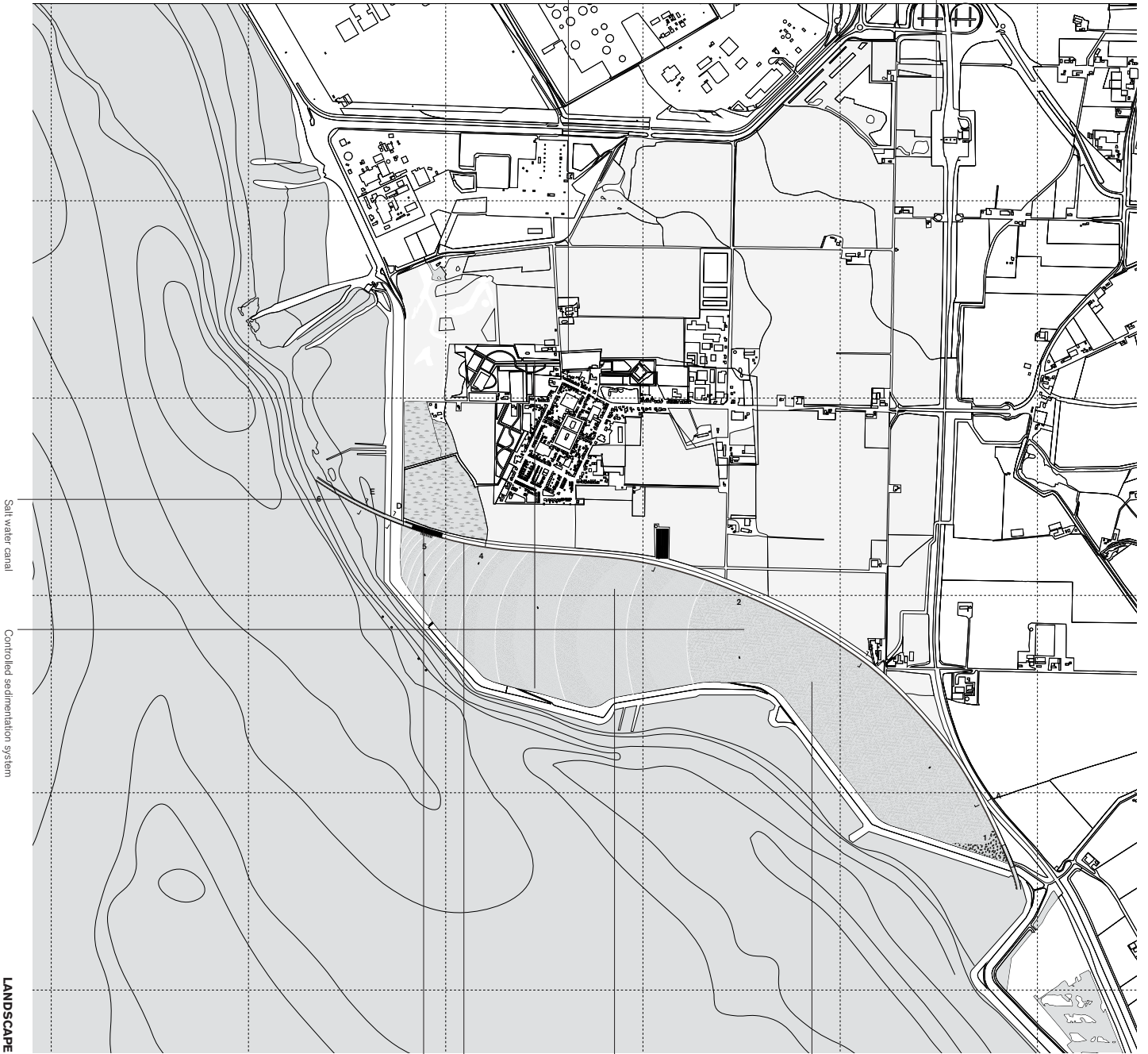

Salt water canal

Controlled sedimentation system

LANDSCAPE

Productive inner dike

Ceramics works

Silt collection

Sand collection

CULTURAL



[Dutch landscape painting] serves and energises a system of values in which meaning is not 'read' but 'seen,' in which new knowledge is visually recorded.

*Svetlana Alpers, The Art of Describing (1983)*

## 6 Composition A Performative Landscape

## 6.1 Polder system as a performative landscape

Huge de Groot referred to the polder as an “enclosed garden” as early as 1630, and its garden character has defined my understanding of it. As a piece of engineering, the polder is a cultural landscape with a particular history of reciprocal negotiation with the forces of the sea, wind, plants and animals. In this way it resembles a garden in its interplay of intentional and unintentional arrangements, exemplified by Borssele's creek bed division of gridded arable land. The hydraulic works which were used to control water laid the foundation for the structure of the landscape, and these forms were instilled with cultural meaning. In *Water in Sight* Bobbink emphasises the creative nature of this landscape creation, as an act of image making which embodies the immediate landscape's specific character.

### Sources:

I. Bobbink, S. Loen *Water in Sight* (2013)  
C. Steenbergen, I. Bobbink, S. de Wit, *Polder Atlas* (2009)  
C. Steenbergen, D. Aten, W. Reh, *Sea of Land* (2007)

**FUNCTION**

**LAND**

**WATER**

**GARDEN**

**STORE**

**FIELD**

**BASIN**

**LAKE**

**OPEN**

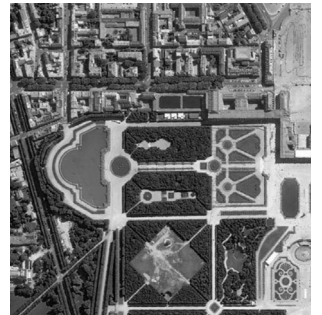

**PROTECT**

**DIKE**

**CHANNEL, MOAT**

**WALL**

**LINEAR**

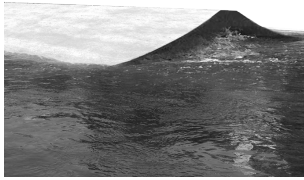

**INHABIT**

**MOUND**

**ISLAND**

**HOUSE**

**CLOSED**

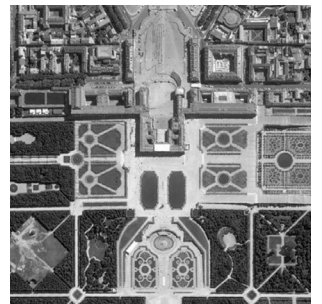

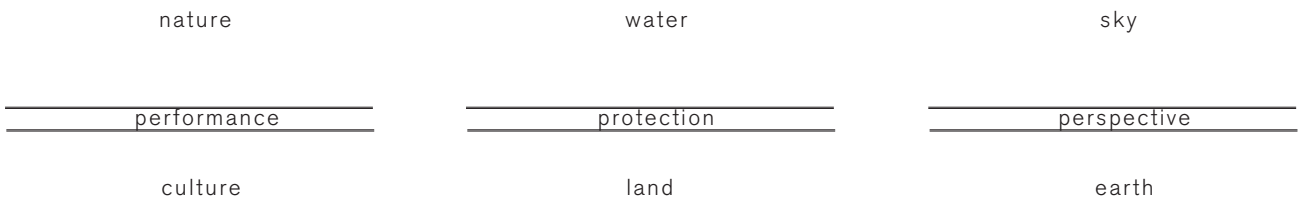

## 6.2 Wall typology

After testing various arrangements of basins in relation to the town of Borssele and with reference to the river flow, sediment volumes and the scale of sedimentation basins, as well as the volumes of material processed in industrial clay processing plants and ceramics factories, I arrived to an arrangement of functions which is stacked vertically. Using the height of the retaining wall of the basin (required to be above the height of the spring tide and a potential storm surge) to its advantage, an active facade incorporates all of the elements of water drainage, clay lifting, storage, drying, treatment and processing. This process of arrangement distilled the proposal into a single architectural element, expressing the nature of the project as a filter, of material flows, water flows and of the view beyond.

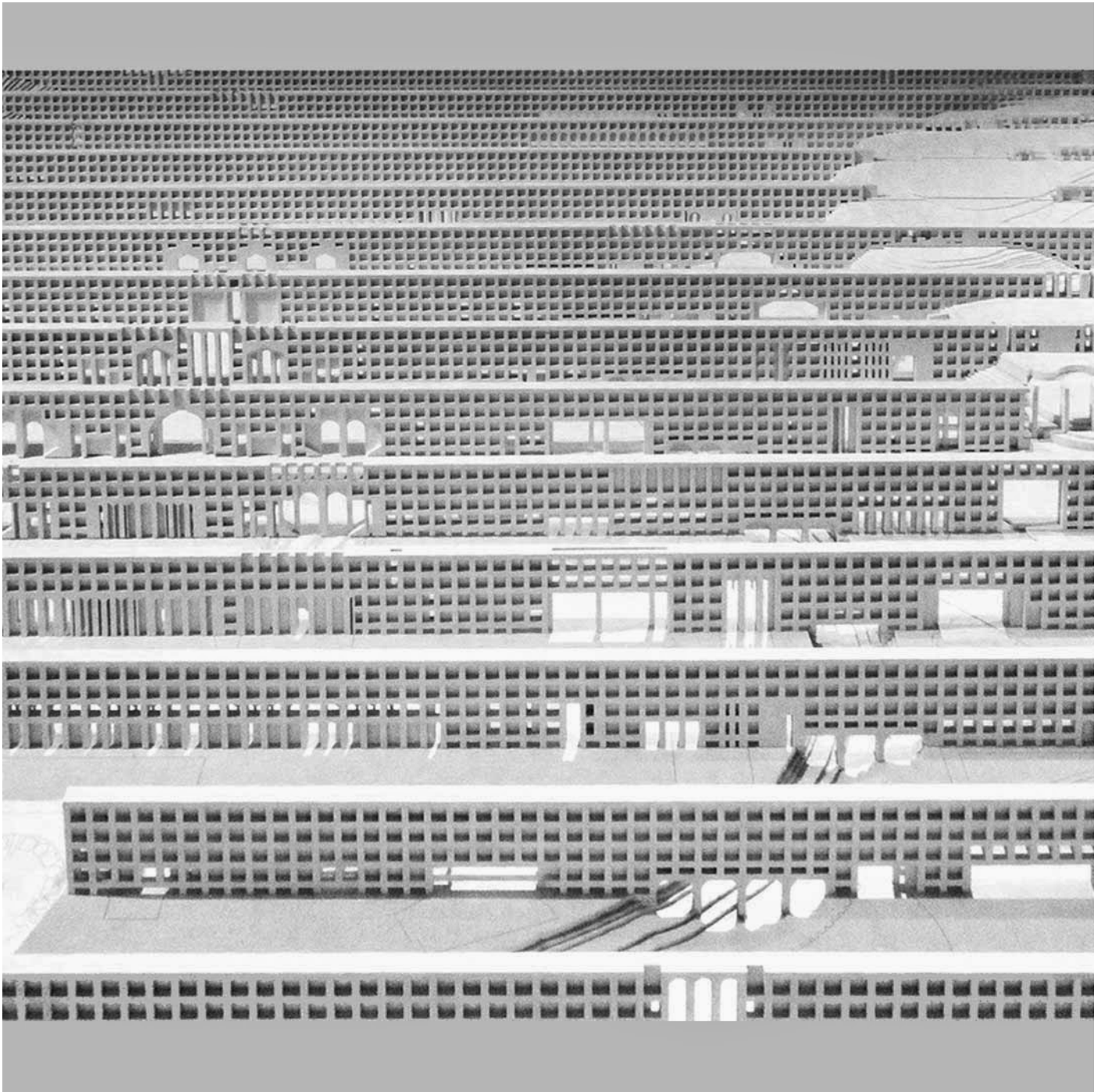

The wall represents "architecture's relationship to the ground and the political, social, and philosophical consequences that develop from that relationship"

- Peter Eisenman on The Piranesi Variations / 13th International Architecture Exhibition

### 6.3 Construction and materiality

The wall is constructed of locally mined aggregate in a cut and fill based construction across the giant scale of the polder. In lieu of aggregate mined elsewhere the system of sedimentation beds is used to provide local gravel and sand which can be mixed with concrete and poured into a reusable form-work to create a boundary out of the movement of the earth itself.



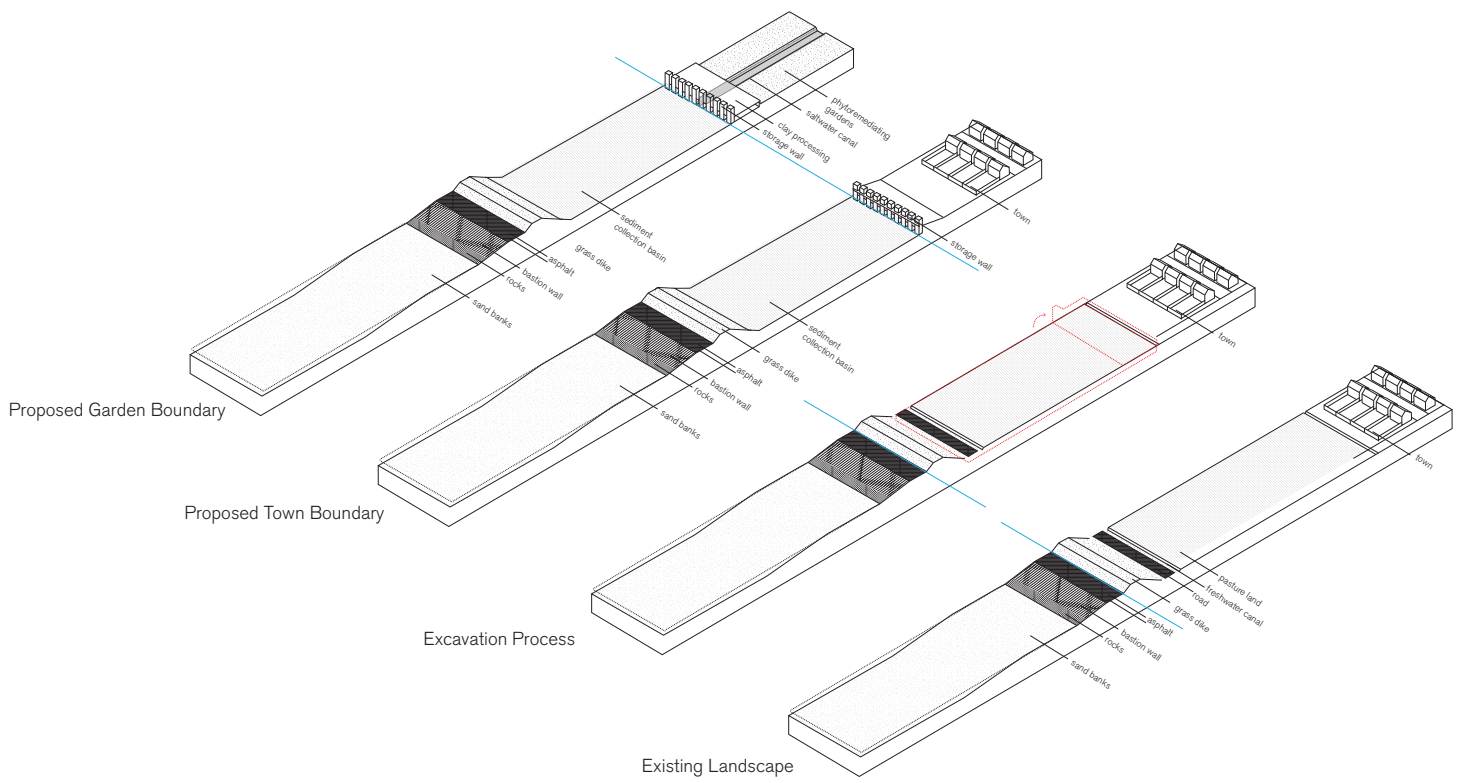

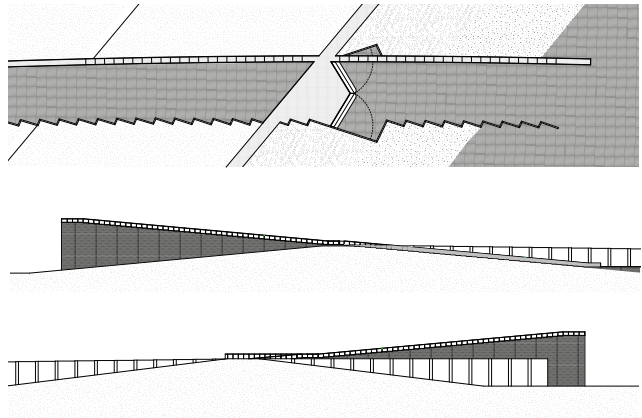

## 6.4 Landscape elements

### Tidal Inlet

The wall begins with a sluice gate which opens to allow water inside during the high tide. At this point in the dike, the tidal height will be 1.7m above the height of the basin, allowing this height of water to enter the first basin of the system.

The protective wall of the basin extends past the dike it cuts through creating a clear cut in the landscape. Beyond it, a pedestrian walkway reaches its maximum height, creating a viewing platform with which to see beyond the visual barrier of the dike.



Tidal Inlet

51°411'02.59" N, 3°77'02.19" E

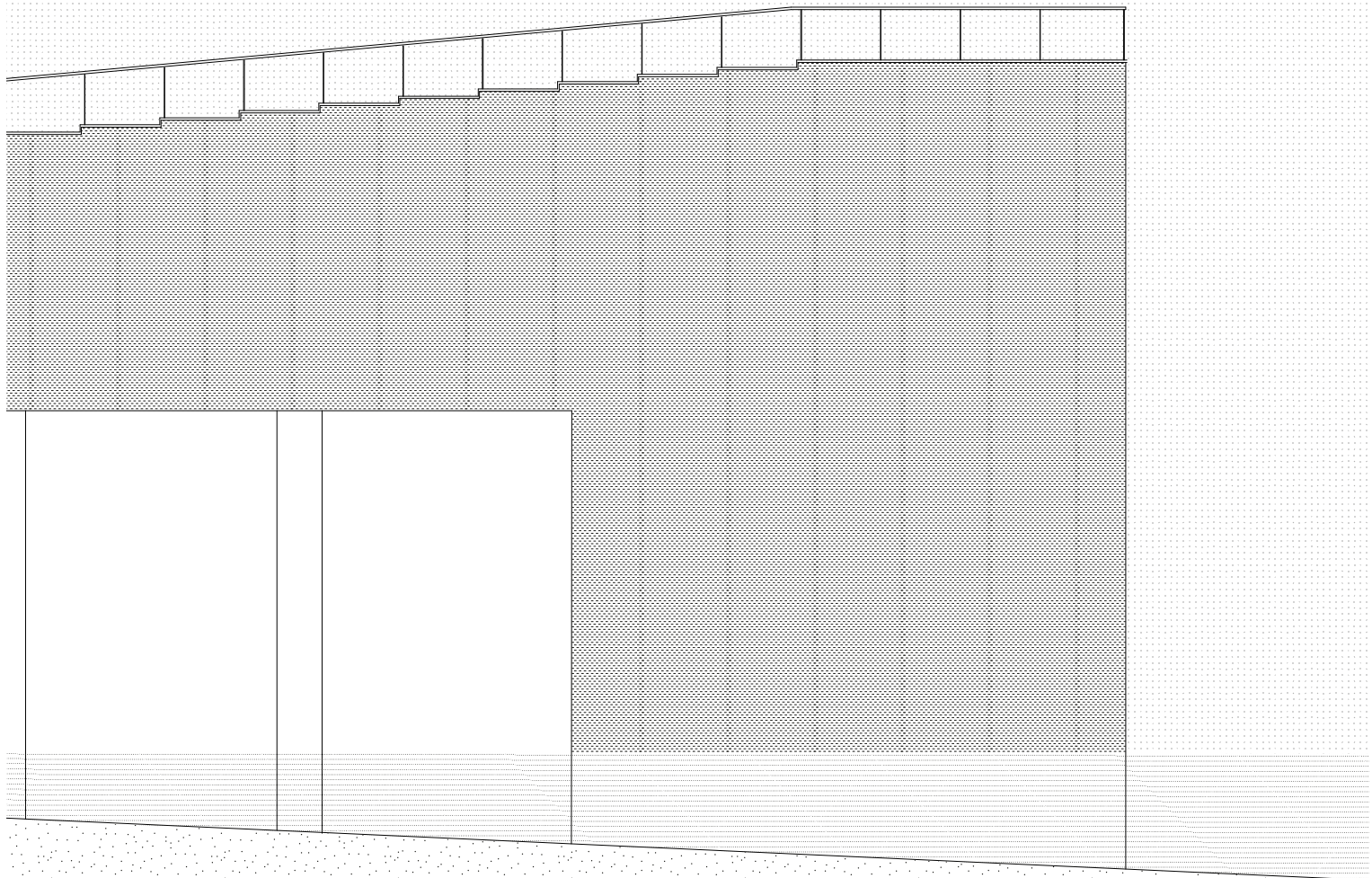

Outer Wall

Scale 1:200

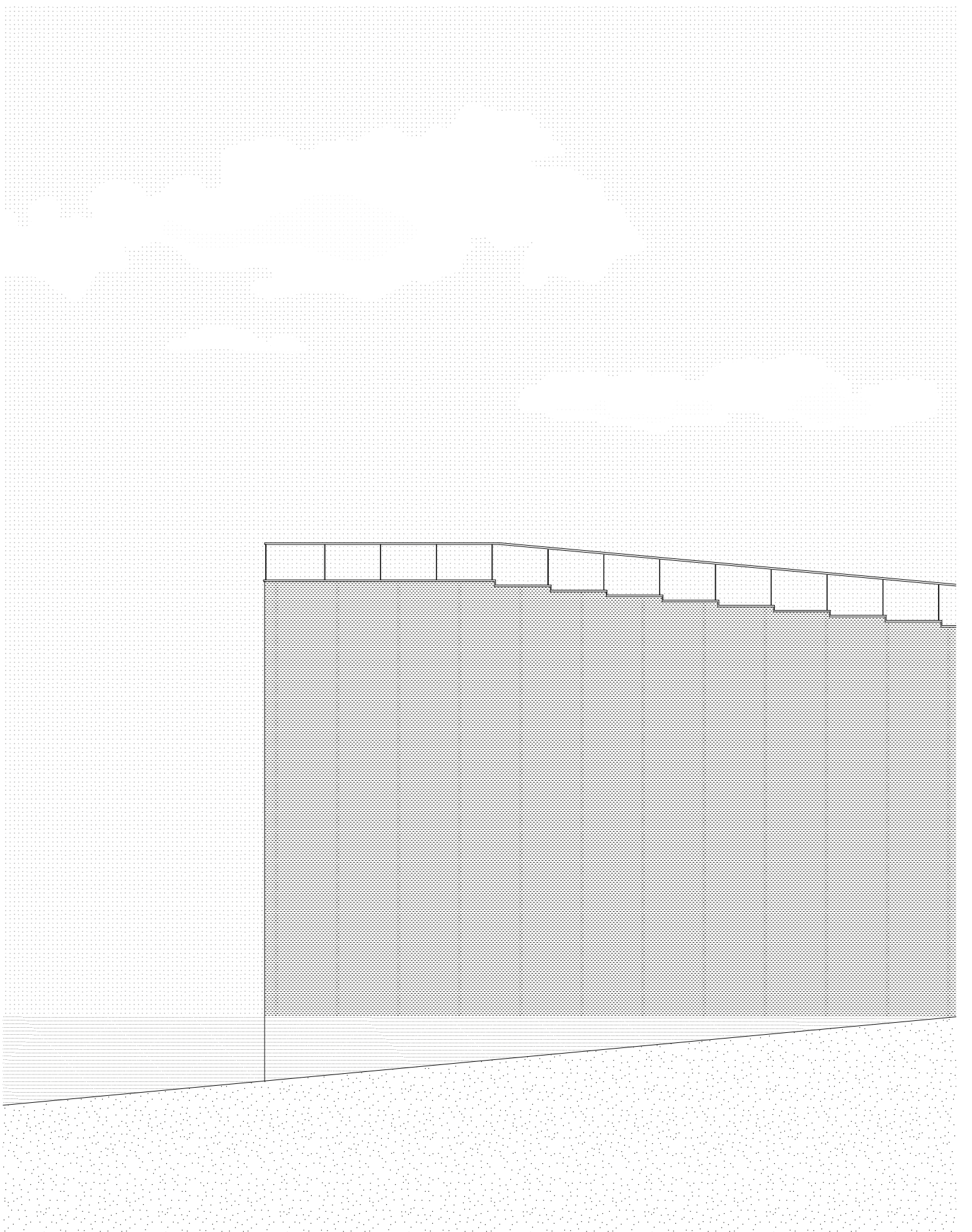

Inner Wall

Scale 1:200

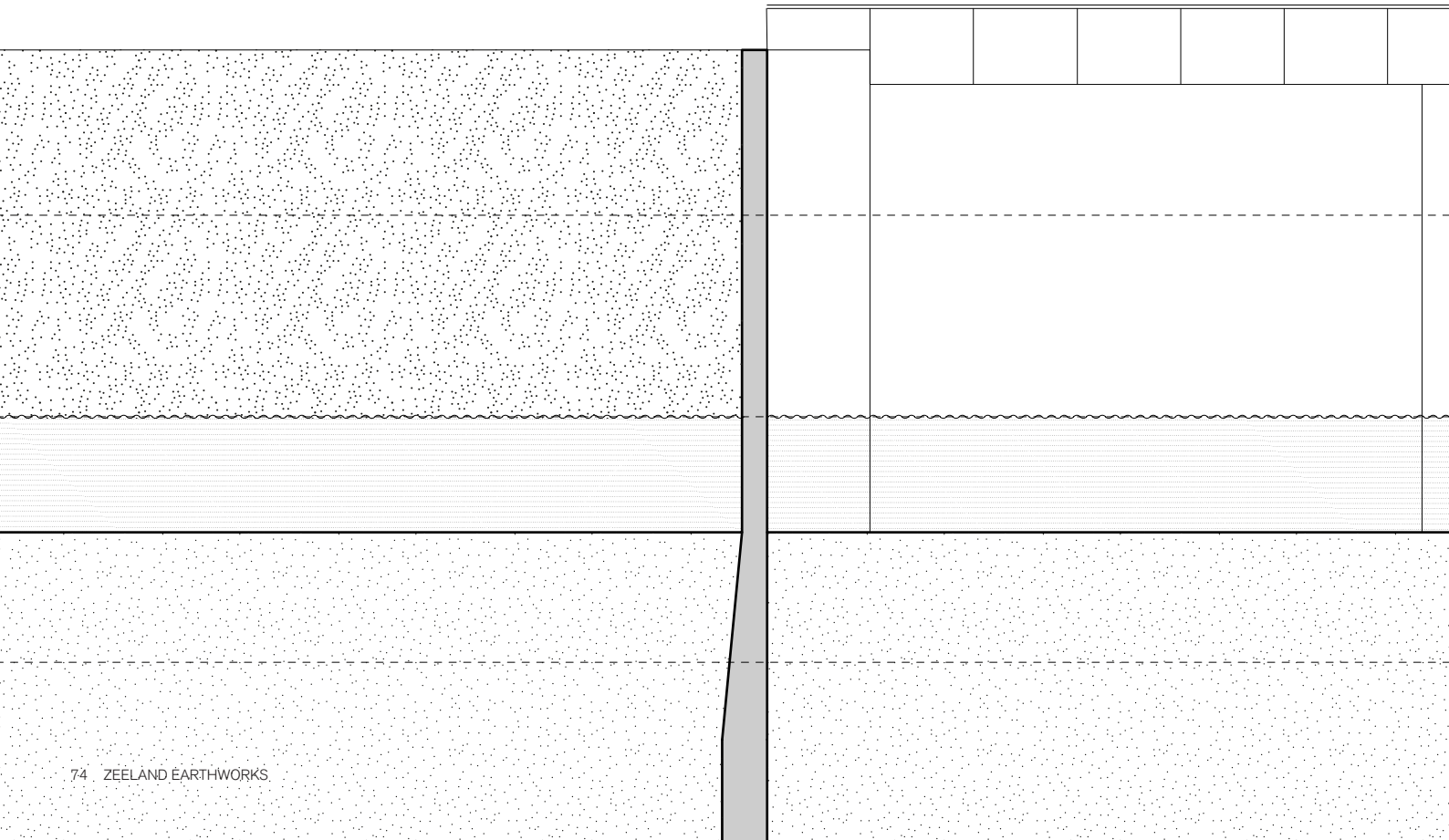

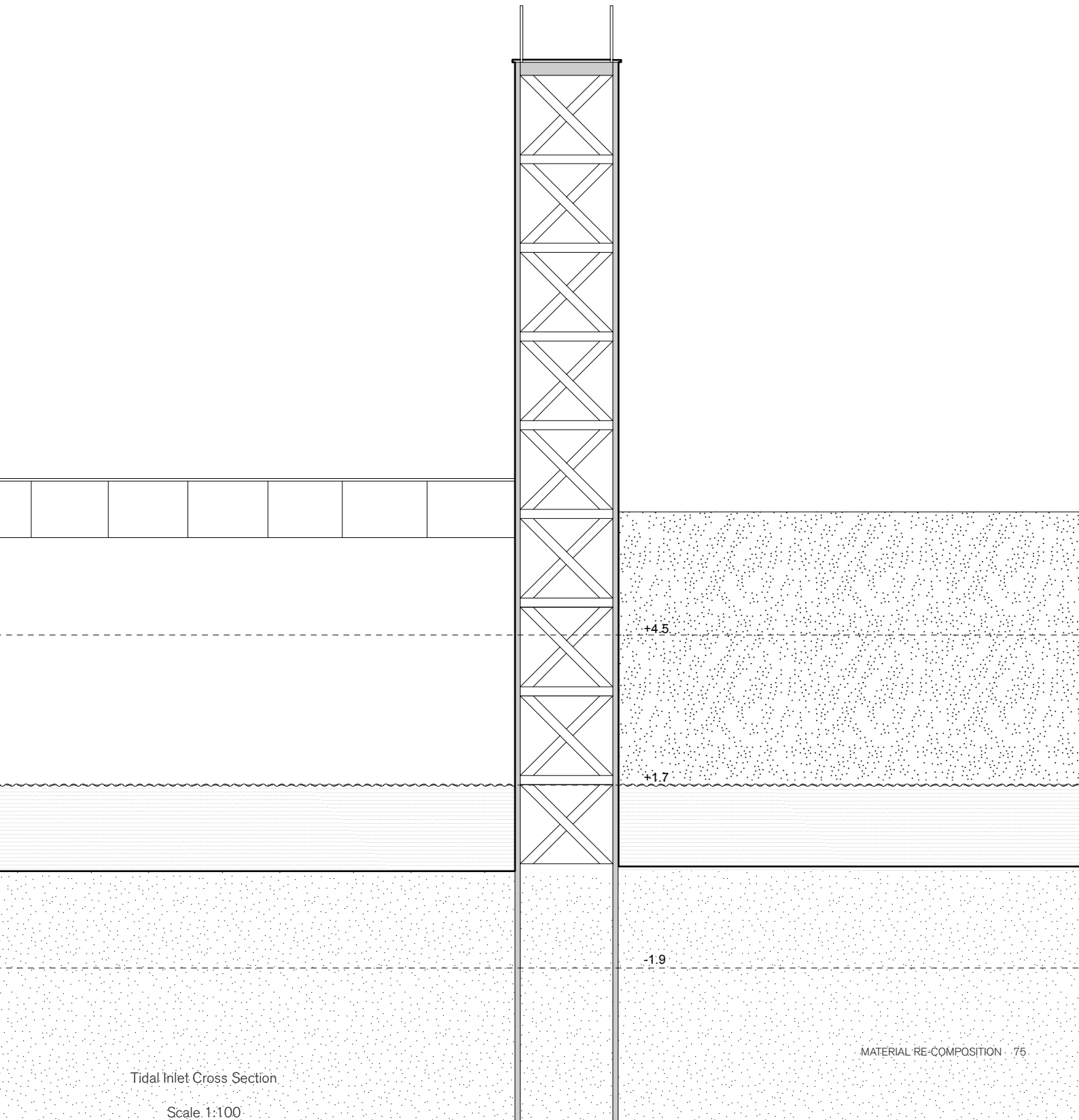

Tidal Inlet Cross Section

Scale 1:100

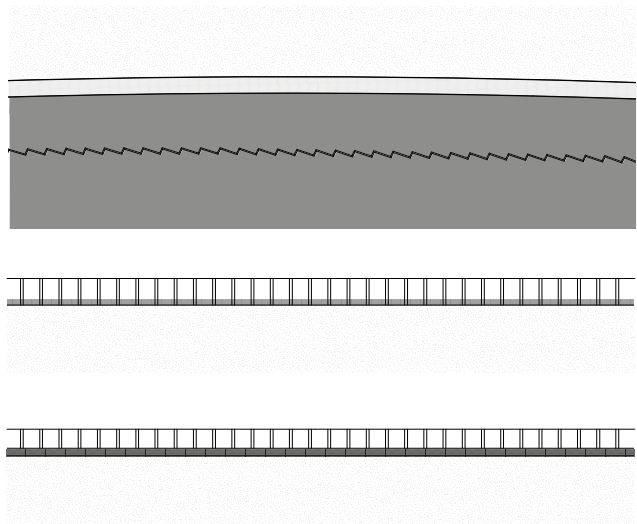

#### Retaining Wall

The gravel settles out immediately upon entering the first basin, while the sand begins to settle as the washes across the first basin in a few minutes (according to Stoke's Law). This water is drained into the width of the wall itself, where it creates a channel, depositing the last of the sand and ready to move into the silt basin.

The protective wall stands at 6.5m, ready to withstand the weight of water in the system in the event of a storm surge. For now it creates a linear rhythmic boundary to the polderscape, mirrored by a low pedestrian route from which residents can see the process of sedimentation and excavators can extract the sand.





Retaining Wall

51°24'34.57" N, 3°47'32.50" E

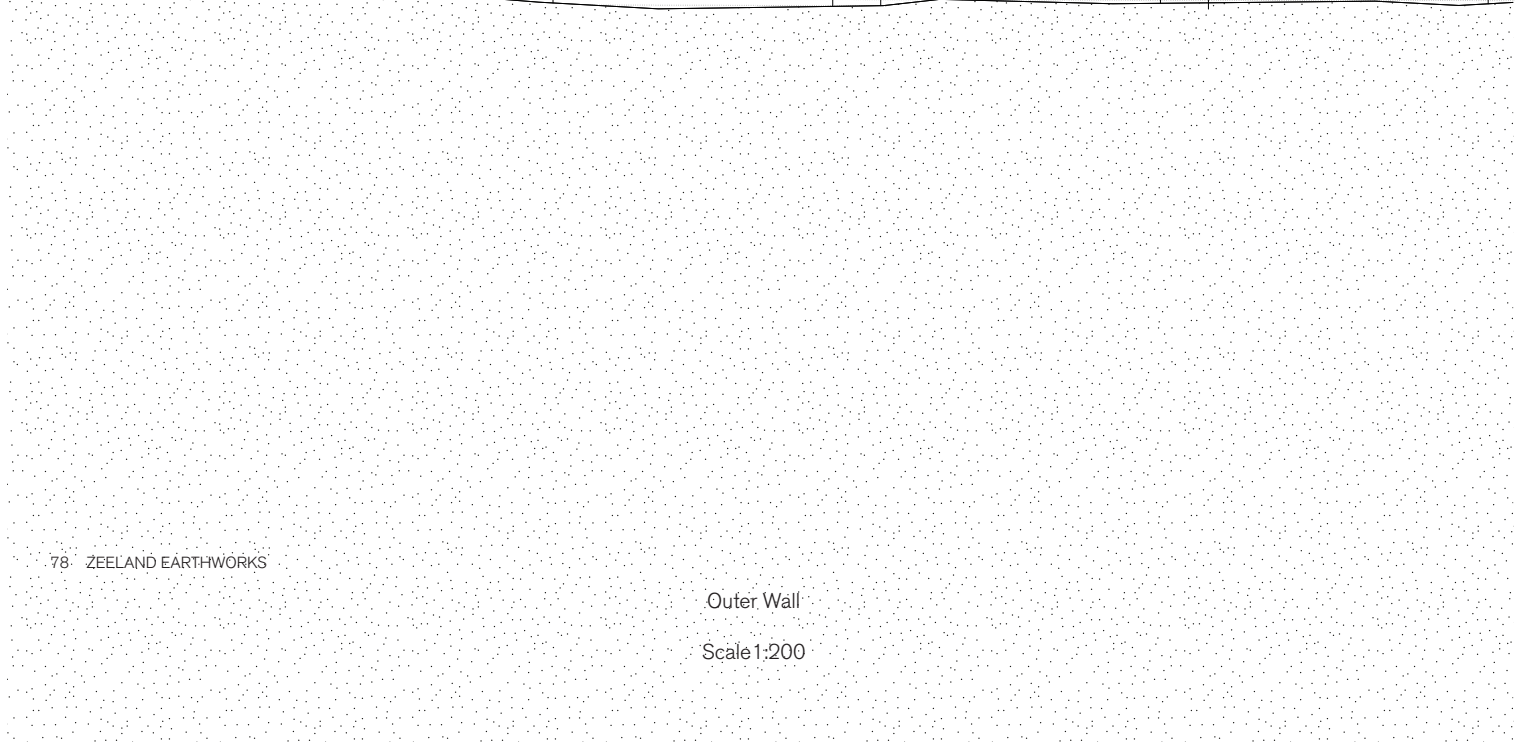
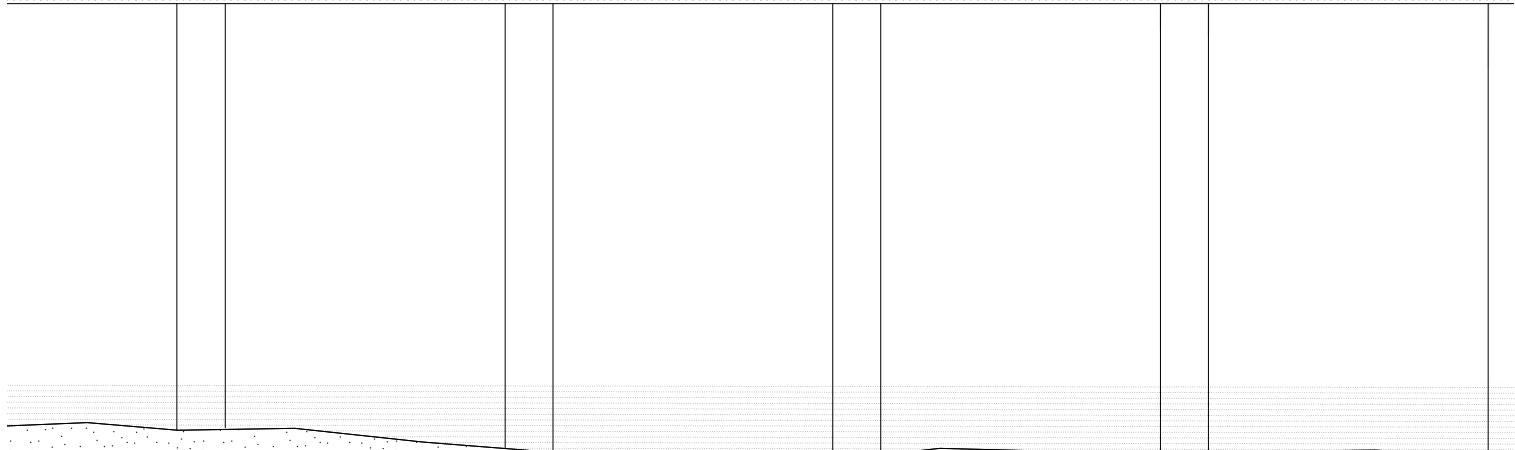

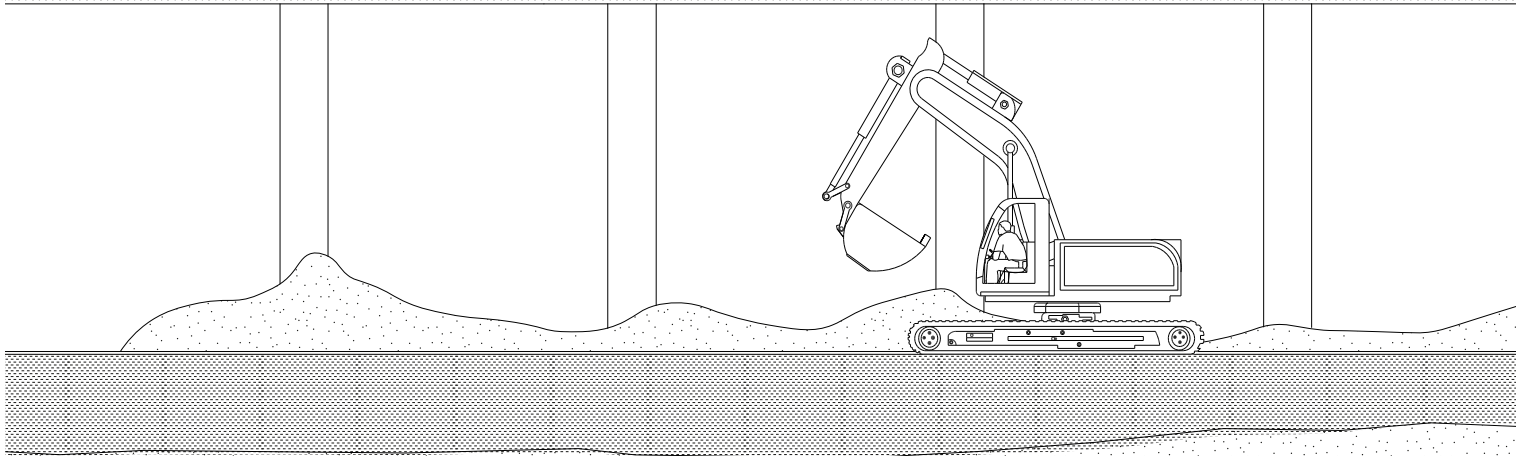

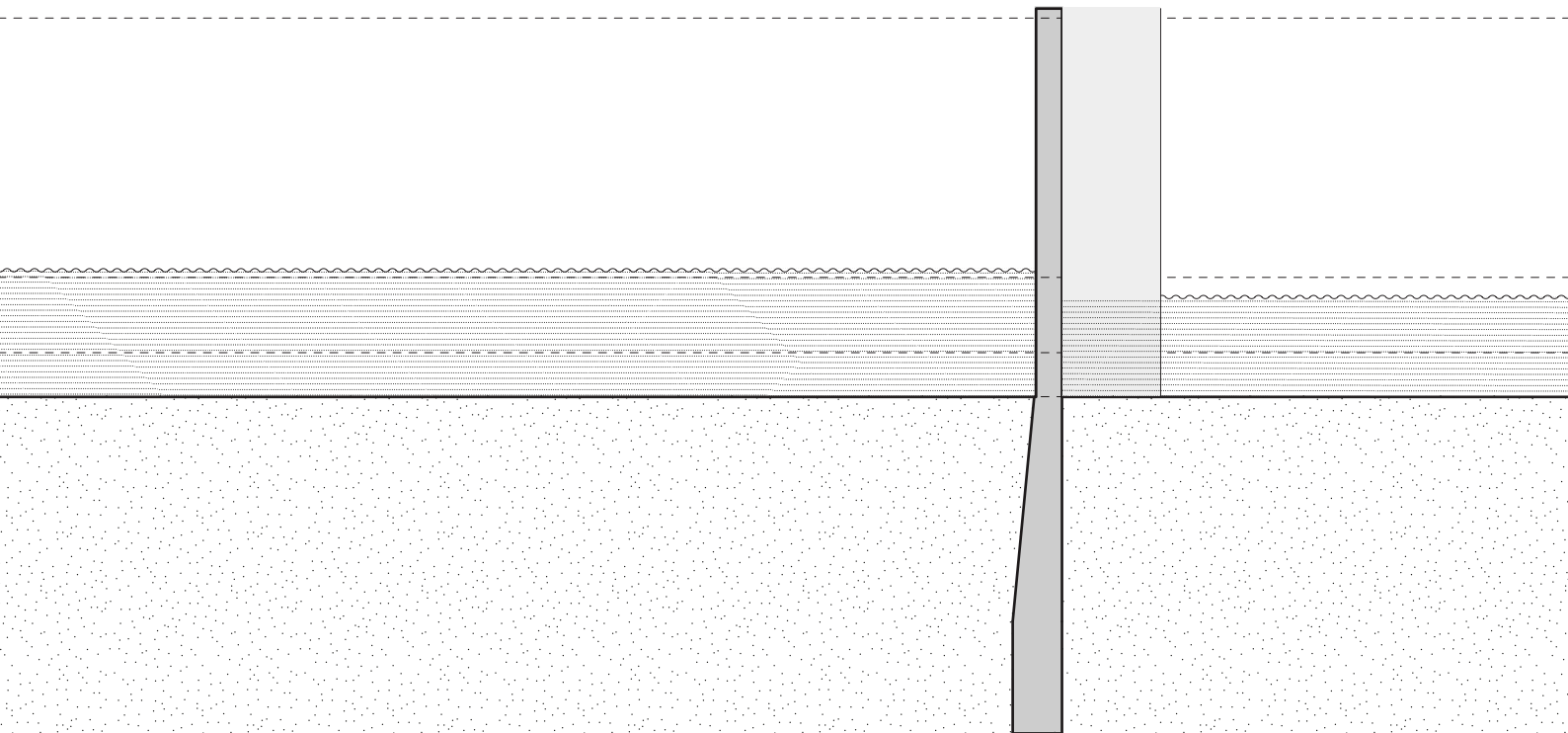

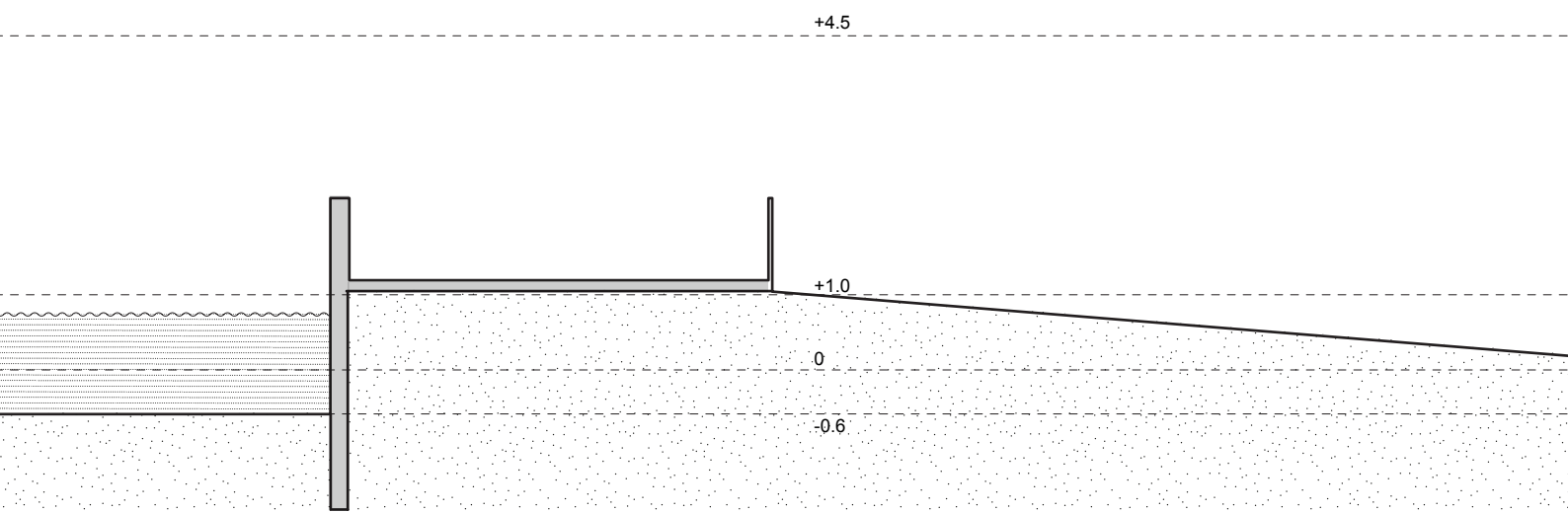

Retaining Wall

Scale 1:100

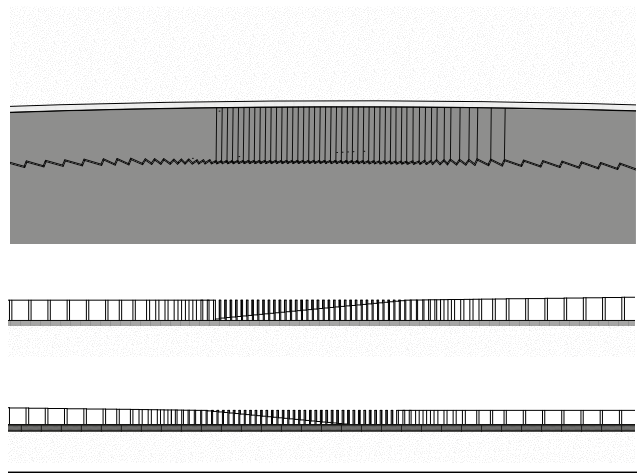

### Sluice Gate

In the silt and clay basins, sets of coir baffles speed up the sedimentation process to within the tidal period of 6 hours. The silt collected is used to create fertile wetlands within the polderscape.

The productive outer wall creates an operable facade with gates set within the concrete columns. These sluice gate creates a series of falls from which the water flows into the second basin, making a performance of the landscape function. Here, the rhythm doubles, marking a point of concentration at the beginning of the new basin.



Sluice Gate

51°25'12.57" N, 3°44'45.63" E

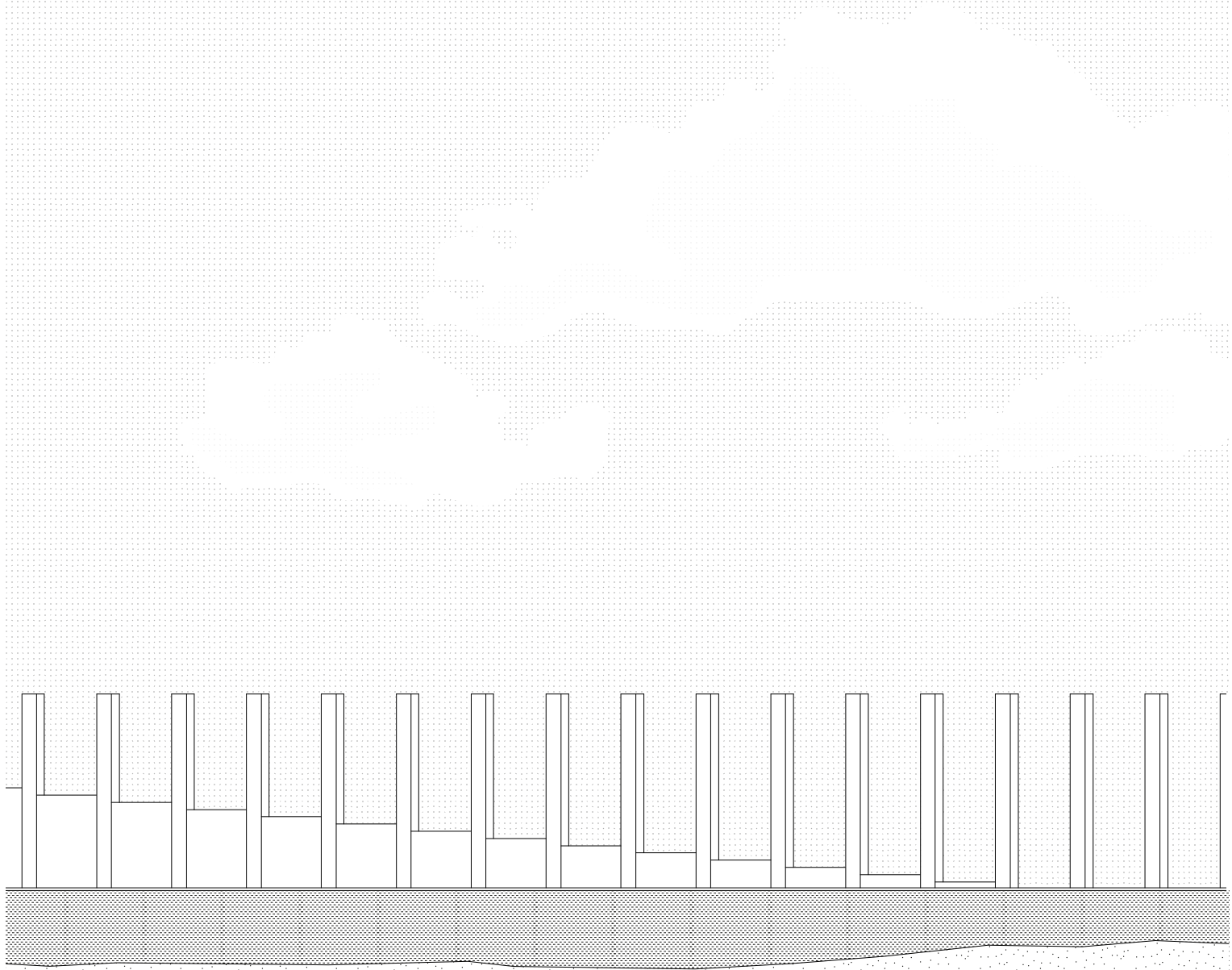

Outer Wall

Scale 1:200



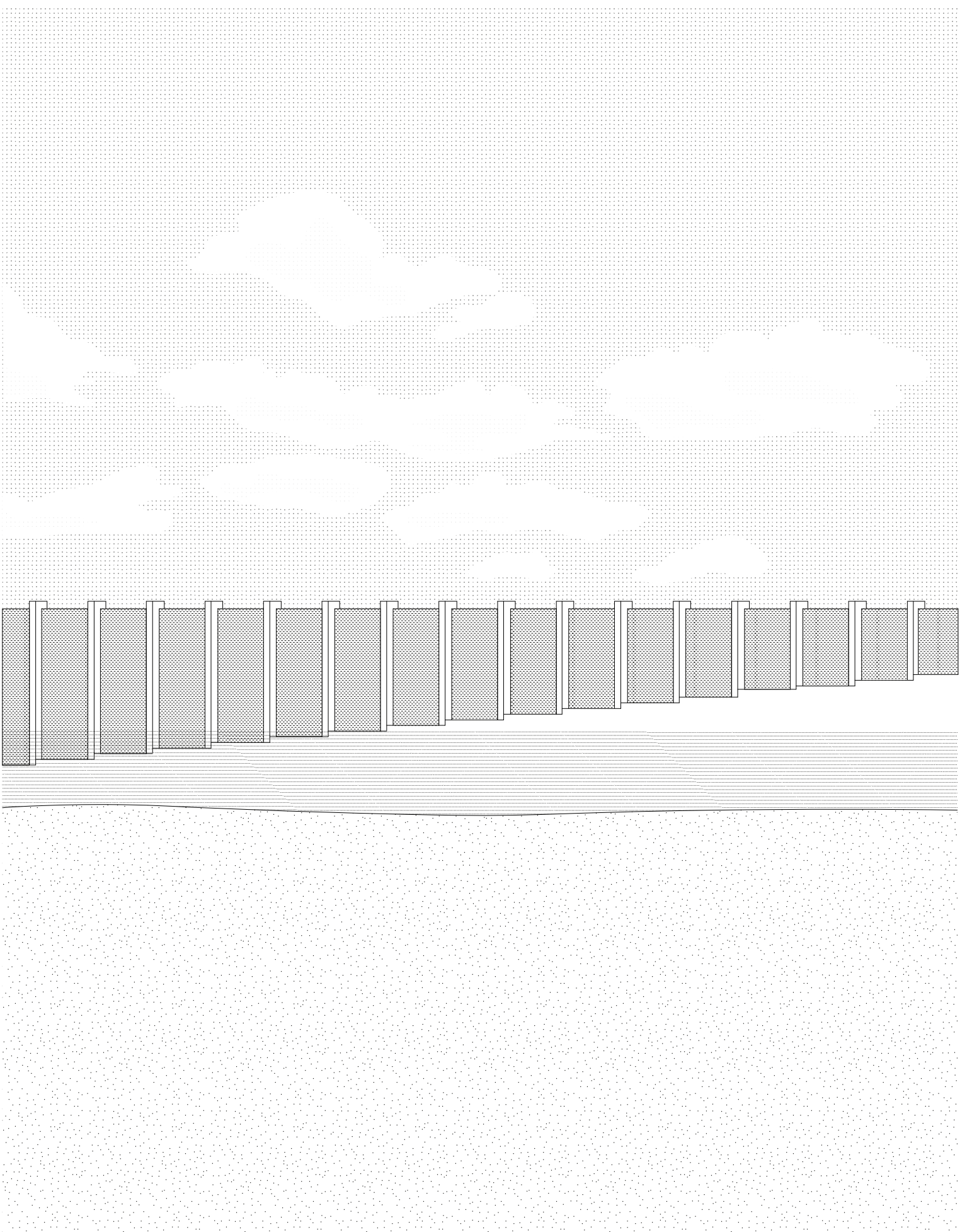

Inner Wall

Scale 1:200

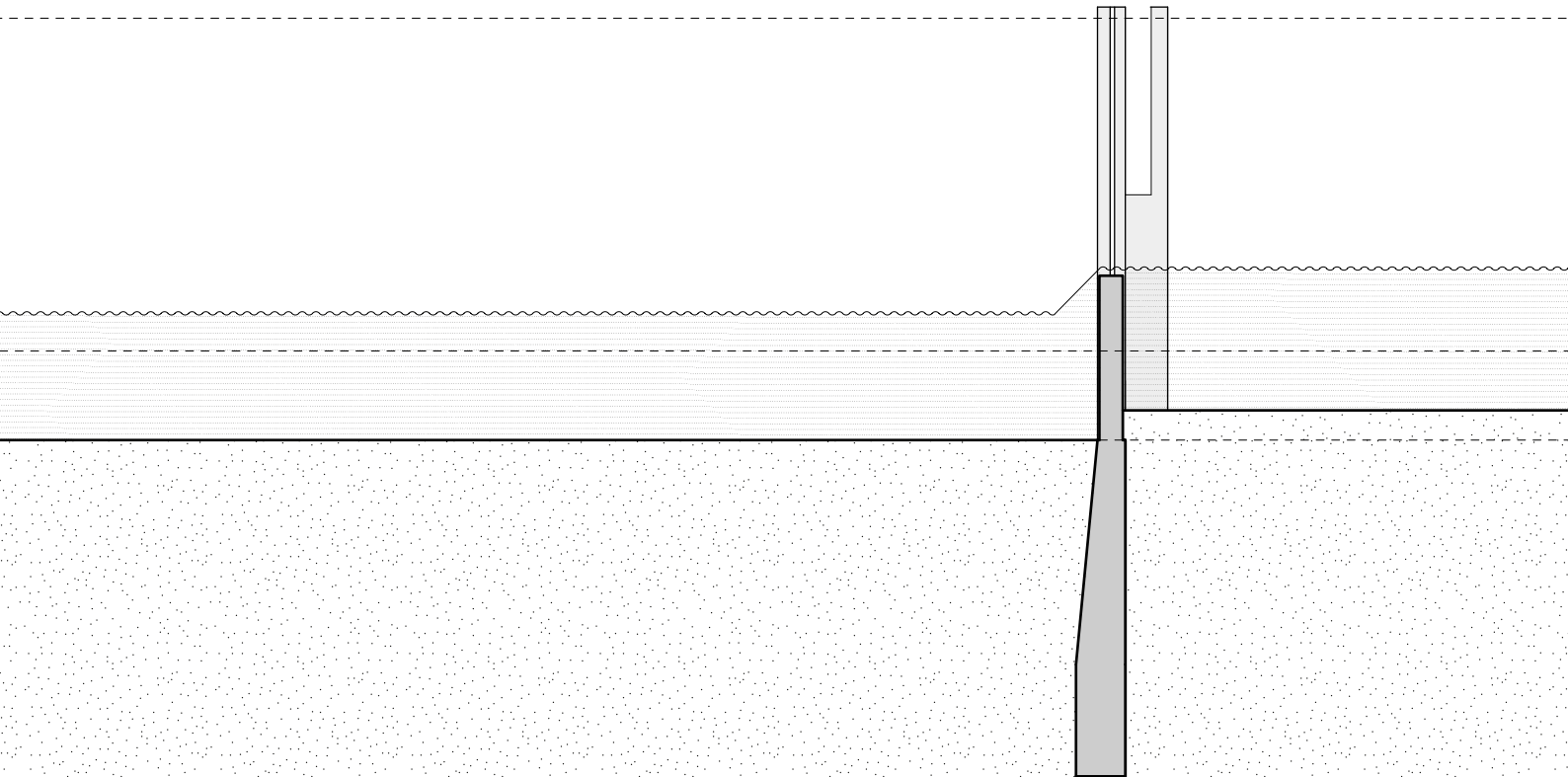

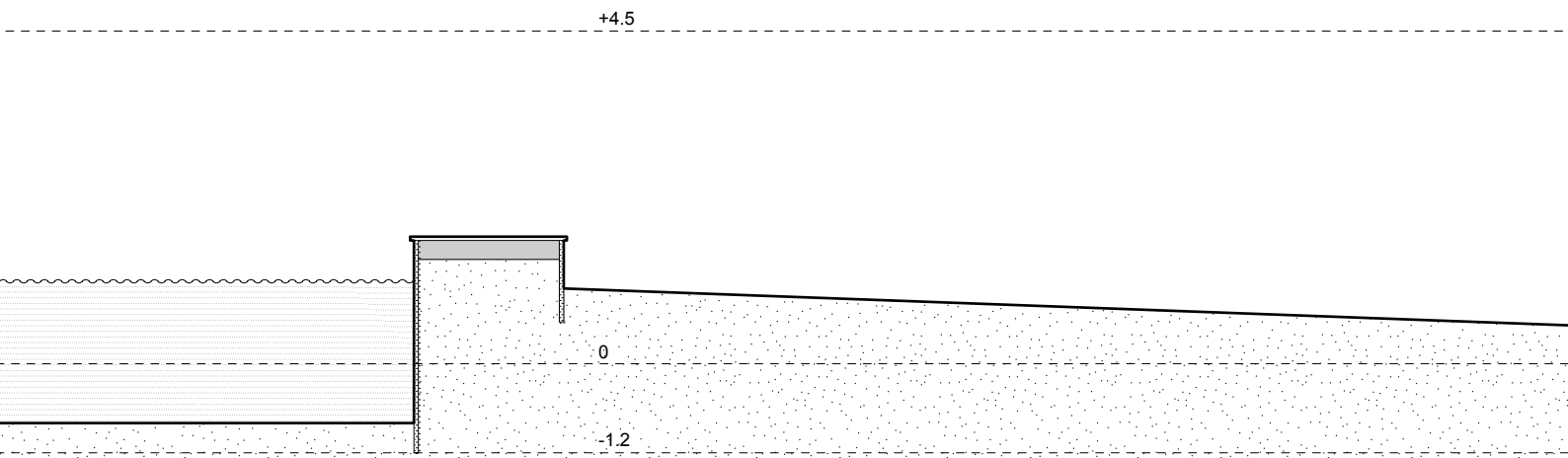

Sluice Gate

Scale 1:100

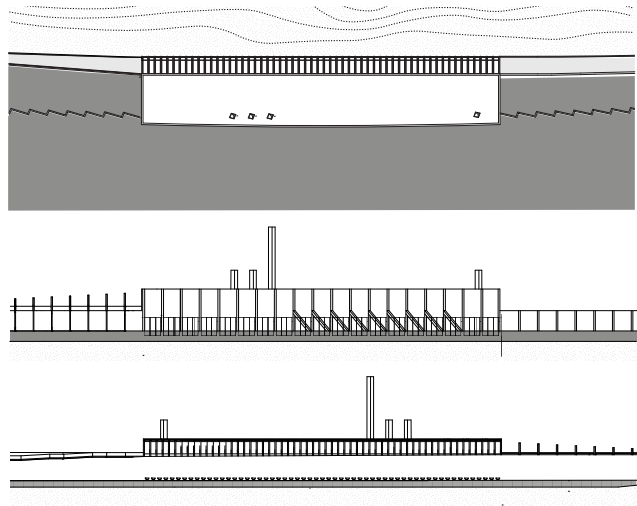

### Earthworks Factory

In the final stage of the process the clay slurry is pumped up into the facade of the wall and processed within a deep facade. This highly interior space is organised vertically by the movement of earth within the storage tank, into a drying pit and through a processing hall. Below this space, the water drained from the system is controlled to move either into the polder system or into the canal and from there into the estuary.

Alongside this contained and automated process the human functions of the processing in the labs, studios and management offices sit below a long exhibition hall. Here the pedestrian walkway widens to a long room, exhibiting the bricks, tiles and sculptures created from the landscape, with a view over the emerging wetland beyond.



Exhibition Walkway Through Factory

51°41'81.39" N, 3°72'67.83" E

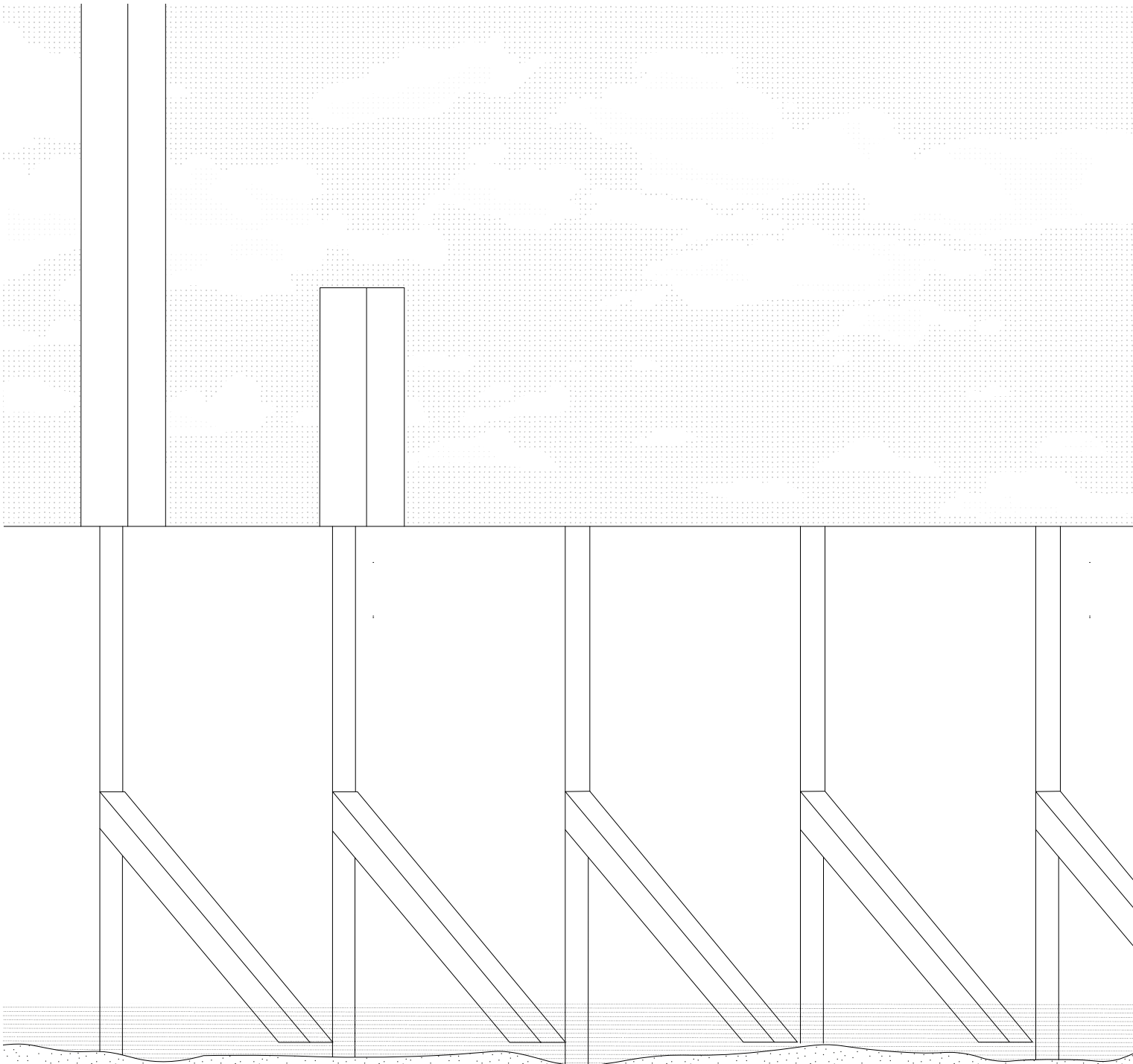

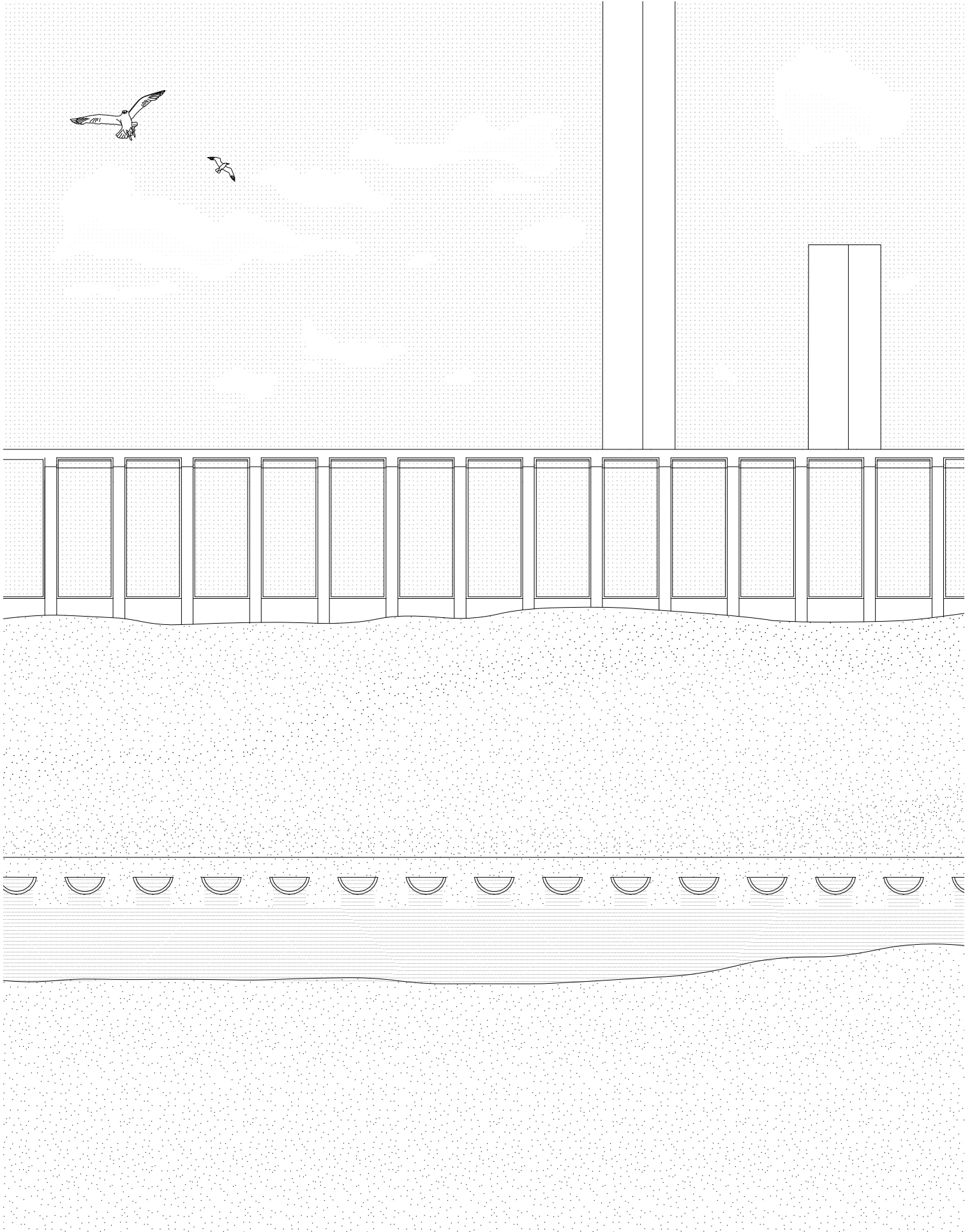

Inner Wall

Scale 1:200

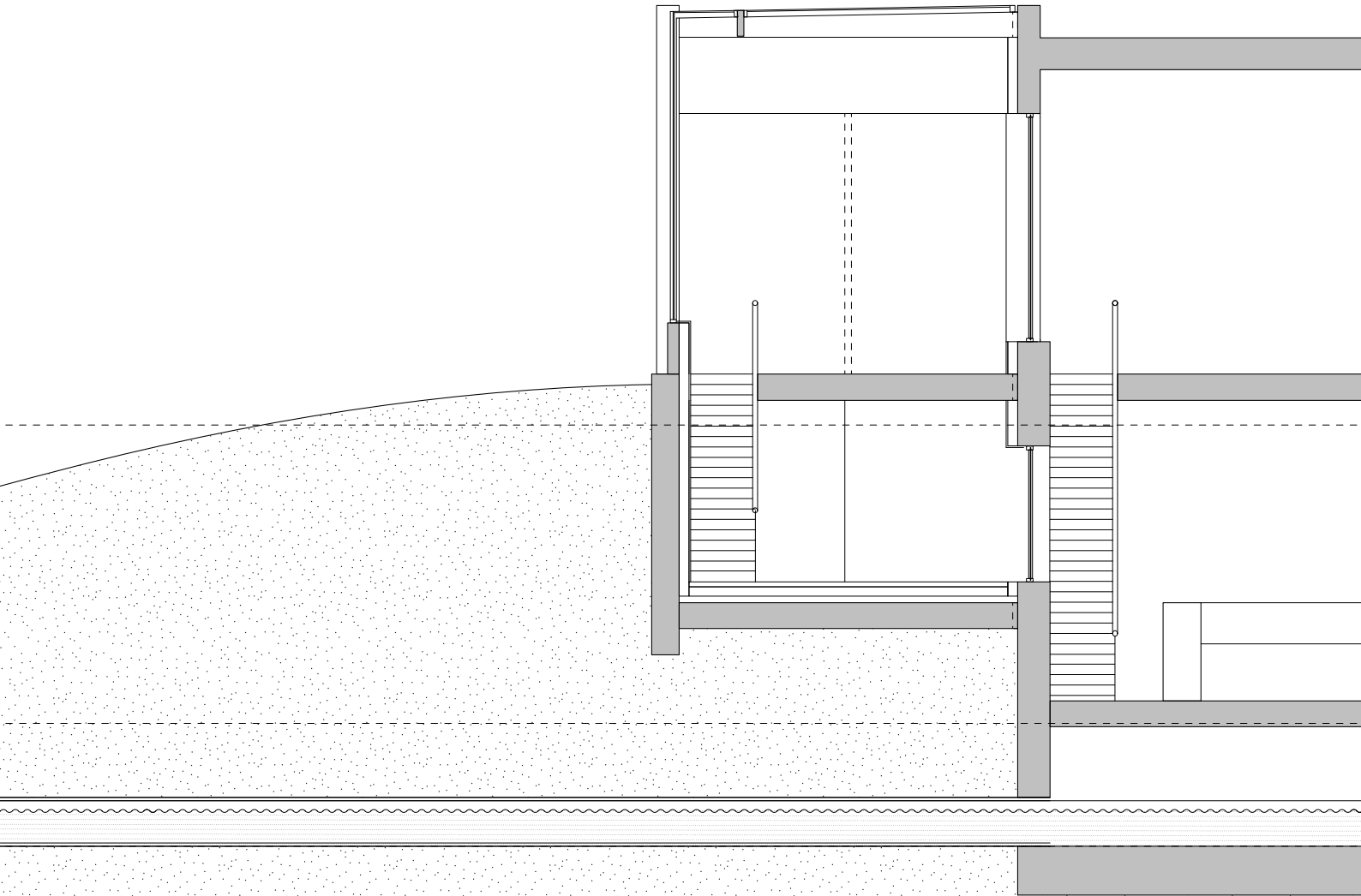



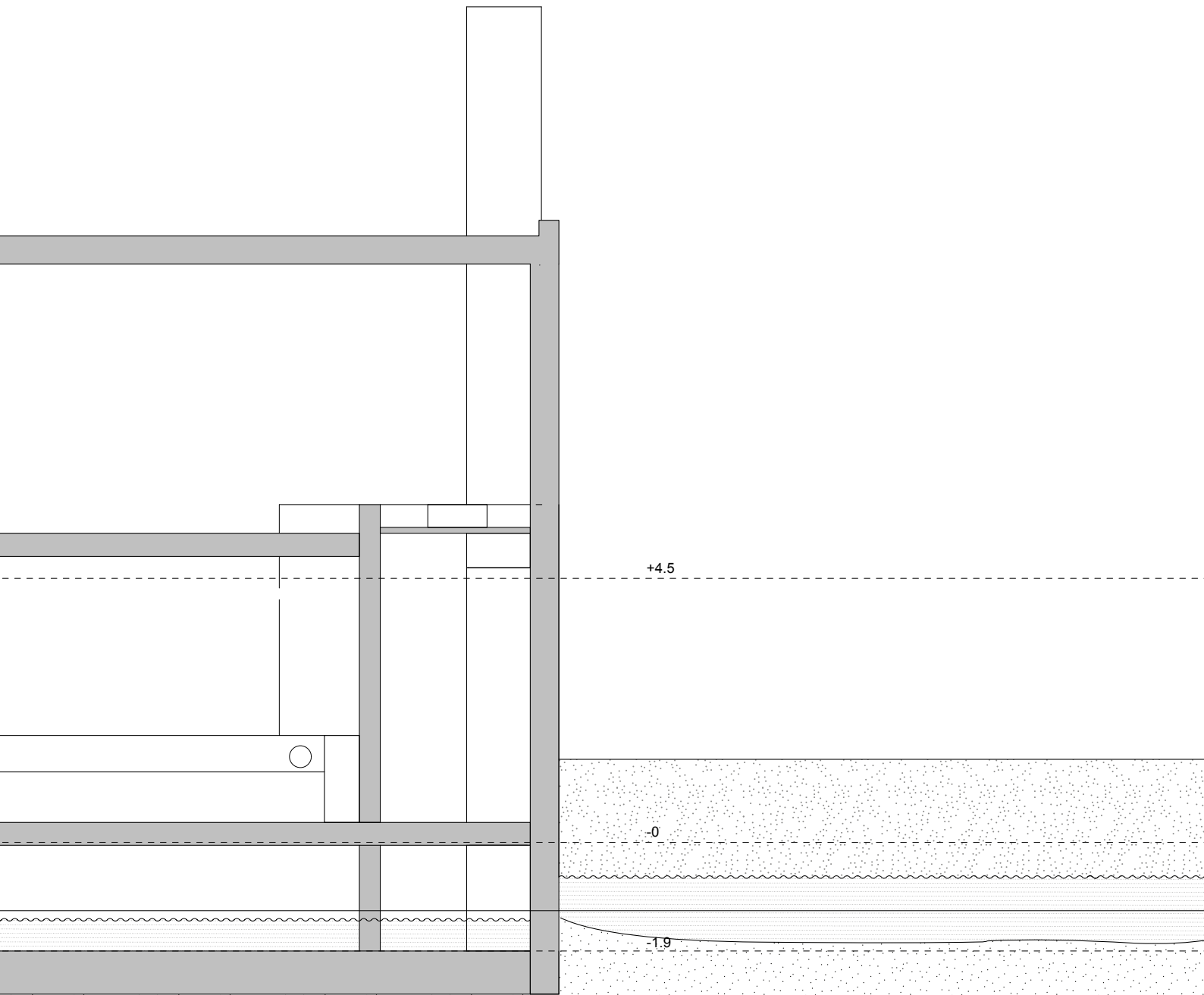

Earthworks Factory

Scale 1:100

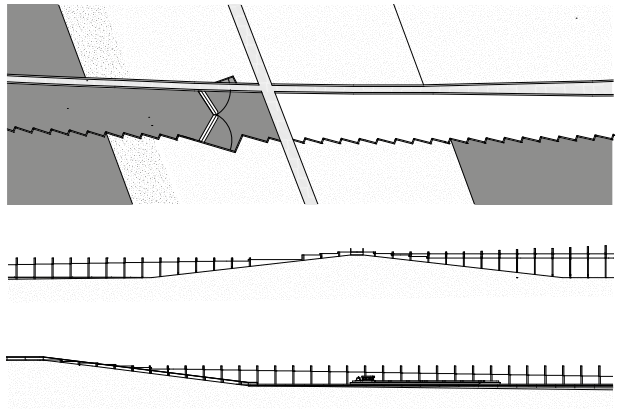

#### Canal Outlet

The water from the system passes through the Earthworks and into a canal, intersecting the dike a second time. The walls become retaining walls to hold back the cut earth.

As visitors leave the factory, they slowly emerge from the hillside it is set into as the path rises to the height of the dike as they look down into the salt-water canal and can see the barges transporting the transformed materials via the Scheldt.



Walkway Across the Dike

51°25'06.72" N, 3°43'41.53" E

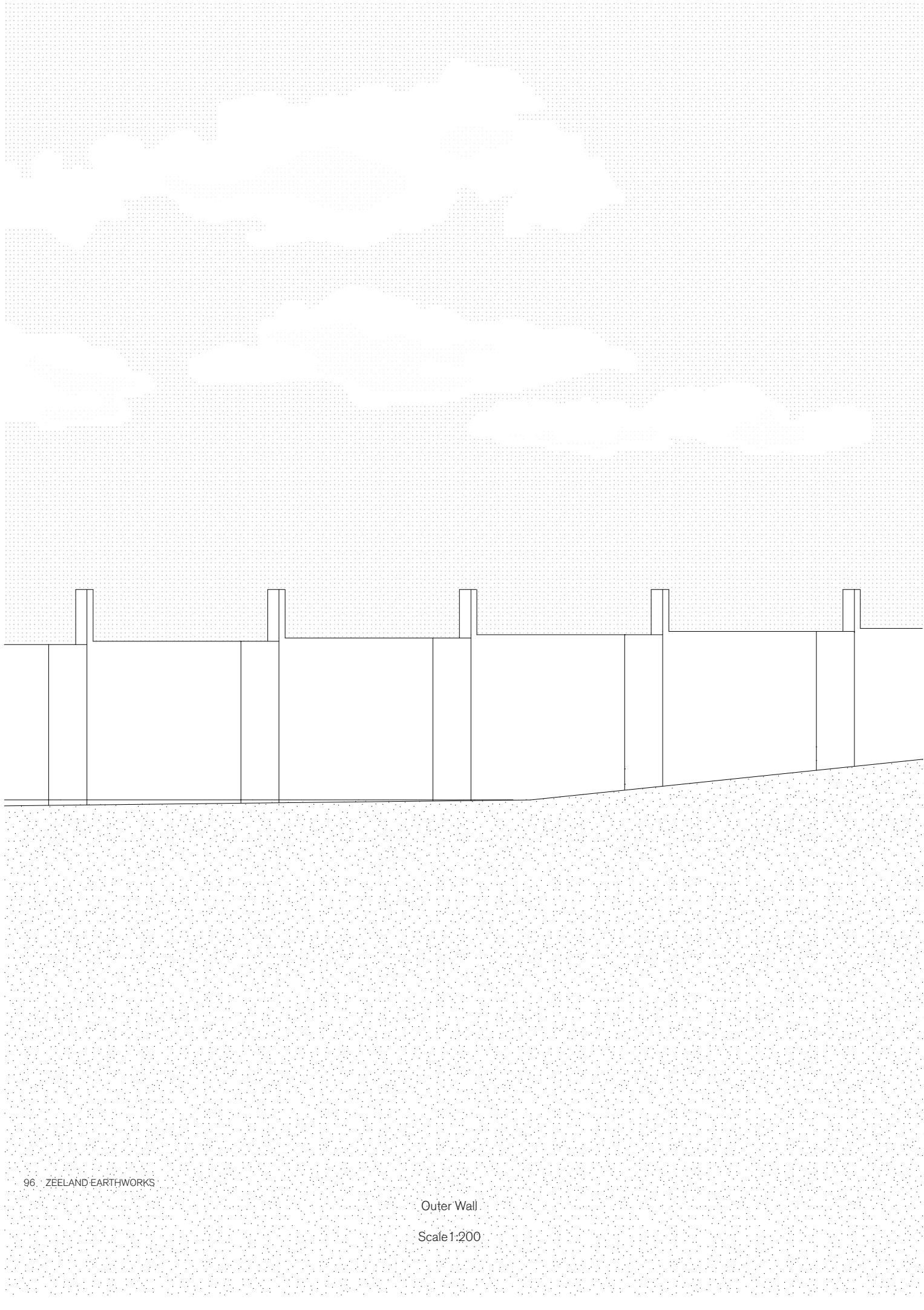

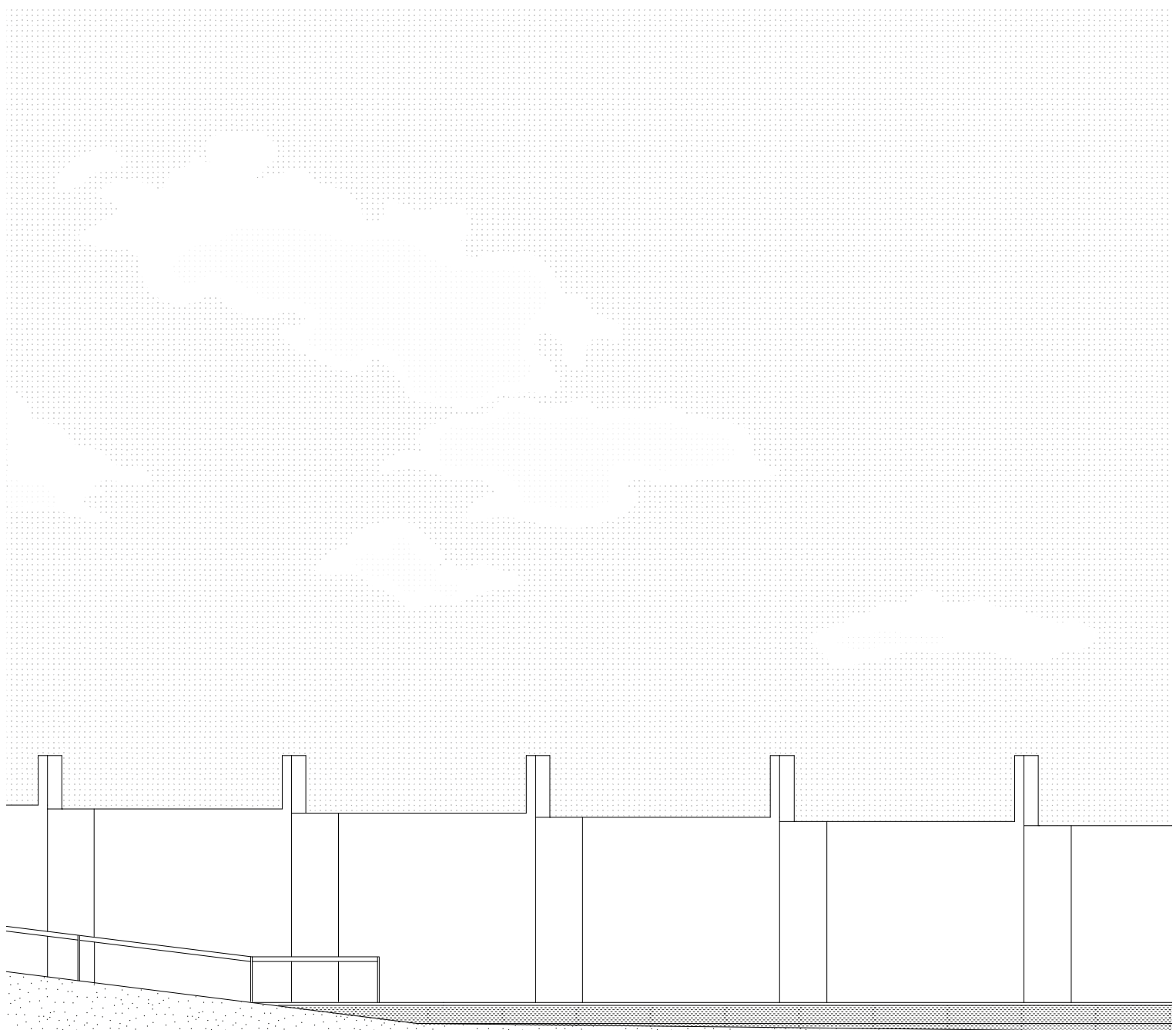

Inner Wall

Scale 1:200

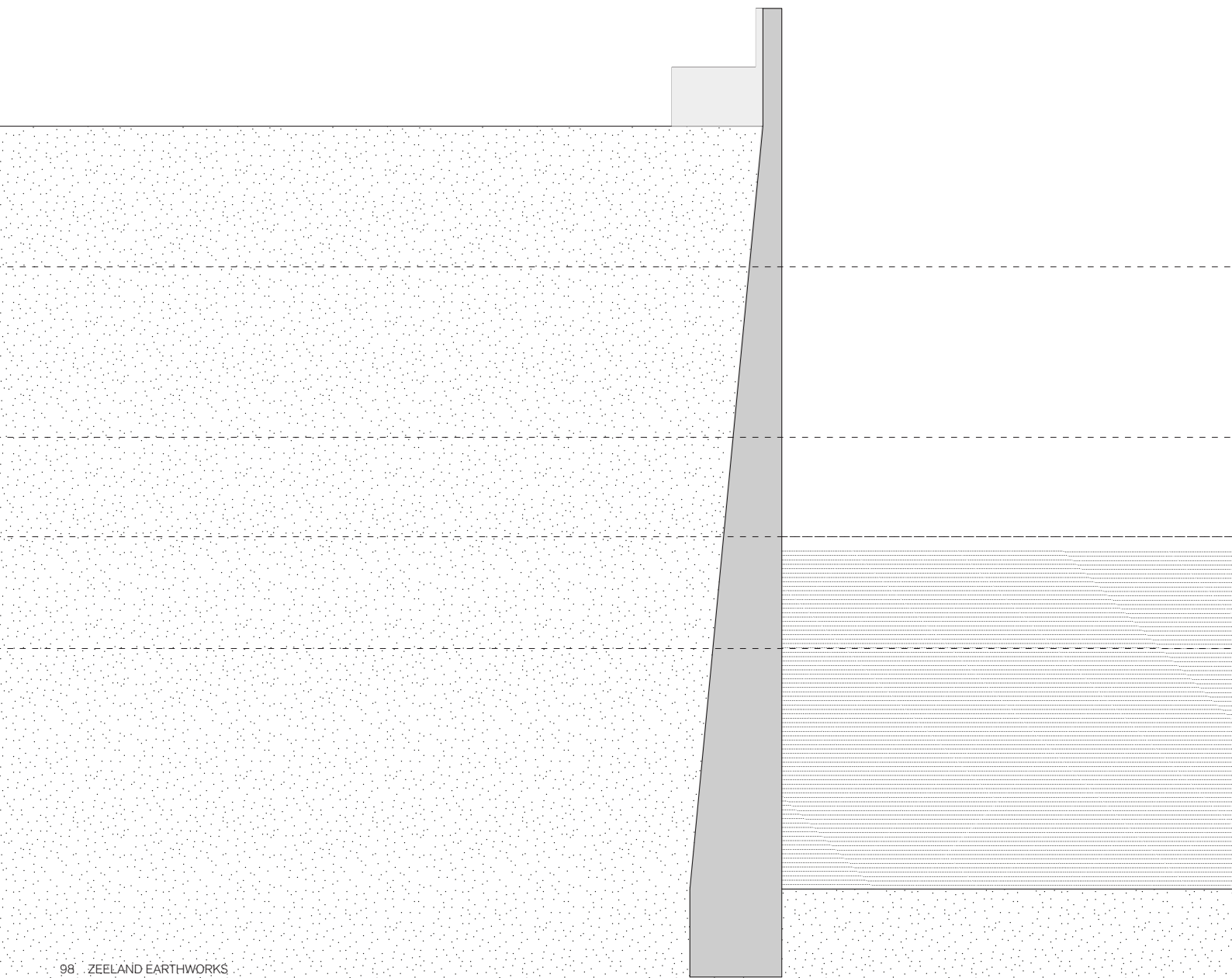

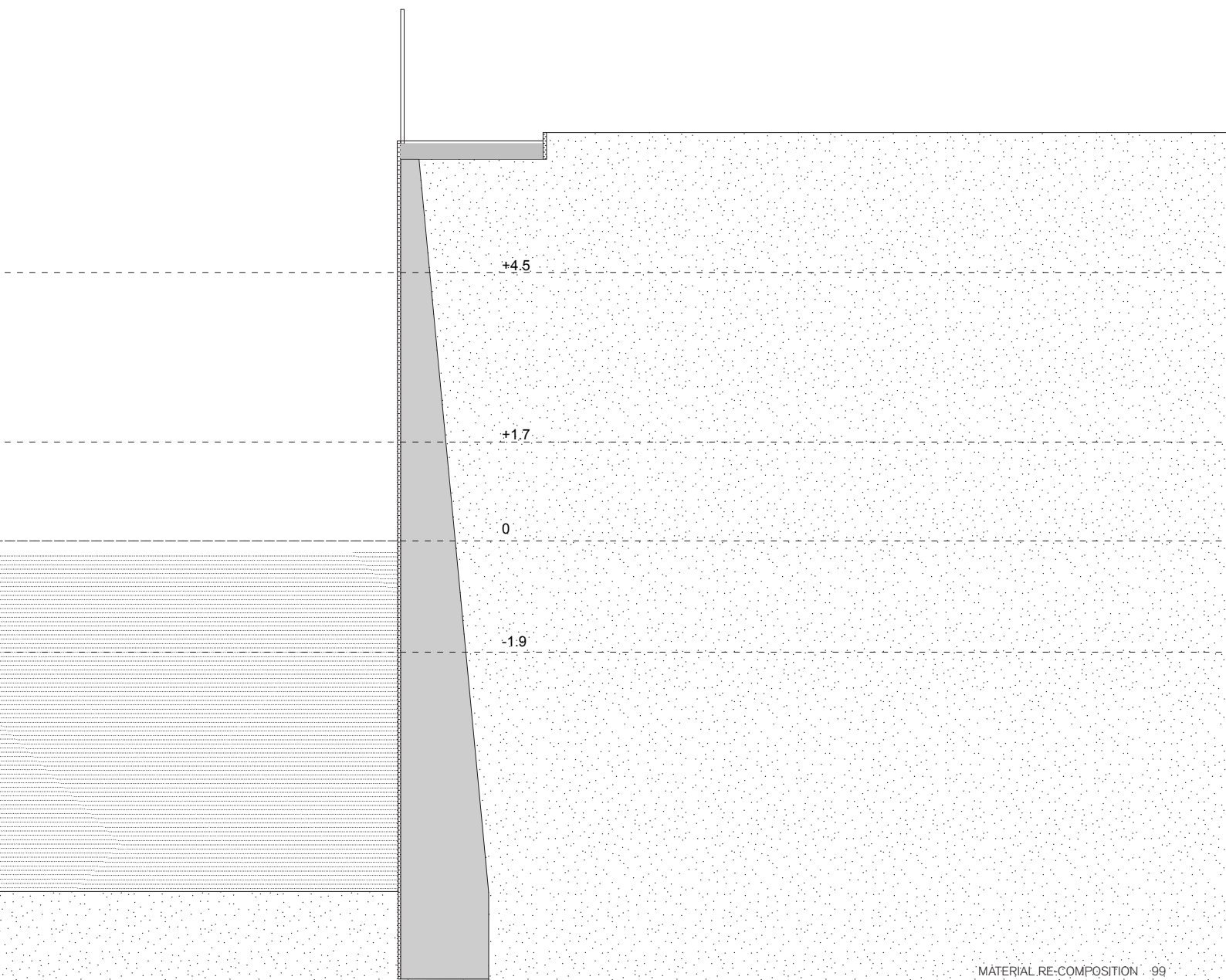

Canal Outlet

Scale 1:100

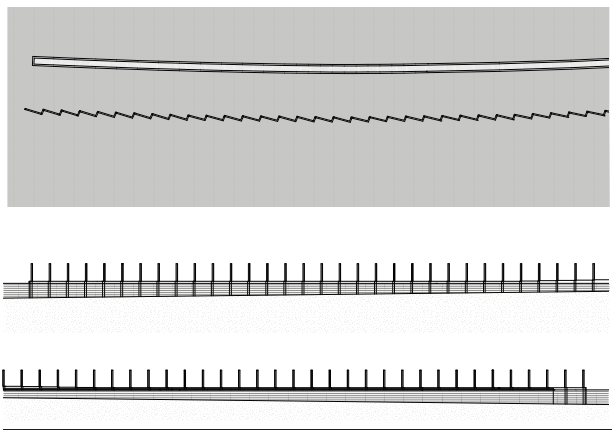

#### Pier into the Estuary

The walls extend into the estuary, gradually lowering in height until they stand at the height of the low tide. Here, they hold back the deposition of the sand banks, maintaining the depth of the distribution canal.

The pedestrian route follows the natural topography of the landscape, reaching down the side of the existing dike and following the sand banks into the Scheldt. The view from the pier is framed by the columns which remain as a filter of the view as the wall gradually lowers.





Pier into the Estuary

51°25'12.57" N, 3°44'45.63" E





Inner Wall  
Scale 1:200

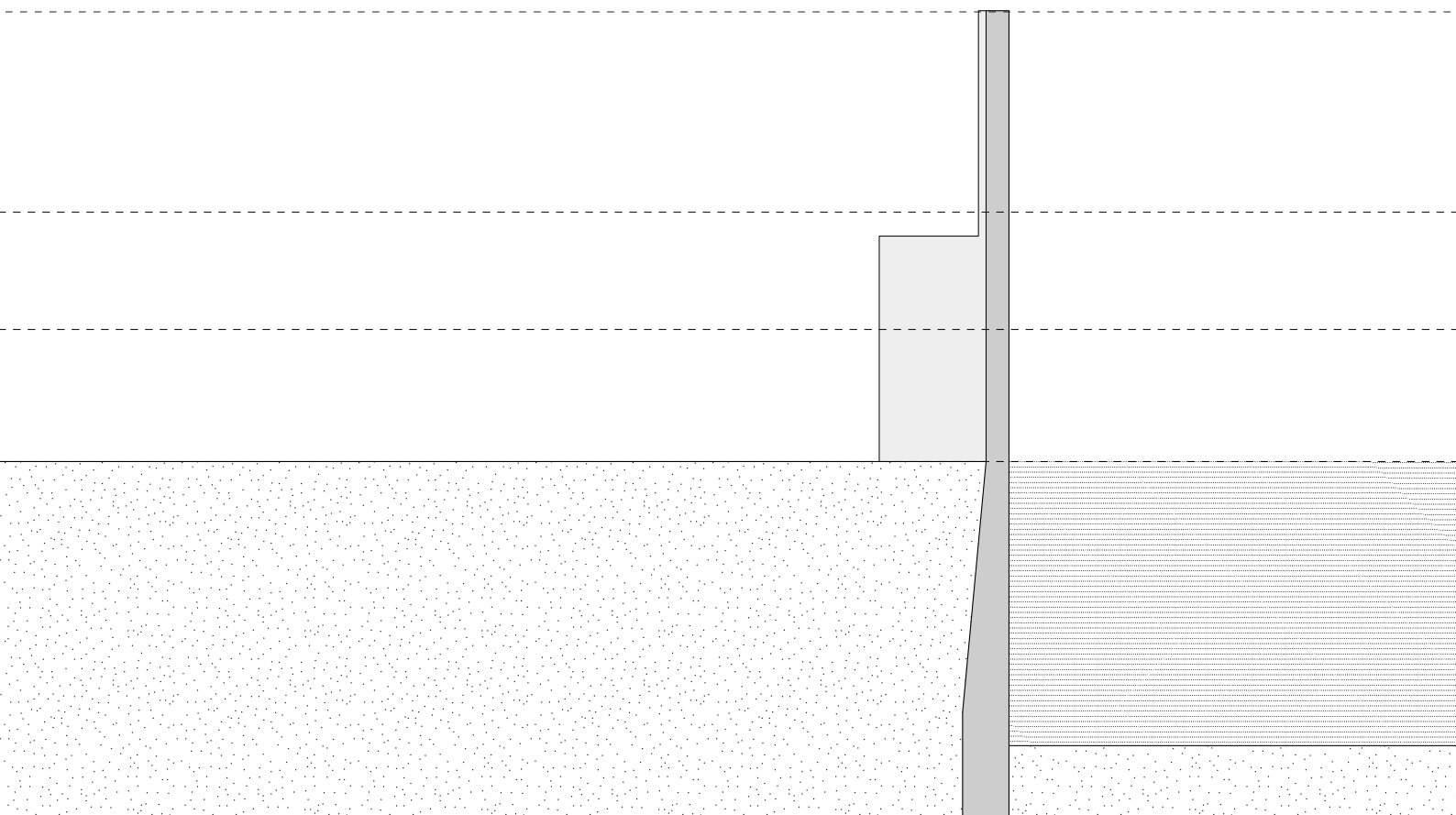

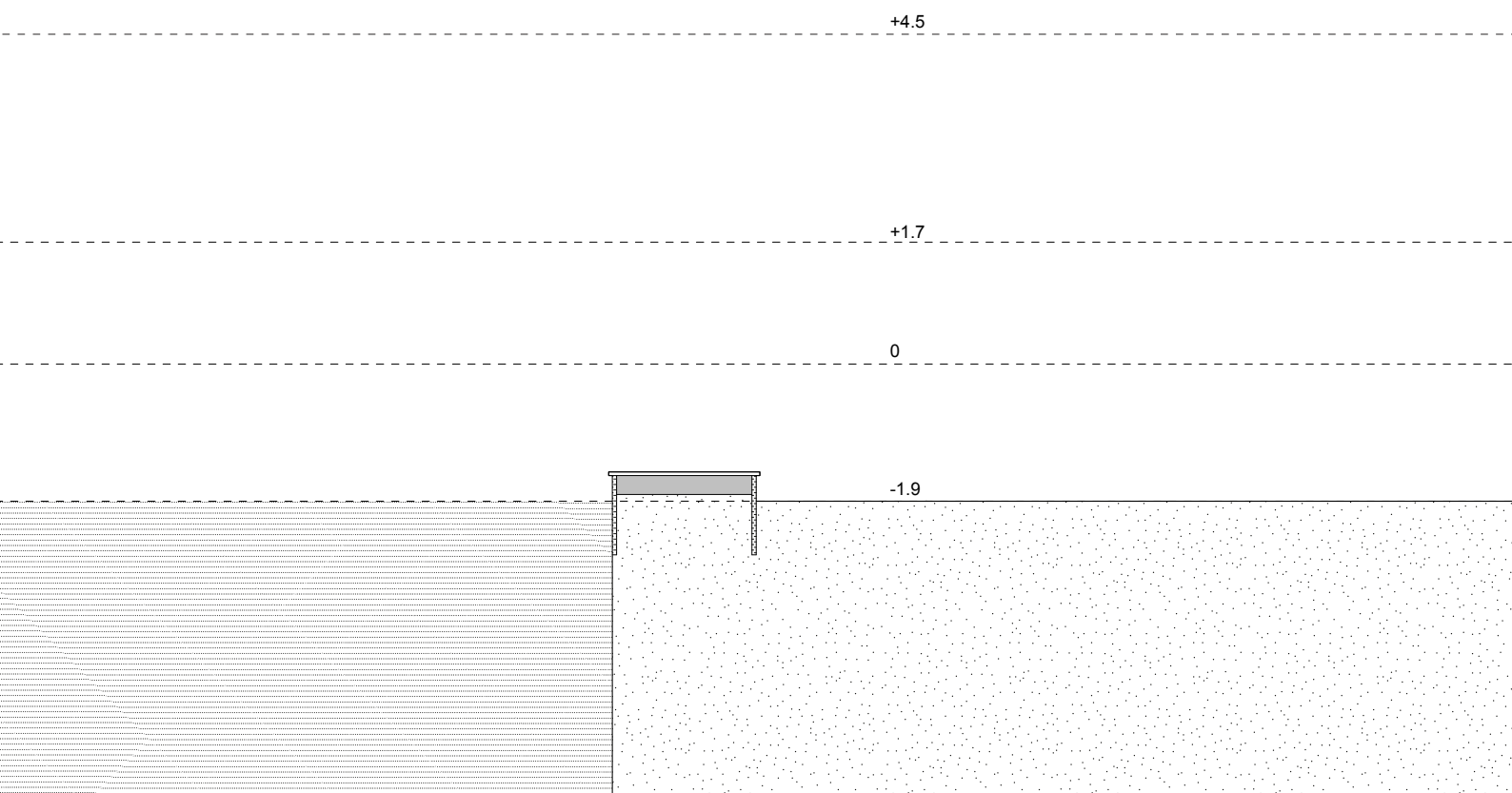

Pier into the Estuary

Scale 1:100



Looking to the future, the single element of the wall makes a new landscape condition, with a reciprocal relationship to the landscape and waterscape surrounding it.

## 7 [Re]Composition An Altered Landscape

## 7.1 Extended history of earthworks

By imagining the historic movement of earth from the earliest inhabitation of the estuarine island of Borssele, through its history of gradual polderisation and land elevation we can read the growing control of man over nature and the increasing dominance of the shoreline by industry. Projecting this pattern into the future the proposal embeds a new logic into the landscape one adaptive to the future threats of sea level rise, coastal flooding and the need to re-mediate the landscape to promote healthy habitats.



976 - Estuarine Island



1200 - Castle motte



1357 - First polderisation



1370 - Re-flooding



1616 - Polderisation



1973 - Land elevation for nuclear power plant



2019 - Earthworks created



2100 - Gradual depolderisation and land elevation





The contemporary status quo is embedded in the land itself, visible in the separation of land and water and the elevation of industrial functions. The port dictates the character of the waterscape and agriculture dictates the character of the land. There are few spaces which are uncontrolled and so precious intertidal habitats are minimal.

The materiality of the landscape is similarly distinct from the waterscape, the salt and pollutants are kept out at all costs as materials are brought in from further inland to build upon the polder.

This landscape is threatened by sea level rise and extreme weather. The expansion of the port and the falling cost efficiency of the dikes throw this way of life into question.

## 7.2 Current Condition



An aerial photograph showing a large body of water on the left, a dike or embankment in the center, and a road or canal on the right. The water has a greenish-brown hue, and the land is a mix of brown and green. A white line, possibly a path or boundary, runs along the dike.

In a reversal of contemporary logic, I proposed to breach the dikes and allow for an extended foreshore by a controlled depolderisation. By allowing sediments in, the economic loss of farmland is compensated by a new industry, a ceramics factory which both provides a point of expansion for the town and seeks to capture heavy metal pollutants emanating from the port.

An initial phase of digging out sees the construction of a set of sedimentation basins and phytoremediating wetlands transforms the polderscape as it begins to perform new functions. As a single element the new earthworks wall allows residents of Borssele to experience the waterscape in a way previously impossible, from up close and through its materiality.

### 7.3 Proposed Condition



An aerial photograph of a wetland landscape. A wide, dark green river flows from the top left towards the bottom left. To the right of the river, a long, straight dike runs parallel to the water. The land between the dike and the river is a mix of dark green and brownish-green, indicating a transition from agricultural fields to a more natural, wetland state. The sky is a pale, hazy blue.

The Earthworks begins to adapt to future trends in sea level rise and extreme weather events. As high tides become more frequent the fields around Borssele are excavated, and seasonally inundated until they are permanently depoldered. Over time the land returns to a more ancient form of inhabitation as a series of terpen emerging out of a changeable and fertile wetland.

A new set of spatial relations has been embedded, with local industries providing a temporary means by which natural forces are allowed to return to the landscape. The port is protected from storm tides and water-borne pollutants are captured, having a series of knock on effects in the interconnected ecosystem of the Scheldt.

#### 7.4 Future Condition



The studio's research began at the scale of the North Sea, where the analysis of various flows of goods, animals, and materials through the fluid body of the sea was the subject of our shared cartographic investigation. The Atlas produced highlighted the role of the North Sea estuaries as hot spots where conflicting human and non-human systems are made visible as they compete for space along the banks. It was out of an interest in these spaces of conflict that my urban scale research began in Zeeland, in the South of the Netherlands. A literature review of reports on the future of the Scheldt from the Port of Antwerp, the Dutch and Belgian water management boards, and ecologists enabled me to understand the conflicting logics between Antwerp's huge urban port, Dutch agricultural polderland, and the biodiverse wetlands and sandbars.

Using a scenario-based approach I translated this research into a future narrative where the threat of sea level rise and the trend towards automation and larger ships necessitate the depolderisation of Zeeland's estuarine banks citing the co-benefits of decreased dredging requirements and greater areas of biodiverse intertidal wetlands.

With this scenario in mind my project asked the question; how can an open system of flood defence create a new estuarine condition? By imagining an open system I was led to examine the new elements entering the inland water system, sediment, saltwater, and heavy metal contaminants. This led to a second stage of territorial research which focused on the way that the port, the polder and the wetland all manipulate the earth as a method of elemental control, evident in the dike system of the polder, in the dredging land and spoils grounds of the port and the physiology of resistant wetland plant species which contain and sequester heavy metals.

My projective design was a direct result of this locally specific research; the manipulation of earth to create a new estuarine condition capable of dealing with the scenario of a growing port, and a rising sea. By choosing the historic town of Borssele as the site for locally managed depolderisation the twin role of my project as protective and productive led me to research flood defence strategies of dikes, moats and storage basins.

Once the stage was set the design phase research focused in on the micro scale potential of the Scheldt's sediment, leading me to discover of the ability of river clay to capture heavy metal pollutants

and make them inert through firing. The programmatic proposal for a contaminated ceramics factory therefore came as a response to the existing conditions of conflict present at the territorial scale. Further elaboration of the proposal required research into the specific composition of this sediment and the methods employed in various industrial typologies to collect, filter and fire clay.

#### Method

The translation of research into design was achieved by a combination of projective maps and volumetric calculations based on the expected inflows of sediment, eventually leading to a list of programmatic requirements. An iterative design process negotiated the reciprocal relationships between the scale of the landscape intervention, the volumes of captured sediment, the scale of the processing machinery and the method of flood defence. This process led through a series of landscape systems with which to filter and collect sediments, and a series of systems of flood defence. While early iterations included a dispersed field of ceramic factory functions positioned around a moat, consultations with water managers and hydraulic engineers emphasised the necessity of a defensive wall.

The key steps in synthesising the diverse worlds of dredging, sea walls, soil remediation, clay mining and ceramic factories occurred as acts of design imposition. The wall typology became a key holder of architectural investigation where the dual functions of a filter, of holding back and of letting through are expressed in their most simple form, expressed by the design of a productive and a public façade. Functionally, the wall limits the flow of water inland and thickens to hold the productive functions of the ceramic factory. The wall as a limit further leads to the creation of a rhythm, where moments of breaks or changes in that rhythm reflect the adaptation of the ubiquitous dike to its local condition and the alteration of existing flows which became the conceptual foundation of the project. In this way the various requirements and constraints emerging out of the site are clarified into a single communicable element through the employment of a symbolic and fundamental architectural typology.  
Graduation Topic and Studio Brief

My interest in the Transitional Territories studio came from the central role of a dynamic environment to the design work. These dynamics were central to the creation of an Atlas of New Geographies which used a scenario-based approach to spatialise changes to the North



Sea region along four themes: Climate, Flows, Habitat and Ground. An important idea which emerged through this process was that of design as a dynamic act which alters the environmental network in which it is enmeshed. In the same line, the studio's emphasis on flows as a conceptual thread through which to move through scales highlighted for me the role of architecture as an alteration of existing conditions, by which natural phenomena, whether views or climate conditions, topography or raw materials are recomposed to be brought into the cultural sphere where their value is mediated by the human experience. In my case, by studying the potentials held within the existing territory; of the Scheldt, of marine sediment and of the typology of a dike wall, the re-composition of elements as a design act created a coherent logic derived from the site itself.

Beyond this methodological approach the interdisciplinary nature of the studio, which includes architects, urbanists and water managers, provided a broadened frame of reference on which to draw. Since my project acts as a landscape machine, performing the collection of sediment and the control of water, I looked to knowledge and precedents outside of the architectural field for tools. However, by broadening the problem field to the specific and quantifiable manipulation of sediment I also took on constraints which are typically outside of the architectural field, and which have absolute limits. It was only through the employment of an architectural typology, the wall, that I was able to overcome the diverse absolute interdisciplinary constraints and test the project as a specific spatial manifestation. In this way the importance of the architectural field's knowledge of ordering systems and their experiential potential redefined the project from the general to the specific. As a result, my project seeks to use design to make manifest a set of complex ideas in a simple and self-evident form.

#### Wider Implications

The trans-scalar methodology employed within the studio and within my project, which moved from the macro scale of the Scheldt to the micro scale of the sediment composition, has led to an architecture which is fundamentally tied to the specifics of its location. Its programme is linked to the health of both the river and the economy of the existing town, while its form is informed by the flow of water and the volumes of sediment it carries, and the materiality of the project is

directly drawn from the environment in the logic of the polder system. In this way the project in method and outcome goes against the current logic of global ubiquity in both architecture and engineering where programme, function and material are primarily drawn from a globalised market logic, and the same solutions are applied at large both at the scale of seawalls and building components. In this way, the project is not for a transferable solution but a transferable approach to the manipulation of existing flows.

#### Ethical Issues and Dilemmas

By imposing a new element in the context of a system in conflict my project necessarily encountered an ethical dilemma: which actors to instil with agency. By assuming that the port of Antwerp will continue to grow and be allowed to pollute the Scheldt the scenario developed gives it overwhelming agency, and for some time this ethical dilemma undermined my own belief in the project. However, the position taken in response to this scenario is one in which the devolution of power leads to the local adaptation of the ubiquitous coastal dike with positive effects for both the local population of Borssele, who gain an alternative means of inhabiting the flooded land, and the surrounding wetlands, where the reduction in heavy metals pollution increases biodiversity. In this way the project reflects my own belief that by refocusing on the local and specific potentials the global threats of sea level rise and pollution can be best tackled and that by employing an ecological approach design benefits can be sought at multiple scales and for multiple actors.

The scale and nature of the human imposition of the proposal into its environment represents a second ethical dilemma which emerged from the project. The function of the proposal as a contaminated ceramics factory brought with it technical challenges only able to be solved outside the realm of architecture, including the potential pollution created by the firing of heavy metal-containing clay, and the energy intensity of this process. The potentially dangerous but ubiquitous industrial functions of material mining and processing are often overlooked in architectural imaginings of the future, necessarily restating the current status quo of polluting industries being pushed to an ever-further hinterland. In response, the project argues for the relevance of industrial typologies in developed countries and seeks to harness the naturally occurring flows of sediment and heavy metals in order to promote an opportunistic localism in which growth is limited by the bounds of the natural system.

Zeeland Earthworks

Re-composition of an Altered Landscape

## 8 Project Reflection