

Closed-Form Solutions for Current Distribution in Ladder-Type Textile Heaters

Jansen, K.M.B.

DOI

[10.3390/thermo4040023](https://doi.org/10.3390/thermo4040023)

Publication date

2024

Document Version

Final published version

Published in

Thermo

Citation (APA)

Jansen, K. M. B. (2024). Closed-Form Solutions for Current Distribution in Ladder-Type Textile Heaters. *Thermo*, 4(4), 433-444. <https://doi.org/10.3390/thermo4040023>

Important note

To cite this publication, please use the final published version (if applicable). Please check the document version above.

Copyright

Other than for strictly personal use, it is not permitted to download, forward or distribute the text or part of it, without the consent of the author(s) and/or copyright holder(s), unless the work is under an open content license such as Creative Commons.

Takedown policy

Please contact us and provide details if you believe this document breaches copyrights. We will remove access to the work immediately and investigate your claim.

Article

Closed-Form Solutions for Current Distribution in Ladder-Type Textile Heaters

Kaspar M. B. Jansen 

Department of Sustainable Design Engineering, Delft University of Technology, 2628 CE Delft, The Netherlands; k.m.b.jansen@tudelft.nl

Abstract: Textile heaters are made from knitted conductive yarns integrated into their fabric, making them stretchable, washable, breathable and suitable for close-to-skin wear. However, the non-zero resistance in the lead wires causes non-uniform power distribution, which presents a design challenge. To address this, the electrical performance of the heaters is modeled as an n-ladder resistor network. By using the finite difference method, simple, closed-form expressions are derived for networks with their power source connected to input terminals A_1B_1 and A_1B_n , respectively. The exact results are then used to derive approximations and design criteria. The solutions for the ladder networks presented in this paper apply to a wider class of physical problems, such as irrigation systems, transformer windings, and cooling fins.

Keywords: knitted heater; electrothermal performance; ladder network; equivalent resistance

1. Introduction

Heated garments have been applied to prevent hypothermia in cold environments, as heat therapy for relieving joint and muscle pain, or simply as a means to increase thermal comfort. The latest advancements focus on developing all-textile heating systems that are stretchable, breathable, washable, and that can be produced using existing manufacturing equipment [1–3]. Knitted heaters are made from lead wires composed of conductive yarns interconnected by parallel heating lines with a higher resistance. These heaters aim to provide a uniform temperature distribution, but the non-zero resistance of the lead wire sections causes more power to be dissipated near the power source connection and less further away (see Figure 1).



Citation: Jansen, K.M.B. Closed-Form Solutions for Current Distribution in Ladder-Type Textile Heaters. *Thermo* 2024, 4, 433–444. <https://doi.org/10.3390/thermo4040023>

Academic Editor: Ignazio Blanco

Received: 14 August 2024

Revised: 12 September 2024

Accepted: 24 September 2024

Published: 26 September 2024



Copyright: © 2024 by the author. Licensee MDPI, Basel, Switzerland. This article is an open access article distributed under the terms and conditions of the Creative Commons Attribution (CC BY) license (<https://creativecommons.org/licenses/by/4.0/>).

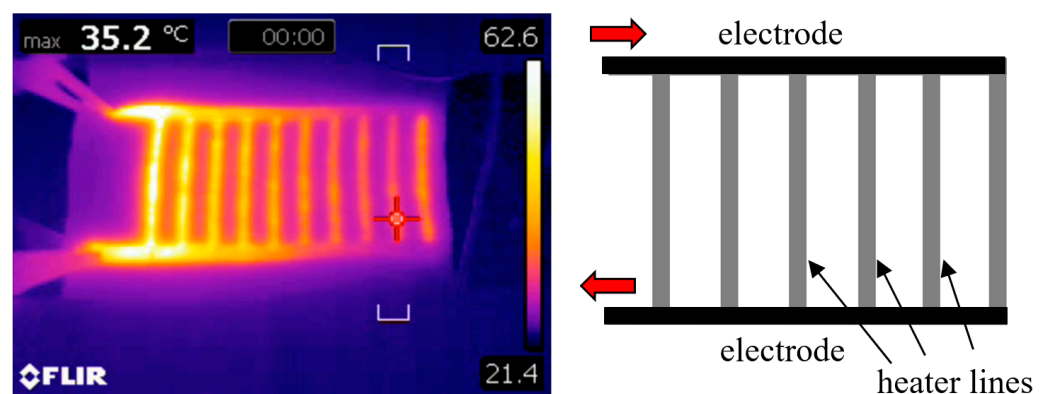

Figure 1. (Left): thermal image of a knitted textile heater. (Right): schematic representation.

The decrease in the heating power of a ladder-type heater system is governed by three main parameters: the resistance of the lead wire sections, the resistance of the heating lines and the number of heating lines. For the design of garments with various sizes of heaters it would be beneficial to have a simple model that interrelates those parameters.

A heating element, as shown in Figure 1, can be modeled as a ladder network of series and parallel resistors, a well-known concept in the literature. In fact, ladder networks are commonly used as equivalent models for transport phenomena in systems composed of a series of identical cells. They are thus not limited to the electrical domain, but are also applicable to problems in the optical, mechanical, thermal, and chemical domains. Examples include pressure losses in irrigation systems, respiratory tissues [4], energy loss in parallel-connected streetlamps, reflect array antennas [5], wave propagation in transmission lines [6], transformer windings [7], charge transfer in conductive polymers [8], and the heat spreading in a heat sink with cooling fins [9].

The electrical characteristics of ladder networks can be obtained by applying Kirchoff’s laws to all elementary cells, resulting in a set of recursive relations for the node voltages, branch currents and equivalent resistance. In the past, various methods have been applied to find solutions for both finite and infinite ladder networks, including the use of Fibonacci sequences [10], Z-transforms [11], Green’s functions [12], and the recursion–transform method [13,14]. As the number of cells in the ladder network increases, the number of equations also increases and either rigorous recursive circuit equations have to be solved or complex state–space matrices need to be handled, resulting in rapidly increasing computational costs [7]. It would therefore be useful to be able to express the results in simple-to-use analytical expressions. Solving the difference equation for the unit cell, Mondal [7] derived generalized analytical expressions for the electrical characteristics of finite homogeneous ladder networks. Generalized analytical expressions for the electrical characteristics of finite homogeneous ladder networks are available, but they are often lengthy despite being in closed form. In this paper, we will derive more compact and user-friendly solutions, and apply these to obtain asymptotic expressions and design criteria. While this work focuses on purely resistive networks, the solutions can be easily extended to resistor–inductor–capacitor networks by substituting the resistances with the corresponding complex impedances [6,7].

2. Theory

2.1. Layout and Definitions for Ladder Configuration

We consider a sequence of n heaters with resistance R_h that are connected by two lead wire lines, A and B, resulting in $n - 1$ lead wire parts with resistance R_A , and R_B , respectively (see Figure 2). A potential V_0 is applied over nodes A_1 and B_1 . The currents in the lead wires and heater resistances are indicated with $i_{A,k}$, $i_{B,k}$ and $i_{h,k}$ respectively.

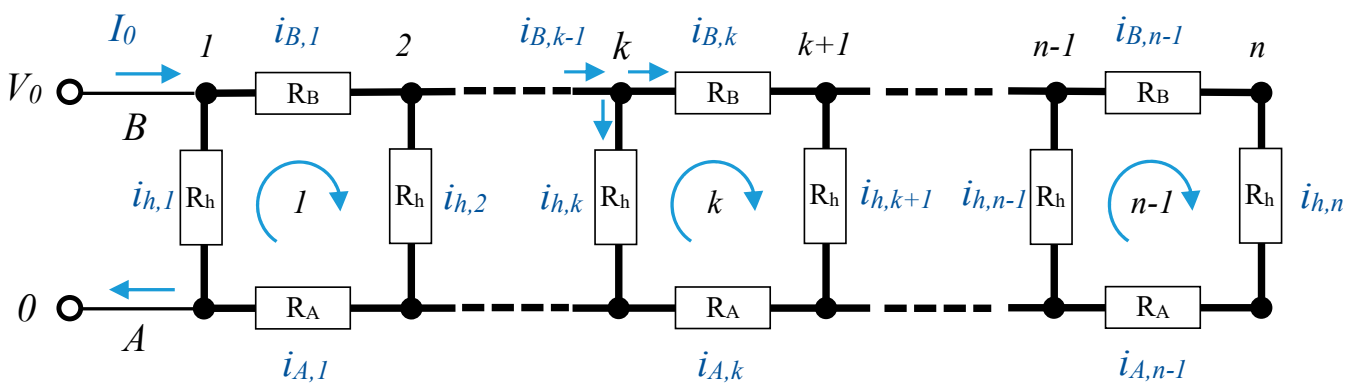

Figure 2. Resistances for the ladder configuration with input terminals connected to A_1B_1 .

Applying Kirchoff’s voltage law (KVL) to segment k , we obtain

$$R_h i_{h,k} + R_B i_{B,k} - R_h i_{h,k+1} - R_A i_{A,k} = 0 \tag{1}$$

Then, using

$$i_{h,k} = i_{A,k-1} - i_{A,k} \quad \text{and} \quad i_{B,k} = -i_{A,k} \tag{2}$$

and introducing the lead wire resistance ratio as $\varepsilon = (R_A + R_B)/R_h$ we can rewrite Equation (1) as

$$i_{A,k+1} - (2 + \varepsilon)i_{A,k} + i_{A,k-1} = 0 \tag{3}$$

This is a second order finite difference equation for which $e^{k\delta}$, $e^{-k\delta}$ or combinations thereof are known solutions. Here, we use it as a trial function:

$$i_{A,k} = A \cosh[k\delta] + B \sinh[k\delta] + C \tag{4}$$

Inserting this in Equation (3) then results in $\cosh[\delta] = 1 + \frac{1}{2}\varepsilon$ and $C = 0$. Next, we apply the KVL to the first and the last mesh:

$$V_0 - R_h i_{h,1} = 0, \quad R_h i_{h,n-1} + (R_A + R_B + R_h) i_{B,n-1} = 0$$

which can be rewritten as

$$i_0 - i_{A,1} + \frac{V_0}{R_h} = 0, \quad (2 + \varepsilon)i_{A,n-1} - i_{A,n-2} = 0 \tag{5}$$

The solution for A and B then follows by substituting the trial solution in Equation (5). These solutions can be simplified by using the addition formulas for hyperbolic functions. Solving for A and B then gives

$$A = \frac{\frac{V_0}{R_h} \sinh[n\delta]}{\sinh[n\delta] - \sinh[(n-1)\delta]}, \quad B = \frac{-\frac{V_0}{R_h} \cosh[n\delta]}{\sinh[n\delta] - \sinh[(n-1)\delta]}$$

from which we obtain

$$\frac{R_{eq}^L}{R_h} = 1 - \frac{\sinh[(n-1)\delta]}{\sinh[n\delta]}, \quad I_0 = \frac{V_0}{R_{eq}^L} \tag{6}$$

$$i_{A,k} = I_0 \frac{\sinh[(n-k)\delta]}{\sinh[n\delta]}, \quad i_{h,k} = \frac{V_0}{R_h} \frac{\cosh\left[\left(n-k+\frac{1}{2}\right)\delta\right]}{\cosh\left[\left(n-\frac{1}{2}\right)\delta\right]} \tag{7}$$

Here, R_{eq}^L denotes the equivalent resistance of the ladder heater configuration and I_0 the total current through the heater. The lead wire and heater currents in Equation (7) result in compact closed-form equations with the node number, k , and the total number of heater wires, n , as the main parameters. With this formulation it can immediately be seen that the lead wire current decreases from I_0 at $k = 0$ (near the source) to 0 at the end ($k = n$). The heater current starts at V_0/R_h at $k = 1$, as expected.

2.2. Solution for Diagonal Configuration

In what we call the diagonal configuration, we connect the power source to nodes A_1 and B_n , respectively (see Figure 3). The solution procedure is similar to that for the ladder configuration, except now that we have

$$i_{B,k} = I_0 - i_{A,k} = i_{A,n-k} \tag{8}$$

From symmetry considerations, we can see that $i_{A,1} = i_{B,n-1}$, which is similar for the other node numbers. In addition, for the heater currents, we have $i_{h,k} = i_{k,n-k+1}$.

Applying Equation (8) in the governing KVL equation for the k th mesh (Equation (3)) we obtain

$$i_{A,k+1} - (2 + \varepsilon)i_{A,k} + i_{A,k-1} + \frac{1}{2}\varepsilon I_0 = 0 \tag{9}$$

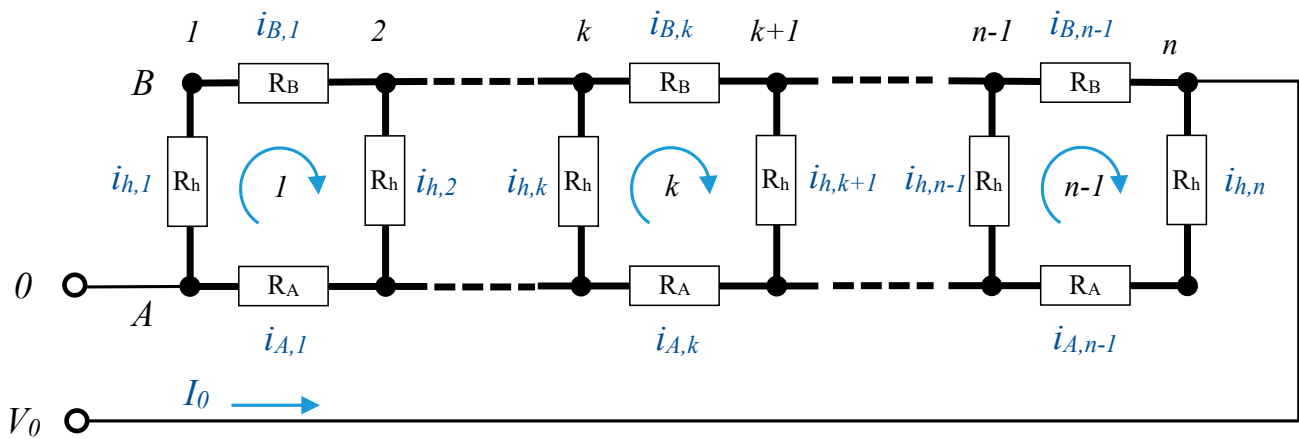

Figure 3. Resistances for the diagonal configuration with input terminals connected to A_1B_n .

The boundary condition is obtained by applying the KVL over the power source connections:

$$R_A \sum_{k=1}^{n-1} i_{A,k} + R_h i_{h,n} = V_0 \tag{10}$$

Because of the symmetry, we now propose it as trial function:

$$i_{A,k} = A \cosh \left[\left(k - \frac{n}{2} \right) \delta \right] + B \sinh \left[\left(k - \frac{n}{2} \right) \delta \right] + C \tag{11}$$

Applying this to Equation (11) then yields $\cosh[\delta] = 1 + \frac{1}{2}\epsilon$ and $C = \frac{1}{2}I_0$. By combining Equations (8) and (11) we obtain

$$i_{A,k} + i_{A,n-k} = 2A \cosh \left[\left(k - \frac{n}{2} \right) \delta \right] + 0 + 2C = I_0 \tag{12}$$

and, hence, we find $A = 0$. From $i_{A,0} = I_0$, we find $B = -\frac{1}{2}I_0 / \sinh[\frac{n}{2}\delta]$. From Equations (10), (A2) and (A3) in Appendix A, we obtain $\frac{1}{2}\epsilon(n-1)I_0 + B \sinh[\frac{n}{2}\delta] + \frac{1}{2}I_0 = \frac{V_0}{R_h}$ and, finally

$$\frac{R_{eq}^D}{R_h} = \frac{1}{2} \coth \left[\frac{n}{2} \delta \right] \sinh[\delta] + \frac{1}{4}(n-2)\epsilon, \quad I_0 = \frac{V_0}{R_{eq}^D} \tag{13}$$

$$i_{A,k} = \frac{1}{2} I_0 \left(1 - \frac{\sinh \left[\left(k - \frac{n}{2} \right) \delta \right]}{\sinh \left[\frac{n}{2} \delta \right]} \right), \quad i_{h,k} = \frac{I_0 \sinh \left[\frac{\delta}{2} \right]}{\sinh \left[\frac{n}{2} \delta \right]} \cosh \left[\left(k - \frac{n+1}{2} \right) \delta \right] \tag{14}$$

The expressions in Equations (13) and (14) are simpler and more condensed than those reported by Mondal [7]. Direct inspection shows that $i_{A,k}$ decreases to 0 at the last branch, $k = n$ and that the heater currents are symmetric around $(n + 1)/2$.

2.3. Simplified Solutions

The above expressions are exact and can be simplified by assuming that $\epsilon \ll 1$. In that case for the parameter δ we obtain the following:

$$\delta \cong \sqrt{\epsilon} - \frac{1}{24} \epsilon^{\frac{3}{2}} + \dots \tag{15}$$

For $\epsilon < 0.4$, the error from omitting the second and higher-order terms is less than 0.01. Further simplification by Taylor series development, however, do not result in practical results, since the arguments of the sinh functions scale are $n\delta$ which, in this case, is of order unity or larger.

The equivalent resistances are important parameters for calculating the overall current and power dissipated by the network. For small ε , the equivalent resistances should converge to the solution of a parallel resistor network R_h/n . In addition, for $n \gg 1$ for the equivalent ladder and diagonal resistances, we obtain

$$\frac{R_{eq}^L}{R_h} \sim 1 - e^{\sqrt{\varepsilon}}, \quad \frac{R_{eq}^D}{R_h} \sim \frac{1}{2}\sqrt{\varepsilon} + \frac{1}{4}(n-2)\varepsilon \quad (16)$$

For the diagonal configuration, we may approximate the solutions for the lead wire and heater currents as

$$i_{A,k} \cong I_0 \left(1 - \frac{k}{n}\right), \quad i_{h,k} = \frac{I_0 \frac{\sqrt{\varepsilon}}{2}}{\sinh\left[\frac{n}{2}\sqrt{\varepsilon}\right]} \left\{1 + \frac{\varepsilon}{2} \left(k - \frac{n+1}{2}\right)^2\right\} \quad (17)$$

2.4. Design Criteria

In this paper our goal is to minimize the difference between dissipated heat across different heating wires. This requires us to consider the individual heating powers: $P = i^2 R$. For the ladder configuration, this means the ratio between the minimum and maximum heating wire power must exceed a certain value, denoted as f_{hw} . To quantify uniformity, we define the heater current decay criterion r_{hw} as:

$$r_{hw} = \frac{\min(i_{h,k}^2)}{\max(i_{h,k}^2)} > f_{hw} \quad (18)$$

For the ladder and diagonal configuration these ratios amount to, respectively,

$$r_{hw}^L = \frac{\cosh^2\left[\frac{1}{2}\sqrt{\varepsilon}\right]}{\cosh^2\left[\left(n - \frac{1}{2}\right)\sqrt{\varepsilon}\right]}, \quad r_{hw}^D = \frac{1}{\cosh^2\left[\frac{n-1}{2}\sqrt{\varepsilon}\right]} \quad (19)$$

in which we introduce the approximation Equation (15) for convenience. A r_{hw} ratio close to one indicates that the heater wire powers and temperatures are nearly uniform. To ensure the ratio between the lowest and highest power across the heater is not less than, say, 0.70, the designer can attempt to decrease the lead wire resistances, increase the heater wires resistances, or change the number of heating wires per unit length. The manipulation of the lead and heater wire resistances can be achieved by selecting yarns with different conductivity or by altering the width of the knitted strip.

For the second criterion, we consider the heat generated by the different sections of the lead wires. Figure 1 shows that the generated heat is largest close to the power connections and decreases further downstream. For our application, a knitted heater structure, it is no problem that the lead wires also contribute to the heating, but we should ensure that the power of the lead wires does not exceed that of the heater wires. Therefore, we require that the maximum lead wire power is always equal to or less than that of the heater wires

$$r_{lw} = \frac{i_{A,1}^2 R_L}{i_{h,1}^2 R_h} \leq 1 \quad (20)$$

Again, using Equations (7) and (14), we obtain with some rewriting:

$$r_{lw}^L = \left(\frac{R_h}{R_{eq}^L} - 1\right)^2 \varepsilon, \quad r_{lw}^D = \left(\frac{\tanh\left[\frac{n-1}{2}\sqrt{\varepsilon}\right]}{\tanh\left[\frac{1}{2}\sqrt{\varepsilon}\right]}\right)^2 \varepsilon \cong 4 \tanh^2\left[\frac{n-1}{2}\sqrt{\varepsilon}\right] \quad (21)$$

Note that, from the latter equation, it can be deduced that the criterion $r_{lw}^D = 1$ is met if

$$(n - 1)\sqrt{\epsilon} \cong 1.099 \tag{22}$$

3. Example Cases

In order to validate our closed-form expressions we will compare it with numerical simulations (using the block diagram environment of MatLab Simulink, version 10.2). In addition, we will show how the approximations discussed in Section 2.3 relate to these exact solutions. For this, we will consider a typical case for a knitted heater strip and assume $V_0 = 10$ V, $R_h = 100$ Ω and $R_A = R_B = 1, 5$ or 10 Ω , resulting in ϵ values of 0.02, 0.10 and 0.20, respectively.

First, we consider the equivalent resistances as given by Equations (6) and (13) and their approximations, Equation (16). As shown in Figure 4 for the ladder configuration, the equivalent resistances decrease monotonically with increasing n until they reach their asymptotic value given by the first of Equation (16). For small ϵ , the curves approximate the $1/n$ limit of the parallel resistor configuration. The closed-form solutions (full lines) and simulation results agree exactly. The approximations obtained by substituting $\delta = \sqrt{\epsilon}$ (Equation (15)) almost coincide with the full solution (maximum deviation 0.65%) and can thus be considered as accurate and practical simplifications. The equivalent resistance of the diagonal configuration, on the other hand, first follows a $1/n$ decay, which is later taken over by a $\frac{1}{4}n\epsilon$ asymptotic increase (2nd of Equation (16)). The asymptotes (shown as the intermittent lines in Figure 5) are shown to converge well with the closed form solutions (full lines) and the simulations (symbols).

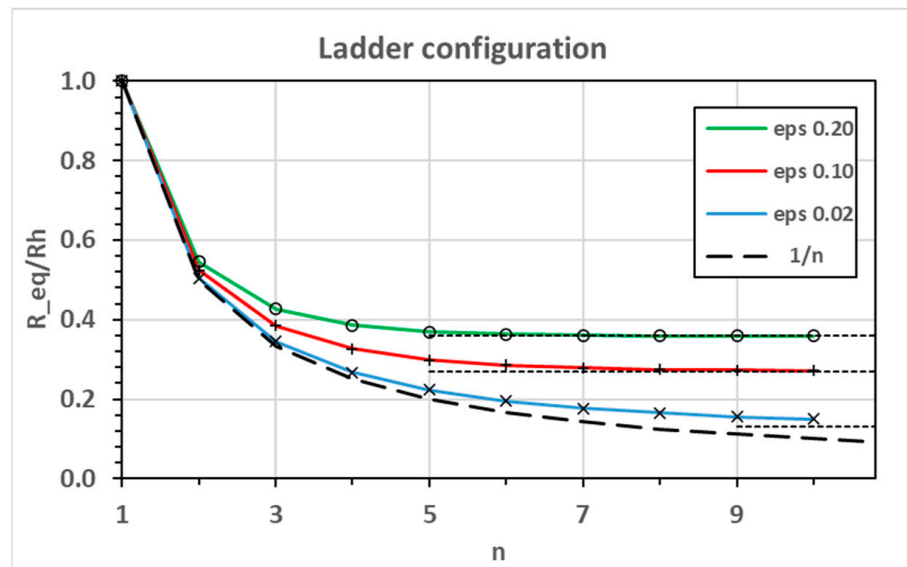

Figure 4. Equivalent resistances for ladder configuration. Full lines are exact solutions; symbols are Simulink data; dashed lines are limiting solutions.

The currents in the lead wires and heaters (Equation (7)) are depicted in Figures 6 and 7 for 5, 10 and 15 heater wires with an ϵ value of 0.02 (colored full lines) and for ϵ values of 0.10 and 0.20 (dashed lines). The simulated values (symbols) agree exactly with the closed-form expressions in all the considered cases. The lead wire currents are at maximum near the power source and vanish at $k = n$. The heater currents (Figure 7) always start at a value of V_0/R_h at $k = 1$. The curves have a parabolic shape and a minimum at $k = n$.

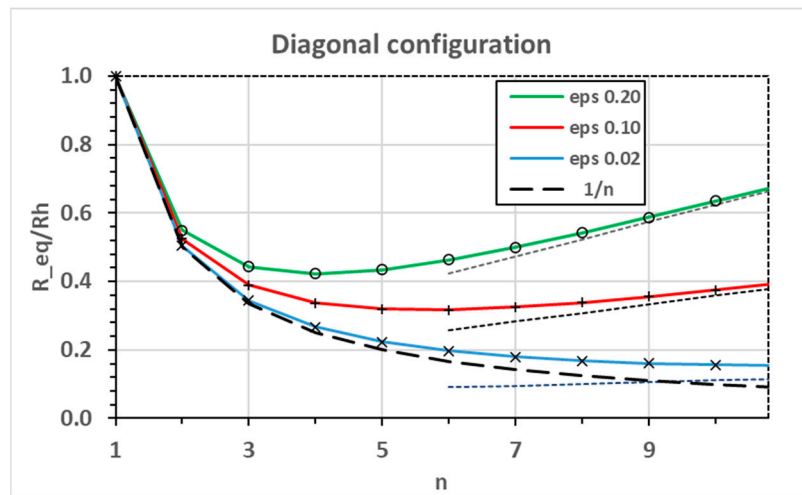

Figure 5. Equivalent resistances for diagonal configuration. Full lines are exact solutions; symbols are Simulink data; dashed lines are limiting solutions.

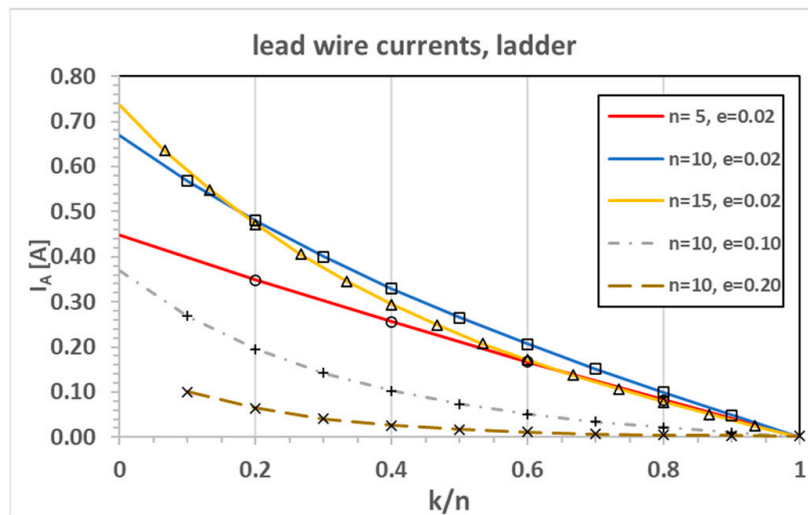

Figure 6. Lead wire currents for ladder configuration. Lines are exact solutions; symbols are Simulink data.

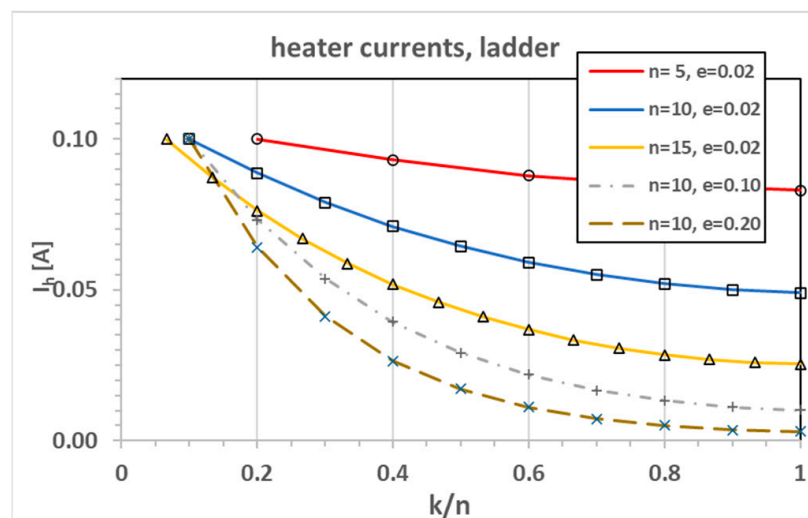

Figure 7. Heater currents for ladder configuration. Lines are exact solutions; symbols are Simulink data.

Figures 8 and 9 show similar plots for the diagonal configuration. In this case, the lead wire currents (Figure 8) show a more linear behavior and Equation (17) (dashed lines) turns out to give good approximations. The heater currents have a minimum at $k = \frac{n+1}{2}$ and show much more uniformity over the different heater nodes as compared to the ladder currents. The approximations now deviate more from the exact solutions.

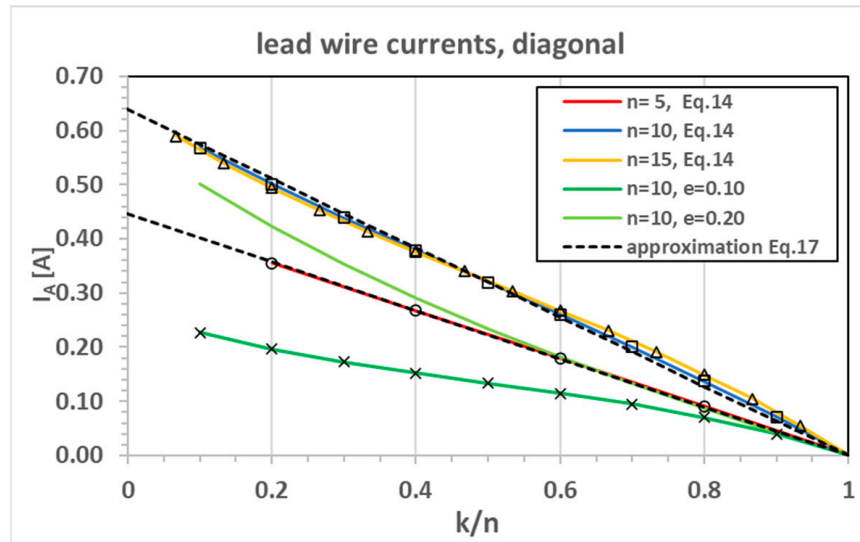

Figure 8. Lead wire currents for diagonal configuration. Lines are exact solutions; symbols are Simulink data and dashed lines are approximations.

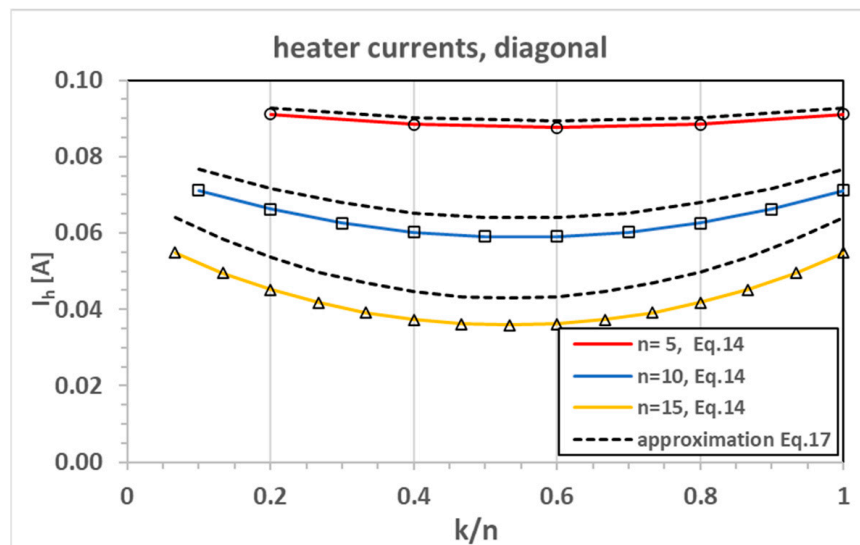

Figure 9. Heater currents for diagonal configuration. Lines are exact solutions; symbols are Simulink data. Dashed lines are the approximation according to Equation (17).

In Figures 10 and 11, we present the uniformity criterion for the ladder and diagonal cases. A uniformity of unity signifies that all heating wires have equal temperatures, which is only achievable in the ideal cases of $\epsilon = 0$ or $n = 1$. For a configuration with seven heaters, a uniformity value of 0.5 would require an ϵ value of 0.08 for the diagonal case and a value of 0.02 for the ladder case, indicating that, in the latter case, a four times lower lead wire resistance would be needed.

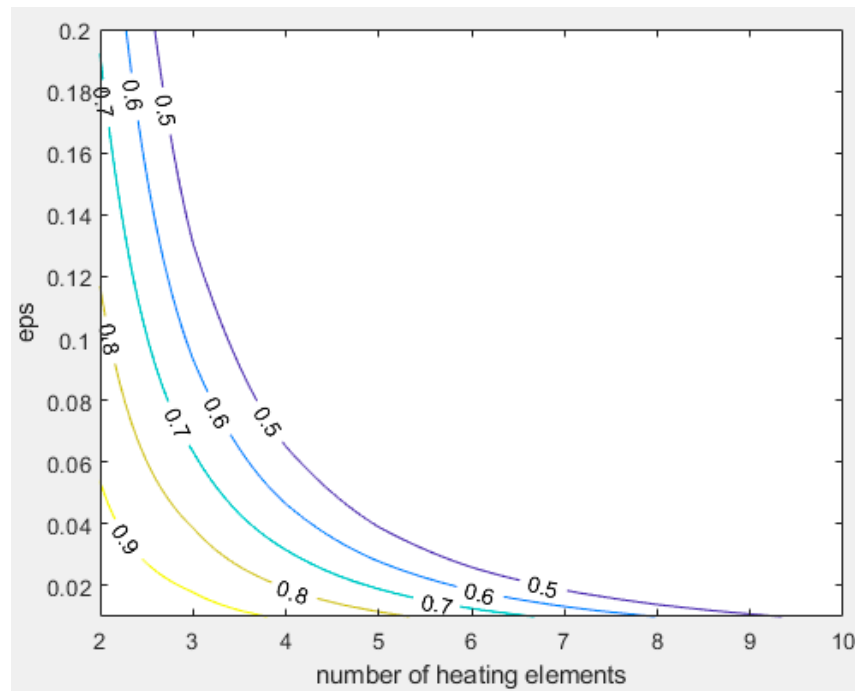

Figure 10. Contour plot for criterion Equation (18). Ladder configuration.

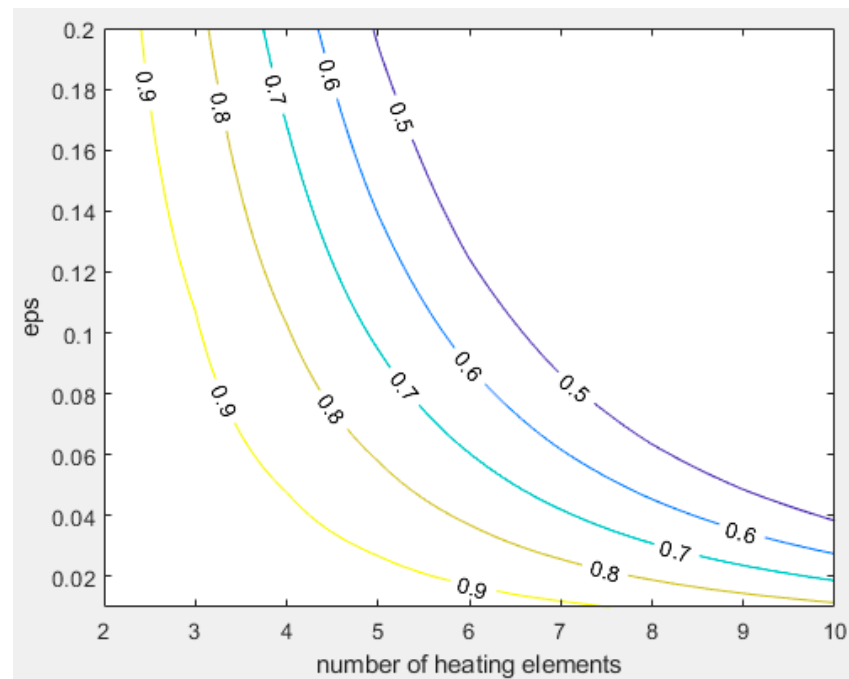

Figure 11. As in Figure 10. Diagonal configuration.

The plots for the 2nd criterion are depicted in Figures 12 and 13. Of practical importance is the case where the maximum heat generated by the lead wires matches that of the heater's maximum, i.e., $r_{lw}^D = 1$. Assuming that we have a lead wire resistance of a fixed minimum value, we can use this criterium to calculate the maximum number of heaters in relation to a chosen heater resistance. With lead wire resistances of 1Ω and a heater resistance of 100Ω , we obtain an ϵ of 0.02 and, thus, can have no more than 12, respectively: nine heaters for the ladder and diagonal configurations.

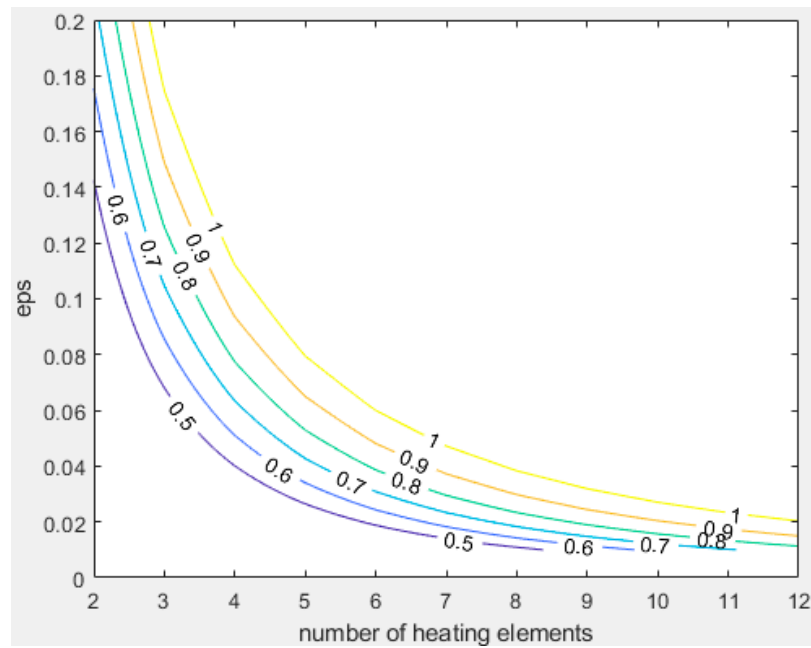

Figure 12. Contour plot for criterion Equation (20). Ladder configuration.

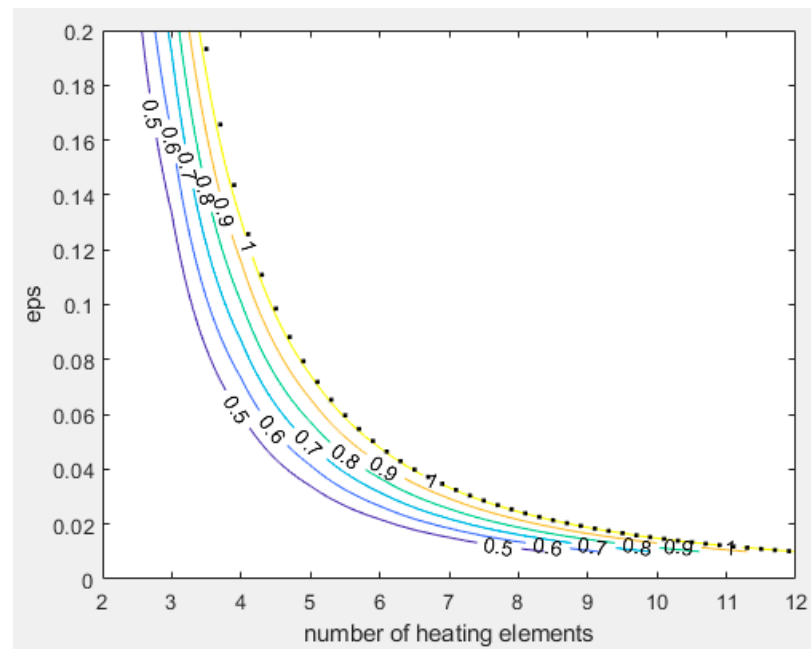

Figure 13. As in Figure 12. Diagonal configuration. The dots are in accordance with Equation (22).

4. Discussion and Conclusions

This paper presents simple closed-form solutions for the electrical characteristics of finite homogeneous ladder networks with their power sources connected to input terminals A_1B_1 and A_1B_n , respectively. Explicit expressions are derived for the equivalent resistances and mesh currents and, based on those, approximations and asymptotic solutions are presented. In addition, we formulated two criteria: one for the uniformity of the current distribution over the heating wires and one to ensure that the power dissipated in the lead wires does not exceed that of the heater wires. When designing heated garments that cover larger surface areas, such as an arm, leg or torso, the designer must consider several factors: whether to use a single ladder-like configuration, use multiple parallel-connected heating elements or adjust the placement and number of power sources. The solutions presented in

this paper can be a valuable tool for designers, offering direct feedback on the impact of design decisions, e.g., overall power consumption and heating uniformity.

As previously mentioned, the work presented here is also applicable as a model for other transport systems, such as the respiratory system and irrigation channels. In these cases, electrical potential, current and resistance correspond to pressure, flow speed and flow resistance, respectively. Additionally, our solutions can be applied to describe the dynamic behavior of more complex ladder-like electrical systems, such as transformer windings. In this case, the resistances in our model should be replaced with the equivalent complex impedances of the repeating electrical units, which consist of resistors, capacitors and inductors.

In future work, we plan to validate the model using physical knitted samples and compare predicted power distributions with measured overall resistances and temperature distributions.

Funding: This research received no external funding.

Data Availability Statement: The data will be made available upon request from the author.

Conflicts of Interest: The author declares no conflict of interest.

Appendix A

For the evaluation of Equation (10), we use the sum of power identities

$$\sum_{k=1}^m e^{k\delta} = \frac{e^{m\delta} - 1}{1 - e^{-\delta}}, \quad \sum_{k=1}^m e^{-k\delta} = \frac{1 - e^{-m\delta}}{e^{\delta} - 1} \quad (\text{A1})$$

Applying this to the hyperbolic functions eventually leads to

$$\sum_{k=1}^m \sinh \left[\left(k - \frac{n}{2} \right) \delta \right] = \frac{\sinh \left[\frac{m}{2} \delta \right]}{\sinh \left[\frac{1}{2} \delta \right]} \sinh \left[\frac{m - n + 1}{2} \delta \right] \quad (\text{A2})$$

$$\sum_{k=1}^m \cosh \left[\left(k - \frac{n}{2} \right) \delta \right] = \frac{\sinh \left[\frac{m}{2} \delta \right]}{\sinh \left[\frac{1}{2} \delta \right]} \cosh \left[\frac{m - n + 1}{2} \delta \right] \quad (\text{A3})$$

Note that, for $m = n - 1$, the sinh term in Equation (A2) vanishes and the corresponding cosh term in Equation (A3) reduces to unity.

References

- Saidi, A.; Gauvin, C.; Ladhari, S.; Nguyen-Tri, P. Advanced Functional Materials for Intelligent Thermoregulation in Personal Protective Equipment. *Polymers* **2021**, *13*, 3711. [[CrossRef](#)] [[PubMed](#)]
- Tabor, J.; Chatterjee, K.; Ghosh, T.K. Smart Textile-Based Personal Thermal Comfort Systems: Current Status and Potential Solutions. *Adv. Mater. Technol.* **2020**, *5*, 1901155. [[CrossRef](#)]
- Roh, J.-S.; Kim, S. All-fabric intelligent temperature regulation system for smart clothing applications. *J. Intell. Mater. Syst. Struct.* **2016**, *27*, 1165–1175. [[CrossRef](#)]
- Ionescu, C.M.; Machado, J.A.T.; Keyser, R.D. Modeling of the Lung Impedance Using a Fractional-Order Ladder Network with Constant Phase Elements. *IEEE Trans. Biomed. Circuits Syst.* **2011**, *5*, 83–89. [[CrossRef](#)] [[PubMed](#)]
- Hum, S.V.; Du, B. Equivalent Circuit Modeling for Reflectarrays Using Floquet Modal Expansion. *IEEE Trans. Antennas Propag.* **2017**, *65*, 1131–1140. [[CrossRef](#)]
- Smith, P.W. *Transient Electronics: Pulsed Circuit Technology*; John Wiley & Sons: Chichester, UK, 2002.
- Mondal, M.; Kumbhar, G.B. Generalized analytical formulae to compute electrical characteristics of a homogenous ladder network of the transformer winding. *Int. J. Circuit Theory Appl.* **2018**, *46*, 911–925. [[CrossRef](#)]
- Nagashima, H.N.; Onody, R.N.; Faria, R.M. ac transport studies in polymers by resistor-network and transfer-matrix approaches: Application to polyaniline. *Phys. Rev. B* **1999**, *59*, 905–909. [[CrossRef](#)]
- Farkas, G. Fundamentals of Thermal Transient Measurements. In *Theory and Practice of Thermal Transient Testing of Electronic Components*; Rencz, M., Farkas, G., Poppe, A., Eds.; Springer International Publishing: Cham, Switzerland, 2022; pp. 171–208. [[CrossRef](#)]
- Faccio, M.; Ferri, G.; Amico, A.D. A new fast method for ladder networks characterization. *IEEE Trans. Circuits Syst.* **1991**, *38*, 1377–1382. [[CrossRef](#)]

11. Dutta Roy, S.C. Difference Equations, Z-Transforms and Resistive Ladders. In *Circuits, Systems and Signal Processing: A Tutorial Approach*; Springer: Singapore, 2018; pp. 135–140. [[CrossRef](#)]
12. Cserti, J. Application of the lattice Green's function for calculating the resistance of an infinite network of resistors. *Am. J. Phys.* **2000**, *68*, 896–906. [[CrossRef](#)]
13. Tan, Z.-Z.; Asad, J.H.; Owaidat, M.Q. Resistance formulae of a multipurpose n-step network and its application in LC network. *Int. J. Circuit Theory Appl.* **2017**, *45*, 1942–1957. [[CrossRef](#)]
14. Zhou, S.; Wang, Z.-X.; Zhao, Y.-Q.; Tan, Z.-Z. Electrical properties of a generalized $2 \times n$ resistor network. *Commun. Theor. Phys.* **2023**, *75*, 075701. [[CrossRef](#)]

Disclaimer/Publisher's Note: The statements, opinions and data contained in all publications are solely those of the individual author(s) and contributor(s) and not of MDPI and/or the editor(s). MDPI and/or the editor(s) disclaim responsibility for any injury to people or property resulting from any ideas, methods, instructions or products referred to in the content.