





masterplan

49.2

12.3

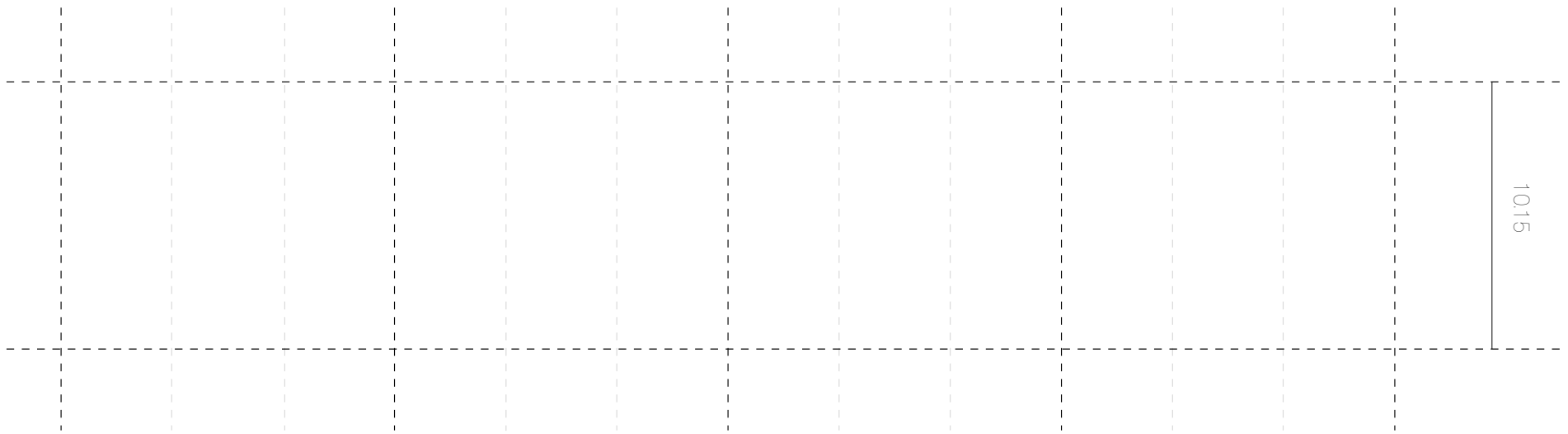

10.15

4.1

4.1

4.1

0 1 5 10



floor plan grid

49.2

12.3

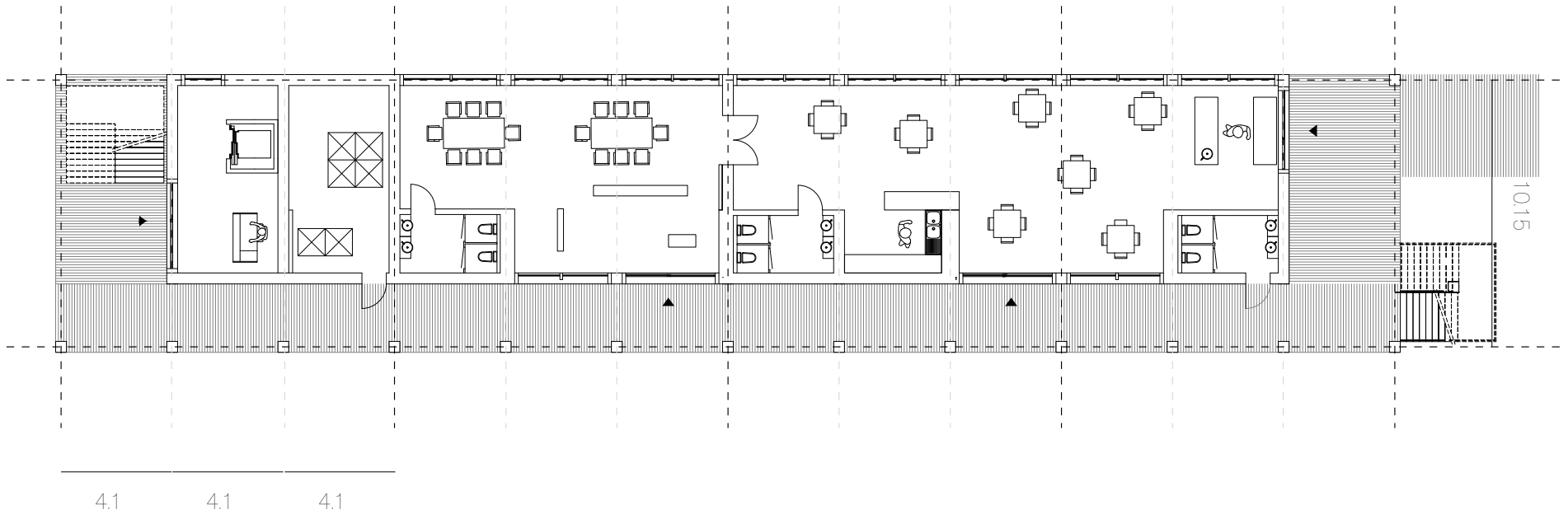

floor plan ground floor

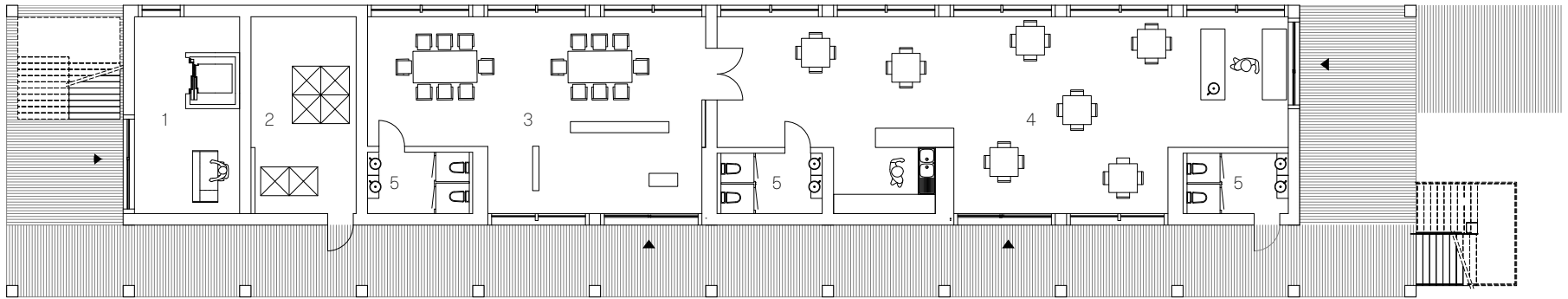

- 1. reception
- 2. technical room
- 3. gallery/workshop space
- 4. cafe
- 5. bathroom

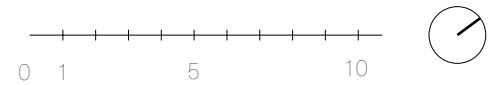

floor plan ground floor

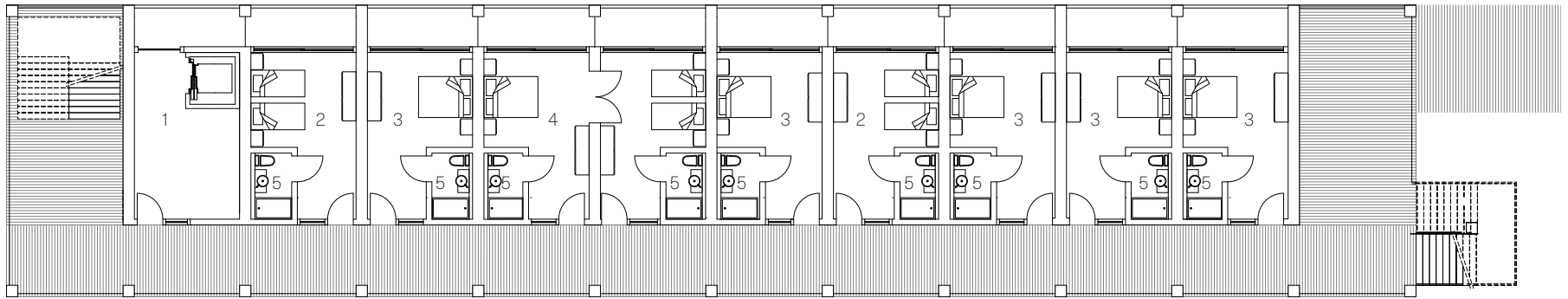

- 1. reception/lounge room
- 2. double room single beds
- 3. double room double bed
- 4. family room
- 5. bathroom

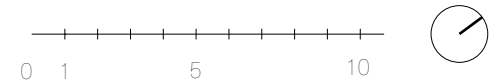

floor plans 1-4

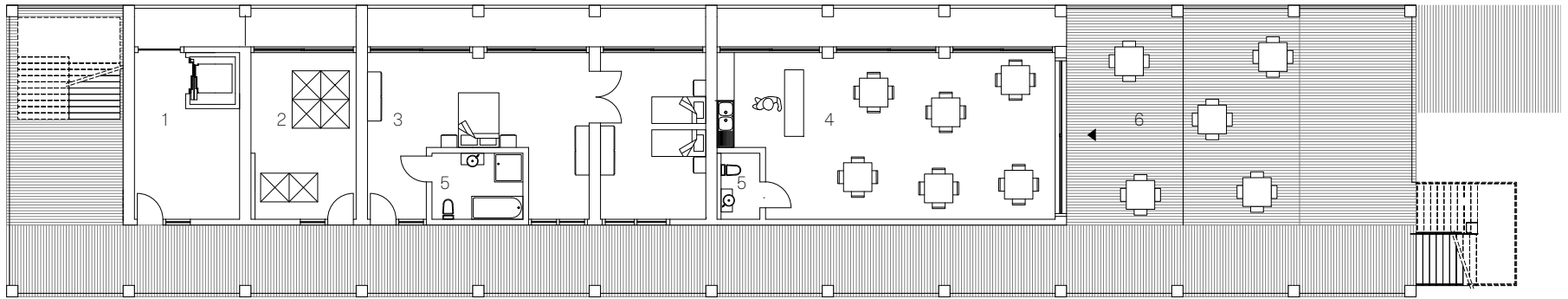

- 1. reception/lounge
- 2. technical room
- 3. penthouse apartment
- 4. rooftop cafe
- 5. bathroom
- 6. outdoor terrace

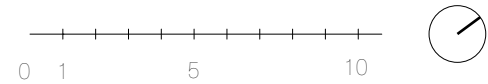

floor plan top floor

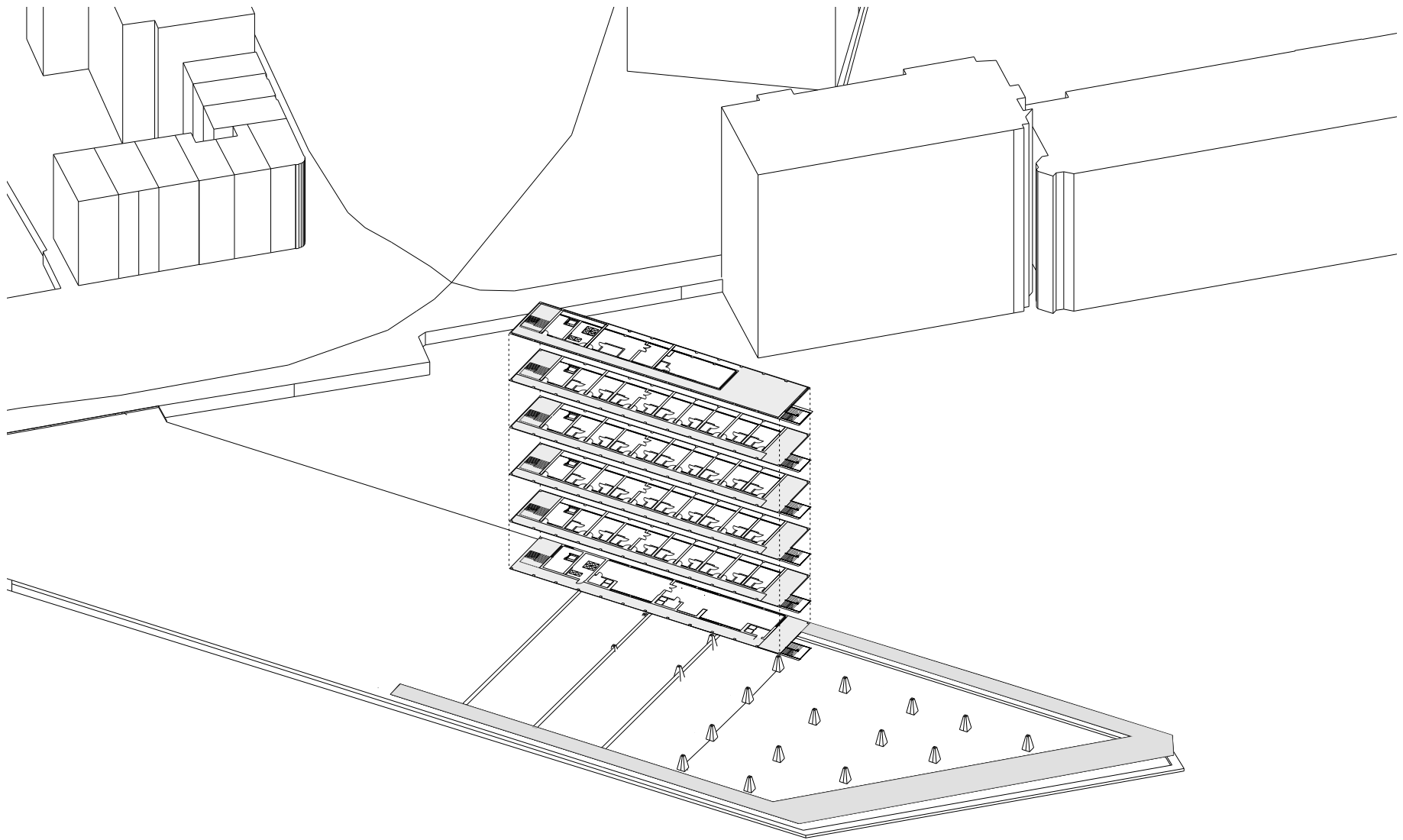

circulation diagram



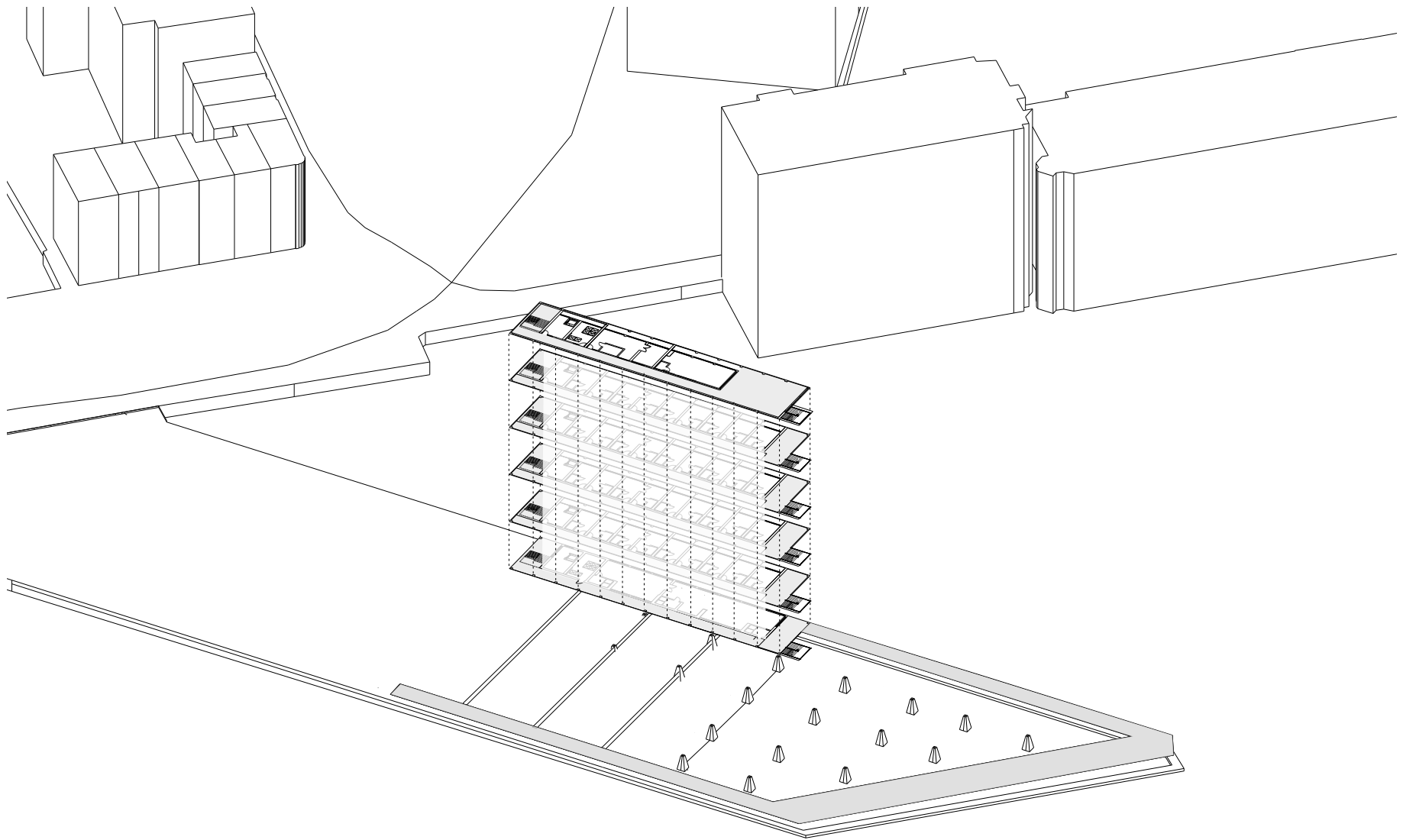

circulation diagram

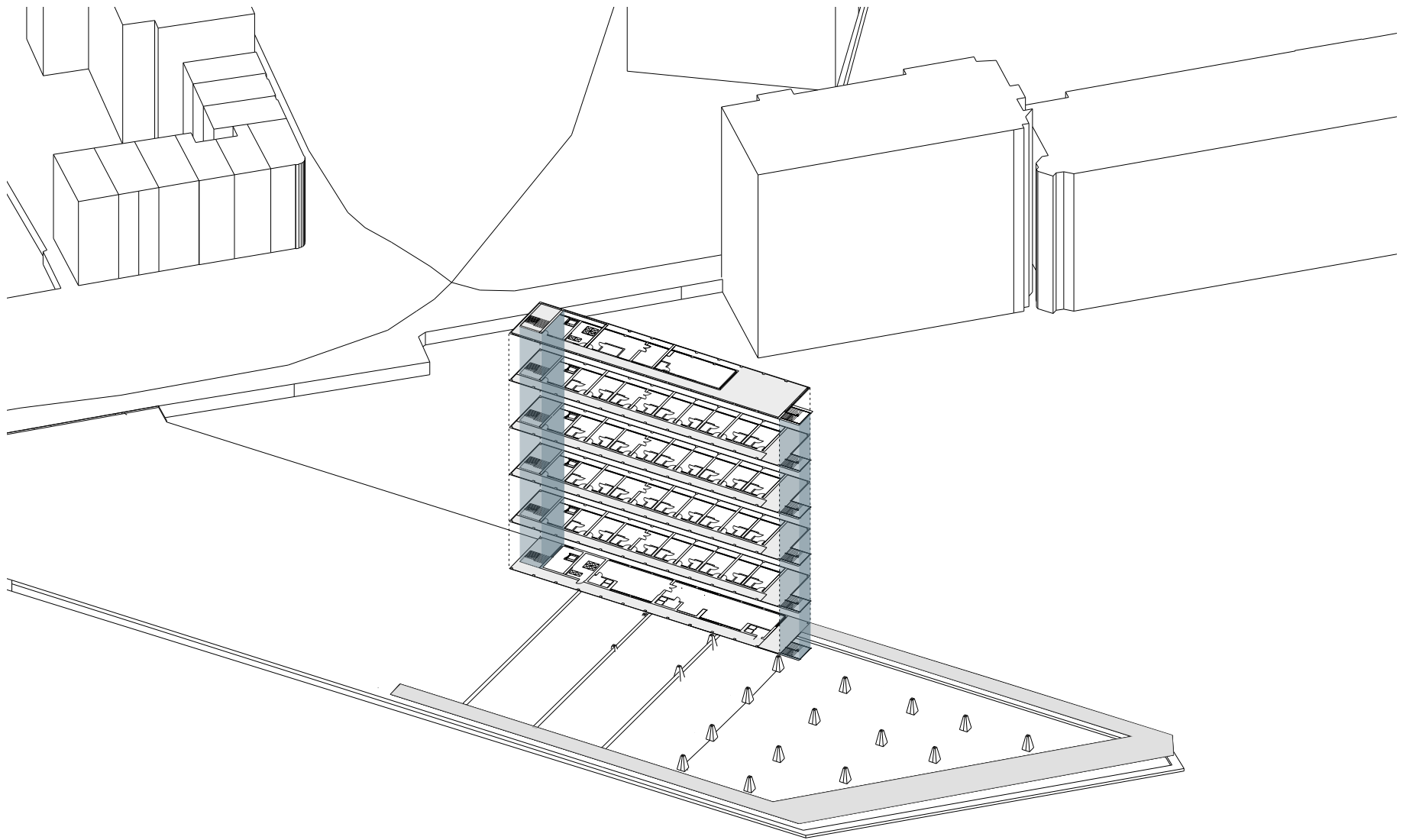

circulation diagram

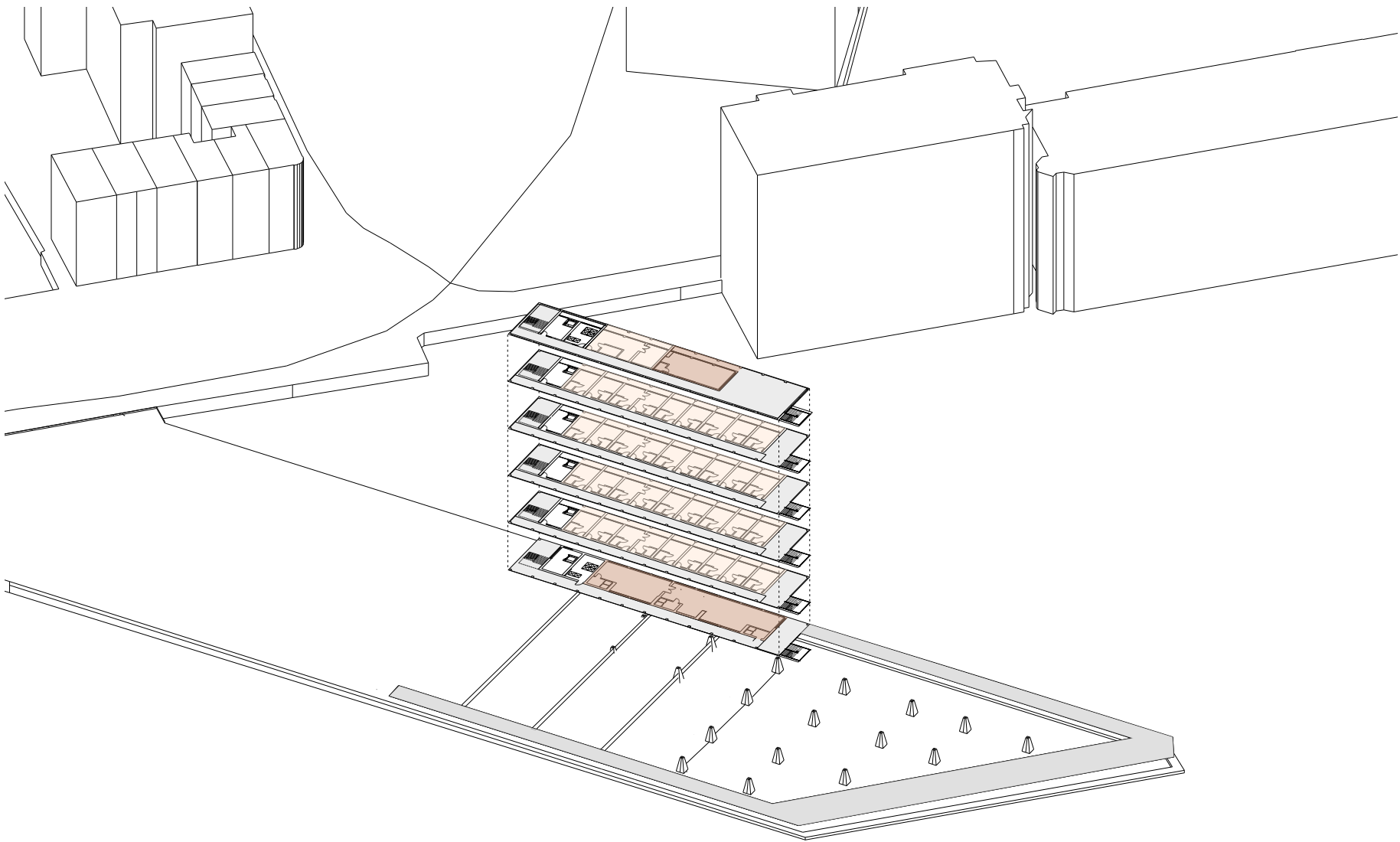

public vs. private

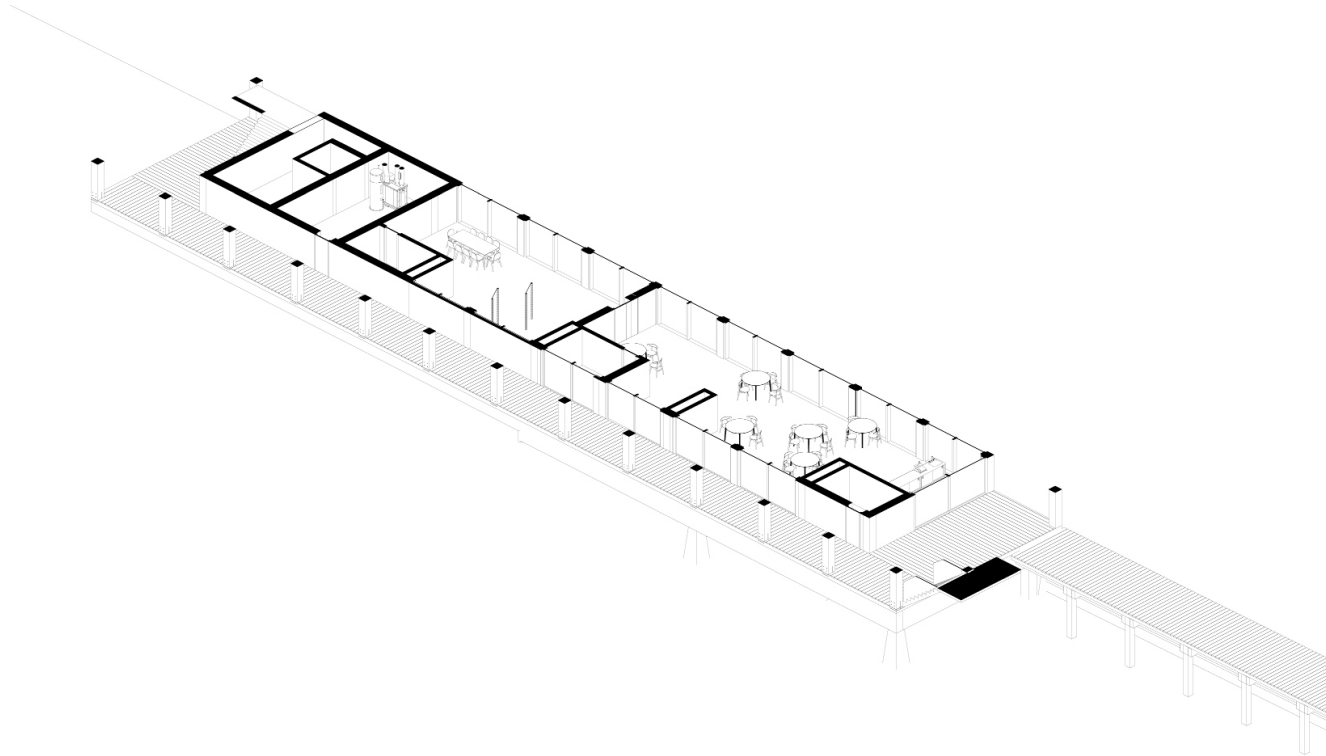

ground floor functions

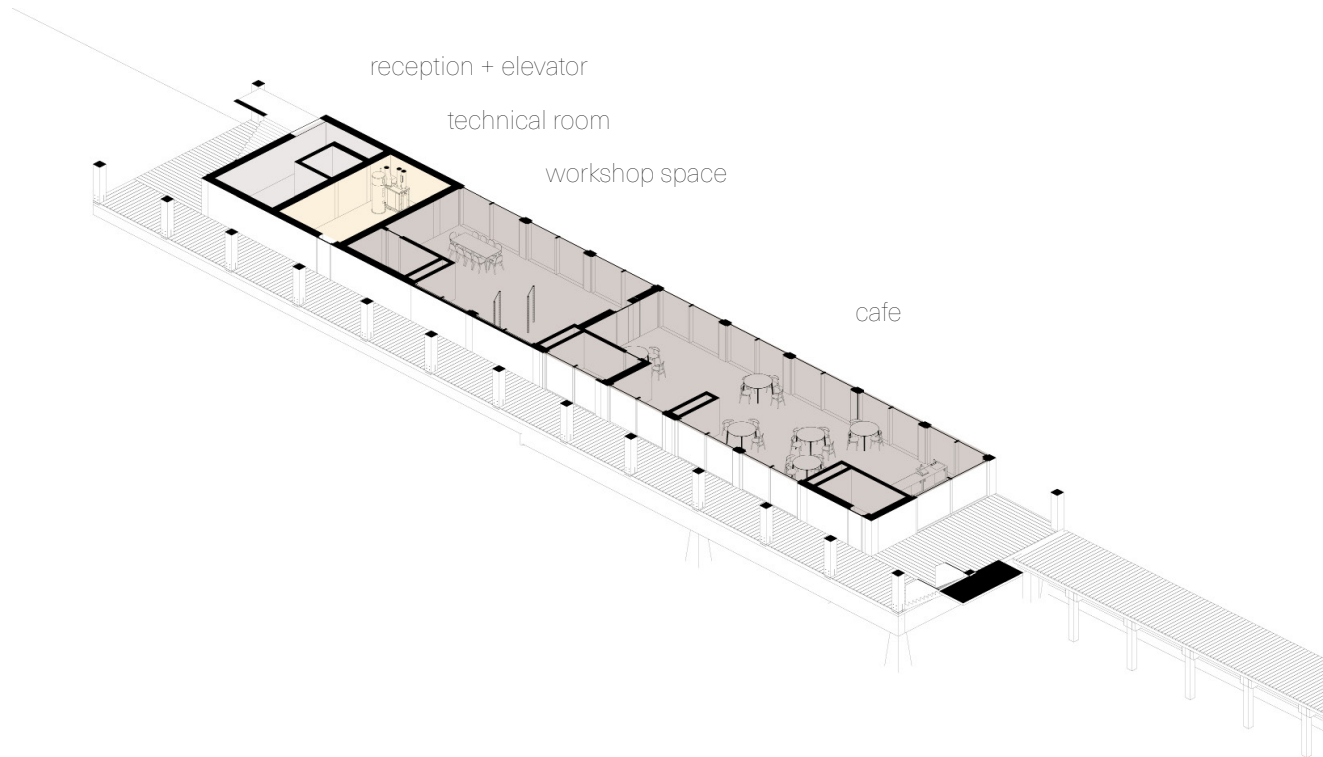

reception + elevator

technical room

workshop space

cafe

ground floor functions public/private

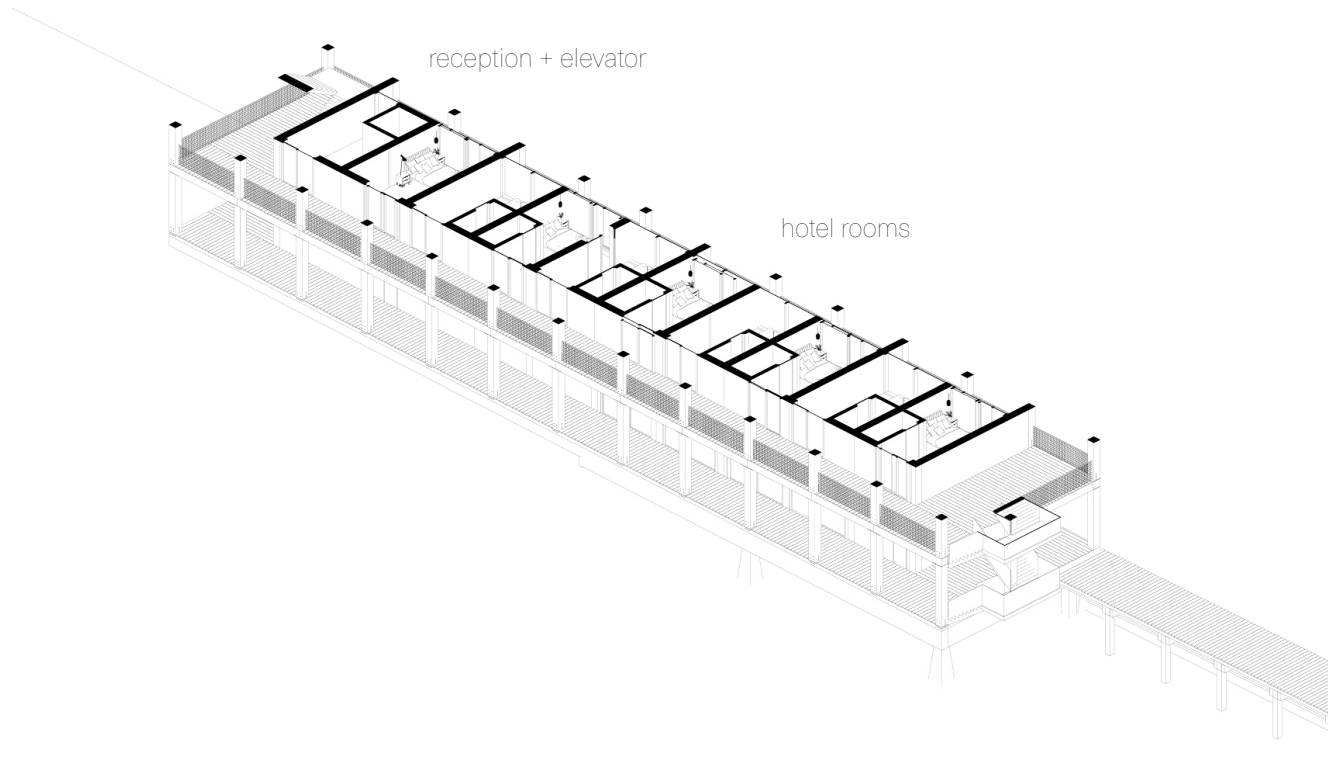

reception + elevator

hotel rooms

first floor functions

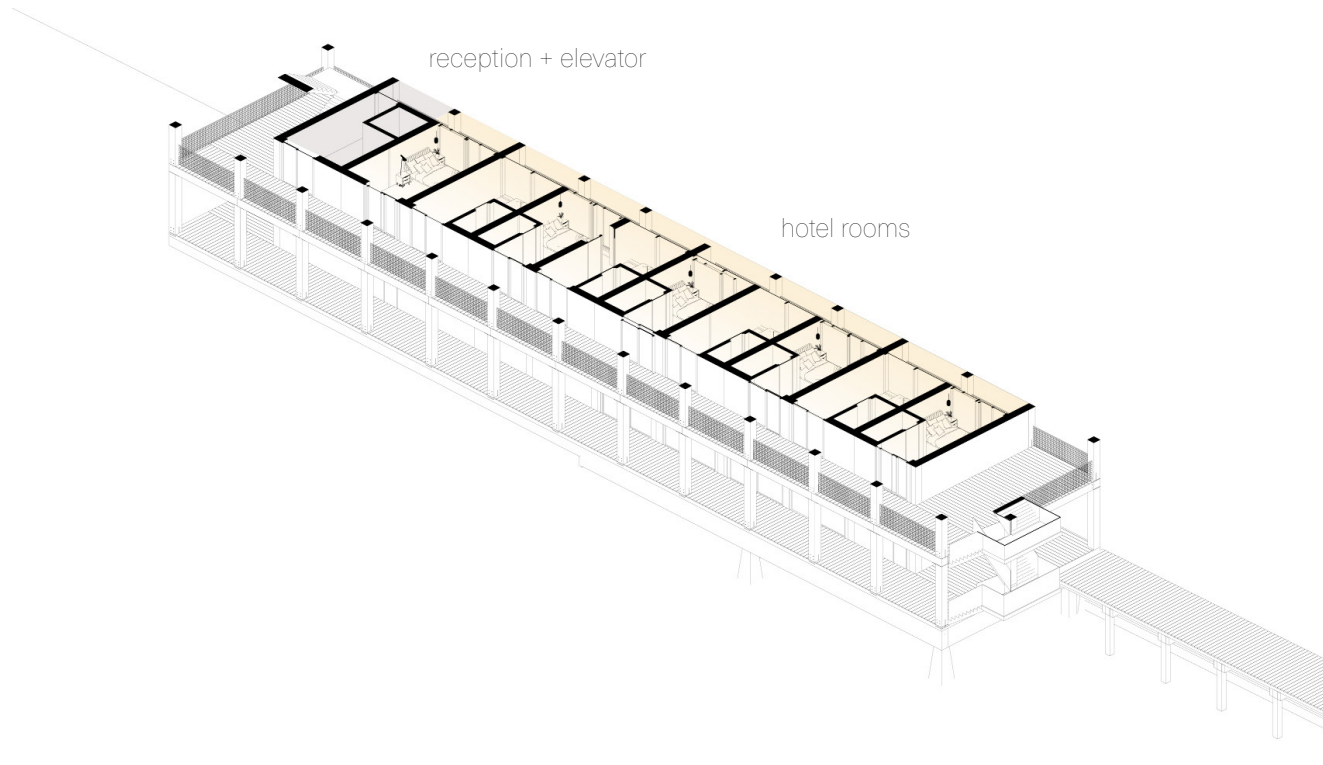

first floor privacy gradient

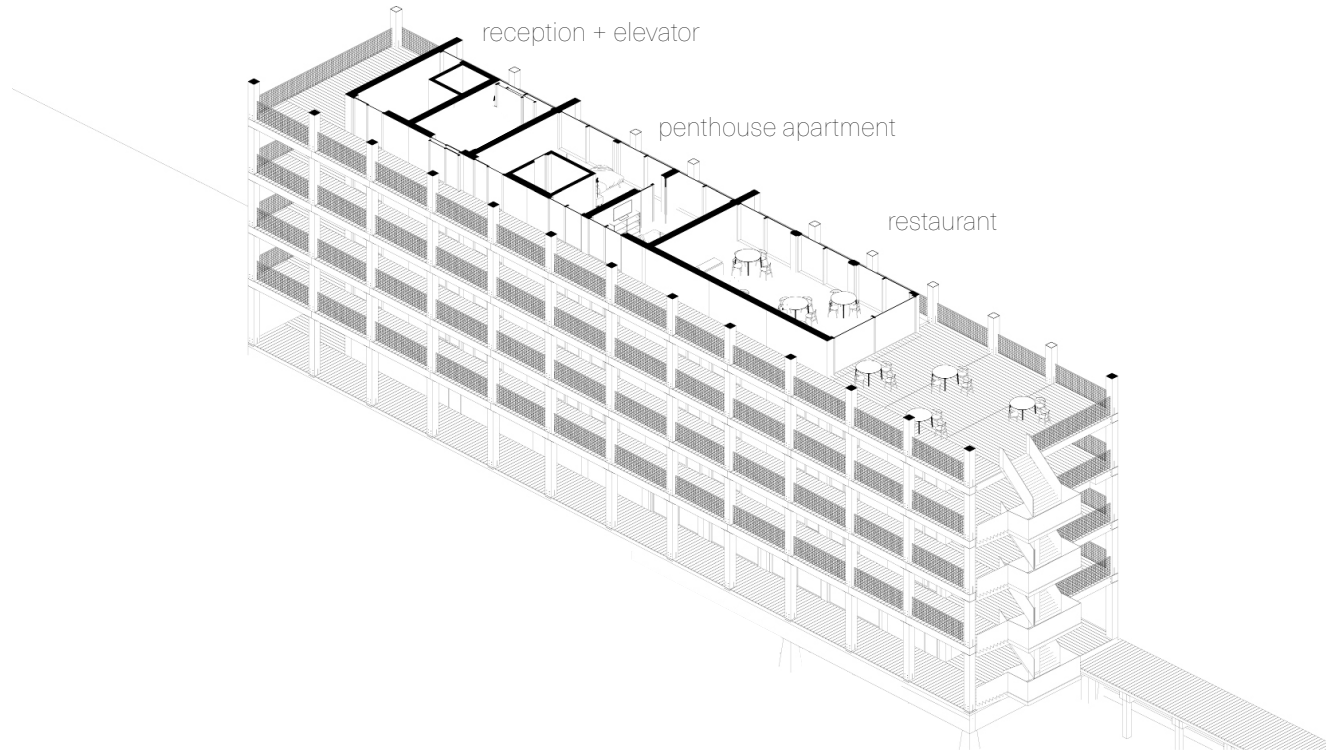

top floor functions



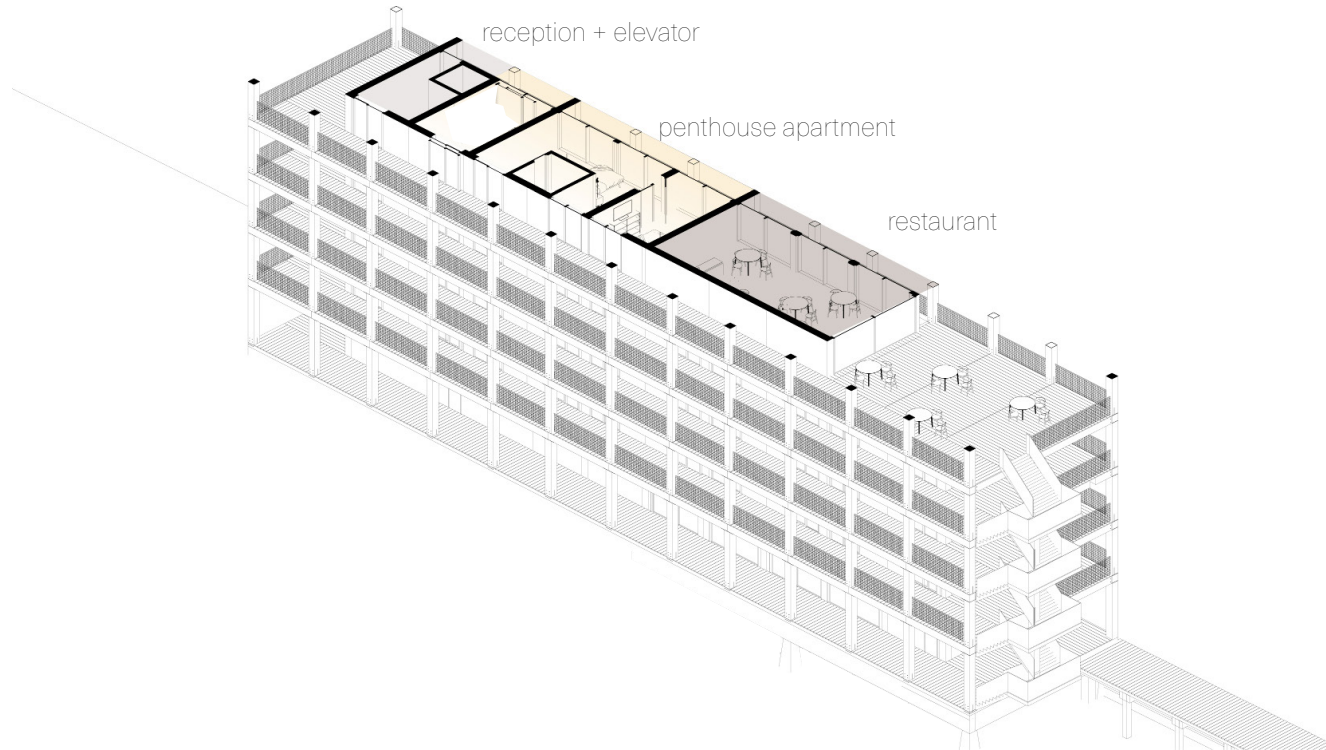

top floor public/private

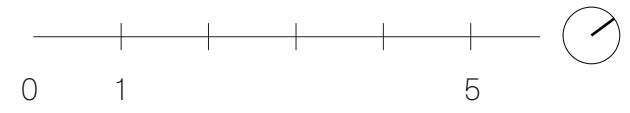
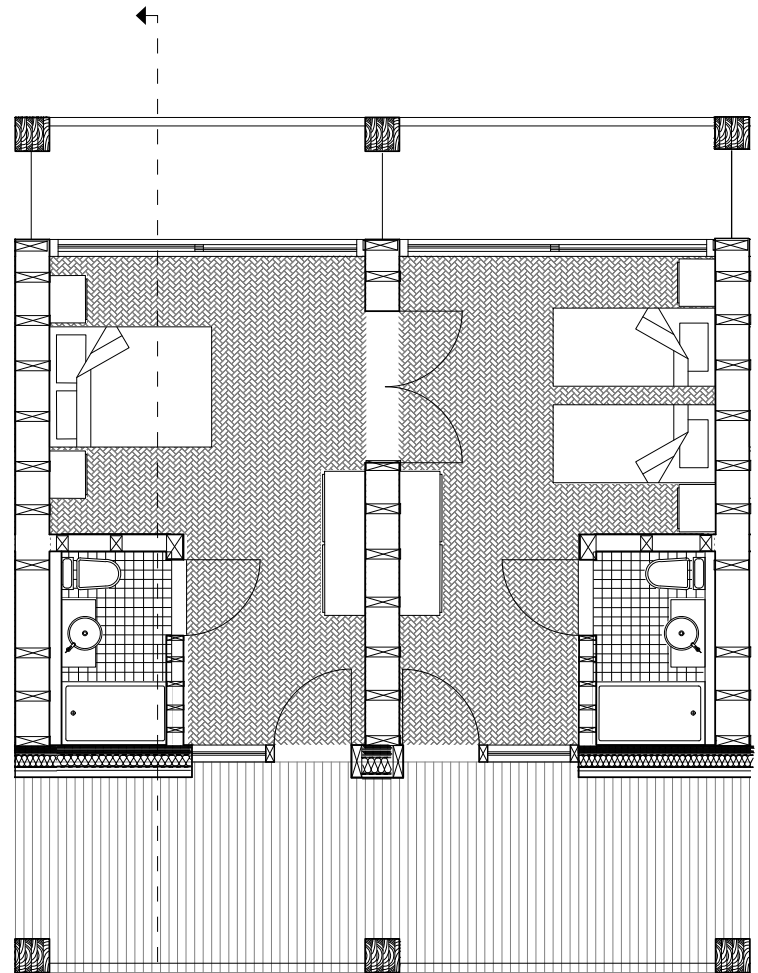
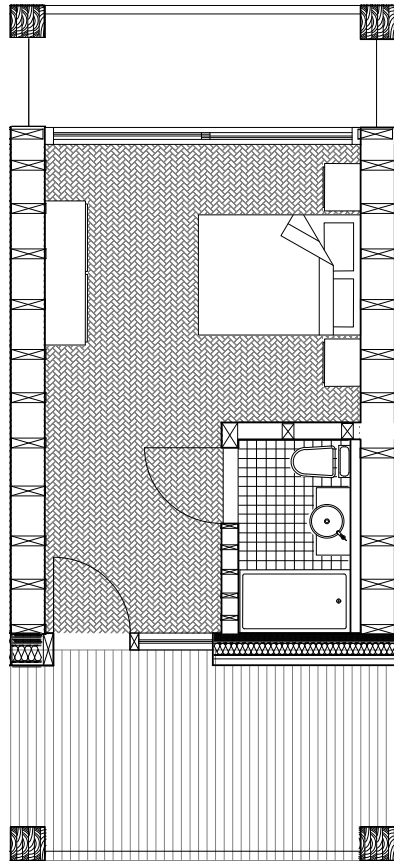
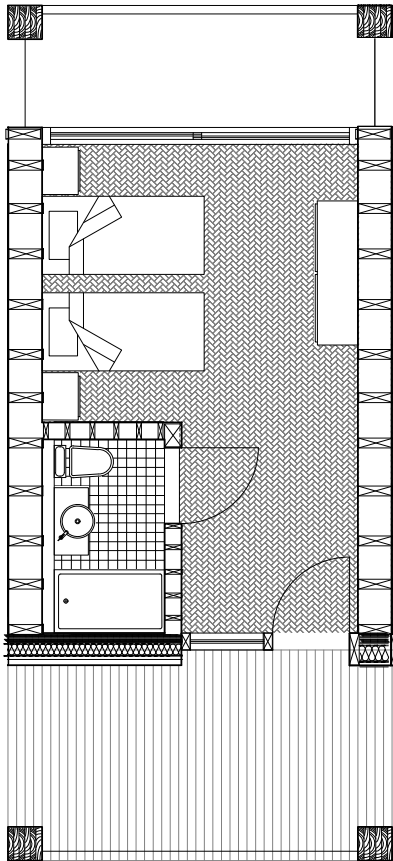

room types

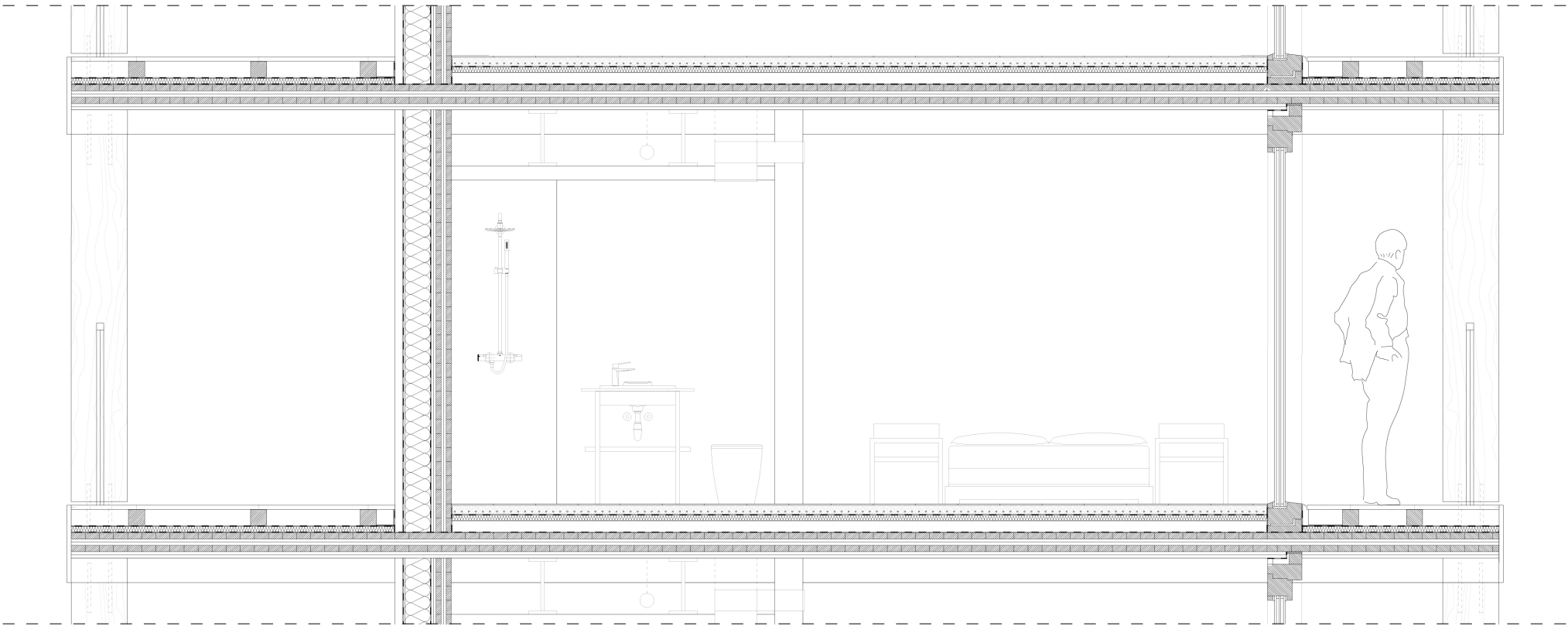

room section

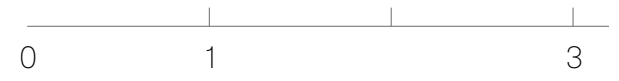

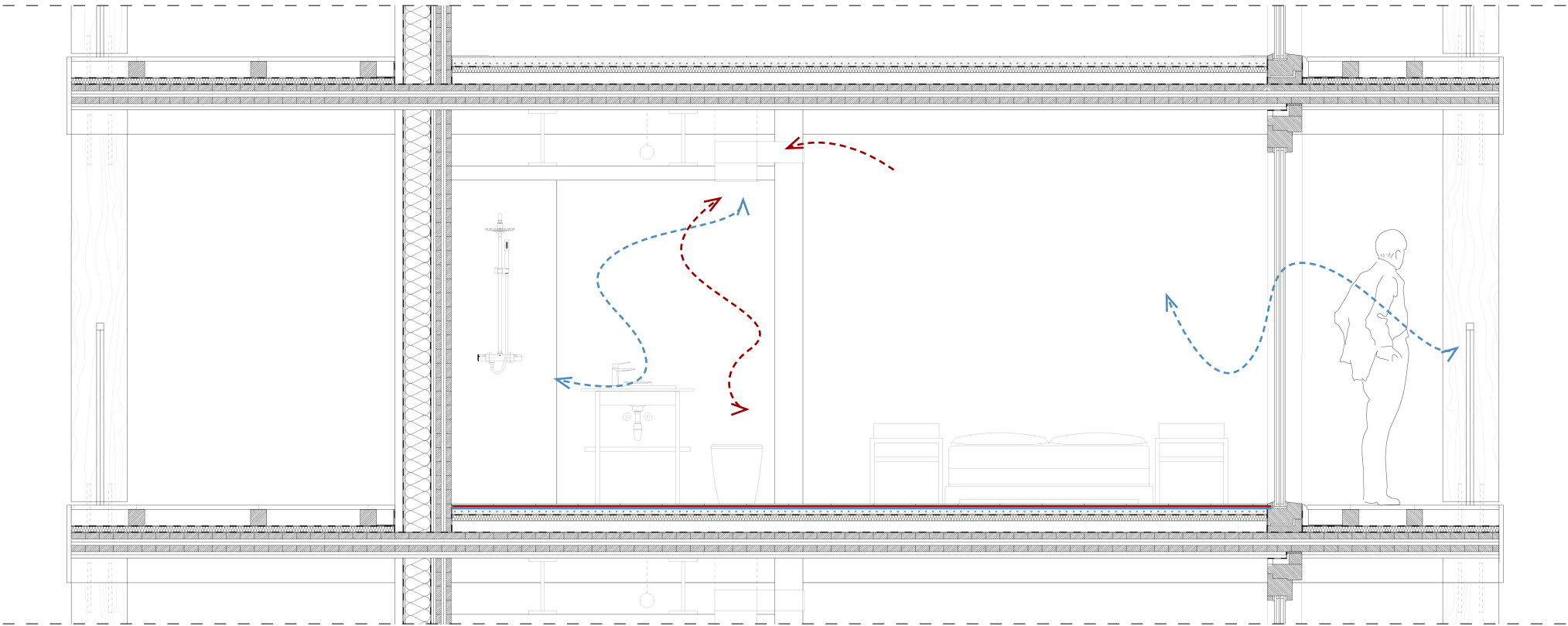

room section ventilation

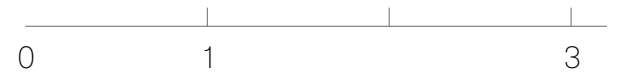

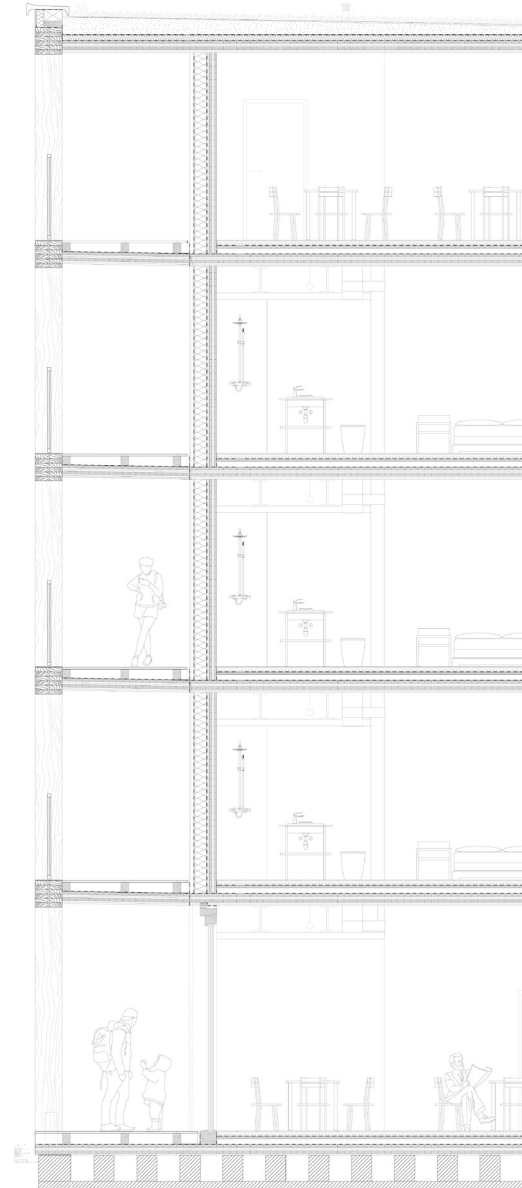

elevation detail





upland

upper border

high marsh

low marsh

tidal flat

site plan wetland

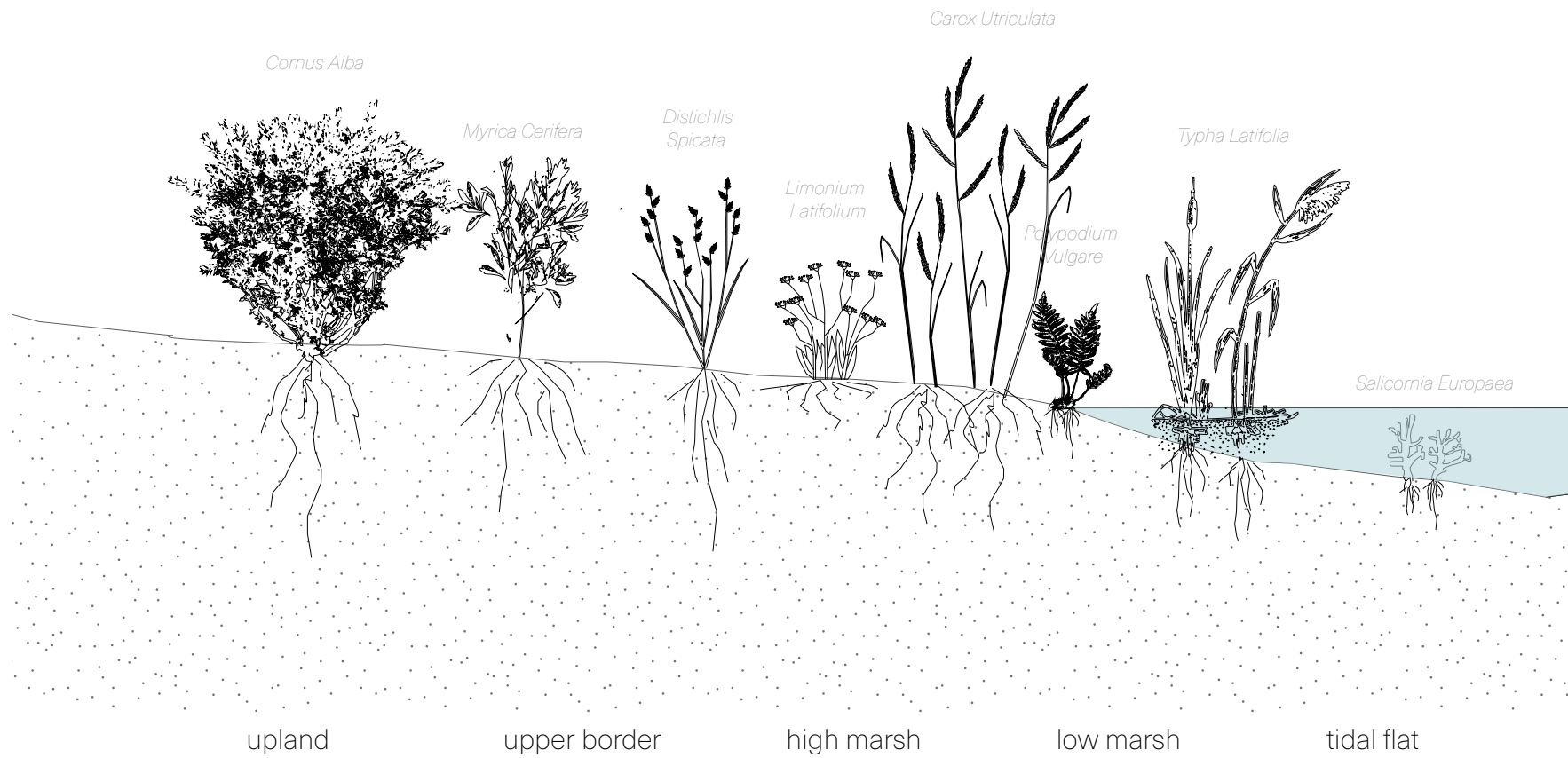

wetland plant types



wetland section



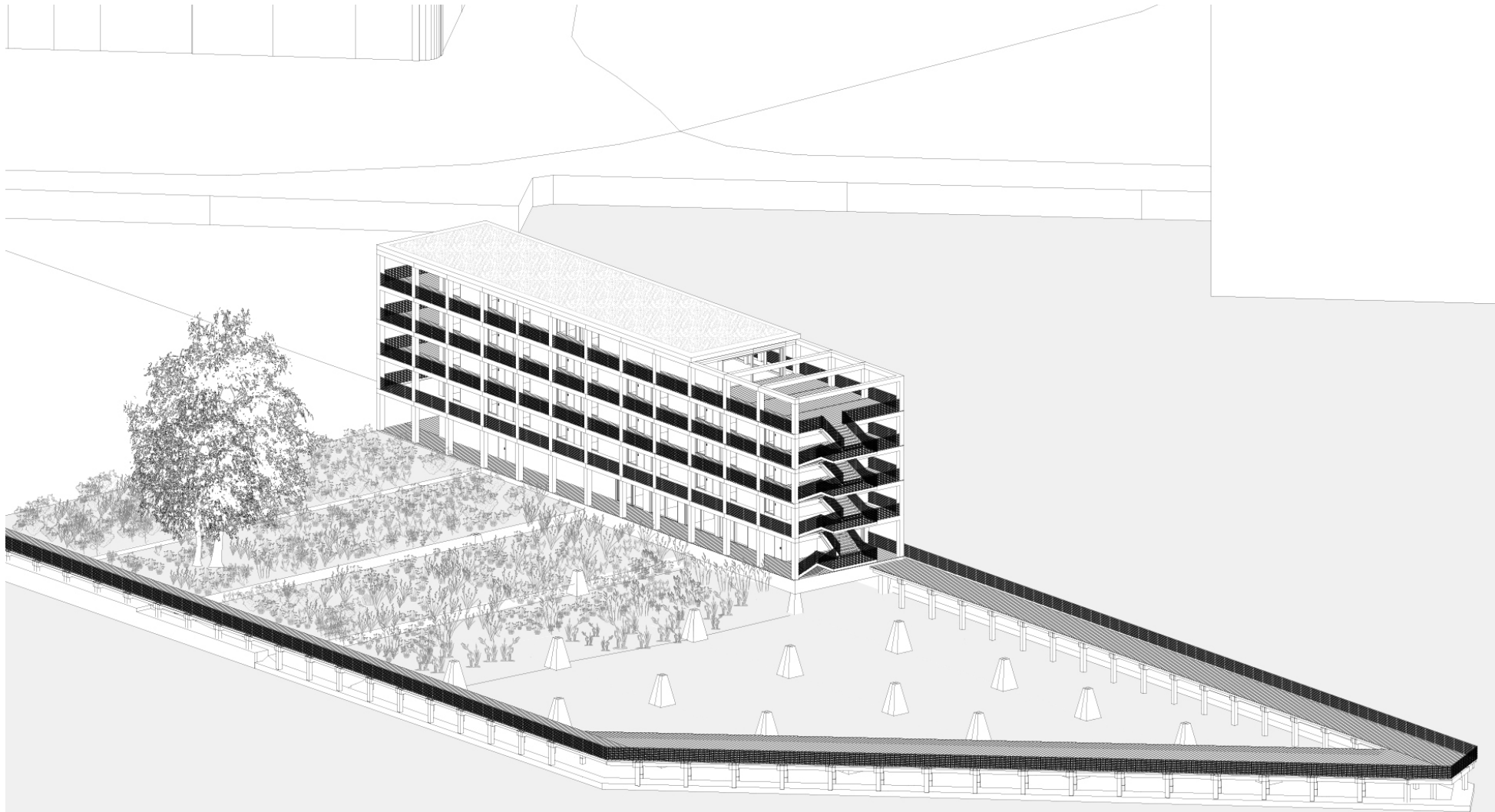

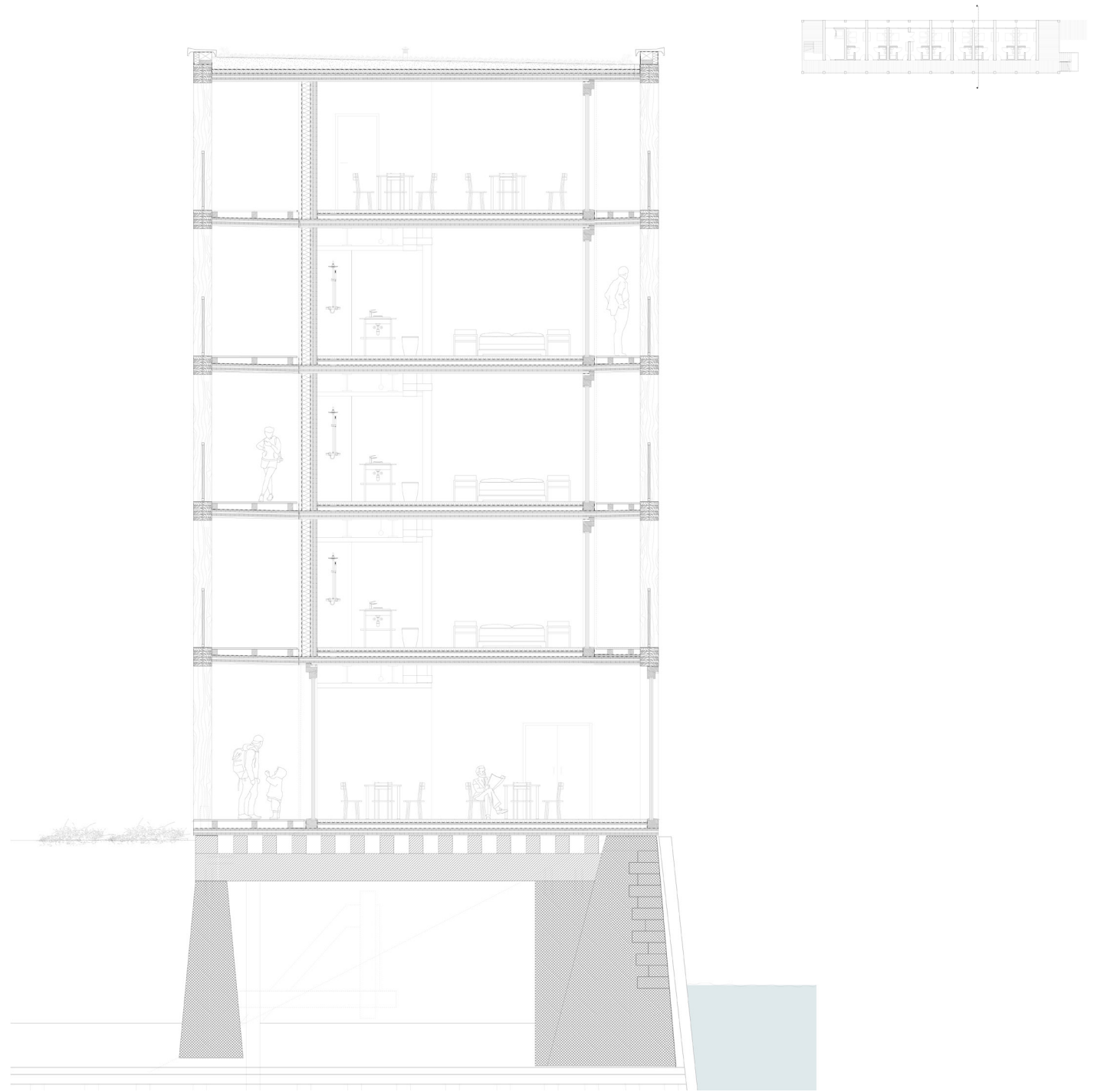

section det ail

0 1 5

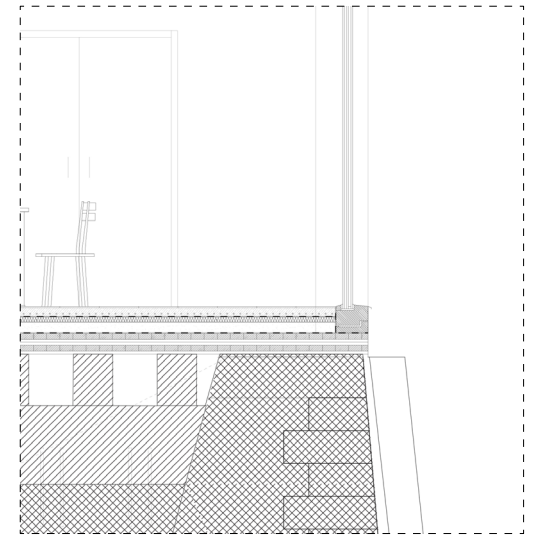
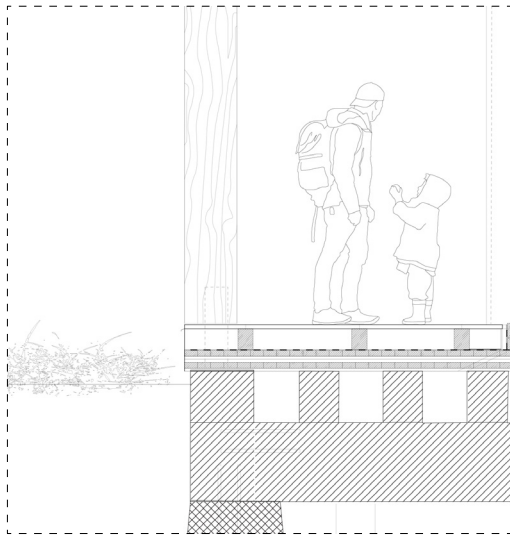
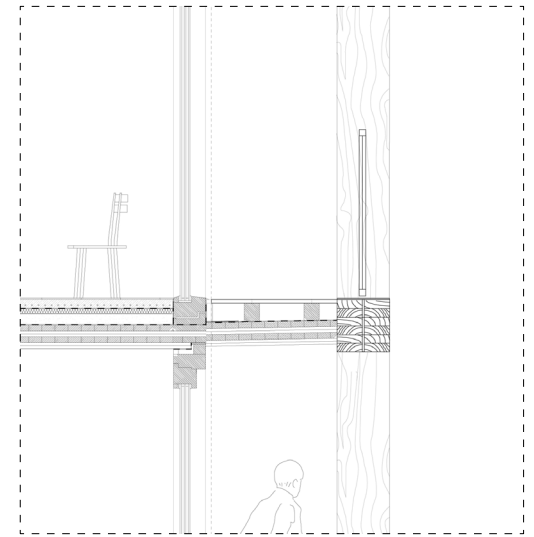
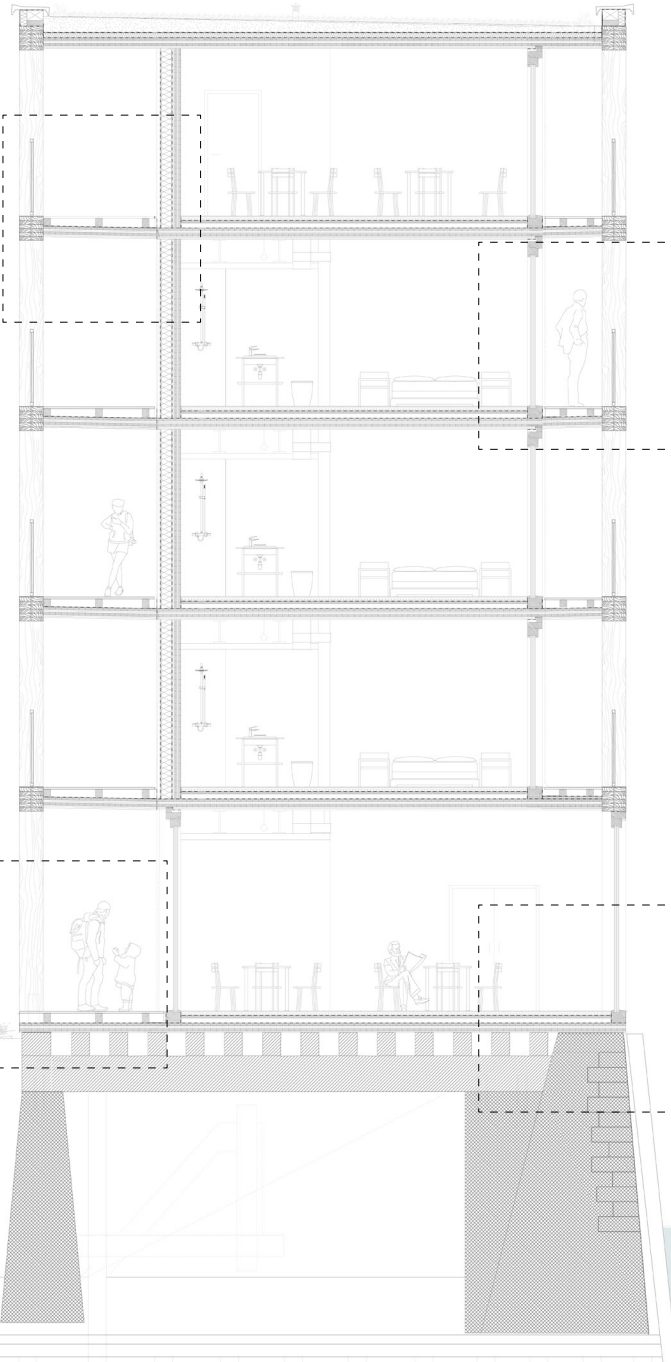
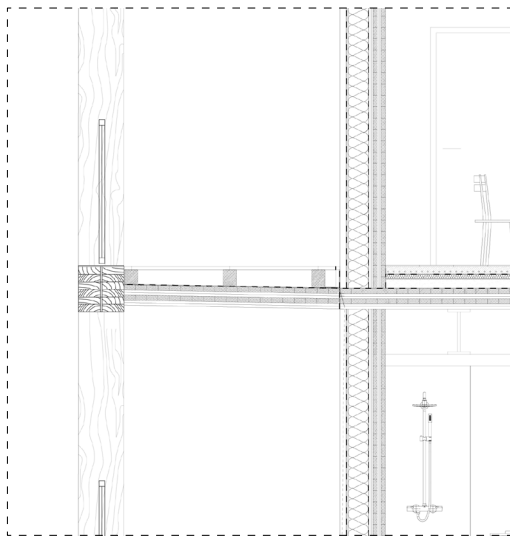

section detail

0 1 5

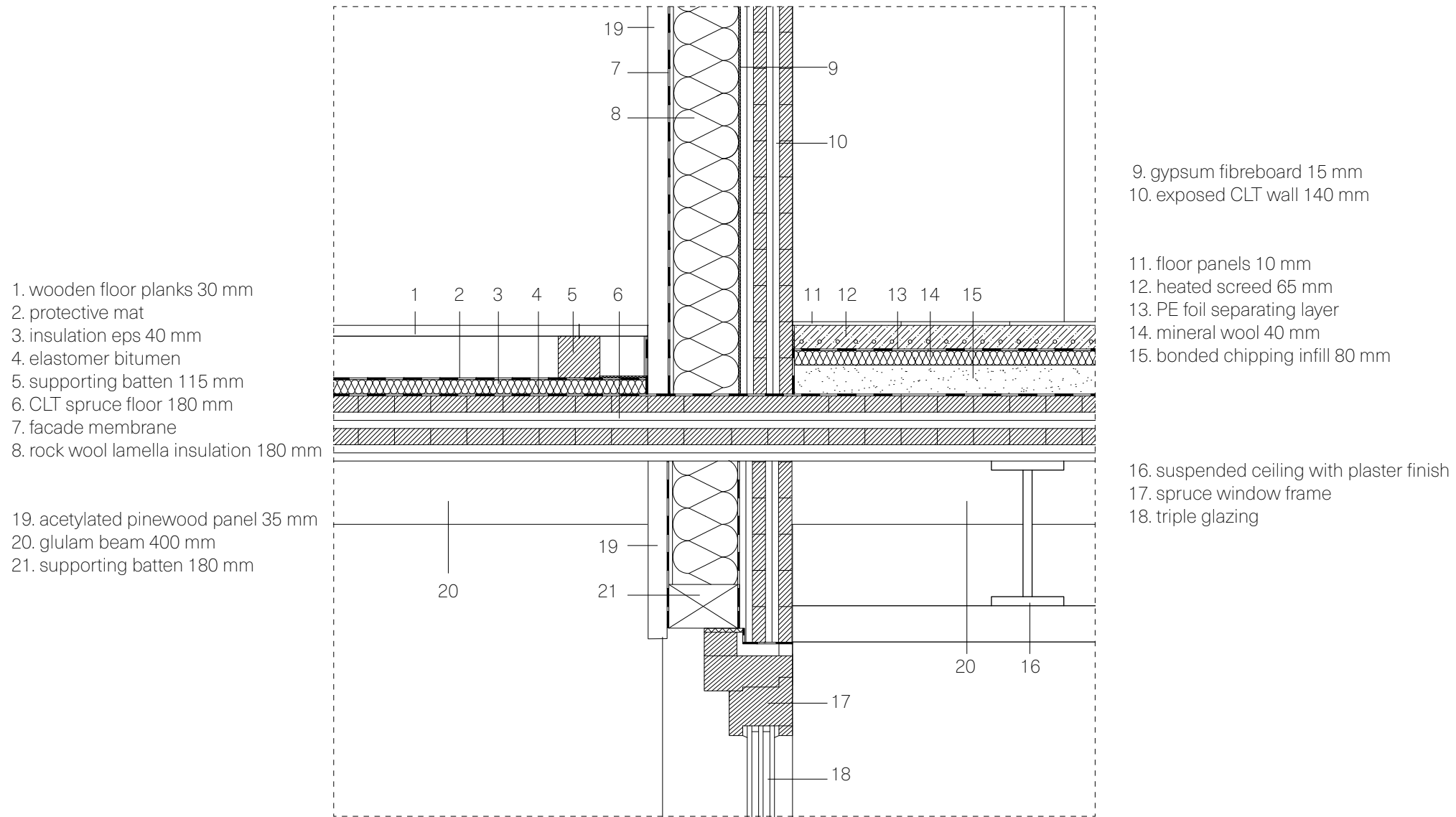

section detail wall - floor connection

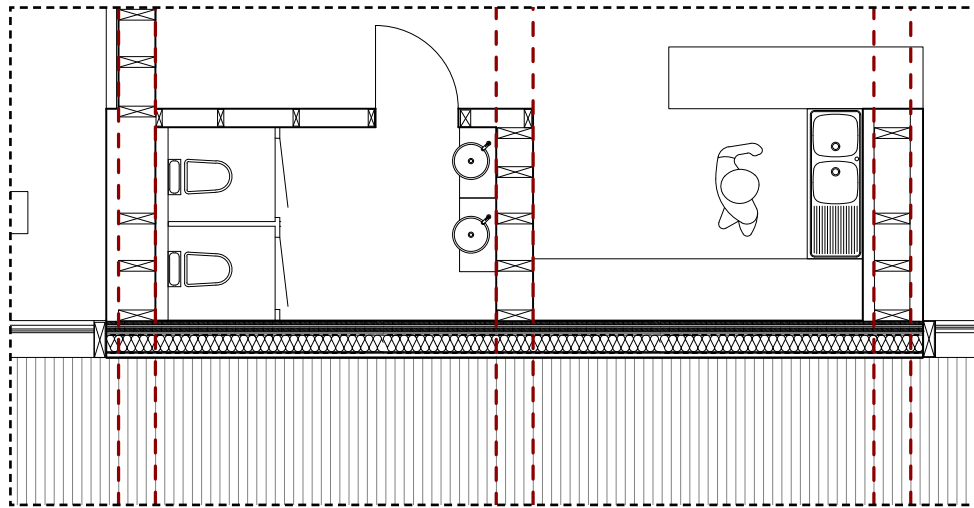
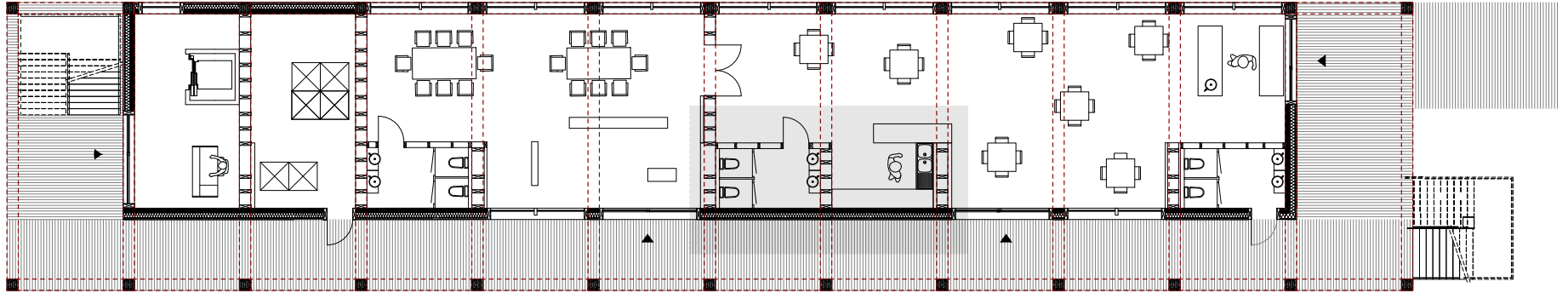

structure ground floor

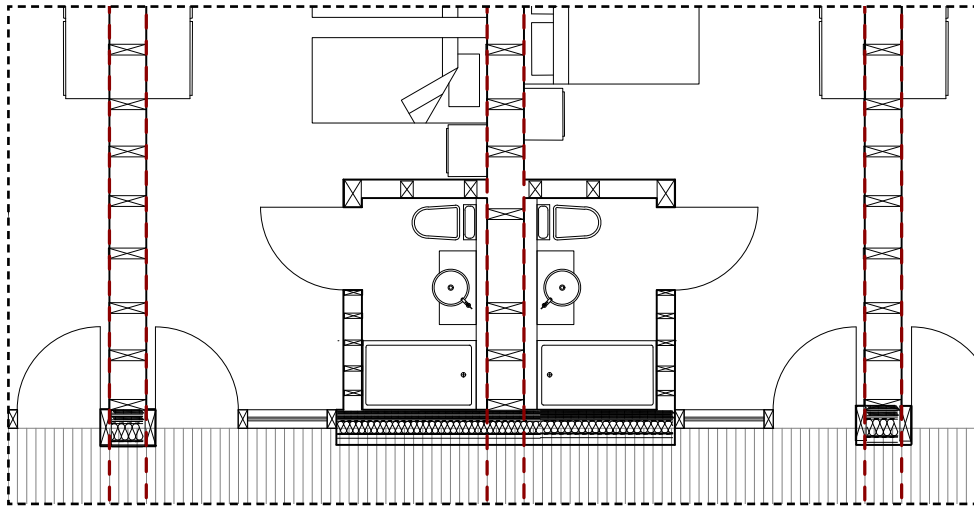
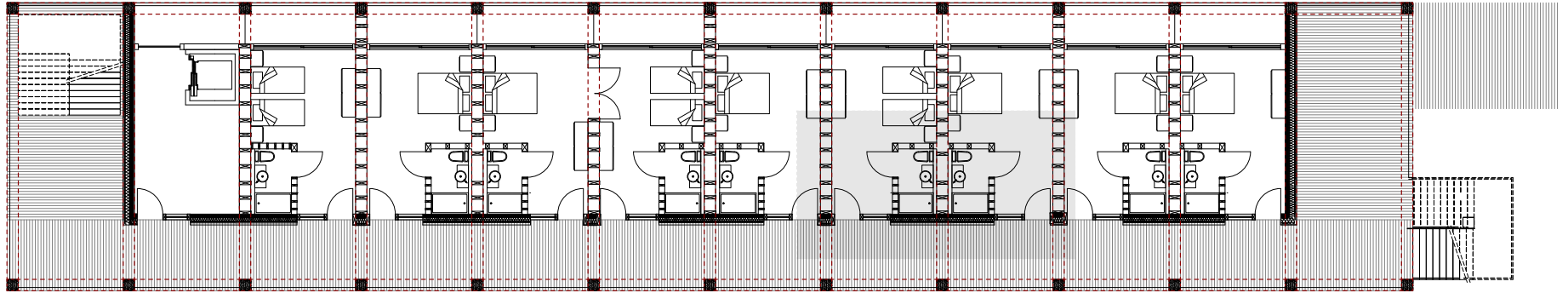

structure 1-4

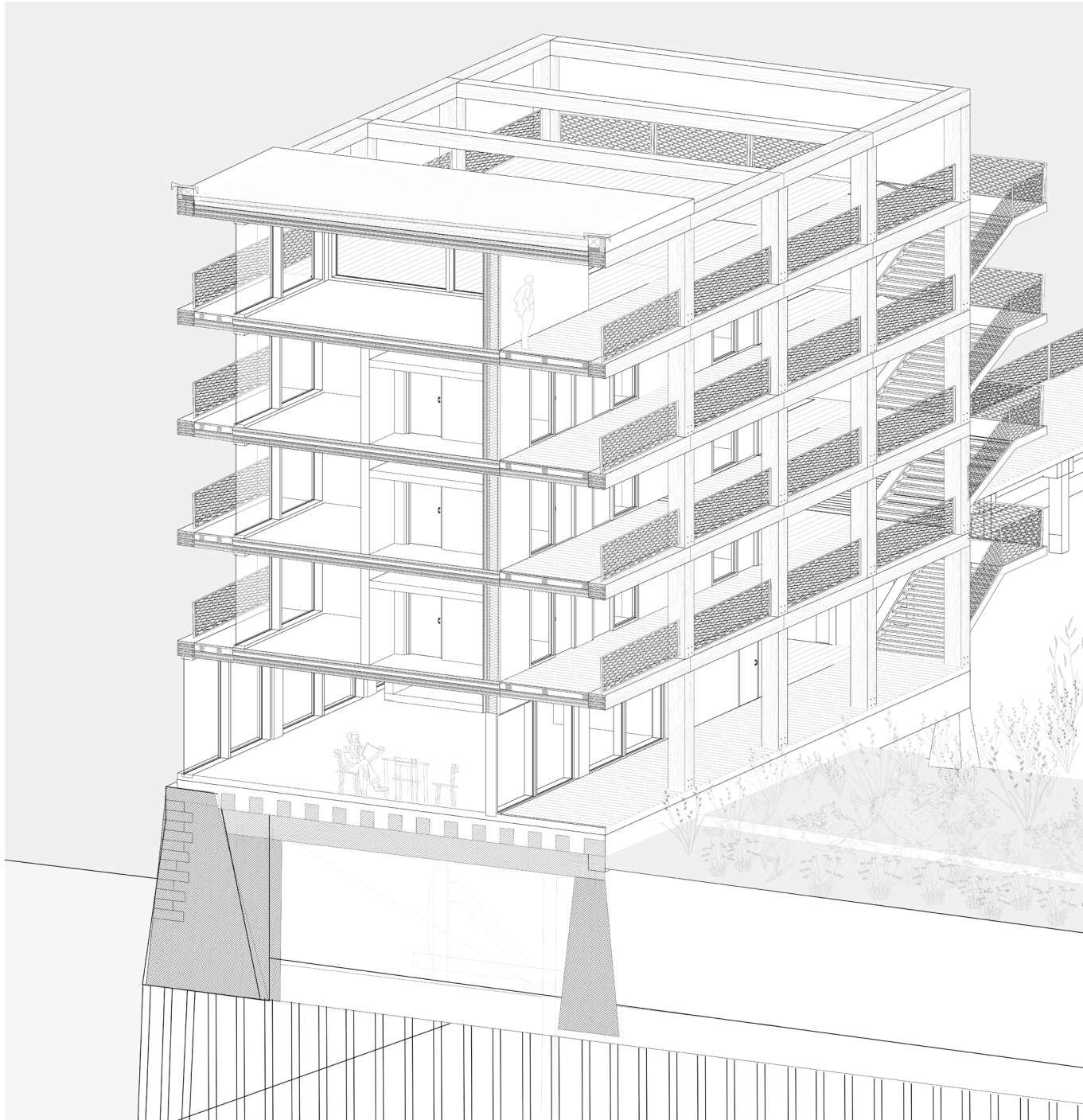

wetland section detailed

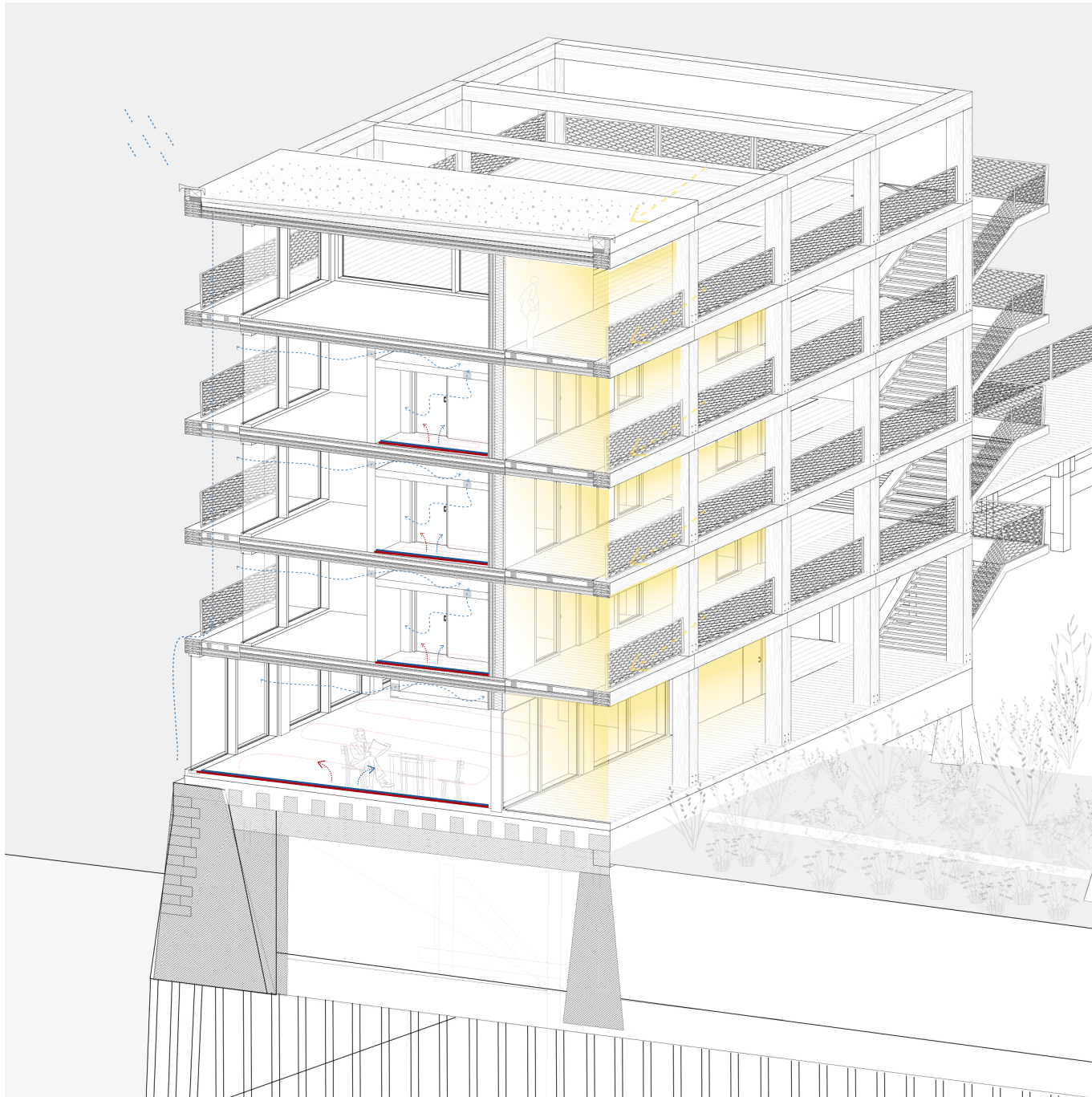

wetland section climate





climate - ventilation

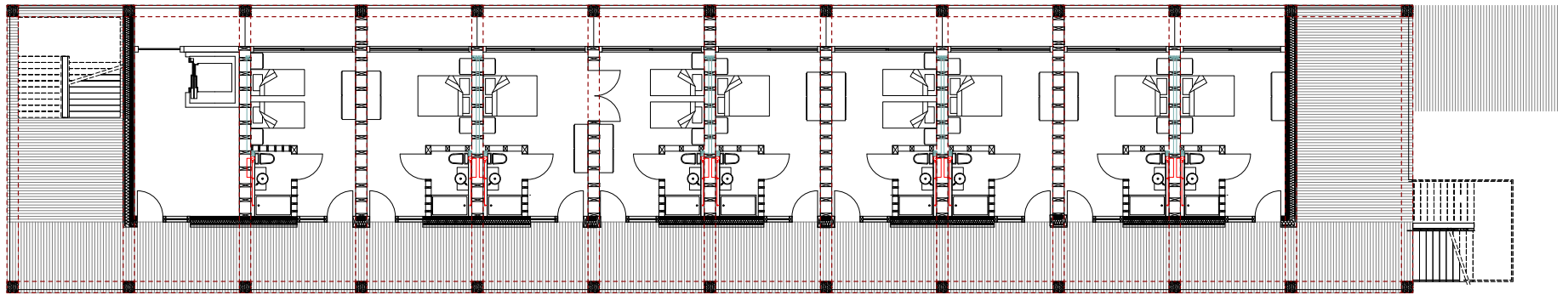
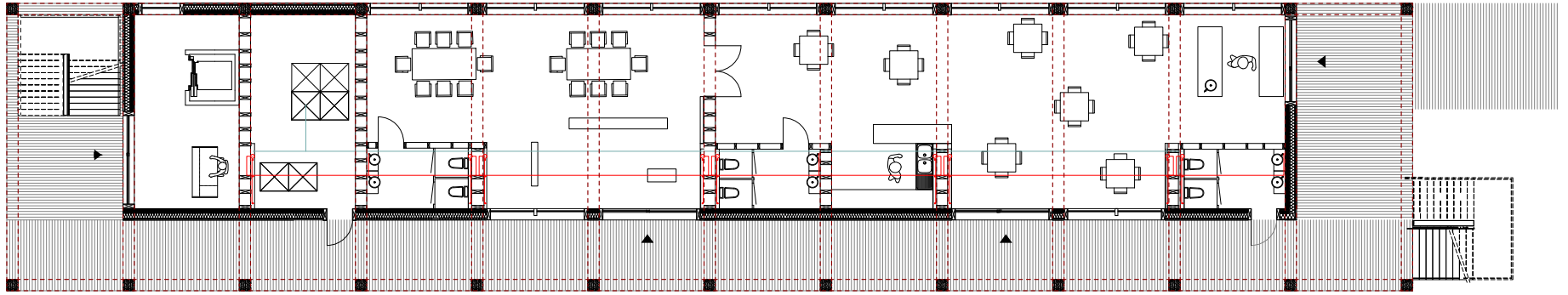

floor plan installations









