



HAVANA STUDIO - ALAMAR

CHI ZHANG - 4474617

○.....INTRODUCTION.....●

○.....THESIS TOPIC.....●

□.....RESEARCH QUESTION.....●

○.....PROBLEM STATEMENT.....●

□.....THEME STUDY.....●

○.....TYPOLOGY STUDY.....●

□.....STRATEGY.....●

INTRODUCTION

Population aging of the world

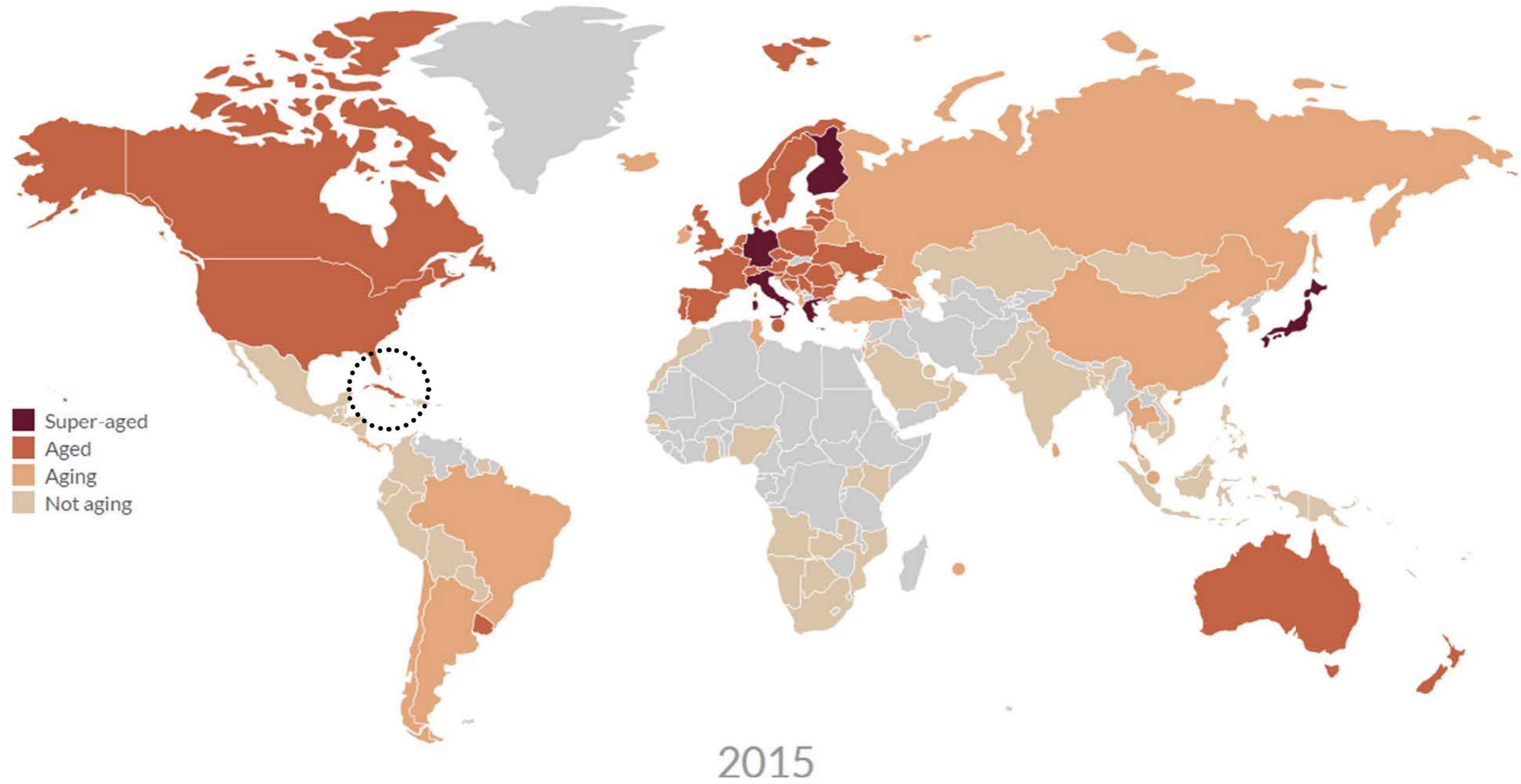

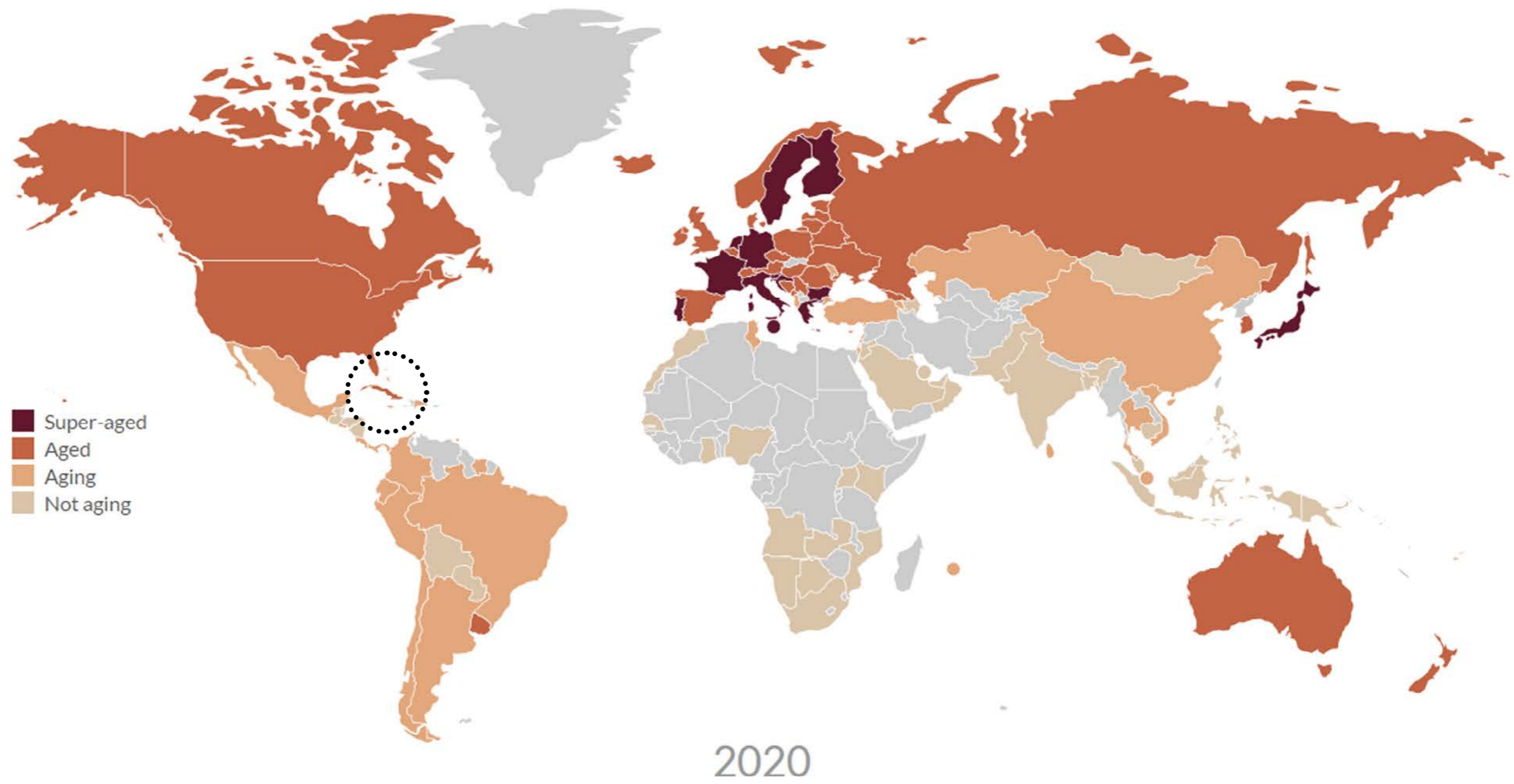

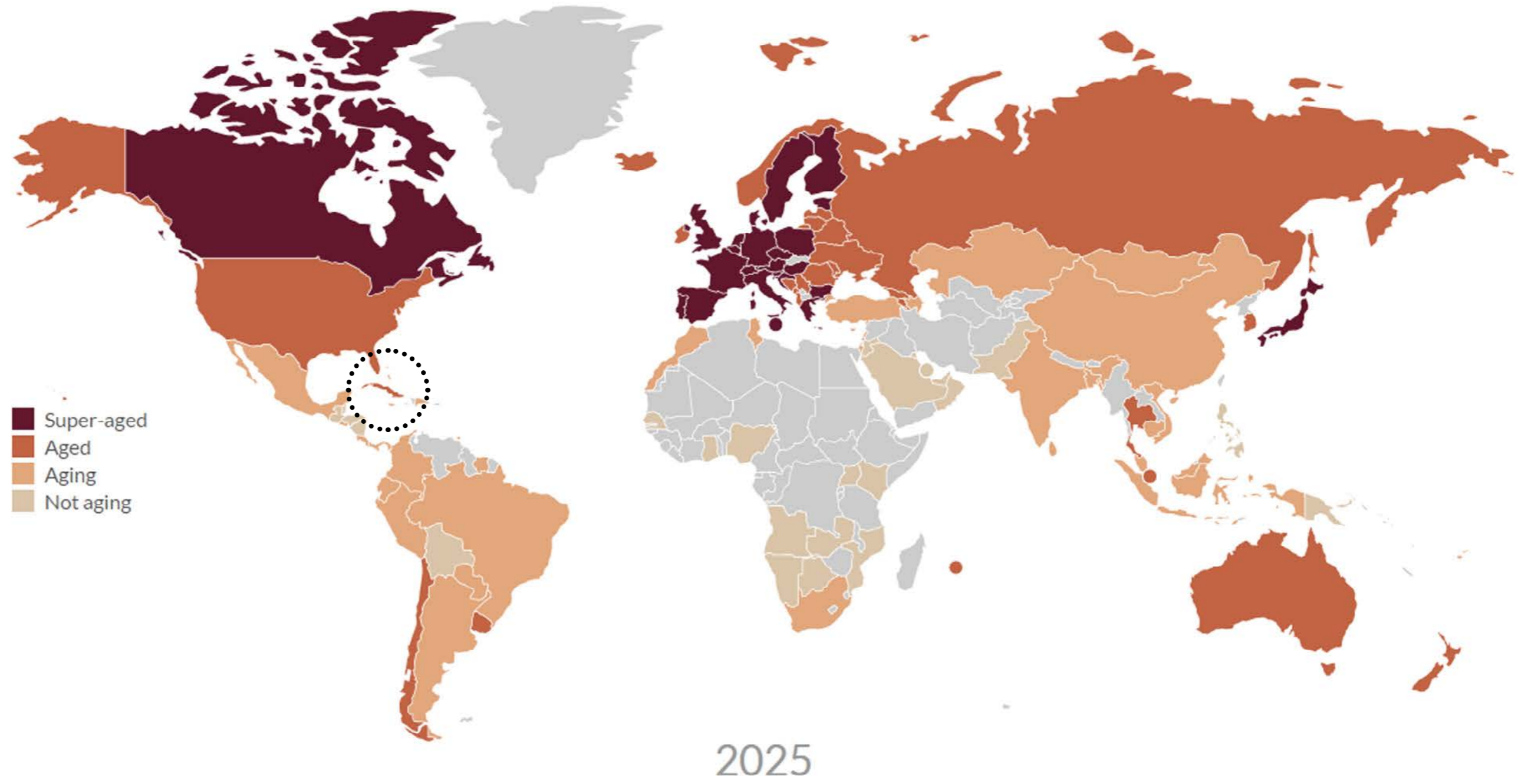

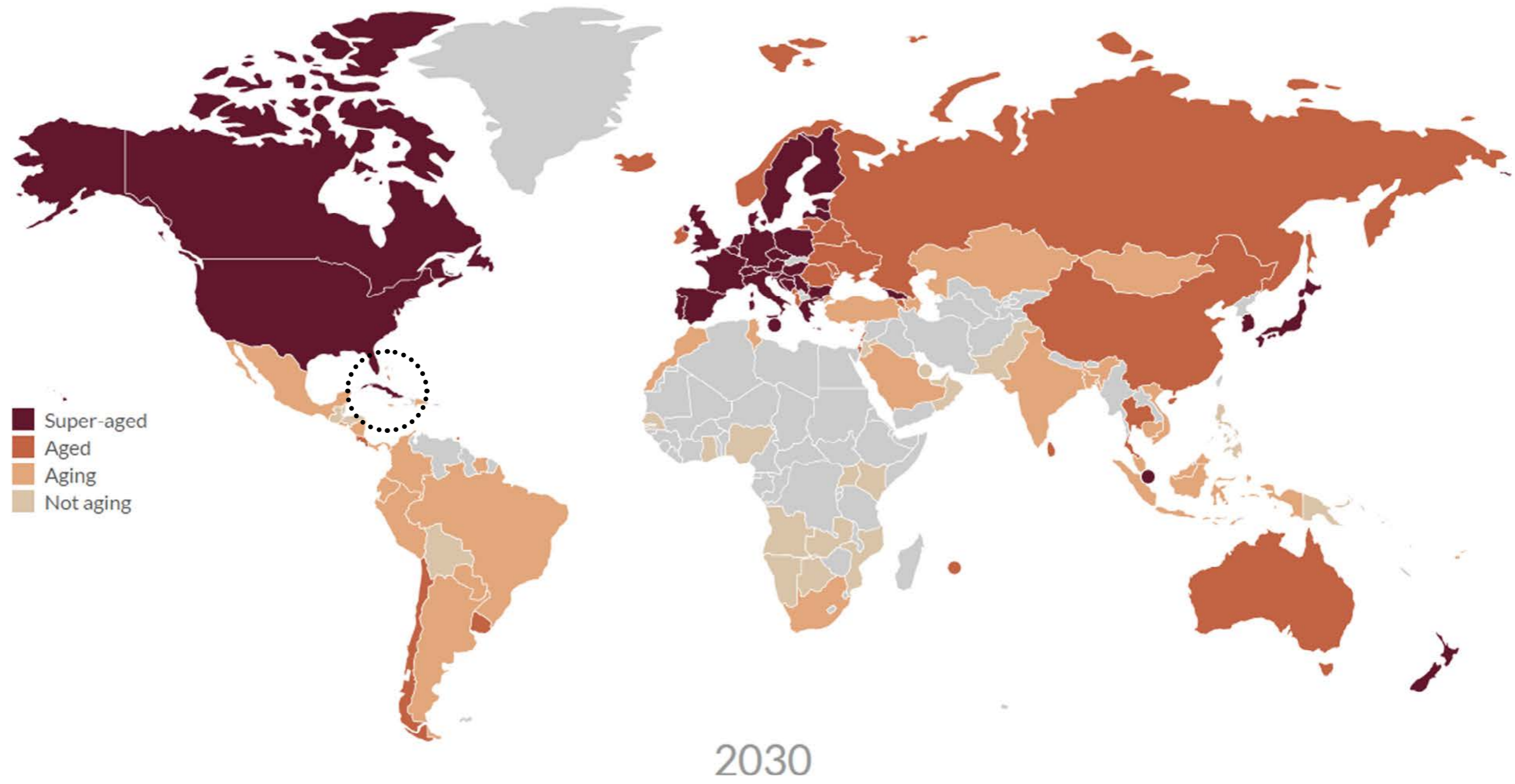

Technological delveopment



Quality of life



Migratory pattern



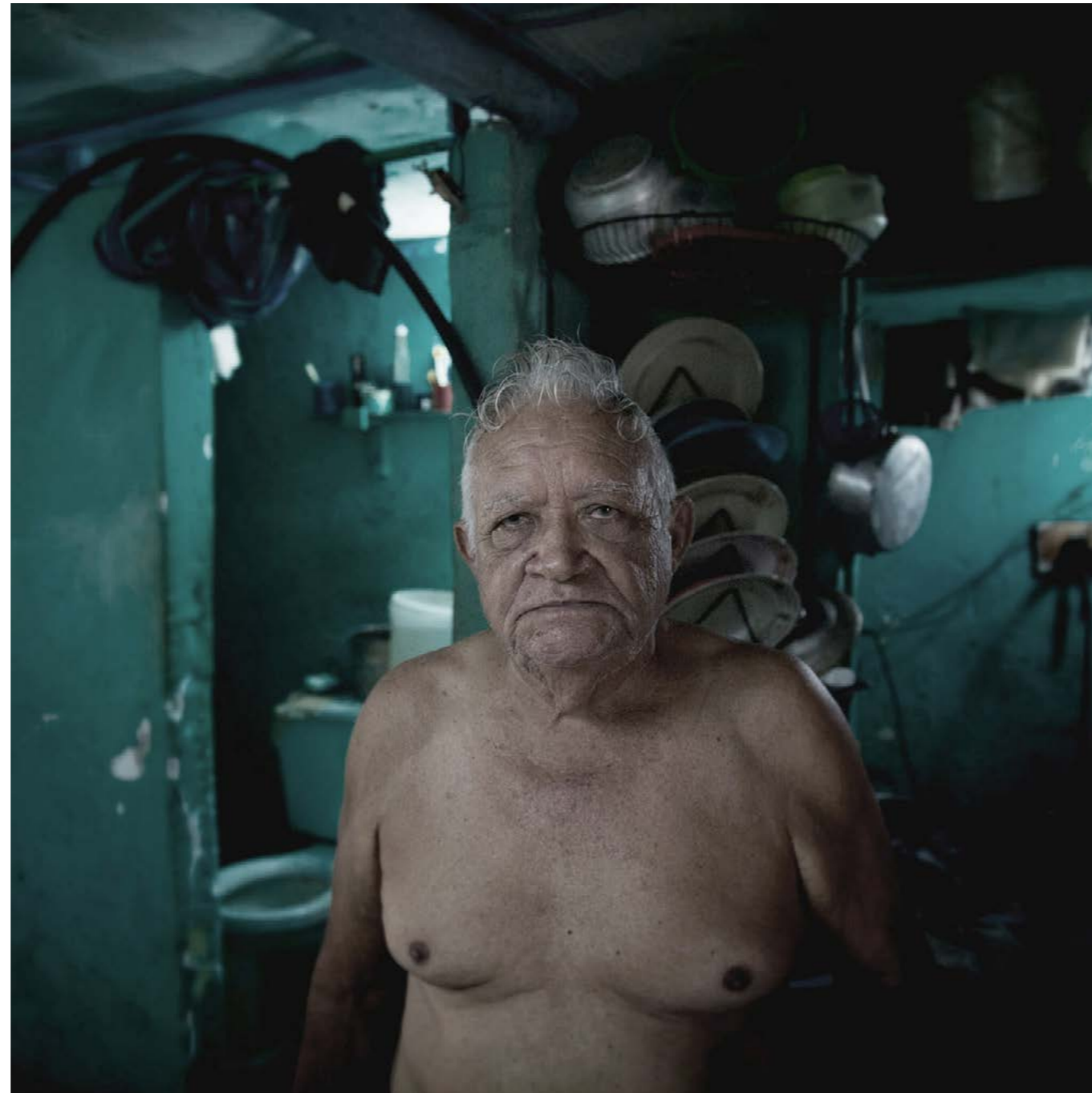



THESIS TOPIC

Tackle the issue of frail elderly in Cuba within the social, cultural and economical background of Cuba

Isolated by The Society



Elderly Sell Stuff for Living



Low State Salary of Elderly

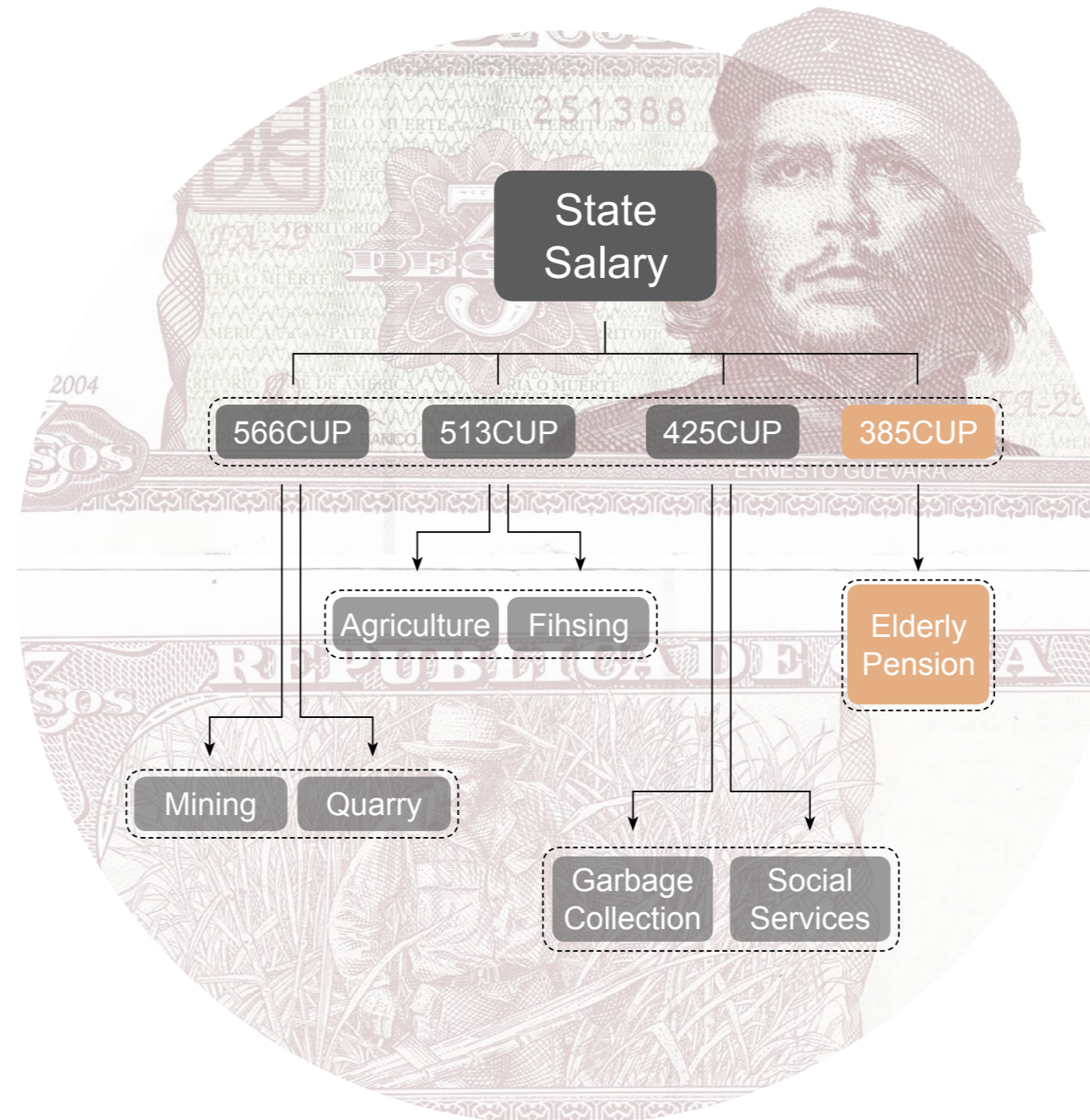

Increasingly Growth of Aged Population

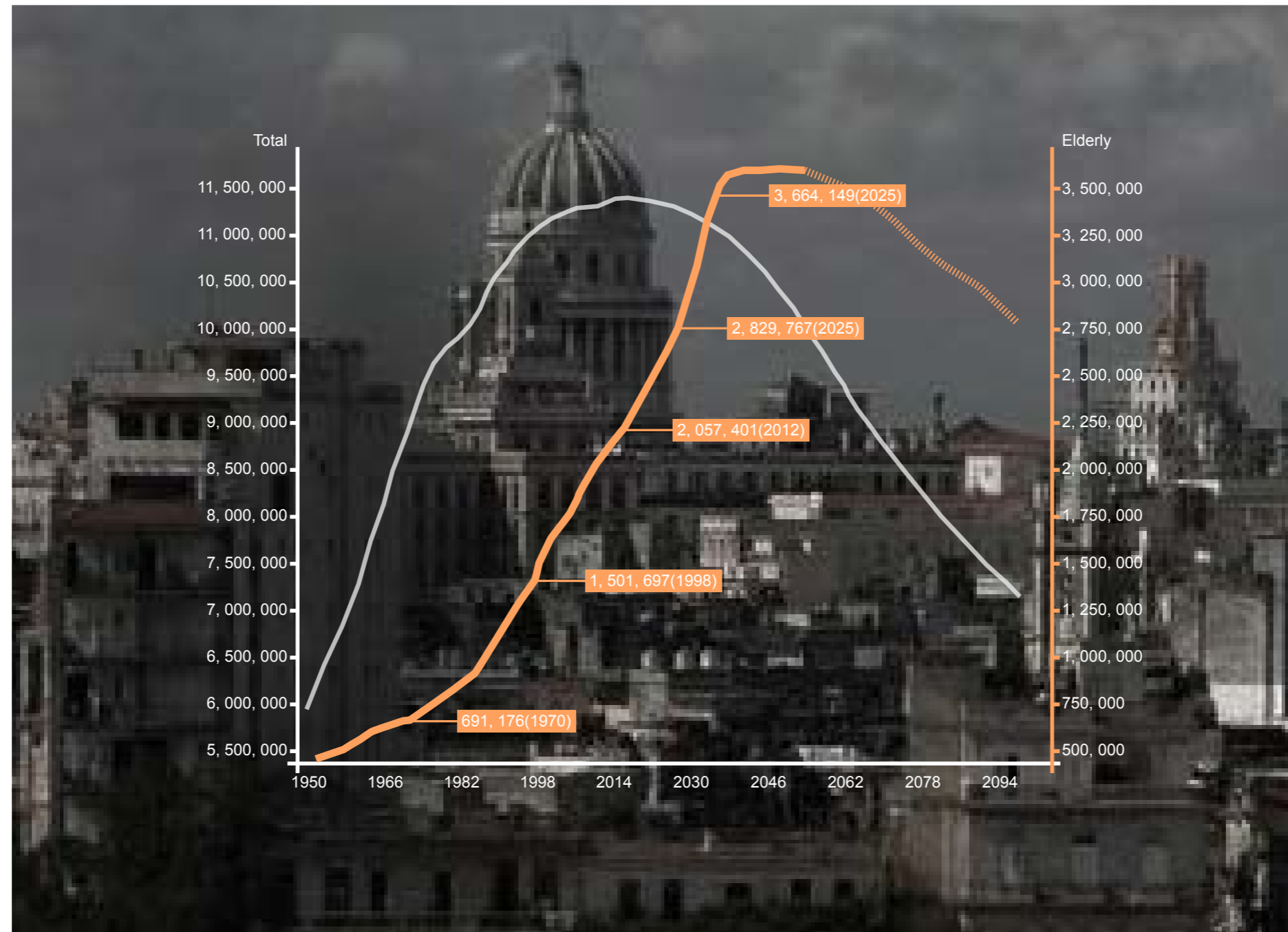

High Percentage of Elderly

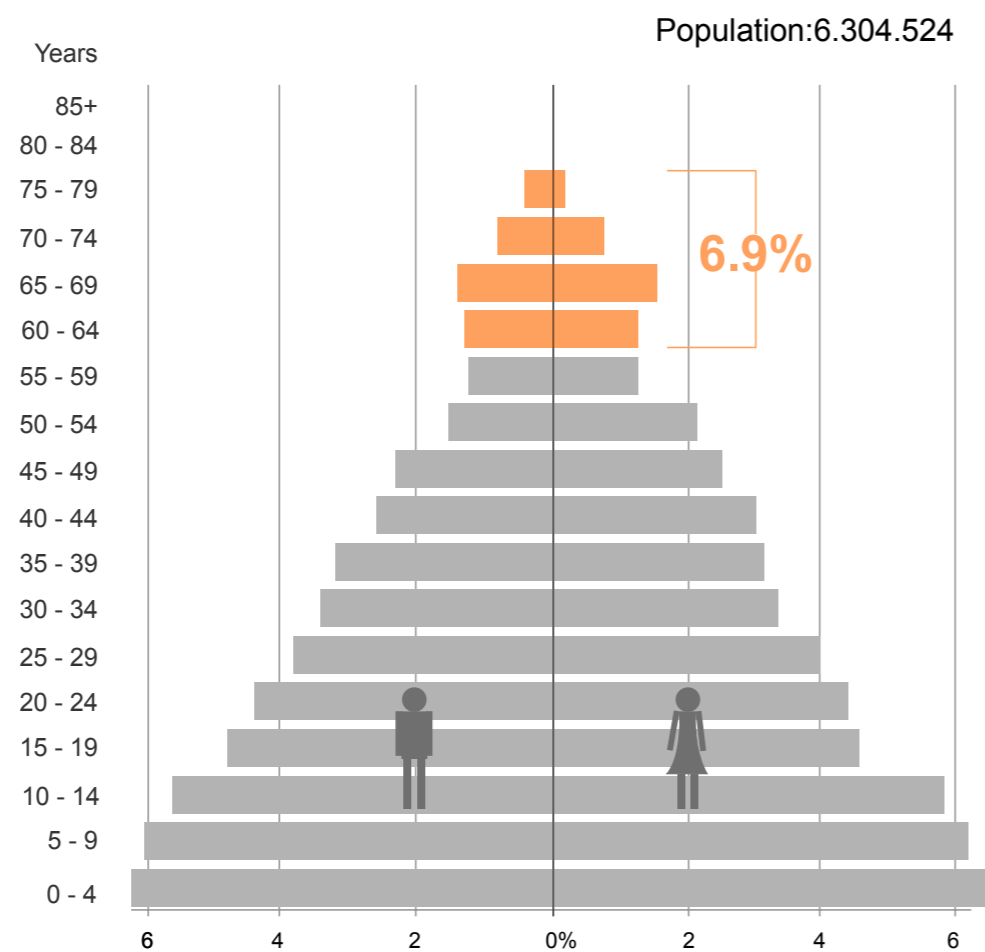

Population pyramid of cuba 1953

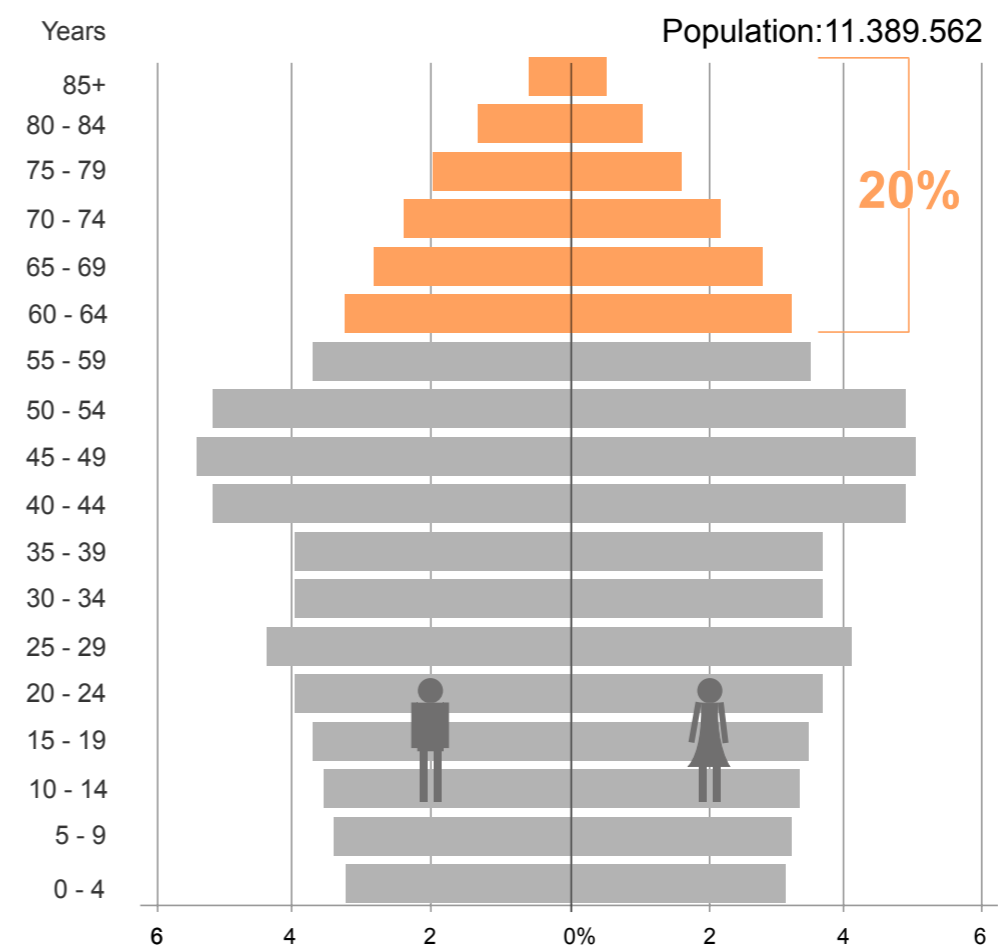

Population pyramid of cuba 2015

Insufficient Number of Nursing Home



Calculation of Needed Nursing Home



Inequality of The Society - Tourism Oriented



Inequality of The Society - Poverty



Dilemma Between The Policy and Reality



PROBLEM STATEMENT

The contradiction between the lack of attention from the society and the need for dealing with increasingly growing number of frail elderly

RESEARCH QUESTION

How to improve the living condition of the elderly with less allocation by government, less investment from private sector and lack of attention from family members

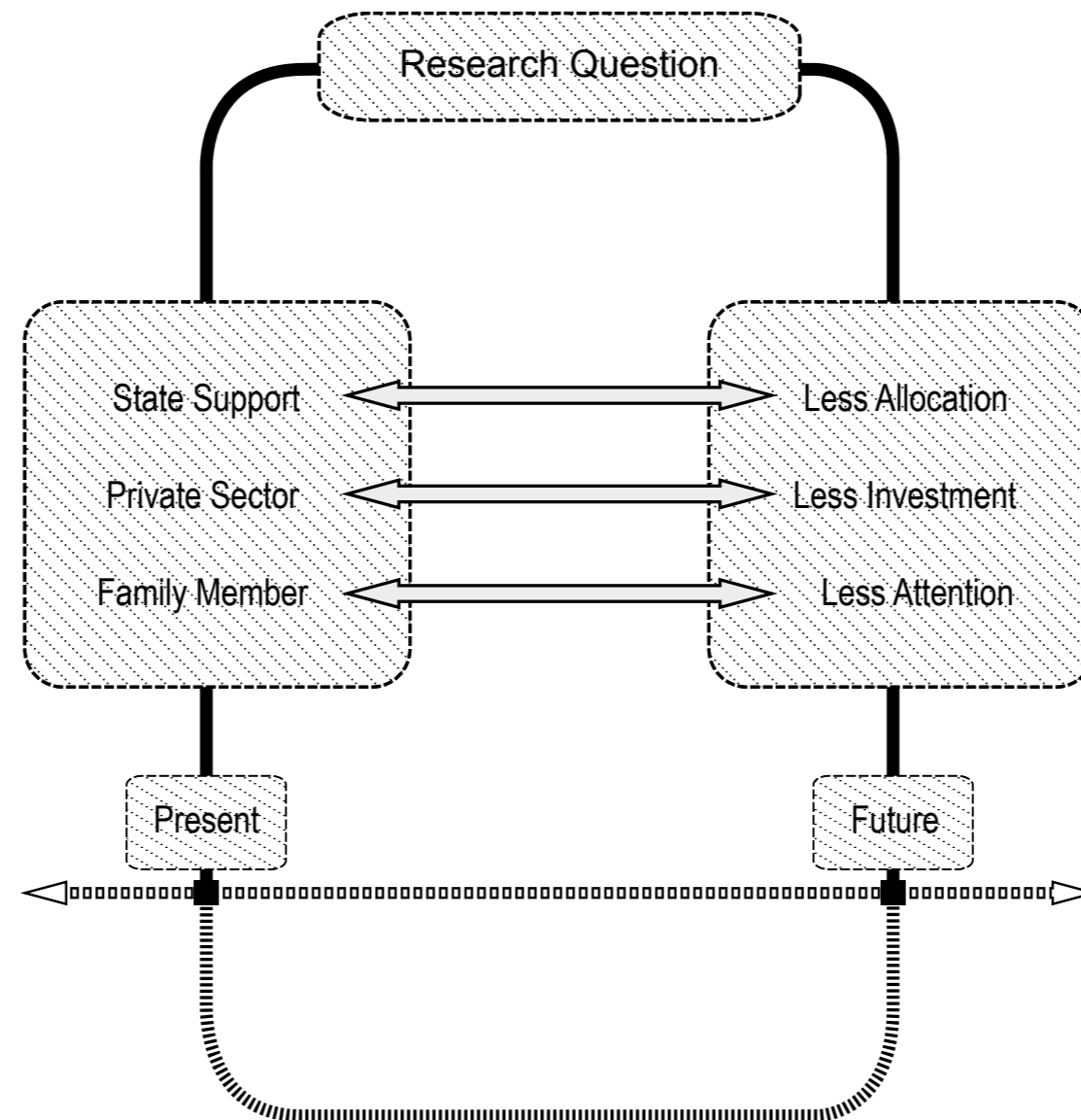

THEME RESEARCH

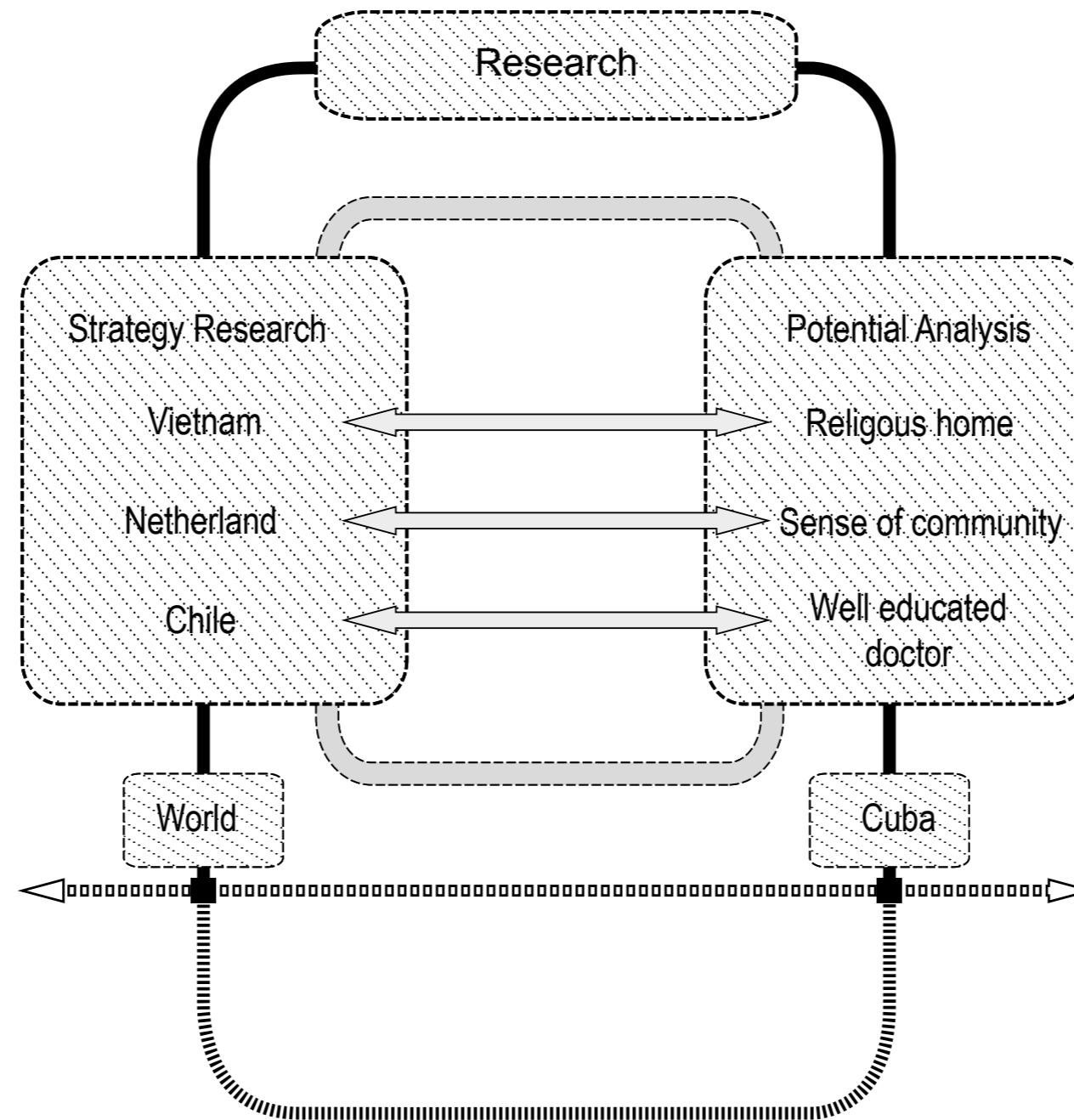

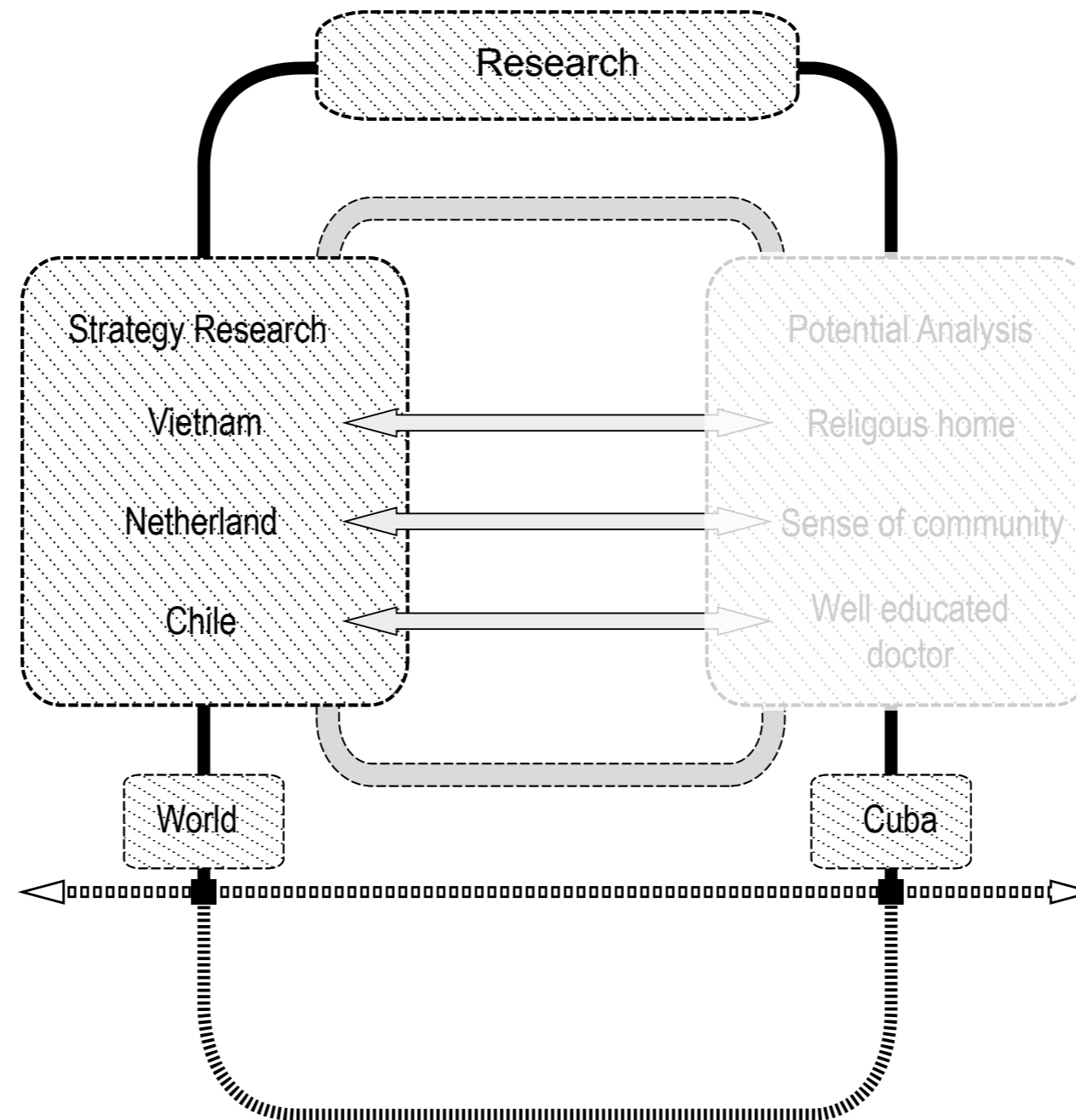

Elderly Care in Chile(South-America)



Elderly Care in Chile(South-America)

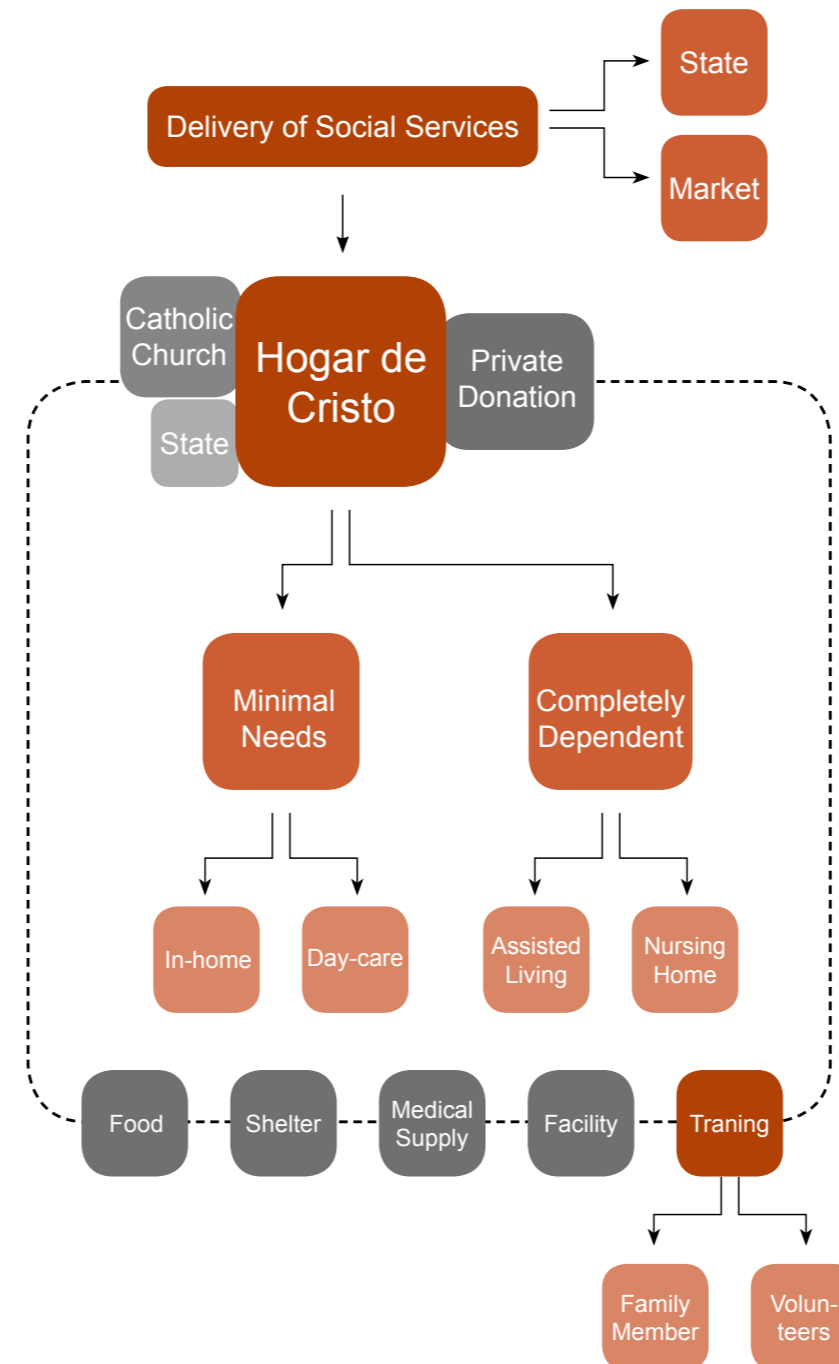

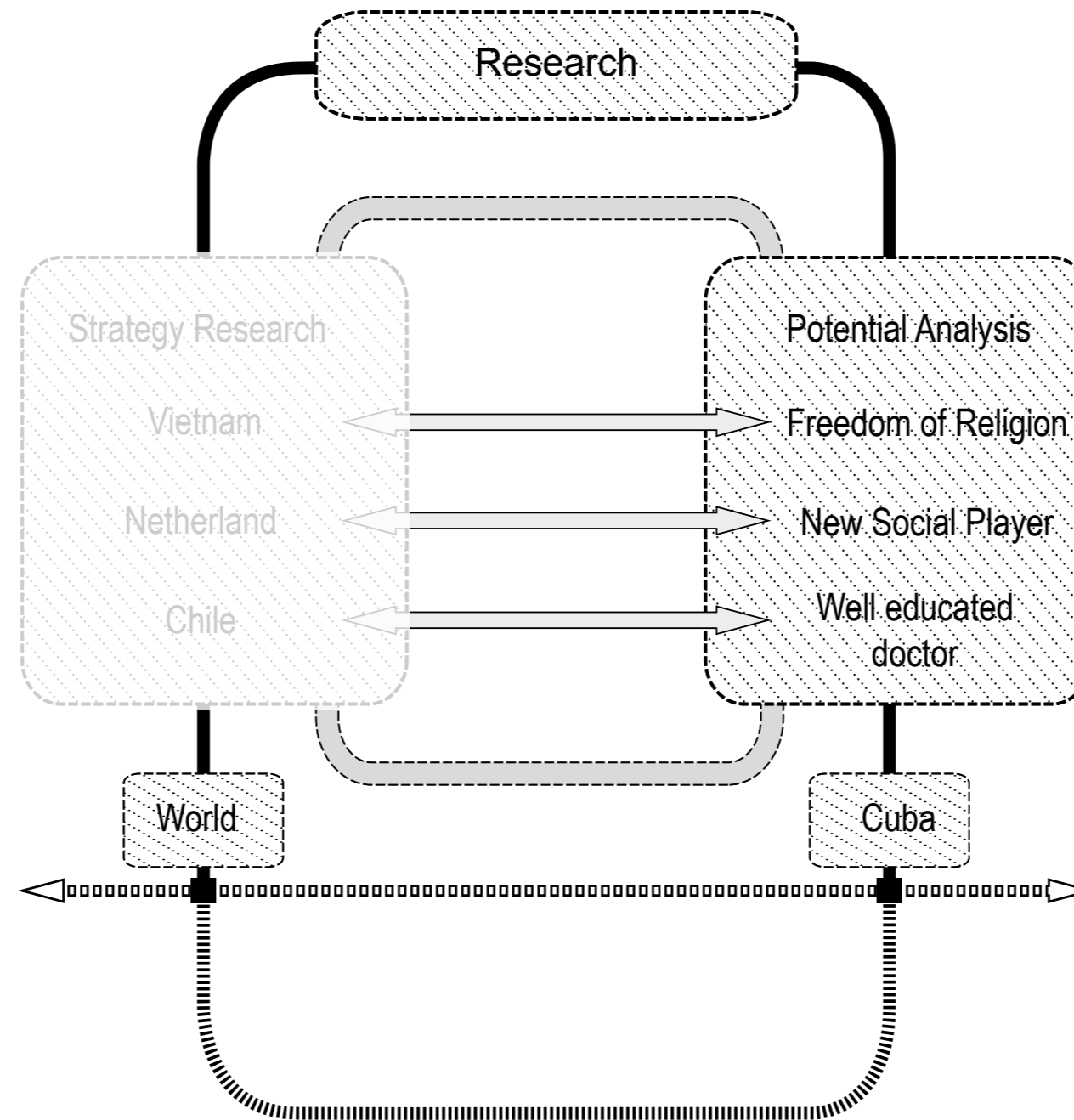

Religious Background of Cuba

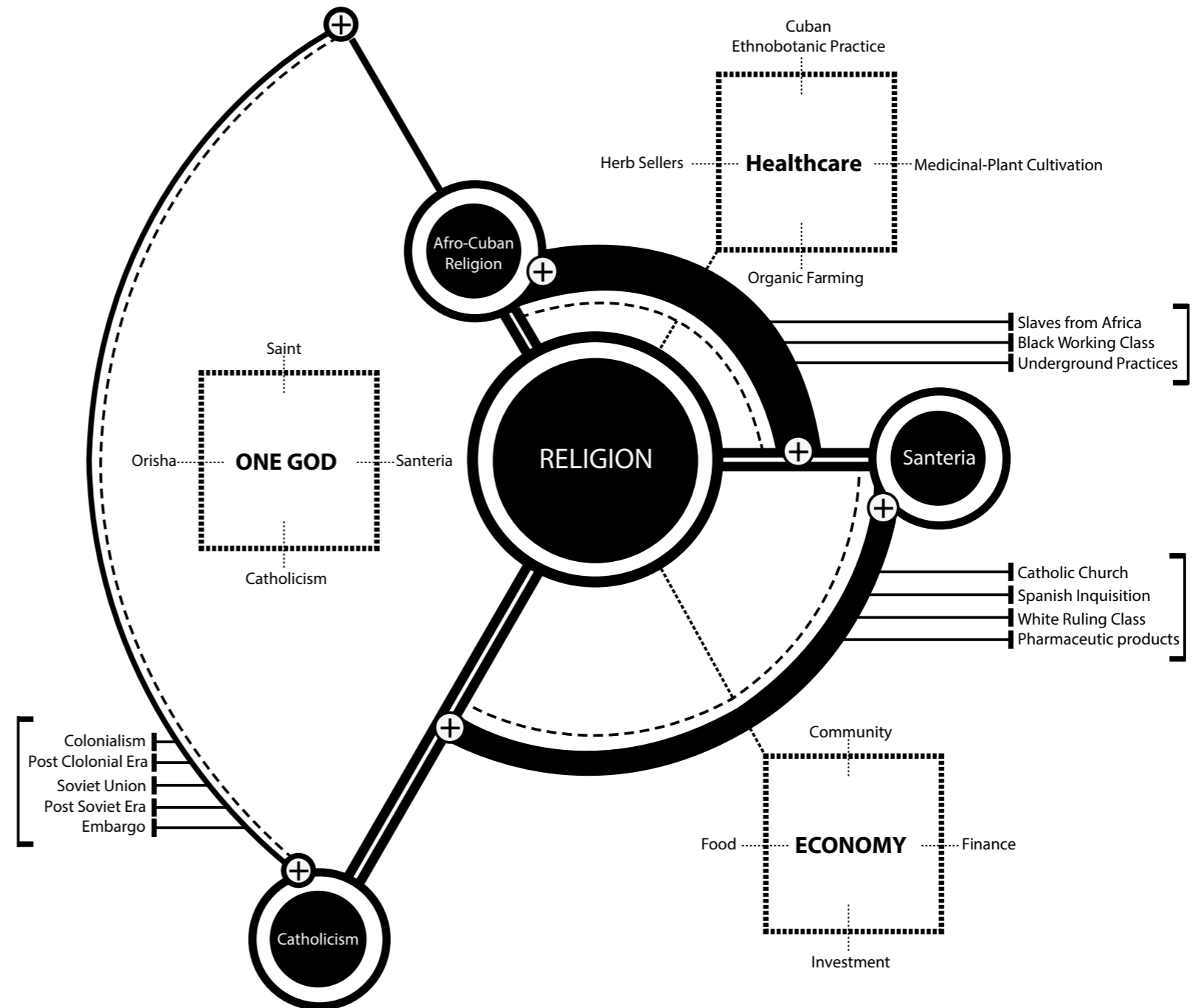

Local NGO in Cuba

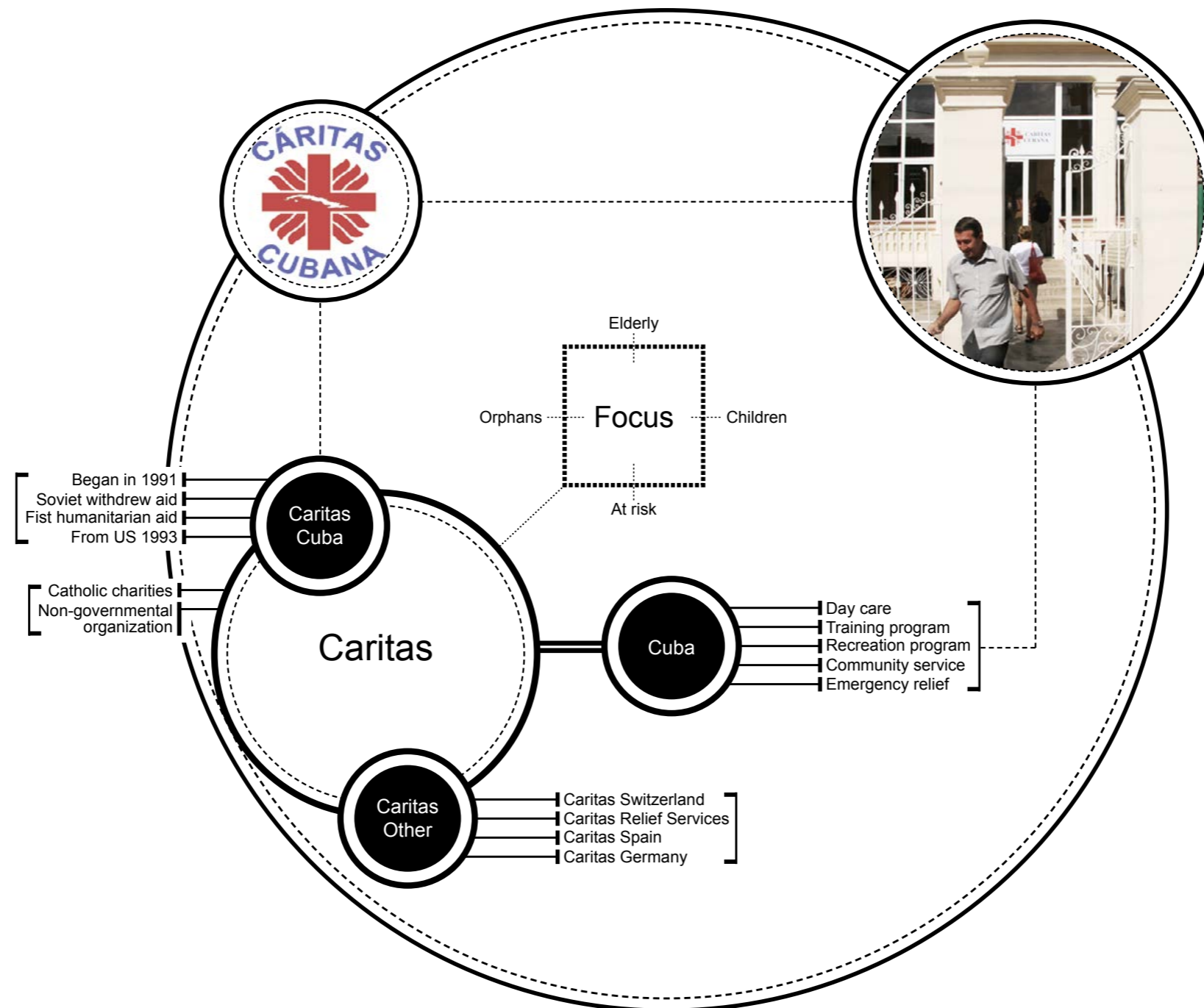

Current Religious Nursing Home

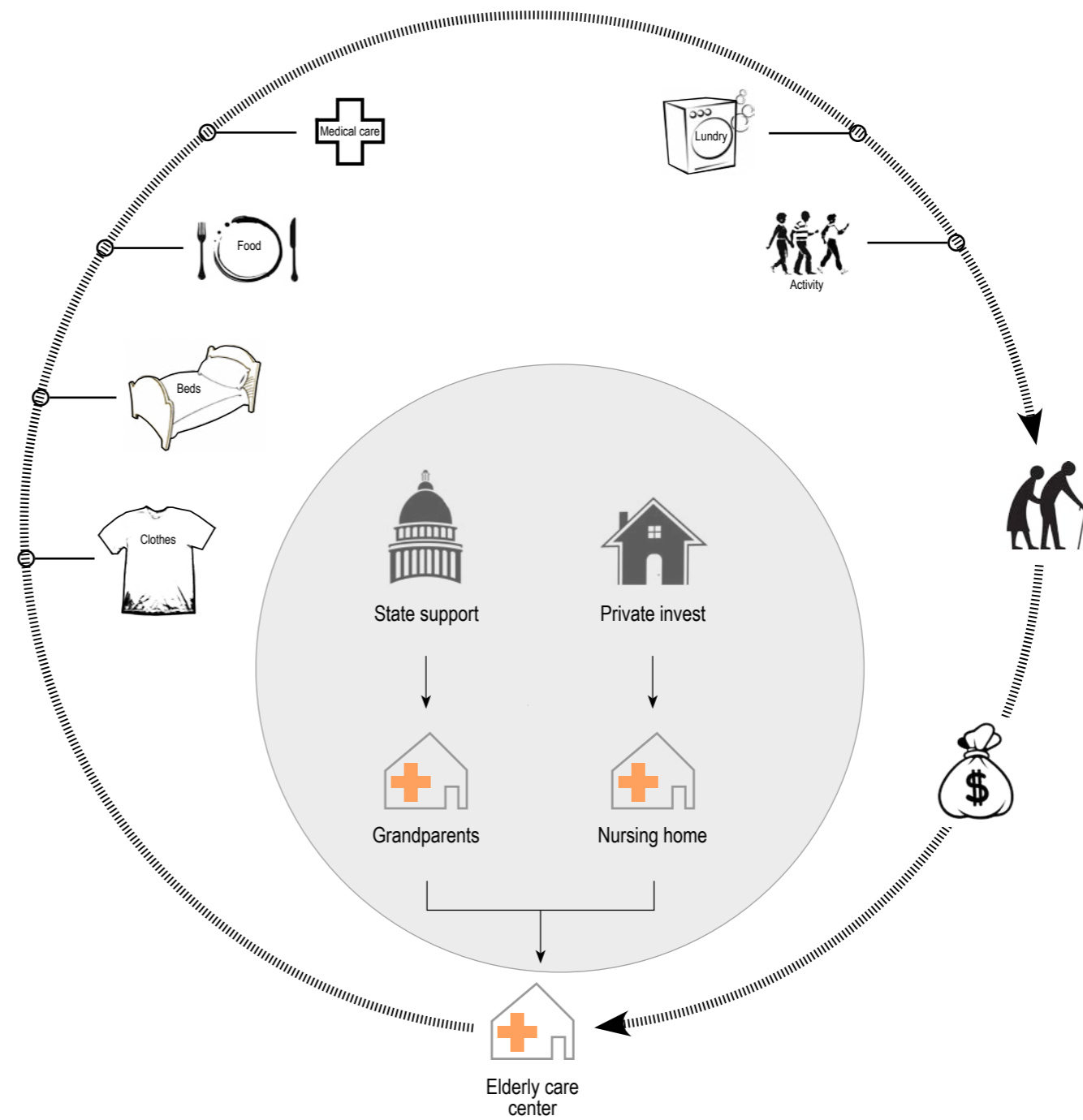

Well Educated Doctors and Nurses



AMBITION

New bridge between elderly and the community which links them together both physically and mentally. At the same time redefining the centrality within the neighborhood by creating hierarchy.

SITE RESEARCH

Why alamar

Choice of location

Site photos

SITE RESEARCH

Why alamar

Choice of location

Site photos

Isolation Makes it an “Untouched” Green Land

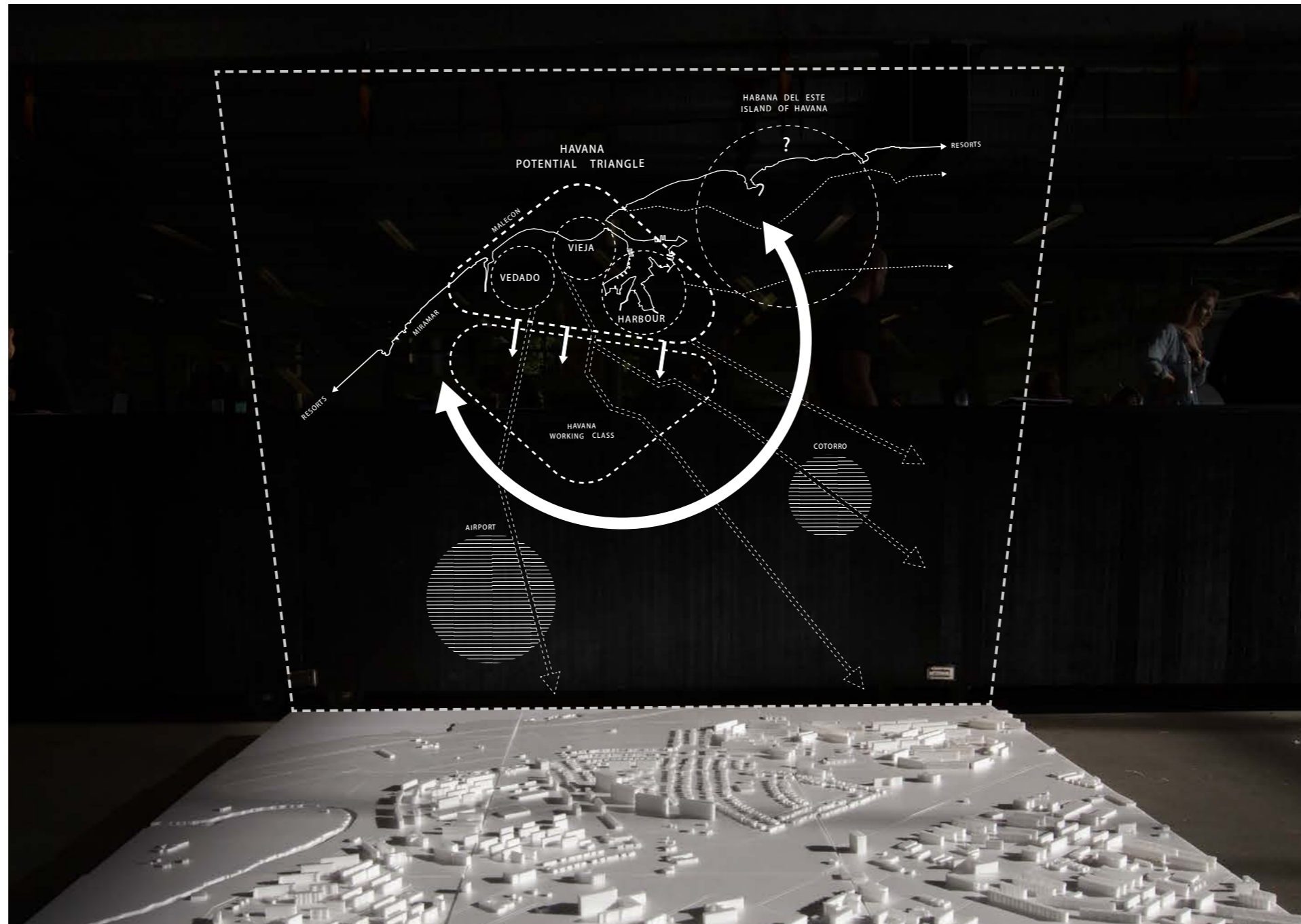



Havana



Alamar

Vision of Alamar

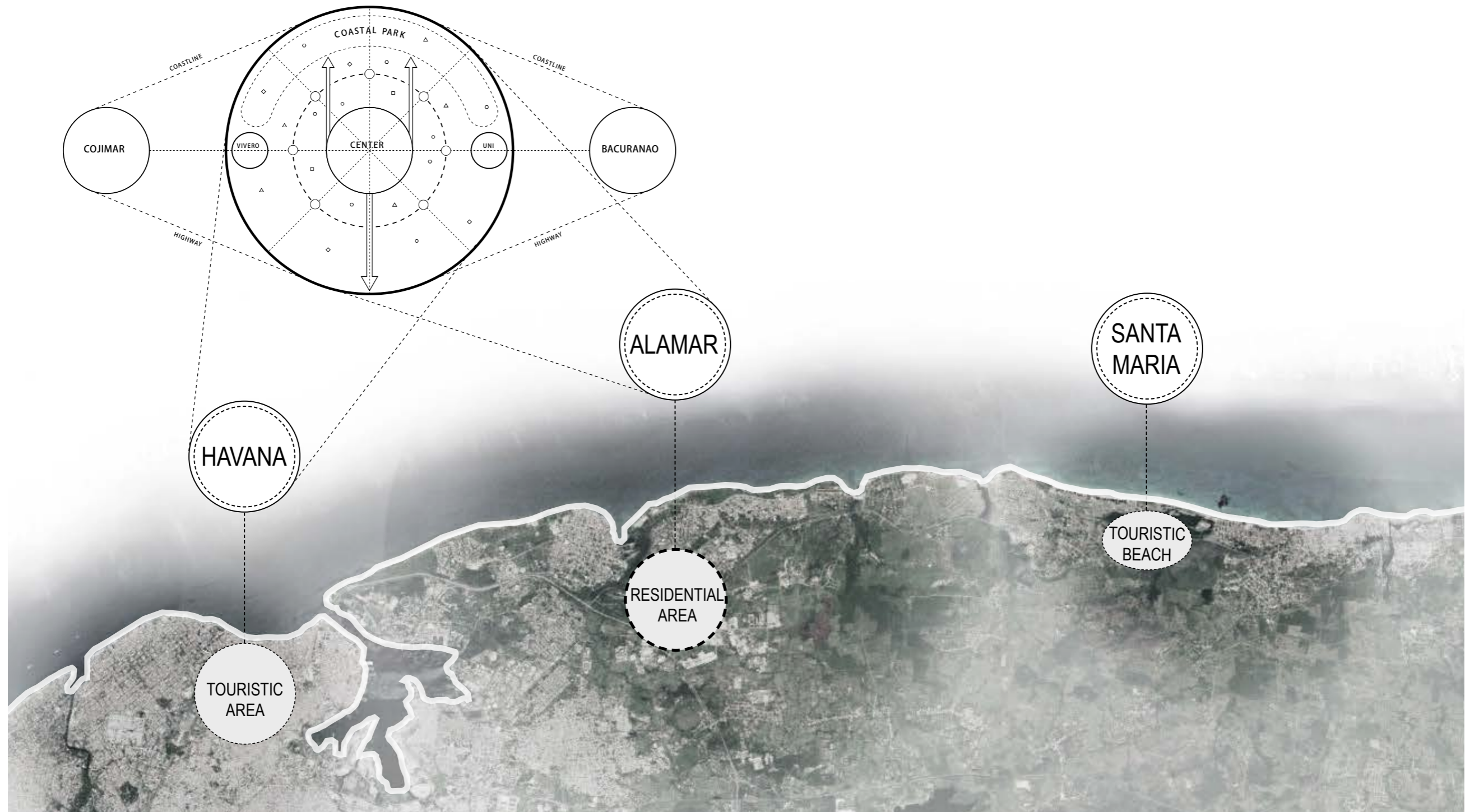

Ideal Residential Area - Short Traffic Time

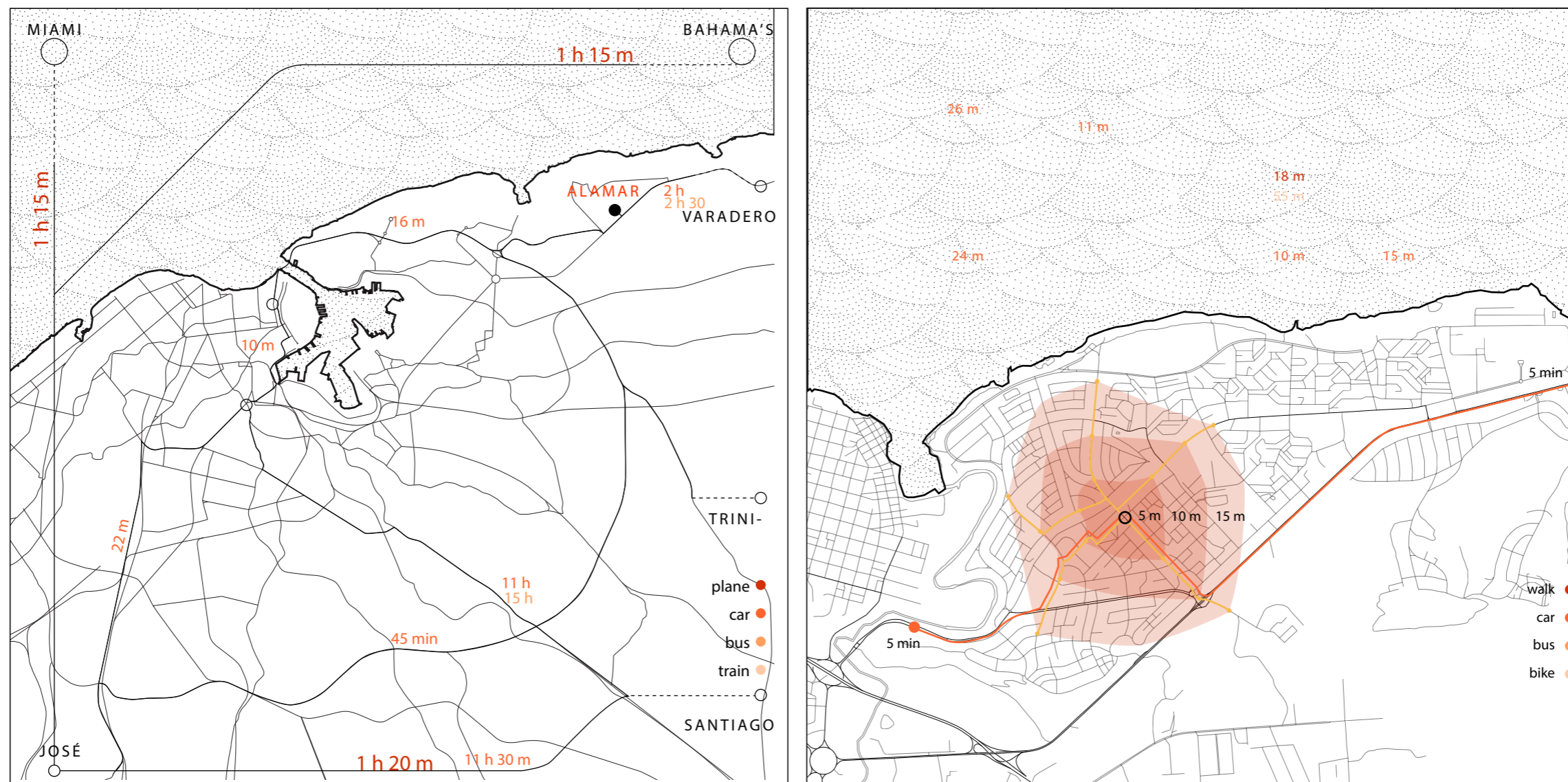

Alamar Potential - Microbrigades



Working System of Microbrigades

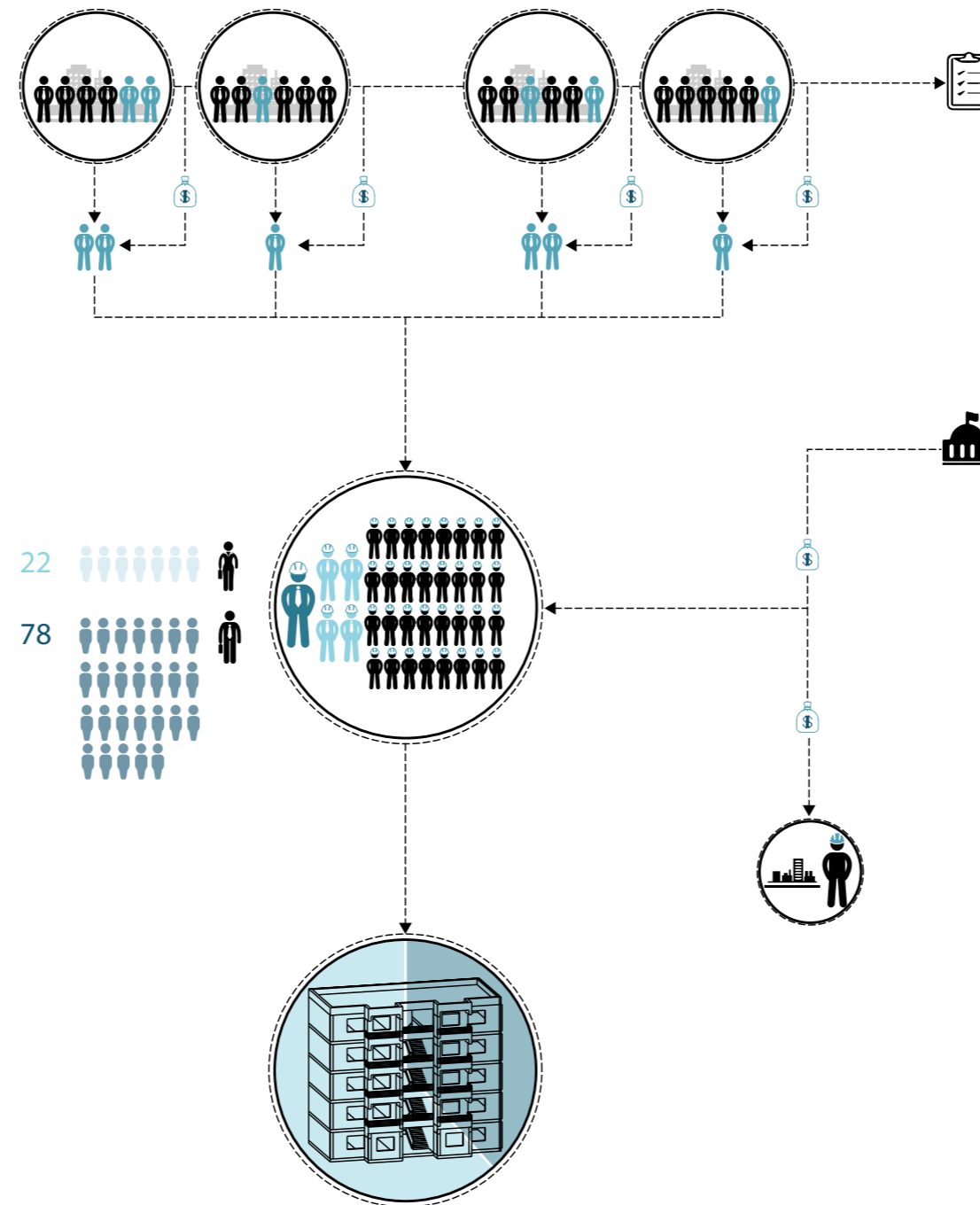

Strong Sense of Community

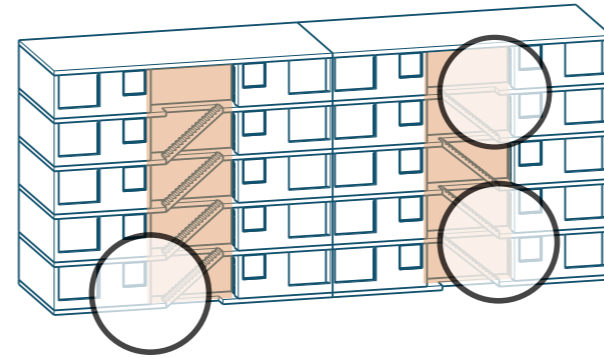

Increasingly Growing of Elderly In Alamar

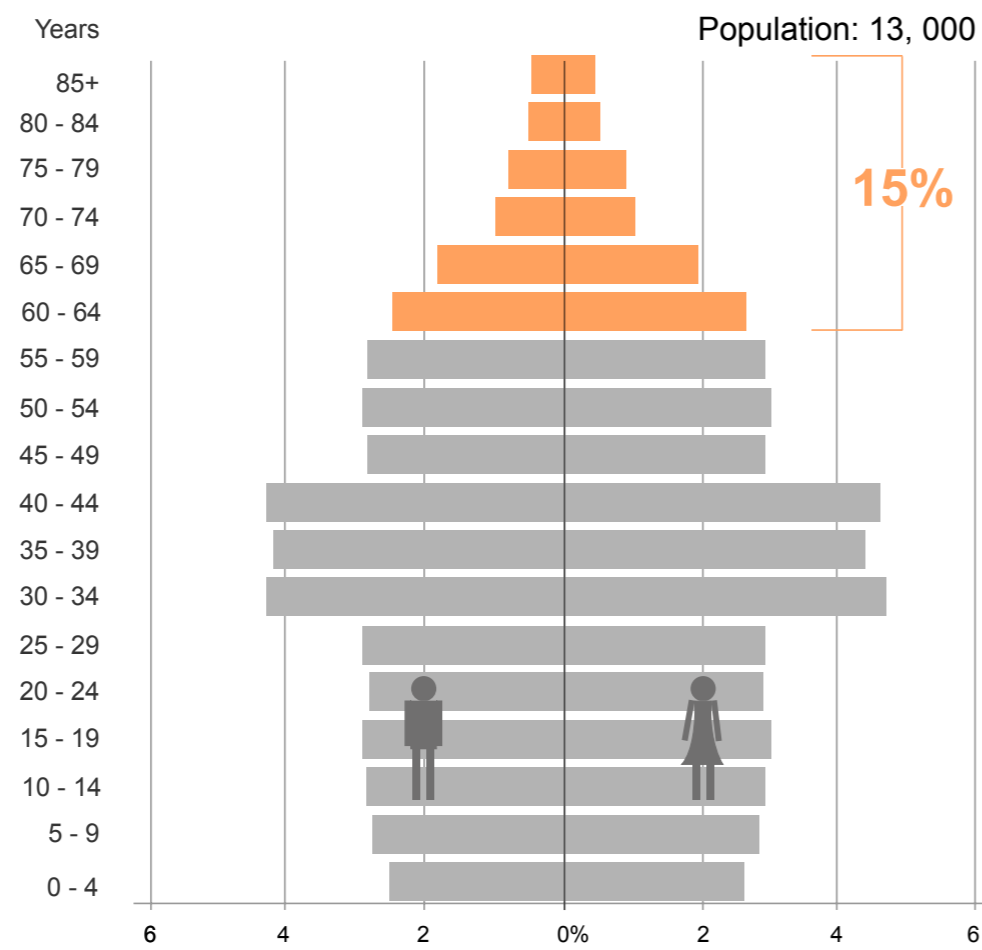

Population pyramid of alamar 2002

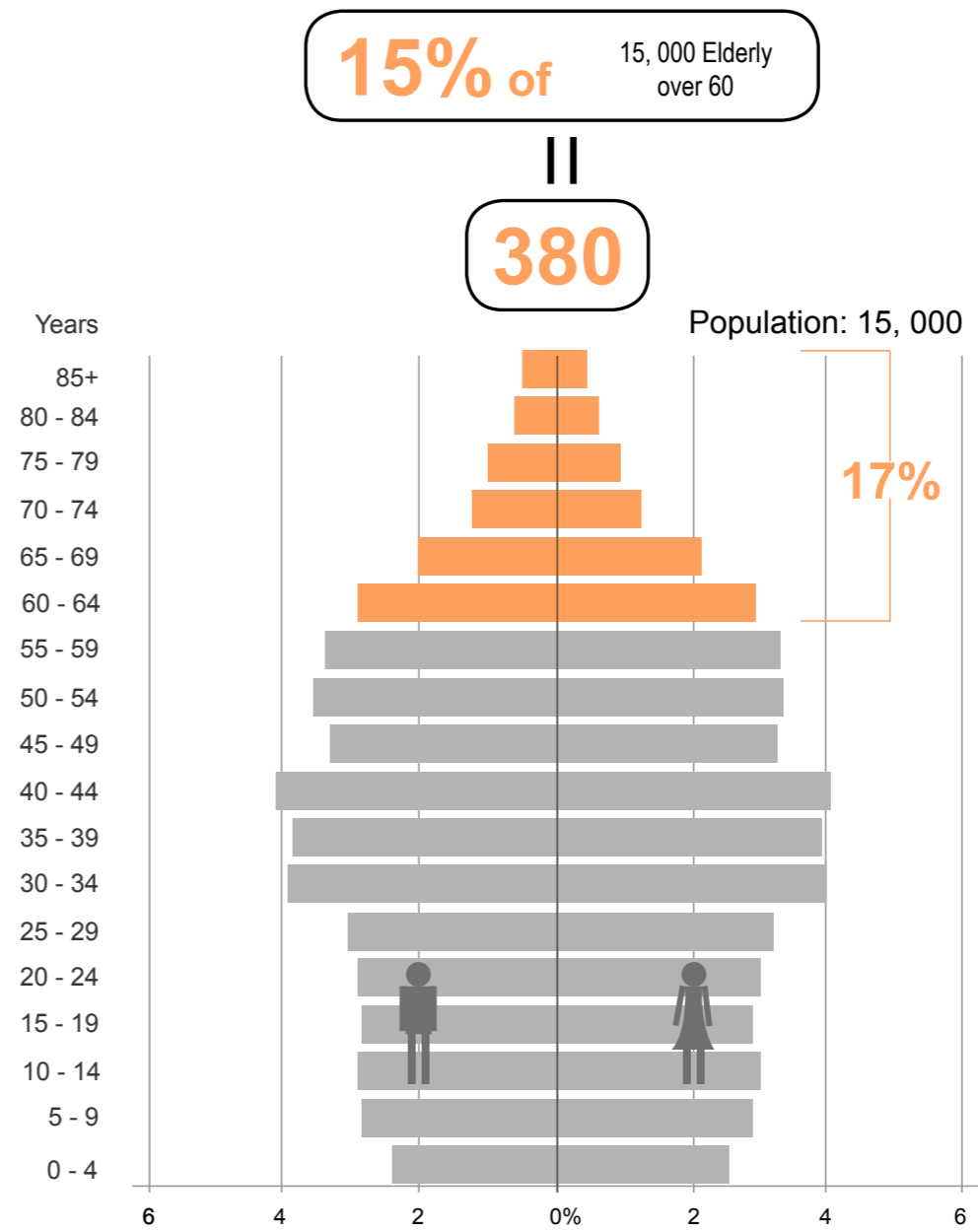

Population pyramid of alamar 2015

SITE RESEARCH

Why alamar

Choice of location

Site photos

Site Overview

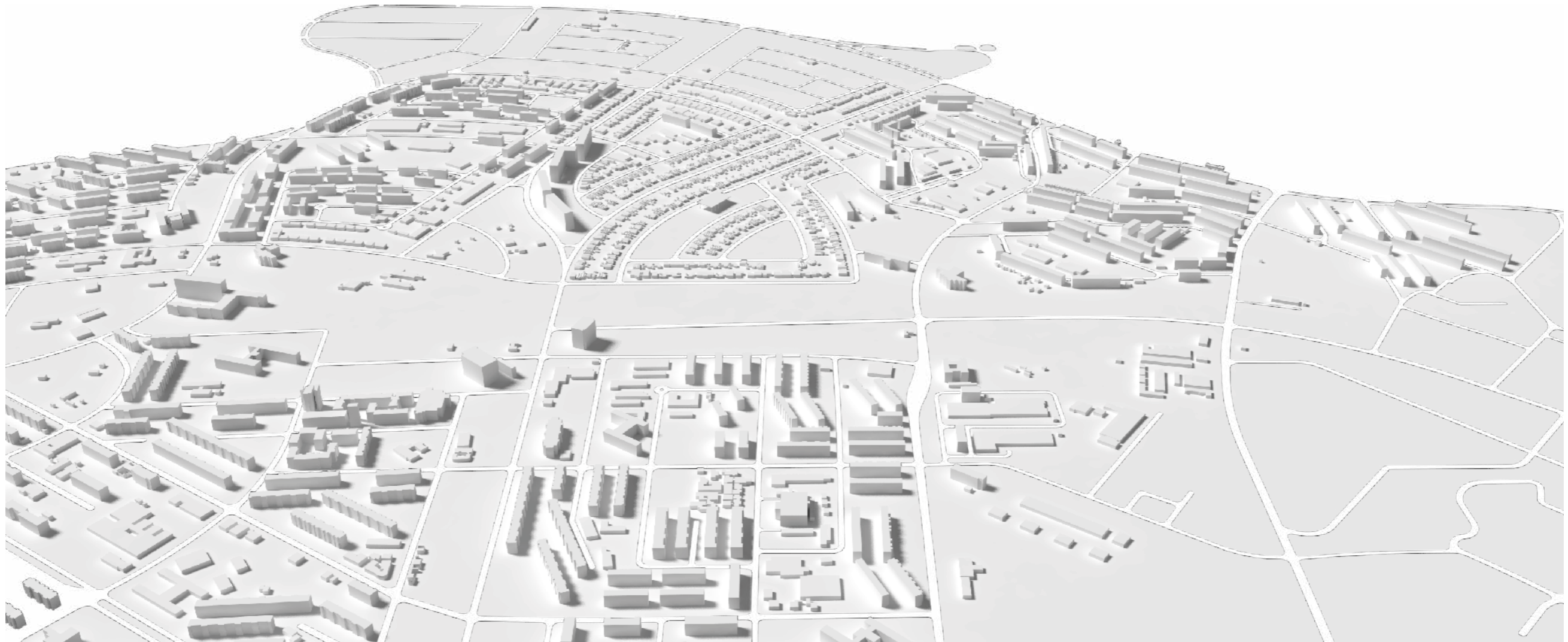

Site Urban Condition

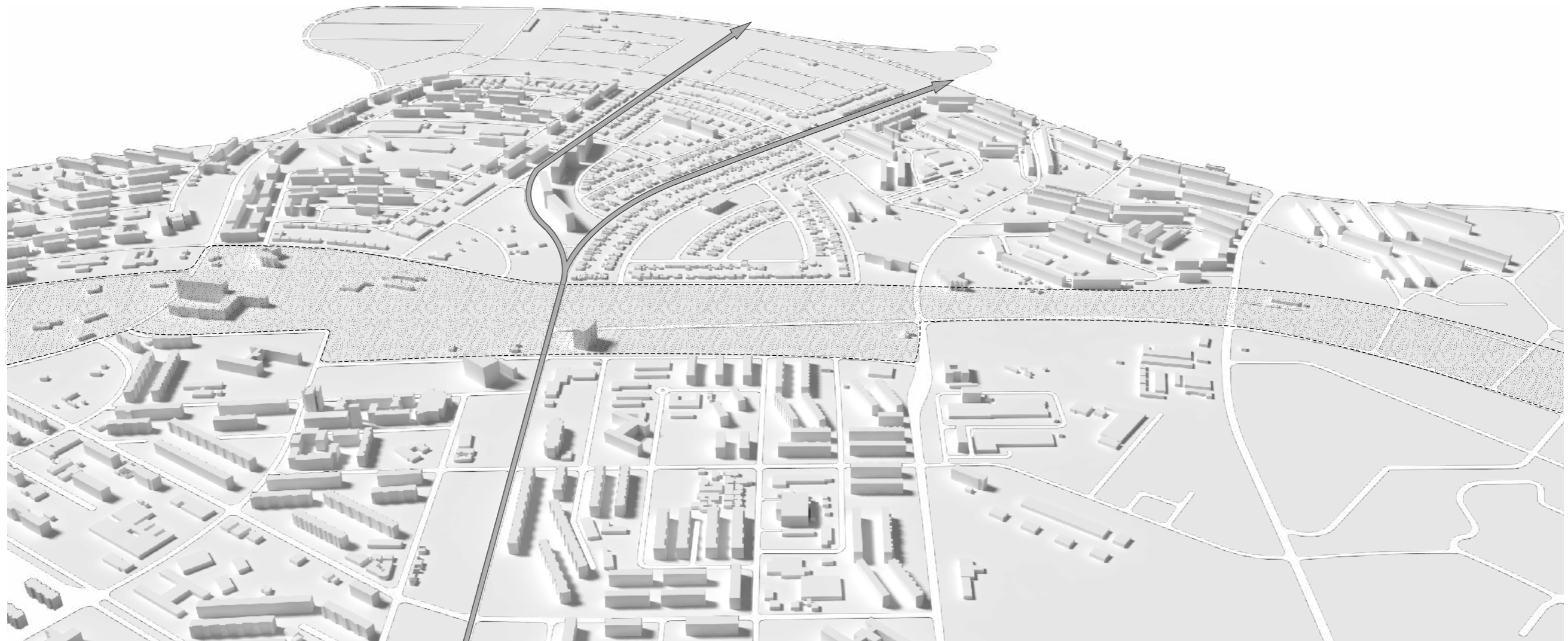

Disconnected on Urban Scale

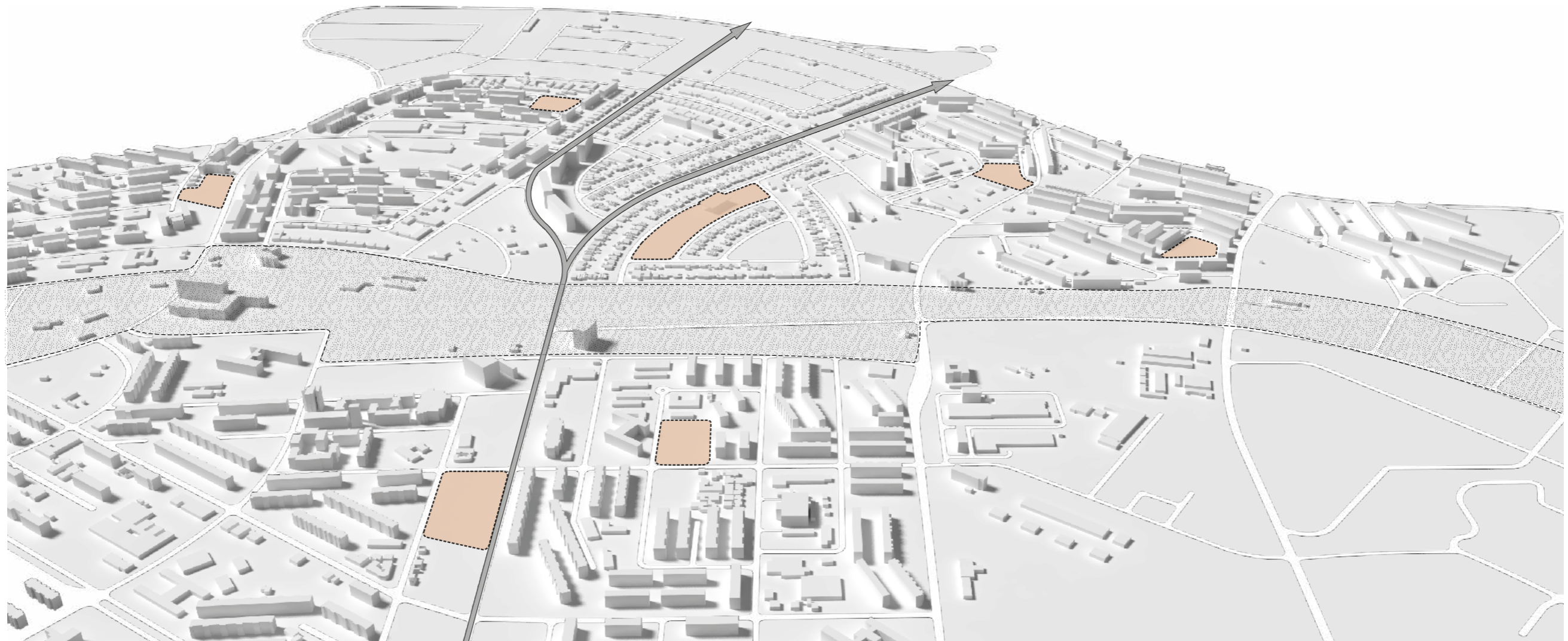

Network of Neighbourhood

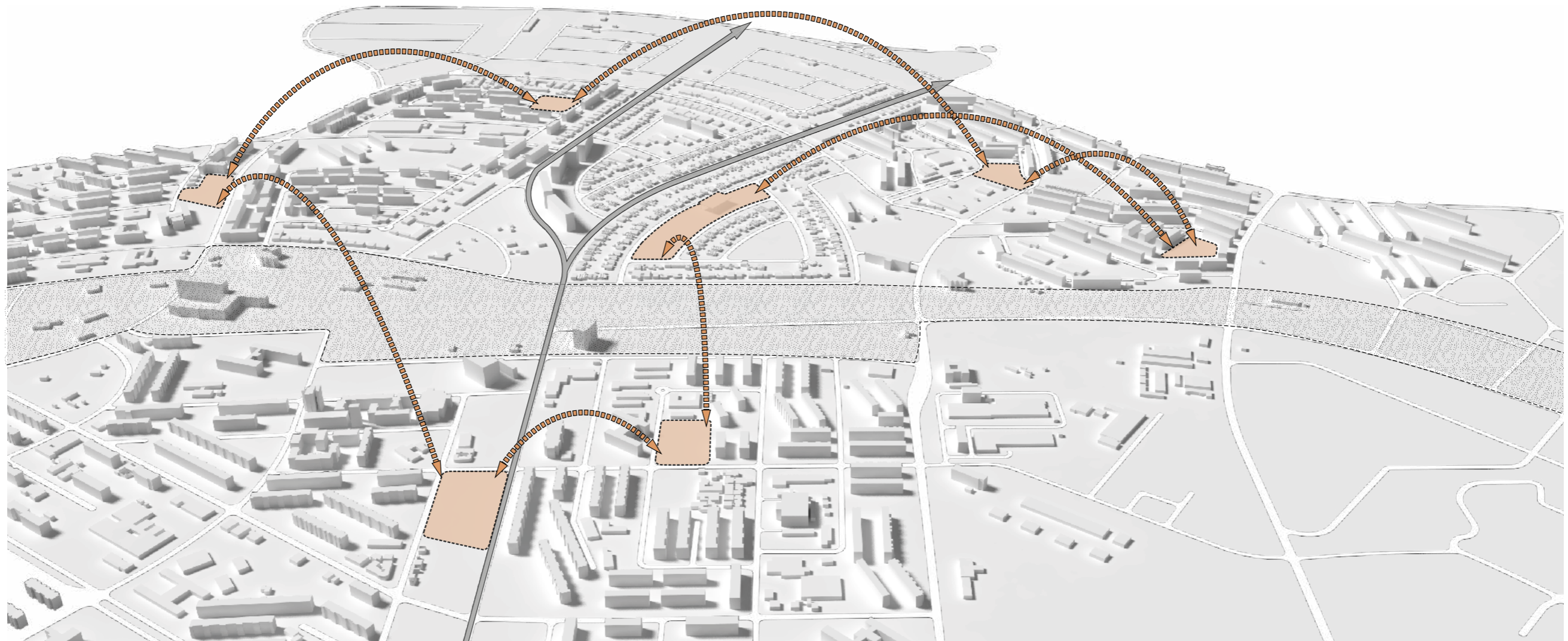

Disconnected on Neighborhood Scale

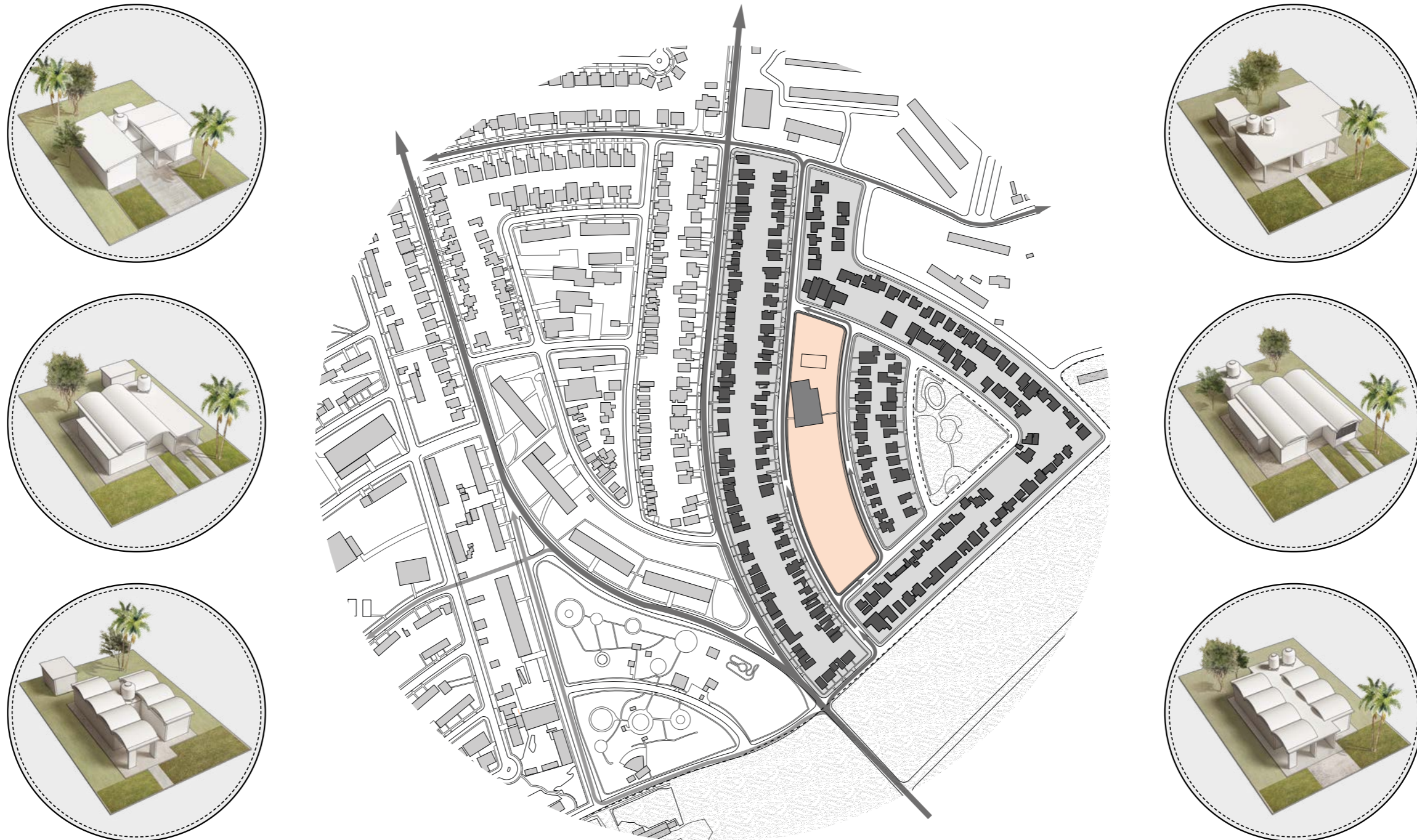

Typical Neighbourhood

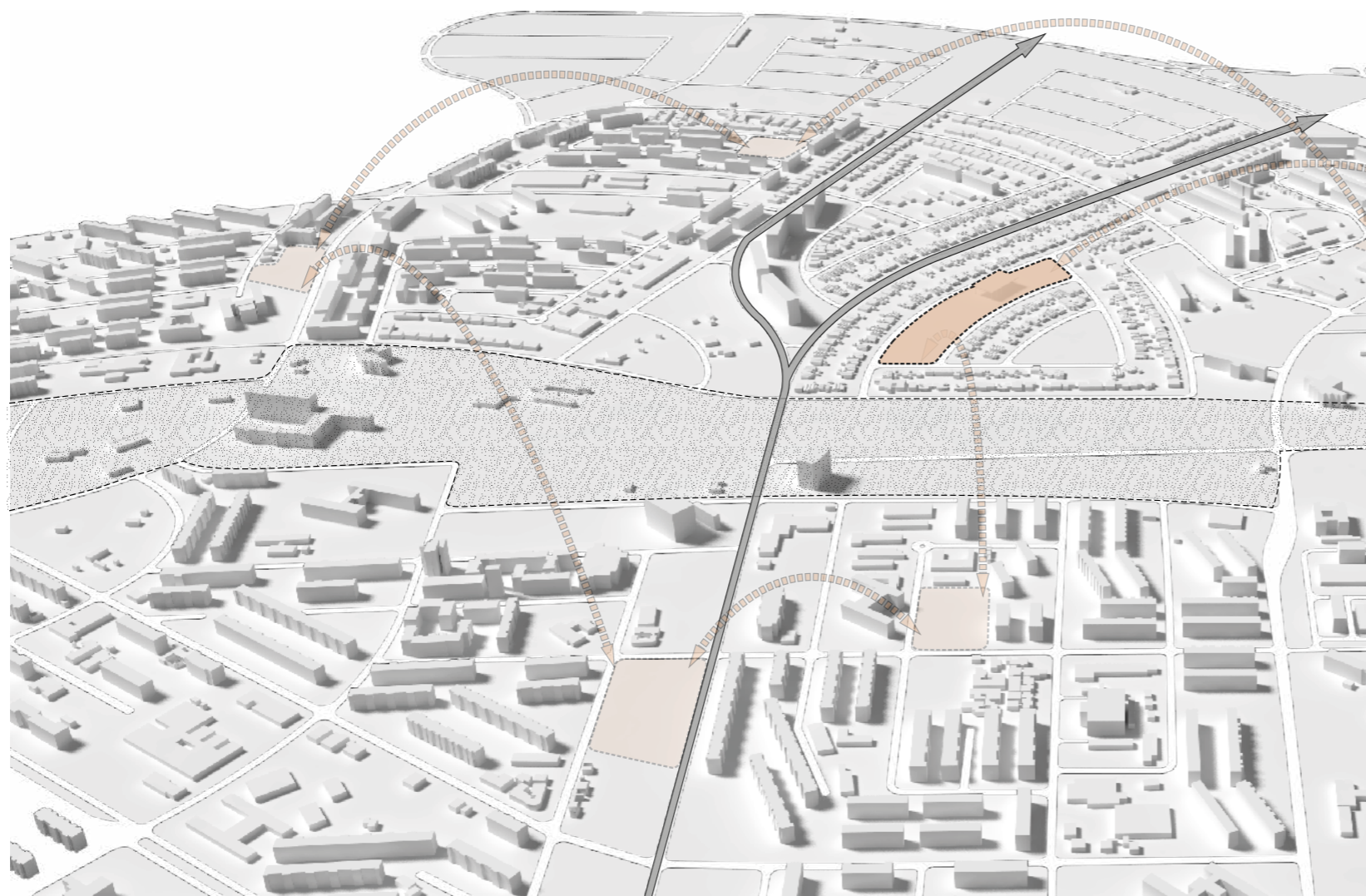

SITE RESEARCH

Why alamar

Choice of location

Site photos

Site Photos



TYOLOGY RESEARCH

Catholic Charity Institution

92-Bed Nursing Home

Dependent Elderly Care Center

Catholic Charity Institution



92-Bed Nursing Home



Dependent Elderly Care Center



Conclusion of Typology Research

Catholic Charity Institution

Daycare Center- 40 Places

1. Reception.
Administration area.
2. Social Area
Multipurpose computer rooms,TV and coexistence.
3. Dining area
For users with mental dependence and elderly residence
4. Day center
Kitchen, services, hygienic, wardrobe, laundry.
5. Area Professionals
Security controls, barber Shop.
6. Occupational Therapy Unit
Psychologist, Therapist, Physiotherapist, Chiropodistand Den tistry.
7. Medical Unit
Multi-purpose medical unit of continued care, Control
Doctor, room of cures / 7 places, pharmacy.
8. Social Unit / Rehabilitation:
rehabilitation. Social unit room. Pool heated hydrotherapy.
Bio-healthy park. Therapeutic garden.

Nursing Home - 150 Places

1. Non-smoking rooms
(Users with moderate dependence, Light or valid).
2. Single rooms adapted
(Users with moderate dependence, Light or valid).
3. Single rooms for large dependents.
Individual rooms for usersWith mental dependence.
4. Non-smoking rooms
(Users with moderate dependence, Light or valid).

28% 24% 9% 8% 4% 27%

92-Bed Nursing Home

Daycare Center 3000m2

1. Reception.
Administration area.
2. Social Area
Multipurpose computer rooms,TV and coexistence.
3. Dining area
For users with mental dependence and elderly residence
4. Day center
Kitchen, services, hygienic, wardrobe, laundry.
5. Area Professionals
Security controls, barber Shop.
6. Occupational Therapy Unit
Psychologist, Therapist, Physiotherapist, Chiropodistand Den tistry.
7. Medical Unit
Multi-purpose medical unit of continued care, Control
Doctor, room of cures / 7 places, pharmacy.
8. Medical consultation

Nursing Home - 92 Places 1700m2

1. Non-smoking rooms
(Users with moderate dependence, Light or valid).
2. Single rooms adapted

Adiministration 240m2

1. Staff dressing room
2. Technical rooms
3. Deliveries area.
4. Office

40% 30% 4% 26%

Dependent Elderly Care Center

Daycare Center 3000m2

1. Main reception lobby
2. Activity room, workshop, relaxing space
3. Dining area
For users with mental dependence and elderly residence
4. Day center
Kitchen, services, hygienic, wardrobe, laundry.
5. Area Professionals
Security controls, barber Shop.
6. Occupational Therapy Unit
Psychologist, Therapist, Physiotherapist, Chiropodistand Dentistry.
7. Medical Unit
Multi-purpose medical unit of continued care, Control
Doctor, room of cures / 7 places, pharmacy.
8. Social Unit / Rehabilitation:
rehabilitation. Social unit room. Pool heated hydrotherapy.
9. Gardens

Nursing Home - 118 Places 1700m2

1. Single rooms for large dependents.
Individual rooms for users

Adiministration 240m2

1. Staff dressing room
2. Secretary room
2. Technical rooms
3. Deliveries area.
4. Office

44% 23% 4% 30%

Conclusion of Typology Research

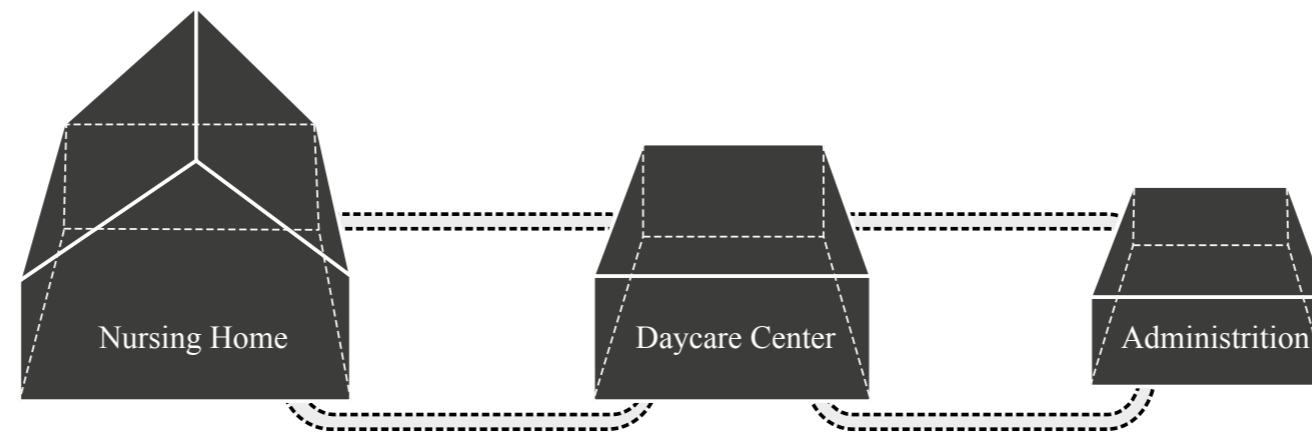

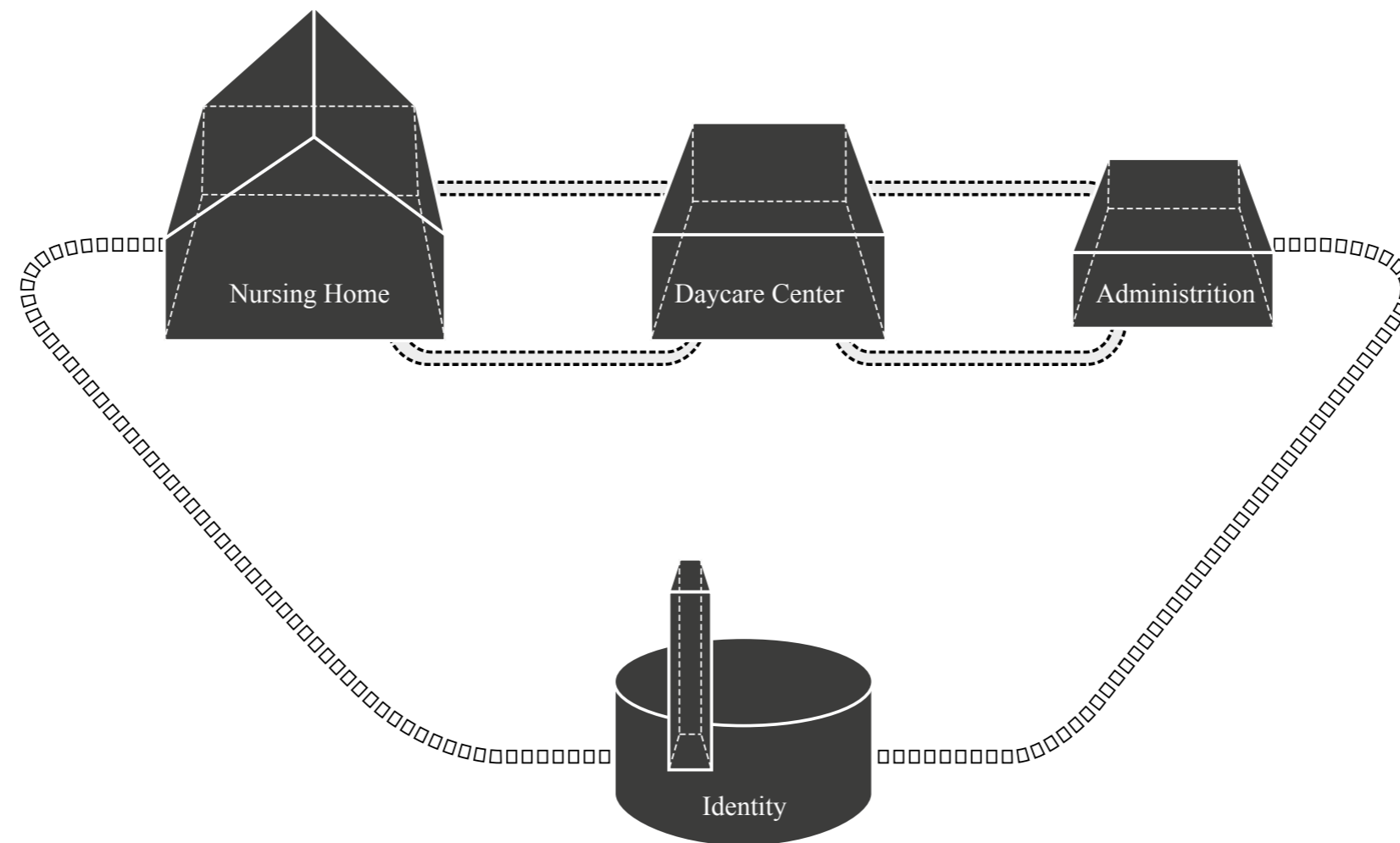

Conclusion - Lack of Public Function (For City)

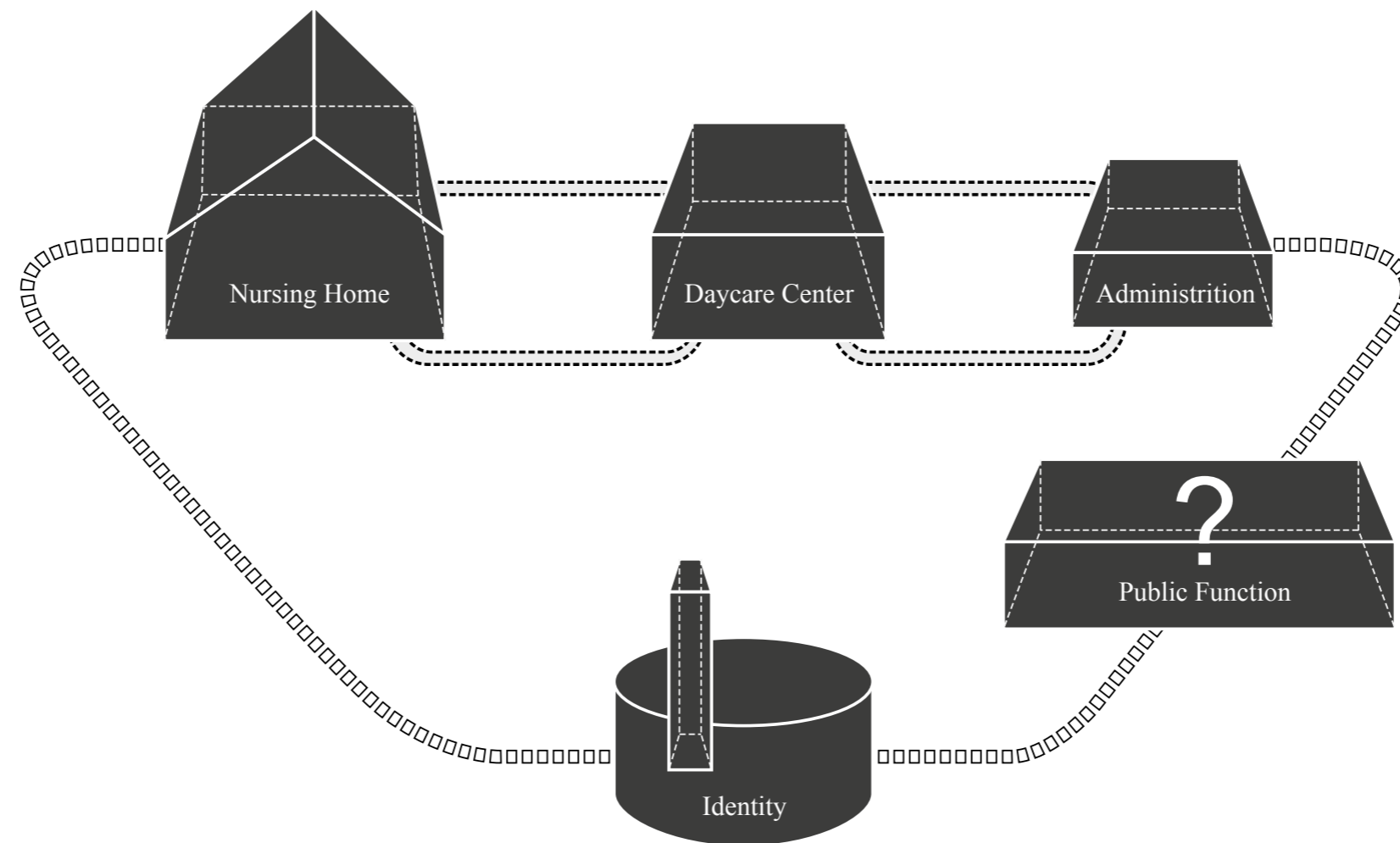

STRATEGY

Proposal

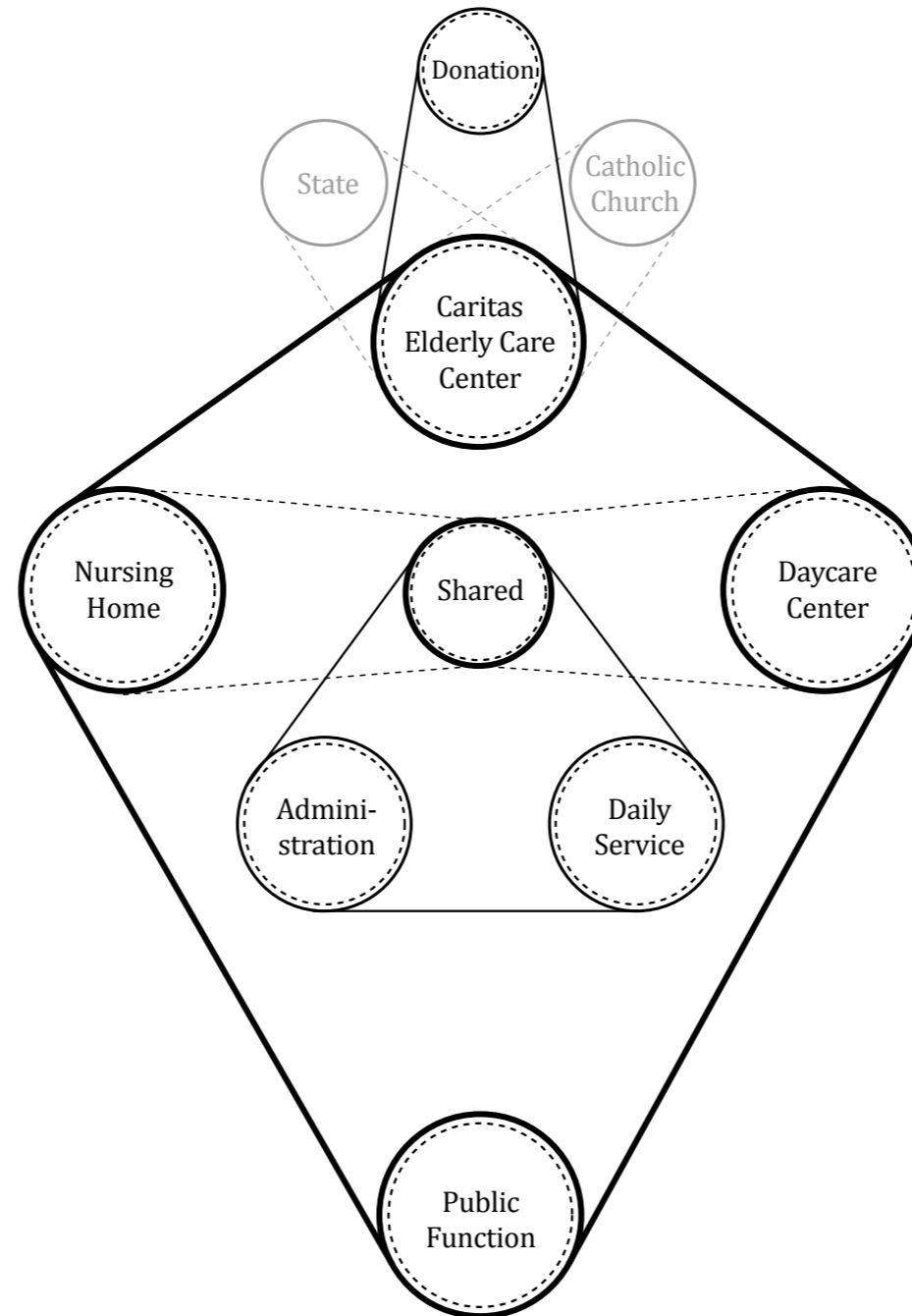

Proposal

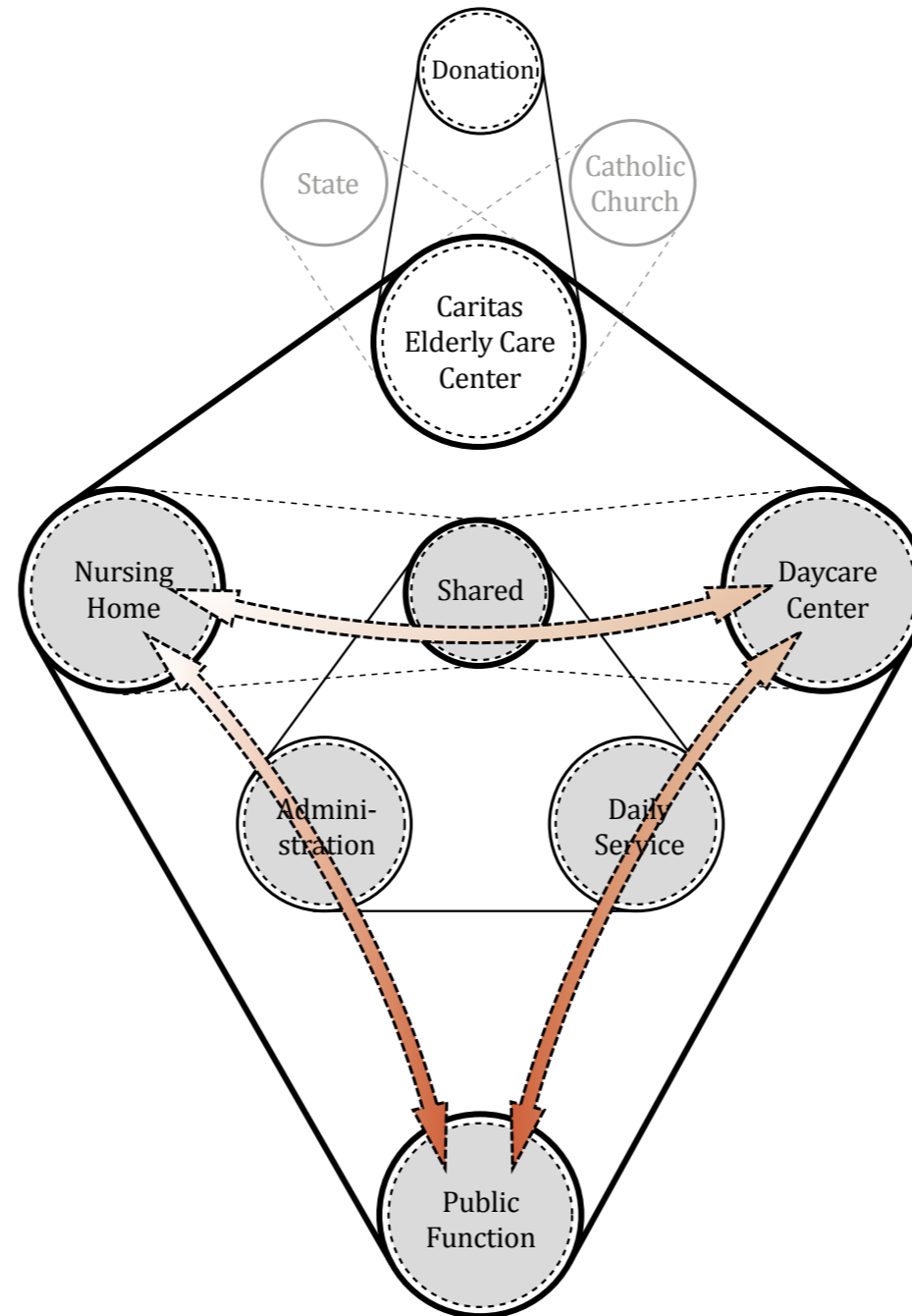

Targeting Group - Elderly

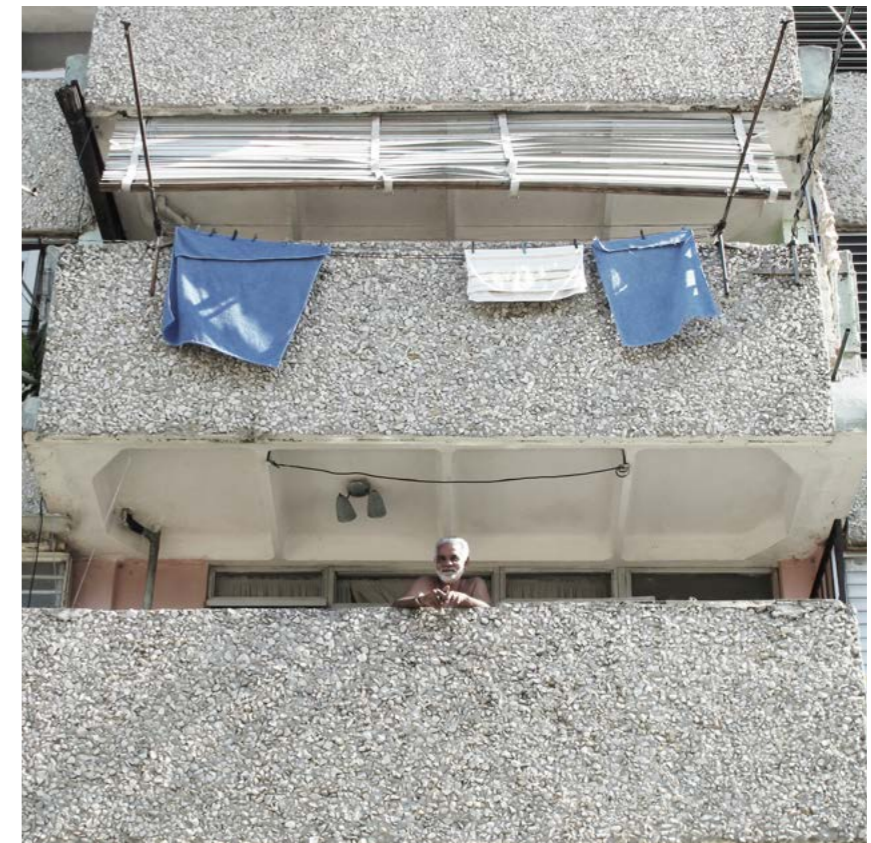
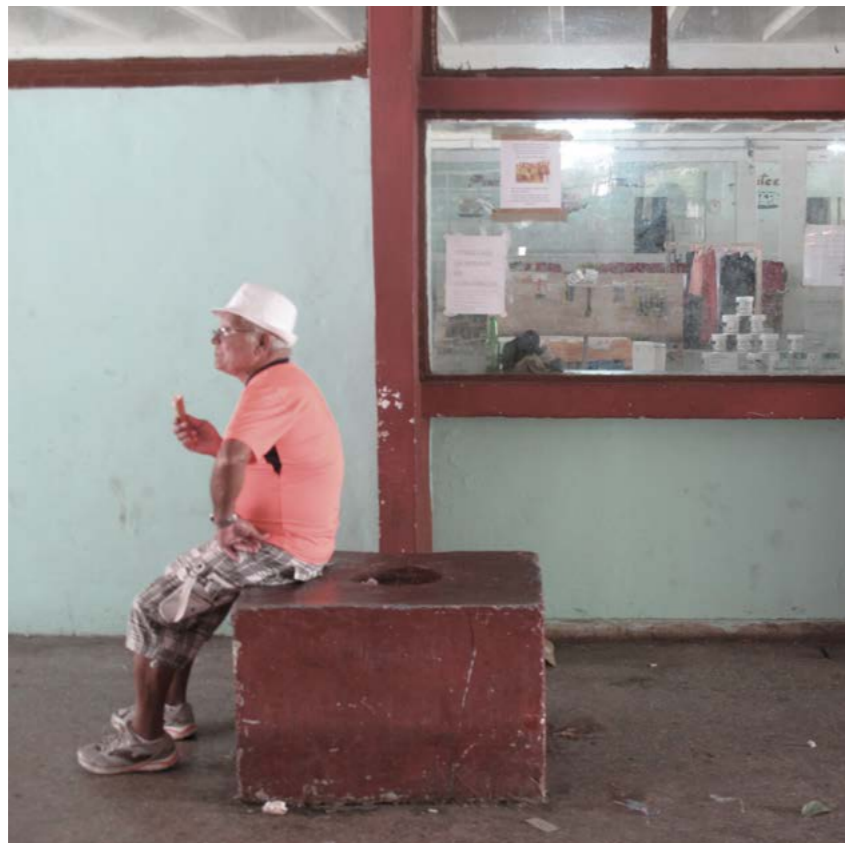
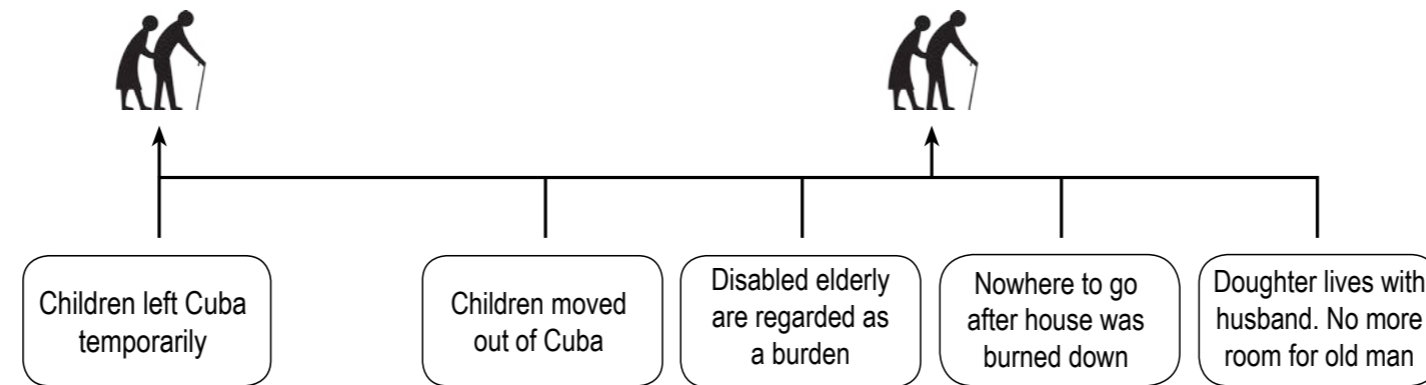

Expecting Users - Children

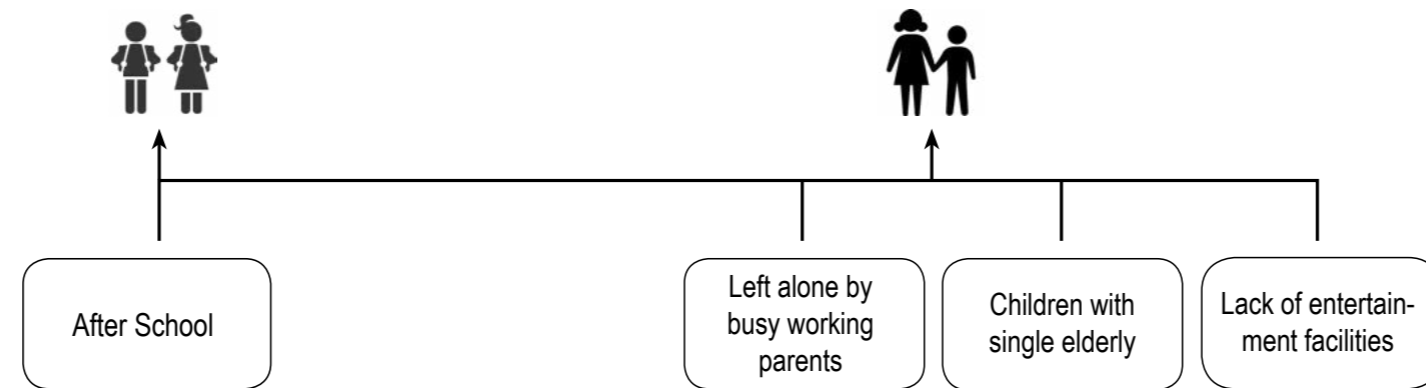

Urban Strategy



Location of Intervention



Mass Study

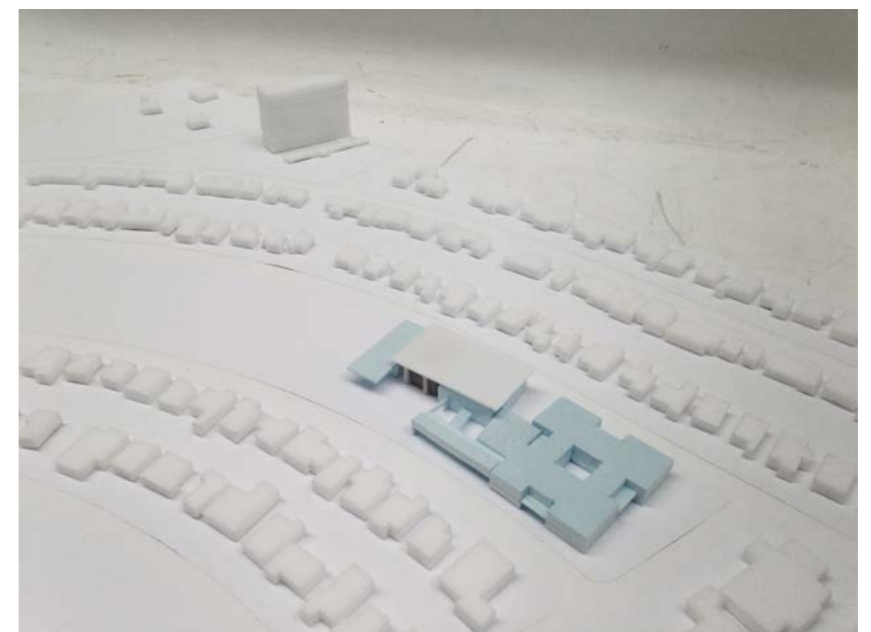
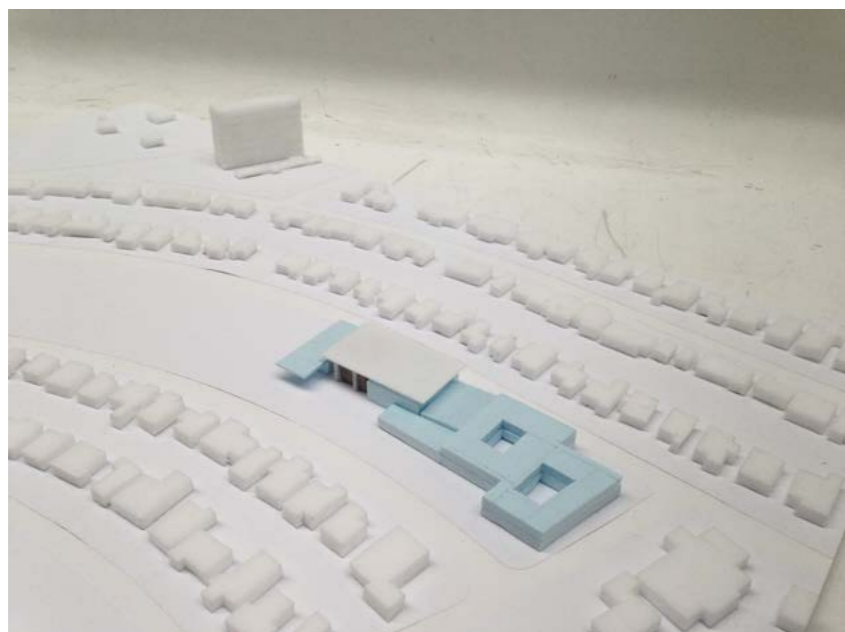
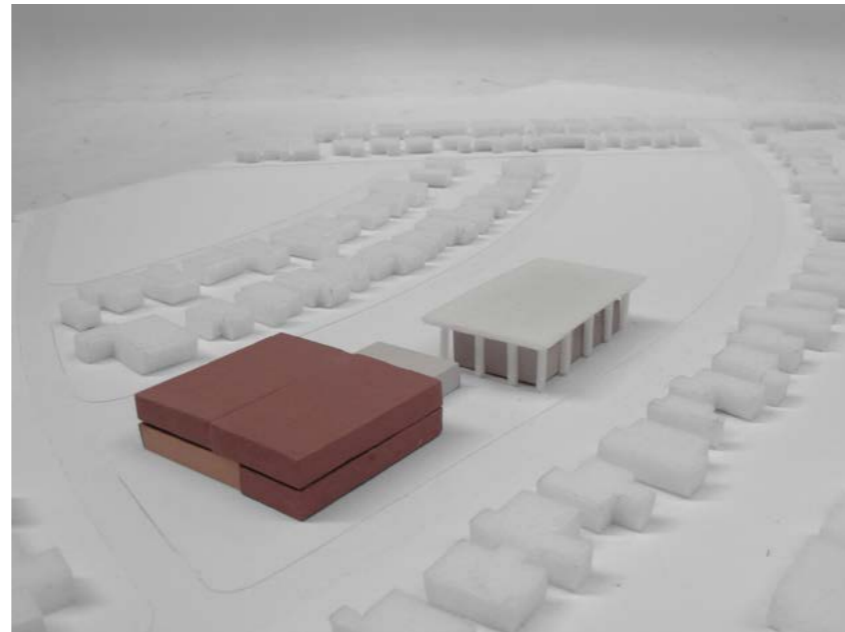

Bird view

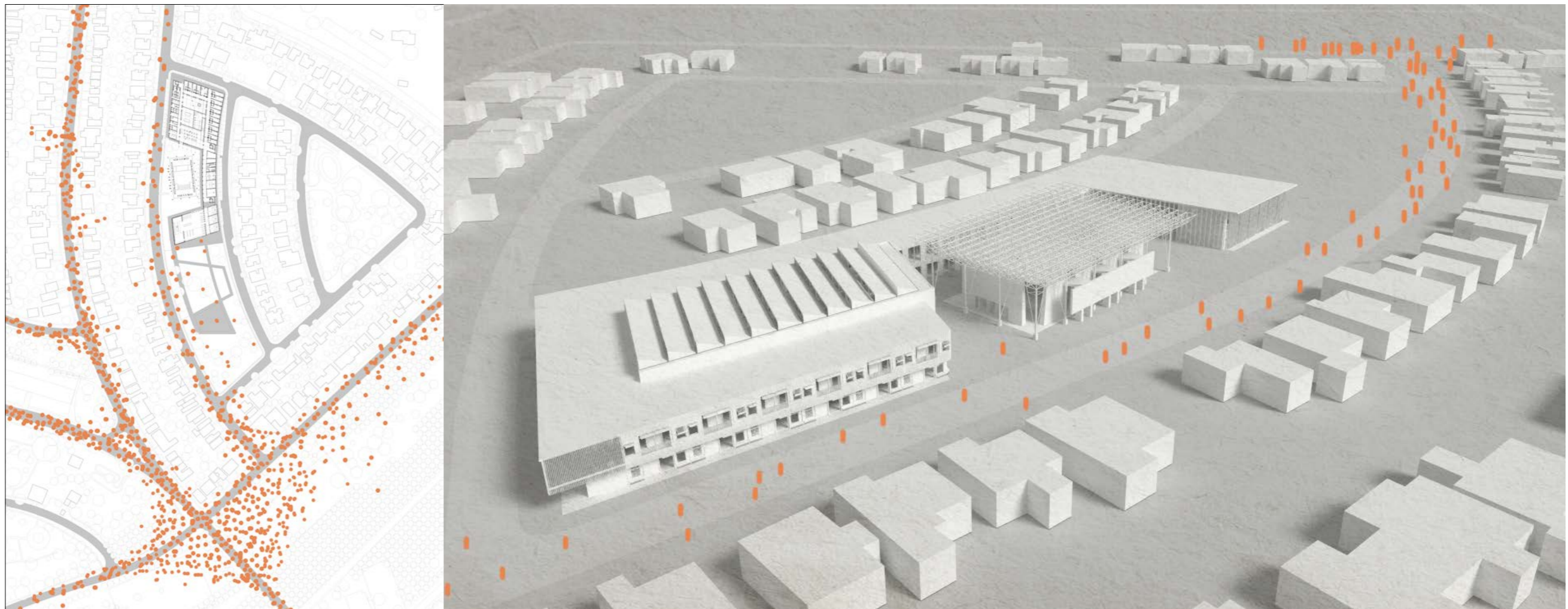

Final Result of testing

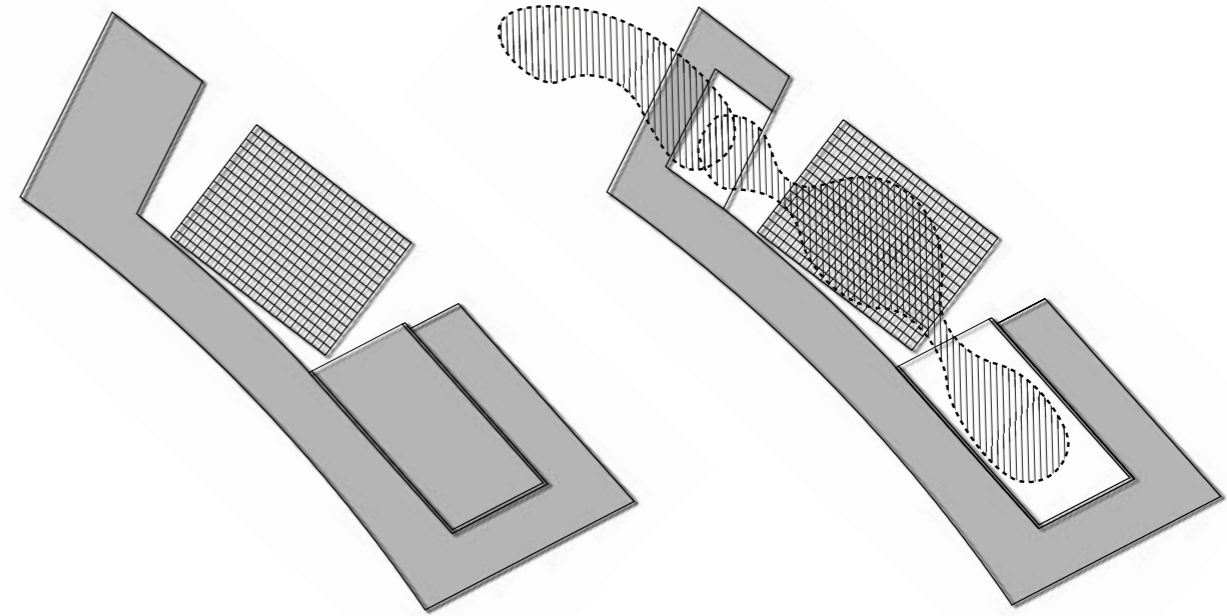

Volumn of Building

Volumn of function

Program

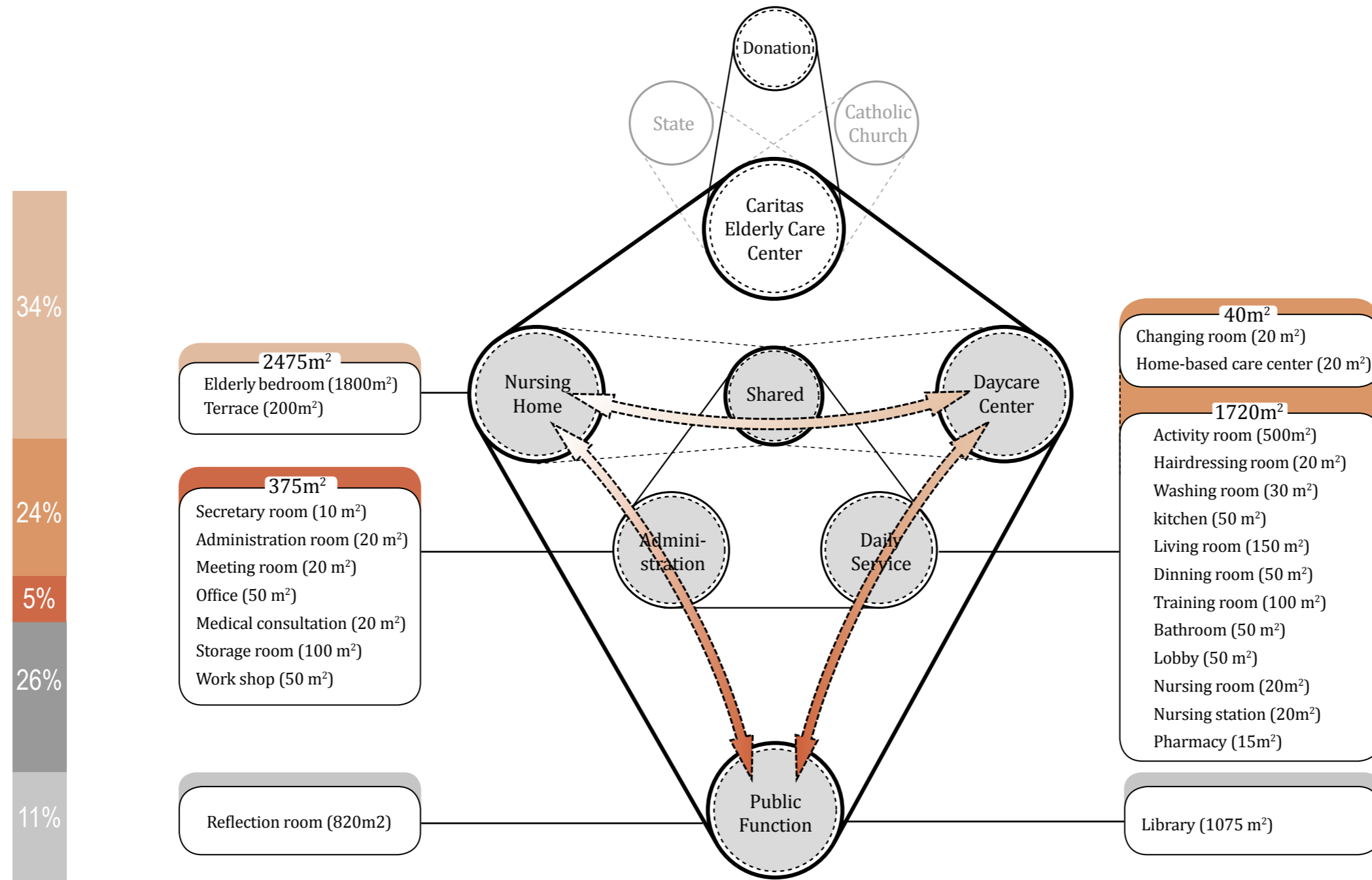

Function Organization

- Public Function : 1895m²
- Administration : 375m²
- Daycare Center : 1720m²
- Nursing Homes : 2475m²
- Circulation : 775m²

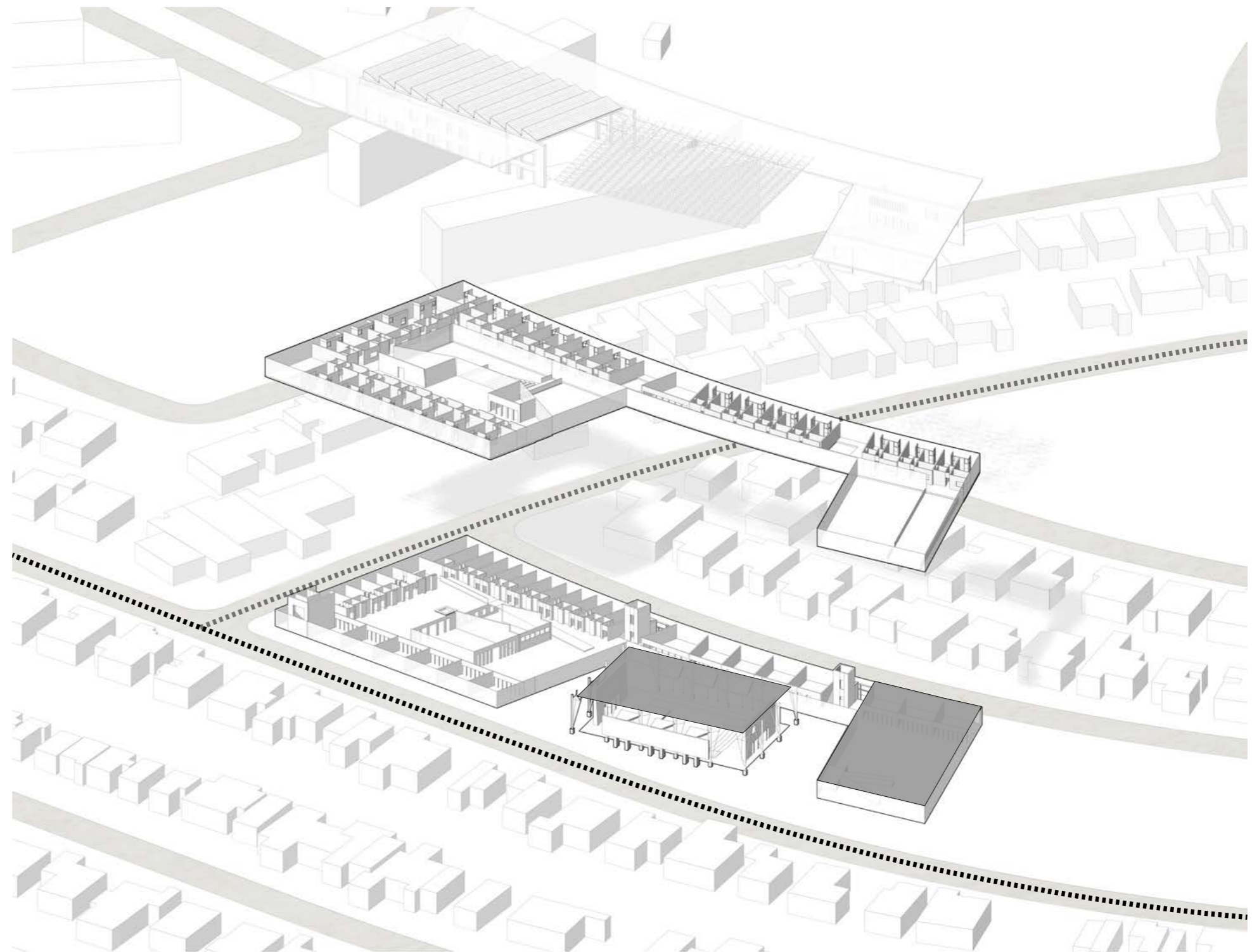

Function Organization

- Public Function : 1895m²
- Administration : 375m²
- Daycare Center : 1720m²
- Nursing Homes : 2475m²
- Circulation : 775m²

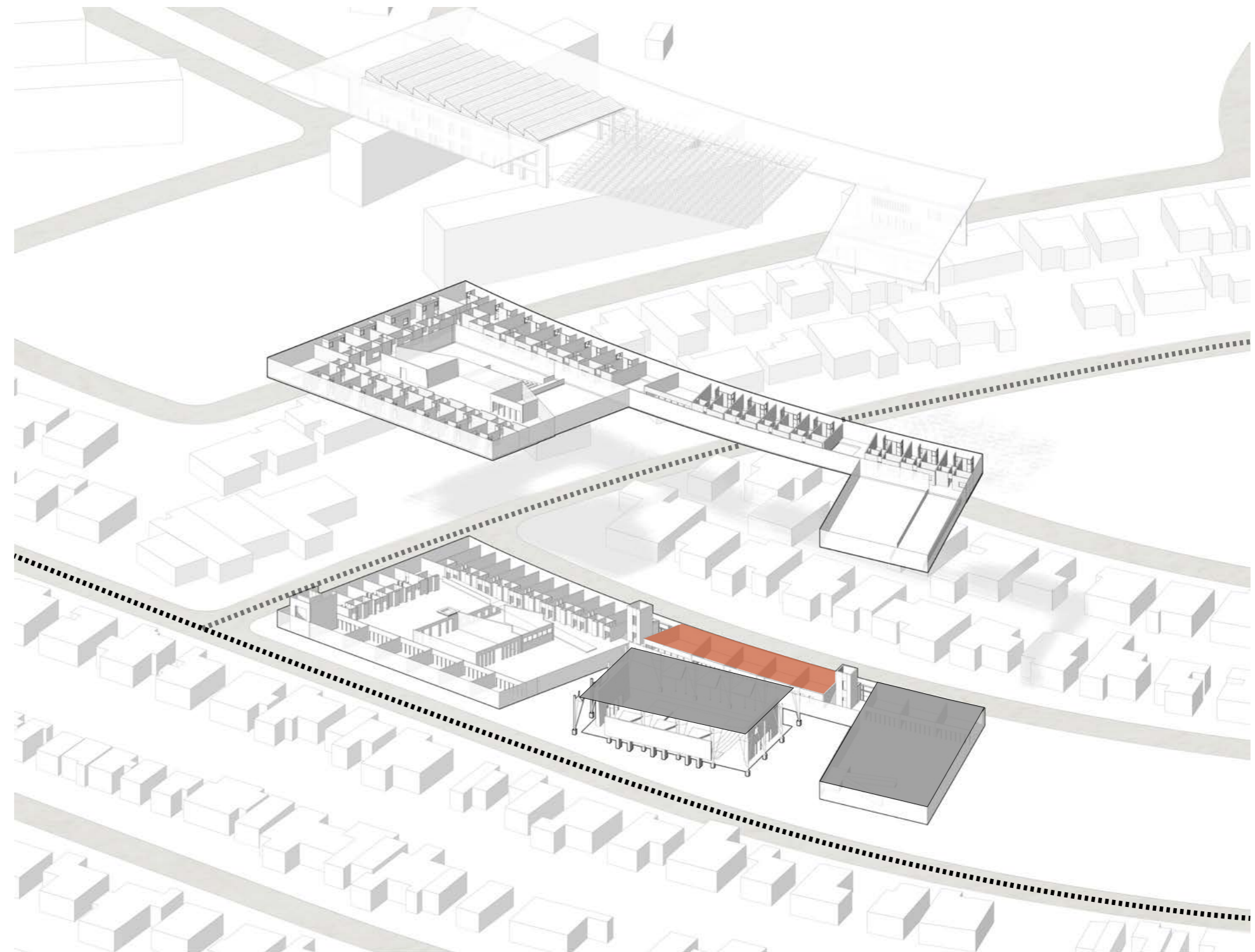

26%

5%

Function Organization

- Public Function : 1895m²
- Administration : 375m²
- Daycare Center : 1720m²
- Nursing Homes : 2475m²
- Circulation : 775m²

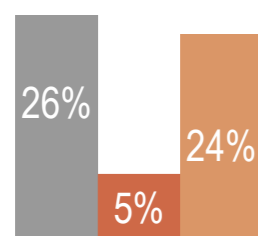
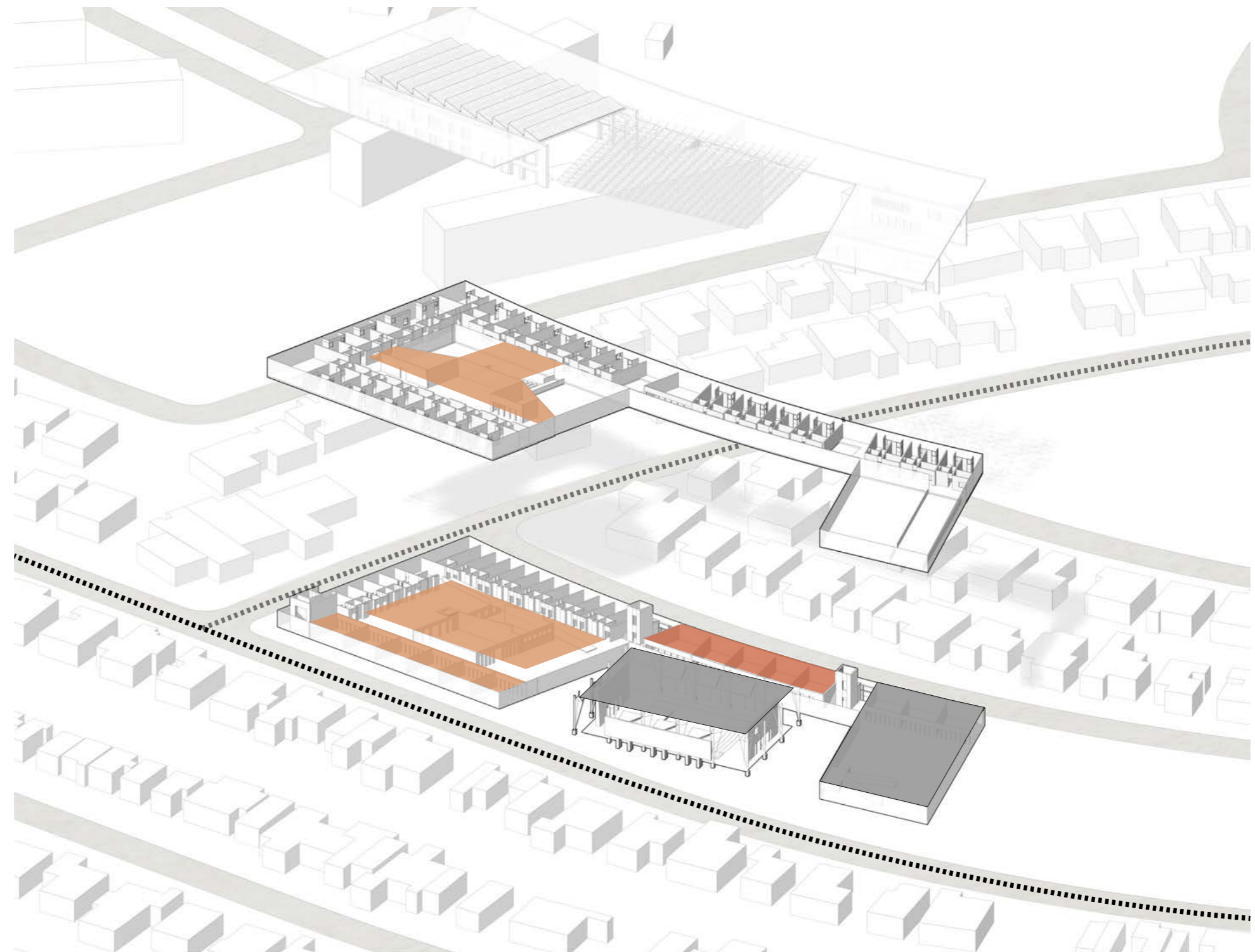

Function Organization

- Public Function : 1895m²
- Administration : 375m²
- Daycare Center : 1720m²
- Nursing Homes : 2475m²
- Circulation : 775m²

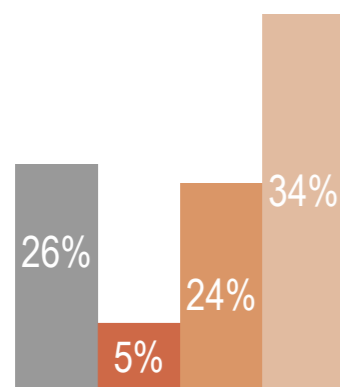
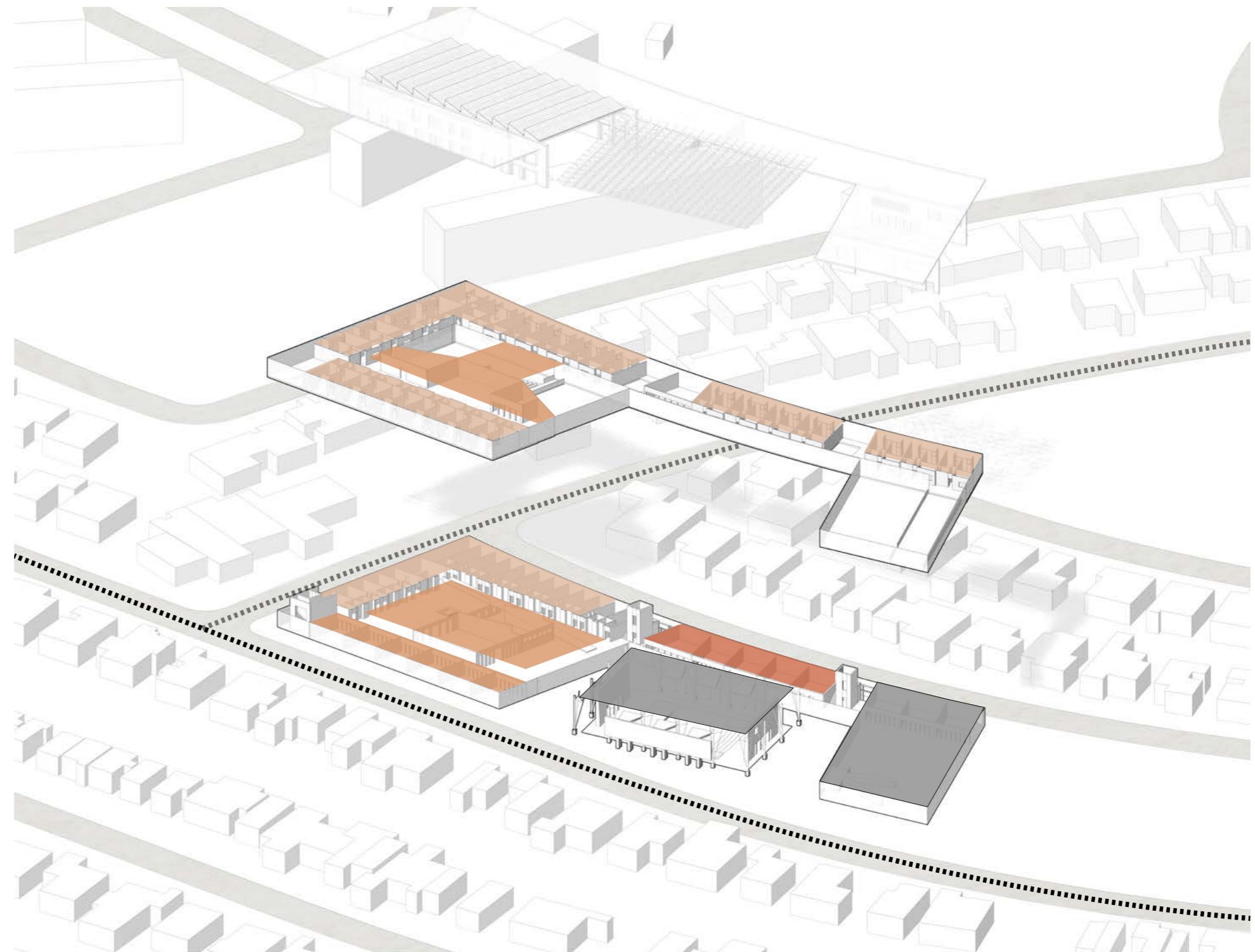

Function Organization

- Public Function : 1895m²
- Administration : 375m²
- Daycare Center : 1720m²
- Nursing Homes : 2475m²
- Circulation : 775m²

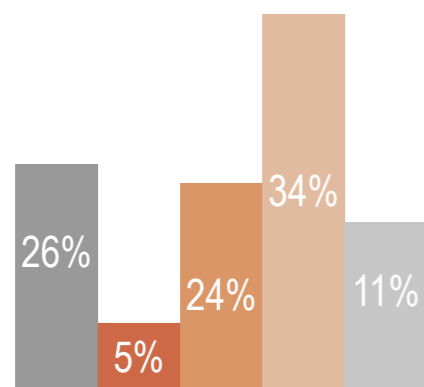
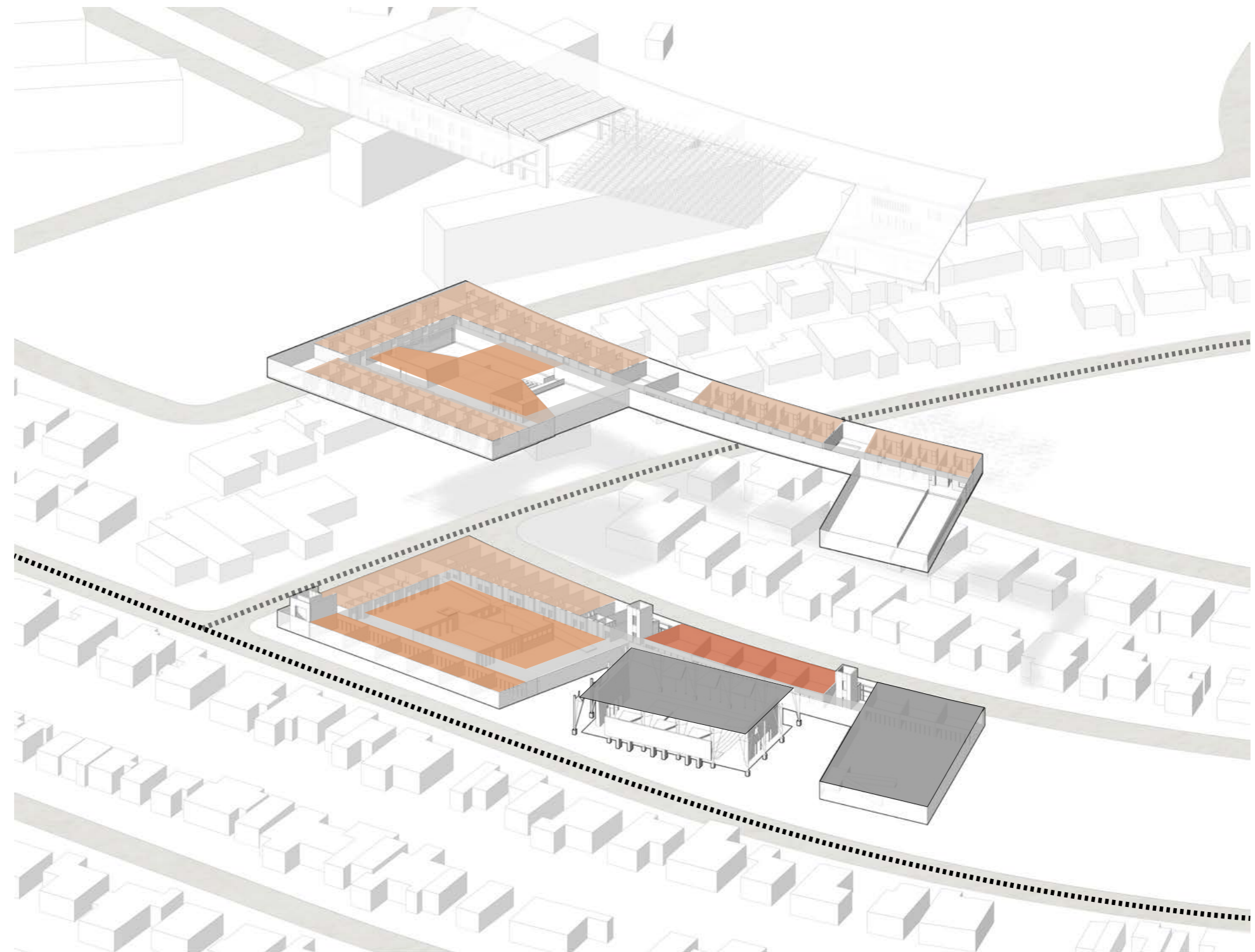

Axonometry

Roof Level

Skylight
Existing shed

First Level

Nursing Home
Living Room
Open Theatre
Library for Elderly

Ground Level

Nursing Home
Administration
Public Service
Workshops
Training Rooms
Reflection Room
Public Library

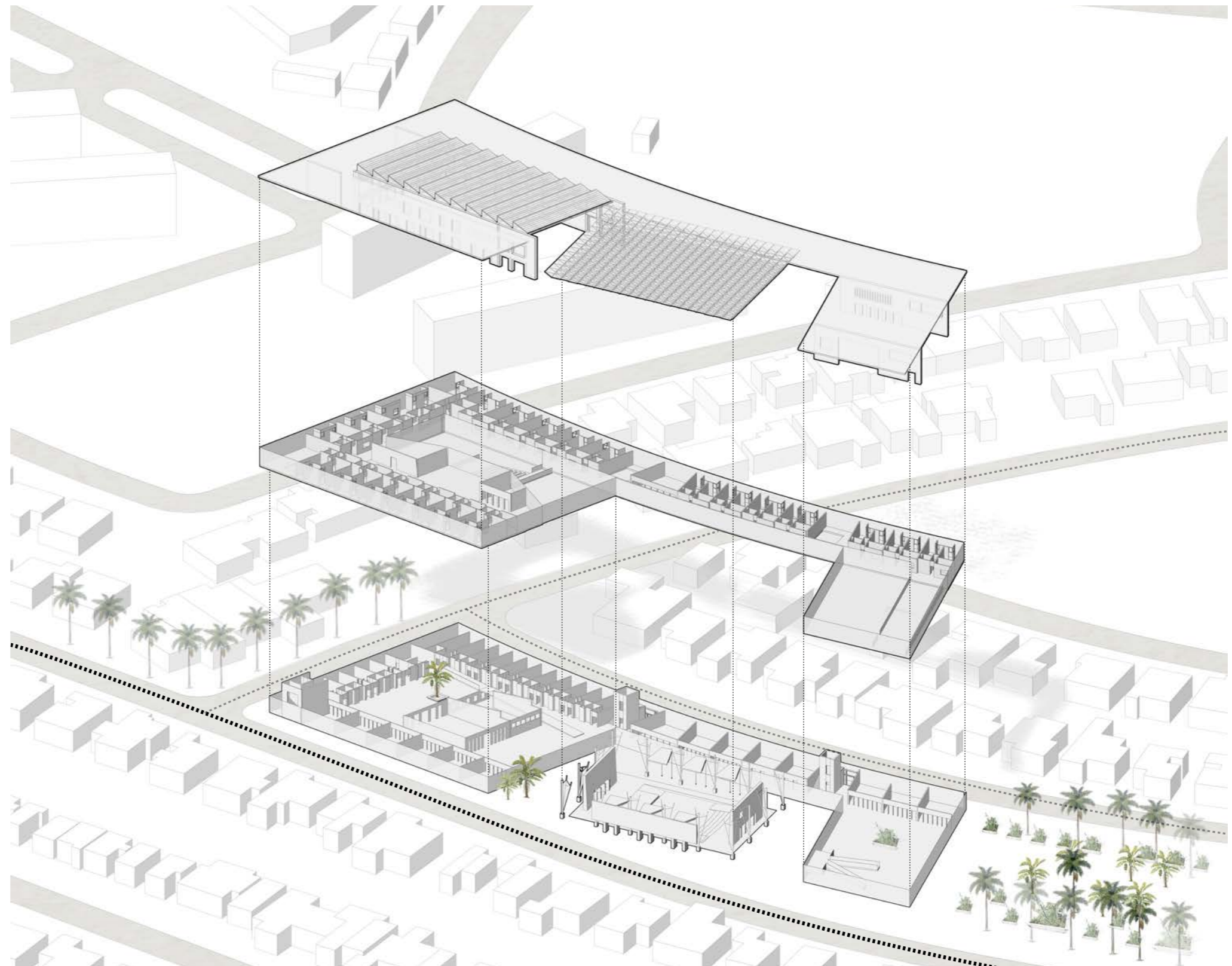

Site Circulation

Roof Level

Skylight
Existing shed

First Level

Nursing Home
Living Room
Open Theatre
Library for Elderly

Ground Level

Nursing Home
Administration
Public Service
Workshops
Training Rooms
Reflection Room
Public Library

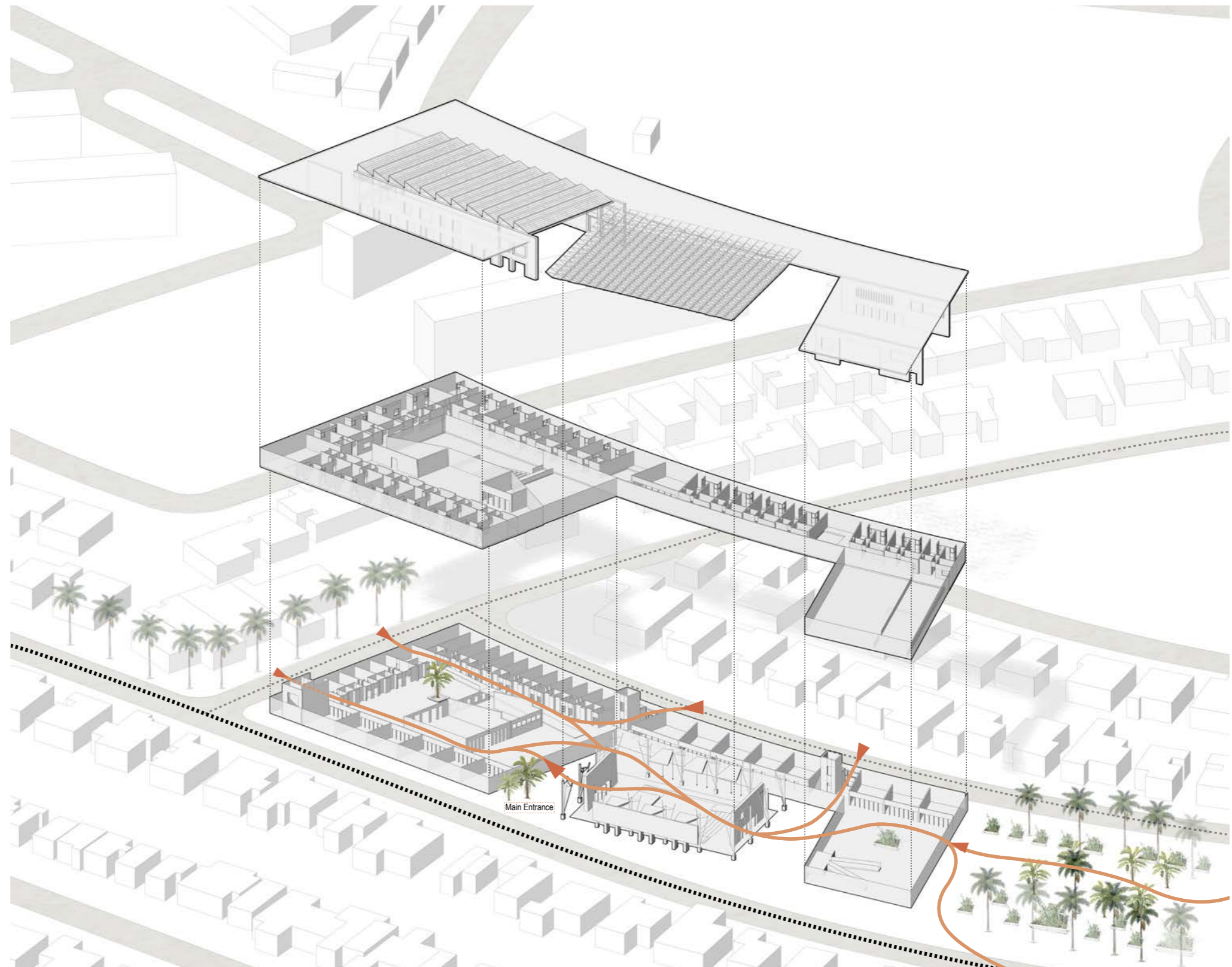

Basic circulation

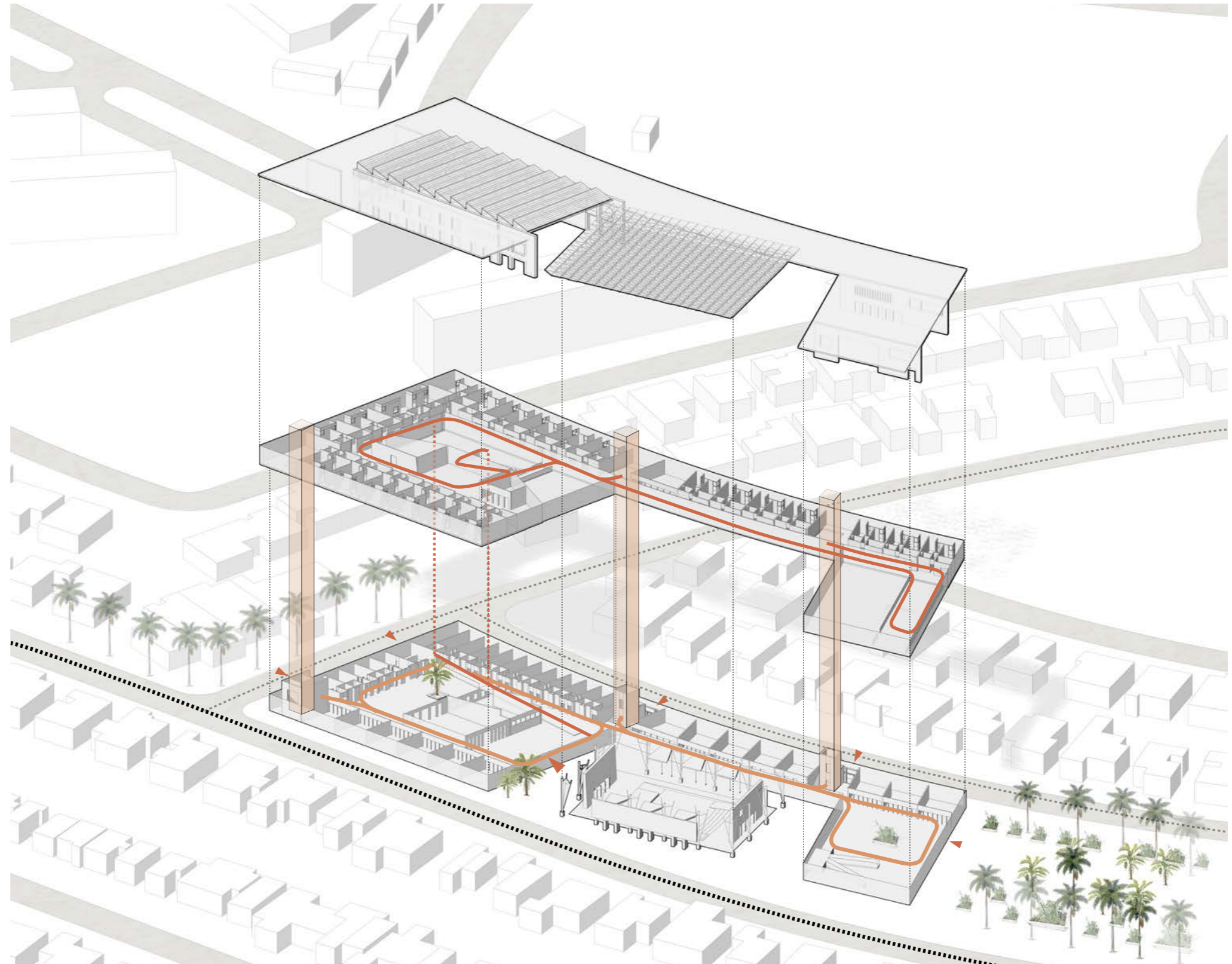
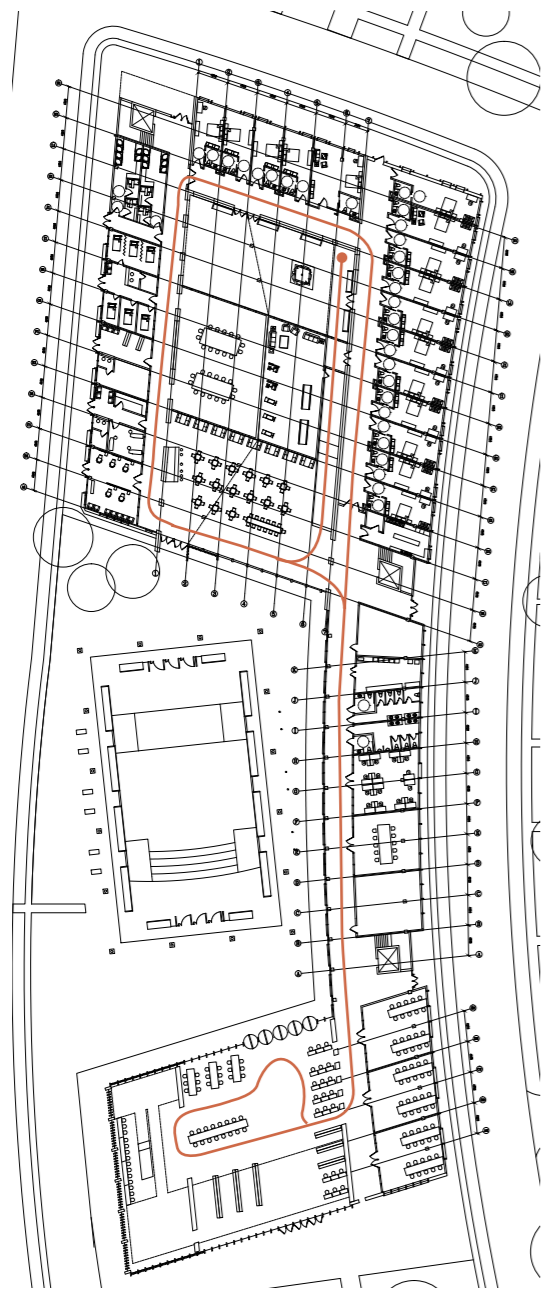

Main Entrance

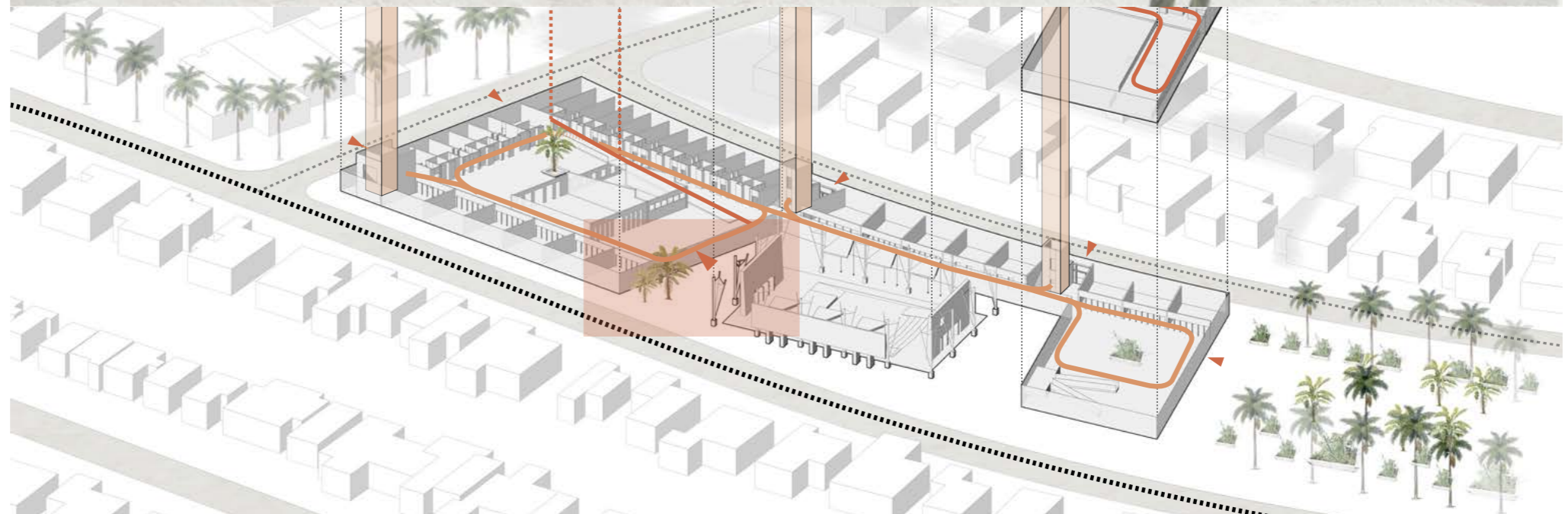
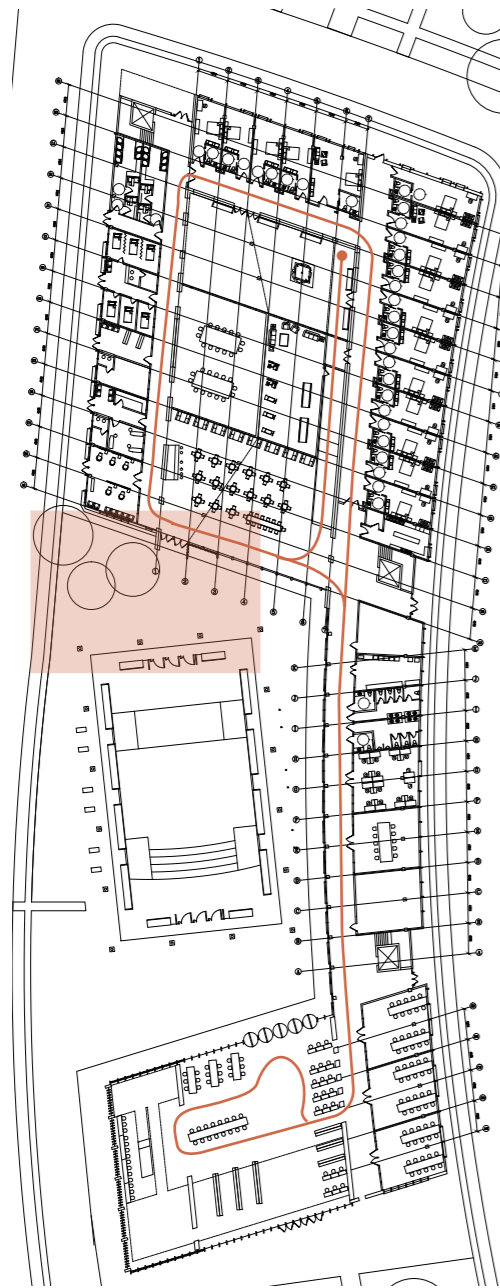

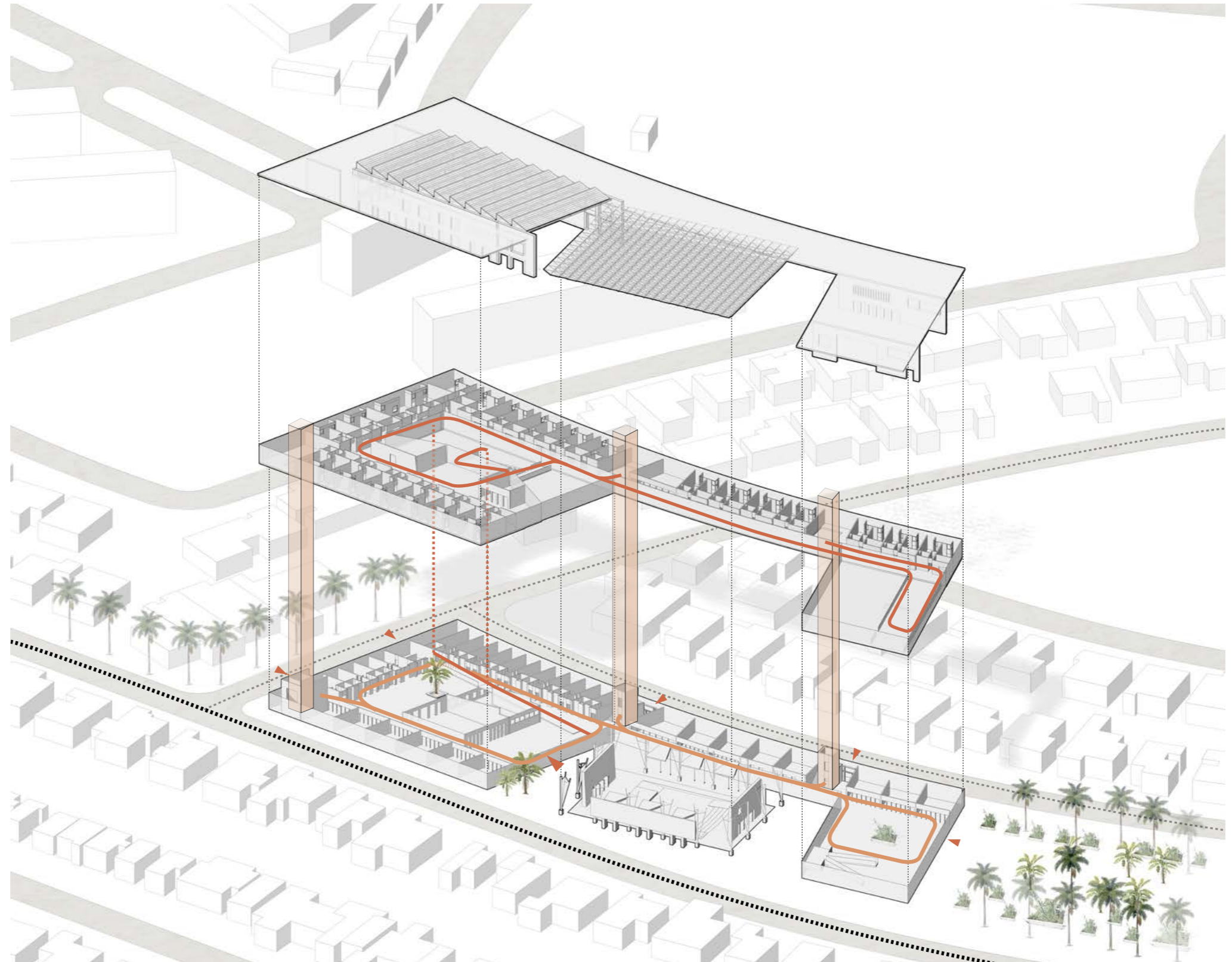
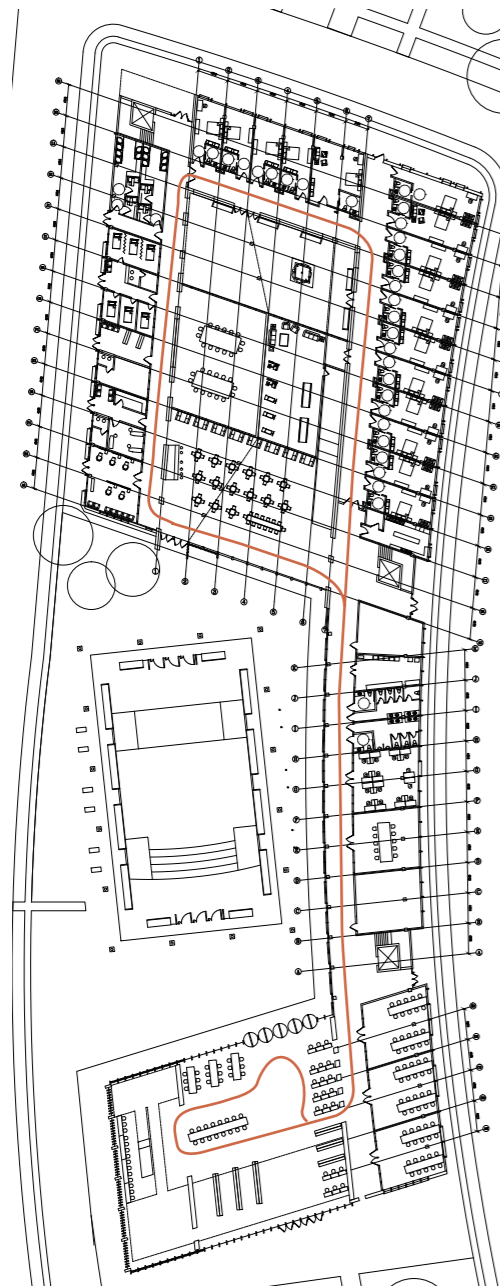

Central courtyard

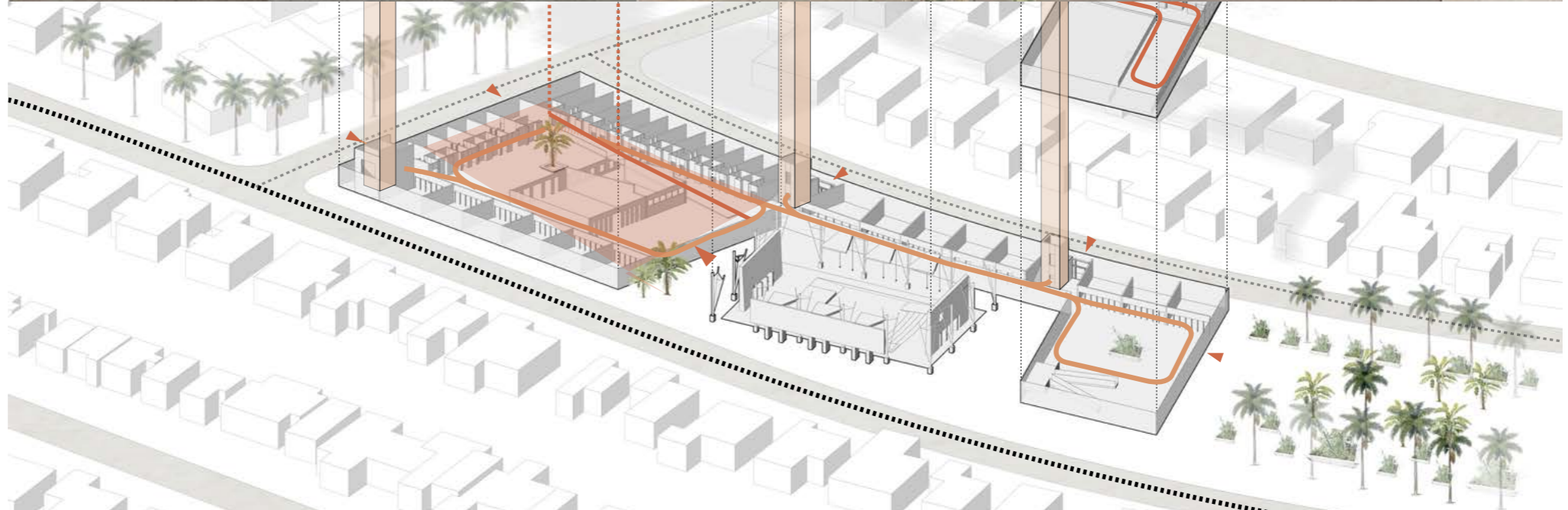
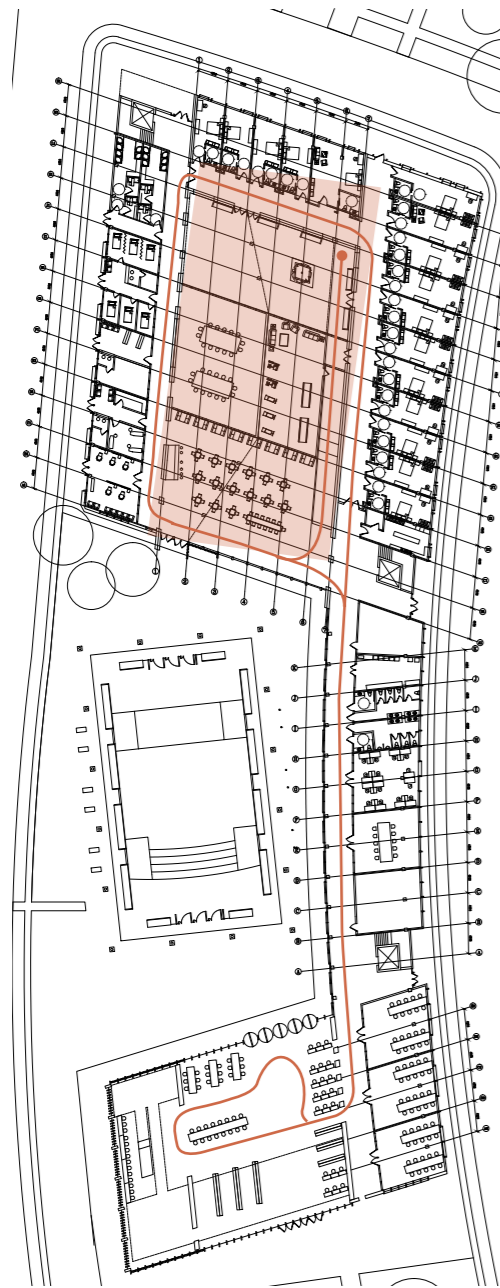

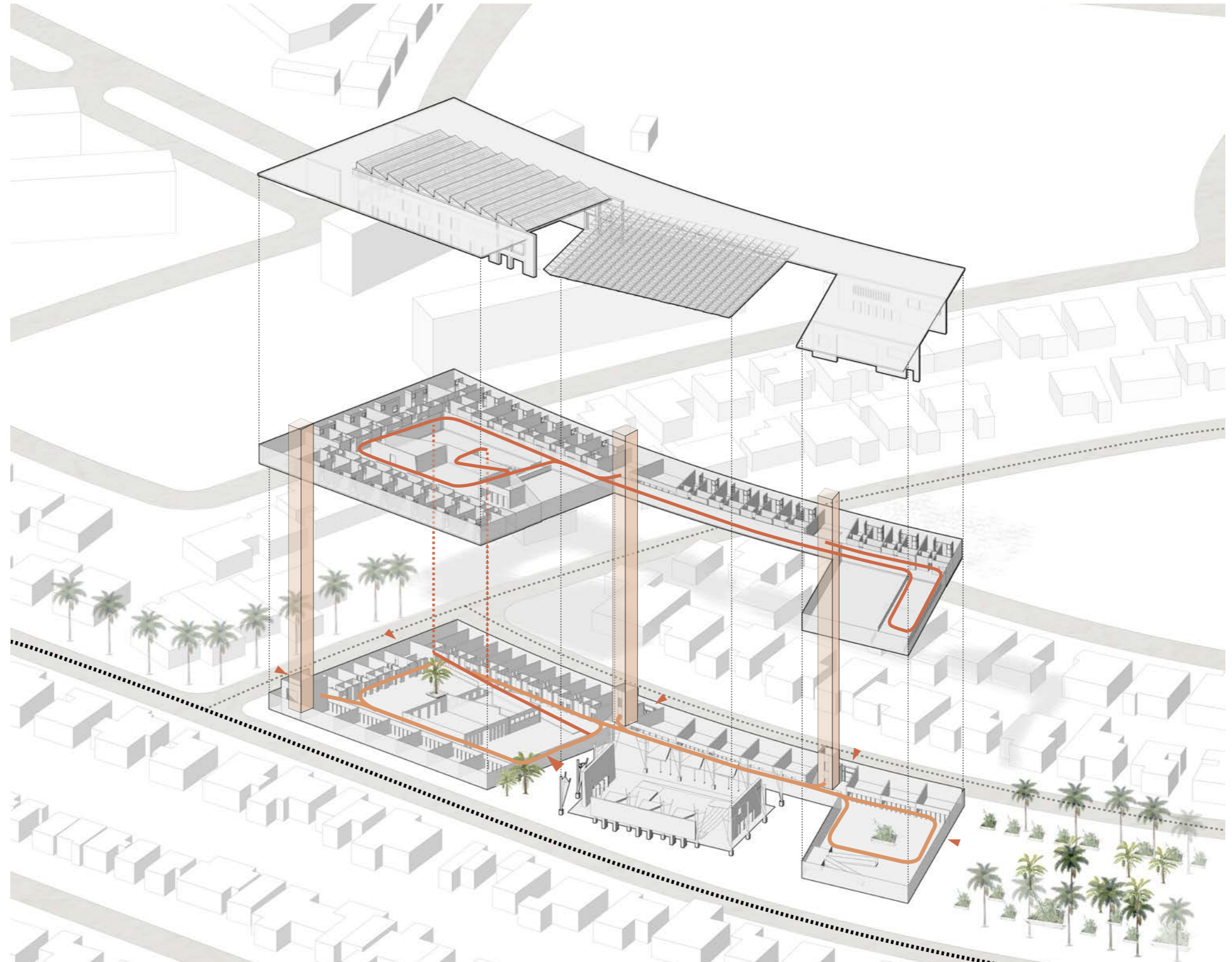
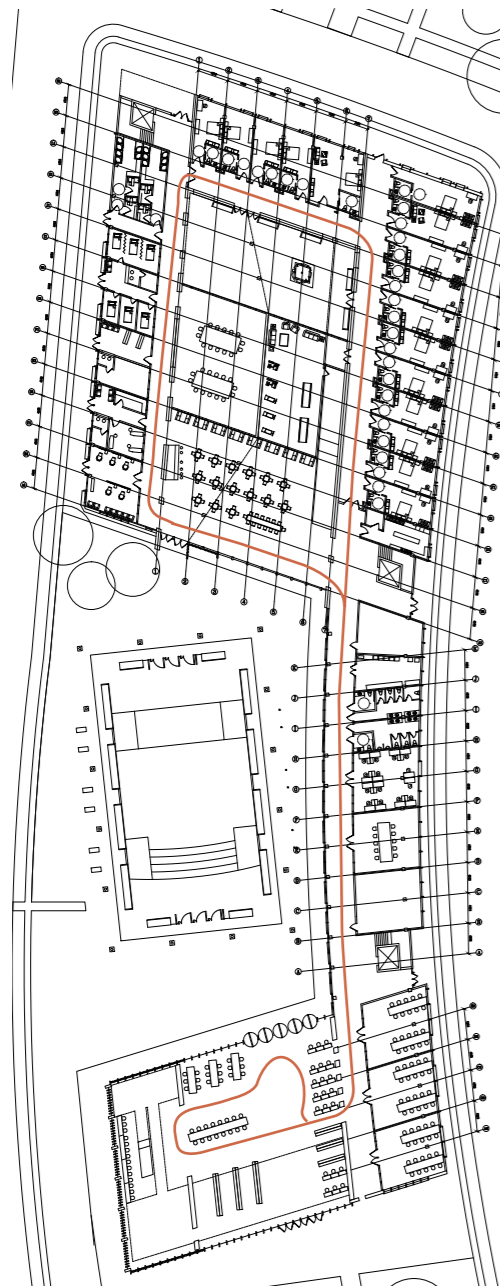

Corridor/Wall as Furniture

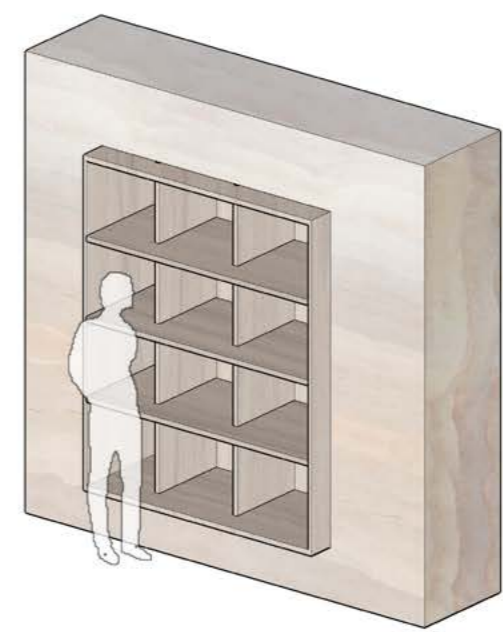
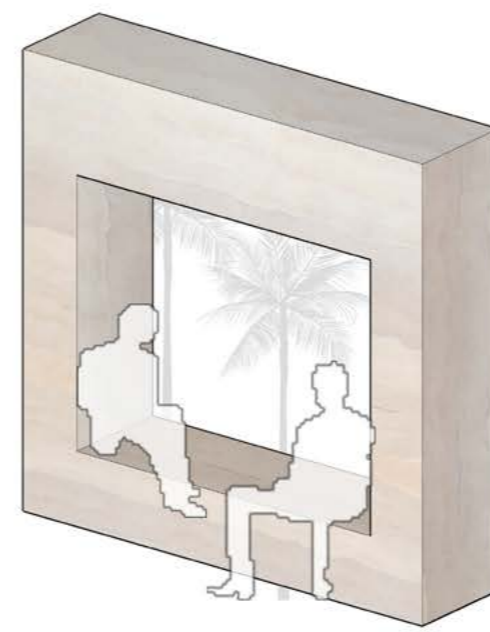
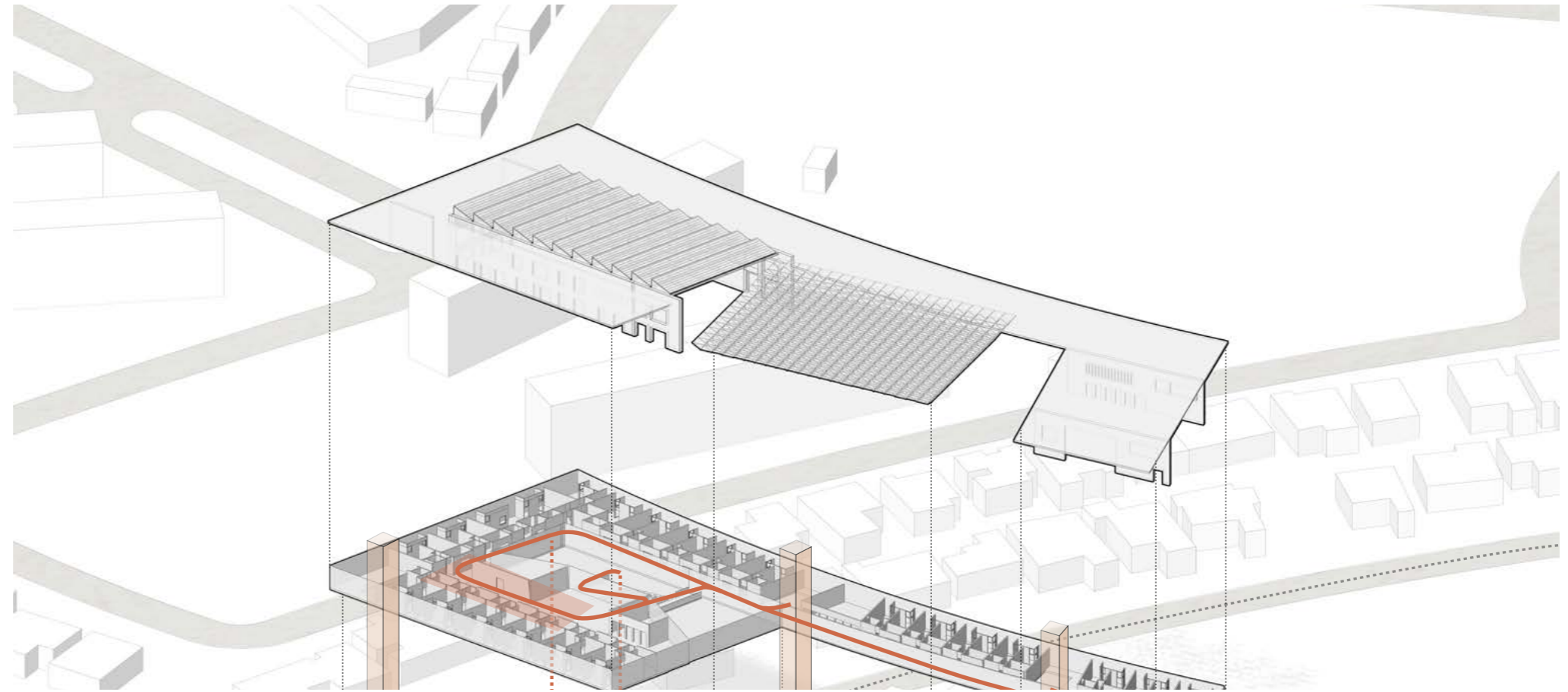
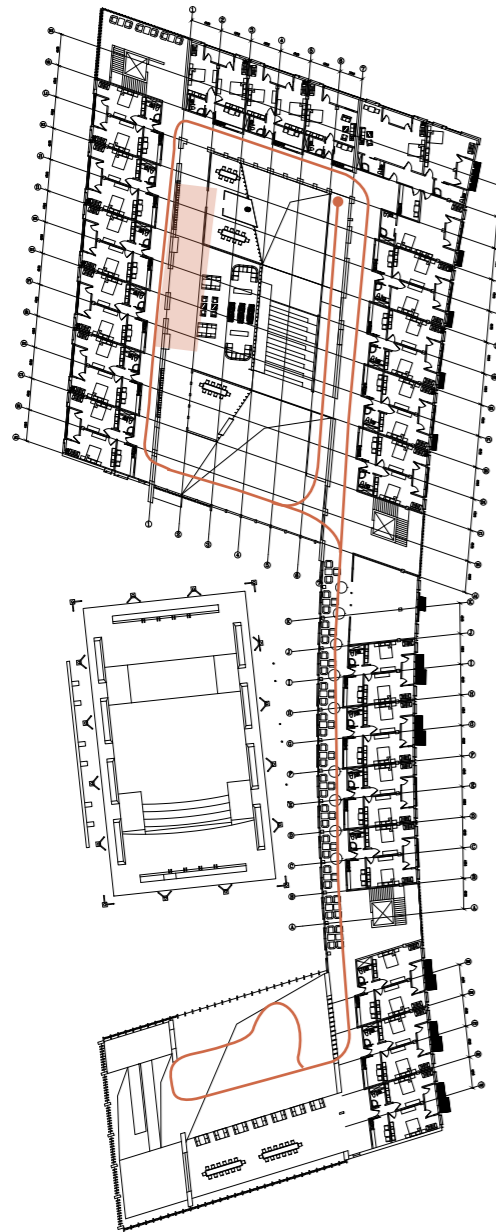

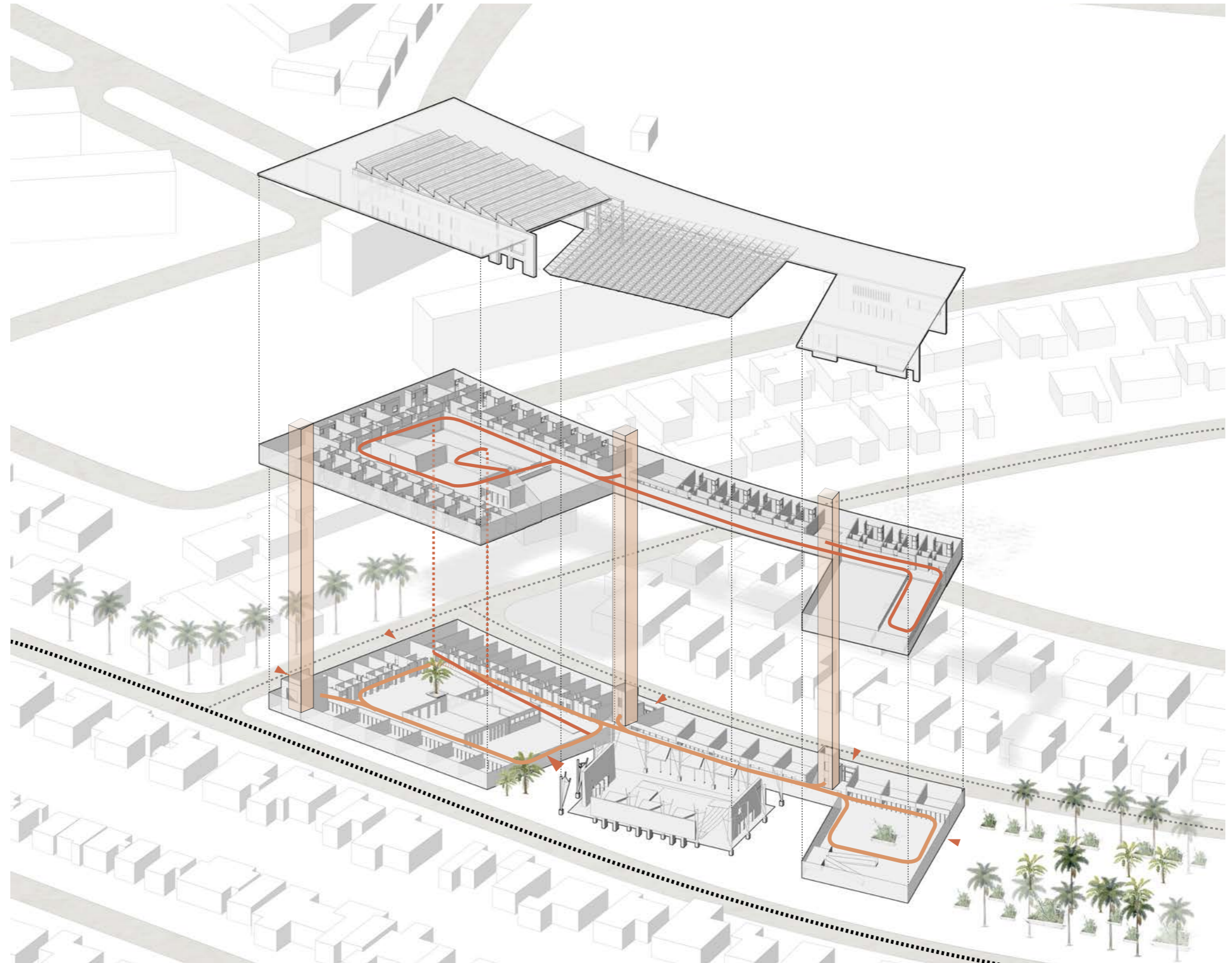
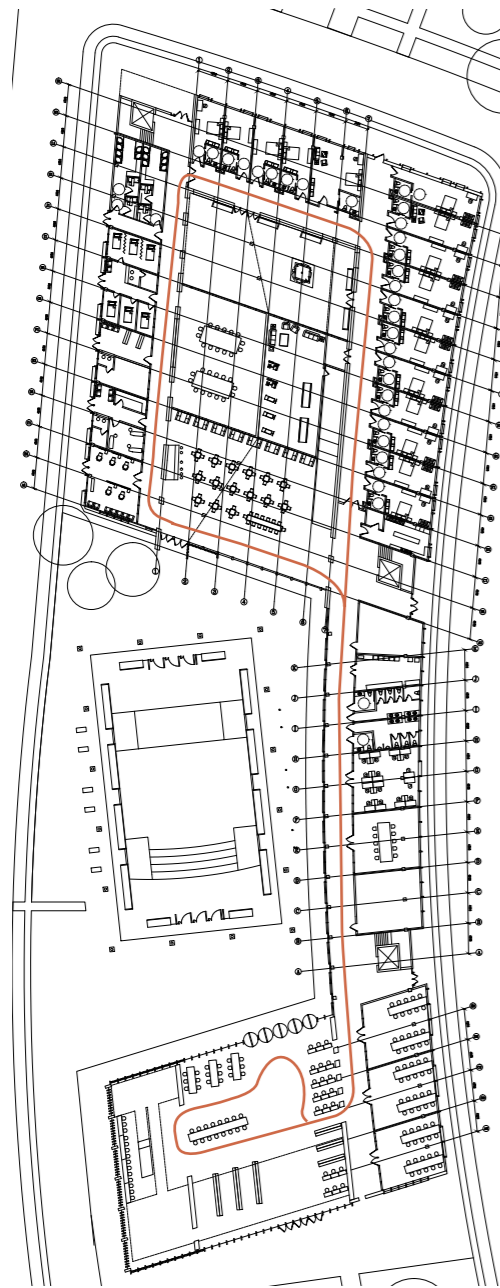

Reflection Room

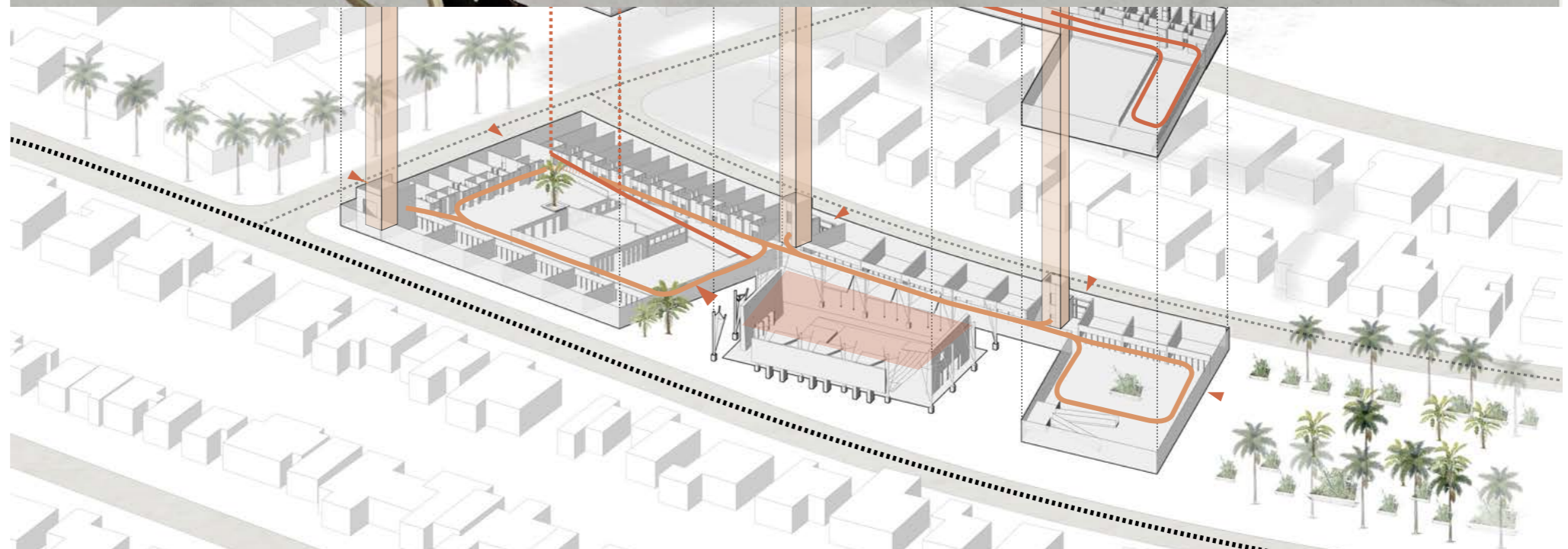
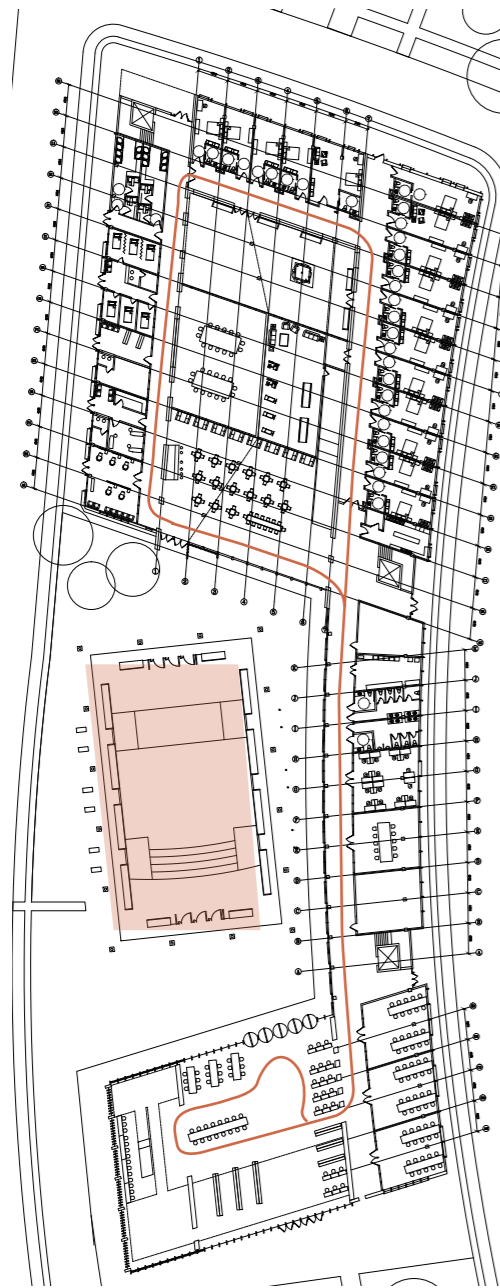

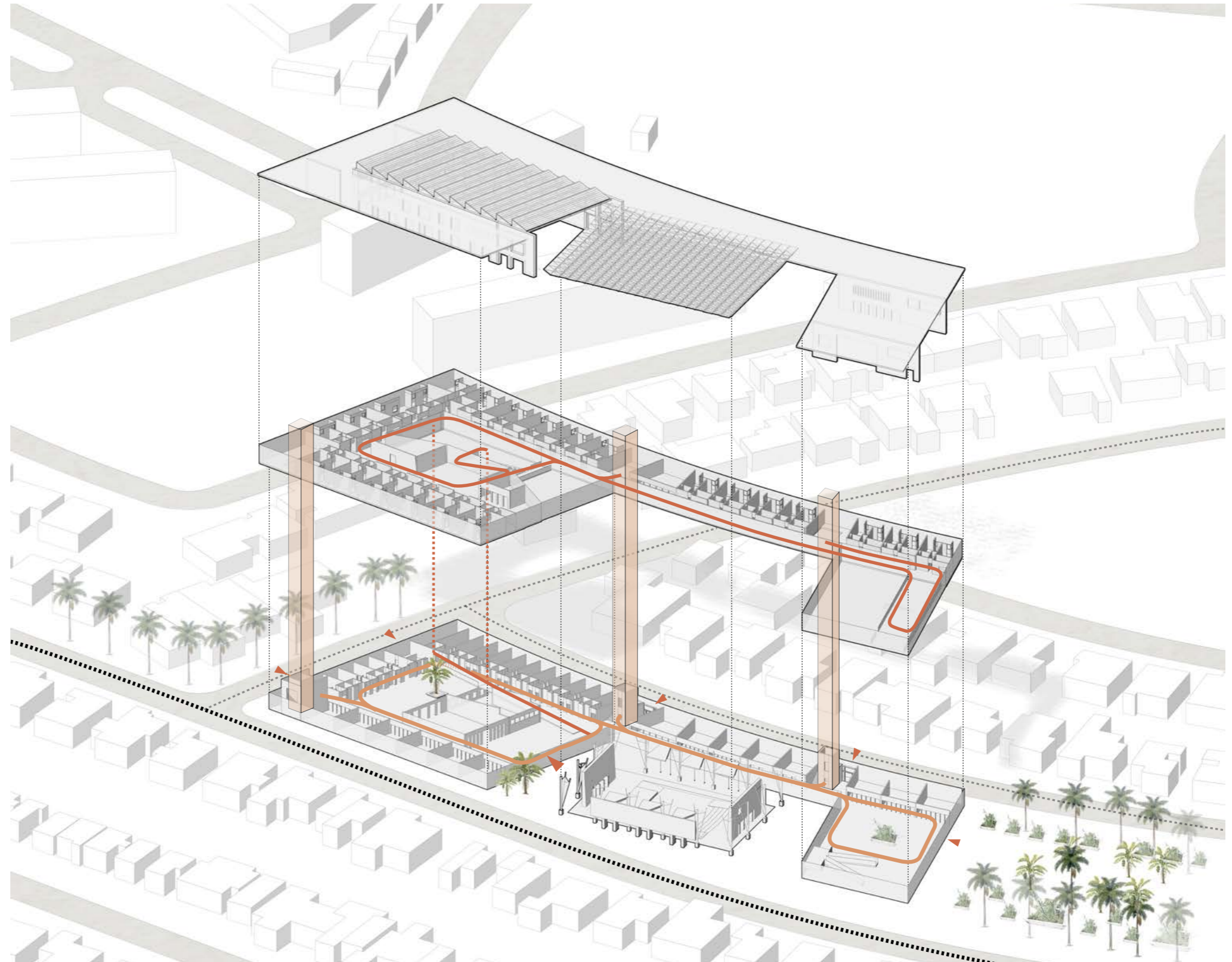
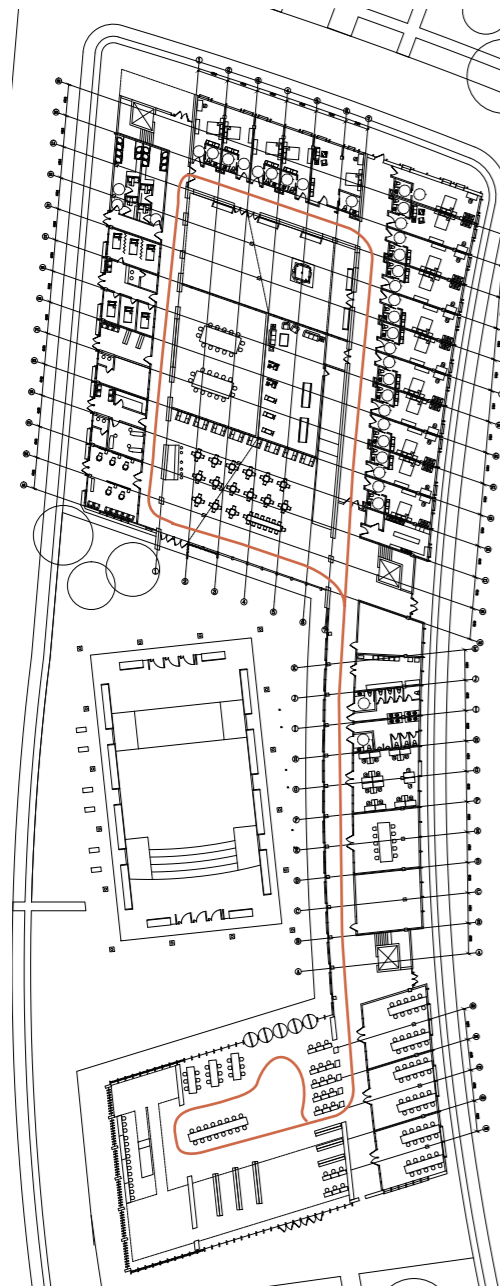

Library

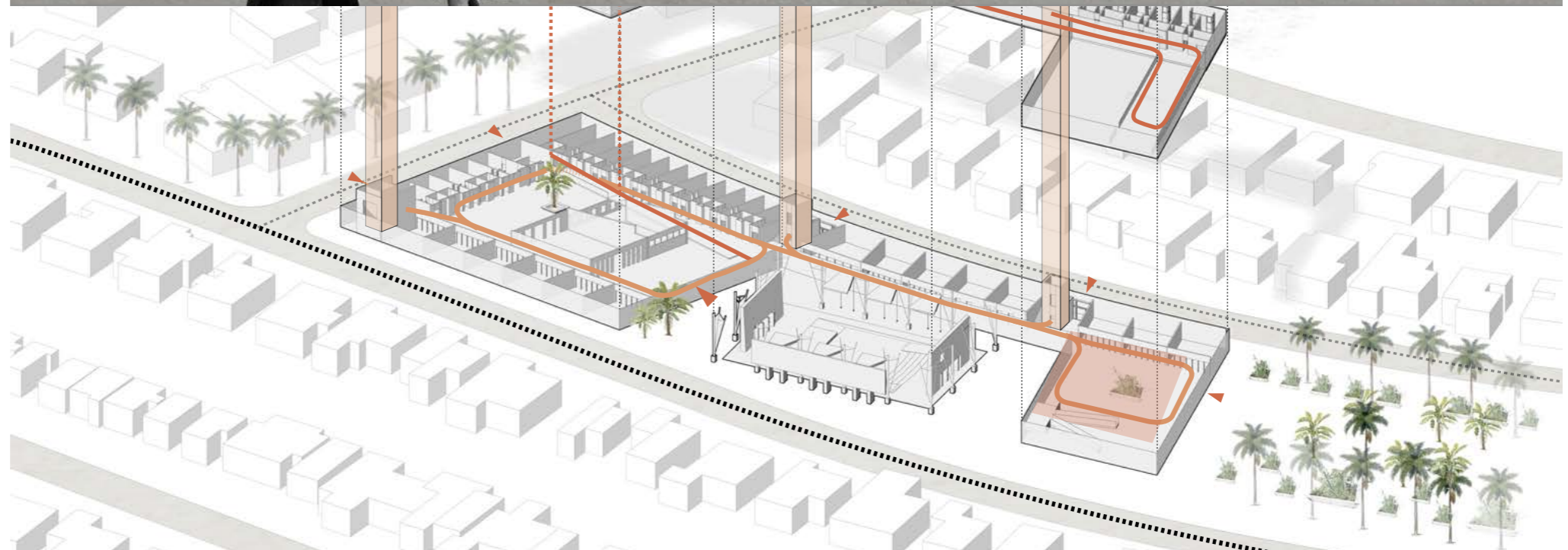
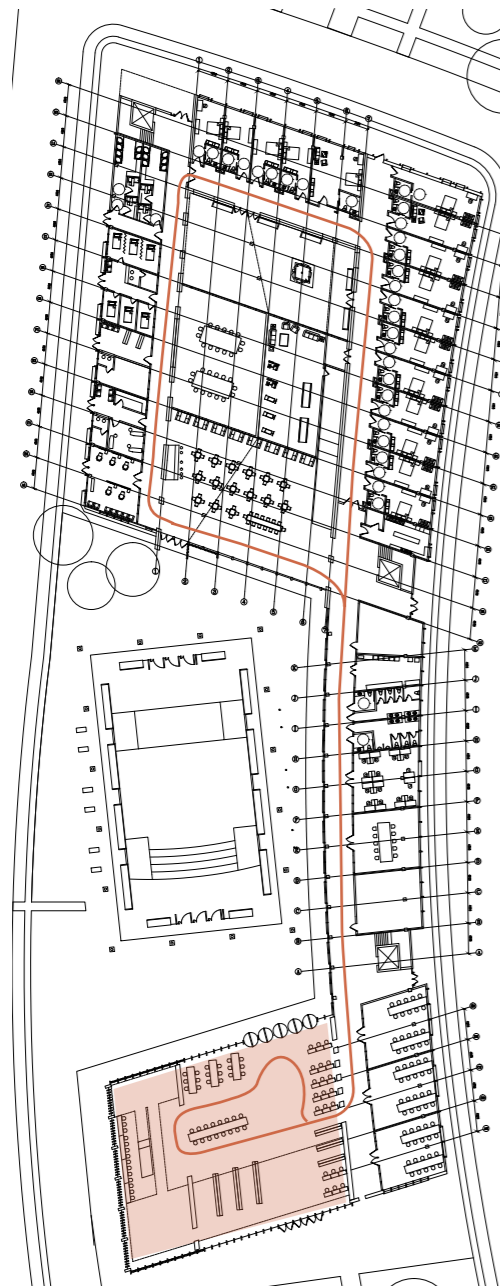

Room unit / Corridor
Hierarchy of living
space

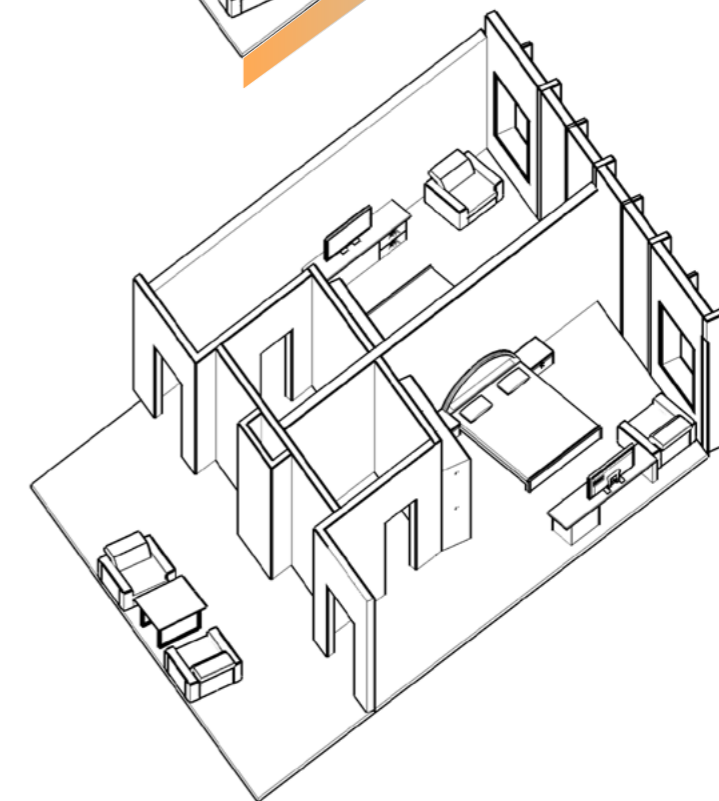
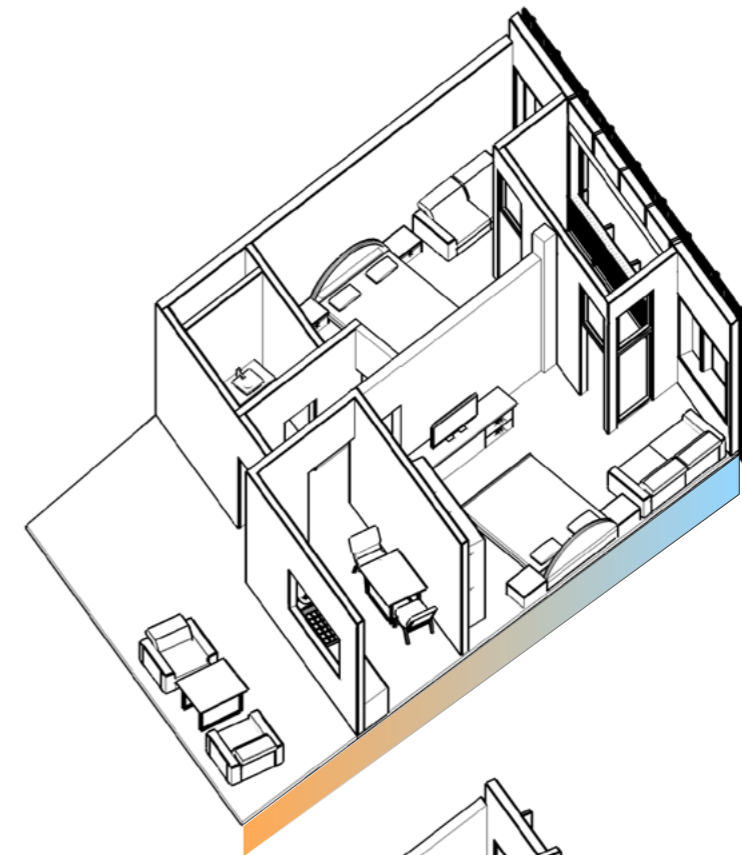
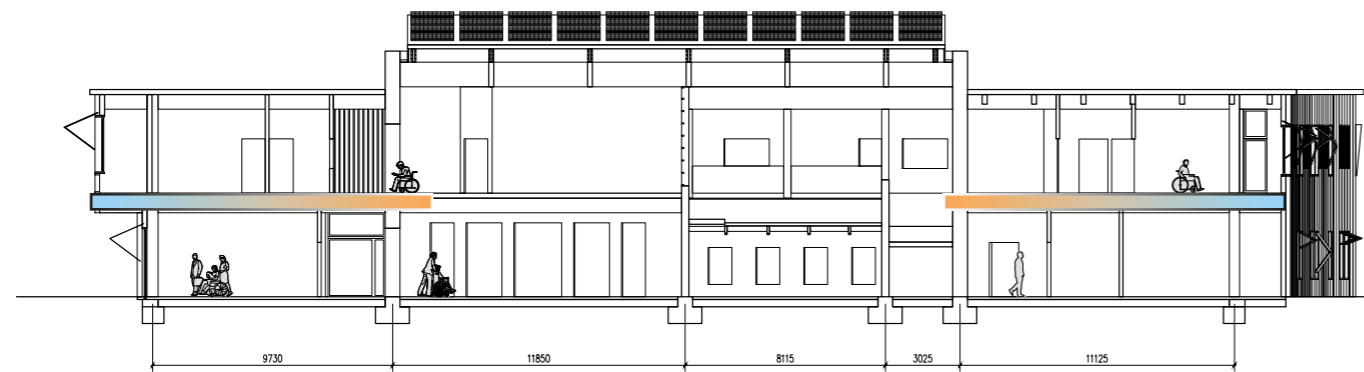

User Density

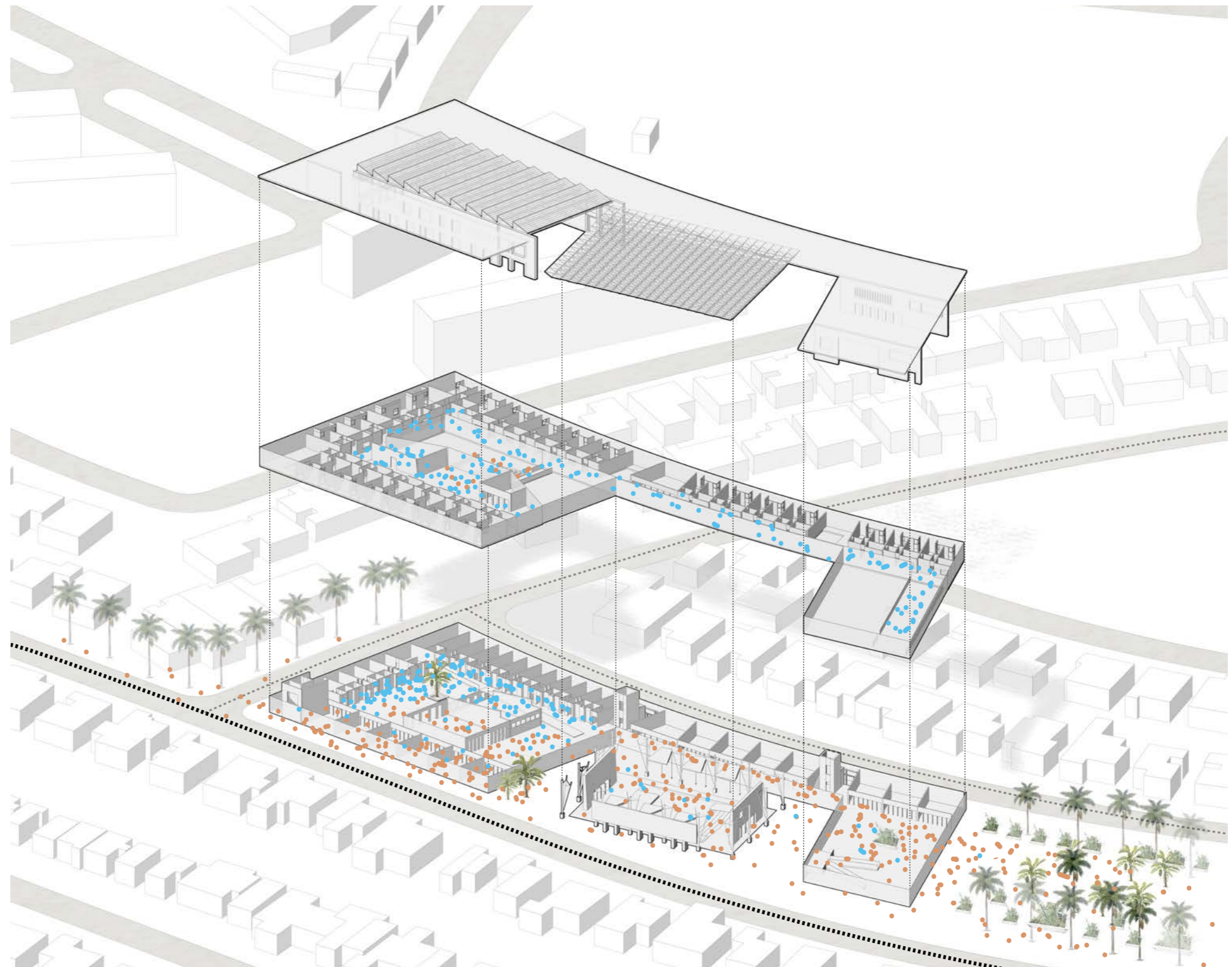

Cantilevering Balcony

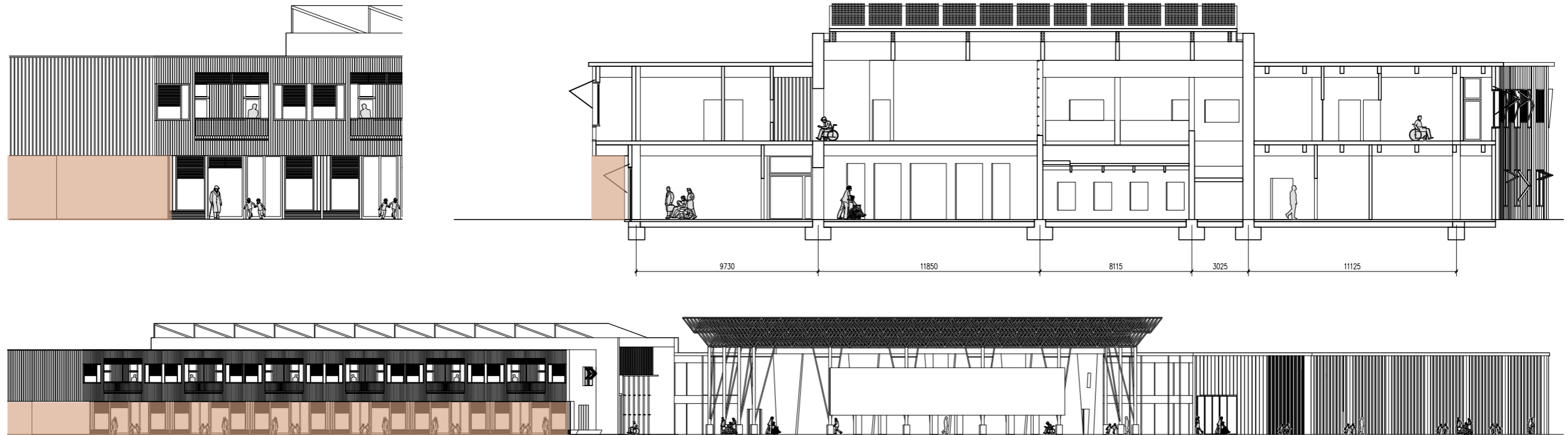

Section/Elevation

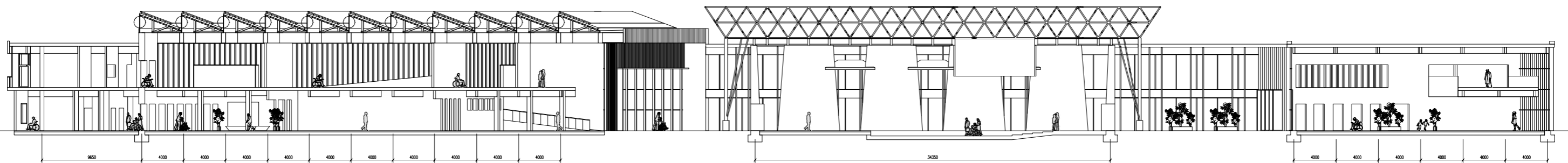
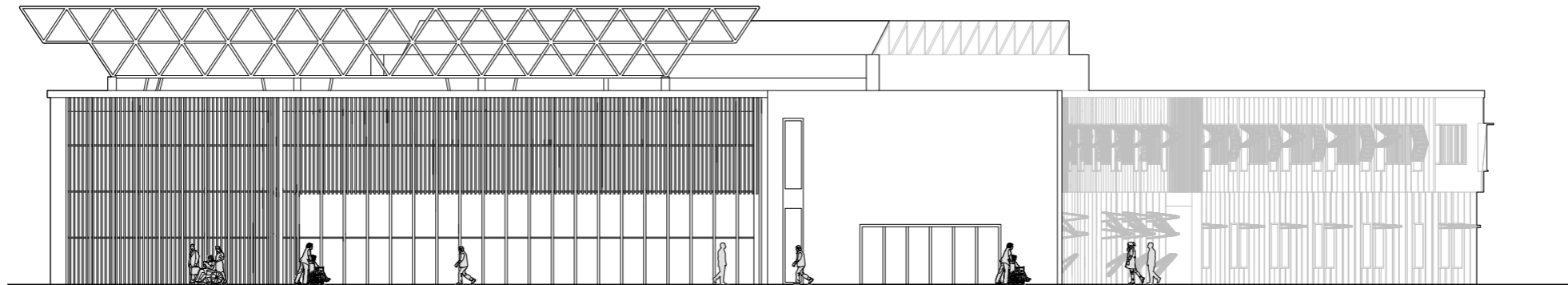

Structure Design

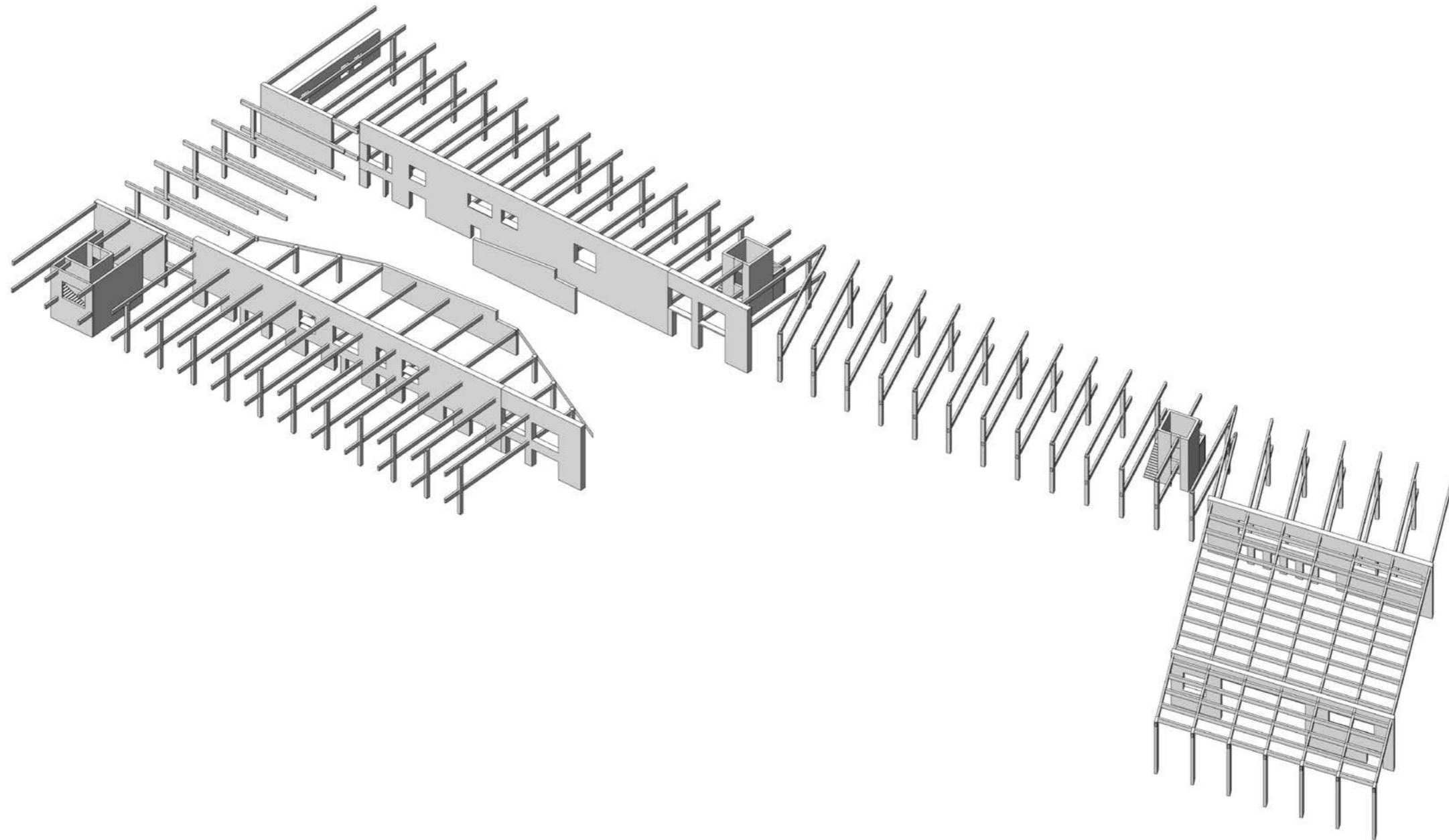

Existing Structure

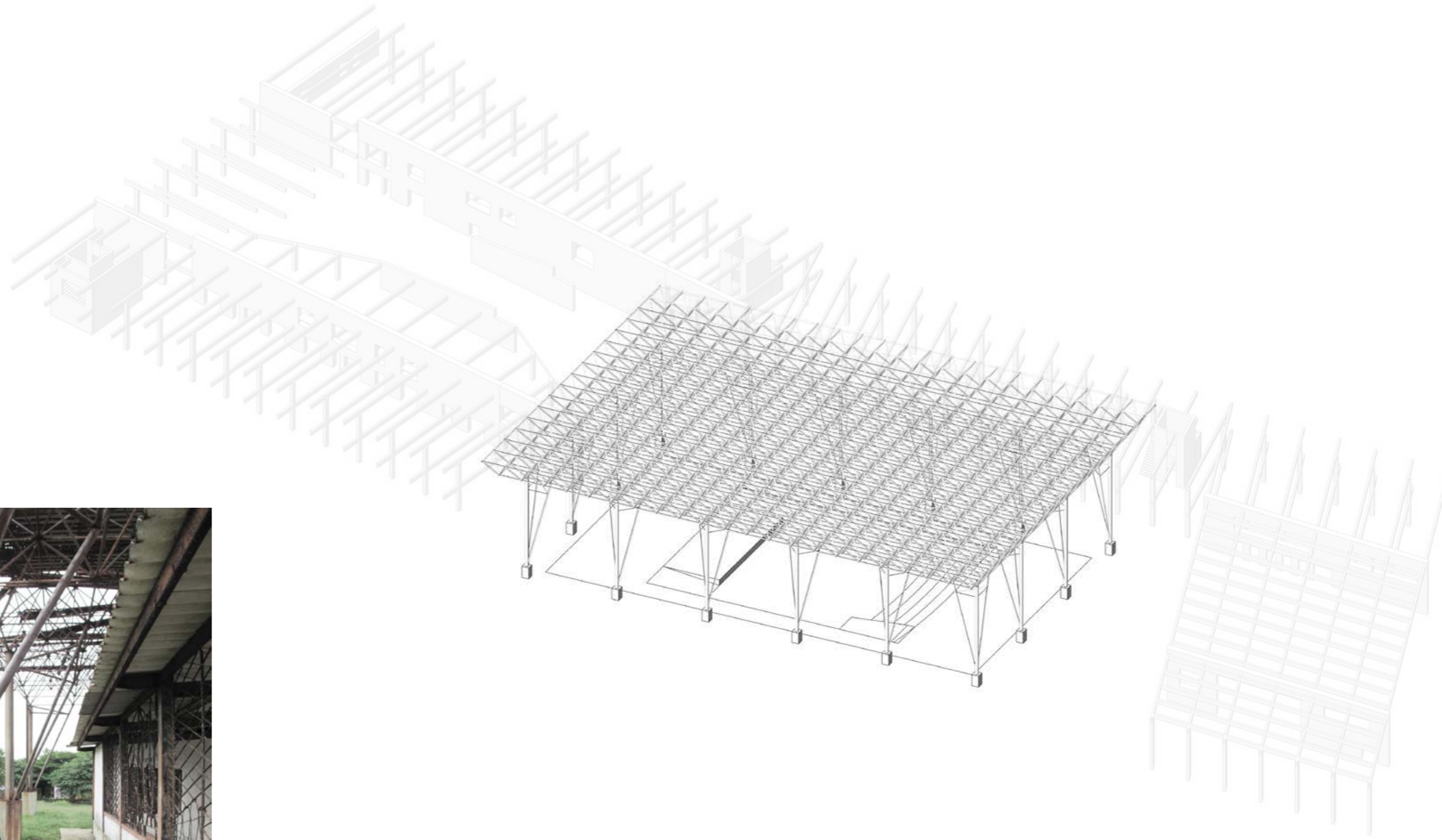

Primary Wall Structure Rammed Earth Wall

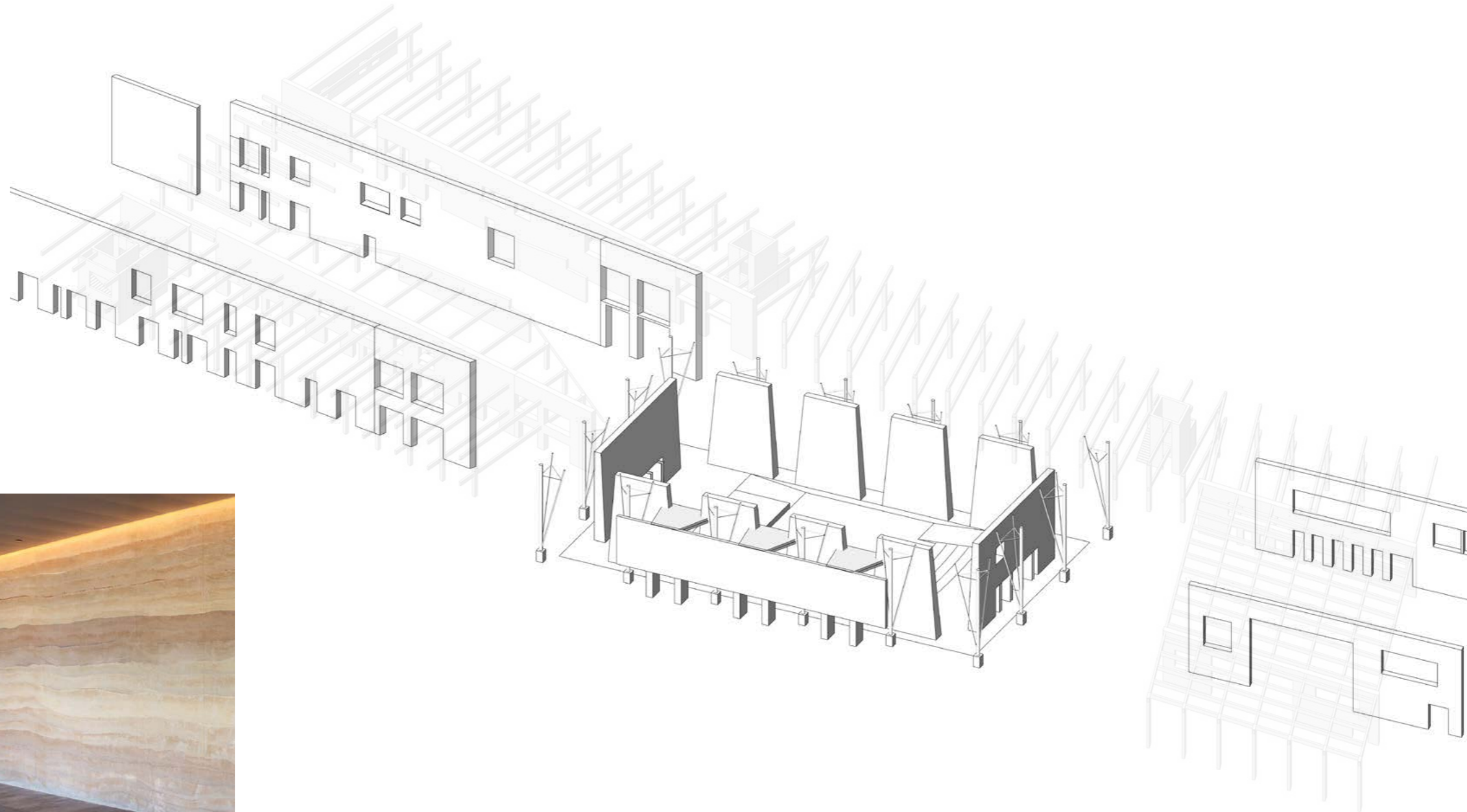

Primary Column Structure Timber Column

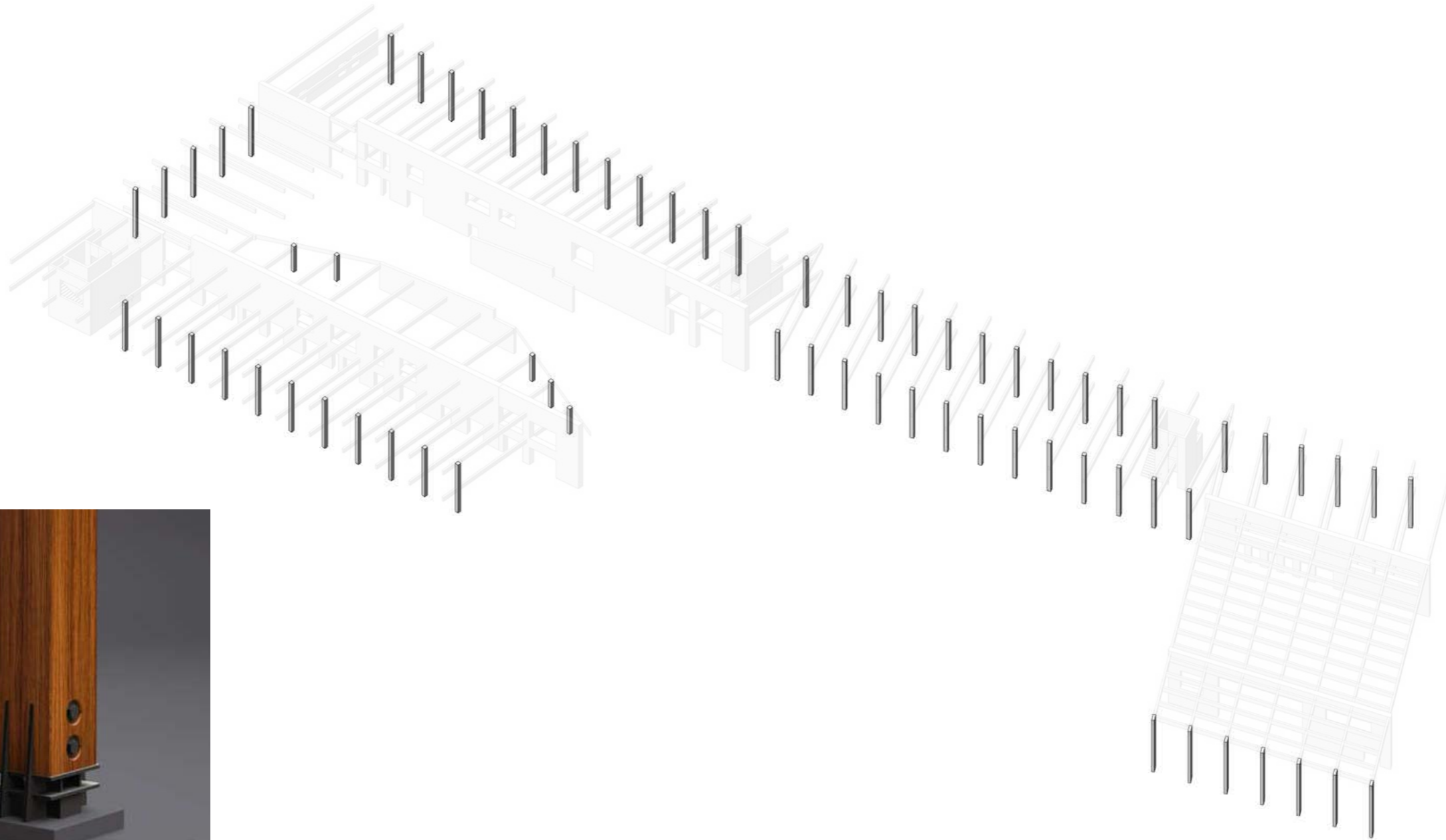

Primary Beam Structure Timber Beam

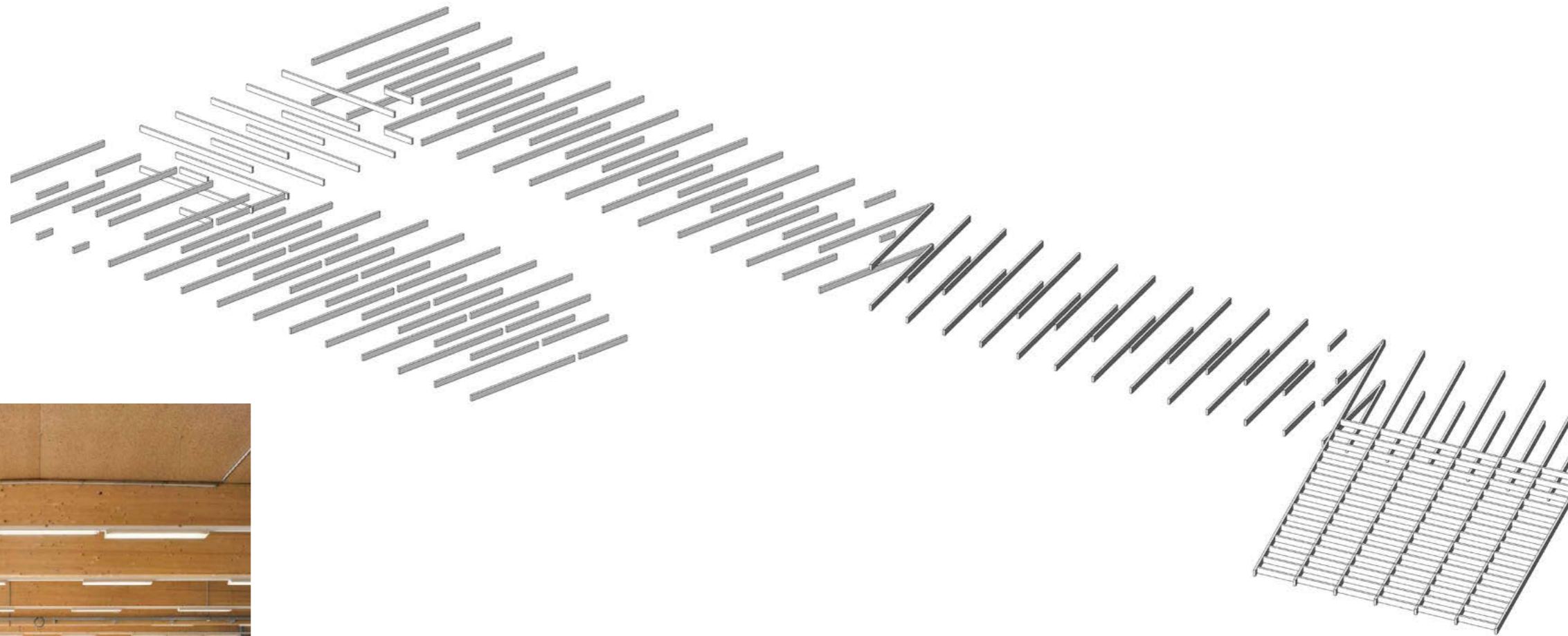

Secondary Floor Structure CLT Panel

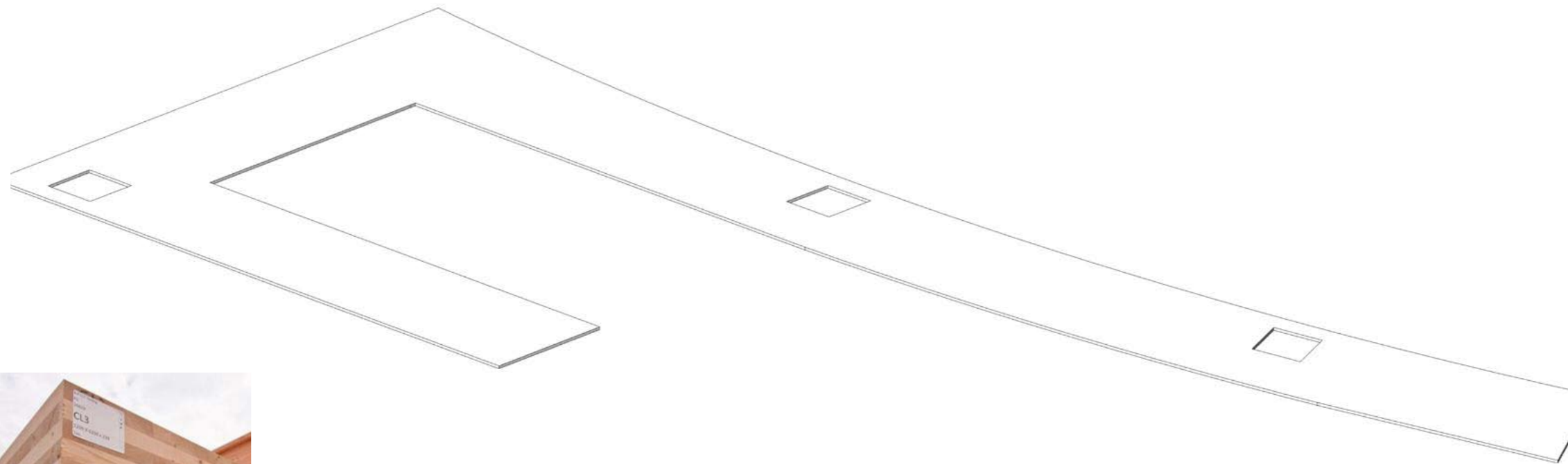

Assambly Scheme

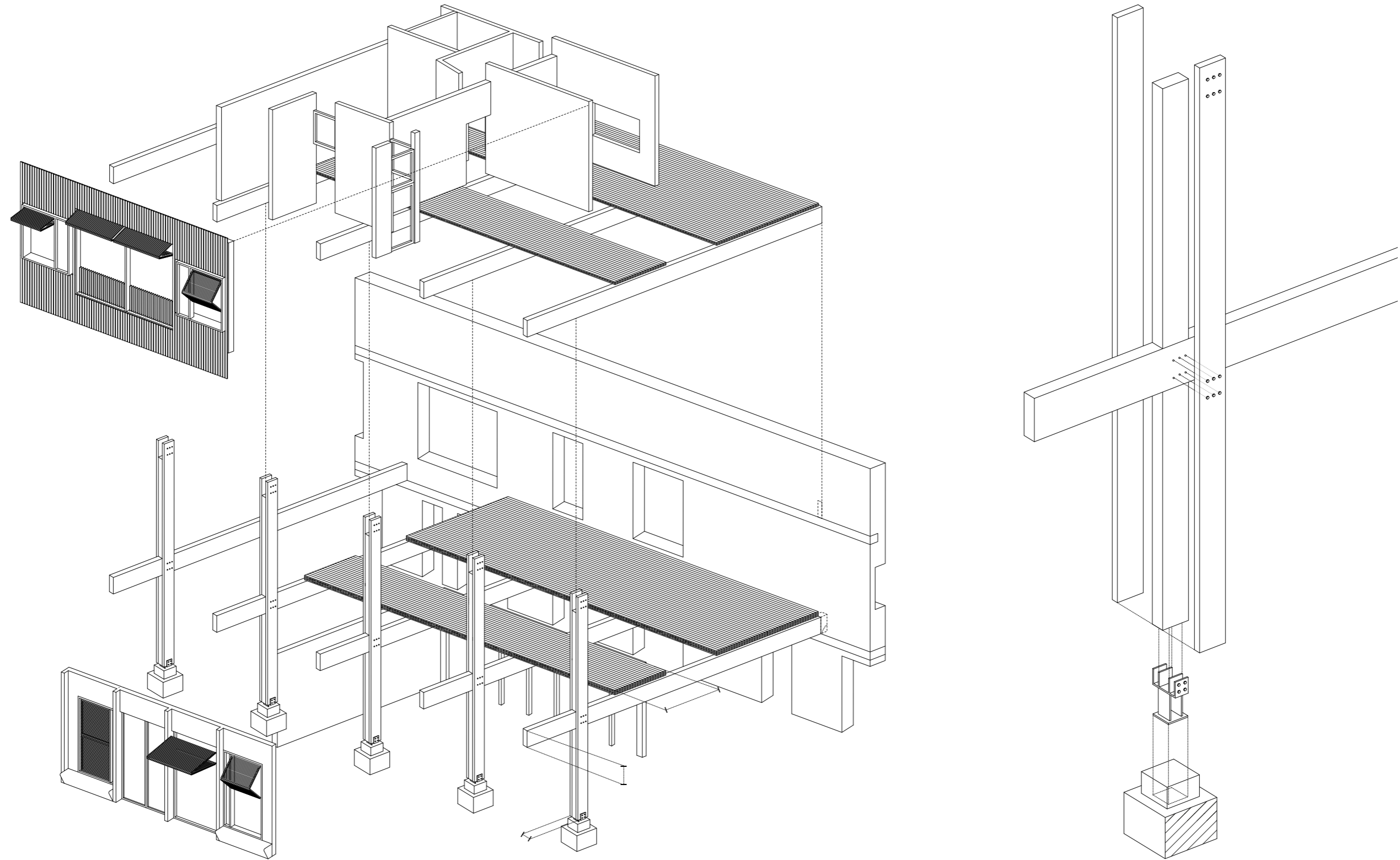

Sustainability Scheme

