

C.L. Montenegro Cardona

Energy flatness in the renovation of Non-residential existing buildings

**Reducing the energy mismatch between demand and supply
in the Gemini south building**

Energy flatness in the renovation of Non-residential existing buildings

Reducing the energy mismatch between demand and supply
in the Gemini south building

By

Cindy Lorena Montenegro Cardona

in partial fulfilment of the requirements for the degree of

Master of Science architecture, Urbanism & Building Sciences

In the track of **Building Technology**

at the Delft University of Technology,
to be defended publicly on Monday 24 June, 2019
at the Faculty of Architecture of Delft University of Technology



Thesis committee:

Dr. Ir. Sabine Jansen,
Dr. Ir. Thaleia Konstantinou,
Dr. ir. Martijn Stellingwerff,
Ir. Vincent Höfte,

TU Delft
TU Delft
TU Delft
ABT Company

Delegate examiner:
Company supervisor:

abt



TU Delft

Faculty of Architecture
Julianalaan 134
2628 BL Delft
Tel: +31 15 27 89805

Contact information

lorenamontenegro03@gmail.com
Tel: +31 6 43 73 84 09

An electronic version of this thesis is available at <http://repository.tudelft.nl/>.

© 2019 C.L.Montenegro

Acknowledgments

Since the beginning of my professional career, I have always been interested in how to make the world a more sustainable place. After my graduation in architecture, the three years working with LEED certification and during this master, I explored topics such as energy zero buildings and building climate design that made me understand the importance of energy performance in buildings in order to achieve a more sustainable world.

That is the main reason for me to choose the topic developed during this thesis. It was not an easy path, but what I can say is that after these 8 months, I have learned more of what I expected and I am ready to share my knowledge in the next step.

I want to thank my three mentors Sabine, Thaleia and Vincent for their guidance and criticism, which were of great value for my work.

Additionally, thanks to Vincent Höfte and Jaap Wiedenhoff that gave me the opportunity to do my research at ABT, I have really enjoyed the atmosphere in the office and appreciate all the people that helped me with their expertise to understand the huge world of the energy performance in buildings.

Furthermore, I want to thank and dedicate not only this research but also all my master degree to the people that have been present during these two years of master. First my family than even in the distance were always sharing their Colombian warmth and love to me. To Benjamin, for the unconditional support which made this path more enjoyable and feasible. Moreover, to all the friends that have been next to me during these two years of adventure.

Looking forward for the next adventure to come.

*Lorena Montenegro
Delft, June 2019*

Contents

Acknowledgments	iv
Contents	v
Abstract	vii
Nomenclature	viii
1 Introduction	1
1.1. Problem statement	2
1.2. Scope of the research	2
1.3. Objectives	3
1.4. Research questions	3
1.5. Research methodology	4
1.6. Energy simulation tool	5
1.7. Design assignment	5
1.8. Boundaries and limitations	5
1.9. Relevance	6
1.10. Organization of the document	6
2 Literature research	7
2.1. Energy	7
2.1.1 The energy chain	7
2.1.2 Renewable energy sources	8
2.1.3 Energy transition	9
2.1.4 Built environment	10
2.1.5 International certifications	10
2.1.6 Dutch policies and regulations	11
2.2. Energy Demand	11
2.2.1. Energy factors	12
2.2.2. Heat Balance & thermal energy demands	14
2.2.3 Electricity energy demand	19
2.3. Solar energy production	20
2.3.1. Solar energy technologies	21
2.4. Energy mismatch	27
2.5. Current approaches for developing sustainable energy for buildings	29
2.6. Complementary energy systems	34
2.7. Conclusions	39
3 Energy flatness	40
3.1. Definition	40
3.2. System boundaries	41
3.3. Assumptions of the energy flatness	44
3.4. Key Performance Indicators (KPI's)	45
4 What is the mismatch in the case study	51
4.1. The case study	51
4.2. Energy model of the existing situation	58
4.2.1 Energy simulation input data	58
4.2.2 Validation of the model of the existing situation	64
4.3. Parameters influencing the energy demand	69
4.4. Current energy mismatch	72
5 How to reduce the mismatch in the case study	75
5.1. Step 1 – Energy demand reduction	75
5.1.1 Feasibility of the demand reduction parameters	75
5.1.2 Output of the proposed renovation	80

5.1.3	Mismatch analysis	82
5.2.	Step 2 – On-site solar energy production	85
5.2.1	Feasibility of the solar energy technologies	85
5.2.2	Output of the proposed technologies.....	88
5.2.3	Mismatch analysis	89
5.3.	Step 3 – Complementary energy system	91
5.3.1	Feasibility study of the complementary energy system	91
5.3.2	Output of the proposed complementary energy system.....	96
5.3.3	Mismatch analysis without the energy storage	98
5.3.4	Energy storage proposal and output	103
5.4.	Final mismatch reduction analysis after the storage	106
5.5.	Conclusions of the final mismatch	110
6	What would the design of the renovation look like	112
7	Which are the parameters and technologies that help to reduce the mismatch.....	125
8	Conclusions.....	128
9	Reflection.....	131
	References	133
	Appendixes.....	136

Abstract

The building sector uses 40% of the primary energy worldwide. Energy demand in a non-residential existing building is rising due to higher comfort conditions, population growth and the enhancement of the building services. On the other hand, renewable energy technologies are every time more accessible for the built environment, especially the ones that use the sun as their primary energy source.

The difference between that energy demand and that production of energy in existing buildings is causing a mismatch of energy that needs to be solved if problems such as an increase in the electricity bills, an oversized energy grid or the dependence on fossil fuels wants to be avoided. Currently there is not research on how to reduce the mismatch in non-residential existing buildings; therefore, this research aims to be the beginning of the exploration of this topic.

By matching the energy demand and the energy produced at any point of time within the building boundary, the building will be energy flat. During this research, the renovation of a case study building towards energy flatness was proposed. A three steps approach was described for existing buildings that want to be renovated towards a full energy balance and a renovation proposal was design for the case study building towards energy flatness.

The first step is to reduce the energy demand; the second is to produce on-site solar energy and third is to achieve energy balance with a complementary energy system that includes energy storage for the renovation of non-residential existing buildings.

The renovation of the building by changing the physical parameters and integrating technologies to transform, produce, store, discharge and distribute energy, were explored during this research through the three steps. As a result, energy flatness in the renovation of non-residential existing buildings is limited to the extent of their physical and functional parameters which restrains the energy demand, production and distribution. Furthermore, the three steps strategy helped to reduce the energy mismatch and is relevant because the energy mismatch problem is going to be every time more visible in the built environment.

Nomenclature

ZEB	Zero Energy Buildings
HVAC	Heating, ventilation and Air Conditioning
DHW	Domestic Hot Water
KPI	Key Performance Indicators
DBD	Dutch Building Decree
EPC	Energy Performance Coefficient
BENG	Bijna Energieneutraal Gebouw
NOM	Nul-Op-de-Meter
EPB	Energy Positive Building
PV	Photovoltaic
PV/T	Photovoltaic / Thermal
BIPV	Building Integrated Photovoltaic
AC	Alternating Current
DC	Direct Current
KPI	Key Performance Indicator
AEF	Absolute Energy Flatness
MMP	Maximum Mismatch Peak
MCEM	Maximum Cumulative Energy Mismatch
HP	Heat Pump
HWT	Hot Water Tank
PCM	Phase Change Material
TES	Thermal Energy Storage
ATES	Aquifer Thermal Energy Storage

1 Introduction

The world is still dependent on fossil fuels as the main energy source, which is leading to environmental issues such as air pollution, acid precipitation, ozone depletion and climate change (Konstantinou, 2014). As a result, the dependency on fossil fuels is putting current and future generations in danger to live on this planet.

Energy consumption has been increasing rapidly since 1990 and it will continue this trend at least for the coming 20 years (Graph 1). According to the World Energy Outlook (IEA, 2017), the world population is assumed to grow from 7.4 billion in 2016 to 9.1 billion in 2040, mostly added to urban areas in developing economies, which will push up global energy demand by more than a quarter as well as increasing the CO₂ emissions.

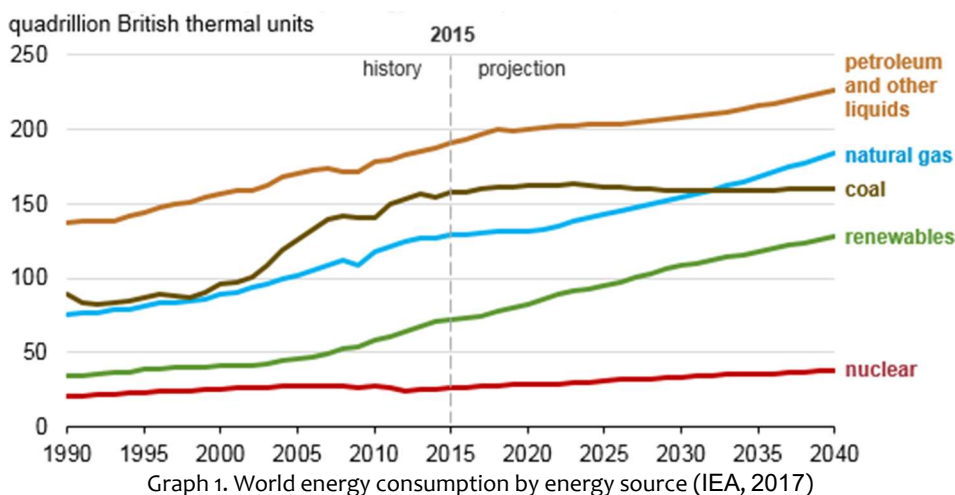

The building sector uses 40% of all primary energy worldwide and emits 36% of the global greenhouse gas emissions. In addition, 75% of the building stock is energy inefficient and about 90% of those buildings, will remain on earth by 2050 (European Commission, 2018). Therefore, the renovation of those buildings is one of the targets of this research.

All sources, except for the renewable ones are going to be depleted in the coming years, leading to an increased use of renewable energy sources. Currently, around 6.6% of the primary energy produced comes from RES (Renewable Energy Sources) in the Netherlands (CBS, 2018b), and it will continue increasing as the target is to produce 16% by 2023 and 100% by 2050.

Therefore, renewable energy technologies need to be integrated into the built environment, and the Dutch government is implementing subsidies in order to make them more accessible for everyone with the aim to reach energy neutrality in all buildings by 2050. Energy neutrality is achieved when the energy needs of buildings are equal to the energy production on the building plot, on a yearly basis.

Nonetheless, solar energy is the most common primary renewable energy source implemented in the built environment. Solar energy comes from an unpredictable and weather dependent source, which results in periods of overproduction or lack of energy production that do not fulfil the demand in short time periods of hours, causing a mismatch between the demand and supply of energy, that is not visible in the energy neutrality balance (yearly basis).

The aim of this research is to develop knowledge on how to reduce that mismatch of energy at a building level. For existing buildings, this is an additional challenge since the potential parameters and technologies are limited to the extent of the renovation. Furthermore, research has been done on how to reduce the mismatch in new residential buildings; nonetheless, there is no research on how to reduce the mismatch in non-residential existing buildings.

1.1. Problem statement

The population growth, the enhancement of building services and high comfort levels and the growing time spent inside buildings have increased the building energy demand (Pérez-Lombard, Ortiz, & Pout, 2008). Solar primary energy supply has also increased in the built environment because of the local subsidies and the reduction in the prices of solar energy technologies (Goorden, 2016); furthermore, solar energy is unpredictable and weather dependent.

The difference between energy demand and energy supply might result in an electricity grid overload in summer or at daytime, or a lack of energy supply in winter, cloudy days or at night, causing a mismatch between energy demand and energy supply (figure 1). This mismatch should be solved to avoid future problems such as an increase in electricity bills, an oversized energy grid or the dependence on other energy sources such as fossil fuels or nuclear energy to provide constant energy.

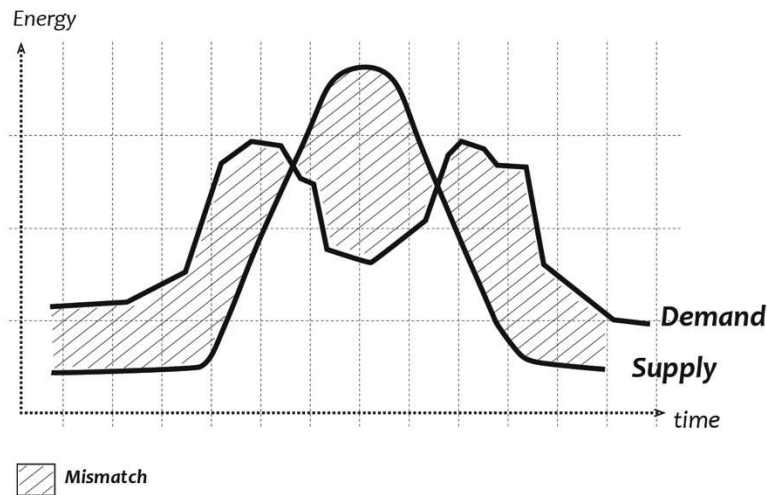

Figure 1. Estimated daily mismatch between supply and demand of energy in a building

Current approaches focus on reducing the demand and on promoting the integration of renewable energy sources, to reach energy neutrality. However, those approaches do not focus on reducing the mismatch between demand and supply. Vincent Höfte did a research on how to reduce of the mismatch in new residential buildings. However, there is no research on how to reduce the mismatch in non-residential existing buildings.

Consequently, this research focuses on the analysis of the possible parameters and technologies that can reduce the mismatch between energy demand and supply in existing buildings that are non-residential, by proposing the renovation of the case study, the Gemini south building in the Eindhoven University of Technology was used throughout the research.

1.2. Scope of the research

This master thesis is a follow up of the master thesis by Vincent Höfte on reducing the mismatch in new residential buildings through architectural design (Höfte, 2018). Nonetheless, 90% of the buildings that are in the built environment nowadays will still exist in 2050. In addition, also non-residential buildings will also have a mismatch of energy that should also be reduced.

Other approaches focus their attention on reducing the mismatch at a neighbourhood level (Ala-Juusela, Crosbie, & Hukkalainen, 2016).

Energy flatness is a new approach towards reducing the mismatch, is a state in which the energy demand and supply match at any time of the year (Höfte, 2018). However, the adaptation of the demand and the supply does not completely reduce the mismatch.

The integration of a complementary energy system including storage, to compensate for the high demand and lack of supply could help to achieve complete energy flatness. Hence, this thesis focusses on achieving energy flatness in existing, non-residential buildings, and includes the effect of the building energy system.

1.3. Objectives

The main objective of this research is to develop knowledge on how to reduce the mismatch between energy demand and supply in non-residential existing buildings. The proposed approach is to achieve energy flatness in the case study, which is the Gemini south building in the Eindhoven University of Technology.

The following sub-objectives during the research will help to reach the main objective.

- a. Understand what is energy flatness and to set the Key Performance Indicators to visualize the extent of the compliance of the energy flatness.
- b. Analyse what is the mismatch in the case study, by understanding what are the main parameters influencing energy demand that can be renovated in an existing building and by understanding what could be the potential solar energy supply for the case study building.
- c. To gain knowledge on the possible complementary energy systems that could bridge the mismatch between demand and supply as much as possible, and that can be integrated into an existing building. Moreover, to propose different steps where the mismatch is reduced based on the energy demand, supply, and complementary energy system.
- d. To propose the renovation of a case study building towards energy flatness.
- e. To analyse until what extent the energy flatness of a case study existing building can help to develop knowledge on how to reduce the energy mismatch of non-residential existing buildings.

1.4. Research questions

To achieve the main objective and drive the research, the main goal is to answer and develop knowledge on the following question:

Which are the parameters and technologies that could help to reduce the mismatch between demand and supply in the renovation of non-residential existing buildings by proposing the renovation of a case study building towards energy flatness?

With this question, the goal is to develop knowledge by proposing the energy flatness of a case study building and then analysing until what extent the energy flatness in one building can help to reduce the mismatch in all non-residential existing buildings.

To answer the main research question, the following sub-questions were formulated:

1. What is energy flatness?
2. What is the mismatch in the case study?
3. How to reduce the mismatch in the case study?
4. What would the design renovation of the case study look like?
5. Which are the parameters and technologies of the case study that can be implemented for the reduction of the mismatch in the renovation of non-residential existing buildings?

1.5. Research methodology

This graduation project follows a process of design through research and the methodology through this research will mainly follow the sub-questions order. First, a background research on what is energy and the current situation of the energy chain in the Netherlands will be developed, as well as, the analysis of the current policies and regulations the local government and other sectors are working on in order to reduce the mismatch.

Second, based on the thesis of Vincent Höfte and research on the complementary energy system, the term “Energy flatness” and its KPI’s will be defined. Third, an analysis of the mismatch in the case study Gemini south building, followed by the literature review and analysis of the parameters and technologies influencing the demand, supply and complementary energy system of the building. Finally, the renovation of the building towards energy flatness will be proposed. In scheme 1 the steps of the research are displayed in order to understand the sequence of the research.

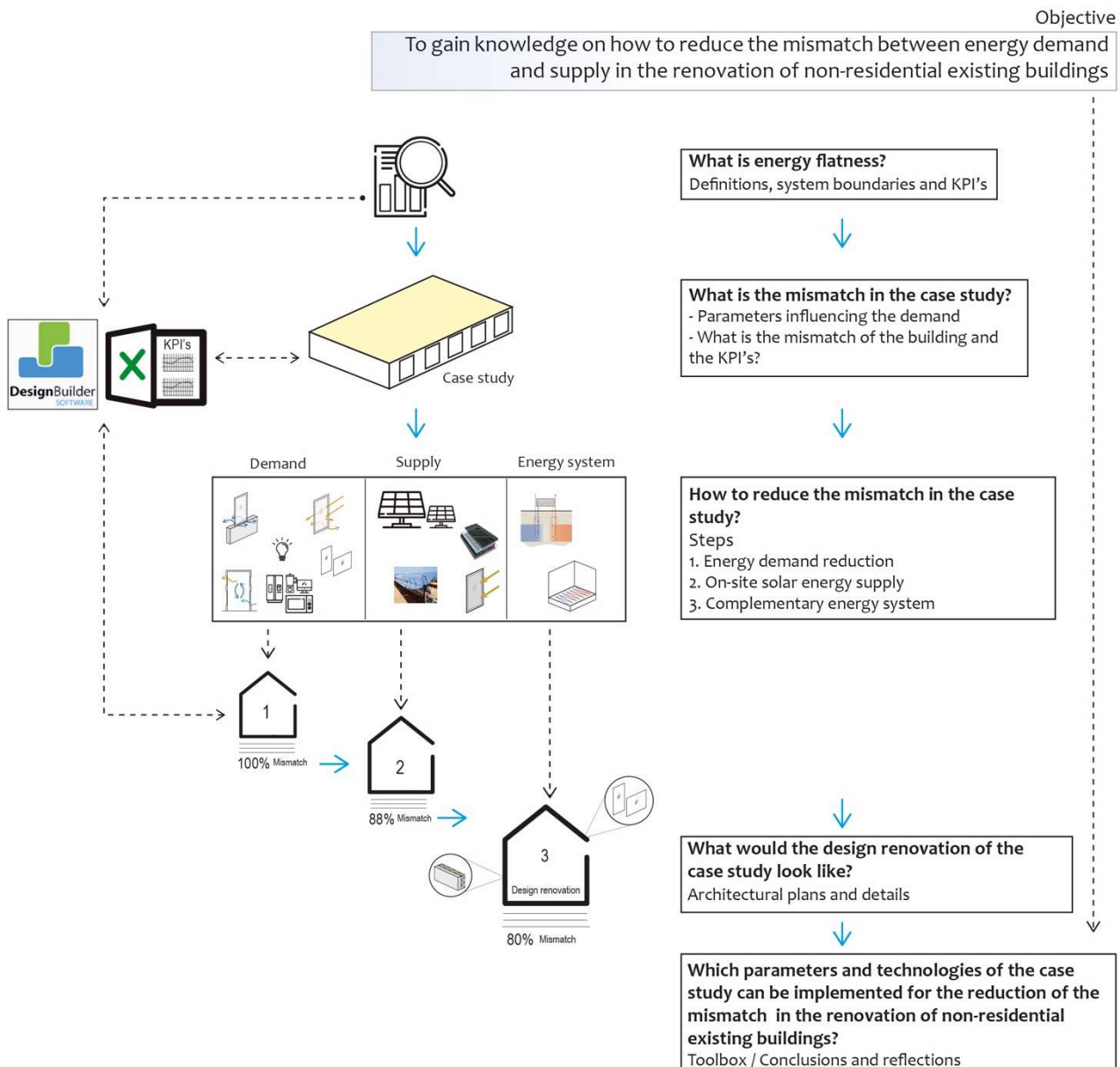

The sub-questions of the research aim mainly to achieve the following:

1. What is energy flatness?

The definition of energy flatness and the system boundaries based on the thesis “Energy-flat housing” (Höfte, 2018), complementing the concept with an energy system that includes energy storage and its Key Performance Indicators (KPI's).

2. What is the mismatch in the case study?

An introduction of the case study building and the typical floor to be analyzed through the research will be developed and the understanding of the following aspects:

- What are the parameters influencing the demand that can be renovated in the case study building?
- What is the mismatch of the case study and what are the KPI's?

3. How to reduce the mismatch in the case study?

Definition of the steps to reduce the energy mismatch.

- Demand reduction.
- On-site solar energy supply.
- Complementary energy system.
- Mismatch reduction analysis.

4. What would the design renovation of the case study look like?

The design proposal of the renovation of the Gemini south building towards energy flatness.

5. Which are the parameters and technologies of the case study that can be implemented for the reduction of the mismatch between demand and supply in the renovation of non-residential existing buildings?

Toolbox of the renovation parameters and technologies that can be implemented in non-residential existing buildings.

1.6. Energy simulation tool

To analyze the energy demand of the building the software Design Builder was used. Design builder is a program used for energy simulations, in which the different properties of the building can be changed in order to visualize the demand adaptations in the building. An excel file has been developed for the analysis of the different technologies of the supply and complementary energy system. In addition, the KPI's of the energy flatness and the different steps were calculated using excel.

1.7. Design assignment

The Gemini south building of TU Eindhoven has been used as a case study to drive the research. The design renovation proposal for the building aims to help to develop knowledge on the main parameters and technologies that can help to reduce the mismatch between demand and supply in existing buildings towards energy flatness.

The building was built in 1974 and is going to be renovated in the coming years, it serves the functions of laboratories and offices of the faculty of mechanical and biomedical engineering. Due to the size of the building and that most of the functions repeat through the floors, only the 4th floor of Gemini south building was analyzed to understand the energy demand, as this part includes the main factors that are interesting for this research. Furthermore, the analysis of the mismatch was calculated for the whole building and well as the design renovation.

1.8. Boundaries and limitations

Boundaries in the research and design are set in order to meet the main objectives of the research in the limited time of the graduation project. The research is limited develop knowledge on how to reduce the mismatch in non-residential existing buildings in the Netherlands. In addition, only the physical and quantitative parameters and technologies will be taken in to account in the research in order to demonstrate with numbers and design proposals the energy flatness concept in the case study. Therefore, the user behavior and demand side management of equipment are for example not part of the scope of the research.

The analysis of the energy demand will only be analyzed for the 4th floor of the Gemini south building in design builder, because it is considered that the parameters implemented in this floor are repeated in the whole building. Furthermore, the results will be extrapolated to understand the total energy demand of the building; additionally, the analysis of the mismatch and the different steps will be calculated for the whole building as well.

1.9. Relevance

Climate change is a common problem worldwide, the existence of future generations is in danger if we do not change our current way of living. The built environment is responsible for 40% of this disaster; therefore, solutions need to be implemented now. The Netherlands want to achieve energy neutrality in all buildings by 2050, energy neutrality alone already has some problems because it does not lead to a balanced energy system.

This research aims to explore the approach of energy flatness in the built environment to solve the mismatch in the Netherlands and elsewhere. Currently not enough is known on how to achieve energy flatness in existing buildings. Therefore, this research will help to gain knowledge on the possible parameters and technologies that can help to reduce the mismatch in non-residential existing buildings.

1.10. Organization of the document

The document has been divided in the following chapters:

Chapter 2. Literature review

Summarizes a research about energy, energy demand, energy supply, the energy mismatch and current approaches and the complementary energy systems for existing buildings.

Chapter 3. Energy flatness

Definition, assumptions, system boundaries and Key Performance Indicators.

Chapter 4. Energy mismatch in the case study

- Description of the case study
- Parameters influencing the energy demand
- What is the mismatch of the building and the KPI's?

Chapter 5. Steps to reduce the mismatch in the case study

1. Energy demand reduction
2. On-site solar energy supply
3. Complementary energy system
4. What is the mismatch reduction?

Chapter 6. Design renovation of the case study

Design renovation proposal, architectural details

Chapter 7. Which parameters and technologies of the case study can be implemented for the reduction of the mismatch in the renovation of non-residential existing buildings?

Toolbox of parameters and technologies

Chapter 8,9. Conclusions of the mismatch in non-residential existing buildings and reflections for future research.

Chapter 10,11. Bibliography & Appendixes

2 Literature research

This graduation project follows a design through research methodology. It is based on two graduation projects elaborated in TU Delft, "Integration of seasonal thermal energy storage in refurbishment projects" (Goorden, 2016) and "Energy – flat housing, towards a continuous balance in the residential energy system" (Höfte, 2018). These two researches tackle the mismatch problem, one by solving the inter-seasonal thermal demand through thermal energy storage and the other one by solving the mismatch in new housing buildings through architectural configurations.

The literature review is divided into six research topics: the first one dedicated to understanding what is energy and the current stage of the energy chain, the second to understand what is influencing the energy demand in an existing building, the third to understand what is the potential solar energy supply for an existing building. The fourth part is dedicated to understand the energy mismatch in the Netherlands and the next chapter to the current approaches to solve it. Finally, the last chapter contains a literature review on complementary energy systems for existing buildings.

2.1. Energy

2.1.1 The energy chain

Energy is a system capacity of work that can be transferred and converted (Konstantinou, Ćuković Ignjatović, & Zbašnik-Senegačnik, 2018). Energy goes through processes of transformation, conversion, transportation and distribution before it is finally used by the building users as is explained in figure 2.

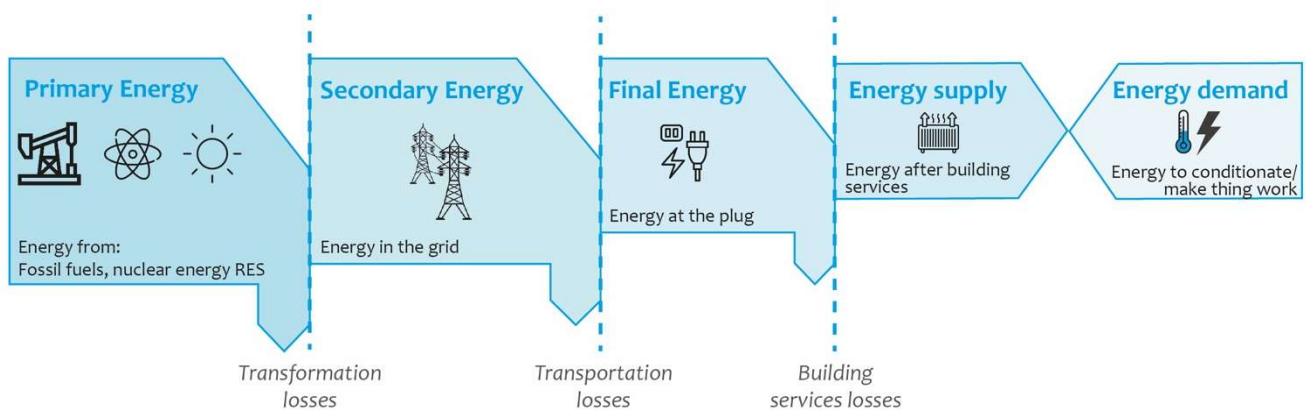

Figure 2. Energy transformation and transportation losses in the energy chain

Primary energy is the energy from renewable and non-renewable sources that has not undergone any transformation, conversion or transportation process (Konstantinou et al., 2018). Within the building sector, primary energy comes mostly from fossil fuels such as coal, petroleum and natural gas that are responsible for the climate change and are going to be depleted in the coming years. Primary energy can also come from nuclear energy sources such as uranium, thorium and plutonium and from Renewable energy sources such as the sun, wind, water or biomass.

Secondary energy is the primary energy that has gone through a transformation or conversion processes and because of that, it has lost a great amount of the primary energy.

Final energy is the secondary energy delivered to a building, also understood as the energy bought at the meter. It is the energy needed to make the different building services of the building work. Final energy covers the energy supplied to the final consumer's door for all energy uses, it thus refers to the energy in the form it is delivered to the consumer: as electricity, gas, or sometimes as heat.

HVAC Energy is the final energy used by the users of a building after the building services. For instance, a boiler will use the final energy entering in the building to transform it into heat (HVAC energy supply) for the building. This is the same as the energy after the building services; therefore, it depends on the efficiency of the building services.

Energy demand is the energy needed in order to condition a space or to make devices to work. Existing building use this energy for heat, cold or to for devices such as lights and equipment. For heating and cooling, this is the heat delivered or extracted to or from a space to maintain the thermal conditions of a space.

2.1.2 Renewable energy sources

Renewable energy sources, also called **renewables**, are energy sources that replenish (or renew) themselves naturally. Typical examples are solar energy, wind and biomass. (Eurostat glossary: https://ec.europa.eu/eurostat/statistics-explained/index.php/Glossary:Renewable_energy_sources)

In the Netherlands, only 6.6% (138 petajoules) of primary energy came from renewable sources, of the 2,100 petajoules (PJ) in 2017 (CBS, 2018b). The CO₂ released from the combustion of 1 PJ of gas, oil or coal is about 57, 73 and 94 kilotonnes respectively, therefore, total CO₂ emissions are about 114 Mt (PBL, 2011). Figure 3 shows the renewable energy supply for the Netherlands since 2000. Most of the renewable energy has been used for heat and electricity.

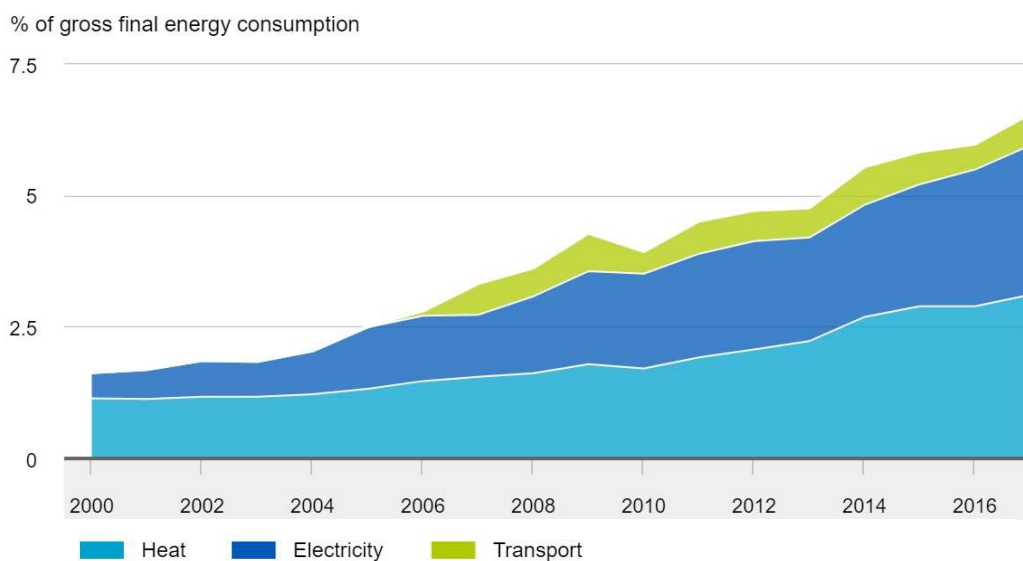

Figure 3. Renewable energy consumption in the Netherlands
Source: Centraal Bureau voor de Statistiek (CBS, 2018b)

The target is to have a supply of primary energy by RES of 14% by 2020, and the government already knows that this goal will not be met, because the Dutch foundation 'Urgenda', which aims for a fast energy transition, have sued the Dutch government for not implementing stringent climate policies in order to achieve energy agreements. They won the case in June 2015 (BBC News, 2015).

It is estimated that the 16% share of renewable sources by 2023 is more realistic. In any case, subsidy schemes are the chief means for achieving this target, and this measure will contribute to the creation of green jobs and green economic activity in the country (Ministry of Economic Affairs, 2016).

Energy from renewable sources is mainly used to generate heat, electricity, and transport. In 2017, nearly half of renewable energy consumption was destined for heat, over 40% for electricity and 10% for transport (CBS, 2018b). Biomass was the most common renewable source in the Netherlands in 2017 as figure 4 is showing.

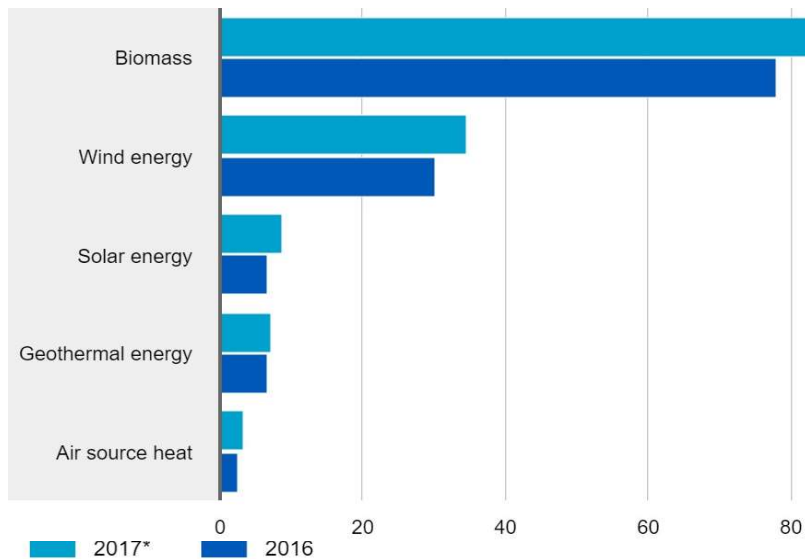

Figure 4. Renewable energy consumption by source in PJ in the Netherlands
Source: Centraal Bureau voor de Statistiek (CBS) 2018.

Nonetheless, in order to use biomass as the primary energy supply for a building, a great amount of biomass is needed, which can usually not be produced on the building site. Biomass is, therefore, not considered for energy flatness on building site.

In addition, wind energy production rose by 15% (35PJ). The installation of offshore wind turbines with a total capacity of 600 MW in the second half of 2016 led to a substantial rise in production levels. However, offshore wind, as well as photovoltaic farms, do not contribute to energy neutrality, because this term is only reached at building level (Ministry of Economic Affairs, 2016). Wind turbines for single housing supply are not convenient, as this technology requires a lot of space and it is not commonly used in single buildings, among other considerations.

2.1.3 Energy transition

The main problem with the energy used nowadays is the huge impact on climate change due to the CO₂ released to the atmosphere by the extraction, transformation, and distribution of energy processes. The Paris Agreement has set some requirements in order to hold the increase in the global average temperature to well below 2°C, recognizing that this would significantly reduce the risks and impacts of climate change worldwide (United Nations, 2015)

These requirements and policies from different governments and societal actors have to be developed along many years, this period of change is called “the energy transition period”, and every country must have a plan to work on the global target for 2050.

According to the Energy report, the main objective during this energy transition period is to achieve a CO₂ neutral supply system by 2050. Therefore, the Dutch government will need to implement strategies such as energy conservation, clean electricity production and the capture and storage of CO₂ (CCS) (Ministry of Economic Affairs, 2016).

Currently, The Netherlands is still dependent on fossil fuels for almost 94% of the primary energy supply. According to the energy report there will be no place for new coal-fired power plants in this transition, in addition, price reduction incentives will ensure that operators of coal-fired plants take measures to reduce their emissions by implementing carbon capture and storage systems (CCS) or even shutting their plants down (Ministry of Economic Affairs, 2016)

Moreover, the extraction and exportation of natural gas have been contributing to the national wealth of the country. But, due to the earthquakes in Groningen in 2012, gas extraction has been reduced by almost half between 2013 and 2017 (CEER, 2018). Therefore, a shift in the natural gas consumption must be implemented, giving even more importance to the electrification scenario and the introduction of renewable energy sources such as solar panels for building implementation (Ministry of Economic Affairs, 2016)

2.1.4 Built environment

It is estimated that the building sector uses 40% of all primary energy worldwide and produces 36% of the global greenhouse gas emissions (United Nations Environment Programme).

The European Energy Performance of Buildings Directive (EPBD) has the ambition to achieve energy neutrality for all the new buildings from 2021. But, the biggest task is to provide low-carbon heating for existing buildings, taking into account that 90% of the buildings that are built environment nowadays will remain on earth by 2050 and that the main goal for the existing built environment is to be nearly energy neutral.

About 35% of the European Union buildings are over 50 years old and almost 75% of the building stock is energy inefficient (European Commission, 2018). In addition, according to the International Energy Agency, energy demand in buildings could increase 50% by 2050 if additional energy efficiency measures are not taken, therefore, a strict energy transition period in order to reduce the energy consumption needs to be implemented (JLL & AKD, 2018)

Consequently, the renovation of buildings and complexes is needed, the challenge is to provide an efficient energy system that will not depend on fossil fuels or any other non-renewable source and for existing buildings, this drives to the ambition to become energy neutral nowadays (A. a. I. Ministry of Economic Affairs, 2011).

Energy Neutrality

Energy neutrality is achieved when the energy needs of buildings are equal to the energy production on the building plot, on a yearly basis (kWh/year). Offshore wind and photovoltaic farms do not contribute to energy neutrality, because this term is only reached at building level.

International and national certifications, policies, and agreements have been set in order to achieve this goal. The European Parliament set as a minimum requirement that by 31 December 2020, all new buildings must be zero-energy buildings; and the targets for all existing buildings must stimulate the transformation of buildings that are refurbished into nearly zero-energy buildings by 2050.

However, energy neutrality does not guarantee a continuous energy balance, because this term focuses on matching the energy demand and supply on a yearly basis, but does not count that on one hand, energy demand depends on many variables that makes it variable in time, which makes it unpredictable in short periods of hours. On the other hand, the supply of energy for the built environment mostly comes from the sun, making the supply also unpredictable and weather-dependent; causing a mismatch in short periods that is not visible in the yearly balance.

Nevertheless, The Dutch government introduced policies and regulations to ensure the compliance of the energy neutrality. A completely energy-neutral building has an EPC (Energy Performance Coefficient) of zero and is nearly energy neutral when the EPC is almost zero.

2.1.5 International certifications

Not only the Dutch government, but also the European community has the goal of achieving energy neutrality in all buildings. BREEAM and LEED are the most common international certifications that have their own chapters for energy efficiency and intend not only to promote the integration of renewable energy systems to allow for self-sustained buildings but also the reduction of energy consumed in existing buildings.

LEED (Leadership in Energy and Environmental Design) has 20% percent of all points allocated to building energy efficiency and emphasizes on enhanced building commissioning for greater energy and operational performance. In addition, it integrates benefits for smart-grid thinking through an option that rewards projects for participating in demand-response programs (USGBC, 2016).

BREEAM (Building Research Establishment Environmental Assessment Method) encourages the specification and design of energy efficient building solutions towards a reduction of carbon emissions, a 16% can be achieved for an energy efficient design from the 70% needed to become BREEAM excellent (BREEAM, 2019).

These certifications are mainly implemented in commercial buildings because they can attract potential investors. The certifications do not take in to account the mismatch problem because demand and supply of energy are counted separately.

2.1.6 Dutch policies and regulations

By implementing the EPBD, the government is reinforcing the national energy saving policy for existing buildings. Elements of this reinforcement are efficiency standards for installation systems and a cost optimization standard for insulation of external walls during the renovation.

New buildings: Energy performance certification (EPC) and BENG

The energy performance certification provides a means of rating individual buildings on how efficient (or inefficient) they are in relation to the amount of energy needed to provide users with expected degrees of comfort and functionality. The degree of efficiency depends on many factors including local climate, the design of the building, construction methods, materials, systems installed to conditionate the building or to heat water, and the appliances and equipment needed to support the functions of the building and its users (IEA, 2010).

The National Plan for the advancement of nearly zero-energy buildings in the Netherlands (Nationaal Plan voor het bevorderen van bijna energieneutrale gebouwen) has sets the BENG (Bijna Energieneutrale Gebouwen) regulations or the regulations for nearly energy-neutral buildings (nZEB) that will guide the Dutch policies for buildings from January 2021.

One of the BENG requirements from January 2023 for existing buildings is to have an energy label C with an energy index (EI) of 1.3 or lower and label A by 2030. Buildings are obliged to ensure that when those are constructed, sold or rented out, an Energy Performance Certificate (EPC) is made available to the owner or by the owner to the tenant or potential buyer. The certification shall also include advice and information on how to improve energy performance.

In addition, three preliminary requirements are set in the BENG regulations for housing buildings. Energy demand should not be more than ≤ 25 kWh/m²/year use surface, which includes energy for heating, cooling, and ventilation. Primary energy consumption of ≤ 25 kWh/m²/year use surface, which includes the energy used by the building services for building-related energy use, including hot tap water. And share of renewable primary energy supply sources of $\geq 50\%$ (NEEAP, 2012).

Existing buildings: Nul-op-de-meter (Zero-on-the-meter)

This is one of the strategies of the Dutch government and private companies are implementing for the renovation of existing buildings towards zero fossil energy consumption. Nowadays a household pays approximately 150 euros of energy bill per month, if this tenant pays 7 years in advance for its energy bill, retrofitting companies can use that money to retrofit the house in order to make it zero energy consumption by changing the building properties and installing PV panels on the roof. However, this concept only works in neighborhood or village scale, where after the renovation, the overproduction of renewable energy is given back to the shared grid and because of the compensation, the energy bill becomes zero in the building (Nul 20, 2014).

This strategy allows for the share of waste energy streams between buildings, similar idea as the REAP project in Rotterdam (Tillie et al., 2009). However, it does not consider that PV panels do not produce much during winter and that batch of time will obligate the energy companies to keep the dependency on fossil fuels or nuclear energy during shortage periods, increasing the energy bills and contributing to climate change.

2.2. Energy Demand

The population growth, the enhancement of building services and high comfort levels and the growing time spent inside buildings have increased the building energy demand (Pérez-Lombard et al., 2008).

The energy demand in a building depends mainly on three factors (figure 5): The first factor is the occupant and its behavior towards energy because he/she is the final user of the energy in the building. The second factor are the physical parameters of the building and the ability of the building to maintain thermal comfort for the occupant, and the last factor are the external factors of the place where the building is located. Figure 5. Diagram of the factors influencing the energy demand

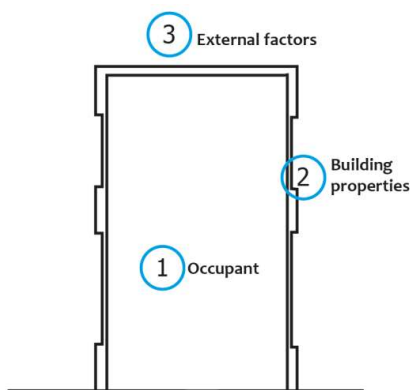

Figure 5. Energy factors in existing buildings

Most of those factors can be adapted or influenced in a new building, but in an existing building, the options are more limited as the location, orientation and main building properties are a given.

2.2.1. Energy factors

Occupant

A person can influence the energy demand of a building because he or she decides the level of comfort inside a space, for instance at which temperature he/she wants its indoor space to be. On the other hand, actions such as opening the blinds to allow for natural lighting and heat in the space, turning off the light when not needed, among others; also influence the energy demand.

Therefore, the occupant can modify the energy demand in the way the building is functioning based on its behavior towards energy. According to the survey "Perceptions 2017" where 3.339 households were interviewed, 90% said they are conscious of their energy use in and around the house. People who indicate they are energy-conscious in their behavior are more likely to unplug the charger as soon as the phone is fully charged.

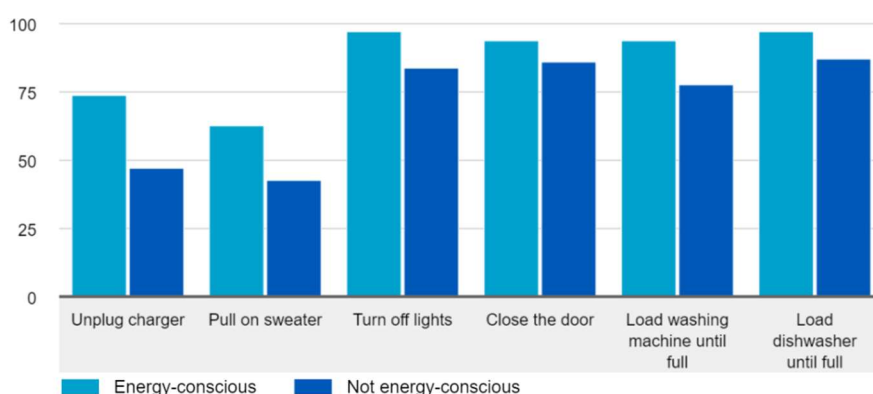

Figure 6. Energy-consciousness around the house, 2017
Source: Centraal Bureau voor de Statistiek (CBS, 2018a)

A large majority of the people interviewed are energy-conscious due to energy cost considerations. Half of them unplug the charger as soon as their phone or tablet is fully charged in order to save costs, but less than one-third do so because it is better for the environment, and over one-fifth do it for other reasons (Figure 7).

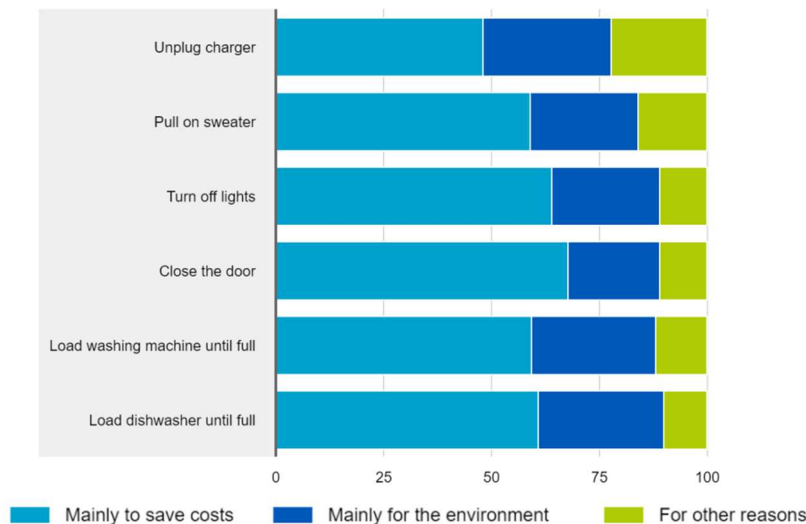

Figure 7. Reasons for energy-conscious behavior, 2017
 Source: Centraal Bureau voor de Statistiek (CBS, 2018a).

Two-thirds of the population is motivated by costs rather than the environment when turning off lights and closing doors when the heating is on in a room (CBS, 2018a). Therefore, being energy-conscious for most of the people means also to save cost in the energy bill, which shows the relevance of good policies and incentives towards the reduction of energy.

Therefore, it is an important task for the Dutch national government, municipal authorities, and private organizations to support and guide occupants through this transition (Ministry of Economic Affairs, 2017). The energy transition period will modify our current way of living, and a big change on the behavior of people towards energy consumption, is needed as a part of this environmental challenge. In addition, occupant behavior is not being currently counted in the energy simulations of new buildings nor for the renovation of existing buildings, which according to Yash Dugar can result in an energy gap of over 60% (Dugar, 2019).

Thermal comfort requirements of the user

The temperature inside or the air temperature of a building is defined based on the thermal comfort desired by the user of a certain space, this indoor temperature can be calculated based on the Fanger’s model or the PMV (predictive Mean Vote). Fanger’s model introduced in 1973, assumes an energy balance for people in a stationary situation in which the energy released by the body’s metabolism is equal to the energy removed from the area, this heat balance is also influenced by the clothing (heat resistance) (Van der Linden, Erdtsieck, Gaalen , & Zeegers, 2013).

Thermal comfort is difficult to measure because it is highly subjective. Comfort is not only been influenced by the air temperature, but also by other five parameters; the mean radiant temperature, relative air velocity, relative humidity, activity level and clothing thermal resistance. The air temperature is the average temperature of the air surrounding the occupant, with respect to location and time and can be changed depending on the level of comfort desired for the building (Mamat, 2016).

Building physical properties

The building physical properties influence the energy balance in the building, which will be explained in the next chapter. The physical properties must respond to the location and function of the building, for example a building located in a cold weather region should be have physical properties to protect it from the low temperatures outside and reduce heat losses.

External factors

The local climate greatly influences the energy demand of a building. In a new building, several parameters, such as location, orientation, the surrounding buildings and the connection with a shared network can be considered during the pre-designing phase of a. Nonetheless, for existing buildings, these parameters cannot be modified, and are therefore fixed factors.

2.2.2. Heat Balance & thermal energy demands

The energy demand in a building for heating and cooling is calculated using a heat balance. In the European standard (ISO 13790: 2008), the energy need for heating and cooling is defined as “heat to be delivered to, or extracted from, a conditioned space to maintain the intended temperature”.

The energy need for the thermal zones of a building is mainly based on physical properties of the building (ventilation, infiltration, internal loads and comfort), and is influenced by the location of the building and its occupants as explained before.

The thermal balance of a certain space consists of all the heat flows that enter or leave the space. Under stationary conditions, when the heat flows are constant, the following equation applies to achieve energy balance.

$$Q_{in} = Q_{out} \quad \text{or} \quad Q_{in} - Q_{out} = 0$$

Where the Q_{in} and the Q_{out} are influenced by five different heat flows. Figure 8 and Table 1 shows the different energy flows entering and leaving the building.

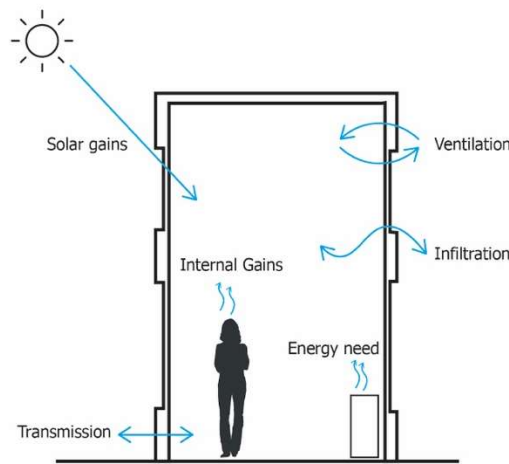

Figure 8. Thermal energy flows in a building

Table 1. Thermal energy flows in a building

Flows	Description
Transmission	Heat transfer through the building skin or facade
Ventilation	Intended/controlled air exchange of a room
Infiltration	Airflow through cracks and services
Solar gains	Solar radiation coming in through transparent surfaces
Internal gains	Production of heat in a room by persons, equipment and lighting
Energy need	Energy need for heating or for cooling

Therefore, in order to achieve energy balance the formula is:

$$Q_{Transmission} + Q_{Ventilation} + Q_{Infiltration} + Q_{Solar} + Q_{Internal} + Q_{finalenergyuse} = 0$$

The theory on these components is explained below, based on literature (van Bueren et al. 2012). In addition, the parameters that can be changed in existing buildings are identified and described in relation to each component.

Transmission ($Q_{\text{Transmission}}$)

The transmission of heat takes place through the building envelope from warm to cold .. The envelope consists mainly of the roof, floor, external walls and windows and each of them has its own characteristics that prevent or allow for the heat exchange. To calculate the heat flow through transmission the following formula must be used:

$$Q_{\text{Transmission}} = \sum U * A * (T_e - T_i)$$

U = Thermal transmittance of the surface [W/m²k]
 A = area of a surface [m²]
 T_e = Temperature of the exterior [°C or K]
 T_i = Temperature of the interior [°C or K]

The main component influencing the thermal transmission is the transmittance coefficient (U) also called u-value, which is the amount of energy (heat), lost through a square meter (A) of that material for every degree (°C or K) difference in temperature between the inside and the outside. The difference between the outdoor temperature (T_e) and the indoor temperature (T_i) differs in the time of the year and the level of comfort desired by the occupant.

For buildings located in cold climates such as the Netherlands, where the outside temperature is most of the time colder than the inside, the equation ends up in energy losses from the building. Compared with hot climates such as in Colombia, where the climate outside is most of the time warmer, therefore the equation results on heat gains in the building.

In an existing building, the area (A) of the envelope can change with a second skin or by taking one part of the envelope. The heat transfer coefficient (U) can also change by adding better-insulated material or changing the existing ones.

Indoor temperature is based on the user requirements, and outdoor temperature is a given based on the local climate. With the following formula it is possible to understand the parameters that can be changed in an existing building in order to avoid or promote the heat transmission, a representation of the parameters influencing the transmission are shown.

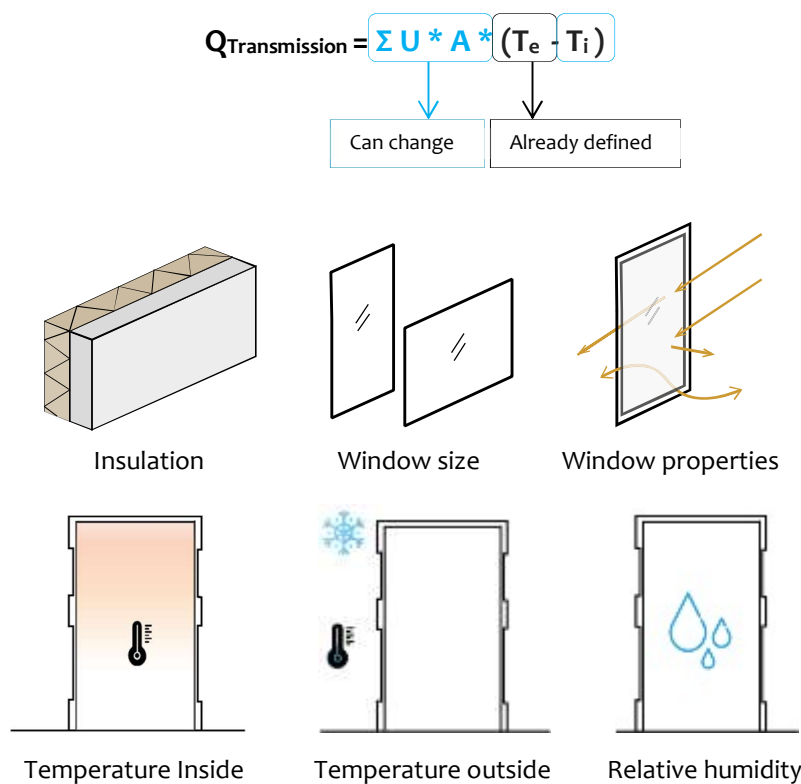

Transparent surfaces, such as the windows make a huge impact on the heat transmission. About 40% of indoor thermal energy is lost through standard façade doors and windows; therefore, those need to receive special attention in order to reduce heat losses (Konstantinou et al., 2018).

Ventilation and Infiltration ($Q_{\text{ventilation}} + Q_{\text{infiltration}}$)

Heat gains or losses also occur because of the ventilation and infiltration of the building. Ventilation works with the principle of convection heat flow between the interior of the building and the exterior and it depends on the ventilation rate. The infiltration is the exchange of air between the inside and the outside through gaps or seams in the envelope of the building. Both ventilation and infiltration are represented in air changes per hour (ac/h) or (m³/sec). The infiltration can lead to draughts, prevent the air to be properly distributed inside the building and cause energy losses, therefore, infiltration should be avoided (Van der Linden et al., 2013).

Ventilation can be natural (without any use of mechanical equipment for example by the opening of a window to allow for fresh air) or mechanical (by the use of mechanical equipment, for example for the mechanical extraction of air in bathrooms). Heat flows by ventilation and infiltration are calculated as follows:

$$Q_{\text{ventilation}} = V_{\text{vent}} * \rho * c_p * (T_e - T_i)$$

$$Q_{\text{infiltration}} = V_{\text{infil}} * \rho * c_p * (T_e - T_i)$$

V_{vent} = Ventilation flow	[m ³ /sec]
V_{infil} = Infiltration flow	[m ³ /sec]
ρ = air density = 1.2	[kg/m ³]
c_p = heat capacity of the air (at constant pressure) = 1000	[J/kg.k]

In order to provide with a healthy air inside buildings, it's necessary to allow for natural or fresh air constantly (to clean the indoor air from pollutants and to avoid high concentrations of CO₂) but due to the temperature difference between inside and outside, this can lead to undesired heat losses or gains.

The density (ρ) and heat capacity (c_p) of the air are steady parameters that cannot be changed for any building. However, the ventilation flow and infiltration flow are parameters that differ greatly between buildings and that can be optimized. In addition, in an existing building, due to its defined location, the temperature outside is an already defined parameter that cannot be changed as it was explained in the transmission flows.

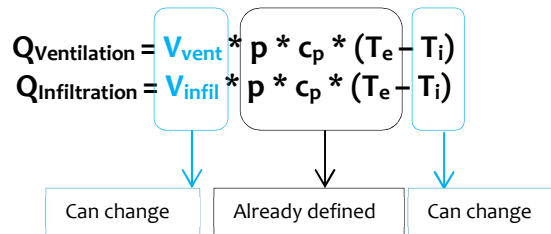

Therefore, the parameters that could be change in order to avoid energy infiltration and ventilation in an existing building are as follows.

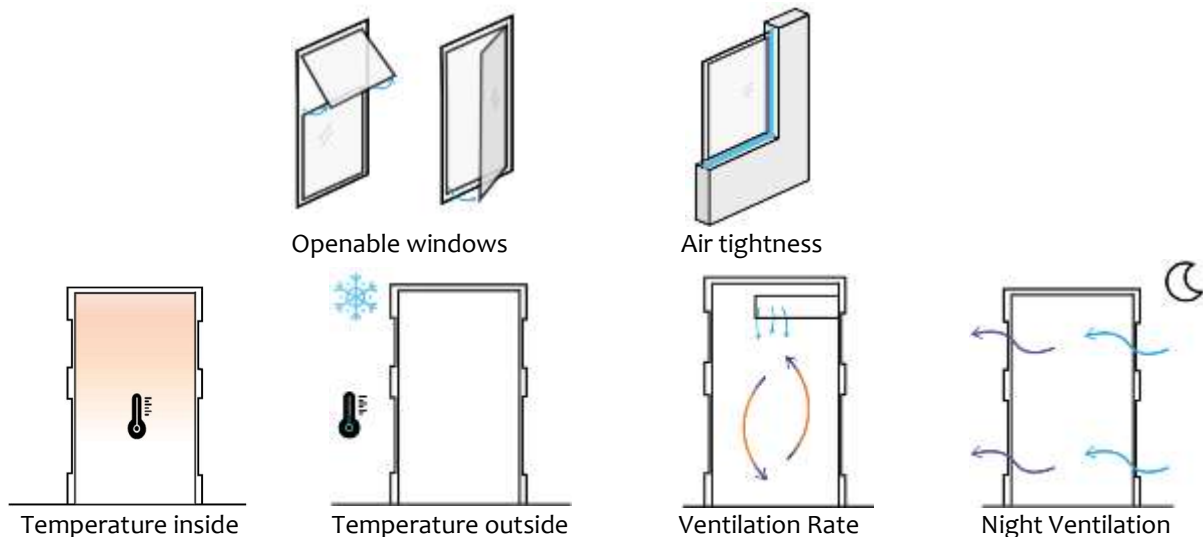

In cold climates such as the Netherlands where the heating demands are higher than the cooling demands, it is advised to avoid heat losses through ventilation and infiltration, as this can represent an unnecessary energy consumption. The idea is to promote an airtight building, which consist of moisture and a seal barrier in the connection between the different parts of the envelope, and are meant to prevent rainwater and outside air to enter the building. In addition, mechanical ventilation can include ventilation heat recovery systems, which greatly reduce heat losses.

Solar Gains (Q_{solar})

The transfer of energy through radiation is described as the transportation of energy (heat) through electromagnetic waves. Since the temperature of the building is lower than the temperature of the sun, the electromagnetic waves travel from the sun to the building through radiation and enter in the building mainly through the transparent surfaces such as the windows.

This radiation depends greatly on the properties of the surface to transmit or to absorb energy, which mainly represent heat gains if the heat enters the building. The solar gains in a building are greatly influenced by the orientation of the outer walls. The shade from external geometries such as other building or trees and shading systems from the building itself such as blinds, overhangs, and the characteristics of the glass influence the solar gains.

The following formula is used to calculate the solar gains:

$$Q_{sun} = A_{glass} * q_{sun} * g$$

A_{glass} = area of the glass	[m ²]
q_{sun} = Intensity of the solar radiation on the glass	[W/m]
g = g-value (solar transmittance factor of the glass)	[-]

The area of the glass (A) in the envelope of an existing building can be changed in a refurbishment, although that will mean a lot of construction work and modification of the external appearance of the building. The properties of the glass can be changed more easily.. The g -value (g) can be adapted or solar shading can be added.

This radiation consists on visible and invisible rays, light and heat. Specific glass types aim to combine a low g -value with high light transmittance, by mainly blocking the invisible rays (heat) and transmitting the visible rays (light). On the other hand, q_{sun} is the solar power and it depends on the location of the building, the season, the cloudiness and the orientation. The solar gains are already defined for the building because the location, orientation, and weather are implicit in the place. Therefore, from the formula, the following parameters can be changed:

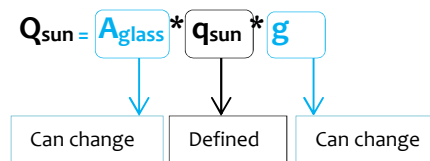

The physical parameters that can be changed in an existing building in order to allow for solar radiation to enter in the building are mainly the properties of the transparent surfaces.

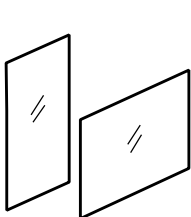

Window size

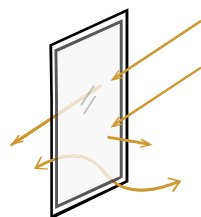

Window properties

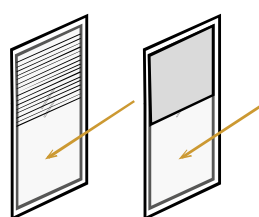

Interior sun protection

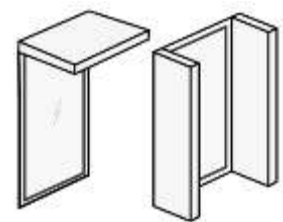

Exterior sun protection

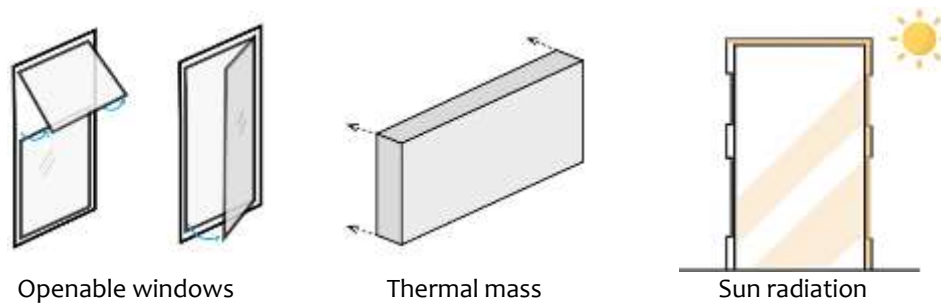

To reduce heat loads in a building it is a good idea to allow for solar gains, although that might be a disadvantage in summer because extra cooling will be needed for the building. A smart control of shading systems or a good selection of glazing can allow for the solar gains in winter and sun protection in summer.

Internal gains

Energy in forms of heat are not only caused by flows from the outside to the inside of the building, but also from the inside heat is generated. People and certain appliances generate heat.

The number of people inside the space and main activity they develop directly influences the heat produced by people (Q_{people}). For example, if the people in the building use to be sitting mainly (office building), their metabolism level will be around 130W, and will produce less heat than if they were continuously standing like in a factory with a metabolism level of 160W.

The schedule of usage also impacts the heat gains, therefore, for a house the heat gains from people happen mainly during the early morning and late night, while in an office building, the internal heat gains will happen mainly during working hours.

Light heat gains (Q_{light}), work with visible and invisible rays. In traditional lighting systems most of the energy is liberated as heat (invisible rays), and the rest as light (visible rays) which also eventually becomes heat after multiple reflections in the space.

Therefore, lighting heat gains are influenced by many other factors, if the light is suspended or mount, the radiant fraction (heat from lights that goes into the zone as long-wave or thermal radiation), fraction visible (heat from lights that goes into the zone as visible or short-wave radiation), fraction convected (heat from lights convected to the zone air), light control (daylight, occupancy, among others) and light schedule and the number of lights in the space.

The heat gains by equipment ($Q_{\text{equipment}}$), are caused by all appliances that require electricity to worksuch as computers, microwaves, fridge, toaster, among others. For the different equipment and appliances, the most important heat gains are through radiation or the amount of long-wave radiant heat being given off by office equipment and other equipment such as fridges and microwaves in a zone. The specification and number of equipment also influences this heat release to the space and the time of usage (schedule).

Process equipment ($Q_{\text{processEquip}}$), includes all special equipment that needs constant energy in order to work properly. This includes equipment for hospitals, laboratories and equipment in the technical areas. The heat gain by that process equipment depends on the energy demand of the equipment, the number of equipment and the schedule and specification of usage.

The formula to calculate the internal gains sums up all the already discussed factors:

$$Q_{\text{internal}} = Q_{\text{people}} + Q_{\text{light}} + Q_{\text{equipment}} + Q_{\text{ProcessEquip}}$$

Some building renovations include the change of the function or the inclusion of new functions as well as the increase of the number of people or the opposite, which at the end will result in more or less energy demand.



Lighting

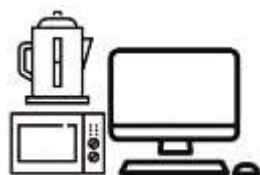

Equipment



People

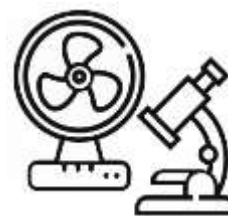

Process equipment

Energy need for heating and cooling

After calculating all energy flows that happen because of the building properties and occupant usage (internal heat gains, solar gains, ventilation and infiltration gains and transmission gains), the energy need accounts for the amount of heat that need to be supplied or extracted from the thermal zones in order to achieve thermal comfort.

Final energy use for heating and cooling

The final energy that is necessary to realize the heating and cooling of a building and in which the energy losses from the technical equipment are included depends on the selected heating and cooling system(Jansen, 2018). This includes the energy use by equipment such as radiators, boilers, pumps, fans and similar and the efficiency of the system to produce heat or cold and to distributed until the final usage in the space (Domestic Hot water and space heating). This is further explained in he section on energy systems.

2.2.3 Electricity energy demand

The electricity demand accounts for the need of electricity in order to make lighting, devices, equipment, among others to work.

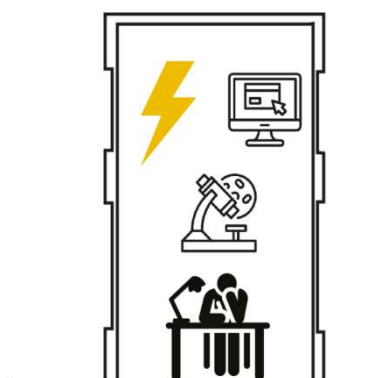

Figure 9. Electricity balance in a building

Light

In Europe, the artificial lighting causes 25 - 40% of the energy expenditure of buildings. Therefore, improving the energy performance of buildings in order to reduce electricity consumption from the lighting system will help to achieve the goal of the overall reduction of energy used. The objective of the European Commission is to give guidelines for the better utilization of daylighting in buildings with the aim of reducing electricity consumption. As an alternative to artificial lighting, natural light is the source of light most suited to the human eyes and makes the working environment most pleasant, therefore by allowing for natural light in building it is possible to achieve energy savings (Konstantinou et al., 2018).

Nonetheless, daylight is not the only parameter influencing electricity consumption; the main is the technical characteristics of the lighting devices. LED lights are known for consuming less energy, while still providing for quality of light in the space.

Also daylight sensors or presence sensors can reduce the electricity needs for lighting. There are two ways of defining the lighting energy use in a zone: Watts per m² - where the maximum lighting gains are defined as W/m² independent of the

required illuminance level, and Watts per m² per 100lux - where the maximum lighting gains are defined as W/m²-100lux and the actual lighting energy used for the zone is based on this value plus floor area and illuminance requirements as follows: Max Lighting power (W) = Lighting energy (W/m²-100lux) x Zone floor area (m²) x Zone Illuminance requirement / 100 (DesignBuilder, 2019).

Equipment

Equipment account for the devices that need to be plugged in order to get energy and work. This includes refrigerators, microwaves, dishwashers, TV, blenders, computers, printers, and cellphones, among others. as for buildings, there is an energy label certificate for devices. The European Energy labeling of major appliances and other products is a tool for consumers, advising them on the energy efficiency and other functional performance qualities of products.

The purpose of the energy labels is to rank all models of certain type of products within certain energy class range, typically from A to G, or A+++ to D and show this ranking at the points of sale. Through their purchases and everyday habits, consumers have a key role to play in reducing energy use by their appliances and the energy labeling is a key to arise awareness (European Commission, 2013)

Process equipment

Process equipment from laboratories, warehouses or any other place that use the electricity of the building are part of the electricity demand and most of the time this is the most difficult equipment to optimize in terms of energy reduction because of its special function.

2.3. Solar energy production

Solar energy supply comes from the sun that radiates energy into the earth. This radiation is rarely over 950 W/m² and it can be converted in useful energy as heat and electricity. Solar radiations reaches the earth as direct solar radiation, diffuse solar radiation and reflected solar radiation (the last one is neglected in this research).

Solar technologies do not produce any direct greenhouse gas emissions. They also have the potential to produce much more than the current electricity demand in the Netherlands. In addition, the Dutch government is making this technology more accessible for everyone by implementing subsidies. This, in combination with a shift in energy demand from fossil fuels to electricity, could provide a basis for a clean system (PBL, 2011).

In 2017, solar energy consumption (for electricity and heat) increased by 31% (9PJ) as figure 4 is showing, compared with the consumption in 2016 (CBS, 2018b). In addition, solar panels come in different sizes, colors, and configurations, which makes it easier to integrate them in the built environment. The total established capacity of solar panels used to generate solar power saw a record increased from over 800 to nearly 2,900 megawatts (MW) and it will continue increasing.

The direct and diffuse daily solar radiation in the Netherlands according to the weather data for the Netherlands of 1964, are shown in Figure 10 (Laure Itard, Energy demand excel). The maximum direct solar radiation on a horizontal pane is 700W/m² and the maximum diffuse solar radiation in the pane is around 600W/m². These numbers will be used later for the simplified calculations of the energy generation potential of the system.

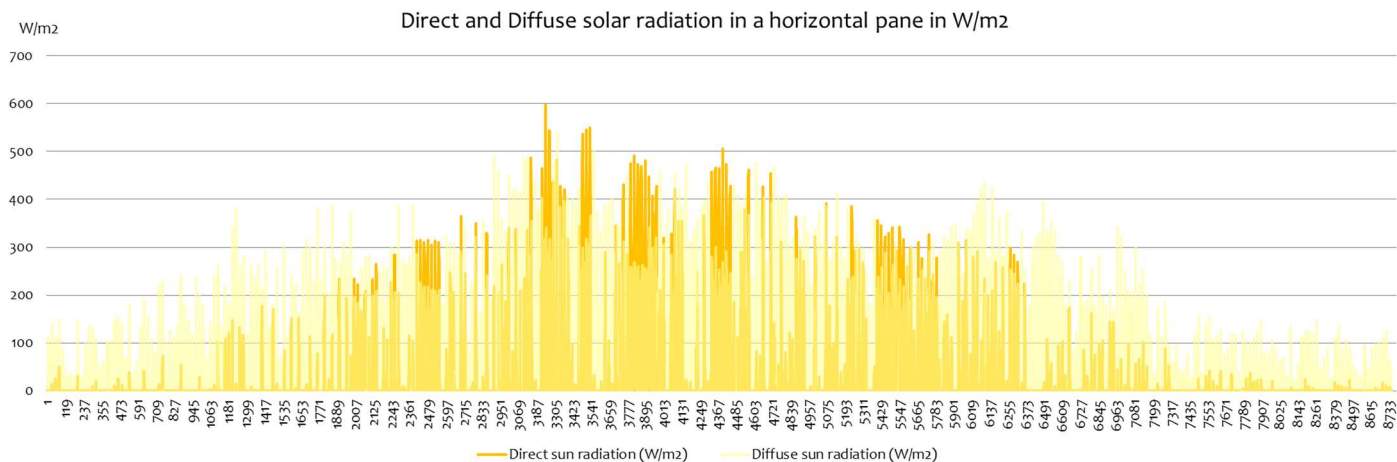

Figure 10. Direct and diffuse daily solar radiation in W/m^2 at the latitude for the Netherlands

In order to produce heat and electricity from solar power, different technologies have been developed in the last few decades. Solar thermal collectors convert solar energy into heat; solar photovoltaic (PV) panels convert the solar energy into electricity, and the mix of both technologies are the Solar PV/Thermal collectors (PV/T) which convert solar energy into heat and electricity at the same time.

2.3.1. Solar energy technologies

Solar power for heating

Solar collectors can be divided in Flat Plate Collectors (FPC), Evacuated tube Collectors (ETC) and Concentrated parabolic collectors (figure 11) (Sarbu & Sebarchievici, 2017a). These technologies can provide buildings with thermal energy for space heating, domestic hot water, process heating, among others.

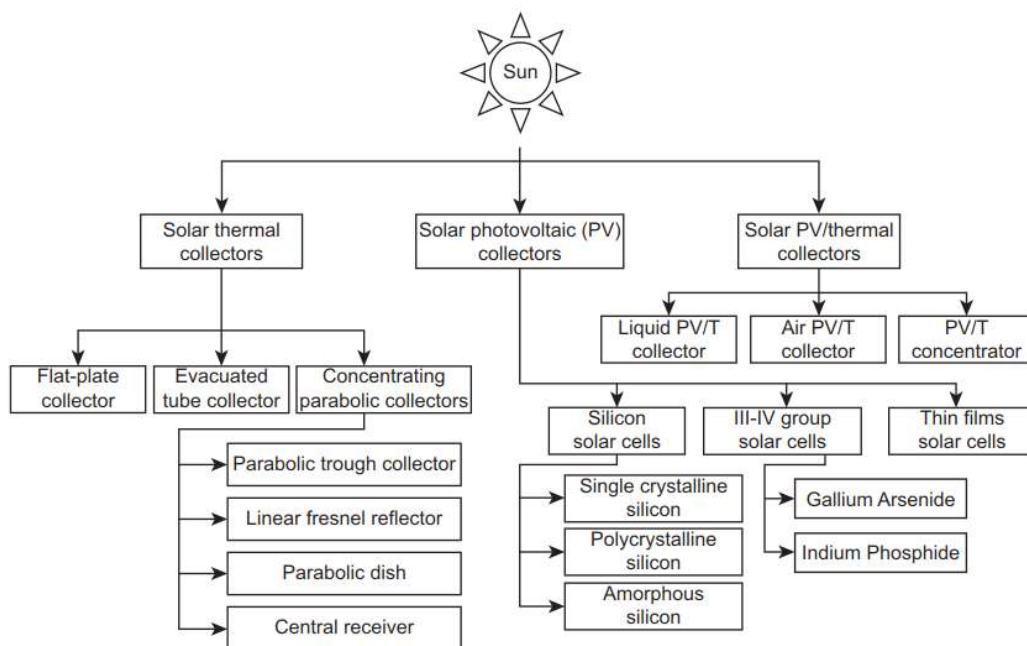

Figure 11. Solar power technologies (Sarbu & Sebarchievici, 2017a)

The solar collector works as shown in figure 12. The solar radiation heats up the circulating fluid (water, anti-freeze or air) at a certain temperature and it circulates with the help of circulating pumps to a solar storage tank. In this tank, the input cold water comes in the system and exchanges heat with the circulating water until certain temperature in order to be used for space heating and DHW ($40^{\circ}C$ to $80^{\circ}C$) and the circulating water continues circulating towards the solar collector to repeat the process.

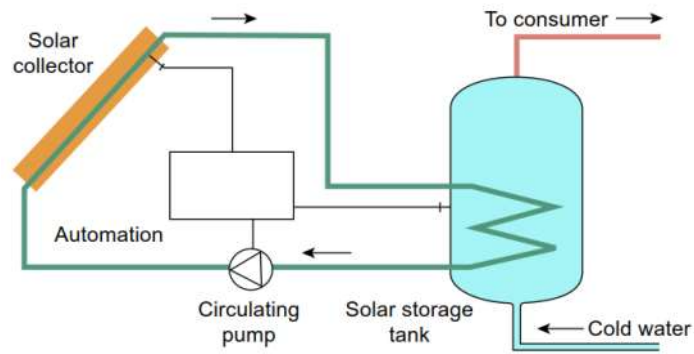

Figure 12. Solar energy conversion in thermal energy (Sarbu & Sebarchievici, 2017a)

Table 2 contains the three different solar thermal technologies which were explored in order to produce heat and the advantages and disadvantages of each system were described for the implementation of this technologies in existing buildings.

Table 2. solar thermal technologies

Solar thermal technologies			
Technologies	Picture	Advantages	Disadvantages
<p>Flat plate collectors (FPC)</p> <p>Converts the solar radiation by transferring the heat to a liquid or gas. Are fixed systems that do not need to track the sun. The working temperatures are between 30°C to 80°C</p>		<ul style="list-style-type: none"> Use direct and diffuse solar radiation Are mostly used for floor and walls heating systems or low temperature radiators Their operation is more simpler than concentrating collectors Come in different design and configurations of material to optimize their operation Requires few maintenance 	<ul style="list-style-type: none"> The air collectors are not so common in Europe Air collectors cannot be used directly for DHW production
<p>Evacuated tube collectors (ETC)</p> <p>An ETC uses liquid vapor phase change materials (PCM) to transfer heat at high efficiency. Consist of single tubes that are connected to a header pipe and to prevent heat losses every single tube is evacuated. The working temperatures are between 50°C to 200°C</p>		<ul style="list-style-type: none"> Are highly use for DHW because of the high temperatures They have higher heat extraction compared with FPC Commonly use in the residential sector Have to be installed at a fixed tilt that optimizes the performance for a specified period; for a summer use, a tilt equal to the latitude minus 10 degrees can be optimal. 	<ul style="list-style-type: none"> Most be always mounted with a certain tilt angle in order to allow the condensated liquid to return to the hot absorber
<p>Concentrated solar power (CSP)</p> <p>Consists of a concentrator (mirrors or lenses) which is the system that directs the radiation to the receiver (tube with a liquid) to convert the energy into heat. The working temperatures are between 60°C to 240°C</p>		<ul style="list-style-type: none"> Provide higher temperatures than FPC and ETC Less heat losses The thermal efficiency is greater because of the small heat-loss area relative to the receiver area. 	<ul style="list-style-type: none"> Are not good with capturing diffuse solar radiation, requiring sun tracking. This system is hardly use in the built environment. Requires constant maintenance to clean the mirrors or even replace them because they also loss their reflectance with time.

The information collected in table 2 was taken from the book solar heating and Cooling systems (Sarbu & Sebarchievici, 2017a). From the technologies mentioned before, flat plate collectors can be used for the low temperature heating system in existing building, while the evacuated tube collectors can be used for the DHW for higher temperatures. Concentrated solar power is a more complex system that requires more maintenance and specification; therefore, this system will not be further explored.

The efficiencies in a solar collector depend on the temperature of the fluid entering and leaving the collector. In order to calculate the efficiencies of the FPC and the ETC, the calculation of thermal energy output from Saleh Mohammadi was used. Saleh used the following formula to calculate the efficiencies.

$$\eta = \frac{\text{solar irradiance } \left(\frac{W}{m^2}\right) * C_0 - C_1(T_m - T_a) - C_2 (T_m - T_a)^2}{\text{solar irradiance } \left(\frac{W}{m^2}\right)}$$

Solar irradiance = 700W/m² (most common for the Netherlands)

C₀ = Optical efficiency = 0.76 for ETC and 0.78 for FPC

C₁ = First order heat loss coefficient = 1.2 W/m²K for ETC and 3.2 W/m²K for FPC

C₂ = Second order heat loss coefficient = 0.080 W/m²K² for ETC and 0.015 W/m²K² for FPC

T_m = Temperature of the fluid in the collector

T_a = Temperature ambient

With the formula, the following efficiencies can be achieved depending on the temperature difference between the collector fluid and in the ambient (T_m – T_a) (figure 13). Therefore, for a low temperature system of 60°C at a temperature ambient of 20°C, the evacuated solar collector has a final efficiency of η= 0.67 and the flat plate collector will have a final efficiency of η = 0.56.

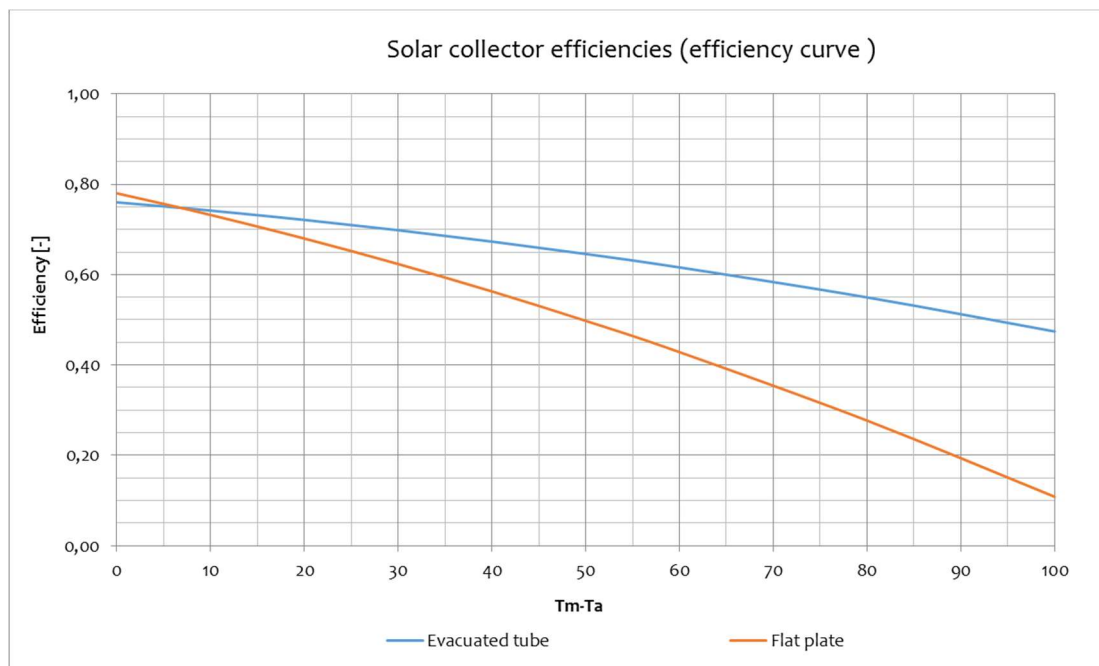

Figure 13. Solar collector FPC and ETC efficiencies. Source: Saleh Mohammadi, TU Delft.

The validation of the formula can be found in the book solar Heating and Cooling systems where a similar formula is used, the C₀ is an optical efficiency or zero loss collector efficiency and C₁ and C₂ are heat loss coefficients dependent on temperature (Sarbu & Sebarchievici, 2017a).

Solar power for electricity

The Photovoltaic panels (PV) is the solar technology that is being most used nowadays. These panels contain solar cells to convert the solar energy into electricity. They produce electricity from electromagnetic radiation that hits the surface of each of the solar cells; the term 'photo' refers to light and 'voltaic' to electricity (Sarbu & Sebarchievici, 2017a).

Solar cells can come in different materials and even colors as crystalline silicon (polycrystalline and monocrystalline), cadmium sulfide (Cds), gallium arsenide (GaAs), amongst others. Nonetheless, crystalline silicon is the most used technology nowadays. Each module of cells can be connected in parallel or in series. Most of the crystalline solar panels in the market have efficiencies between 15% and 25% (Konstantinou et al., 2018). Nonetheless, there has been records of monocrystalline crystalline silicon cell working with an efficiency of 25%. In addition, other experiments with more layers of material have reach efficiencies of 30% as it is shown in the book solar heating and cooling systems (Sarbu & Sebarchievici, 2017a).

The efficiency of the PV system depends on the cells temperature, the radiation, the reflectance effect, cables and inverter, which causes energy loses. The energy from the cells comes in a Direct Current – DC, on the other hand, energy in buildings comes in Alternative Current – AC, therefore, the current needs to be converted from DC to AC, which causes the most of the losses of energy in this system. For the aim of this research, an efficiency of the solar panels of 18% will be taken for the calculations of the system..

Photovoltaic systems integrate different parts depending on whether the system is standalone or on-grid: a PV generator, inverter (from DC/AC), storage batteries (to discharge energy during the shortage time) and controls that protect the battery from overload and full discharge. The capacity of the storage is defined by each system, which helps to reduce the mismatch, but the batteries in the system will be explored in the chapter 5.

The monthly average energy in kWh can be calculated using the following formula. Where E_a is the monthly average amount of energy in kWh, A_c is the area of the PV panel system, I_m is the monthly average radiation in W/m² and η_a is the total efficiency of the system (Sarbu & Sebarchievici, 2017a).

$$E_a = A_c I_m \eta_a$$

BIPV (Building integrates solar panels), are solar panels integrated in the different elements of a building, such as in the walls, windows, roofs, sunscreens, and similar. PV can be integrated in the sun screens, the company Pilkington provides this technology (image 1), which works with monocrystalline cells with a power of 120W and efficiency of around 8,8%. This technology has the advantage that it can be integrated in the sunscreens without interrupting the aesthetics of the building. The disadvantage is that has a lower efficiency than a normal PV panel. Also because of the price of the technology is hardly compensated in time (Pilkington, 2019).



Image 1. BIPV in sun screens

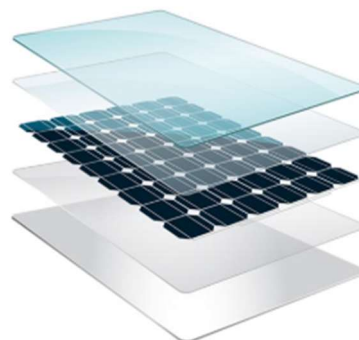

Image 2 BIPV in glass

PV in glass is becoming common in the built environment (image 2), the PV cells are integrated in the glass that can be installed in the building as part of the window or on top of the eternal walls. The company Kameleon Solar provides BIPV panels of different colors and patterns, this technology works with efficiencies of around 75-90% of a standard module (standard modules have an average efficiency of 18% nowadays) and power between 80-150 Wp per m² depending on the color and pattern of the panel, in which darker colors work with higher efficiencies (Kameleon solar, 2019).

Solar PV/Thermal solar collectors

The Photovoltaic Thermal solar collector combines both technologies, PV panels and Solar thermal collectors in one panel, which also means that both electricity and heat can be produced from the same structure or panel. The advantage of the combination of these technologies is that in the same area, electricity and heat can be produced, which complements the demand for energy in an existing building.

When the radiation hits the cells of the PV panel and solar energy is converted into electricity, heat that is released in the process is used in the solar collector to heat up the medium that can be a liquid or air. Because of the constant circulation of the air or liquid in the solar collector, the cold temperature coming in the module helps to lower the temperature of the PV, which helps to maintain an overall efficiency.

Table 3. PV/T technologies

PV/T technologies			
Technologies	Picture	Advantages	Disadvantages
<p>PV/T Liquid</p> <p>It uses FPC collectors to heat the liquid (water, antifreeze-water mix) which depending on the technology it can run through pipes or in between the glass and the PV cells.</p>		<p>Work better with systems that are water to water heat transfer (DHW, Radiators, floor or wall heating).</p> <p>Are more efficient than PV/T air because of the high thermophysical properties of water as compared to air</p>	<p>The liquid needs to be pumped through the system, which requires extra energy.</p>
<p>PV/T air</p> <p>the air is used as a medium for heat transfer, which is pushed through the system with fans and the out coming air is used in the building for the heat balance</p>		<p>Require low construction cost due to minimal material use and operating cost</p>	<p>The fans to push the air through the panel need extra energy</p> <p>Heat transfer from air to water in order to provide DHW is more inefficient compared with systems that run on water.</p>
<p>CPV/T concentrated collector</p> <p>Use concentrated reflectors that increase the efficiency of the solar cells while heating the air.</p>		<p>Can operate at higher temperatures than those using FPC collectors</p>	<p>Is a technology still in research, which makes it difficult to find in the market</p> <p>Even though the efficiency of the PV panel can be increased with the reflectors. The air speed should be reduced to maintain the efficiency, which results in lower efficiency for heating.</p>

There are three types of PV/T technologies that can be used in the built environment according to the book solar heating and cooling systems, which are explained in table 3. The efficiency of this system also depends on the inclination, in order to allow for an easier flow of water or air, the panels should be installed at a certain angle, which should be less than 90° (to reduce the energy need to pump the water through the system).

Because of the combination between solar PV and solar thermal collectors in one system, it is assumed that the efficiency of both systems working together is reduced between 10% to 20% (Sarbu & Sebarchievici, 2017a).

Furthermore, PV/t technologies can also be used for innovative applications such as solar cooling, water desalinization, solar greenhouse, PV/T solar heat pump /air conditioning systems and building integrated BIPV/T (Sarbu & Sebarchievici, 2017a). A study by Fang et al. tested the PV efficiency of PV/T heat pump air-conditioning system, which improved from 10.4% to 23.8% in comparison with that of the conventional PV panels, the COP of heat pump was around 2.8 (Fang, Hu, & Liu, 2010). This study shows that this kind of system has better performance while reducing the cooling demand in a building and can be an alternative to reduce the cooling demand in addition to the heating and electrical demand in the building.

A product called energiedak uses the PV/T technology integrated in flat roofs; this technology is well integrated to existing buildings as it works as an additional insulation material for flat roofs, while producing heat and electricity. The system is composed by light concrete that work as a thermal resistant material where the water tubes are integrated. Polystyrene material covers the tubes and the last layer is a PV cell cover. The advantages of this system are that is lightweight and can be integrated without interrupting the esthetics of the existing buildings (Solartech, 2019).

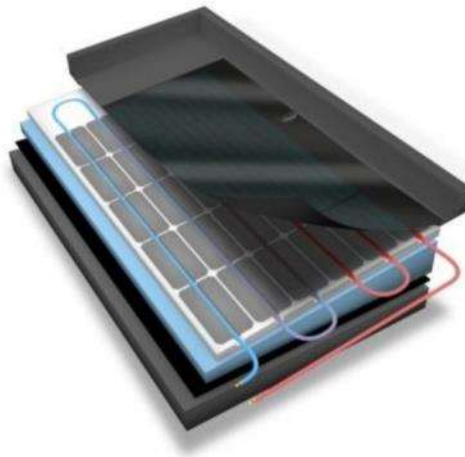

Image 3. Energiedak plus system for flat roofs. Appendix 3. EnergieDak Data sheet.

2.4. Energy mismatch

Energy demand

As it has been explained in this document, energy demand in buildings is increasing because of the population growth, the enhancement of building services and high comfort levels. Also the increasing time spent inside buildings has increased building energy consumption (Pérez-Lombard et al., 2008). Energy demand is also unpredictable in short time intervals of hours (figure 14) because every building is different and its energy demand depends on many variables such as the occupant behavior, the physical properties of the building, the function and the external variables such as outdoor temperature and location.

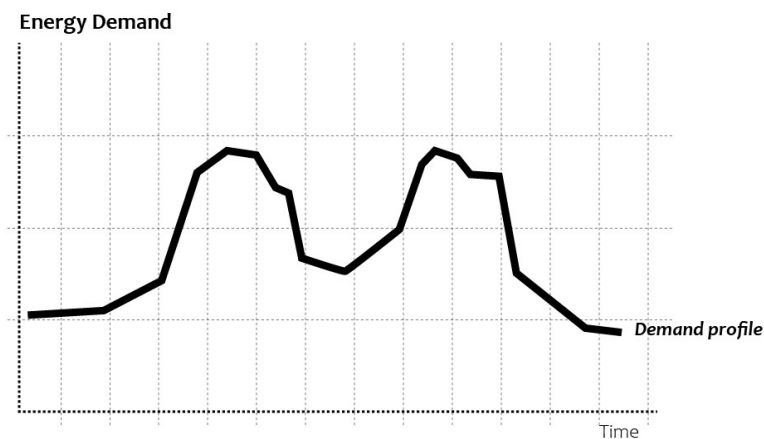

Figure 14. Increasing and unpredictable demand profile over short time intervals of hours

The Dutch government is implementing regulations such as the EPC and BENG to reduce the consumption of energy in the built environment, but energy will always be needed for buildings and it will never be constant in time.

The average temperature in summer in the Netherlands is between 17°C and 20°C (Weather Online, 2018), therefore, heating is not needed in summer and cooling is rarely required. Therefore, there is not so much energy required to condition spaces in summer. In winter, because the minimum average temperature in the Netherlands is between 2°C and 6°C, heating systems are needed to condition spaces; therefore, buildings in the Netherlands are in principle characterized to have high heat demands. However, due to high solar or internal heat gains and well-insulated buildings this can be different: heating can be reduced and cooling becomes more necessary in buildings.

Moreover, even though the energy demand is not the same among all non-residential existing buildings, it can be said that energy demand is mainly characterized for being hard to predict in short time periods of hours, because it has been and it will continue increasing for the coming years and is mainly been used in order to conditionate (heat or cool) indoor spaces in existing buildings.

Energy supply

The current energy supply system depends on the extraction of non-renewable sources, which are constantly available. This makes the system manageable and adjustable to produce energy as much and at any time as the built environment needs it.

Taking into account that renewable energy sources must be integrated into the built environment, the most common renewable energy systems implemented at building level nowadays are the photovoltaic panels. These come in different sizes, colors, forms and with different efficiencies that facilitate their integration into almost any building type.

Nevertheless, solar energy supply is weather dependent, because it depends on the sun as the main source of energy. Figure 15 shows the average power output of a solar energy production system in hours in the 12 months of the year. During cloudy days or during the winter season, there is a low energy production. In summer, the supply potential is higher because the sun is available for longer periods and because of the higher altitude results in higher solar radiation.

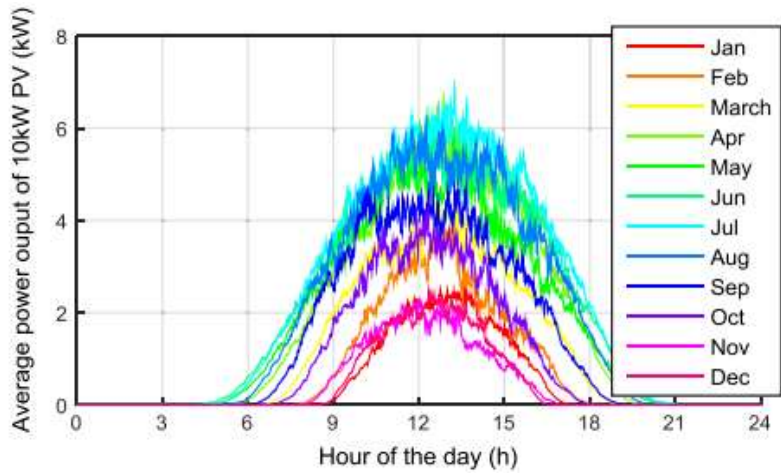

Figure 15. Hourly energy production of a Solar panel

Source : System design for a solar powered electric vehicle charging station. (G.R. Chandra Mouli, P. Bauer. 2016)

As a result, more energy can be captured by the solar panels in summer, which is actually more than the energy needed in the building. However, in winter the energy production is not enough, especially taking into account that more heat is required in this season.

The difference between the unpredictable and weather-dependent demand and the weather-dependent supply results in a mismatch in short time periods of hours (figure 16) as well as over the year. This mismatch needs to be solved in order to avoid future problems such as an increase in electricity bills, an oversized energy grid or the dependence on fossil fuels or nuclear energy to compensate for the lack of production, . It is necessary to know what are the possible parameters and technologies that could help to reduce that mismatch, which is the main objective of this research.

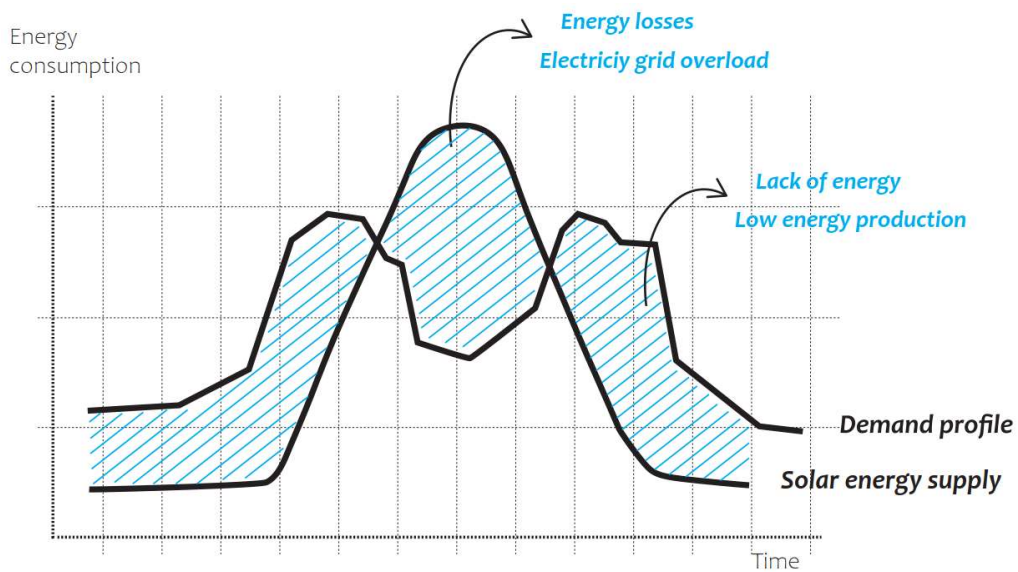
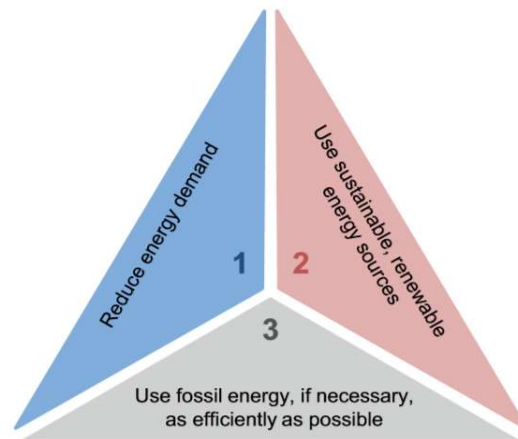

Figure 16. The mismatch between demand and supply of energy

2.5. Current approaches for developing sustainable energy for buildings

Approaches to sustainable buildings have followed the "Trias Energetica" strategy since 1980, which consists of a three-stepped strategy. The scheme 2 followed this three steps: first, to prevent the use of energy; secondly, to use renewable energy sources as much as possible, and finally, if still needed, to use fossil fuels as efficiently as possible (AgentschapNL, 2013).

The "Trias Energetica" was adopted internationally, starting in 2001. For zero-energy buildings, the second step suggests using renewable energy sources very efficiently and compensating them with non-renewable sources, which implies the generation of greenhouse gas emissions.



Scheme 2. "Trias Energetica"

The New Stepped Strategy (NSS) by Professor Andy Dobbelsteen (Van den Dobbelsteen & Tillie, 2011) proposes a substitution of the "Trias energetica" principle in order to avoid the use of non-renewable sources and make sure waste is used as food, inspired by the cradle to cradle approach.

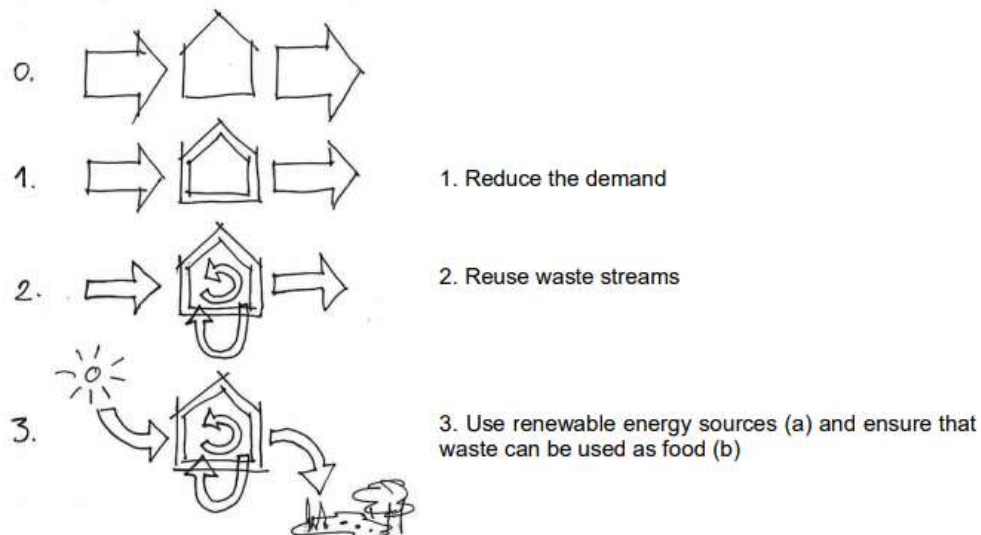

Scheme 3. The principle of the New Stepped Strategy (Van den Dobbelsteen & Tillie, 2011)

However, this proposed principle of scheme 3 also might result in a mismatch, as this approach does not take into account the intermittences occurred in short periods of hours when the renewable energy sources are integrated in the built environment.

Energy Positive Neighborhood (EPN)

Research on how to reduce the mismatch at neighborhood scale proposed the shared of energy waste streams between buildings to solve the mismatch and achieve energy positive neighborhoods (Ala-Juusela et al., 2016). The idea is to share the surplus on-site renewable energy generated of one building, with other buildings in order to fulfill their periods of shortage and vice versa. The authors describe energy positive neighborhoods as follows:

“Energy positive neighborhoods are those in which the annual energy demand is lower than annual energy supply from local renewable energy sources. Their energy infrastructures are connected to and contribute to the efficient operation and security of the wider energy networks. The aim is to support the integration of distributed renewable energy generation into wider energy networks and provide a functional, healthy, user friendly environment with as low energy demand and little environmental impact as possible.”

(Ala-Juusela, Hukkalainen, & Crosbie, 2016)

However, even when the energy positive neighborhoods measure the mismatch in hours and months, the positiveness aims a balance at the yearly basis, similar to the concept of energy neutrality, but at the neighborhood level. Furthermore, the peak mismatch is reduced but 100% match is not achieved.

The SUI (smart Urban Isle) project aims to design an integrated energy system for the built environment that optimizes the use of local renewable energy resources. This means that the energy should be generated and used in the area, minimizing the import and export of energy from outside. This project tackles the demand and supply mismatch by the connection and exchange of energy between different buildings and optimizing the energy supply from renewable sources (S.C. Jansen et al., 2019).

Nonetheless, taking into account that most of the buildings will depend on solar energy supply as their main energy renewable source, the periods of surplus and lack of energy demand might be more or less equal for one building than for a bunch of buildings. Therefore, the energy mismatch will still occur, forcing the system to integrate order energy sources from outside such as fossil fuels or nuclear energy to compensate for the lack of energy.

On the other hand, photovoltaic farms and wind energy production can contribute to the energy generation at the neighborhood level, but both sources are weather-dependent, making the system to have periods of abundant production and lack of production, probably with bigger mismatching periods.

Zero energy buildings (ZEB)

Research based on the mismatch compensation factor in zero energy buildings stated that Zero Energy Buildings (ZEB) are the ones that minimize heating and electricity demand with on-site renewable energy generation. There are on-grid ZEB and off-grid ZEB, and the difference is the on-grid has the possibility to purchase energy from the grid when the energy produced by itself is not enough, or it can sell the excess of energy to the same grid when there is surplus (H. Lund, Marszal, & Heiselberg, 2011).

Within the grid-connected ZEBs, the issue of the mismatch is bigger as the demand and supply are higher. This research states that the mismatch should be solved at a neighborhood level because at the building level is not economically feasible compared with the impact on solving it at a neighborhood level. Batteries in 2011 were expensive systems, the cost of one battery versus compensation was completely different at building level than at neighborhood level, especially when energy waste streams can help to compensate the mismatch and reduce the need for the batteries.

On the other hand, batteries are technologies under development, according to the PV magazine the price of battery cells has fallen by 70% between 2012 and 2017 and it will continue decreasing as its every time more integrated into the built environment (Rapier, 2018). In addition, this research states that when the mismatch is managed at the building level, it has a negative definition and is counted as a problem that needs to be solved.

However, the mismatch at the building level does not necessarily have a negative conception if the integration of energy storage is possible. Reducing the mismatch at a neighborhood level implies higher mismatch and the dependence on the general grid and on other buildings energy efficiency.

By reducing the mismatch at the building level, there is no stress on the shared grid and the energy efficiency or inefficiency of each individual building, will not affect the mismatch on other buildings.

The authors propose that a flexible demand should be worked out in the building level, to balance the whole system, and provide as much supply as needed as the neighborhood needs. This research also states that each building has to balance the heat demand and production within the building itself before achieving balance at a neighborhood level. Therefore, it does make sense to completely achieve energy balance at the whole building level as well, before trying to solve it at the neighborhood level (H. Lund et al., 2011).

Energy flexibility

The increase inclusion of renewable energy sources pushes the need for a flexible system to balance supply and demand. All energy systems need flexibility in the supply to adapt to the variable demand and match at each point over time (P. D. Lund, Lindgren, Mikkola, & Salpakari, 2015).

Lund et al, defined energy flexibility as of when the system is in balance and power demand and supply in the electricity grid match at each point on time. To reach an energy flexible system is very important, as it has the same importance as to reduce the mismatch between the demand and supply, which is the same goal of the energy flatness.

The rising inclusion of renewable energy technologies in the market, raise the importance of the adaptation of these technologies to reduce the intermittencies. Because higher intermittencies will result in higher prices in the electricity bills, it is very important to reach a flexible energy system. The concept aims to reduce the share of rigid base-load power plants and increase the system flexibility to incorporate shares of variable renewable generation.

Six different approaches aim to increase the energy system flexibility, first by tackling the demand with the demand side management (DSM), then the grid ancillary services, energy storage, supply-side flexibility, the connection with the grid and advanced technologies.

Demand-side management (DSM)

Comprises a set of patterns and magnitudes on how to modify end-use electricity consumption. Figure 17 is displaying the possible categories of demand-side management. The most common categories used in the built environment with non-renewable and renewable sources are the load shifting by either changing occupant behavior to shift the demand peaks, or also by the integration of storage systems that acts as an intermediate to shift the peaks.

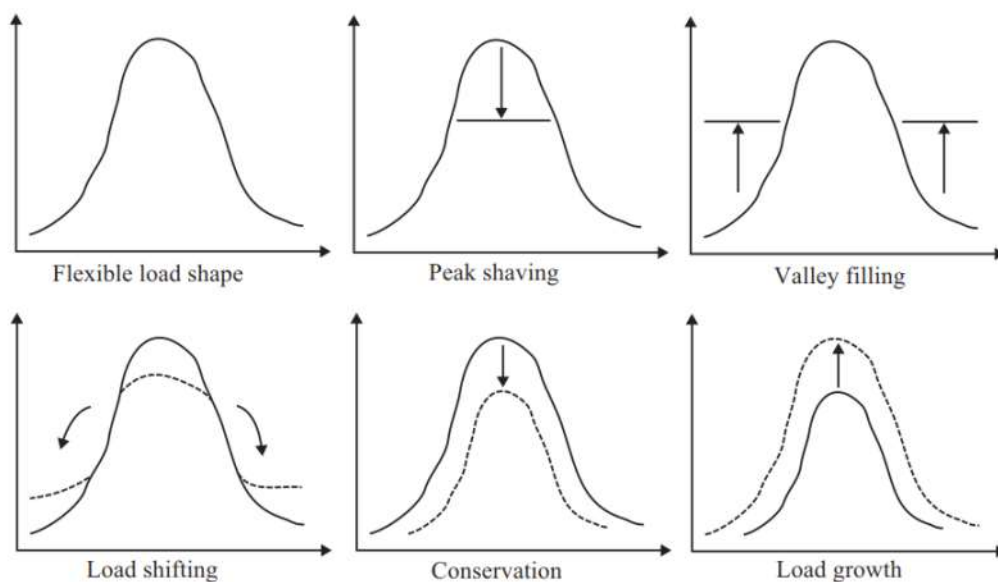

Figure 17. Categories of demand site management
Source: Review of energy system flexibility measures to enable high levels of variable renewable electricity (P. D. Lund et al., 2015).

Peak shaving is also very common in buildings with strategies such as starting the washing machine at different hours of the day, among others to reduce the peaks of consumption. The conservation category mainly aims to reduce the whole

consumption of energy in the building and is the strategy most of the governmental institutions are implementing. These categories are oriented to promote a change in occupant behavior through price incentives and physical improvements such as house renovation (P. D. Lund et al., 2015).

The categories such as valley filling and load growth are not so commonly implemented in the built environment as those required to increase the energy demand. Demand side management seems to be in line with the idea of adapting the demand to the supply and the complementary storage system and will be later analyzed through the exploration of the demand adaptation in the case study building.

Grid Ancillary services

The different services in the grid require different time responses, and the difference between the time also cause instability issues in the grid. When a system depends on 100% renewable energy sources, due to their intermittencies, those periods of response have to be filled out with other constant sources. The implementation of batteries help a lot to manage those time responses, but it really depends on the system requirements as some systems require an instant response for shorter periods and other ones require a longer duration or a longer availability of energy with a slow response.

Different battery systems are also required, as it is different to require a high instant provision of energy for 1 to 5 minutes than to provide not so much energy but for a whole day or to store energy inter-seasonally. Therefore, the storage capacity, and the charging and discharging cycles are very important if the stabilization of the system depends on a storage system. Taking into account that storage systems will be explored and further integrated into this research, this topic and approach will be further explored.

Energy Storage

Energy storage is used to time-shift the delivery of power (P. D. Lund et al., 2015), that allows for energy mismatches by taking advantage of them to balance the system. Two main things, their energy power storage, and their energy capacities characterize energy storage systems. A higher capacity of storage allows to respond to longer periods of mismatch, while a higher power capacity allows to respond to bigger magnitude mismatches.

All storage technologies nowadays are focused on one of those two characteristics, hence to provide high power or high capacity, but not so often on both or not at an affordable price, high density, and high efficiency. This means that a suitable energy storage system to reduce the mismatch depends on each case study.

Energy storage systems have economical and energetical advantages, because, during periods of low energy demand and high energy production, the surplus energy can be stored, avoiding energy losses, and during periods of high demand and low energy production, the stored energy can be discharged in the system, avoiding the building to purchase off-site energy from the grid (economic benefit), while reusing the surplus energy and closing the loop between production of energy and consumption (energy benefit).

Energy storage also have downsides, as it can increase the overall CO₂ emission levels, for example, in the Dutch and Irish energy system, energy storage allows for storing power from cheap coal plants to avoid the use of expensive gas during peak demand. In addition, energy storage is a net consumer of energy that means it includes conversion processes and therefore conversion losses to the system, but if the system is well integrated those losses should be compensated with the economic and energy benefits from the system.

The integration of an energy storage system should be linked to not only the operation of the individual facility supply system but to the whole system-level flexibility to gain economic and efficiency benefits from the system. The energy storage systems will be further explored in the next chapters.

Supply-side flexibility

With supply-side management, the supplied power can be modified to achieve energy balance. The flexibility on the generation allows to turn off energy production (from renewable or non-renewable sources), which can be favorable for the energy balance. The overproduction of renewable energy is one of the main causes of the mismatch, by avoiding the surplus of energy, the mismatch can be reduced, but there will be energy waste in the system.

A solution could be the combined-cycle gas turbines, but in order to avoid the use of gas or fossil fuels, this solution will not be explored. The other solution is the combined heat and power (CHP) plant, which produce heat and power simultaneously

which leads to a highly efficient system, this can allow for load shifting which could help to balance the energy system and will be further explored in this research.

Another way to supply in a more flexible way in the built environment from solar sources will be by adjusting the supply to the demand of the building. Bifacial solar modules, solar panels in the façade or a different configuration or specification of the solar panel, can help to modify the supply of energy, those making it more flexible to some extent. Again, storage systems are essential for a flexible supply system if those technologies aim to compensate for the lack of energy with the surplus.

Connection with the grid

A robust and well-connected grid can result in a flexible energy system, different strategies have been researched for the built environment as such are the supergrids, smart grids, and microgrids.

A supergrid aims for a strong network transmission incorporating High Voltage Direct Current (HVDC). These supergrids avoid losses of energy in the system by transformation means. Solar energy and most of the renewable energy comes in a Direct Current network, while energy in the city is transported in Alternative Current (AC) networks, the transformation of energy from AC to DC implies energy losses that can be avoided if all the network works in a Direct Current. However, to adopt this concept there needs to be a whole change in the grid that requires high economic investment and technological inclusion.

Smart grids (SG) are one of the best solutions to integrate energy producers and customers as it aims to provide with a shared grid that is mainly supplied with renewable energy, this smart grids include high capacity storage systems, advanced metering, vast automatization and a good communication system that allows tracking the production and consumption of energy. These smart grids include all the different services of buildings within the neighborhood, which makes the system very complete.

The microgrids especially focus on avoiding the mismatch as much as possible, the buildings can connect to the grid to share their surplus and feed other buildings, which can mean an economic advantage. During disturbances in the grid, they can unplug themselves and secure their own energy. This concept can be further proposed in the last chapter for future investigations with the connection with the grid.

Other technologies

Technologies to take advantage of the surplus energy can be also integrated into the built environment. In this part, only some technologies will be mentioned and aim to achieve energy flexibility in the connection with a large scale (for instance, neighborhood).

Electricity-to-thermal (E2T) could be a solution to use the surplus of energy from renewables; the idea is to transform the electrical surplus into heat, allowing for easier storage. This technology needs electric boilers, pumps and until some extend thermal storage and implies energy losses through transformation processes.

Power-to-gas (P2G) and power-to-hydrogen (P2H), by transforming the excess electricity enables to produce hydrogen and synthetic methane. This two technologies act as energy carries, sort of like a storage system as Hydrogen can be converted into electricity again with zero CO₂ emissions.

Vehicle-to-grid (V2G), can be a solution for the integration of the increasing usage of electric vehicles (EV) and the increasing use of renewable energy sources. The vehicles can act as a storage service while fulfilling the needs for clean transportation systems.

These technologies are usually integrated into a bigger scale such as neighborhood or even district but will be further explored in the research as they could complement the system and reduce the mismatch in the building.

2.6. Complementary energy systems

The complementary energy systems aim to be the link between the energy demand and the energy supply in order to reduce the mismatch in the building. In the thesis of energy-flat housing (Höfte, 2018), it was explored how to reduce the mismatch by the adaptation of the demand to the supply and vice versa. From this thesis, it was concluded that only by the means of adapting demand and supply is not possible to reach a complete match between demand and supply. Therefore, this research project aims to explore complementary energy systems that could help to reduce the energy mismatch in non-residential existing buildings.

The systems researched are all related on how to distribute, store and produce thermal energy efficiently. Taking into account that the buildings explored in this research are located in a country where the heating demands are higher than the cooling demands, the efficiency of the heating system plays an important role in the reduction of the mismatch.

Thermal energy storage systems

Thermal energy storage systems can be divided in passive or active solutions (table 4). Passive solutions take advantage of available heat sources and as a result, the use of mechanical heating or cooling systems is reduced. Active thermal storage includes the connection to or with mechanical systems, while passive takes advantage of the current characteristics of the building and its environment or store heat or cold. Active solutions allow for control of the heat or cold stored and released and are mostly used to provide the demanded temperatures for DHW, space heating, mechanical ventilation and air conditioning.

Passive solutions can include the use of solar buffer spaces or building materials to store the radiation entering the building. Solar buffer spaces are intermediate spaces between the outside and the inside that can store intermediate temperatures (temperatures in between the outside temperature and the inside temperature) to lower down the difference of temperature between the outside and the inside.

This passive solar thermal technology using solar buffer spaces has been currently proposed from the solar decathlon team 2019 for the renovation of the Marconi tower in Rotterdam and also in the project Prêt-à-loger (image 4) in the solar decathlon 2014, where a winter garden that acts as a solar buffer space to preheat the air before entering the house.



Image 4. Prêt-à-Loger project part of the solar decathlon 2014.

Table 4. Thermal energy storage systems

Thermal energy storage systems						
Technologies		Description		Advantages	Disadvantages	
Passive solutions						
Solar buffer spaces		Are intermediate spaces between the inside and the outside and are used for preheating areas so the difference between the temperature outside and inside is not that big		Reduce the need for mechanical energy systems	It is hard to control the temperature in the buffer spaces, therefore in summer those can cause an increase on the cooling needs	
				Make use of available spaces to preheat the incoming air		
				Help to reduce noise and pollutant entrance to the building		
Trombe walls		Store solar heat in the thermal mass of a wall and released to the air		Can reduce the need for mechanical heating in winter periods	The trombe walls need to be exposed directly to the sun radiation, which also means near the façade. The heat stored is hard to control, which in warm periods can increase the need for mechanical cooling	
Thermal mass		The thermal mass of different materials can store heat for long periods		Increasing the thermal mass or incorporating materials with high thermal mass can help to store heat passively	The heat stored is hard to control, which in warm periods can increase the need for mechanical cooling	
Active solutions						
Sensible heat storage	Water tanks	Can store Hot, warm or cold water	Depending on the density of the fluid, size of the tank and the thermal resistance it can store water at different temperatures for long periods	It complements the solar thermal technologies as the heated water can be stored in the water tanks	It can be a heavy and big structure, therefore special space planning is required to include this technology	
				with the right specification it can store heated water for months which will help to reduce the interseasonal mismatch		
	Underground heat storage		Ground heat exchangers	Also called boreholes extract low temperatures from the ground, therefore are usually used in combination with heat pumps	It reduces the energy need to heat up the water by heating up the water with the underground temperatures	Extracts low temperatures from the ground, which means that needs to be complemented with other technologies to be used in the building
			ATES (Aquifer Thermal Energy Storage)	It works with water as a medium that circulates at low rate through the ground while transferring heat and cold. The excess heat produced in summer can be stored and be used in the winter.	Is a way of storing heat and cold underground, which not only reduces the need for mechanical heat but also mechanical cold.	Only aquifer that have low natural flow can be used, therefore, it depends a lot on the location of the building
Is very common in the Netherlands, In fact the building is currently connected to an ATES						
		Cavern storage or pit storage	Based on the underground water reservoirs to store heat or cold. They work same as a tank.	If there is an available cavern then the energy can be stored	It depends on the availability and characteristics of the cavern. Also is a technology still under development.	
Latent heat storage	PCM		Heat can be store thanks for the materials properties	PCM can be added directly to other insulation materials in the construction by impregnating them into other materials like gypsum	High risk of leakage and erosion when the PCMs are encapsulated	

High thermal mass materials such as alveolar bricks, concrete and stone are commonly used to store heat passively in buildings. Other passive thermal storage strategies can be the trombe walls, which store heat in a high thermal mass. This thermal mass must be as close to the solar radiation in order for the heat to be absorbed (Konstantinou et al., 2018).

According to the chapter 4 of the book solar heating and Cooling systems, Thermal Energy Storage (TES) can be described in terms of the capacity, power, efficiency and storage period. The capacity depends on the size of the system and the medium of storage (heat, water, chemical). The power of the system describes how fast the system can be discharged and the efficiency takes into account the energy losses that happen while charging, storing and discharging, high power and efficiency are desired when choosing a thermal energy storage system. The storage period refers to the amount of time that the energy can be stored (hours, days, weeks, months) and it depends on the mismatch periods of shortage of energy in the building (Sarbu & Sebarchievici, 2017b).

Thermal energy can be stored in thermochemical materials (TCMs) or in sensible or latent storage systems (Figure 18). The chemical energy storage releases and stores heat in a reaction process, by applying heat to a material, it gets divided into B + C materials which are materials that can be easily stored, during the shortage periods B and C materials can be combined together at the required environmental conditions in order to release the energy; examples of these materials can be paraffin, gallium, air and aluminum. Hydrogen storage is an example of electrical chemical energy storage. These chemicals can be further explored in buildings where there is electrical energy surplus.

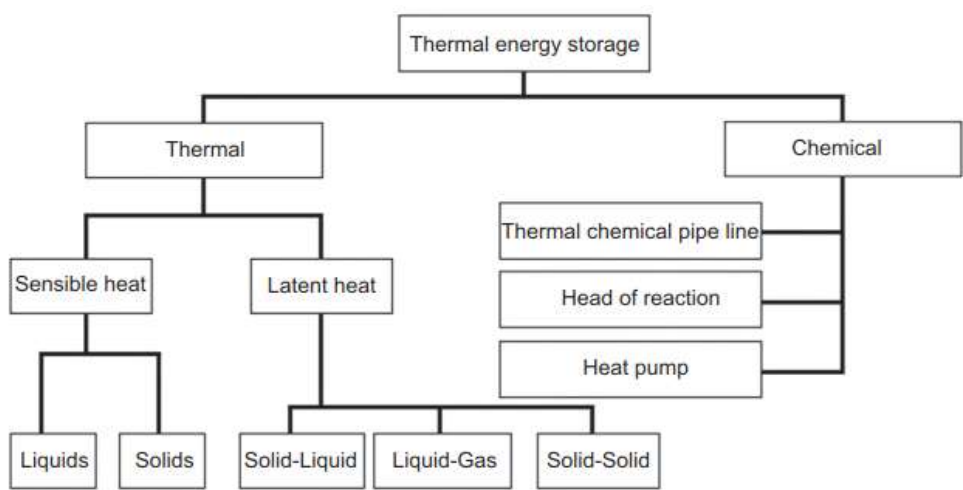

Figure 18. Thermal energy storage systems. (Sarbu & Sebarchievici, 2017b)

In addition, Sensible Heat Storage (SHS) systems use mediums such as water, sand, molten salt and rocks to store the heat or cold. SHS are usually cheap systems that do not use any toxic materials. Water is the most common medium of heat storage because it is easy to get it as well as cheap (Sarbu & Sebarchievici, 2017b).

The easiest and common way to store water is in tanks. Heated water stored in tanks can complement solar energy supplied systems because the heated water in the solar collectors can be directed and stored in the storage tank. When implementing a water tank as a heat storage system it is important to ensure an optimal thermal water stratification (different heat levels in the tank) and a high thermal efficiency of the material of the tank (to reduce heat losses). According to Sarbu & Sebarchievici, the capacity of a hot water tank can be measured by the following formula.

$$Q_s = mc_p \Delta t_s$$

Where Q_s is the heat capacity, which is equal to m (mass of water) times C_p (Specific heat), times the delta of temperature. Water tanks store heated water for DHW and for the building heating systems and are mostly combined with heat pump systems. Hot water tanks work are known as hot water tank (80°C to 90°C), warm water tank (40°C to 50°C) and cold water tank (7°C to 15°C).

Another SHS is the Underground Thermal Energy Storage (UTES). These technologies use the ground as a heat or cold storage medium (soil, rocks, sand, and clay) for seasonal thermal energy storage. The heat fluid travels through pipes to the ground where the heat transfer occurs. There are three UTES systems, boreholes, aquifers and cavern storage (Table 4). Boreholes or ground heat exchangers usually extract low temperature heat from the ground, the heat transferred depends on the length of the pipes, the difference in temperature and the thermal resistance of the pipe.

Cavern storage or pit storage work as water tanks and storing the heat or cold in water reservoirs, these systems depend on the availability of the reservoirs and are commonly used for large applications (Sarbu & Sebarchievici, 2017b).

In aquifers or ATEs systems (Aquifer Thermal Energy Storage), heat or cold can be store in the aquifer, which has a constant temperature throughout the whole year; this system is commonly used in the Netherlands, because of the properties of the aquifer in terms of low water velocity. It is a seasonal heat and cold storage, because in summer, the cold water from the ground which is about 9°C, exchange heat with the warm circulation water on the building, as a result water at about 20°C is stored in another well underground in order to be used during winter (figure 19). This storage system reduces the temperature difference between the water circulating in the building and the incoming water temperature, which reduces the energy need to heat up the water by systems such as heat pumps or electrical boilers.

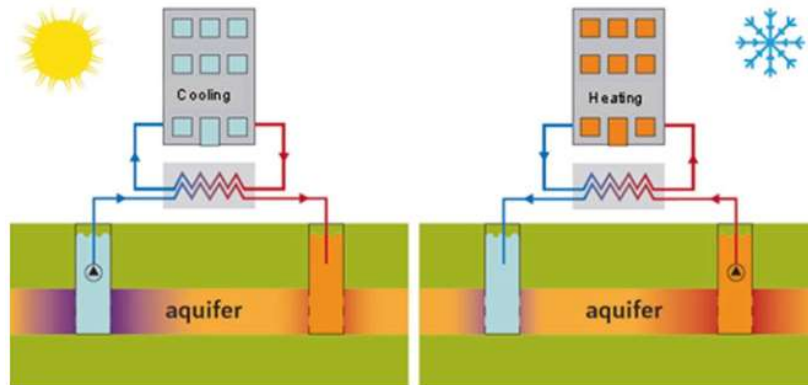

Figure 19. Aquifer Energy Storage system (Van Bueren et al., 2012).

Latent heat storage is net heat that can be store due to phase-change processes. Phase change Materials (PCM) absorb of release heat when the material change phase from solid to liquid or liquid to gas or vice versa. Phase change materials are divided into organic (paraffin or non-paraffin), inorganic (salt hydrate or metallic) or eutectic (organic-organic, inorganic organic, inorganic-inorganic) (Sarbu & Sebarchievici, 2017b).

PCM materials can be incorporated in the different components of a building, the walls, ceiling and floors by different methods, encapsulated, microencapsulated, direct incorporation, impregnated, shape stabilization or mixed with concrete or mortar, which also influences the heat released to the air.

Heat distribution systems

In order to define a complementary energy system, it is necessary to analyze the possible heat distribution systems. There are two distribution systems available for non-residential existing buildings, high temperature and low temperature systems.

Low temperature system operates with temperatures between 30°C and 80°C to distribute heat in the building. In the built environment, the most common low temperature systems are the Floor and wall heating systems that need temperatures between 30-45°C and low temperatures radiators need between 55-75°C. These systems are usually larger than high temperature systems, because since the difference of the temperature of the system and the ambient are not so high, the efficiency of the system to distribute the heat is lower, requiring higher areas for heat exchange than high temperature systems (Van Bueren et al., 2012). These systems are also chosen in places where low temperatures are important for safety, such as schools, daycares, hospitals, among other where people with direct contact with this system can be in danger.

High temperature systems in an existing building use high temperatures around 90°C to transfer heat. This kind of system is use in spaces where the space requirements are very specific, for example, where the radiators have space limitations or where high temperatures are required (Sarbu & Sebarchievici, 2017c).

According to Laure Itard, the choice for a high temperature or low temperature system does not influence the energy demand. However, it does influence the efficiency of the energy conversion system (Van Bueren et al., 2012). Therefore, low temperature systems are preferable when they are combined with low temperature solar energy production, because at low temperatures there is less energy losses in the conversion.

Heat pumps

A heat pump (HP) works with the same principle as a refrigerator, because of the pressure applied to a certain medium (water or refrigerant), evaporation and condensation takes place releasing and/or absorbing heat in the process. Heat pumps are also called cooling machines, because in the process of heating the medium, waste cold is released, which usually is used for cooling purposes (Van Bueren et al., 2012). Figure 20 shows the principal components of a heat pump.

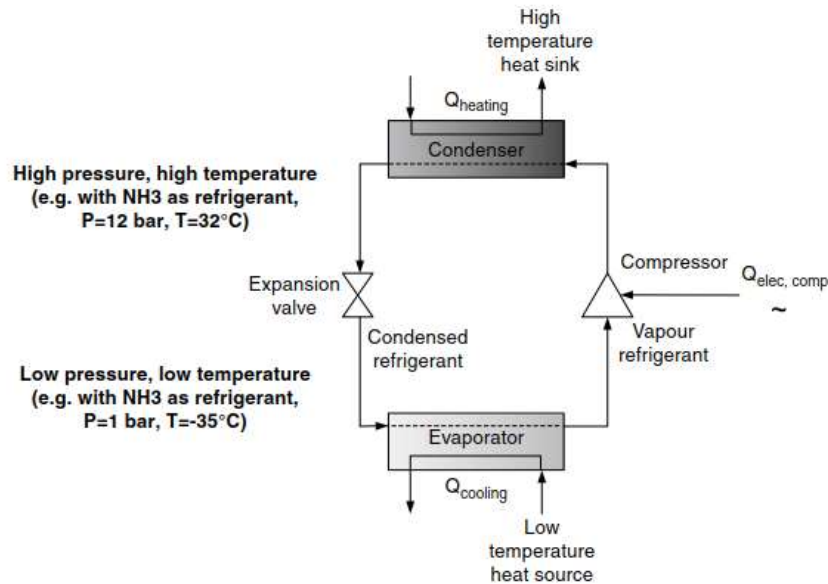

Figure 20. Heat pump / cooling machine (Van Bueren et al., 2012).

The COP (Coefficient of Performance) defines the efficiency of a heat pump, which is the same as the electricity needed by the compressor in order to produce heat or cold. There are different types of heat pumps and the types depends on the heat source (ground, ground-water, air exhaust air, etc.), the reason for the heated water need (space heating, DHW, ventilation, heat recovery, etc) and the medium (air-to-air, air-to-water, water-to-water, water-to-refrigerant, among others). However, only the systems that use water as a medium in order to provide heated water for space heating and DHW connected to ground water will be analysed (Sarbu & Sebarchievici, 2017d).

There are three Geothermal Heat Pumps (GHP), Surface Water Systems (SWHP), Ground Water Heat Pumps (GWHP), and Ground Coupled Heat Pumps (GCHP) (Figure 21). SWHP use surface water from ponds, lakes or streams as a heat source, GCHP use the ground as heat source and Refrigerant-to-water medium and GWHP uses the ground as a heat source and use Water-to-Water mediums (LIVESCIENCE, 2008).

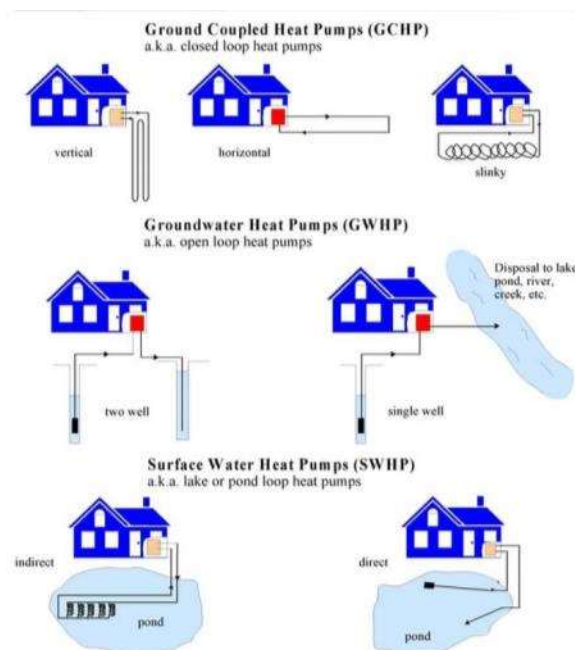

Figure 21. Geothermal heat pumps (LIVESCIENCE, 2008)

2.7. Conclusions

The world is still dependent on fossil fuels as the main energy source, which are going to be depleted in this century and are the main responsible for climate change, leading to the necessary integration of renewable energy sources as the primary supply source. The building sector is responsible for 36% of the CO₂ emissions (Konstantinou, 2018), and the inclusion of renewable sources is leading to the European goal to reach energy neutrality by all buildings by 2050.

Buildings need energy in order to condition a space or to make things work. Heating and cooling are needed to provide a living space that has a comfortable temperature suitable for the occupant to realize the activities needed in the space. The electricity demand accounts for the need of electricity in order to make lighting and equipment to work. The optimization of the building properties and usage of the space are the main strategies to reduce the energy demand in existing buildings.

Many parameters of the demand were listed in this chapter, but only the ones that can be changed in existing buildings will be taken into account in the following chapters. Different technologies of the solar energy supply and the complementary energy system were also described in this chapter. However, a feasibility study needs to be elaborated before choosing a technology for a non-residential existing building.

Energy neutrality aims to achieve a balance between demand and supply on a yearly basis. However, it does not take into account that the most common renewable energy source implemented in the built environment depends on the sun, which is not always available, unbalancing the system and producing a mismatch in short periods of hours, as well as seasonal periods, that are not visible in the energy neutrality.

If this mismatch is not solved during this phase of the energy transition, future problems such as an increase in the electricity bills, oversized energy grid or the dependence in other sources of energy such as fossils and nuclear energy to supply during periods of lack of sun can occur.

Few research has been done on solving this mismatch, and these focus on how to solve the mismatch at the neighborhood level or in new residential housing, but not on solving the mismatch in nonresidential existing buildings. In addition, taking into account that most of the buildings will remain on earth by 2050, the renovation of those towards an energy efficient system will be the target of this research.

The concept of energy flatness is a state in which the energy demand and supply match at any time of the year in a single building. This concept is in line with the objective of this research, therefore is going to be further explored in the next chapter.

3 Energy flatness

This chapter aims to answer the first sub-question of the methodology, which is: what is energy flatness?. The definition is based on the thesis report "Energy-flat housing" (Höfte, 2018) and complementary literature review. The definition as described in that thesis is in favour of the scope of this thesis. Furthermore, the system boundaries and Key Performance Indicators of the energy flatness will be adapted in order to include a complementary energy system capable of storing energy and discharging in the building when needed.

3.1. Definition

Energy flatness is a state of a building energy performance in which the difference between the final energy and the energy supply to the building services is zero at any time. This concept has been developed in the thesis "Energy-flat housing" (Höfte, 2018) and was further developed in this thesis. Different concepts complement and help to understand the term of energy flatness, but do not mean the same.

Related terminology

An energy flat building takes into account the **energy flexibility** of the building, because it allows for a flexible adaptation of the demand to the supply and vice versa. In addition, an energy-flat building goes beyond the flexibility concept by aiming for a flexible complementary energy system that includes energy storage. The flexibility to adapt each factor one to another avoids stresses between them.

Energy flatness accomplishes the requirement for an energy neutral building by balancing the demand and supply in a yearly basis. Furthermore, this concept goes beyond **energy neutrality** because it aims to achieve energy balance in a yearly, monthly, daily and hourly basis.

When aiming for **Zero Energy Buildings (ZEB)** the scope is not clear, as it can include either the thermal balance, or the electricity balance or it can allow for energy inefficient buildings to achieve the status of ZEB by having an oversized PV energy supply and without energy saving measures (Sartori, Napolitano, & Voss, 2012a). Energy flatness in this research offers a complete ZEB because it aims to balance the final energy and the energy supply at every hour.

Imported energy as described by Sartori et al. (2012) is the same as the energy delivered to the building from a shared grid, which implies that the building compensates its energy balance through the connection with the general grid. The **exported energy** is the surplus energy generated by the building that it is not needed in the building at a given moment in time, and can be given to the general grid.

Energy flatness aims to have a 100% match between the final energy and the energy supply. This balance happens within the building boundary, as figure 22 is displaying. Therefore, the building does not need to export energy to the grid because the surplus of energy is used in favour to the shortage of energy, by storing the surplus.

Energy flatness happens when the final energy and the energy supply match at any time of the year. If a complete match cannot be achieved, there are two possible mismatches. **Negative mismatch** indicates the moments of shortage of energy, which means that the building will need to import energy from the external grid. **Positive mismatch** indicates a surplus of energy; the building can store the extra energy or export it to the shared grid. Both exporting and importing energy are not the aim of the energy flatness, because the building should be able to be self-energy sustainable.

When the building has a surplus of energy that is not needed to compensate the mismatch by the means of energy storage, then the building can be an **Energy Positive Building (EPB)**. Nowadays, an energy positive building aims to achieve the positive balance at the yearly basis and with the oversized energy production the building can become EPB (Kolokotsa, Rovas, Kosmatopoulos, & Kalaitzakis, 2011). For the energy flatness concept, the building should not aim to be EPB, because this could indicate an oversized grid or an unnecessary stress on any of the factors (demand, supply or storage).

Moreover, energy flatness contemplates the **balance at the final energy**, which is the on-site energy produce from renewable energy sources that should be the same as the energy delivered to the building services. When the building compensates its needs of energy only with energy produced on-site, energy losses through transportation and distribution are reduced.

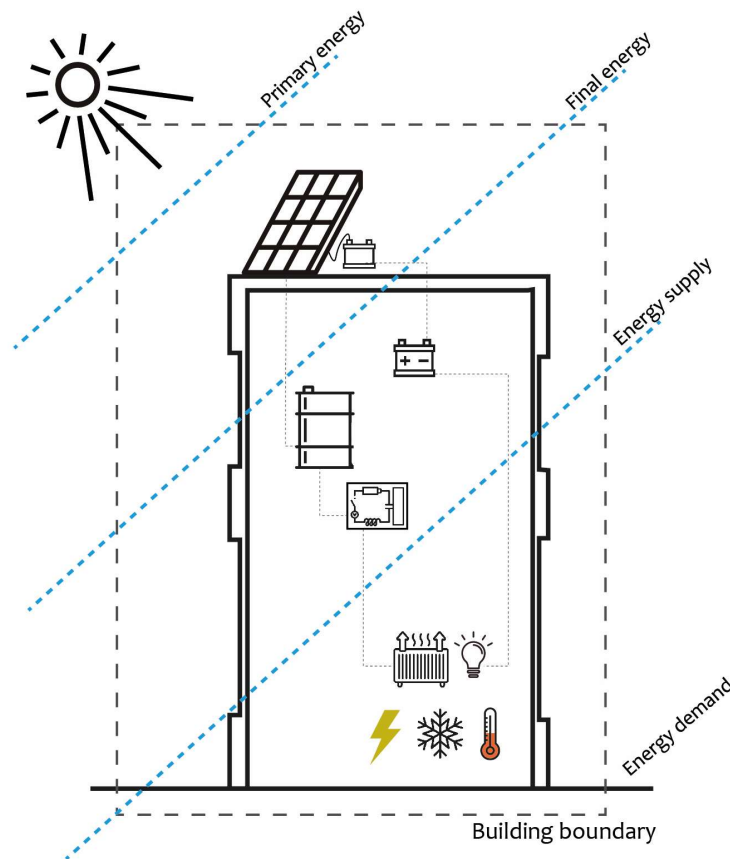

Figure 22. Energy chain of the Energy flatness

When referring to the **energy supply** in this research, it refers to the energy used by the building services in order to produce or store heat, cold or electricity for the building, as it can be seen in figure 22. Therefore, the energy chain for the energy flatness starts with the primary energy that comes from renewable energy sources (water, biomass, sun, wind, etc) and is transformed into usable final energy by technology such as PV or PV/T. This final energy is delivered to the building services, which transform it into the energy demand in the space.

The **complementary energy system** used to reach energy flatness is based on the energy final energy technology and the energy demand of the building because is the link between what is produced and what the needs of the building are. The complementary energy system aims to compensate for the energy shortage periods by storing the energy surplus in order to be able to be used again. The energy stored comes from the renewable energy produce that is not needed by the building to make the building services work in each hour. The energy storage system to be integrated in the built environment need a whole energy system that complements its function by means of distributions, conversion and transportation.

Energy Storage technologies have great potential for smoothing out the electricity and thermal energy, ensuring that the on-site energy produce matches the needed energy demand of the building. Energy storage is well known for its rapid response, if the system is located within the building boundary and it aims to balance the energy within the building. The capacity and power of the storage can be dimensioned according to the building requirements, making feasible a fast response, which is important for ensuring energy balance.

For example, if the energy is locally produced from a PV/T technology, the complementary energy system is responsible for the energy balance between the on-site energy produce and the energy demand. A heat pump or an electric boiler can provide the heating temperature needed inside the building and when there is a surplus of energy produce by the PV/T, this energy can be store before is use in the building to compensate for the lack of energy. Therefore, the complementary energy system includes all the systems needed to transform, store, discharge and distribute energy while connecting the on-site energy produce and the energy demand.

3.2. System boundaries

Three boundaries of the energy flatness are defined based on the boundaries of the net-zero energy buildings (Sartori, Napolitano, & Voss, 2012b) and other literature review.

Balance Boundary

Energy flatness aims for a complete energy balance in a building level, and it includes not only the heat and cold balance (thermal balance) but the electricity balance in the building, which represents the difference between the approach by Vincent Höfte (2018).

The energy balance of the energy flatness happens in the final energy or the energy delivered to the building. This balance is an electricity balance, but the thermal balance happens in between the energy supply after the building services and the energy demand. Therefore, energy flatness includes two different balances.

Because the energy that is produced from renewable technologies needs to be converted, stored, discharged and distributed from a complementary energy system before is used in the building for heating, cooling and electricity. The **thermal balance** happens between the energy supply and the energy demand. Therefore, the energy supplied from the complementary energy system should be the same as the energy demand in the building.

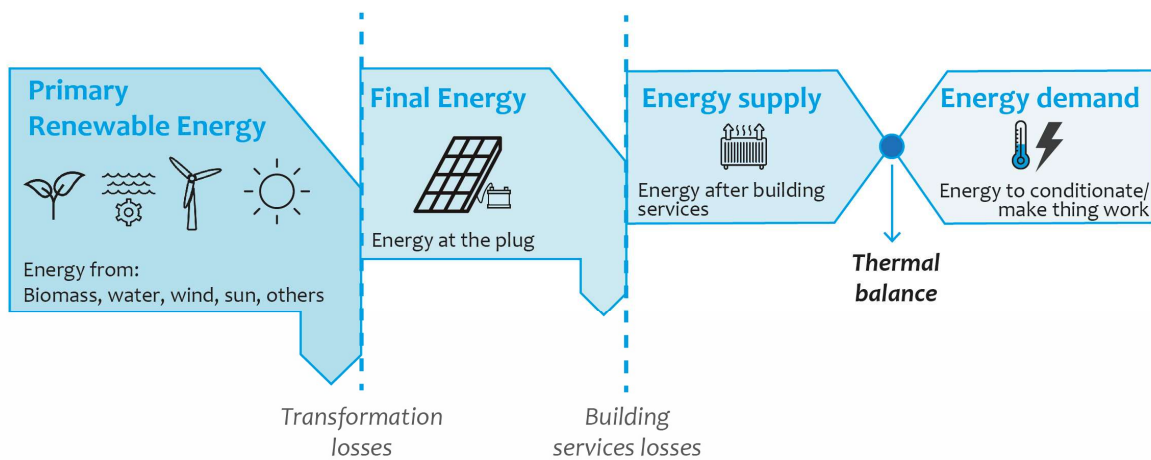

Figure 23. Energy flatness thermal balance

Once the thermal balance between supply and demand is analyzed, the second balance happens at the final on-site electricity supplied to the complementary energy system. The **Electricity balance** happens between the total production of on-site renewable electricity and the total electricity needed by the complementary energy system that includes the conversion, storage, discharge and distribution losses of energy in the building.

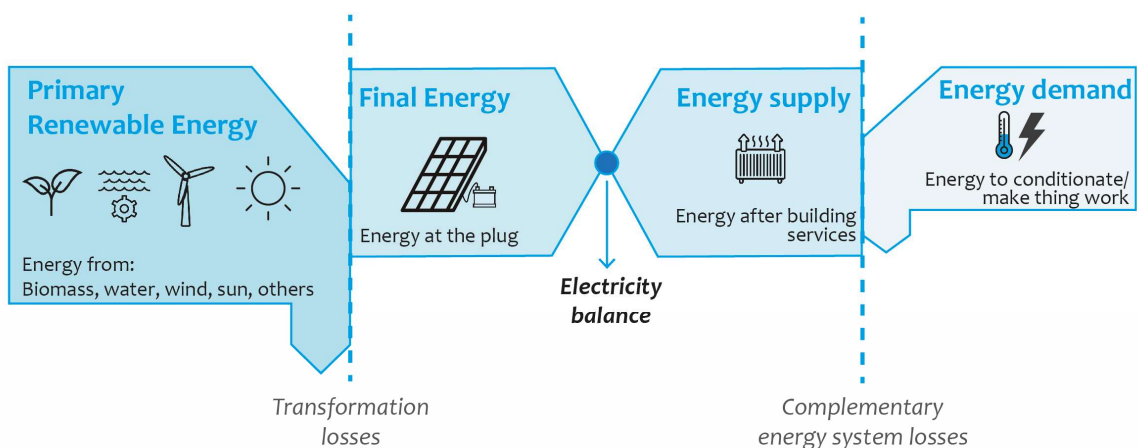

Figure 24. Energy flatness electricity balance

The final energy flatness balance is calculated with the electricity balance. Therefore, the electricity produce from on-site renewable technologies should match at any point in time the energy supplied to the complementary energy system.

Physical boundary

Final energy can only come from renewable energy sources that are within the building boundary and serve the needs for energy of one building. The energy flatness can use different renewable energy technologies from different renewable primary energy sources in order to reach the energy balance. However, during this research only solar primary energy will be explored because it is very time more implemented in the built environment and the mismatch is every time more evident than with other renewable energy sources.

Within the energy chain, two different balances are usually achieved in the conventional system; the balance between the imported and exported energy when connected to the grid and the balance between load and generation (demand and supply). The balance between imported and exported energy is not part of the scope of the energy flatness as this balance is in the connection with the general grid.

Energy flatness aims to reach an energy balance at the building level because one single building is the most effective unit to make meaningful energy gains (Ala-Juusela et al., 2016). This means that even though the building is connected to a general grid, it does not aim to balance energy through the connection with the general grid; therefore, no energy should be imported, nor exported. Nonetheless, if there is a surplus of energy, it is preferable to export it than to lose it in the system.

The connection between other buildings in order to reach energy flatness is not contemplated in this research, because it is assumed that when the building is connected to a grid where the other buildings have more or less the same mismatch profile, the connection between them will increase the mismatch instead of decreasing it. Therefore, it is better to solve the mismatch within the each building boundary.

The balance between the final on-site energy produce and the energy supply is the aim of the energy flatness. Figure 25 displays the balance of the energy flatness with the complementary energy system. The system must be balanced within the building boundary and not with the connection with the general grid as it is shown in figure 25.

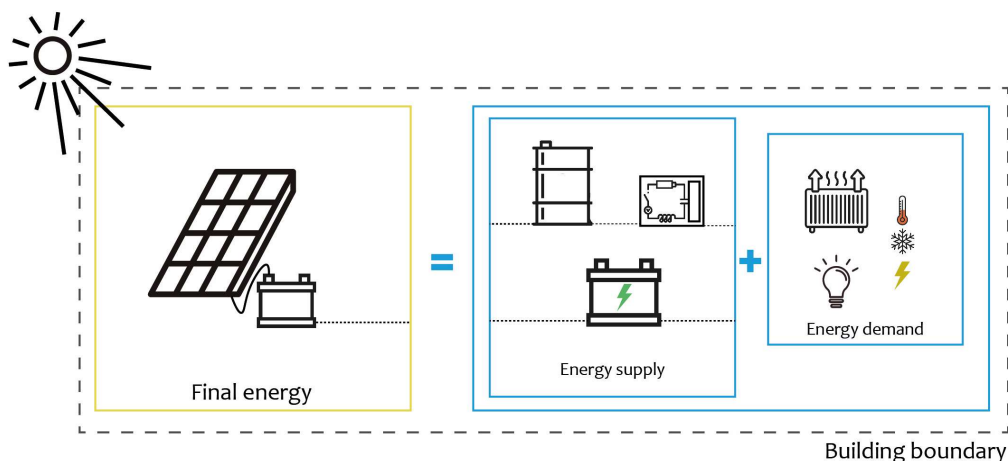

Figure 25. Energy flatness electricity balance

The occupants' behavior greatly influences the energy demand in a building, which is not being counted in energy performance modeling software, resulting in an energy gap (Dugar, 2019). Energy flatness does not aim to solve the mismatch by solving the energy gap, because it is hard to predict or quantify the impact of the human behavior in the energy demand. Therefore, occupant behavior will not be included in the calculations of the energy flatness; nonetheless, this factor should be taken into account in further research.

It is impossible not to conceive the efficiencies of the on-site energy production technologies and the complementary energy system. However, it is not the aim of this research to make the technology more or less efficient, but to work with the current efficiencies and implement them to balance the whole energy chain in existing buildings. Furthermore, it is the aim to explore the optimal integration of both renewable energy production technologies and complementary energy system and the optimization of the physical properties of non-residential existing buildings.

Balancing period

Energy balance should be reached at any period of time. Energy neutrality aims to achieve balance at the yearly basis, energy flatness at an hourly basis. In between, there are other mismatches that are solved by the energy flatness, such as the daily, weekly, monthly and seasonal mismatch.

The shorter the time, the harder it gets to solve the mismatch. Hourly energy flatness aims to balance the system at the end of the 60 minutes of time. Since the information about energy consumption and production are usually displayed in fractions of hours, this is going to be the smaller fraction of time of the mismatch (H. Lund et al., 2011). The final idea of the energy flatness is to achieve a 100% match between the final energy and the energy supply in the 8760 hours of the year.

The next time step will be the daily mismatch, as the main source will not produce energy during night hours; there are periods in the Netherland where the lack of energy production is more than 15 hours out of the 24 hours of the day. Therefore, the complementary energy system should have the capacity to compensate those hours on a daily basis.

The weekly mismatch is mainly differenced by the usage of the building during weekdays (Monday to Friday) and weekends (Saturday, Sundays and holidays). An education and commercial building is mainly characterized by a higher time of usage during the weekdays and not so much during the weekend. In the weekly mismatch, the unit of time analyzed is the hour as the 168 hours are easy to visualize and measure.

The monthly mismatch will be analyzed in terms of days and hours, which means 28 or 31 days or the 672-744 hours depending on the month. In this monthly analysis, it is important to understand that the summer months May to August are the months when less heating demand and more solar energy production is available. During winter months, there is more heating demand and lower solar energy production, which cause a seasonal mismatch.

The yearly match is the final goal of the energy flatness, after analyzing the hourly, daily, weekly and monthly mismatch. Therefore, at the end of the 12 months and 8760 hours the mismatch should be zero.

Table 5. Energy flatness balancing periods

Balancing period	Size of the time-steps
Hourly mismatch	1 hour (60 minutes)
Daily mismatch	24 hours
Weekly mismatch	168 hours or 7 days
Monthly mismatch	672 to 744 hours and the 28-31 days (depending on the month)
Yearly mismatch	8760 hours and the 12 months

3.3. Assumptions of the energy flatness

There is a negative and a positive mismatch, the positive mismatch occurs when the on-site energy produce is higher than the energy supplied to the complementary energy system, this energy is also called as the surplus of energy and can be stored in an energy storage system in order to be used again in the system. Energy flatness aims to have a complete energy balance system, but in the case of mismatch, it is preferred to have a positive than a negative mismatch.

Positive mismatches happens because the production of on-site renewable energy depends on the sun, in summer periods the sunny hours are longer and the radiation is higher, sometimes it is so high that exceeds the energy demand in the building in a certain moment. This causes an unbalance between what is needed and what is produced, as figure 26 is showing.

The negative mismatch happens when the energy supply to the building services is higher than the final on-site energy production from renewable technologies as the figure 26 is displaying. In this case, there is a need for energy compensation by previously stored energy (from surplus energy); the idea of the energy flatness is to avoid importing energy to fulfill the shortage of energy.

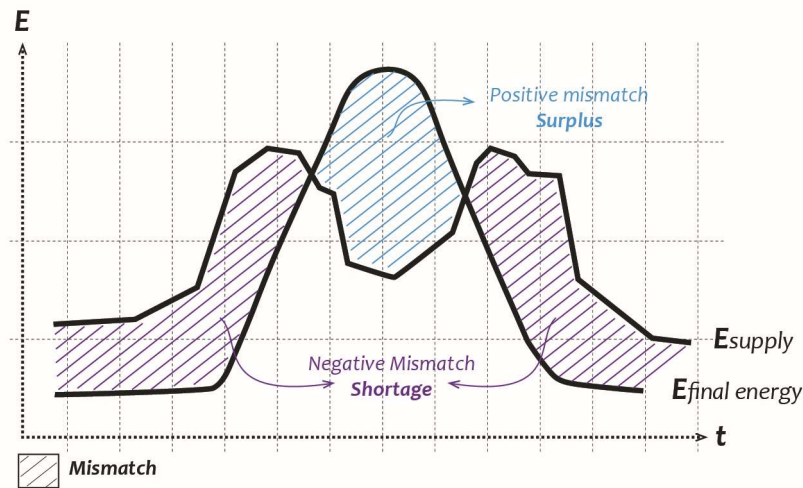

Figure 26. Positive and negative mismatch

Negative mismatch does not imply a bad mismatch, but represents the importance of a complementary energy system to balance the energy chain. If the system has no shortage periods, the building will be an energy flat building or an EPB, and the connection to the grid will be for exporting energy. The negative mismatch is the opportunity to reach a balance with in the building itself by the integration of the complementary energy storage to use the surplus of energy.

The analysis of the positive and negative mismatches happening between the final energy and the energy supply, help to dimension the complementary energy system and the peak power needed to fully compensate the system. Therefore, in order to solve the overall mismatch an analysis of the current positive and negative mismatches has to be developed.

3.4. Key Performance Indicators (KPI's)

The Key Performance Indicators (KPI's) aim to quantify the mismatch, because the smaller the mismatch, the closer the building is to be energy flat. Three KPIs are analyzed based on the KPI proposed by V. Höfte (2018), H. Lund et al. (2011) and Ala-Juusela et al. (2016).

In order to define the KPIs, an analysis of the main characteristics of the mismatch was developed. The first KPI shows how to measure the total mismatch in different time steps. Second mismatch focuses on the type of mismatch and the period when the peak of the mismatch is happening. Moreover, the third KPI is the accumulative mismatch by type that can help to dimension the energy storage system.

KPI 1 – Absolute energy flatness (AEF)

Energy flatness is a state of a building energy performance in which the difference between the final energy and the energy supply to the building services is zero at any time of the year.

$$\sum_{t=1}^{t=8760} |E_{final\ energy}(t) - E_{Energy\ Supply}(t)|$$

Energy flatness can be calculated with the previous formula, where the sum of the energy delivered ($E_{final\ energy}$) in a time step (t) in kWh, minus the sum of the energy supply ($E_{energy\ supply}$) at the same time step (t) in kWh is equal to Zero at any time step. The (t) refers to the time steps in hours from the energy simulation that can be between 1 hour or 8760 hours in a year.

When the result of this equation is different to zero, absolute energy flatness was not reached. Therefore, a mismatch of energy is occurring. In order to calculate the total mismatch, is necessary to understand what is influencing the mismatch and

what type of balance do we want to achieve. As explained before, the thermal balance is different to the electricity balance. Nonetheless, the electricity balance is the one used to quantify the energy flatness.

$$\text{Electricity mismatch} = \sum_{t=1}^{t=8760} |E_{final\ energy(t)} - E_{Energy\ Supply(t)}|$$

The result of this equation does not differentiate the positive or negative mismatch, but it aims to show the absolute total mismatch during a t time. The perfect energy flat building will reach a result equal to zero at any time. In this equation, it is necessary to have the system boundaries and the balance boundary clear because the complementary energy system plays an important role to achieve a complete flatness.

The electricity mismatch equation is not the same as the thermal mismatch equation. The thermal mismatch equation account for the difference between energy supply and energy demand in a time step between 1 and 8760 hours of the year. In addition, this equation is different from the Zero Energy Buildings equation, because the energy flatness formula accounts for all the hours where the mismatch is present during the whole year in the building and not only the total balance in the year.

In the figure 27, the formula represents the sum of all the hatched areas, which are the mismatch, in a full energy flat building there will be a single line that will show the matched final energy and the energy supply. The unit of measurement of this KPI is in kWh/year, because it aims to measure the total mismatches during the 8760 hours of the year.

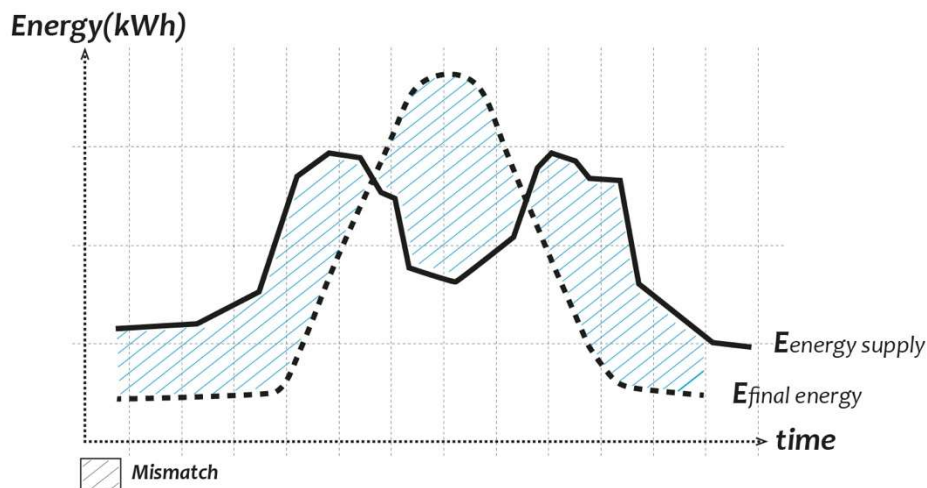

Figure 27. Energy mismatch between final energy and energy supply in kWh during time

KPI 2 – Maximum Mismatch Peak (MMP)

The second KPI shows the peak of the mismatch. In order to understand what the maximum peak of the mismatch is, it is necessary to analyze it in terms of the highest positive and negative mismatch that can occur between final energy and energy supply during a year.

$$MMP = \max_{0 \leq t \leq 8760} |E_{Final\ energy(t)} - E_{Energy\ supply(t)}| [kW]$$

The formula describes a time (t) that is between hour 0 and the hour 8760, when the difference between the final energy and the energy supply is on its maximum peak compared to the other mismatches during the year. Therefore, compared with the KPI 1, the unit of measurement of KPI 2 is in KW (Kilowatts). Furthermore, with this KPI is possible to calculate the maximum positive mismatch peak (peak of the surplus) and the maximum negative mismatch peak (peak of the shortage).

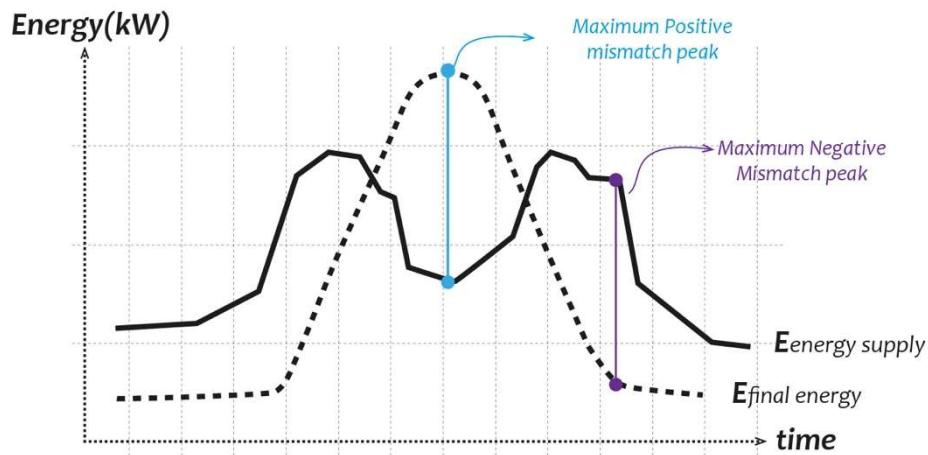

Figure 28. KPI 2 Maximum Mismatch Peak

This formula can also be formulated by type of energy mismatch in order to understand the maximum thermal mismatch peak and the maximum electricity mismatch peak. The main idea of this mismatch is to understand the moment and maximum amount of energy that needs to be supplied or stored at an hourly step. Furthermore, the next KPI will contemplate the maximum of the shortage and surplus of energy when those get cumulated in time.

KPI 3 – Maximum Cumulative Energy Mismatch (MCEM)

The energy mismatch can be positive or negative and a zero mismatch is equal to energy flatness. When the periods of shortage are repetitive within the hours, there is a cumulative negative mismatch (CEM_{negative}). This is calculated by the sum of the negative mismatches of the previous time steps before there is an on-site renewable energy production available to compensate for the shortage.

The cumulative positive mismatch (CEM_{positive}) is calculated by the sum of all the positive mismatches of the previous time steps before there is a period of shortage that needs to be compensated with the renewable energy production.

After the cumulative positive and negative mismatches are calculated, the difference between the maximum of the cumulative positive mismatch that happened at a (a) time and the maximum of the cumulative negative mismatch that happened at another (b) time will be the answer to the KPI 3 as well as the required size of the energy storage system.

$$MCEM = \max_{0 < a < 8760} \text{positive}(CEM_{\text{positive}(a)}) - \max_{0 < b < 8760} \text{negative}(CEM_{\text{negative}(b)}) \text{ [kWh]}$$

The figure 29 shows a graph of the mismatch where is possible to see the positive cumulative mismatch and negative cumulative mismatch. KPI 3 shows how big the surplus of energy (potential storage energy) could be when it is cumulated within the hours because it was not use by the building energy balance. The negative cumulative mismatch comprises the energy through the hours where there was not enough final on-site energy production to compensate for the energy need by the complementary energy system in the building.

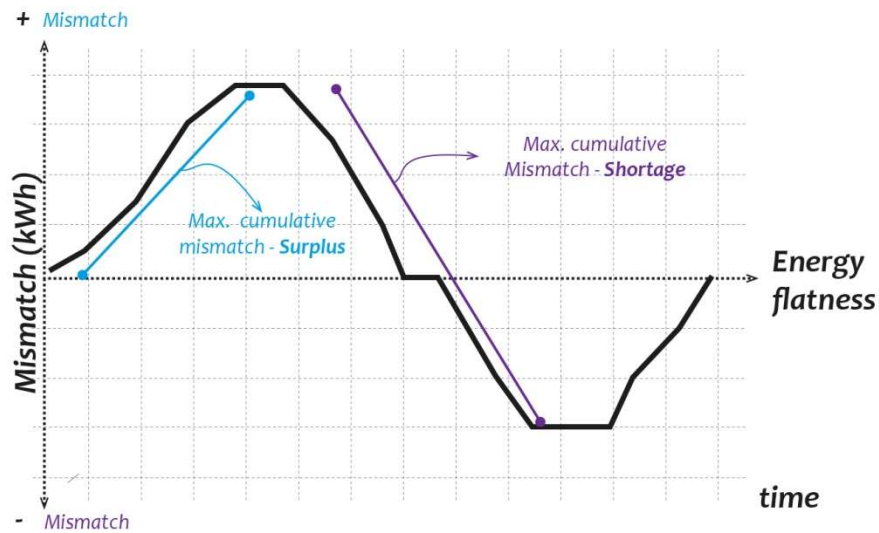

Figure 29. KPI 2 maximum peak of the mismatch

The difference between the maximum cumulative positive and the maximum cumulative negative is the approximate size of the complementary energy storage system, without counting the energy losses through conversion or distribution.

Example

In order to make the KPIs clear, an example of the analysis of the mismatch in an office building with solar panels and only one person working during one day is displayed in the next table.

Table 6. Example of an office building mismatch analysis.

Time (hour)	Final energy (kW)	Energy supply (kW)	Energy Mismatch (kW)	Cumulative mismatch (kWh)
1	0	0,04	-0,04	-0,04
2	0	0,04	-0,04	-0,08
3	0	0,04	-0,04	-0,12
4	0	0,04	-0,04	-0,16
5	0	0,04	-0,04	-0,2
6	0,15	0,15	0	-0,2
7	0,25	0,3	-0,05	-0,25
8	0,3	0,3	0	-0,25
9	0,35	0,3	0,05	-0,2
10	0,55	0,6	-0,05	-0,25
11	0,75	0,6	0,15	-0,1
12	0,85	0,75	0,1	0
13	0,9	0,75	0,15	0,15
14	0,85	0,6	0,25	0,4
15	0,65	0,5	0,15	0,55
16	0,45	0,5	-0,05	0,5
17	0,35	0,5	-0,15	0,35
18	0,25	0,3	-0,05	0,3
19	0,1	0,1	0	0,3
20	0	0,1	-0,1	0,2
21	0	0,06	-0,06	0,14
22	0	0,06	-0,06	0,08
23	0	0,04	-0,04	0,04
24	0	0,04	-0,04	0
Total	6,75	6,75	0	

Complete match
 Maximum Cumulative negative mismatch (CEM_{negative})
 Maximum positive mismatch peak
 Maximum Cumulative positive mismatch (CEM_{positive})
 Maximum negative mismatch peak
 Complete match at the daily basis

In this example the total mismatch in the 24 hours of the day is equal to Zero, which means that the daily basis is solved, but the building itself is not energy flat, because in the hourly basis the mismatch is not solved. Nonetheless, there are three hours in the day when a perfect flatness is reached, at 6, 8 and 19 hours. During those hours the building was energy flat, because the final energy use by the building matches perfectly with the energy supply.

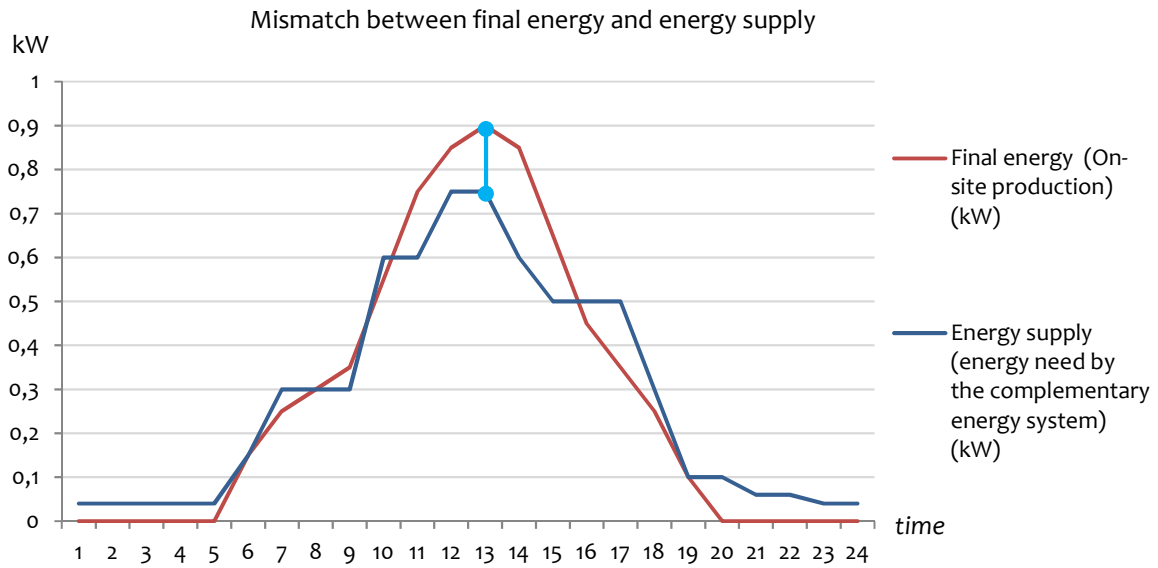

Graph 2. Example of an office building mismatch analysis of one day.

In graph 2 can be seen the mismatch period that happen during 24 hours between final energy and energy supply. Energy flatness is reached in a period of 24 hours because the sum of the final energy that happens during the 24 hours minus the sum of the energy supply during those 24 hours is the same.

$$KPI 1 = \sum_{t=1}^{t=24} |6,75kW_{(24h)} - 6,75 kW_{(24h)}|$$

Eventhough the buidling in energy flat during that day, in the hourly basis is not energy flat. The maximum mismatch happens during the hour 14 ($t = 14$). During this hour the difference between final energy an denegy supply is 0,25 kw of positive mismatch (energy surplus) that can be store in order to compensate the energy shortage. During the hour 22 the difference was 0.06 kW of the negative mismatch (shortage of energy) that needs to be supplied from the energy surplus.

$$KPI 2 = \max_{t=14} \text{positive} |0,85 kW_{(t)} - 0,6 kW_{(t)}|$$

$$KPI 2 = 0,25 kW$$

$$KPI 2 = \max_{t=22} \text{negative} |0 kW_{(t)} - 0,06 kW_{(t)}|$$

$$KPI 2 = -0,06 kW$$

KPI 3 account for the maximum of the cumulative negative and positive mismatches. Therefore, duing the hour 8 the maximum cumulative negative mismatch takes place, which is the sum of all the shortage hours between hour 1 and 8, which means that a shortage of 0,25 kWh needs to be compensated by the complementary energy system.

On the other hand, the maximum cumulative positive mismatch happens in the hour 15, and is the sum of the positive mismatches between hour 13 and 15, when 0,55 kWh represent the cumulative surplus of energy that can help to compensate the energy shortage period.

$$KPI 3 = 0.55kWh - (-0.25kWh) [kWh]$$

$$KPI 3 = 0.80kWh$$

The difference between the maximum cumulative mismatches represent the KPI 3. This means that the size of the energy storage system which be minimum 0,80 kWh in order to be able to compensate the shortage periods and store the surplus energy.

The idea of the energy flatness is that the final on-site energy production should provide as much energy for the longest period possible during the year, and the building should reduce its consumption or adapted to the hours of energy production. In this case, the panels should be oriented to provide the most of the energy during the peak hour to be able to store it and use it during the shortage periods.

The energy supply can be optimized to reduce further the energy demand during the hours of no occupancy of the building between the 20 hours and 5 hours. The complementary energy system should at least have a capacity to store 0.8 kWh to be able to charge and discharge during the maximum cumulative surplus and the maximum cumulative shortage and also during the peaks of the mismatch. The periods when there is a positive cumulative mismatch, the complementary energy system will be charged, while in the periods when the cumulative mismatch is negative, the complementary system will discharge the stored energy.

The dimension of the energy storage system also needs to take into account the efficiency of the system, which means to include the energy losses by conversion, distribution and/or transportation of energy in order to ensure the complete match with the energy used in the building.

Conclusions of the energy flatness

Energy flatness is a state of a building energy performance in which the difference between the final energy and the energy supply to the building services is zero at any time. This concept was developed in the thesis “Energy-flat housing” (Höfte, 2018), and the system boundaries and KPIs were complemented during this thesis.

The boundaries proposed are based the balance boundary (thermal and electricity balance), physical boundary (within the building boundary) and balancing period (time steps of hours). Energy flatness considers a complete electricity balance (after the thermal balance) within the building boundary between the final energy (from on-site renewable energy technologies) and the energy supply which includes the energy delivered to the complementary energy system. The unit of measure of the nergy flatness is in kWh, to achieve energy balance during each of the 8760 hours of the year.

The thermal balance happens between the difference of energy demand versus energy supply when the complementary energy system is implemented in the building. Nonetheless, the electricity balance happens between the final energy and the energy supply, and this is the balance that is contemplated for the energy flatness.

The balance should be is achieved within the building boundary, which means that no connection with the shared grid is contemplated for the energy balance. In the case of achieving an energy positive building, the surplus energy can be exported to the shared grid, but it is not the aim of the energy flatness concept.

There are negative and positive mismatches, and those define the ability of the complementary energy system to be charged or discharged. By the analysis of the maximum mismatch peaks, the characteristics of the complementary energy system can be identified.

The aim is to achieve a complete balance during the 8760 hours of the year. To calculate the energy mismatch, three KPI's were discusses during this thesis. The first KPI aims to calculate the absolute energy flatness or the electricity mismatch which is the difference between the final energy and the energy supply during the 8760 hours of the year.

The second KPI measures the peak of the mismatch in terms of positive mismatch (surplus) and negative mismatch (shortage) to undersand the hours of the year where the difference between final energy and energy supply is at its peak.

The KPI 3 calculates the cumulated surplus and shortage of energy before it can be compensated with the complementary energy system. The diference between the maximum cumulative positive and maximum cumulative negative mismatch represent the size of the energy storage system in order to balance the energy system.

4 What is the mismatch in the case study

This chapter aims to answer the second question of the methodology: What is the mismatch in the case study building?. In the first subchapter there is a description of the non-residential existing building that was used as a case study. Second the energy simulation of the existing situation of the building and the validation of the simulation.

The third subchapter is the analysis of the parameters that influence the energy demand and that have a potential for being renovated in the case study building. The last chapter is the analysis of the current mismatch and KPIs of energy flatness in the case study building.

4.1. The case study

Part of the Tu/e campus 2020 housing master plan includes the renewal of four buildings in the campus of the Technical University of Eindhoven. The renovation of the Gemini building is the fourth building in the master plan.



Image 5. Gemini building of the Technical University of Eindhoven.
Source: google maps 2019

This building comprises the faculty of Mechanical Engineering (WTB) and Biomedical engineering (BMT). The ambition of the University for this building is to provide with new facades and installations while achieving a BREEAM Excellent Status with particular emphasis on the energy efficiency. This building will host part of the Applied Physics faculty (TN) and Coherence and Quantum Technology (CQT) laboratory.

The building was designed by the architect and urban designer S.J. van Embden between the sixties and seventies and finally completed in 1974. Since then it is an icon of the brutalism of the Netherlands, characteristic that has made it win the Betonprijs (concrete price) for the best use of concrete in a building of the Netherlands.

It is divided in two large masses (figure 30), Gemini South and Gemini North that are connected by 3 bridges and 2 more bridges connecting the Metaforum building (renovated in 2012) in the west and the FLUX building (renovated in 2015) in the East.

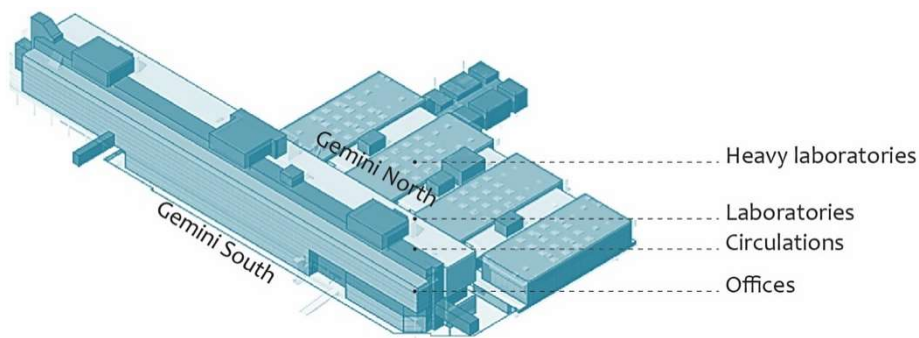

Figure 30. Gemini building at TU/e

The Gemini north building consists mainly of heavy laboratories and offices for the association groups of the university. The Gemini South building consist of laboratories, educational areas, a cafeteria and offices as figure 30 is showing.

For the aim of this research the Gemini south building will be used as a case study for the mismatch calculations because it integrates different functions within the building, is not residential and its renovation represents an important challenge for TU/e. The renovation of the façade is very important because it has not been updated since its construction and has been influencing greatly the heat losses inside the building as it will be explained in more detail in the chapter 4.3 of this report.

Gemini South building

Is a large horizontal concrete building south oriented with a gross floor area of 18811 m² approximately. It is composed by 6 floors on the south side that are mainly used for offices and 4 floors on the north side used for supporting facilities and educational purposes. The center is used for vertical and horizontal circulations, technical areas, education areas and other services of the building. The last part of the building, the 5th and 6th floor contains technical areas for HVAC equipment, as the section on the figure 31 of the building is displaying.

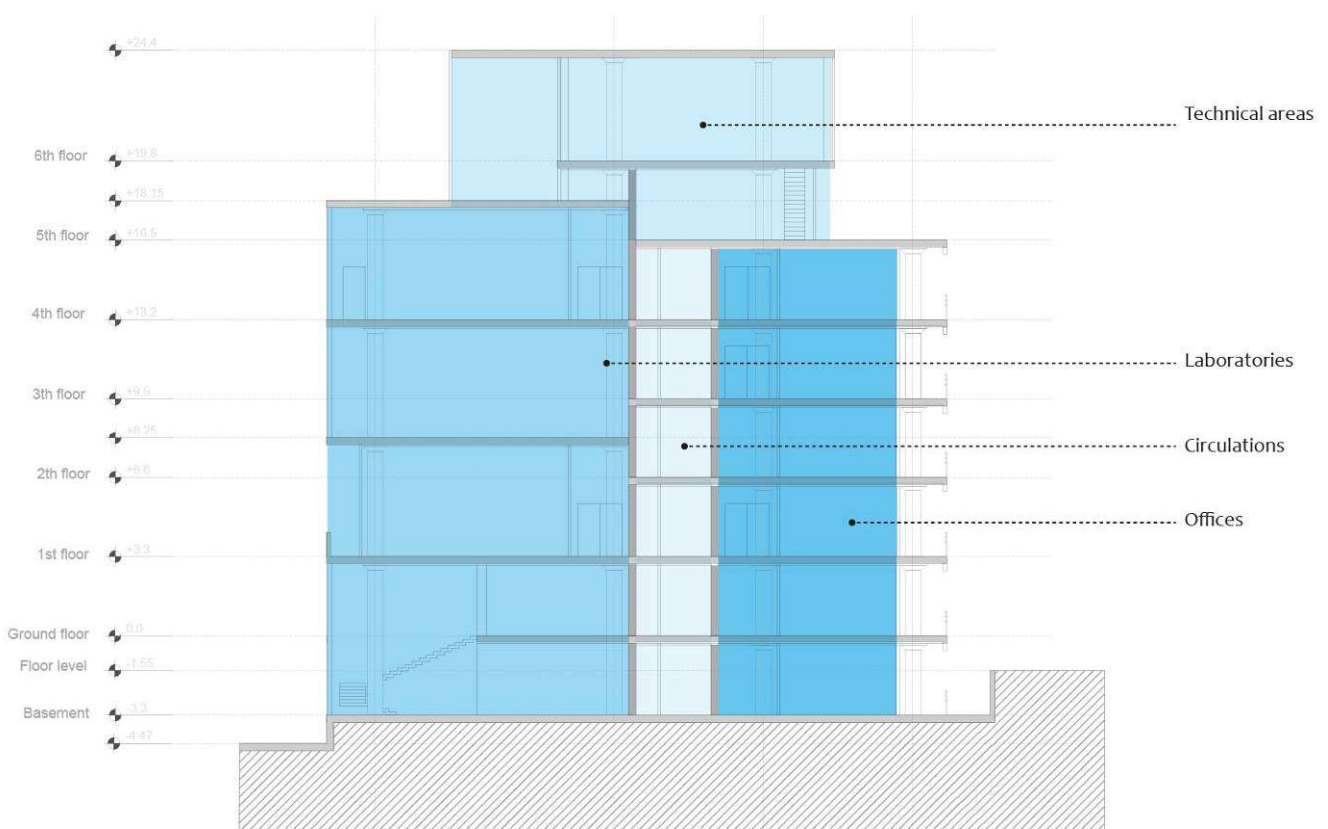

Figure 31. Section of the Gemini south building

An analysis of the total areas of the building carried out for the current plans shared by the Technical University of Eindhoven. The building has approximately 6485 m² of offices, 4567m² of laboratories and educational areas, 692 m² of cafeteria and 2399 m² of technical areas and services. For the aim of the analysis of the current mismatch of the building, the fourth floor was used for the basis of the energy simulation because it comprises the most common uses of the building and it has the same floor level though the whole floor as the section in figure 31 is showing.

The fourth floor consists of 3840 m² excluding the area of the balcony in the south because these are not occupied and not conditioned areas, the balconies are mainly used for the maintenance of the south façade. Offices for the different faculties staff are around 1234 m² located mainly in the south side of the building. The laboratories and educational areas consist of 1581 m² mainly located at the north side and central areas of the building. The central area hosts the functions of technical areas and services (177 m²), the rest of the areas are used for vertical (staircases and elevators) and horizontal circulations (847 m²).

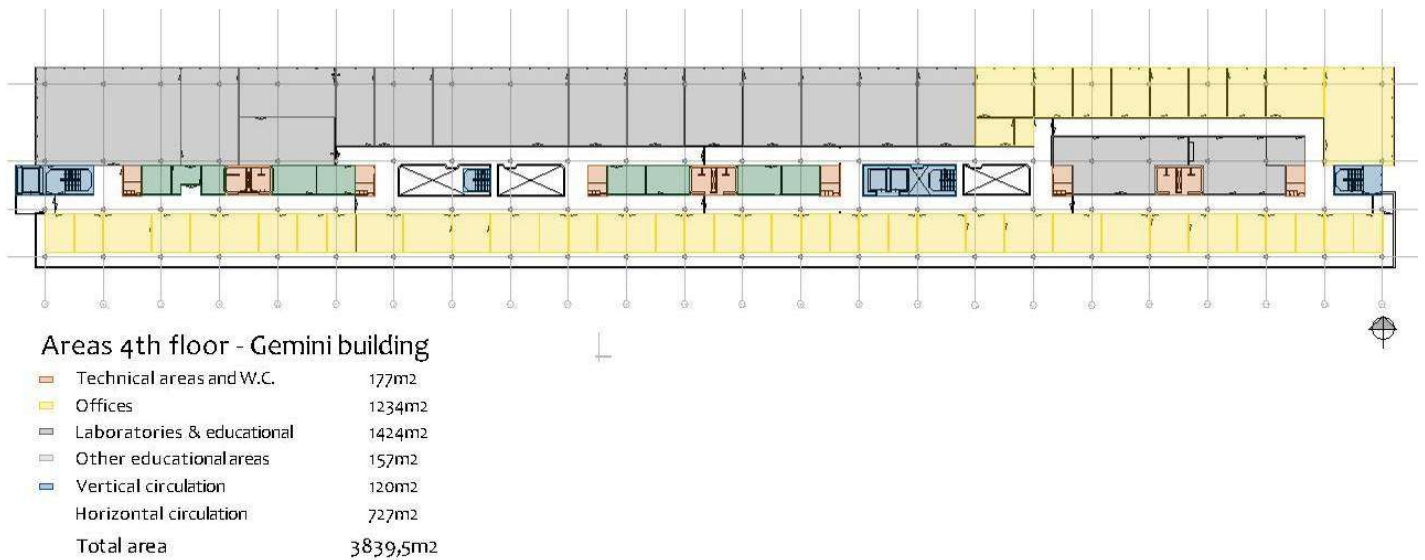

Figure 32. Floor plan of the 4th floor of the Gemini south building

The configuration of the building varies depending on the orientation, since it is south oriented the south façade has a different configuration compared with the north façade and the east and west façades are a mix of the configuration of the north and south.

The **south façade** (image 6) of the Gemini south building is characterized for defined concrete elements, circular concrete columns of 65cm of diameter, with flat concrete slabs, a curtain wall attached to it, followed by prefabricated concrete balconies of 2.0 meters offset from the façade with no thermal insulation in the connection and a metal substructure that contains the balustrade and the automated sun protection blinds, as the exploded axonometry in figure 33 is displaying.

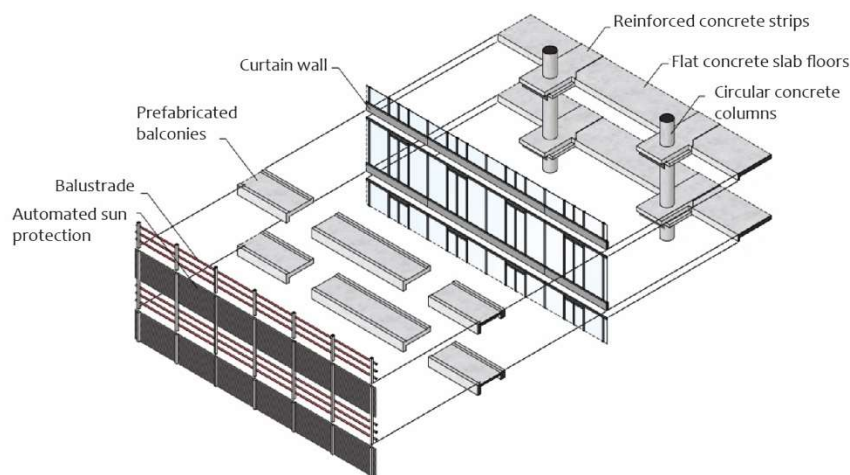

Figure 33. Axonometry of the south façade of the Gemini south building



Image 6. South façade of the Gemini south building

The net façade height is 3.0 m and remains the same height in all floors. The curtain wall façade has 513 m² (figure 34) and is 75% composed by single glazing with a U-value of 6.1 W/m²K and metallic frame with no thermal break. A ventilation grill is located on the top of the window panel and is manually controlled from the inside.

The opaque surfaces of the façade are sandwich panels of 3mm steel plate, polyurethane foam and 3mm of steel plate with a thermal resistance R_c value of 2.56 m²K/W as it can be seen in the section of the south façade in figure 35. The sun protection blinds outside the façade are mechanically controlled with sunlight sensors, and a second set of blinds is located inside the space and these ones are controlled manually.

The round concrete columns and prefabricated concrete balconies are visible through the whole façade, as well the red balustrade as it can be seen in the image 6. The white boxes on top of the building are also very important for the whole exterior esthetic of the building and are very important elements to consider in the renovation proposal of the building.



Figure 34. South façade of the Gemini south building

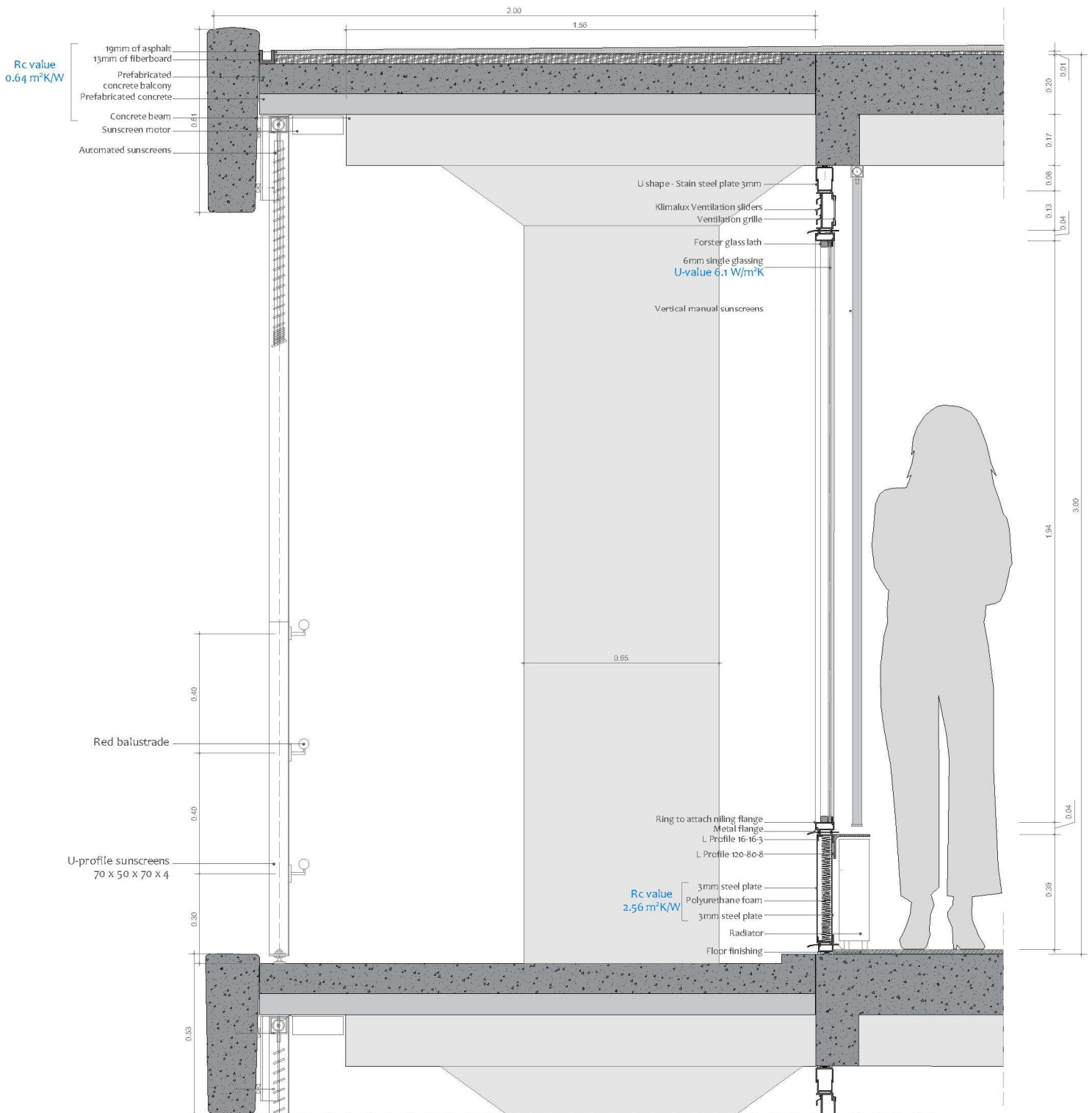

Figure 35. Façade south of the Gemini south building.
Façade detail scale 1:20

The **north façade** (image 7) is 860 m² and is characterized for having different height than the south facade and serving different functions within the education and research field, such as classrooms, meeting rooms and laboratories. In this facade the rounded concrete columns and concrete slabs are hidden behind the IPE profiles and a curtain wall as the axonometry of figure 36 is showing.



Image 7. North façade of the Gemini south building

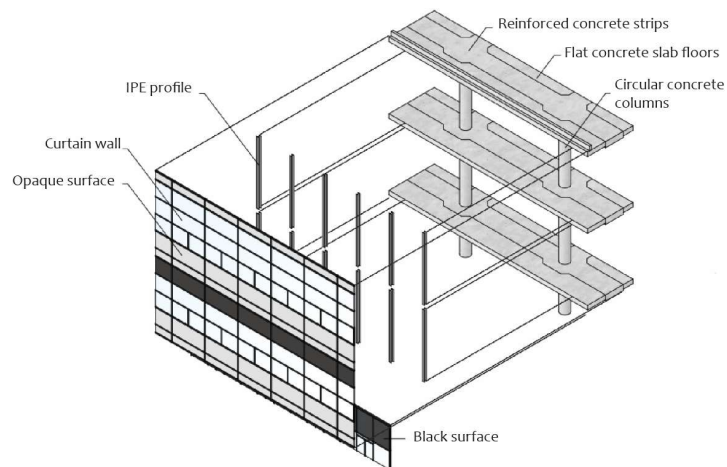

Figure 36. Axonometry of the North façade

This façade is more exposed to the sun and it has sun protection blinds inside that are controlled manually, it has 65% of single glass of U-value 6.1 W/m²K and metallic frame with no thermal break (figure 38). The opaque panels are sandwich panels of 3mm steel plate, polyurethane foam and 3mm of steel plate with a thermal resistance Rc value of 2.56 m²K/ all attached to an IPE metal profile. A part of the window is operable to allow for fresh air.



Figure 37. North façade of the Gemini south building

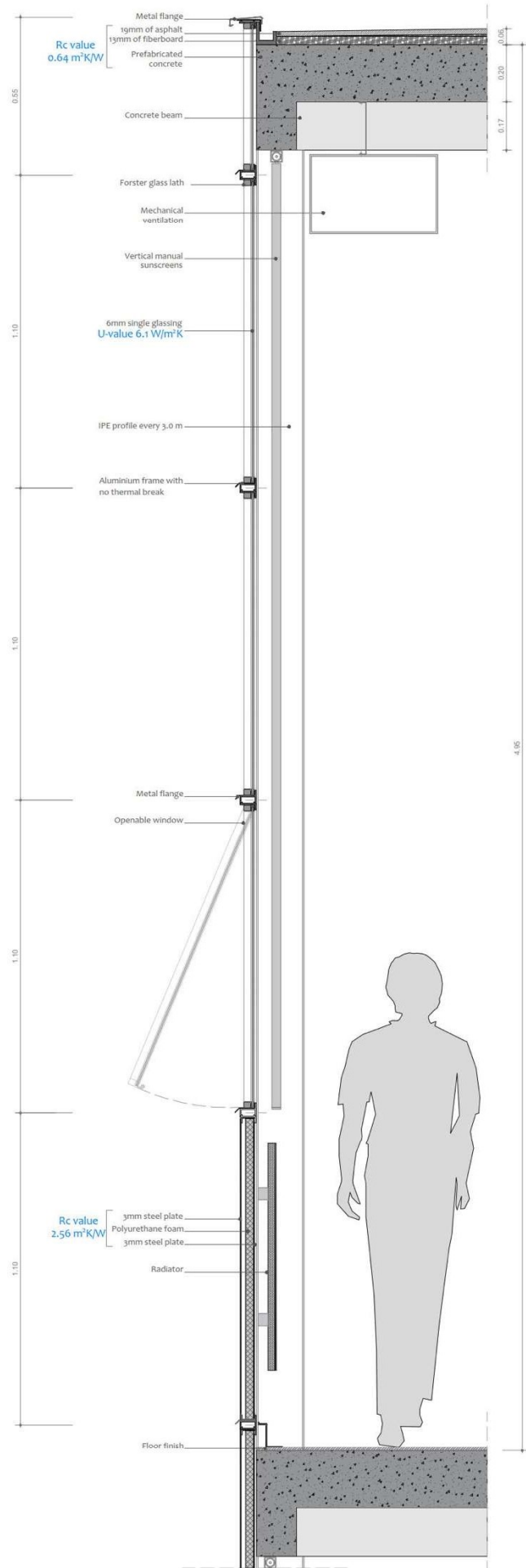

Figure 38. North façade of the Gemini south building. Façade detail scale 1:20

4.2. Energy model of the existing situation

To analyze the energy demand of the Gemini south building, a model of the building have been elaborated using the program Design Builder, which is mainly used for energy calculations, the input of the model, are explained in the subchapter 4.2.1.

The Technical University of Eindhoven shared the information regarding energy supply of the building in terms of electricity, cooling from the ATES and heating from the ATES + m³ of natural gas from the gas boiler in monthly basis for the year 2018. The information in the model was validated with the information received from the university and other literature review, further validations on the model results were made by hand calculations and other analysis explained in chapter 4.2.2.

4.2.1 Energy simulation input data

The collected data have been model using the Design Builders software specialized for energy simulations. The input data of the model has been base on a site visit to the building, information read in the webpage of the Technical University of Eindhoven and assumptions based on the function of the building and year of construction.

The model corresponds to the fourth floor of the building (Figure 39), which comprises the main functions and represents the typical functioning of the building. The input data have been separate by function in terms of thermal (internal gains, transmission, ventilation and infiltration and solar gains) and electrical balance per type of space and extra notes of the model.

Due to the different heights in the building, the model has two difference blocks, the north block is characterized for having a height of 4.95m and the south is 3m height. The north block hosts 1294m² of laboratories, 400m² of offices and 157m² of circulations, and the south block contains the 344m² of open balcony, 817m² of offices, 286m² of educational areas and 654m² of circulations.

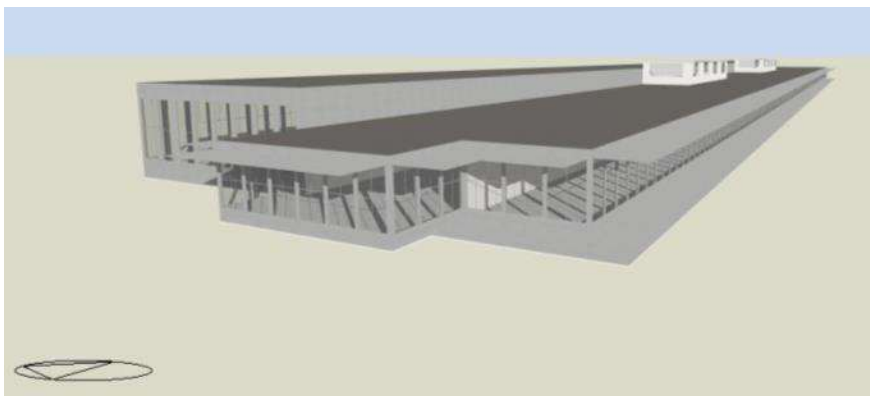

Figure 39. 4th floor of the Gemini building modeled in Design builder

Gemini south building hosts 5 main functions in the building: educational, laboratories, offices, technical and services areas and circulations. The educational function represents 7% of the areas of the building and is mainly used for classroom and auditoriums. The laboratories of biomedical and mechanical engineering are the functions that demand most of the energy, because they account for 34% of the total area of the building and have constant demand of energy for lighting, special equipment and process cooling.

The offices account for 32% of the area of the building with 650 total employees approximately, the offices located in the south side of the building. The technical and service areas account for 5% of all the areas in the building and include all the rooms used for mechanical and electrical purposes as well as all the services such as bathrooms or storage rooms. These areas are not regularly occupied; therefore, there is no occupancy schedule for them. The circulation areas account for all the semipublic areas (that are not closed) in the building for vertical and horizontal circulation, waiting areas, lobby and the cafeteria of the first floor. These areas account for 22% of the area of the building and do not have much energy consumption by equipment, but demand constant lighting, same as in the laboratories.

The tables 7 to 11 aim to show the input data modeled in the energy simulation program, each space (circulations, offices, educational areas, laboratories and technical areas) have different input data in terms of thermal balance and electricity balance.

Table 7. Input data for the circulation areas

Circulations	The circulations modeled for the north and south block account for the same input except of the areas and height																																																	
Internal Gains																																																		
People	A peak of 81 people approximately (occupancy density of 0.1 people/m ²). It has been assume that people were mostly standing or walking with a metabolic rate of 140W/m ² . A metabolic factor of 0.9 has been set, considering an average between men (1.00) and women (0.85). Cloth resistance during winter is 1.00 clo and during summer is 0.50 clo (1 clo = 0.155m ² K/W).																																																	
	<p>Schedule</p> <table border="1"> <caption>Occupancy Schedule Data</caption> <thead> <tr> <th>Hour</th> <th>Occupancy (%)</th> </tr> </thead> <tbody> <tr><td>1</td><td>0</td></tr> <tr><td>2</td><td>0</td></tr> <tr><td>3</td><td>0</td></tr> <tr><td>4</td><td>0</td></tr> <tr><td>5</td><td>0</td></tr> <tr><td>6</td><td>0</td></tr> <tr><td>7</td><td>0</td></tr> <tr><td>8</td><td>10</td></tr> <tr><td>9</td><td>50</td></tr> <tr><td>10</td><td>75</td></tr> <tr><td>11</td><td>100</td></tr> <tr><td>12</td><td>75</td></tr> <tr><td>13</td><td>75</td></tr> <tr><td>14</td><td>100</td></tr> <tr><td>15</td><td>100</td></tr> <tr><td>16</td><td>100</td></tr> <tr><td>17</td><td>100</td></tr> <tr><td>18</td><td>50</td></tr> <tr><td>19</td><td>50</td></tr> <tr><td>20</td><td>10</td></tr> <tr><td>21</td><td>0</td></tr> <tr><td>22</td><td>0</td></tr> <tr><td>23</td><td>0</td></tr> </tbody> </table>	Hour	Occupancy (%)	1	0	2	0	3	0	4	0	5	0	6	0	7	0	8	10	9	50	10	75	11	100	12	75	13	75	14	100	15	100	16	100	17	100	18	50	19	50	20	10	21	0	22	0	23	0	During national holidays and weekends there is no occupancy
Hour	Occupancy (%)																																																	
1	0																																																	
2	0																																																	
3	0																																																	
4	0																																																	
5	0																																																	
6	0																																																	
7	0																																																	
8	10																																																	
9	50																																																	
10	75																																																	
11	100																																																	
12	75																																																	
13	75																																																	
14	100																																																	
15	100																																																	
16	100																																																	
17	100																																																	
18	50																																																	
19	50																																																	
20	10																																																	
21	0																																																	
22	0																																																	
23	0																																																	
Lighting	With a target of 200 luxes the power density was set to 4 W/m ² -100lux. The lights are set to be 100% ON from 8am to 8pm during weekdays and 50% ON the rest of the time (weekends and holidays)																																																	
Equipment	The power density was set to 4 W/m ² and it includes all the printers and other equipment placed in the circulations. The model assumes convective and radiant heat gains, where 0.2 is the amount of radiant heat given off by the equipment. The equipment is set to be 100% ON from 8am to 8pm during the weekdays and 4% ON the rest of the time including weekends.																																																	
Transmission																																																		
Area	812 m ² (North 158 m ² + south 654 m ²)																																																	
Floor	200mm of concrete slab with a U-value of 3.5 W/m ² K																																																	
Roof	19mm of asphalt + 13mm of fiberboard + 200mm cast concrete with a Rc-value of 0.64 m ² K /W																																																	
External walls	Panel of 3mm of stainless steel + 64mm of polyurethane + 3mm of stainless steel with a Rc-value of 2.56 m ² K /W																																																	
Windows	6mm single clear glassing with a U-value of 6.1 W/m ² K. In the north block, 65% of the façade area is glassing and in the south block, 75.5% of the area is glazing.																																																	
Partitions material	100mm of cast concrete slab with an U-value 4.7 W/m ² K																																																	
Air temperature for heating	During all weekdays the set point temperature is 22 °c and the rest of the days a setback or minimum temperature of 15 °c																																																	
Air temperature for cooling	During all weekdays the set point temperature is 24 °c and the rest of the days a setback or minimum temperature of 28 °c																																																	
Ventilation & infiltration																																																		
Area volume	2539 m ³ (North 708 m ³ + south 1831 m ³)																																																	
Relative humidity	Humidification set point of 30 minimum and dehumidification set point of 60 maximum																																																	
Infiltration Rate	The connection between windows, walls and partitions have no thermal break or any insulation that could reduce the heat losses through infiltration. Constant rate of 0.6 ac/h (air changes per hour)																																																	
Fresh air	0.01 m ³ /s per person of outside air using the occupancy schedule																																																	
Operable window	10% of the area of all windows are operable for natural ventilation																																																	
Solar gains																																																		
Due to the prefabricated concrete balconies, the circulation spaces in the south do not get any sunlight which in summer becomes an advantage to prevent overheating, but in winter it does not allow for solar gains. Solar gains are mainly through the core which has a glassed roof.																																																		
Solar transmission	6mm single clear glassing with a G-value 0.8. In the north block, 65% of the façade area is glazing and in the south block, 75.5% of the area is glassing.																																																	
Electricity																																																		
Lighting	With a lighting power of 4W/m ² -100lux and the 200 luxes required by the space, the electricity consumption is 8W/m ²																																																	
Equipment	4W/m ² during the weekdays from 8am to 8pm and 0.16 W/m ² the rest of the time.																																																	

Table 8. Input data for the offices areas

Offices	The offices in the south block are mainly use for 2 or 3 people and the ones in the north block are mostly open floor plan.																																																
Internal Gains																																																	
People	A peak of 120 people approximately (occupancy density of 0.1 people/m ²). It has been assume that people were mostly have a light work or are standing with a metabolic rate of 123W/m ² . A metabolic factor of 0.9 has been set, considering an average between men (1.00) and women (0.85). Cloth resistance during winter is 1.00 clo and during summer is 0.50 clo (1 clo = 0.155m ² K/W).																																																
	<p>Schedule</p> <table border="1"> <caption>Occupancy Schedule Data</caption> <thead> <tr> <th>Hour</th> <th>Occupancy (%)</th> </tr> </thead> <tbody> <tr><td>1</td><td>0</td></tr> <tr><td>2</td><td>0</td></tr> <tr><td>3</td><td>0</td></tr> <tr><td>4</td><td>0</td></tr> <tr><td>5</td><td>0</td></tr> <tr><td>6</td><td>0</td></tr> <tr><td>7</td><td>0</td></tr> <tr><td>8</td><td>10</td></tr> <tr><td>9</td><td>50</td></tr> <tr><td>10</td><td>75</td></tr> <tr><td>11</td><td>75</td></tr> <tr><td>12</td><td>100</td></tr> <tr><td>13</td><td>75</td></tr> <tr><td>14</td><td>75</td></tr> <tr><td>15</td><td>100</td></tr> <tr><td>16</td><td>100</td></tr> <tr><td>17</td><td>100</td></tr> <tr><td>18</td><td>50</td></tr> <tr><td>19</td><td>50</td></tr> <tr><td>20</td><td>10</td></tr> <tr><td>21</td><td>0</td></tr> <tr><td>22</td><td>0</td></tr> <tr><td>23</td><td>0</td></tr> </tbody> </table> <p>During national holidays and weekends, there is no occupancy.</p>	Hour	Occupancy (%)	1	0	2	0	3	0	4	0	5	0	6	0	7	0	8	10	9	50	10	75	11	75	12	100	13	75	14	75	15	100	16	100	17	100	18	50	19	50	20	10	21	0	22	0	23	0
Hour	Occupancy (%)																																																
1	0																																																
2	0																																																
3	0																																																
4	0																																																
5	0																																																
6	0																																																
7	0																																																
8	10																																																
9	50																																																
10	75																																																
11	75																																																
12	100																																																
13	75																																																
14	75																																																
15	100																																																
16	100																																																
17	100																																																
18	50																																																
19	50																																																
20	10																																																
21	0																																																
22	0																																																
23	0																																																
Lighting	With a target of 400 luxes the power density was set to 4 W/m ² -100lux. The lights are set to be 100% ON from 8am to 8pm during weekdays and 100% OFF the rest of the time (weekends and holidays).																																																
Office equipment	The power density of 7 W/m ² and it includes all the office equipment such as computers and printers. The model assumes convective and radiant heat gains, where 0.2 is the amount of radiant heat given off by the equipment. The equipment is set to be 100% ON from 8am to 8pm during the weekdays and 4% ON during weekends.																																																
Transmission																																																	
Area	1197 m ² (North 400 m ² + south 797 m ²)																																																
Floor	200mm of concrete slab with a U-value of 3.5 W/m ² K																																																
Roof	19mm of asphalt + 13mm of fiberboard + 100mm cast concrete with a Rc-value of 0.64 m ² K /W																																																
External walls	Panel of 3mm of stainless steel + 64mm of polyurethane + 3mm of stainless steel with a Rc-value of 2.56 m ² K /W																																																
Windows	6mm single clear glassing with a U-value of 6.1 W/m ² K. In the north block, 65% of the façade area is glassing and in the south block, 75.5% of the area is glassing.																																																
Partitions material	100mm of cast concrete slab with an U-value 4.7 W/m ² K																																																
Air temperature for heating	During all weekdays the set point temperature is 22 °c and the rest of the days a setback or minimum temperature of 15 °c																																																
Air temperature for cooling	During all weekdays the set point temperature is 24 °c and the rest of the days a setback or minimum temperature of 28 °c																																																
Ventilation & infiltration																																																	
Area volume	4031 m ³ (North 1799 m ³ + south 2232 m ³)																																																
Relative humidity	Humidification set point of 30 minimum and dehumidification set point of 60 maximum																																																
Infiltration Rate	Constant rate of 0.6 ac/h (air changes per hour). Window frames without thermal break.																																																
Fresh air	0.01 m ³ /s per person of outside air using the occupancy schedule																																																
Operable window	10% of the area of all windows are operable for natural ventilation																																																
Solar gains																																																	
Due to the prefabricated concrete balconies and the automated sunscreens, the offices in the south block do not get any sunlight which in summer becomes an advantage to prevent overheating, but in winter it does not allow for solar gains.																																																	
Solar transmission	6mm single clear glassing with a G-value 0.8. The north block, has 53% of glassing and manual sunscreens in every space and the south block has 75.5% of glassing and it has 2m of balcony (overhang) with external automated vertical sunscreen that activate with horizontal sun and internal manual horizontal sunscreens in each office.																																																
Electricity																																																	
Lighting	With a lighting power of 4W/m ² -100lux and the 400 luxes required by the space, the electricity consumption is 16W/m ²																																																
Equipment	7W/m ² during the weekdays from 8am to 8pm and 0.28W/m ² the rest of the time.																																																

Table 9. Input data for the educational areas

Educational	Are spaces used for teaching and have an special schedule
Internal Gains	
People	A peak of 29 people approximately (occupancy density of 0.1 people/m ²). It has been assume that people were mostly having lectures with a metabolic rate of 115W/m ² . A metabolic factor of 0.9 has been set, considering an average between men (1.00) and women (0.85). Cloth resistance during winter is 1.00 clo and during summer is 0.50 clo (1 clo = 0.155m ² K/W).
	<p>Schedule</p> <p>According to the calendar of the university, classes start on the 6 of January, there is a break between march 4 and march 8 and summer vacations are between the 8 of July and 24 of August, therefore those day were customize in the occupancy schedule.</p>
Lighting	With a target of 400 luxes the power density was set to 4 W/m ² -100lux. The lights are set to be 100% ON from 8am to 8pm during weekdays, 50% ON during weekends and no lighting during the holidays.
Equipment	The power density was set to 7 W/m ² and it includes all the office equipment such as computers and printers. The model assumes convective and radiant heat gains, where 0.2 is the amount of radiant heat being given off by the office equipment. The equipment is set to be 100% ON from 8am to 8pm during weekdays and 25% ON during weekends and no equipment during the holidays.
Transmission	
Area	286 m ²
Floor	200mm of concrete slab with a U-value of 3.5 W/m ² K
Roof	19mm of asphalt + 13mm of fiberboard + 100mm cast concrete with a Rc-value of 0.64 m ² K /W
External walls	Panel of 3mm of stainless steel + 64mm of polyurethane + 3mm of stainless steel with a Rc-value of 2.56 m ² K /W
Windows	6mm single clear glassing with a U-value of 6.1 W/m ² K. In the north block, 65% of the façade area is glassing and in the south block, 75.5% of the area is glassing.
Partitions material	100mm of cast concrete slab with an U-value 4.7 W/m ² K
Air temperature for heating	During all weekdays the set point temperature is 22 °c and the rest of the days a setback or minimum temperature of 15 °c
Air temperature for cooling	During all weekdays the set point temperature is 24 °c and the rest of the days a setback or minimum temperature of 28 °c
Ventilation & infiltration	
Area volume	800 m ³
Relative humidity	Humidification set point of 30 minimum and dehumidification set point of 60 maximum
Infiltration Rate	Constant rate of 0.6 ac/h (air changes per hour). Window frames without thermal break.
Fresh air	0.01 m ³ /s per person of outside air using the occupancy schedule
Operable window	10% of the area of all windows are operable for natural ventilation.
Solar gains	
Due to the prefabricated concrete balconies and the automated sunscreens, the educational areas do not get any solar gains.	
Solar transmission	6mm single clear glassing with a G-value 0.8.
Electricity	
Lighting	With a lighting power of 4W/m ² -100lux and the 400 luxes required by the space, the electricity consumption is 16W/m ² during weekdays from 8am to 8pm and 8W/m ² the rest of the time, during the holidays of the university there is not lighting consumption.
Equipment	7W/m ² during the weekdays from 8am to 8pm and 1.75W/m ² the rest of the time, during the holidays of the university there is not equipment electricity consumption.

Table 10. Input data for the laboratories

Laboratories	Biomedical and mechanical engineering laboratories with special requirements of usage based on the function of the building and safety regulations.																																																	
Internal Gains																																																		
People	A peak of 130 people approximately (considering an occupancy density of 0.1 people/m ²). People are mostly doing work that involves constant walking with a metabolic rate of 160W/m ² . A metabolic factor of 0.9 has been set, considering an average between men (1.00) and women (0.85). Cloth resistance during winter is 1.00 clo and during summer is 0.50 clo (1 clo = 0.155m ² K/W).																																																	
	<p>Schedule</p> <table border="1"> <caption>Occupancy Schedule Data</caption> <thead> <tr> <th>Hour</th> <th>Occupancy (%)</th> </tr> </thead> <tbody> <tr><td>1</td><td>0</td></tr> <tr><td>2</td><td>0</td></tr> <tr><td>3</td><td>0</td></tr> <tr><td>4</td><td>0</td></tr> <tr><td>5</td><td>0</td></tr> <tr><td>6</td><td>0</td></tr> <tr><td>7</td><td>0</td></tr> <tr><td>8</td><td>25</td></tr> <tr><td>9</td><td>75</td></tr> <tr><td>10</td><td>75</td></tr> <tr><td>11</td><td>100</td></tr> <tr><td>12</td><td>100</td></tr> <tr><td>13</td><td>100</td></tr> <tr><td>14</td><td>50</td></tr> <tr><td>15</td><td>50</td></tr> <tr><td>16</td><td>100</td></tr> <tr><td>17</td><td>100</td></tr> <tr><td>18</td><td>50</td></tr> <tr><td>19</td><td>50</td></tr> <tr><td>20</td><td>25</td></tr> <tr><td>21</td><td>0</td></tr> <tr><td>22</td><td>0</td></tr> <tr><td>23</td><td>0</td></tr> </tbody> </table>	Hour	Occupancy (%)	1	0	2	0	3	0	4	0	5	0	6	0	7	0	8	25	9	75	10	75	11	100	12	100	13	100	14	50	15	50	16	100	17	100	18	50	19	50	20	25	21	0	22	0	23	0	During national holidays and weekends there is no occupancy
Hour	Occupancy (%)																																																	
1	0																																																	
2	0																																																	
3	0																																																	
4	0																																																	
5	0																																																	
6	0																																																	
7	0																																																	
8	25																																																	
9	75																																																	
10	75																																																	
11	100																																																	
12	100																																																	
13	100																																																	
14	50																																																	
15	50																																																	
16	100																																																	
17	100																																																	
18	50																																																	
19	50																																																	
20	25																																																	
21	0																																																	
22	0																																																	
23	0																																																	
Lighting	With a target of 550 luxes the power density was set to 5 W/m ² -100lux. The lights are set to be 100% ON from 8am to 8pm during weekdays, 50% ON during weekends and holidays.																																																	
Laboratory Equipment + process equipment	The power density for the normal equipment was set to 7 W/m ² and it includes all the office equipment such as computers and printers and additional process equipment was set with a 5w/m ² load for special machines used in the laboratory that run through the 24 hours of the day the whole year. The model assumes convective and radiant heat gains, where 0.2 is the amount of radiant heat being given off by all the laboratory equipment. The office equipment is set to be 100% ON from 8am to 8pm during weekdays and 25% ON during weekends and holidays, and the process equipment 100% ON during 24hours / 7days.																																																	
Transmission																																																		
Area	1294 m ²																																																	
Floor	200mm of concrete slab with a U-value of 3.5 W/m ² K																																																	
Roof	19mm of asphalt + 13mm of fiberboard + 100mm cast concrete with a Rc-value of 0.64 m ² K /W																																																	
Ceiling	To simulate the ceiling gypsum plasterboard of 13mm was set with a U-value of 5.2 W/m ² K.																																																	
External walls	Panel of 3mm of stainless steel + 64mm of polyurethane + 3mm of stainless steel with a Rc-value of 2.56 m ² K /W																																																	
Windows	6mm single clear glassing with a U-value of 6.1 W/m ² K. In the north block, 65% of the façade area is glassing and in the south block, 75.5% of the area is glassing.																																																	
Partitions material	100mm of cast concrete slab with an U-value 4.7 W/m ² K																																																	
Air temperature for heating	During all days a constant temperature of 21 °c																																																	
Air temperature for cooling	During all days a constant temperature of 23 °c																																																	
Ventilation & infiltration																																																		
Area volume	800 m ³																																																	
Relative humidity	Humidification set point of 40 minimum and dehumidification set point of 50 maximum																																																	
Infiltration Rate	Constant rate of 0.6 ac/h (air changes per hour). Window frames without thermal break.																																																	
Fresh air	0.012 m ³ /s per person of outside air using the occupancy schedule																																																	
Operable window	10% of the area of all windows are operable for natural ventilation.																																																	
Solar gains																																																		
The laboratories are located in the north part of the building which has manual sunscreens that partily allows for solar gains																																																		
Solar transmission	6 mm single clear glassing with a G-value 0.8.																																																	
Electricity																																																		
Lighting	With a lighting power of 5W/m ² -100lux and the 550 luxes required by the space, the electricity consumption is 27.5W/m ² during weekdays from 8am to 8pm and 13.75W/m ² the rest of the time																																																	
Office equipment	7 W/m ² during the weekdays from 8am to 8pm and 1.75W/m ² the rest of the time.																																																	
Process equip.	7 W/m ² electricity consumption during the 24 hours of the day for the whole year.																																																	

Table 11. Input data for the technical and services areas

Technical & services	Include all the technical rooms for electrical and mechanical equipment and the restrooms
Internal Gains	
People	These spaces are not regularly occupied, therefore there is no occupancy schedule and no heat gains from people
Lighting	With a target of 200 luxes the power density was set to 4 W/m ² -100lux. The lights are set to be 100% ON from 8am to 8pm during weekdays, OFF during weekends and holidays.
Process Equipment	Process equipment from the electrical and mechanical rooms was set to need a constant power density of 7 W/m ² during the whole days of the year.
Transmission	
Area	167 m ²
Floor	200mm of concrete slab with a U-value of 3.5 W/m ² K
Roof	19mm of asphalt + 13mm of fiberboard + 100mm cast concrete with a Rc-value of 0.64 m ² K /W
External walls	Panel of 3mm of stainless steel + 64mm of polyurethane + 3mm of stainless steel with a Rc-value of 2.56 m ² K /W
Partitions material	100mm of cast concrete slab with an U-value 4.7 W/m ² K
Air temperature for heating	During all weekdays the set point temperature is 22 °c and the rest of the days a setback or minimum temperature of 15 °c
Air temperature for cooling	During all weekdays the set point temperature is 24 °c and the rest of the days a setback or minimum temperature of 28 °c
Ventilation & infiltration	
Area volume	467 m ³
Relative humidity	Humidification set point of 30 minimum and dehumidification set point of 60 maximum
Infiltration Rate	Constant rate of 0.6 ac/h (air changes per hour).
Fresh air	0.01 m ³ /s per area of outside air
Solar gains	
Technical areas and services are placed in the core of the building with closed partitions, so there is no solar gains through transparent surfaces.	
Electricity	
Lighting	With a lighting power of 4W/m ² -100lux and the 200 luxes required by the space, the electricity consumption is 8W/m ² during weekdays from 8am to 8pm and 8W/m ² and is OFF during the rest of the time.
Process equipment	7 W/m ² during the whole days of the year.

Current thermal energy supply system

The building is connected to a shared network to supply thermal energy, which is an ATES (Aquifer Thermal Energy Storage). A graduation report named 'supporting the Eindhoven University of Technology to reach Thermal Energy balance at the campus 2020', explains the system. In the Netherlands, water contained in ground layers (Aquifers) are often used to store the thermal energy because of their commonly available in the country, it is even expected that in the year 2020 around 20.000 of these systems will be operating (Spruijt, 2015).

This system has been providing the warm and cold water to 12 buildings of the Technical University of Eindhoven, including the Gemini South building since its year of construction in 2002, the main objective of this system is to reduce the energy consumption in the whole campus. This open ATES system stores heat and cold water underground; during summer, cold is extracted and heat is stored underground and during winter the opposite happens, the stored warm water preheats the water entering in the building and reduces the final energy for heating.

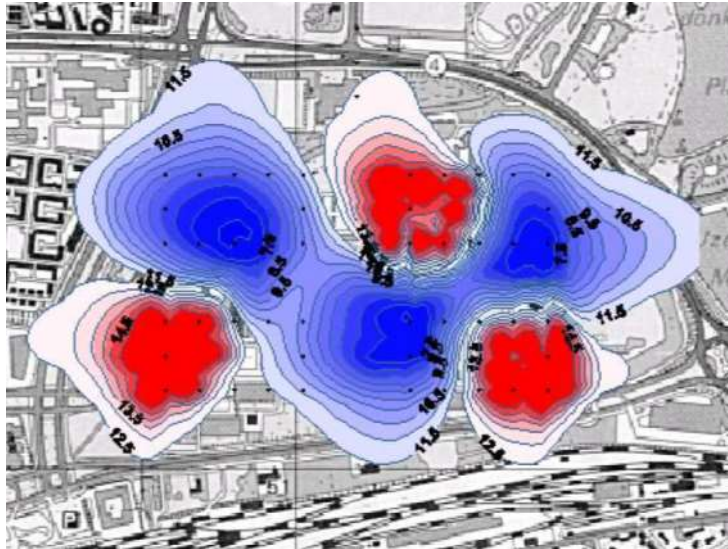

Figure 40. The six clusters of the TU/e ATEs system (Spruijt, 2015).

4.2.2 Validation of the model of the existing situation

Real energy data received for validation

In order to analyze the current energy mismatch in the building, it was necessary to understand the current energy performance of the case study building. The following data was available on the energy use of the building:

Table 12. Final energy data of the Gemini south building

Date/Time	Energy supply for cooling - Outcome from the ATEs	Energy supply for heating - Outcome from the ATEs + boiler	Energy supply for lighting, appliances and process equipment
	kWh	kWh	kWh
January	29000	393208	217992
February	32000	481483	205870
March	32000	371659	222580
April	68000	119793	198047
May	138000	50125	224918
June	147000	17051	216954
July	206000	3745	213703
August	169000	14488	209564
September	109000	64050	207089
October	76000	158239	220678
November	35000	319132	220963
December	41000	320258	202047
Total	1082000	2313230	2560405
Total kWh/m2	58	123	136

This data was used for the validation of the model. Some assumptions had to be made to be able to compare the energy simulation with the available data. Figure 41 explain the energy data from the building compared with the energy data from the energy simulation in Design builder. The Information in the figure will be explained later in the text.

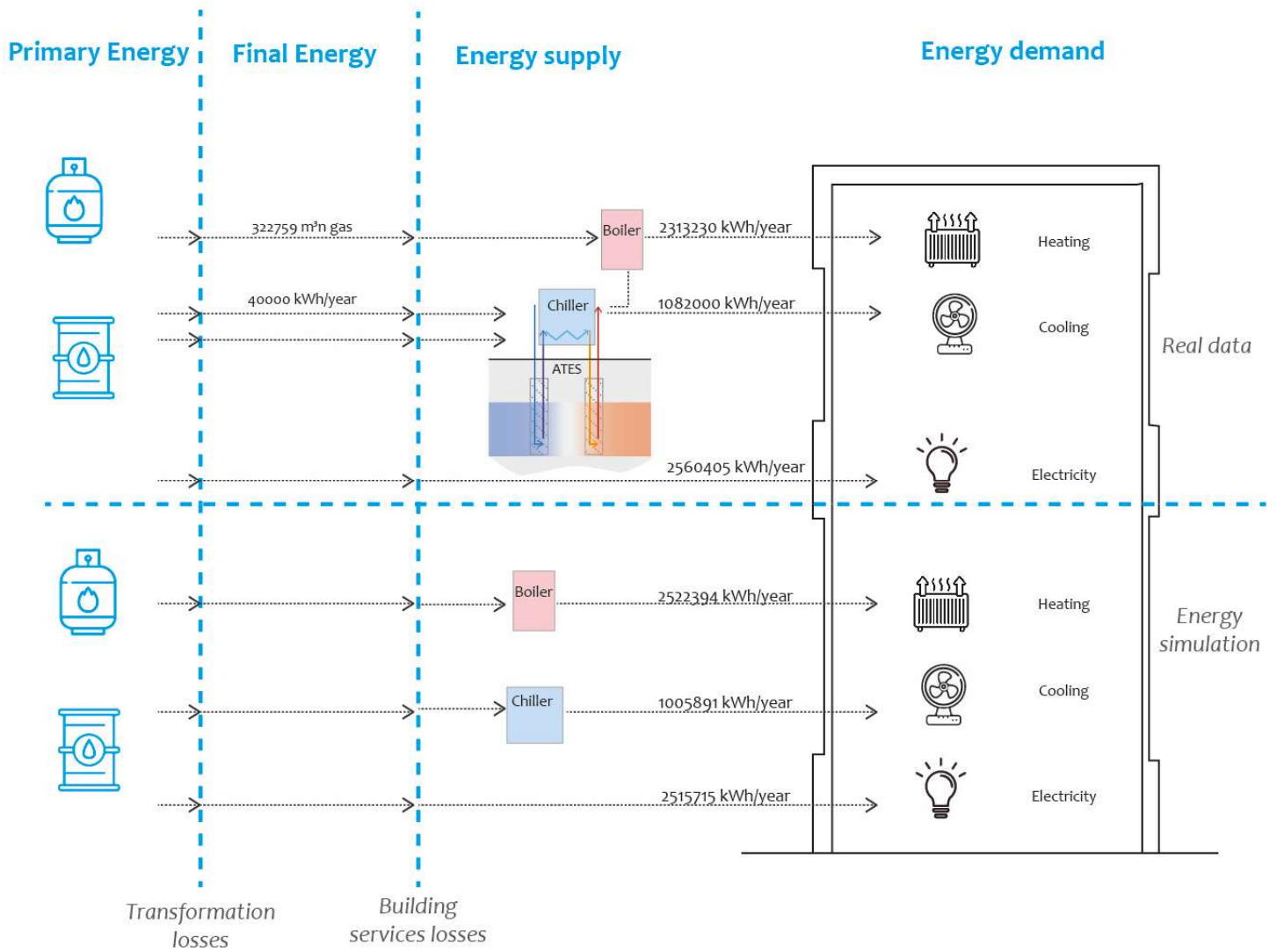

Figure 41. Real energy data compared with energy simulation data

Cooling energy supply

The aim of this section is to compare the calculated cooling demand of the Gemini south building with the real measured data. The cooling demand (table 13) was calculated using Design builder for the 4th floor and extrapolated to the whole building.

The measured data provide the final energy for cooling in the Gemini south building as it is provided by the ATES system (refer to the figure 41). The ATES supplies 1082.000 kWh of cooling per year to the building services (HVAC equipment room).

Table 13. Cooling demand from the energy simulation

Date/Time	Model energy supply for cooling whole building	Process cooling whole building	Model energy supply cooling whole building
	kWh	kWh	kWh
Jan	-2	30000	30002
Feb	-11	30000	30011
Mar	-3975	30000	33975
Apr	-21732	30000	51732
May	-88095	30000	118095
Jun	-105904	30000	135904
Jul	-210163	30000	240163
Aug	-150903	30000	180903
Sept	-53349	30000	83349
Oct	-11012	30000	41012
Nov	-724	30000	30724
Dec	-21	30000	30021
Total	-645891	360000	1005891
Total kWh/m2			53

Design builder cannot model an ATES system; therefore, a chiller was simulated instead of the ATES system. The total cooling output for the whole building of 645.891kWh/year, which is the building services cooling delivered to the building. This value is compared with the output of the ATES system from the table 12.

When comparing the monthly values of the model with the monthly measured data, it can be seen that in winter, there is no cooling from the model, but the real data display a constant cooling output from November to March. Therefore, an additional process cooling of 30.000 kWh / month was added. As can be seen in figure 42, the measured data closely match the modelled cooling output plus the assumed process cooling.

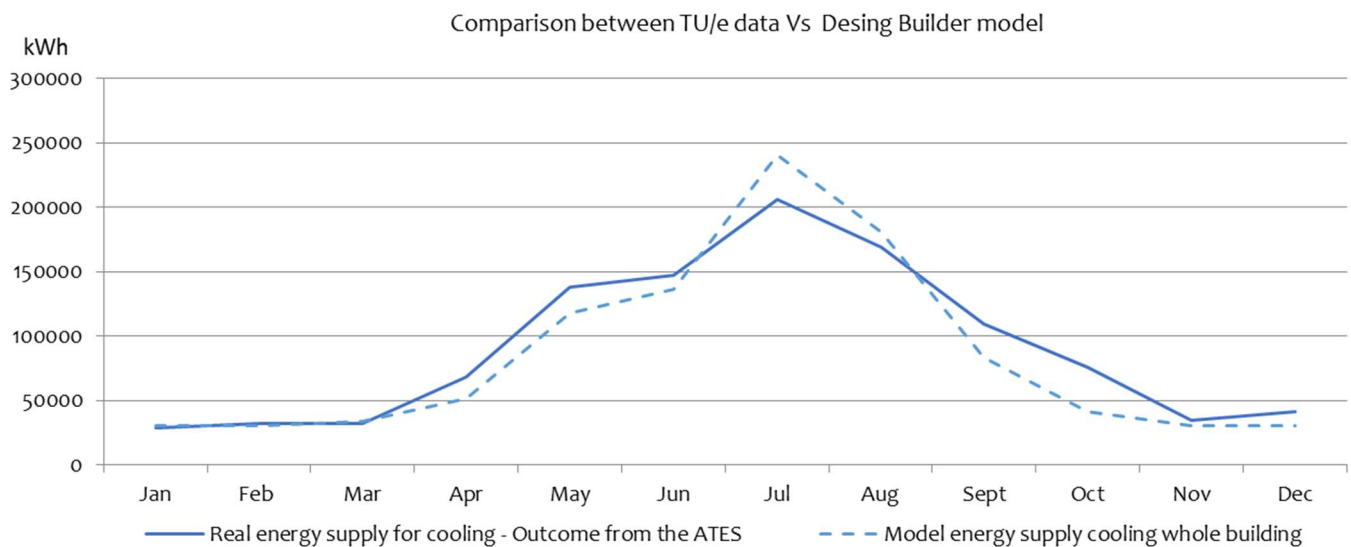

Figure 42. Cooling demand comparison between real data and energy simulation data

Heating energy supply

The aim of this section is to compare the calculated heating demand with the real measured data. The heat demand (refer to the related system boundary in a figure 41) is calculated with Design builder for the 4th floor and extrapolated to the whole building.

The current heating system works in three stages as follows: First the ATES provides pre-heated water (around 20°C) from the ground, which passes through the chiller (in heat pump mode) where it is cooled down and injected to the cold well. The chiller preheats water in a boiler. The final step happens in the boiler (running with natural gas) where the water is heated to probably 70°C or 90°C for the radiators in each room.

The ATES system delivers 40.000 kWh of heat per year preheated. The gas boiler uses 322.000 m3 of gas per year, which equals 2.840 MWh/year.

In order to estimate the heat demand from the measured data, it is assumed that the gas boiler works with an efficiency of 80%, which means the heat provide to the rooms is 2.272230 kWh/year. In addition, the heat form the ATES is added. Since the COP of the chiller is not known, it was assumed that the heat from the ATES is the energy delivered to the heating system. This is not fully correct but the heat from the ATES only represents a small portion of the total.

As a result, 2.313.230 kWh of heat is delivered to the rooms by the building services per year. This value is compared with the heat demand of the model (refer to table 12).

Since Design builder does not allow to model the ATES system, the energy model of the building includes a boiler running on natural gas. The domestic hot water (DHW) is also not included in the model; therefore, taking into account the table 13.1 of the NTA 8800, 1.4 kWh/m2 per year was included to the calculations. The space heating demand from the model accounts for 2.496.057kWh/year (table 14).

Table 14. Heating demand from the energy simulation

Date/Time	Model energy supply for the whole building	Domestic hot water for the Whole building	Model energy supply for heating whole building
	kWh	kWh	kWh
Jan	484544	2237	486781
Feb	428381	2020	430402
Mar	296816	2237	299053
Apr	189025	2165	191190
May	60408	2237	62645
Jun	31583	2165	33748
Jul	9814	2237	12050
Aug	18942	2237	21179
Sept	50484	2165	52648
Oct	157192	2237	159428
Nov	301255	2165	303419
Dec	467613	2237	469850
Total	2496058	26336	2522394
Total kWh/m2			134

Therefore, the heat demand (space heating + DHW) for the base calculation of the Gemini south building is 2522.394 kWh/year. This is considered sufficiently accurate considering the available data and scope of the study.

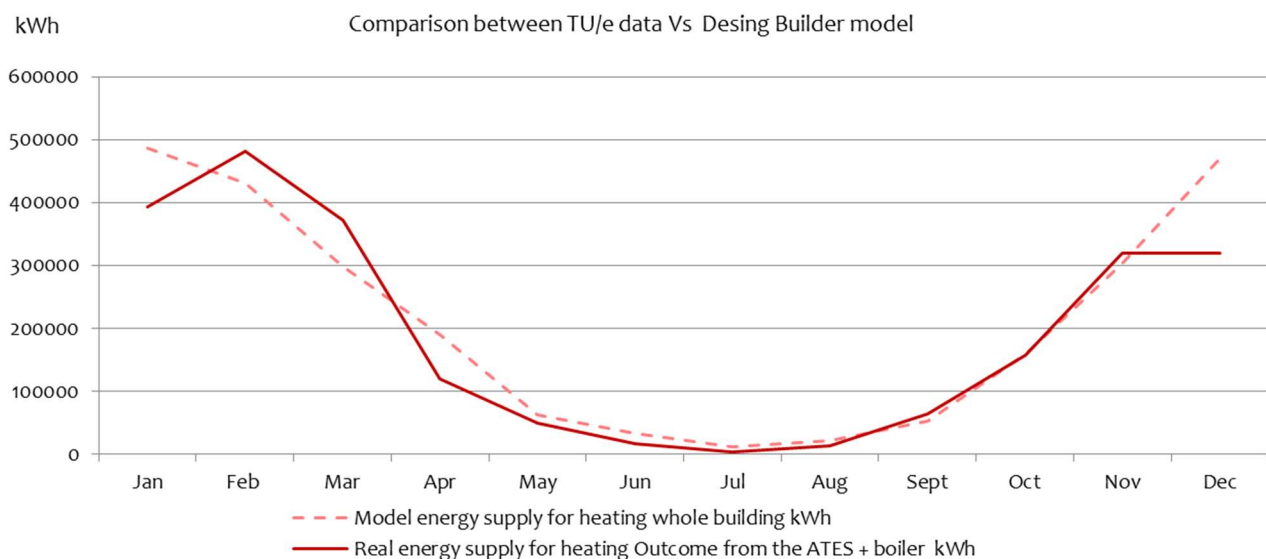

Figure 43. Heating demand comparison between real data and energy simulation data

Electricity supply

The use of electricity in the building comes from the lighting, equipment, process equipment, pumps, and fans. The use of lighting in the building accounts for 60% of the electricity demand of the building (Figure 44) and is mainly influenced by the type of lighting system, the schedule of usage, the amount of luxes required per space and the low amount of natural lighting entering the building.

The equipment in the whole building use a total of 776120 kWh per year, which corresponds mainly to the computers, printers and especial equipment in the laboratories. The laboratories have specific requirements for lighting and equipment time of usage, which influences greatly the electricity use.

Table 15. Electricity demand from the energy simulation

Period	Jan	Feb	Mar	Apr	May	Jun	Jul	Aug	Sept	Oct	Nov	Dec	Total
Equipment kWh	13373	12032	12925	13026	13523	12554	12915	12667	12790	13523	12790	13106	155224
Lighting kWh	27296	24644	26333	26711	27744	25639	25975	25384	26175	27744	26175	26675	316495
Fans kWh	2635	2380	2635	2550	2635	2550	2635	2635	2550	2635	2550	2635	31025
Pumps kWh	49	44	28	21	27	30	57	38	15	15	27	48	399
Total electricity kWh 4th floor model	43353	39100	41921	42308	43929	40773	41582	40724	41530	43917	41542	42464	503143
Total electricity whole building kWh	216765	195500	209605	211540	219645	203865	207910	203620	207650	219585	207710	212320	2515715

In order to compare the information from the table 7, the electricity demand per month was divided by 5, because the 4th floor represents the 20% of the total area of the building. When comparing the data from table 7 to the electricity demand in table 10, the information is enough accurate to validate the data of the simulation model as it can be seen in figure 42.

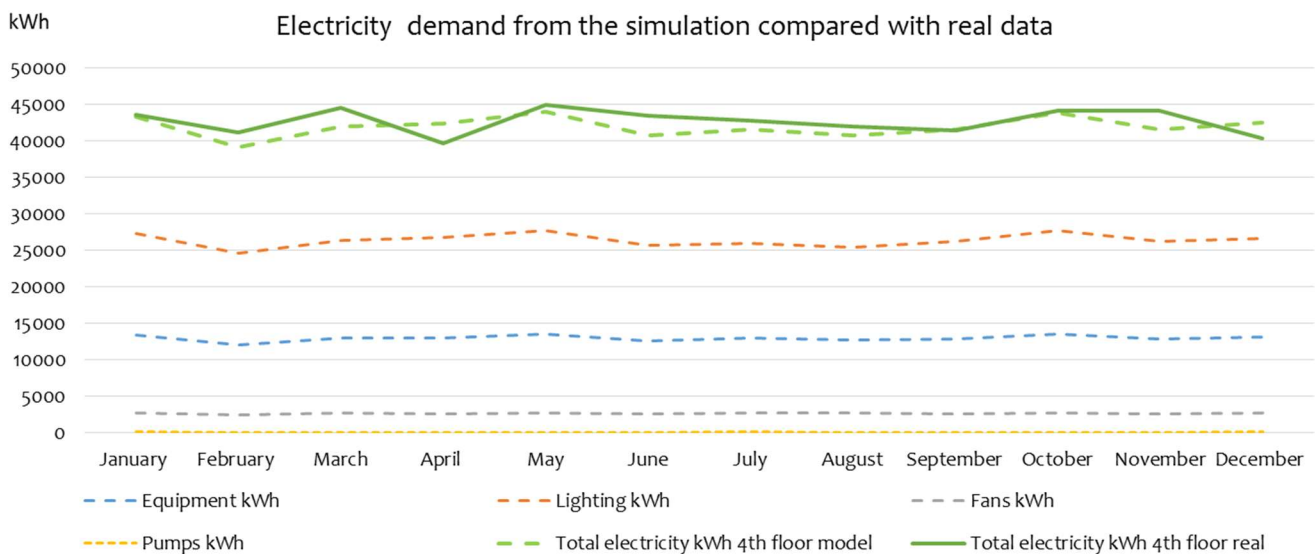

Figure 44. Electricity demand comparison between real data and energy simulation data for the 4th floor

Additional validation of the model was developed using the book Sustainable Urban Environments (Van Bueren et al., 2012) compares a graph of the energy demand in an average commercial building, in which heating the space and water heating is what requires the most of the energy in the building, followed by the electricity from lighting and equipment and then the cooling system.

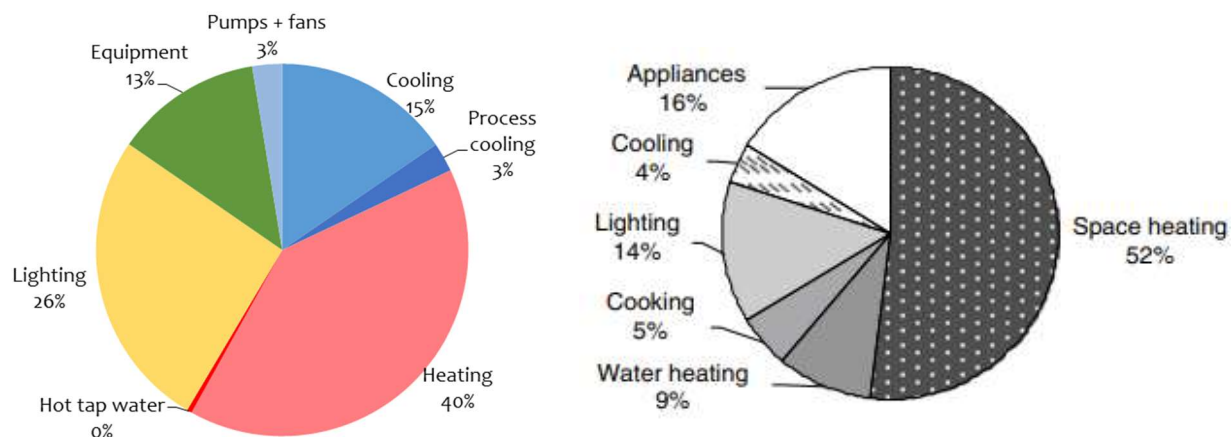

Figure 45. Energy consumption from the model compared with energy consumption from an average commercial building

In the Gemini building the heating demand includes the water heating and account for the most of the energy demand in the building, followed by the electricity demand of lighting, equipment, fans and pumps and then the demand for cooling and process cooling.

4.3. Parameters influencing the energy demand

During the energy simulation and after analyzing the input data, the parameters that influence greatly the demand of energy in an existing building are described in three factors, the occupant behavior, external factors and building properties.

Occupant behavior

The occupants of the Gemini south building are mainly professors, students and staff from the different uses such as the technical rooms that use the building mainly during weekdays between 8am and 8pm and are the principle responsible for the energy demand in the building. Nonetheless, taking into account that the occupant behavior towards the building energy consumption cannot be easily measured because it depends on many factors that vary between building users and that are difficult to quantify and predict. The occupant behavior in the Gemini south building will not be taken into account in order to solve the mismatch between demand and supply.

External factors

The Gemini south building is being influenced by external geometries such the threes and surrounding buildings that can influence the direct sunlight entrance into the building, for the aim of this research, it is consider that these external parameters cannot be moved nor modified. Moreover, changing the location of the building is almost impossible to consider. However, the connection of the building to the general grid as its source of energy should be changed because the building should not depend on a shared grid to solve the mismatch, but it should solve it within the building itself.

Building properties

The building physical properties are the main parameters explored in order to understand the energy demand of the current building. The parameters defined in this research are based on the analysis of the thermal and electricity balance of the building showed in the appendix 1. Current thermal balance results of the Gemini south building

The façade plays an important role in the heat losses and gains and its renovation is essential to reach energy flatness. Parameters such as the insulation and thermal mass of the external walls and roof influenced greatly the heat losses. An adaptation of these parameters can result in a reduction of energy demand by avoiding heat losses.

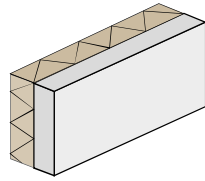

Insulation

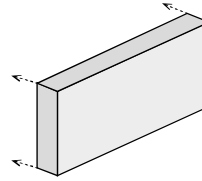

Thermal mass

The internal gains from people are very hard to modify. Nonetheless, the impact from current lighting devices accounts for 26% of the total energy consumption and the equipment accounts for 13%, this electricity demand can be reduced by changing the specification of the devices and adding control with centralized system such as a BMS and sensors such as presence and daylight sensors.

In addition, process cooling and process equipment in the laboratories and technical areas consume energy constantly and the optimization of those is hard to analyze because of the specific usage requirements. These parameters therefore, are limited to the usage of the building and the proposal for the optimization of those is very limited.

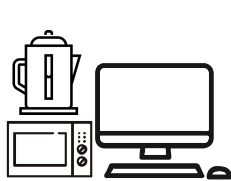

Equipment



Lighting



People



Process cooling

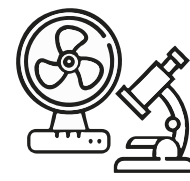

Process equipment

Heat losses and gains through windows make a huge impact in the thermal balance; by changing the window properties the energy demand for heating and cooling can be reduced. In the Gemini South building the current specification of the glazing is very poor in terms of thermal resistance, which is cause huge heat losses in winter and heat gains in summer. Decreasing the U-value of the glass will increase the thermal resistance of the whole façade.

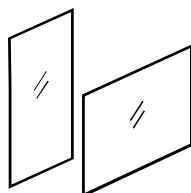

Window size

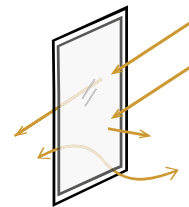

Window properties

To provide thermal comfort the requirements for the temperature inside increase the need for heating and cooling. The temperature outside cannot be change because the building cannot be moved. Furthermore, the temperature inside the building can be modified by implementing adaptative comfort. This strategy can reduce the heating and cooling demand in an existing building.

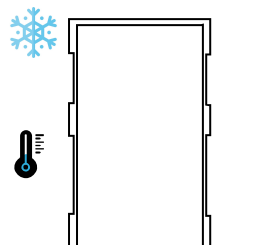

Temperature outside

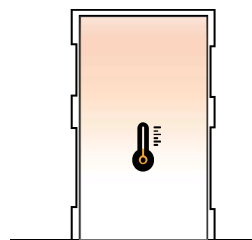

Temperature inside

Solar radiation in the building influences the heat gains for the Gemini south building. However, this parameter cannot be changed in an existing building because is limited to the location of the building.

Sun protection systems are needed in order to reduce cooling demand in the building, but the current sunscreens in the building do not allow for solar gains in the south façade in winter and do not block the sun in summer in the north façade, smart control of the sunscreens and better specification of the glass is needed. The concrete balconies in the south currently block the sunlight entering in the building, which is an advantage in summer, but a disadvantage in winter.

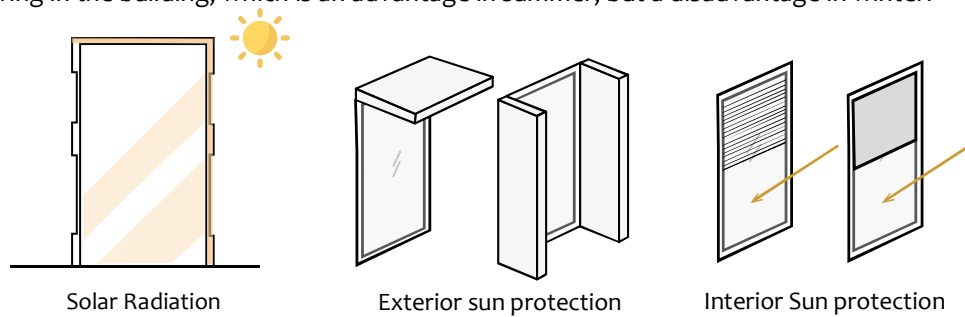

Another solution to allow the solar radiation to enter the building will be the solar buffer space, which are intermediate space between the occupied, interior space and the exterior. This buffer space is unconditioned and heated passively through solar irradiation. Because the south façade already has an unoccupied transition space (concrete balconies), this represents the opportunity in the building for a solar buffer area. By closing the balconies, the temperature in the buffer space will be higher than the external temperature and the transmission heat losses through this façade will be reduced.

Other strategies can be the trombe walls, which store heat in a high thermal mass. For the Gemini south building it will make sense to place a trombe wall in the south façade of the building, but this will also mean to reduce the daylight entrance in the offices, which is already to less.

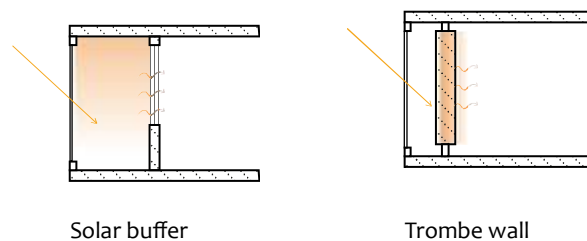

Additionally, heat losses through ventilation and infiltration make a great impact in the energy demand of the building. The mechanical ventilation has two functions, one to supply air and the other one to extract the air and avoid pressure in the space. In this case two different ventilators are used (supply and extraction) and two different ducts, one with the fresh air and the other one with the recycled air that also comes with the temperature of the air inside. Therefore, it makes sense to use heat recover systems to reuse the heat of the recirculated air to preheat the fresh air. In old buildings, this heat recovery is not so common and could main a reduction in the energy need by the system (Van Bueren et al., 2012).

It is necessary to avoid infiltration of air through gaps and seams in the building. This can be done by the proper connection of the different material in the façade and through thermal breaks in the connection of the glass with the frame among others. Air-barrier sealants, such as expanded foam, gun-applied sealants, tapes, and fillers, should be applied to prevent uncontrolled air flow (Konstantinou et al., 2018).

Cooling demand is very high in summer, night passive cooling is an strategy to cool the building down at night during summer time, when the temperature is lower than during day time and there are no comfort requirements to be meet because there is no occupancy. This strategy can be use in the Gemini south building because the building is unused from 8 pm to 8 am, by opening the windows the whole night, the building will be cooled naturally, reducing the cooling demand of any mechanical system at least in the morning periods.

Cooling and heating loads are also influenced by the requirements of relative humidity in the space in order to avoid condensation, by allowing for constant circulation of fresh air with relative humidity controls and high efficient equipment the need for energy from the system will be lower.

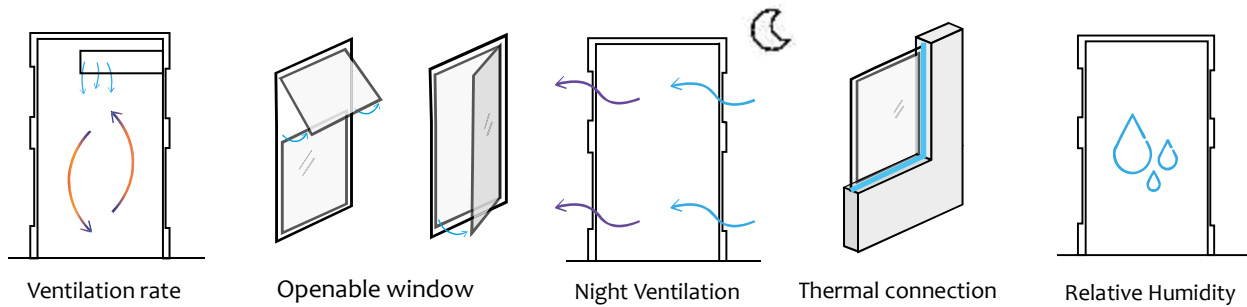

The building primary HVAC system is connected to the campus of TU/e and is using a lot of energy, In order to reach energy flatness the building must be disconnected from the grid and supply its own energy. Therefore, a new HVAC system must be proposed for the building.

4.4. Current energy mismatch

Currently there is no mismatch between final energy (on-site energy supply from renewable energy technologies) and the energy supply (energy for the complementary energy system in the building) because in the building there is no on-site energy production.

KPI 1 – Absolute energy Flatness

Therefore, the KPI 1 – Absolute energy flatness cannot be calculated for the electricity balance. However, the analysis of the KPI can be adjusted to the thermal balance in order to make an estimation of the comparison between energy demand and supply. Therefore, the formula of the KPI 1 for the thermal balance for heating will be as it follows. Where the energy supply is the heat supplied from complementary energy system when there is on-site heat production and the energy demand will be the energy supplied from the complementary energy system.

$$\sum_{t=1}^{t=87} |E_{energy\ supply(t)} - E_{Energy\ demand(t)}|$$

Since currently the building does not have any on-site energy production, the energy supply from the complementary energy system is equal to zero. Therefore, the result of the KPI 1 in the thermal balance for heating will be as it follows according to figure 41.

$$KPI1 (thermal\ balance) = \sum_{t=1}^{t=876} |0 - 2313230kWh (8760h)|$$

Furthermore, some assumptions can be made for the KPI 2 – Maximum Mismatch Peak based on the potential on-site energy production and the energy demand in terms of thermal energy and electricity. The KPI 3 – Maximum cumulative Energy Mismatch cannot be calculated because the on-site renewable energy production is not provided.

Assumptions of the KPI 2 - Maximum Mismatch Peak

Heating demand peak

The current demand for heating in the building happens mainly during the winter periods. The peak of the demand happens at the hour 1037 (February 12 at 20 hours) when 295 kW are needed during that specific hour for heating.

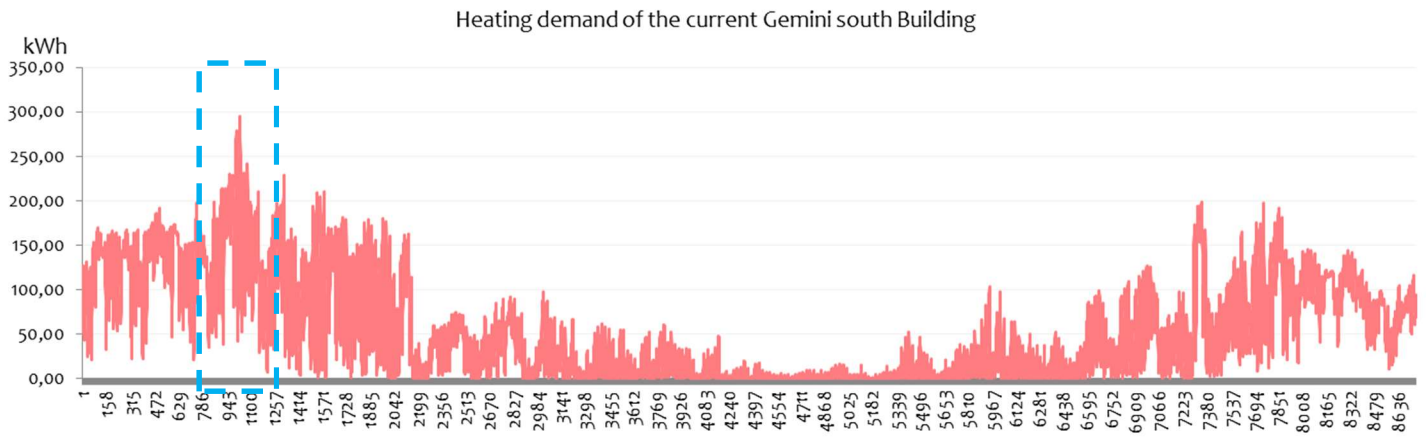

Figure 46. Heating demand of the current Gemini south building.

Cooling demand peak

The current demand for cooling in the building happens mainly during the summer periods. The peak of the demand happens at the hour 5177 (August 3 at 7 am) when 294.3 kWh are needed during that specific hour for cooling. Since there is no on-site renewable energy production, this demand is currently being supplied by the shared grid in the campus (ATES).

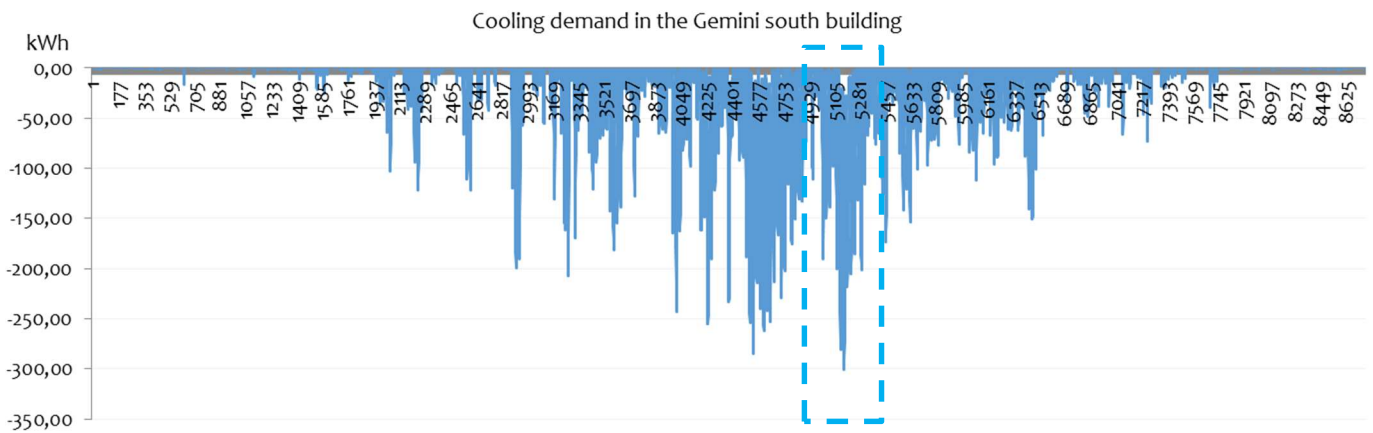

Figure 47. Cooling demand of the current Gemini south building.

Electricity demand peak

Furthermore, the electricity demand is more or less constant, which makes it difficult to identify the peak of the demand. The electricity demand for heating is not being counted in this figure, therefore the electricity profile could be different but this figure aims to give an idea of the electricity demand. The important analysis from figure 48 is the difference between the electricity demand during the weekdays and weekend.

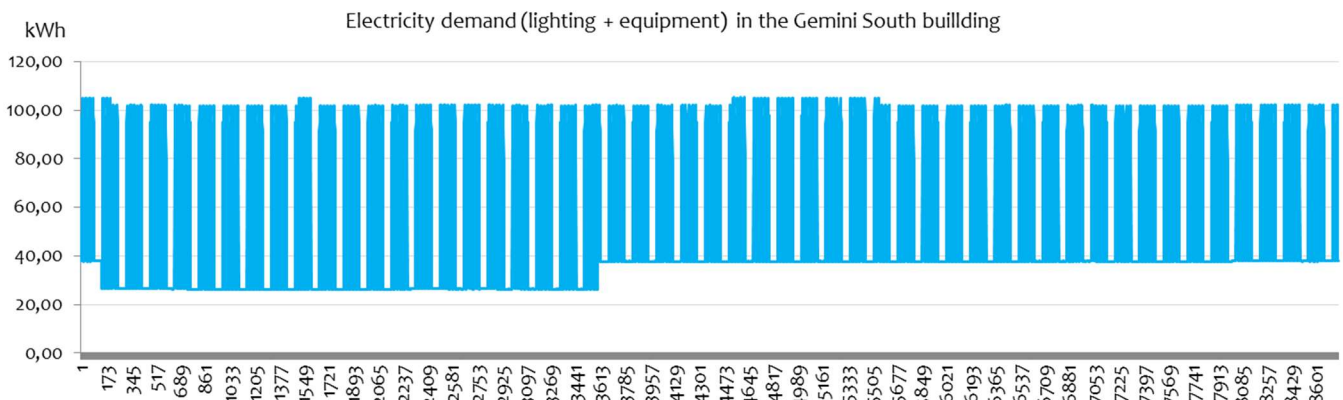

Figure 48. Electricity demand of the current Gemini south building.

Potential on-site energy supply

The direct and diffuse solar radiations contemplated in the analysis are according to the Figure 49. From this figure, it is important to highlight that the highest radiation occurs during summer months and the lowest during winter.

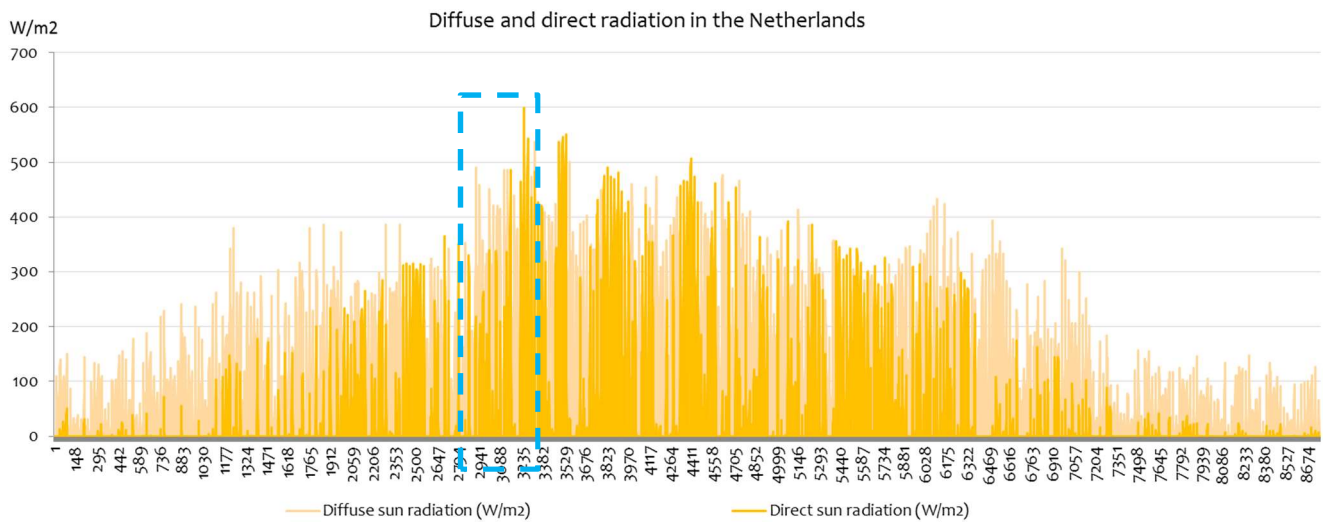

Figure 49. Potential on-site energy supply for the Gemini south building.

The profile of the potential on-site solar energy production matches better the cooling demand profile because cooling demand are more or less dependent on the solar radiation profile. The total electricity profile is more or less constant throughout the year, therefore, it can be solve with solar power during summer. However, during winter the on-site solar energy supply will not be enough to match the demand. Therefore, the complementary energy system needs to be able to solve an inter-seasonal mismatch, storing energy (heat and electricity) in summer and discharging it during winter.

During January, November and December months there is not enough solar radiation in the place where the building is located. Nonetheless, during those months, the heating demand is higher which will cause a mismatch.

The biggest possible mismatch will happen between winter and summer seasons, because the solar renewable energy depends on the times the most of the radiation is present, which is during summer time. On the other hand, the building needs most of its energy during winter, because the difference of temperature between inside and outside, the poor building insulation and the high comfort requirements inside the space in winter require a higher consumption of heat in the building.

In order to solve the mismatch, the complementary energy system must be able to store energy for long periods, at least 6 months without losing much energy, to solve the inter-seasonal mismatch. In addition, the hourly mismatch needs to be solved in order to reach energy flatness. Therefore, the complementary energy system needs to be able to charge and discharge energy in short periods.

5 How to reduce the mismatch in the case study

The objective of this chapter is to answer the third question of the methodology: How to reduce the mismatch in the case study?. In chapter 4 the current mismatch of energy in the case study building was described and in chapter 5 the proposal of the renovation of the case study building towards the reduction of the mismatch is going to be proposed. At the end of this chapter, an analysis of the final mismatch reduction after the renovation proposal will help to answer the main question of this research.

In order to solve the hourly energy mismatch, a renovation of the building in three steps is proposed, first by reducing the energy demand, second by producing on-site solar energy, and third by integrating a complementary energy system capable of transforming, distributing, storing and discharging energy within the building boundary will be proposed. Therefore, these three steps will be explained and the outcome of each will be analysed in terms of energy mismatch reduction after each step. The steps aim to be a progression of the optimization of the previous one. To build upon the previous step a better renovation strategy and test the impact of each of them.

Therefore, first step will be to evaluate the demand reduction potential in the Gemini south building according with current regulations and literature review, and an analysis of the output and mismatch reduction will be part of chapter 5.1. The second step will evaluate the optimal solar energy production by a feasibility analysis of the possible technologies to implement for the renovation of the building (chapter 5.2), the outcome and mismatch analysis will also be developed for this step. Finally, the complementary energy system will be proposed for the building, and the impact of the energy storage will drive to the final renovation proposal of the building towards energy flatness (chapter 5.3). The final mismatch reduction scenario for the building will be described in chapter 5.4 in order to answer the main question of the chapter.

5.1. Step 1 – Energy demand reduction

In order to propose the energy demand reduction of the building, the different parameters influencing the energy demand in the Gemini south building are going to be listed in terms of the thermal and electricity parameters and a feasibility study of each of them will help to define the demand reduction proposal.

5.1.1 Feasibility of the demand reduction parameters



The internal gains, electricity, transmission, ventilation, infiltration and solar radiation parameters are going to be analyze in order to do a feasibility study of the most suitable parameters of the demand that can be modify for the renovation of the Gemini South building. It is proposed to update the parameters of the column demand reduction proposal that have a green background color and those will be updated in the energy demand simulation to analyze the demand reduction impact.

Demand parameters influenced by the internal gains and electricity need

In the Gemini south building the heating demand is very high, it seems logical that passive heating gains from people, lights, and equipment are favorable to reduce the heating demand. However, large internal heat gains can also produce a high electricity demand for cooling, which in order to reduce the interseasonal mismatch it should be avoided.

The table 16 aims to show the energy demand parameters influencing the internal gains and electricity demand that can be changed in order to reduce the energy demand in the building. For each parameter, the importance of the parameter for the building is described; the optimization strategies for each parameter according to literature and the demand reduction proposal for the building are explained.

Table 16. Parameters of the demand reduction - Internal gains and electricity parameters.

Parameters	Importance	Optimization strategies base on literature review	Demand reduction proposal
 People	There is passive heating because of people inside the building, which is determined by the schedule, number of people, metabolic rate, and cloth thermal resistance.	In order to reduce the internal gains by people, the number of people and the schedules can be change in the space to increase heat gains in winter and reduce them in summer. Adaptative comfort by increasing or reducing the thermal resistance of cloth can reduce the heat demand.	The number of people , schedule or metabolic rate will not be changed on the building because that is not currently being contemplated by the owner.
 Lighting	Passive heating and electricity demand because by the lighting system because of the specification of the equipment, luxes required by type of space, schedule and low daylight entrance.	LED lights produce more luxes and release less heat than conventional lighting systems (European Commission, 2018).	All lighting devices will be changed to LED lights of 2 W/m ² -100 luxes.
		Reduce the lighting usage when no needed	The schedule will not be change, but when there is no occupancy in the laboratories and circulations, the lights will work ON only at 25% of their efficiency, not at 50% as is counted in the current situation.
		Daylight sensors can further reduce the time of usage of the lighting while still ensuring a good quality of natural light in the interior.	Daylight sensors will turn OFF the lights near the window (50% of the area of each space) when glare index of 22 is detected, the lights far from the window (the other 50% of the area) will remain ON.
 Equipment	Office equipment such as printers, televisions, servers, computers, coffee machines, among others, also heat up the space and need electricity, and because their constant usage in the building, those are helping to reduce the heating demand during in winter, but still require a lot of electricity.	Change the schedule of usage and comply with energy star and /or energy labelling of A or above. According to the Nederlandse technische afspraak table 7.3 (NTA 8800, 2018), office equipment should not demand more than 4W/m ² and educational equipment no more than 2W/m ² , compared with the current load of 7W/m ² and 4W/m ² respectively.	For the office, laboratories and circulation the equipment was optimized in order to consume 4W/m ² maximum and in the educational areas no more than 2W/m ² .dc
 Process equipment	Process equipment produces and needs 7w/m ² of constant heat and electricity, by implementing the process equipment that complies with the energy labeling, the heating and electricity demand can be reduced.	Change the schedule of usage and specification of the process equipment in the laboratories and technical areas. Comply with energy labelling and energy star if applicable. For the renovation of the building, it is advisable to optimize old equipment that could be demanding a lot of energy.	Process equipment from the laboratories and from the technical areas are difficult to optimize and since the specification of the equipment is unknown, no reduction of energy will be proposed. Therefore, special equipment in the laboratory and technical areas will remain in 7W/m ² constantly.

The parameters that can be changed in an existing building in order to reduce the heating and electricity demand in the Gemini south building are therefore: the lighting devices, the office equipment and until some extend the process equipment, in order to comply with the energy labeling and /or energy star recommendations, eco-design legislations and other recommendations of the European Commission.

Demand parameters influenced by the transmission

The façade plays an important role in the renovation of the building, because is on direct contact with the outside environmental conditions and the inside conditions. The current configuration of the façade implies a great amount of heat losses and unwanted infiltration to the inside, is not capable to store heat because of the low thermal mass and is not being use for natural ventilation (although it provides the window area for it).

As a first step the building should comply with the minimum requirements of the DBD for the Rc in the façade, roof and floors, an if possible even comply with the requirements for new buildings, which are even more hard to accomplish. Table 17 aims to show the parameters influencing the transmission of heat in the building and the demand reduction proposal for every parameter.

Table 17. Parameters of the demand reduction - Transmission parameters

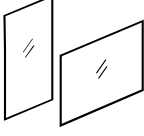
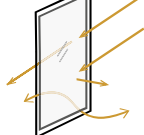
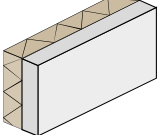
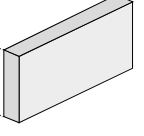
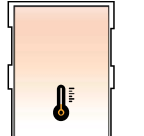
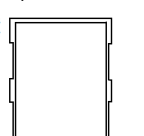
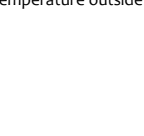
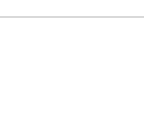
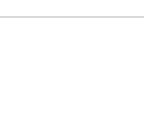
Parameters	Importance	Optimization strategies base on literature review	Demand reduction proposal
 Window size	71% of the heat losses through transmission are happening through the glass. Therefore, the window size and window properties have a great impact in the energy demand of the building.	The bouwbesluit recommends for the renovation of existing building that all windows, door, frames should have an U-value of 2.2 W/m ² K. Nonetheless, it is advisable to use a lower U-value of 1.6W/m ² K for the glazing of new buildings.	The lowest U-value is achieved with triple clear glazing 3mm/13mm with argon gap and Low-e coating in the inner pane (U-value of 1.6 W/m ² K) which will be placed in all the facades of the building. For the solar buffer façade, the window will have a u-value of 3.2W/m ² K to allow for heat transmission.
 Window properties	The current metal window frame without thermal break is also responsible for unwanted infiltration and heat losses.	By changing the frame to a plastic uPVC material with thermal break, the window will act as a compact insulation panel that together with a good connection with the opaque surface can protect the building from the outside temperatures.	The frame is made of plastic (uPVC) with U-value of 3.4W/m ² K. This type of frame is going to be use in all the envelop of the building.
 Insulation	The external walls are also very important to avoid heat losses, by adding insulation or replacing the external walls, the heat will remain in the building.	The bouwbesluit recommends for the renovation of existing building that the whole façade should have an Rc no lower than of 1.3 m ² K/W. Nonetheless, it is advisable to increase the Rc value to the required for new buildings which is 4.5 m ² K/W.	The exterior walls will be completely renovated , to a panel of 6mm lightweight metal cladding + 121mm XPS Extruded polystyrene + 13mm of Gypsum plastering with an Rc : 4.5 m ² K/W.
 Thermal mass	The external walls in the current façade are mainly composed by glass. 75% of the south façade and 65% of the north façade are glassing influencing the heat transmission in the façade.	By changing the window to wall ratio the thermal mass of the façade will increase reducing the extra energy needed from the mechanical equipment. Heat can accumulate in the thermal mass of the building, which reduces the heat losses through the external walls.	The window to wall ratio of the south facade is changed from 75% window and 25% opaque surface to 50% window and 50% opaque surface. North facade has a window to wall ratio of 65% to 35% and is going to be changed to 45% window and 55% wall.
 Thermal mass	Thermal bridge between the concrete balconies and the concrete slabs of the south block of the building cause heat transmission.	In order to avoid thermal bridges, a good insulation in the junction of the material should be placed. In addition, thermal bridges in the connection with new external walls and the existing floor should be consider in the renovation of the building (Van Bueren et al., 2012).	Thermal bridge in the concrete slab are causing heat losses. By insulating the connection between the concrete balconies and concrete slabs, this thermal bridge will be avoided.
 Temperature inside	The roof. heat losses through the roof are also relevant for the building, specially because the amount of exposed roof in very large. By adding insulation to the roof and increasing the thermal resistance (Rc), the heat will remain in the indoor spaces.	The bouwbesluit recommends for the renovation of existing building that all the roof should have an Rc of 2.0 m ² K/W. Nonetheless, it is advisable to increase the Rc value to the required for new buildings which is 4,5 m ² K/W.	The proposed configuration of the roof consist of 20mm of expanded polystyrene + 70mm light concrete + 4mm bituminous vapour barrier + 19mm of asphalt + 150mm of expanded polystyrene + 200mm existing cast concrete + 2mm cellulose which gives a total Rc of 4,5m ² K/W.
 Temperature outside	The floors and partitions. Some heat losses occur through the internal floors and partitios. Nonetheless, those heat losses are not so relevant for the current building energy demand.	The bouwbesluit recommends for the renovation of existing building that all internal floors should have an Rc of 2.5 m ² K/W.	The heat losses through the internal floors and partitions are not that high and a renovation of them will be harder to implement in the building, Therefore, this is not going to be proposed.
 Temperature inside	The temperature inside responds to thermal comfort requirements by each space, and the difference between outside and inside temperature causes heat losses by transmission.	The set point temperature inside makes a great influence to the energy demand in the building. In an office building is much harder to keep everyone at a satisfied temperature level. Fange's comfort model propose that keeping a small number of people unsatisfied is also fine for the overall comfort level of the building.	The proposed temperature inside accounts for a 5% of the people unsatisfied with the thermal conditions; the heating set point is 21°C and the setback is 15°C and cooling set point is 26°C and the setback is 30°C. The temperature inside the laboratories remains the same because of the technical requirements of this space.
 Temperature outside	The temperature outside determines the heat flow or exchange for the building. Changing the temperature outside will represent changing the heat flows.	In an existing building the temperature outside can not be changed, unless the building is moved to different location.	Cannot be changed

Demand parameters influenced by the ventilation and infiltration

Important heat losses and gains happen because of the ventilation and infiltration through the façade and other elements of the building. Table 18 aims to describe the parameters influencing the demand of energy through the natural and mechanical ventilation and infiltration through gaps and seams.

Table 18. Parameters of the demand reduction – Ventilation and Infiltration parameters

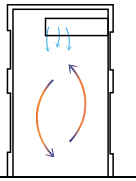
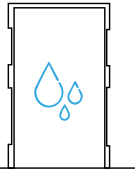
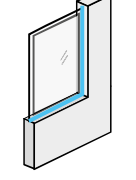
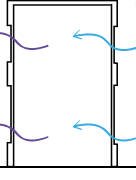
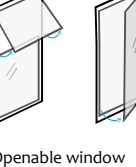
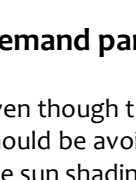
Parameters	Importance	Optimization strategies base on literature review	Demand reduction proposal
 <p>Ventilation rate</p>	<p>Fresh air is required for every space that is occupied and the constant renovation of it is part of the indoor quality. This requires energy and generates passive cooling or heating depending of the temperature inside.</p>	<p>Using CO₂ sensors and plants that absorb CO₂ to reduce the amount of fresh air introduced in the building when no needed.</p>	<p>The impact of CO₂ sensors and CO₂ absorbing plants in the energy demand of the building is hard to measure. Therefore, it is not going to be proposed for the building.</p>
 <p>Relative Humidity</p>		<p>The mechanical ventilation has two functions, to supply air and extract air. In the building case two different ventilators are used with two different ducts, one with fresh air and the other one with recycled air that comes with the temperature of the air inside. A heat recovery system can reuse the heat of the recycled air to preheat the clear air (Van Bueren et al., 2012).</p>	<p>Therefore, it makes sense to use heat recover systems to reuse the heat of the recirculated air to preheat the fresh air. The mechanical ventilation will have an efficiency of 90%.</p>
 <p>Relative Humidity</p>	<p>In order to maintain a relative humidity in the space in order to avoid condensation, causes passive cooling of heating</p>	<p>Implement ventilation systems with high efficiency and reduce the chance of condensation in the façade. Avoid condensation with a constant circulation of air.</p>	<p>Humidity and dehumidification will remain the same 30% minimum and 60% maximum and 40%-50% in laboratories.</p>
 <p>Thermal connection</p>	<p>Most of the infiltration through the façade happens during winter time when the temperature outside is lower than inside, which increases the need for heat in the space.</p>	<p>To avoid the infiltration of air through gaps and seams, it is advisable to keep a 0.2 ac/h in the façade. This can be done by the proper connection of the different materials in the façade and through thermal breaks in the connection of the glass with the frame among others. Air-barrier sealants, such as expanded foam, gun-applied sealants, tapes, and fillers, should be applied to prevent uncontrolled air flow (Konstantinou et al., 2018).</p>	<p>Taking into account that all the façade will be renovated the Infiltration rate proposed in design builder is 0.3 ac/h, because the renovation of an existing building hardly manage to keep a value lower than 0.2 ac/h.</p>
 <p>Night Ventilation</p>	<p>Natural ventilation can reduce cooling loads in summer and the energy used by the mechanical ventilation system. Night natural ventilation is a passive strategy for cooling down buildings at night when those are not occupied.</p>	<p>Natural cooling can reduce cooling loads by exchanging air with the outside.</p>	<p>Night passive cooling between 8pm and 8 am in all spaces but the laboratories to keep environmental conditions. The windows can be opened and close automatically to allow for natural ventilation.</p>
 <p>Openable window</p>	<p>People are not encourage to open windows in the current building.</p>	<p>At least 25% of the façade should be operable windows to allow the occupant to manage its fresh air (Bouwbesluit Online, 2019).</p>	<p>All windows have 25% of the area operable to encourage people to open the windows more often.</p>

Demand parameters influenced by the solar radiation

Even though the solar gains in the Gemini building will be welcome during winter to reduce the heating demand, these gains should be avoided during summer to prevent overheating of the occupied spaces. The proper placement and functioning of the sun shading systems can maximize or reduce the solar radiation to the building.

Passive strategies such as solar buffer spaces and trombe walls can store heat from the solar radiation in order to release it in the indoor space when needed. Table 19 aims to show the feasibility study of the parameters influenced by the solar radiation and that are influencing the energy demand in the Gemini South building.

Table 19. Parameters of the demand reduction – Solar radiation parameters

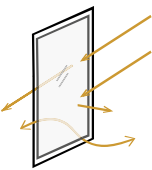
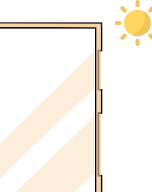
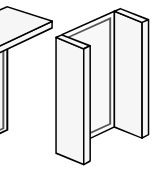
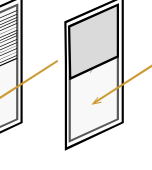
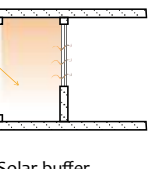
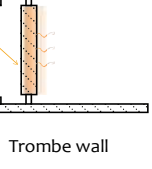
Parameters	Importance	Optimization strategies base on literature review	Demand reduction proposal
 <p>Window properties</p>	<p>The current specification of the glass allow for solar radiation through the entire year, which is increasing the cooling demand in summer.</p>	<p>Solar transmission coefficient or g-value of 0.8 or near to allow for solar transmittance or a lower value when solar transmittance is not desired.</p>	<p>The windows in the solar buffer space have a g-value of 0.83 which represents a higher solar transmittance allowing this space to preheat faster. The rest of the windows in the south and north facades have a g-value of 0.57 to avoid high transmittance in summer.</p>
 <p>Solar Radiation</p>	<p>The solar radiation is the heat that enters the inside space through radiation.</p>	<p>The solar radiation in an existing building cannot be change, but passive strategies such as the Solar buffer spaces can take advantage of the solar radiation to passively heat the indoor space.</p>	<p>The solar radiation cannot be change in the building because is a characteristic of the location.</p>
 <p>Exterior sun protection</p>	<p>The overhang (balcony) in the south blocks the sun in summer which reduces the need for cooling. In winter the balcony does not allow for solar gains which increase the need for extra heat. This balconies are used for the maintenance of the façade.</p>	<p>Replace the balconies or change the specification of them can be an option but the overall esthetic of the building will change and the maintenance of the façade will have to be proposed differently.</p>	<p>The overhang will be modified to integrate a solar buffer space while keeping the elements of the current façade.</p>
 <p>Interior Sun protection</p>	<p>Inside manual sunscreens do not block the sun in the north façade and do not allow for daylight in the south façade.</p>	<p>Outside sunscreens can help to reduce the cooling loads in the building. Automated sunscreens with glare control Inside the space can reduce the cooling demand while still allowing for natural light to enter the space.</p>	<p>Inside automated sunscreen roll medium translucent activated with glare (glare index of 22 for office purpose), visible transmittance of 0.3 for the north façade. The south façade has the same sunscreens in the balcony to allow for solar transmission in the solar buffer but not in the indoor space.</p>
 <p>Solar buffer</p>	<p>Solar passive heat storage can reduce the heating demand of buildings. Solar buffer spaces and trombe walls can be a solution to store heat passively.</p>	<p>Solar buffer spaces, are intermediate spaces between the occupied interior space and the exterior. This buffer space is unconditioned and heated passively through solar radiation.</p>	<p>Because the south façade already has an unoccupied transition space (balcony), this represents the opportunity in the building for a solar buffer area. By closing the balconies, the temperature in the buffer space will be higher than the external temperature and the heat losses through this façade will be reduced.</p>
 <p>Trombe wall</p>	<p>The trombe walls, store heat in a high thermal mass in order to released when needed in the indoor space.</p>	<p>The trombe walls, store heat in a high thermal mass in order to released when needed in the indoor space.</p>	<p>For the Gemini south building it will make sense to place a trombe wall in the south façade of the building, but this will also mean to reduce the daylight entrance in the offices, which is already to less. Therefore, this strategy will not be proposed.</p>

Since there is process cooling demand in the building and is hard to propose the demand reduction of this parameter because the specification of the equipment and usage is known, the 360000kWh/year cooling demand will remain the same for the demand reduction proposal.

DHW (Domestic How Water) was also added to the basic analysis of the demand of the building, therefore, this parameter is already complying with the local standard (NTA 8800, 2018). In the hourly analysis of the demand, the DWH was added taking into account a daily schedule of usage.

Therefore, the renovation of the building towards reducing the energy demand mainly considered the parameters as it can be seen in figure 50, the detail of the integration of these parameters in the north and south façade will be explained in chapter 6.

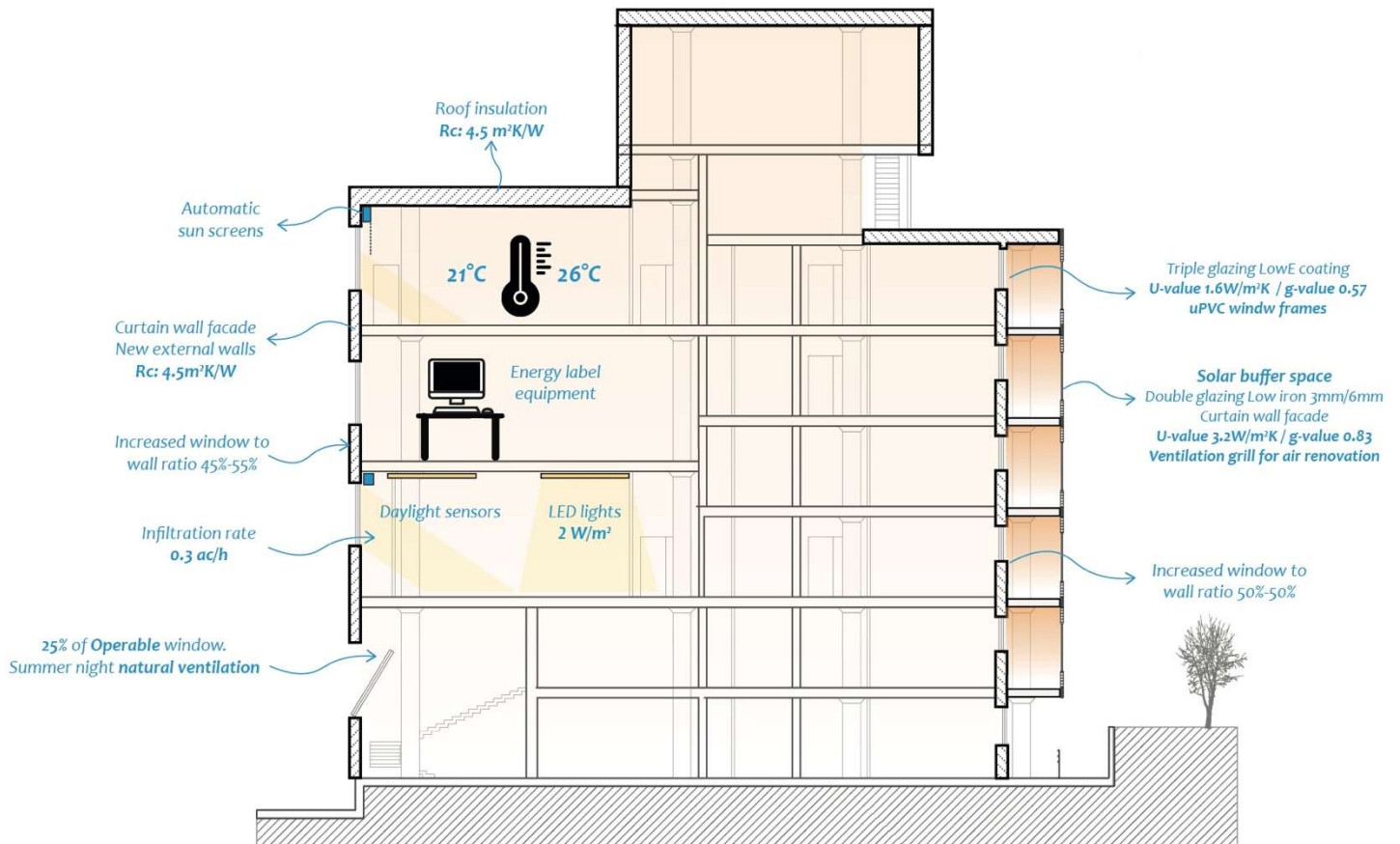

Figure 50. Step 1 – Renovation towards energy demand reduction

After the feasibility study of all the parameters influencing the demand of energy in the building and proposing the renovation of the building towards the reduction of the demand, it is necessary to analyze the impact of the renovation in this first step.

5.1.2 Output of the proposed renovation

After the feasibility analysis of the different parameters that influence the energy demand in the case study, the figure 50 shows most of the parameters adapted in order to reduce the energy demand. In the design builder model, the data of the renovation proposed in chapter 5.1.1 was adjusted in the model in order to see the impact of the renovation towards energy demand.

Figure 51 shows the comparison between the demand of energy in the building current building and the energy demand after the renovation towards energy demand reduction, the results of the design builder model were analyzed for the 4th floor and extrapolated to the whole building.

The heating demand was reduced by 75% by changing the building parameters described in the feasibility study and shown in figure 50. The renovation of the façades was very important in order to reach this energy demand reduction. In the previous configuration of the façades, a great amount of heat losses and infiltration were occurring because of the low thermal values of the materials. The proposed renovation of the façades result in a more compact solution that keeps the warm inside the building and maximized the solar gains through passive solutions such as the solar buffer space.

The heat demand for DHW was not modified because the values used for the analysis of the current building were calculated with the current requirements of the NTA 8810, 2018.

The cooling demand was reduced by 44% compared with the current cooling demand in the Gemini south building. Cooling demand reduction is not as high as the heating demand reduction because most of the parameters implemented for the demand reduction were proposed in order to reduce the heating demand.

Furthermore, passive strategies such as the solar buffer space increase the cooling demand in summer. Furthermore, process cooling demand stayed the same as for the current building analysis, because the equipment used and usage schedule is known for the building.

The electricity demand for lighting and equipment was also reduced. The impact of the daylight sensors and specification of the lighting system help to reduce 69% the electricity demand for lighting. The electricity demand by the normal equipment in the offices, laboratories and circulation was reduced to 27%, by optimizing the specification of the equipment.

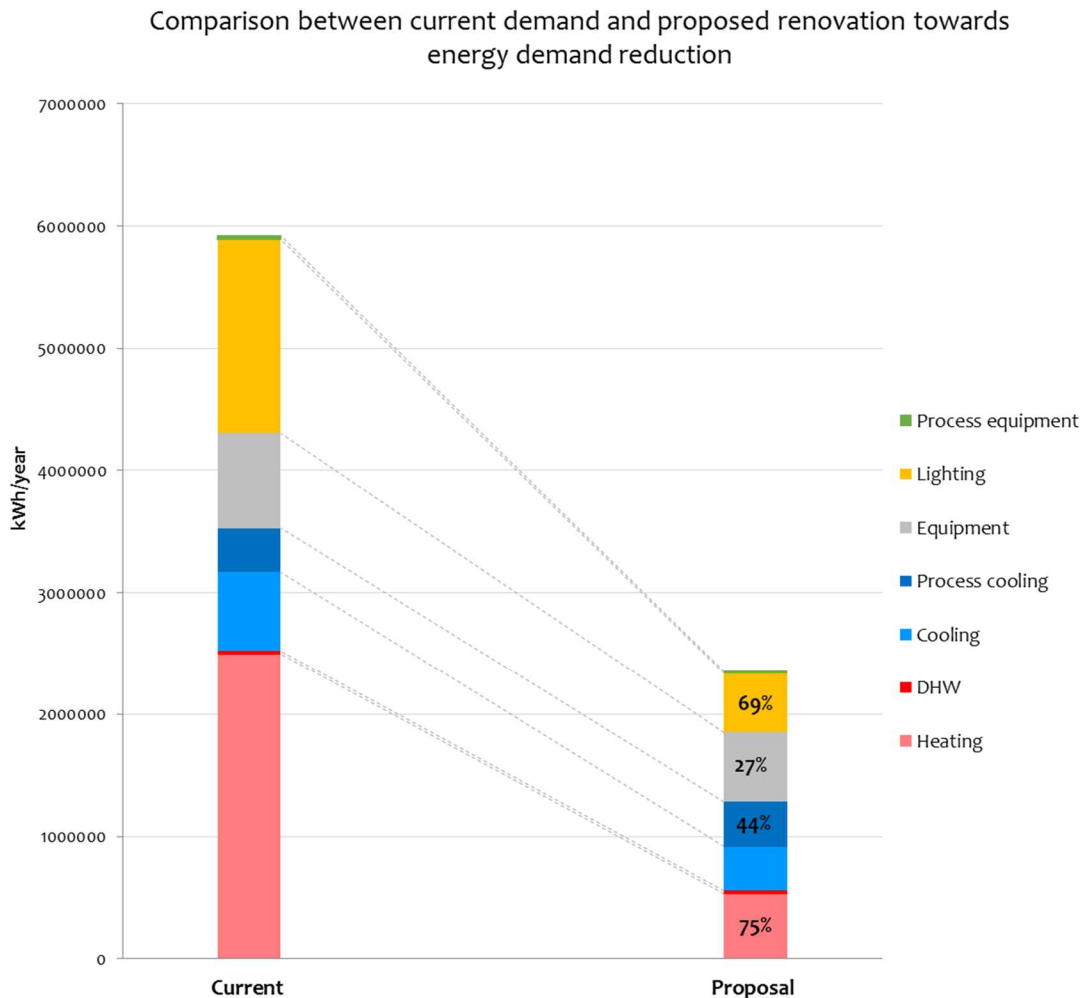

Figure 51. Comparison of the current demand and the demand reduction energy proposed for the Gemini south building

From figure 51 it can be concluded that the energy demand for the proposed building after the renovation proposal towards the energy demand reduction, is mainly characterized for a high-energy demand for lights and equipment, high cooling demand specially for process cooling and a heating demand mainly for space heating.

The appendix 2. Energy demand after the renovation proposal towards energy demand reduction shows the yearly demand for heating, cooling and lighting and equipment after the demand reduction step.

5.1.3 Mismatch analysis

The analysis of the mismatch for the first step towards reducing the energy demand is briefly described analyzing the three different KPIs.

KPI 1 - Absolute energy flatness

The energy flatness balance happens between the final electricity when comparing the on-site energy produced to the energy delivered to the complementary energy system, lighting and equipment. Taking into account that there is no on-site energy proposed (second step) and no complementary energy system proposed (third step), the analysis of the absolute energy flatness is not possible.

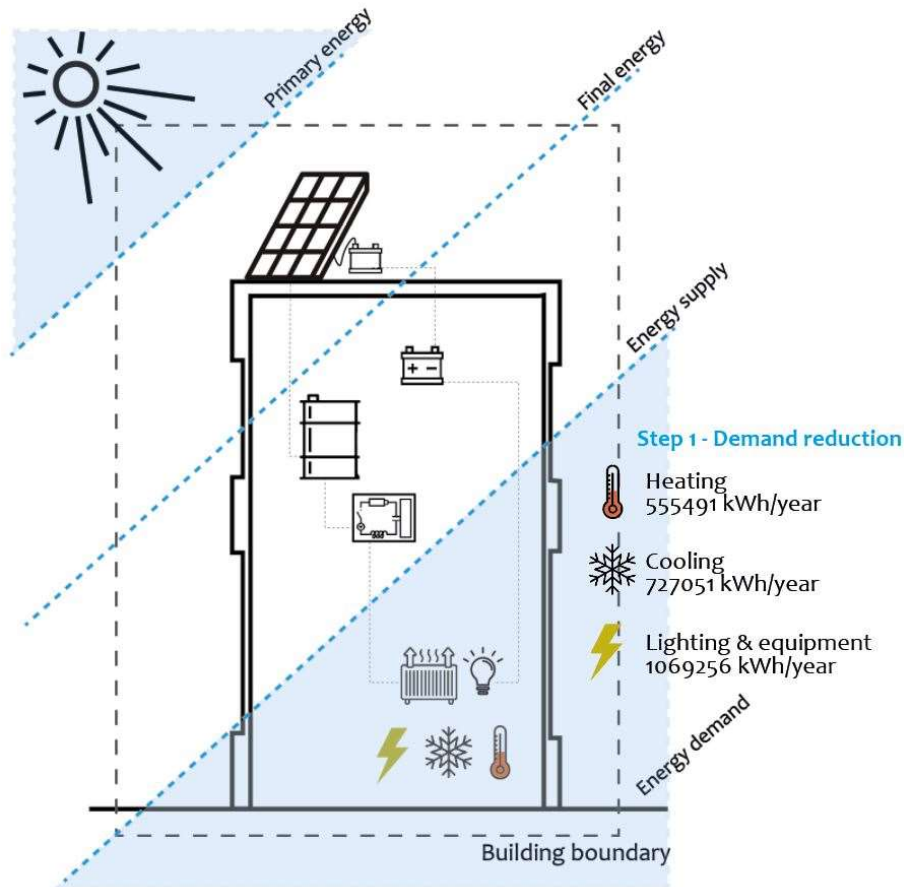

Figure 51a. Energy balance for step 1.

KPI 2 - Maximum mismatch peak

The maximum mismatch cannot be analyzed either. Nevertheless, some characteristics of the energy demand can help to understand the mismatch in the renovation of the building.

The heating and cooling demand might have their peaks every Monday in the morning because of the different temperature setback for the weekend in comparison with the weekdays, which forces will force the mechanical heating and cooling system to condition the space in very short time in the early morning (figure 52). This peak is important for the energy flatness because the complementary energy system needs to be able to supply that peak, which most likely will represent a mismatch with the on-site energy produced.

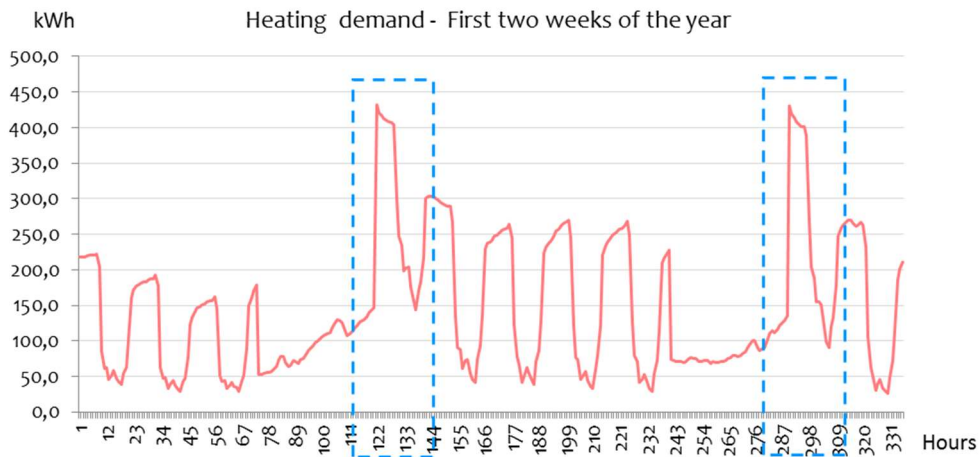

Figure 52. Energy demand analysis of the first two weeks of the year

The natural ventilation in the night might help to reduce the cooling demand in the building during summer, especially in the beginning of the day when there will be no electricity production, which is very helpful in order to reduce the mismatch in the daily basis. Additionally, the reduction of the electricity consumed for lighting in the night, compared with the current demand of energy in the building also helps to reduce the possible daily mismatch as figure 53 is showing.

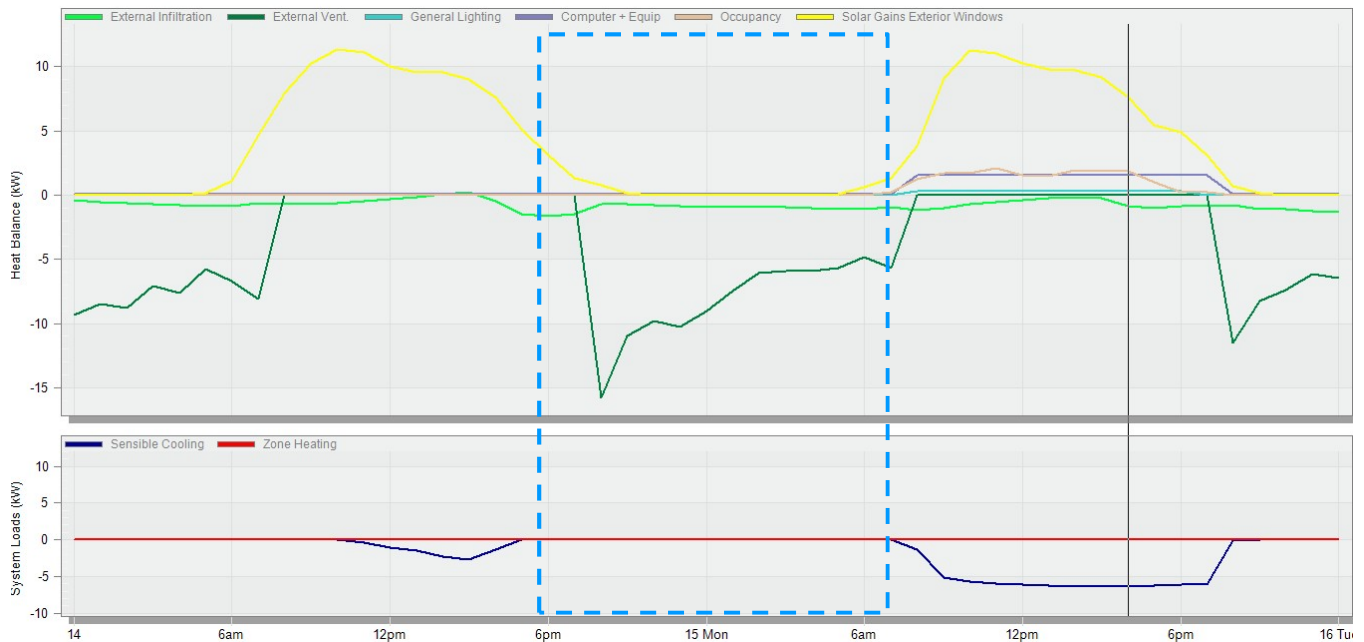

Figure 53. Analysis of the energy demand for the 4th floor of two days in summer

KPI 3 – Maximum cumulative mismatch

The cumulative maximum cannot be analyzed either, but the peaks of the negative mismatch can be foreseen based on the previous analysis, which will probably result in a cumulative negative mismatch in winter due to the fact that the solar radiation is lower in winter and the peaks of the demand are higher during winter.

Conclusions of the renovation proposal towards energy demand reduction

The building parameters changed in the building, reduced the demand of energy, especially the heating demand in a 75% by reducing the heat losses through the façades with higher thermal resistance materials and incrementing the heat gains with the solar buffer and the specification of the glazing.

The cooling demand was reduced in 44% thanks to the parameters such as night natural ventilation and automated sunscreens. Process cooling and Domestic hot water stayed the same as the current analysis because the DHW was already complying with the NTA 8800 of 2018 and the equipment influencing the process cooling is unknown.

For the first step there is no complementary energy system proposed, therefore the electricity needed for mechanical heating or cooling was not analyzed.

The electricity demand for lighting was reduced by 27% thanks to the implementation of daylight sensors, LED lights and the reduction of the percentage of lighting used during unoccupied hours in the laboratories. The equipment demand was reduced by 69% because it is assumed that for the renovation of the building, all the equipment needs to comply with the requirements of the NTA 8800 for type of space.

The current demand of energy after the demand reduction proposal is characterized for high cooling demand, especially for process cooling as it can be seen in the appendix 2. Electricity for lighting and equipment is still very high, this happened because of the special equipment in the laboratory and technical areas that cannot be optimized because their functionality is unknown in this research. In addition, the special schedule of lighting in the laboratories and process equipment results in a constant demand of electricity that might result in mismatch.

The peaks of the demand for heating happen in winter, especially at the beginning of the week when the mechanical system will have to provide more heat in short periods; which might cause a mismatch between the on-site energy production and the energy demand.

From the previous step it can be said that compared with a new building, the energy demand reduction in an existing building is limited to the properties and function of the building itself. Therefore, parameters such as the location, temperature outside and solar radiation are limited to the extent of the location of the building and cannot be changed.

Additionally, internal gains from people impact greatly the energy demand in the building, changing the number of people, schedule or metabolic rate, the internal gains can be modified. However, in an existing building, this parameter is limited to the extent of the function and occupant of the building.

Process cooling and process equipment in the laboratories and technical areas respond to a specific function of the building. Therefore, these parameters are limited to the function of the building and cannot be adapted easily.

Moreover, since there is no on-site solar energy production and the complementary energy system has not been proposed, the energy flatness cannot be calculated in this step.

5.2. Step 2 – On-site solar energy production

After the reduction of the energy demand in the building by the modification of the parameters that influence the demand of energy in the building, is necessary to analyze what could be the potential on-site solar energy production.

Solar energy supply comes from the sun that radiates energy into the earth. This radiation is rarely over 950 W/m² and it can be converted in useful energy as heat and electricity. Solar radiation reaches the earth as direct solar radiation, diffuse radiation and reflected radiation (which will be neglected in this research). In addition, the Netherlands is located in a northern hemisphere at latitude of 52°N. The Gemini south building is oriented to the south with a sun path as shown in Figure 54 and 56 from Design builder. The lowest angle of the sun is 15° on the 22 of December and the highest is at 62° on June 22.

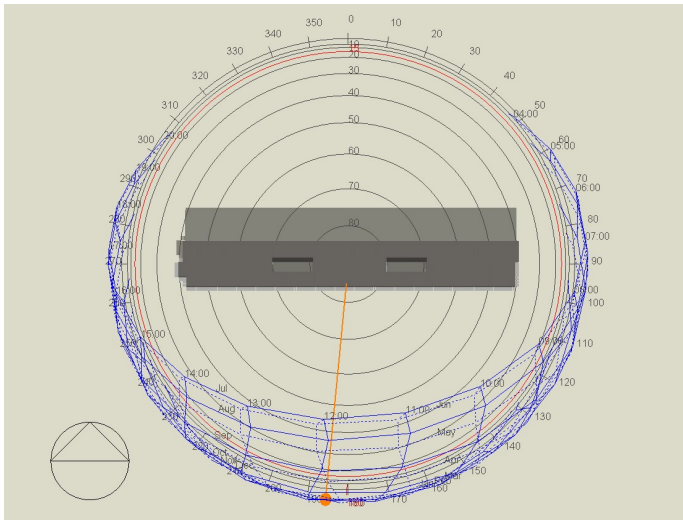

Figure 54. Solar radiation December 22 at 12mid day

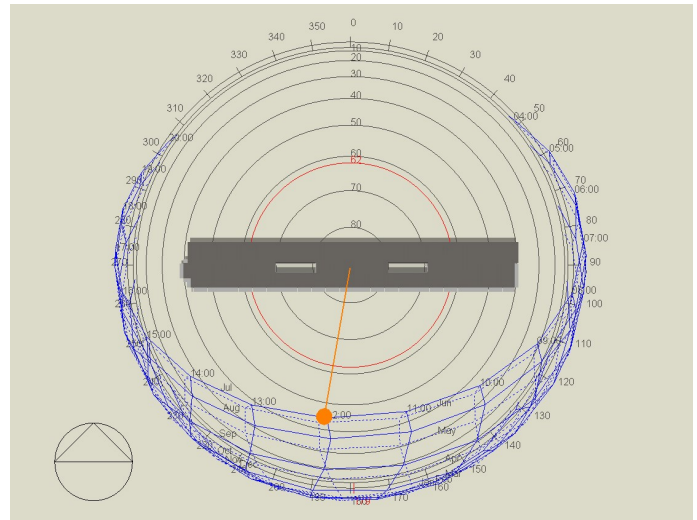

Figure 55. Solar radiation in June 22 at 12mid day

5.2.1 Feasibility of the solar energy technologies

In order to provide with on-site solar energy production for the building is necessary to do a feasibility analysis of the technologies described in chapter 2.3. Solar energy production for the building. Taking into account the previous step of the demand reduction, the heating and electricity demand is very high and the technologies chosen for the building should respond to this demand of heat and electricity.

For the proposal of the solar on-site energy production for the Gemini south building the following factors were considered:

1. The solar technology must not generate any mayor visual modification to the building; therefore, the technology implemented needs to be integrated to be building as much as possible.
2. The technology chosen must respond for the requirements of heat, cold and electricity in the building; therefore, solar thermal and solar electrical energy must be produced.
3. The technology chosen needs to be available in the market and should correspond to the feasibility study.
4. The technology must not interrupt the development of any activity in the building.

Table 20 aims to show the feasibility study of the possible on-site solar energy production technologies that can be implemented in the Gemini south building.

Table 20. Feasibility analysis of the technologies of the solar energy production for the Gemini south building

On-site solar energy production technologies

Technologies

Feasibility for Gemini building

Flat plate collectors (FPC)

Converts the solar radiation by transferring the heat to a liquid or gas. Are fixed systems that do not need to track the sun. The working temperatures are between 30°C to 80°C



Evacuated tube collectors (ETC)

An ETC uses liquid vapor phase change materials (PCM) to transfer heat at high efficiency. Consist of single tubes that are connected to a header pipe and to prevent heat losses every single tube is evacuated. The working temperatures are 50°C to 200°C



Concentrated solar power (CSP)

Consists of a concentrator (mirrors or lenses) which is the system that directs the radiation to the receiver (tube with a liquid) to convert the energy into heat. The working temperatures are between 60°C to 240°C



Monocrystalline Photovoltaic Panels

Out of the different PV panels, Monocrystalline work with higher efficiencies and are commonly used in the built environment.



Kameleon Solar Panel

Are glazing panels that integrate PV cells in the same panel, it comes in different configuration and colors that makes easier their integration in the buildings.

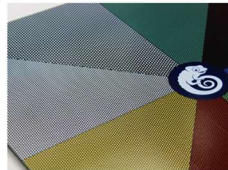

PV in sun screens

This technology works with a power of 120W and efficiency of around 8,8% with monocrystalline cells, can be easily integrated in the building envelop of the building.



PV on the glass

Solar cells on the glazing are getting every time more popular in buildings, furthermore this technology does not allow for natural daylight to enter the space.

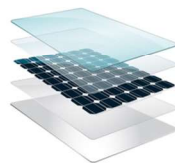

PV/T Liquid (EnergieDak)

It uses FPC collectors to heat the liquid (water, antifreeze-water mix) which depending on the technology it can run through pipes or in between the glass and the PV cells.

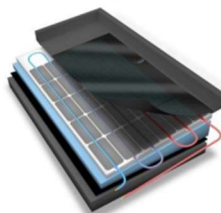

PV/T air

the air is used as a medium for heat transfer, which is pushed through the system with fans and the out coming air is used in the building for the heat balance

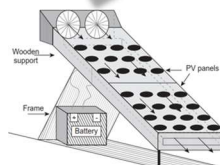

CPV/T concentrated collector

Use concentrated reflectors that increase the efficiency of the solar cells while heating the air.

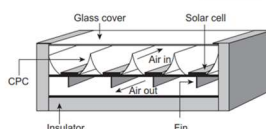

Since tis systems require and extra structure as well as a lot of space and only produce heated water, it will not be proposed for the building

This system could be a good solution for high temperatures, but it is preferable a system that could generate heat and electricity at the same time due to the lack of area to produce energy.

The high temperatures produced by this system are not needed in the building. It is complex system (sun tracking) that requires more maintenance which can be difficult to guarantee in an educational building.

This monocrystalline panels can be integrated in the vertical areas of the technical boxes. The panel can reach an efficiency of 25%, but for this research an efficiency of 20% will be used for the calculations.

Taking into account that this system can be easily integrate in the building, it will be proposed for the renovation of the south façade. This panels work with 20% to 40% less efficiency than a normal panel, depending on the color.

This technology is still under development, which makes it more expensive and harder to find in the market. Therefore, this technology will not be proposed for the building.

Taking into account that the building currently needs more daylight from the façade, and that this technology blocks part of the daylight, it will not be proposed for the renovation of the building.

Taking into account that the building needs a lot of electricity and heat. This technology can be integrated in the building roof and balconies of the south facade and while allowing for the maintenance of both ares. currently uses radiators to heat the spaces. The efficiencies of the system is around 20% less that the separated systems.

Gemini building uses radiators as a heat distribution system. Therefore the heated air in the collectors must be enough to heat up the water, which turns to be no so efficient. Therefore, this technology is not feasible for the project

Since is not a common technology and the efficiencies for heating are not so high. This technology is not feasible for the project

With this feasibility study on mind, and taking into account the energy demand of the building, PV/T technologies provide heat and electricity at the same time, therefore these technologies and more specific the Energiedak system will be proposed for most of the areas. Since PV/T does not work so well in vertical positions, PV panels will be used for vertical areas in the south façade and the technical boxes and PV/T for areas that are more flat areas, which are the roof and the balconies.

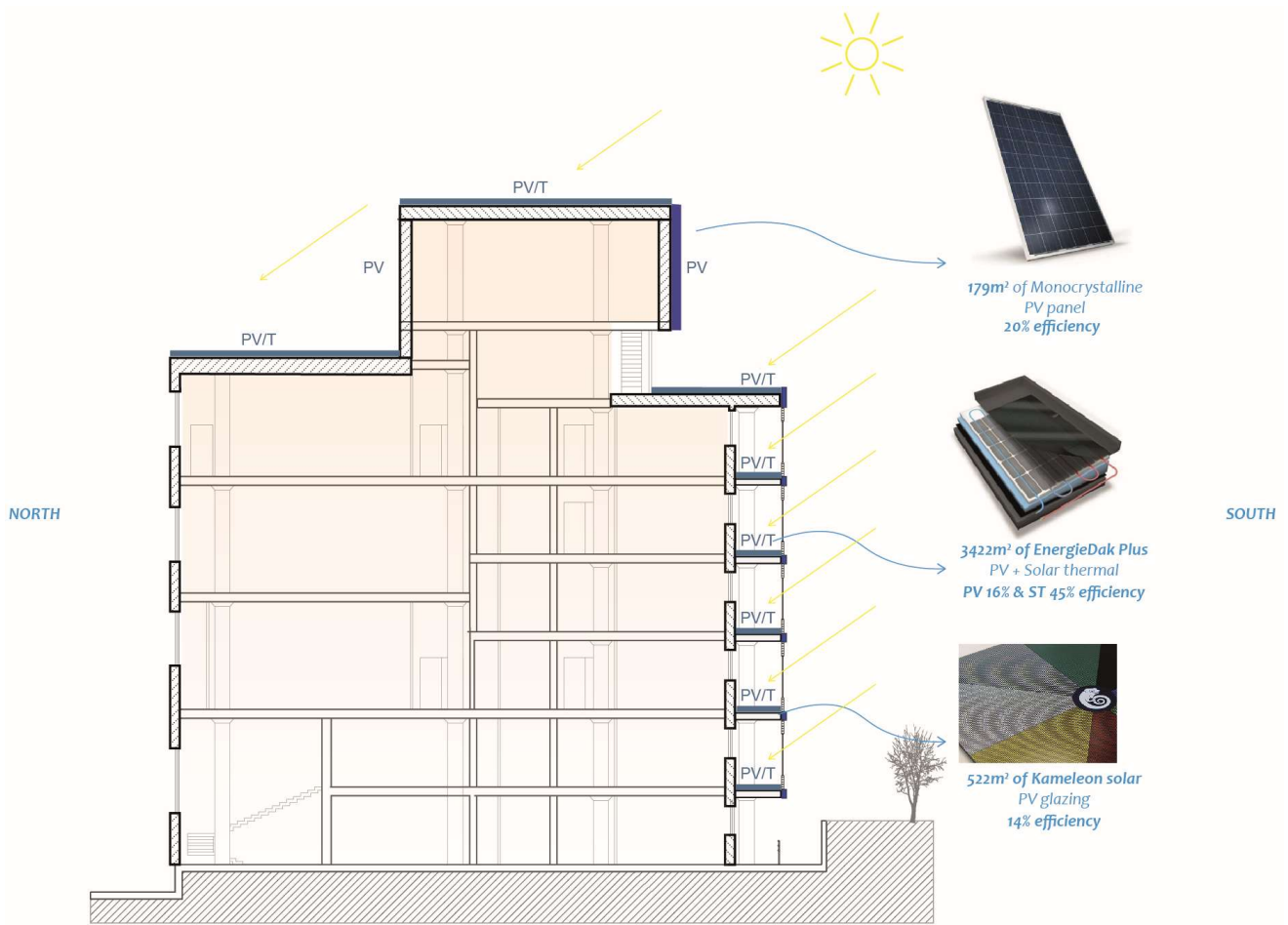

Figure 56. Renovation proposal towards on-site solar energy production for the Gemini South Building

The figure 56 shows the areas where the PV/T and PV technologies area located. The Energiedak system is proposed to be integrated with the building in the roof and in the balconies of the south façade. In the roof, the 80% of the 2755 m² of roof area available (not counting technical areas) will be use for the PV/T (2204 m²). In the balconies of the south façade, each of the five balconies have 348 m², but only 70% of this area is going to be use for the calculations of the energy production from the Energiedak system, which represents 1218 m² available.

The advantage of the Energiedak technology is that the PV/T has a protection film on top of the system that protects the technology from damages and allows people to work on top. This technology has not been designed to resist a lot of constant load, but allows for the maintenance of the façade and the roof. In addition, since it is integrated with the roof and balconies, is almost impossible to see it from the outside of the building (Appendix 3. Energiedak product data sheet).

For the calculation of the energy supplied from this technology. The PV panels were calculated assuming an efficiency of 16% based on the analysis of this technology and the solar collectors are flat plate collectors with an efficiency of 45% based on the analysis of the system, and assuming that 20% of the efficiency of these two systems could be lost when they are combined.

The monocrystalline Photovoltaic panels are placed in the technical boxes are going to be placed in vertical position, facing south in 179m², this technology will work with an efficiency of 20% (Appendix 4. Data sheet solar panel).

The panels in the south façade are Kameleon solar technology and act as a glazing panel that contains solar cells inside. This technology works with an efficiency of around 20-40% less than a normal solar panel, depending on the color of the glass, in the darker is gets the more efficient it is (Appendix 5. Data sheet Kameleon Solar panel).

5.2.2 Output of the proposed technologies

The solar radiation information used for the calculations of the on-site energy produce, were extracted from the excel of the demand calculation of Laure Itard, where the weather data in W/m^2 of direct and diffuse solar radiation is calculated for each orientation in the Netherlands for every hour of the whole year of 1964.

The results were analyzed in two steps. First, the calculations for the on-site thermal energy produce from the EnergieDak technology accounts for $3422m^2$ of roof and balcony area, times 45% of efficiency of the system times the radiation in a horizontal pane for every hour of the year as the figure 57 is showing. Between March and October, the amount of heated water from this technology, is higher than during the winter months January, February, November and December and a total of 1266896 kWh/year are produced with this technology.

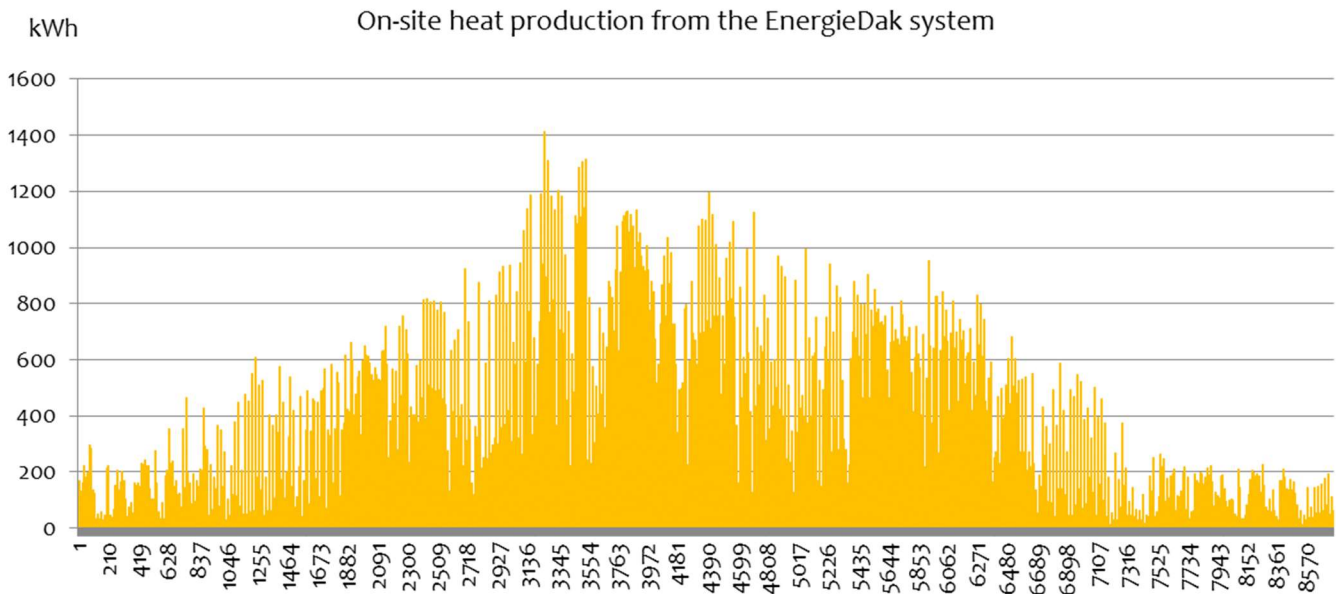

Figure 57. On-site heat production from the EnergieDak technology in the year

Second, the calculations of the electricity production were developed separately for each system. The Kameleon solar technology was calculated by multiplying the $522 m^2$ of façade area times 12% the efficiency of the panels, times the solar radiation in kWh with a south orientation. During the whole year, the Kameleon technology produces 39898 kWh.

The calculation of the monocrystalline PV panels counted the $179m^2$ of usable are in the technical boxes, times 20% efficiency of the monocrystalline PV, times the radiation in kW of each hour of the year for a south orientation. As a result, 22803 kWh/year of electricity are produced with the PV technology.

The EnergieDak system produces electricity with an efficiency of 16%, that multiplied with the area of the system ($3422m^2$), times the solar radiation in kW per each hour, gives as a result an electricity production of 450452 kWh/year.

When summing up the yearly results from the three technologies, 513153 kWh/year of on-site electricity is produced in the building boundary of the Gemini South building.

Figure 58 show the combined electricity production from the three technologies together for every hour during the whole year. With this figure, is possible to see that the electricity production mainly happens during summer, while in winter the production rarely exceeds the 100kWh.

Therefore, the electricity production requires more space and produces less energy that the heat production from the EnergieDak technology and this is mainly because of the efficiency of the technology to transform into heat or electricity the primary energy that comes from the sun.

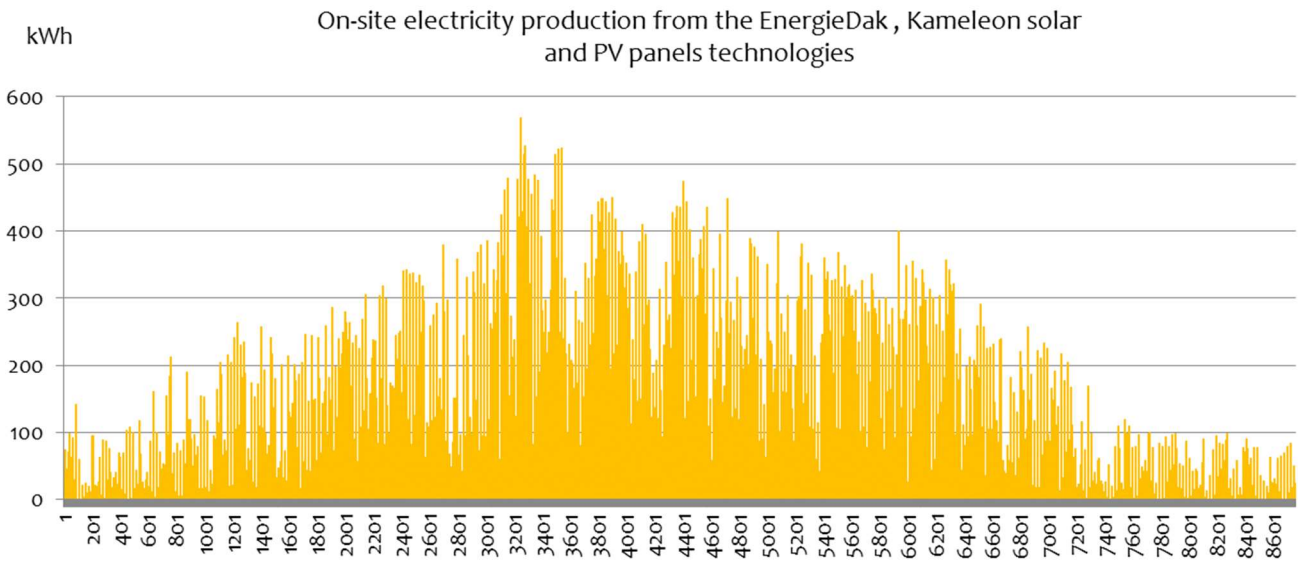

Figure 58. On-site heat production from the EnergieDak technology in the year

5.2.3 Mismatch analysis

KPI 1 - Absolute energy flatness

The energy flatness balance happens between the final electricity when comparing the on-site energy produced to the energy delivered to the complementary energy system, lighting and equipment. In step 2, the on-site energy production was proposed for the Gemini South Building, but there is still no complementary energy system proposed (third step); therefore, the analysis of the absolute energy flatness is not possible.

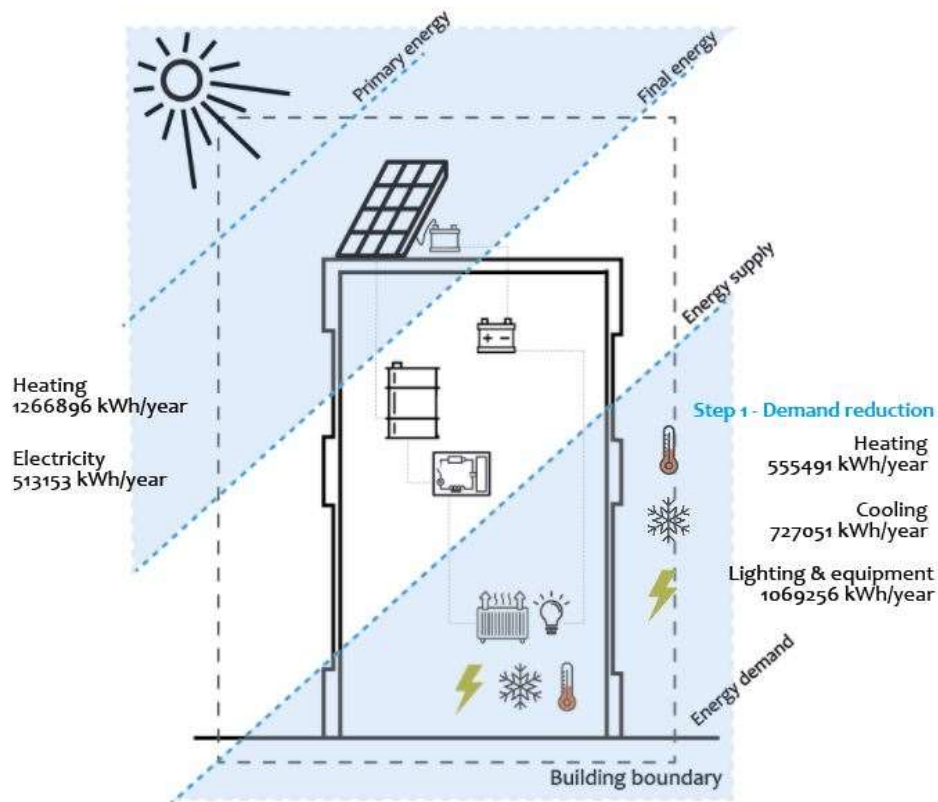

Figure 59. Energy balance in the step 2 towards energy production

KPI 2 - Maximum mismatch peak

The maximum mismatch cannot be analyzed either. However, some characteristics of the on-site energy production can help to understand the mismatch for the renovation of the building.

As figure 57 is showing, the peak of the on-site heat production happens in the hour 3251, when 1411 kWh of heated water are produced by the EnergieDak technology. This peak of heat production might result in a positive mismatch between the energy delivered to the complementary energy system.

For the on-site electricity production, after the analysis of the three technologies together, the peak of the production happens in hour 3251 (same as the heat production peak), in which 568 kWh of electricity were produced in the combination of the three technologies. This means that the peaks of the energy produced are limited to the peak of the radiation.

Since the electricity production from the three technologies requires more space and produces less energy than the heat production from the EnergieDak technology. There will be a bigger mismatch between the electricity balance compared with the thermal balance. Because the demand for electricity is bigger than the demand for heating and the production of heating is higher than the production of electricity.

KPI 3 – Maximum cumulative mismatch

The cumulative maximum cannot be analyzed either, but the peaks of the positive mismatch can be foreseen based on the previous analysis of the step 2, which will probably result in a cumulative positive mismatch in summer due to the fact that the solar radiation is higher in summer and the peaks of the demand are higher in winter (step 1).

Conclusions of the on-site solar energy production

After the demand reduction in step 1 the heating demand was not that high compared with the cooling and electricity demand. Nonetheless, the heating demand is still a priority for building located in cold climates; therefore, the PVT EnergieDak systems were located in the balconies and roof of the building. During summer, the peak of the production might end up in a positive mismatch (surplus) of heat, which shows the potential for heat storage for the building.

Even though there is a surplus of heated water in summer from the PVT, there is still the need for a complementary energy system capable to produce the temperature needed for the heating demand from the on-site solar energy production plus a complementary heating production system to be used during the shortage of on-site production (winter).

Lighting and equipment electricity demand is very high and is more or less constant throughout the whole year. On the other hand, the on-site electricity production is not that high and has moments of shortage during winter, which might cause cumulative negative energy mismatch. In addition, the electricity demand has to be complemented with any electricity need from the complementary energy system, which will make the electricity demand even higher.

From the previous analysis, it can be said that the on-site heat and electricity production compared with a new building, in an existing building is limited to the extent of the radiation in the location of the building and the area available for the integration of solar technologies.

It is necessary to propose a complementary energy system capable to store the possible surplus of energy and supplied to the building during the shortage moments.

5.3. Step 3 – Complementary energy system

The third step towards energy flatness is to propose a complementary energy system capable of transforming, distributing, storing, and discharging heat, cold and electricity in order to be used in the building at any time of the year.

First, a feasibility analysis of the possible complementary energy systems that can be implemented in the building based on its energy demand after the proposal in step 1, building function, location and the on-site energy production proposed in step 2. The on-site energy production for the building is based on solar energy; therefore, the complementary energy system has to be able to complement that energy production mainly for heat.

Second, the subchapter 5.3.2 includes the energy calculations with the incorporation of the complementary energy system and the analysis of the results. Third, the subchapter 5.3.3 will show an analysis of the mismatch after the complementary energy system in order to analyze the three KPI's for the building.

Fourth, after the analysis of the KPI 3 (maximum cumulative energy mismatch), the energy storage can be dimensioned and the analysis of the complementary energy system including storage can be done again in chapter 5.3.4 in order to show the impact of this system. Chapter 5.3.5 will have the analysis of the final mismatch after the integration of the complementary energy system and storage in order to verify how close is the building to be energy flat after the renovation proposal.

5.3.1 Feasibility study of the complementary energy system

The table 21 shows the feasibility study of the complementary energy systems in terms of the possible systems for heat distribution, heat storage, booster heat systems and electricity storage systems that can be included in the building.

The feasibility study is based on the literature review of chapter 2.6. Complementary energy systems and the characteristics of the energy demand after the first step and on-site energy production in the second step. The systems analyzed in this research are the most common systems that are being used nowadays in the Netherlands and the ones that make more sense for the building.

Table 21. Feasibility study of the complementary energy systems

Complementary energy system

Technologies

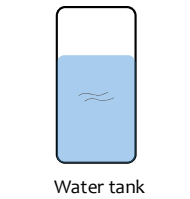

Water tank

Water tank storage

Depending on the density of the fluid, size of the tank and the thermal resistance it can store water at different temperatures for long periods in order to reduce the heating mismatch.

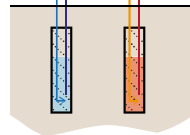

Heat exchanger

Underground heat exchange

Also called boreholes extract low temperatures from the ground, therefore are usually used in combination with heat pumps

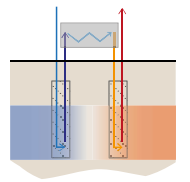

ATES

ATES

It works with water as a medium that circulates at low rate through the ground while transferring heat and cold. The excess heat produced in summer can be stored and be used in the winter.

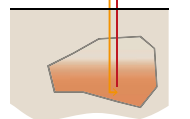

Cavern storage

Cavern Storage

Based on the underground water reservoirs to store heat or cold. They work same as a water tank.

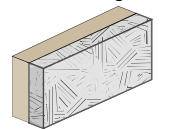

PCM

PCM

Heat can be stores thanks to the materials properties. Heat is resealed in the space when needed reducing the heating demand.

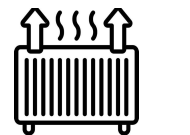

Radiator

Radiators

Are heat distribution systems that can work with high temperatures in order to heat the space.

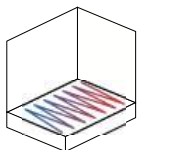

Floor/wall heating

Floor and wall heating

This is another heat distribution system that uses low temperatures to circulate the heat through the spaces.



Electrical Battery

Electricity batteries

When there is a surplus of electricity from solar panels, electricity batteries can store this surplus energy in order to be used later in the building.



Heat pump

Heat pump (HP)

It works with the same principle as a refrigerator, because of the pressure applied to a certain medium (water or refrigerant), evaporation and condensation takes place releasing and/or absorbing heat in the process.

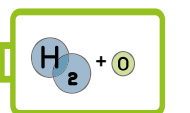

Chemical storage

Chemical storage

Energy can be also store in chemical reactions, for example hydrogen storage. When energy is combined with the hydrogen, the different elements separate in order to store them and when bringing them together energy is released.

Feasibility for Gemini building

Taking into account that currently there might be a surplus of heated water from the EnergieDak. Hot water tanks can store the surplus heat of the building and give it back when needed. Therefore is a feasible technology that will be integrated in the complementary energy system.

Ground heat exchangers do not store heat, but extract the stored heat from the underground. In order to reduce the mismatch the idea is to store the surplus of energy and use it during shortage times. Therefore, this system will not be integrated in the building.

ATES systems are very common in the Netherlands, energy can be store underground the building. Even the building was connected to a shared ATES system. Therefore, is a feasible technology for the building, but this time it will only be used by the Gemini south building.

There are no caverns next to the site. Therefore, this technology is not feasible for the building

PCM materials could be integrated in the facades. Furthermore, this technology did not make so much impact in the energy demand reduction. Therefore, it is not going to be proposed for the renovation of the building.

Taking into account that the current building is using radiators as a heat distribution system and those are still working as expected. Therefore, the renovation of the building will keep the same radiators.

Taking into account that the integration of this system to the building will represent the renovation of all the floors/ walls of every space. This system will not be included in the renovation and the current radiators will be reused in the building.

This technology will be explored in the building in order to store the surplus of electricity.

Taking into account that HP can be well integrated with solar energy systems, this technology will be proposed for the building in order to make the energy from the solar collectors, usable in the building.

Taking into account that the integration of this system to the building will represent the renovation of all the floors/ walls of every space. This system will not be included in the renovation and the current radiators will be reused in the building.

The heat distribution system for the building, according to the building function and the current distribution system implemented, low temperature heating systems makes more sense to be implemented in the building. Low temperature radiators are already placed in the whole building which means that this system can be reuse (including all the pipes and radiators).

Floor and wall heating distribution systems are also low temperature. However, these systems are not going to be integrated in the building, because it requires a mayor renovation of the indoor spaces, which is not required for the building.

The EnergieDak system can be connected to a thermal energy storage based on water storage, therefore, water tanks should be integrated in the system. The water tanks can be placed in the technical areas in the basement. This water storage tank must be dimensioned based on the water surplus, the capacity, power, efficiency and storage period after the analysis of the KPI 3. The tank should be made of high thermal resistance materials in order to avoid heat losses.

Because the thermal energy produced does not have the required temperature to supply the heat distribution systems, a booster energy system must be incorporated. A Heat Pump connected to an ATES system for the building can supply heat when the solar thermal energy cannot. This heat pump can produce the heat needed for the radiators and DHW in the building.

Water Temperature at Evaporator Inlet t_s (°C)	Water Temp. at Condenser Outlet, t_u (°C)				
	30	35	40	45	50
5	4.55	4.10	3.70	3.40	3.15
10	5.30	4.65	4.15	3.75	3.45
15	6.25	5.35	4.70	4.20	3.85
20	7.70	6.35	5.45	4.80	4.30
25	9.95	7.80	6.45	5.55	4.85
30	14.10	10.10	7.95	6.55	5.60

Figure 60. COP of a GWHP (Sarbu & Sebarchievici, 2017d)

The ATES system for the building can reduce the temperature entering in the HP. According to Laure Itard, in the Netherlands warm water can be store in ATES systems at a temperature of 20°C. This system also allows to store cold temperatures of around 9°C. For a Heat Pump (HP) the COP (Coefficient of Performance) can be taken from figure 60 according to the book solar heating and cooling systems. Therefore, if the inlet temperature is 20°C and outlet temperature is 45°C, the COP for the calculations of the HP is 4.8.

Therefore, the system proposed for the Gemini south building is explained in figure 61.

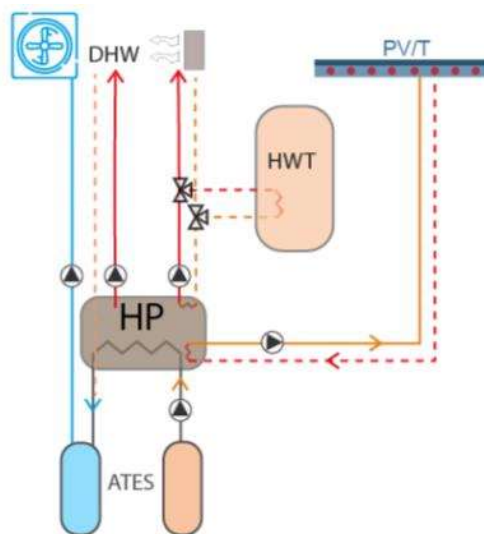

Figure 61. Complementary energy system for the Gemini south building

The system proposed for the building consists of three functions. For heating, the on-site solar energy produced from the energieDak system in the roof and balconies of the building is send directly to the HP in order to be heated up to be used by the radiators and DHW. When there is a surplus of heated water from the energieDak, the heated water after the HP will be stored in the Hot Water Tank (HWT) as the figure 62 is showing.

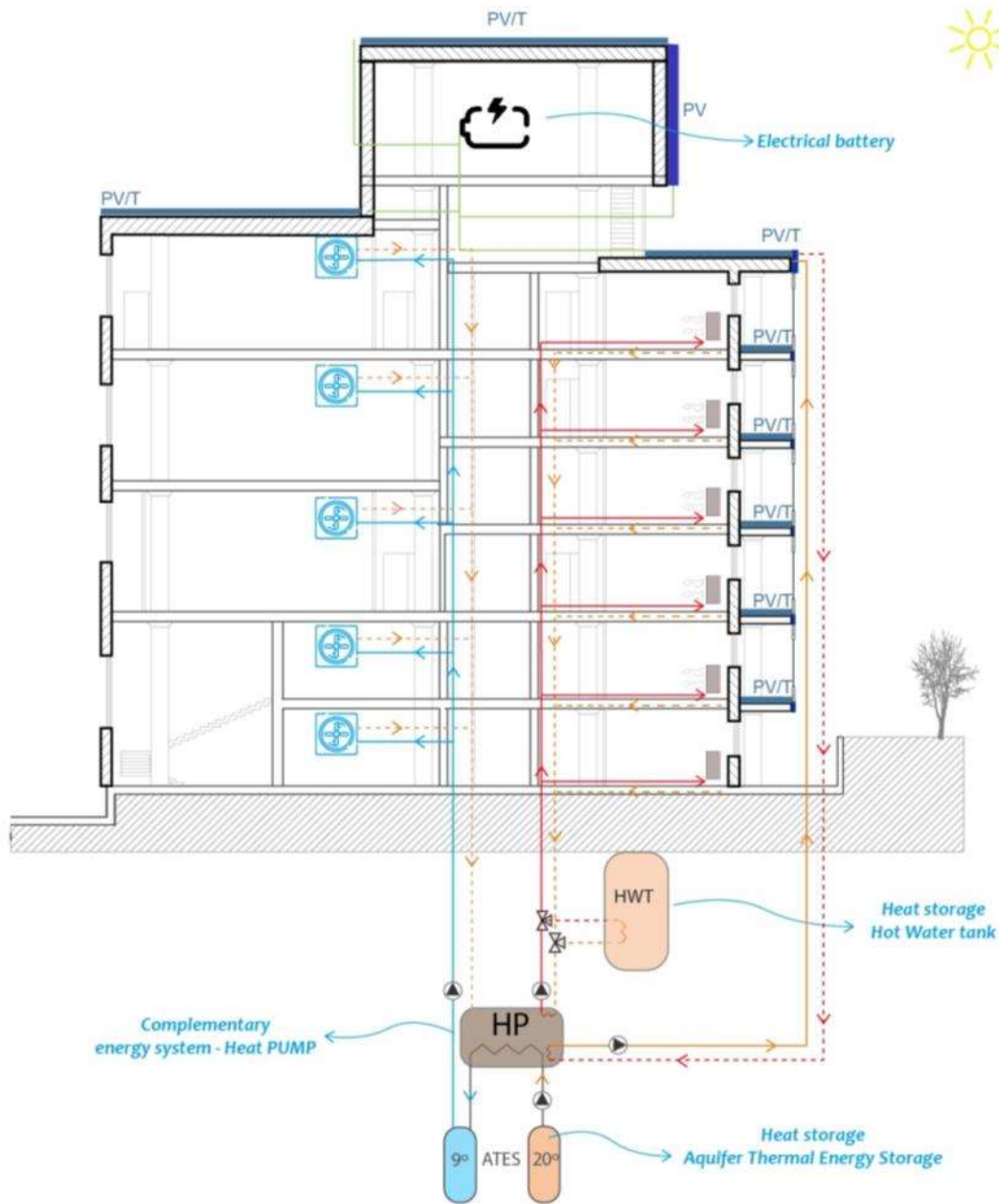
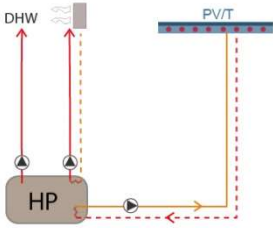

Figure 62. Complementary energy system for the Gemini south building

The heat pump uses the heat from the energieDak system in order to produce even more heated water for the building services. This HP system uses electricity in order to heat up the water. Therefore, the electricity balance of the building includes the electricity needed for heating as well as for lighting, equipment, process equipment, etc.

In addition, this system proposes 4 different operation modes depending on the availability of the heat production and heat storage state.

1. Solar Heat production



When there is on-site heat production from the energieDak system, the heated water passes through the heat pump where is further heated in order to be send to the radiators and for domestic hot water.

2. Surplus of heat

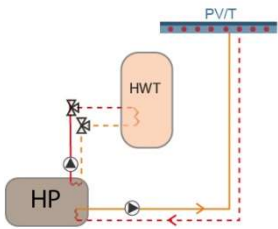

When there is on-site heat production that is not needed in the building, a positive mismatch occurs. The surplus of heat production goes from the energieDak system, to the HP, where is heated up before is sent to the Hot Water Storage tank. The water is going to be store until is needed gain for the building.

3. Heat storage

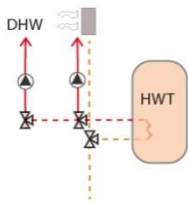

When there is heated water stored in the water tank, this water can be directly used by the radiators and for DHW. The good point about this operation mode is that water stored in the tank does not need any extra energy to be used again, because the ATES is not needed anymore.

4. No heat production, no storage



When there is no on-site energy produce and no heated water stored in the tank. The heat pump must run with water stored in the ATES in order to achieve a heat balance. This connection with the ATES requires a constant need of electricity, which has to be supplied from the solar panels.

Cooling mode

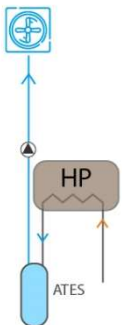

Cooling demand is solved entirely from the ATES system, in which the cold water can be stored in winter, in order to be used in summer. The return water from the cooling system can be stored again in the ATES or can be connected to a heat exchanger to preheat the water entering into the HP. This last application is not going to be explored in this research; but can be a good idea for further research.

For electricity, the on-site electricity proposed in step 2 with the three different technologies, is going to be connected to an electrical energy storage system capable of storing the surplus of electricity when no needed for the heating, lighting and equipment demand.

5.3.2 Output of the proposed complementary energy system

For the first analysis of the energy balance in the step 3, the energy storage systems for heating and electricity will not be integrated in order to compare the impact of this system. Therefore, for the calculation, the heating balance was calculated first and then the electricity balance.

For the heating balance, as explained in the system balance of the energy flatness chapter, happens between the energy demand in the building and the energy supply from the complementary energy system, which in this case is the heat pump.

The heating demand in hours was taken from the design builder model and extrapolated for the whole building. On the other hand, the heat supply from the heat pump was calculated using the final on-site heat produced by the energieDak system and divided the COP of 4.8 of the heat pump in order to find out the electricity need to make the heat pump work. After these calculations, the final heat produce from the energieDak was divided the COP minus one, times the COP in order to find the heat supply from the HP.

The figure 64 show the comparison between the heat supply from the heat pump and the energy demand of the building from the energy simulation in hours during the whole year. It is important to see the difference between the moments when the heating demand of the building is happening (winter) and the moments where most of the heating supply is happening (summer).

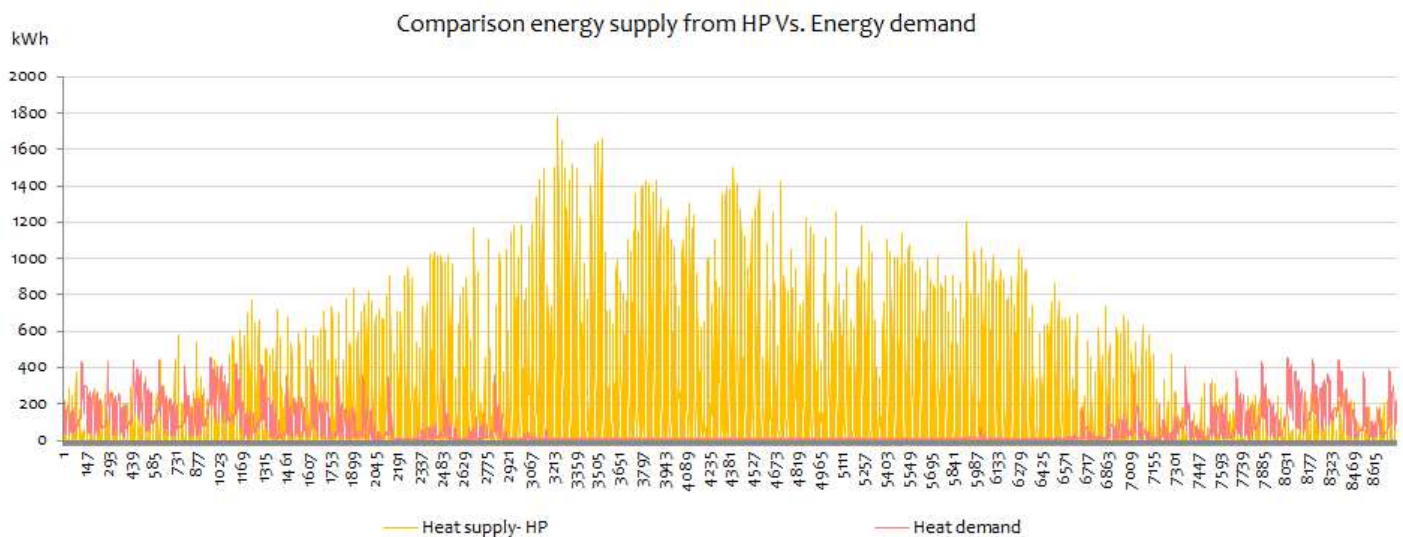

Figure 64. Comparison between energy demand and energy supply form the heat pump

Furthermore, when the on-site energy production is not enough to compensate the demand, the system needs to use the store water in the ATEs system in order to find a heat balance. Figure 65 shows the negative mismatch between the heat demand and heat supply form the HP that needs to be compensates with the ATEs system. In this figure is relevant to note the impact of the on-site heat production from the energieDak system.

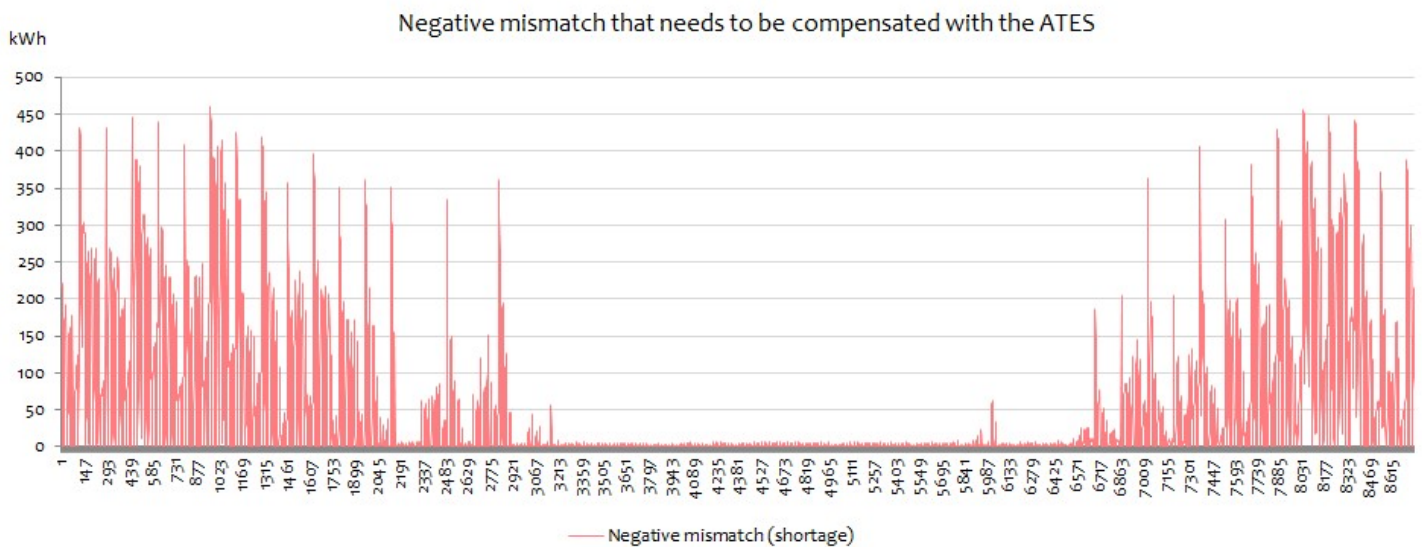

Figure 65. Negative mismatch between the energy supply of the HP and the energy demand

The cooling balance is solved with the ATES system during the whole year. The cold water is taken from the underground cold storage and delivered to the building services. Therefore, it is assumed that no need for electricity for cooling is needed.

Therefore, the heat pump is supplying all the heating demand in the building, because it is being used either for the on-site energy production or for the ATES system. This means that the final electricity need to make the heat pump work is equal to the energy demand in the building divided by the COP of the heat pump. As a result, in every hour of the year when there is heating demand in the building, there is a final electricity need for the heat pump.

The electricity balance happens between the final electricity delivered from the on-site electricity production and the energy need for the complementary energy system. Therefore, the final electricity need for the heat pump was summed to the electricity need for lighting and equipment in every hour of the year. This number was compared in figure 66 with the on-site electricity production from the three different technologies explained in the step 2.

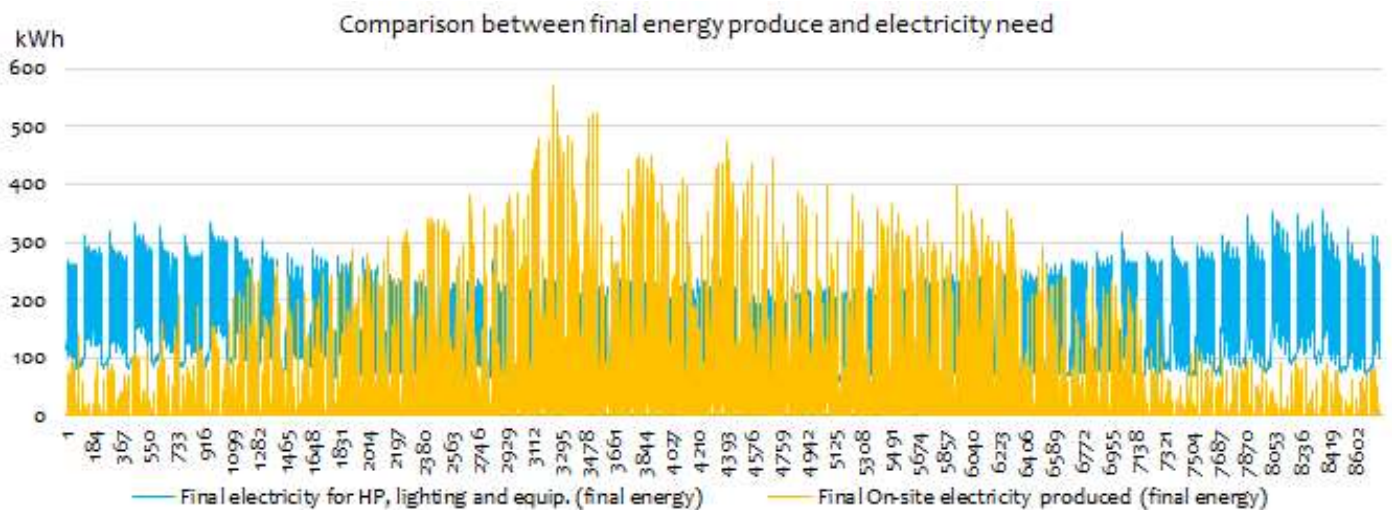

Figure 66. Comparison between final on-site electricity produced Vs final electricity for the HP, lighting and equipment.

From this comparison it is relevant to see that the electricity need in the building has a more or less constant profile during the whole year. However, the on-site supply has a different profile of energy production that will cause a mismatch of electricity in the building. In order to calculate the mismatch of the building with the complementary energy system and without the energy storage, the next chapter is going to calculate the 3 different KPI's of the energy flatness.

5.3.3 Mismatch analysis without the energy storage

The mismatch between final on-site energy production and the energy need for the complementary energy system could not be calculated for the previous steps because either the on-site energy production or the complementary energy system were not proposed for the renovation of the building. After the proposal of the complementary energy system in the step 3, it is possible to calculate the mismatch using the three KPI's. In order to verify the impact of the energy storage in terms of heat and electricity is necessary to analyze the mismatch in terms of heat balance and electricity balance. The cooling balance is solved with the ATES system; therefore, it is not included in the mismatch analysis.

Thermal balance mismatches

KPI 1 – Absolute energy flatness (thermal balance)

KPI 1 should be calculated in the electricity balance, but in order to make an analysis the impact of the energy storage it was necessary to adjust the calculations of the KPI 1 to the thermal balance. Therefore, the formula of the KPI 1 for the thermal balance for heating is as it follows. Where the energy supply is the heat supplied from complementary energy system when there is on-site heat production and the energy demand is the energy supplied from the complementary energy system should be zero at any point of time.

$$KPI\ 1\ (thermal\ balance) = \sum_{t=1}^{t=8760} |E_{energy\ supply(t)} - E_{Energy\ demand(t)}|$$

Therefore, based on the results from the step 1 for heating demand (figure 51) and the results of heat pump energy supply. The KPI 1 is equal to 1044799 kWh (8760h), which means that the on-site energy supply is bigger that the energy demand, resulting on a positive mismatch.

$$KPI\ 1\ (thermal\ balance) = \sum_{t=1}^{t=8760} |1600290\ kWh\ (8760h) - 555491kWh\ (8760h)| = 1044799\ kWh/year$$

The figure 67 shows the mismatch between the supply of the heat pump and the energy demand in the building. With this figure is possible to see the positive and negative mismatches in the thermal balance.

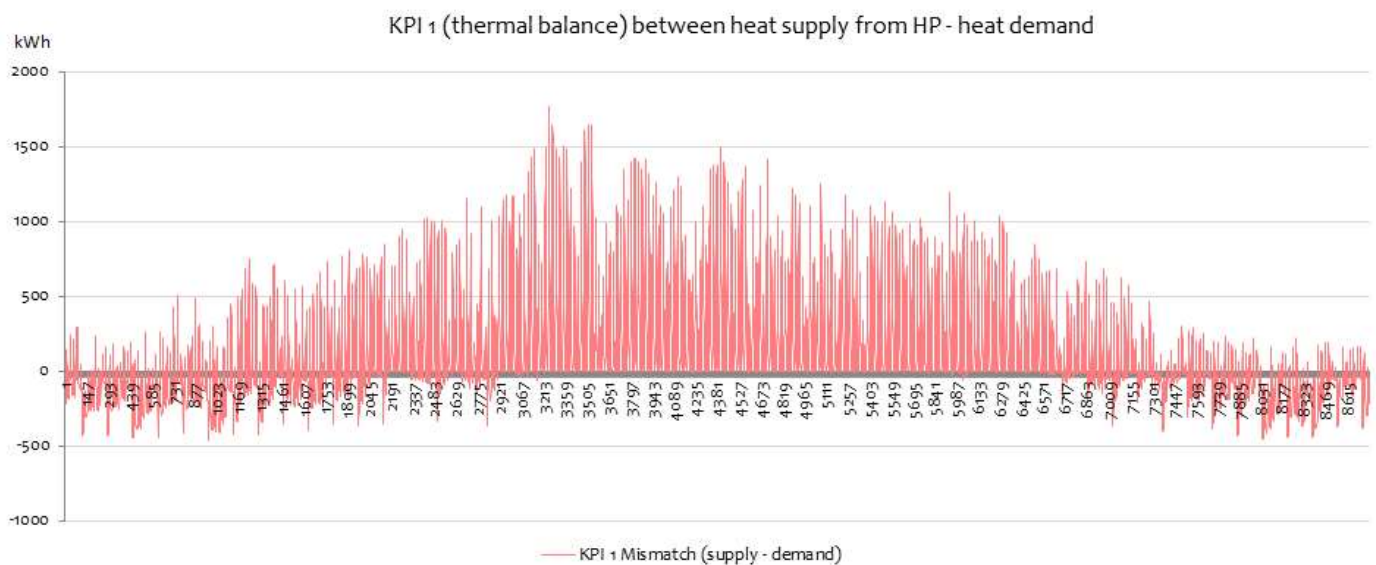

Figure 67. KPI 1 for the thermal balance between heat supply from the HP minus heat demand

For the current energy situation of the building before the renovation proposal, the analysis of the KPI 1 was done in the thermal balance, in order to be able to compare results with the proposed situation for the building. As a result, the KPI 1 in the current situation was equal to -2313230 kWh/year and compared with the proposed situation, which is 1044799kWh/year, there is a huge difference, because the current situation represents a negative mismatch and the proposed situation a positive mismatch. Therefore, the proposed situation is closer to achieve energy flatness if an energy storage system is included in order to store the energy surplus.

However, none of the situations end on an energy flatness (or better said thermal flatness), but the proposed situation shows the potential for heating storage.

KPI 2 – Maximum Mismatch Peak (MMP) (thermal balance)

The analysis of the second KPI in the thermal balance also requires the adjustment of the main formula. Therefore, the formula is as it follows and can be used for calculating the maximum positive peak and the maximum negative peak.

$$MMP = \max_{0 \leq t \leq 8760} |E_{Energy\ supply(t)} - E_{Energy\ demand(t)}| [kW]$$

Therefore, after the hourly analysis of the mismatch, it was possible to identify the positive and negative mismatches and using excel the maximum number of the positive mismatch is 1774 kW during the hour 3249 and the peak of the negative mismatch happens during hour 960 with 461kW as it is shown in figure 68.

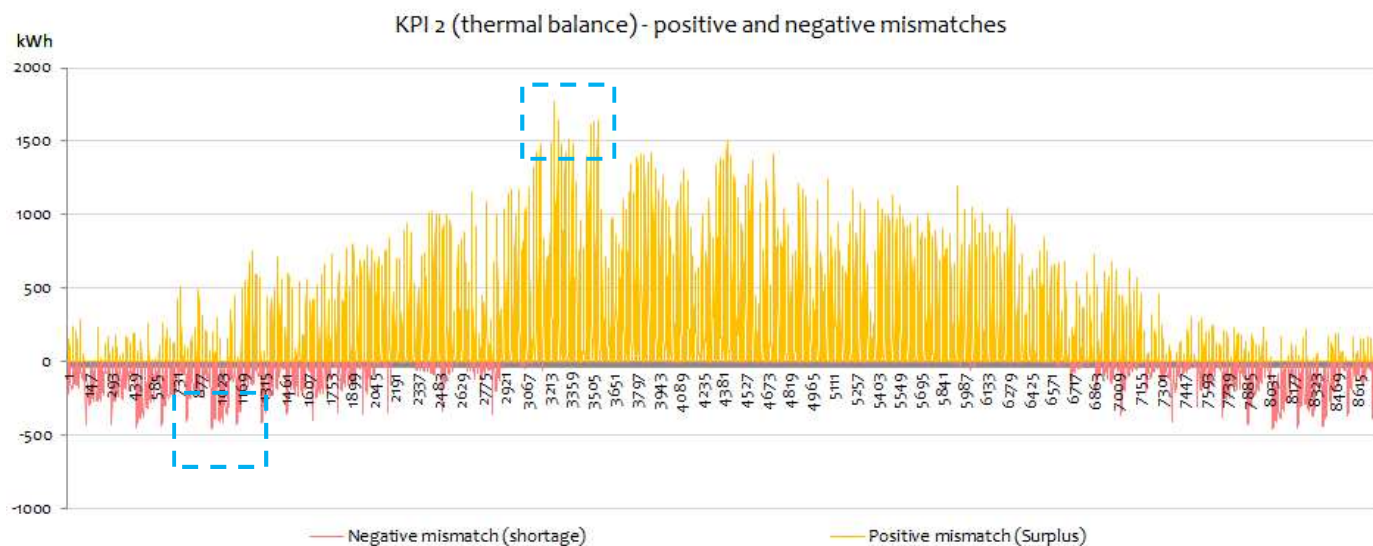

Figure 68. KPI 2 for the thermal balance – positive and negative mismatches.

KPI 3 – Maximum Cumulative Energy Mismatch (MCEM)

After the calculation of the peak of the negative and positive mismatches, the cumulative mismatch was calculated by the sum of the negative mismatches of the previous time steps before there is an on-site heat production available to compensate for the shortage. Therefore, the peak of the cumulative negative mismatch is 17812 kWh and it happens during the hour 8095 (figure 69).

The cumulative positive mismatch was calculated by the sum of all the positive mismatches of the previous time steps before there is a period of shortage that needs to be compensated with the on-site heat production. As a result, the positive MCEM is 12752 kWh and happens during the 3519 hour. Therefore, the calculation of the KPI 3 in the thermal balance and the size of the water tank will be:

$$MCEM = \max_{0 < a < 8760} \text{positive}(CEM_positive_{(a)}) - \max_{0 < b < 8760} \text{negative}(CEM_negative_{(b)}) \text{ [kWh]}$$

$$MCEM = \max_{3519h} \text{positive}(12752 \text{ kWh}) - \max_{8095h} \text{negative}(-17812 \text{ kWh})$$

$$MCEM = 30564 \text{ kWh}$$

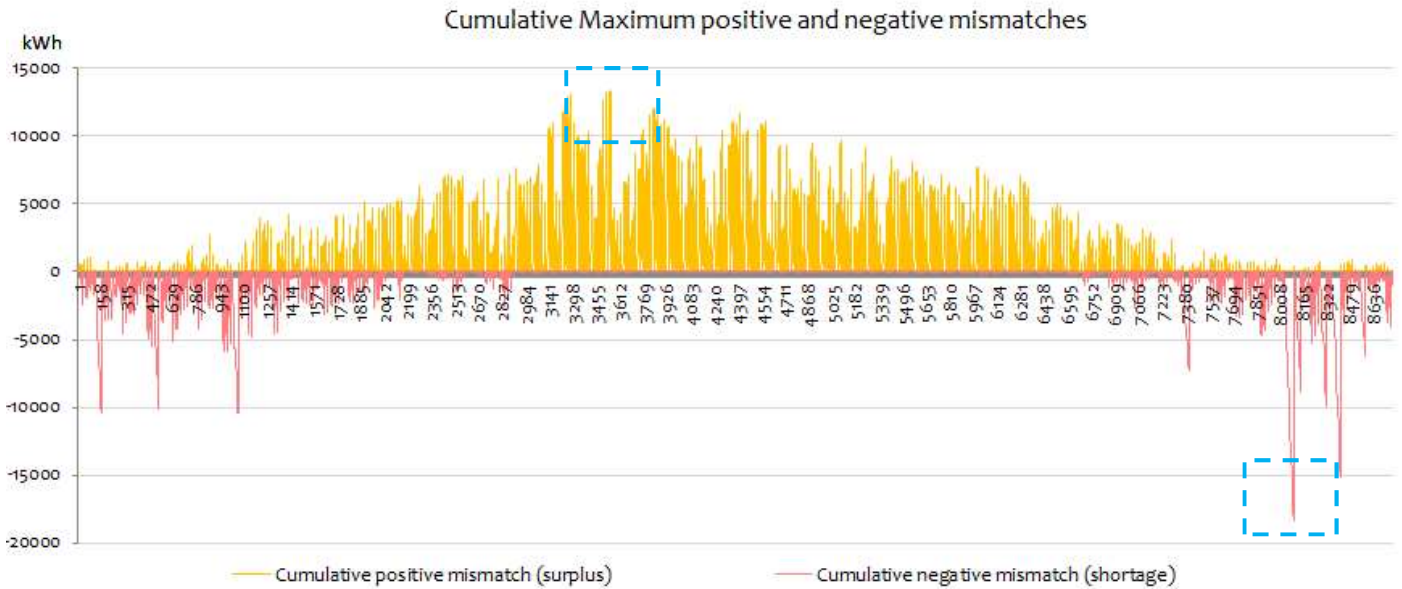

Figure 69. KPI 3 for the thermal balance – Maximum cumulative peak of the positive and negative mismatches

The analysis of the KPI 2 and KPI 3 show the potential for heat storage for the Gemini south building. Furthermore, the electricity balance needs to be calculated.

Electricity balance mismatches

For the electricity balance, the final electricity need for the HP was summed with the final electricity need for lighting and equipment. This number was compared with the on-site electricity produced from the three technologies in the step 2.

KPI 1 – Absolute energy flatness (thermal balance)

Therefore, the calculation of the energy flatness was developed with the original formula showed in chapter 3 for every hour of the year as show in figure 66 and figure 70.

$$\sum_{t=1}^{t=876} |E_{final\ energy(t)} - E_{Energy\ Supply(t)}|$$

$$\sum_{t=1}^{t=8760} |513152 \text{ kWh}_{(8760h)} - 1222993_{(8760h)}| = -709841 \text{ kWh (8760h)}$$

This number represents a negative mismatch, which means that the on-site energy produce is not enough to compensate the energy need for the complementary energy system plus lighting and equipment. Figure 70 shows the mismatches per hour in where is visible the positive and negative mismatches in the electricity balance.

KPI 2 – Maximum Mismatch Peak (MMP) (thermal balance)

The second KPI in the electricity balance uses the original formula. Therefore, the formula is as it follows and can be used for calculating the maximum positive peak and the maximum negative peak. Where the $E_{Final\ energy(t)}$ is equal to the on-site electricity produce and the $E_{Energy\ supply(t)}$ is the electricity need for the HP, lighting and equipment.

$$MMP = \max_{0 \leq t \leq 8760} |E_{Final\ energy(t)} - E_{Energy\ supply(t)}| \text{ [kW]}$$

Therefore, the analysis after the 8760 hours is:

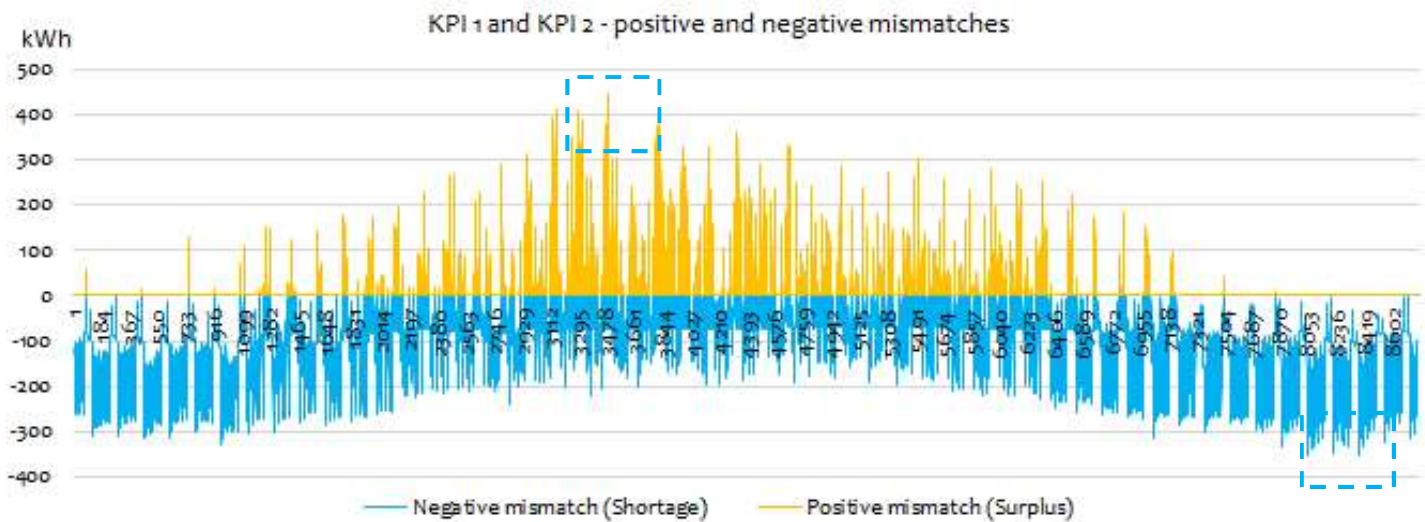

Figure 70. Representation of the KPI 1 and KPI2 negative and positive peaks in the electricity balance

The maximum positive mismatch using the formula of the KPI 2 is 434 kW and happen during the hour 3490 as shown in figure 70. The negative mismatch peak happens in hour 8385 with 355kW. With this information is possible to analyze the KPI 3 for the electricity balance.

KPI 3 – Maximum Cumulative Energy Mismatch (MCEM)

The cumulative mismatch was calculated by the sum of the negative mismatches of the previous time steps before there is an on-site electricity production available to compensate for the shortage. Therefore, the peak of the cumulative negative mismatch is 132035 kWh and it happens during the hour 8696 (figure 71). This means that the shared grid must have the capacity to supply during these shortage periods.

The cumulative positive mismatch was calculated by the sum of all the positive mismatches of the previous time steps before there is a period of shortage that needs to be compensated with the on-site electricity production. As a result, the positive MCEM is 2976 kWh and happens during the 3833 hours as it can be seen in figure 71.

As it can be seen in figure 71, the periods of shortage are more and bigger than the periods of surplus, which means that the on-site energy production is not going to be capable of compensating the electricity need in the building. Still, there are moments of surplus of electricity that can be store in electrical batteries in order to help to compensate the negative mismatch.

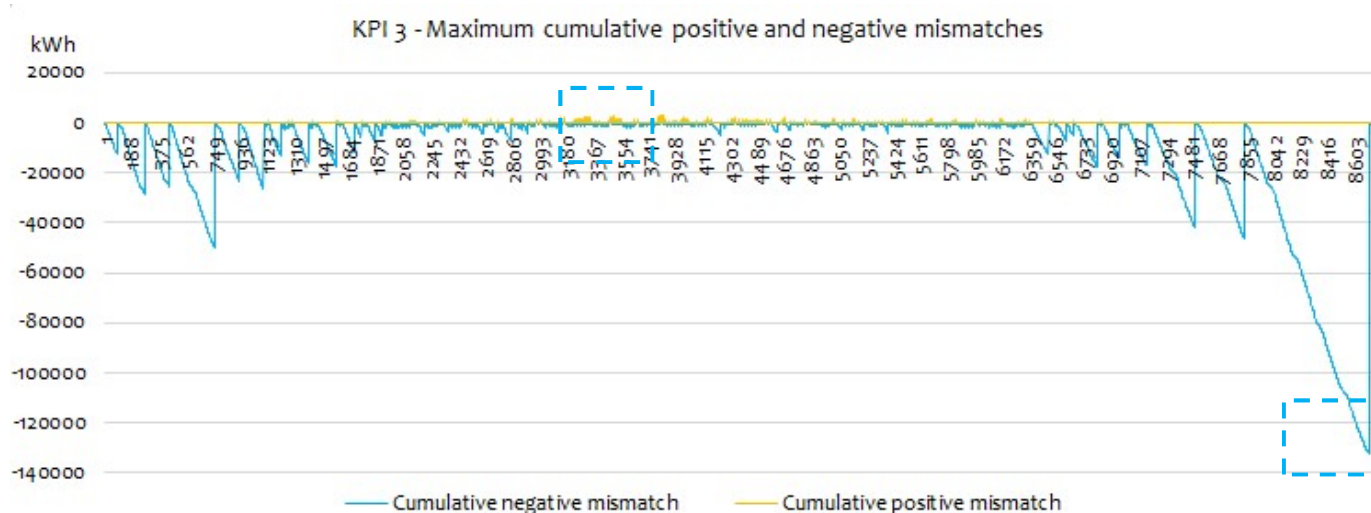

Figure 71. KPI 3 maximum cumulative positive and negative mismatches

Therefore, the calculation of the KPI 3 in the electricity balance, and the size of the electrical battery is:

$$MCEM = \max_{0 < a < 8760} \text{positive}(CEM_positive_{(a)}) - \max_{0 < b < 8760} \text{negative}(CEM_negative_{(b)}) \text{ [kWh]}$$

$$MCEM = \max_{3833 \text{ h}} \text{positive}(2976 \text{ kWh}) - \max_{8690 \text{ h}} \text{negative}(-132035 \text{ kWh})$$

$$MCEM = 135011 \text{ kWh}$$

Conclusions of the mismatch without energy storage

From the thermal balance analysis, it can be concluded that the on-site heat production after the proposal of the step 2. Results on a surplus of heated water, especially during summer, that can be store in a hot water tank in order to compensate for the hours of shortage of heat in winter.

In the KPI 3, the analysis of the water storage tank results in a capacity of the tank of 30564 kWh in order to compensate the whole mismatch. Nonetheless, the purposed tank will not have that capacity because other factors such as the dimensions and space available in the building have to be considered.

For the electricity balance, the on-site electricity production is not enough to balance the whole electricity need for the heat pump, lighting and equipment in the building. An electricity battery system could help to compensate the electricity shortage, especially in summer when there is a potential surplus of electricity. Furthermore, the will not be electricity balance between on-site energy production and electricity need in the building because there is not enough surplus of electricity to compensate the mismatch.

Therefore, the size of the battery needs to be dimensioned in terms of the possible shortage compensation based on KPI 3 and on the available space in the building.

5.3.4 Energy storage proposal and output

The energy storage proposal has to be described separately for the thermal storage and the electricity storage.

The heat water storage happens between the on-site heat produced by the energieDak system delivered to the heat pump where is heated to the temperature needed in the building. When there is surplus of energy, which means that the heated water is no needed for the DHW nor for the space heating system, then it can be stored in a hot water tank.

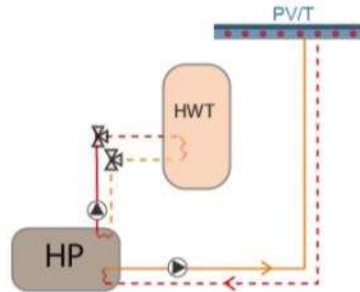

Figure 72. Complementary energy system with hot water tank

In order to dimension de Hot water tank the results of the KPI 3 for the thermal balance were used. Furthermore, the hot water tank can be place in the technical areas in the basement of the building, therefore, the maximum dimension of the tank was decided based on the height of the basement, which is 4m. The following formula was used in order to dimensioned the water tank.

$$Q_s = mc_p \Delta t_s$$

Taking into account the size calculated in the KPI 3 which is 30564 kwh which result in 110030400000 J, the delta of temperature inside the tank which is assumed to be 25°C (because around 35°C enter and 60°C leave the tank) and the Cp of 4200 J/kgK. The mass of the tank should be 1047908 kg or 1047 m3).

If a tank has a radius of 2.5m and the total height of the tank will have to be 53.3m.

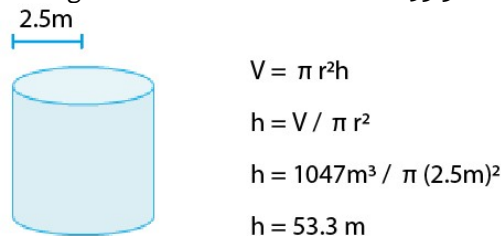

Since that is more or less impossible for a building, with the maximum height of 4m, is will be necessary to store the water in 13 tanks.

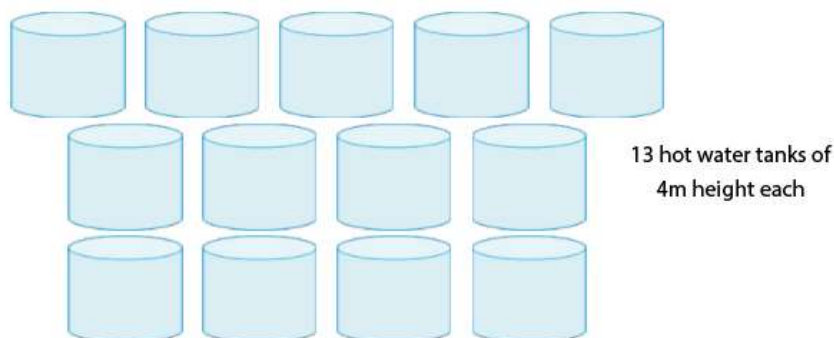

Figure 73 show the mismatch in the water tank if the capacity of the 13 tanks together were 53.3m³ according to KPI 3.

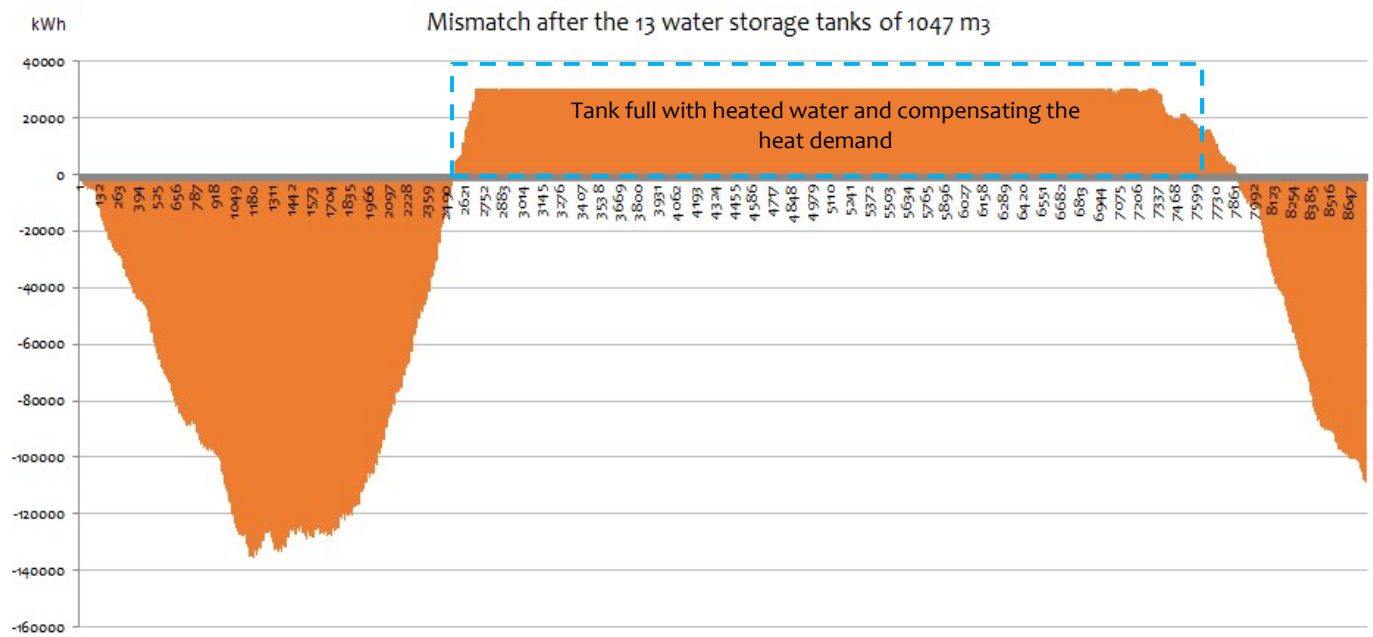

Figure 73. Mismatch in the 13 hot water tank after the analysis of the 1047m³ of heated water stored.

Since the 13 hot water tanks are more or less impossible to be placed in the building. The calculation of the hot water tank was done assuming only 2 hot water tanks with radius of 2.5m and height of 4m each which has a capacity of 157m³

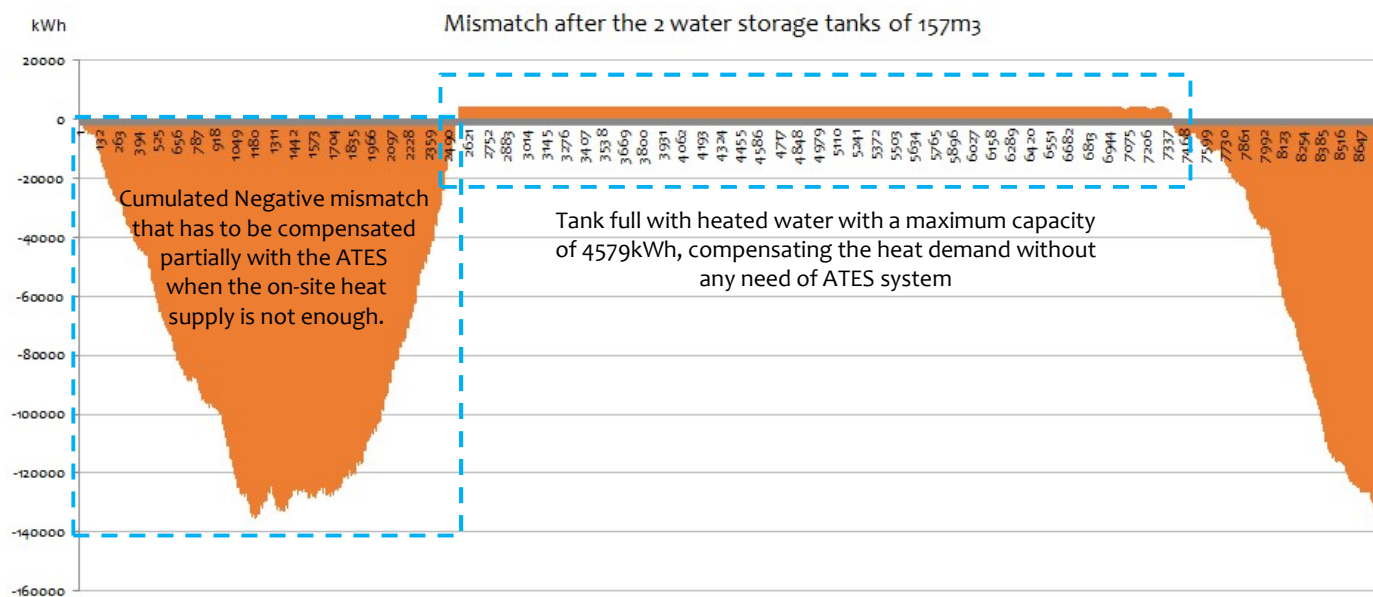

Figure 74. Mismatch in the 2 hot water tank after the analysis of the 1047m³ of heated water stored.

The important difference between the 13 tanks and the 2 tanks happens between the hours 7000 and 8000, in the 13 water tanks more heated water was stored and then used to compensate the heat demand of the building, which has to be compensated with the ATES system only after the hour 7891. On the other hand, with the 2 hot water tanks, the stored water in the tank is enough only to until the hour 7387, from then on, the ATES system has to work in combination with the on-site heat production from the energieDak system in order to achieve the thermal balance (figure 75).

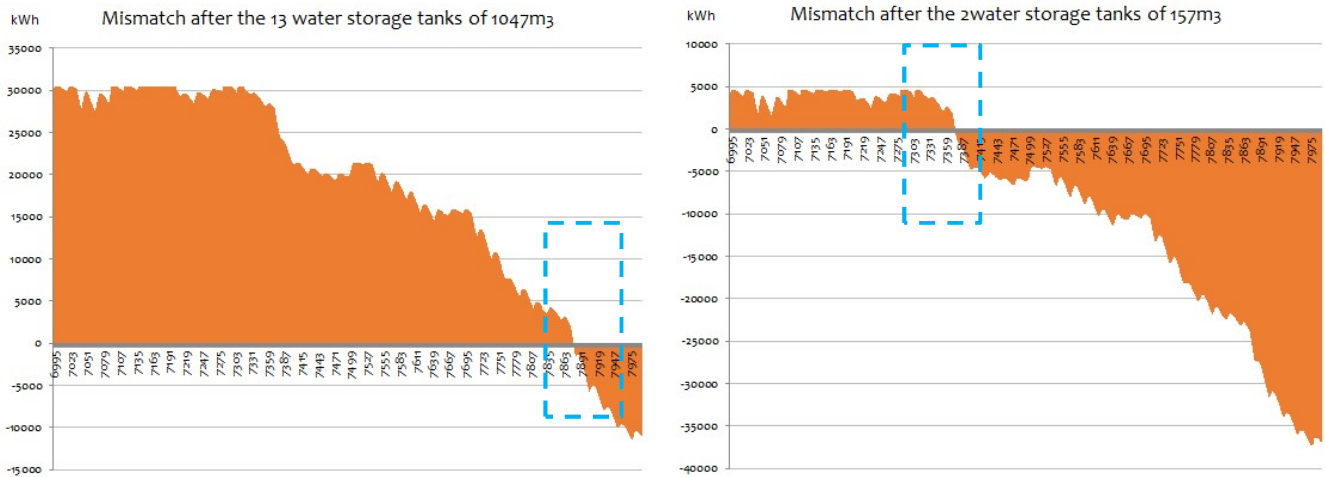

Figure 75. Difference in Mismatch between the 2 tanks and the 13 tanks

Therefore, the calculations of the final mismatch will be done with the 2 hot water storage tanks located in the basement of the building.

The electricity storage happens between the on-site electricity produced by the energieDak system, Kameleon solar panels, and the monocrystalline solar panel that is delivered the system or store in a electricity battery when there is a surplus of electricity. For the sizing of the batteries, the following information was assumed using the data sheet of the solar battery in appendix 6 and the calculations in the KPI 3 for the electricity balance.

A battery of 250Ah of 12V could store 3000Wh or 3kWh maximum and has a volume according to the data sheet of 0.034m³. It was assumed that in order to be able to store the maximum cumulative positive mismatch of 2976 kWh, it is necessary to install 992 batteries. If one battery cost 224 euros, then the 992 batteries will cost around 222208 euros and according to the dimension for the batteries and that those can be save in racks to optimize the space, this storage system will need a room of at least 3m x 3m x 3m where half of the area will store the electricity batteries.

Therefore, after the analysis of the hourly mismatch, after the electricity storage the figure 76 shows the impact of the electricity storage.

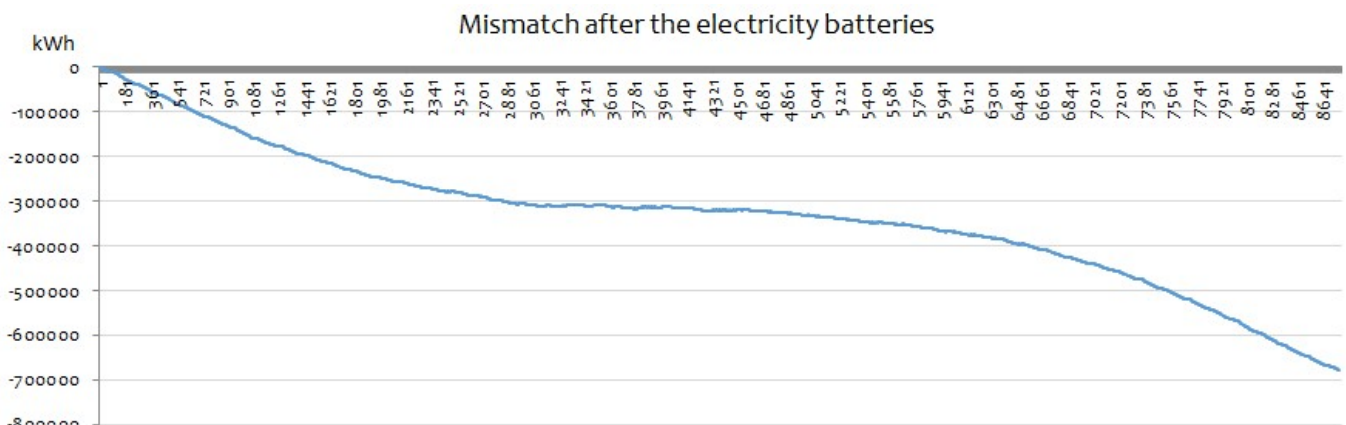

Figure 76. Mismatch after the electricity batteries

5.4. Final mismatch reduction analysis after the storage

In order to analyse the impact of the energy storage for the renovation proposal towards energy flatness, the KPI's for the thermal balance and electricity balance will be analysed again.

Thermal balance

After the analysis of the impact of the hot water storage, is possible to see that the storage is enough to supply the demand of heat during summer time as the figure 74 is showing. The energy supply during the 8760h is equal to the hot water tank supply (147032 kWh) + the ATES supply (408234 kWh) + The surplus of heat that did not fit in the hot water tank (511689 kWh), which results in 1066955 kWh. The calculations of the mismatch is as follows:

$$KPI\ 1\ (thermal\ balance) = \sum_{t=1}^{t=8760} |1066955\ kWh_{(8760h)} - 555491\ kWh_{(8760h)}| = 511464kWh\ (8760h)$$

Therefore, the thermal balance inside the building was achieved, but there is a surplus of heat that could not be stored in the tank and needs to be exported to the grid. Furthermore, even when the balance was achieved in the sum of all the hours of the year, it was not achieve in the hourly basis.

Therefore, in order to achieve a complete thermal balance during the whole year, the ATES system needs to compensate for the moments when there is no on-site heat supply and there is no heated water store in the hot water tank. The figure 78 show the moments when the mismatch between heat demand and heat supply from the HP, when the HP runs on water from the ATES.

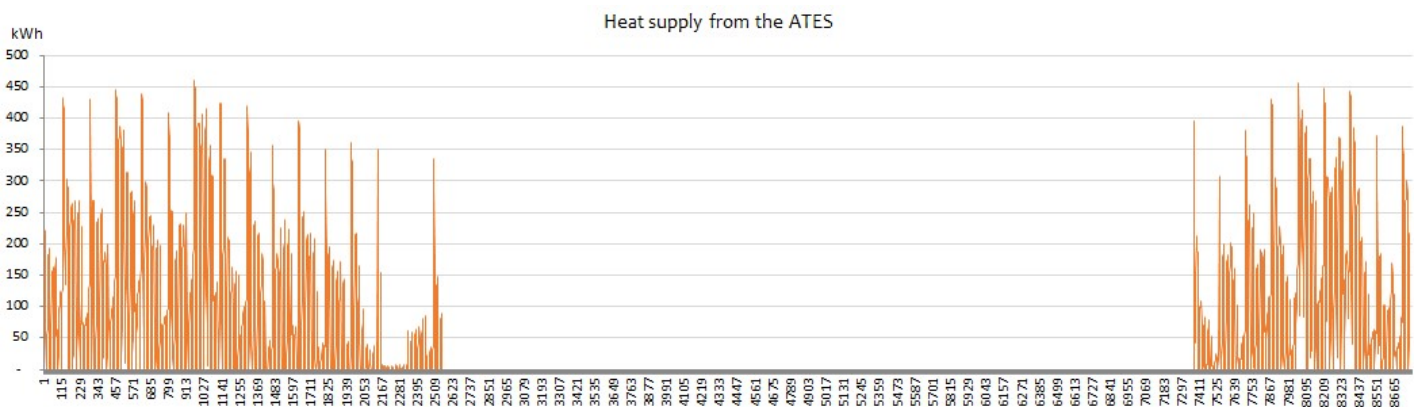

Figure 77. Mismatch after the electricity batteries

Before the heat storage the ATES had deliver all the heat for the system when there was no on-site heat production. The figure 78 shows the mismatch in the ATES when there was no heat storage. Thanks to the heat storage the HP connected to the ATES doesn't have to run, furthermore, the heat pump will only run for the On-site energy production.

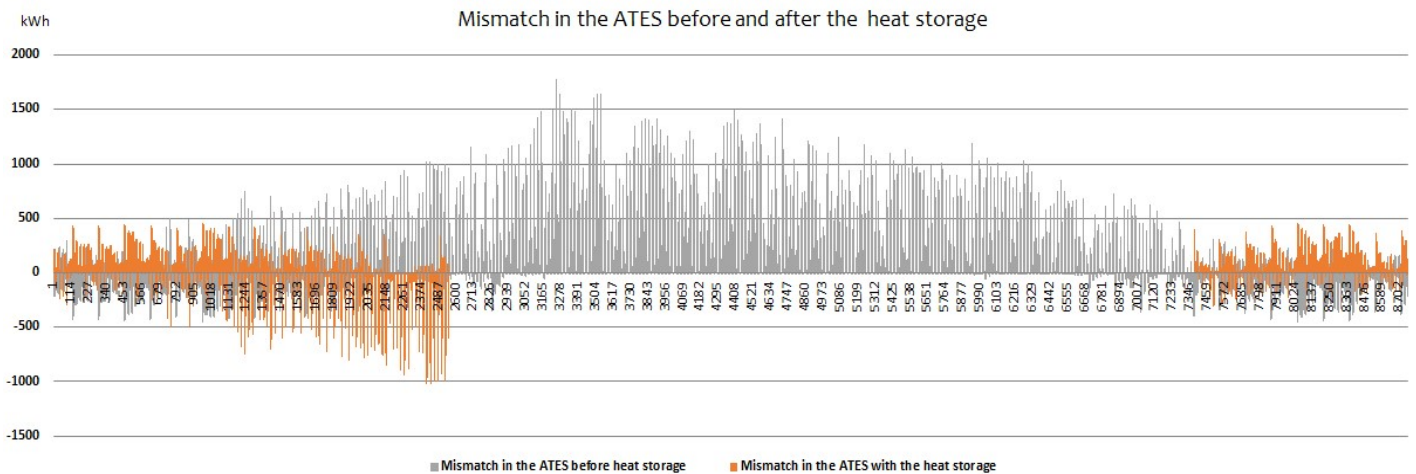
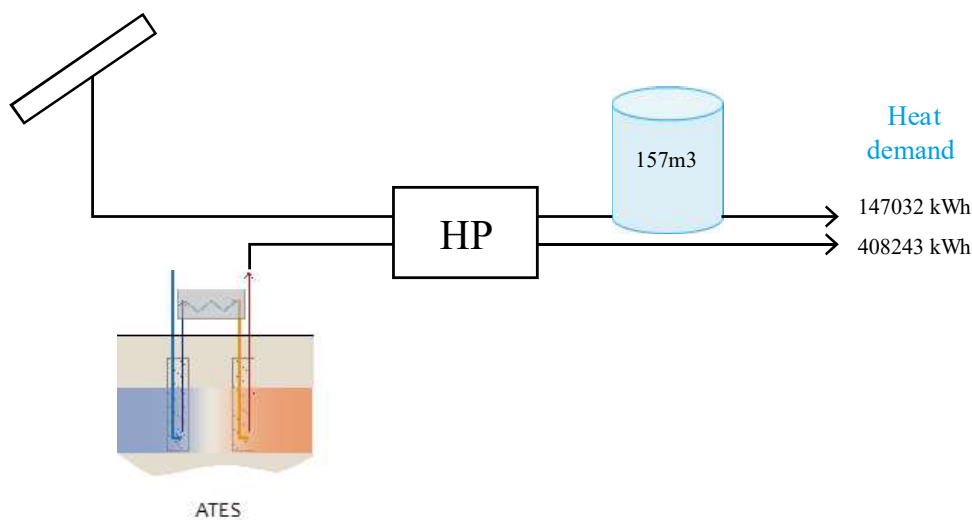

Figure 78. Mismatch before and after the heat storage

From the heat balance for the Gemini south building is as shown in scheme 3 where 36% of the heat comes from the heat storage tank and the rest from the ATEs system. This shows the great influence of the hot water tank in order to reduce the heat need by using the surplus heat stored in the hot water tank.



Scheme 3. Thermal balance in the Gemini south building

The comparison with the previous analysis of the KPI 1 thermal balance is equal to:

The current situation of the building: **-2313230 kWh/year**

The proposed renovation towards energy flatness without storage: **1044799 kWh/year**

The proposed renovation towards energy flatness with heat storage: **511464 kWh/year**

This means that the building has still a positive mismatch in the thermal balance thanks to the heat tank and the ATEs system. Furthermore, this surplus of heated water that could not be stored in the 2 hot water tanks, can be exported to the shared grid in order to be used for other buildings in the campus.

With the heat storage, the electricity need was reduced from 115682 kWh/year to 85051 kWh/year, which means that the electricity need was reduced by **26.5%**. Therefore, the 2 water storage tanks have a great impact in the electricity demand reduction.

Electricity balance mismatches

After the calculations of the impact of the heat storage tanks in the building. The total electricity need for the heat pump plus the electricity need for lighting and equipment was 1222993 kWh/year without the heat storage tanks. After the heat storage, the electricity need for the heat pump plus the electricity for lighting and equipment is 1192362 kWh/year. Therefore, the heat storage tank reduced the total final electricity need in **3.6%**.

KPI 1 – Absolute energy flatness

Therefore, the calculation of the energy flatness was developed with the original formula showed in chapter 3 for every hour of the year after the reduce electricity need for the heat pump.

$$\sum_{t=1}^{t=8760} |E_{final\ energy(t)} - E_{Energy\ Supply(t)}|$$

$$\sum_{t=1}^{t=8760} |513152\ kWh_{(8760h)} - 1192362_{(8760h)}| = -629209\ kWh\ (8760h)$$

This number represents a negative mismatch, which means that the on-site energy produce is not enough to compensate the energy need for the complementary energy system plus lighting and equipment. However, when comparing the energy flatness without energy storage and with energy storage. Therefore, from the result of the KPI 1 without energy storage was -709841 kWh/year and now with the energy storage is -629209, which means a reduction of the mismatch in 11.4%.

Figure 79 shows the mismatch per hour between the final electricity need for the HP, light and equipment and the final on-site electricity produced from the solar technologies.

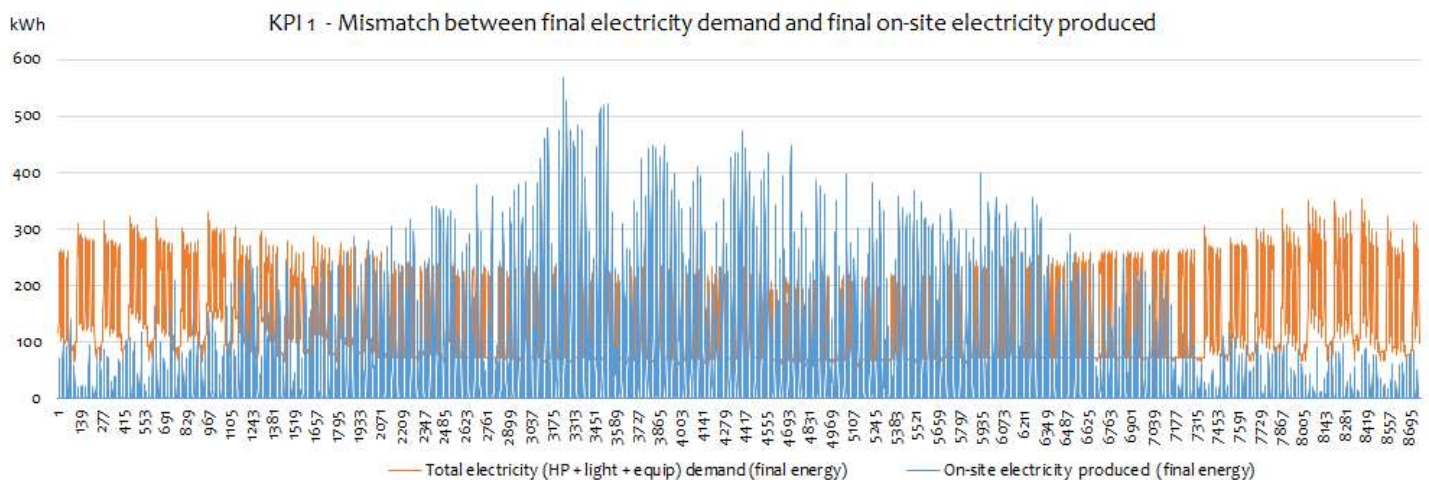

Figure 79. Mismatch between the final electricity need for the HP, light and equipment and the final on-site electricity produced

KPI 2 – Maximum Mismatch Peak (MMP)

The second KPI in the electricity balance uses the original formula. Therefore, the formula is as it follows and can be used for calculating the maximum positive peak and the maximum negative peak. Where the $E_{Final\ energy(t)}$ is equal to the on-site electricity produce and the $E_{Energy\ supply(t)}$ is the electricity need for the HP, lighting and equipment.

$$MMP = \max_{0 \leq t \leq 8760} |E_{Final\ energy(t)} - E_{Energy\ supply(t)}| [kW]$$

Therefore, the analysis after the 8760 hours is:

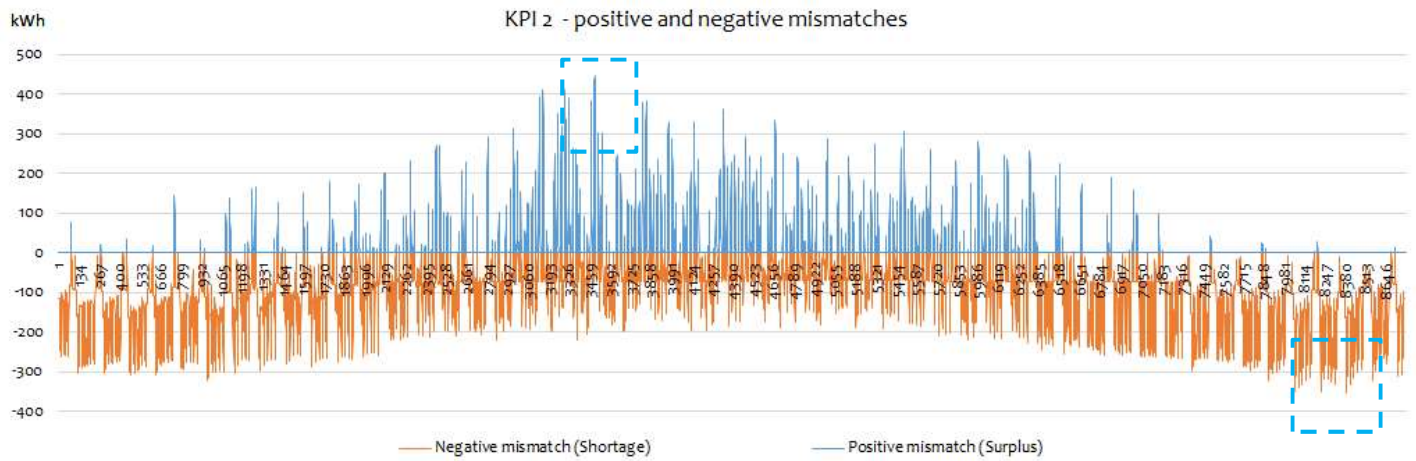

Figure 79. Analysis of the KPI2 positive and negative mismatches

The maximum positive mismatch using the formula of the KPI 2 is 435 kW and happen during the hour 3491 as shown in figure 79. The negative mismatch peak happens in hour 8395 with 355kW. With this information is possible to analyze the KPI 3 for the electricity balance.

KPI 3 – Maximum Cumulative Energy Mismatch (MCEM)

The cumulative mismatch was calculated by the sum of the negative mismatches of the previous time steps before there is an on-site electricity production available to compensate for the shortage. Therefore, the peak of the cumulative negative mismatch is 72643 kWh and it happens during the hour 8659 (figure 80). This means that the shared grid must have the capacity to supply during this shortage periods in order to balance the system.

The cumulative positive mismatch was calculated by the sum of all the positive mismatches of the previous time steps before there is a period of shortage that needs to be compensated with the on-site electricity production. As a result, the positive MCEM is 2441 kWh and happens during the 3831 hour as it can be seen in figure 80.

As it can be seen in figure 80, the periods of shortage are more and bigger than the periods of surplus, which means that the on-site electricity production is not going to be capable of compensating the electricity need in the building. The electrical batteries helped to compensate the mismatch by 0.64%, but taking into account that there is not much surplus to store, this storage system is not recommended for the building because of its low impact in the energy balance.

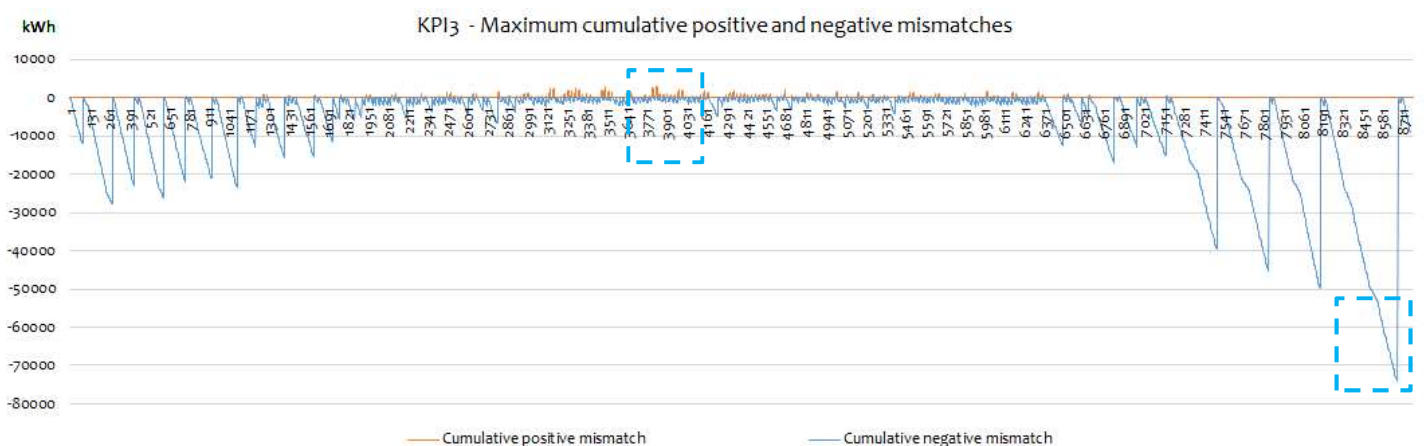

Figure 80. Analysis of the KPI3 maximum cumulative positive and negative mismatches

5.5. Conclusions of the final mismatch

- Before choosing a complementary energy system, a feasibility study should be developed in order to understand what is the best system that can be implemented in the building according to its energy demand, building function, location and the on-site energy production. In addition, the efficiencies of the system affect greatly the thermal and/or electricity demand in the building, therefore, by selecting the best efficiency of a system. The energy need by the system can be lower than expected.
- The configuration of the complementary energy system between the on-site energy production and the energy demand has to be proposed based on the energy produced and the energy demand because the placement of the different technologies can influence greatly the efficiency of the system. For example, if the water tank is situated before the heat pump or after the heat pump, the impact of the water storage is different for the system.
- Working with systems that allow for multiple operation modes increases the efficiency of the system and integrates all the energy systems. The temperatures managed by every system for the thermal balance analysis can help to select better the complementary energy system.
- Cooling storage systems were not investigated during this research because the main focus was heat and electricity production taking into account that the primary energy source is the sun. For further research it will be a good idea to investigate ways to produce cold and stored in order to reduce the cooling demand in the building. Currently the Gemini south building cooling balance is solved directly with the ATES system.
- The ATES system was not dimensioned during this research because the focus was the heat storage. Further research needs to be developed in order to size the possible the ATES proposed for this building.
- The analysis of the mismatch in the thermal balance (between energy demand and energy supply from the complementary energy system) and the electricity balance (between the electricity need for the complementary energy system and the on-site electricity production) can be confusing sometimes. Therefore, it is necessary to make clear of which balance is every step.
- The 3422m² area in the roof and balconies used for the energieDak system in order to produce heat, were enough to generate a surplus that could be stored in 2 hot water tanks in the basement of the building.
- Furthermore, the 4123m² areas in façade, roof and balconies of electricity production from the three solar technologies, were not enough to generate a meaningful surplus that could be stored in order to reduce the final mismatch of energy in the building. This is because the solar heat production technologies work with higher efficiencies of 45% compared with the solar electrical technologies that work with maximum efficiencies of 20%.
- The complementary energy system proposed helps to reduce the mismatch between demand and supply of heat, especially when there is heat storage. Therefore, energy storage is of great importance to solve the mismatch of energy in a non-residential existing building.
- The technologies in order to store heat or electricity have to be dimensioned according to the KPI3 maximum cumulative positive and negative mismatch and the available space in the building in order to integrate the technology not only to the energy balance requirements but also to the function of the building.
- The comparison with the previous analysis of the KPI 1 thermal balance shows the reduction of the mismatch in each step. The results of the KPI 1 for the current situation of the building was -2313230 kWh/year and when comparing with the proposed renovation towards energy flatness without storage which was 1044799 kWh/year, the mismatch was reduced by 145% which resulted in a positive mismatch, allowing the building to store energy. When comparing the impact of the complementary energy system with the storage, the mismatch was 511464 kWh/year, which means a reduction of the positive mismatch by 48%. These results show the importance of the energy storage systems in order to reduce the mismatch of energy in the building and the implementation of the steps 1 and 2 in order to reduce the negative mismatches.

- The building still has a positive mismatch in the thermal balance thanks to the heat tank and the ATEs system. Therefore, this surplus of heated water that could not be stored in the 2 hot water tanks, can be exported to the shared grid in order to be used for other buildings in the campus.
- After the calculations of the impact of the heat storage tanks in the building. The total electricity need for the heat pump plus the electricity need for lighting and equipment was 1222993 kWh/year without the heat storage tanks. After the heat storage, the electricity need for the heat pump plus the electricity for lighting and equipment is 1192362 kWh/year. Therefore, the heat storage tank reduced the total final electricity need in 3.6%. Showing once again the relevance of the energy storage.

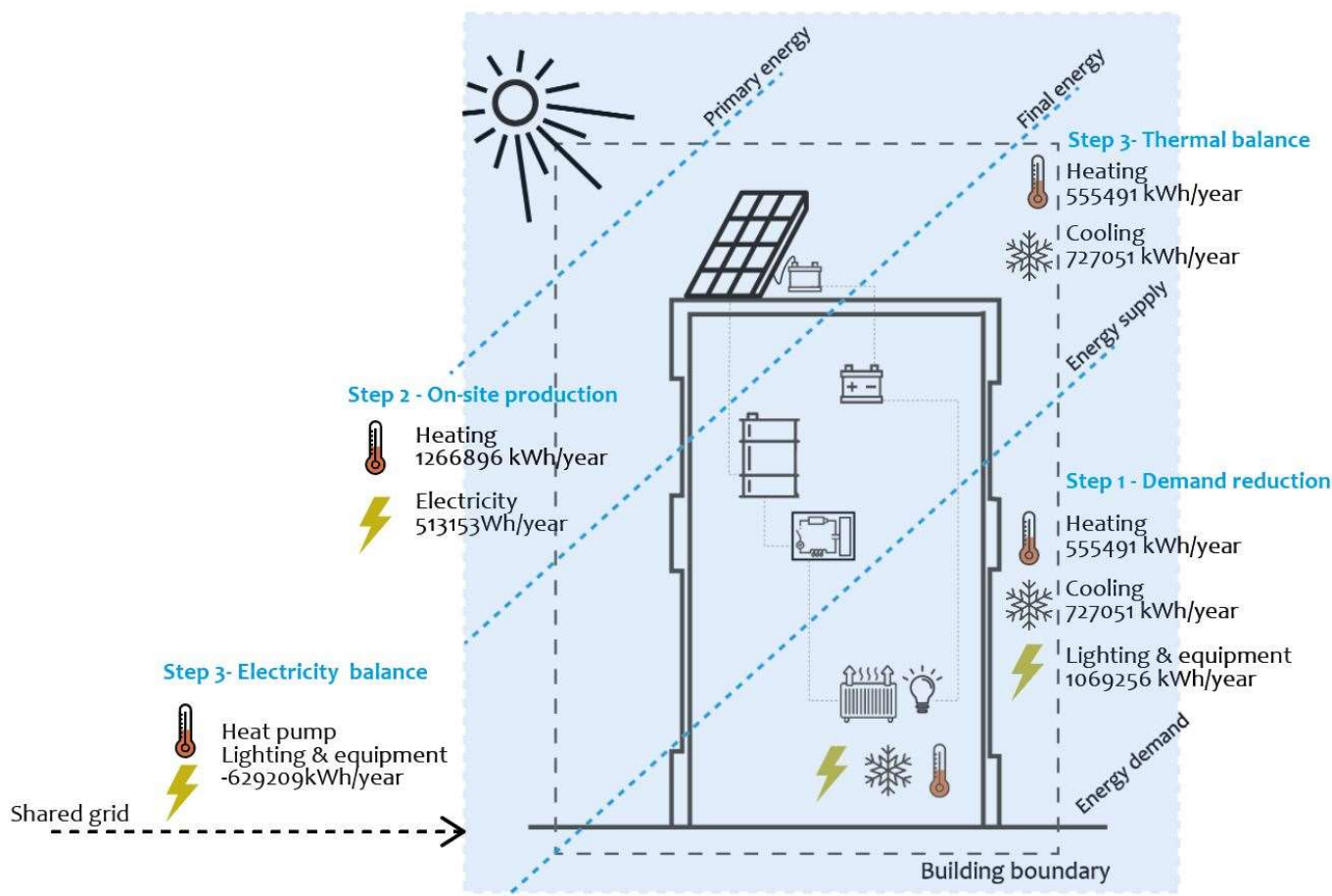

Figure 81. Energy balances after the three steps

Figure 81 show the final energy balance, in which the thermal balance was solved within the building boundaries with on-site energy production and energy storage and the electricity balance has to be partially solved with the connection to the shared grid.

6 What would the design of the renovation look like

In order to propose the renovation towards energy flatness for the Gemini South building, three steps were followed as explained in chapter 5. In each step, a different strategy was proposed for the building renovation. However, in this chapter the physical renovation is explained through the renovation to the south and north façade.

South Façade renovation

In order to propose the renovation of the south façade, the current configuration of the façade was analysed first in terms of energy performance as chapter 4 and 5 have showed and second in the physical and esthetical factors that are important for the building.

The prefabricated concrete slabs and balconies are very relevant for the image of the building. The concrete is a material that is widely used in the building and plays an important role in the renovation of the building. In addition, the building won the concrete award in 1979 and is considered one on the best representations of brutalism in the whole Netherlands, even nowadays. Therefore, the image of the concrete elements (columns and slabs) is important for the renovation of the building.

Figure 82 shows a collage of the current image of those elements in the façade. The columns play an important role as it can be seen from every point of the south façade.



Figure 82. Collage of images of the current state of the concrete elements of Gemini south building.

After the analysis of the energy demand in the current building, the first step towards energy flatness was to reduce the current energy demand in the building. The demand in the current case study building was characterised for high heating, high electricity and high cooling demand, in that order.

Therefore, the parameters explored during the first step were mainly oriented to reduce the heating demand by proposing the renovation of the Gemini south building in order to reduce the heat losses by transmission and infiltration through the façade and roof and to increase the solar gains. The modification of the parameters by increasing the thermal mass, increasing the thermal resistance of the exterior walls and windows, changing the window to wall ratio and implementing a solar buffer space, helped to reduce the demand of energy in the building.

To reduce the heat losses by transmission, it is proposed to increase the thermal resistance of the exterior walls and windows. The renovation of the indoor south façade is complying with the requirements of the bouwbesluit for existing building and even better with the requirements for new buildings. Therefore, an Rc value of 4.5 m²K/W is proposed for the external walls by changing the current panels to ones of metal cladding + extruded polystyrene + gypsum plasterboard, these specifications reduce the heat losses through the façade.

In order to increase the thermal mass of the façade the window to wall ratio was changed from 75% window and 25% opaque surface to 50% window and 50% opaque surface. This will reduce the heat losses through transmission that is favourable for the building in winter. The composition from bottom to top is 0.80 m of external panel wall, 1.30 m of triple glazing window and 0.50 m of exterior wall. The windows are composed of triple glazing 3mm/13mm with argon filling and LowE coating, which results in a U-value of 1.6 W/m²K and g-value of 0.57. The frame of the window is composed by a uPVC plastic frame and thermal break to reduce infiltration through gaps.

The configuration of the solar buffer space in the south façade adds a new look to the building while storing heat. In winter, from October to March, the solar buffer space is partially close allowing the solar radiation to enter in the buffer space and release the heat to the inside on the building. In summer, the solar buffer space is 50% open in order to allow natural ventilation to flow through the buffer space and avoid overheating in the building.

This solar buffer space curtain wall façade has a composition from top to bottom of 0.50 m of PV Kameleon panel, 0.30 m of ventilation grill, 1.90 m of sliding double glazing that repeat through the whole south façade until the ground floor.

In addition, 25% of the area of the windows open and close automatically every night during summer (April to September). Night natural ventilation through automated openable windows will work from 8am and 8pm in order to reduce the cooling demand in the building.

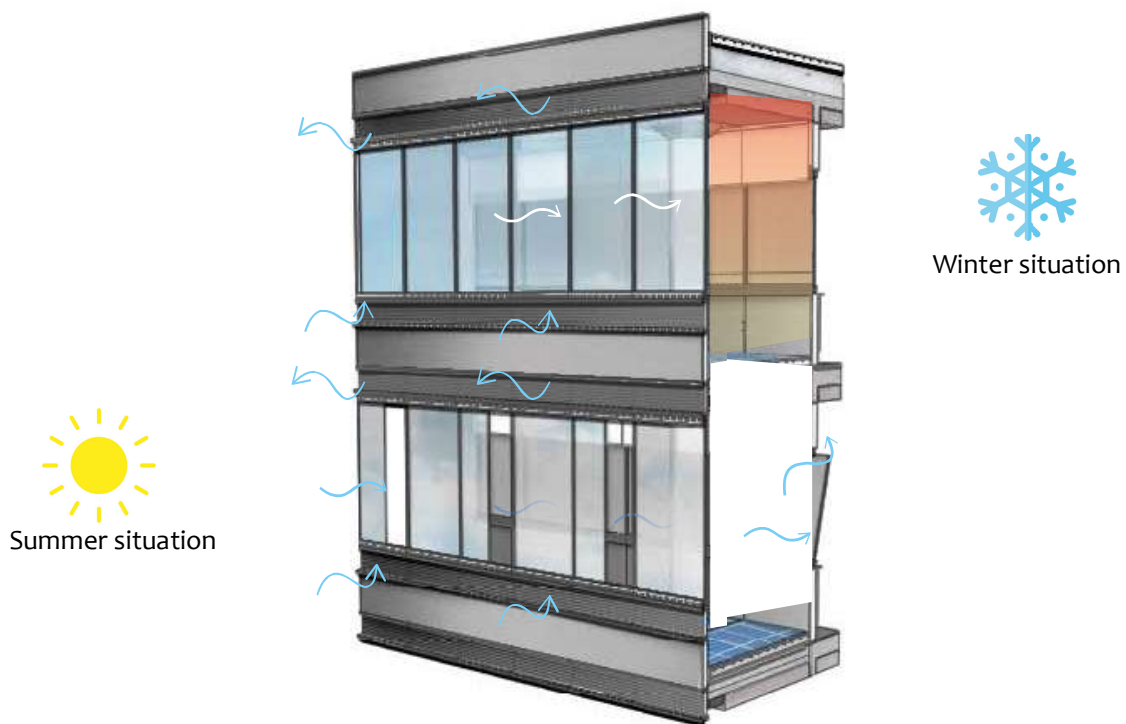

Figure 83. Summer and winter situation for the solar buffer space in the south facade

Cooling demand after the renovation proposal is still very high in the Gemini south building; process cooling is having a great impact in the overall energy demand. Nonetheless, the optimization of the process cooling in the building was not proposed because the characteristic of the equipment in the laboratories is unknown.

The strategies to reduce the heating and cooling demand in the building happen all in the renovation of the south façade as it is going to be shown in the detail section of the façade in image 8,9 10, 11 and 12.

The electricity demand for lighting and equipment is still high after the renovation proposal, mainly because of the process equipment in the laboratories. In the first step, the optimization of the lighting system from standard lighting to LED lights was proposed. Daylight sensors and the reduction of the light usage during unoccupied hours are part of the renovation strategies for the Gemini south building. These parameters made a huge impact in the reduction of the electricity demand of the building and should be considered for the renovation of every non-residential existing building.

The second step was to propose the renovation of the building towards producing heat and electricity from technologies that use the sun as a primary energy source. After the study of the main technologies used nowadays in the built environment, three technologies have been selected after the feasibility study.

For heat production, the energieDak is installed in the balconies and roof of the south façade (Image 9. Detail A). This technology is well integrated with the building because it acts as an insulation material while producing heat and electricity at the same time. The detail of this system is going to be shown in the image 9. Considering that the south façade is very exposed to the sun radiation, especially the exterior façade of the solar buffer. Most of the technologies of the on-site energy production system were placed in this façade.

The Kameleon solar system is integrated in the curtain wall façade of the solar buffer space. This technology was integrated to an exterior wall panel with R_c of 3.2 m²K/W and on top the Kameleon solar PV glazing is exposed directly to the south radiation. The details of the system, such as the inverter and all the electricity cables are not part of the scope of this renovation proposal. In the technical boxes, the monocrystalline solar panel were vertically placed facing south radiation.

The third step was to propose a complementary energy system, the ATES system is placed underground within the building boundary, the heat pump, water tanks, electricity batteries, water pumps and other components of the complementary energy system were placed in the technical room in the basement of the Gemini south building.

South façade detail
Scale 1:20

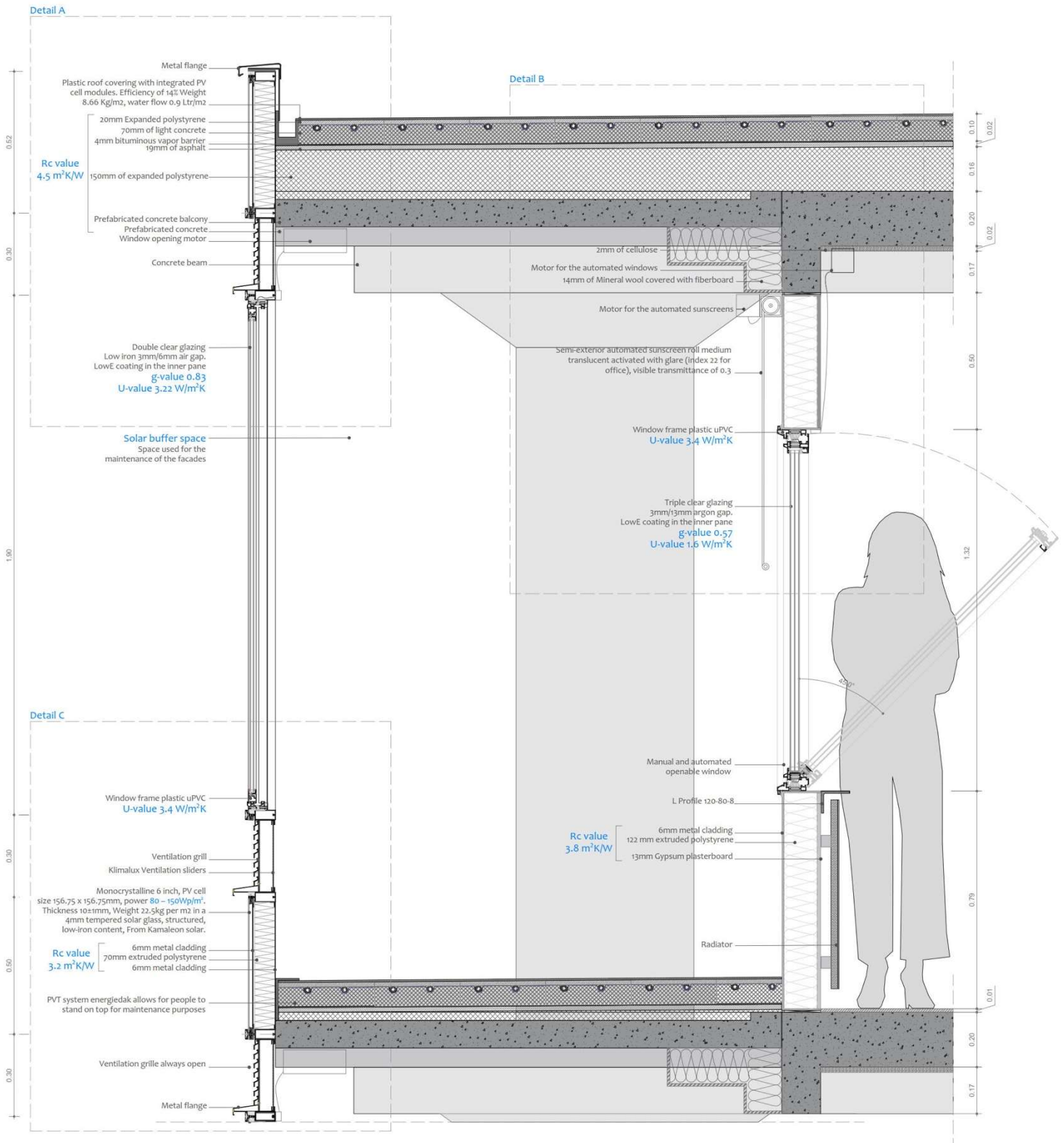

Image 8. South façade detail, scale 1:20

Detail A – South façade

Scale 1:10

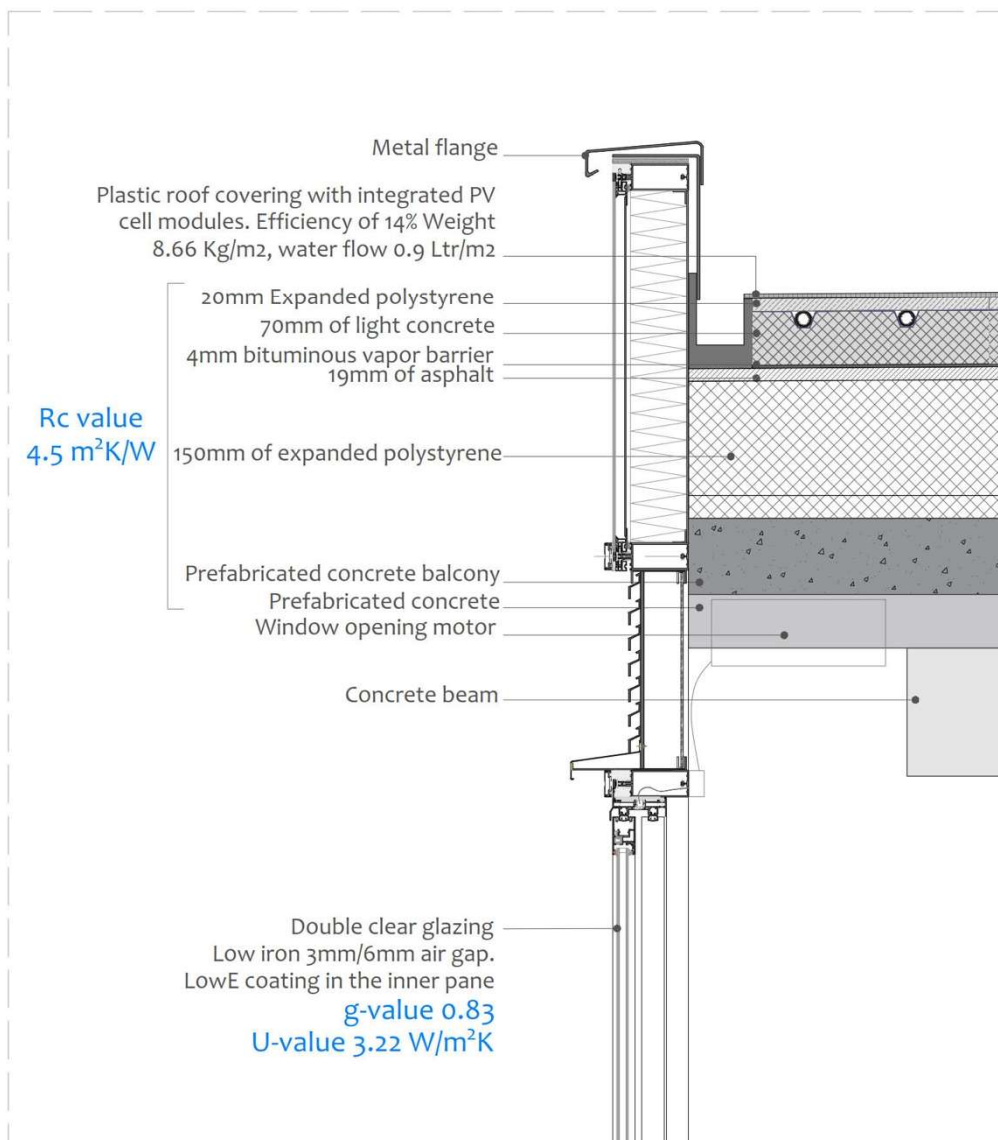

Image 9. South façade detail A, scale 1:10

Detail B – South façade

Scale 1:10

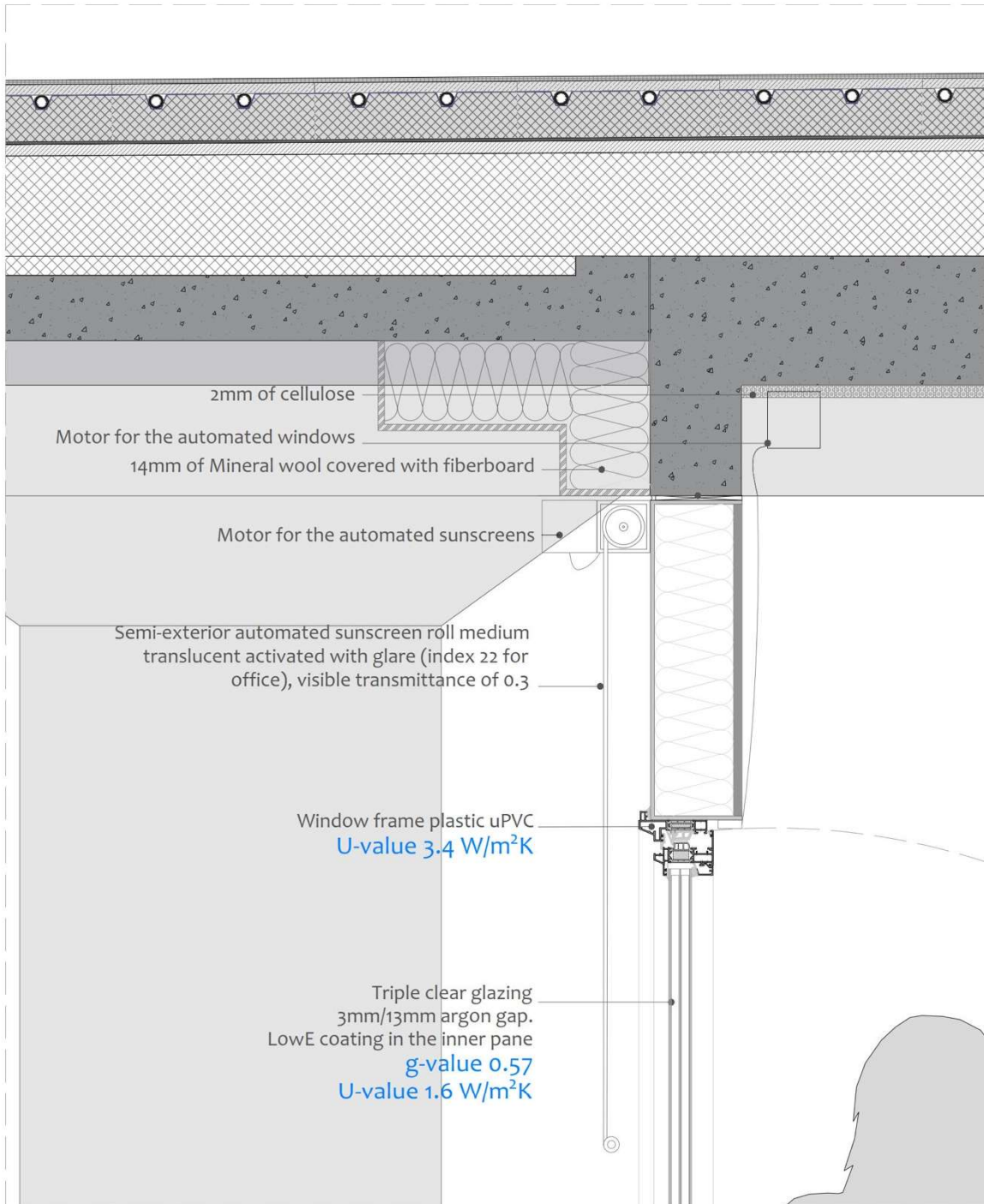

Image 10. South façade detail B, scale 1:10

Detail C – South façade

Scale 1:10

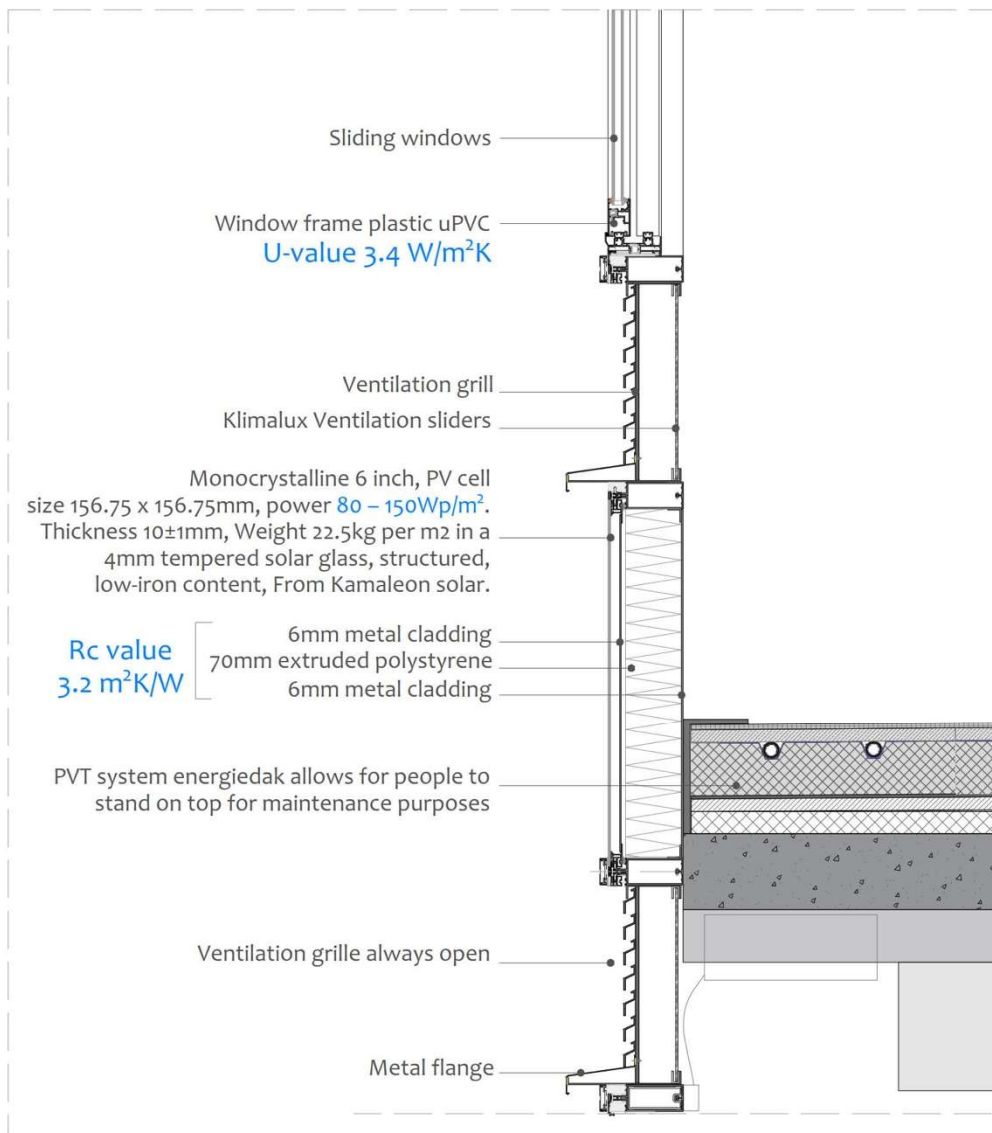

Image 11. South façade detail C, scale 1:10

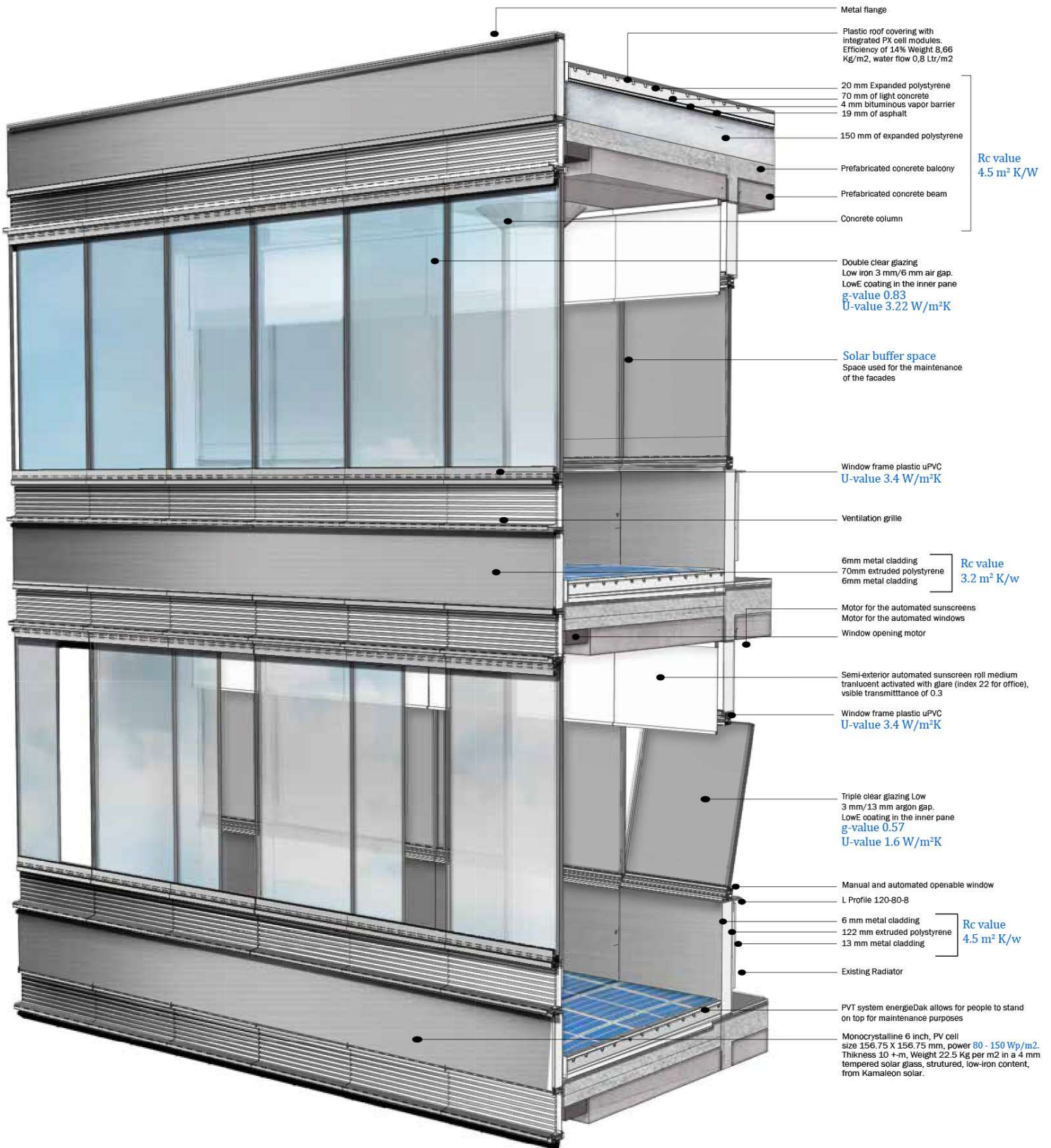

Image 12. South façade axonometry with materials

North façade renovation

The renovation of the north façade is very similar to the south façade. Nonetheless, the curtain wall composition follows the existent modulation of the façade in order to keep the same language as the existent one. Therefore, the modulation from top to bottom starts with an exterior wall panel of 0.55m, 1.10 m of second exterior wall panel, two modules of 1.10 each of triple glazing and one of them is operable and the last piece is a exterior wall panel of 1.10.m.

Because the north façade is not so exposed to solar gains, the parameters explored during the first step aimed to increase the solar gains and reduce the heat losses by infiltration and transmission. To reduce the heat losses by transmission, it is proposed to increase the thermal resistance of the exterior walls and windows. The renovation of the north façade includes external walls with R_c value of 4.5 m^2K/W with the same specification as the south façade.

The current sun protection systems in the exterior of the facades do not meet function as they were designed, furthermore, the automatization and specification of this elements is configured in such way that no entrance of daylight is allowed in the building. The new sun shading system proposed for the renovation of the building includes interior sun shading systems that activate automatically in order to avoid glare.

The modification of the parameters by increasing the thermal mass, increasing the thermal resistance of the exterior walls and windows, changing the window to wall ratio and implementing a solar buffer space, helped to reduce the demand of energy in the building.

In order to increase the thermal mass of the façade the window to wall ratio was changed from a window to wall ratio of 65% to 35% and is going to be changed to 45% window and 55% wall. This will reduce the heat losses through transmission that is favourable for the building in winter. The windows are composed of triple glazing 3mm/13mm with argon filling and LowE coating in the inner pane, which results in a U-value of 1.6 W/m^2K and g-value of 0.57. The frame of the window is composed by a uPVC plastic frame and thermal break to reduce infiltration through gaps.

The strategies to reduce the heating and cooling demand in the building happen all in the renovation of the north façade same as the south facade, as it is going to be shown in the detail section of the façade in images 13, 14, 15 and 16. The parameters implemented in order to reduce the cooling and electricity demand are the same as for the south façade.

The second step was to propose the renovation of the building towards producing heat and electricity solar energy technologies. For heat, production with the energieDak system was installed in the roof of the north part of the building considering the areas of shading because of the technical boxes. The other two technologies were not integrated in the north façade, because the solar radiation in this façade is not as high as in the south façade.

Detail North façade

Scale 1:20

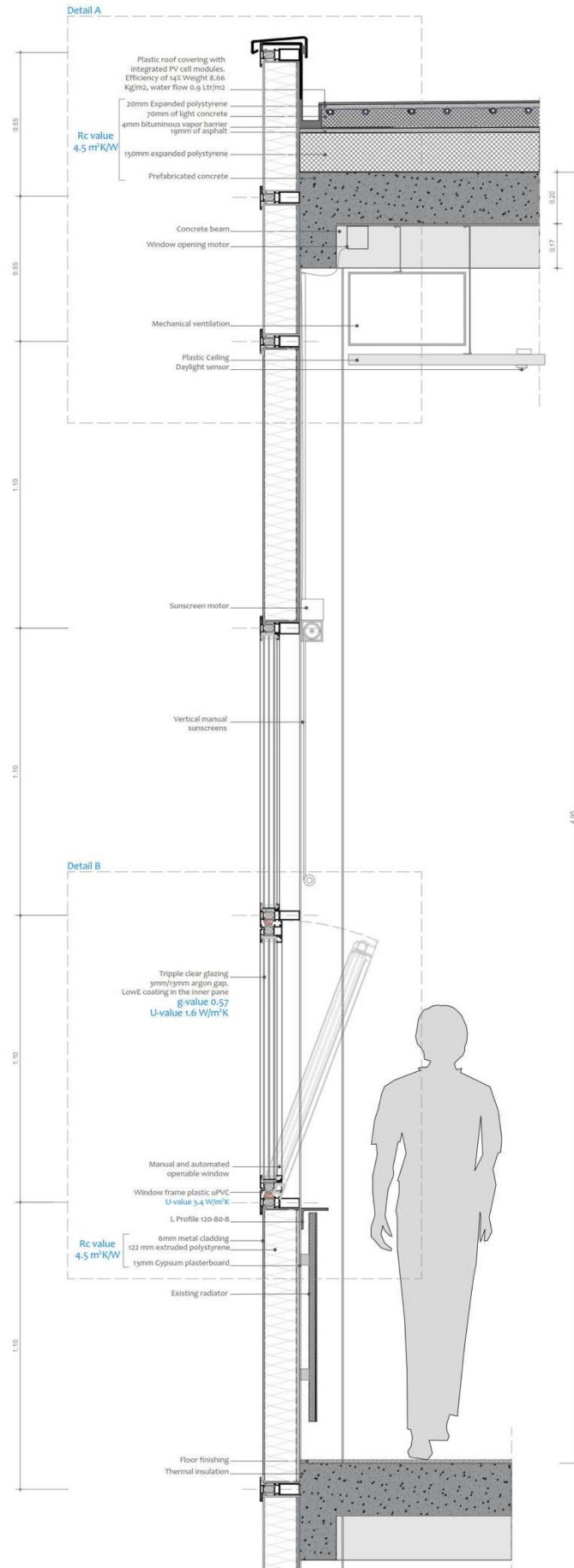

Image 13. North façade detail, scale 1:25.

Detail A – North façade

Scale 1:10

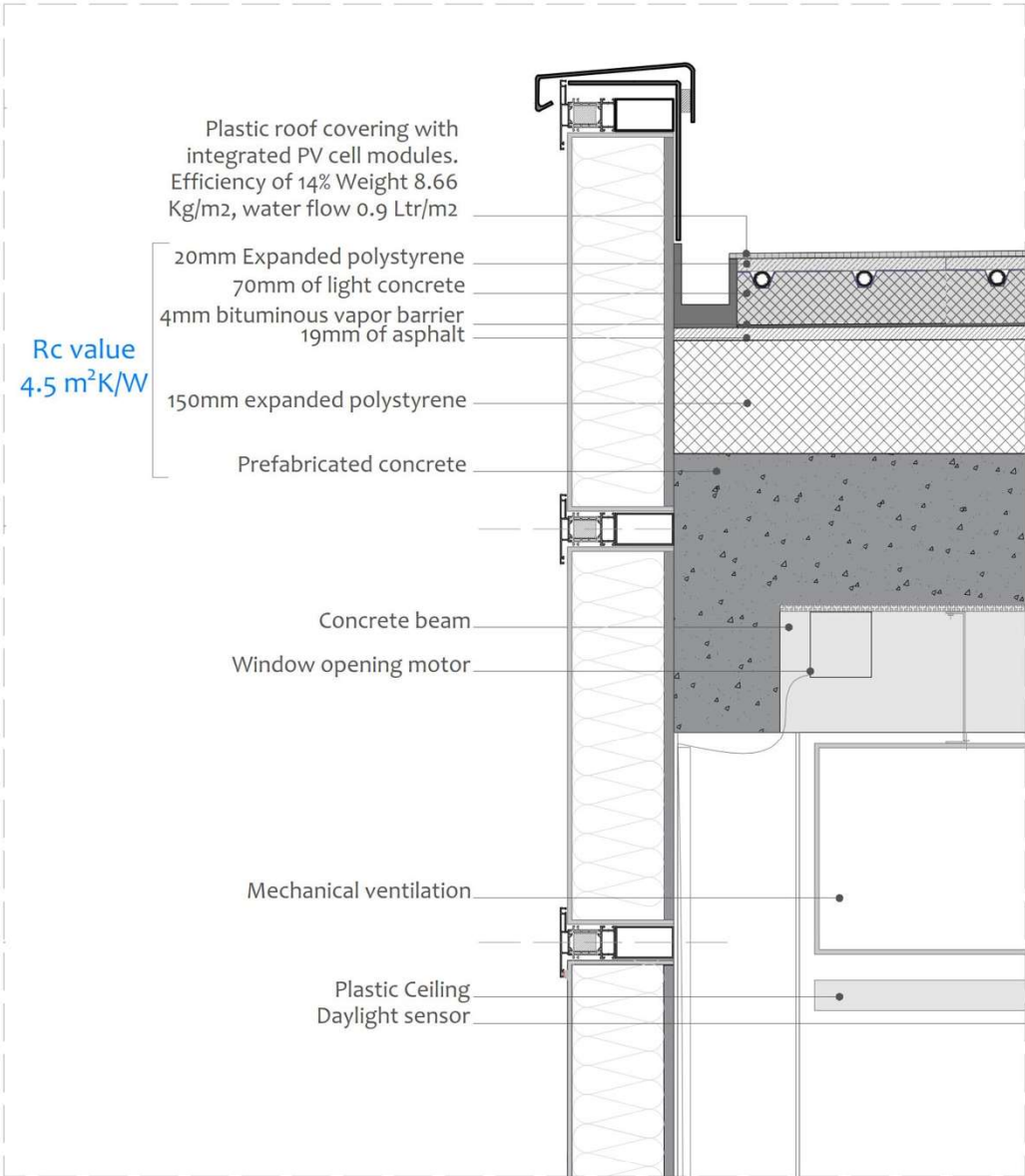

Image 14. North façade detail A, scale 1:10.

Detail B – North façade

Scale 1:10

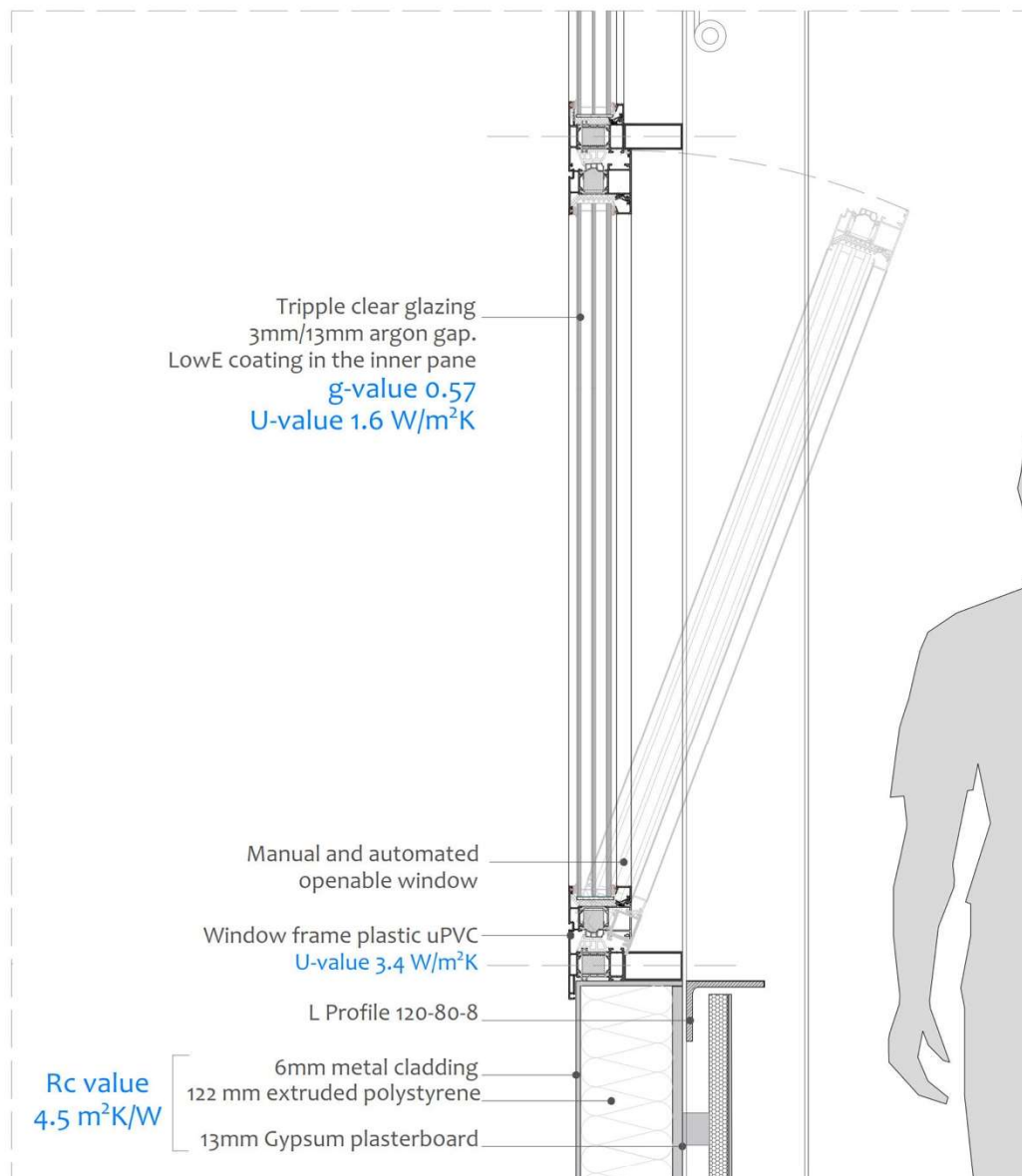

Image 15. North façade detail B, scale 1:10.

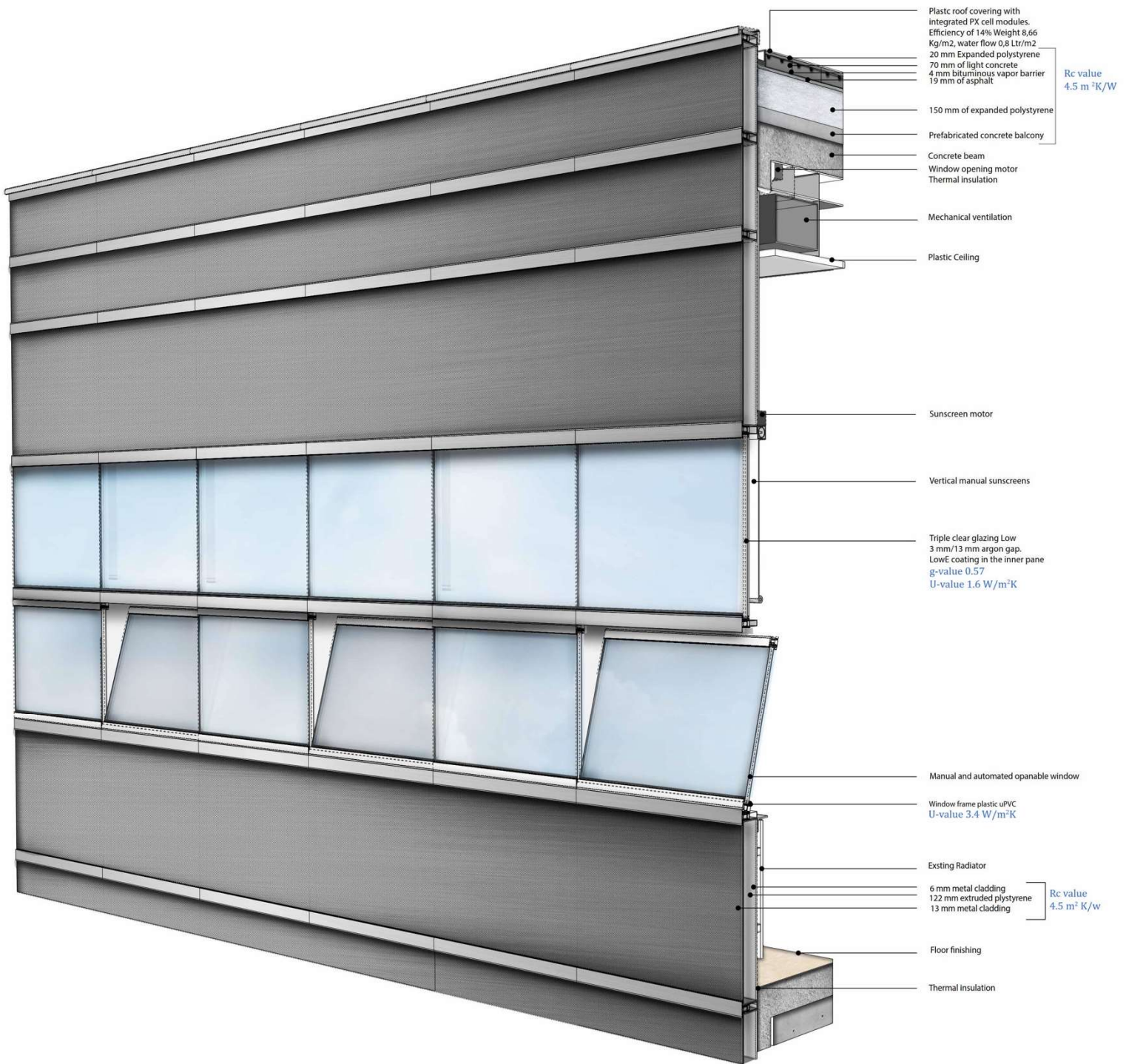

Image 16. Axonometry of the north façade detail with materials

7 Which are the parameters and technologies that help to reduce the mismatch

To answer the main question of this research, Which are the parameters and technologies of the case study that can be implemented for the reduction of the mismatch between demand and supply in the renovation of non-residential existing buildings?, a three step approach was followed in the case study building and aims to be followed for the renovation of any non-residential existing building.

All the analysis was developed with the help of literature review and specially the book Solar Heating and Cooling Systems (Sarbu & Sebarchievici, 2017b), the book Sustainable urban environments (Van Bueren et al., 2012), the online page of the Bouwbesluit (Bouwbesluit Online, 2019), the book building physics (Van der Linden et al., 2013) and the book Energy sources and building performance (Konstantinou et al., 2018).

The first step included the analysis of the physical parameters than influenced the energy demand in an existing building and that could be modified in order to reduce the energy need. These parameters were oriented mainly to reduce the heat losses, increase the solar gains and reduce unwanted infiltration.

By increasing the thermal resistance of the **insulation** and incrementing the **thermal mass** of the building, the building can reduce the heat losses. Incrementing the **size of the windows**, **changing the window properties**, including **interior or exterior sun shading systems** can increase or reduce the solar gains inside the spaces. Changing the **air tightness**, **ventilation rate**, allowing for **natural ventilation** and taking advantage of **natural ventilation during unoccupied hours** can reduce the cooling demand in summer periods. Implementing strategies such as **trombe walls**, **solar buffer spaces** or **PCM materials**, thermal energy can be stored passively in the building and released when needed.

By changing the specification of the **lighting** system, the office **equipment** and **process equipment** the electricity demand in the building can be reduced. In addition, implementing strategies such as daylight sensors, lighting automatization and dimerization can further reduce the electricity need.

Existing building in comparison with new buildings are limited in parameters that depend on the location and function of the building, such as the **temperature outside** and **solar radiation**. Other parameters depend on the user and the way he/she uses the space, such as **occupant behavior** and the **indoor temperature**.

The second step proposed for the renovation is to produce on-site energy especially from solar technologies. The technologies described in this research can be all integrated in the built environment and aim to produce heat and electricity. Solar thermal technologies such as the **flat plate collectors**, **evacuated tube collectors** and **concentrated solar power** use the water as a medium to transfer the heat.

Technologies to produce electricity can be integrated in the building in the **sunscreens**, **the exterior walls**, in the **glass** or attached to any surface facing the sun such as the **PV panels**. Other technologies integrate heat and electricity production in one product such as the **PV/T** working with air and the **energieDak** system.

The third step is to choose a complementary energy system capable to transform, store, discharge and distribute energy in the building. First, the type of heat distribution system such as **radiators** or **wall and floor heating** influences greatly the energy demand in an existing building. Second, the transformation system such as the **heat pumps** impact the way the thermal energy is supplied to the building.

The different technologies to store heat in a building located in cold climates make an important impact towards balancing energy. **Water stored in tanks** or **electricity stored in chemical reactions** or in **batteries** can compensate for the moments of

shortage of energy in the building. Passive heat storage underground is very common in the Netherland, especially the **ATES** systems. However, the **underground heat exchangers** and **cavern heat storage** are also used in the built environment.

All these parameters and technologies aim to answer the main question of this research and work as a toolbox that in combination with the three steps strategy can help non-residential existing building to achieve a complete balance of energy at any point of time.

Furthermore, the implementation of any parameter or technology described in this research needs to be analyzed first with a feasibility study for the building in order to see if the parameter correspond to the physical properties or the building and its adaptation will make an impact on the energy demand of the building. The feasibility study of the technologies to produce and of the complementary energy system is also relevant in order to choose a system that responds to the energy needs of the building.

Moreover, this research did not include any economic feasibility analysis of the parameter nor of the technologies. However, it is recommended to develop an economic analysis before implementing any technology for any building.

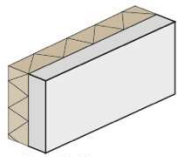

Insulation

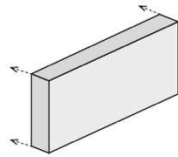

Thermal mass

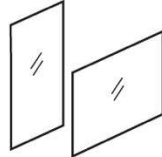

Window size

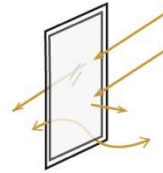

Window properties

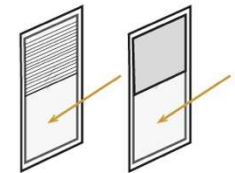

Interior Sun protection

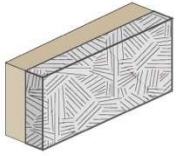

PCM

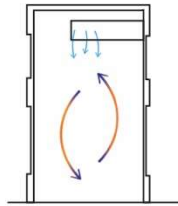

Ventilation rate

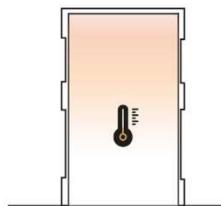

Temperature inside



Lighting

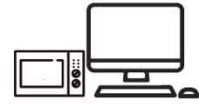

Equipment



People



Process cooling

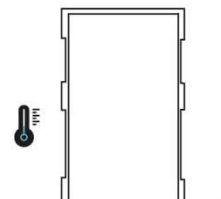

Temperature outside

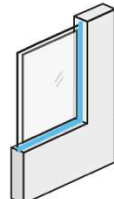

Air tightness

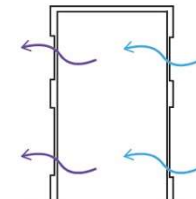

Night Ventilation

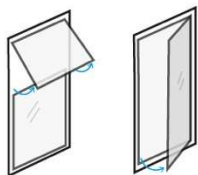

Openable window

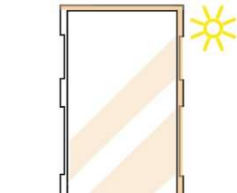

Solar Radiation

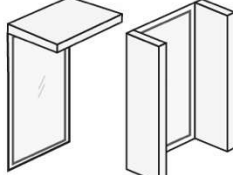

Exterior sun protection

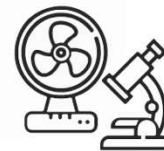

Process equipment

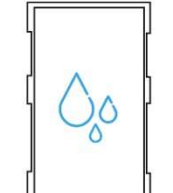

Relative Humidity



Flat plate collectors



Evacuated tube collectors



Concentrated solar power



Kameleon solar



PV in sunscreens



PV in glass

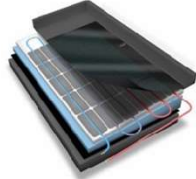

EnergieDak

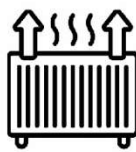

Radiator

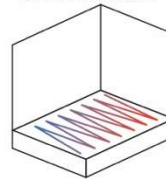

Floor/wall heating



Monocrystalline

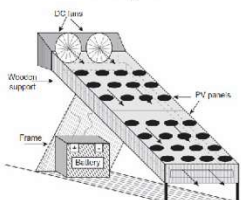

PV/T air



Electrical Battery

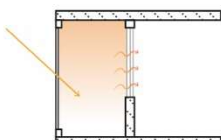

Solar buffer

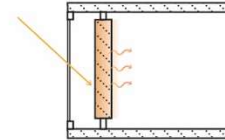

Trombe wall

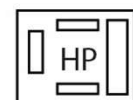

Heat pump

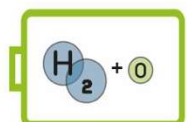

Chemical storage

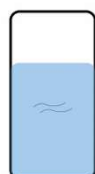

Water tank

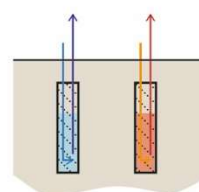

Heat exchanger

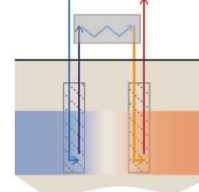

ATES

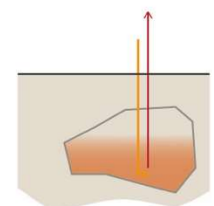

Cavern storage

8 Conclusions

This research started with the aim to balance energy in non-residential existing buildings by changing physical parameters and integrating technologies that could reduce, produce and distribute energy in the building.

In order to balance the final building energy with the on-site final energy produced while avoiding energy mismatches, the objective of this research was to gain knowledge on how to reduce the mismatch in non-residential existing buildings by adapting the physical parameters influencing the energy demand and integrating technologies to produce, transform, store, discharge and distribute energy in the building.

Energy flatness is the state of time in which the final on-site energy produced and the energy supplied to the complementary energy system, match at any hourly in a year, within the building boundary. Which also means that if a building is energy flat, is also energy balanced. Therefore, this term was further research as part of the approach to reduce the mismatch.

Currently there is no research on how to reduce the mismatch in non-residential existing building; therefore, the aim of this research is to gain knowledge on how to reduce the mismatch and to analyze the building parameters and technologies that influence that mismatch.

The research methodology helped to answer the main question of the research, which was, 'Which are the parameters and technologies that could help to reduce the mismatch between demand and supply in the renovation of non-residential existing buildings by proposing the renovation of a case study building towards energy flatness'. The methodology proposed aims to answer the 5 sub-questions of the research and follows a three steps strategy using a case study building.

The first sub question aimed to understand what energy flatness is and what does it mean for a non-residential existing building. Energy flatness is a state of a building energy performance in which the difference between the on-site energy produced and the final building energy need is zero at any time; many concepts help to understand what energy flatness is and the different physical boundaries, energy balances and balancing periods involved. Additionally, energy flatness can be quantified with the help of three Key Performance Indicators in which the absolute energy flatness, maximum mismatch peak and maximum cumulative positive and negative mismatch can be calculated.

The second sub question was to understand what the current mismatch of energy is in the case study building. First, an analysis of the case study building and the demand of energy consumption in terms of heating, cooling and electricity was developed. By using a model in design builder, the energy demand of the building was calculated based on the physical parameters influencing the demand. The results from the model were analyzed and validated in order to understand the current mismatch of energy in the case study building.

A study of the possible parameters that can be renovated in the case study building was developed. This study shows the parameters that influence the thermal and electricity balance in any non-residential existing building.

The third sub question of how to reduce the mismatch in a case study was answer in chapter 5. This chapter includes the description of the three-step strategy. The first step is to reduce the energy demand in the building by developing a feasibility study of the physical parameters that can be renovated in the building and an analysis of the impact in the reduction of the mismatch. The second step was to develop a feasibility analysis of the on-site solar energy technologies that can produce heat and/or electricity within the building boundary of the case study and analyze their impact in the reduction of the mismatch.

The third step was to develop the feasibility study of the technologies of the complementary energy system; only technologies that can be integrated with the solar technologies of the step 2 and that correspond to the energy demand of step 1 were analyzed. The complementary energy system included energy storage and the impact of this system in order to solve the mismatch was analyzed.

These steps can be implemented in any non-residential existing building. However, the parameters changed and the technologies implemented are mainly for building located in weathers such as the Netherlands and oriented for buildings with educational and commercial function.

The renovation of the building has been proposed in order to reduce the mismatch between demand and supply in the thermal and the electricity balance. In addition, an analysis of the current facades and renovation opportunities in the building was developed. The renovation of the building not only accounts for the physical renovation of the façade, but also for the renovation of the different systems that demand energy in the building.

From the first step it can be said that compared with a new building, the energy demand reduction in an existing building is limited to the properties and function of the building itself. Furthermore, it is important to emphasize that:

- The parameters analysed in this research aimed mainly to reduce the heat losses and increase the solar gains in order to reduce the heat demand in the building. The parameters of the cooling demand aimed to block the sun in summer and allow for natural ventilation. The parameters of the electricity demand aimed to optimize the specification and function of the lighting and equipment in the building.
- Parameters such as the location, temperature outside and solar radiation are limited to the extent of the location of the building and cannot be changed.
- Internal gains from people impact greatly the energy demand in the building, changing the number of people, schedule or metabolic rate, the internal gains can be modified. However, in an existing building, this parameter is limited to the extent of the function and occupant of the building.
- Process cooling and process equipment in the laboratories and technical areas respond to a specific function of the building. Therefore, these parameters are limited to the function of the building and cannot be adapted easily.

The integration of on-site energy production systems in an existing building is also limited to the space, orientation, and configuration of the building. New technologies in terms of solar energy production are being explored around the world in order to increase the possibilities of solar production in existing buildings. Nonetheless, the integration of renewable energy systems in a non-residential existing building is also limited; contrary to new building, in existing building the physical configuration of the building and the environment is already defined, which means that the technology needs to adapt to the existing situation.

Many complementary energy systems have been developed for buildings in cold climates, but the selection of a system is limited to the building characteristics, function, location, distribution of energy system, energy supply, energy demand, among so many other factors mentioned in this report, that limits the possibilities for each building.

Energy storage in an existing building helps to reduce the mismatch between demand and supply only if the surplus of energy is enough to compensate the shortage. In the thermal balance, the sizing of the storage system must be calculated based on the availability of space in the building and the results of the KPI 3 when analyzing the maximum cumulative mismatch of energy. Ground heat storage systems are commonly used in the Netherlands that help to store thermal energy underground; these technologies help greatly to balance the thermal energy in the buildings but the integration of these systems in existing buildings can be difficult because of the specification for the system.

The comparison with the previous analysis of the KPI 1 thermal balance shows the reduction of the mismatch in each step. The results of the KPI 1 for the current situation of the building was -2313230 kWh/year and when comparing with the proposed renovation towards energy flatness without storage which was 1044799 kWh/year, the mismatch was reduced by 145% which resulted in a positive mismatch, allowing the building to store energy. When comparing the impact of the complementary energy system with the storage, the mismatch was 511464 kWh/year, which means a reduction of the positive mismatch by 48%. These results show the importance of the energy storage systems in order to reduce the mismatch of energy in the building and the implementation of the steps 1 and 2 in order to reduce the negative mismatches.

This means that the building still has a positive mismatch in the thermal balance thanks to the heat tank and the ATEs system. Therefore, this surplus of heated water that could not be stored in the 2 hot water tanks, can be exported to the shared grid in order to be used for other buildings in the campus.

After the calculations of the impact of the heat storage tanks in the building. The total electricity need for the heat pump plus the electricity need for lighting and equipment was 1222993 kWh/year without the heat storage tanks. After the heat storage, the electricity need for the heat pump plus the electricity for lighting and equipment is 1192362 kWh/year. Therefore, the heat storage tank reduced the total final electricity need in 3.6%, showing once again the relevance of the energy storage system.

Before implementing any technology in existing buildings, a feasibility analysis should be developed in order to understand the impact of the technology in terms of availability of the technology, required area, required system to make the technology work and energy losses from each technology. A cost analysis of each technology should also be developed before implementing any of these technologies or changing any parameter, but this analysis was out of the scope of this research.

After changing, the parameters listed in step 1, producing energy with the technologies analyzed in step 2 and integrating the complementary energy system in the building. It can be said that energy flatness in the thermal balance can be easier than energy flatness in the electricity balance for an existing building. This is because of the efficiencies of the on-site energy production system that can produce more heat than electricity in the same area. This also means that in order to produce the same amount of heating energy, it is necessary more than double the area to produce electrical energy.

This influenced greatly the final mismatch in the case study building. After the three steps there is a mismatch of surplus energy after the analysis of the 8760 hours. The thermal energy storage technologies helped greatly to reduce the negative mismatch and as a result the energy surplus has to be exported to other buildings.

However, the electricity balance was not achieved, mainly because the electricity demand for heating, lighting and equipment is still very high. Higher than the on-site electricity produced which as a result caused a negative mismatch that needs to be solved through the connection with the shared grid.

Even though the case study did not reach energy flatness. The three steps strategy followed in this research and the toolbox of parameters and technologies, helped to reduce the energy mismatch in the case study, this shows the relevance of the approach implemented in this research to reduce the mismatch in non-residential existing buildings.

9 Reflection

Academic

The world is in need of innovation and integration of technology. The Dutch government and educational institutions are supporting greatly the exploration of new technologies to achieve the goals of the Paris agreement. The integration of shared renewable sources needs to happen in an optimal way in order to avoid mismatches or any other problem that might unbalance the energy system. Therefore, the built environment should be prepared to integrate renewable energy as the only source of energy for the buildings in a balance way between demand and supply.

The MSc in Building technology included courses such as climate design, zero energy buildings and other different studios that help to understand the possible parameters and technologies that can be implemented in the built environment to reduce the mismatch. Nonetheless, it is not common to discuss about the mismatch or the intermittences that happen because of the integration of shared renewable energy sources.

Moreover, the built environment is responsible for 40% of the energy consumption worldwide. During the master, the different ways to reduce the demand in a building and the different technologies of the supply are discussed. Nonetheless, the complementary energy systems and their efficiencies (heat and cold distribution systems, thermal and electrical energy storage systems, heat and cold booster energy systems, such as heat pumps, chillers and boilers) are not discussed. If this kind of topics were discussed during the master, the inclusion of shared renewable energies in the built environment will be easier and more balanced.

Personal

This research did not encounter any moral nor ethical issues or dilemmas during the process.

The main research question worked during this research helped me to understand many concepts, parameters, factors, technologies and limitations involved in the renovation of a non-residential existing building towards energy flatness. Energy flatness is a new concept described by Vincent Höfte (Höfte, 2018) in his master graduation thesis. In this graduation thesis, the term was further explored and complemented. Nonetheless, more research should be developed in this topic in order to raise awareness on the importance to solve the mismatch between demand and supply of energy.

The research approach proposed has been very helpful, as most of it was aimed to understand and gain knowledge of the current and future energy mismatch that can happen when solar energy is supplied to existing buildings and the parameters and technologies that can help to reduced it for the renovation in non-residential existing building by following a three steps strategy. In addition, the research approach helped to define the design proposed for the renovation of the case study building towards energy flatness.

The planning scheme proposed at the beginning of the research was very hard to follow, because some steps such as the analysis of the current energy demand in the building, took more time than planned. In addition, the tool selected for the analysis of the demand, was not completely known which required additional time to learn how to use it and how to validate the output.

Because the data input of the energy demand analyzed many parameters and because design builder assumes a lot of information, it is hard to validate the accuracy of the basic energy model. For this reason, more time that the planned was required for the model. In addition, the given information of the building was not enough to fully understand the current final energy used by the building, and some assumptions had to be made in order to reach the final energy used as specified from TU/e (the owner).

The analysis of the mismatch in such detail such as the analysis in the hourly basis was part of the aim of this research. Furthermore, this analysis requires more time, which makes it hard to develop.

Societal impact

The analysis of the toolbox provided in this research can be implemented for the analysis and proposal of the renovation of any non-residential existing building, because the analysis of the parameter was based on the current thermal and electrical balance in existing buildings. The analysis of the technologies is very brief, and it aims to give an overview of the possible technologies of the solar supply and complementary energy system that can be implemented in a non-residential existing building. A more detail investigation, a feasibility study and a cost analysis should be developed before any technology is proposed for the renovation of existing buildings.

Currently there is no so much research on how to reduce the mismatch in non-residential existing buildings. Therefore, this research is very useful in order to understand the problems related to the mismatch between energy demand and supply and the parameters and technologies that can help to reduce it. In this research only the solar renewable energy supply systems were analyzed, but for future investigations the analysis of wind and biomass technologies integrated in the built environment can be very useful.

Considering that 90% of the buildings that existing nowadays will remain on earth by 2050. Energy flatness in those buildings is a challenge and it should be the aim of the current governments and building owners.

The integration of renewable energies in the built environment is happening fast and without much planning, which in the future might cost an increment in the electricity bills, and the possible dependence on fossil fuels or nuclear energy to supply energy when the renewable energies cannot. This research aims to gain knowledge on how to reduce the mismatch between solar renewable energy supply and final building energy use with the integration of a complementary energy system that includes energy storage.

Renewable solar energy supply technologies should be more and better integrated in the built environment because these technologies have not much negative impact to the environment and use the available sources such as the sun to produce energy without putting in danger any specie. A good and balanced integration of renewable energy technologies in existing buildings will avoid the need for fossil fuels and reduce the CO₂ emissions responsible for the climate change.

The research on the possible thermal energy storage systems is useful for the environment because since it is a goal to promote the use of renewable energy sources such as solar technologies, thermal passive and active energy storage systems make more viable the utilization of renewable energy sources by reducing the unbalance periods. It also reduces the need for additional conventional energy supplied systems that depend on fossil fuels and the need for additional power plants.

References

- AgentschapNL. (2013).** *Infoblad Trias Energetica en energieneutraal bouwen*. Retrieved from <http://www.energ.nl/agentschap-nl.html>
- Ala-Juusela, M., Crosbie, T., & Hukkalainen, M. (2016).** *Defining and operationalising the concept of an energy positive neighbourhood* (0196-8904). Retrieved from Science Direct.
- BBC News. (2015).** BBC News. Retrieved from <https://www.bbc.com/news/world-europe-32300214>
- BREEAM. (2019).** Building Research Establishment Environmental Assessment Method. Retrieved from <https://www.breeam.com>
- CBS, C. B. v. d. S. (2018a).** Most households practise energy conservation. Retrieved 15/03/2019 <https://www.cbs.nl/en-gb/news/2018/43/most-households-practise-energy-conservation>
- CBS, C. B. v. d. S. (2018b).** Share of renewable energy at 6.6 percent. Retrieved from <https://www.cbs.nl/en-gb/news/2018/22/share-of-renewable-energy-at-6-6-percent>
- CEER, C. f. E. E. R. (2018).** *Gas production and earthquakes in Groningen*. Retrieved from Groningen: DesignBuilder. (2019). Design builder software Retrieved from https://designbuilder.co.uk/helpv4.6/#_Introducing_DesignBuilder.htm%3FTocPath%3DGetting%2520Started%7C__o
- Dugar, Y. (2019).** *Investigating the effect of human behaviour on the energy performance of 3 typical Dutch residential dwellings using sensors and dynamic performance modelling*. Delft University of Technology,
- European Commission. (2013).** *Intelligent Energy - Europe II. Performance report 2007 - 2012*. Retrieved from
- European Commission. (2018).** Energy Efficiency in buildings. Retrieved from <https://ec.europa.eu/energy/en/topics/energy-efficiency/energy-performance-of-buildings>
- Fang, G., Hu, H., & Liu, X. (2010).** Experimental investigation on the photovoltaic–thermal solar heat pump air-conditioning system on water-heating mode. *Experimental Thermal and Fluid Science*, 34(6), 736-743. Retrieved from <http://www.sciencedirect.com/science/article/pii/S089417711000004X>.
doi:<https://doi.org/10.1016/j.expthermflusci.2010.01.002>
- Goorden, J. J. H. (2016).** *Integration of seasonal thermal energy storage in refurbishment projects: Development of an integrated thermal battery system towards renewable solar heat throughout the year*. Retrieved from <http://resolver.tudelft.nl/uuid:1c78afe1-a05e-40bb-8d2b-ocf3ad7ec143>
- Höfte, V. (2018).** Energy-flat housing: Towards continuous balance in the residential energy system. Retrieved from <http://resolver.tudelft.nl/uuid:b10b29bf-a926-478d-8dac-7600cc09544b>
- IEA, I. E. A. (2010).** *Energy Performance certification of buildings*. Retrieved from Paris, France:
- IEA, I. E. A. (2017).** *World energy Outlook* Retrieved from Paris, France.:
https://www.iea.org/publications/freepublications/publication/buildings_certification.pdf
- Jansen, S. (2018).** *Building Physics Energy, Energy Balance and Energy Need of a Building*. Retrieved from Delft, The Netherlands:
- JLL & AKD, J. L. L. a. A. (2018).** *Manage your EPC risk, The upcoming EPC regulation for buildings in the Netherlands*. Retrieved from <http://www.jll.nl/netherlands/nl-nl/Research/Manage%20Your%20EPC%20Risk.pdf>
- Kameleon solar. (2019).** Retrieved from <https://kameleonsolar.com>.

- Kolokotsa, D., Rovas, D., Kosmatopoulos, E., & Kalaitzakis, K. (2011).** *A roadmap towards intelligent net zero-and positive-energy buildings* (0038-092X). Retrieved from Elsevier
- Konstantinou, T. (2014).** *Facade Refurbishment Toolbox.: Supporting the Design of Residential Energy Upgrades*: TU Delft.
- Konstantinou, T., Ćuković Ignjatović, N., & Zbašnik-Senegačnik, M. (2018).** *Energy: resources and building performance* (Vol. 4).
- LIVESCIENCE. (2008).** How geothermal heat pumps can power the future
- Lund, H., Marszal, A., & Heiselberg, P. (2011).** *Zero energy buildings and mismatch compensation factors* (0378-7788). Retrieved from
- Lund, P. D., Lindgren, J., Mikkola, J., & Salpakari, J. (2015).** *Review of energy system flexibility measures to enable high levels of variable renewable electricity* (1364-0321). Retrieved from Science Direct
- Mamat, H. B. (2016).** *Thermal comfort and indoor air conditions in laboratories at university sains malaysia*. Universiti Sains Malaysia,
- Ministry of Economic Affairs. (2016).** *Energy Report - Transition to sustainable energy*. Retrieved from www.government.nl/ministries/ez
- Ministry of Economic Affairs. (2017).** *Energy Agenda - Towards a low-carbon energy supply*. Retrieved from The Hague, The Netherlands:
- Ministry of Economic Affairs, A. a. I. (2011).** *Energy report*. Retrieved from The Hague, The Netherlands:
- NEEAP. (2012).** *Nationaal Plan voor het bevorderen van bijna-energieneutrale gebouwen in Nederland*. Retrieved from https://ec.europa.eu/energy/sites/ener/files/documents/netherlands_nl_version.pdf
- NTA 8800. (2018).** *Energy Performance of buildings - Determination method* Netherlands
- Nul 20. (2014).** Nul 20. Retrieved from <https://www.nul20.nl>
- PBL. (2011).** *Exploration of pathways towards a clean economy by 2050*. Retrieved from The Hague, The Netherlands.:
- Pérez-Lombard, L., Ortiz, J., & Pout, C. (2008).** *A review on buildings energy consumption information* (0378-7788). Retrieved from Science Direct
- Pilkington. (2019).** Pilkington Sunplus™ BIPV Retrieved from <https://www.pilkington.com/en/global/products/product-categories/solar-energy/pilkington-sunplus-bipv#overview>
- Rapier, R. (2018).** *A Battery That Could Change The World*. Retrieved from <https://www.forbes.com/sites/rrapier/2018/05/20/a-battery-that-could-change-the-world/#4406fc364cf2>
- S.C. Jansen, S. Mohammadi, & A.A.J.F. van den Dobbelsteen. (2019).** *Smart Urban Isle project. SUI mini network Guidelines for developing SUI enery concepts.* .
- Sarbu, I., & Sebarchievici, C. (2017a).** Chapter 3 - Solar Collectors. In I. Sarbu & C. Sebarchievici (Eds.), *Solar Heating and Cooling Systems* (pp. 29-97): Academic Press.
- Sarbu, I., & Sebarchievici, C. (2017b).** Chapter 4 - Thermal Energy Storage. In I. Sarbu & C. Sebarchievici (Eds.), *Solar Heating and Cooling Systems* (pp. 99-138): Academic Press.
- Sarbu, I., & Sebarchievici, C. (2017c).** Chapter 6 - Heat Distribution Systems in Buildings. In I. Sarbu & C. Sebarchievici (Eds.), *Solar Heating and Cooling Systems* (pp. 207-239): Academic Press.
- Sarbu, I., & Sebarchievici, C. (2017d).** Chapter 9 - Solar-Assisted Heat Pumps. In I. Sarbu & C. Sebarchievici (Eds.), *Solar Heating and Cooling Systems* (pp. 347-410): Academic Press.
- Sartori, I., Napolitano, A., & Voss, K. (2012a).** *Net zero energy buildings: A consistent definition framework*. *Energy and buildings*, 48, 220-232.

- Sartori, I., Napolitano, A., & Voss, K. (2012b).** *Net zero energy buildings: A consistent definition framework* (0378-7788). Retrieved from Science Direct
- Solartech. (2019).** Energiedak plus Retrieved from <https://www.energiesdak.nl/>
- Spruijt, J. G. (2015).** *Supporting the Eindhoven University of Technology to reach Thermal Energy Balance at the Campus 2020.* (Master Thesis), University of Technology Eindhoven, Eindhoven, the Netherlands
- Tillie, N., Van Den Dobbelsteen, A., Doepel, D., Joubert, M., De Jager, W., & Mayenburg, D. (2009).** *Towards CO2 neutral urban planning: presenting the Rotterdam Energy Approach and Planning (REAP)* (1552-6100). Retrieved from
- United Nations. (2015).** *Paris Agreement.* Retrieved from https://unfccc.int/sites/default/files/english_paris_agreement.pdf
- United Nations Environment Programme.** Energy sustainable goals. Retrieved from <https://www.unenvironment.org/explore-topics/energy>
- USGBC, U. S. G. B. C. (2016).** *Building Design and Construction, Design Guideline.*
- Van Bueren, E., van Bohemen, H., Itard, L., & Visscher, H. (2012).** *Sustainable urban environments. An Ecosystems Approach.*
- Van den Dobbelsteen, A., & Tillie, N. (2011).** *Energetic urban planning: A novel approach to carbon-neutral cities.* Retrieved from Science Direct
- Van der Linden, A. C., Erdtsieck, P., Gaalen , L. K., & Zeegers, A. (2013).** *Building Physics:* ThiemeMeulenhoff.
- Weather Online. (2018).** *Weather in the Netherlands.* Retrieved from <https://www.weatheronline.co.uk/reports/climate/The-Netherlands.htm>

Appendixes

Appendix 1. Current thermal and electricity balance results of the Gemini south building

The internal gains are the sum of the sensible heat gains due to occupants, lighting and office and process equipment based on the information from the input data.

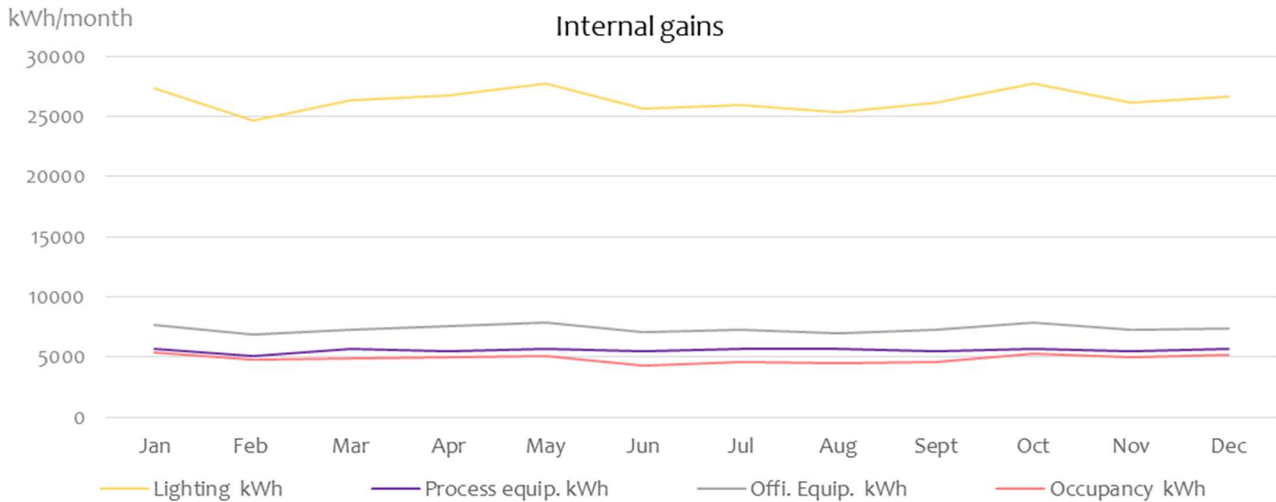

The heat transmission in the Gemini building is mainly defined by the characteristics of the envelope and temperature inside and outside.

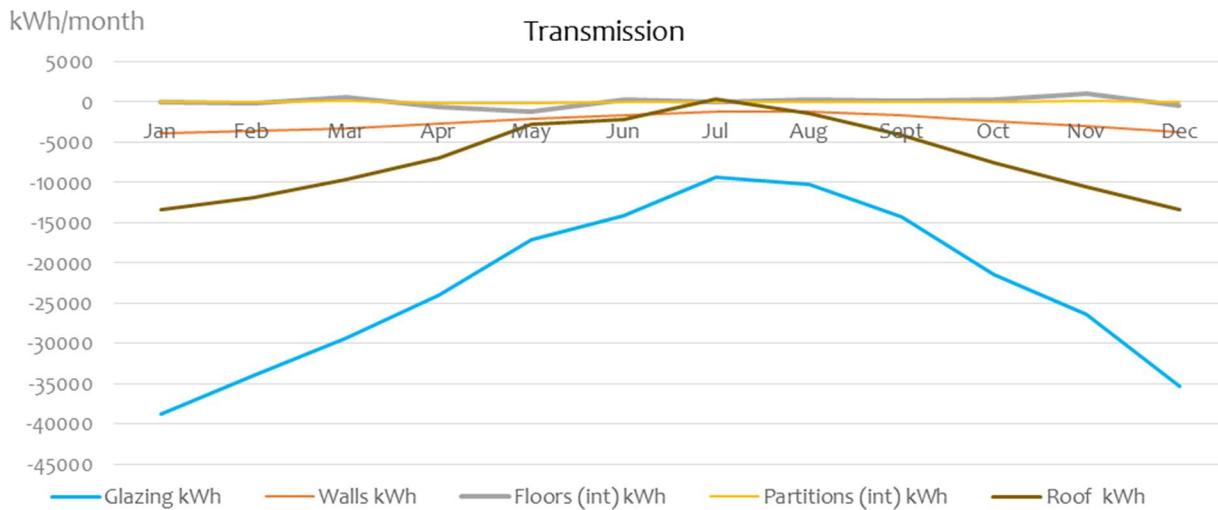

The outside air or the fresh air flows in and out the building through the windows and grills and through the mechanical ventilation.



In an analysis of the building daylight entrance through the south facade made by ABT Company, show the daylight entrance during the January and July months. The study shows that because of the prefabricated concrete balconies, there is almost no daylight entrance in January and very little entrance in July.

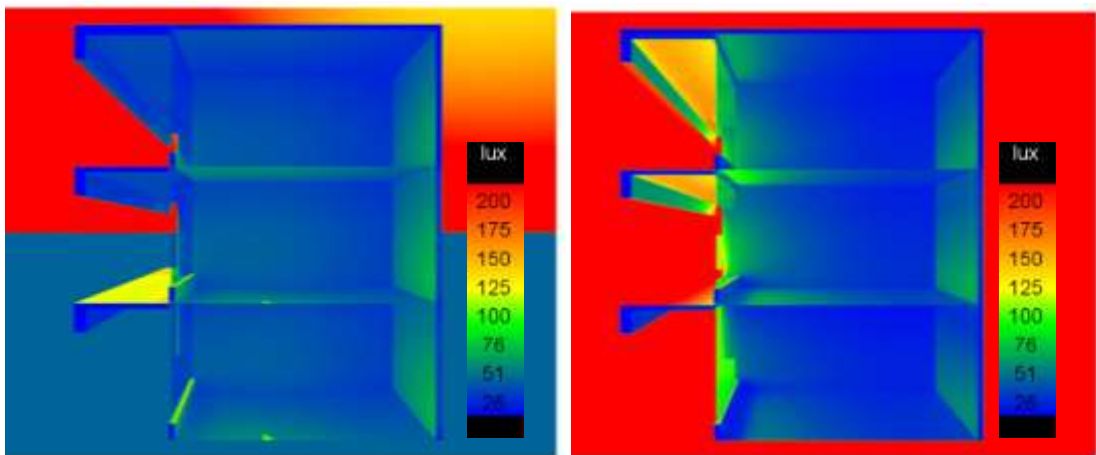

Daylight analysis of the south façade for January and July months developed by ABT company

Using the design builder software the analysis of the distribution of the daylight in the south block has been elaborated.

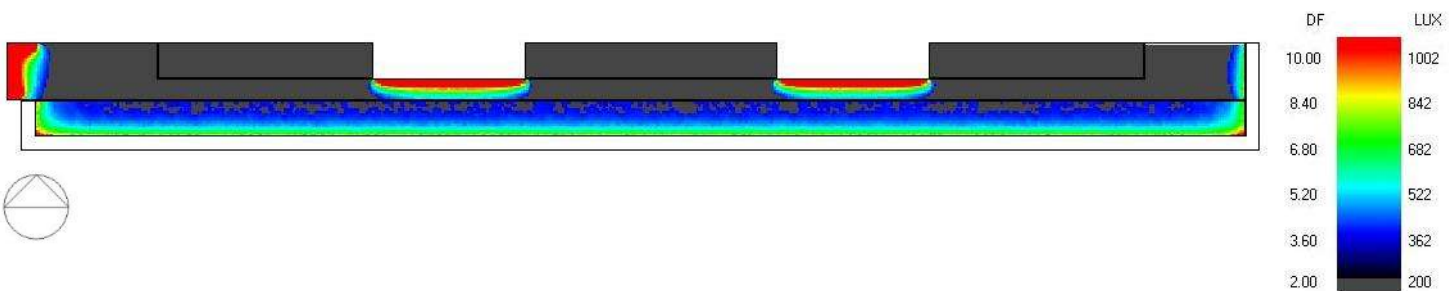

Appendix 2. Energy demand after the renovation proposal towards energy demand reduction

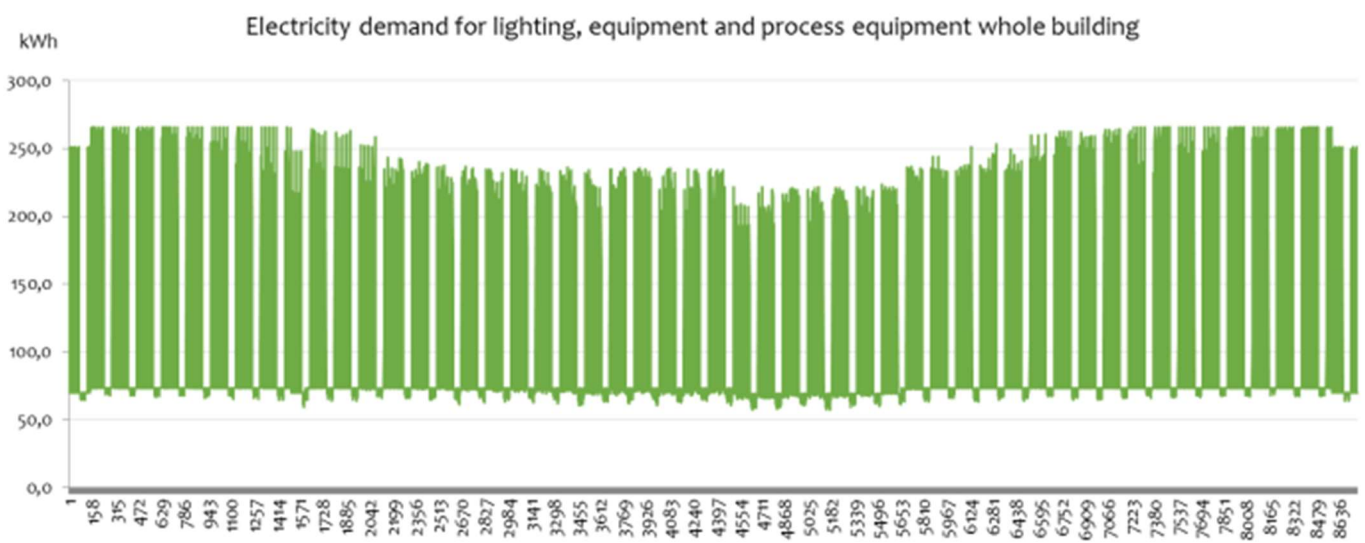
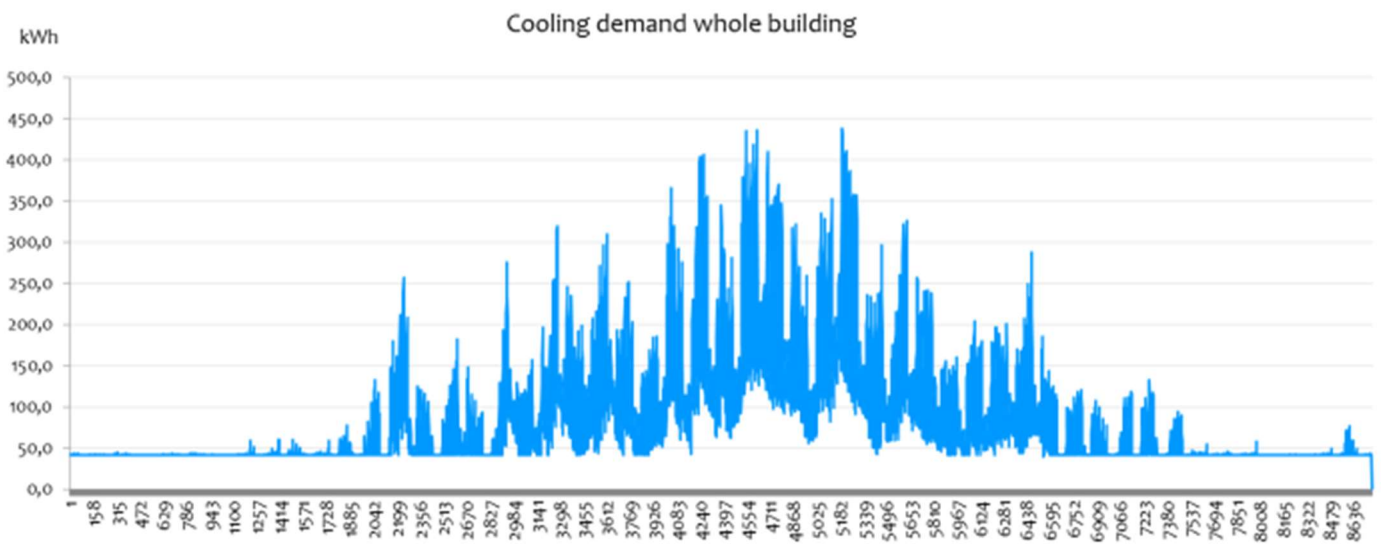
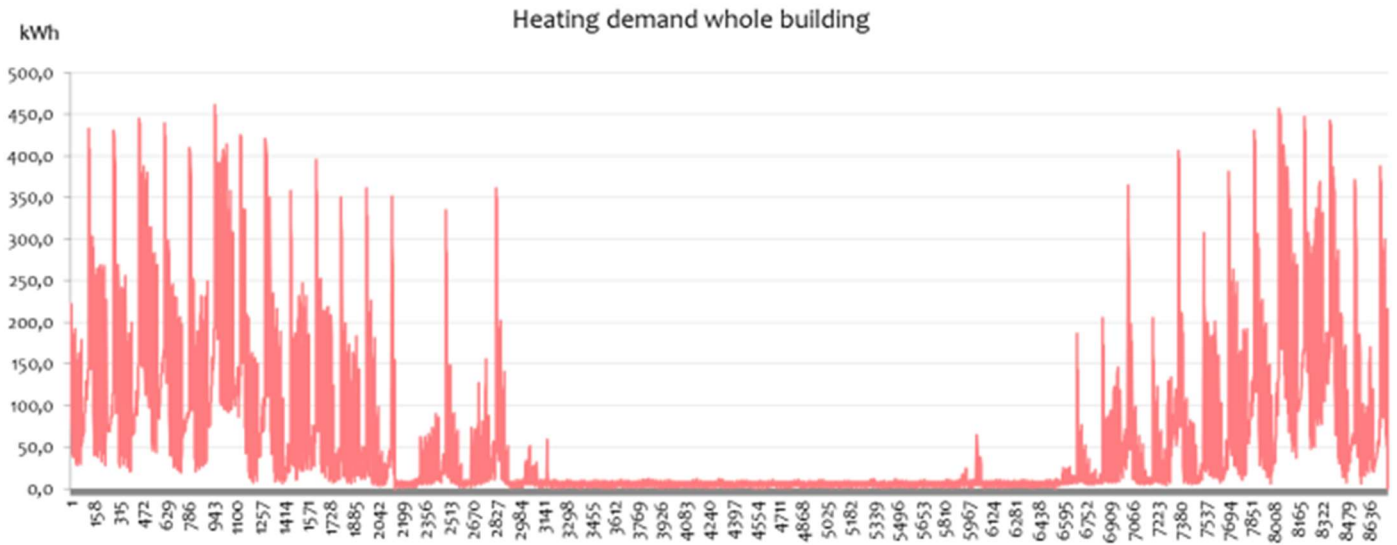



Energiedak®

Energiedak® maakt van uw dak een energiebron. Het Energiedak® is een uiterst innovatief en duurzaam systeem waarmee u én het milieu optimaal profiteren van de energie die de zon ons schenkt. Met Energiedak® beschikt u over een slim systeem dat onzichtbaar zijn energiebesparende werk doet. En niet onbelangrijk: het dak blijft als vanouds waterdicht....



www.energiedak.nl

Energiedak®

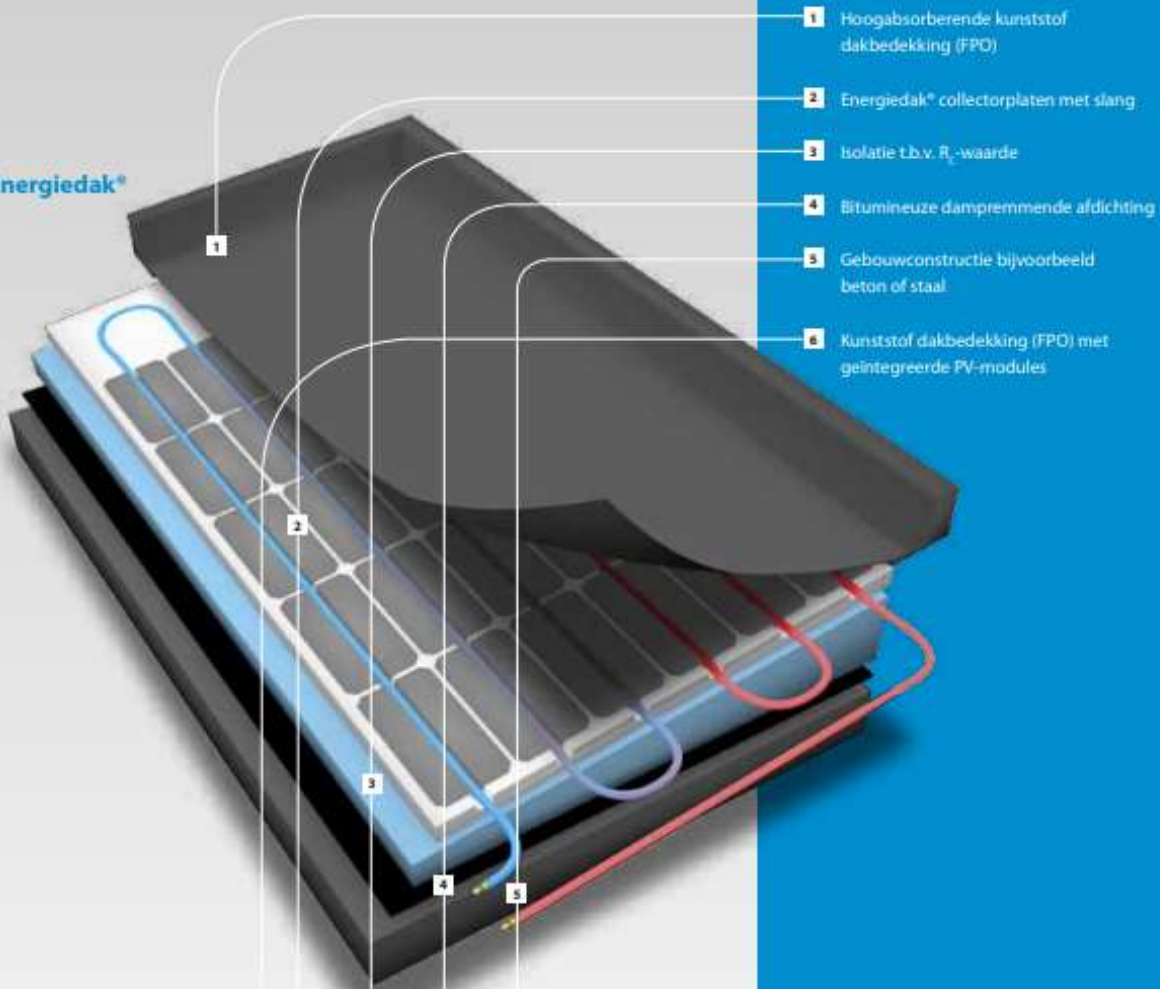

- 1 Hoogabsorberende kunststof dakbedekking (FPO)
- 2 Energiedak® collectorplaten met slang
- 3 Isolatie t.b.v. R_c -waarde
- 4 Bitumineuze dampremmende afdichting
- 5 Gebouwconstructie bijvoorbeeld beton of staal
- 6 Kunststof dakbedekking (FPO) met geïntegreerde PV-modules

Energiedak®-Plus

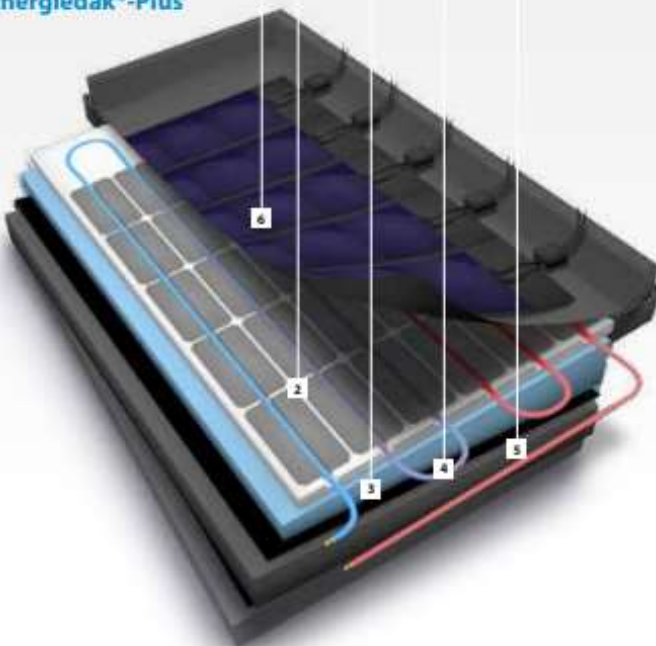

Technische gegevens

Werkdruk: 1,5 - 3,0 Bar

Flow: 2,5 - 3,5 Ltr / min.

Weerstand per sectie: 43,1 KPa

Systeemgewicht Energiedak®: 4,16 Kg / m²

Systeemgewicht Energiedak®-Plus: 8,66 Kg / m²

Vloeistof inhoud: 0,9 Ltr / m²

Anti-vries middel: 0,27 Ltr / m²

1400 uren vollast vermogen bij 300 Wp

Gen. opbrengst Energiedak® bij WKO:

1,45 GJ / m² (403 kWh / m²)

Gen. opbrengst PV laminaat 98 Wp / m²

Geadviseerde technische benodigheden

Drukvat

Warmtewisselaar (TSA)

Dauwpuntregeling

Vulpunt / aftappunt

Toerengeregelde circulatiepomp

Appendix 4. Data sheet solar panel

BISOL BIPV Series

Monocrystalline Roof Integrated PV Modules / BSO 285-310 Wp







Made in EU



Replaces conventional roof tiles



Strictly positive output power tolerances



PID free



Module presorting for higher profitability



Supremely low degradation



Module efficiency up to 19.0 %



Up to 13 % higher real-life performance



Excellent low light performance

Warranties:



In compliance with:



Certificates available upon special request. Additional charges may apply.

I-V Curve at Various Irradiation Levels and Various Cell Temperatures

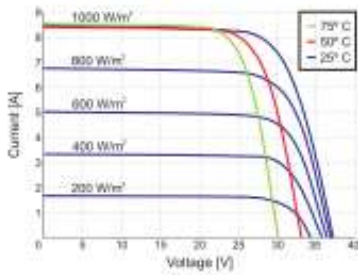

Effective Efficiency

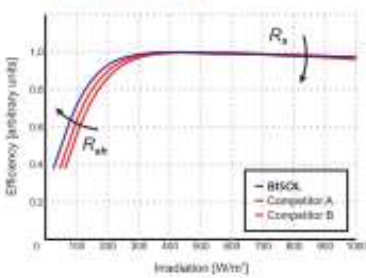

Dimensions

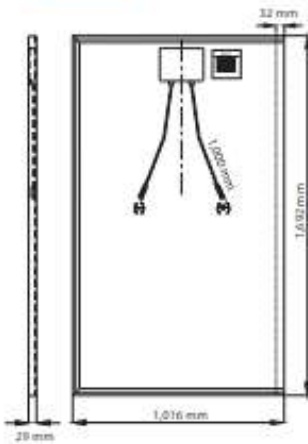

Electrical Specifications @ STC (AM1.5, 1,000 W/m², 25 °C):

Module Type	B50	285	290	295	300	305	310
Nominal Power	P_{MPP} [W]	285	290	295	300	305	310
Short Circuit Current	I_{SC} [A]	9.50	9.60	9.75	9.90	9.95	10.05
Open Circuit Voltage	V_{OC} [V]	40.0	40.2	40.3	40.4	40.8	41.0
MPP Current	I_{MPP} [A]	9.10	9.20	9.35	9.50	9.60	9.75
MPP Voltage	V_{MPP} [V]	31.3	31.5	31.6	31.6	31.8	31.8
Solar Cell Efficiency	η_c (%)	19.9	20.2	20.6	20.9	21.3	21.5
Module Efficiency	η_M (%)	17.4	17.7	18.1	18.4	18.7	19.0
Power Output Tolerance		±3 %					
Maximum Reverse Current		18 A					
Maximum System Voltage		1,000 V (Application Class A)					

Additional power classes available upon request. | Efficiency at irradiation 200 W/m²: 99.3 % of STC efficiency or higher. | Power measurement tolerance: ±3 %.

Electrical Specifications @ NOCT (AM1.5, 800 W/m², 20 °C, wind: 1m/s; Cell Temperature 44 °C):

Module Type	B50	285	290	295	300	305	310
Nominal Power	P_{MPP} [W]	211	214	218	222	225	229
Short Circuit Current	I_{SC} [A]	7.69	7.77	7.89	8.01	8.05	8.13
Open Circuit Voltage	V_{OC} [V]	36.5	36.7	36.8	36.9	37.2	37.4
MPP Current	I_{MPP} [A]	7.37	7.45	7.57	7.69	7.77	7.90
MPP Voltage	V_{MPP} [V]	28.6	28.8	28.8	28.8	29.0	29.0

Power measurement tolerance: ±3 %.

Thermal Specifications:

Current Temperature Coefficient	α	+ 0.046 %/K
Voltage Temperature Coefficient	β	- 0.30 %/K
Power Temperature Coefficient	γ	- 0.39 %/K
NOCT		44 °C
Temperature range		- 40 °C to + 85 °C

Mechanical Specifications:

Length x Width x Thickness	1,692 mm x 1,016 mm x 29 mm
Weight	18.4 kg
Solar Cells	60 mono c-Si in series / 156 mm x 156 mm (6+)
Junction Box / Connectors	Three bypass diodes / MC4 compatible / IP 67
Frame	Solnt®
Glass	3.2 mm glass with anti-reflective coating / tempered / high-transparency / low-iron content
Packaging	24 modules per pallet / stackable 2 pallets high
Certified Nominal Load (snow/wind)	2,400 Pa / 2,400 Pa
Impact resistance	Hailstone / Ø 25 mm / 83 km/h (51 mph)

All unspecified tolerances are ±5 %. Unspecified product properties remain under full discretion of BISOL.



Solar company!

Dealer Information

www.bisol.com | www.bisol.co.uk

Additional terms & conditions apply. Please see Standard Limited Warranty and General Terms and Conditions.

© BISOL Group & Co., January 2019. All rights reserved. All information presented in this document is subject to change without prior notice and serve for informative purposes only.

ColorBlast™



KameleonSolar

Standing out by blending in

In a nutshell

ColorBlast modules grant complete freedom of design. **Almost any color, image, or pattern can be depicted.**

Kameleon Solar is a Dutch company that designs and manufactures custom solar panels at its factory in Roosendaal, the Netherlands.

By providing a myriad of customization options, Kameleon Solar's modules can be manufactured in the size, shape, thickness, and even the color that compliments or matches a building's design.

This way existing building materials, such as façade elements, can be substituted with panels/modules that generate electricity without sacrificing structural support, lifespan, or aesthetic value.



Studio Solarix

Colored PV



Studio Solarix

Building integrated

How it works

Step 1: Truly black

The optical illusion that is ColorBlast only works on a homogenous background. In order to maintain the high efficiency of our monocrystalline cells, we opted for black.

Using black enameled rear-glass and by hiding the silver solar components, we crafted a truly black image and PV module.



Step 2: Creating color

Printing a color or image on glass in its entirety almost completely blocks the usable light. This can be prevented by printing on only a part of the surface.

By using a metric pattern, and by optimizing the shapes within it, light is able to pass through gaps to generate power in the solar cells beneath. Concurrently, the shapes act as pixels to create a homogenous image.

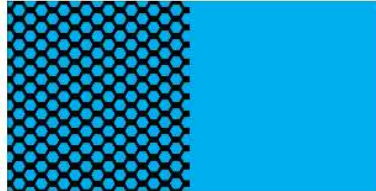

Step 3: Color and power optimization

The gaps in the design and the black background cause the overall printed image or color to fade. To counter this darkening effect, each color must be digitally enhanced.

Some colors are so bright that the pattern must have greater coverage to accurately represent it. Darker colors can be represented with a lower coverage.

For each project we design a custom pattern to achieve the desired effect at the lowest coverage (so the highest power rating) possible.

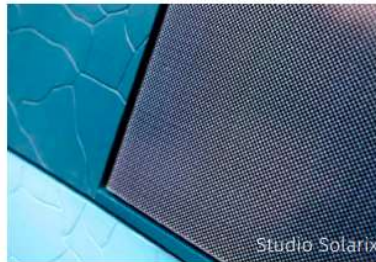

Specs

Physical

Length (mm)	255 - 1850 *
Width (mm)	190 - 1200 *
Thickness (mm)	10 (+/- 1)
Weight (kg per m ²)	22.5
Junction box	IP67, rear placement
Framing	Frameless
Mounting	Standard options for glass (keep cables and junction box in mind) Holes for point fixing available upon request

*Larger sizes available on request

Electrical

Power (Wp per m ²)	80 - 150 *
Cell type	Monocrystalline 6 inch
Cell size (mm)	156.75 x 156.75

*Dependent on colors and coverage.



Glass

Front	4mm tempered solar glass, structured, low-iron content
Rear	4mm tempered black enameled glass
Fire protection	Heat resistant, non-combustible

ColorBlast

Ink	Ceramic ink deposited and hardened on glass side 1 (outside)
Printing	Digital printing for images, patterns, and designs Depending on quantity, screen printing available for single colors
Color fastness	50+ years

Appendix 6. Data sheet of the electricity battery



TECHNICAL DATASHEET

LEAD - ACID SOLAR BATTERY

BATTERY TYPE SOLAR	12V 250Ah	TB250
CATALOGUE NUMBER		

GENERAL PROPERTIES	
Case Type	A
Voltage (V)	12 V
Capacity C100	250Ah
Charge condition	Wet
Technology	Pb - Sb
Weight	57,00Kg (+/-1.5%)

(+) PLATE	
Grid casting technology	Molten grid
Alloy type	Pb - Sb

(-) PLATE	
Grid casting technology	Molten grid
Alloy type	Pb - Sb

SEPARATOR	
Type	Envelope
Material	Polyethylene HP

ELECTROLYTE	
Electrolyte	1.270 (+/-0.01g/cm ³)

TECHNICAL PROPERTIES	
Overall dimensions	518x273x240 mm
Case material	Polypropylene
Lid material	Polypropylene
Case colour	Black
Lid colour	Black
Degassing system	Central
Terminal type	1 (DIN)
Terminal layout	3
Base hold down	B00

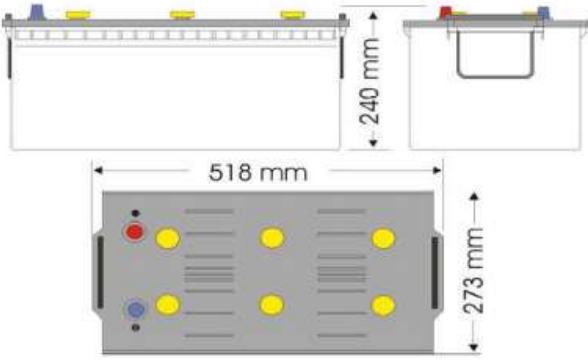

NORMA DURACION DE VIDA CEI - EN - 50342-1
 Fabricado en C.E. según las normas ISO 9001 – ISO 14001 e I.P.P.C.