

Switched Control Strategy for Robust Formation Flight with HIL and In-Flight Validation

Ambroziak, L. ; Kownacki, C. ; Simha, A.

DOI

[10.1109/ICC45855.2022.9838250](https://doi.org/10.1109/ICC45855.2022.9838250)

Publication date

2022

Document Version

Final published version

Published in

ICC 2022 - IEEE International Conference on Communications

Citation (APA)

Ambroziak, L., Kownacki, C., & Simha, A. (2022). Switched Control Strategy for Robust Formation Flight with HIL and In-Flight Validation. In *ICC 2022 - IEEE International Conference on Communications* (pp. 1-6). Article 9838250 (IEEE International Conference on Communications; Vol. 2022-May). IEEE. <https://doi.org/10.1109/ICC45855.2022.9838250>

Important note

To cite this publication, please use the final published version (if applicable).
Please check the document version above.

Copyright

Other than for strictly personal use, it is not permitted to download, forward or distribute the text or part of it, without the consent of the author(s) and/or copyright holder(s), unless the work is under an open content license such as Creative Commons.

Takedown policy

Please contact us and provide details if you believe this document breaches copyrights.
We will remove access to the work immediately and investigate your claim.

Green Open Access added to TU Delft Institutional Repository

'You share, we take care!' - Taverne project

<https://www.openaccess.nl/en/you-share-we-take-care>

Otherwise as indicated in the copyright section: the publisher is the copyright holder of this work and the author uses the Dutch legislation to make this work public.

Switched Control Strategy for Robust Formation Flight with HIL and In-Flight Validation

L. Ambroziak¹, C. Kownacki¹ and A. Simha²

Abstract—In recent times, Unmanned Aerial Vehicles (UAVs) have been intensively studied for a wide range of military and civil applications such as surveillance and reconnaissance missions, agriculture, traffic monitoring, pollution control, meteorological data collection, pipeline survey, early fire detection, rescue missions, wildlife population monitoring, etc. The above tasks can be carried out faster and more efficiently by a group of UAVs flying in formation. This paper presents the application of two stage switching controller in autonomous formation flight of UAVs based on the leader follower configuration. The constructed UAV airframe, as well as the autopilot, formation flight control unit and wireless communication link for data sharing between UAVs were presented and described. The advantages of the switched control were demonstrated in terms of a significantly larger region of stability in maintaining formation, as opposed to the standard, one stage control laws with classical compensators. Hardware In The Loop (HIL) tests of proposed formation flight control were performed, during which the inertial states and flight parameters were logged. The HIL test rig enabled us to verify the formation flight control performance which was further substantiated by actual flight tests.

I. INTRODUCTION

Autonomous formation flight can significantly increase the applicability of Unmanned Aerial Vehicles (UAVs). A group of cooperating UAVs can imitate large air targets, as well as help transmit radio signals over long distances via efficient relays [1] and act as composite antennas [2] [3]. Furthermore, formation flight can reduce the drag and save energy. Flying in formation is an effective way to perform tasks like reconnaissance, scouting or scanning and joint operations in agriculture industrial and tactical applications. To achieve efficient formation flight, the control law should account for communication constraints while ensuring a large region of formation stability. Some recent works on formation flight control are stated as follows. The proportional-integral ([10]; [18]; [24]), nonlinear ([13]; [21]) or switching ([9]) are used most often and these have been examined experimentally during in-flight tests. A few other methods are presented in ([12]) and ([26]). The leader-follower structure is the most prominent while

other frameworks such as virtual structure, behavioral or hybrid structures are also studied. All these methods of formation control depend heavily on communication and wireless telemetry data exchange between UAVs. A few other vision based methods are also studied in [20]; [23]) and [15], however due to the large distance between the UAVs, wireless methods are most suited. A comprehensive survey of formation flight control methods and its classification is presented in [6], and communications architectures are studied in [4] [5]. One of the major drawbacks in the existing flight control laws is that the stability degrades significantly when the initial separation between the leader and follower is large. For this reason, we propose a *switched control* law in order to ensure global (or large) region of stability. Effective formation flight control requires accurate testing in emulated flight conditions before deployment. An effective method for flight control validation is hardware in the loop (HIL) simulation ([22]) where the controller is simulated while the actual UAV is in the feedback loop. HIL allows validation in safe environment and close to real conditions thereby enabling accurate control tuning by monitoring all states. An interesting configuration of the HIL simulator is presented in ([11]). This system is composed with four modules which are onboard hardware, flight control, ground station and software integrated together in one effective simulator of the unmanned helicopter. A few other vision based HIL frameworks are studied in [16] and [25]. The HIL based formation flight control framework as well as the communication technology discussed in this paper is also applied to other nonholonomic multi-agent system swarms such as vehicular platoons, which is currently a major focus in the IoT domain (see for e.g. www.insect.eu/).

This paper presents the HIL tests of the two stage switching controller, applied to formation flight of UAVs along with details of HIL test rig. The presentation includes thorough description of UAV airframe, autopilot, formation flight controller unit and wireless communication links between UAVs. The results of HIL tests were also substantiated by actual flight tests with comparable performance.

¹ Mechatronics Department, Faculty of Mechanical Engineering, Bialystok University of Technology, Wiejska St. 45C, 15-351 Białystok, Poland (e-mail: l.ambroziak@pb.edu.pl)

² Delft University of Technology, Netherlands

II. UAV PLATFORM

A. The Twister

The HIL tests and flight experiments were carried out using Twister (Fig 1) which is a hobby RC plane model by Multiplex.



Fig. 1. Twister UAV (leader and follower) with HIL testbed setup.

B. Twister's equipment

The Twister was equipped with a Kestrel autopilot produced by Procerus Technologies Lockheed Martin L.C. Kestrel autopilot is a small-scale device designed for autonomous flight control that provides UAV stabilization in three-axis. In addition, the GPS antenna and radio modems were mounted for communication purpose with ground control station (GCS) and between UAVs during formation flight. The Twister was provided with Gumstix computer to establish communication between UAVs and to execute the formation flight control algorithm. The schematic of the onboard equipment is presented in Fig. 2.

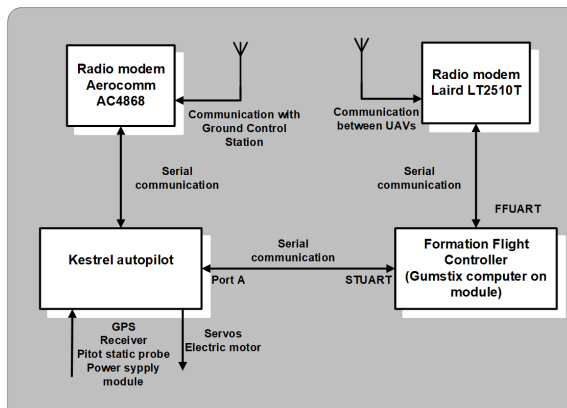

Fig. 2. Schematic of control and communication hardware on Twister

Kestrel autopilot connects with Virtual Cockpit software which is a Windows-based ground control software system for the Kestrel autopilot that allows the operator to configure, monitor, to issue the commands to the autopilot, to upload flight plans, and to change waypoints

Xbee PRO	Xbee WiFi	Gumstix WiFi	LT2510
2.4 GHz ISM	2.4 GHz ISM	2.4 GHz ISM	2400-2483,5 MHz
250 kbps	1Mbps	1Mbps	500kbps

Fig. 3. Radiomodems tested for data exchange between UAVs.

mid flight. During the HIL tests, data exchange between Kestrel autopilot and GCS (with installed Virtual Cockpit) was performed via serial connection using a special modem communication port allowing HIL simulation with Gumstix COM connected to the autopilot. Kestrel autopilot was properly configured for the Twister platform and tested during simulations and in-flight tests via pilot in the loop technique. All gains and parameters in control and navigational loops were selected and carefully verified ([8]; [17]). The exchange of data directly between the UAVs in the air (during formation flight) is performed by the group flight autopilot integrated with Laird LT2510T radio modem. Before this device was selected for the final version of the system, a number of communication devices presented in Fig. 3 was tested. The use of radio modems is a modern way of creating a Private Radio Network (PRN) which is widely used in industry for real time data communication. The use of radio modems also makes the system independent of satellite communication or systems such as GSM or GPRS, the effectiveness of which depends on the range of base stations of the operator of a given network, and time of logging into the network to establish a connection. In the case of radio modems, we can use a free frequency band that is available in every country or buy a given frequency band and use it exclusively. In turn, wireless network cards and the wi-fi communication standard ensure very fast data exchange, however over short distances. Xbee radio modems produced by MaxStream are a family of embedded radio modems that can work in the Point to Point or Point to Multi Point configuration. Xbee radio modems are easy-to-use devices for wireless transmission. There are many frequency bands in which these devices can operate, the most popular one being 2.4 GHz. There are also versions of the 900MHz band (the band is forbidden in Europe because of mobile frequency range) as well as versions for the 868MHz band (long range versions in Europe). Xbee radio modems come in various antenna variants with radio transmission speed up to 250kbaud per second for a 4km range. The power consumption may vary between 1mW to 100mW depending on the version and the range desired by the user. They are characterized by low power consumption (45mA for transmitting, 50mA for receiving data). In the operation of radio modems, it was found that xbee very often lost communication and range between objects. It was not possible to resume communication after re-entering the transmitter and re-

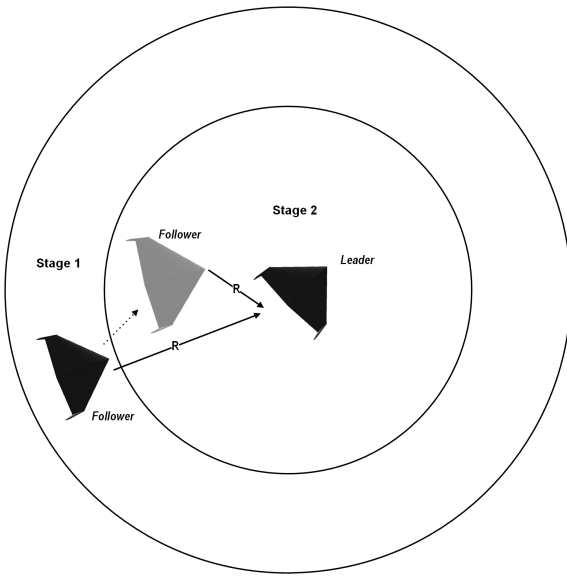

Fig. 5. Switching scheme between algorithms.

IV. HIL TESTS

A. HIL software

The Kestrel Autopilot and the Virtual Cockpit has a built-in ability to simulate a 6 degree of freedom UAV through the use of a 3rd party, open source simulator called Aviones. The Aviones is developed by the Brigham Young University Human Centered Machine Intelligence (HCMI) and Multiple Agent Intelligent Coordination & Control (MAGICC) labs. It displays the simulated flight in 3D allowing the user to quickly and easily test flight plans and new software development prior to full outdoor flight. Aviones software uses two libraries – physics.dll and autopilot.dll. The physics library computes how the airplane responds in its natural environment using user-defined airplane coefficients, wind, and 6 DoF models. The autopilot library describes its response to its orientation and position in the simulated world. Moreover, with an autopilot library, the Aviones can communicate with the Kestrel autopilot and replace the autopilot's sensor information generated by the physics library. HIL simulations and communication scheme were presented in Fig 6.

B. Developed HIL testbed

HIL testbed used in the studies comprised two Twister aircrafts with autopilots, radio modems, antennas and Gumstix computers on module. This HIL testbed uses all the equipment expected for flight tests. The developed HIL test rig enables testing different types of radio modems and schemes for exchanging information between UAVs during formation flight. In addition, it provides the opportunity to explore a variety of formation flight control algorithms, including vision based and vision aided algorithms. Fig 1 shows the general view of the developed laboratory test rig for HIL tests.

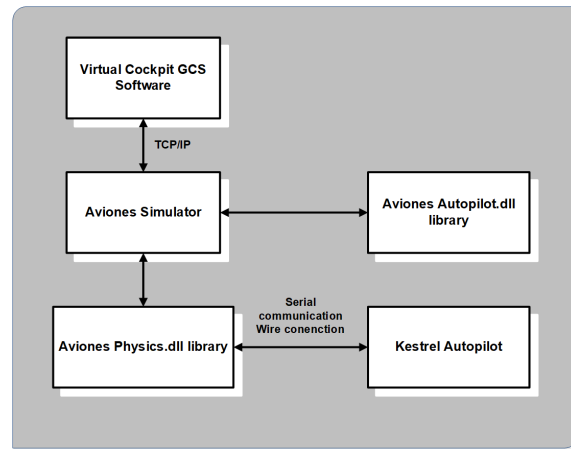

Fig. 6. The HIL software scheme.

The developed HIL test rig consists of two fully functional flying platforms that are pivotably mounted on tripods. It lets us observe the behavior of the aircraft control surfaces and correctness of their response, depending on control signals. In addition, the testbed is equipped with 4 computers, out of which two of them have the task of handling two autopilots and running Aviones and Virtual Cockpit (HIL simulations). The other two computers are connected to the Gumstix systems and are responsible for monitoring the formation flight controllers (Fig 7).

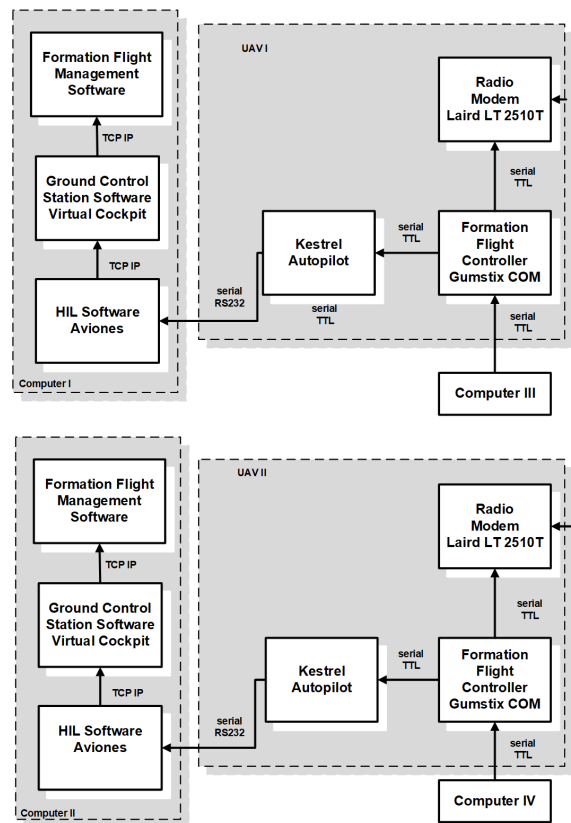

Fig. 7. The HIL testbed scheme.

V. HIL AND FLIGHT TEST RESULTS

The conducted HIL tests allowed us to verify the correctness of the designed formation flight control system and to check the quality of data exchange as well as to detect errors in the control software. This enabled accurate tuning of control and communication parameters which were used in flight tests subsequently. The flight mission was configured as follows (similarly for the in-flight tests as well).

- Start with a leader using the automatic start function and move to a circle with a given radius (70m),
- Switching the leader into the NAV mode (set path in the form of a circle with a radius of 250m and center,
- Start with a follower using the automatic start function and move to a circle with a given radius (70m) but at lower altitude than Leader,
- Enabling the leader tracking/following control system,
- Formation flight,
- Deactivation of the leader tracking control system and return to the initial circle following path with a given radius (70m),
- Follower and leader landing.

Fig 8 shows the drawback of using a single stage control law. It can be seen that for initial separation error over 150m, the control law fails and instability sets in. This issue is clearly mitigated by our proposed switched control law as seen in Fig 9 , Fig 11 where the state error and planar trajectory with the switched controller are logged during HIL tests for a circular trajectory. In Fig 9, it can be clearly seen that the error converges to zero at an exponential rate, in spite of large initial errors. In-flight tests of the proposed formation flight control method and the communication system were also carried out, which is presented in Fig. 11. It can be seen that the in-flight performance is appreciably comparable to the HIL tests, which also proves that the proposed HIL setup quite accurately models the flight performance, and also enables effective controller tuning for stable and robust flight performance.

VI. CONCLUSIONS

The paper proposes a two-stage switching control law and a HIL testbed to verify the closed loop performance in a leader-follower configuration of formation flight of UAVs. It was shown that the two-stage controller had appreciable closed loop performance which was robust to large initial separation between the leader and follower, unlike existing single stage methods. Moreover, the simplicity of the control law enabled easy integration with flight controller and radio communication hardware. The chosen radio modem also enabled switching and decentralized control even during large separation. The performance was validated on the HIL testbed, and the obtained optimally tuned gains were also employed in

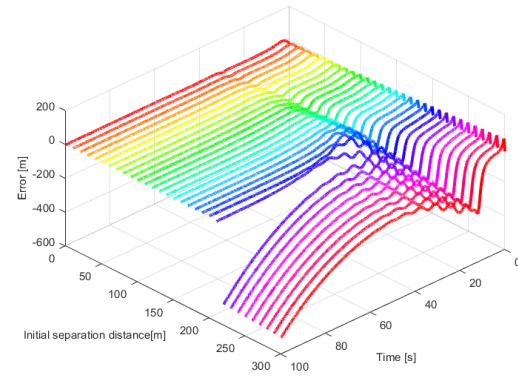

Fig. 8. Drawback of non-switching control: Instability is seen for initial error above 150m

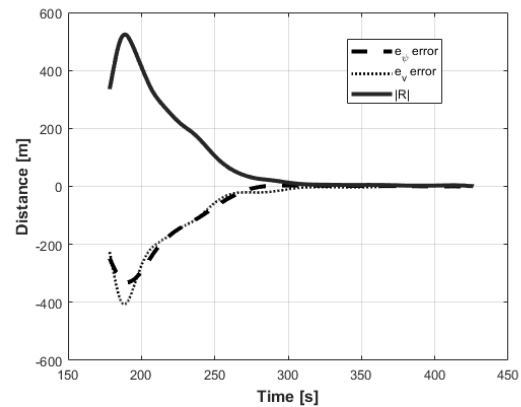

Fig. 9. Robustness of switching: The e_ψ , e_v errors and R parameter during formation flight show stability in spite of large initial error.

actual in-flight tests which were appreciably comparable to HIL results despite external disturbances such as wind gusts. This showed that the proposed HIL test rig is an excellent tool for testing the formation flight control algorithms and communication protocols. The designed HIL testbed also enables computation of control bounds and stability regions within airframe and communication constraints.

VII. ACKNOWLEDGEMENTS

This research was partially funded by BUT project No. WZ/WM-IIM/1/2019 and InSecTT (www.insectt.eu) project that has received funding from the ECSEL Joint Undertaking (JU) under grant agreement No 876038. The JU receives support from the European Union's Horizon 2020 re-search and innovation programme and Austria, Sweden, Spain, Italy, France, Portugal, Ireland, Finland, Slovenia, Poland, Netherlands, Turkey. The document reflects only the author's view and the Commission is not responsible for any use that may be made of the information it contains. The EU expects us to include this disclaimer.

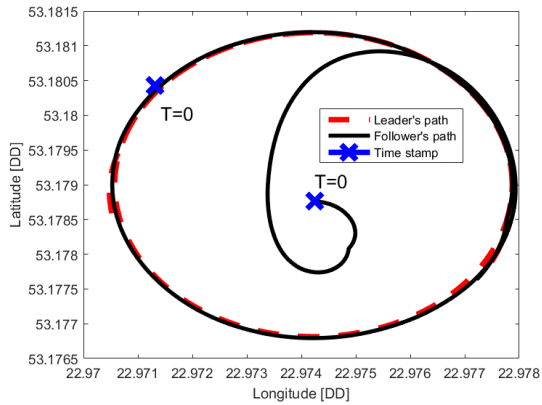

Fig. 10. The UAVs circle path during formation flight HIL tests.

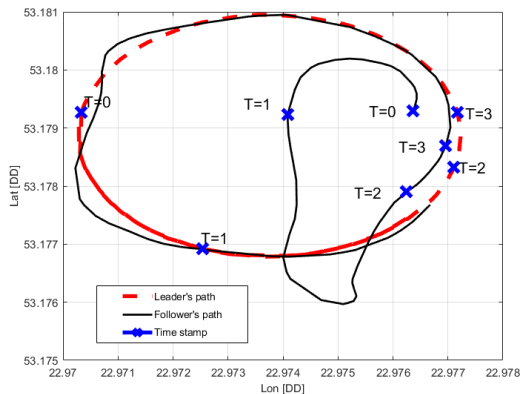

Fig. 11. The UAV trajectory during in-flight tests of switching formation flight controller.

REFERENCES

- [1] Rohde, Sebastian, Markus Putzke, and Christian Wietfeld. "Ad hoc self-healing of OFDMA networks using UAV-based relays." *Ad Hoc Networks* 11.7 (2013): 1893-1906.
- [2] Mohanti, Subhramoy, et al. "AirBeam: Experimental Demonstration of Distributed Beamforming by a Swarm of UAVs." 2019 IEEE 16th International Conference on Mobile Ad Hoc and Sensor Systems (MASS). IEEE, 2019.
- [3] Mozaffari, Mohammad, et al. "Drone-based antenna array for service time minimization in wireless networks." 2018 IEEE International Conference on Communications (ICC). IEEE, 2018.
- [4] Campion, Mitch, Prakash Ranganathan, and Saleh Faruque. "UAV swarm communication and control architectures: a review." *Journal of Unmanned Vehicle Systems* 7.2 (2018): 93-106.
- [5] Campion, Mitch, Prakash Ranganathan, and Saleh Faruque. "A Review and Future Directions of UAV Swarm Communication Architectures." EIT. 2018.
- [6] Ambroziak, L.; Ciezkowski, M. Virtual Electric Dipole Field Applied to Autonomous Formation Flight Control of Unmanned Aerial Vehicles. *Sensors* 2021, 21, 4540.
- [7] Ambroziak L., Gosiewski Z. (2011) *Aerodynamics Characteristics Identification of Micro Air Vehicle (in Polish)*, Transactions of the Institute of Aviation, 216, pp. 17-29.
- [8] Ambroziak L., Gosiewski Z. (2013) *Preliminary UAV Autopilot Integration and In-Flight Testing*, Solid State Phenomena, Vol. 198, pp. 232-237.
- [9] Ambroziak L., Gosiewski Z. (2015) *Two stage switching control for autonomous formation flight of unmanned aerial vehicles*, Aerospace Science and Technology, Vol. 46, pp. 221 – 226.
- [10] Buzogany L.E., Pachter M., D'azzo J. J. (1993) *Automated control of aircraft in formation flight*, Proceedings of AIAA Guidance, Navigation and Control Conference, Monterey, pp.1349-1370.
- [11] Cai G., Lee B.M., Chen T.H., Dong M. (2009) *Design and implementation of a hardware-in-the-loop simulation system for small-scale uav helicopters*, Mechatronics, Vol. 19, No. 7, pp. 1057–66.
- [12] Chen Y., Wang Z. (2005) *Formation control: a review and a new consideration*, Proceedings of the 2005 IEEE/RSJ international conference on intelligent robots and systems, pp. 3181–3186
- [13] Cheng Z., Neculescu D. S., Kim B., Sasiadek J. Z. (2008) *Nonlinear Control for UAV Formation Flying*, Proceedings of the 17th World Congress The International Federation of Automatic Control, Seoul, Korea, July 6-11, pp.791-796.
- [14] Dehghani M. A., Benhaj M. B., Ghaderi H. (2017) *A hardware in the loop simulation testbed for vision-based leader-follower formation flight*, Mechatronics, Vol. 47, pp.223-232.
- [15] Dehghani M. A., Menhaj M. B. (2016) *Communication free leader-follower formation control of unmanned aircraft systems. Robotics and Autonomous Systems*, Mechatronics, Vol. 47, pp.223-232.
- [16] Gans NR , Dixon WE , Lind R, Kurdila A. (2009) *A hardware in the loop simulation platform for vision-based control of unmanned air vehicles*, Mechatronics, Vol. 19, No. 7, pp.1043–1056.
- [17] Gosiewski Z., Ambroziak L. (2011) *UAV autonomous formation flight experiment with Virtual Leader control structure*, Solid State Phenomena, Vol. 198, pp. 254-259.
- [18] Hall J. K., Pachter M. (2000) *Formation maneuvers in three dimensions*, 39th IEEE Conference on Decision and Control, Vol. 1, pp.364–369.
- [19] Isermann R , Schaffnit J , Sinsel S. (1999) *Hardware-in-the-loop simulation for the design and testing of engine-control systems*, Control Engineering Practices, Vol. 7, No.5, pp.643–53.
- [20] Johnson E. N., Calsie A. J., Sattigeri R., Watanable Y., Madyastha V. (2004) *Approaches to vision-based formation control*, 43rd IEEE Conference on Decision and Control CDC Vol. 2, pp.1643–1648.
- [21] Kim D. M., Nam S., Suk J. (2009) *A modified nonlinear guidance logic for a leader-follower formation flight of two UAVs*, ICCAS-SICE conference, Fukuoka, Japan, pp. 5734–5739
- [22] Leitner J. (2001) *A hardware-in-the-loop testbed for spacecraft formation flying applications*, IEEE proceedings of Aerospace Conference, pp. 615–20.
- [23] Lin F., Peng K., Dong X., Zhao S., Chen B. M. (2014) *Vision-based Formation for UAVs*, 11th IEEE International Conference on Control and Automation (ICCA), pp. 1375 – 1380.
- [24] Pachter M., D'Azzo J., Dargan J. L. (1994) *Automatic formation flight control*, Journal of Guidance, Control, and Dynamics, Vol. 17, No. 6, pp. 1380-1383.
- [25] Prabowo YA , Trilaksono BR , Triputra F. R. (2015) *Hardware in-the-loop simulation for visual servoing of fixed wing uav*, The 5th International Conference on Electrical Engineering and Informatics, pp. 247–52.
- [26] Oh K. K., Park M.C., Ahn H. S.(2015) *A survey of multi-agent formation control*, Automatica, vol. 53, pp. 424–40
- [27] Zhao Weihua, Tiauw Hiong Go, and Eicher Low, "Formation Flight Control Using Model Predictive Approach", 47th AIAA Aerospace Sciences Meeting Including The New Horizons Forum and Aerospace Exposition 5 - 8 January 2009, Orlando, Florida