

Optimum Turbine Design for Hydrogen Production from Offshore Wind

Mehta, M.K.; Zaaijer, M B; von Terzi, D.A.

DOI

[10.1088/1742-6596/2265/4/042061](https://doi.org/10.1088/1742-6596/2265/4/042061)

Publication date

2022

Document Version

Final published version

Published in

Journal of Physics: Conference Series

Citation (APA)

Mehta, M. K., Zaaijer, M. B., & von Terzi, D. A. (2022). Optimum Turbine Design for Hydrogen Production from Offshore Wind. *Journal of Physics: Conference Series*, 2265(4), Article 042061. <https://doi.org/10.1088/1742-6596/2265/4/042061>

Important note

To cite this publication, please use the final published version (if applicable). Please check the document version above.

Copyright

Other than for strictly personal use, it is not permitted to download, forward or distribute the text or part of it, without the consent of the author(s) and/or copyright holder(s), unless the work is under an open content license such as Creative Commons.

Takedown policy

Please contact us and provide details if you believe this document breaches copyrights. We will remove access to the work immediately and investigate your claim.

PAPER • OPEN ACCESS

Optimum Turbine Design for Hydrogen Production from Offshore Wind

To cite this article: Mihir Mehta *et al* 2022 *J. Phys.: Conf. Ser.* **2265** 042061

View the [article online](#) for updates and enhancements.

You may also like

- [Wind farm optimization with multiple hub heights using gradient-based methods](#)
Andreas Wolf Ciavarrá, Rafael Valotta Rodrigues, Katherine Dykes et al.

- [Modeling and analysis of the solar photovoltaic levelized cost of electricity \(LCoE\) - case study in Kupang](#)
Rusman Sinaga, Nonce F. Tuati, Marthen D.E. Beily et al.

- [To dee or not to dee: costs and benefits of altering the triangularity of a steady-state DEMO-like reactor](#)
J.A. Schwartz, A.O. Nelson and E. Kolemen



ECS Membership = Connection

ECS membership connects you to the electrochemical community:

- Facilitate your research and discovery through ECS meetings which convene scientists from around the world;
- Access professional support through your lifetime career;
- Open up mentorship opportunities across the stages of your career;
- Build relationships that nurture partnership, teamwork—and success!

Join ECS!

Visit electrochem.org/join



Optimum Turbine Design for Hydrogen Production from Offshore Wind

Mihir Mehta, Michiel Zaaier, Dominic von Terzi

Wind Energy Section, Delft University of Technology, Delft, Netherlands

E-mail: M.K.Mehta@tudelft.nl

Abstract. To limit the consequences of climate change, generation from renewables coupled with large scale electrification is necessary. However, the deployment of renewables has its own challenges and not all sectors can be electrified. Hydrogen production from wind energy emerges as a promising solution that can alleviate these challenges. The current costs of green hydrogen production are high due to the high costs of electricity used for electrolysis. This study looks into the benefits of optimizing a turbine specifically for hydrogen production and the reduction in the Levelized Cost of Hydrogen (LCoH) compared to the use of conventional Levelized Cost of Energy (LCoE) optimized turbine. The case presented shows that turbines designed specifically for hydrogen production tend to have a higher specific power but these provide only a marginal advantage over using LCoE-optimized turbines for hydrogen production. Oversizing the electrolyzer compared to the turbine was shown to be a good design strategy. In the future, designing turbines specifically for hydrogen production could have certain benefits, depending on how the electrolyzer efficiencies, hydrogen production costs and the hydrogen market evolve.

1. Introduction

Electrification of sectors forms the core of the strategy to tackle climate change. To deal with energy-dense sectors where electrification may not be possible, a lot of research focuses on hydrogen as an energy carrier where the electricity from renewables is converted to hydrogen. Hydrogen finds its direct use in industries like steel, chemical, transport, agriculture etc., and their demand is predicted to grow significantly [1]. It also enables cost-efficient bulk transport of energy over large distances [2]. This makes it essential to produce low-cost emission-free green hydrogen. The technology for green hydrogen production (via electrolysis) is already in use. The key obstacle in producing green hydrogen at large scale lies in its production costs [3]. The Levelized Cost of Hydrogen (LCoH) for green hydrogen is still higher than the conventional hydrogen production costs (from fossil sources), which can be mainly attributed to the high cost of renewable electricity required to produce hydrogen via electrolysis [3, 4]. However, with the declining costs of offshore wind and electrolyzers, hydrogen production from renewable energy sources (green hydrogen) is expected to be competitive with blue hydrogen, i.e. production from natural gas with carbon capture, by 2030 [5]. As the LCoH of green hydrogen production from wind is highly sensitive to the cost of electricity [6], it is crucial to reduce the costs of the wind farm. Hydrogen also finds its application in alleviating grid integration issues by providing flexibility [7] or by using wind energy that would otherwise be curtailed [8]. However, this is outside the scope of this study, which addresses dedicated hydrogen production for direct use.



Most studies focused on green hydrogen production from wind energy assume a fixed turbine and farm configuration, originally optimized for electricity production. However, the turbine design has a direct impact on the Capital Expenditure (CAPEX) and Operational Expenditure (OPEX) of a wind farm and the amount of hydrogen produced. This study explicitly focuses on how a turbine designed specifically for hydrogen production would differ from a turbine designed for electricity production, and to know whether it further reduces the LCoH. The economics of various hydrogen production configurations has been studied before [9]. However, that study assumes both electricity and hydrogen infrastructure to be present where the production of electricity or hydrogen depends on the most economical strategy. A similar hybrid usage strategy is demonstrated by Glenk and Reichelstein [10]. For the hydrogen production configuration used in this study, the electrolyzer is integrated into the turbine, and the hydrogen is directly transported to the shore via pipelines. This is assumed to be more economical than the centralized offshore hydrogen production, as centralized offshore hydrogen production requires an additional expensive offshore platform to mount the hydrogen production related components.

For electricity production, Levelized Cost of Energy (LCoE) as a metric has been widely adopted by wind farm designers [11]. The industry has observed a general trend of going towards higher capacity turbines along with longer blades, in order to minimize the LCoE [3]. This study carries out an upscaling study for green hydrogen production (LCoH minimization) and for electricity production (LCoE minimization) and draws a comparison between the two.

2. Research objective

The primary objective of this study is *‘to know how a turbine design optimized for hydrogen production can further reduce the LCoH compared to a turbine optimized for electricity production, by assessing a turbine-integrated hydrogen production configuration.’*

The tasks/sub-objectives can be stated as:

- (i) Perform an upscaling study of turbines optimized for LCoE and LCoH.
- (ii) Understand the differences in turbine design for electricity production and for the hydrogen production configuration.
- (iii) Gain insights into the key drivers for optimal turbine design for hydrogen production.

3. Methodology

A turbine with integrated hydrogen production is assumed in this study where each turbine has an integrated electrolyzer which produces hydrogen at 30 bar which is later compressed to 100 bar and exported onshore, as shown in Figure 1.

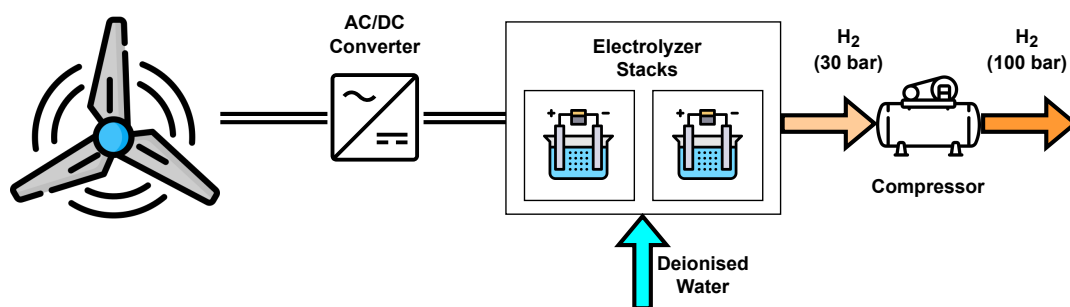

Figure 1: Schematic of the turbine-integrated hydrogen production configuration

A Multi-disciplinary Design Analysis and Optimization (MDAO) approach is used to perform the turbine optimization study. The turbine parameters considered for optimization are the rotor

diameter and the rated power. A change in these turbine parameters leads to a redesign of various components in the farm thereby affecting the costs and the annual energy/hydrogen production. The turbine is optimized for electricity production (with LCoE being the objective function) and for hydrogen production (with LCoH being the objective function). The two designs are then compared and the additional benefit of designing a turbine separately for hydrogen production is evaluated. For the optimization, the ‘rotor diameter’ is optimized for a fixed power rating and the ‘rated power’ is optimized for a fixed rotor diameter. This optimization is performed via a brute force approach over a range of values for rated power and rotor diameter. An MDAO framework is used to perform the upscaling and sensitivity studies. For every combination of rated power and rotor diameter, the entire framework is run as an analysis block and the LCoE/LCoH values are recorded. The various modules of a wind farm, namely turbine, support structure, wake losses, cable design, finance, etc., are coupled. The framework, also known as WINDOW, was developed at TU Delft [12]. An eXtended Design Structure Matrix (XDSM) of the framework, with the added ‘Hydrogen production’ module, is shown in Figure 2.

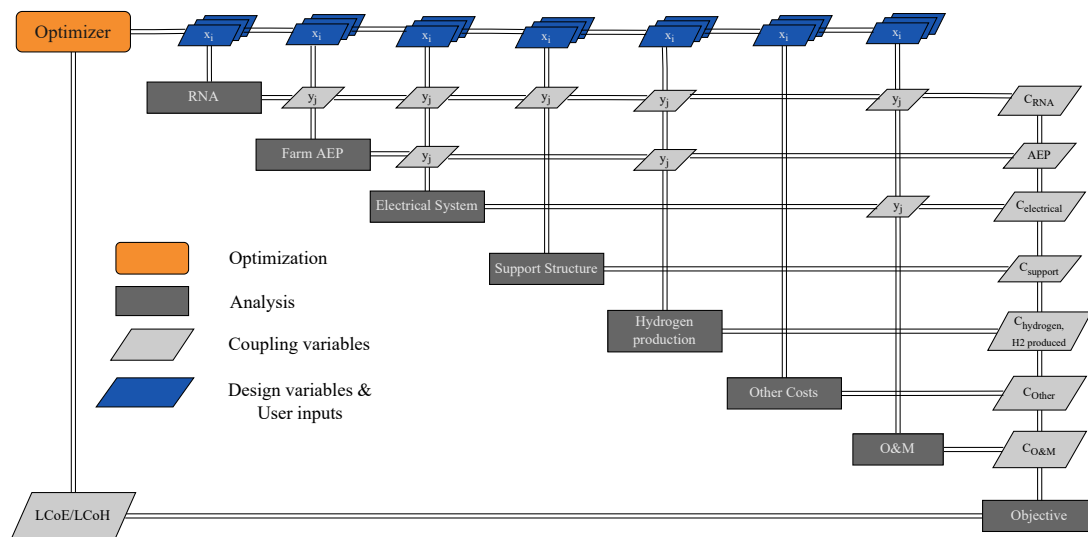

Figure 2: XDSM of the wind farm level MDAO framework

The blocks in dark gray represent various disciplines modelled in the framework. The hydrogen production is only used when the objective is to minimize LCoH. For electricity production, the module can be simply skipped. The Rotor Nacelle Assembly (RNA) module evaluates all the rotor aerodynamic properties, mass of various components and their respective costs. The rotor geometry and hub height follow linear geometric scaling rules. For every design, the power coefficient (C_p) is evaluated, which is then used to calculate the rated wind speed and subsequently the partial and full-load regions of the turbine. Along with that, the effect of a change in loading due to a change in the rated wind speed (from the reference) is also taken into account by adjusting the rotor mass. The upscaling coefficients for rotor mass and cost are based on the work of Griffith [13] and Bortolotti [14]. The FarmAEP module uses the layout and wind characteristics as inputs to determine the farm power at any given instant and the overall Annual Energy Production (AEP). The electrical system optimizes the infield cable layout and evaluates the cost of cabling. The support structure module determines the mass and costs of the tower and the monopile using water depth, turbulence intensity, RNA properties, etc. as inputs. The module for ‘Other costs’ calculates the cost of installation, commissioning, decommissioning, and project development, while the O&M module calculates the Operations & Maintenance (O&M) costs based on the number of turbines, overall repair costs, fixed costs, etc.

The hydrogen production module evaluates the overall hydrogen production along with the costs of all the components needed for hydrogen production. A PEM electrolyzer is used inside each turbine due to its compactness, high output pressures, high efficiencies, and near-zero base load requirement [3]. The electrical export cable and substation is replaced by pipelines. The cost of the transformers, converters, switch gears used in the RNA is also reduced for a hydrogen producing turbine. However, the additional costs of a compressor, water purification unit, etc. are taken into account. The system efficiency is based on the work of Kopp [15] where it is assumed to be higher for lower input loads, peaking at about 30 % input load, followed by a drop in the efficiency for higher input loads. The costs for the in-turbine hydrogen system are based on the work performed by NREL [16] and de Klerk [17]. The work of de Klerk was supported by an industrial partner, Hygro Technology, that offers design solutions for wind turbine-integrated hydrogen production. The infield pipelines from each turbine carry hydrogen at 100 bar that finally connects to a central hydrogen export pipeline. The export pipeline cost factor is based on the estimations of the ‘European hydrogen backbone’ project [18].

The IEA 15 MW - 240 m turbine [19] is used as the reference design and for the optimization, the turbines are scaled using this design as the starting point. The study is performed for a typical offshore wind site in the North Sea. The framework is first used to optimize the rated power and diameter of the IEA turbine for LCoE. This is done in order to have a fair comparison of designs optimized using the same set of assumptions and models. The LCoE-optimized design can then be used as a comparison point for the turbine design for hydrogen production, which is optimized for LCoH. Lastly, a sensitivity study is performed w.r.t. various parameters.

For every combination of power and diameter, the support structure is redesigned due to the change in RNA mass and the thrust acting at the tower top. A change in diameter also results in an increase in the absolute spacing between the turbines resulting in a redesign of the infield cabling layout. The change in rotor power and diameter leads to a change in the thrust coefficient, layout, rated wind speed, etc., as a result of which the wake losses are re-evaluated. A change in power and/or diameter also has a direct effect on the amount of hydrogen produced and the costs of the hydrogen system.

4. Case study

As the base case, a sample wind farm, with a fixed power of 1 GW, in the North Sea region is used to carry out all analyses. This represents a scenario where the developer bids for a given grid capacity, making the farm power fixed. For this case, an increase in the rated power of the turbine results in a decrease in the number of turbines. The case is run for a discrete set of points where the number of turbines hold integer values and the rated power of the turbine is adjusted to get a farm power of 1 GW. As an additional case, a farm with a fixed number of turbines is also simulated. The general specifications of the farm are given in Table 1. In the results section, the two cases will be referred to as ‘Fixed farm power’ case and ‘Fixed N_t ’ case.

Table 1: Reference farm specifications

Parameter	Value	Unit
Distance to shore	60	km
Water depth	30	m
Mean wind speed	9.4	m s^{-1}
Lifetime	25	years

For the given farm specifications and using the 15 MW reference turbine in a farm with 70 turbines, the cost breakdown of various components for both the electricity and the hydrogen

configuration are shown in Figure 3 and Figure 4, respectively. The ‘Other turbine’ costs include assembly, profit, warranty, etc. while ‘Other installation and commission’ costs include contingency, insurance, etc. [20]. For the hydrogen production configuration, instead of cables and substation, the costs of export and infield pipelines are added. The electrolyzer system costs, which include stacks, Balance of Plant (BoP) and indirect costs, are labelled as ‘H2 costs.’ It can be seen that O&M takes up a major share of both LCoE and LCoH, which makes the scaling of O&M costs crucial.

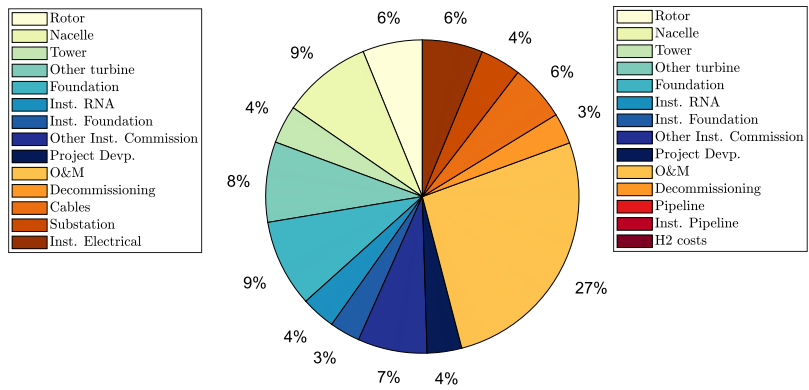

Figure 3: LCoE cost breakdown

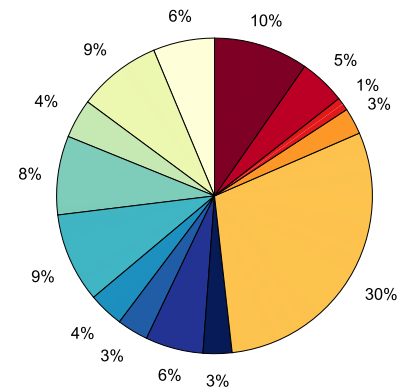

Figure 4: LCoH cost breakdown

5. Results and sensitivities

Turbine upscaling has largely contributed to the reduction in LCoE. Figure 5 shows the upscaling process observed in the industry.

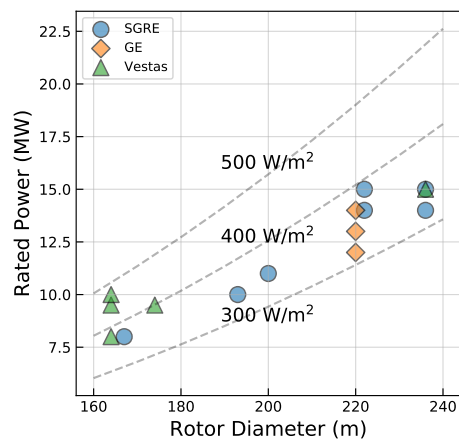

Figure 5: Recent offshore wind turbine designs observed in the industry

This upscaling process, however, depends on several limitations. Various physical constraints and challenges related to loads, installation, manufacturing, transport, etc. limit the rotor size, which is then offered in the market. For this platform, the generator power of the turbine is then optimized or up-rated for the offered rotor size until a technological innovation makes a larger rotor size possible. A new platform with a larger rotor size is then offered in the market

where the generator is again re-designed or up-rated for the available rotor size, and the process continues. In line with this, the results presented in this section for a ‘rotor diameter constrained’ environment are relevant, where the rated power of the turbine is optimized for a given rotor diameter (or blade size). Along with this, another set of results are presented where the rotor diameter is optimized for a given rated power of the turbine. This would be a case where the developments in generator technologies become the bottleneck, making the industry ‘rated power constrained.’

The results for the ‘fixed farm power’ case shown in Figure 6 and Figure 7 are for both ‘rotor diameter constrained’ and ‘rated power constrained’ environments. The ‘optimum rated power’ (dashed line) is for a ‘rotor diameter constrained’ environment, which is when the wind turbine manufacturer is limited by the maximum available blade size. The ‘optimum rotor diameter’ (dash-dotted) is for a ‘rated power constrained’ environment, which is when the wind turbine manufacturer is limited by the maximum available generator size. Along with the optimum data points, the figures also show a colormap containing iso-lines at various LCoE and LCoH levels. The crossover point in each figure represents the global optimum beyond which LCoE or LCoH start to increase, and any further upscaling is no longer of interest.

It should be noted that this study uses cost data available in the public domain, and it is known that these numbers may not exactly represent current industrial values. However, the conclusions don’t depend on the absolute numbers but rather on the modelled proportions and scaling of various cost components.

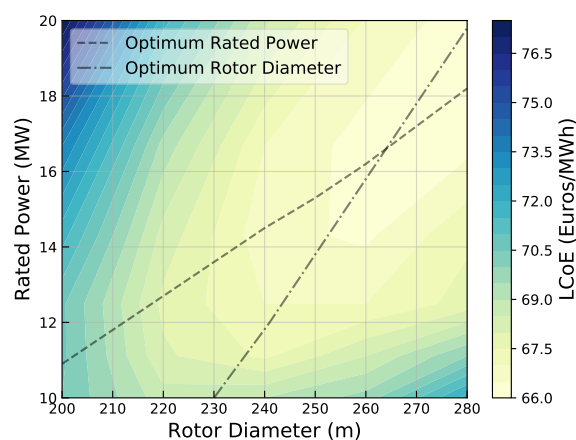

Figure 6: Upscaling results for LCoE: ‘Fixed farm power’

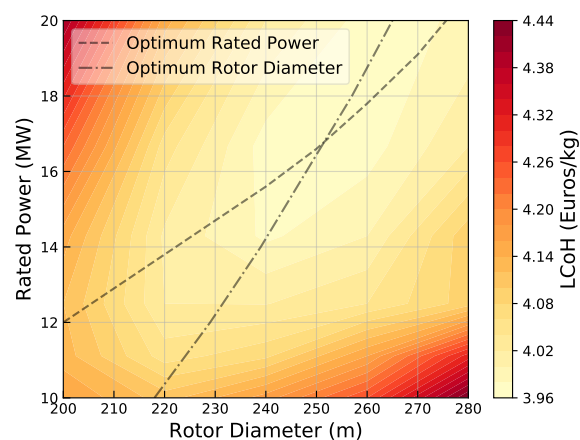

Figure 7: Upscaling results for LCoH: ‘Fixed farm power’

With the current costs of offshore wind farms and in-turbine hydrogen production configurations, it is observed that the LCoH-optimized turbine has a higher specific power compared to the LCoE-optimized turbine. This can be partly explained by the efficiency curve of the electrolyzer system. As the efficiency peaks at lower input loads, the optimizer tries to increase the rated power for the same rotor diameter to operate more often near these favourable input loads. Figure 8 shows a comparison of normalized electricity and hydrogen production. It should be noted that the normalized production decreases with an increase in rated power due to the decreasing number of turbines to maintain the same overall farm power. It can be seen that for the same rotor diameter, the drop in the hydrogen production with the upscaling of power is lower than that of the electricity production, which results in a tendency to go towards higher power ratings. For a larger rotor size (280 m), the number of full-load hours (for the given rated

power range of 10-20 MW) is higher than that of the 200 m rotor. As a result, the normalized production is relatively higher in the given range of rated power values.

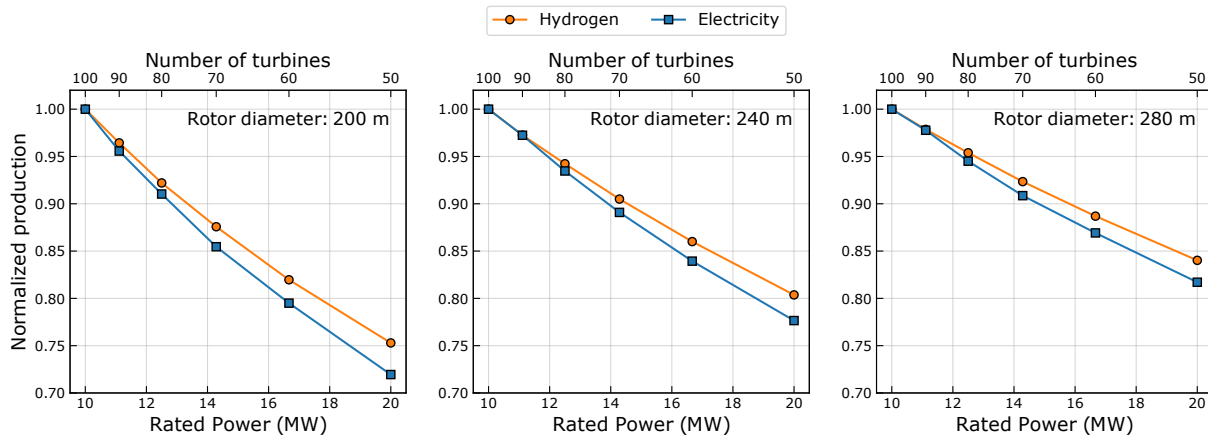

Figure 8: Differences in production of electricity and hydrogen normalized by the respective production values of the 10 MW turbine

The global optimum for hydrogen production and electricity production are found to differ, but the difference in LCoH values for the two designs is roughly 1%. This indicates that the turbine optimized for electricity production (LCoE) performs well when used for hydrogen production compared to a turbine specifically optimized for hydrogen production (LCoH). The capacity factors of both the optimum designs lie around 0.56. It is also important to note that in this optimization, the maximum tip speed is not constrained, which may lead to issues like erosion. The maximum tip speed attained for any optimum point is less than 100 m s^{-1} , which is close to the reference turbine value of 95 m s^{-1} .

The results for the ‘Fixed N_t ’ case are shown in Figure 9 and Figure 10. It can be seen that in comparison to the ‘Fixed farm power’ case, the optimizer yields a much higher rated power for the same rotor diameter. This difference can be largely attributed to the scaling of O&M costs in both the cases.

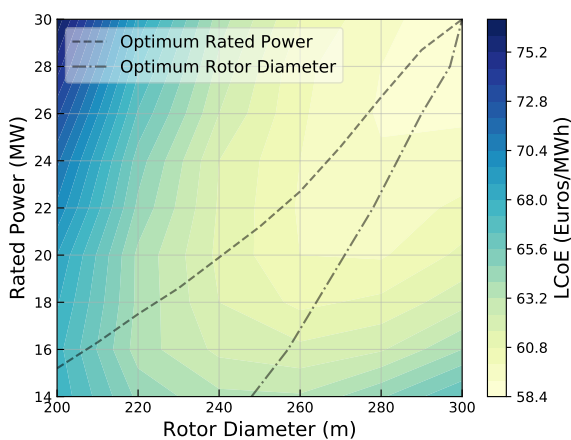

Figure 9: Upscaling results for LCoE: ‘Fixed N_t ’

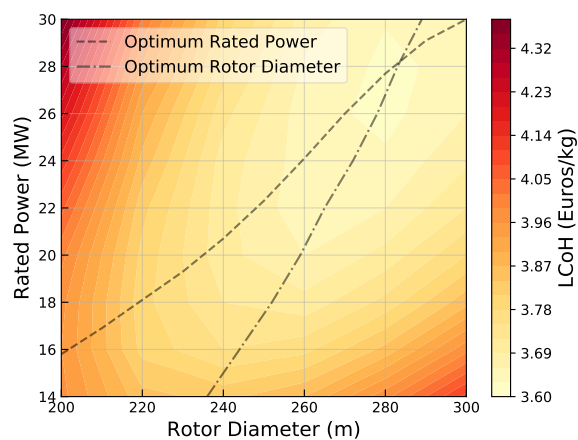

Figure 10: Upscaling results for LCoH: ‘Fixed N_t ’

The O&M model has a component for fixed costs, which includes training, insurance, environmental survey, turbine and BoP inspection, etc., that does not scale with turbine power or diameter. The major share of O&M costs is taken by the variable part which depends on turbine and BoP related repairs. The O&M cost model is calibrated with cost values for a reference 1 GW farm defined by BVG [20]. The variable costs, C_{variable} , are thus of the form:

$$C_{\text{variable}} = f(C_{\text{RNA}}, N_t) + f'(C_{\text{BoP}}, N_t) \quad (1)$$

where C_{RNA} is the cost of RNA, C_{BoP} is the cost of Balance of Plant (BoP), and N_t is the number of turbines. The scaling of costs with N_t represents the change in the overall mission time for repairs and hence the costs (as the costs are dominated by per day vessel rates). The scaling of costs with C_{RNA} and C_{BoP} represents the change in spare part cost which constitutes a small portion of the overall repair costs. The difference in scaling of O&M costs with diameter and power leads to different optimum values for the two use cases. For the ‘Fixed farm power’ case, the number of turbines reduce with the upscaling of rated power while the cost of spare parts goes up, resulting in an overall reduction of O&M costs. However, for the ‘Fixed N_t ’ case, a large portion of the O&M costs remains constant due to the constant number of turbines. This results in a significant decrease in the overall O&M costs per MW of rated power. This is why the rated power values are higher than those in the ‘Fixed farm power’ case. This can also be seen in Figure 11 and Figure 12. These are re-arrangements of the information presented in all the colormaps, providing a direct comparison between the optimum for hydrogen production and electricity production. The specific power value of all the optimum designs in Figure 11 is between 300 W m^{-2} and 400 W m^{-2} , which is close to the value of recent commercial turbines offered in the market (see Figure 5).

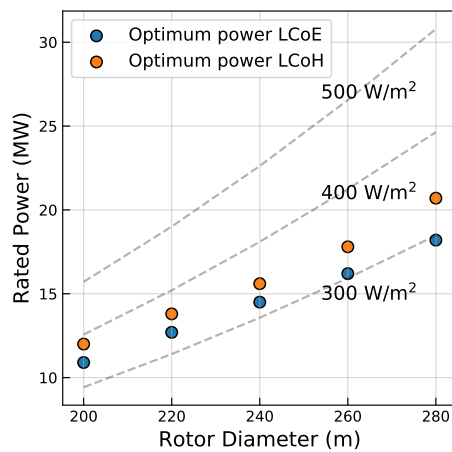

Figure 11: Optimum rated power for different rotor diameters: ‘Fixed farm power’

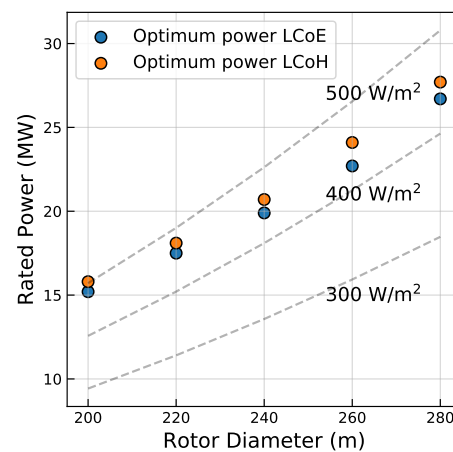

Figure 12: Optimum rated power for different rotor diameters: ‘Fixed N_t ’

As the electrolyzer system constitutes most of the hydrogen-related costs, a sensitivity study w.r.t. its costs is performed. A range of 200 to 500 \$/kW for the electrolyzer system (stack and BoP) is used for the analysis. The results, performed for the ‘Fixed farm power’ case, are shown in Figure 13. The blue full circles are the optimum points for LCoE while the error bars for the orange circles represent the minimum and maximum optimum values of rated power obtained for LCoH.

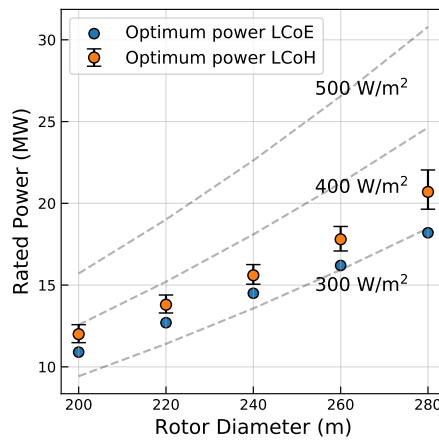

Figure 13: Optimum rated power sensitivity to hydrogen system costs

The maximum value points are the points with the lowest electrolyzer costs while the minimum value points are the points with the highest electrolyzer costs. With the decreasing trend of costs for electrolyzers, the average optimum rated power of in-turbine hydrogen turbines (optimized for LCoH) is expected to be higher than that of turbines for electricity production (optimized for LCoE). This again indicates a trend towards higher specific power turbines for hydrogen production.

The nature of the electrolyzer efficiency curve and the low costs of the electrolyzer are identified as major drivers that lead LCoH-optimized turbines towards high power ratings. To further explore this, the ratings of the turbine and electrolyzer are decoupled and the electrolyzer is allowed to have a higher rating compared to the turbine. In the results presented so far, the power rating of the electrolyser plus its ancillary equipment is equal to the rating of the turbine. Figure 14 shows the optimum power rating when the rated power of the electrolyser equipment is 20% higher than that of the turbine. As an example, a rated power of 15 MW on the y-axis of the graph indicates a turbine rated power of 15 MW and electrolyzer rating of 18 MW.

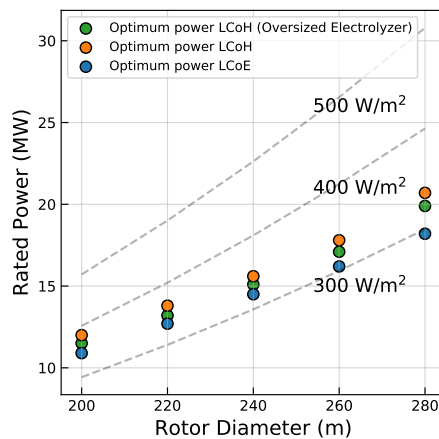

Figure 14: Optimum turbine rated power for oversized electrolyzers

As expected, this results in a drop in the optimum turbine rated power. A higher rating for the electrolyzer allows it to operate at low input loads more of the time, resulting in a higher efficiency. The oversizing of electrolyzers, instead of upscaling every turbine in the farm, does not have a significant impact on the costs due to their low overall share in LCoH relative to the costs of the turbines in the wind farm. This strategy also resulted in a drop of LCoH by about 3-5% compared to the reference 'Fixed farm power' case. Oversizing the electrolyser equipment by 20% in power rating is just an example. The results indicate that it is worthwhile to consider electrolyser-equipment rating as a separate variable to optimise, with the likely outcome that the equipment will be higher rated than the turbines.

6. Conclusions

This study explores an upscaling study for both electricity and hydrogen production and also presents the possibility of a global optimum for both configurations, which is within reach of current turbine sizes. The relevance of these global optima to the current study is that the comparisons between hydrogen and electricity turbines hold all the way up to the scale at which these are reached. This indicates a strong general validity of the conclusions presented below, also for future developments. However, the absolute value of these global optima depends on the case setup, the cost modelling of various elements, their scaling, and on how these costs evolve in the future. The key insights that can be drawn from this study are listed below:

- (i) The upscaled optimum designs for both electricity and hydrogen production show specific power trends similar to values currently observed in the industry. Turbines optimized for hydrogen production show a tendency to go towards higher specific powers due to the gain in operating efficiencies. However, due to the similarity in scaling up of the costs of most wind farm components for both electricity and hydrogen production, the LCoH values for LCoH-optimized and LCoE-optimized designs do not show a significant deviation. As a result, the LCoE-optimized turbine designs are already well suited for hydrogen production.
- (ii) In an upscaling study like this, several elements play a significant role in determining the global optimum. For instance, the definition of a wind-farm level optimization problem is shown to largely affect the optimum values of rated power and rotor diameter. The 'fixed farm power' case is shown to reduce the specific power of optimum designs by more than 100 W m^{-2} compared to the 'Fixed N_t ' case.
- (iii) Oversizing the electrolyzer compared to the turbine is shown to be a good strategy for designing turbines with integrated-hydrogen production. This results in operating efficiency gains without scaling up the costs of all the turbines in the wind farm. However, the optimum oversizing ratio depends on the efficiency curve and the cost share of the electrolyzers.

At the moment, there is a marginal advantage in resizing a turbine specifically for hydrogen production. Instead, oversizing the electrolyzer compared to the turbine rating is observed to be a better design strategy. The sensitivity of the optimum values to the case description suggests that it is difficult for an academic study to pinpoint the absolute best design, but that the difference between a hydrogen turbine and an electricity turbine remains marginal under a wide range of cost assumptions and conditions. This is caused by the large part that the systems for both applications have in common. Therefore, LCoE-optimized turbines with oversized electrolyzers are well suited to cater to the current hydrogen market. The next generation of turbines for electricity, however, will arguably be optimized for the fluctuating market prices and for system flexibility which may lead to lower specific power designs [21]. Also, the demand for hydrogen is expected to increase while the costs of hydrogen production will likely decrease. Both trends would lead to a benefit for turbines being optimized for hydrogen production. As a consequence, differentiated designs may well appear in the future.

Acknowledgments

The authors would like to thank Hugo Groenemans, from Hygro Technology, for his inputs and insights w.r.t. the principal design of a hydrogen turbine and the costs of various components required for in-turbine hydrogen production. Icons for Figure 1 are made by Freepik, and taken from www.flaticon.com.

References

- [1] Schnettler A, Pflug V, Zindel E, Zimmermann Gerhard, Olvera O R, Pyc I and Trulley C 2021 Power-to-X: The crucial business on the way to a carbon-free world [White Paper] Tech. rep. Siemens Energy
- [2] van Wijk A and Wouters F 2021 *Shaping an inclusive energy transition* (Cham: Springer International Publishing) pp 91–120
- [3] IRENA 2020 Green Hydrogen Cost Reduction: Scaling Up Electrolysers to meet the 1.5°C Climate Goal Tech. rep. International Renewable Energy Agency Abu Dhabi
- [4] Levene J I, Mann M K, Margolis R M and Milbrandt A 2007 An analysis of hydrogen production from renewable electricity sources *Solar Energy* **81** 773–780 ISSN 0038-092X
- [5] Spyroudi A, Wallace D, Smart G and Stefaniak K 2020 OSW-H2: Solving the Integration Challenge Tech. rep. ORE Catapult
- [6] Babarit A, Gilloteaux J C, Clodic G, Duchet M, Simoneau A and Platzer M F 2018 Techno-economic feasibility of fleets of far offshore hydrogen-producing wind energy converters *International Journal of Hydrogen Energy* **43** 7266–7289 ISSN 0360-3199
- [7] Gusain D, Cvetkovic M, Bentvelsen R and Palensky P 2020 Technical Assessment of Large Scale PEM Electrolyzers as Flexibility Service Providers *IEEE International Symposium on Industrial Electronics* **2020-June** 1074–1078
- [8] Chandrasekar A, Flynn D and Syron E 2021 Operational challenges for low and high temperature electrolyzers exploiting curtailed wind energy for hydrogen production *International Journal of Hydrogen Energy* **46** 28900–28911 ISSN 03603199
- [9] Singlitico A, Østergaard J and Chatzivasileiadis S 2021 Onshore, offshore or in-turbine electrolysis? Techno-economic overview of alternative integration designs for green hydrogen production into Offshore Wind Power Hubs *Renewable and Sustainable Energy Transition* **1** 100005 ISSN 2667-095X
- [10] Glenk G and Reichelstein S 2019 Economics of converting renewable power to hydrogen *Nature Energy* **4** 216–222
- [11] Dykes K 2020 Optimization of wind farm design for objectives beyond LCOE *Journal of Physics: Conference Series* **1618** 042039 ISSN 1742-6588
- [12] Sanchez Perez Moreno S 2019 *A guideline for selecting MDAO workflows with an application in offshore wind energy* Ph.D. thesis Delft University of Technology
- [13] Griffith D T and Johanns W 2013 Large blade manufacturing cost studies using the Sandia blade manufacturing cost tool and Sandia 100-meter blades Tech. rep. Sandia National Laboratories
- [14] Bortolotti P, Berry D, Murray R, Gaertner E, Jenne D, Damiani R, Barter G and Dykes K 2019 A Detailed Wind Turbine Blade Cost Model Tech. rep. NREL/TP-5000-73585
- [15] Kopp M, Coleman D, Stiller C, Scheffer K, Aichinger J and Scheppat B 2017 Energiepark Mainz: Technical and economic analysis of the worldwide largest Power-to-Gas plant with PEM electrolysis *International Journal of Hydrogen Energy* **42** 13311–13320 ISSN 0360-3199

- [16] Mayyas A, Ruth M, Pivovar B, Bender G and Wipke K 2019 Manufacturing Cost Analysis for Proton Exchange Membrane Water Electrolyzers Tech. rep. NREL/TP-6A20-72740
- [17] de Klerk F D 2021 *Hydrogen turbines: Effects of an increasing power density on the levelised cost of hydrogen* Master's thesis (confidential until 2023) Delft University of Technology
- [18] Wang A, van der Leun K, Peters D, Buseman M *et al.* 2020 European hydrogen backbone: How a dedicated hydrogen infrastructure can be created Tech. rep. Gas for Climate
- [19] Gaertner E, Rinker J, Sethuraman L, Zahle F, Anderson B, Barter G E, Abbas N J, Meng F, Bortolotti P, Skrzypinski W *et al.* 2020 IEA wind TCP Task 37: Definition of the IEA 15-Megawatt Offshore Reference Wind Turbine Tech. rep. NREL/TP-5000-75698
- [20] The Crown Estate and Offshore Renewable Energy Catapult 2019 Guide to an offshore wind farm Tech. rep. BVG Associates URL <https://thecrownestate.co.uk/media/2861/guide-to-offshore-wind-farm-2019.pdf>
- [21] Swisher P, Murcia Leon J P, Gea-Bermúdez J, Koivisto M, Madsen H A and Münster M 2022 Competitiveness of a low specific power, low cut-out wind speed wind turbine in North and Central Europe towards 2050 *Applied Energy* **306** 118043 ISSN 0306-2619