

South facade 1:200

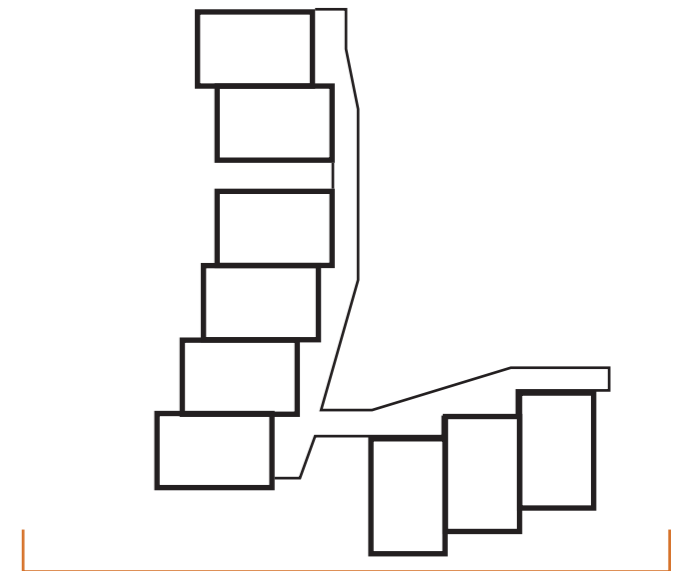

East facade 1:200

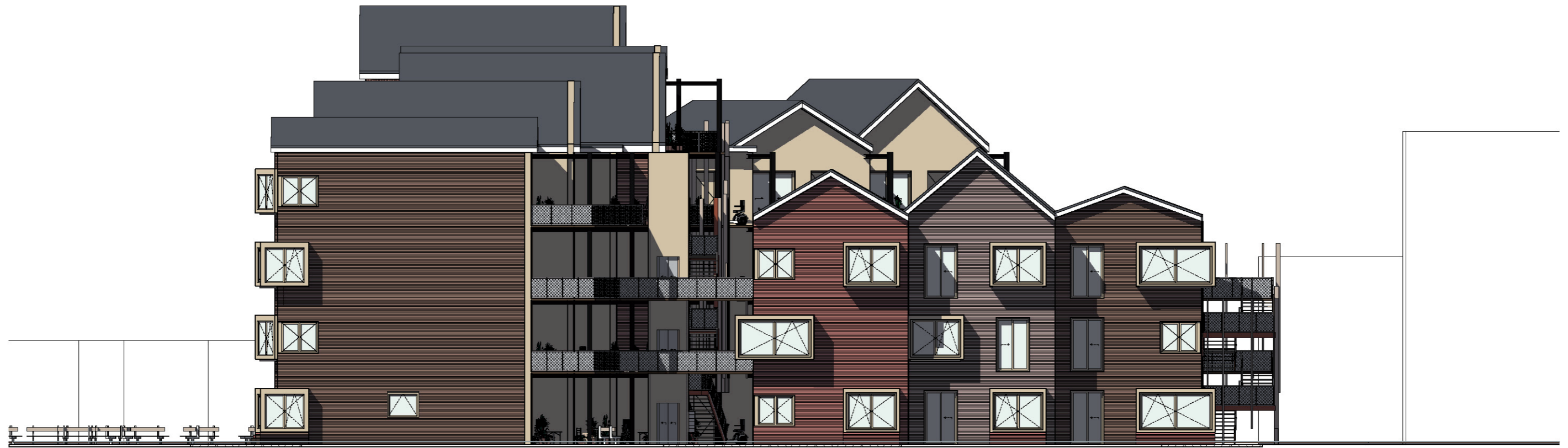
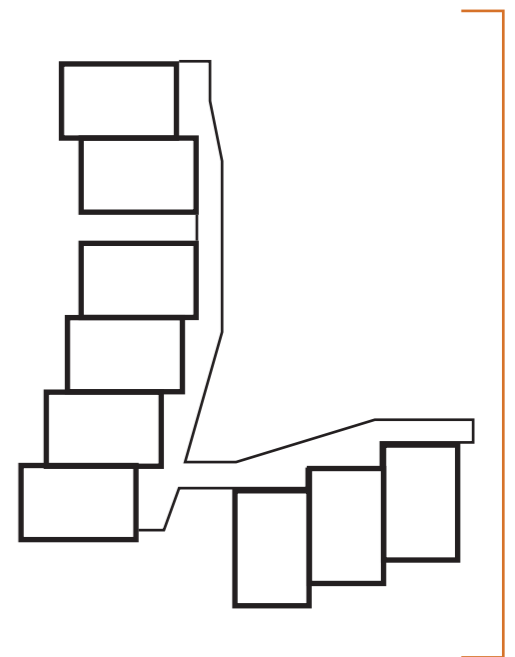

North facade 1:200

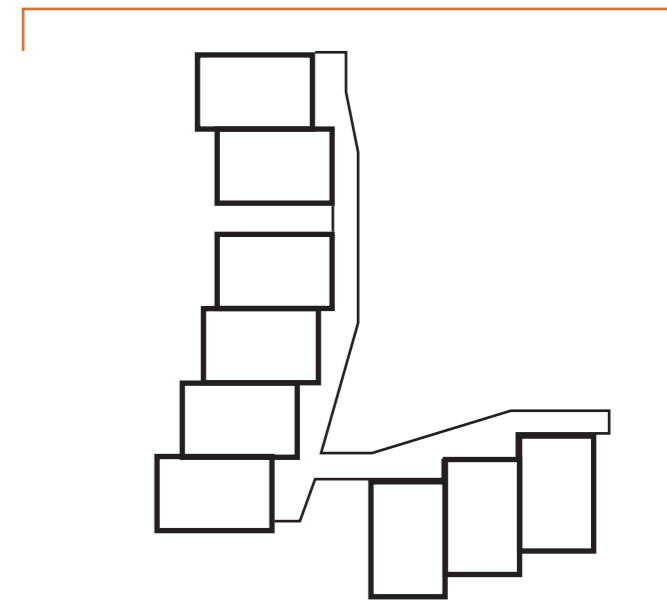

West facade 1:200

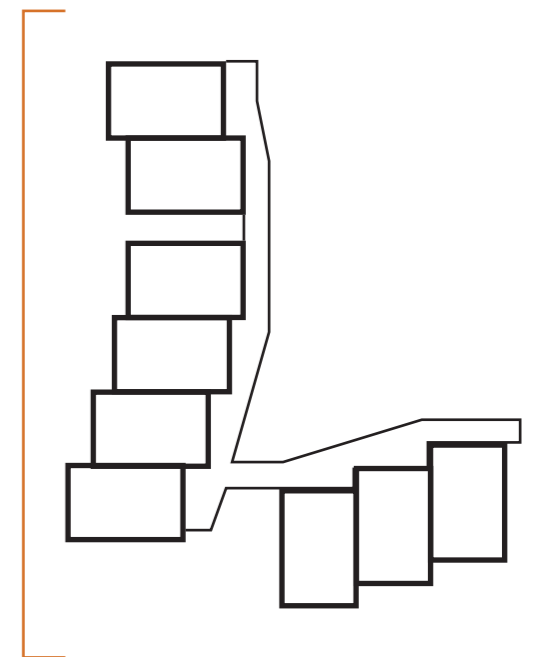

Masterplan



Masterplan



1:500

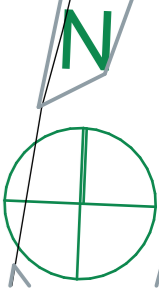

Ground floor



1:200

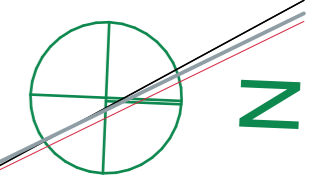

First floor



1:200

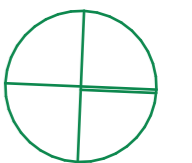

N

Second floor



1:200



N

Third floor

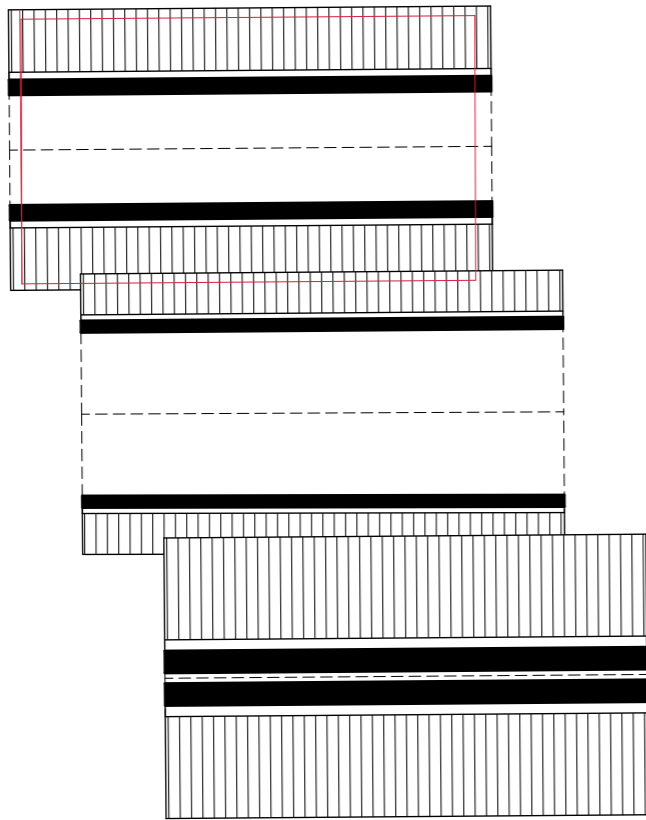
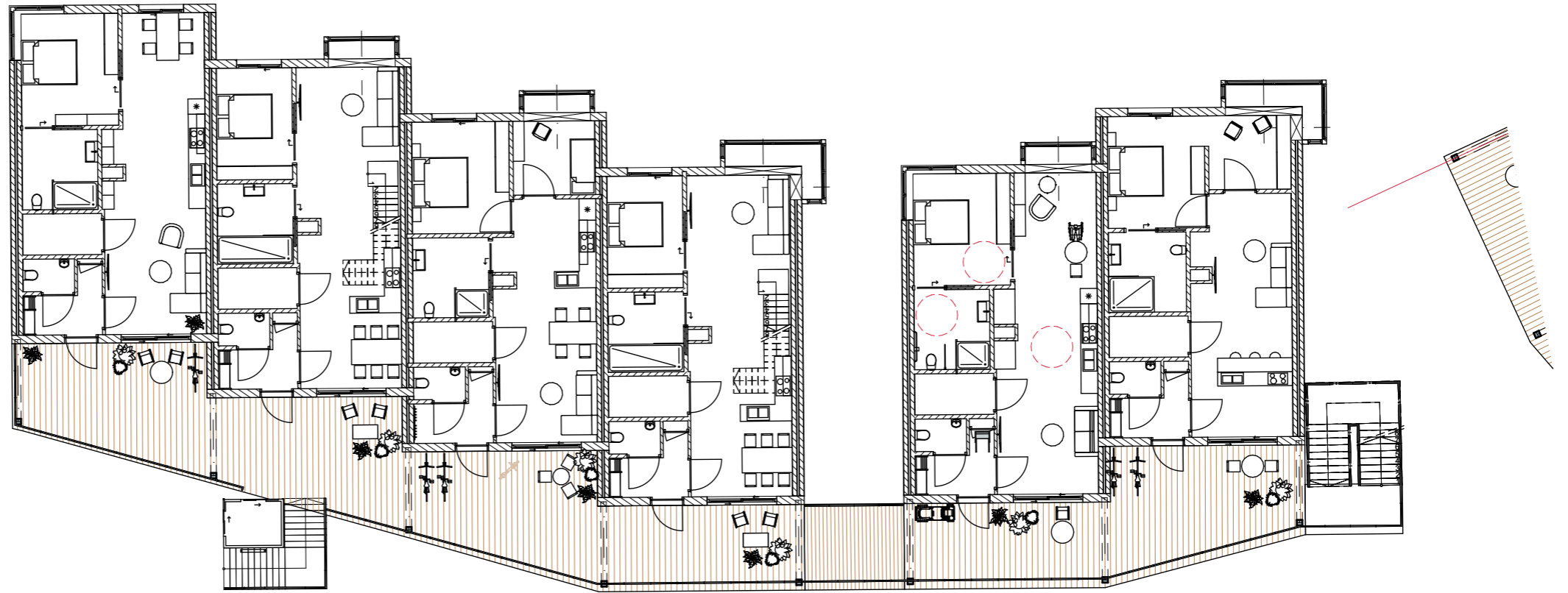

1:200



Fourth floor

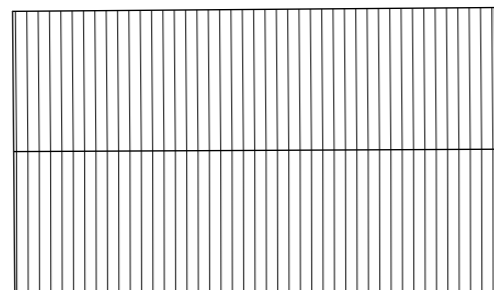
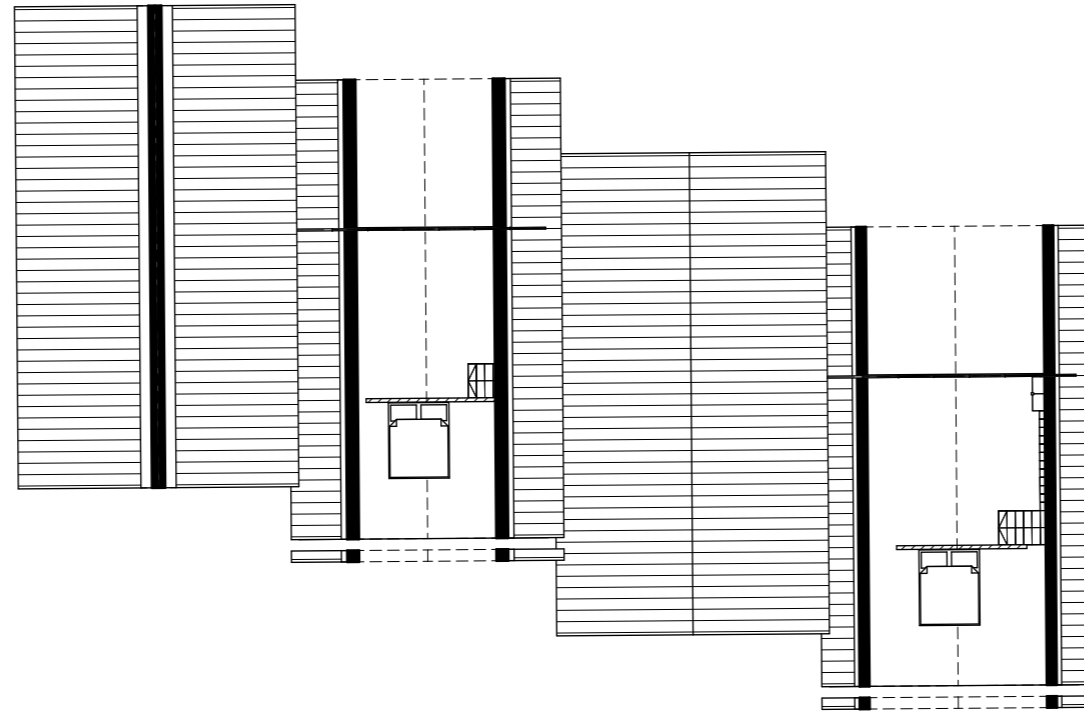

1:200



Fifth floor

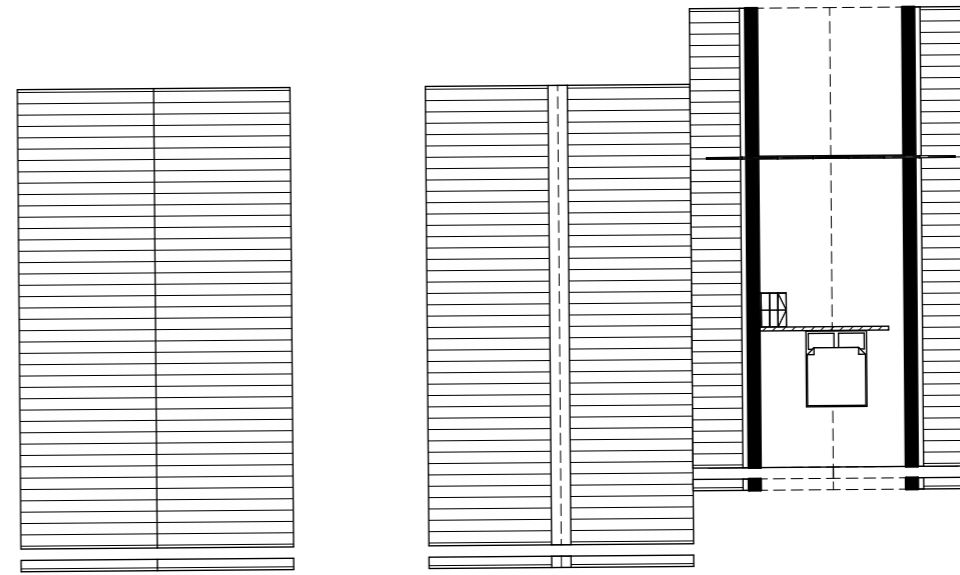

Sixth floor

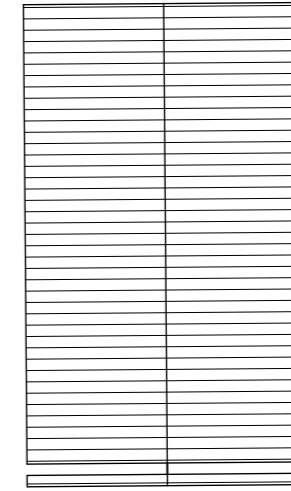

1:200

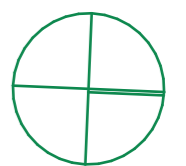

N

Section

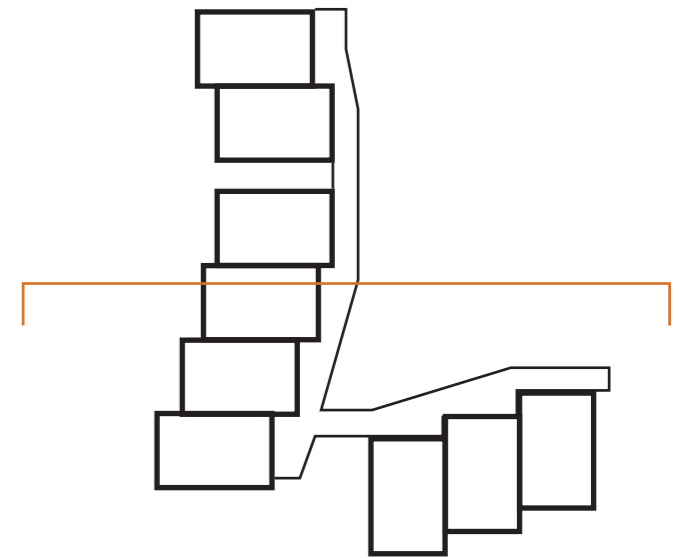

Section

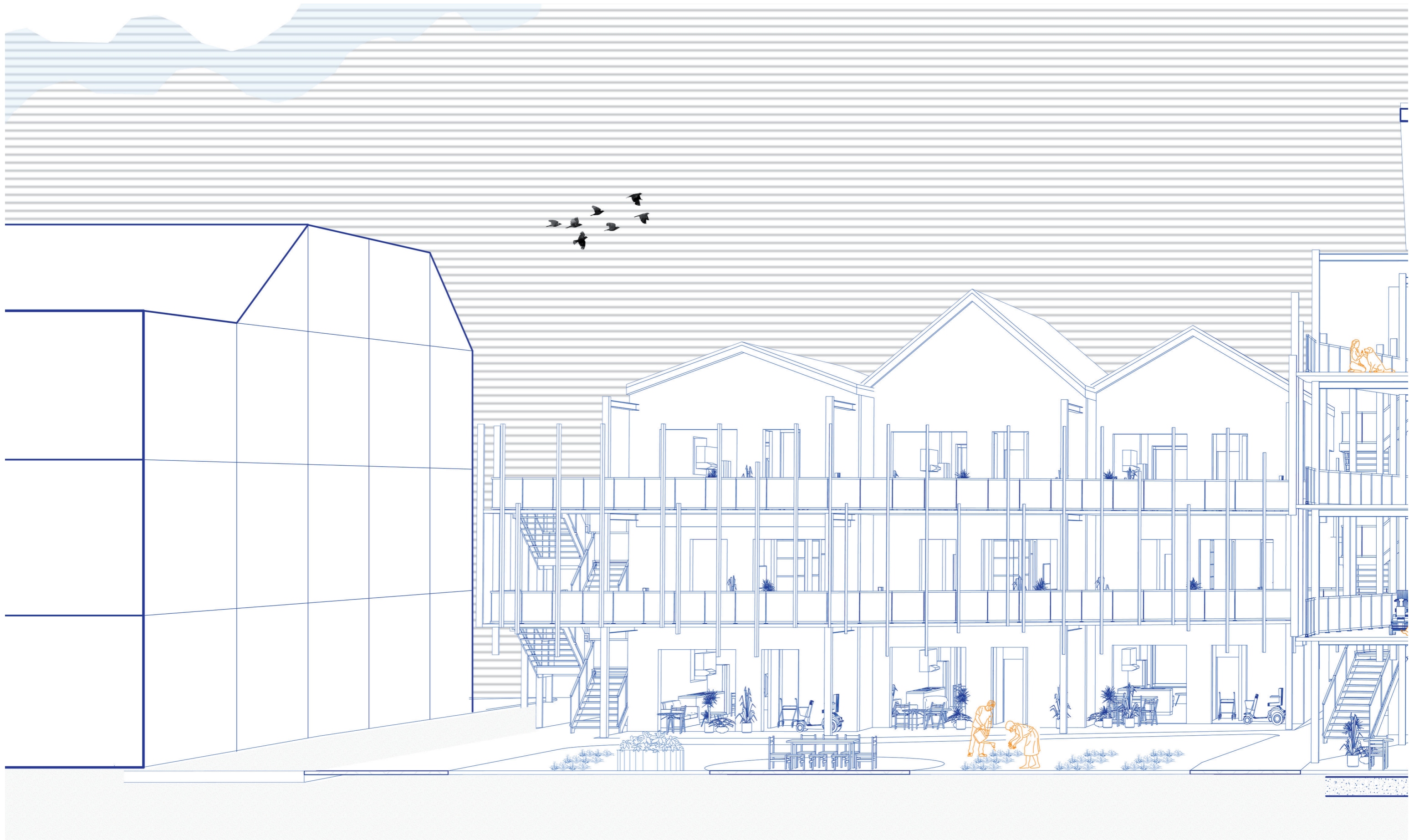

Section

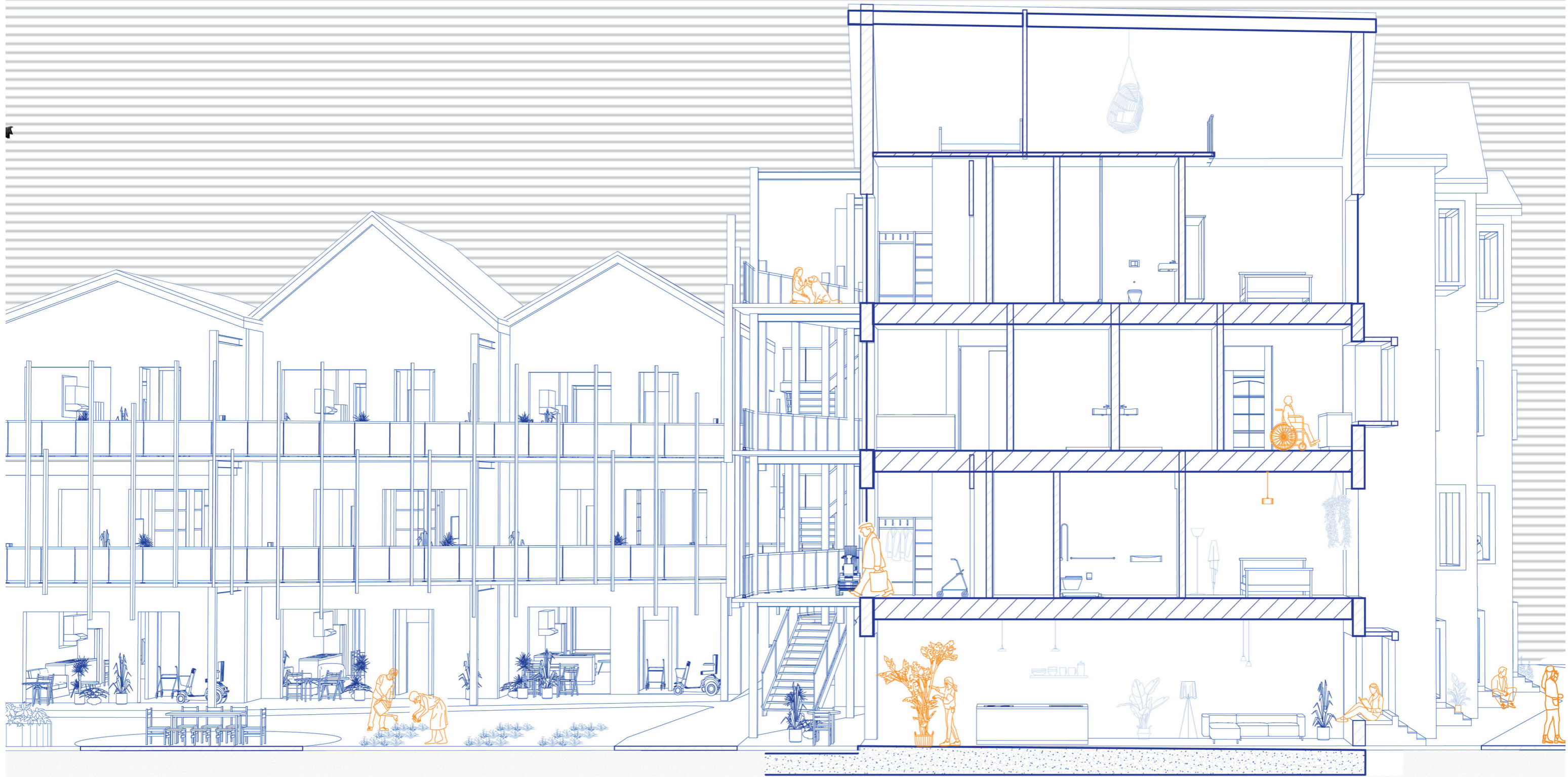

Section



Facade fragment

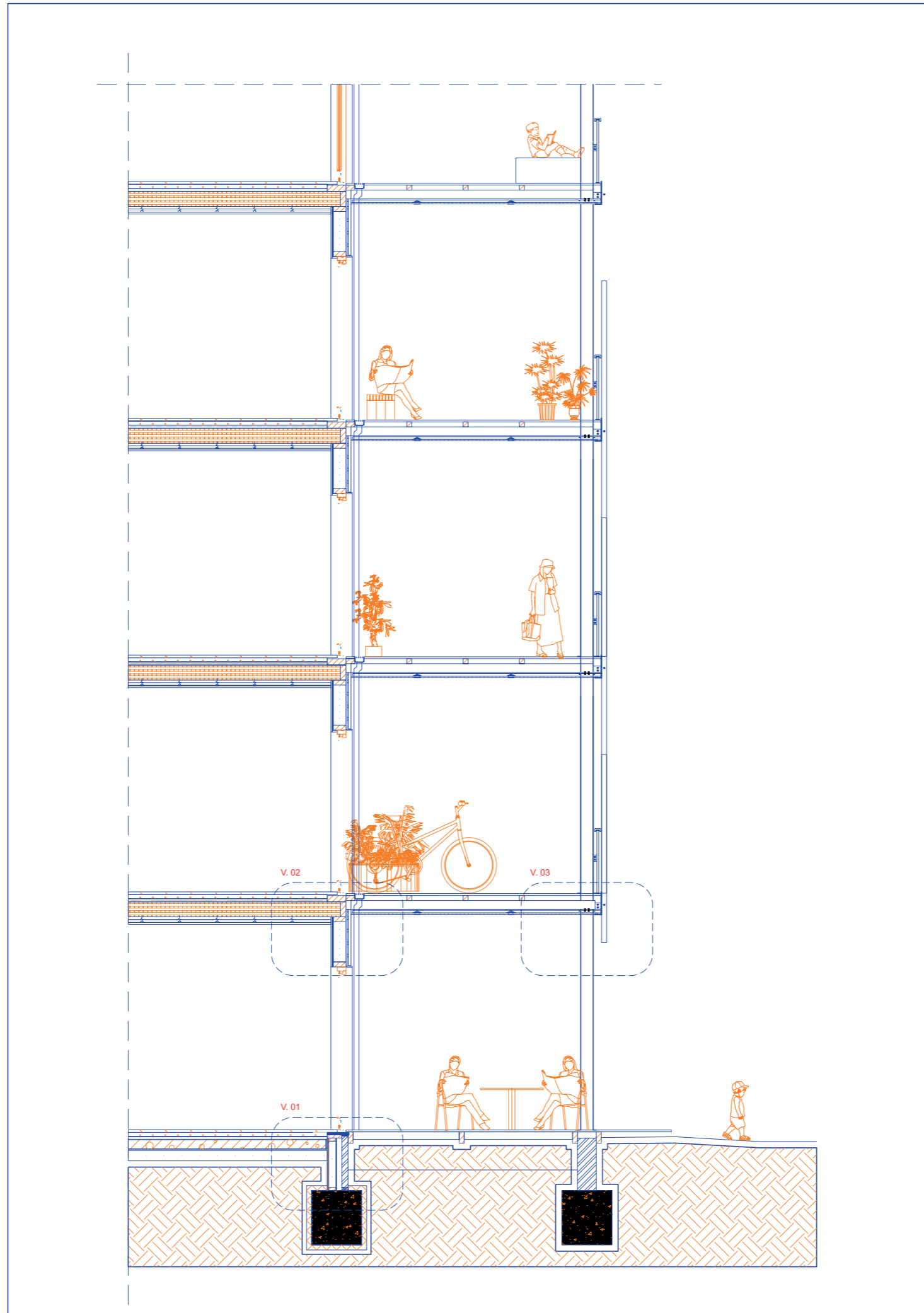

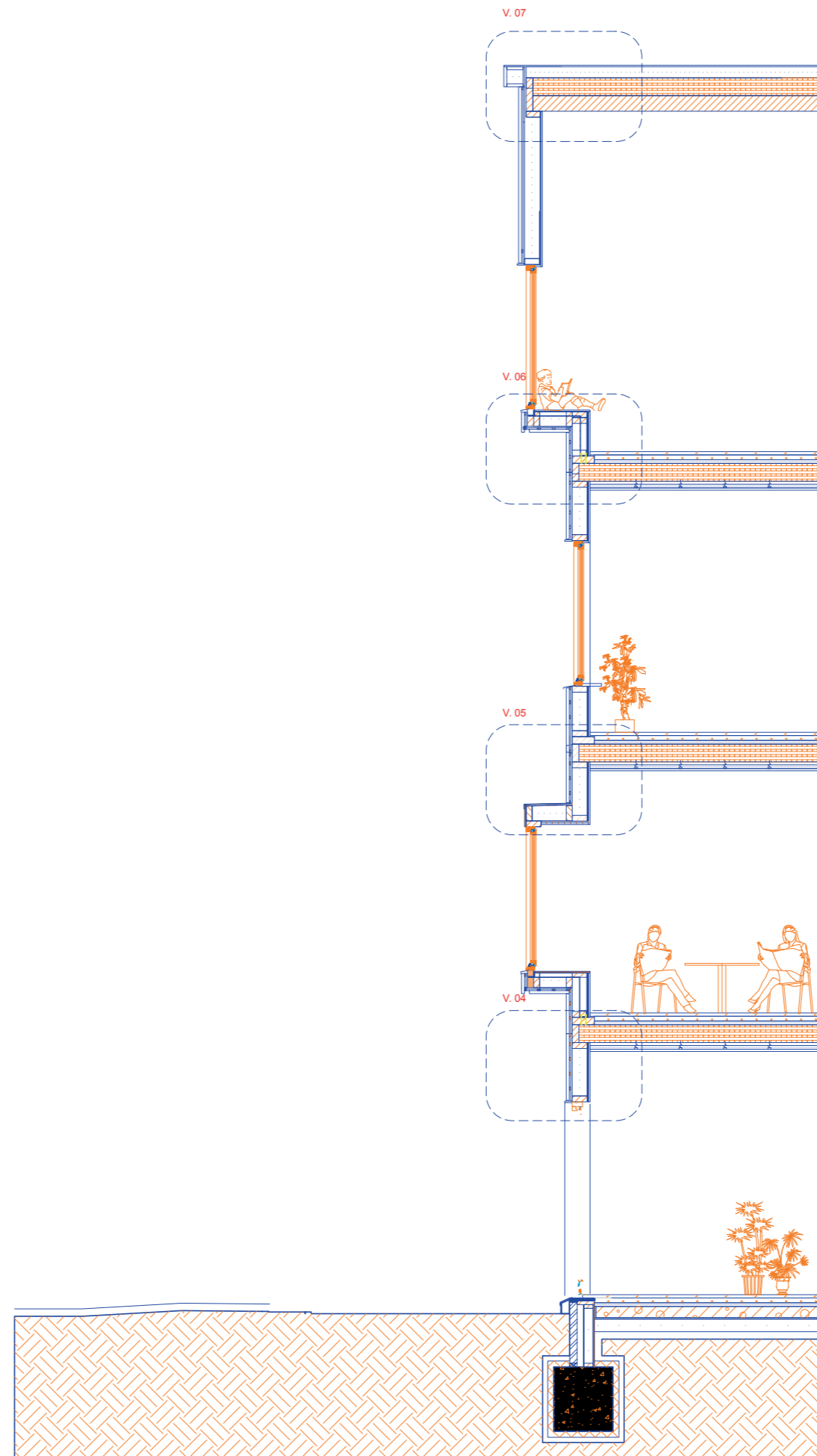

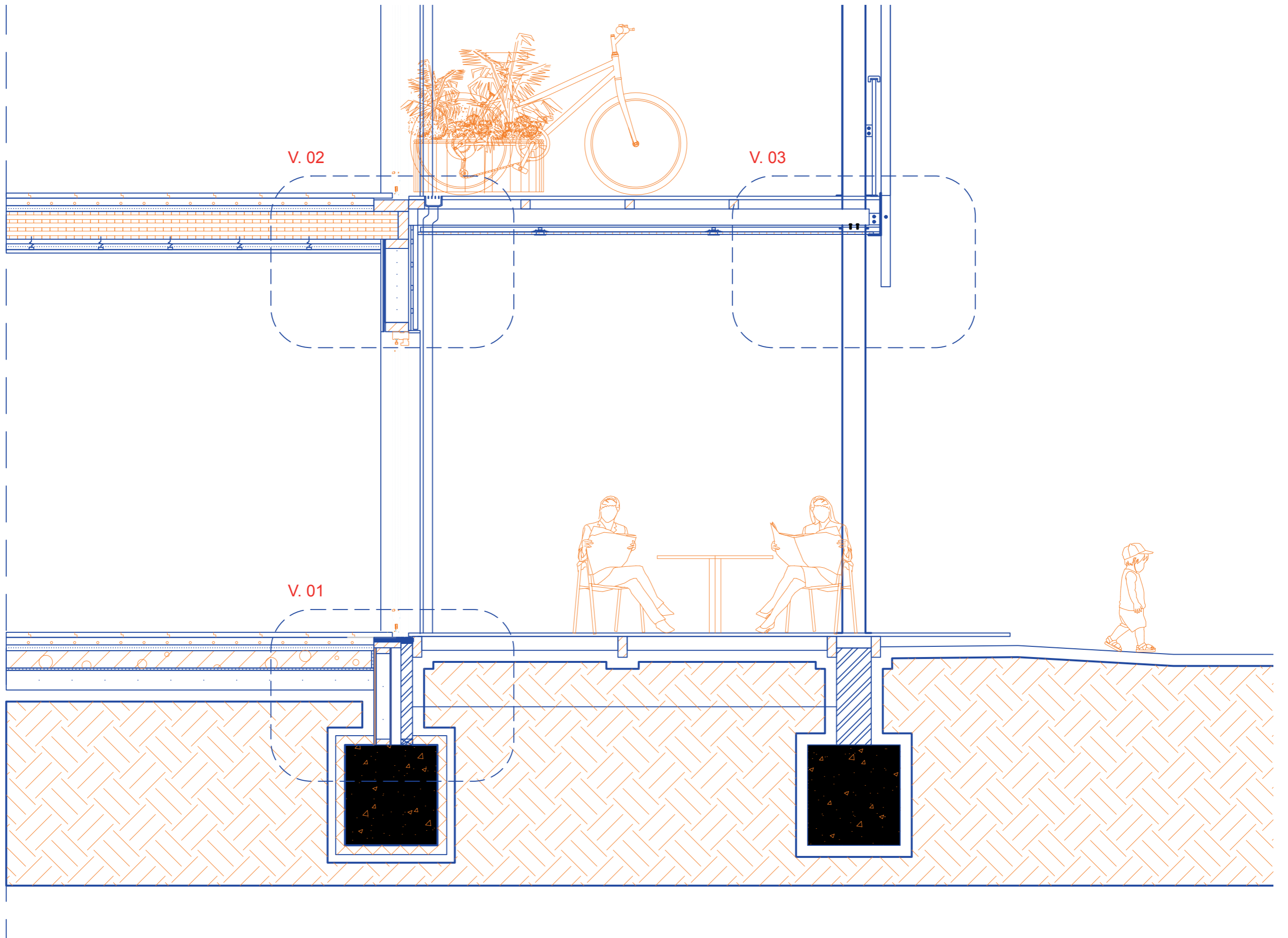

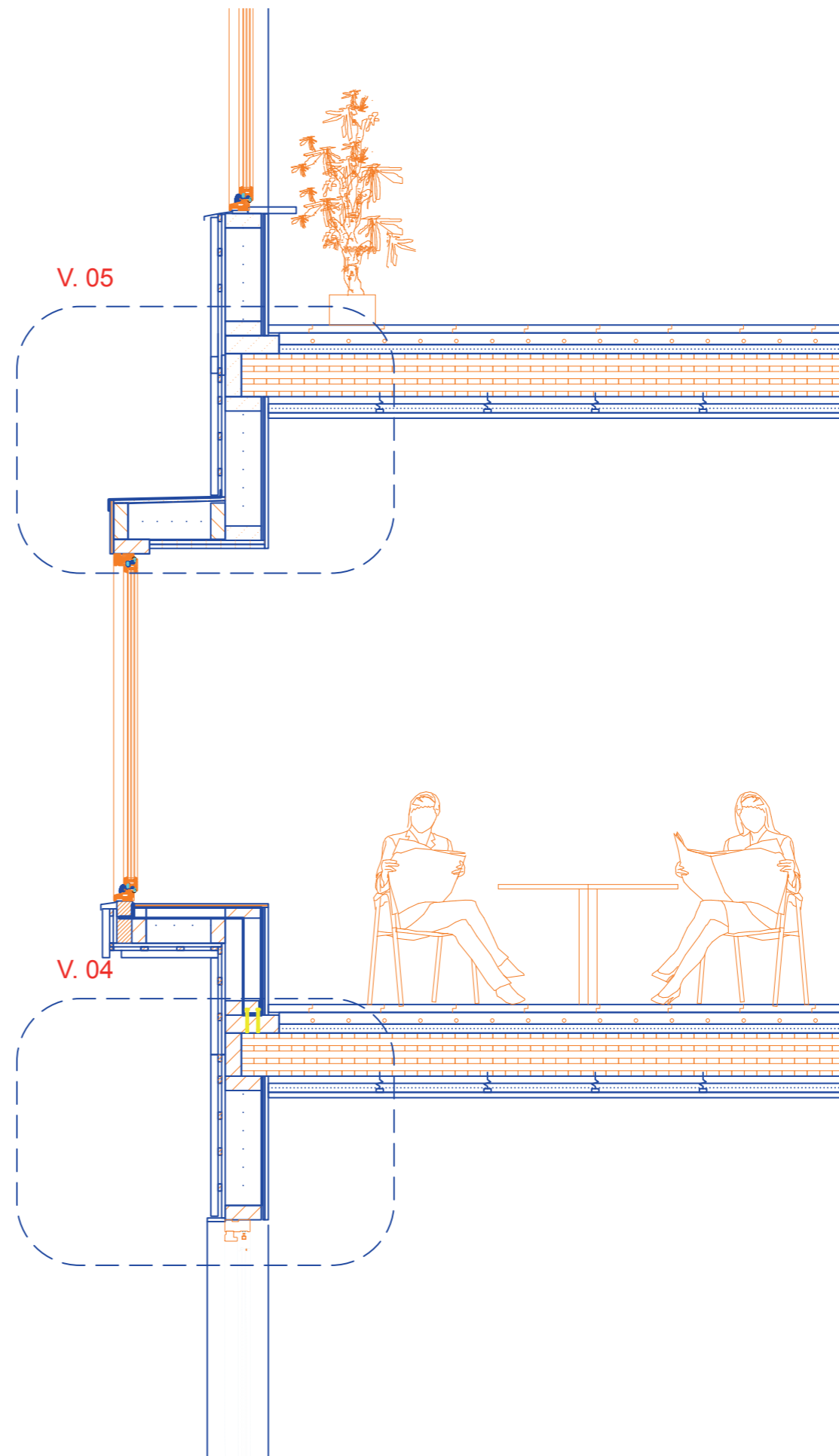

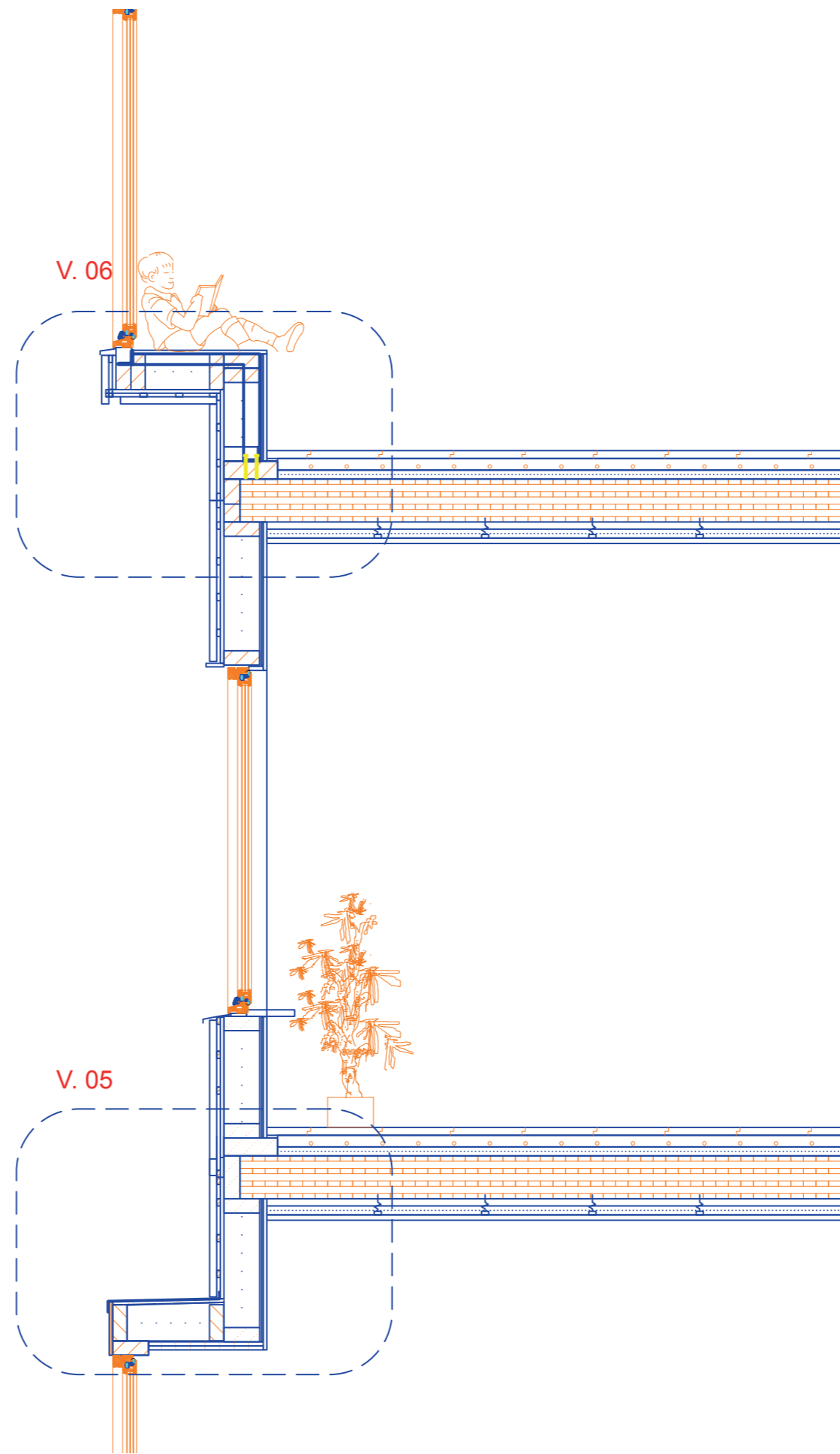

V. 07

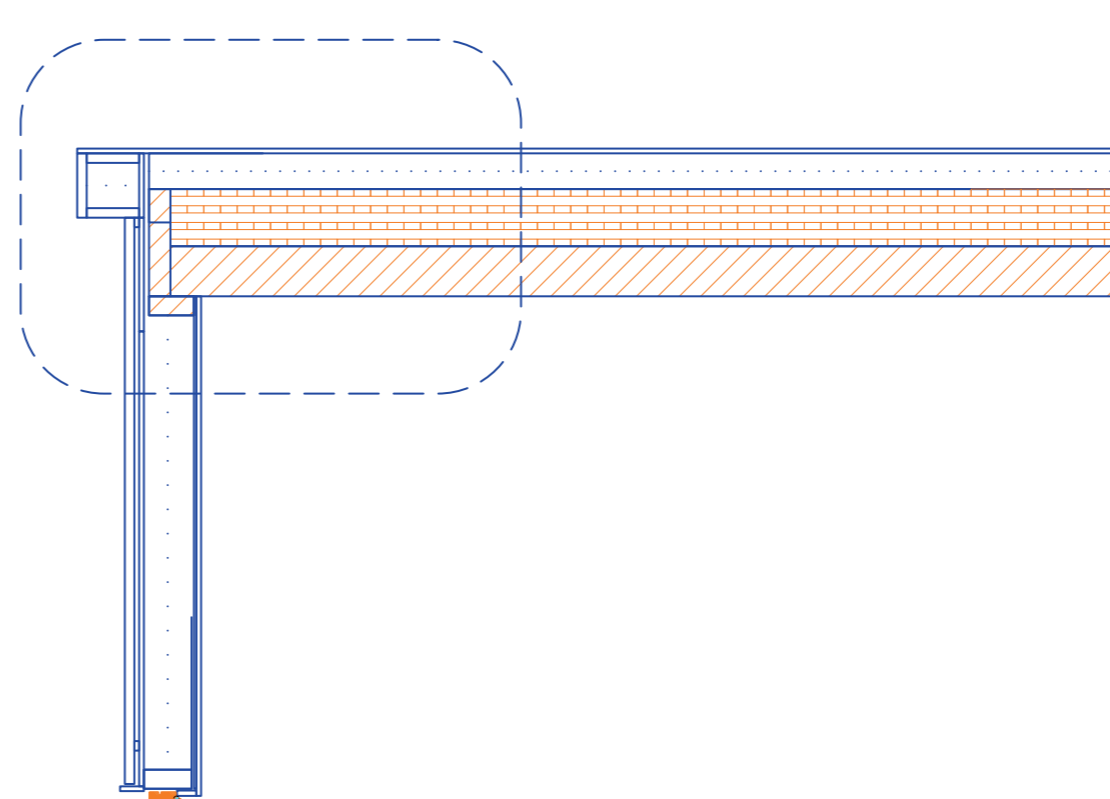

V. 06

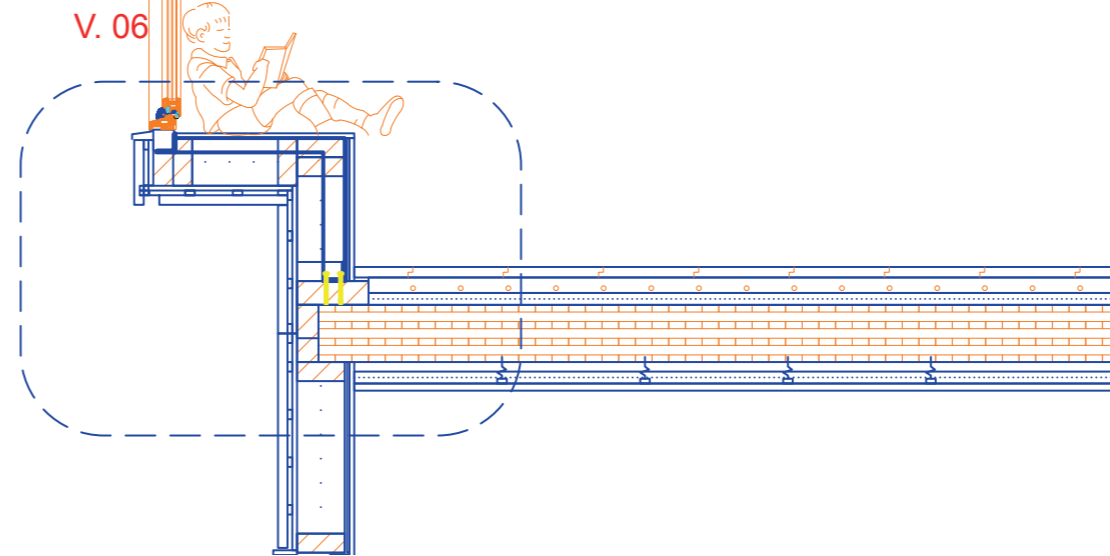

Facade fragment

