

Simulation-based optimization approach for material dispatching in continuous mining systems

Shishvan, Masoud Soleymani; Benndorf, Jörg

DOI

[10.1016/j.ejor.2018.12.015](https://doi.org/10.1016/j.ejor.2018.12.015)

Publication date

2019

Document Version

Accepted author manuscript

Published in

European Journal of Operational Research

Citation (APA)

Shishvan, M. S., & Benndorf, J. (2019). Simulation-based optimization approach for material dispatching in continuous mining systems. *European Journal of Operational Research*, 275(3), 1108-1125. <https://doi.org/10.1016/j.ejor.2018.12.015>

Important note

To cite this publication, please use the final published version (if applicable). Please check the document version above.

Copyright

Other than for strictly personal use, it is not permitted to download, forward or distribute the text or part of it, without the consent of the author(s) and/or copyright holder(s), unless the work is under an open content license such as Creative Commons.

Takedown policy

Please contact us and provide details if you believe this document breaches copyrights. We will remove access to the work immediately and investigate your claim.

Manuscript Number: EJOR-D-17-02503R1

Title: Simulation-based Optimization Approach for Material Dispatching in Continuous Mining Systems

Article Type: Innovative Application of OR

Section/Category: (D) OR in natural resources

Keywords: simulation-based optimization; opencast coal mining; short-term scheduling; material dispatching.

Corresponding Author: Dr. Masoud Soleymani Shishvan, Ph.D.

Corresponding Author's Institution: Delft University of Technology

First Author: Masoud Soleymani Shishvan, Ph.D.

Order of Authors: Masoud Soleymani Shishvan, Ph.D.; Jörg Benndorf, Professor

Abstract: This paper examines a problem related to dispatching materials to spreaders in coal (lignite) mines operated under the paradigm of continuously excavated material flow. In the considered particular case, complexity arises from different material types of overburden to be placed on the dump site in pre-defined patterns that guarantee geotechnical safety. These types include wet, semi-wet and dry material, which are accessed on the excavation site according to the geological deposition and the mining plan. Controlling of the dispatch system has to take into account the extraction sequence and geological stratification on the excavation site and the available dump space per material on the dumping site. With eight excavators on the excavation site and seven spreaders on the dump site the problem is already complex, having not stated yet that random breakdowns may make some options temporarily unavailable. To optimize the dispatch system in terms of minimum idle time due to unavailability of dumping space, a new multi-stage simulation-based optimization approach is proposed. This approach consists of running alternately a deterministic optimization model and a stochastic simulation model. It combines simulation and algorithms to solve a transportation problem and a job-shop scheduling problem. The proposed approach is tested on a large continuous mine under given different dumping sequences, and results are reported. The merits and limitations of the proposed approach as pinpointed and farsighted operations management are discussed.

Dear Prof. Dr. Robert Graham Dyson,

Enclosed, our revised manuscript is submitted. We truly appreciate all the constructive comments and suggestions from all reviewers. We have adopted all the suggestions in our revised manuscript.

We would appreciate, if the manuscript is considered for publication in European Journal of Operational Research.

Yours sincerely,
On behalf of authors,
Dr. Masoud Soleymani Shishvan

TU Delft
Department of Geosciences and Engineering, CEG
Room 3.31
Stevinweg 1
2628 CN Delft, NL
P.O. box 5048
2600 GA Delft, NL
T: +31 15 2787159
E: M.SoleymaniShishvan@tudelft.nl

*Detailed Response to Reviewers

Dear Reviewers,

We take this opportunity to express our profound gratitude and deep regards for spending your time for reviewing our paper, very appreciated.

The following is the point-to-point responses to your recommendations after applying the suggested corrections:

Reviewer #1:

This paper has developed a simulation-based optimised model for Continuous Mining System and applied on Hambach mine in Germany.

The authors appreciate your comments/suggestions and the below is the point-to-point responses to your valuable comments.

Comments:

i-1) How is this approach of simulation different from other simulation models?

Generally, simulation models only function as system analysis tools. In the context where decisions have to be made to obtain pre-defined objectives, simulation studies help to perform the computational experimentation. Feasible solutions can be explored using what-if analyses and among these solutions, the best decision can be found. These analyses are normally performed in an iterative routine. Results of previous experiments are used to perform following experimentations. In summary, the assessments against forthcoming uncertainties are used to make representative decisions. The only drawback here is that it requires additional effort from the decision maker to come to the best decisions.

Considering the drawback in simulation studies, optimization techniques can clearly help by providing the structure required to achieve the best decisions. The search process of finding the best decisions can be automated, if the optimization method is implemented in a computer program. In fact, the reported successful efforts in combining simulation and optimization methods encourage the development of research into this so-called simulation-based optimization field. In the simulation-based optimization method, optimization performs as the search method that discovers the alternative space of a simulation model in such a way that solutions contributing to the desired system performance(s) can be found.

Using this method, optimal solutions can be obtained from the modeled mining system without tiresome effort (manually going through the whole set of feasible alternatives for the input of the simulation model) while the dynamics and stochasticity of the system are taken into account.

i-2) Add some literature on simulation based optimisation techniques.

We have added much literature; they are highlighted in the text of the revised manuscript. Section 2 has been altered extensively. Please see the revised manuscript.

ii) How the company made their decisions before this model? What recommendations are given to the company after executing the simulation model?

They have their own MS Excel based planning software. However, they mostly rely on the very experienced planning staff that they have. Every morning, before the start of the first working shift, they get together and make decision on the schedule of that day based on the yesterday's outcome and what targets should be achieved.

The company, especially managers and staff of R&D division, are very happy with the outcome of this research. We had many meeting with them and they showed a serious interest to implement this in their mine.

iii) In table 3 why excavators S1, B7, and spreader I7 are unavailable? If that are available, then how much the results are affected?

We requested company to send us real data for the validation of the approach. For the day that they sent the data, those machines were not working due the planned maintenance. In order to compare the result of our approach with the actual result, we had to make them unavailable.

For the second part of your question, in this paper, we focused on the overburden management. B7, mostly produces coal (because it works on the lowest/deepest bench in the mine), consequently, its effect is negligible; S1, is a small excavator in comparison to the other bucket wheels and I7 is a big spreader (its capacity is twice as S1). Accordingly, S1 is not a bottleneck and if they were available, the total production would rise.

The approach has been also tested it with the full availability of machines. It works perfectly and change in the calculation time is insignificant.

Reviewer #2:

The authors presented a paper dealing with a stochastic simulation-based optimization approach applied to mining industry. In general, the paper is well written and well structured. However, we suggest addressing the following point before a publication in EJOR:

Comments:

i) In section 2, Page 5, Line 18: The authors state the scientific gap of the actual paper only mentioning that there is few application of simulation optimization approach in mining. We suggest to better states and discuss the innovation of the current research comparing to existing literature. What is different and what is new in your approach as you applied for the article type "Innovative Application of OR"

We truly appreciate all the constructive comments and suggestions from you. Section 2 has been rewritten in the revised manuscript in responding to the reviewer's comments. We have added much literature and discussed the proposed simulation-based optimization platform in detail to show the novelty of the approach in the mining field.

ii) As mentioned several time in the paper (P17 L47, Fig8, Fig9, P21 L62, P22 L20) a stochastic discrete event simulation DES is coupled with optimization in this development. However, there is no detailed information about this stimulation. The main stochastic variables are not described. What are the probability density functions? How many iteration are performed? Is the convergence reached? How are the breakdown rates implemented? As the DES is one of the key elements of the approach we believe that more details and discussions on this module should be addressed. One possibility is that the simulation is not stochastic at all. Then, a major revision of the paper should be performed in order to clearly state this hypothesis.

To address your comment and make it clear for the readers, we have added a small paragraph in the section 2 of the revised manuscript mentioning that the stochastic simulation model of the Hambach mine is presented in the below stated papers. Moreover, it is stated in page 20 line 2 of the original manuscript that, "The detail of the construction of the simulation model of an opencast mine and simulation model interface can be found in (Shishvan & Benndorf, 2014; Shishvan & Benndorf, 2016; Shishvan & Benndorf, 2017)."

Shishvan, M. S., & Benndorf, J. (2014). *Performance optimization of complex continuous mining system using stochastic simulation*. Paper presented at the Engineering Optimization IV, LISBON, PORTUGAL.

Shishvan, M. S., & Benndorf, J. (2016). The effect of geological uncertainty on achieving short-term targets: A quantitative approach using stochastic process simulation. *Journal of the Southern African Institute of Mining and Metallurgy*, 116(3), 259-264.

Shishvan, M. S., & Benndorf, J. (2017). Operational Decision Support for Material Management in Continuous Mining Systems: From Simulation Concept to Practical Full-Scale Implementations. *Minerals*, 7(7), 116. doi: 10.3390/min7070116

Shishvan & Benndorf, (2017), (~ 26 pages), discuss the development of the simulation model of the Hambach mine in very detail. Integrating all the detail of the simulation model to the current paper,

which is already a long paper, was not possible. We recommend the reader to read the previous paper, as well.

Reviewer #3:

The reviewed manuscript provided a good example of applications of OR, which would attract certain number of readers and makes contributions to the research area, although the theoretical contribution is NOT much. In general, it is still worth publishing, but should NOT be in a journal as good as EJOR.

The authors appreciate your comments on practical quality of presented method and your insightful feedback. However, as the title reads, this study is an “Innovative applications of OR” and can be considered as an added value to existing theory (for both validation and completion purposes). Additionally, to address your comment and to improve the theoretical background of the paper for a more general group of readers, we have updated the discussed literature to a greater extent and described the proposed simulation-based optimization platform in more details. Please see the section 2 of the revised manuscript.

Hope to be satisfied from our changes. We are always looking forward for comments and new suggestions from researchers to make our works stronger than before.

Highlights:

- Simulation-based optimization approach is capable of optimizing dispatch decisions.
- It is highly efficient for short-term production scheduling of opencast mines.
- It combines deterministic optimization with stochastic simulation in a closed loop.
- Number of feasible solutions increases as the sim-opt iteration loop progresses.

1 *Innovative Applications of OR*
2
3
4
5
6
7

8 **Simulation-based Optimization Approach for**
9 **Material Dispatching in Continuous Mining Systems**
10
11
12
13
14
15
16
17
18

19 **Masoud Soleymani Shishvan¹**
20
21

22 Resource Engineering Section, Department of Geoscience and Engineering, Delft
23 University of Technology, 2628 CD Delft, The Netherlands.
24

25
26 Email: m.soleymanishishvan@tudelft.nl
27
28

29 **Jörg Benndorf**
30

31 Professor in Geomonitoring and Mine Surveying, Institute for Mine Surveying and
32 Geodesy, Freiberg University of Technology, 09599 Freiberg, Germany.
33
34

35
36 Email: joerg.benndorf@mabb.tu-freiberg.de
37
38
39
40
41
42
43
44
45
46
47
48
49
50
51
52
53
54
55
56
57
58
59
60

61
62 ¹ Corresponding author: Email: m.soleymanishishvan@tudelft.nl; Tel: +31 15 27 87159.
63
64
65

1
2
3
4
5
6
7
8
9
10
11
12
13
14
15
16
17
18
19
20
21
22
23
24
25
26
27
28
29
30
31
32
33
34
35
36
37
Abstract—This paper examines a problem related to dispatching materials to spreaders in coal (lignite) mines operated under the paradigm of continuously excavated material flow. In the considered particular case, complexity arises from different material types of overburden to be placed on the dump site in pre-defined patterns that guarantee geotechnical safety. These types include wet, semi-wet and dry material, which are accessed on the excavation site according to the geological deposition and the mining plan. Controlling of the dispatch system has to take into account the extraction sequence and geological stratification on the excavation site and the available dump space per material on the dumping site. With eight excavators on the excavation site and seven spreaders on the dump site the problem is already complex, having not stated yet that random breakdowns may make some options temporarily unavailable. To optimize the dispatch system in terms of minimum idle time due to unavailability of dumping space, a new multi-stage simulation-based optimization approach is proposed. This approach consists of running alternately a deterministic optimization model and a stochastic simulation model. It combines simulation and algorithms to solve a transportation problem and a job-shop scheduling problem. The proposed approach is tested on a large continuous mine under given different dumping sequences, and results are reported. The merits and limitations of the proposed approach as pinpointed and farsighted operations management are discussed.

38
39
40
41
42
Keywords: OR in natural resources; simulation-based optimization; opencast coal mining; short-term scheduling; material dispatching.

43 44 45 46 47 48 49 50 51 52 53 54 55 56 57 58 59 60 61 62 63 64 65 **1. Introduction**

Short-term production scheduling of a continuous mining system defines a sequence of extraction and dumping operations over time within a predefined production plan. This schedule is concerned with the present operating conditions and constraints within the confines of the most recent long or medium-term plan. It plans extraction and dumping sequences in terms of weeks or days. The optimization of short-term production scheduling is conventionally performed in two distinct steps, (Hustrulid & Kuchta, 2006). The first step optimizes only the sequence of extraction of materials. The second step optimizes the dispatch decisions based on the dumping sequences, equipment capacity,

1 performance, and availability. The focus of this study is on the second step of the
2 optimization.

3
4 In the real world, there are limitations to the above mentioned distinct optimization
5 steps, which may result in non-optimal or infeasible short-term production schedules.
6 First, uncertainty in input parameters is not considered in the optimization steps. Second,
7 the optimization of the extraction sequence of material ignores operational considerations
8 and equipment availability, and thus can be unrealistic. Lastly, most of the mathematical
9 programming approaches are limited by the amount of the decision variables. Indeed,
10 simplifying assumptions should be made to develop a manageable mathematical model.
11 The performance of the production scheduling can be adversely affected by these
12 limitations and this may lead to: (a) increased operating costs due to the unscheduled
13 downtimes; (b) uncertainty in equipment performance and lower utilization of equipment;
14 and (c) inability to meet expected production targets. This paper proposes a new
15 simulation-based optimization approach that can accommodate these limitations. This
16 approach consists of running alternately a deterministic optimization model and a
17 stochastic simulation model. It uses a top staged down approach by combining simulation,
18 the transportation problem, and the job-shop scheduling problem. The transportation
19 problem provides a mechanism to optimize dispatch decisions. In other words, it finds
20 optimal connections between excavators and spreaders. Because of the nature of the
21 transportation problem, it is possible to have multiple connections for an excavator.
22 Therefore, the job-shop scheduling problem deals with the allocation of spreaders to
23 different excavators over time. Its objective is to find the processing sequences and starting
24 times of each operation on each spreader, in order to minimize the total weighted
25 tardiness. Finally, the system simulation uses the dispatch decisions generated by
26 optimization and evaluates particular performance indicators under uncertainty in system
27 performance. The calculated values are then introduced into a control module. The control
28 module suggests refinements to parameters of the optimization model (e.g. transportation
29 costs, jobs order, and jobs weight). The iterative process ends after a stopping criterion is
30 met. The proposed approach is tested on a large continuous mine under given different
31 dumping sequences, and results are reported. The merits and limitations of the proposed
32 approach as pinpointed and farsighted operations management are discussed.
33
34
35
36
37
38
39
40
41
42
43
44
45
46
47
48
49
50
51
52
53
54
55
56
57
58
59
60
61
62
63
64
65

1 In the following sections, a literature review and a brief background about continuous
2 mining systems will be given. It continues by defining the problem. Then, the solution
3 strategy is discussed in detail. After that, the computational framework and its
4 implementation are presented. Finally, the description of a real-size case study is given
5 and the obtained results are reported. The last section concludes the findings of this study.
6
7
8
9

10 **2. Review of Literature and Proposed Simulation-based Optimization Platform**

11 A considerable amount of literature has been published on the optimization of short-
12 term production scheduling. These studies in early attempts have focused on evolving
13 concepts and related formulations for finding extraction sequences based on mathematical
14 programming, e.g. (Gershon, 1983; Wilke & Reimer, 1977; Wilke & Woehrle, 1980). Their
15 objective is to minimize production deviations from the long-/medium-term production
16 targets. While allocating resources, the conventional optimization process considers
17 mining direction and fleet capacity. Nevertheless, it does not integrate the fleet
18 management, i.e. dispatching of mining equipment and uncertainty in equipment
19 availability. More recent attentions thus focus on the provision of real-time fleet allocation
20 for short-term production scheduling (Alarie & Gamache, 2002; L'Heureux, Gamache, &
21 Soumis, 2013) and stochastic optimization of short-term production scheduling
22 (Matamoros & Dimitrakopoulos, 2016; Topal & Ramazan, 2012). They have been
23 successfully applied for over three decades to find optimal solutions for real size case
24 studies. However, a large and growing body of literature has mainly investigated the
25 applications that are in the discontinuous block mining with the diffuse deposits.
26
27
28
29
30
31
32
33
34
35
36
37
38
39
40
41

42 Simulation-optimization is a method that stems from the rapid and successful
43 development of simulation and optimization techniques. The idea is to discover
44 simultaneously the great detail provided by simulation and the capability of optimization
45 techniques to find good or optimal solutions (Fu, 2002). The possibilities of coupling
46 simulation and optimization are vast and the appropriate approach highly depends on the
47 problem characteristics. Thus, before all, it is very important to have a good overview of
48 the different approaches.
49
50
51
52
53
54
55

56 In the literature, different criteria are used to classify simulation-optimization
57 approaches. Fu (1994) distinguished them based on properties of the optimization
58 problem. The author separately discusses the discrete and the continuous parameter cases
59
60
61
62
63
64
65

1 including techniques for optimization, however, the focus of the paper is on the latter.
2 Some discriminated simulation–optimization methods by the applied techniques, e.g.
3 gradient approaches, stochastic optimization, heuristics, statistical methods, etc., (Ammeri,
4 Hachicha, Chabchoub, & Masmoudi, 2011; Andradóttir, 1998; Carson & Maria, 1997; Fu,
5 2001). Banks, Carson, Nelson, and Nicol (2005) classified the approaches by their
6 algorithms into four categories; approaches that (i) guarantee asymptotic convergence, (ii)
7 guarantee optimality, (iii) guarantee a pre-specified probability of correct selection from a
8 set of alternatives, or (iv) are based on heuristics. Fu (2002) considered the purpose of the
9 stochastic simulation in the overall design as a key criterion. Based on this criterion the
10 approaches are categorized into two main categories namely, “optimization for
11 simulation” and “simulation for optimization”. Fu (2002) stated that their relation is not an
12 equal partnership, but a subservient one. The former uses the optimization routine as an
13 add-on to suggest candidate solutions to the simulator. The latter, in contrast, uses
14 stochastic simulation to generate scenarios for math programming formulations from a set
15 of possible realizations. However, the author has not discussed it further in the paper.
16 Other classifications focus on the problem characteristics such as objective functions (e.g.
17 single or multiple objectives), solution space (e.g. discrete or continuous), or shape of the
18 response surface (e.g. global or local optimization) (Ammeri et al., 2011; Barton &
19 Meckesheimer, 2006; Tekin & Sabuncuoglu, 2004). Recently, a comprehensive taxonomy
20 for simulation–optimization methods was proposed by (Figueira & Almada-Lobo, 2014).
21 The authors classified the simulation-optimization approaches based on four key
22 dimensions: Simulation Purpose, Hierarchical Structure, Search Method, and Search
23 Scheme. The first two are related to different ways in which simulation and optimization
24 interact, whilst the other two concerned with the design of the search algorithm. The
25 authors claim that, considering these four dimensions (and their full spectrum), they were
26 able to cover the complete range of simulation–optimization methods and distinguish
27 them in at least one dimension. Based on the Simulation Purpose, they distinguished three
28 major streams as follows:

- 29 • Solution Evaluation (SE): Here, simulation is used to evaluate solutions and hence
30 assess the response surface.

- Analytical Model Enhancement (AME): Simulation is used to enhance a given analytical model, either by refining its parameters or by extending it (e.g. for different scenarios).
- Solution Generation (SG): Simulation generates the solution based on the optimization output.

Based on the Hierarchical Structure, Figueira and Almada-Lobo (2014) categorized the simulation-optimization methods into four classes namely:

1. Optimization with simulation-based iterations – in all (or part) of the iterations of an optimization procedure, one or multiple complete simulation runs are performed, see Figure 1-a.
2. Alternative simulation-optimization – both components run alternately, see Figure 1-b.
3. Sequential simulation-optimization – both components run sequentially (either optimization following simulation or the opposite), see Figure 1-c.
4. Simulation with optimization-based iterations – in all (or part) of the iterations of a simulation process, a complete optimization procedure is performed, see Figure 1-d.

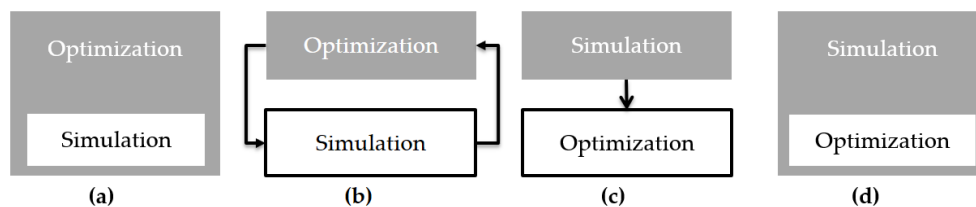

Figure 1. Four classes of simulation-optimization based on Hierarchical Structure, (Figueira & Almada-Lobo, 2014).

The categories defined for Search Method dimension are aligned with the major dichotomies in optimization problems such as exact vs heuristic; and continuous vs discrete (or combinatorial). Finally, in the Search Scheme the sequence of solutions and realizations are concerned, i.e. deterministic and stochastic problems are distinguished.

In the field of mining, little research to date has been carried out in the simulation-based optimization method. Mena, Zio, Kristjanpoller, and Arata (2013) presented simulation and optimization modeling framework for allocating trucks by route based on their operating performance. In their optimization problem, equipment availability is a variable and the objective is to maximize the overall productivity of the fleet. Their computational cycle is such that the optimization model provides an initial set of decision

1 variables. During the simulation run, when specific events (e.g. failure of a truck, etc.)
2 occur, the optimization model is called to provide a new set of variables to the simulation
3 model. Nageshwaraniyer, Son, and Dessureault (2013a) proposed a two-level hierarchical
4 simulation-based planning framework to maximize the revenue in each shift in one of the
5 largest coal mine in the world. Trucks and trains system are used for the transportation of
6 the material. Their framework reduces the decision space by separating the problem into
7 sub-problems. These sub-problems are then solved such that the lower-level problems (the
8 machinery scheduling problem) are constrained by the solution of the preceding higher-
9 level problem (train-loading problem). In another study, Nageshwaraniyer, Son, and
10 Dessureault (2013b) investigated a robust simulation-based optimization approach for a
11 truck-shovel system in surface coal mines. The objective is to maximize the expected value
12 of revenue obtained from the delivered trains to customers. The Response Surface Method
13 (RSM, (Jones, 2001)) is applied to define the variance expression of the objective function
14 under different parameter settings of the simulation model. To obtain robust solutions, the
15 authors added the variance expression as a constraint to the formulation of the
16 optimization model.

17 Since there are few applications of the simulation-optimization approach in mining, it
18 seems wise to focus on related fields, such as supply chain management, process system
19 engineering, and scheduling of manufacturing environments to build upon their findings.

20 A supply chain management problem under demand uncertainty was presented by
21 Jung, Blau, Pekny, Reklaitis, and Eversdyk (2004) whereby safety stock levels were
22 determined using a simulation-based optimization method in a rolling horizon manner.
23 Their proposed approach consists of running alternately a deterministic planning model
24 and a stochastic Monte-Carlo based simulation model in a loop structure. Their algorithm
25 ends when the difference between the estimation and the target values of the customer
26 satisfaction level is equal to very small number. Wan, Pekny, and Reklaitis (2005) present
27 an extension to the proposed simulation-based optimization framework for analyzing
28 supply chains. The extension consists of the iterative construction of a surrogate model
29 based on simulation results. The model captures the relation between the decision
30 variables and the performance of the supply chain. Instead of individual simulation runs,
31 the decision variables can then be optimized using the surrogate model. The authors claim
32 that the proposed framework can generally obtain better solutions with a smaller number
33
34
35
36
37
38
39
40
41
42
43
44
45
46
47
48
49
50
51
52
53
54
55
56
57
58
59
60
61
62
63
64
65

1 of simulation runs. The framework can also readily handle chance constraints and does
2 not present serious scale-up problems. Truong and Azadivar (2003) developed a hybrid
3 optimization approach to address the supply chain configuration design problem. Their
4 approach combines simulation, mixed integer programming and a genetic algorithm. The
5 genetic algorithm provides a mechanism to optimize qualitative and policy variables. The
6 mixed integer programming model reduces computing efforts by manipulating
7 quantitative variables. Finally, simulation is used to evaluate performance of each supply
8 chain configuration with non-linear, complex relationships, and under assumptions that
9 are more realistic. Yoo, Cho, and Yücesan (2010) used discrete-event simulation to
10 improve the efficiency of the supply chain optimization. This is done with the application
11 of Nested partitioning (NP; global random search) and optimal computing budget
12 allocation (OCBA; statistical selection). A general framework using a combination of
13 simulation and optimization is presented by Almeder, Preusser, and Hartl (2009) to
14 support operational decisions for supply chain networks. The authors claim that results
15 are competitive and the method is faster compared to conventional methods. Othman and
16 Mustaffa (2012) reviewed simulation and optimization methods applied in supply chain
17 management.

18
19
20
21
22
23
24
25
26
27
28
29
30
31
32
33
34
35
36
37
38
39
40
41
42
43
44
45
46
47
48
49
50
51
52
53
54
55
56
57
58
59
60
61
62
63
64
65
Inventory optimization is one of the important topics in supply chain management. Köchel and Nieländer (2005) presented the application of the simulation optimization approach in multi-echelon inventory models. The search process in the optimization model is done by repeated processing of four stages using a genetic algorithm. The objective is to define optimal policies for the defined system. Lately, Chu, You, Wassick, and Agarwal (2015) proposed a simulation-based optimization framework to optimize multi-echelon inventory systems under uncertainty. The framework is composed by agent-based modeling, simulation, the Monte-Carlo technique, a cutting plane algorithm, an experimental design technique, and statistical hypothesis tests. For the given inventory parameters, the agent-based model simulates the performance measures. The output of the model forms the objectives and the constraints of the optimization problem. The functions expectations in terms of sample averages are estimated using the Monte-Carlo method. After that, an iterative cutting plane algorithm is used to solve the optimization problem. When a solution passes the hypothetical tests, it can be considered as a local optimal solution. Subramaniam and Gosavi (2007) examined a problem related to replenishing

1
2
3
4
5
6
7
8
9
10
inventories at retailers in distribution networks operated under the paradigm of Vendor-Managed Inventory (VMI). A simulation-optimization approach is developed to minimize the average cost per unit time of operating the entire system. A combination simultaneous perturbation (SP) and simulated annealing (SA) is integrated to a discrete-event simulation. Jalali and Van Nieuwenhuyse (2015) reviewed and classified the applied simulation-optimization methods for the inventory management problem.

11
12
13
14
15
16
17
18
19
20
21
22
23
24
25
26
27
28
29
30
31
32
33
34
35
36
37
38
39
40
41
42
43
44
45
46
47
48
49
50
51
52
53
54
55
56
57
58
59
60
61
62
63
64
65
The scheduling problem in manufacturing environments is another related field of interest. Hierarchical production planning creates a bridge between the long-term plans and short-term schedules. It has been applied in different problems such as a multi-plant production planning, planning of semiconductor wafer fabrication, flexible manufacturing system, a make-to-order environment, etc. (Albey & Bilge, 2011; Bang & Kim, 2010; Gansterer, Almeder, & Hartl, 2014; Venkateswaran & Son, 2005). Lim, Jeong, Kim, and Park (2006) studied a production-distribution plan taking into account a multi-facility, multi-product, and multi-period problem. Their solution procedure for production-distribution planning consists of a mathematical solution procedure and a simulation solution procedure. First, the mathematical procedure is solved to decide the capacities of facilities and then outputs from this procedure are used to set the values of the inputs in the simulation procedure. The simulation procedure generates outputs, such as the production-distribution plans, as well as performance measures. If the outputs do not satisfy the required level, the replenishment policy in the factory and DC stages will be changed for the procedure. This approach continues iteratively until the desired optimal solutions are obtained. For a cooperative transportation problem, Sprenger and Mönch (2012) suggested a heuristic method using ant colony optimization combined with stochastic simulation. Discrete-event simulation is used to assess the method in a rolling horizon setting. Aqlan, Lam, and Ramakrishnan (2014) applied simulation-optimization in the consolidation of production lines in a configure-to-order production environment. On one hand, the method uses MIP model to minimize transportation cost and waiting time. On the other hand, simulation provides recommendations and supports the decision-making. Lin and Chen (2015) studied the problem related to a real-world semiconductor back-end assembly facility. Simulation combined with a genetic algorithm is used to solve a hybrid flow-shop scheduling problem.

Subramanian, Pekny, and Reklaitis (2001) tackled a stochastic optimization problem in the context of R&D Pipeline management. The problem is an optimal resource-constrained project selection and task-scheduling problem in the face of significant uncertainty. They proposed a two-layer simulation-based optimization approach. The inner loop consists of a process optimizer, a process simulator, and a trigger event module. The simulator starts with an initial solution. When the simulation module encounters a need for control actions, it momentarily suspends itself and communicates the state of the system to the decision making module. The optimizer solves a combinatorial problem that is appropriately modified to account for the current system state. After that, the simulation is re-primed and it continues marching in time until its subsequent need for a control action. The outer loop (Subramanian, Pekny, Reklaitis, & Blau, 2003) modifies the problem formulation, based on the knowledge obtained from the inner loop. It attempts to drive the controlled trajectories in the inner loop toward improving solutions with respect to probability distribution of the NPV in the system. Figure 2 shows the “Sim-Opt” architecture, which is introduced by Subramanian et al. (2003).

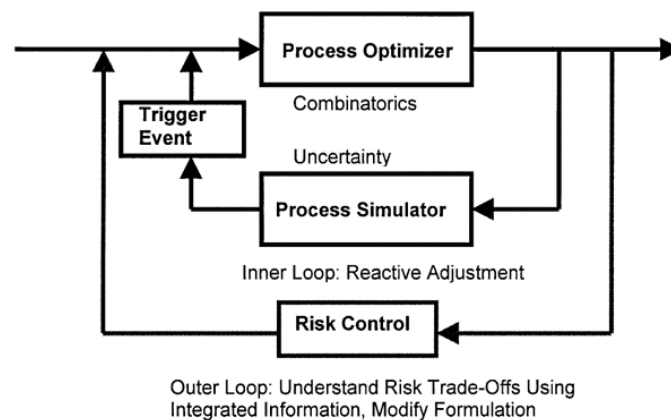

Figure 2. The “Sim-Opt” architecture (Subramanian et al., 2001).

To decide which methods are of particular interest, the problem characteristics presented in section 4 need to be considered. Shishvan and Benndorf (2017) presented the development of the simulation model for continuous mining systems from extraction to coal stockpiling and waste dumping. It captures different sources of uncertainty (e.g. equipment failures, geological uncertainty) and their interdependencies. Additionally, the simulator integrates decision variables representing decisions to be made in short-term production scheduling and therefore can be utilized during the optimization process to suggest optimal dispatch decisions to the user. Choices that need to be made might be for

instance the equipment's schedule, the equipment's digging/dumping locations, the equipment's capacities, or the schedule of auxiliary actions such as belt shifting. Thus, the optimization and the simulation modules need to be alternately connected. Moreover, the simulation module always requires inputs from the optimization module. Taken together, the alternating simulation-optimization class (Figure 1-b) seems to be more suitable for this problem. Furthermore, based on the size and the characteristics of the problem, the exact search method with stochastic search scheme is recommended.

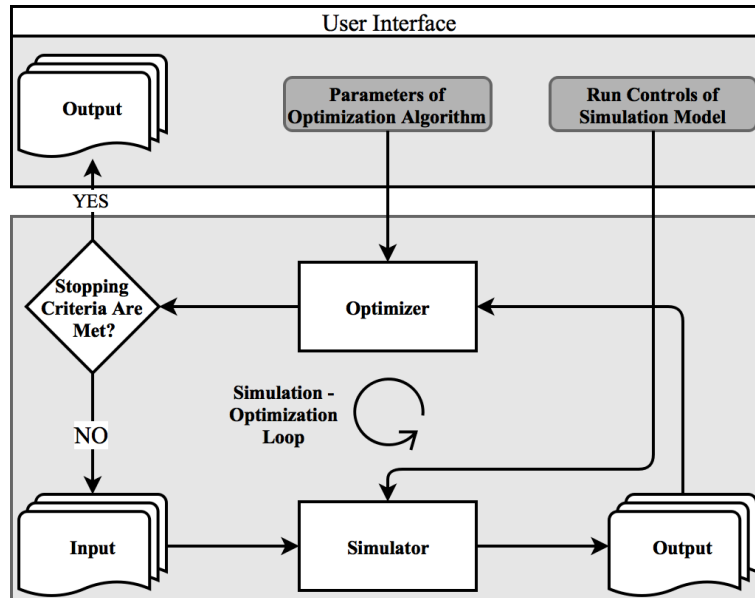

Figure 3. The suggested simulation-based optimization platform (reproduced after (Halim & Seck, 2011)).

Figure 3 depicts the concept of the suggested platform in this paper for the simulation-optimization process. Hereafter, this platform is called “simulation-based optimization” approach (Halim & Seck, 2011). In this approach, the simulation model functions as the evaluator of the objective functions that are to be optimized by the optimization module. The user interface provides the user the flexibility to set the parameters of the optimization algorithm and the run control of the simulation model (the details are discussed in the following). Once the entire necessary configuration has been set, the optimizer will start with initial solutions for which evaluations using the simulation are performed. In other words, the optimizer calls the simulator and provides a new set of decision variables in each iteration step. The simulator simulates the mining operation for the given set of decision variables and based on the results, the system's KPIs can be estimated. The results of the evaluations are then used by the optimization algorithm to generate new solutions that are expected to be better than the previous solutions. This loop continues until the

1
2
3
4
5
6
7
8
9
10
11
12
13
14
15
16
17
18
19
20
21
22
23
24
25
26
27
28
29
30
31
32
33
34
35
36
37
38
39
40
41
42
43
44
45
46
47
48
49
50
51
52
53
54
55
56
57
58
59
60
61
62
63
64
65

stopping criteria of the optimization algorithm are met. The following presents a brief background about continuous mining systems.

3. Background

Continuous mining systems, usually known as opencast mines, consist of excavators, belt conveyors, and spreaders operating in series and under the paradigm of continuously excavated material flow. Figure 4 shows a schematic section view of a continuous coal mining system. The operation starts with the excavation of materials by excavators at the extraction site. It continues by the transportation of the extracted materials from mining benches to dumping benches or a coal bunker. The transportation process includes a network of conveyor belts consisting of face conveyor belts, main conveyor belts, and a mass distribution center. Finally, coal is stacked at the bunker or waste materials are dumped at the dumping site. In such a paradigm, the excavators can be seen as supply points and the spreaders together with the coal bunker can be considered as demand points.

The production planning in an opencast mine covers various periods, namely long-, medium-, and short-term planning horizons. The long-term planning affects an opencast mine across its entire life, all the way to the end of mining supervision after the land reclamation. The medium-term planning often covers the next five-year period. Finally, the short-term planning is a yearly seam-focused detailed plan.

Besides operational and economical parameters that are necessary for any production planning process, the major input here is the geological block model. It is divided to two separate block models namely, the extraction block model and the dumping block model. The former includes the geological strata, quality parameters, volumes-tonnages, and material types. The latter includes dumping profiles and volumes.

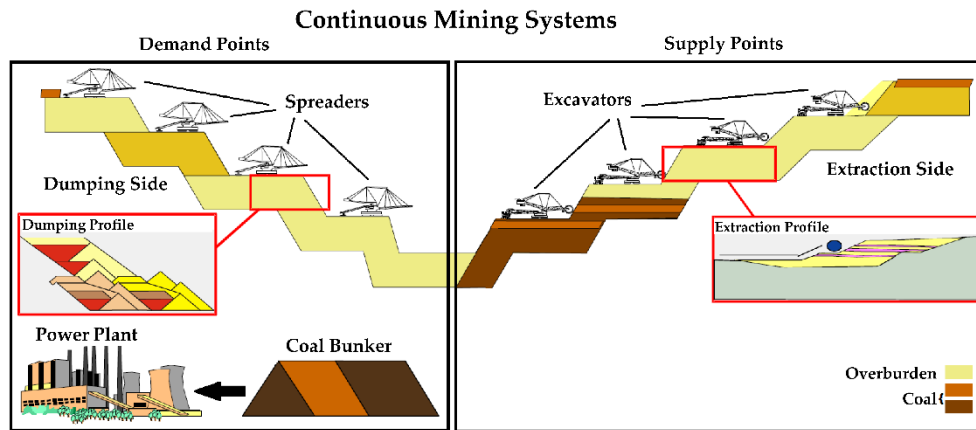

Figure 4. A schematic view of continuous mining systems, reproduced after (Gärtner, Hempel, & Rosenberg, 2013).

As mentioned earlier, the short-term plan is guided by medium and long-term plan. Forasmuch as the complex deposit formations require selective mining of coal as well as overburden on different benches. The objective of short-term planning is to find the sequence of blocks, known as the extraction sequence, that meet the defined targets under current operating conditions and constraints. After the creation of the extraction sequence, basically, the first step of the optimization of the short-term scheduling is completed. The created extraction sequence can be used as a guide to create the dumping sequence. It is also an input for the second step of the optimization, which is the focus of this paper. The next section describes the problem with the defined objectives.

4. Problem Description

Figure 5 presents the flow diagram of the short-term production scheduling in continuous mining systems. Three major processes can be seen in the diagram namely, short-term planning, dumping sequence creation, and material dispatching. These should be completed in the presented logical order to have a short-term schedule. Here, there are two underlying assumptions; the first is that the extraction block model, the dumping block model, and the extraction sequence are given as discussed in the previous section. Stable dump construction needs different material types with special sequences; while these materials are distributed unevenly at the extraction side, the second underlying assumption becomes very important. It is defined as that the problem should be relatively a balanced problem. In a sense, the difference between the total amounts of different overburden materials at the extraction site with the amounts of available spaces at the dumping site should be a small number. In the presence of finite available space for a

1 material type, when the extraction of that material type becomes sufficiently large, then for
2 any given dumping sequence it will no longer be possible to meet the defined production
3 targets. The optimization of dispatch decisions thus must involve the dumping capacity
4 constraints. Furthermore, uncertainty is associated with input parameters, equipment
5 availability, and their performances thus the resulting problem is a constrained stochastic
6 optimization problem.
7
8
9
10

11 The different ranges of the ratio of the expected amount of materials at the extraction
12 site to the dumping capacities of the same materials give rise to three different scheduling
13 scenarios. In scenario I, when the extracted to dumped capacity ratio is sufficiently small,
14 the dumping site has sufficient spare capacity to cope with abrupt changes in the extracted
15 materials due to the uncertainty involved. Therefore, in this scenario, challenges are
16 mostly related to the optimization of the dispatch decisions. In scenario II, characterized
17 by an intermediate range of the extracted to dumped capacity ratio, the production
18 capacity may be quite constrained by the dumping capacity when the extraction of
19 different materials spikes at some point in time. In this scenario, even with an optimal
20 dispatch decision, the production for some excavators may fail to reach their targets due to
21 the downtimes. Finally in scenario III, the extracted to dumped capacity ratio is
22 sufficiently large that most of the extracted materials simply cannot be dumped and thus
23 excavators will compete for dumping spaces. In this scenario, dispatch decisions and
24 dumping spaces must be assigned strategically to meet the demands of some excavators in
25 preference to others. In this paper, the optimization problem that is under scenario I and II
26 will be addressed. The optimization of short-term scheduling for the case of scenario III
27 involves strategies for the prioritization of excavators. Such strategies, while of
28 considerable interest, are beyond the scope of this study.
29
30
31
32
33
34
35
36
37
38
39
40
41
42
43
44
45
46
47
48
49
50
51
52
53
54
55
56
57
58
59
60
61
62
63
64
65

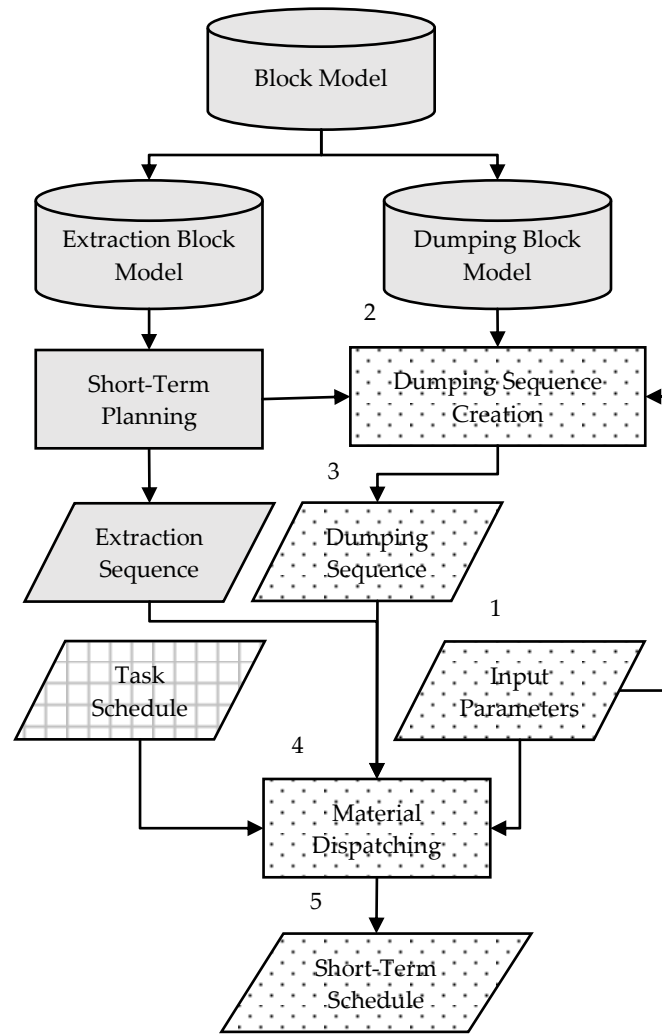

Figure 5. Flow diagram of short-term production scheduling in continuous mining systems.

To formulate the problem, the following problem context is assumed:

- An opencast mine has multiple extraction benches with only one excavator operating on each bench. Different excavators may have different production capacities and each can extract any type of material. Furthermore, the mine has multiple dumping benches while only one spreader can operate on each bench. Similar to the excavators, different spreaders can have different dumping capacities.
- The units at different benches cannot send material to a same destination at the same time.
- The daily/weekly schedule known as the task schedule is an external input for the short-term scheduling problem. This schedule includes the planned availabilities and downtimes (i.e. planned maintenance) of the equipment.
- Each excavator can supply any spreader and the transportation network is always available. Hence, in the first part of this study, namely optimization, availability of the

1 transportation network is not explicitly considered. Later, in the simulation part, it
2 will be added to the problem as a feedback from the simulator.
3

4 The objective is to minimize downtimes of equipment by effective resource
5 allocations. This will result in decrements in overall costs, including extraction costs,
6 dumping costs, and penalties for deviating from the predefined targets. There are two
7 types of decisions, on the excavator and on the spreader side:
8
9

- 10 • Decision on the excavator side:
 - 11 ○ Production rate of each excavator (between 0% and 100%)
 - 12 ○ Connection to the spreader
 - 13 • Decision on the spreader side:
 - 14 ○ Dumping sequence (depending on material type available)
- 15
16
17
18
19
20
21
22

23 5. Solution Strategy

24

25 To address the above-mentioned problem this paper proposes a new simulation-based
26 optimization approach that relies on the use of a deterministic optimization model and a
27 stochastic simulation model. The deterministic model is built using a certain feasible
28 dumping sequence and incorporates a transportation problem and a job-shop scheduling
29 problem. The transportation problem provides a mechanism to optimize dispatch
30 decisions. In other words, it finds optimal connections between excavators and spreaders.
31 Because of the nature of the transportation problem, it is possible to have multiple
32 connections for an excavator. Therefore, the job-shop scheduling problem deals with the
33 allocation of spreaders to different excavators over time. Its objective is to find the
34 processing sequences and starting times of each operation on each spreader, in order to
35 minimize the total weighted tardiness. A discrete event simulation of the system is
36 executed implementing the dispatch decisions obtained via the deterministic model for a
37 given dumping sequence. The results of multiple simulation replications serve to provide
38 an estimate of a particular performance measure (e.g. utilization). The calculated values
39 are then introduced into a control module. The control module suggests refinements to
40 parameters of the deterministic optimization model (e.g. transportation costs, jobs order,
41 and jobs weight). The iterative process ends after a stopping criterion is met. The strategy
42 uses two aspects of the “Sim-Opt” architecture, which is introduced by (Subramanian et
43
44
45
46
47
48
49
50
51
52
53
54
55
56
57
58
59
60
61
62
63
64
65

al., 2001). Figure 6a-b presents the configuration of the discussed simulation optimization approach.

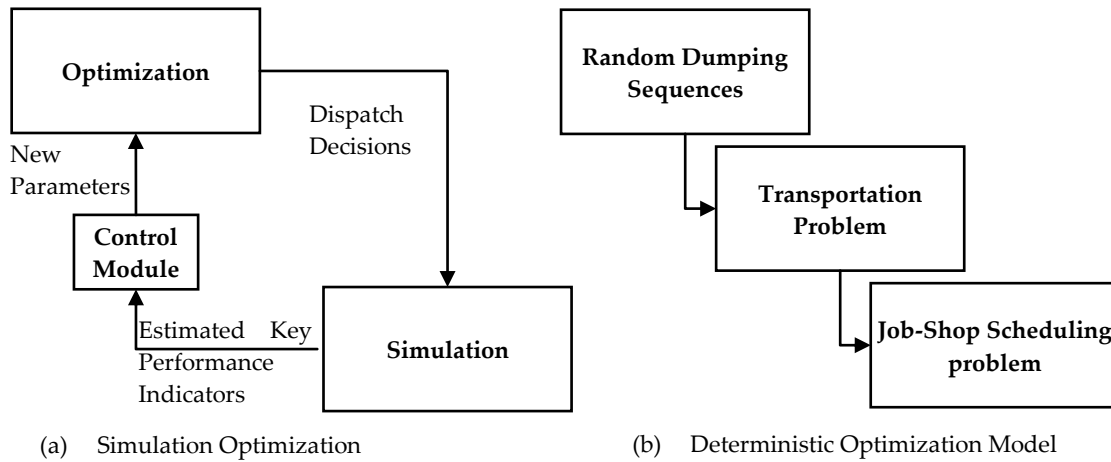

Figure 6. Configuration of the simulation-based optimization approach.

The following will discuss the three key sub-problems, the creation of a random dumping sequence, the transportation problem, and the job-shop scheduling problem. In the subsequent section, the various computational details that are needed to link these sub-problems and to drive the computations to obtain the desired short-term schedule will be discussed.

5.1 Random Dumping Sequences

Schematic representations of different dumping conditions are shown in Figure 7. Based on the dumping profile, after building a polder (a 100 m section), the possible dumping options are to continue building the polder or dump the type 2 material inside the polder, see Figure 7-a. If option 2 is randomly selected, the outcome is Figure 7-b. Similarly, there are two possible dumping options available in next stage of dumping. If option 1 is randomly selected, after the first stage, the type 2 material can be filled inside the polder, see Figure 7-c. After that, there are again two possible dumping options available; to continue to build the polder or to dump the type 3 material above the type 2 material. In this stage, if the option 1 is randomly chosen, the type 3 material can be dumped inside the polder, Figure 7-d. Due to the fixed dumping sequence, here, the only possible dumping option is to continue building the polder with the type 1 material type.

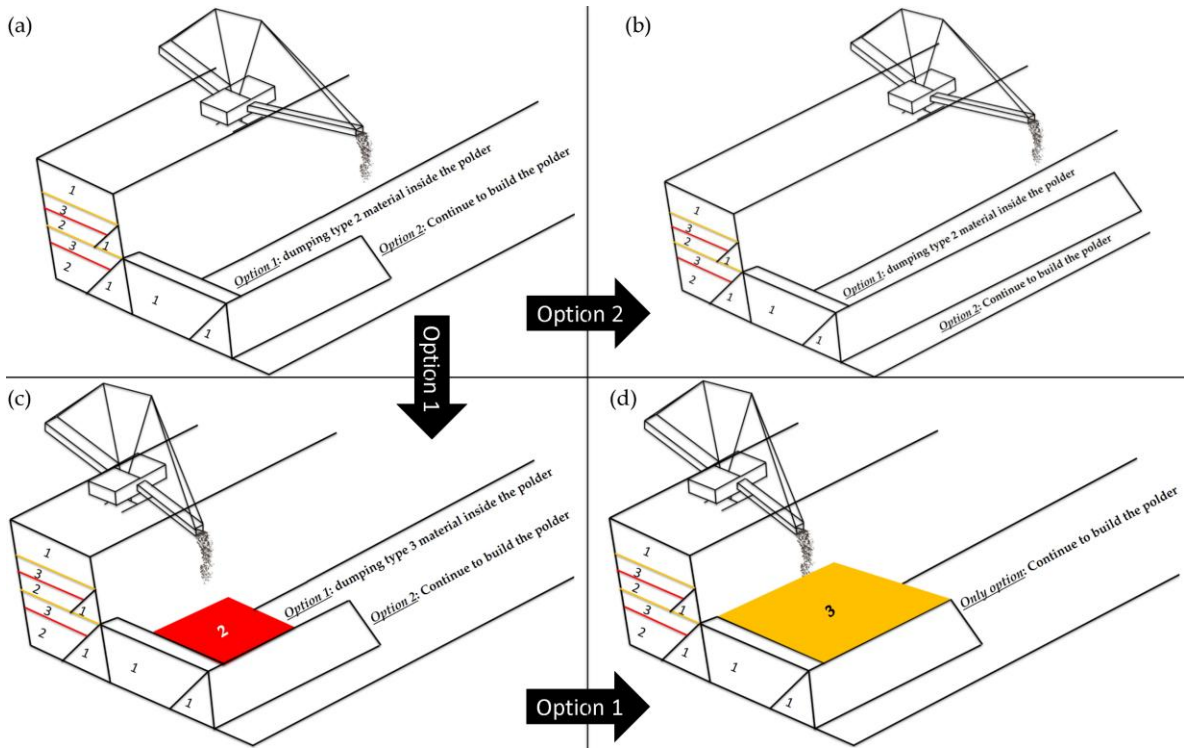

Figure 7. Schematic representations of dumping options.

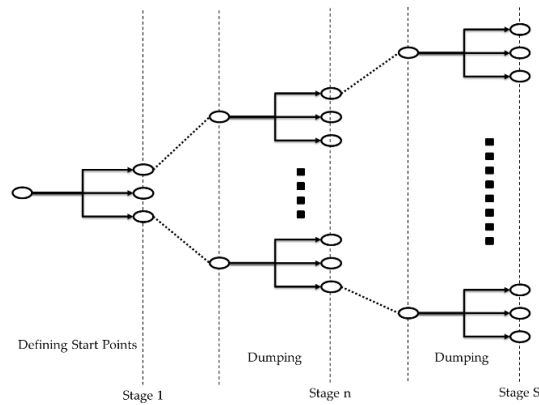

Figure 8. Schematic diagram of evolution of random dumping sequences.

If the dumping benches with their special profiles are discretized in defined sections (e.g. every 100 m), then the evolution of the random dumping sequences over time can be represented by the tree-like structure presented in Figure 8. Starting from each node, a large number of possible dumping options at the next dumping stage are expressed as branches stemming from that node. Assuming m possible next-stage dumping options at each node, the total number of scenarios will amount to m^S , where S is the total number of dumping stages. Each scenario as a feasible dumping sequence is an input for the transportation problem as is shown in Figure 6-b.

5.2 Transportation Problem

The transportation problem (TP) is concerned with shipping a commodity between a set of sources (e.g. excavators) and a set of destinations (e.g. spreaders). Each source has a capacity dictating the amount it supplies and each destination has a demand dictating the amount it receives, (Winston & Goldberg, 2004). The TP is a subset of network models and the set of resources and destinations can be illustrated, respectively, by a set nodes. Nodes are connected to each other via arcs; each arc has two major attributes namely the cost of sending a unit of a material from one node to the others and the maximum capacity of the arc, see Figure 9.

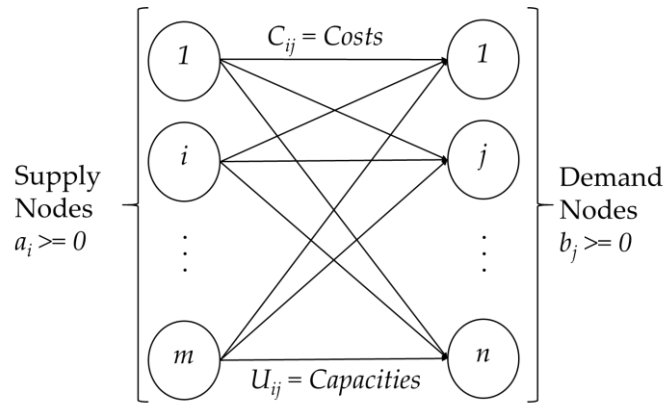

Figure 9. A transportation problem with m sources and n destinations.

An opencast mine extracts material at m different benches ($i = 1, \dots, m$). The amount of material to be extracted at bench i is a_i . The demands for the extracted materials are distributed at n different dumping benches ($j = 1, \dots, n$). The amount of material to be dumped at bench j is b_j . The problem is to find connections between excavators and spreaders at minimum cost. The linear programming (LP) formulation of the problem is as follows, (Winston & Goldberg, 2004):

Objective function:

$$\text{Minimize } z = \sum_{\text{all arcs}} C_{ij} X_{ij} \quad (1)$$

s. t.

$$\sum_{j=1}^n X_{ij} \leq a_i \quad \text{for } i = 1, \dots, m \quad (2)$$

$$\sum_{i=1}^m X_{ij} \geq b_j \quad \text{for } j = 1, \dots, n \quad (3)$$

$$X_{ij} \geq 0 \quad \text{for all } i \text{ and } j, \quad (4)$$

where, X_{ij} is the number of units of materials sent from node i to node j through arc (i, j) ; C_{ij} is the cost of transporting one unit of material from node i to node j via arc (i, j) . The objective function, denoted by Eq. (1) involves a deterministic optimization in which the total cost of sending materials from supply points to demand points is minimized. In constraint (2), the sum of all shipments from a source cannot exceed the available supply. Constraint (3) specifies that the sum of all shipments to a destination must be at least as large as the demand. Constraint (4) is a binding constraint.

Consider the feasibility of the problem. The only way that the problem can be feasible is if total supply exceeds total demand ($\sum_{i=1}^m a_i \geq \sum_{j=1}^n b_j$). Two conditions can be implied from this:

- When the total supply is equal to the total demand (i.e. $\sum_{i=1}^m a_i = \sum_{j=1}^n b_j$) then the transportation model is said to be balanced.
- A transportation problem in which the total supply and total demand are unequal is called unbalanced. If there is excess demand, a dummy source is introduced (i.e. a fictitious bench). The amount shipped from this dummy source to a destination represents the shortage quantity at that destination. If there is excess supply, a dummy destination is added to the network. Likewise, the amount received from this dummy destination from a source represents the excess quantity at that source.

Due to the nature of the transportation problem, it is possible that an excavator has to send materials to multiple spreaders. The next section will discuss the job-shop scheduling problem, which deals with the allocation of spreaders to different excavators over the time.

5.3 Job-Shop Scheduling Problem

The job-shop scheduling problem (JSP) consists of a finite set of jobs $J = \{1, \dots, n\}$ and a finite set of machines $M = \{1, \dots, m\}$. In this paper, excavators are defined as jobs and spreaders are defined as machines. The aim is to find a schedule of J on M under the below mentioned conditions:

- 1 • For each job $j \in J$, a list $(O_1^j, \dots, O_h^j, \dots, O_m^j)$ of the machines which represents the
2 processing order of j through the machines is given. Note that O_h^j is called the h -th
3 operation of job j and O_m^j is the last operation of job j .
4
- 5 • The processing order for each job is fixed, thus, a machine-sequencing problem for
6 every job should be taken into account.
7
- 8 • For every job j and machine i , a non-negative P_{ij} is given, which represents the
9 processing time of j on i .
10
- 11 • Each machine must always be available and can process at most one job at a time, and
12 once a job starts on a given machine, preemption is not allowed.
13
- 14 • Every job j has an assigned release time $r_j \geq 0$ so that the first operation cannot start
15 before r_j . In this paper, r_j is given in the task schedule.
16
- 17 • An additional attribute of a job j is its weight w_j , which represents the relative
18 importance of j in comparison to other jobs.
19
- 20 • Furthermore, every job j has a due date $r_j \geq 0$ which should, but does not necessarily
21 have to, be met in a schedule.
22

23
24
25
26
27
28
29
30
31 In this study, the objective is to minimize the obtained total weighted tardiness, as
32 defined $TWT = \sum_{j=1}^n w_j \cdot t_j$, where $t_j = \max \{0, c_j - d_j\}$ is the resulting tardiness of job j in a
33 schedule, d_j is the due date of the job, and c_j is its completion time. From now on, this
34 problem is referred to as JSPTWT. Ku and Beck (2016) investigated the size of problem that
35 can be solved by a Mixed Integer Programming (MIP) formulation. For a moderately sized
36 problem up to 10 jobs and 10 machines, with the recent technology, MIP finds the
37 optimum solution in a very reasonable amount of time. They also compared the
38 performance of the four MIP models for the classical JSP. They concluded that the
39 disjunctive MIP formulation with the use of the GUROBI v6.0.4 solver (Gurobi
40 Optimization, 2016) gives the fastest result for a moderate sized problem. The list below is
41 the disjunctive MIP formulation of JSPTWT, based on Manne (1960)'s formulations. The
42 decision variables are defined as follows:
43

- 44 • X_{ij} is the integer start time of job j on machine i
45
- 46 • Z_{ijk} is equal to 1 if job j precedes job k on machine i
47

48 *Objective function:*
49
50
51
52
53
54
55
56
57
58
59
60
61
62
63
64
65

$$\text{Minimize } \sum_{j=1}^n w_j \cdot t_j \quad (5)$$

s. t.

$$X_{\sigma_h^j, j} \geq X_{\sigma_{h-1}^j, j} + P_{\sigma_{h-1}^j, j}, \quad \forall j \in J, h = 2, \dots, m \quad (6)$$

$$X_{ij} \geq X_{ik} + P_{ik} - V \cdot Z_{ijk}, \quad \forall j, k \in J, j < k, i \in M \quad (7)$$

$$X_{ik} \geq X_{ij} + P_{ij} - V \cdot (1 - Z_{ijk}), \quad \forall j, k \in J, j < k, i \in M \quad (8)$$

$$t_j \geq X_{mj} + P_{mj} - d_j, \quad \forall j \in J \quad (9)$$

$$t_j \geq 0, \quad \forall j \in J \quad (10)$$

$$X_{1j} \geq r_j, \quad \forall j \in J \quad (11)$$

Constraint (6) is the precedence constraint. It ensures that all operations of a job are executed in the given order. The disjunctive constraints (7) and (8) ensure that no two jobs can be scheduled on the same machine at the same time. V has to be assigned to a large enough value to ensure the correctness of (7) and (8). In this paper, it is defined as $V = \sum_{j \in J} \sum_{i \in M} P_{ij}$, since the completion time of any operation cannot exceed the summation of the processing times from all the operations. Constraint (9) and (10) measure the resulting tardiness of each job. Finally, constraint (11) ensures that a job cannot start before its release time, and thus, captures the non-negativity of the decision variables X_{ij} .

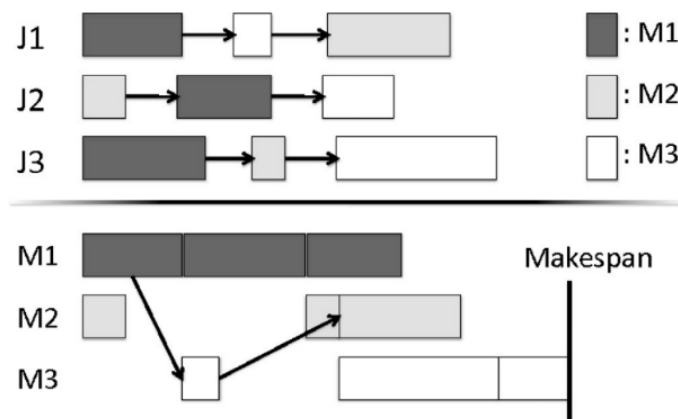

Figure 10. A simple job-shop scheduling problem, (Ku & Beck, 2016).

As an example, Figure 10 shows a simple JSP in which three jobs J1, J2, and J3 are to be scheduled on three machines M1, M2, and M3. The graph on the top represents the precedence constraints. The Gantt chart on the bottom displays a feasible schedule that

satisfies the precedence constraints (Ku & Beck, 2016). As can be seen, the makespan is the total length of the schedule (that is, when all the jobs have finished processing). The term makespan will frequently be used in the case study section. The next section will elaborate more on the computational framework of the connection of the sub-problems.

6. Computational Framework

In this section, the overall computational approach is described. First, input parameters are explained. Then, the computational logic with the details of the integration of the sub-problems together and with the discrete event simulation is discussed. After that, the simulation based optimization framework is presented.

6.1 Input Parameters

The second step of the optimization of short-term scheduling starts with the assignment of input parameters. The definitions and their functionalities are as follows:

- Start points of dumping in different benches, i.e. the start locations of spreaders on benches at the beginning of the working shift. This is an input for the creation of random dumping sequences.
- The allowed range of movement for spreaders, i.e. in what range it is allowed to transport spreaders and start a new dumping profile. This is also an input for the creation of random dumping sequences.
- Transportation costs, these costs are used to distinguish between different destinations for a source in the transportation problem.
- Machine sequencing, the Earliest Due Date (EDD) sequencing method is used to create processing orders of the jobs in the JSP.
- Finally, Job weights are some other input parameters for the JSPTWT. For instance, they can be used to prioritize an excavator if a bottleneck is seen after the simulation.

The aim is to find the best combination of these parameters using simulation based optimization approach to achieve the optimum short-term schedule.

6.2 Deterministic Optimization with Embedded Simulation

The following describes the details of the integration of the sub-problems, together and with the discrete event simulation, in walk-through steps.

1 Step 1: start with an arbitrary set of input parameters.

2 Step 2: create a sufficient number of random dumping sequences, $\{1, \dots, R_s\}$.

3
4 Step 3: for a certain dumping sequence, $d = 1, d \in R_s$, optimal connections can be found
5 using the transportation problem.
6

7 Step 3.1: check the availability of the equipment based on the given task schedule and
8 create the nodes.
9

10 Step 3.2: start with first blocks in the given extraction sequence and assign their
11 volumes as a_i to supply nodes in the TP formulation.
12

13 Step 3.3: assign the volumes of the first sequence of blocks in the given dumping
14 sequence as b_i to demand nodes in the TP formulation.
15

16 Step 3.4: check if problem is balanced; if not add dummy nodes to the network.
17

18 Step 3.5: create arcs between supply and demand nodes. Only these nodes get
19 connected that have the same type of material.
20

21 Step 3.6: add a capacity to the arcs. In the TP, the capacity is set to be infinite for all the
22 arcs.
23

24 Step 3.7: add costs to the arcs. In an opencast mine, the potential costs can be:
25

- 26 • Excavators and spreaders on the same level (altitude) get lower cost of
27 transportation.
28
- 29 • Length of belt conveyors between supply nodes and demand nodes, the closer
30 the equipment the lower the costs.
31
- 32 • Difference between the production capacity and dumping capacity of the
33 equipment, the lower the difference the lower the costs.
34

35 Step 3.8: build the LP model with the help of Eqs. (1)–(4) and solve it by the GUROBI
36 solver.
37

38 Step 3.9: calculate the residual volumes and add them to the next iteration of the
39 optimization.
40

41 Step 3.10: go to the step 3.1 and repeat steps 3.1–3.10 until all the blocks are extracted
42 in the given extraction sequence.
43

44 Step 3.11: check for feasibility of the schedule, if there is residual volume left on the
45 extraction side, set $d = d + 1$ and go to the step 3 until $d = R_s$.
46

47 Otherwise, continue.
48
49
50
51
52
53
54
55
56
57
58
59
60
61
62
63
64
65

Step 4: create the input for the JSPTWT and build the MIP model using Eqs. (5)–(11) and solve it with the GUROBI solver.

Step 5: create the Gantt chart. The output of the JSPTWT is the optimum short-term schedule for the given extraction and dumping sequence (d).

Step 6: run the discrete event simulation for the given short-term schedule.

Step 7: record the state (utilizations, amounts) at the end of the time horizon.

Step 8: set $d = d + 1$ and go to the step 3 until $d = R_s$.

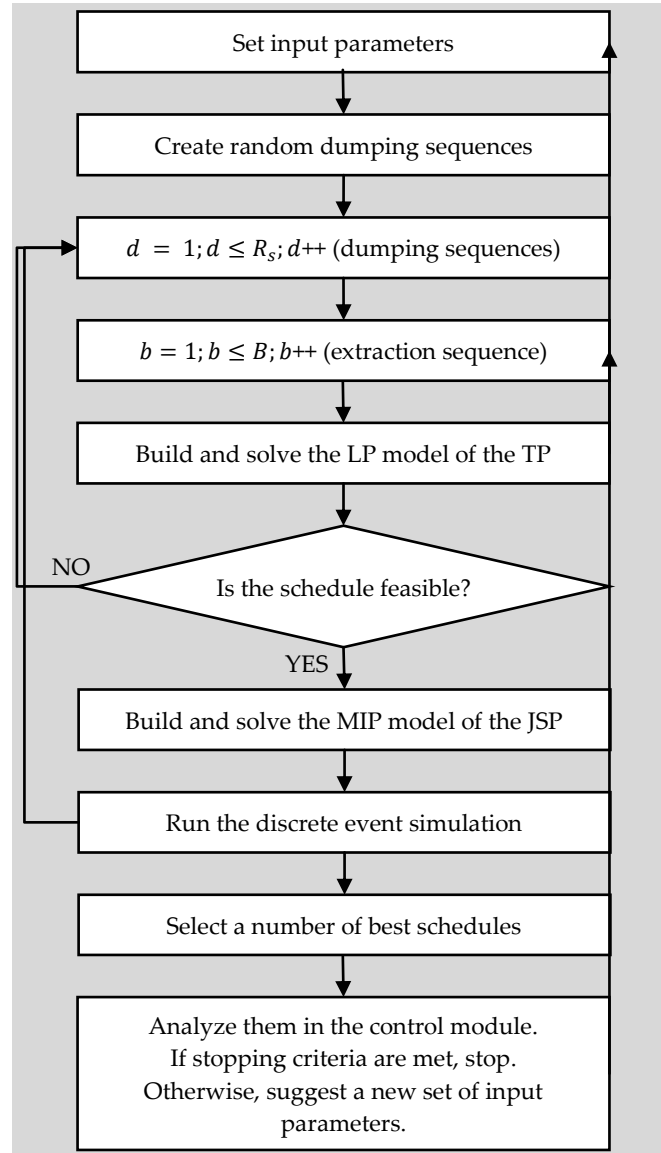

Figure 11. Computational flow diagram.

6.3 Simulation Based Optimization Framework

A more detailed flow diagram, which summarizes the overall computational framework, is presented in Figure 11. It combines the deterministic optimization with the stochastic simulation in a closed loop. Most of the steps are explained in detail in the

1 previous section. As can be seen, the simulation is implicitly built over the embedded
 2 optimization. Once the computations over the simulation loop are completed, a number of
 3 best schedules based on the user-defined targets such as shorter makespan, higher
 4 utilization of equipment are selected. These are analyzed in the control modules; if the
 5 stopping criteria are met, the algorithm stops; otherwise a new set of input parameters is
 6 introduced to the optimizer. The following section presents more details about the
 7 interactions between the components in a simulation-optimization platform.
 8
 9
 10
 11
 12

13 **7. Implementation of the Computational Framework**

14
 15
 16
 17 The implementation of the proposed simulation-based optimization approach consists
 18 of the following major components: the computational control module, the databases, the
 19 three modules for the creation of random dumping sequences, the transportation problem
 20 and the job-shop scheduling problem, the discrete event simulation with its interface, the
 21 post-processing module, and finally the control module, Figure 12. The computational
 22 control module is responsible for controlling interactions of computational components. It
 23 has various functions including:
 24
 25
 26
 27
 28
 29
 30

- 31 • Issuing commands for retrieving information from the database.
- 32
- 33 • Generating/updating and releasing commands for executing the steps of the
- 34 algorithm.
- 35
- 36 • Re-processing and controlling the output of each computational component before
- 37 issuing the next command.
- 38
- 39 • Selecting a number of best schedules based on the defined criteria to proceed the
- 40 algorithm to the simulation part.
- 41
- 42
- 43
- 44
- 45

46 The database contains information about the geological block model, the given
 47 extraction sequences, and the task schedule. These data are stored in a spreadsheet file.
 48 Since the computational control module is coded in Python, a publicly available Pandas
 49 library (McKinney, 2010) is used to access each cell in the spreadsheets. Big datasets can be
 50 readily read and stored in DataFrames with the help of Pandas library.
 51
 52
 53
 54

55 The three major components of the deterministic optimization procedure were
 56 explained in detail in the previous sections. It should be noted that to solve the LP or the
 57 MIP models, the GUROBI Python interface is used. After the selection of a number of best
 58 schedules by the computational control module, the data are recorded in two separate
 59
 60
 61
 62
 63
 64
 65

databases, namely, the block model and the schedule. These two are the major inputs for the discrete event simulation of an opencast mine. The detail of the construction of the simulation model of an opencast mine and simulation model interface can be found in (Shishvan & Benndorf, 2014; Shishvan & Benndorf, 2016; Shishvan & Benndorf, 2017).

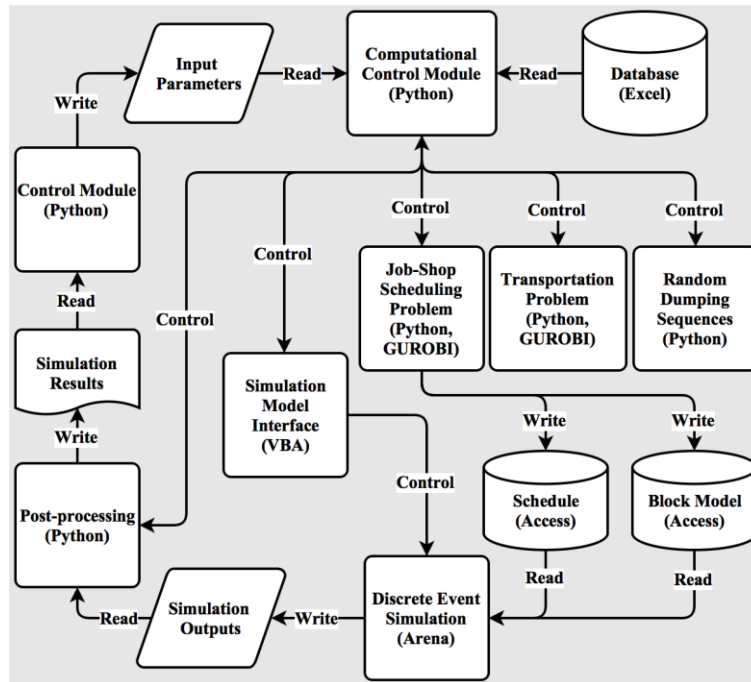

Figure 12. Simulation-optimization platform.

The post-processing module processes the simulation outputs and creates plots and tables. Finally, the control module calculated the differences between the current results with the predefined targets. If another loop of simulation-optimization is required, the new input parameters are suggested to the computational control module. Next, the real-size case study is presented.

8. Case Study

To demonstrate the performance of the proposed simulation based optimization approach, a real case study has been developed. The case study is the Hambach mine; it is located in Germany and is a large opencast coal mine. It produces over 100 million tons of coal and over 500 million m³ of overburden materials per year.

8.1 Case Problem

8.1.1 Overview of the Production System

A schematic view of the Hambach mine is shown in Figure 13. In total eight bucket-wheel excavators (BWEs) have to be scheduled to serve continuously seven spreaders with waste materials and two bunkers with coal. Each BWE excavates either coal or waste in terrace cuts and transfers materials to the face conveyor belt, which carries it along the bench to the main conveyor belt. All excavated materials of the eight benches are distributed to their destinations at the mass distribution center. Based on the daily short-term schedule, waste is distributed to the seven spreaders for dumping, and coal (lignite) is forwarded to two coal-bunkers. Table 1 shows the technical specifications of the BWEs.

The mine operates 24 hours per day and seven days per week. Regular maintenance is carried out on weekly, monthly, and annually based schedules. During the regular maintenance or an unscheduled breakdown, the production process ceases on the bench.

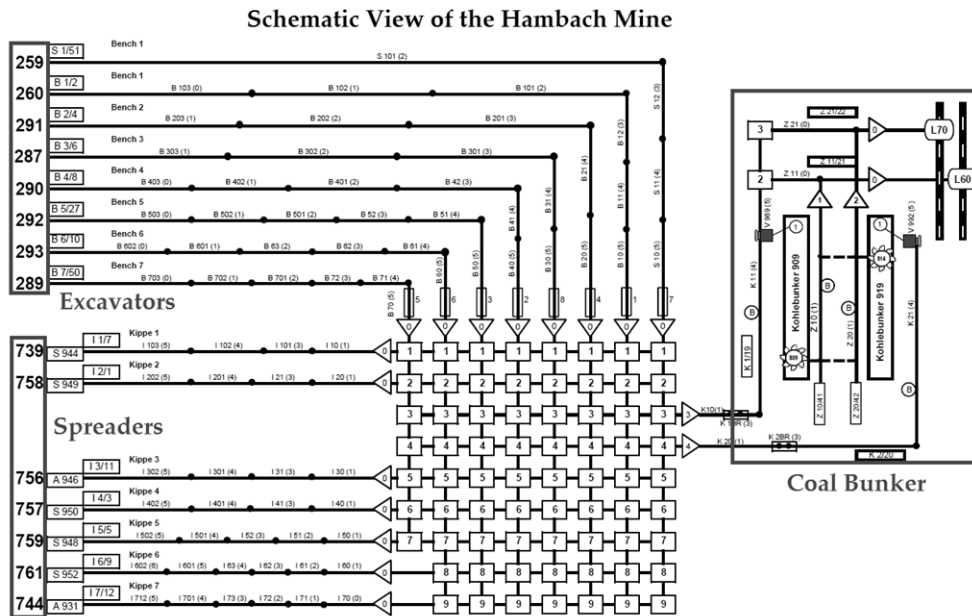

Figure 13. Schematic overview of the production system of the Hambach mine.

Table 1. Technical specification of BWEs.

Bench	BWE model	Discharge per min	Bucket capacity (m ³)	Theoretical capacity (m ³ /h)*
S1	259	44	2.6	5700
B1	260	38	3.5	5700
B2	291	48	5.0	12500
B3	287	43	5.1	10400
B4	290	48	5.0	12500
B5	292	48.6-72.0	5.0	12500
B6	293	48.6-72.0	5.0	12500
B7	289	48	5.0	12500

* 19.3 hours per day

8.1.2 Problem in Mining

Waste materials at the Hambach mine are categorized in three types of mixed soils, dry mixed soils type1 (M1), semi-wet mixed Soils type2 (M2T) and wet mixed soils type2 (M2N). The extraction of M2 type materials is increasingly facing deficiencies in output due to difficult mining materials. This type of soil, specifically M2N, exhibits a high share of cohesive components and is difficult to drain. M2N material cannot be used for stable dump construction and needs to be filled in between prebuilt polders constructed of dry material (Figure 14). The fact that only a limited quantity of these unstable mixed soils can be placed in the waste dump causes downtimes and bottlenecks in the placement process on the dumping side.

Furthermore, historical data show that next to scheduled maintenance, breakdowns of the equipment occur in a random manner. Due to the “in series” system configuration, equipment units feeding or connected to the ceased equipment are blocked and set out of the operation while the maintenance is being done or the failure is being repaired. Furthermore, because of the multi-layer nature of the deposit, changes from one material type (e.g., M1) to another material type (e.g., M2N) happen very frequently. Each time a material change takes place, the BWE stops excavating while the mass distribution center changes the drop-point of the belt conveyor to its new destination. In reality, this operation approximately takes five to eight minutes. This time may increase due to the unavailability of the new destination. The combined effect of random equipment breakdowns and frequent changes in extracted materials, makes the prediction of the exact material flow rate at any given future time span a major source of uncertainty. Thus, the problem is a constrained stochastic optimization problem. It is formulated in the before mentioned problem context.

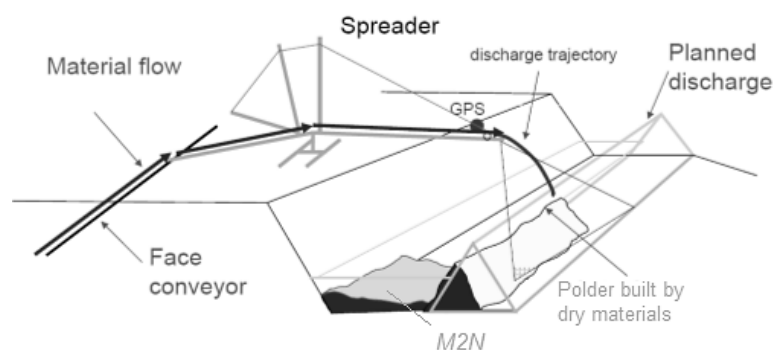

Figure 14. Placement of M2N materials in between a prebuilt polder, (Gärtner et al., 2013).

The objective is to optimize dispatch decisions to decrease downtimes/increase efficiency of excavators and spreaders by effective resource allocations while ensuring stable dump construction using the proposed simulation based optimization approach. Here, decisions on the dumping site are the length of polders to be built while on the extraction side, decisions are production rates of excavators and their connections to spreaders.

8.1.3 Input Data

The following presents the input data used for this case study. Table 2 gives the extraction sequences of different material types as an input. These will be used as a guide in the creation of random dumping sequences. In total, over 830 thousands m^3 of different material types should be scheduled to be extracted. The amounts of different material types for each sequence are shown in the table.

Table 2. Extraction sequences as an input.

Extraction Sequence	Material Types				
	M2T (m^3)	Coal (T)	M2N (m^3)	M1 (m^3)	Total (m^3)
1	9,001	3,621	1,215	5,983	19,648
2	4,573	2,008	-	15,486	21,971
3	4,845	3,621	1,090	17,505	26,889
4	10,093	2,008	8,642	22,805	43,452
5	16,989	3,621	-	28,089	48,527
6	14,343	2,008	-	28,385	44,640
7	13,984	6,613	12,832	26,089	59,203
8	22,732	11,520	18,346	12,769	64,818
9	21,368	6,613	-	28,316	55,982
10	-	11,520	25,313	33,264	69,548
11	15,166	6,613	10,944	25,642	58,050
12	21,115	11,520	8,949	19,189	60,224
13	19,732	6,583	-	37,663	63,665
14	-	7,742	9,721	35,246	52,340
15	7,991	6,583	13,593	15,143	42,997
16	-	7,742	-	31,333	38,706
17	-	6,583	9,721	11,979	27,970
18	-	7,742	-	16,075	23,448
19	-	12,115	-	-	11,538
Total	181,932	126,376	120,366	410,961	833,617

As discussed earlier, the extraction sequence of material ignores operational considerations and equipment availability. The availability of the equipment (the task schedule in Figure 5) as another external input is given in Table 3. The number "0" denotes

that the equipment is unavailable and “1” vice versa. A closer look at the task schedule reveals that excavators S1, B7, and spreader I7 are unavailable, and thus the transportation problem will have six supply nodes and seven demand nodes. The maximum allowed ranges of movement for different spreaders are presented in Table 4. They are important parameters for the creation of the random dumping sequences. Here, their range is defined as $\pm (200 - 500)$ meters for all spreaders. During the simulation-optimization loop iterations the optimum value will be determined. The plus-minus sign indicates that the spreader has the option to choose a dumping location from the front or back site of its standing position. Other important input parameters are the job weights for the job-shop scheduling problem. With the help of these parameters different excavators can be prioritized against each other. For example, if two excavators have to send extracted materials to one spreader, the one whose job weight is higher will be scheduled first. In this case, job weights are considered to be the same for all excavators, see Table 5.

Table 3. Task schedule of BWEs and spreaders.

Bench	First Shift	Second Shift	Third Shift
S1	0	0	0
B1	1	1	1
B2	1	1	1
B3	1	1	1
B4	1	1	1
B5	1	1	1
B6	1	1	1
B7	0	0	0
I1	1	1	1
I2	1	1	1
I3	1	1	1
I4	1	1	1
I5	1	1	1
I6	1	1	1
I7	0	0	0

Table 4. Maximum and minimum allowed range of movements for the spreaders.

	Benches						
	I1	I2	I3	I4	I5	I6	I7
Range of allowed movement	$\pm(200 - 500)$	$\pm(200 - 500)$	$\pm(200 - 500)$	$\pm(200 - 500)$	$\pm(200 - 500)$	$\pm(200 - 500)$	$\pm(200 - 500)$

Table 5. The job weights which are used in the job-shop scheduling problem.

	Benches							
	S1	B1	B2	B3	B4	B5	B6	B7
Job weights	1	1	1	1	1	1	1	1

The defined costs for the transportation problem are as follows:

- Distance to the destination: This cost can be calculated by Eq. (12). Where, C_1 is the associated cost coefficient, distance (m) is the length of the belt conveyors between the source and the destination and $Speed_{belt} \left(\frac{m}{s}\right)$ is the speed of the belt conveyors. It can be interpreted as the amount of time that is needed to transport one m^3 of any material from the supply point to the demand point. The closer the equipment are the lower the cost is.

$$Cost_{Distance} (min) = C_1 \left(\frac{Distance(source, destination) * 60}{Speed_{belt}} \right) \quad (12)$$

- Capacity difference: This cost can be calculated by Eq. (13). Here, C_2 is the associated cost coefficient, inflow (m^3) is the amount of material to be sent to the destination from the source. $Capacity_{source}$ and $Capacity_{destination} \left(\frac{m^3}{h}\right)$ are the theoretical capacities of the supply point and demand point, respectively. It can be interpreted as the penalty for connecting a small excavator to a big spreader or vice versa. Altogether, the calculated value is the amount of extra time that is needed to extract or dump the material.

$$Cost_{Capacity} (min) = C_2 \left(\left(\frac{Inflow(source, destination)}{|Capacity_{source} - Capacity_{destination}|} \right) * 60 \right) \quad (13)$$

- Altitude difference: This cost can be calculated via Eq. 14. Here, C_3 is the associated cost coefficient. For a better clarification, Figure 15 is used to describe the parameters of this equation. In summary, it measures the amount of the extra transportation time that is needed if the supply point and the demand point are not at the same level. As can be seen in Figure 15, it is assumed that the maximum angle of inclination of the belt conveyors is 20 degrees. Here, $elev.(BWE)$ and $elev.(SP)$ are the elevations of excavators and spreaders, respectively.

$$Cost_{Altitude} (min) = C_3 \left(\left(\frac{|elev.(BWE) - elev.(SP)|}{\sin 20^\circ} \right) - \left(\frac{|elev.(BWE) - elev.(SP)|}{\tan 20^\circ} \right) \right) \left(\frac{60}{Speed_{belt}} \right) \quad (14)$$

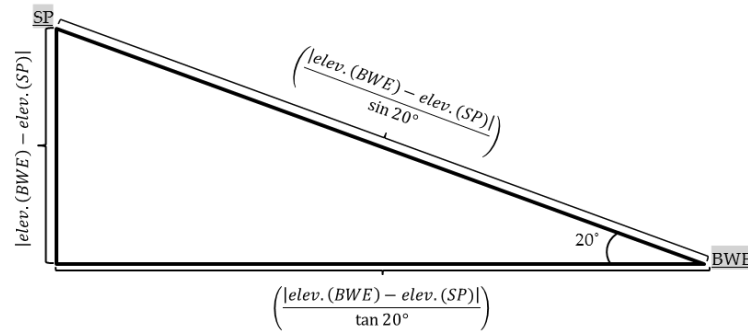

Figure 15. A schematic illustration of the parameters of Eq. (14).

The level of the importance of the different costs is determined by cost coefficients (i.e. C_1 , C_2 , and C_3). The variation ranges of the cost coefficients are given in Table 6. In this case, their variation range is defined to be from zero to three for all arcs in the transportation problem. Zero means that the related cost has no influence on the solution of the transportation problem; on the contrary, three means the related cost has the maximum influence on the solution of the transportation problem. The following section presents and discusses the obtained results.

Table 6. Different cost coefficients used in the transportation problem.

	Cost Coefficients		
	Distance to destination	Capacity difference	Altitude difference
	C_1	C_2	C_3
Variation ranges	0 – 3	0 – 3	0 – 3

8.2 Results

The case problem was solved with the proposed simulation-optimization approach. The extracted to dumped capacity ratio is set to be sufficiently small (scenario I) thus the dumping site has sufficient spare capacity. For each loop iteration, one hundred random dumping sequences with a slice (section) length of 100 m are set to be created. The number of simulation replications is set to 20 replications as is suggested by (Shishvan & Benndorf, 2016). The computation for the complete case was run on a Core™ i5-3380M Intel CPU @ 2.90GHz and each loop iteration took about seven minutes.

Figure 16 illustrates the trajectory of the number of feasible short-term schedules as the simulation-optimization loop iterations progressed. In the 1st loop iteration, no feasible schedules were seen. After that, the control module suggested a new set of input parameters. Here is the beginning of an upward trend. From the 2nd to the 7th loop iteration, the number of feasible schedules increased gradually, but rose sharply in the 8th loop iteration. It reached the highest point, with a figure of 76 feasible schedules, in the 9th

loop iteration. There was a slight drop in the last loop iteration when the stopping criteria were met.

Box plots are drawn for makespan values of the feasible short-term schedules, see Figure 17. They provide a useful way to visualize the range, overall patterns, and also to study the distributional characteristics of a group of makespans as well as the level of the makespans. A single striking observation about the box plots could be a downward trend of the minimum values as the simulation-optimization loop proceeds. This indicates that the quality of solutions increases, with a figure of 24%, until it reaches its optimum value in the 10th loop iteration.

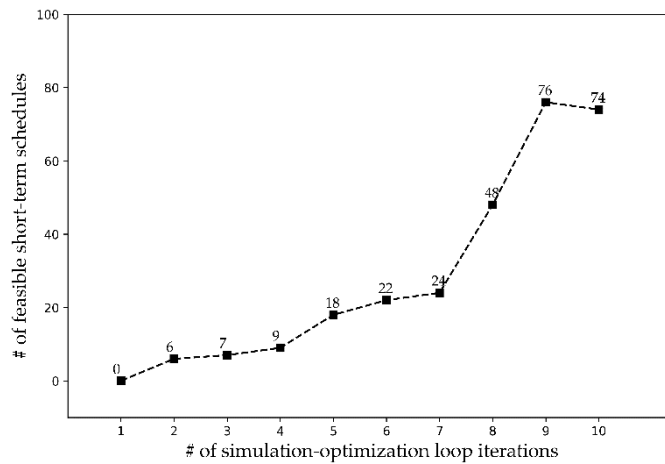

Figure 16. Trajectory of feasible short-term schedules as simulation-optimization loop proceeds.

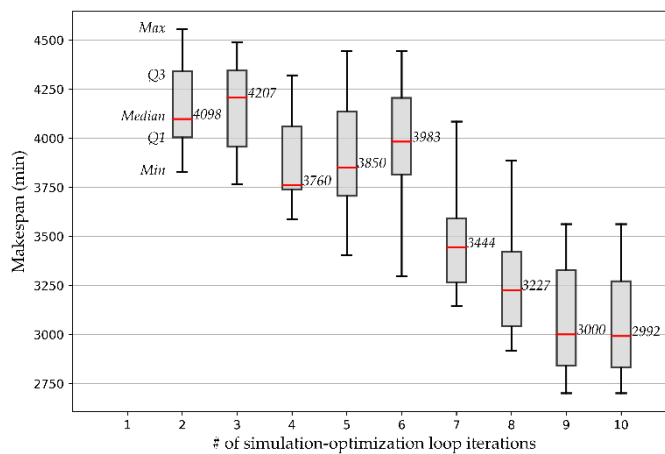

Figure 17. Box plots of makespan values of the feasible short-term schedules for different simulation-optimization loop iterations.

Some observations emerge from the box plots:

- The box plots of the 5th and the 6th loop iterations are comparatively tall. This suggests that the range of makespan values are quite disperse. The possible explanation for this

could be that the algorithm starts to explore a wider range in the solution space of this problem.

- In almost all the box plots, the 4 sections (quartiles) of the box plot are uneven in size. This shows the diversity, in the thicker section, and the similarity, in the thinner section, of the obtained results.
- The medians of the box plots of the 9th and the 10th loop iterations are at the same level, however they show a different distributional characteristic.
- Most of the box plots are positively (right) skewed and only two of them show a symmetric distribution (7th and 8th).

To reduce the computational load quite effectively, in every simulation-optimization loop iteration, the ten best schedules are selected to be tested by the simulator and only their outputs are analyzed by the control module to redefine the input parameters. The criteria for the selection of the best schedules are:

- Makespan: Having a short makespan is a necessary condition for the selection of the best schedules but it is not sufficient. The following two criteria should also be considered.
- Utilizations of excavators: After the makespan, the total and also individual utilizations of the excavators should be analyzed in order to select the best schedules. For example, Figure 18 presents the utilizations of nine different schedules ((a) – (i)) which their makespan are about 2700 (*min*). The total utilizations of the equipment vary from 62% – 67%. Among these, schedules (b), (e), (f), and (i) have the highest utilizations and are added to the selection list. Next, the other criterion should be taken into account to narrow down the list.
- Utilizations of Spreaders: Likewise to the excavators, the total and individual utilizations of the spreaders should be analyzed. Figure 19 displays the utilization of the same nine schedules ((a) – (i)). Based on the selection list's items ((b), (e), (f), and (i)), the total utilizations fluctuate between 48% – 49%. Here, the individual utilizations play a crucial role. For instance, consider schedule (f) of Figure 19, the utilization of *I2* is about 97% while other spreaders have lower utilizations. In this case, experiments revealed that there is a high chance of not meeting the target

utilization when the unscheduled breakdown behavior is added to the model by the simulator. The

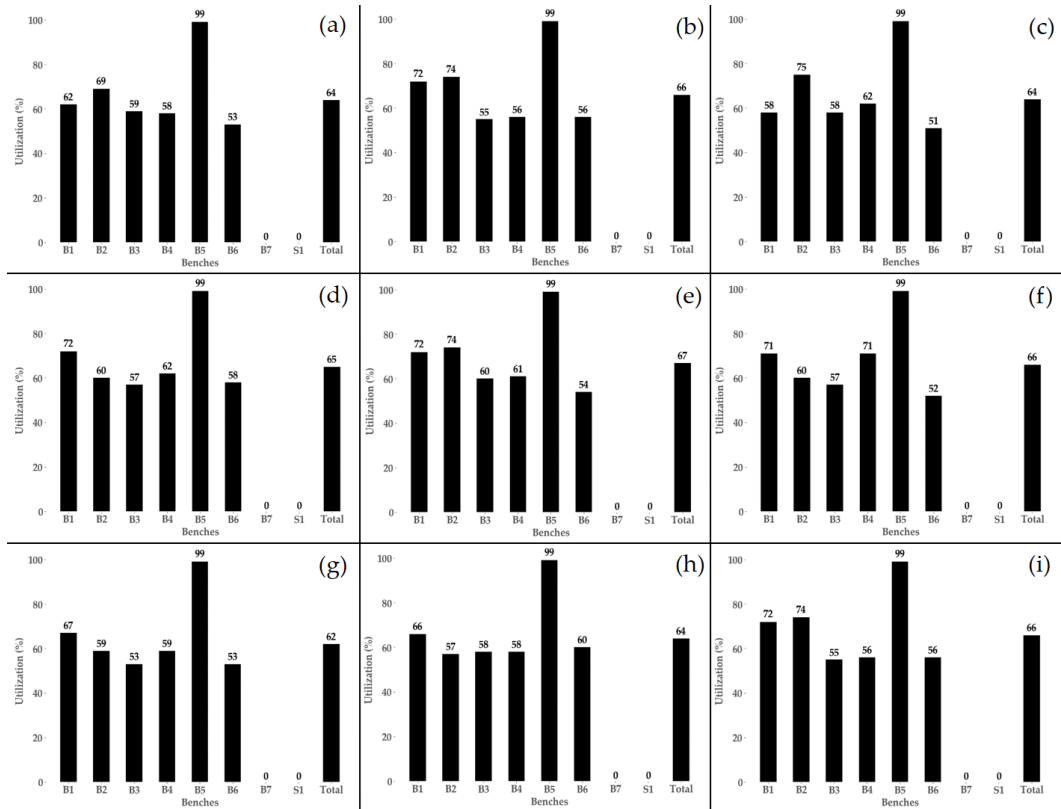

Figure 18. Utilizations of nine different feasible schedules, output of optimization block.

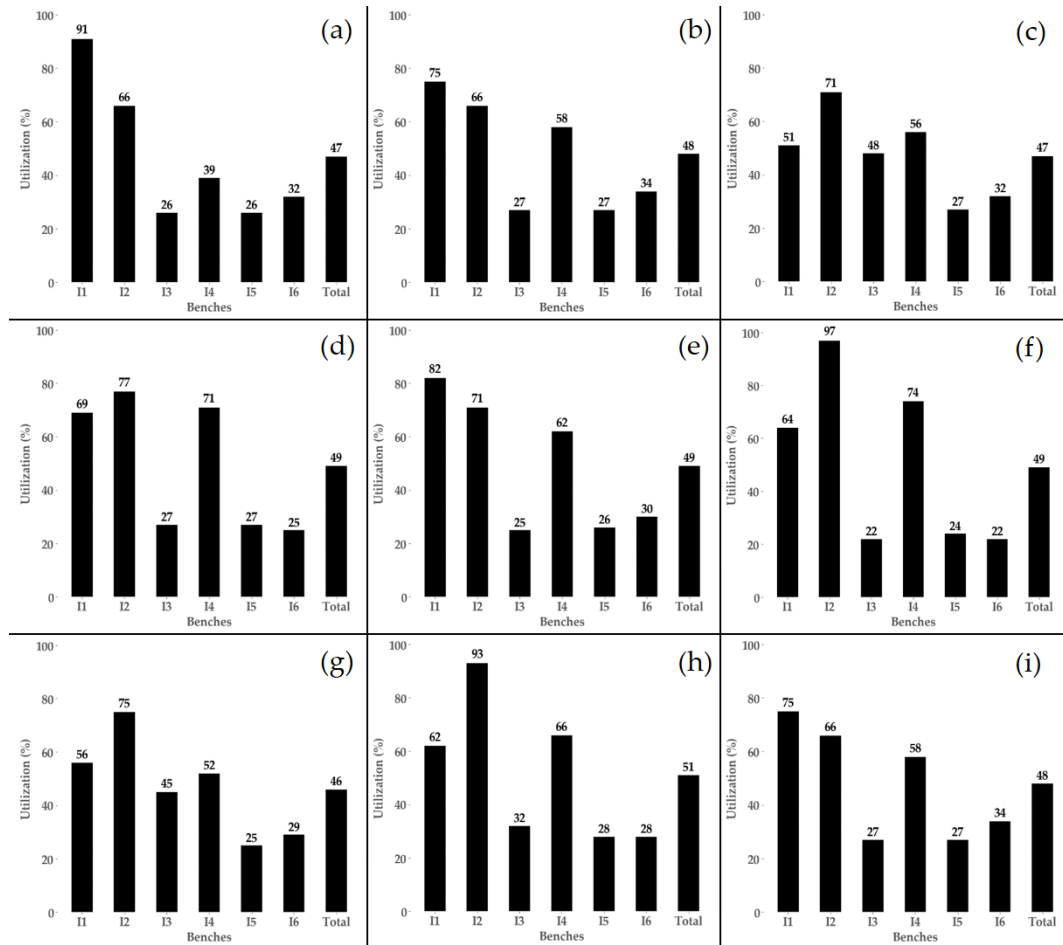

Figure 19. Utilizations of nine different feasible schedules, output of optimization block.

argument can be correct for the schedule (g) as well; its total utilization is about 51%, but there is a high chance to not to meet the target in the reality. These investigations narrow down the list to the schedule (e) in Figure 19 to be the best schedule. Having defined the best schedule, the following will now move on to discuss more details of its results.

The output result of the transportation problem is given in Table 7. For each extraction sequence, the transportation problem finds the optimal connections between the excavators and the spreaders. For instance, in the first extraction sequence, bench *I1* will receive materials from extraction benches *B4* and *B1*. The question is now “which one of the excavators sends the materials first?” The job-shop scheduling problem will find the optimal schedule over time. Its detail and the formulation were discussed earlier in Section 5.3. The output of the job-shop scheduling problem in the form of a Gantt chart is presented in Figure 20. The completion times (c_i) and start/end times of different tasks of benches are shown in the figure. As can be seen, bench *B4* sends first, then bench *B1*. Waiting for the assigned spreader causes the gap between two tandem tasks. In the case of bench *B5*, which produces only coal, no waiting times were expected as a result of material

changes. In summary, the proposed method minimizes the number of these gaps with effective resource allocations.

Table 7. Output of the transportation problem.

Extraction Sequence	Connections of the Spreaders to Excavators
1	(I1 => B4), (I1 => B1), (I2 => B3), (C => B5), (I2 => B6), (I3 => B2)
2	(I1 => B3), (I1 => B1), (I2 => B2), (C => B5), (I2 => B6), (I1 => B4)
3	(I1 => B4), (I2 => B3), (I1 => B1), (I5 => B6), (C => B5), (I2 => B6), (I3 => B2)
4	(I1 => B1), (I4 => B4), (I2 => B3), (I4 => B6), (C => B5), (I3 => B2)
5	(I2 => B3), (I2 => B6), (I1 => B4), (I4 => B1), (C => B5)
6	(I2 => B2), (I1 => B3), (I1 => B1), (I4 => B4), (C => B5), (I2 => B6), (I1 => B4)
7	(I2 => B2), (I1 => B3), (I4 => B4), (I4 => B6), (C => B5), (I2 => B1)
8	(I6 => B2), (I1 => B1), (I2 => B3), (C => B5), (I5 => B4), (I2 => B6)
9	(I6 => B2), (I1 => B1), (I4 => B4), (C => B5), (I2 => B6), (I3 => B2), (I4 => B1)
10	(I6 => B2), (I4 => B4), (I2 => B3), (C => B5), (I5 => B4), (I2 => B6), (I1 => B4), (I4 => B1)
11	(I2 => B2), (I1 => B3), (I1 => B1), (I4 => B4), (I4 => B6), (C => B5)
12	(I1 => B1), (I5 => B2), (C => B5), (I5 => B3), (I1 => B4), (I2 => B6)
13	(I6 => B2), (I4 => B4), (I3 => B6), (I3 => B1), (C => B5), (I3 => B3), (I1 => B4)
14	(I6 => B2), (I1 => B1), (I2 => B3), (C => B5), (I3 => B3), (I1 => B4), (I1 => B6)
15	(I5 => B6), (I2 => B3), (C => B5), (I4 => B4), (I3 => B6)
16	(I4 => B4), (I2 => B6), (I6 => B3), (I6 => B6), (C => B5)
17	(I4 => B3), (C => B5), (I4 => B4), (I1 => B4)
18	(I1 => B4), (I1 => B6), (I1 => B3), (C => B5)
19	(I5 => B6), (I5 => B3), (C => B5), (I4 => B4), (I3 => B6)

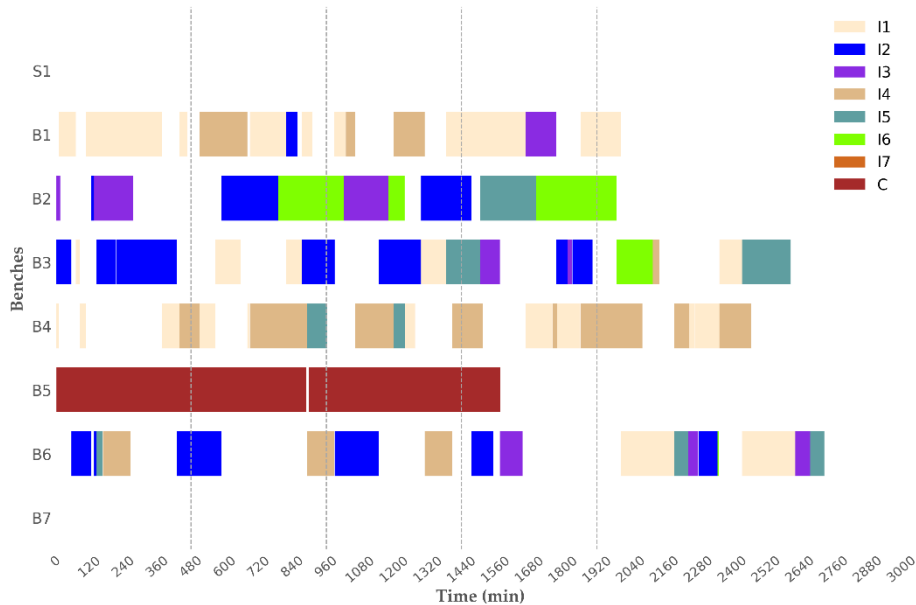

Figure 20. A feasible Gantt chart.

The details of the simulation model of the Hambach mine from the simulation concept to practical full-scale implementation can be found in (Shishvan & Benndorf, 2017). The following will conclude the salient findings of this study.

9. Conclusions

Throughout this study, a new simulation-based optimization approach has been proposed. The approach is capable of optimizing the dispatch decisions in an opencast mine operated under the paradigm of continuously excavated material flow. It combines deterministic optimization with stochastic simulation in a closed loop. A transportation problem and a job-shop scheduling problem composed the optimization model. The performance of the proposed approach was tested in a real-size case study. The Hambach mine is an opencast coal mine and is the biggest producer of coal (lignite) in Germany. In this case, for a given extraction sequences, one hundred random dumping sequences were created. From the obtained results, it can be concluded that:

- The number of feasible short-term schedules increased as the simulation-optimization loop progressed.
- The algorithm stopped after ten loop iterations when no further improvements were seen.
- The box plots of the makespans of the schedules showed a downward trend of the minimum values as the simulation-optimization loop proceeded. This indicated that the quality of solutions increased, with a figure of 24%, until it reached to its optimum value in the 10th loop iteration.
- The selection of the ten best schedules to be run in the simulation software reduced the computational load quite effectively. The criteria for the selection of the best schedules were the makespans, total/individual utilizations of excavators, and total/individual utilizations of spreaders.

As future work, a single step optimization approach is recommended, i.e. physical sequencing can be merged into the deterministic optimization. This is because in a two step optimization approach of short-term production scheduling, the scheduling elements, i.e. physical sequencing and equipment utilization, are artificially separated so that they do not benefit from their simultaneous optimization.

Acknowledgement

This research is supported by the Research Fund for Coal and Steel of European Union. RTRO-Coal, Grant agreement no. RFCR-CT-2013-00003. We are immensely grateful to Prof. Jan-Dirk Jansen for his comments on an earlier version of the manuscript.

References

- 1 Alarie, S., & Gamache, M. (2002). Overview of solution strategies used in truck dispatching
2 systems for open pit mines. *International Journal of Surface Mining, Reclamation and*
3 *Environment*, 16(1), 59-76.
- 4 Albey, E., & Bilge, Ü. (2011). A hierarchical approach to FMS planning and control with
5 simulation-based capacity anticipation. *International Journal of Production Research*, 49(11),
6 3319-3342.
- 7 Almeder, C., Preusser, M., & Hartl, R. F. (2009). Simulation and optimization of supply chains:
8 alternative or complementary approaches? *OR spectrum*, 31(1), 95-119.
- 9 Ammeri, A., Hachicha, W., Chabchoub, H., & Masmoudi, F. (2011). A comprehensive literature
10 review of mono-objective simulation optimization methods. *Advances in Production*
11 *Engineering & Management*, 6(4), 291-302.
- 12 Andradóttir, S. (1998). *A review of simulation optimization techniques*. Paper presented at the
13 Proceedings of the 30th conference on Winter simulation.
- 14 Aqlan, F., Lam, S. S., & Ramakrishnan, S. (2014). An integrated simulation–optimization study
15 for consolidating production lines in a configure-to-order production environment.
16 *International Journal of Production Economics*, 148, 51-61.
- 17 Bang, J.-Y., & Kim, Y.-D. (2010). Hierarchical production planning for semiconductor wafer
18 fabrication based on linear programming and discrete-event simulation. *Automation Science*
19 *and Engineering, IEEE Transactions on*, 7(2), 326-336.
- 20 Banks, J., Carson, J. S., Nelson, B. L., & Nicol, D. M. (2005). *Discrete-event system simulation*:
21 Pearson.
- 22 Barton, R. R., & Meckesheimer, M. (2006). Metamodel-based simulation optimization. *Handbooks*
23 *in operations research and management science*, 13, 535-574.
- 24 Carson, Y., & Maria, A. (1997). *Simulation optimization: methods and applications*. Paper presented
25 at the Proceedings of the 29th conference on Winter simulation.
- 26 Chu, Y., You, F., Wassick, J. M., & Agarwal, A. (2015). Simulation-based optimization
27 framework for multi-echelon inventory systems under uncertainty. *Computers & chemical*
28 *engineering*, 73, 1-16.
- 29 Figueira, G., & Almada-Lobo, B. (2014). Hybrid simulation–optimization methods: A taxonomy
30 and discussion. *Simulation Modelling Practice and Theory*, 46, 118-134.
- 31 Fu, M. C. (1994). Optimization via simulation: A review. *Annals of Operations Research*, 53(1), 199-
32 247.
- 33 Fu, M. C. (2001). *Simulation optimization*. Paper presented at the Proceedings of the 33rd
34 conference on Winter simulation.
- 35 Fu, M. C. (2002). Optimization for simulation: Theory vs. practice. *INFORMS Journal on*
36 *Computing*, 14(3), 192-215.
- 37 Gansterer, M., Almeder, C., & Hartl, R. F. (2014). Simulation-based optimization methods for
38 setting production planning parameters. *International Journal of Production Economics*, 151,
39 206-213.
- 40 Gärtner, D., Hempel, R., & Rosenberg, H. (2013). Operations management systems in RWE
41 Power AG's opencast mines. *World of Mining, GdmB*, 65(3).
- 42 Gershon, M. E. (1983). Mine scheduling optimization with mixed integer programming. *Min.*
43 *Eng.(Littleton, Colo.)(United States)*, 35(4).
- 44 Gurobi Optimization, I. (2016). Gurobi Optimizer Reference Manual. from
45 <http://www.gurobi.com>
- 46 Halim, R. A., & Seck, M. D. (2011). *The simulation-based multi-objective evolutionary optimization*
47 *(SIMEON) framework*. Paper presented at the Proceedings of the Winter Simulation
48 Conference.
- 49 Hustrulid, W., & Kuchta, M. (2006). *Open pit mine planning & design: Fundamentals* (Vol. 1):
50 Taylor & Francis.
- 51 Jalali, H., & Van Nieuwenhuyse, I. (2015). Simulation optimization in inventory replenishment:
52 A classification. *IIE Transactions*(just-accepted), 00-00.
- 53
54
55
56
57
58
59
60
61
62
63
64
65

- 1 Jones, D. R. (2001). A taxonomy of global optimization methods based on response surfaces.
2 *Journal of Global Optimization*, 21(4), 345-383.
- 3 Jung, J. Y., Blau, G., Pekny, J. F., Reklaitis, G. V., & Eversdyk, D. (2004). A simulation based
4 optimization approach to supply chain management under demand uncertainty. *Computers*
5 *& chemical engineering*, 28(10), 2087-2106.
- 6 Köchel, P., & Nieländer, U. (2005). Simulation-based optimisation of multi-echelon inventory
7 systems. *International Journal of Production Economics*, 93, 505-513.
- 8 Ku, W.-Y., & Beck, J. C. (2016). Mixed Integer Programming models for job shop scheduling: A
9 computational analysis. *Computers & Operations Research*, 73, 165-173.
- 10 L'Heureux, G., Gamache, M., & Soumis, F. (2013). Mixed integer programming model for short
11 term planning in open-pit mines. *Mining Technology*, 122(2), 101-109.
- 12 Lim, S. J., Jeong, S. J., Kim, K. S., & Park, M. W. (2006). A simulation approach for production-
13 distribution planning with consideration given to replenishment policies. *The International*
14 *Journal of Advanced Manufacturing Technology*, 27(5-6), 593-603.
- 15 Lin, J. T., & Chen, C.-M. (2015). Simulation optimization approach for hybrid flow shop
16 scheduling problem in semiconductor back-end manufacturing. *Simulation Modelling*
17 *Practice and Theory*, 51, 100-114.
- 18 Manne, A. S. (1960). On the job-shop scheduling problem. *Operations research*, 8(2), 219-223.
- 19 Matamoros, M. E. V., & Dimitrakopoulos, R. (2016). Stochastic short-term mine production
20 schedule accounting for fleet allocation, operational considerations and blending
21 restrictions. *European Journal of Operational Research*, 255(3), 911-921.
- 22 McKinney, W. (2010). *Data structures for statistical computing in python*. Paper presented at the
23 Proceedings of the 9th Python in Science Conference.
- 24 Mena, R., Zio, E., Kristjanpoller, F., & Arata, A. (2013). Availability-based simulation and
25 optimization modeling framework for open-pit mine truck allocation under dynamic
26 constraints. *International Journal of Mining Science and Technology*, 23(1), 113-119.
- 27 Nageshwaranier, S. S., Son, Y.-J., & Dessureault, S. (2013a). Simulation-based optimal planning
28 for material handling networks in mining. *Simulation*, 89(3), 330-345.
- 29 Nageshwaranier, S. S., Son, Y.-J., & Dessureault, S. (2013b). *Simulation-based robust optimization*
30 *for complex truck-shovel systems in surface coal mines*. Paper presented at the Proceedings of
31 the 2013 Winter Simulation Conference: Simulation: Making Decisions in a Complex World.
- 32 Othman, S. N., & Mustafa, N. H. (2012). *Supply chain simulation and optimization methods: an*
33 *overview*. Paper presented at the Intelligent Systems, Modelling and Simulation (ISMS), 2012
34 Third International Conference on.
- 35 Shishvan, M. S., & Benndorf, J. (2014). *Performance optimization of complex continuous mining*
36 *system using stochastic simulation*. Paper presented at the Engineering Optimization IV,
37 LISBON, PORTUGAL.
- 38 Shishvan, M. S., & Benndorf, J. (2016). The effect of geological uncertainty on achieving short-
39 term targets: A quantitative approach using stochastic process simulation. *Journal of the*
40 *Southern African Institute of Mining and Metallurgy*, 116(3), 259-264.
- 41 Shishvan, M. S., & Benndorf, J. (2017). Operational Decision Support for Material Management
42 in Continuous Mining Systems: From Simulation Concept to Practical Full-Scale
43 Implementations. *Minerals*, 7(7), 116. doi: 10.3390/min7070116
- 44 Sprenger, R., & Mönch, L. (2012). A methodology to solve large-scale cooperative transportation
45 planning problems. *European Journal of Operational Research*, 223(3), 626-636.
- 46 Subramaniam, G., & Gosavi, A. (2007). Simulation-based optimisation for material dispatching
47 in Vendor-Managed Inventory systems. *International Journal of Simulation and Process*
48 *Modelling*, 3(4), 238-245.
- 49 Subramanian, D., Pekny, J. F., & Reklaitis, G. V. (2001). A simulation - optimization framework
50 for research and development pipeline management. *AIChE Journal*, 47(10), 2226-2242.
- 51 Subramanian, D., Pekny, J. F., Reklaitis, G. V., & Blau, G. E. (2003). Simulation - optimization
52 framework for stochastic optimization of R&D pipeline management. *AIChE Journal*, 49(1),
53 96-112.
- 54
55
56
57
58
59
60
61
62
63
64
65

- 1 Tekin, E., & Sabuncuoglu, I. (2004). Simulation optimization: A comprehensive review on theory
2 and applications. *IIE Transactions*, 36(11), 1067-1081.
- 3 Topal, E., & Ramazan, S. (2012). Mining truck scheduling with stochastic maintenance cost.
4 *Journal of Coal Science and Engineering (China)*, 18(3), 313-319.
- 5 Truong, T. H., & Azadivar, F. (2003). *Simulation optimization in manufacturing analysis: simulation
6 based optimization for supply chain configuration design*. Paper presented at the Proceedings of
7 the 35th conference on Winter simulation: driving innovation.
- 8 Venkateswaran, J., & Son, Y.-J. (2005). Hybrid system dynamic—discrete event simulation-based
9 architecture for hierarchical production planning. *International Journal of Production Research*,
10 43(20), 4397-4429.
- 11 Wan, X., Pekny, J. F., & Reklaitis, G. V. (2005). Simulation-based optimization with surrogate
12 models—Application to supply chain management. *Computers & chemical engineering*, 29(6),
13 1317-1328.
- 14 Wilke, F., & Reimer, T. (1977). Optimizing the short term production schedule for an open pit
15 iron ore mining operation. *15th Internat. Appl. Comput. Oper. Res. in Mineral Indust.(APCOM)
16 Sympos. Proc*, 425-433.
- 17 Wilke, F., & Woehrlle, W. (1980). *A model for short-range planning and monitoring of mining in
18 potassium deposits of level formation*. Paper presented at the 16th APCOM.
- 19 Winston, W. L., & Goldberg, J. B. (2004). *Operations research: applications and algorithms* (Vol. 3):
20 Duxbury press Belmont, CA.
- 21 Yoo, T., Cho, H., & Yücesan, E. (2010). Hybrid algorithm for discrete event simulation based
22 supply chain optimization. *Expert Systems with Applications*, 37(3), 2354-2361.
- 23
24
25
26
27
28
29
30
31
32
33
34
35
36
37
38
39
40
41
42
43
44
45
46
47
48
49
50
51
52
53
54
55
56
57
58
59
60
61
62
63
64
65