



Integrating a Community-Engaged Decision Process in a Sanitation Design Process: An Explorative Case Study in the Philippines

Preface

This report was written as my graduation project for my Master's degrees in Environmental Engineering and Construction Management and Engineering at Delft University of Technology. Within this report, I present the research I have conducted over the last year regarding applying a participatory decision-making method to a sanitation design process. Within the context of this research, I have conducted 2,5 months of field work in Hagonoy, Bulacan, the Philippines. This field work would not have been possible without the support of the following organisations, to which I extend my gratitude: TU Delft Global Initiative, Stichting Fundatie van de Vrijvrouwe van Renswoude, FAST-fund Delft, and the Lamminga Fund.

The audience targeted by this report consists of scientists and practitioners interested in concrete participatory methods for designing sanitation systems. Readers interested in an overview of relevant design criteria for sanitation design are referred to chapter 2. Background. Those interested in a systematic method to understand demands and needs as perceived by stakeholders are referred to chapter 2. Methodology describes the setup of the Fuzzy Analytical Hierarchy Process and the Focus Group Discussions. To readers who want to understand how the inclusion of local stakeholders affects the process and benefits the design outcome, reading chapter 5. Discussion is recommended.

Lastly, I would like to thank those who have supported me, helped me, and provided feedback to me. First and foremost, I extend my gratitude to my own family and my newly gained family. To the Bautista family, especially Nanay Amy, thank you from the deepest of my heart for making me feel at home in Hagonoy. All this would not have been possible without you. To my supervisors, thank you for challenging me, providing me with the freedom I experienced in conducting this research, and allowing me to discover my passion for this research subject that will keep me in Delft for four more years. Thanks to Ahlen for guiding me when I needed it. Lastly, I would like to thank my dear friends who have kept me from going insane because, well... thesis...

Again, thanks to everyone, and may the story continue.

Sander Wingelaar

13-12-2023

Delft

Abstract

This research addresses the critical issue of the poor implementation of sanitation and its effect on community and environmental health in the Global South. To overcome the social, cultural, technical, and financial complexities underlying poor sanitation, the participation of local community members in sanitation planning processes is deemed crucial for the successful development and implementation of sanitation systems.

To engage local stakeholders as decision-makers and improve design freedom, it is proposed to engage stakeholders in determining their demands, needs, and priorities by combining the Fuzzy Analytical Hierarchy Process (FAHP) and Focus Group Discussions (FGD) as a participatory decision-making method. The applicability and suitability of this method are assessed through a case study in Hagonoy, the Philippines, in which two parallel design cycles are carried out: one with only local sanitation experts as decision-makers and one with only local community members as decision-makers. A systematic literature review of design criteria applicable to sanitation design processes was conducted to overcome selectors' bias regarding the decision criteria assessed in the FAHP and the FGD. The FAHP data was collected among 60 community members evenly distributed over six neighbourhoods in Hagonoy and six local sanitation experts. Three FGDs were held with local community members, whilst one FGD was held with local sanitation experts. The design cycle based on the defined design scope was limited to the development of a conceptual design, proposing a treatment train capable of treating the produced domestic wastewater such that the effluent satisfies the local General Effluent Standards, specifically for the parameters water volume, Total Phosphorus (TP), Chemical Oxygen Demand (COD), Ammonia (NH₃), and Nitrate (NO₃²⁻). Wastewater treatment technologies aligning with the demands and needs specified by the stakeholders were obtained from scientific literature, which were combined into a sanitation system configuration that could treat the water sufficiently.

The completion of a sanitation design process without predefining the possible solutions, but by integrating the FAHP + FGD in the systematic derivation of the design scope, demonstrated how a demand- and need-driven design approach allows increased flexibility and sensitivity for the context in the development of a design. The parallel design cycles showed how the FAHP + FGD method could be applied as a systematic procedure to understand how design criteria in sanitation design are preferred and interpreted differently between local community members and local sanitation experts and how this can influence the conceptual design. Altogether, this research contributes to the body of knowledge in community-engaged sanitation design by demonstrating the effectiveness of the FAHP and FGD method in engaging community members in a need-driven design process, overcoming selectors' bias for technologies and trade-offs, and producing relevant design proposals. However, acknowledging that the FAHP + FGD method was limited to engaging stakeholders only in defining the needs and demands, verification of the designs' alignment with the perspectives of stakeholders and continuous engagement throughout the entire design process is essential to be further researched in the future.

Content

Preface.....	2
Abstract	3
Figures	6
Tables	10
Nomenclature.....	11
1. Introduction.....	12
1.1. Introducing Sanitation.....	12
1.2. Participation: Who, When, and How Much?.....	14
1.3. Knowledge Gap	16
1.4. Scope.....	Error! Bookmark not defined.
1.5. Reading Guide	22
2. Background	23
2.1. The Stages of a Sanitation System	23
2.2. Overcoming Complexity in Sanitation Design.....	24
2.3. Factors Determining Sanitation Design	26
3. Methodology	31
3.1. Case study	31
3.2. Fuzzy Analytical Hierarchy Process (FAHP).....	33
3.2.1. Pairwise Comparisons Format.....	34
3.2.2. Pairwise Comparisons Exercise	34
3.2.3. Pairwise Comparison Data Collection.....	36
3.2.4. Structuring the Fuzzy Analytical Hierarchy Process Data	37
3.2.5. Assessing the Judgment and Consistency	37
3.3. Focus Group Discussions	40
3.4. Development of Conceptual Designs	44
3.4.1. Influent and Effluent Characteristics.....	44
3.4.2. Selection of Treatment Technologies.....	45
3.4.3. Sizing of Design Proposals	46
3.4.4. Comparison of Conceptual Designs	47
4. Results	48
4.1. Fuzzy Analytical Hierarchy Process.....	48
4.1.1. Respondents FAHP	48
4.1.2. Assessment of Collected FAHP Data	50
4.1.3. Consistency Ratio.....	51

4.1.4.	Spread of Relative Weights of Design Criteria	52
4.1.5.	Aggregate weights	54
4.2.	FGD - End-users.....	56
4.3.	Designs of the Sanitation Systems	59
4.3.1.	Treatment Processes.....	59
4.3.2.	Treatment Design.....	60
5.	Discussion	63
5.1.	Engaging Local Community Members in a Sanitation Design Process.....	63
5.1.1.	Assessing the Suitability of the Fuzzy Analytical Hierarchy Process	65
5.1.2.	Assessing the Suitability of the Focus Group Discussions	70
5.2.	Reconsidering the Design Criteria for the Design Scope.....	70
5.2.1.	Reviewing the Completeness of the Design Scope.....	71
5.2.2.	Improved Participation Regarding the Design Scope	72
5.3.	Deriving the Design Scope.....	73
5.3.1.	Community Health and Safe Product Disposal	74
5.3.2.	Job Opportunities.....	75
5.3.3.	Operational Expenditure and Capital Expenditure.....	76
5.3.4.	Policy Alignment	77
5.3.5.	Robustness and Resilience	77
5.3.6.	Resource Recovery Potential	78
5.3.7.	Interpretation of the Design Scopes	78
5.4.	Tailoring Sanitation Design to the Preferences of Stakeholders	79
5.4.1.	Comparing the Designs of Local Community Members and Sanitation Experts	80
5.4.2.	Comparing the Participatory Developed Designs to Existing Designs.....	81
5.4.3.	From Conceptual Design to Practice.....	81
5.5.	Revisiting Participation in the Sanitation Design Cycle	82
6.	Conclusion.....	84
6.1.	Recommendations for Future Research	85
	Bibliography Main Text	86
	Overview Appendices	86

Figures

Figure 1 Position of chapter 1. Introduction in document	12
Figure 2 Visual representation of the successive design stages in the design cycle	15
Figure 3 Participation ladder as proposed by The International Association for Public	16
Figure 4 Overview of reviewed participation in assessed sanitation planning frameworks, linked to the design phases proposed in the Design Cycle and complemented by 'Design Selection'. The degree of participation is assessed using the levels of participation proposed by The International Association for Public Participation (2007).	18
Figure 5 Overview of shortcomings of twenty assessed sanitation planning frameworks. The frameworks were	19
Figure 6 Overview of the structure of this research and the connection of the different methods to the research questions.....	21
Figure 7 Chapter structure of this report	22
Figure 8 Position of chapter 2. Background in document.....	23
Figure 9 The sequential wastewater treatment phases from the domestic wastewater source to the final discharge point	23
Figure 10 Positioning of the systematic literature review into design criteria relevant to sanitation design within the overall method of this research.....	26
Figure 11 Overview of search query used in Web of Science to assess design criteria for community-engaged sanitation.....	27
Figure 12 Overview systematic literature review for assessment of sanitation design criteria as mentioned in the literature	27
Figure 13 Structure used in definition of design criteria, including example for the definition of 'Community Health' as used in this research.	28
Figure 14 Overview of derivation and categorization of design criteria, including the methods used. The letter 'n' is referring to the number of design criteria	29
Figure 15 Exemplification of the relation between the definition, scenario, and example for the design criterion 'Job Opportunites' as determined and used in this research	30
Figure 16 Position of chapter 3. Methodology in document.....	31
Figure 17 Geographical Location of Hagonoy, Bulacan, the Philippines (own figure).....	31
Figure 19 Picture of situation in Hagonoy during tidal flood pt.2 (own figure).....	32
Figure 18 Picture of situation in Hagonoy during tidal flood pt.1 (own figure).....	32
Figure 20 Picture of street in informal settlement in Hagonoy, adjacent to river (own figure).....	33
Figure 21 Picture of permanent flooded courtyard in Hagonoy (own figure).....	33
Figure 22 Positioning of Fuzzy Analytical Hierarchy Process (FAHP) within research	33
Figure 23 Example of pairwise comparison used in Fuzzy Analytical Hierarchy Process. This example is a screenshot from the Qualtrics Survey used in this research, in which Environmental Friendly is scored as more essential and is ranked on the 9-point Likert scale.....	35
Figure 24 Example of on-paper answer sheet for Fuzzy Analytical Hierarchy Process used in this research	35
Figure 25 Process of Fuzzy Analytical Hierarchy Process data collection.....	36
Figure 26 Triangular Fuzzy Number - graphical overview. Figure 26a, on the left, shows the concept of a Triangular Fuzzy Number (TFN). Figure 26b, on the right, shows the transformation from the linguistic variables used in the 9-point Likert Scale to the fuzzy numbers.	38
Figure 27 Overview applied calculation steps within Fuzzy Analytical Hierarchy Process (FAHP) as applied in this research.	39
Figure 28 Positioning of Focus Group Discussions within this research.....	40
Figure 29 Process of Focus Group Discussions as applied in this research	41

Figure 30 Picture Focus Group Discussion	Figure 31 Picture Focus Group Discussion Pt.2..	42
Figure 32 Visual representation of the questions asked (depicted light yellow) and exercises conducted (depicted dark yellow) during Focus Group Discussions		43
Figure 33 Positioning of Design Cycles within research		44
Figure 34 Example of the spreadsheet used to calculate the design dimensions and efficiencies. The blue rectangles point out the input values, in which the yellow values refer to the 'adjustable parameters' and the blue values to the 'scientific parameters'. The red boxes refer to the calculated values, represented by the green values.		47
Figure 35 Position of chapter 4. Results in document.....		48
Figure 36 Pie-chart of the monthly household income of the local community members participating in the Fuzzy Analytical Hierarchy Process exercise, expressed in Filipino Pesos.....		48
Figure 37 Pie-chart showing the number of people with whom participants shared their toilet. Participants refer to local community members from Hagonoy, the Philippines, who participated in the Fuzzy Analytical Hierarchy Process exercise.		49
Figure 38 Pie-chart of the sanitation systems used by local community members in Hagonoy, the Philippines, participating in the Fuzzy Analytical Hierarchy Process exercise		49
Figure 39 Range of Consistency Ratios of Pairwise Comparison Matrices as provided by local sanitation		51
Figure 40 Distribution of relative weights of social design criteria as obtained from the Fuzzy Analytical Hierarchy Process, using the data of 60 local community members in Hagonoy, The Philippines. The whiskers represent the 1.5xInterQuartileRange , the dots represent the outliers in the data, the box represents the 50% quartile of the values, and the line in the middle of the box represents the median value.		52
Figure 41 Distribution of relative weights of social design criteria as obtained from the Fuzzy Analytical Hierarchy Process, using the data of 6 local sanitation experts in Hagonoy, The Philippines. The whiskers represent the 1.5xInterQuartileRange. The dots represent the outliers in the data, the box represents the 50% quartile of the values, and the line in the middle of the box represents the median value.....		52
Figure 42 Distribution of relative weights of technical design criteria as obtained from the Fuzzy Analytical Hierarchy Process, using the data of 60 local community members in Hagonoy, The Philippines. The whiskers represent the 1.5xInterQuartileRange, the dots represent the outliers in the data, the box represents the 50% quartile of the values, and the line in the middle of the box represents the median value.		53
Figure 43 Distribution of relative weights of technical design criteria as obtained from the Fuzzy Analytical Hierarchy Process, using the data of 6 local sanitation experts in Hagonoy, The Philippines. The whiskers represent the 1.5xInterQuartileRange, the dots represent the outliers in the data, the box represents the 50% quartile of the values, and the line in the middle of the box represents the median value.....		53
Figure 44 Comparison of the relative weights for social design criteria for sanitation systems as calculated from the aggregate judgment matrix, based on the Fuzzy Analytical Hierarchy Process data from six local sanitation experts and sixty local		54
Figure 45 Comparison of the relative weights for technical design criteria for sanitation systems as calculated from the aggregate judgment matrix, based on the Fuzzy Analytical Hierarchy Process data from six local sanitation experts and sixty local community members in Hagonoy, the Philippines. The weights are on a scale of 1.		55
Figure 46 Schematic overview of the treatment stages of the conceptual sanitation system design developed based on the local design guidelines in Hagonoy, the Philippines		60

Figure 47 Schematic overview of the treatment stages of the conceptual sanitation system design developed based on the input from local community members in Hagonoy, the Philippine	60
Figure 48 Schematic overview of the treatment stages of the conceptual sanitation system design developed based on the input from local sanitation experts in Hagonoy, the Philippines	60
Figure 49 Flow-chart sanitation system currently in place, in which the colours represent the pollutant concentration in the effluent of the treatment step. GES refers to the Filipino General Effluent Standards. TP, COD, NH ₃ , and NO ₃ ²⁻ refer to Total Phosphorus, Chemical Oxygen Demand, Ammonia and Nitrate.....	62
Figure 50 Flow-chart of sanitation system designed using end-user input, in which the colours represent the pollutant concentration in the effluent of the treatment step. GES refers to the Filipino General Effluent Standards. TP, COD, NH ₃ , and NO ₃ ²⁻ refer to Total Phosphorus, Chemical Oxygen Demand, Ammonia and Nitrate	62
Figure 51 Flow-chart of sanitation system designed using expert input, in which the colours represent the pollutant concentration in the effluent of the treatment step. GES refers to the Filipino General Effluent Standards. TP, COD, NH ₃ , and NO ₃ ²⁻ refer to Total Phosphorus, Chemical Oxygen Demand, Ammonia and Nitrate	62
Figure 52 Boxplots showing the results of 30 runs of the algorithm to determine the consistency ratio of the aggregated judgment matrix assigned to pairwise comparisons in the Fuzzy Analytical Hierarchy Process. The algorithm used a pool of data from thirty participants, aggregating the data from a specific number of random participants	66
Figure 53 Boxplots showing the results of 30 runs of the algorithm to determine the average absolute score (on a scale of 1 to 9) assigned to pairwise comparisons in the Fuzzy Analytical Hierarchy Process as observed in the aggregated judgment matrix. The algorithm used a pool of data from thirty participants, aggregating the data from a specific number of random participants	66
Figure 54 Comparison between weights calculated with Fuzzy Analytical Hierarchy Process using mean vs using median.....	68
Figure 55 Comparison between weights calculated with Fuzzy Analytical Hierarchy Process using mean vs using median.....	68
Figure 56 Positioning the systematic literature review (SLR) in the design process as applied in this research, before the Fuzzy Analytical Hierarchy Process, the Focus Group Discussions, and the Design Cycle leading to the Design Proposal	70
Figure 57 Proposing an additional Focus Group Discussion to engage local stakeholders in determining the trade-offs assessed in the Fuzzy Analytical Hierarchy Process and the Focus Group Discussions, before the Design Cycle leading to the Design Proposal	73
Figure 58 Positioning the Fuzzy Analytical Hierarchy Process and the Focus Group Discussions after the systematic literature review (SLR) in the design process as applied in this research, before the Design Cycle leading to the Design Proposal	73
Figure 59 Comparison between weights calculated from Fuzzy Analytical Hierarchy Process for social design criteria: experts vs end-users.....	74
Figure 60 Comparison between weights calculated from Fuzzy Analytical Hierarchy Process for technical design criteria: experts vs end-users	74
Figure 61 Proposing the Fuzzy Analytical Hierarchy Process in combination with Focus Group Discussions to engage local stakeholders in defining the design scope using the input regarding relevant design criteria from a Focusu Group discussion, before the Design Cycle leading to the Design Proposal	79
Figure 62 Positioning the development of the conceptual designs after the systematic literature review (SLR), the Fuzzy Analytical Hierarchy Process (FAHP) and the Focus Group Discussions (FGD), before the Design Cycle leads to the Design Proposal	80

Figure 63 | Proposing an additional Focus Group Discussion after the development of the designs, to verify the alignment of the design with the design scope derived from the Fuzzy Analytical Hierarchy Process in combination with Focus Group Discussions, before the final design is proposed..... 82

Figure 64 | Design cycle for sanitation design processes, as derived from the findings in this research. The proposed design cycle is an adapted version of the the design cycle as proposed by Liedtka (2015) for Design Thinking 83

Tables

Table 1 Overview design criteria obtained from literature review and merging exercise, categorized in social and technical design criteria	29
Table 2 Numerical values with their linguistic counterpart as used in the pairwise comparison exercise as part of the Fuzzy Analytical Hierarchy Process.....	34
Table 3 Table containing the wastewater-influent characteristics based on literature and effluent guidelines. Wastewater influent characteristics are derived from literature, including a peak factor of 1.5 for the loadings. *= no guidelines were in place for the quantity of water discharged, but the loadings assume similar volumes as the influent, as guidelines are based on concentrations.	45
Table 4 Summarized overview of the outcome of Focus Group Discussion with local sanitation experts and local community members in Hagonoy, the Philippines. The superscripts refer to the number of Focus Group Discussions from which this statement originates, as three separate Focus Group Discussions were carried out with local community members. The bold printed questions in the light yellow boxes refer to the questions asked to the audience, while the text between brackets refers to the corresponding design criteria used in this research.	58

Nomenclature

ABR	Anaerobic Baffled Reactor
AF	Anaerobic Filter
AHP	Analytical Hierarchy Process
COD	Chemical Oxygen Demand
FAHP	Fuzzy Analytical Hierarchy Process
FGD	Focus Group Discussion
HSFF	Horizontal Subsurface Flow Filter
LCE	Local Sanitation Expert
LCM	Local Community Member
LLSM	Logarithmic Least Squares Method
MCDM	Multi-Criteria-Decision-Making Method
NH ₃	Ammonia
NO ₃	Nitrate
PHP	Philippine Pesos
SDG	Sustainable Development Goal
SSF	Slow Sand Filter
TFN	Triangular Fuzzy Numbers
TP	Total Phosphorus
TU Delft	Delft University of Technology
WASH	Water, Sanitation and Hygiene

1. Introduction

This chapter introduces the context of this research, in which the problems and challenges currently faced regarding the design and implementation of sanitation systems are addressed. Being proposed by the scientific literature as a possible means to overcome these challenges, participatory sanitation design is introduced. Afterwards, the potential role of a participatory approach is elaborated upon before in-place sanitation planning frameworks are assessed. A knowledge gap is identified based on scientific literature and the assessment of existing frameworks. To contribute to the salvation of this knowledge gap, the research questions underlying the research presented in this report are introduced, as well as the method used to answer these questions. Lastly, the scope adopted in this research is explained before presenting the reading guide for the rest of this report.

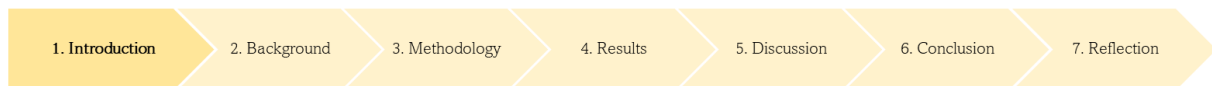

Figure 1 | Position of chapter 1. Introduction in document

1.1. Introducing Sanitation

Despite the United Nations' efforts to implement improved sanitation worldwide, many people – primarily in the Global South – lack access to safe sanitation systems. In 2015, the United Nations adopted the Sustainable Development Goals (SDG), a set of 17 global goals targeting the eradication of poverty, protection of the planet, and healthy and safe well-being for people worldwide (United Nations, 2015). Among these SDGs, SDG6 aims to “ensure access to water and sanitation for all” (United Nations, 2023). When published in 2016, only 68% of all global households had access to improved sanitation, while 91% had access to improved drinking water sources (WHO/UNICEF, 2015). The figures on sanitation, however, tell only a part of the story, as Hawkins et al. (2014) concluded from a case study across 12 cities (located in Southeast Asia, Africa, and Latin America) that while 98% of the inhabitants had access to improved toilets, only 29% of the produced faecal waste was handled safely (Hawkins et al., 2014; Hutton and Chase, 2016). Mara and Evans estimated in 2017 that to reach SDG6 by 2030, 5.3 billion additional people require safely managed sanitation, which converted to approximately 1 million people being helped daily (Mara and Evans, 2017).

The combination of poor sanitation and natural hazards affects community and environmental health, highlighting the urgent need for improved sanitation in the Global South. In low-income areas, the population is often directly exposed to the source of illnesses due to the absence of a sewage system (Londe et al., 2014; Diep et al., 2020). Consequentially, water-borne diseases spread rapidly. The effect of ‘sanitation poverty’ is further increased when vulnerable populations are also affected by natural hazards such as cyclones, floods, and heavy rainfall, which can increase the spread of diseases. Poor sanitation and faecal sludge management pose a direct threat to human health, as infections caused by inadequate sanitation have led to an estimated 432.000 deaths worldwide in 2016 (Pruss-Ustun et al., 2019). Moreover, poor sanitation can lead to polluted air and water bodies, flooding, dirt spreading across the landscape, and clogged drainage systems (Mensah et al., 2022). Poor sanitation thereby becomes a threat to not only human life but all life on earth. Although sanitation is globally perceived as an essential aspect of well-being and health in local communities, there is room for improvement in implementing sanitation in the Global South (Schertenleib et al., 2021; Iossifova et al., 2022).

Sanitation is obstructed from being widely applied by social, cultural, technical, and financial complexities (World Bank, 2019; Russel et al., 2019). While the need for sanitation is evident, the available initial investment funds are often insufficient (OECD, 2019). Water utilities, therefore, turn to local governments for additional grants. However, government institutions in the Global South are reluctant to invest in sanitation due to the perceived lack of possible cost recovery (Dos Santos et al., 2017; Pierce, 2017; Sinharoy et al., 2019). Likewise, the private sector perceives investment opportunities in water projects as unattractive because cost recovery solely based on customers paying for access is financially unfeasible in low-income areas (Machete and Marques, 2021). Cameron et al.

1 (2021) nevertheless conclude that assisting targeted end-users financially during sanitation
2 implementation projects increases the number of installed sanitation systems.

3 The adoption of sanitation does not only depend on sufficient funding, as barriers are defined
4 as contextual factors (E.G., demographics and anthropogenic geography), psychosocial factors (E.G.,
5 values and beliefs), and technological factors (E.G., available materials and applicability of technologies)
6 (Tamene and Afework, 2021). The effectiveness of sanitation systems depends on the compliance of
7 targeted end-users of the system (Berhe et al., 2020). The end-users require knowledge and willingness
8 to use and eventually profit from the improved sanitation system (Dreibelbis et al., 2013).

9 To sustain the behaviour change required for improved sanitation, practices deeply embedded
10 in local cultures must evolve in parallel with improving the sanitation system (Coffey et al., 2014; Orgill-
11 Meyer et al., 2019). Hence, integrating local cultural habits and proven technologies is essential in
12 encouraging environmentally sustainable behaviour (Okumah et al., 2019; Radini et al., 2021).
13 Bhattacharjee et al. (2020) and Hosseinpourtehrani et al. (2022) argue that not identifying unfavourable
14 end-user perceptions towards proposed wastewater management interventions increases the risk of
15 implementing unsupported (and hence doomed) strategies.

16 Consequentially, the desire to align design products with market desires has led to an increased
17 influential role of end-users through their active participation in the design process. Jimenez et al. (2019)
18 propose to include the knowledge of local practices present in communities through the participation
19 of the public, as this improves the quality and implementation of plans. Murungi and Blokland reviewed
20 50 Water, Sanitation and Hygiene (WASH) related articles, from which they concluded that community
21 engagement and ownership were among the main drivers of successful WASH implementation
22 (Murungi and Blokland, 2016). Furthermore, Davis et al. (2019) concluded that all successfully
23 implemented sanitation systems in a sample set of 20 case studies in India involved community
24 participation in the planning process. Appiah et al. (2019) and Tseklevs et al. (2022) concluded that
25 stakeholder engagement should be direct and straightforward to increase community engagement in
26 sanitation projects. Similarly, Kain et al. (2021) argue that enhancing stakeholder participation in
27 sanitation design requires translating the technical design process into information and a decision-
28 making process accessible to all parties involved. By allowing community members to voice their
29 concerns regarding sanitation issues, Corburn et al. (2022) experienced increased incentive and urgency
30 among residents, consequently improving their engagement. It is thus hypothesized that including
31 stakeholders as decision-makers in the design process and adjusting the design according to their input
32 increases the alignment between the design and the demands and wishes of the stakeholders,
33 consequentially improving the acceptance (Duarte et al., 2018).

1.2. Participation: Who, When, and How Much?

Active involvement of stakeholders in the (co-)design of products, systems, and tools forms the foundation of participatory design (Spinuzzi, 2005). Stakeholder participation aims to create understanding and instigate learning processes between facilitators and stakeholders (Robertson and Simonsen, 2012). Thereby, participatory design includes stakeholders in the design process through their active involvement in design activities while fostering stakeholder capacity-building (Drain et al., 2018). However, who are these stakeholders? When should they be involved? Moreover, to which degree should they be involved?

The literature distinguishes stakeholders into 'local sanitation experts' and 'local end-users' based on their experience in sanitation development. The term 'stakeholder' refers to all those (possibly) affected by a design intervention, including government officials and traditional powerholders (Gomez and Nakat, 2002). Therefore, the participation of 'stakeholders' does not inherently equal the inclusion of future end-users or marginalized community members (Black and McBean, 2017). Instead, stakeholders are separated into two groups by their relation to the to-be-designed system, following Cole et al. (2013) and Trischler et al. (2019). The 'local sanitation experts' are defined by their professional involvement in sanitation systems through their role in local government and water bodies, private companies, and non-profit organizations. On the other hand, the 'end-user' group is defined by their intended role as consumers in sanitation systems, gaining their expertise from solely previous user experience. Traditionally, decisions regarding sanitation planning are made by groups/individuals belonging to the 'local sanitation experts' group, excluding end-users from this process (Dery et al., 2020).

As a previous participatory design process by Nayono (2014) has shown, applying participation to all design phases does not necessarily result in successful implementation. Participation is reflected in different phases within sanitation design. The sequence of the design process of sanitation systems in this research is described by the 'Design Thinking' concept as proposed by Liedtka (2015), which provides a structured approach to addressing complex problems (Dell'Era et al., 2020) and innovations (Gruber et al., 2015). While multiple definitions of Design Thinking exist within scientific literature (Micheli et al., 2019), the most adopted definition is the one proposed by Brown (2008, p.86): "[*Design Thinking is*] a discipline that uses the designer's sensibility and methods to match people's needs with what is technologically feasible". Design Thinking as a methodology is, however, criticized because it discards other possible design concepts (Kimbell, 2012) and because of its perceived shortage of methodological approaches (Kolko, 2015), which stem from its attempt to replicate and apply a simplifying concept to complex and ill-defined problems (Laursen and Haase, 2019), shifting its application from design processes to management processes (Micheli et al., 2019). Design Thinking as a framework, on the other hand, provides a systematic structure for the discussion of design processes (Buhl et al., 2019), with innovation, user engagement, complex problem-solving, and iterating designs as cornerstones (Verganti et al., 2021). The original process, as proposed in Design Thinking, is shown by the cycle in Figure 2. The design process structure described by Design Thinking consists of a sequence of three phases, which are also depicted in the cycle in Figure 2:

- **Identifying Needs** seeks to set the outline of the design by identifying the needs of future users and translating these into boundary conditions (Liedtka, 2015; Redante et al., 2019);
- **Ideation** proposes a set of possible solutions by brainstorming ideas following the design criteria formed based on the identified needs and demands (Liedtka, 2015; Redante et al., 2019);
- **Prototyping** further develops the preferred solution proposed in the ideation phase before it is tested for its ability to solve the initial problem (Liedtka, 2015; Redante et al., 2019).

1 Figure 2 shows a cyclic and iterative process instead of a linear sequence of events, emphasizing the
 2 experimental thinking required for solving complex design issues. Moreover, the process initializes with
 3 an extensive problem analysis, forming the reference point for the subsequent design events, ensuring
 4 a need-driven problem-solving approach (Buhl et al., 2019; Micheli et al., 2019). In a fully participatory
 5 design cycle, each design stage depicted by the light blue boxes is conducted while engaging
 6 stakeholders (Redante et al., 2019). To complete the entire Design Cycle, the design has to be
 7 implemented and assessed regarding its ability to solve the initial problem, as is depicted in the left
 8 Design Cycle.

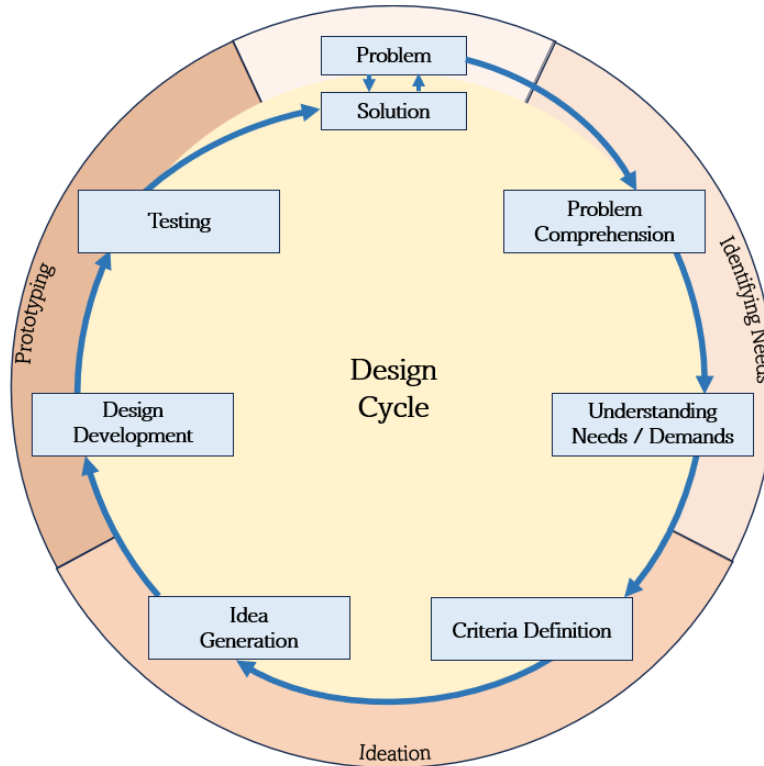

9
 10 *Figure 2* | Visual representation of the successive design stages in the design cycle
 11 as proposed in 'Design Thinking' by Liedtka (2015)
 12

1 Participation occurs on different levels, as the role of 'end-users' ranges from completely dependent
 2 on powerholders' decisions to being empowered as the main decision-makers themselves (Contreras,
 3 2019). Arnstein (1969) first introduced her 'Ladder of Participation', which depicted eight levels of
 4 participation. The described levels range from a passive role of participants involving only top-down,
 5 one-way communication at the bottom level to participants playing an active role in decision-making
 6 with their ideas and plans being implemented (Arnstein, 1969; Mensah, 2020). Similarly, as depicted in
 7 Figure 3, The International Association for Public Participation (2007) defines five levels of
 8 participation: Informing, Consulting, Involving, Collaborating, and Empowering. Following Disterheft
 9 et al. (2012) and Vaughn and Jacquez (2020), these five levels describe participation in this research
 10 because of their simplicity and self-explanatory meaning.

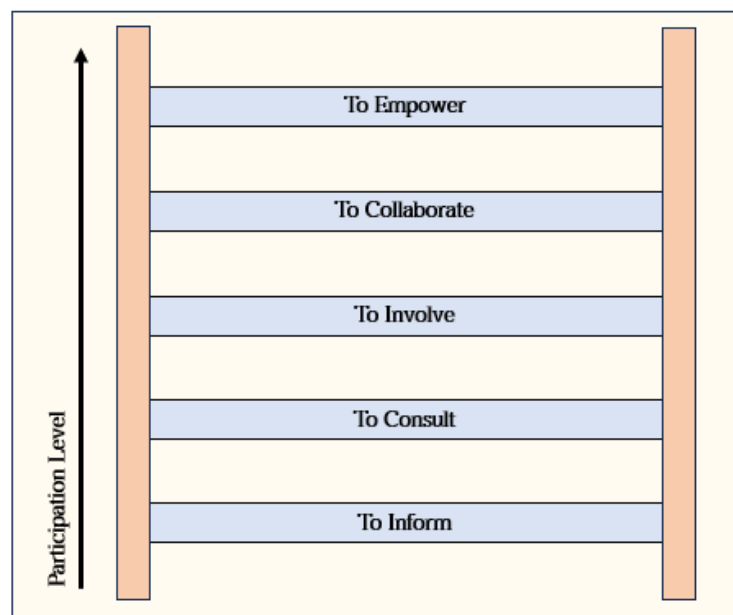

11
 12 *Figure 3 | Participation ladder as proposed by The International Association for Public*
 13 *Participation (2007), formatted in the ladder principle as proposed by Arnstein (1969)*
 14

15 1.3. Knowledge Gap

16 According to scientific literature, researchers state that the need for sanitation design tools to allow
 17 community engagement and end-user participation in sanitation design is crucial for successfully
 18 developing and implementing sanitation systems. The urge for participation has raised the question of
 19 how to involve end-users in a complex matter covering many disciplines (Hyun et al., 2019). Billger et
 20 al. connect the successful implementation of sanitation systems to knowledge development and
 21 transparent communication about sustainable wastewater options, pointing out the need for accessible
 22 and easy-to-use collaborative tools (Billger et al., 2020). While agreeing with the necessity to involve
 23 community members in the assessment and planning of sanitation, Dery et al. (2019) state that
 24 stakeholder input is based on their understanding of the relevant information, emphasizing the need for
 25 suitable tools enabling them to provide such input. Knowledge transfer and education are crucial to
 26 include community members in addressing sanitation challenges (Silvestri et al., 2018; Appiah et al.,
 27 2020), but tools aiding community members in this challenge are necessary to enable them to manage,
 28 sustain, and upscale the sanitation practices (Banana et al., 2015; Intriago Zambrano et al., 2020).
 29 According to Geekiyanage et al. (2021), sanitation development processes lack practical tools to engage
 30 community members while producing usable input for decision-making processes.

1 The existing sanitation design tools and processes do not allow inclusive participation of end-
2 users but limit the level of stakeholders' participation to informing and consultation (see Figure 3). Tilley
3 et al. (2014) recognized the systematic failure of including marginalized stakeholders in participatory
4 sanitation planning, pointing out that the involvement of end-users is merely limited to consultation
5 instead of decision-making in the design process. After reviewing 15 participatory sanitation design
6 tools, Spuhler and Luthi concluded that existing models use pre-determined design solutions,
7 introducing selectors' bias and decreasing (stakeholder) ownership (Spuhler and Luthi, 2020). Both
8 Silvestri et al. (2018) and Intriago Zambrano et al. (2020) acknowledge the need for a bottom-up
9 approach to sanitation, considering both social and technical complexities related to sanitation. This
10 bottom-up approach should allow all community members to participate in decision-making
11 meaningfully (Shields et al., 2021; Tseklevs et al., 2022). Acknowledging the need to identify and
12 include local knowledge and practices in sanitation design processes, Jimenez et al. (2019) recommend
13 developing tools that effectively include community members in the design process to improve user
14 acceptance.

15 Community participation is thus recommended for sanitation design processes, but the
16 literature does not specify in which phases of the design process and how participation should be
17 fostered. According to Vaughn et al. (2020), stakeholder participation is possible at each level of the
18 design cycle. However, questions must be asked about the forms of participation implemented in the
19 different design phases and the capabilities required of the participating stakeholders (Dearden and
20 Rizvi, 2008).

21 To understand how these questions are currently answered, a thorough review of twenty
22 sanitation planning tools and frameworks focused on community engagement involvement in sanitation
23 planning. The review, which is added as Appendix A, addresses the following questions per planning
24 tool:

- 25 • How does the tool work, and which method is applied?
- 26 • Which design criteria are used?
- 27 • What are the advantages of this tool for sanitation planning?
- 28 • What are the disadvantages of this tool for sanitation planning?

29 The participation as used or proposed in the frameworks was assessed per design phase, as
30 proposed in Figure 2 and scored according to the degrees of participation, as proposed in Figure 3.
31 Additionally to these phases, the participation of stakeholders in selecting the preferred design was
32 added to the review, shown in Figure 4 by the boldly printed column. Based on the answers to the
33 abovementioned questions, a conclusion on the suitability of the framework for community-engaged
34 sanitation planning was drawn.

35

Problem	Solution						
	Problem Comprehension	Understanding Needs/Demands	Criteria Definition	Idea Generation	Design Selection	Design Development	Testing
Van Buuren (2010)	inf	inf	inf	inf	inf	inf	
Filho et al. (2019)	inf	cons	inf	inf	inf	inf	
Finney et al. (2009)	inf	inf	inf	inf	inf	inf	
Franceys et al. (2013)	inf	inf	inf	inf	inf	inf	
Jimenez et al. (2019)							
IWA (2014)	inv	inv	coll	inf	cons	inf	
Kalbermatten (1982)	inf	cons	inf	inf	inf	inf	
Katukiza et al. (2010)	cons	inf	inf	inf	coll	inf	
Kvarnstrom and Petersens (2004)	inv	inv	cons	inf	emp	inf	
Langergraber et al. (2015)	inf	inf	inf	inf	inf	inf	
Loetscher and Keller (2002)	cons	cons	inf	inf	inf	inf	
Mara et al. (2007)	inf	inf	inf	inf	inf	inf	
Nayono (2014)	inf	cons	inf		inf	inf	
Olschewski (2013)	inf	cons	inf		inf	inf	
Prouty et al. (2018)							
Schmitt et al. (2017)	inf	inf	inf	inf	inf	inf	
Schrecongost et al. (2020)							
Schutze et al. (2019)	inf	inf	inf	inf	inf	inf	
Spuhler et al. (2020)	inf	coll	cons	inf	inf	inf	
Strande et al. (2014)	inf	inf	inf	inf	inv	inf	

Legend

	Informing Stakeholders (inf)
	Consulting Stakeholders (cons)
	Involving Stakeholders (inv)
	Collaborating Stakeholders (coll)
	Empowering Stakeholders (emp)
	No link to design phase

1
2 **Figure 4** | Overview of reviewed participation in assessed sanitation planning frameworks, linked to the design phases proposed in the
3 Design Cycle and complemented by 'Design Selection'. The degree of participation is assessed using the levels of participation proposed
4 by The International Association for Public Participation (2007).

5 The reviewed frameworks were assessed for community participation in the different phases of
6 sanitation design and their ability to provide concrete input, from which it was concluded that the
7 assessed frameworks fell short in offering complete design freedom to stakeholders in all phases or did
8 not provide concrete input for the design (process). From the review in Appendix A and the schematic
9 overview of participation in these frameworks depicted in Figure 4, it appears that participation in the
10 frameworks proposed by Mara et al. (2007), Franceys et al. (2013), van Buuren (2010), Langergraber et
11 al. (2015), Schmitt et al. (2017), Finney et al. (2009), and Schutze et al. (2019) is strictly limited to
12 informing stakeholders about decisions made throughout the design cycle. The frameworks proposed
13 by Schrecongost et al. (2020), Prouty et al. (2019), and Jimenez et al. (2019) focus on the implementation
14 stage of sanitation planning but do not provide concrete input for the design process and could not be
15 linked to the design cycle itself. The frameworks by Kalbermatten (1982), Katukiza et al. (2010), and
16 Filho et al. (2019) obtain the possible sanitation technologies from a set of technologies previously
17 selected by the developers of the framework. They limit the possible designs to the technologies
18 included in the framework, influencing the freedom of choice by reducing the options. The frameworks
19 proposed by Olschewski (2013) and Nayono (2014) evaluate the suitability of one technology, which is
20 to be pre-selected by the facilitator, hence excluding stakeholders from participation. The frameworks
21 proposed by Loetscher and Keller (2002) and Spuhler et al. (2020) require information input regarding
22 the local situation for specific parameters pre-determined by the framework's developers. While
23 stakeholders provide input for the design criteria, the developers determine the design criteria
24 themselves. Strande et al. (2014) developed a framework for which expertise in wastewater treatment
25 is required, ruling out the participation of stakeholders with no technical background in the design
26 development itself. Kvarnstrom and Petersens (2004) and IWA (2014), on the other hand, describe a
27 framework for the process, specifying the different stages of the design cycle, the desired outcome of
28 each stage, and the tasks in each stage. However, neither prescribes a method to achieve these aspects,
29 as they describe the process instead of providing a method.

30

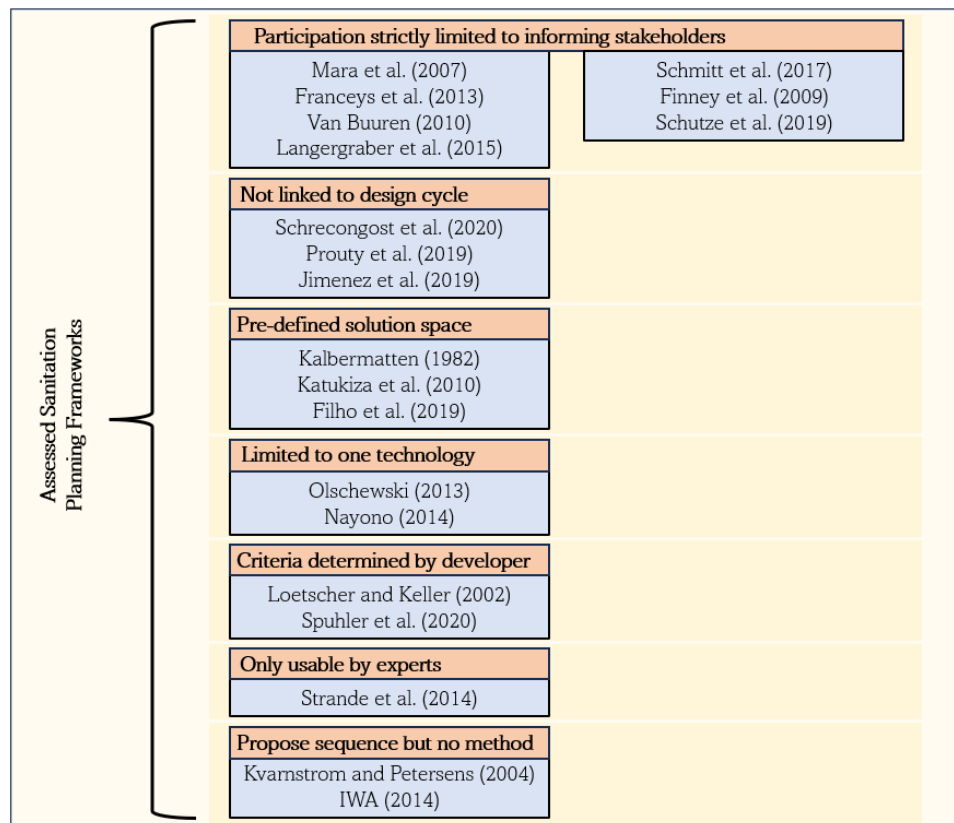

1
2
3 *Figure 5* | Overview of shortcomings of twenty assessed sanitation planning frameworks. The frameworks were assessed for their ability to engage local community members as decision-makers in a sanitation planning process.

4 This assessment observed a lack of knowledge and experience regarding participatory design
5 processes without predefined scope limitations (regarding design criteria and technologies) for
6 sanitation systems. The overviews presented in Figures 4 and 5 show that existing sanitation design
7 frameworks have limited the design freedom by pre-selecting possible technologies or the design scope,
8 introducing selectors' bias from the developer and limiting stakeholder participation in the decision-
9 making process. Consequentially, the participation of stakeholders is often limited to stating their
10 preference within the selection made by the developer. While frameworks by Kvarnstrom and Petersens
11 (2004) and IWA (2014) foresee stakeholders with a decision-making-oriented role, these frameworks do
12 not provide concrete methods for deriving a sanitation system design.

Objective

15 To gain understanding of how stakeholders can be engaged earlier in an open-ended sanitation
16 design process, to explore how early engagement of stakeholders in setting the design scope affects
17 the eventual design proposal

19 To include stakeholders as decision-makers in the design process and simultaneously improve
20 design freedom, it is proposed to engage stakeholders in determining the design agenda and priorities
21 by applying a participatory decision-making method. This research uses the Fuzzy Analytical Hierarchy
22 Process (FAHP) to democratize the decision-making process regarding preferences. It is needed for the
23 design scope because of its ability to derive rankings of (design) criteria objectively (Yu et al., 2021) and
24 its ease of use (Kubler et al., 2016). Focus Group Discussions (FGD) are used to collaborate with
25 stakeholders on determining and interpreting the preferences and design scope. The applicability and
26 suitability of this method are assessed through a case study in which two parallel design cycles are
27 carried out: one with only local sanitation experts as stakeholders and one with only local community
28 members as stakeholders.

1 The central research question and sub-questions in this research and their substantiation are
2 therefore posed as:

3
4 **RQ:** *How can a participatory decision-making approach be implemented in the design of a sanitation
5 system in the Global South to engage the local community?*
6

7 The reviewed literature identifies the need for an open design process for sanitation in which the end-
8 user is included as a decision-maker. Currently, available design tools for sanitation exclude the end-
9 user as a decision-maker regarding design trade-offs, possible solutions, and interpreting (intermittent)
10 results. Within this research, a community-engaged mixed methodology is applied to a real-life case
11 study of a sanitation system design for Hagonoy, the Philippines, testing its ability to assist in the early
12 stages of a participatory design process. Through comparison between the design process itself and its
13 outcome fuelled by input from local sanitation experts (sanitary inspectors, municipality engineers,
14 health office employees) to one process fuelled by input from end-users, the mixed methodology's
15 contribution to developing a community-engaged sanitation design is discussed. The design cycle with
16 the local sanitation experts is the base case to which the design cycle with local community members
17 is compared. The comparison shows how including local community members in the sanitation design
18 cycle affects the process and the eventual design generated.
19

20 **SQ1:** *What design criteria should be considered when defining the scope of community-engaged sanitation
21 design processes?*
22

23 The different design criteria of interest form the design scope. Hence, an overview of relevant design
24 criteria was required to set the design scope for the sanitation design process by experts and end-users.
25 A draft list of design criteria was generated through a systematic literature review. A final concise set of
26 design criteria relevant to community-engaged sanitation design processes was obtained through
27 clustering.
28

29 **SQ2:** *To what extent are sanitation design criteria prioritized differently by local experts and members of the
30 local community during sanitation design sessions?*
31

32 To understand how the perception of the relative importance of the design criteria differs between local
33 experts and the local community, a mixed methodology of the FAHP and FGD was applied. To
34 determine the perceived importance of the end-users, sixty randomly selected end-users were recruited
35 to fill in the FAHP. In addition to the FAHP, three FGDs were organized with members of the local
36 community to assess and interpret the outcome of the FAHP. The exact process was conducted in
37 parallel with six local sanitation experts. The result is two tangible design scopes based on the input of
38 experts and end-users. The differences in trade-offs, outcomes, and perceptions between the two groups
39 are discussed.
40

41 **SQ3:** *How does involving the local community, rather than exclusively depending on expert perspectives or
42 local guidelines, impact the results of a community-engaged design process for sanitation systems?*
43

44 Two design cycles are carried out to assess how the mixed methodology of FAHP and FGD could
45 contribute to a community-engaged design process for sanitation systems. The process and the output
46 are compared to understand how suitable this mixed methodology is for including end-users in the
47 design process and developing a sanitation design. The differences and similarities between the
48 sanitation designs are discussed. Also, the complete design process is assessed and compared to other
49 sanitation design tools, discussing the suitability of the proposed method for a community-engaged
50 design process for sanitation.
51

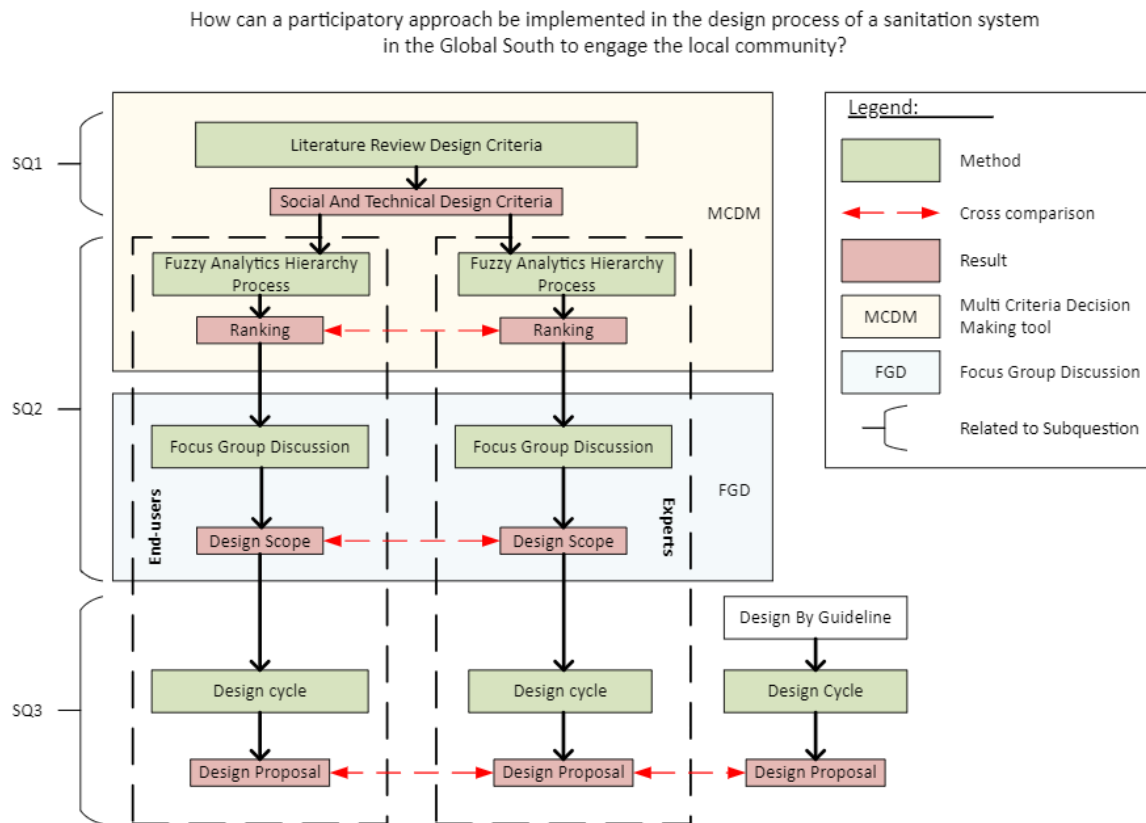

1

2

Figure 6 | Overview of the structure of this research and the connection of the different methods to the research questions

3

1.4. Scoping the Research

4

This research aims to explore the usability of the FAHP in combination with FGD for a community-engaged design process for sanitation in a low-income area. A real-life case study was carried out in Hagonoy, Bulacan, Philippines, to understand the suitability of this mixed method and its impact.

7

Both the FAHP and the FGD are conducted with members of the local community and with local sanitation experts in parallel, which enables comparing the outcome of a sanitation design process based on the input of the two parties. The FAHP data collection for the 'community design process' is limited to 60 community members (age 18+ years) evenly distributed over six neighbourhoods in Hagonoy. The neighbourhoods of interest are selected based on the severity of the flooding, as this increases the urgency for an improved sanitation system. The FAHP data collection for the 'expert design process' is limited to 6 local sanitation experts (water district employees, sanitary inspectors, and municipality engineers) active in Hagonoy. The data collection for the FAHP takes place between the 22nd of May and the 11th of June, 2023. Three FGDs are held with members of the local community, whilst one FGD will be held with the local experts, all between the 4th of July and the 3rd of August 2023. While the limited sample size does not allow for interpreting the results as representative of the local community, it does provide insights into the applicability of the FAHP & FGD for community-engaged design processes for sanitation.

20

21

22

23

24

25

26

27

Two design cycles are carried out to assess the suitability of the proposed mixed methodology for designing a community-engaged sanitation system. One design cycle uses the input of the end-users, and the other uses the input from the experts. The designs are limited to the treatment of Chemical Oxygen Demand (COD), Total Phosphorus (TP), Ammonia (NH₃), and Nitrate (NO₃²⁻). Information on the influent wastewater composition, treatment efficiencies, and design parameters for the treatment technologies is obtained from the scientific literature. The design cycle is limited to a sanitation treatment train proposal, including sizing and expected removal efficiencies for the water quality parameters.

1.5. Reading Guide

This research is divided into seven chapters (see Figure 7), including the **1. Introduction** chapter. The second chapter, **2. Background**, introduces the reader to the theory of Multi-Criteria Decision-Making and the design criteria deemed relevant for sanitation design processes. The third chapter explains the **3. Methodology** followed within this research, elaborating on the mixed methodology (FAHP and FGD) used to capture the perception of experts and end-users regarding the importance of design criteria. Chapter **4. Results** presents the results of the AHP, the FGDs, and the design cycles. These findings will be analyzed and discussed in Chapter **5. Discussion**. Next, chapter **6. Conclusion** concludes the research by summarizing the main findings of this research regarding the research questions and presenting a set of recommendations for future research. Lastly, chapter **7. Reflection** contains a personal reflection of the author on the process, the observations, and the outcome.

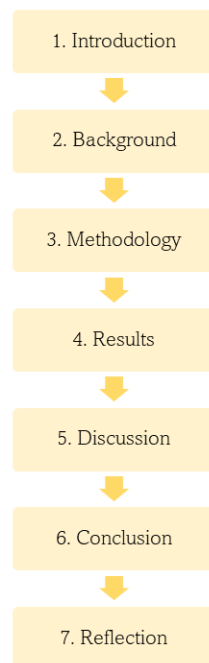

Figure 7 | Chapter structure of this report

2. Background

Within this chapter, information on the design of sanitation systems is provided. First, the conventional stages of a sanitation system are explained, providing the reader with background information on the standard lay-out of a system and additional factors to consider when designing sanitation systems. The variety of possibilities and choices to be made causes the design of sanitation systems to be a complex decision-making process. Literature suggests the application of Multi-Criteria Decision-Making methods because of their systematic way of assessing such problems, after which the FAHP is introduced. Furthermore, a literature review and its outcomes into design criteria involved in community-engaged sanitation design processes are explained. A literature-based definition, a scenario, and an example explain each design criterion.

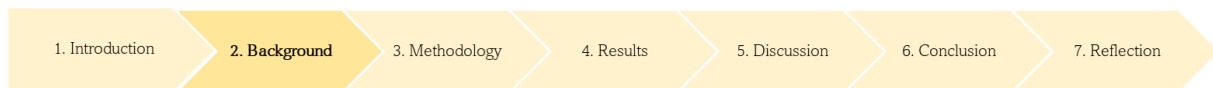

Figure 8 | Position of chapter 2. Background in document

2.1. The Stages of a Sanitation System

Wastewater produced by households contains pollutants, which must be treated to dispose of the water without any safety issues for the community or the environment. Domestic wastewater indicates the water discharged by a community after using the water for domestic activities such as cooking, flushing the toilets, personal washing, and cleaning (Mara, 2013). The purpose of sanitation systems for domestic wastewater is to treat the contaminated water to a degree in which the water can be disposed into the environment without causing harm to the community or the environment (Saravanan et al., 2021). The origin of the produced wastewater, however, causes it to contain various contaminants, ranging from detergents originating from laundry practices to oil and grease from washing the dishes to the nutrients and intestinal bacteria from the toilet effluent (Akpor et al., 2014). The variety of contaminating components and their distinct characteristics require specific treatment to satisfy the discharge standards (Koul et al., 2022).

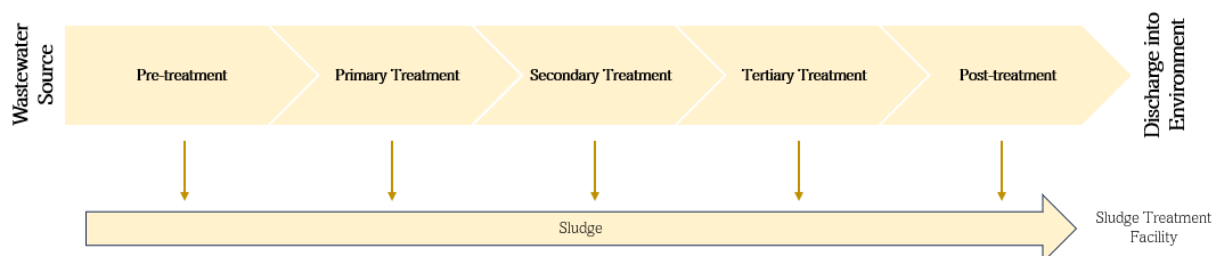

Figure 9 | The sequential wastewater treatment phases from the domestic wastewater source to the final discharge point

Wastewater treatment can be divided into five successive stages: preliminary treatment, primary treatment, secondary treatment, tertiary treatment, and post-treatment treatment, as depicted in Figure 9 above. Additionally, the solid waste product of the treatment processes, sludge, must be treated before disposal (Abelleira et al., 2012). The wastewater enters the treatment system at the preliminary treatment stage, where the wastewater is physically or mechanically treated (Crini and Lichtfouse, 2019). This step aims to remove debris and coarse suspended particles (Koul et al., 2022). The effluent from the pre-treatment step enters the primary treatment stage, where the water is physicochemically or chemically treated (Sonune and Ghate, 2004; Crini and Lichtfouse, 2019). Primary treatment is conventionally focused on removing particles through physical separation, using techniques such as screening, grit removal, and sedimentation (Englande Jr et al., 2015). Secondary treatment uses chemical and/or biological removal processes, and is concerned with removing colloidal and dissolved organic matter (Sonune and Ghate, 2004; Englande Jr et al., 2015; Crini and Lichtfouse, 2019). Secondary treatment typically involves activated sludge or filtration (Englande Jr et al., 2015). Tertiary

1 treatment revolves around physical and chemical treatment, removing toxics, remaining organics, and
 2 nutrients (Sonune and Ghate, 2004; Crini and Lichtfouse, 2019). Post-treatment is used to improve the
 3 quality of the effluent further to protect the receiving water bodies. The applicability of post-treatment,
 4 therefore, depends on the efficiency of the previous treatment stages for the present contaminants and
 5 the effluent standards in place at the location of interest (Mai et al., 2018). Sludge contains most of the
 6 removed pollutants and is characterized by its high concentrations of heavy metals, viruses, protozoa,
 7 and residual organic pollutants (Englande Jr et al., 2015; Anjum et al., 2016).

8 Sanitation systems can be designed to serve as little as one household in a decentralized system
 9 to as much as an entire community in a centralized system. While the latter has advantages related to
 10 its increased scale and, therefore, the distribution of costs and responsibilities among all those served
 11 by the system, it also requires a sewer system with an end-of-pipe treatment plant, hence complicating
 12 the implementation of the system (Wilderer and Schreff, 2000). Moreover, the wastewater treatment
 13 sector in countries in the Global South often lacks the required resources to construct the treatment
 14 plant and the expertise to operate it (Massoud et al., 2009).

15 Many treatment technologies have been developed throughout the years, with differing
 16 applicability based on the present contaminants, the degree of centralization, and the configuration of
 17 the other treatment steps. Consequently, the suitability of the technologies combined into one
 18 wastewater treatment system is dependent on but not limited to treatment efficiency, feasibility,
 19 complexity, geographical location, and costs (Crini and Lichtfouse, 2019; Saravanan et al., 2021).

21 2.2. Overcoming Complexity in Sanitation Design

22 The variety in technology configurations, treatment goals, and stakeholder preferences complicates the
 23 design process of sanitation systems, for which consensus building through systematic decision-making
 24 tools can assist in aligning diverse perspectives. From the assessment of technology options for a
 25 wastewater treatment decision problem, Bottero et al. (2011) concluded that the more complex the
 26 problem is, the more a systematic decision method is required to analyse the criteria to be compared.
 27 However, decisions on the implementation of sanitation are rarely made by individuals, adding to the
 28 complexity of the decision (O’Keefe et al., 2015; Simiyua et al., 2017). Hence, a significant difficulty on
 29 the road to sustainable sanitation is the differences in perception and characterization of sanitation by
 30 different actors. According to Hyun et al. (2019), the overall purpose among involved actors is similar
 31 (*“the protection of human health and the environment from exposure to potentially harmful waste”* Hyun et al.,
 32 2019, P.308). However, variations exist regarding perspectives on how to satisfy this purpose. Similarly,
 33 Setty et al. (2019) observed a variance in the perception of WASH challenges among WASH
 34 professionals with different backgrounds and knowledge levels, increasing the complexity of the
 35 decision-making process.

36 Acknowledging the diversity in opinions, Kvarnstrom and McConville advocated for a
 37 collaborative decision-making process, which *“fosters mutual understanding between stakeholders in a
 38 difficult planning situation”* (P.8, Kvarnstrom and McConville, 2007). The required synthesis of differing
 39 stakeholder opinions for the selection of an appropriate and sustainable sanitation system makes
 40 sanitation planning a ‘complex multi-criteria decision-making problem’ according to Spuhler et al.
 41 (2020) and Kvarnstrom and Petersens (2004), who hence propose the use of Multi-Criteria Decision-
 42 Making (MCDM) techniques.

43 MCDM techniques were explicitly developed to solve complex decision-making problems
 44 involving conflicting criteria and decision-makers with different perspectives and judgments (Kaya et
 45 al., 2019; Belay et al., 2022). MCDMs are used to assess and systematically compare variables and
 46 alternatives within a problem context because they provide tangible input for decision-making (Shen
 47 and Tzeng, 2018). From a review of the application of MCDM to sanitation problems, Leonetti and
 48 Pires (2017) concluded that the MCDM’s advantages of comparing a multitude of criteria, including a
 49 more decision-makers, and the possibility of including qualitative variables make MCDM “particularly
 50 suitable” for decision-making in sanitation problems.

51 The most widely used and studied MCDM is the Analytic Hierarchy Process (AHP) (Ho, 2008;
 52 Ho and Ma, 2018), which uses pairwise comparisons to calculate the weights of criteria and the ranking

1 of predefined alternatives (Darko et al., 2018; Santos et al., 2019; Yang et al., 2019). Since its
2 development by Saaty 1980 (Saaty, 1980), facilitators have used the AHP to objectively process the
3 preferences of multiple participants and arrive at a hierarchy of alternatives (Kan and Ali, 2020; Yu et
4 al., 2021). The main advantage of the AHP is its objective and logical scoring system and its flexibility
5 for integration with other techniques in the domain of MCDM (Kubler et al., 2016). Over the years, its
6 simple and convenient data-inputting technique, in combination with its ability to highlight the relative
7 importance of elements composing the problem, has led to both widespread use and extensive literature
8 on the subject (Moreno-Jimenez and Vargas, 2018; Tavana et al., 2023). Consequently, its ability to
9 systematically determine criteria weights through an easy pairwise comparison exercise causes the
10 AHP to outperform other MCDM techniques (Liu et al., 2020).

11 To handle the impreciseness of opinions by decision-makers, fuzzy theory, as proposed by
12 Zadeh (1978), was combined with AHP, resulting in the FAHP. Fuzzy theory is applied when the natural
13 language used in the assessment has no clear definition, introducing variability in the decision-maker's
14 interpretation of the proposed comparison (van Laarhoven and Pedrycz, 1983). Fuzziness is introduced
15 in AHP by replacing the so-called 'crisp' numbers, assigned to each pairwise comparison by the
16 decision-maker to score the importance, with the fuzzy numbers representing the 'crisp' number. The
17 fuzzy numbers are interpreted as a probability distribution, resembling the range of values the 'crisp'
18 number can interpret (Liu et al., 2020). Over the years, the FAHP has become the most studied and
19 applied fuzzy MCDM (Mardani et al., 2015), with its applications ranging from the selection of the
20 preferred technology from a set of alternatives (see Balusa and Gorai, 2019; Piadeh et al., 2018) to the
21 determination of the relative importance of design criteria (Zyoud et al., 2016; Sahoo and Choudhury,
22 2021).

23 Because of its ability to derive the prioritization of design criteria in an easy, transparent,
24 community-engaging manner (Zhang, 2015), the FAHP was chosen in this research to determine the
25 scope of the sanitation design. Following the research of Moslem and Duleba (2019), the FAHP was
26 employed to determine the cruciality of design criteria as perceived by both end-users and experts. The
27 FAHP can be used as a consensus-building tool between stakeholders, through which single criteria and
28 weights can be discussed to understand each other's viewpoints (De Marinis and Sali, 2020). The FAHP
29 is hence used to gain an understanding of the needs and preferences of stakeholders in the design
30 process for a local sanitation system, addressing how stakeholders can be systematically engaged early
31 in the design cycle (by involving them in the definition of the design scope).

2.3. Factors Determining Sanitation Design

Structuring the design scope requires insights into the factors relevant to the scope of sanitation systems, which was obtained through a systematic literature review of sanitation design criteria. The design criteria obtained from the literature review are used to shape the design scope, serving as input for the FAHP and the FGDs. The position of this review within the overall research is depicted in Figure 10 below.

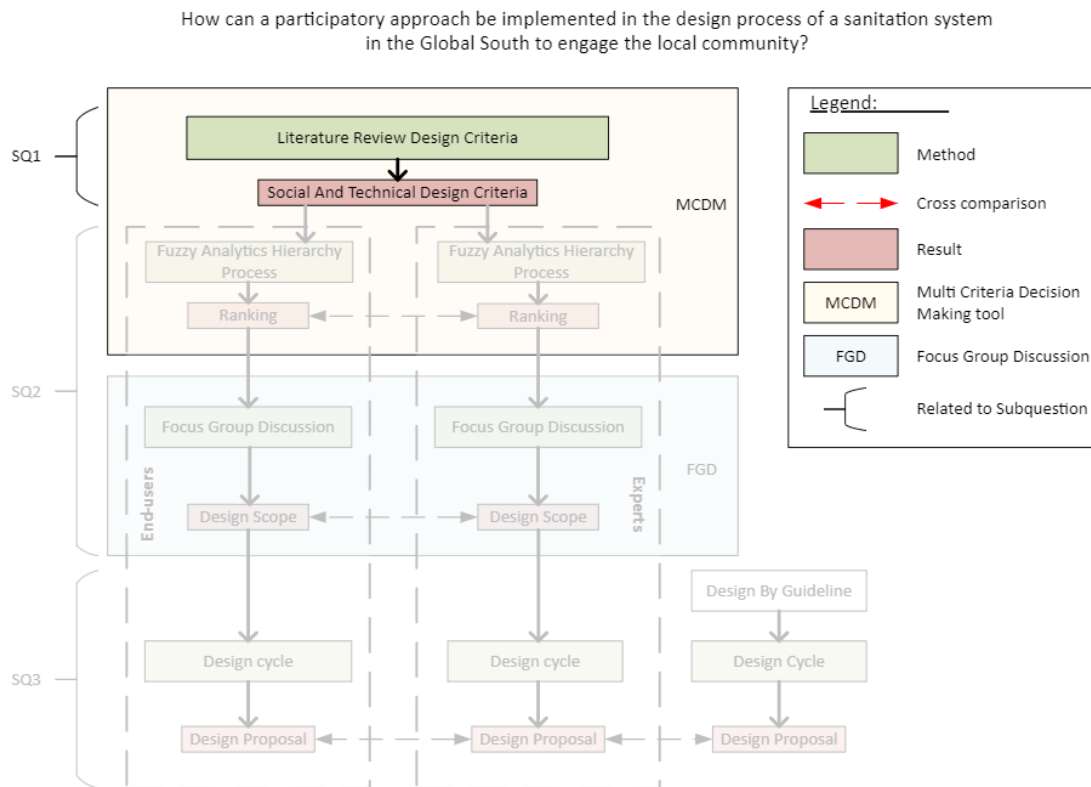
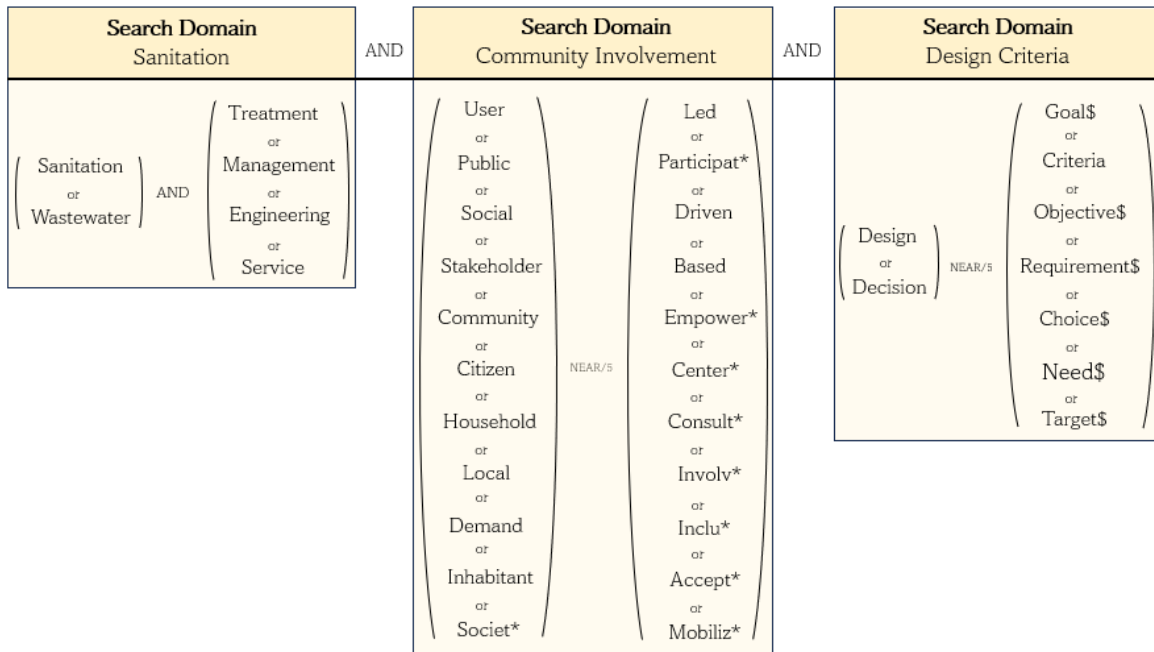

Figure 10 | Positioning of the systematic literature review into design criteria relevant to sanitation design within the overall method of this research

To overcome selectors' bias when choosing the decision criteria (Linnenluecke et al., 2019), a systematic literature review of design criteria applicable to sanitation design processes was conducted. Systematic literature reviews allow one to integrate findings and perspectives on a specific topic in a research field (Kunisch et al., 2018; Snyder, 2019), creating objectivity (Parums, 2021). The SPAR-4-SLR review protocol developed by Paul et al. (2021) was adopted for conducting the systematic literature review because of its ability to justify review decisions.

The search query for this literature review – a schematic overview provided in Figure 11 - was centred around community-engaged sanitation design and conducted in the Web of Science search engine. This search query aimed to obtain a set of design criteria currently used in participatory sanitation design processes to increase the relevancy of the design criteria assessed to the involved stakeholders. Starting with '(Sanitation) AND (Community NEAR/5 Involvement) AND (Design NEAR/5 Criteria)' as the first search query, the quantity and relevancy of the obtained papers were assessed. The search query was expanded with relevant synonyms obtained from the thesaurus for the initial search terms to increase the number of results, boolean operators to combine these search terms, and truncation and wildcard functions to cover the diversity in language use (Atkinson and Cipriani, 2018). Web of Science was used as the search engine due to the quality of its search results, ease of use, and exhaustiveness (Gusenbauer and Haddaway, 2020; Prankute, 2021; Singh et al., 2021). The search query targeted the articles' abstracts to increase the results' relevancy. To include up-to-date scientific papers, only papers published in the ten years before this research – day of execution search query: 23-02-2023 – have been included. The search query was expanded until the arbitrary number of results neared 100

1 initial results, which was deemed sufficient to provide a complete overview of the information on design
 2 criteria in community-involved sanitation design.



3
4 *Figure 11* | Overview of search query used in Web of Science to assess design criteria for community-engaged sanitation

5 The papers resulting from the search query were assessed for their relevance, from which the
 6 initial set of 101 scientific papers was reduced to 36. A schematic overview of this process is provided
 7 in Figure 12. The abstracts of the obtained scientific papers were read to determine their relevance,
 8 excluding papers that did not cover domestic wastewater treatment processes. The full text was read
 9 to verify its relevance, and five more papers were deemed irrelevant and excluded. Of the 101 pre-
 10 selected scientific papers, 36 were deemed relevant, as depicted in the graphical overview in Figure 12.
 11 This report includes an overview of the 101 original papers, including the results of the screening
 12 rounds, as Appendix B. The included papers were uploaded into Atlas.ti (version 23.2.3), which was
 13 used to code the design criteria. Each paper was read and coded twice to verify the completeness of
 14 the coding step.

15

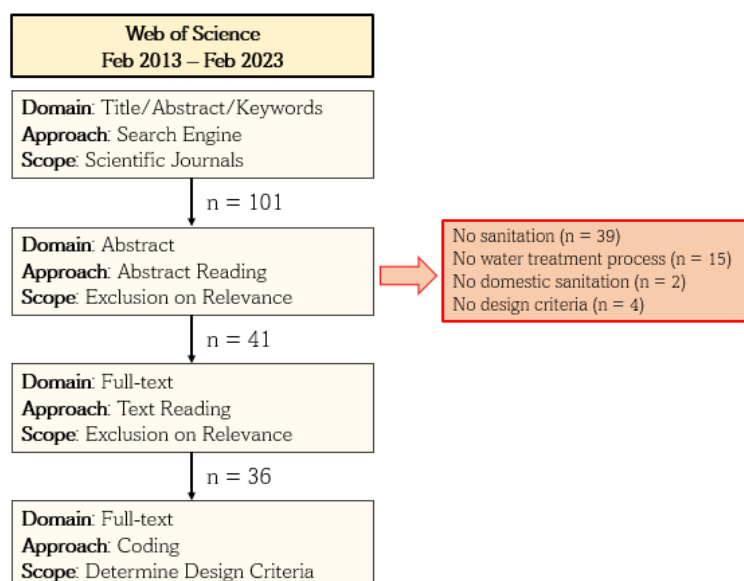

16
17 *Figure 12* | Overview systematic literature review for assessment of sanitation design criteria as mentioned in the literature

1 The content of the 36 relevant papers was assessed for the mentioning of design criteria, which
 2 were coded in Atlas.ti, which in turn served as input for determining the definitions of the synthesized
 3 design criteria. The results from the systematic literature review were inductively coded for the
 4 synthesis. The coding strategy was developed by analysing the collected data, as the definitions of
 5 relevant design criteria and hence coding guidelines were not known beforehand (Hays and McKibben,
 6 2021). Following Krippendorff (2018), the definitions were synthesised using the coded quotes as input
 7 to maximize inferential and analytic generalizability. After two iterations of coding in Atlas.ti for design
 8 criteria and synthesis of the coded fragments, 57 distinctive design criteria were deducted. Following
 9 the guidelines for drawing up definitions as proposed by Hansson (2006), and as shown in Figure 13,
 10 definitions for the draft design criteria were formed using the coded fragments from the substantiating
 11 sources. An overview of the papers mentioning the different design criteria is added in Appendix C.
 12

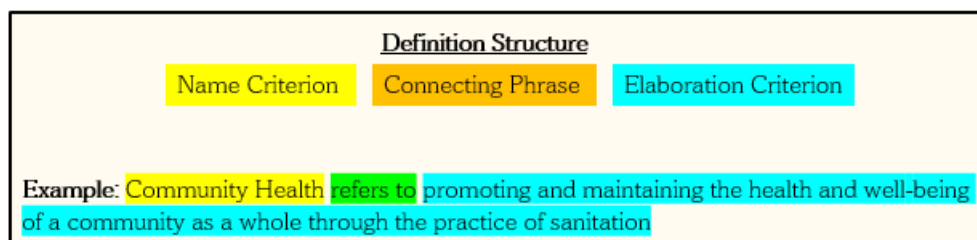

13 **Figure 13** | Structure used in definition of design criteria, including example for the definition of 'Community Health' as used in this
 14 research.
 15

16 The 57 initial design criteria were assessed for the quantity of scientific papers derived through
 17 the literature review mentioning the criteria, after which criteria mentioned only once were discarded
 18 due to perceived irrelevancy. Across the analyzed papers, the design criterion 'Capital Expenditure' was
 19 mentioned most frequently (26/36 papers), while design criteria 'Collective Efficacy', 'Market Competition',
 20 'Replicability', and 'Income Recovered Resources' were mentioned least frequently (1/36 papers). Guided
 21 by Gaur and Kumar (2018), the four criteria only mentioned once were deemed irrelevant based on
 22 relative importance. Substantiated by the proposal of Russo and Camanho (2015) to remove irrelevant
 23 criteria to ensure alignment between criteria and the targeted decision problem, these four criteria were
 24 removed from the selection.

25 The remaining 53 design criteria were compared for overlap, discussed with engineering
 26 students, and combined into new overarching design criteria, reducing the total number of criteria to 20
 27 after two iteration rounds, as is depicted in Figure 14. Both Mazri et al. (2012) and Tavana et al. (2023)
 28 argue that methods requiring fewer pairwise comparisons and less lengthy interactions provide better
 29 results, as participants are more motivated and attentive during the data collection. Moreover,
 30 Rodriguez et al. (2009) state that alternatives assessed in a pairwise comparison have to be
 31 distinguishable, to be able to compare them. The definitions were therefore compared for overlap, with
 32 the goal of merging criteria with similar definitions and reducing the total number of criteria. Three
 33 Environmental Engineering students at Delft University of Technology (TU Delft) were asked to cluster
 34 design criteria that they perceived as similar. Similar definitions were combined into one overarching
 35 definition, reducing the number of distinctive design criteria from 53 to 30. An overview of the merges
 36 is added in Appendix D. The thirty resulting design criteria were cross-compared to the design
 37 statements of another Environmental Engineering student at TU Delft, researching "the exploration of
 38 stakeholder priorities for DEWATS implementation in the Brantas, Indonesia". The thirty criteria were
 39 proposed to a researcher with relevant experience in urban planning at the target location, who
 40 provided feedback on the relevancy of the design criteria. Furthermore, the 30 criteria were proposed
 41 to ten Environmental Engineering students at TU Delft, who were asked to select the twenty most
 42 relevant criteria. This exercise was carried out using Qualtrics. This second review round assisted in
 43 reducing the number of design criteria to 20.

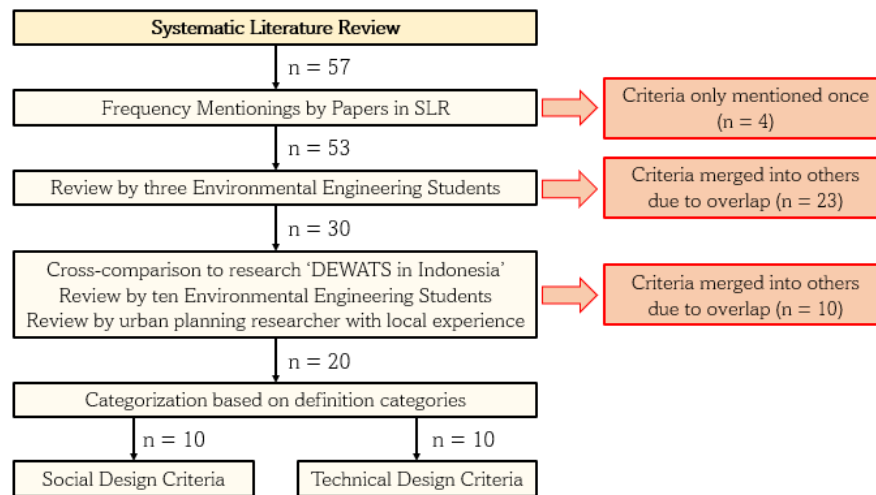

Figure 14 | Overview of derivation and categorization of design criteria, including the methods used. The letter 'n' is referring to the number of design criteria

These merges are also shown in Appendix D, which contains a graphical overview of the merges transforming the initial design criteria into the final set of criteria as used in this research. The resulting definitions were assigned to two categories based on the definitions of these categories, of which the final version is depicted in Table 1;

- Social Design Criteria, referring to the factors that should be considered when designing sanitation systems or facilities to ensure they meet the social needs and requirements of the communities they serve and the institutions that are involved (adopted from van Vliet et al., 2011)
- Technical Design Criteria, referring to the technical aspects that must be considered when designing a product, system, or facility to ensure it meets its intended function and performance requirements (adopted from Spuhler et al., 2020)

Social Design Criteria		Technical Design Criteria	
S.1	Centralization/Decentralization	T.1	Capital Expenditure
S.2	Community Health	T.2	Geographical Suitability
S.3	Cultural Alignment	T.3	Locally Available Construction Resources
S.4	Ease of Use	T.4	Operational Expenditure
S.5	Environmental Friendly	T.5	Resilience
S.6	Expertise Required	T.6	Resource Recovery Potential
S.7	Job Opportunities	T.7	Resource Use
S.8	Nuisance	T.8	Robustness
S.9	Policy Alignment	T.9	Safe Product Disposal
S.10	Aesthetics	T.10	System Performance

Table 1 | Overview design criteria obtained from literature review and merging exercise, categorized in social and technical design criteria

For each of the design criteria shown in Table 1, a definition in the style of Figure 13 was set up. However, as these definitions were constructed using input from scientific articles, these definitions were deemed complex and vague to potential community members. Therefore, to provide additional explanation regarding the design criteria and their interpretation with regards to sanitation system design, guiding examples and scenarios were determined. The 'scenario' elaborated on the influence of the design criterion on the design, while the 'example' complemented this information by explaining how this design criterion affects the interaction between stakeholders and the system. An example is provided in Figure 15, showing the definition, scenario, and example for the design criterion 'Job Opportunities' as was used in this research. Between brackets, the definitions of 'Definition', 'Scenario', and 'Example' are provided, adopted from the Cambridge Dictionary (Cambridge University Press, n.d.).

1 The complete set of definitions, scenarios and examples for all twenty design criteria as mentioned in
2 Table 1 and as used in this research is added as Appendix E.
3

Job Opportunities

Definition: *(Description of features and limits of something)*
'Job Opportunities' refers to the process of generating new employment opportunities through activities aimed at improving sanitation conditions

Scenario: *(Description of possible actions or events in the future)*
The implementation of the sanitation system creates job opportunities for members of the local community

Example: *(Illustration of characteristic)*
Community members operate the system and are paid for their efforts

4
5 **Figure 15** | Exemplification of the relation between the definition, scenario, and example for the design criterion 'Job Opportunities' as
6 determined and used in this research

3. Methodology

This chapter explains the methodology of this research (See Figure 16). First, the location and context of the case study in Hagonoy in the Philippines are introduced. Following this introduction, the FAHP methodology is elaborated. The format of the pairwise comparison exercise as used in this research is shown before the process of collecting and assessing the data is illustrated. Similarly, the process and the format of the FGDs are shown. To exemplify how this led to the conceptual designs is explained in paragraph 3.4., in which the used influent and effluent characteristics, the process of selecting treatment technologies, the determination of the dimensions and efficiencies of treatment steps, and the eventual comparison of technologies are explained.

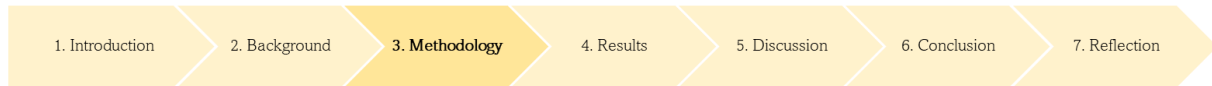

Figure 16 | Position of chapter 3. Methodology in document

3.1. Introducing the Case study

To illustrate in detail the applicability and integration of the mixed methodology to a participatory design process for sanitation, the methodology was applied to a case study in Hagonoy, the Philippines. The municipality of Hagonoy is located in the southwestern part of the province of Bulacan, the Philippines, approximately 54 kilometres from the capital, Manila (Schaik, 2016; Abenir et al., 2022). The municipality spans 103.10 km², is divided into 26 so-called barangays (neighbourhoods), and houses approximately 133,000 inhabitants (Follosco-Aspiras & Santiago, 2016; PSA, 2020).

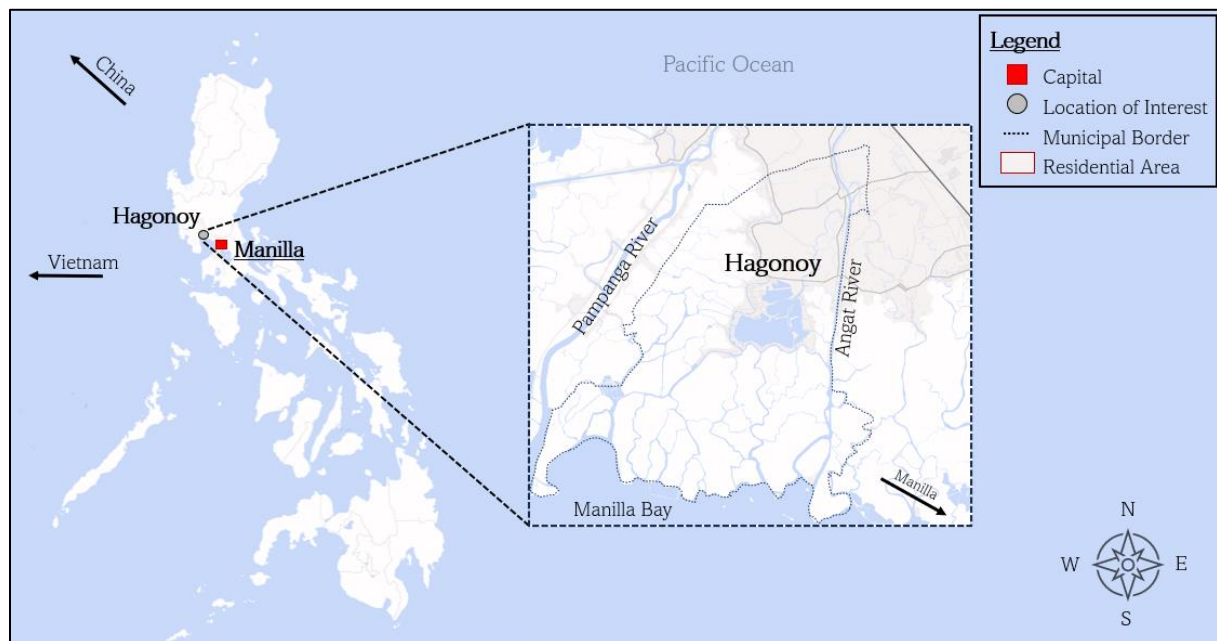

Figure 17 | Geographical Location of Hagonoy, Bulacan, the Philippines (own figure)



Figure 198 | Picture of situation in Hagonoy during tidal flood pt.1 (own figure)



Figure 189 | Picture of situation in Hagonoy during tidal flood pt.2 (own figure)

1 Hagonoy faces pluvial, fluvial and coastal flooding, in combination with ground subsidence, due to its
 2 location at the convergence of the Pampanga River and the Angat River discharging into Manila Bay
 3 (Tabios III and de Leon, 2020; Jacinto et al., 2006; Rodolfo and Siringan, 2016; Lagos et al., 2022).
 4 While the local government and community have tried to overcome the resulting problems caused by
 5 the flooding, many streets and homes are still affected daily. This persistent flooding, in combination
 6 with poor sanitation, has led to the spread of contaminated wastewater (Harper et al., 2020; Odagiri et
 7 al., 2021), threatening the well-being of Hagonoy's residents (Williams et al., 2020). Figures 18 and 19
 8 are pictures taken during a tidal flood in Hagonoy, showing the severity of the flooding.

9 Most households rely on septic tanks as their sanitation system, highlighting the need for more
 10 comprehensive solutions to address wastewater discharge's existing health and environmental risks.
 11 Survey data from the Hagonoy Water District, the party in Hagonoy responsible for drinking- and waste-
 12 water infrastructure, states that the only wastewater treatment system encountered in 19625 out of
 13 20680 households is the septic tank or a variation to the septic tank. In comparison, 1055 (5.1%)
 14 households do not have a septic tank (Hagonoy Water District, personal communication, June 8, 2023).
 15 The municipality of Hagonoy provided similar figures by stating that 90% of the houses contain a septic
 16 tank. The other 10% directly discharges into the environment (Engineering Office Municipality
 17 Hagonoy, personal communication, May 26, 2023). The in-place design guidelines for sanitation explain
 18 the homogeneity of technologies, as the guidelines only propose a septic tank (DOH Adm. Order
 19 No.2019-0047, 2019). A septic tank, however, is only a form of primary treatment and does not suffice
 20 to reduce the health and environmental risks related to wastewater effluent, hence only offering a partial
 21 solution to the sanitation problem existing in Hagonoy (Baltazar et al., 2021).

22 Background information on the topography, climate, demographics, socio-economic status,
 23 sanitation systems, and sanitation law in Hagonoy is added in Appendix F. Additionally, Figures 20 and
 24 21 on the next page provide an image of the housing situation in Hagonoy.

25



Figure 20 | Picture of street in informal settlement in Hagonoy, adjacent to river (own figure)

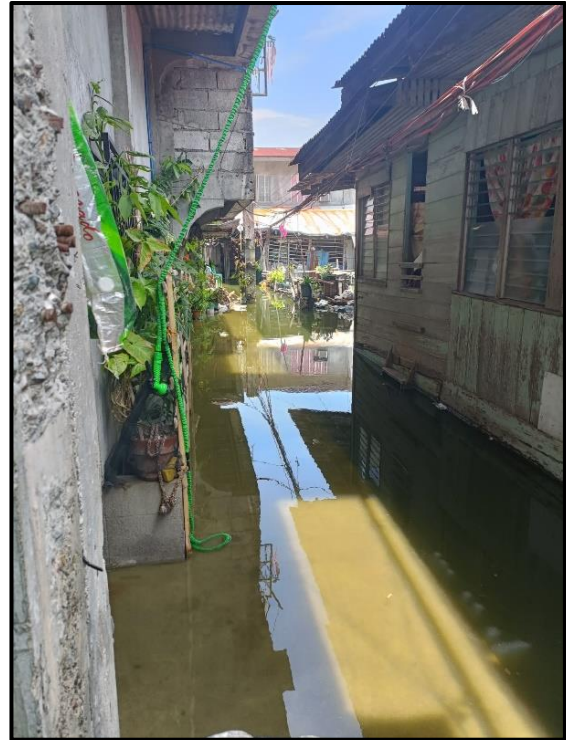

Figure 21 | Picture of permanent flooded courtyard in Hagonoy (own figure)

1

2 **3.2. Introducing the Fuzzy Analytical Hierarchy Process**

3 The FAHP methodology was applied to systematically gather information and insights into the
 4 preferences of end-users and experts regarding the design of a new sanitation system because of its
 5 ability to simplify complex decision problems by using pairwise comparisons. Thereby, a systematic
 6 approach for 'Identifying Needs' is assessed in the Design Cycle of Figure 2. The design criteria assessed
 7 through the pairwise comparisons in the FAHP were obtained through the systematic literature review
 8 described in the previous chapter. Figure 22 below depicts the position of the FAHP within this research.

How can a participatory approach be implemented in the design process of a sanitation system
 in the Global South to engage the local community?

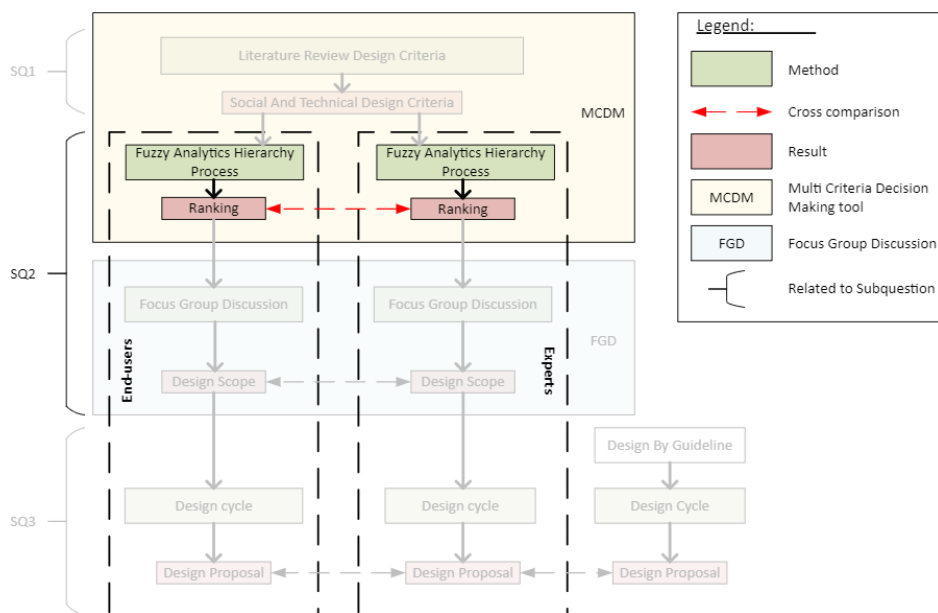

Figure 22 | Positioning of Fuzzy Analytical Hierarchy Process (FAHP) within research

9
10

3.2.1. Pairwise Comparisons Format

The FAHP aims to simplify the decision-making process by decomposing the problem into manageable subsets, which are proposed to the decision-maker in pairs because a binary comparison is more comprehensible and more straightforward to judge than a comparison of ten facets (Brunelli, 2018). The design criteria belonging to the same category (either social design criteria or technical design criteria, not cross-category) were proposed to participants in pairs. The facilitator presented and explained each design criterion to participants, together with its definition in the context of sanitation. The definitions used were based on the systematic literature review in Chapter 2. Background. To further elaborate upon the meaning of the design criterion within the context of sanitation design, the composed scenario for the stated design criterion was added to the answer sheet. The design criteria were compared on a 9-point Likert scale, as proposed in Table 2, following Kannan et al. (2013)

Numerical Rate	Definition
1	Equally Important
3	Moderately More Important
5	Strongly More Important
7	Very Strongly More Important
9	Extremely More Important
2, 4, 6, 8	Intermediate values between adjacent judgments
Reciprocals	If factor i has one of the above numerical rates assigned to it when compared to factor j, then j has the reciprocal value when compared to i

Table 2 | Numerical values with their linguistic counterpart as used in the pairwise comparison exercise as part of the Fuzzy Analytical Hierarchy Process

3.2.2. Pairwise Comparisons Exercise

An online survey was developed to collect the pairwise comparison data, as it allows the facilitator to force survey guidelines and survey logic upon participants, ensuring correct data formatting and reducing mistakes caused by misinterpretation of the question format (Nayak and Narayan, 2019). The survey was built in Qualtrics (Qualtrics, Provo, UT). It was piloted twice: once with 2 Environmental Engineering students at the TU Delft and once with three sanitary engineering professors (>15 years of experience each) at the TU Delft. The feedback was used for the next iteration. An example of the final iteration as it was proposed to participants is provided in Figure 23. The participant was first presented with the question F23a, 'Which criterion is more important?'. The possible answers shown are the two criteria (in this example, 'Environmental Friendly' and 'Expertise Required') and their scenarios, as well as the option 'Equally Important'. The definition was shown when the participant hovered over the boldly printed name of the design criterion. In case 'Equally Important' was selected, Qualtrics automatically filled in the corresponding numerical rate as depicted in Table 2 (hence 1) without showing the slider depicted in Figure 23. However, when 'Environmentally Friendly' was selected in question F23a, the slider was shown while posing statement F23b 'Environmental Friendly is compared to Expertise Required', requiring the participant to move the slider along the Likert scale and quantify how much more important the participant deemed 'Environmental Friendly' to be compared to 'Expertise Required'. In case 'Expertise Required' was selected in question F23a, statement F23b was inverted into 'Expertise Required is compared to Environmental Friendly', again shown with the slider.

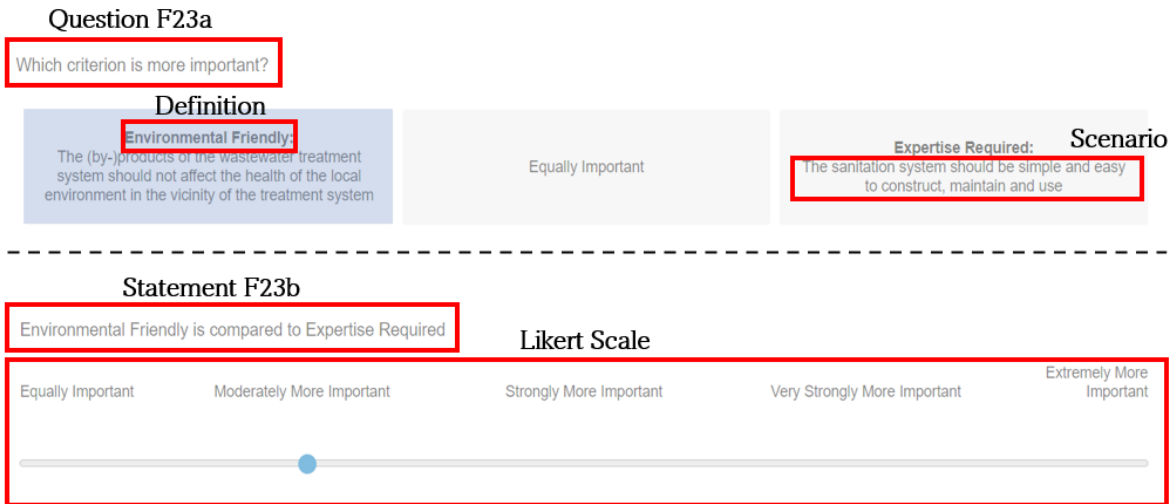

1
2 **Figure 23** | Example of pairwise comparison used in Fuzzy Analytical Hierarchy Process. This example is a screenshot from the Qualtrics
3 Survey used in this research, in which Environmental Friendly is scored as more essential and is ranked on the 9-point Likert scale

4 Unexpected poor local internet conditions ruled out the use of the online survey, after which
5 the on-paper answer form, as depicted in Figure 24 was developed. In the on-paper version, the design
6 criteria were presented in pairs, depicted by the columns ‘Option A’ and ‘Option B’. The participant was
7 asked to check the checkbox left of the design criterion deemed more important before quantifying the
8 perceived relative importance on the Likert Scale. If the criteria were deemed ‘Equally Important’, both
9 checkboxes had to be checked, and the score one on the Likert scale was to be assigned. The scenarios
10 clarifying the design criteria asked in the pairwise comparisons were depicted on the right. A separate
11 supporting sheet contained the definitions of the design criteria.

Answer Sheet Pairwise Comparison Exercise - Social

End-user centered decision tool regarding sanitation in flood-prone areas

In the second exercise for ‘social design criteria’, you are provided with two design criteria from which you should pick the most important one. Also, you have to state on a scale from 1 (= equally important) to 9 (how much more important) how much more important the chosen criterion is compared to the other.

Option A	Option B	Likert Scale
<input type="checkbox"/> Ease of Use	<input type="checkbox"/> Policy Alignment	Scale 1 = Equally important 3 = Moderately More Important 5 = Strongly More Important 7 = Very Strongly More Important 9 = Extremely More Important
<input type="checkbox"/> Centralization	<input type="checkbox"/> Policy Alignment	1 2 3 4 5 6 7 8 9
<input type="checkbox"/> Cultural Alignment	<input type="checkbox"/> Environmental Friendly	1 2 3 4 5 6 7 8 9
<input type="checkbox"/> Ease of Use	<input type="checkbox"/> Aesthetics	1 2 3 4 5 6 7 8 9
<input type="checkbox"/> Cultural Alignment	<input type="checkbox"/> Aesthetics	1 2 3 4 5 6 7 8 9
<input type="checkbox"/> Community Health	<input type="checkbox"/> Environmental Friendly	1 2 3 4 5 6 7 8 9
<input type="checkbox"/> Comm	<input type="checkbox"/>	1 2 3 4 5 6 7 8 9
<input type="checkbox"/> Expert	<input type="checkbox"/>	1 2 3 4 5 6 7 8 9
Pairwise Comparison		
<input type="checkbox"/> Community Health	<input type="checkbox"/> Nuisance	1 2 3 4 5 6 7 8 9
<input type="checkbox"/> Centralization	<input type="checkbox"/> Aesthetics	1 2 3 4 5 6 7 8 9
<input type="checkbox"/> Centralization	<input type="checkbox"/> Community Health	1 2 3 4 5 6 7 8 9
<input type="checkbox"/> Centralization	<input type="checkbox"/> Environmental Friendly	1 2 3 4 5 6 7 8 9
<input type="checkbox"/> Ease of Use	<input type="checkbox"/> Nuisance	1 2 3 4 5 6 7 8 9

Scenarios

Centralization
In the context of this project, decentralized sanitation refers to a sanitation system on an individual household level, while centralized sanitation refers to a sanitation system on the neighborhood level.

Community Health
The sanitation system should improve the overall health and cleanliness of the community.

Cultural Alignment
The use of the sanitation system aligns with values, beliefs, and ideologies present in the community.

Ease of Use
The sanitation system is accessible and convenient in its use.

Environmental Friendly
The (by-)products of the wastewater treatment system should not affect the health of the local environment in the vicinity of the treatment system.

Expertise Required
The sanitation system should be simple and easy to construct, maintain and use.

Job Opportunities
Implementation of the sanitation system creates job opportunities for members of the local community.

Nuisance
The sanitation system causes no pest, noise, or other nuisance.

Policy Alignment
The sanitation system complies with the regulations and policies installed by the government.

Aesthetics
The sanitation system is aesthetically pleasing.

12
13 **Figure 24** | Example of on-paper answer sheet for Fuzzy Analytical Hierarchy Process used in this research

14

3.2.3. Pairwise Comparison Data Collection

Between the 22nd of May and the 11th of June 2023, AHP data was collected from 60 community members and six sanitation experts in Hagonoy, Bulacan, the Philippines. The community members were recruited from six neighbourhoods in Hagonoy, which were selected in collaboration with prominent local community members. These neighbourhoods were selected based on the poor status of sanitation in these neighbourhoods and their proneness to flooding, which together increases the urge for improved sanitation. It was hypothesized that inhabitants of these areas experienced more urgency regarding the need for improved sanitation and, thereby, would be more willing to participate in this research. Furthermore, including these low-income and disaster-prone areas ensured the inclusion of the marginalized informal settlers. The informal settlements are – at the Bay of Manila in the Philippines specifically – characterized by the negative effects endured by land subsidence and flooding (Purwar et al., 2020), in combination with the effects of poor urban planning and the negligence of construction guidelines (Usamah et al., 2014).

The community members participating in the FAHP were recruited randomly on the street by the principal author and a local translator. In contrast, the local sanitation experts participating in the FAHP were recruited through local contacts. Before recruiting the participants, the local translator was instructed regarding the layout and purpose of the research to ensure alignment with the objective and story communicated to the participants. In each of the six neighbourhoods, ten participants (18+) were recruited – five men and five women. Participants were required to live in the respective neighbourhoods. The local sanitation experts were recruited through the snowballing approach (Parker et al., 2019), recruiting one participant active as municipality engineer, three active as sanitary inspectors/sanitation workers, and two active for the local water district. The experts were required to live and work in Hagonoy. The layout and purpose of the research project were explained to all participants before they were asked for their informed consent regarding the use of the data they provided, as depicted in Figure 25.

The survey was conducted by the principal author and the local translator, who assisted the participant in filling out the survey, ensuring correct data formatting and understanding of the questions. The survey with local community members started by asking demographical questions regarding the age, household size, household income, educational level, and their current sanitation system. The inquiring part of the survey started by asking the participants open questions regarding their sanitation system, their perception of sanitation, and what they perceived as important in sanitation systems. After that, the design criteria and their definitions were discussed with the participant, during which additional clarification was provided when needed. Because of illiteracy among participants, the local translator proposed pairwise comparisons to the participants and filled in their answers. Once all pairwise comparisons were completed, participants were asked for additional remarks and their experience. In case the participant had expressed a particular opinion or observation, follow-up questions were asked to delve deeper into this comment.

The conversations with community members were held in the local language (Tagalog) to improve the comprehensiveness of the research towards participants. The local translator was familiar with the research content through an introductory meeting and a pilot of the survey to communicate the objective of the research correctly. Furthermore, the survey itself was translated into Tagalog (Filipino Language) by another local translator. The Tagalog version was back-translated, allowing verification of the similarity in meaning and the alignment between the Tagalog and the English version (Klotz et al., 2023).



Figure 25 | Process of Fuzzy Analytical Hierarchy Process data collection

3.2.4. Structuring the Fuzzy Analytical Hierarchy Process Data

To mitigate potential survey fatigue and improve participant engagement in the data collection, it was decided to reduce the number of pairwise comparisons asked of each participant from 45 to 30, using an unbiased sampling algorithm. The pairwise comparisons were constructed for each category of design criteria (ten social design criteria and ten technical design criteria). From Equation (1), it is understood that cross-comparing $n = 10$ criteria would result in 45 pairwise comparisons per category, as a 10×10 matrix has 45 pairs of opposite entries. To decrease the repetitiveness and the possible fatigueness of participants, the total number of questions asked to each participant was reduced. The reduction of questions asked adhered to research by Backor et al. (2007), who observed a significant link between the number of questions and survey fatigue. Each participant was required to provide judgments on the categories of social design criteria and technical design criteria; hence, two pairwise comparison matrices were constructed for each participant. Each participant was asked 30 out of 45 pairwise comparisons within each category, totalling 60 pairwise comparisons asked to each participant. The 30 comparisons asked of a participant were randomly selected from the complete list of comparisons by an algorithm written in Python (version 3.11.3). The algorithm was built such that the selection provided an unbiased sample of pairwise comparisons.

The 15 empty data entries in each category for each participant were calculated based on the provided data points using the DEMATEL method as proposed by Zhou et al. (2016) and Mohamad and Zainuddin (2021), which is further elaborated upon in Appendix G. Applying randomization however can lead to an unbalanced distribution of the data gathered (Lim and In, 2019), as some questions might be asked more than others. In the worst-case scenario, a pairwise comparison is not picked, causing the value obtained from the data collection to rely on exclusively calculated values and no stakeholder-input at all. To ensure that the obtained data for a pairwise comparison did not rely solely on calculated values but on obtained judgments, the algorithm verified that each pairwise comparison was asked of at least half of the respondents. Consequently, the ratio of judgments gathered per pairwise comparisons to total data points (= data collected through judgments + data calculated through DEMATEL) was at least 50%.

$$\text{Unique Entries} = \frac{n(n-1)}{2} \quad (1)$$

3.2.5. Assessing the Judgment and Consistency

A combination of the FAHP and DEMATEL methods was applied to obtain the perceived relative importance of the design criteria as assessed by the participants and to understand their degree of consistency throughout the exercise. This paragraph provides an overview of the mathematical substantiation of the analysis method, while a more elaborate version is included in Appendix G. The relative weights and consistency ratios were calculated in Python 3.11.3 running in PyCharm (the Python script is added as Appendix H).

Each decision-maker t provided 30 scored pairwise comparisons for each category, from which a Pairwise Comparison Matrix (PCM) called A_t was constructed using the structure as depicted in Equation (2). The non-scored pairwise comparisons were filled in as blanks. The constructed PCMs had the structure as depicted below:

$$A_t(n \times n) = \begin{bmatrix} a_{11} & \cdots & a_{1n} \\ \vdots & \ddots & \vdots \\ a_{n1} & \cdots & a_{nn} \end{bmatrix}, \text{ for participant } t \quad (2)$$

To account for the impreciseness of the participants' opinions, fuzzy numbers were introduced to AHP (Liu et al., 2020). Because of their simple and accessible mathematical operations (Yeh, 2017; Liu et al., 2020), Triangular Fuzzy Numbers (TFN), as depicted in Figure 26, were applied. Every entrance a_{ij} in the PCM A can be rewritten as the fuzzy number $(a_{ijlow}, a_{ijmed}, a_{ijup})$, representing the lower, modal and upper values. Consequentially, the fuzzy matrix \tilde{A} can be rewritten into the three separate matrices $\tilde{A}_{low}, \tilde{A}_{med}, \tilde{A}_{up}$, by constructing separate matrices using the values a_{ijlow}, a_{ijmed} and a_{ijup} respectively. A graphical overview of a TFN is shown in Figure 26, transforming the linguistic variables from the 9-point Likert scale into fuzzy numbers as proposed by Kannan et al. (2013).

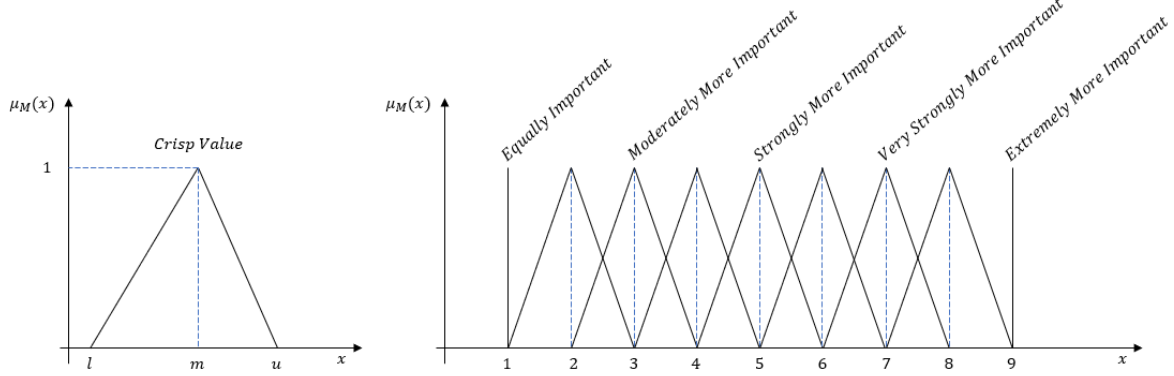

Figure 26 | Triangular Fuzzy Number - graphical overview. Figure 26a, on the left, shows the concept of a Triangular Fuzzy Number (TFN). Figure 26b, on the right, shows the transformation from the linguistic variables used in the 9-point Likert Scale to the fuzzy numbers.

Each participant provided 30 out of the 45 pairwise comparisons required to fill in the PCM, after which the missing values were calculated using the Decision-Making Trial and Evaluation Laboratory (DEMATEL) as proposed by Zhou et al. (2016) and Mohamad and Zainuddin (2021). The missing values in $\tilde{A}_{low}, \tilde{A}_{med}, \tilde{A}_{up}$ were replaced with zeros, which resulted in the direct relation matrices denoted as D_{low}, D_{med}, D_{up} . The total relation matrices T_k – with $k = low, med, up$ – were obtained through normalization of the direct relation matrices in combination with the absorbing state of Markov chain matrices. By applying Equation (3), a complete pairwise comparison matrix M_k for each decision-maker was obtained, with the empty entries being replaced by values:

$$M_k[i, j] = \sqrt{\frac{T_k[i, j]}{T_k[j, i]}}, \text{ with } (i, j = 1, 2, \dots, n) \text{ and } k = low, med, up \quad (3)$$

From the complete PCMs, the weight vector representing the relative importance perceived by participants and the degree of consistency of the judgment were determined through a series of mathematical methods. The aggregated score of the individual decisionmakers was determined following the Geometric Mean method described by Zimmer et al. (2017) and Liu et al. (2020). As fuzzy numbers are hard to interpret, the aggregated matrices were defuzzified using the Centroid Method, through which complete crisp matrices were obtained (Maheswari et al., 2019; Yayla et al., 2015; Calabrese et al., 2019). Of the crisp complete matrices, the consistency of the judgements was determined using the Consistency Ratio (Saaty, 1977; Mohamad and Zainuddin, 2021; Sato and Tan, 2023). This ratio quantifies the irrationality of the participants' judgment, providing insights into how much the provided judgment matrix diverges from a consistent matrix. The matrix is deemed entirely consistent when the consistency ratio equals zero. As the consistency ratio is calculated by averaging the eigenvalues of the matrix, an inconsistent matrix implements error margins in the eigenvalues, causing a deviation of the average of the eigenvalues (and hence the consistency ratio) from zero (Pant et al., 2022). Because providing a consistent matrix becomes more complicated when the number of pairwise comparisons is increased, Saaty (1994) introduced the consistency threshold of 0.10, which was adopted in this research. Saaty argued that exceeding this threshold qualifies the provided judgment

1 matrix as unreliable, as the scores assigned to the different pairwise comparisons are inconsistent and
 2 do not represent the participant's judgment correctly (Aguaron et al., 2020). To calculate the weight
 3 vector containing the relative weights (on a scale of 1) of the judged criteria, the Logarithmic Least
 4 Squares Method (LLSM) was applied to the complete crisp matrices (Crawford and Williams, 1985;
 5 Gyarmati et al., 2023). The weight vector showed the prioritization of the criteria assessed through
 6 pairwise comparisons; hence, it quantified the relative importance of the design criteria as perceived by
 7 the participant (Lyu et al., 2020). This method was used to calculate the consistency, judgment matrix,
 8 and weight vector for both end-users and experts as individuals and as a group. An overview of the
 9 calculation steps, the tools used, and the applied methods is depicted in Figure 27.
 10

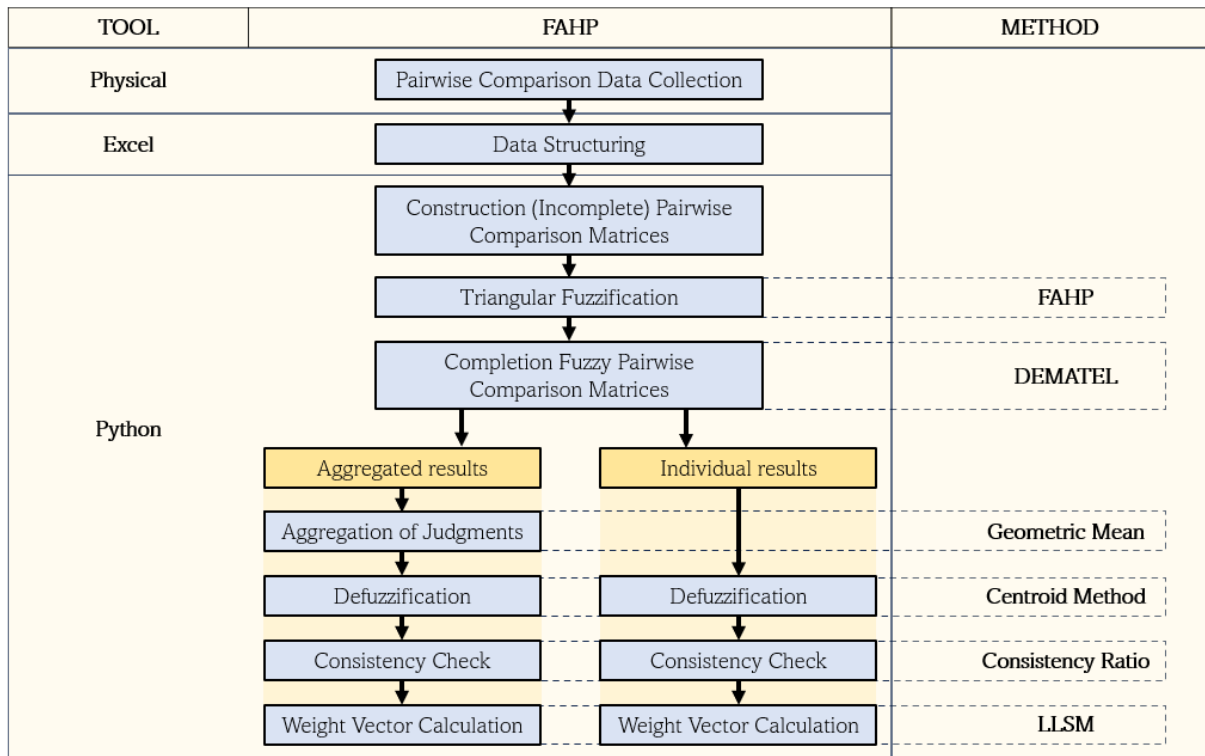

11
 12 *Figure 27 | Overview applied calculation steps within Fuzzy Analytical Hierarchy Process (FAHP) as applied in this research.*

1 **3.3. Introducing Focus Group Discussions**

2 The FAHP was followed by four FGDs with members of the local community (3 FGDs) and with local
 3 sanitation experts (1 FGD) to qualitatively explore how these groups would interpret the design criteria
 4 and how this would translate into a design scope for sanitation systems. The FGDs were hypothesized
 5 to contribute to the understanding of the needs and demands of the participants, as well as to lead to
 6 the definition of the design scope required for the ideation phase (see Figure 28). FGDs allow data to
 7 be obtained through discussing a specific topic from a purposely selected group (Nyumba et al., 2018).
 8 Furthermore, Cornwall and Jewkes (1995) deemed FGDs helpful in integrating local community
 9 knowledge with scientific research methods. The outcome of such sessions is often knowledge of
 10 existing practices, solutions to occurring problems, or visions for the future (Hansen et al., 2019).
 11
 12

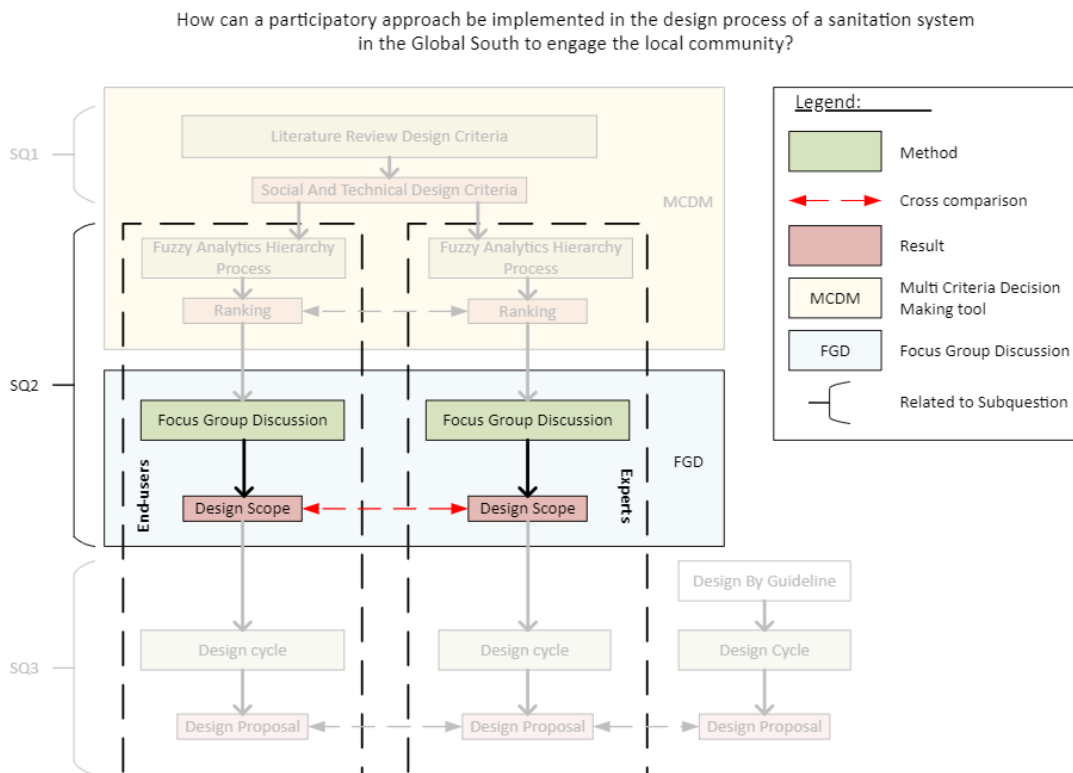

13
 14 *Figure 28 | Positioning of Focus Group Discussions within this research*

13
 14
 15

1 The four FGDs held in Hagonoy in July 2023 each involved 4-7 participants recruited through
 2 the snowballing approach. The hierarchy in Filipino cultures (Ebaeguín & Stephens, 2014) led to the
 3 separation of local community members and local sanitation experts, reducing the risk of
 4 misalignments and mismatches between participants when involving multiple societal layers in one
 5 activity (Roma & Jeffery, 2010; Irani, 2018b). Three neighbourhoods of interest were selected from the
 6 neighbourhoods involved in the FAHP exercise because the previously established contacts with
 7 community representatives in these neighbourhoods facilitated participant recruitment for the FGD.
 8 The recruited participants were all affiliated with the local neighbourhood office, posing the participants
 9 as community members with an active role in their local community. The FGDs with the community
 10 members were held in the central offices of the respective neighbourhoods. One design session – the
 11 ‘expert’ session – was held with representatives of the municipalities’ engineering department and the
 12 sanitation/health office. These attendants were the same experts as the local sanitation experts who
 13 provided the input for the FAHP. Representatives of the local water district were invited but were not
 14 present during the FGD. The meeting with the local sanitation experts was held at an external meeting
 15 location. The participants were informed in person of the purpose, layout, and ethical guidelines of the
 16 FGDs one week before the actual session and through a written letter in the local language, Tagalog. An
 17 overview of the FGD process is depicted in Figure 29.

18 Before the session started and any questions were asked, the participants were asked for their
 19 informed consent and made familiar with the set-up. Each FGD started with an introduction of the
 20 attendants and an explanation of the research before explaining the purpose of the session. The sessions
 21 with the neighbourhood representatives were held in the local language (Tagalog), while the session
 22 with experts was conducted in English. The sessions were conducted by a team of two local translators
 23 (one leading the session, one taking notes) and the lead researcher. The team was instructed and
 24 involved in developing the session to ensure the purpose and context of each question were clear.
 25



Figure 29 | Process of Focus Group Discussions as applied in this research



1
2 *Figure 30 | Picture Focus Group Discussion*

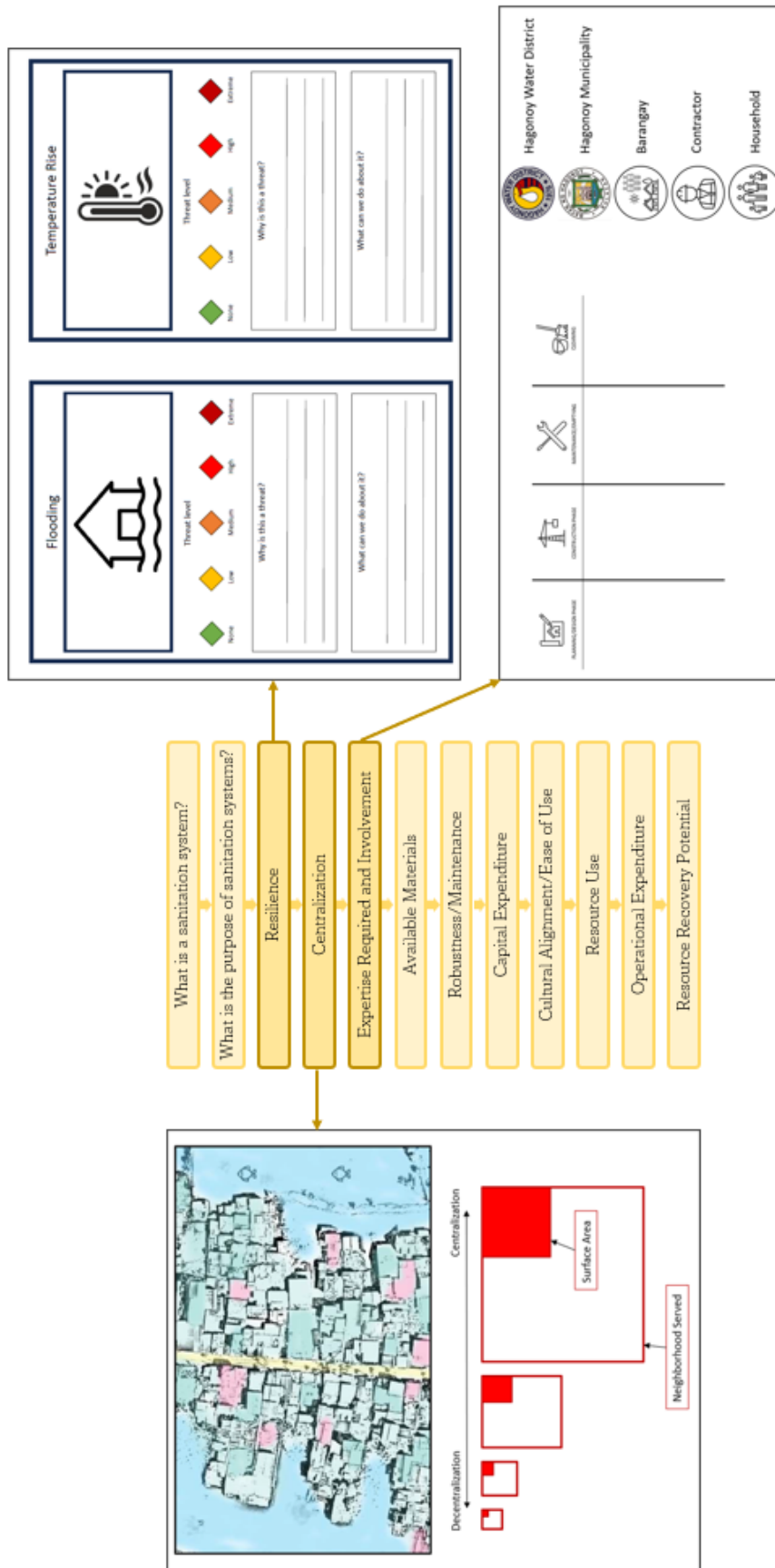

Figure 31 | Picture Focus Group Discussion Pt.2

3 The sessions made use of asking open questions, discussing opinions, and engaging in
4 collaborative exercises, enabling participants to voice their perspectives (Nyumba et al., 2018;
5 Robinson, 2020; Mills, 2020). Each session started by asking the participants about their perception of
6 sanitation systems and the purpose of sanitation systems. The sessions were started with these
7 questions to obtain an unbiased opinion from the participants on the definition of sanitation systems.
8 These discussions were followed by an exercise regarding the definition and quantification of the biggest
9 threats to sanitation systems in Hagonoy (referring to '*Resilience*'), an exercise regarding the
10 centralization or decentralization and preferred geographical location of the sanitation system (referring
11 to '*Centralization/Decentralization*' and '*Geographical Suitability*'), and an exercise regarding the roles that
12 stakeholders should fulfil in the life cycle stages of sanitation systems (referring to '*Expertise Required*'
13 and '*Policy Alignment*'). These exercises used visualizations of the question, as depicted in Figure 32, to
14 clarify these design criteria and ignite a discussion on the interpretation and application of the criteria.

15 Additionally, open questions were asked about the budget available among end-users for
16 sanitation systems, preferences regarding the lay-out and use of the system, and possible opportunities
17 regarding resource recovery (see Figure 32). The format of the design sessions is added as Appendix I,
18 which served as the guiding protocol throughout the sessions. The sessions each took 1,5 – 2 hours.

19
20



1

2 **Figure 32** | Visual representation of the questions asked (depicted light yellow) and exercises conducted (depicted dark yellow) during
 3 Focus Group Discussions

3.4. Development of Conceptual Designs

The outcome of the FAHP and the FGDs served as the input for developing the conceptual designs to understand how the mixed methodology could fit in a community-engaged design process for sanitation systems (see Figure 33). Parallel design cycles using the design scope determined by the local sanitation experts and the local community members were carried out, allowing the comparison between the two design scopes and how the engagement of the community has influenced the design process and the developed conceptual designs. As the purpose of this exercise was to explore how input from community members could result in different treatment trains and to show the ability of the method to engage the community in a complex design process, differences between the design input from the community and experts were emphasized.

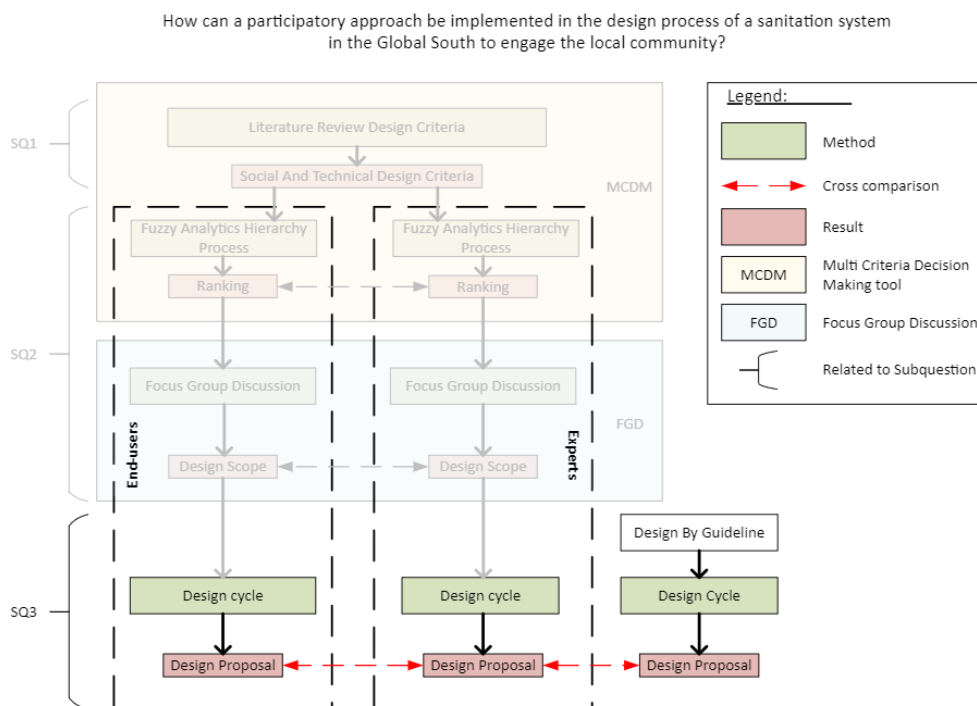

Figure 33 | Positioning of Design Cycles within research

3.4.1. Influent and Effluent Characteristics

The design cycle was limited to the development of a conceptual design, proposing a treatment train capable of treating the produced domestic wastewater such that the effluent satisfies the local General Effluent Standards, specifically for the parameters water volume, TP, COD, NH_3 , and NO_3^{2-} . Guided by the design scope set by the FAHP and the FGDs, the configuration and sizing of a sanitation system were determined. Only a selection of possible water pollutants was taken into account in the development of the design of the sanitation system to simplify the conceptualization process. Consequently, the resulting design cannot be implemented without further assessment of its ability to treat other pollutants present in domestic wastewater, such as pathogens (Wang et al., 2021), heavy metals (Chai et al., 2021), and new emerging pollutants such as PFAS (Zhou et al., 2019).

The focus on treating the COD, phosphorous, and nitrogen originates from their impact on the water quality of the receiving water body and the ecological balance, as COD affects the oxygen level in the water, and high phosphorous and nitrogen levels can lead to eutrophication. High COD levels in the water imply high oxygen consumption by organic matter, possibly leading to oxygen depletion and thereby suffocating oxygen-dependent flora and fauna present in the water (Geerdink et al., 2017). High levels of phosphorous and nitrogen can cause algal blooms, as algae feed on nutrients such as phosphorous and nitrogen (Rout et al., 2021). The increased population of algae excretes algal toxins,

1 while decomposing algae blooms deplete the oxygen in deep water layers, leading to so-called 'dead
2 zones' where no aquatic life is possible (Wurtsbaugh et al., 2019).

3 Because the governmental parties in Hagonoy did not possess data on the composition of
4 locally produced domestic wastewater, influent characteristics were assumed based on scientific
5 literature. The influent characteristics were based on information from the scientific literature on the
6 composition of faeces and urine and the frequency of excretion of faeces and urine. This allowed the
7 determination of fictive volumes and concentrations of TP, COD, NH₃, and NO₃²⁻. Similar assumptions
8 were made for greywater. Potential variations in concentrations were considered by applying a peak
9 factor to the concentrations of 1.5, ensuring a buffer in the treatment capacity. The adopted influent
10 loadings in kilogram per day, including the peak factor, are shown in Table 3.

11 The target effluent concentrations were obtained from the Water Quality Guidelines and the
12 General Effluent Standards (GES) as published by the Filipino Government, adopting the concentrations
13 required for a fictive freshwater body (DENR Adm. Order No.2016-08, 2016; DENR Adm. Order
14 No.2021-19; 2021). The receiving freshwater body was assumed to belong to Class C as specified by
15 the Filipino Government, qualifying the water for fish farming, agriculture, and recreational activities
16 such as boating and fishing (DENR Adm. Order No.2016-08, 2016). The targeted effluent loadings in
17 kilogram per day for the parameters of interest as used in this research are shown in Table 3.
18

Blackwater	Influent		Effluent	
Parameter	Loading	Unit	Loading	Unit
Water Volume	1.11E+01	L/cap/day	-*	-*
Total Phosphorus	3.69E-03	kg/cap/day	9.67E-03	kg/cap/day
Chemical Oxygen Demand	1.01E-01	kg/cap/day	2.42E-01	kg/cap/day
Ammonia	9.91E-03	kg/cap/day	9.67E-03	kg/cap/day
Nitrate	1.42E-04	kg/cap/day	3.38E-02	kg/cap/day

Greywater	Influent		Effluent	
Parameter	Loading	Unit	Loading	Unit
Water Volume	1.50E+02	L/cap/day	-*	-*
Total Phosphorus	1.24E-03	kg/cap/day	9.67E-03	kg/cap/day
Chemical Oxygen Demand	8.87E-02	kg/cap/day	2.42E-01	kg/cap/day
Ammonia	1.09E-03	kg/cap/day	9.67E-03	kg/cap/day
Nitrate	8.73E-04	kg/cap/day	3.38E-02	kg/cap/day

19 **Table 3** | Table containing the wastewater-influent characteristics based on literature and effluent guidelines derived from General Effluent
20 Standards in the Philippines. Wastewater influent characteristics are derived from literature, including a peak factor of 1.5 for the
21 loadings. *= no guidelines were in place for the quantity of water discharged, but the loadings assume similar volumes as the influent, as
22 guidelines are based on concentrations.

23 3.4.2. Selection of Treatment Technologies

24 Possible wastewater treatment technologies were obtained from scientific literature, which were
25 combined into a sanitation system configuration that could treat the water so that the effluent standards,
26 as shown in Table 3, were satisfied. Treatment technologies were obtained from the Compendium of
27 Sanitation System and Technologies of EAWAG (Tilley et al., 2014), complemented by the review of
28 Borges Pedro et al. (2020) into sanitation technologies for flood-prone areas, the overview of sanitation
29 solutions for flood-prone and high table water areas by Mamani et al. (2014), and the Philippines –
30 Sanitation sourcebook and decision aid (Elvas and Sy, 2008). These sources were selected as they
31 contained elaborate overviews of wastewater treatment technologies and their advantages and
32 disadvantages.

33 The configuration of the sanitation system was composed based on the design scope set by the
34 FAHP + FGD methodology, the suitability and treatment efficiency of the treatment technologies
35 obtained from scientific literature, and the outline provided by the sequential wastewater treatment
36 phases as introduced in Paragraph 2.1. The Stages of a Sanitation System (Pre-Treatment, Primary
37 Treatment, Secondary Treatment, Tertiary Treatment, and Post-Treatment). The design scopes

1 determined by the local community members and the local sanitation experts, stating their needs and
2 demands, were leading in developing their respective configurations. The sequential process guided the
3 selection of treatment technologies based on the required treatment focus; hence, the first phase of the
4 configuration ought to focus on the removal of solids and particles through physical separation. The
5 next phase of the configuration was required to (partially) remove the organic matter, organics, and
6 nutrients through chemical, biological, or physical treatment steps. The final phase of the configuration,
7 or the polishing step, was implemented to further refine the wastewater to satisfy the effluent standards.
8 The suitability of the treatment technologies was assessed through consultation with scientific literature
9 and discussions with a sanitation expert at Delft University of Technology.

10 Additionally to the system configurations based on the design scopes formed through the FAHP
11 + FGD method, a baseline scenario was worked out representing the currently in place local design
12 guidelines for sanitation systems. The baseline scenario proposes the use of only septic tanks.
13 Furthermore, the treatment of the produced sludge was not considered, as the Hagonoy Water District
14 operates a sludge treatment plant in the northern part of Hagonoy, which is currently not operating at
15 its total capacity.

16 17 **3.4.3. Sizing of Design Proposals**

18 The dimensions and the treatment efficiencies of the individual treatment steps and the overall system
19 configuration were calculated in Excel using design guidelines provided by the literature. The calculation
20 sheets were built in Excel following the calculation steps as provided by the guidelines while allowing
21 the user of the spreadsheet to tweak a specific set of parameters and thereby tailor the calculated design
22 to the set of requirements. The spreadsheet categorized design parameters into 'adjustable parameters',
23 'scientific parameters', and 'calculated parameters. The 'adjustable parameters' referred to the values
24 that could be altered to the desires of the spreadsheet user to enable the user to make design choices.
25 The 'scientific parameters' referred to the values obtained from scientific literature, providing input on
26 design efficiencies, required flow conditions, material characteristics, and optimal design parameters.
27 For each of these parameters, information from scientific literature was gathered to form a range of
28 reasonable values (see Appendix J) to substantiate the value for these parameters used in the
29 calculation. The 'calculated values' referred to the output of the calculation, providing reactor
30 dimensions, hydraulic retention times, and effluent concentrations of the pollutants. An example of the
31 spreadsheet and its structure is provided in Figure 34.

32 Determining the dimensions and treatment efficiency of the baseline scenario, the septic tank,
33 followed the Filipino design guidelines in place for septic tanks (see Administrative Order No.2019-0047
34 by the Department of Health – Republic of the Philippines; 2019).

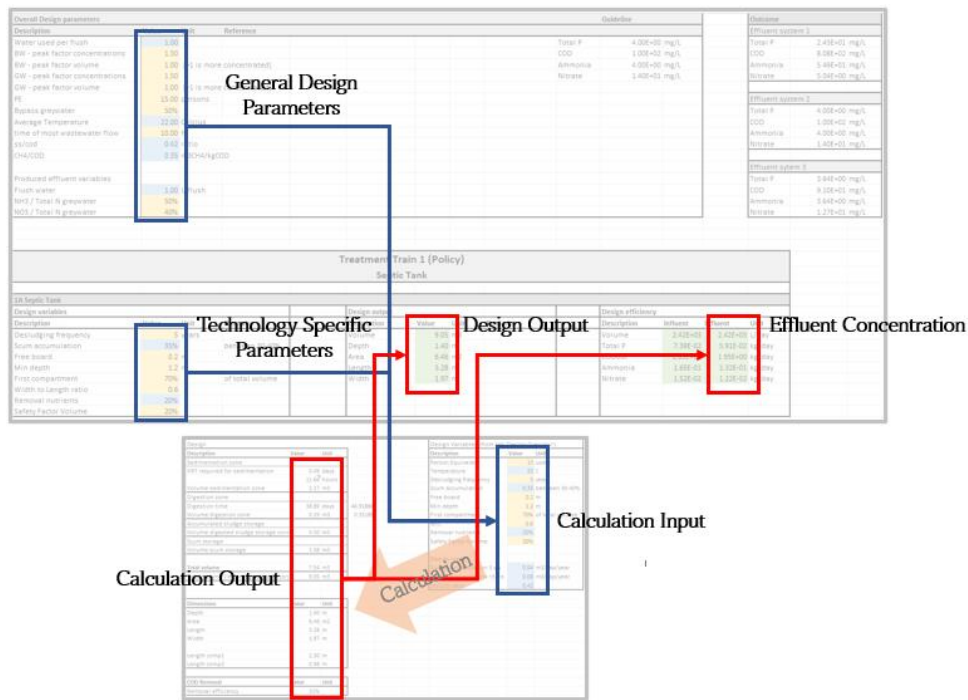

1
2 **Figure 34** | Example of the spreadsheet used to calculate the design dimensions and efficiencies. The blue rectangles point out the input
3 values, in which the yellow values refer to the 'adjustable parameters' and the blue values to the 'scientific parameters'. The red boxes
4 refer to the calculated values, represented by the green values.

3.4.4. Comparison of Conceptual Designs

5
6 The designs developed based on the design scopes set by the local community members and the local
7 sanitation experts were compared to designs of septic tanks serving a similar number of end-users,
8 using the septic tanks as the baseline scenario. The comparison of the design configurations aimed to
9 evaluate the integration of the needs and demands put forward by the participants in the FAHP + FGD
10 in the conceptual designs. Including the baseline scenario in this comparison allowed the assessment
11 of the deviation of the new configuration to the current situation, providing input for the discussion of
12 the added value of engaging stakeholders in the design process. Hence, the comparison focussed on
13 the differences in treatment technologies, the resemblance between the conceptual designs and the
14 outcome of the FAHP and the FGD, and the process leading up to the conceptual designs.

4. Results

This chapter provides the results of the FAHP, the FGDs, and the Design Cycle. First, information on the local community members participating in the FAHP is provided. This is followed by the results obtained from the FAHP, including the consistency ratios of the judgment matrices and the calculated criteria weights. The results from the FGDs are presented in a table, which presents the main findings from each exercise and questions addressed during the FGD. Lastly, the designs developed based on the input from the local community members and sanitation experts are presented.

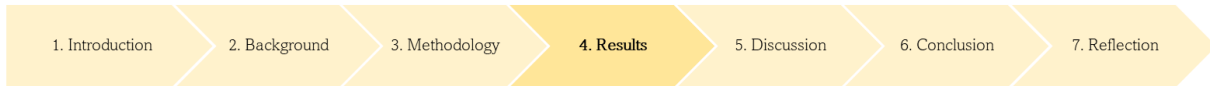

Figure 35 | Position of chapter 4. Results in document

4.1. Fuzzy Analytical Hierarchy Process

This study applied the FAHP as a systematic method to understand the relative importance of design criteria for sanitation systems as perceived by local community members and local sanitation experts. The aim of applying this method to a case study in Hagonoy, the Philippines, is to understand the differences in demands and needs between end-users and experts and how this affects the development of sanitation system designs.

4.1.1. Respondents of the FAHP

In total, 60 local community members and six local sanitation experts were recruited for the FAHP exercise. The local community members recruited for the FAHP were evenly distributed over six neighbourhoods, as ten participants were recruited in each neighbourhood. Out of ten participants in each neighbourhood, five were males and five were females, totalling 30 male and 30 female participants for the FAHP. Six local sanitation experts were recruited to fill in the FAHP. The experts were one engineer from the municipality office, three employees from the sanitation/health office, and two employees from the Hagonoy Water District. As only six local sanitation experts were part of this study, information of too few experts was available to draw conclusions linking these experts' demographical distribution to the FAHP outcome. Therefore, no demographic distributions were constructed of the local sanitation experts.

The age of the community members participating in the FAHP was evenly distributed over the specified age categories. All participants were adults. Out of all participants, 12% were below 24 years old. Out of 60 participants, 18% were between 25 and 34 years old, 23% were between 35 and 44 years old, 20% were between 45 and 54 years old, and 27% were over 55 years old.

The community members were asked about the highest finished educational level. Five of the sixty participants were unwilling to share this information. Of the remaining participants, 23% stated primary school as their highest completed education, 30% mentioned high school, and 38% stated they had attended college.

Participating local community members were asked to quantify their household's monthly income according to the income ranges, as shown in Figure 36. Of sixty participants, 40% were unwilling to share their monthly income or could not disclose a monthly amount. Therefore, these participants were assigned to the group 'undisclosed'. Of the participating community members, 32% stated that their household earned less than 10,957 Filipino Pesos (PHP) per month, while 18%

Distribution Monthly Household Income of Local Community Members Participating in FAHP

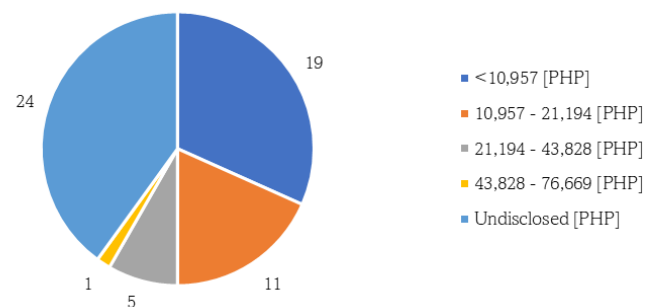

members participating in the Fuzzy Analytical Hierarchy Process exercise, expressed in Filipino Pesos

1 mentioned earning between 10.957 PHP and 21.194 PHP monthly. Eight percent stated a monthly
 2 income between 21.194 and 43.828 PHP, while the remaining two percent earned more than 43.828
 3 PHP per month.

4 Participating community members were asked how many people they shared their sanitation
 5 system. Of sixty participants, 62% shared their toilet with one to five persons, while 27% shared their
 6 toilet with six to eight persons, as can be seen in Figure 37. Only one participant stated to share their
 7 toilet with more than twelve persons, while four participants shared their toilet with nine to twelve
 8 persons. Two participants did not provide information on how many people they shared their sanitation
 9 system with.

10

Distribution Household Size of Local Community
Members Participating in FAHP

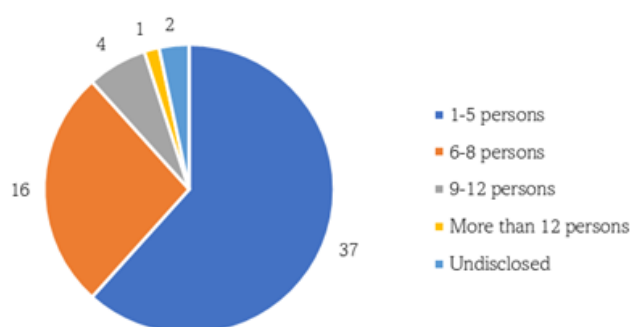

11

12 **Figure 37** | Pie-chart showing the number of people with whom participants shared their toilet. Participants refer to local community
 13 members from Hagonoy, the Philippines, who participated in the Fuzzy Analytical Hierarchy Process exercise.

14 Among the participating local community members, the main variant of sanitation systems
 15 present was the septic tank, as 76% of the participants flushed their toilet effluent into a septic tank.
 16 Most toilets connected to septic tanks were manually flushed (44 out of 46), while only two toilets were
 17 mechanically flushed to septic tanks. One interviewee had no toilet and defecated directly into the river,
 18 while 20% of the participants flushed their toilet effluent straight into the river. One of the
 19 neighbourhoods had piloted the installation of plastic drums instead of septic tanks, explaining one
 20 participant's mentioned use of a drum (see Figure 38).

21

Distribution Toilet System Use of Local
Community Members Participating in FAHP

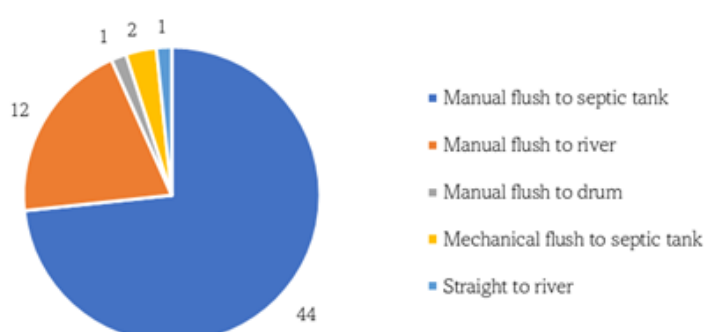

22

23 **Figure 38** | Pie-chart of the sanitation systems used by local community members in Hagonoy, the Philippines, participating in the Fuzzy
 24 Analytical Hierarchy Process exercise

4.1.2. Assessment of Collected FAHP Data

While data was collected from sixty local community members and six local sanitation experts, the number of data entries per pairwise comparison differed because of the applied randomization. Nevertheless, the randomization of pairwise comparisons ensured a minimum of thirty data points obtained from community members per pairwise comparison. The random selection of the pairwise comparisons asked of each participant resulted in between 32 and 47 (out of 60 possible) answers from local community members per pairwise comparison of social design criteria. For technical design criteria, the minimum is 32, and the maximum is 49 data entries for each pairwise comparison. Six local sanitation experts took part in the FAHP exercise, which, because of the randomization, resulted in two to six data entries per pairwise comparison for both the social and the technical design criteria.

The average absolute scores assigned to the individual pairwise comparisons ranged from 4.47 to 6.49 for the local community members, while the average absolute scores of each pairwise comparison as assigned by local sanitation experts ranged from 1.00 to 8.75. The scores are the absolute averages; hence, these averages measure the weight assigned by a participant. The scores are measured on a scale of 1.00 to 9.00, in which 1.00 refers to the compared criteria being considered '*Equally Important*', while 9.00 refers to one of the two criteria being deemed '*Extremely More Important*' than the other criterion. Local community members assigned average scores between 4.47 and 6.49 to the pairwise comparisons of social design criteria, with percentual standard deviations ranging between 34% and 71%. Similarly, the scores assigned to the pairwise comparisons of technical design criteria ranged from 4.75 to 6.36, with percentual standard deviations between 35% and 57%. The local sanitation experts assigned average absolute scores between 2.33 and 8.75 to the pairwise comparisons of social design criteria, with percentual standard deviations ranging from 6% to 138%. For technical design criteria, the pairwise comparisons were scored on average between 1.00 and 8.33, with percentual standard deviations ranging from 0% to 133%.

Individual participating local community members provided average absolute scores (determined per participant) ranging from 1.33 to 9.00, while the scores provided by local sanitation experts ranged from 2.79 to 9.00 per expert. Scores assigned by individuals belonging to the local community ranged from 2.60 to 9.00 for social design criteria, while scores ranged from 1.33 to 9.00 for technical design criteria. The local sanitation experts provided scores ranging from 3.27 to 9.00 and 2.79 to 9.00 for social and technical design criteria, respectively. Among both the local community members and the local sanitation experts, one individual provided average absolute scores of 9.00 to one of the design criteria in each pairwise comparison.

4.1.3. Consistency Ratios of the FAHP

Out of the sixty participating community members, only 13 (21.60%) could provide pairwise comparison matrices for both the social and technical design criteria that satisfied the consistency threshold of 0.10, while three out of six experts (50%) provided two consistent matrices. The consistency ratio proposed by Saaty (1980) was calculated to quantify the (mis-)alignment between the scores assigned to the pairwise participant comparisons. If the CR of a pairwise comparison matrix was equal to or below 0.10, the matrix and hence the judgment were deemed consistent. Out of the sixty local community members participating in the exercise, 34 participants provided an inconsistent matrix for the social design criteria, and 34 community members provided an inconsistent matrix for the technical design criteria. Among the local sanitation experts, one expert provided an inconsistent matrix for the technical design criteria, while two (other) experts provided inconsistent matrices for the social design criteria. The consistency ratios for social design criteria matrices provided by local community members ranged from 0.04 to 0.23 with a median of 0.11, while the social design criteria matrices of local sanitation experts had consistency ratios ranging from 0.03 to 0.14 with a median of 0.07, as is depicted in Figure 39 below.

The consistency ratio was also calculated for the matrices constructed by aggregating all matrices by individual participants, equalling $1.47\text{E-}03$ and $2.09\text{E-}03$ for the social and technical matrices from local community members, respectively and equalling $1.81\text{E-}02$ and $1.12\text{E-}02$ for the social and technical matrices from local sanitation experts.

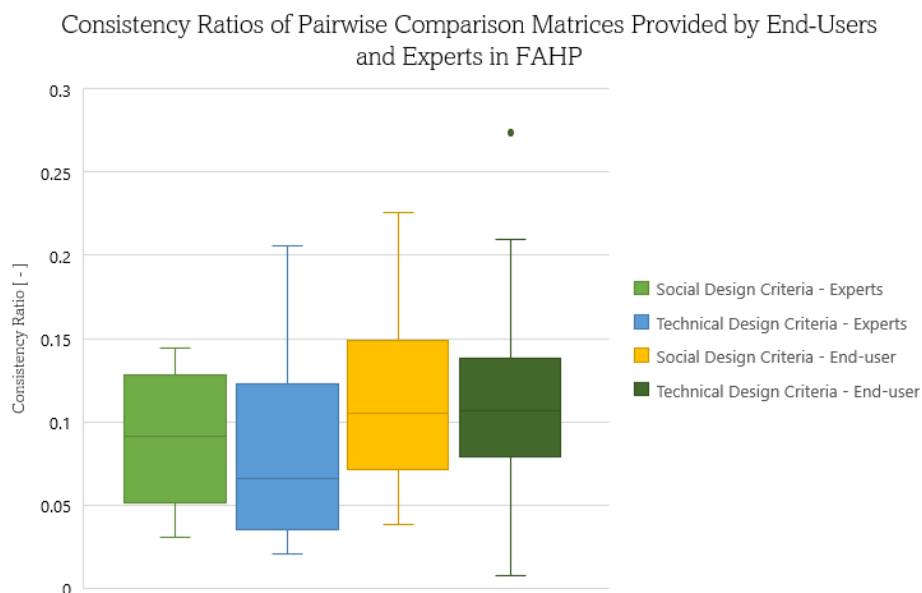

Figure 39 | Range of Consistency Ratios of Pairwise Comparison Matrices as provided by local sanitation experts and local community members in Fuzzy Analytical Hierarchy Process exercise.

21
22
23
24
25

1 **4.1.4. Spread of Relative Weights of Design Criteria Calculated by the FAHP**

2 For each local community member and the local sanitation experts, the weight vector depicting the
 3 relative importance of each criterion was calculated from the pairwise comparison matrices. The
 4 calculated weights per social design criterion of the sixty individual local community members are
 5 shown in Figure 40, while the weights calculated for the six individual local sanitation experts are shown
 6 in Figure 41. Both boxplots show the spread of the calculated criteria weights. Each boxplot for each
 7 design criterion shows the minimum (the lower whisker), the 25th percentile or first quartile (the lower
 8 boundary of the box), the median (the line in the middle of each box), the 75th percentile or third quartile
 9 (the upper boundary of the box), the maximum (the upper whisker), and the outliers (the dots outside
 10 of the whiskers). In this case, both the minimum and maximum are defined as 1.5 times the interquartile
 11 range.
 12

Distribution of Social Design Criteria Weights Calculated by FAHP with Input from Local Community Members
 (n = 60)

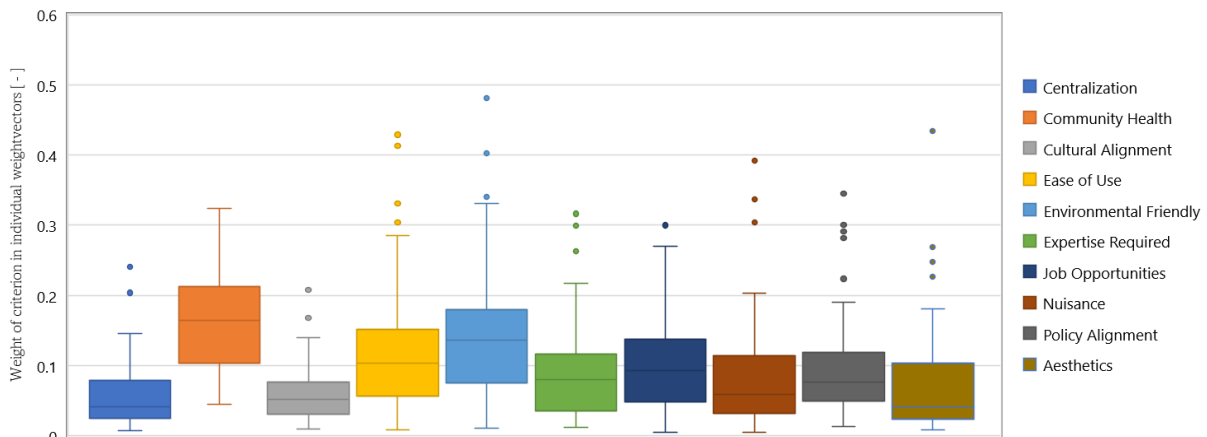

13 **Figure 40** | Distribution of relative weights of social design criteria as obtained from the Fuzzy Analytical Hierarchy Process, using the
 14 data of 60 local community members in Hagonoy, The Philippines. The whiskers represent the 1.5xInterQuartileRange, the dots represent
 15 the outliers in the data, the box represents the 50% quartile of the values, and the line in the middle of the box represents the median
 16 value.
 17

Distribution of Social Design Criteria Weights Calculated by FAHP with Input from Local Sanitation Experts
 (n = 6)

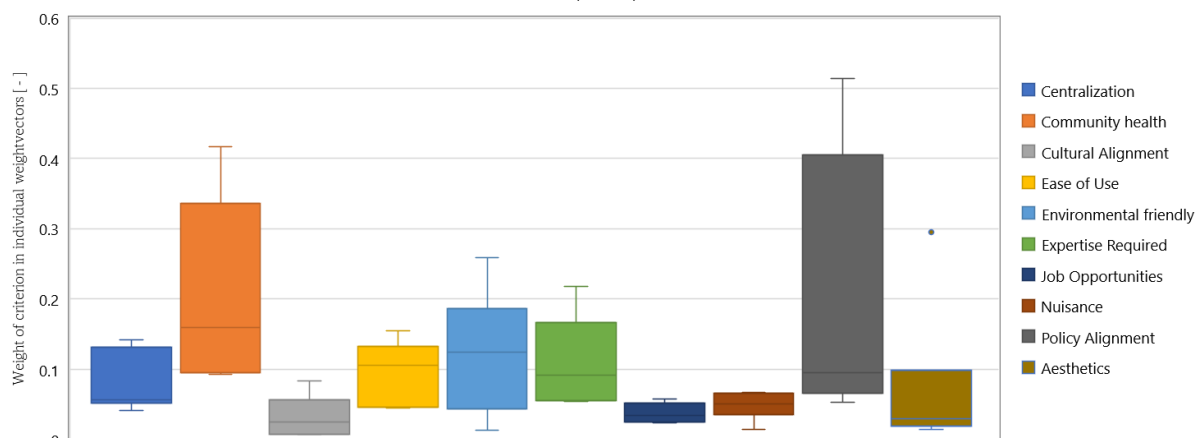

19 **Figure 41** | Distribution of relative weights of social design criteria as obtained from the Fuzzy Analytical Hierarchy Process, using the
 20 data of 6 local sanitation experts in Hagonoy, The Philippines. The whiskers represent the 1.5xInterQuartileRange. The dots represent
 21 the outliers in the data, the box represents the 50% quartile of the values, and the line in the middle of the box represents the median
 22 value.
 23

1 The boxplots of the weight vectors calculated for the technical design criteria based on the input
 2 from the local community members and the local sanitation experts are depicted in Figure 42 and
 3 Figure 43 below.
 4

Distribution of Technical Design Criteria Weights Calculated by FAHP with Input from Local Community Members
 (n = 60)

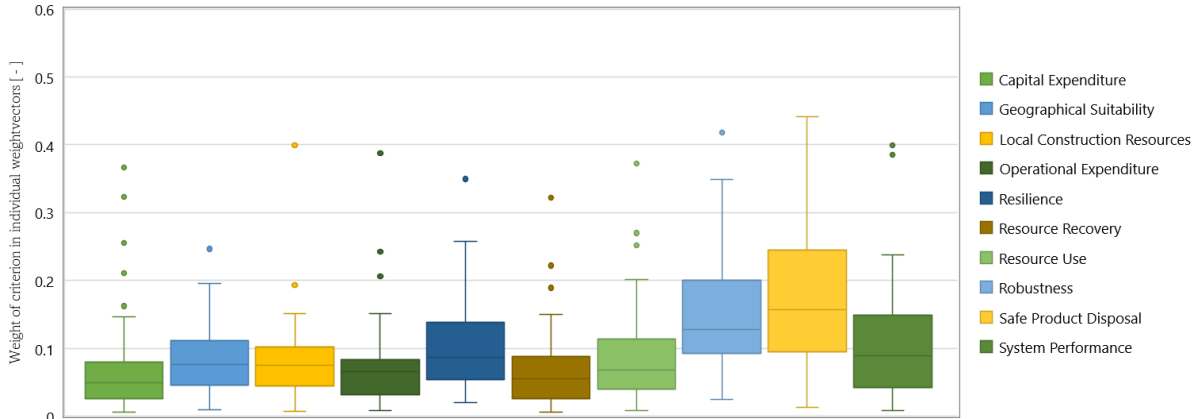

5
 6 **Figure 42** | Distribution of relative weights of technical design criteria as obtained from the Fuzzy Analytical Hierarchy Process, using
 7 the data of 60 local community members in Hagonoy, The Philippines. The whiskers represent the 1.5xInterQuartileRange, the dots
 8 represent the outliers in the data, the box represents the 50% quartile of the values, and the line in the middle of the box represents the
 9 median value.

Distribution of Technical Design Criteria Weights Calculated by FAHP with Input from Local Sanitation Experts
 (n = 6)

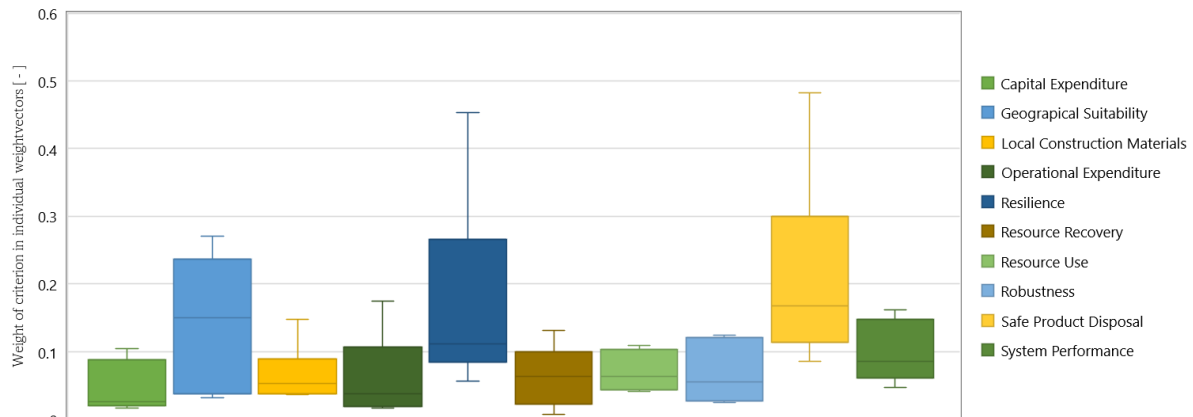

10
 11 **Figure 43** | Distribution of relative weights of technical design criteria as obtained from the Fuzzy Analytical Hierarchy Process, using
 12 the data of 6 local sanitation experts in Hagonoy, The Philippines. The whiskers represent the 1.5xInterQuartileRange, the dots represent
 13 the outliers in the data, the box represents the 50% quartile of the values, and the line in the middle of the box represents the
 14 median value.

4.1.5. Aggregate Weights Calculated by the FAHP

The FAHP combined the pairwise comparison matrices of the individual participants into one aggregate judgment matrix, from which the aggregate relative weight of the design criteria was calculated for both the local community members and the local sanitation experts. The weights from the weight vector for the social and technical design criteria are shown in Figure 44 and Figure 45, in which the weights determined by the local sanitation experts and the local community members are compared. The determined weights are on a scale of 1.

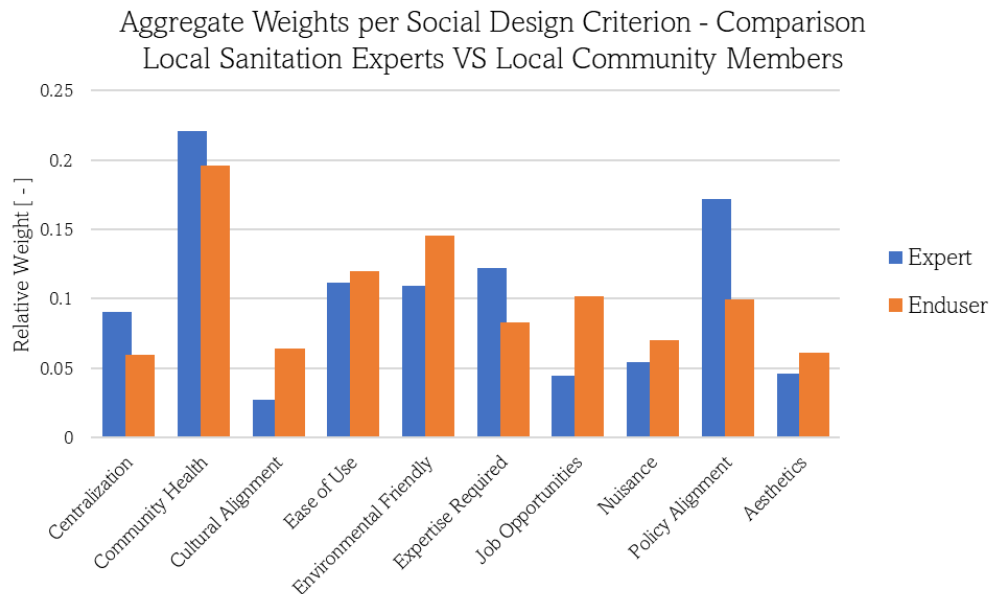

Figure 44 | Comparison of the relative weights for social design criteria for sanitation systems as calculated from the aggregate judgment matrix, based on the Fuzzy Analytical Hierarchy Process data from six local sanitation experts and sixty local community members in Hagonoy, the Philippines. The weights are on a scale of 1.

The weight vector for the social design criteria calculated from the aggregated pairwise comparison matrix shows that local community members (end-users) and local sanitation experts (experts) perceive 'Community Health' as the most crucial social design criterion when designing sanitation systems. The local community members assign a relative weight of 0.20 on a scale of 1.00 to 'Community Health', followed by 'Environmental Friendly' and 'Ease of Use' with scores of 0.15 and 0.12, respectively. Among experts, 'Community Health' was assigned a score of 0.22, followed by 'Policy Alignment' and 'Expertise Required' with scores of 0.17 and 0.12, respectively. Out of the sixty participating local community members, fourteen community members (23%) pointed out 'Community Health' as the most important design criterion. Other community members highlighted 'Environmental Friendly' (11/60 community members; 18%) and 'Ease of Use' (9/60 community members; 15%) as the most important social design criterion for a sanitation system. The local sanitation experts appointed 'Community Health' (3/6 experts; 50%), 'Policy Alignment' (2/6 experts; 33%), and 'Aesthetics' (1/6 experts; 17%) as the most crucial social design criteria.

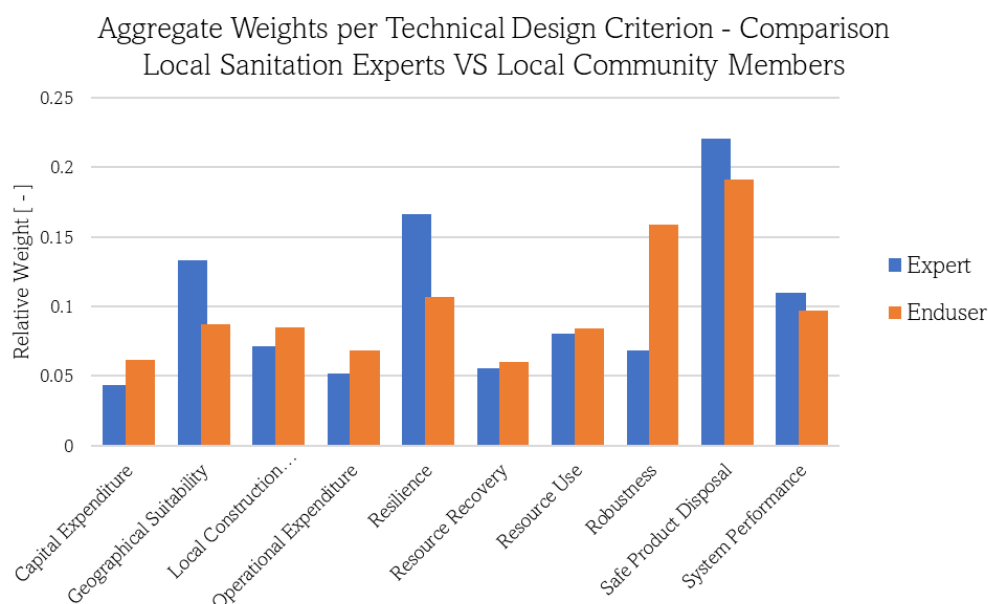

Figure 45 | Comparison of the relative weights for technical design criteria for sanitation systems as calculated from the aggregate judgment matrix, based on the Fuzzy Analytical Hierarchy Process data from six local sanitation experts and sixty local community members in Hagonoy, the Philippines. The weights are on a scale of 1.

1
2
3
4
5
6
7
8
9
10
11
12
13
14
15
16
17
18
19
20

Among the technical design criteria, the local community members and sanitation experts participating in the FAHP point out ‘*Safe Product Disposal*’ as the most critical technical design criterion when designing sanitation systems. The local community members have assigned a relative weight of 0.19 on a scale of 1.00, while the local sanitation experts assign a weight of 0.22 to ‘*Safe Product Disposal*’. Furthermore, local community members perceived ‘*Robustness*’ and ‘*Resilience*’ as crucial technical design criteria, as the calculated relative weights are equal to 0.16 and 0.11, respectively. On the other hand, the local sanitation experts assigned relative weights of 0.17 to ‘*Resilience*’, while ‘*Geographical Suitability*’ completed the top three with a relative weight of 0.13. Out of sixty participating community members, eighteen individuals (30%) appointed ‘*Safe Product Disposal*’ as the most critical technical design criteria, followed by ‘*Robustness*’ (10/60 community members; 17%) and ‘*Resilience*’ (7/60 community members; 12%). Additionally, 7/60 community members (12%) appointed ‘*System Performance*’ as the most critical technical design criterion but was assigned a lower relative weight on average. For the local sanitation experts, the criteria appointed to be the most critical technical design criteria are ‘*Safe Product Disposal*’ (2/6 experts; 33%), ‘*Geographical Suitability*’ (2/6 experts; 33%), ‘*Resilience*’ (1/6 experts; 17%), and ‘*System Performance*’ (1/6 experts; 17%).

4.2. Focus Group Discussions

The results of the FGDs contribute to the understanding of the desires, needs and perceptions of the participating local community members and the local sanitation experts regarding the design of a sanitation system. A summary of the main takeaways of the FGD with the local sanitation experts and the three FGDs with local community members is provided in Table 4. The results stated in the column of the 'Local Community Members' are marked by superscripts, referring to discussion from which this specific answer to the question or perception regarding a design criterion was obtained.

Local Sanitation Experts	Local Community Members
What is a sanitation system?	
<ul style="list-style-type: none"> • Complete system for collection and disposal of liquid and solid waste from households and enterprises 	<ul style="list-style-type: none"> • Septic systems^{1,2,3} • A system that properly disposes human waste into environment^{1,2,3}
What is the purpose of sanitation systems?	
<ul style="list-style-type: none"> • To improve community health by preventing the spread of water-borne diseases • To improve environmental health by decreasing the contamination of water 	<ul style="list-style-type: none"> • To improve community health by preventing the spread of water-borne diseases^{1,3} • To improve the quality of surface water and groundwater² • To protect fish farms from diseases¹
What do you perceive as threatening a functioning sanitation/toilet system, and why? [Resilience]	
<p><u>Ground Subsidence</u></p> <ul style="list-style-type: none"> • Causes septic tanks to sink, crack and leak • Increased relative water level, submerging septic tanks and disabling their use <p><u>Temperature</u></p> <ul style="list-style-type: none"> • Higher temperature increases the efficiency of the sanitation system due to increased bacterial activity <p><u>Earthquake</u></p> <ul style="list-style-type: none"> • In severe cases, it causes cracks in systems, resulting in leaks <p><u>Flooding</u></p> <ul style="list-style-type: none"> • Systems cannot be used during floods 	<p><u>Ground Subsidence</u></p> <ul style="list-style-type: none"> • Causes septic tanks to sink, crack and leak³ • Increased relative water level, submerging septic tanks and disabling their use² • No effect, as the system is underground¹ <p><u>Temperature</u></p> <ul style="list-style-type: none"> • Increased temperature raises the pressure in the tank, which, in the absence of ventilation, can lead to an explosion^{2,3} • No problems expected¹ <p><u>Earthquake</u></p> <ul style="list-style-type: none"> • In severe cases, it causes cracks in systems, resulting in leaks^{1,2,3} <p><u>Flooding</u></p> <ul style="list-style-type: none"> • Systems cannot be used during floods^{1,2} • Transmits waterborne diseases^{1,3} <p><u>Typhoon</u>¹</p> <ul style="list-style-type: none"> • Increases the effects of the floods¹ <p><u>Discipline of Community</u>³</p> <ul style="list-style-type: none"> • Not all households abide by the rules and possess a septic tank³ <p><u>Poverty</u>³</p> <ul style="list-style-type: none"> • The quality of materials in systems is insufficient to save money³ • Less knowledgeable experts are consulted to save money³

Local Sanitation Experts	Local Community Members
For how many households should a sanitation system be designed, and where should it be placed? [Centralization/Geographical Suitability]	
<ul style="list-style-type: none"> • One household per system • Placed in river 	<ul style="list-style-type: none"> • 4-5 households per system¹ • 2 households per system² • 5-10 household per system³ • Placed near fishpond^{1:3}
Which parties should be involved in the design phase, the construction phase, the maintenance phase, and the daily operation? [Expertise Required]	
<p><u>Barangay</u></p> <ul style="list-style-type: none"> • Concerned with communication between parties in every phase • Prepares initial plan/design <p><u>Contractor</u></p> <ul style="list-style-type: none"> • Executes the design <p><u>Hagonoy Water District</u></p> <ul style="list-style-type: none"> • Overseeing construction • Responsible for maintenance <p><u>Household</u></p> <ul style="list-style-type: none"> • Consulted for planning construction <p><u>Municipality</u></p> <ul style="list-style-type: none"> • Overseeing progress and parties • In charge of the final design 	<p><u>Barangay</u></p> <ul style="list-style-type: none"> • Controlling the design, the permits, and maintenance^{1:2} • Concerned with communication between parties³ <p><u>Contractor</u></p> <ul style="list-style-type: none"> • Reviews and executes the design^{1:2:3} • Initiates the process² <p><u>Hagonoy Water District</u></p> <ul style="list-style-type: none"> • Initiates and leads the process^{1:3} • Overseeing progress and parties² <p><u>Household</u></p> <ul style="list-style-type: none"> • Consulted for opinion on plan^{2:3} • Involved after implementation¹ <p><u>Municipality</u></p> <ul style="list-style-type: none"> • Overseeing progress and parties^{1:2:3} • In charge of final design¹
Which materials would you preferably use for a sanitation system? [Locally Available Construction Materials]	
<ul style="list-style-type: none"> • Hollow blocks and cement • Plastic tanks 	<ul style="list-style-type: none"> • Double-walled concrete tanks¹ • Metal tanks^{1:2:3} • Single-walled concrete tanks^{2:3} • Fiber tanks² • Plastic tanks²
What is the targeted frequency of replacement and maintenance? [Robustness]	
<ul style="list-style-type: none"> • Replacement only after malfunctioning • Maintenance, in theory, every five years, in practice when malfunctioning 	<ul style="list-style-type: none"> • Replacement only after malfunctioning^{1:2:3} • Maintenance in theory every five years, in practice when malfunctioning^{1:2:3}
What should be the maximum initial costs per household of a sanitation system? [Capital Expenditure]	
<ul style="list-style-type: none"> • 30.000 – 50.000 PHP per household 	<ul style="list-style-type: none"> • 15.000 – 20.000 PHP per household³ • 20.000 PHP per household¹ • 20.000 – 30.000 PHP per household² • Government should provide subsidy¹

Local Sanitation Experts	Local Community Members
Which current practices have to be implemented in a new sanitation system? [Cultural Alignment]	
<ul style="list-style-type: none"> • Sitting toilet, more comfortable • Bucket with dipper, due to little water consumption 	<ul style="list-style-type: none"> • Sitting toilet, more comfortable^{1,2,3} • Bucket with dipper, prevents additional waste^{1,3}, does not irritate skin², and is cheap³
Which other resources are allowed to be used for the treatment of wastewater? [Resource Use]	
<ul style="list-style-type: none"> • As long as the costs are low, the use of resources to treat the water is possible 	<ul style="list-style-type: none"> • As long as the costs are low, the use of resources to treat the water is possible^{1,3}
Which amount are people willing to pay monthly for wastewater treatment? [Operational Expenditure]	
<ul style="list-style-type: none"> • 50 – 150 PHP per month per household 	<ul style="list-style-type: none"> • 150 PHP per month per household³ • 150-400 PHP per month per household¹ • 200-500 PHP per month per household² • Currently, paid HWD fare is unfair, as not everyone was aware of the instalment and the use of the money^{1,2}
Are you willing to reuse materials recovered from treating wastewater daily? [Resource Recovery Potential]	
<ul style="list-style-type: none"> • Biogas and fertilizer are both desired products • Unfamiliar process raises scepticism about social acceptance 	<ul style="list-style-type: none"> • Biogas and fertilizer are both desired products^{1,2,3} • Unfamiliar process raises scepticism about social acceptance^{1,2,3}

1 **Table 4** | Summarized overview of the outcome of Focus Group Discussion with local sanitation experts and local community members
2 in Hagonoy, the Philippines. The superscripts refer to the number of Focus Group Discussions from which this statement originates, as
3 three separate Focus Group Discussions were carried out with local community members. The bold printed questions in the light yellow
4 boxes refer to the questions asked to the audience, while the text between brackets refers to the corresponding design criteria used in this
5 research.

6

1 4.3. Designs of the Sanitation Systems

2 The design cycles using the design scope as determined by the FAHP + FGD method resulted in the
 3 sanitation system for local community members, as shown on the next page in Figure 46, and the
 4 sanitation system for local sanitation experts, as shown in Figure 47. In addition to the developed
 5 conceptual designs, designs for septic tanks following the locally in-place design guidelines were
 6 developed (see Figure 48) to show how the newly developed designs compare to the current situation.
 7 The sanitation systems were designed such that the effluent of the final treatment stage complies with
 8 the General Effluent Standards of the Filipino government for the parameters TP, COD, NH₃, and NO₃²⁻
 9 as they were earlier depicted in Table 3.

10 The dimensions and treatment efficiency of the septic tank design were determined twice, in
 11 which the two designs differed in the number of people served. One version was designed to serve 20
 12 persons, while the other version was designed to serve five persons. This was done to demonstrate an
 13 equal comparison based on the number of people served between the improved and conventional
 14 designs according to the local guidelines.

16 4.3.1. Treatment Processes

17 For both the LCM¹ and LSE² designs, (partial) source separation of blackwater (the effluent from the
 18 toilet) and the greywater (the effluent from the shower, kitchen, washing, etc.) was assumed, while both
 19 systems consist of the successive stages described in Chapter 1.1; pretreatment, primary treatment,
 20 secondary treatment, tertiary treatment, and post-treatment. The technologies for each of the stages
 21 were obtained from scientific literature (used sources: Tilley et al. (2014); Borges Pedro et al. (2020);
 22 Mamani et al. (2014); Elvas and Sy (2008)) and were selected based on the alignment of the technologies
 23 with the design scope set by the local community members and the local sanitation experts.
 24 Additionally, the principal author assessed the possible technologies for their applicability and suitability
 25 in the local context before the technologies for the conceptual design were selected and worked out.
 26 The greywater in both systems was partially (50%) by-passed to the aerobic phase of the treatment to
 27 increase the dissolved oxygen level of the Anaerobic Filter effluent. The other 50% of the greywater
 28 influent was merged with the blackwater before entering the primary treatment step. In both systems,
 29 an oil-and-grease trap was included as the pre-treatment step for 100% of the greywater to remove the
 30 oil and grease to prevent clogging of the successive treatment steps. The design of the oil-and-grease
 31 trap was not included in this research.

32 The first design, using input from the local community members, consisted of an Anaerobic
 33 Baffled Reactor (ABR), Anaerobic Filter (AF), Horizontal Subsurface Flow Filter (HSFF), and a fishpond.
 34 The LCM system contained an ABR as the primary treatment step. The ABR was designed with a
 35 settling chamber and four vertical baffle chambers, targeting the decrease of COD through the physical
 36 removal of organic and oxidizable inorganic substances. The effluent of the ABR was directed to the
 37 AF, which was the secondary treatment step. An AF removes dissolved organic matter through
 38 biological removal processes and filtration, which was implemented to decrease the COD level further.
 39 The effluent from the AF in the LCM system was combined with the by-passed greywater to increase
 40 the dissolved oxygen level. The combined water flow was directed into an HSFF; the tertiary treatment
 41 step mainly focussed on removing the nutrients (TP, NH₃, and NO₃²⁻) present in the wastewater. The
 42 wastewater effluent from the HSFF entered the fishpond, which was the polishing or post-treatment
 43 step in this treatment system.

44 The LSE design consisted of an Anaerobic Biodigester (AnB), an Anaerobic Filter (AF), a Slow
 45 Sand Filter (SSF), and a Horizontal Subsurface Flow Filter (HSFF). The primary treatment step in the
 46 LSE system was an AB. In an AB, organic material is broken down through digestion in anaerobic
 47 conditions by microorganisms, which produce biogas during the conversion of the organic material. The
 48 effluent of the AB is directed to the secondary treatment step containing an AF, in which the
 49 concentration of dissolved organic matter is further reduced through biological removal and filtration.

¹ LCM = The conceptual design for the sanitation system developed based on the input of the Local Community Members

² LSE = The conceptual design for the sanitation system developed based on the input of the Local Sanitation Experts

1 The wastewater obtained from the AF is mixed with the by-passed greywater to increase the dissolved
 2 oxygen level. The mixed water enters the tertiary treatment step of the SSF, targeting the further removal
 3 of nutrients and organics through physical removal.

4 Biological removal occurs in the SSF due to the schmutzedecke (= film of biologically active
 5 microorganisms) formed on top of the sand column. The effluent of the SSF enters an HSFF, in which
 6 the plants planted in the soil layer take up nutrients present in the wastewater flowing through the porous
 7 soil medium. Furthermore, the porous medium entraps particles, filtering the wastewater. The effluent
 8 of the HSFF is discharged into the river.

Local Guidelines

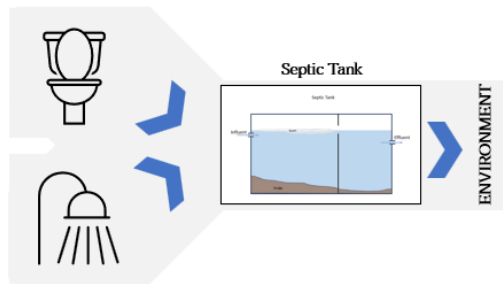

9

10 **Figure 46** | Schematic overview of the treatment stages of the conceptual sanitation system design developed based on the local design
 11 guidelines in Hagonoy, the Philippines

End-user-based

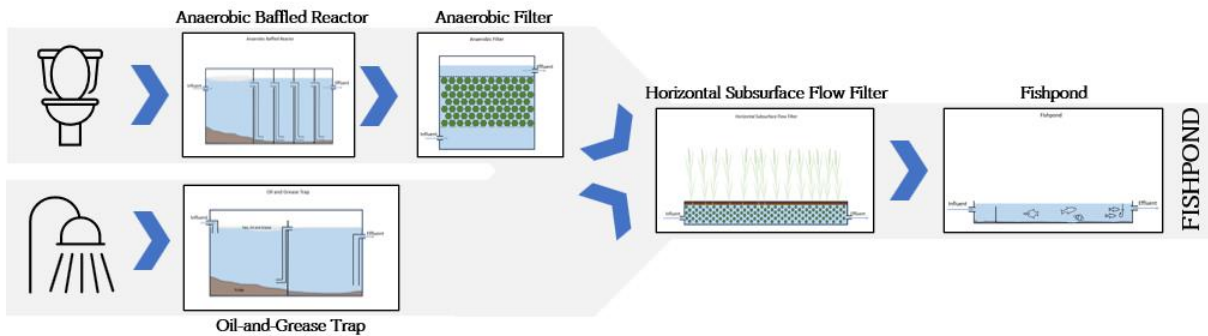

12

13 **Figure 47** | Schematic overview of the treatment stages of the conceptual sanitation system design developed based on the input from
 14 local community members in Hagonoy, the Philippine

Expert-based

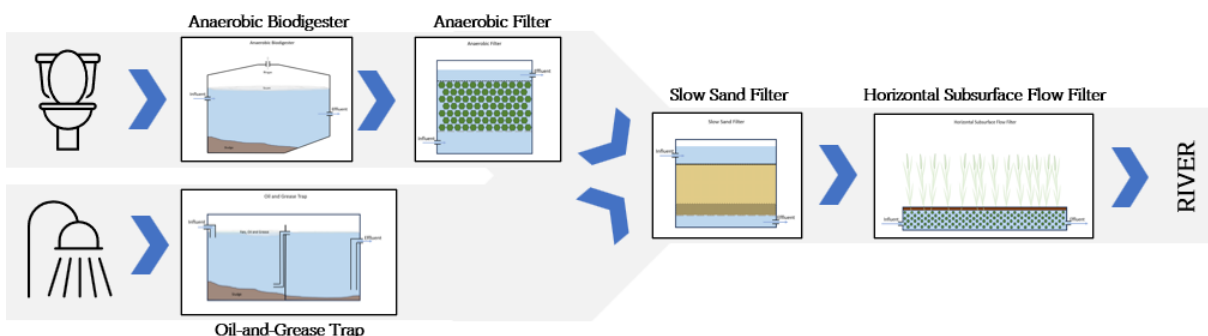

15

16 **Figure 48** | Schematic overview of the treatment stages of the conceptual sanitation system design developed based on the input from
 17 local sanitation experts in Hagonoy, the Philippines

18 **4.3.2. Treatment Design**

19 The septic tanks proposed by the local design guidelines are classified as primary treatment systems
 20 but have a lower COD removal efficiency ($\approx 30\%$) compared to the AnB ($\approx 40\%$) and the ABR ($\approx 90\%$).

1 It is important to note that the influent water volume in the AnB and the ABR was equal to the
2 blackwater influent and half of the greywater, while the septic tanks were designed to treat both the
3 blackwater influent and all of the greywater influent. The design guidelines for septic tanks allowed the
4 determination of the removal efficiency of COD, while the removal efficiency of the AnB was
5 determined through its COD balance and the removal efficiency of the ABR was determined through
6 the design guidelines of UPM (UPM, 2021a). The nutrient removal was assumed to be 20% for TP,
7 COD, NH_3 , and NO_3^{2-} in each of the treatment designs. The COD removal efficiency of the septic tank,
8 as determined through the design guidelines, was dependent on the number of people served; hence,
9 the COD removal efficiency was 31% for the septic tank serving 20 people (four households) and 33%
10 for the septic tank serving five people (one household). The calculated volume of the septic tank serving
11 five people – the baseline scenario for the LSE system – was equal to 3.15 m^3 , while the AnB in the LSE
12 system had a calculated volume of 10.33 m^3 . The septic tank serving twenty people has a volume of
13 11.92 m^3 , while the ABR has a total volume of 4.89 m^3 . Appendix K includes technical drawings,
14 including the dimensions and parameters of each treatment technology's designs.

15 The AF in the LCM system had a calculated COD removal efficiency of 55%, serving 20 people.
16 In comparison, the AF in the LSE system had a calculated COD removal efficiency of 63%, serving five
17 people. The COD removal efficiency and the sizing of these secondary treatment steps were
18 determined following the guidelines set by UPM for the design of AFs – see UPM (2021b). On the other
19 hand, the removal efficiencies for the nutrients were based on scientific literature, based on which a
20 nutrient removal efficiency of 20% was assumed. The AF in the LCM system had a reactor volume of
21 11.25 m^3 and a filterbed volume of 5.63 m^3 . The AF in the LSE system, serving five people, was designed
22 to have a reactor volume of 3.00 m^3 and a filterbed volume of 1.50 m^3 . An overview of the dimensions
23 and flow conditions of the designs are included in Appendix K.

24 The tertiary treatment system in the LSE system consisted of the SSF and the HSFF to target
25 the removal of the remaining COD and the nutrients, while the tertiary treatment step in the LCM
26 system consists of only a HSFF. In both systems, the by-passed greywater is mixed with the effluent of
27 the secondary treatment step, which causes an increase in COD- and nutrient-loading due to the
28 pollutants present in the by-passed greywater. The LSE system's SSF removed 80% of the COD and
29 20% of the nutrients in the reactors' influent, with all removal efficiencies derived from the scientific
30 literature. The column of the SSF had a total volume of 0.81 m^3 . The dimensions and efficiencies of the
31 HSFF were determined following the design guidelines proposed by Reed et al. (1998). In these
32 guidelines, the desired effluent concentration is the leading parameter, as the dimensions are calculated
33 based on the targeted removal efficiency, which is directly proportional to the chosen effluent
34 concentration. The HSFF in the LSE system is the final treatment step before the wastewater is
35 discharged. Hence, the effluent has to comply with the General Effluent Standards.

36 Consequently, the HSFF in this system is required to remove 89% of the NH_3 and 76% of the
37 TP, while the concentration of COD and NO_3^{2-} already comply with the regulations and hence were not
38 leading in the design. The removal of NH_3 was the leading factor in the design process, requiring a total
39 surface area of 65.98 m^2 and a depth of 0.60 m. The HSFF in the LCM system is required to remove
40 75% of the TP, 58% of the COD, and 88% of the NH_3 . The effluent standard for NO_3^{2-} was already
41 satisfied. Again, removing NH_3 was the process determining the sizing of the HSFF, resulting in a
42 required surface area of 64.80 m^2 with a depth of 0.60 m. An overview of the dimensions and flow
43 conditions of the designs are included in Appendix K. The treatment efficiency of the fish pond was
44 assumed to be 30% for all parameters. As no design guidelines for the sizing of fishponds were available,
45 the dimensions of the fish pond required for sufficient nutrient removal could not be determined.

46 Schematic overviews of removing the pollutants of interest per process phase for the
47 conventional septic tank system, the LSE system, and the LCM system are provided in Figures 49, 50,
48 and 51.

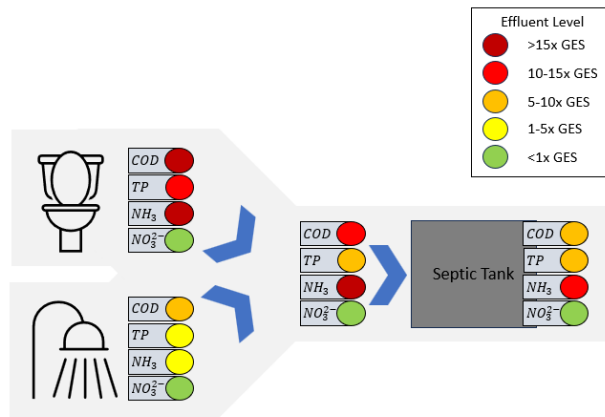

1
2
3
4

Figure 49 | Flow-chart sanitation system currently in place, in which the colours represent the pollutant concentration in the effluent of the treatment step. GES refers to the Filipino General Effluent Standards. TP, COD, NH₃, and NO₃⁻ refer to Total Phosphorus, Chemical Oxygen Demand, Ammonia and Nitrate

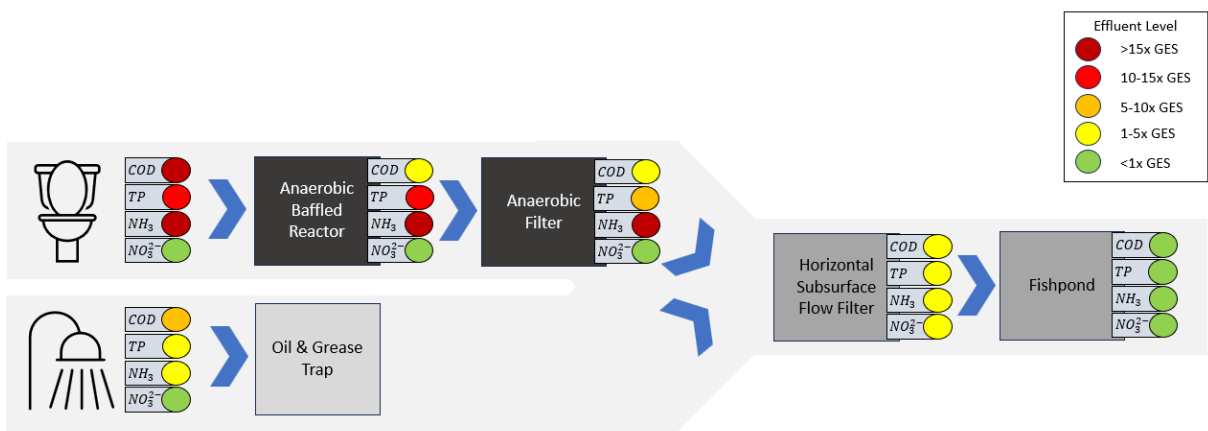

5
6
7
8
9

Figure 50 | Flow-chart of sanitation system designed using end-user input, in which the colours represent the pollutant concentration in the effluent of the treatment step. GES refers to the Filipino General Effluent Standards. TP, COD, NH₃, and NO₃⁻ refer to Total Phosphorus, Chemical Oxygen Demand, Ammonia and Nitrate

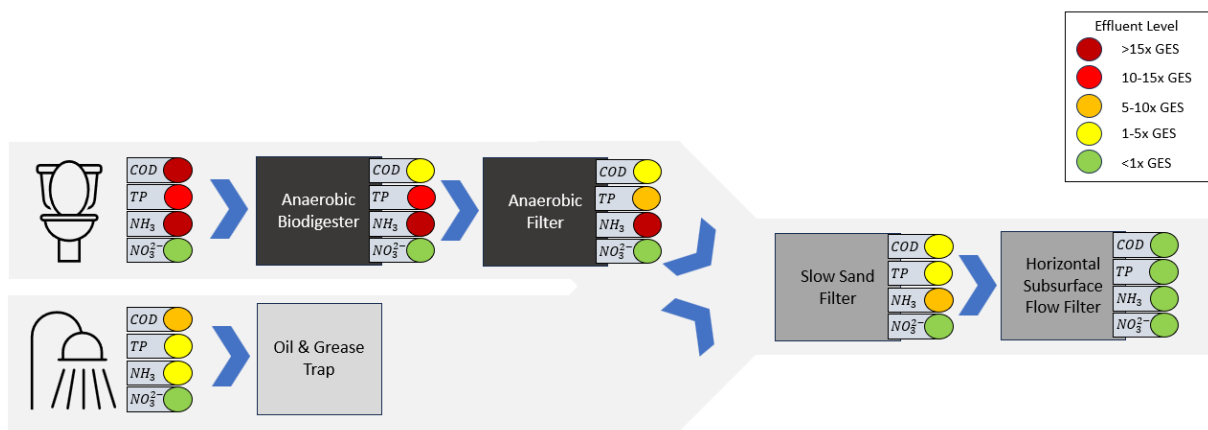

10
11
12
13
14

Figure 51 | Flow-chart of sanitation system designed using expert input, in which the colours represent the pollutant concentration in the effluent of the treatment step. GES refers to the Filipino General Effluent Standards. TP, COD, NH₃, and NO₃⁻ refer to Total Phosphorus, Chemical Oxygen Demand, Ammonia and Nitrate

5. Discussion

Having presented the results in the previous chapter, this chapter presents the interpretation of the results in light of the research questions. Moreover, the findings of this research are connected to previous findings stated in the literature. The paragraph presented in this chapter aims to answer the research questions in Chapter 1. Introduction. First, the main research question is answered before moving on to the sub questions. At the end of this chapter, the discussion cycles back to participatory sanitation planning, after which the design cycle as carried out in this research is thoroughly assessed. Building on this assessment, the limitations are discussed, and recommendations for future sanitation planning processes are developed.

5.1. Engaging Local Community Members in a Sanitation Design Process

This research addressed the scientific knowledge gap on how to systematically engage local community members in the Global South by applying a mixed methodology of FAHP and FGDs to a sanitation planning process in Hagonoy, the Philippines. It was hypothesized that applying the mixed methodology of FAHP + FGD would allow the systematic engagement of community members in determining the needs and demands posed centrally in the design process, thereby overcoming the limitations of confined decision freedom observed in sanitation planning tools in which the solution space is predetermined.

The proposed conceptual designs showed that using the FAHP + FGD method enables stakeholders to develop the designs, as the differences in the design scopes derived from the mixed method can be recognized in the proposed designs. Because the design process did not make use of a preselected set of technologies on which the trade-offs were based but instead defined the design scope using the preferences of stakeholders as expressed through the FAHP + FGD, the outcome of the design process became flexible (Kvarnstrom and McConville, 2007). This flexibility increases the relevance of the planning tool for local cases while increasing the engagement of the community in decision-making regarding their future (Luthi et al., 2009).

It was demonstrated that the FAHP + FGD could improve the alignment of the sanitation system designs with the experiences and perceptions of the local community members and the local sanitation experts. From the FAHP + FGD results with local community members, a preference for a semi-centralized system (serving four to five households) located near the fish pond was understood. Consequently, the developed sanitation system is designed to serve four households and discharges in the fish pond. Similarly, the negative experience of local sanitation experts regarding the maintenance of sanitation systems shared among households and the high ranking of 'Resource Recovery Potential' in the FAHP have led to a decentralized sanitation system in which the primary treatment step is an AnB producing biogas. Thereby, the FAHP + FGD method answers the call of Jimenez et al. (2019) for an effective sanitation design tool that includes community members and their local knowledge.

However, applying the FAHP + FGD method was limited to understanding the demands and needs of stakeholders and shaping the design scope, as the design criteria were obtained from literature and the principal author led the development of the conceptual design. The aim of the first step among the successive steps of the design cycle, as described by Liedtka (2015), is 'problem comprehension', which aims to understand the challenges and experiences of stakeholders regarding sanitation systems. The principal author shaped the problem definition regarding the sanitary situation in Hagonoy and the observed lack of participation in the design process based on scientific literature and local observations, limiting the participation of stakeholders in this phase to 'consultation'. Local community members and sanitation experts were asked about their problematic experiences regarding sanitation systems and the design process. However, the principal author phrased the methodology to obtain the design and the objectives of the design process. While this choice was made because of time and financial constraints, it is argued that the implementation of the FAHP + FGD does not establish stakeholder participation surpassing the level of 'consultation' in the comprehension of the problem, as the expectations of stakeholders regarding the outcomes of the design process are not adequately defined (Kpamma et al., 2017).

1 The FAHP + FGD, on the other hand, did offer a systematic method through which stakeholders
2 could express their preferences regarding a sanitation system, allowing them to influence the design
3 scope. Through pairwise comparisons, the complex problem is translated into information and
4 decisions accessible for non-expert stakeholders (Liu et al., 2020), hence answering the prerequisite set
5 by Kain et al. (2021) to make the technical design process more understandable and enhance
6 stakeholder participation. Because of the influence asserted by stakeholders on the demands, the needs,
7 and the formed design scope, the stakeholders are deemed to be ‘collaborating’ with the facilitator in
8 understanding the needs and demands and defining the criteria. Both the perceived importance and the
9 interpretation of the design criteria are directly obtained from the design criteria ranking provided by
10 the FAHP and the insights provided by the FGD. However, as the method was not observed to instigate
11 self-sustainability among participating stakeholders regarding the design of sanitation systems,
12 Zamenopoulos et al. (2019) argue that the method cannot be deemed to ‘empower’ stakeholders.

13 While the generation of the conceptual design was bound by the design scope set by the
14 stakeholders, the facilitator selected the configuration of the sanitation system. Consequently, the
15 stakeholders were merely informed about the ‘idea generation’ and the ‘design development’. It is
16 argued that implementing the FAHP + FGD in the sanitation design process limits the collaboration
17 between stakeholders and facilitators to the decision-making regarding the design scope, instead of
18 decision-making throughout the design process from problem comprehension to design development.
19 Although it did allow a participatory definition of the demands and needs and the method thereby
20 contributed to a need-driven approach as advocated by Buhl et al. (2019), the lack of stakeholder
21 engagement during and after the development of the design and the absence of the systems’
22 implementation limit statements regarding alignment of the design with the desires and demands of
23 stakeholders to unproven hypotheses.

24 The comparison of the FAHP + FGD-based design process to the existing sanitation planning
25 frameworks described in the introduction shows that the FAHP + FGD fills in the methodological void
26 in the process described by Kvarnstrom and Petersens (2004) and IWA (2014). Both described
27 successive design steps and the desired outcomes of these design steps but did not specify methods to
28 be systematically applied to achieve these outcomes. The FAHP + FGD structures the collaboration
29 between facilitators and stakeholders in defining the design and demands, as described by Kvarnstroms
30 and Petersen (2004) and IWA (2014). Compared to the frameworks by Spuhler et al. (2020) and
31 Loetscher and Keller (2002), two frameworks in which collaboration and elaborate consultation of
32 stakeholders were prescribed, the FAHP + FGD method described in this research also used predefined
33 design criteria as input. However, this limitation originates from the degree of participation applied
34 when defining the design criteria, as the criteria assessed through the FAHP + FGD method can be
35 interchanged to the likes of the facilitator in stakeholders. The frameworks by Spuhler et al. (2020) and
36 Loetscher and Keller (2002), on the other hand, do not contain this freedom in the shaping of the design
37 scope, hence showing the additional value of the FAHP + FGD method compared to these frameworks.
38 Furthermore, the FAHP + FGD method overcomes the shortcomings of the frameworks by
39 Kalbermatten (1982), Katukiza et al. (2010), and Filho et al. (2019) as a prespecified set of treatment
40 technologies does not limit the idea generation. Instead, the FAHP + FGD applies a criteria-driven
41 design approach in which the treatment technologies are selected based on their alignment with the
42 design scope defined by the participating stakeholders. Altogether, the FAHP + FGD method
43 outperforms other sanitation design frameworks based on its systematic and straightforward approach,
44 open-ended design process, improved stakeholder participation in shaping the design scope, and
45 flexible implementation.

46
47

5.1.1. Assessing the Suitability of the Fuzzy Analytical Hierarchy Process

While FAHP is often highlighted due to its advantages like ease of use and disentanglement of complex problems (Karthikeyan et al., 2016), applications of FAHP are hindered by its subjective nature, its attempt to aggregate opinions and the extensiveness of pairwise comparisons needed when comparing many design criteria (Canco et al., 2021). While this is undeniable, this synthesis of opinions is also one of the main functions of AHP (de FSM Russo and Camanho, 2015). It is generally unavoidable in decision-making processes to include actors with differing opinions.

The subjective nature of the FAHP is introduced by its attempt to capture opinions through comparisons on a linguistic scale (Salvia et al., 2019). As a result, both the observed assigned scores to pairwise comparisons and the calculated weights show significant variance. Aligning with findings from Lienert et al. (2016), individuals interpretation of the linguistic scale resulted in average absolute scores assigned to the pairwise comparisons ranging from a minimum of two (intermediate value between equally essential and slightly more important) to nine (all comparisons scored as 'extremely more important'). Similarly, the calculated weights per design criteria show percentual standard deviations among end-users up to 108% - the percentual standard deviation obtained for the design criterion '*Aesthetics*'.

Nevertheless, Moslem and Duleba (2019) argue that following the "wisdom of crowds" as proposed by Solomon (2006), the judgment obtained from aggregating opinions does represent the knowledge and perspective of a group, as extreme opinions are compensated for. The consistency ratios from the FAHP substantiate this argument. While assessing the consistency ratios of the aggregated 'social criteria' judgment matrices for end-users, it is observed that the consistency ratio of the aggregate judgment matrix (1.60E-03) is a factor of ≈ 69 (!) lower than the aggregated consistency ratio of the individual judgment matrices (1.11E-01). A similar trend is observed in the consistency ratios for the experts, with consistency ratios of 1.81E-02 and 6.34E-02 (a factor of 3.5) for the aggregated judgment matrix and the individual matrices, respectively. Similar factors were found for the 'technical criteria' judgment matrices, with the ratios differing by a factor of ≈ 51 and ≈ 7 for end-users and experts, respectively. As the ratio of consistent matrices to participants was higher for experts (social design criteria: 66%, technical design criteria: 83%) than for end-users (social design criteria: 43%, technical design criteria: 43%) for both social and technical design criteria, a relationship between the number of judgment matrices aggregated, and consistency ratio of the aggregated matrix was hypothesized.

To test whether an increase in the number of participants causes a decrease in the consistency ratio of the aggregated judgment matrix, an algorithm testing this relationship was developed in Python (version 3.11.3) and applied to a complete pairwise comparison dataset. This dataset contained complete 10 x 10 judgment matrices (hence no blanks, preventing bias introduced by the DEMATEL method) from thirty participants. This dataset was explicitly obtained for this analysis; hence, it was not used to develop the designs or included in the definition of the design scopes. The algorithm was run 30 times, selecting different judgment matrices from the sample set of thirty matrices in each run. The results, depicted in Figure 52, confirm that an increase in the number of participants on average causes the consistency ratio to decrease, confirming the hypothesis.

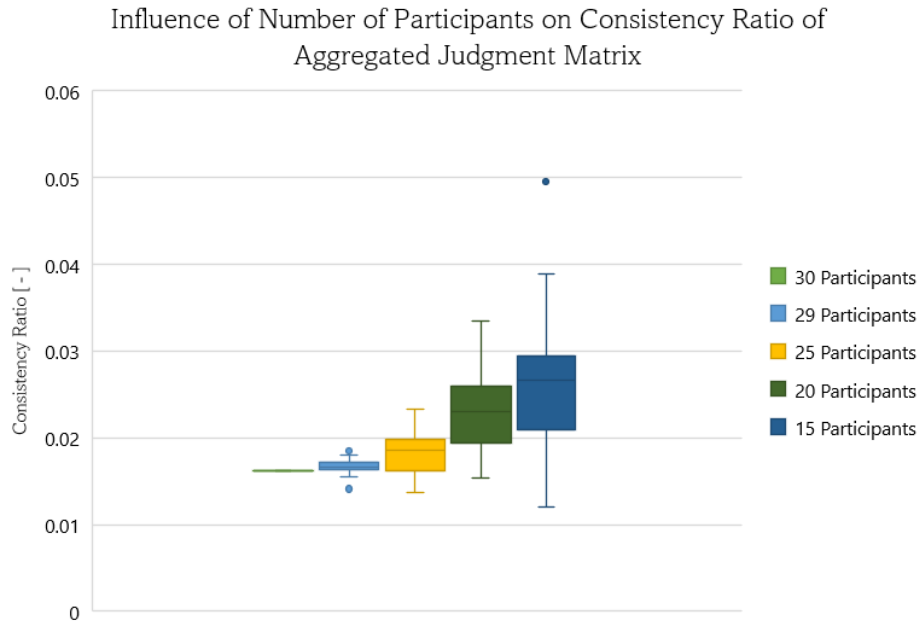

1
2 **Figure 52** | Boxplots showing the results of 30 runs of the algorithm to determine the consistency ratio of the aggregated judgment
3 matrix assigned to pairwise comparisons in the Fuzzy Analytical Hierarchy Process. The algorithm used a pool of data from thirty
4 participants, aggregating the data from a specific number of random participants

5

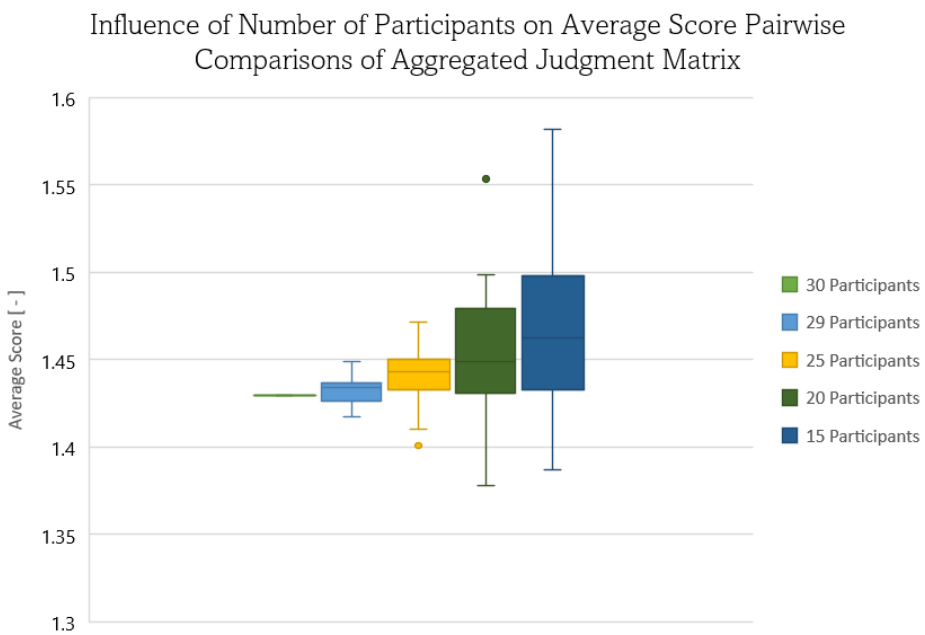

6
7 **Figure 53** | Boxplots showing the results of 30 runs of the algorithm to determine the average absolute score (on a scale of 1 to 9)
8 assigned to pairwise comparisons in the Fuzzy Analytical Hierarchy Process as observed in the aggregated judgment matrix. The
9 algorithm used a pool of data from thirty participants, aggregating the data from a specific number of random participants.

10
11
12

1 The relationship between the number of judgments and the resulting consistency ratio might
2 be explained by the aggregating nature of the FAHP (Zhang et al., 2022), as aggregating an increased
3 number of matrices mitigates the extreme judgments of individual matrices. This relationship is
4 confirmed by comparing the average value of the entries in the aggregated judgment matrix. Figure 53
5 shows that the aggregated matrix calculated using the input of an increasing number of participants has
6 a lower average score assigned to the pairwise comparisons, indicating that increasing the number of
7 participants balances out the extremity of judgments. Building on the findings of Danner et al. (2016),
8 who concluded that the extremity of judgment scores (> 5 on a 9-point Likert Scale) indeed negatively
9 influences the consistency ratio, it is hence concluded that increasing the number of participants in the
10 FAHP mitigates the extremity of individual judgments, consequently improving the consistency of the
11 aggregated judgment matrix. However, this can also be perceived as a shortcoming of the method, as
12 the synthesized opinion might differ too much from the opinion of an individual decision-maker,
13 resulting in his/her rejection of the synthesized opinion (Palomares et al., 2014). Furthermore, it
14 questions the added value of calculating the consistency ratio for the aggregated judgment matrix, as
15 the established relationship shows that the consistency threshold can be satisfied by increasing the
16 number of individual judgment matrices.

17 Consequently, a dilemma arises regarding the optimal number of aggregated judgment matrices,
18 in which the elaborateness of data collection and loss of possibly relevant extreme judgments are set
19 off against an increased consistency and consolidation of irrelevant extreme judgments. Conventionally,
20 there are no strict requirements for the number of participants in an AHP (Muhlbacher and Kaczynski,
21 2013), with a literature review by Schmidt et al. (2015) reporting a range of 1 to 1,300 participants for
22 AHP. Instead, the number of participants should be determined according to a study's sample size and
23 experts' availability (Schmidt et al., 2015). It should be acknowledged that within this research, sample
24 representation was not taken into account during the recruitment of participants and the collection of
25 data, as this research is an explorative study regarding the early engagement of stakeholders in the
26 design process. Financial and time constraints also made executing a complete and representative
27 participatory design process from problem comprehension to implementation unfeasible.

28 When comparing the mean of the calculated weight vectors per end-user decision-maker to the
29 median of the same weight vectors, the difference in weights caused a shift in the obtained ranking of
30 design criteria. This difference is explained as the aggregating nature of calculating the mean adopted
31 in FAHP increases the influence of outliers – read extreme judgments - on the value of the mean – read
32 the aggregated opinion (Yang et al., 2019). Figures 54 and 55 show the median weights and the mean
33 weights for social and technical design criteria as assessed by end-users in which the secondary axis
34 shows the ranking of the criteria, with ranking one referring to the most crucial design criterion and
35 ranking 10 to the least important criterion. Both figures show shifts in the calculated weights for the
36 design criteria, as well as in the rankings of design criteria when using the median instead of the mean
37 - design criterion '*Cultural Alignment*', for example rises from rank 10 in mean-method to rank 8 in
38 median-method, see Figure 54. Hence, it is questionable if aggregation through calculation of the mean
39 is most suitable to represent a synthesized opinion, as extreme judgments have a significant influence
40 on the final judgments when compared to the median value. While extreme judgments in the FAHP are
41 mitigated when many opinions are synthesized, this behaviour poses severe threats to the credibility of
42 the calculated mean weight vector when only a few judgments are considered (Kulakowski et al., 2023).
43 For future research, this shortcoming should be addressed by employing a weighting technique for
44 decision-makers' judgments, as proposed by Blagojevic et al. (2020).

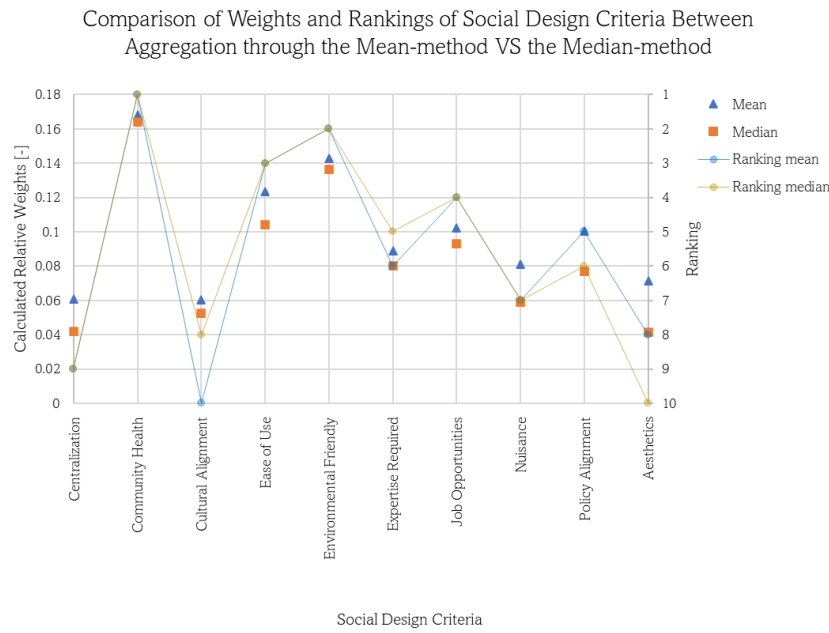

1
2
3

Figure 54 | Comparison between weights calculated with Fuzzy Analytical Hierarchy Process using mean vs using median for social design criteria, using end-users judgments as obtained in this research

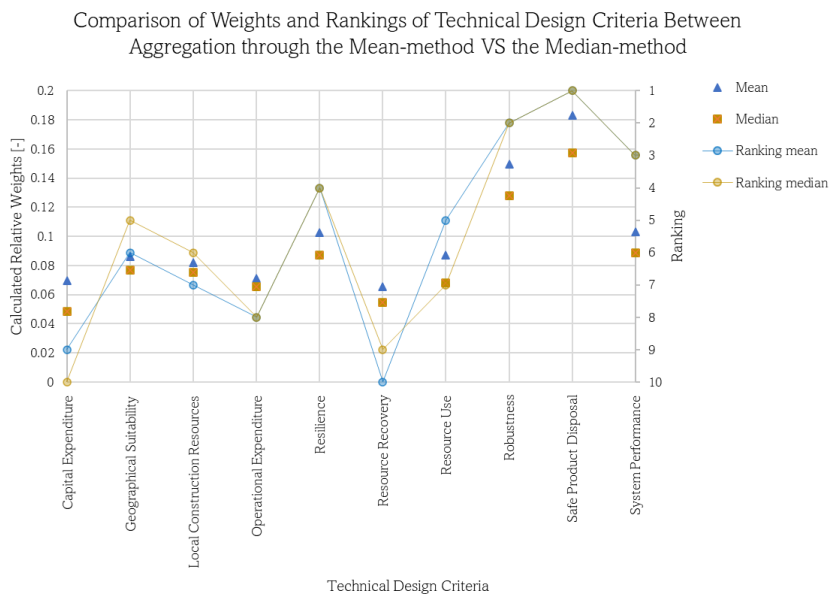

4
5
6

Figure 55 | Comparison between weights calculated with Fuzzy Analytical Hierarchy Process using mean vs using median for technical design criteria, using end-users judgments as obtained in this research

7 The methodology was deemed as suitable to end-users as to experts, as no significant
 8 relationship between the level of knowledge required (experts vs non-experts) and the reliability of the
 9 judgment (consistent vs inconsistent) was observed when applying Boschloo’s test. Boschloo’s test
 10 assesses the statistical significance of the association between two random variables in case of limited
 11 sample size (Lydersen et al., 2009). Boschloo’s test was used because of its superior statistical power
 12 compared to other significance tests for small data samples (Mehrotra et al., 2003). The ease of use for
 13 end-users of the FAHP was a primary driver in its selection as an MCDM that can be used to engage
 14 end-users in the design process. Involving end-users in a design process requires lower-complexity
 15 planning tools, as high complexity can prevent end-users from participating in the tool (Zellner et al.,
 16 2022). However, applying Boschloo’s test to the ratio of consistent matrices among experts and the
 17 ratio among end-users provided a p-value of 0.16. Applying a significance threshold of 0.05, the

1 relationship between the level of knowledge and judgment consistency is deemed insignificant with a
2 95% confidence interval and, hence, statistically independent. Therefore, it was concluded that the
3 experts were not significantly better at providing consistent judgment matrices among the interviewed
4 end-users and experts. As a result, the FAHP is considered an accessible and easy-to-use tool to
5 collaborate with non-expert stakeholders in the decision process, aligning with the criteria stated by
6 Billger et al. (2020) for participatory sanitation planning tools.

7 Nevertheless, only 46% of all provided judgment matrices –experts and end-users, technical
8 and social – were consistent, which is explained by the increased complexity when the number of
9 assessed criteria is increased (Sakhardande and Gaonkar, 2022). As a result, the increase in
10 inconsistency of the provided matrix in the case of cross-comparing more than three criteria is a
11 common concern of the AHP (Piengang et al., 2019). However, this is not necessarily a result of the
12 applied method but is merely a result of the incapability of humans to remain consistent when providing
13 judgments through pairwise comparisons (Miller, 1956). Another possible explanation for the observed
14 inconsistency among decision-makers is fatigue, which is caused by the repetitiveness and
15 extensiveness of the exercise (Vohs et al., 2005; Hodgett, 2016). This aligns with observations during
16 data collection, as multiple end-users showed unwillingness to continue the exercise and decreased
17 interest over time. While judgment inconsistency is usually dealt with by iterating the judgment matrix,
18 Asadabadi (2017) noticed that these iterations forced decision-makers to change their initial judgment,
19 distancing themselves from their actual opinion.

20 Similarly, Danner et al. (2016) concluded that highly inconsistent judgment matrices can still be
21 plausible since the included extreme judgments causing the inconsistency might reflect what the
22 participants perceive as necessary. To prevent consolidation of the initial judgments and the exercise
23 from becoming more elaborate because of required iterations, the initial provided comparison matrix
24 was used for further assessment, regardless of its consistency. Moreover, research by Aguaron et al.,
25 2020 showed that a lower consistency ratio does not necessarily cause participants to support the
26 weights assigned to the weight vector more than in the case of a high consistency ratio, hence
27 contradicting the line of reasoning of Saaty. As a result, the relevancy of calculating the consistency
28 ratio and consolidating inconsistent judgment matrices is questioned. The synthesis of individual
29 judgment matrices has been shown to mitigate the influence of extreme judgments while providing a
30 consistent judgment matrix representing the ‘average’ opinion of the participants. Nevertheless, it is
31 essential to state that building on the ‘average’ opinion, even when it is based on the judgment of the
32 respective individuals, does not necessarily guarantee the acceptance of the final decision by these
33 individuals.

34
35

5.1.2. Assessing the Suitability of the Focus Group Discussions

The FGDs were combined with the FAHP to assess the design trade-offs in sanitation planning with both end-users and experts, as FGDs allow the discovery of collective perspectives and the validation of interpretations (Nyumba et al., 2018). Shortcomings of FGDs, on the other hand, concern the dependency on the skills of the moderator, the creation of conflicts between participants, and the negligence of ethical considerations (Coe et al., 2017).

The FGDs were set up to obtain insights from the participating local community members and local sanitation experts regarding sanitation systems and the design criteria based on their experiences and perceptions. Through the discussions on centralization and the placement of the sanitation system, local experiences regarding shared sanitation systems were explored. Similarly, opinions regarding resource recovery from wastewater were discussed, concluding that resource recovery from wastewater was considered feasible and desirable by local community members and sanitation experts. The observed value of FGDs in this research thereby aligns with the observations of other researchers, who state that the value of FGDs lies within the possibility of participants to clarify opinions and judgments (Rabiee, 2004; Acocella, 2012).

Nevertheless, FGDs must be set up carefully, as misaligned opinions and interests among participants in one FGD can lead to conflicts (Sim and Waterfield, 2019). This research observed no extreme conflicts between participants during the FGDs. The relationships between participants can explain this, as they were recruited based on their geographical location and function. Conflicts between the experts (municipality engineers and municipal sanitary inspectors) and the local community members based on hierarchy were avoided by separating the FGDs for the respective groups. Avoiding these conflicts, however, also reduces the consensus-building ability of FGDs, as a homogeneous group of FGD participants decreases the number of contradicting opinions, leading to less depth in the discussion (Daley, 2013). Malterud et al. (2016) furthermore argue that demographical diversity among focus group participants increases the 'informational power' of the group due to the increased number of perspectives present during the discussion. Separating the groups of participants, therefore, limits the contribution of the FGD to the explanation and interpretation of the opinion of the participants belonging to the respective group, as only consensus building between group members is obtained and not consensus building between the distinct groups. While in this research, this choice was made deliberately to show the applicability of the method for the inclusion of local community members in the design process, it does not integrate the opinions of the local sanitation experts and the local community members into a design solution that satisfies both parties.

5.2. Reconsidering the Design Criteria for the Design Scope

The design scopes for the local community members and sanitation experts were constructed with design criteria from a systematic literature review. It was opted to apply a systematic literature review (see Figure 56), as this would provide an objective overview of design criteria for sanitation systems as depicted by scientific literature. However, by obtaining the design criteria from scientific literature and constructing the definitions and examples based on the input from literature, the local stakeholders were excluded from setting the boundaries of the design scope. Consequently, the participatory level in the 'Problem Comprehension' phase of the design cycle was limited to 'informing' the stakeholders about the definition of the design criteria.

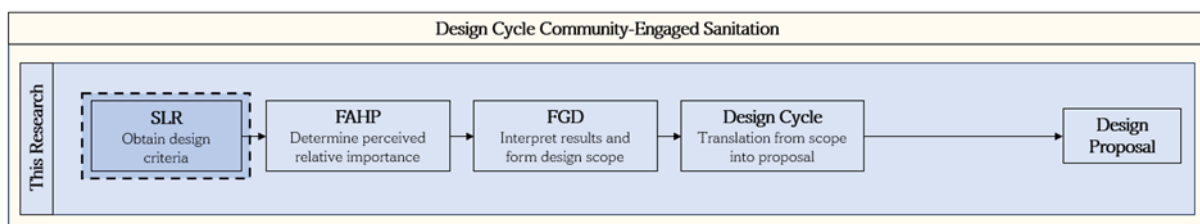

Figure 56 | Positioning the systematic literature review (SLR) in the design process as applied in this research, before the Fuzzy Analytical Hierarchy Process, the Focus Group Discussions, and the Design Cycle leading to the Design Proposal

5.2.1. Reviewing the Completeness of the Design Scope

The search query proposed for the systematic derivation of the design criteria did not include any of the assessed sanitation planning tools, from which it was hypothesized that the search query was too narrow and hence excluded relevant design criteria. A systematic review of the literature regarding design criteria in community-engaged sanitation planning was carried out to determine the design scope of community-engaged sanitation planning while minimising selectors' bias. When assessing the scientific papers obtained from Web of Science through this review, it was observed that none of the twenty assessed sanitation planning tools was among the obtained papers. Of the twenty assessed tools, nine dated from before the timeframe used in the literature review, excluding them from the search results. On the other hand, the other 11 planning tools were expected to be included in the results from the literature review, as they were published in scientific journals included in Web of Science and within the specified timeframe (2013 – 2023). Further assessment of the search query, its results, and the assessed sanitation planning tools showed the following explanation: the search query focused on design criteria, sanitation, and community involvement. The 11 planning tools, however, did not include synonyms related to community involvement in their abstract, hence not satisfying the specified search criteria.

By comparing the design criteria used, it was concluded that the design criteria proposed in this research included the majority of the design criteria used in existing planning tools, either exactly similar to or combined with other criteria. The design criteria proposed in this research matched directly with design criteria used in 11 out of 20 assessed planning tools (Kalbermatten, 1982; Mara et al., 2007; Katukiza et al., 2010; Franceys et al., 2013; Filho et al., 2019; van Buuren, 2010; Olschewski, 2013; Nayono, 2014; Finney et al., 2009; Schutze et al., 2019). Within this comparison, of which an overview is provided in Appendix A, it is essential to note that particular design criteria such as groundwater table (Filho et al., 2019) or eutrophication potential (Schutze et al., 2019) were deemed included in the set of design criteria used in this research, for the examples respectively '*Geographical Suitability*' and '*Environmentally Friendly*'.

The leading causes for misalignment in the design criteria used between this research and the assessed frameworks are differences in the design scope, focusing on the process instead of the design, and differences in level of detail. The misalignment with (Strande et al., 2014), who proposed criteria like dewaterability, sludge stability, and solid-liquid separation, is explained through the difference in scope, as Strande et al. (2014) focus on faecal sludge treatment instead of sanitation. The planning tool by Langergraber et al. (2015) calculates the net present value to substantiate decision-making, basing the trade-off between technologies strictly on their economic value. While net present value is not directly included in the proposed design criteria, it is argued that it is represented in capital and operational expenditures based on their similar definitions (Gallo, 2014). The design criteria Schmitt et al. (2017) used strictly focused on service provisions concerned with sanitation, such as transport costs, distance to treatment facility, and transport capacity. This raises an interesting shortcoming of the proposed list of criteria, as the alignment with existing infrastructure and services proves to be a critical determinant of the sustainability of sanitation systems (Trimmer et al., 2020). The theoretical framework, as adopted by Prouty et al. (2018), uses model factors to predict the theoretical adoption rate of sanitation systems. Spuhler et al. (2020) propose an extensive set of design criteria, ranging from 'spare parts requirements' to 'vehicle access'. This set is more detailed and elaborate than the design criteria used in this research. This is possible due to the method applied by (Spuhler et al., 2020), as the scores of different treatment technologies for each design criterion are predetermined, after which an algorithm assesses the best-fit treatment systems. Applying the 36 design criteria used in Spuhler et al. (2020) to the FAHP used in this research would result in 630 pairwise comparisons to be filled in.

Additionally, due to their complexity and technical background, many of the design criteria are irrelevant to end-users, risking the provision of detrimental input (Stanley-Brown and Weistroffer, 2019). Loetscher and Keller (2002) include design criteria assessing the community's involvement in the process. Similarly, within the Citywide Inclusive Sanitation (CWIS) framework, as proposed by (Schrecongost et al., 2020), essential design principles concern equity among those affected and transparency in the decision-making process. However, these criteria are related to the process leading

1 up to the design (Chu and Cannon, 2021) and not necessarily the design itself. Hence, such criteria are
2 deemed irrelevant for defining the design scope of sanitation systems. Kvarnstrom and Petersens (2004),
3 IWA (2014), and Jimenez et al. (2019) do not provide a list of applied design criteria, as they argue that
4 the trade-offs should be determined through discussion with different stakeholders in the sanitation
5 problem.
6

7 **5.2.2. Improved Participation Regarding the Design Scope**

8 Although the final list of design criteria used in this research for determining the design scopes does
9 provide coverage of design scopes used in other planning tools, it is recommended that future
10 facilitators review the initial set of criteria for their relevancy in the decision-making process. It was
11 observed that some design criteria concerned general objectives of sanitation practices, such as
12 '*Community Health*' and '*Safe Product Disposal*'. Consequently, a pairwise comparison between general
13 objectives does not provide tangible information for the design scope, as these objectives are inherent
14 to improving sanitation practices. It is argued that this inherency is shown in the perceived importance
15 of 'community health' and 'safe product disposal' obtained from FAHP. Furthermore, these were
16 mentioned in the FGD of all three neighbourhoods and of the experts as the primary purpose of
17 sanitation, substantiating the claim that these criteria are rooted in the objectives of sanitation planning.
18 Comparing the significant objectives of sanitation to other criteria does not yield valuable insights into
19 design trade-offs, as these objectives have to be satisfied inherently.

20 Moreover, the complexity of sanitation planning led to the inclusion of twenty design criteria
21 spread across two categories, increasing the number of pairwise comparisons decision-makers asked.
22 Conventional AHP uses hierarchical structures to reduce the number of comparisons, comparing the
23 criteria within hierarchical levels and the hierarchical levels themselves to each other. While the
24 hierarchical structure thereby decreases the complexity for decision-makers and hence improves the
25 reliability of judgments, it neglects the dependencies between components belonging to different
26 hierarchies, simplifying the complexity of the problem drastically (Munier and Hontoria, 2021).

27 Therefore, it is proposed to add FGDs with experts and end-users to establish the indicators
28 compared in the FAHP to ensure the inclusion of trade-offs relevant for end-users and thereby provide
29 valuable insights into what is deemed suitable sanitation. It is recommended that these FGDs, as
30 depicted in Figure 57, focus on minimizing the number of criteria to a set that includes relevant criteria
31 aiding in the differentiation of designs. It aligns with the recommendations set by Chambers et al. (2022),
32 who urged sanitation design criteria to be SMART (specific, measurable, achievable, relevant, and time-
33 bound) while being specific for the context. Moreover, concretizing trade-offs relevant for end-users
34 would align the scope of the process with the scope proposed by Loetscher and Keller (2002), as it
35 would focus on assessing criteria aligning the design proposal with the demands and wishes of the
36 community. As a result of this, the use and appropriateness of FAHP in determining the relative
37 importance of criteria as perceived by decision-makers is safeguarded while aligning with the reasoning
38 of Kvarnstrom and Petersens (2004), IWA (2014) and Jimenez et al. (2019) that the requirements of a
39 system should be determined in collaboration with the stakeholders.
40

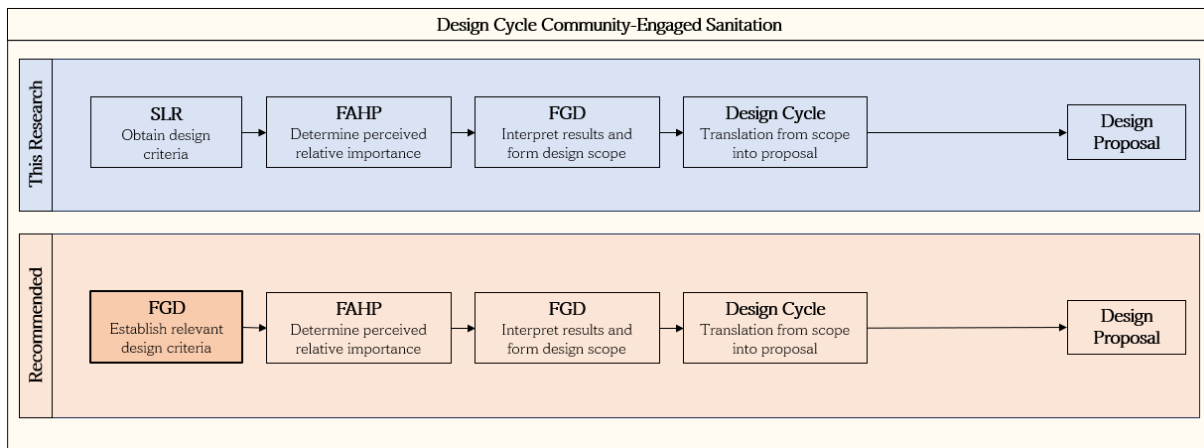

1
2 **Figure 57** | Proposing an additional Focus Group Discussion to engage local stakeholders in determining the trade-offs assessed in the
3 Fuzzy Analytical Hierarchy Process and the Focus Group Discussions, before the Design Cycle leading to the Design Proposal

4 5.3. Deriving the Design Scope

5 Having defined the design criteria deemed relevant for the design of sanitation systems, the FAHP +
6 AHP was applied to understand how local community members and local sanitation experts would
7 shape the design scope of a sanitation system. The FAHP allowed the systematic determination of the
8 relative importance of the design criteria through simple pairwise comparisons, while the FGD offered
9 the opportunity to interpret the FAHP's outcome collaboratively and provide additional context
10 regarding sanitation and sanitation design in the local setting (see Figure 58). The FAHP + FGD was
11 tested as a systematic participatory method to understand the needs and demands of local stakeholders
12 and contribute to defining boundary conditions for sanitation design.

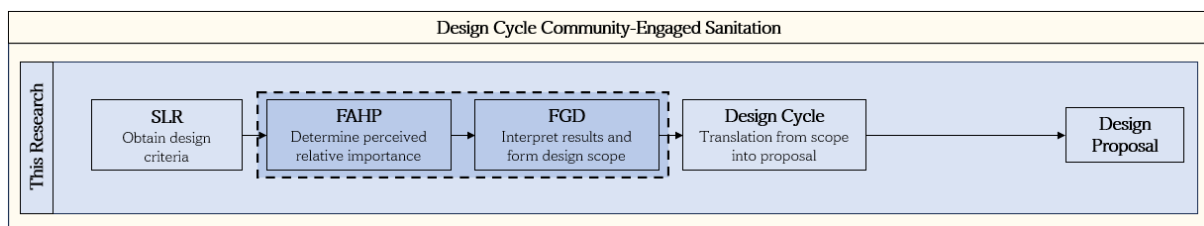

14
15 **Figure 58** | Positioning the Fuzzy Analytical Hierarchy Process and the Focus Group Discussions after the systematic literature review
16 (SLR) in the design process as applied in this research, before the Design Cycle leading to the Design Proposal

17 It was hypothesized that the formation of a design scope through FAHP + FGD solely by local
18 community members would provide a different perception of the relative importance of design criteria
19 as compared to a design scope formed by local sanitation experts because of different interests and
20 experiences regarding sanitation systems between these two groups.

21 In the FAHP and the FGD results, differences were found between the results from the expert
22 group and the end-user group, indicating differing perceptions of the proposed design criteria and
23 sanitation design. The weights calculated from the aggregated judgment matrix show a similar trend for
24 end-users and experts, with both parties perceiving 'Community Health' and 'Safe Product Disposal' as
25 the most critical design criteria, as shown in Figures 59 and 60. Furthermore, the figures show a clear
26 difference in the perceived importance of 'Job Opportunities' and 'Policy Alignment' between experts and
27 end-users. In contrast, both parties perceive 'Capital Expenditure' as relatively unimportant. Significant
28 differences were also observed among the criteria 'Robustness', 'Resilience', and 'Geographical Suitability'.
29

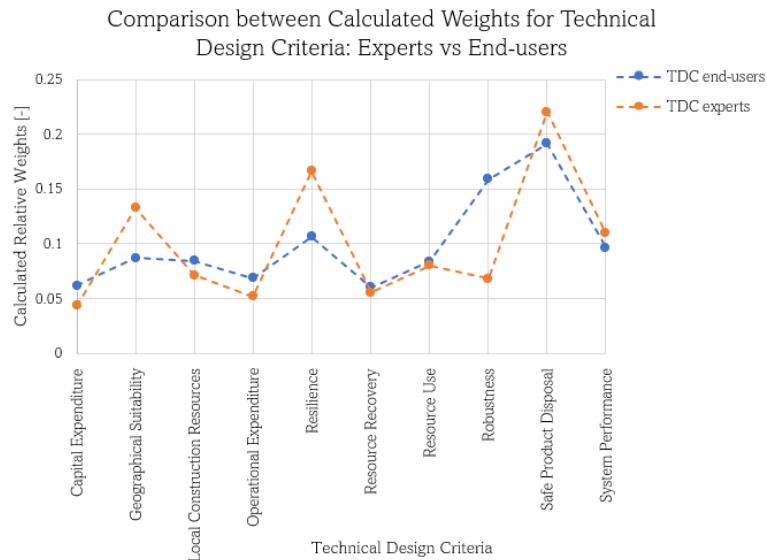

1
2
3
Figure 59 | Comparison between weights calculated from Fuzzy Analytical Hierarchy Process for social design criteria: experts vs end-users

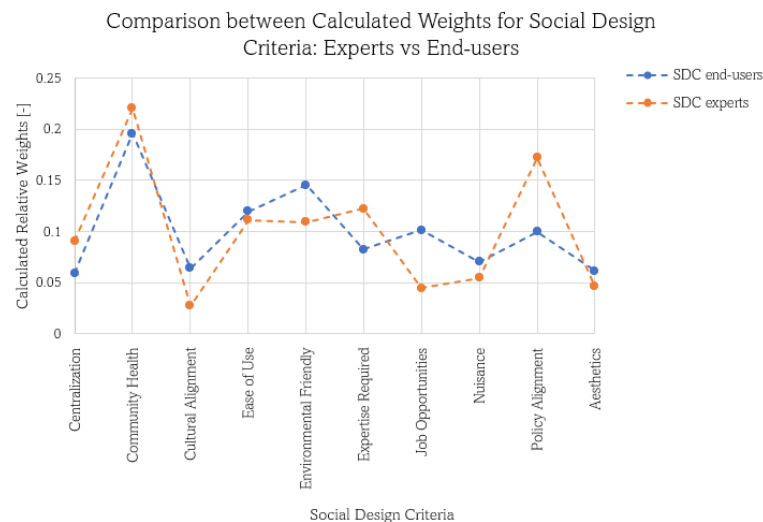

4
5
6
Figure 60 | Comparison between weights calculated from Fuzzy Analytical Hierarchy Process for technical design criteria: experts vs end-users

7
8
9
10
11
12
13
14
15
16
17
18
19
20
21
22
5.3.1. Community Health and Safe Product Disposal

The observed high importance of ‘safe product disposal’ aligns with other preference rankings from the literature. Zheng et al. (2016) explored the preference for sanitation design criteria among ten expert stakeholders in wastewater treatment practices in Switzerland, who appointed ‘*safe wastewater disposal*’ and ‘*protection*’ as the most important objectives when designing wastewater treatment systems. In a study by Vidal et al. (2019), six participants ranked, on average, ‘*risk of pathogen discharge*’ as the most critical indicator for a sustainable sanitation system. Among three groups of stakeholders (scientists/engineers/consultants, policy decision-makers, residents/businesses) studied by Bao et al. (2013), all three groups stated that the main objective of wastewater treatment is the improvement of the local health due to decreased water pollution and a lower risk of microbial infection.

Both end-users and experts show awareness of the benefits of improved sanitation through the high ranking of ‘*Community Health*’ and ‘*Safe Product Disposal*’ but simultaneously show a lack of knowledge on the concept of improved sanitation itself, as the statements are not substantiated by observed practice. The importance assigned to ‘*Community Health*’ and ‘*Safe Product Disposal*’ furthermore agrees with results from interviews and the discussions during the FGD, as both end-users and experts stated the primary purpose of sanitation to be “*promoting health and preventing illnesses*

1 *through reducing the disposal of unmanaged human waste*". Hence, the results of the interviews, the FAHP
 2 rankings, and the FGD appear to indicate awareness among end-users about the benefits of improved
 3 sanitation. However, practice shows that this awareness does not necessarily translate into
 4 implementing improved sanitation. According to the Hagonoy Water District, the only implemented
 5 sanitation system in Hagonoy is the septic tank (Hagonoy Water District, personal communication,
 6 June 8, 2023), which is insufficient to treat domestic wastewater and on its own is incapable of
 7 producing clean water that is harmless to the community and environment (Baltazar et al., 2021). In
 8 one of the neighbourhoods, the representatives had started a new sanitation program that provided
 9 plastic drums to households as an alternative to septic tanks. However, the bottom was removed from
 10 the provided plastic drums, as "*the septage is stored in the drum, before it is absorbed and spread in the soil*",
 11 neglecting the impact of the disposal of untreated septage on the environment and the community's
 12 health. Other interviewees disregarded the effect of septage on the environment: "*We use the river instead
 13 of a septic tank ... [dumping it in the river] has no repercussions [to our health] because the water flows the dirt
 14 away*". These observations align with findings from Dasgupta et al. (2021), who similarly observed
 15 households in India constructing septic tanks that could not treat wastewater but directly disposed of
 16 the untreated effluent into the soil. Based on the observed use of insufficient sanitation systems in China,
 17 Guo et al. (2021) concluded that the respondents lacked knowledge of the decent practice of disposing
 18 of human excreta, as they "*simply tended to follow what they felt was the appropriate way of doing things*".

19 Besides the insufficient treatment capacity of the current sanitation systems in Hagonoy, the
 20 conventional septic systems were also unable to withstand the frequently reoccurring floods in the area
 21 and contributed to the spread of water-borne diseases. This conclusion was drawn based on discussions
 22 with local residents and authorities, who stated that septic tanks would overflow through the toilets
 23 during floods. However, the water level inside a septic tank can only rise if the septic tank is not
 24 watertight (Butler and Payne, 1995), as water is required to enter the tank to make the water level rise.
 25 Consequently, when the flood draws back and the water level inside the septic tank decreases, the
 26 content of the septic tank is flushed out into the environment.

27 As both local sanitation experts and community members valued '*Community Health*' and '*Safe
 28 Product Disposal*' as the most critical design criteria, the proposed designs focused on treating the
 29 wastewater sufficiently. This can be recognized in the designs, as the treatment efficiencies of the
 30 successive treatment steps were assumed conservatively, a 50% peak factor for the concentrations was
 31 included, and each treatment step was designed, including a safety factor of 20%. Nevertheless, the
 32 treatment efficiency of both systems is based on theoretical values and is limited to only the parameters
 33 TP, COD, NH₃, and NO₃²⁻. Hence, before the conceptual design is further developed, let alone
 34 implemented, the treatment systems' efficiency regarding removing other pollutants such as pathogens,
 35 heavy metals, and toxic substances should be assessed and, if necessary, improved (Akpor et al., 2014).
 36 Similarly, the functionality of the system during floods should be thoroughly assessed. The functionality
 37 of the AnB, the ABR, the AFs, and the SSF during floods is dependent on the detailed design, as the
 38 water tightness of these systems depends on the selected pipe connections, junctions, and construction
 39 material for the reactor design.

41 5.3.2. Job Opportunities

42 Among the sixty interviewed end-users, '*Job Opportunities*' was considered an important criterion when
 43 designing sanitation systems, ranked fourth among the ten social design criteria. On the other hand, the
 44 experts ranked '*Job Opportunities*' as relatively unimportant, ranking it second to last. The relative
 45 unimportance of '*Job Opportunities*' as perceived by the experts aligned with the low number of
 46 sanitation-design-related scientific papers referring to '*Job Opportunities*', as only 7 out of the 36 papers
 47 assessed for the literature review into design criteria mentioned phrases such as '*Job Creation*', '*Job
 48 Opportunities*' or '*Creation of Labour*'. Among the twenty assessed sanitation planning tools, none of the
 49 tools explicitly mentioned the inclusion of '*Job Opportunities*' as a design criterion when developing a
 50 sanitation design.

51 Hence, the relative importance assigned by end-users to the creation of job opportunities when
 52 designing sanitation systems was unexpected. An explanation of the desire for job opportunities is

1 unemployment. According to the Philippines Statistics Authority, 4.4% of the available workforce in the
 2 Philippines will be unemployed in 2022 (PSA, 2023a). The unemployment rate appears to be relatively
 3 high when compared to other countries in Southeast Asia, such as Thailand (0.9%), Indonesia (3.5%),
 4 and Vietnam (1.5%) (World Bank, 2023), indicating decreased economic stability and welfare when
 5 observed in developing countries (Uddin and Rahman, 2023). Moreover, the PSA concluded that 30.6%
 6 of all fisherfolks in the Philippines belong to a household with a monthly income below the poverty
 7 threshold of 12030 PHP (PSA, 2023b). Hence, as the Hagonoy Water District (2016) observed fishing
 8 as the main occupation in Hagonoy, the local economy might explain the desire for job opportunities.
 9 Out of the 36 local community members willing to share their household monthly income during the
 10 data collection, 19 stated a household income lower than 10957 PHP, hence below the poverty
 11 threshold. Consequently, it is hypothesized that the poverty among participating local community
 12 members has caused '*Job Opportunities*' to be perceived as a relatively important design criterion among
 13 this group, compared to the local sanitation experts who are all employed by a government institution
 14 and hence have a higher income.

15 Although the local community members had stated '*Job Opportunities*' to be an essential design
 16 criterion, this was not translated into the design of the sanitation systems because the applicability of
 17 this design criterion is merely restricted to the management structure of the design instead of the system
 18 design itself. While this research is limited to the development of a conceptual design, the high ranking
 19 of this design criterion does come into play when the design is further developed, and the
 20 implementation and operation phases are approached.

21

22 5.3.3. Operational Expenditure and Capital Expenditure

23 Both '*Capital Expenditure*' and '*Operational Expenditure*' were perceived as relatively unimportant by end-
 24 users and experts through the FAHP. In contrast, during interviews with end-users, experts, and the
 25 mayor of Hagonoy, the system's costs were repeatedly emphasised as the main barrier to improved
 26 sanitation. During an interview with the foreman of one neighbourhood, he stated that households'
 27 financial capacity was the main restriction of adopting sanitation systems. This was substantiated by
 28 the leading health officer in the municipality, who stated that the primary obstruction to implementing
 29 the design proposed in the sanitation policy was the financial limitations of the households. Moreover,
 30 capital expenditure was the most mentioned design criterion across the 36 scientific papers obtained
 31 through the literature review, cited 26 times as influential to the design of sanitation systems.

32 However, when capital expenditure was proposed in a pairwise comparison to end-users, the
 33 criterion was deemed the least important on average. This aligns with the observations of Zheng et al.
 34 (2016) of 10 sanitation experts in Switzerland. On the other hand, Boukhari et al. (2018) concluded that
 35 the economic criteria were deemed the most prioritized when assessing the sustainability of sanitation
 36 services. Nevertheless, a discrepancy is observed between the interviewees' statements and the FAHP
 37 results. One interviewee stated that poverty was the main restriction from practising improved
 38 sanitation. However, the data from the FAHP show that in the interviewees' pairwise comparisons,
 39 '*Capital Expenditure*' was deemed less important in all proposed comparisons and was ranked least
 40 important overall. A possible explanation for this difference is found in the hypothetical nature of the
 41 method, as was observed in the research of Vasquez and Alicea-Planas (2018) into the willingness-to-
 42 pay of informal settlers in Nicaragua.

43 Both experts and end-users have ranked '*Operational Expenditure*' higher than '*Capital*
 44 *Expenditure*', which aligns with the findings from Mitra et al. (2022). From their findings, they conclude
 45 that the user is the one to pay for maintenance and, hence, is more concerned with operational
 46 expenses. In contrast, the investment is only once and can often be partially subsidized (Mitra et al.,
 47 2022).

48 While the projected construction costs of the designed sanitation systems were not worked out,
 49 sharing the sanitation system among multiple households, as proposed by local community members,
 50 would increase the available funding per sanitation system. Parallel to this increase in available funding,
 51 however, the increased size would also cause costs for materials, land area, and labour to increase.
 52 Furthermore, it is essential to note that the budgets for sanitation systems, as stated during the FGDs,

1 were based on the reference case of a single septic tank serving one household. In contrast, the
 2 proposed sanitation systems consist of 5 different treatment steps. It is, therefore, essential that the
 3 proposed conceptual designs are discussed with local contractors in order to assess the financial
 4 feasibility of the designs. Due to time constraints, it was impossible to include this iteration within the
 5 scope of this research.
 6

7 **5.3.4. Policy Alignment**

8 The experts have valued '*Policy Alignment*' and '*Expertise Required*' as very important, which might be
 9 explained by their function within the governmental system. The interviewed experts were employed
 10 by the municipality or the water district, which is responsible for the implementation and compliance
 11 of the local policy on sanitation. Two of the experts fulfilled the role of sanitary experts, describing their
 12 role as "*advising on the type of toilet systems, based on guidelines provided by engineering office, who base it*
 13 *on the guidelines*".

14 During interviews with end-users, on the other hand, a lack of trust in the ability of the
 15 municipality to improve sanitation in their neighbourhood, in combination with a lack of discipline, was
 16 observed, explaining the relatively low ranking of '*Policy Alignment*' among end-users. Multiple
 17 interviewees specifically mentioned the lack of care from the local government for their neighbourhood,
 18 stating that their local government is not prioritizing sanitation in their barangay. Moreover, during the
 19 FGDs, the community representatives included the neighbourhood office in every phase of
 20 implementing sanitation systems (Plan/Design, Construction, Maintenance, and Cleaning), replacing
 21 the municipality in some phases by assigning themselves municipal tasks such as developing initial
 22 construction plans and checking the permits. While discussing threats to sanitation in one of the
 23 neighbourhood discussions, it was stated that parts of the community lacked discipline, which aligned
 24 with observations from Cagurungas et al. when assessing sanitation in Hagonoy in 2021 (Cagurungas
 25 et al., 2021). During a neighbourhood session, it was mentioned that "*we [the barangay representatives]*
 26 *have attempted to persuade people to construct it [the septic tank] in a proper way, but we simply get "yes" as*
 27 *an answer, rather than any action*". A smaller part of this non-abidance was ascribed to the lack of
 28 repercussions, as one interviewee pointed out that "*the people do not construct their houses according to*
 29 *the policy on sanitation, as there are no consequences to not abiding*". Another interviewee stated that '*we*
 30 *prioritize convenience, so we do not care about policy guidelines installed by the government*'.

31 As the currently in place design guidelines only prescribe the design of septic tanks, which are
 32 unable to treat the wastewater to a level that complies with the General Effluent Standards, the
 33 proposed conceptual designs do not contain a septic tank and hence do not align with the currently in
 34 place design policy. While the design does not align with local policies, the participatory design process
 35 does, as the Filipino government mandated participatory planning of sanitation systems with local
 36 community members in 2019 (Adm Order No. 2019-0054, 2019).
 37

38 **5.3.5. Robustness and Resilience**

39 The relative importance assigned to the criteria '*Robustness*' and '*Resilience*' by both local experts and
 40 end-users is explained by the vulnerability of the system currently experienced, showing the desire for
 41 a more sustainable sanitation system. The high ranking of reliable system performance was also
 42 recognized by Boukhari et al. (2018), as 12 experts in the Algerian water sector deemed the reliability
 43 of sanitation systems to be a crucial factor in the sustainability of a sanitation system. Moreover, the
 44 review of Chambers et al. (2022) shows a similar opinion on resilience regarding sanitation systems in
 45 scientific literature.

46 The desire for '*robust*' and '*resilient*' sanitation systems among end-users and experts can be
 47 explained by the natural hazards experienced in Hagonoy, as the repeated occurrence of floods is
 48 related to increased flood resilience (Kuang and Liao, 2020). During the FGDs with end-users and
 49 experts, the desire to withstand the constant threat of flooding was repeatedly emphasized. Regarding
 50 sanitation, the primary desires were to prevent the spread of contaminated wastewater caused by floods
 51 and to make sanitation systems available during floods. The latter was substantiated throughout the

1 individual interviews with end-users, as multiple interviewees stated that their toilets would overflow
2 during floods.

3 The perceived importance of both '*Robustness*' and '*Resilience*' by local community members
4 and sanitation experts was translated into low-maintenance sanitation systems that require little human
5 interference to operate. The selected treatment technologies are gravity-based and do not contain
6 mechanical parts. Furthermore, except for the HSFF, the selected treatment technologies are
7 constructed in a closed reactor that can be made watertight. However, it should be noted that the
8 included filter systems risk clogging, while the waterhead (and therefore the possible inclusion of pumps)
9 was also not considered. As a result, the proposed conceptual designs should be developed further and
10 assessed for their effectiveness and feasibility in practice.

11 12 **5.3.6. Resource Recovery Potential**

13 The perception regarding resource recovery from human waste expressed during FGDs with
14 neighbourhoods and experts was that while biogas obtained from wastewater treatment was
15 appreciated, reusing (treated) human excreta for agriculture was not desired. In a study into 414 Chinese
16 villagers' perception of resource recovery from sanitation, Guo et al. (2021) mentioned observing
17 willingness to use such resources among 70% of the interviewees. The low ranking of '*Resource Recovery*
18 *Potential*' by end-users does not align with findings from Bao et al. (2013), as residents interviewed in
19 Vietnam perceived potential nutrient and water recovery as the second most important objective after
20 improving local health.

21 The reluctance of experts and end-users is mainly ascribed to the participants' unfamiliarity
22 with recovering resources from human waste. During one of the FGDs, one participant argued that a
23 piggery in the neighbourhood used the excreta of the pigs as a soil conditioner. Based on her
24 observation and experience, she attempted to convince the others of the safety of recovered resources.
25 From assessing the implementation of resource recovery in Indonesia, Marleni and Raspati (2020)
26 concluded that the primal association between human waste and health hazards negatively influences
27 the social acceptance of resources recovered from human waste. While the FGDs with both end-users
28 and experts showed similar perceptions regarding resource recovery, the experts ranked 'resource
29 recovery potential' significantly higher among technical design criteria when compared to end-users
30 (5th against 10th, out of ten). This might be explained by the awareness of experts regarding the
31 production of biogas, which was stated to be desirable, and the unawareness of experts regarding the
32 recovery of nutrients from wastewater. The difference in awareness was detected as the production of
33 biogas was a familiar phenomenon, as "*we [the sanitary inspectors] learned that air vents are required in*
34 *septic tanks, to prevent the septic tank from exploding on hot days [because of the biogas]*". However, The
35 recovery of nutrients was deemed unfamiliar, as the concept required extensive explanation regarding
36 the technology and the possible application.

37 Because of the high ranking of '*Resource Recovery Potential*' among the FAHP results from local
38 sanitation experts, an AnB was picked as the primary treatment step. Although other treatment
39 technologies present in the treatment designs are also able to recover resources such as biogas (AF,
40 ABR), the AnB focuses explicitly on the recovery of biogas and is hence picked to translate the stated
41 preference into the design proposal.

42 43 **5.3.7. Interpretation of the Design Scopes**

44 The FAHP + FGD method allowed the local community members to set the scope of the design of the
45 sanitation system by expressing their demands and needs. Based on the relative importance of the
46 design criteria as derived from the FAHP and the additional input from the FGD, the design scope
47 focused on a more centralized system aiming to serve 4-5 households. The preferred location was near
48 the fish pond, which was included as the polishing step in the treatment system. The system was
49 required to be low maintenance based on the high ranking of '*Robustness*' and '*Ease of Use*', causing the
50 system to consist of gravity-based treatment technologies. The system was desired to contribute to the
51 economy, as '*Job Opportunities*' were ranked fourth among the social design criteria. Although this

1 criterion is mainly influential to the operation and maintenance of the system, including the fishpond as
 2 a polishing step allows the treatment system to contribute to the local economy, as the fishpond is
 3 provided with nutrients by the wastewater.

4 The results obtained from the local community members were compared to the FAHP + FGD
 5 results from the local sanitation experts. Based on the relative importance of ‘*Expertise Required*’
 6 obtained from the FAHP and the additional information on ownership from the FGD, the design scope
 7 set by the experts allows a more complex system regarding maintenance and construction.
 8 Consequently, the SSF was added. Furthermore, ‘*Resource Recovery Potential*’ was ranked relatively high
 9 when compared to the end-user ranking, leading to the implementation of an AnB. The design was
 10 limited to serving one household, as they perceived ‘*Centralization*’ as an important design factor and
 11 mentioned during the FGD that individual treatment systems were preferred. The high ranking of
 12 ‘*Centralization*’ and ‘*Geographical Suitability*’ was elaborated upon by underlining the strong preference
 13 for placing the system near the riverside.

14 Altogether, the FAHP + FGD method allowed both local community members and local
 15 sanitation experts to express their demands and needs regarding the design of sanitation systems. While
 16 the preferences of the local community members and the local sanitation experts were leading in their
 17 respective design cycles, the translation from the expressed relative importance and the interpretation
 18 of the FGD results were still led by the facilitator; hence, it is concluded that the participatory level
 19 achieved during this stage is ‘collaborating’ with the stakeholders. The delimiting factor to participation
 20 in this stage, however, is not necessarily ascribed to the methods deployed in this stage but appears to
 21 be originating from the selectors’ bias present in the input of the FAHP (hence the selection of the
 22 design criteria) and the interpretation of the output (hence the development of the design itself).
 23 Consequently, the FAHP + FGD method is deemed a systematic method that engages local community
 24 members in determining the design boundary conditions. Hence, it is recommended to future sanitation
 25 design facilitators (see Figure 61). When setting up the method, considerations regarding the exercises’
 26 elaborateness, the participants’ sample representativeness, and the outcome and interpretation of the
 27 results must be considered.
 28

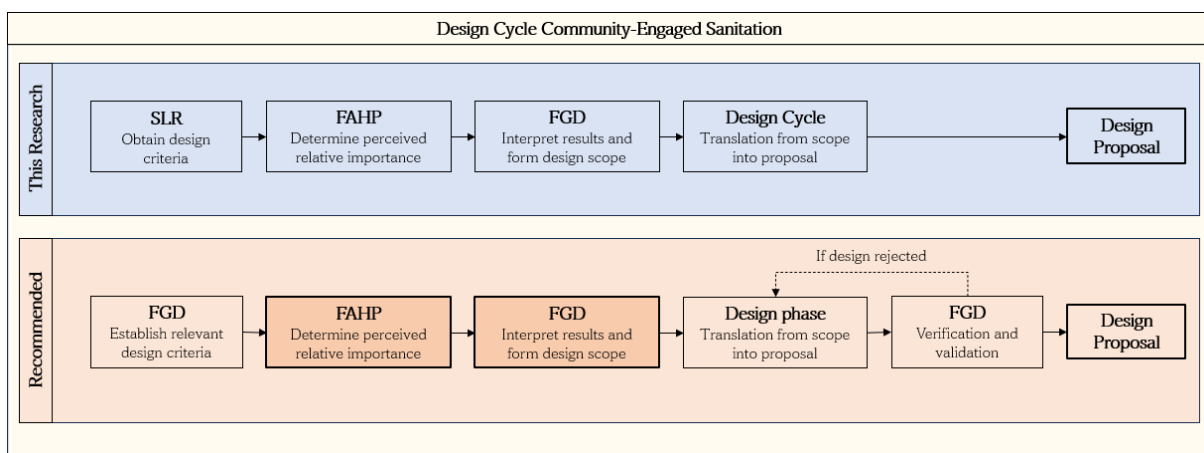

29
 30 **Figure 61** | Proposing the Fuzzy Analytical Hierarchy Process in combination with Focus Group Discussions to engage local
 31 stakeholders in defining the design scope using the input regarding relevant design criteria from a Focus Group discussion, before the
 32 Design Cycle leading to the Design Proposal

33 5.4. Tailoring Sanitation Design to the Preferences of Stakeholders

34 The designs for the sanitation systems were determined based on the design scopes derived from the
 35 FAHP + FGDs with local community members and local sanitation experts. The FAHP + FGD method
 36 obtains information on the relative importance of design criteria as perceived by participants and
 37 contextual information on the interpretation of the design criteria, showing its ability to provide tangible
 38 input for the design of sanitation systems. It was hypothesized beforehand that the FAHP + FGD
 39 method thereby allows the community to engage in the definition of the scope, hence directly
 40 influencing the eventual sanitation design (see Figure 62). This ability is explored by dissecting the two

1 design proposals, as depicted in Figure 47 and Figure 48 and comparing them to each other, to the
 2 FAHP results and the FGD results.

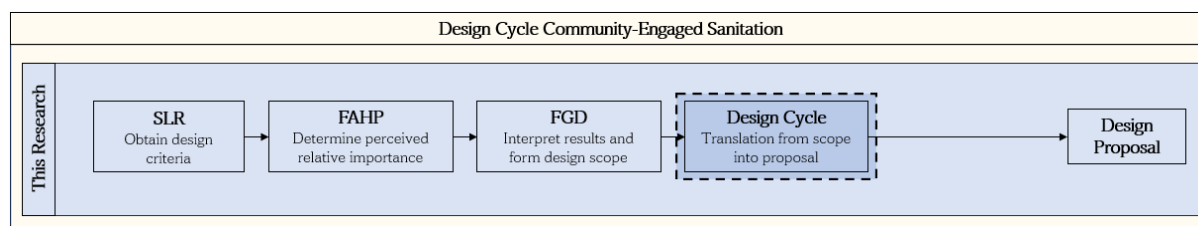

4
 5 **Figure 62** | Positioning the development of the conceptual designs after the systematic literature review (SLR), the Fuzzy Analytical
 6 Hierarchy Process (FAHP) and the Focus Group Discussions (FGD), before the Design Cycle leads to the Design Proposal

7 5.4.1. Comparing the Designs of Local Community Members and Sanitation Experts

8 The blackwater influent in both design proposals was assumed to originate from a manually flushed
 9 sitting toilet, substantiated by the preferences stated during the FGDs by experts and end-users. The
 10 decision to separate blackwater and greywater was a design choice made to reduce the sizing of the
 11 anaerobic section of the treatment system (ABR / AnB + AF) due to reduced influent volume and
 12 oxygenation of the blackwater after this anaerobic treatment through a merger with the greywater
 13 (Tolksdorf and Cornel, 2017).

14 In both design cycles, non-mechanized treatment systems were picked as most suitable, as
 15 'Robustness' and 'Resilience' were interpreted as essential design criteria. Moreover, the established lack
 16 of knowledge regarding wastewater treatment technologies among local experts and end-users, in
 17 combination with the high ranking of 'Ease of Use', led to the selection of low-maintenance systems. The
 18 preference for such systems observed through the FAHP results aligns with Vidal et al. (2019), who
 19 observed a high social acceptance for sanitation systems with low complexity and high convenience.
 20 Furthermore, Vidal et al. (2019) deemed the robustness of correctly designed filter systems high, as the
 21 foremost risk is clogging of the filter material (Rolland et al., 2009). This advantage of filter systems has
 22 led to the selection of an AF and a HSFF for the end-users. In contrast, the same treatment systems are
 23 complemented by a SSF for the design based on expert input.

24 During the FGDs, the experts appointed the riverside as the favoured location for a sanitation
 25 system, while end-users appointed the fishpond as favourable. In both design proposals, this preference
 26 is considered, as seen in Figures 47 and 48. In the end-user-based proposal, the fishpond also functions
 27 as a polishing step for the wastewater, with fish feeding on the nutrients present in the wastewater
 28 (Kumar et al., 2014). Fish species currently farmed in Hagonoy, such as tilapia and milkfish, are known
 29 to be most suitable due to their little demand for oxygen (Ghosh et al., 1980). While sewage-fed
 30 aquaculture is a reliable and responsible treatment system (Mandal et al., 2018), the local sanitation
 31 experts expect the unwillingness of fishpond owners to cooperate, so they prefer a sanitation system
 32 discharging to the river.

33 The experts' experience with failed centralized sanitation systems expressed during the FGD
 34 caused this sanitation system to be designed for one household (5-person equivalents). At the same
 35 time, the community members substantiated their desire for a system shared among 4-5 households
 36 (20-person equivalents) by mentioning increased land use efficiency. The choice for decentralized
 37 sanitation systems furthermore aligns with findings from Seymour et al. (2021), as evidence was found
 38 that the placement of sanitation near their house motivated adoption.

39 Whereas the expert-based design contains an AnB as the first treatment step, the end-user-
 40 based design contains an ABR. This difference refers back to the high relative importance of 'resource
 41 recovery potential' by the experts, as the AnB is designed for the production of biogas from sewage
 42 (Wang, 2014). As this criterion was deemed less critical by end-users, the proposed treatment system
 43 was not designed with a focus on resource recovery.

44 The by-passed greywater in both systems is mixed with the effluent of the anaerobic stages
 45 before it enters the tertiary treatment step. Within the LSE system, this tertiary treatment step consists
 46 of a SSF before entering a HSFF. In contrast, the LCM system includes a HSFF as the tertiary treatment

1 step and includes a fishpond as the polishing step. The SSF in the LSE system provides an additional
 2 barrier against bacteria through filtration and the adsorption of bacteria to a biofilm layer (Clark et al.,
 3 2012), aligning with the high importance of ‘*Safe Product Disposal*’, ‘*Resilience*’, and ‘*System Performance*’
 4 as expressed by the local sanitation experts throughout the FAHP + FGD exercise.
 5

6 **5.4.2. Comparing the Participatory Developed Designs to Existing Designs**

7 The comparison between the designs in this research and the conventional septic tank designs show
 8 an increased complexity of the system and improvements in treatment efficiency. The treatment
 9 efficiency of the septic tanks was determined through the design guidelines proposed by the Filipino
 10 government, but it is insufficient to treat the wastewater sufficiently and make the effluent comply with
 11 the General Effluent Standards of the same Filipino government. Only the GES in place for Nitrate was
 12 achieved among the assessed pollutants of interest. However, this cannot be ascribed to the treatment
 13 efficiency of the septic tank, as the concentration prescribed by the GES was already satisfied in the
 14 influent of the system. Regarding the other parameters, the concentrations of TP, COD, and NH₃ in the
 15 effluent are a factor 6, 8, and 14 higher than the GES, respectively. Moreover, this assessment did not
 16 consider the minimal treatment capacity of septic tanks regarding pathogens, viruses, and toxic
 17 substances (Wang et al., 2021). As a result, even the wastewater deemed ‘treated’ by septic tanks cannot
 18 be considered as safe for the community or the environment (Jasper et al., 2013).

19 Besides the treatment efficiency, the layout of the treatment process containing only the septic
 20 tank was compared to the layout of the LSE and the LCM design. The septic tank is considered a
 21 primary treatment technology; hence, it is directly compared to the AnB in the LSE system and the
 22 ABR in the LCM system. The size of the septic tank (3.15 m³ for five persons) is comparable to the size
 23 of the ABR (3.02 m³ for five persons), while the AnB requires a much bigger volume (10.33 m³ for five
 24 persons) to ensure sufficient retention time for digestion of the organic matter. For an equal comparison,
 25 the number of served people was assumed to be equal between the treatment systems. The ABR had
 26 a much higher treatment efficiency regarding COD ($\approx 90\%$) compared to the septic tank ($\approx 33\%$) and
 27 the AnB ($\approx 40\%$).

28 Comparing the septic tank design derived from the local guidelines to the general effluent
 29 standards and the designs obtained from the open-ended design process proposed through this research
 30 shows that the septic tank comes short in treatment efficiency. Moreover, the frequent floods, combined
 31 with the ground subsidence occurring in the area, compromise the sustainability of concrete septic
 32 tanks. Therefore, the current baseline provided by the design guidelines for both the technology
 33 selection and the design process appears insufficient. The problematic quality of the in-place design
 34 guidelines has been exposed by comparing the proposed sanitation designs and the existing guidelines.
 35 This emphasizes the need for a design approach that meets the local demand for improved sanitation
 36 and ensures the inclusion of wastewater treatment technologies that can withstand environmental
 37 challenges and satisfy local effluent standards.
 38

39 **5.4.3. From Conceptual Design to Practice**

40 Although the developed conceptual designs theoretically satisfy the local effluent standards for the
 41 specified parameters, the treatment efficiencies of the systems were based on assumptions and were
 42 not determined for all possible pollutants. Additional assumptions were made regarding the volume and
 43 pollutant concentrations of the influent, as no local data was available. While the assumptions regarding
 44 both the influent and the treatment technologies were substantiated by scientific literature, both factors
 45 can differ depending on the geographical location and the experimental context (Friedler et al., 2013).
 46 Because of the variance in the empirical data for operational and influent parameters, the actual
 47 performance of the conceptual design might deviate from the theoretical expectations. It is therefore
 48 recommended to further assess the treatment efficiency of the proposed conceptual designs, for the
 49 parameters included in this research and for currently disregarded pollutants (pathogens, viruses, heavy
 50 metals, toxic substances). These pollutants were disregarded to simplify the design process, as the
 51 objective of this research was to gain an understanding of the engagement of local stakeholders in the

design process for a sanitation system instead of developing a technical design ready for implementation.

Operational parameters such as headloss, oxygen demand, and pH were disregarded for simplicity. In case the required further theoretical assessment shows that the required treatment efficiency is not achieved for one of these pollutants or that the operational parameters cannot be safeguarded, it is recommended to redo the design phase and improve the treatment system. Once the sanitation system is (theoretically) able to treat the wastewater sufficiently, it is strongly recommended to verify and optimize the removal efficiency and the operating conditions in practice by carrying out a pilot project (Waqas et al., 2023).

Similarly, aligning the proposed treatment systems with the demands and needs expressed by the local sanitation experts and community members through the FAHP + FGD is hypothetical, as the alignment was not verified with the local stakeholders. Instead, the translation from the design scopes into the developed treatment systems is subjected to the facilitator's interpretation and selectors' bias. As a result, the participation level of local stakeholders in the 'idea generation' and 'development of the design' phases, as depicted in the design cycle in Figure 2, is limited to informing. The limited level of participation of local stakeholders regarding the selection of treatment technologies and the decision process regarding design choices possibly challenges the full integration of local perspectives, expertise, and contextual insights in the final design. While this shortcoming was deemed unavoidable in the scope of this research due to time constraints, it is strongly recommended that verification mechanisms be implemented in future participatory design cycles. Aligning with the iterative characteristic of the design cycle, it is proposed to add a FGD with local community members and sanitation experts after the conceptual design phase. Because the design of sanitation systems requires a deep understanding of the treatment processes and available treatment technologies in order to safeguard the public and environmental safety, it is recommended that sanitation experts carry out the development of the system designs. Including this FGD afterwards would allow validation of the integration of the demands and needs in the developed design through discussion while not compromising the technical validity of the proposed design. In case it is concluded from the FGD that the design does not align, the design should be revised, as is depicted in Figure 63. Once the developed design complies with the effluent guidelines and aligns with the preferences of the local stakeholders, the design is ready to be piloted.

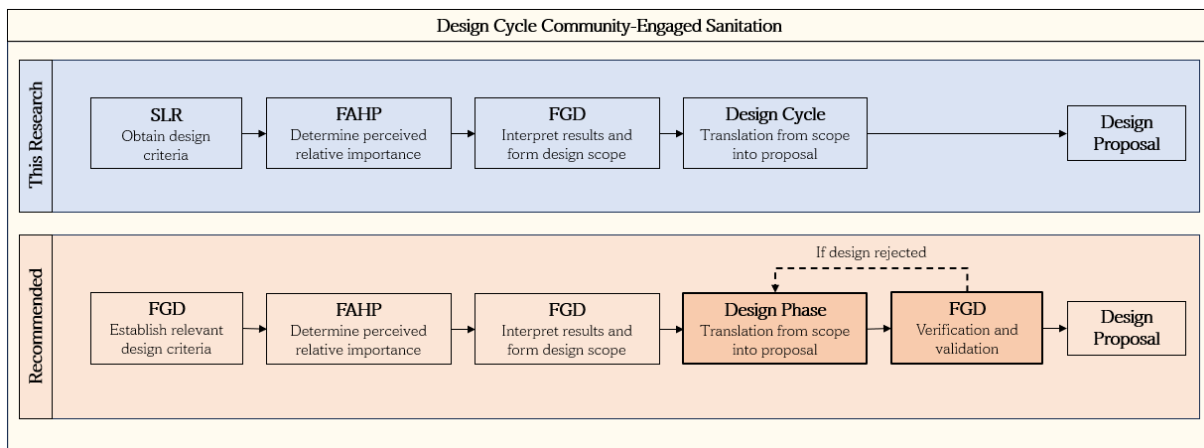

Figure 63 | Proposing an additional Focus Group Discussion after the development of the designs, to verify the alignment of the design with the design scope derived from the Fuzzy Analytical Hierarchy Process in combination with Focus Group Discussions, before the final design is proposed

5.5. Revisiting Participation in the Sanitation Design Cycle

Altogether, the FAHP + FGD provides a systematic and user-friendly method to understand the needs and demands of local stakeholders regarding the design of sanitation systems, but cannot be deemed exhaustive in ensuring alignment between the preferences of local stakeholders and the final sanitation system design. Improvement of the engagement of the local stakeholders is proposed through the additional implementation of the FGD to assess the trade-offs of interest that serve as input for the

1 FAHP and the FGD added after the design phase to validate the alignment of the proposed design and
2 the demands and needs of the local stakeholders.

3 By implementing the FGD with local community members and sanitation experts in the
4 'Problem Comprehension' phase of the design cycle, it is hypothesized that the FAHP will become more
5 tailored to the context and contain trade-offs relevant to the local stakeholders. Consequently, the FAHP
6 becomes less extensive, which improves the user experience of the pairwise comparison exercise.
7 Furthermore, by allowing local stakeholders to determine the FAHP's input, the stakeholders'
8 participation can be improved to 'empowerment', as they are in charge of setting the boundary
9 conditions for the design. To support the stakeholders in determining the input, it is recommended to
10 guide the FGD by providing a directory containing sanitation design criteria, from which design criteria
11 deemed relevant for the context can be selected. Including both local sanitation experts and local
12 community members in the phase is recommended, as this allows the early exploration of tensions and
13 sensitive subjects. Such early confrontations are argued to benefit the negotiation of perspectives and
14 the co-creation of objectives in the later stages of the design cycle (Andersen et al., 2021).

15 To understand the needs and demands and thereby shape the design scope, the use of the
16 FAHP + FGD is recommended. While the participatory level of the FAHP + FGD deployed in this
17 research was deemed limited to 'consultation', implementing the FGD to define the trade-offs is
18 hypothesized to increase the participation level to 'collaborating'. 'Empowering' is not reached, as
19 processing the data itself is still to be executed by a facilitator due to the mathematical complexity.
20 However, the data is collected from the local stakeholders, while the interpretation is made through the
21 FGD. Because the local stakeholders are in charge of determining the input of the process and the
22 interpretation of the output, the participation level is deemed to be increased to 'collaborating'. Again,
23 it is recommended that the FGD be held with both local sanitation experts and community members
24 attending to explore conflicting perspectives and foster consensus building. During this FGD, possible
25 design solutions should be explored to
26 provide concrete input for the
27 development of the design.

28 The development of the design
29 itself should be expert-led to ensure that
30 the system complies with design
31 guidelines and can treat the wastewater
32 safely. The developed design should be
33 discussed with the local community
34 members and the local sanitation experts
35 through additional FGDs to assess
36 whether the developed design aligns with
37 the desires and demands of the local
38 stakeholders. By doing so, the local
39 stakeholders become 'empowered' as the
40 final decision maker regarding the
41 suitability of the developed design.
42

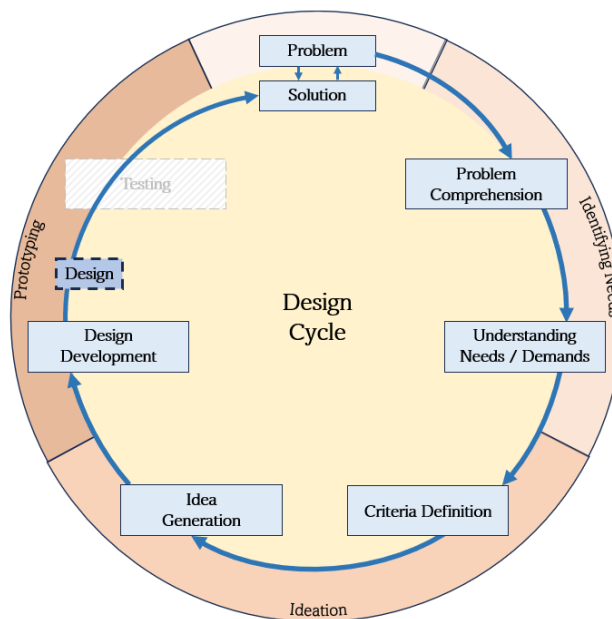

43 **Figure 64** | Design cycle for sanitation design processes, as derived from the findings in this research. The proposed design cycle is an adapted version of the design cycle as proposed by Liedtka (2015) for Design Thinking

6. Conclusion

The lack of access to improved sanitation systems of many people worldwide has sparked an increased need for sanitation planning processes that can address the social, cultural, technical, and financial complexities underlying the hampered implementation of sanitation systems. While the potential benefit of including local sanitation experts and local community members as decision-makers in the planning process has been widely acknowledged, existing planning frameworks fall short in providing total design freedom to local stakeholders and concrete input for sanitation design.

This research aimed to understand how implementing a participatory decision-making process could improve the engagement of local community members and local sanitation experts in a sanitation design process. A combination of the FAHP and FGD was applied to determining the demands and needs deemed relevant by local sanitation experts and local community members in a participatory sanitation design process with the respective groups of stakeholders in Hagonoy, the Philippines. Two conceptual designs of sanitation systems were developed to understand how the engagement of local sanitation experts and community members in an open-ended design process would affect the design itself and how this could contribute to overcoming the limitations of limited decision freedom in conventional sanitation design processes. The mixed method was assessed for its ability to comprise the opinion of local stakeholders on a complex technical subject, its ability to create an understanding of the underlying experiences and beliefs influencing their point of view, and its ability to provide tangible and relevant input for the development of a conceptual design for sanitation system.

- The completion of a sanitation design process without predefining the possible solutions, but by integrating the FAHP + FGD in the systematic derivation of the design scope, demonstrated how a demand- and need-driven design approach allows increased flexibility and sensitivity for the context in the development of a design. The structured engagement of local community members and sanitation experts in the early stage of the design cycle shows a promising method to improve the alignment of the final design with the preferences of the relevant stakeholders.
- The FAHP + FGD method provided a systematic procedure to understand how design criteria in the context of sanitation design are preferred and interpreted differently between local community members and local sanitation experts. Because the FAHP uses pairwise comparisons, complex problems can be simplified to dual choices, which are comprehensible for sanitation experts and regular community members, as no significant difference was observed between the two parties in their ability to provide a consistent judgment. The addition of the FGD allows participants to elaborate on their preferences, proposing a promising method to aid facilitators in interpreting the preferences and translating them into tangible design input. However, it is essential to acknowledge the limitations of the FAHP + FGD methodology, including possible subjectivity in the interpretation of results from FAHP and FGDs, extensive pairwise comparisons increasing the complexity of FAHP, the aggregation of opinions by FAHP, and potential moderator biases in FGDs.
- The proposed conceptual designs demonstrated the ability of the FAHP + FGD method to incorporate the demands and needs of both local community members and local sanitation experts, as their preferences could be recognized in the developed designs. The conceptual designs revealed configurations that can be traced back to the differences in the design scopes defined through the FAHP + FGD by the different local stakeholders. Based on the perceived relative importance stated in the FAHP and local community members' explanation provided in the FGD, the LCM system was semi-centralized and designed to serve four households. At the same time, the LSE system was decentralized and served only one household. Similarly, the local sanitation experts strongly preferred resource recovery through wastewater treatment; hence, the LSE system included an AnB as the primary treatment, compared to an ABR as the primary treatment for the LCM system.

1 In summary, this research contributes to the body of knowledge in community-engaged sanitation
2 design by demonstrating the effectiveness of the FAHP and FGD methods in engaging community
3 members, overcoming selectors' bias for technologies and trade-offs, and producing relevant design
4 proposals. It also emphasizes the importance of a need-driven approach and offers valuable insights for
5 future participatory sanitation planning practices. Nevertheless, it is essential to acknowledge that the
6 FAHP + FGD method did not involve local stakeholders in decision-making throughout the design
7 process, as the method focused on stakeholder engagement in understanding the needs and demands
8 underlying the design scope. Furthermore, the local stakeholders did not verify the alignment of the
9 developed designs with the outcome of the FAHP + FGD method.

11 6.1. Recommendations for Future Research

12 Regarding the proposed sanitation system designs, additional research into the treatment efficiency of
13 the systems is required. Within this research, the treatment assessment was confined to TP, COD, NH₃,
14 and NO₃²⁻. To ensure the system's effluent complies with the local effluent guidelines and does not
15 cause any harm to the community or the environment, the treatment efficiency of other wastewater
16 pollutants should be assessed. Furthermore, the current system was designed using only gravity-based
17 treatment technologies. As a result, the footprint of the designs is big, complicating the system's possible
18 implementation based on limited land area availability in the densely populated town of Hagonoy. It is
19 therefore proposed to optimize the designed treatment systems through iterations of the design
20 development phase, guided by the feedback of local stakeholders.

21 It is recommended for future researchers to delve into the validation of the alignment between
22 successive design planning stages. While the application and possible contribution of the FAHP + FGD
23 method to participatory sanitation planning processes were demonstrated in this research, the
24 developed sanitation designs were not reviewed by the involved local stakeholders. As a result, the
25 actual alignment with their perspectives and, consequently, the hypothesized improved acceptance
26 when implementing the design is speculative. Hence, future research should assess whether the
27 hypothesized alignment caused by the FAHP + FGD improves the acceptance by local stakeholders. It
28 is recommended to include an FGD after the development of the conceptual designs, in which
29 participants of previous phases discuss and provide feedback on the developed designs. Through
30 iteration of the design, alignment between the preferences of the local stakeholders and the design is
31 improved while assigning the role of the final decision-maker to the local stakeholders.

32 Furthermore, it is recommended that future research focuses on dissecting the influence of the
33 aggregating character of participatory design methods and the FAHP in particular. By involving
34 individuals in the design process and asking them for their opinions, expectations regarding the
35 alignment of the design outcome and their individual opinions are raised. However, as the opinion of
36 the mass is not necessarily similar to the opinion of the individual, the misaligned design outcome might
37 cause rejection of the design outcome by the individual, regardless of the previous inclusion of this
38 individual in the process. To overcome this, it is recommended that future research focuses on the
39 drivers of such misaligning opinions and how consensus building might improve the alignment. An
40 expected interesting research direction beholds the demographical background of the participants and
41 expectation management. Within this research direction, the proposed FAHP + FGD method provides
42 a valuable method of obtaining a rough overview of the different opinions, as it provides insights into
43 how people assess the trade-offs between design criteria and how this should be interpreted and
44 translated into the design.

1 Bibliography

2 Abelleira, J., Pérez-Elvira, S. I., Sánchez-Oneto, J., Portela, J. R., & Nebot, E. (2012). Advanced
3 thermal hydrolysis of secondary sewage sludge: a novel process combining thermal hydrolysis and
4 hydrogen peroxide addition. *Resources, Conservation and Recycling*, 59, 52-57.

5 Abenir, M. A. D., Manzanero, L. I. O., & Bollettino, V. (2022). Community-based leadership in
6 disaster resilience: The case of small island community in Hagonoy, Bulacan, Philippines. *International*
7 *Journal of Disaster Risk Reduction*, 71, 102797. <https://doi.org/10.1016/j.ijdr.2022.102797>

8 Acocella, I. (2012). The focus groups in social research: advantages and disadvantages. *Quality*
9 *& Quantity*, 46, 1125-1136.

10 Adm. Order No. 2019-0054. (2019). Guidelines on the Implementation of the Philippine Approach to
11 Sustainable Sanitation (PhATSS). Department of Health (DOH) Republic of the Philippines.

12 Aguarón, J., Escobar, M. T., Moreno-Jiménez, J. M., & Turón, A. (2020). The triads geometric
13 consistency index in AHP-pairwise comparison matrices. *Mathematics*, 8(6), 926.

14 Akpor, O. B., Otohinoyi, D. A., Olaolu, D. T., & Aderiye, B. I. (2014). Pollutants in wastewater
15 effluents: impacts and remediation processes. *International Journal of Environmental Research and*
16 *Earth Science*, 3(3), 050-059.

17 Andersen, P. V. K., & Mosleh, W. S. (2021). Conflicts in co-design: engaging with tangible
18 artefacts in multi-stakeholder collaboration. *CoDesign*, 17(4), 473-492.

19 Anjum, M., Al-Makishah, N. H., & Barakat, M. A. (2016). Wastewater sludge stabilization using pre-
20 treatment methods. *Process Safety and Environmental Protection*, 102, 615-632.

21 Appiah, B., Poudyal, A., Anum, D. A., Appiah, G., Wesuta, A. C., Akodwaa-Boadi, K., Ogado, O.,
22 Nakkazi, E., Mulogo, E. M., & Odai, S. N. (2019). Challenges and facilitators of public engagement with
23 water, sanitation, hygiene and other environmental health issues in Ghana and Uganda: perspectives of
24 scientists, journalists and the public. *Journal of Water, Sanitation and Hygiene for Development*, 10(1),
25 16–26. <https://doi.org/10.2166/washdev.2019.019>

26 Arnstein, S. R. (1969). A ladder of citizen participation. *Journal of the American Institute of*
27 *planners*, 35(4), 216-224.

28 Asadabadi, M. R. (2017). A customer based supplier selection process that combines quality
29 function deployment, the analytic network process and a Markov Chain. *European Journal of*
30 *Operational Research*, 263, 1049–1062. doi:<https://doi.org/10.1016/j.ejor.2017.06.006>

31 Atkinson, L. Z., & Cipriani, A. (2018). How to carry out a literature search for a systematic
32 review: a practical guide. *BJPsych Advances*, 24(2), 74-82.

33 Backor, K., Golde, S., & Nie, N. (2007, October). Estimating survey fatigue in time use study. In
34 international association for time use research conference. Washington, DC.

35 Baltazar, D. E., Harada, H., Fujii, S., Tan, M. F. O., & Akib, S. (2021). A comparative analysis of
36 septage management in five cities in the Philippines. *Eng*, 2(1), 12–26.
37 <https://doi.org/10.3390/eng2010002>

38 Balusa, B. C., & Gorai, A. K. (2019). Sensitivity analysis of fuzzy-analytic hierarchical process
39 (FAHP) decision-making model in selection of underground metal mining method. *Journal of*
40 *sustainable mining*, 18(1), 8-17.

- 1 Banana E., Chitekwe-Biti B. & Walnycki A. 2015 Co-producing inclusive city-wide sanitation
2 strategies: lessons from Chinhoyi, Zimbabwe. *Environment & Urbanization* 27 (1), 35–54.
- 3 Bao, P. N., Aramaki, T., & Hanaki, K. (2013). Assessment of stakeholders' preferences towards
4 sustainable sanitation scenarios. *Water and Environment Journal*, 27(1), 58-70.
- 5 Belay, S., Goedert, J., Woldesenbet, A., & Rokooei, S. (2022). AHP based multi criteria decision
6 analysis of success factors to enhance decision making in infrastructure construction projects. *Cogent*
7 *Engineering*, 9(1), 2043996.
- 8 Berhe, A. A., Desta, A. A., Abreha, A. A., Berhe, A. A., Gebretsadik, A., Negash, D., Gebre-
9 Egziabher, E., Demoz, K. G., Fenta, K. A., & Mamo, N. B. (2020). Knowledge, Attitude, and Practices on
10 Water, Sanitation, and Hygiene among Rural Residents in Tigray Region, Northern Ethiopia. *Journal of*
11 *Environmental and Public Health*, 2020, 1–9. <https://doi.org/10.1155/2020/5460168>
- 12 Bhattacharjee, S., Dersel, G., Shanableh, A., Darwish, N., & Al-Samarai, M. (2020). Challenges
13 & opportunities of wastewater reuse privatization: a case study from Sharjah, UAE. 2020 *Advances in*
14 *Science and Engineering Technology International Conferences*
15 (ASET). <https://doi.org/10.1109/aset48392.2020.9118342>
- 16 Billger, M., Kain, J. H., Niwagaba, C., & McConville, J. (2020). Lessons from co-designing a
17 resource-recovery game for collaborative urban sanitation planning. *IOP Conference Series: Earth and*
18 *Environmental Science*, 588(4), 042041. <https://doi.org/10.1088/1755-1315/588/4/042041>
- 19 Black, K., & McBean, E. A. (2017). Analysis of challenges and opportunities to meaningful
20 Indigenous engagement in sustainable water and wastewater management. *Water Policy*, 19(4), 709–
21 723. <https://doi.org/10.2166/wp.2017.078>
- 22 Blagojevic, B., Athanassiadis, D., Spinelli, R., Raitila, J., & Vos, J. (2020). Determining the relative
23 importance of factors affecting the success of innovations in forest technology using AHP. *Journal of*
24 *Multi-Criteria Decision Analysis*, 27(1-2), 129-140.
- 25 Bottero, M., Comino, E., & Riggio, V. A. (2011). Application of the Analytic Hierarchy Process
26 and the Analytic Network Process for the assessment of different wastewater treatment
27 systems. *Environmental Modelling and Software*, 26(10), 1211–
28 1224. <https://doi.org/10.1016/j.envsoft.2011.04.002>
- 29 Boukhari, S., Djebbar, Y., Amarchi, H., & Sohani, A. (2018). Application of the analytic hierarchy
30 process to sustainability of water supply and sanitation services: the case of Algeria. *Water Science and*
31 *Technology: Water Supply*, 18(4), 1282-1293.
- 32 Brown, T. (2008). Design thinking. *Harvard business review*, 86(6), 84.
- 33 Brunelli, M. (2018). A survey of inconsistency indices for pairwise comparisons. *International*
34 *Journal of General Systems*, 47(8), 751-771.
- 35 Buhl, A., Schmidt-Keilich, M., Muster, V., Blazejewski, S., Schrader, U., Harrach, C., ... &
36 Süßbauer, E. (2019). Design thinking for sustainability: Why and how design thinking can foster
37 sustainability-oriented innovation development. *Journal of cleaner production*, 231, 1248-1257.
- 38 Butler, D., & Payne, J. (1995). Septic tanks: problems and practice. *Building and*
39 *Environment*, 30(3), 419-425.
- 40 Cagurungan, J. M., Factuar, R., Reyes, J. M., Torres, D., Mission, M. P. D., Poso, F. D., ... & Telan,
41 J. A. S. (2021, November). Artificial Neural Network on Solid Waste Generation Based on Five (5)

1 Categories Within Barangay Sagrada Familia in Hagonoy, Bulacan. In 2021 IEEE 13th International
2 Conference on Humanoid, Nanotechnology, Information Technology, Communication and Control,
3 Environment, and Management (HNICEM) (pp. 1-6). IEEE.

4 Calabrese, A., Costa, R., Leviardi, N., & Menichini, T. (2019). Integrating sustainability into
5 strategic decision-making: A fuzzy AHP method for the selection of relevant sustainability
6 issues. *Technological Forecasting and Social Change*, 139, 155-168.

7 Cambridge University Press. (n.d.). *Cambridge Dictionary*. Retrieved April 12, 2023, from
8 <https://dictionary.cambridge.org/dictionary/english/>

9 Cameron, L., Santos, P., Thomas, M., & Albert, J. (2021). Sanitation, financial incentives and
10 health spillovers: A cluster randomised trial. *Journal of Health Economics*, 77,
11 102456. <https://doi.org/10.1016/j.jhealeco.2021.102456>

12 Canco, I., Kruja, D., & Iancu, T. (2021). AHP, A Reliable Method for Quality Decision making: A
13 Case study in business. *Sustainability*, 13(24), 13932. <https://doi.org/10.3390/su132413932>

14 Chai, W. S., Cheun, J. Y., Kumar, P., Mubashir, M., Majeed, Z., Banat, F., Ho, S., & Show, P. L.
15 (2021). A review on conventional and novel materials towards heavy metal adsorption in wastewater
16 treatment application. *Journal of Cleaner Production*, 296, 126589.
17 <https://doi.org/10.1016/j.jclepro.2021.126589>

18 Chambers, K., Sheridan, P., & Cook, S. M. (2022). Sanitation criteria: A comprehensive review
19 of existing sustainability and resilience evaluation criteria for sanitation systems. *Environmental Science*
20 *and Technology Letters*, 9(7), 583–591. <https://doi.org/10.1021/acs.estlett.2c00267>

21 Chu, E. K., & Cannon, C. E. (2021). Equity, inclusion, and justice as criteria for decision-making
22 on climate adaptation in cities. *Current Opinion in Environmental Sustainability*, 51, 85-94.

23 Clark, P. A., Pinedo, C. A., Fadus, M., & Capuzzi, S. (2012). Slow-sand water filter: Design,
24 implementation, accessibility and sustainability in developing countries. *Medical science monitor: international medical journal of experimental and clinical research*, 18(7), RA105.

25

26 Coe, R., Arthur, J., Hedges, L. V., & Waring, M. (2017). Research methods and methodologies in
27 education. *Research Methods and Methodologies in Education*, 1-400.

28 Coffey, D., Gupta, A., Hathi, P., Khurana, N., Spears, D., Srivastav, N., & Vyas, S. (2014). Revealed
29 preference for open defecation. *Economic & Political Weekly*, 49(38), 43.

30 Cole, B., Pinfold, J. V., Ho, G., & Anda, M. (2013). Exploring the methodology of participatory
31 design to create appropriate sanitation technologies in rural Malawi. *Journal of Water Sanitation and*
32 *Hygiene for Development*, 4(1), 51–61. <https://doi.org/10.2166/washdev.2013.166>

33 Contreras, S. (2019). Using Arnstein's ladder as an evaluative framework for the assessment of
34 participatory work in Postdisaster Haiti. *Journal of the American Planning Association*, 85(3), 219-235.

35 Corburn, J., Njoroge, P., Weru, J., & Musya, M. (2022). Urban Climate Justice, Human Health,
36 and Citizen Science in Nairobi's Informal Settlements. *Urban Science*, 6(2),
37 36. <https://doi.org/10.3390/urbansci6020036>

38 Cornwall, A., & Jewkes, R. (1995). What is participatory research? *Social Science and Medicine*,
39 14, 1667–1676.

1 Crawford, G., & Williams, C. (1985). A note on the analysis of subjective judgment
2 matrices. *Journal of mathematical psychology*, 29(4), 387-405.

3 Crini, G., & Lichtfouse, E. (2019). Advantages and disadvantages of techniques used for
4 wastewater treatment. *Environmental Chemistry Letters*, 17, 145-155.

5 Daley, A. M. (2013). Adolescent-friendly remedies for the challenges of focus group
6 research. *Western journal of nursing research*, 35(8), 1043-1059.

7 Danner, M., Venedey, V., Hiligsmann, M., Fauser, S., Gross, C. S., & Stock, S. (2016). How Well
8 Can Analytic Hierarchy Process be Used to Elicit Individual Preferences? Insights from a Survey in
9 Patients Suffering from Age-Related Macular Degeneration. *The Patient: Patient-Centered Outcomes*
10 *Research*, 9(5), 481–492. <https://doi.org/10.1007/s40271-016-0179-7>

11 Darko, A., Chan, A. P., Ameyaw, E. E., Owusu, E. K., Parn, E., & Edwards, D. J. (2018). Review
12 of application of analytic hierarchy process (AHP) in construction. *The International Journal of*
13 *Construction Management*, 19(5), 436–452. <https://doi.org/10.1080/15623599.2018.1452098>

14 Dasgupta, S., Agarwal, N., & Mukherjee, A. (2021). Moving up the On-Site Sanitation ladder in
15 urban India through better systems and standards. *Journal of Environmental Management*, 280,
16 111656.

17 Davis, A., Javernick-Will, A., & Cook, S. M. (2019). The use of qualitative comparative analysis
18 to identify pathways to successful and failed sanitation systems. *Science of the Total Environment*, 663,
19 507–517. <https://doi.org/10.1016/j.scitotenv.2019.01.291>

20 de FSM Russo, R., & Camanho, R. (2015). Criteria in AHP: A systematic review of
21 literature. *Procedia Computer Science*, 55, 1123-1132.

22 De Marinis, P., & Sali, G. (2020). Participatory analytic hierarchy process for resource allocation
23 in agricultural development projects. *Evaluation and Program Planning*, 80, 101793.
24 <https://doi.org/10.1016/j.evalprogplan.2020.101793>

25 Dearden, A., & Rizvi, H. (2008). Participatory design and participatory development: a
26 comparative review.

27 Dell'Era, C., Magistretti, S., Cautela, C., Verganti, R., & Zurlo, F. (2020). Four kinds of design
28 thinking: From ideating to making, engaging, and criticizing. *Creativity and Innovation*
29 *Management*, 29(2), 324-344.

30 DENR Adm. Order No. 2021-19. (2021). Updated water quality guidelines (WQG) and general
31 effluent standards (GES) for selected parameters. Department of Environment and Natural Resources
32 – Government of the Philippines.

33 DENR Adm. Order No.2016-08. (2016). Water Quality Guidelines and General Effluent
34 Standards of 2016. Department of Environment and Natural Resources – Government of the
35 Philippines.

36 Dery, F., Bisung, E., Dickin, S., & Dyer, M. (2019). Understanding empowerment in water,
37 sanitation, and hygiene (WASH): a scoping review. *Journal of Water, Sanitation and Hygiene for*
38 *Development*, 10(1), 5–15. <https://doi.org/10.2166/washdev.2019.077>

39 Dery, F., Bisung, E., Dickin, S., & Dyer, M. (2020). Understanding empowerment in water,
40 sanitation, and hygiene (WASH): a scoping review. *Journal of Water, Sanitation and Hygiene for*
41 *Development*, 10(1), 5-15.

1 Diep, L., Martins, F. P., Campos, L. C., Hofmann, P., Tomei, J., Lakhanpaul, M., & Parikh, P.
2 (2020). Linkages between sanitation and the sustainable development goals: A case study of
3 Brazil. *Sustainable Development*, 29(2), 339–352. <https://doi.org/10.1002/sd.2149>

4 Disterheft, A., Caeiro, S., Ramos, M. D. R., & Azeiteiro, U. M. (2012). Environmental Management
5 Systems (EMS) implementation processes and practices in European higher education institutions –
6 Top-down versus participatory approaches. *Journal of Cleaner Production*, 31, 80–
7 90. <https://doi.org/10.1016/j.jclepro.2012.02.034>

8 DOH Adm. Order No.2019-0054. (2019). National Standard on the Design, Construction,
9 Operation and Maintenance of Septic Tank Systems. Department of Health - Republic of the
10 Philippines.

11 Dos Santos, S., Adams, E. A., Neville, G., Wada, Y., De Sherbinin, A., Bernhardt, E. M., & Adamo,
12 S. B. (2017). Urban growth and water access in sub-Saharan Africa: Progress, challenges, and emerging
13 research directions. *Science of the Total Environment*, 607, 497-508.

14 Drain, A., Shekar, A., & Grigg, N. P. (2018). Insights, Solutions and Empowerment: a framework for
15 evaluating participatory design. *CoDesign*, 17(1), 1–21.
16 <https://doi.org/10.1080/15710882.2018.1540641>

17 Dreibelbis, R., Winch, P. J., Leontsini, E., Hulland, K. R., Ram, P. K., Unicomb, L., & Luby, S. P.
18 (2013). The integrated behavioural model for water, sanitation, and hygiene: a systematic review of
19 behavioural models and a framework for designing and evaluating behaviour change interventions in
20 infrastructure-restricted settings. *BMC public health*, 13(1), 1-13.

21 Duarte, A. M. B., Brendel, N., Degbelo, A., & Kray, C. (2018). Participatory Design and
22 Participatory Research. *ACM Transactions on Computer-Human Interaction*, 25(1), 1–39.
23 <https://doi.org/10.1145/3145472>

24 Ebaegu, M., & Stephens, M. (2014). Cultural challenges in adapting lesson study to a
25 Philippines setting. *Mathematics Teacher Education and Development*, 16(1), n1.

26 Elvas, L. H., & Sy, J. (2008). Philippines - Sanitation sourcebook and decision aid
27 (English). Water and sanitation program. Washington, D.C. : World Bank Group. Retrieved
28 from: [http://documents.worldbank.org/curated/en/791641468146718337/Philippines-Sanitation-](http://documents.worldbank.org/curated/en/791641468146718337/Philippines-Sanitation-sourcebook-and-decision-aid)
29 [sourcebook-and-decision-aid](http://documents.worldbank.org/curated/en/791641468146718337/Philippines-Sanitation-sourcebook-and-decision-aid)

30 Englande Jr, A. J., Krenkel, P., & Shamas, J. (2015). Wastewater treatment & water
31 reclamation. Reference module in earth systems and environmental sciences.

32 Filho, F. J. C. M., De Queiroz, A. a. F. S. L., Machado, B. S., & Paulo, P. L. (2019). Sustainable
33 sanitation management tool for decision making in isolated areas in Brazil. *International Journal of*
34 *Environmental Research and Public Health*, 16(7), 1118. <https://doi.org/10.3390/ijerph16071118>

35 Finney, Brad A., Robert Gearheart, Andrew Salverson, George Zhou, Mary Burke, and Jong
36 Chan Ly. 2009. WAWTTAR, A planning tool for selecting wastewater treatment technologies. *Water,*
37 *Environment, and Technology*, Water Environment Federation, Vol. 21, No. 10, pp. 51-54

38 Follosco-Aspiras, K., & Santiago, A. D. R. (2016). Assessing the Effectiveness of the
39 Decentralisation Policy on Disaster Risk Reduction and Management: The Case of Hagonoy, Bulacan,
40 Philippines. *Springer Geography*, 131–153. https://doi.org/10.1007/978-3-319-29367-7_8

1 Franceys, R., Shaw, R., & Davey, K. (2013). Poster 021: A guide to sanitation selection. Water,
2 Engineering and Development Centre (WEDC). Loughborough University, Loughborough UK.

3 Friedler, E., Butler, D., & Alfiya, Y. (2013). Chapter 17: *Wastewater Composition*. Published in Larsen, T.
4 A., Udert, K. M., & Lienert, J. (2013). Source separation and decentralization for wastewater
5 management. In *IWA Publishing eBooks*. <https://doi.org/10.2166/9781780401072>

6 Gallo, A. (2014). A refresher on net present value. *Harvard Business Review*, 19, 1-6.

7 Gaur, A., & Kumar, M. (2018). A systematic approach to conducting review studies: An
8 assessment of content analysis in 25 years of IB research. *Journal of World Business*, 53(2), 280-289.

9 Geekiyana, D., Fernando, T., & Keraminiyage, K. (2021). Mapping Participatory Methods in
10 the Urban Development Process: A Systematic Review and Case-Based Evidence Analysis.
11 *Sustainability*, 13(16), 8992. <https://doi.org/10.3390/su13168992>

12 Geerdink, R. B., van den Hurk, R. S., & Epema, O. J. (2017). Chemical oxygen demand: Historical
13 perspectives and future challenges. *Analytica Chimica Acta*, 961, 1-11.

14 Ghosh A., Rao L. H. and Saha S. K. (1980) Culture prospects of *Sarotherodon mossambicus* in
15 small ponds fertilized with domestic sewage. *J Inland Fish Soc India*. 12:79-80.

16 Gómez, J. D., & Nakat, A. C. (2002). Community participation in water and sanitation. *Water*
17 *International*, 27(3), 343–353. <https://doi.org/10.1080/02508060208687014>

18 Gruber, M., De Leon, N., George, G., & Thompson, P. (2015). Managing by design. *Academy of*
19 *management journal*, 58(1), 1-7.

20 Guo, S., Zhou, X., Simha, P., Mercado, L. F. P., Lv, Y., & Li, Z. (2021). Poor awareness and
21 attitudes to sanitation servicing can impede China's Rural Toilet Revolution: Evidence from Western
22 China. *Science of the Total Environment*, 794, 148660.

23 Gusenbauer, M., & Haddaway, N. R. (2020). Which academic search systems are suitable for
24 systematic reviews or meta-analyses? Evaluating retrieval qualities of Google Scholar, PubMed, and 26
25 other resources. *Research synthesis methods*, 11(2), 181-217.

26 Gyarmati, L., Orbán-Mihálykó, É., Mihálykó, C., Szádóczi, Z., & Bozóki, S. (2023). The
27 incomplete analytic hierarchy process and Bradley–Terry model: (In)consistency and information
28 retrieval. *Expert Systems With Applications*, 229,
29 120522. <https://doi.org/10.1016/j.eswa.2023.120522>

30 Hagonoy Water District. (2016). *Water Safety Plan*.

31 Hansen, N. B., Dindler, C., Halskov, K., Iversen, O. S., Bossen, C., Basballe, D. A., & Schouten, B.
32 (2019). How Participatory Design Works. *Proceedings of the 31st Australian Conference on Human-*
33 *Computer-Interaction*. <https://doi.org/10.1145/3369457.3369460>

34 Hansson, S. O. (2006). How to define: a tutorial. *Princípios: Revista de Filosofia (UFRN)*, 13(19-
35 20), 05-30.

36 Harper, J., Bielefeldt, A., Javernick-Will, A., Veasna, T., & Nicoletti, C. (2020). Context and
37 intentions: practical associations for fecal sludge management in rural low-income Cambodia. *Journal*
38 *of Water, Sanitation and Hygiene for Development*, 10(2), 191-201.

1 Hawkins, P. M., Heymans, C., & Blackett, I. C. (2014). The missing link in sanitation service
2 delivery : a review of fecal sludge management in 12 cities. Water and Sanitation Program: Research
3 Brief, 1–8. <http://dx.doi.org/10.13140/RG.2.1.4072.7205>

4 Hays, D. G., & McKibben, W. B. (2021). Promoting rigorous research: Generalizability and
5 qualitative research. *Journal of Counseling & Development*, 99(2), 178-188.

6 Ho, W. (2008). Integrated analytic hierarchy process and its applications—A literature
7 review. *European Journal of operational research*, 186(1), 211-228.

8 Ho, W., & Ma, X. (2018). The state-of-the-art integrations and applications of the analytic
9 hierarchy process. *European Journal of Operational Research*, 267(2), 399-414

10 Hodgett, R. E. (2016). Comparison of multi-criteria decision-making methods for equipment
11 selection. *The International Journal of Advanced Manufacturing Technology*, 85, 1145-1157.

12 Hosseinpourtehrani, M., Gajendran, T., Maund, K., & Sing, M. (2022). Preconditions, processes
13 and structures: Interorganisational collaboration in the provision of post-disaster water, sanitation and
14 hygiene (WASH) services. *International Journal of Disaster Risk Reduction*, 80, 103177.
15 <https://doi.org/10.1016/j.ijdrr.2022.103177>

16 Hutton, G., & Chase, C. (2016). The knowledge base for achieving the sustainable Development
17 goal targets on water supply, sanitation and hygiene. *International Journal of Environmental Research
18 and Public Health*, 13(6), 536. <https://doi.org/10.3390/ijerph13060536>

19 Hyun, C., Burt, Z., Crider, Y., Nelson, K. L., Prasad, C. S., Rayasam, S. D. G., Tarpeh, W. A., &
20 Ray, I. (2019). Sanitation for Low-Income Regions: A Cross-Disciplinary Review. *Annual Review of
21 Environment and Resources*, 44(1), 287–318. [https://doi.org/10.1146/annurev-environ-101718-
22 033327](https://doi.org/10.1146/annurev-environ-101718-033327)

23 Intriago Zambrano C., van Dijk R., Michavila J., Arenas Pinilla E., Diehl C. & Ertsen W. (2020).
24 Co-creation of affordable and clean pumped irrigation for smallholders: lessons from Nepal and Malawi.
25 *Water Supply* 20 (4), 1368–1379.

26 Iossifova, D., Baker, J., Byrom, H., Gao, J., Law, Z. H., Stewart, B., Yang, Y., Dewoolkar, P., Gamal,
27 Y., Nelson, T., Ren, Y., & Sengupta, U. (2022). Architecture, Sanitation and COVID- 19: Design
28 Interventions in Resource-Limited Settings (Accra, Ghana). *Urban Infrastructuring*, 277–295.
29 https://doi.org/10.1007/978-981-16-8352-7_17

30 Irani, L. (2018). “Design Thinking”: Defending Silicon Valley at the Apex of Global Labor
31 Hierarchies. *Catalyst: Feminism, Theory, Technoscience*, 4(1), 1–19.
32 <https://doi.org/10.28968/cft.v4i1.29638>

33 IWA. (2014). Sanitation 21: A Planning Framework for Improving City-wide Sanitation Services.
34 International Water Association

35 Jacinto, G.S., Velasquez, I.B., San Diego-McGlone, M.L., Villanoy, C.L., Siringan, F.B. (2006).
36 Biophysical Environment of Manila Bay — Then and Now. In: Wolanski, E. (eds) *The Environment in
37 Asia Pacific Harbours*. Springer, Dordrecht. https://doi.org/10.1007/1-4020-3655-8_18

38 Jasper, J. T., Nguyen, M. T., Jones, Z. L., Ismail, N. S., Sedlak, D. L., Sharp, J. O., ... & Nelson, K.
39 L. (2013). Unit process wetlands for removal of trace organic contaminants and pathogens from
40 municipal wastewater effluents. *Environmental engineering science*, 30(8), 421-436.

- 1 Jiménez, A., LeDeunff, H., Giné, R., Sjödin, J., Cronk, R., Murad, S., Takane, M., & Bartram, J.
2 (2019). The Enabling Environment for Participation in Water and Sanitation: A Conceptual Framework.
3 *Water*, 11(2), 308. <https://doi.org/10.3390/w11020308>
- 4 Kain, J.-H., McConville, J., & Billger, M. (2021). Serious games in support of transformative
5 multi-stakeholder sanitation planning for increased resource recovery: Specifications for game
6 development. Scientific Report No. ACE 2021:7. Department of Architecture and Civil Engineering,
7 Chalmers University of Technology, Gothenburg, Sweden.
- 8 Kalbermatten, J. M. (1982). *Appropriate Sanitation Alternatives: A Planning and Design Manual*.
9 Johns Hopkins University Press, London. Available from:
10 [http://documents.worldbank.org/curated/en/701511468740361506/Appropriate-sanitation-](http://documents.worldbank.org/curated/en/701511468740361506/Appropriate-sanitation-alternatives-a-planning-and-design-manual)
11 [alternatives-a-planning-and-design-manual](http://documents.worldbank.org/curated/en/701511468740361506/Appropriate-sanitation-alternatives-a-planning-and-design-manual)
- 12 Kannan, D., Khodaverdi, R., Olfat, L., Jafarian, A., & Diabat, A. (2013). Integrated fuzzy multi
13 criteria decision making method and multi-objective programming approach for supplier selection and
14 order allocation in a green supply chain. *Journal of Cleaner production*, 47, 355-367.
- 15 Karthikeyan, R., Venkatesan, K. G. S., & Chandrasekar, A. (2016). A comparison of strengths and
16 weaknesses for analytical hierarchy process. *Journal of Chemical and Pharmaceutical Sciences*, 9(3),
17 12-15.
- 18 Katukiza, A., Ronteltap, M., Oleja, A., Niwagaba, C., Kansiime, F., & Lens, P. N. (2010). Selection
19 of sustainable sanitation technologies for urban slums — A case of Bwaise III in Kampala,
20 Uganda. *Science of the Total Environment*, 409(1), 52–
21 62. <https://doi.org/10.1016/j.scitotenv.2010.09.032>
- 22 Kaya, I., Colak, M., & Terzi, F. (2019). A comprehensive review of fuzzy multi criteria decision
23 making methodologies for energy policy making. *Energy Strategy Reviews*, 24, 207-228.
- 24 Khan, A. U., & Ali, Y. (2020). ANALYTICAL HIERARCHY PROCESS (AHP) AND ANALYTIC
25 NETWORK PROCESS METHODS AND THEIR APPLICATIONS: A TWENTY YEAR REVIEW
26 FROM 2000-2019. *International Journal of the Analytic Hierarchy*
27 *Process*, 12(3). <https://doi.org/10.13033/ijahpv12i3.822>
- 28 Kimbell, L. (2012). Rethinking design thinking: Part II. *Design and Culture*, 4(2), 129-148.
- 29 Klotz, A. C., Swider, B. W., & Kwon, S. H. (2023). Back-translation practices in organizational
30 research: Avoiding loss in translation. *Journal of Applied Psychology*, 108(5), 699.
- 31 Kolko, J. (2015). Design thinking comes of age. *Harvard Business Review*.
- 32 Koul, B., Yadav, D., Singh, S., Kumar, M., & Song, M. (2022). Insights into the domestic
33 wastewater treatment (DWWT) regimes: a review. *Water*, 14(21), 3542.
- 34 Kpamma, Z. E., Adjei-Kumi, T., Ayarkwa, J., & Adinyira, E. (2017). Participatory design, wicked
35 problems, choosing by advantages. *Engineering, Construction and Architectural Management*, 24(2), 289-
36 307.
- 37 Krippendorff, K. (2018). *Content analysis: An introduction to its methodology*. Sage publications.
- 38 Kuang, D., & Liao, K. H. (2020). Learning from Floods: Linking flood experience and flood
39 resilience. *Journal of environmental management*, 271, 111025.

- 1 Kubler, S., Robert, J., Derigent, W., Voisin, A., & Traon, Y. L. (2016). A state-of-the-art survey &
2 testbed of fuzzy AHP (FAHP) applications. *Expert Systems With Applications*, 65, 398–
3 422. <https://doi.org/10.1016/j.eswa.2016.08.064>
- 4 Kułakowski, K., Szybowski, J., Mazurek, J., & Ernst, S. (2023). Towards secure judgments
5 aggregation in AHP. arXiv preprint arXiv:2303.15099.
- 6 Kumar, D., Hiremath, A. M., & Asolekar, S. R. (2014). Integrated management of wastewater
7 through sewage fed aquaculture for resource recovery and reuse of treated effluent: a case
8 study. *Apchee Procedia*, 10, 74-78.
- 9 Kunisch, S., Menz, M., Bartunek, J. M., Cardinal, L. B., & Denyer, D. (2018). Feature Topic
10 at Organizational Research Methods. *Organizational Research Methods*, 21(3), 519–
11 523. <https://doi.org/10.1177/1094428118770750>
- 12 Kvarnstrom, E. & Petersens, E. A. (2004). Open planning of Sanitation systems. *EcoSanRes*
13 Programme. Availabe from:
14 http://www.ecosanres.org/pdf_files/ESR_Publications_2004/ESR3web.pdf
- 15 Kvarnström, E., & McConville, J.R. (2007). Sanitation Planning - A Tool to Achieve Sustainable
16 Sanitation : Water Supply and Sanitation for All. Berching, Germany, Sept 26 - 28, 2007.
- 17 Lagos, D. T., Eco, R. C., Rebadolla, L. J., Farin, F. A. B. (2022) Flooding and Subsidence Resear
18 ch: Bulacan Province, Northern Manila Bay Area, Philippines. *Diamonds in the Delta*, Technical Repo
19 rt.
- 20 Langergraber G. Ketema A. A. Casielles Restoy R. Lechner L. 2015 CLARA Simplified Planning
21 Tool v1.6. User Manual. CLARA M4 – Citavi.
- 22 Laursen, L. N., & Haase, L. M. (2019). The shortcomings of design thinking when compared to
23 designerly thinking. *The Design Journal*, 22(6), 813-832.
- 24 Leoneti, A. B., & Pires, E. C. (2017). Decision sciences in the management of water resources:
25 multi-criteria methods and game theory applied to the field of sanitation. *Journal of Water, Sanitation*
26 *and Hygiene for Development*, 7(2), 229-242.
- 27 Liedtka, J. (2015). Perspective: Linking Design Thinking with Innovation Outcomes through
28 Cognitive Bias Reduction. *Journal of Product Innovation Management*, 32(6), 925–
29 938. <https://doi.org/10.1111/jpim.12163>
- 30 Lienert, J., Duygan, M., & Zheng, J. (2016). Preference stability over time with multiple elicitation
31 methods to support wastewater infrastructure decision-making. *European Journal of Operational*
32 *Research*, 253(3), 746-760.
- 33 Lim, C. Y., & In, J. (2019). Randomization in clinical studies. *Korean journal of anesthesiology*, 72(3),
34 221-232.
- 35 Linnenluecke, M. K., Marrone, M., & Singh, A. K. (2019). Conducting systematic literature
36 reviews and bibliometric analyses. *Australian Journal of Management*, 45(2), 175–
37 194. <https://doi.org/10.1177/0312896219877678>
- 38 Liu, Y., Eckert, C., & Earl, C. (2020). A review of fuzzy AHP methods for decision-making with
39 subjective judgements. *Expert Systems with Applications*, 161,
40 113738. <https://doi.org/10.1016/j.eswa.2020.113738>

- 1 Loetscher, T., & Keller, J. (2002). A decision support system for selecting sanitation systems in
2 developing countries. *Socio-economic Planning Sciences*, 36(4), 267–
3 290. [https://doi.org/10.1016/s0038-0121\(02\)00007-1](https://doi.org/10.1016/s0038-0121(02)00007-1)
- 4 Londe, L. D. R., Coutinho, M. P., Di Gregório, L. T., Santos, L. B. L., & Soriano, É. (2014). Water-
5 related disasters in Brazil: Perspectives and recommendations. *Ambiente e Sociedade*, 17(4), 133–
6 152. <https://doi.org/10.1590/1809-4422ASOC1082V1742014>
- 7 Lydersen, S., Fagerland, M. W., & Laake, P. (2009). Recommended tests for association in 2× 2
8 tables. *Statistics in medicine*, 28(7), 1159-1175
- 9 Lyu, H. M., Sun, W. J., Shen, S. L., & Zhou, A. N. (2020). Risk assessment using a new consulting process
10 in fuzzy AHP. *Journal of Construction Engineering and Management*, 146(3), 04019112.
- 11 Machete, I., & Marques, R. C. (2021). Financing the Water and Sanitation Sectors: A hybrid
12 Literature review. *Infrastructures*, 6(1), 9. <https://doi.org/10.3390/infrastructures6010009>
- 13 Maheswari, S. U., Shalini, M., & Yookesh, T. L. (2019). Defuzzification Formula for Modelling
14 and Scheduling A Furniture Fuzzy Project Network. *International Journal of Engineering and Advanced*
15 *Technology*, 9(1s5), 279–283. <https://doi.org/10.35940/ijeat.a1048.1291s519>
- 16 Mai, D. T., Kunacheva, C., & Stuckey, D. C. (2018). A review of posttreatment technologies for
17 anaerobic effluents for discharge and recycling of wastewater. *Critical Reviews in Environmental*
18 *Science and Technology*, 48(2), 167-209.
- 19 Malterud, K., Siersma, V. D., & Guassora, A. D. (2016). Sample size in qualitative interview
20 studies: guided by information power. *Qualitative health research*, 26(13), 1753-1760.
- 21 Mamani, G., Ronteltap, M., & Maessen, S. (2014). Final Report Sante Brac Project Bangladesh
22 - Sanitation solutions for flood prone and high table water areas.
- 23 Mandal, R. N., Chakrabarti, P. P., Paul, B. N., Chattopadhyay, D. D., Das, A., Hussan, A., &
24 Jayasankar, P. (2018). Recycling of sewage in aquaculture: decadal technical advancement. *Wastewater*
25 *Management through Aquaculture*, 95-118.
- 26 Mara, D. (2013). *Domestic wastewater treatment in developing countries*. Routledge.
- 27 Mara, D. D., & Evans, B. (2017). The sanitation and hygiene targets of the sustainable
28 development goals: scope and challenges. *Journal of Water Sanitation and Hygiene for Development*,
29 8(1), 1–16. <https://doi.org/10.2166/washdev.2017.048>
- 30 Mara, D. D., Drangert, J., Nguyen, V. A., Tonderski, A., Gulyas, H., & Tonderski, K. (2007).
31 Selection of sustainable sanitation arrangements. *Water Policy*, 9(3), 305–
32 318. <https://doi.org/10.2166/wp.2007.009>
- 33 Mardani, A., Jusoh, A., & Zavadskas, E. K. (2015). Fuzzy multiple criteria decision-making
34 techniques and applications—Two decades review from 1994 to 2014. *Expert systems with*
35 *Applications*, 42(8), 4126-4148.
- 36 Marleni, N. N. N., & Raspati, G. S. (2020). A critical review of wastewater resource recovery
37 implementation in Indonesia.
- 38 Massoud, M. A., Tarhini, A., & Nasr, J. A. (2009). Decentralized approaches to wastewater
39 treatment and management: applicability in developing countries. *Journal of environmental*
40 *management*, 90(1), 652-659.

1 Mazri, C., Jovanovic, A., & Balos, D. (2012, June). Descriptive model of indicators for
2 environment, health and safety management. In 5. International Conference on Safety & Environment
3 in Process & Power Industry (CISAP-5) (Vol. 26, p. NC). AIDIC. Milano.

4 Mehrotra, D. V., Chan, I. S., & Berger, R. L. (2003). A cautionary note on exact unconditional
5 inference for a difference between two independent binomial proportions. *Biometrics*, 59(2), 441-450.

6 Mensah, J. (2020). Effectiveness of national sanitation day as a community-participatory
7 approach for improving environmental sanitation in Edina traditional area, Ghana. *Management of
8 Environmental Quality: An International Journal*, 31(1), 235-253.

9 Mensah, J., Amoah, J. O., Mattah, P. a. D., & Mensah, A. (2022). Causes and effects of weak
10 enforcement of environmental sanitation laws in Ghana. *Journal of Human Behavior in the Social
11 Environment*, 33(5), 663–684. <https://doi.org/10.1080/10911359.2022.2080146>

12 Micheli, P., Wilner, S. J., Bhatti, S. H., Mura, M., & Beverland, M. B. (2019). Doing design thinking:
13 Conceptual review, synthesis, and research agenda. *Journal of Product Innovation Management*, 36(2),
14 124-148.

15 Miller, G. A. (1956). The magical number seven, plus or minus two: Some limits on our capacity
16 for processing information. *Psychological Review*, 63(2), 81. doi:<https://doi.org/10.1037/h0043158>

17 Mills, K. J. (2020). “It’s systemic”: Environmental racial microaggressions experienced by Black
18 undergraduates at a predominantly White institution. *Journal of Diversity in Higher Education*, 13(1),
19 44–55. <https://doi.org/10.1037/dhe0000121>

20 Mitra, A., Narayan, A. S., & Lüthi, C. (2022). Sanitation potpourri: Criteria for planning mix of
21 sanitation systems for citywide inclusive sanitation. *Environment and Planning B: Urban Analytics and
22 City Science*, 49(8), 2195-2215.

23 Mohamad, D., & Zainuddin, N. S. (2021). Solving incomplete fuzzy pairwise comparison matrix
24 using fuzzy DEMATEL. *Journal of Physics*, 1988(1), 012058. [https://doi.org/10.1088/1742-
25 6596/1988/1/012058](https://doi.org/10.1088/1742-6596/1988/1/012058)

26 Moreno-Jiménez, J. M., & Vargas, L. G. (2018). Cognitive multiple criteria decision making and
27 the legacy of the analytic hierarchy process. *Studies of Applied Economics*, 36(1), 67-80.

28 Moslem, S., & Duleba, S. (2019). Sustainable Urban Transport Development by Applying a
29 Fuzzy-AHP Model: A Case Study from Mersin, Turkey. *Urban Science*, 3(2), 55.
30 <https://doi.org/10.3390/urbansci3020055>

31 Mühlbacher, A. C., & Kaczynski, A. (2013). Der analytic hierarchy process (ahp): Eine methode
32 zur entscheidungsunterstützung im gesundheitswesen. *PharmacoEconomics German Research Articles*, 11,
33 119-132.

34 Munier, N., Hontoria, E., Munier, N., & Hontoria, E. (2021). Shortcomings of the AHP
35 Method. *Uses and Limitations of the AHP Method: A Non-Mathematical and Rational Analysis*, 41-90.

36 Murungi, C., & Blokland, M. (2016). Benchmarking for the provision of water supply and
37 sanitation services to the urban poor: an assessment framework. *International Journal of
38 Water*, 10(2/3), 155. <https://doi.org/10.1504/ijw.2016.075566>

39 Nayak, M. S. D. P., & Narayan, K. A. (2019). Strengths and weaknesses of online surveys.
40 *technology*, 6(7), 0837-2405053138.

1 Nayono, S. (2014). Development of a sustainability-based sanitation planning tool (SusTA) for
2 Developing Countries. *Ingenieurwissenschaften*, Weimar.

3 New sources

4 Nyumba, T. O., Wilson, K. A., Derrick, C. J., & Mukherjee, N. (2018). The use of focus group
5 discussion methodology: Insights from two decades of application in conservation. *Methods in Ecology*
6 *and Evolution*, 9(1), 20–32. <https://doi.org/10.1111/2041-210x.12860>

7 O’Keefe, M., Messmer, U., Lüthi, C., & Tobias, R. (2015). Slum inhabitants’ perceptions and
8 decision-making processes related to an innovative sanitation service: Evaluating the Blue Diversion
9 Toilet in Kampala (Uganda). *International journal of environmental health research*, 25(6), 670-684.

10 Odagiri, M., Thomas, A., Listyasari, M., Mills, F., Bain, R., Muhammad, Z., Slaymaker, T.,
11 Mardikanto, A., Gultom, A., Indiyani, A., Rangkuti, H., & Willetts, J. (2021). Safely Managed On-Site
12 Sanitation: A national assessment of sanitation services and potential fecal exposure in
13 Indonesia. *International Journal of Environmental Research and Public Health*, 18(15),
14 8204. <https://doi.org/10.3390/ijerph18158204>

15 OECD. (2019). *OECD Studies on Water Making Blended Finance Work for Water and*
16 *Sanitation Unlocking Commercial Finance for SDG 6*. OECD Publishing.

17 Okumah, M., Yeboah, A. S., Nkiaka, E., & Azerigyik, R. A. (2019). What Determines Behaviours
18 Towards Water Resources Management in a Rural Context? Results of a Quantitative Study. *Resources*,
19 8(2), 109. <https://doi.org/10.3390/resources8020109>

20 Olschewski, A. (2013). *Technology Applicability Framework (TAF) Manual*. WASHTech
21 Project, St. Gallen.

22 Orgill-Meyer, J., Pattanayak, S. K., Chindarkar, N., Dickinson, K. L., Panda, U., Rai, S., Sahoo, B.,
23 Singha, A., & Jeuland, M. (2019). Long-term impact of a community-led sanitation campaign in India,
24 2005–2016. *Bulletin of the World Health Organization*, 97(8), 523-
25 533A. <https://doi.org/10.2471/blt.18.221572>

26 Palomares, I., Estrella, F. J., Martínez, L., & Herrera, F. (2014). Consensus under a fuzzy context:
27 Taxonomy, analysis framework AFRYCA and experimental case of study. *Information Fusion*, 20, 252-
28 271.

29 Pant, S., Kumar, A., Ram, M., Klochkov, Y., & Sharma, H. K. (2022). Consistency indices in analytic
30 hierarchy process: a review. *Mathematics*, 10(8), 1206.

31 Parker, C., Scott, S., & Geddes, A. (2019). *Snowball sampling SAGE research methods*
32 *foundations*.

33 Parums, D. V. (2021). Editorial: Review Articles, Systematic Reviews, Meta-Analysis, and the
34 Updated Preferred Reporting Items for Systematic Reviews and Meta-Analyses (PRISMA) 2020
35 guidelines. *Medical Science Monitor*, 27. <https://doi.org/10.12659/msm.934475>

36 Paul, J., Lim, W. M., O’Cass, A., Hao, A. W., & Bresciani, S. (2021). Scientific procedures and
37 rationales for systematic literature reviews (SPAR-4-SLR). *International Journal of Consumer*
38 *Studies*, 45(4). <https://doi.org/10.1111/ijcs.12695>

39 Pedro, J. P. B., Da Silva Oliveira, C. A., De Lima, S. C. R. B., & Von Sperling, M. (2020). A review
40 of sanitation technologies for flood-prone areas. *Journal of Water Sanitation and Hygiene for*
41 *Development*, 10(3), 397–412. <https://doi.org/10.2166/washdev.2020.019>

1 Philippine Statistics Authority (PSA). (2023). Labor Force Survey: Employment Rate in August
2 2023 was Estimated at 95.6 percent.

3 Philippine Statistics Authority (PSA). (2023). Poverty Statistics: Fisherfolks and Farmers Remain
4 to Have the Highest Poverty Incidences Among the Basic Sectors in 2021.

5 Piadeh, F., Alavi-Moghaddam, M. R., & Mardan, S. (2018). Assessment of sustainability of a
6 hybrid of advanced treatment technologies for recycling industrial wastewater in developing countries:
7 Case study of Iranian industrial parks. *Journal of Cleaner Production*, 170, 1136-1150.

8 Piengang, F. C. N., Beauregard, Y., & Kenné, J. P. (2019). An APS software selection methodology
9 integrating experts and decisions maker's opinions on selection criteria: A case study. *Cogent
10 Engineering*, (just-accepted), 1594509. doi:<https://doi.org/10.1080/23311916.2019.1594509>

11 Pierce, G. (2017). Why is basic service access worse in slums? A synthesis of
12 obstacles. *Development in Practice*, 27(3), 288-300.

13 Prancutè, R. (2021). Web of Science (WoS) and Scopus: The titans of bibliographic information
14 in today's academic world. *Publications*, 9(1), 12.

15 Prouty, C., Mohebbi, S., & Zhang, Q. (2018). Socio-technical strategies and behavior change to
16 increase the adoption and sustainability of wastewater resource recovery systems. *Water Research*, 137,
17 107–119. <https://doi.org/10.1016/j.watres.2018.03.009>

18 Prüss-Ustün, A., Wolf, J., Bartram, J., Clasen, T., Cumming, O., Freeman, M. C., Gordon, B.,
19 Hunter, P. R., Medlicott, K., & Johnston, R. B. (2019). Burden of disease from inadequate water,
20 sanitation and hygiene for selected adverse health outcomes: An updated analysis with a focus on low-
21 and middle-income countries. *International Journal of Hygiene and Environmental Health*, 222(5), 765–
22 777. <https://doi.org/10.1016/j.ijheh.2019.05.004>

23 PSA. (2020). Census of Population "Region III (Central Luzon)". Total Population by Province,
24 City, Municipality and Barangay. Retrieved 24th of December 2022.

25 Purwar, D., Sliuzas, R., & Flacke, J. (2020). Assessment of cascading effects of typhoons on water
26 and sanitation services: A case study of informal settlements in Malabon, Philippines. *International
27 journal of disaster risk reduction*, 51, 101755.

28 Rabiee, F. (2004). Focus-group interview and data analysis. *Proceedings of the nutrition
29 society*, 63(4), 655-660.

30 Radini, S., Marinelli, E., Akyol, A., Eusebi, A. L., Vasilaki, V., Mancini, A., Frontoni, E., Bischetti,
31 G. B., Gandolfi, C., Katsou, E., & Fatone, F. (2021). Urban water-energy-food-climate nexus in integrated
32 wastewater and reuse systems: Cyber-physical framework and innovations. *Applied Energy*, 298,
33 117268. <https://doi.org/10.1016/j.apenergy.2021.117268>

34 Redante, R. C., De Medeiros, J. F., Vidor, G., Cruz, C. M. L., & Ribeiro, J. L. D. (2019). Creative
35 approaches and green product development: Using design thinking to promote stakeholders'
36 engagement. *Sustainable Production and Consumption*, 19, 247–
37 256. <https://doi.org/10.1016/j.spc.2019.04.006>

38 Robertson, T., & Simonsen, J. (2012). Challenges and Opportunities in Contemporary
39 Participatory Design. *Design Issues*, 28(3), 3–9. <http://www.jstor.org/stable/23273834>

40 Robinson, J. (2020). Using focus groups. *Handbook of Qualitative Research in Education*, 338–
41 348. <https://doi.org/10.4337/9781788977159.00040>

1 Rodolfo, K. & Sirigan, F. (2016). Global sea-level rise is recognised, but flooding from
2 anthropogenic land subsidence is ignored around northern Manila Bay, Philippines. *Disaster*. Vol 30. No
3 1. pp. 118-139

4 Rodriguez, R. R., Saiz, J. J. A., & Bas, A. O. (2009). Quantitative relationships between key
5 performance indicators for supporting decision-making processes. *Computers in industry*, 60(2), 104-
6 113.

7 Rolland, L., Molle, P., Liénard, A., Bouteldja, F., & Grasmick, A. (2009). Influence of the physical
8 and mechanical characteristics of sands on the hydraulic and biological behaviors of sand
9 filters. *Desalination*, 248(1-3), 998-1007.

10 Roma, E., & Jeffrey, P. (2010). Evaluation of community participation in the implementation of
11 community-based sanitation systems: a case study from Indonesia. *Water Science and Technology*,
12 62(5), 1028–1036. <https://doi.org/10.2166/wst.2010.344>

13 Rout, P. R., Shahid, M. K., Dash, R. R., Bhunia, P., Liu, D., Varjani, S., Zhang, T. C., & Surampalli,
14 R. Y. (2021). Nutrient removal from domestic wastewater: A comprehensive review on conventional
15 and advanced technologies. *Journal of Environmental Management*, 296, 113246.
16 <https://doi.org/10.1016/j.jenvman.2021.113246>

17 Russel, K. C., Hughes, K., Roach, M., Auerbach, D., Foote, A., Kramer, S., & Briceño, R. (2019).
18 Taking Container-Based Sanitation to Scale: Opportunities and Challenges. *Frontiers in Environmental*
19 *Science*, 7. <https://doi.org/10.3389/fenvs.2019.00190>

20 Saaty, T. L. (1994). *Fundamentals of decision making and priority theory with the analytic hierarchy process*.
21 RWS publications.

22 Saaty, T. L. (1997). That is not the analytic hierarchy process: What the AHP is and what it is
23 not. *Journal of Multi-Criteria Decision Analysis*, 6(6), 324–335.

24 Saaty, T.L. (1980) *The Analytic Hierarchy Process*. McGraw-Hill, New York.

25 Sahoo, S. K., & Choudhury, B. B. (2021). A Fuzzy AHP Approach to Evaluate the Strategic Design
26 Criteria of a Smart Robotic Powered Wheelchair Prototype. In *Intelligent Systems: Proceedings of*
27 *ICMIB 2020* (pp. 451-464). Singapore: Springer Singapore.

28 Sakhardande, M. J., & Gaonkar, R. S. P. (2022). On solving large data matrix problems in Fuzzy
29 AHP. *Expert Systems with Applications*, 194, 116488.

30 Salvia, A., Brandli, L., Filho, C., & Locatelli Kalil, R.-M. (2019). An analysis of the applications of
31 Analytic Hierarchy Process (AHP) for selection of energy efficiency practices in public lighting in a
32 sample of Brazilian cities. *Energy Policy*, 132(2019), 854–864.

33 Santos, P. H. D., Neves, S. M., Sant’Anna, D. O., De Oliveira, C. H., & Carvalho, H. D. (2019). The
34 analytic hierarchy process supporting decision making for sustainable development: An overview of
35 applications. *Journal of Cleaner Production*, 212, 119–138.
36 <https://doi.org/10.1016/j.jclepro.2018.11.270>

37 Saravanan, A., Kumar, P. S., Jeevanantham, S., Karishma, S., Tajsabreen, B., Yaashikaa, P. R., &
38 Reshma, B. (2021). Effective water/wastewater treatment methodologies for toxic pollutants removal:
39 Processes and applications towards sustainable development. *Chemosphere*, 280, 130595.

40 Sato, Y., & Tan, K. H. (2023). Inconsistency indices in pairwise comparisons: An improvement
41 of the consistency index. *Annals of Operations Research*, 326(2), 809-830.

- 1 Schaik, J. W. J. van. (2016). Finch Philippines: An economical prefabricated residence for
2 Hagonoy, a typhoon prone municipality in the Philippines: analysis, design and implementation [MSc-
3 thesis]. TU Delft.
- 4 Schertenleib, R., Luthi, C., Panesar, A., Buurma, M., Kapur, D., Narayan, A.S., Pres, A., Salian, P.,
5 Spuhler, D. & Tempel, A. (2021). A sanitation journey – Principles, Approaches & Tools for Urban
6 Sanitation. Sustainable Sanitation Alliance (SuSanA).
- 7 Schmidt, K., Aumann, I., Hollander, I., Damm, K., & Von Der Schulenburg, J. G. (2015). Applying
8 the Analytic Hierarchy Process in healthcare research: A systematic literature review and evaluation of
9 reporting. *BMC Medical Informatics and Decision Making*, 15(1). [https://doi.org/10.1186/s12911-015-](https://doi.org/10.1186/s12911-015-0234-7)
10 0234-7
- 11 Schmitt, R. J., Morgenroth, E., & Larsen, T. A. (2017). Robust planning of sanitation services in
12 urban informal settlements: An analytical framework. *Water Research*, 110, 297–312.
13 <https://doi.org/10.1016/j.watres.2016.12.007>
- 14 Schrecongost, A., Pedi, D., Rosenboom, J. W., Shrestha, R. R., & Ban, R. (2020). Citywide
15 Inclusive Sanitation: A public service approach for reaching the urban Sanitation SDGs. *Frontiers in*
16 *Environmental Science*, 8. <https://doi.org/10.3389/fenvs.2020.00019>
- 17 Schütze, M., Wriege-Bechtold, A., Zinati, T., Söbke, H., Wißmann, I., Schulz, M., Vesper, S.,
18 Londong, J., Barjenbruch, M., & Alex, J. (2019). Simulation and visualization of material flows in
19 sanitation systems for streamlined sustainability assessment. *Water Science and Technology*, 79(10),
20 1966–1976. <https://doi.org/10.2166/wst.2019.199>
- 21 Setty, K., Jiménez, A., Willetts, J., Leifels, M., & Bartram, J. (2020). Global water, sanitation and
22 hygiene research priorities and learning challenges under Sustainable Development Goal
23 6. *Development Policy Review*, 38(1), 64-84.
- 24 Seymour, Z. A., Cloete, E., McCurdy, M., Olson, M., & Hughes, J. (2021). Understanding values
25 of sanitation users: examining preferences and behaviors for sanitation systems. *Journal of Water,*
26 *Sanitation and Hygiene for Development*, 11(2), 195-207.
- 27 Shen, K. Y., & Tzeng, G. H. (2018). Advances in multiple criteria decision making for
28 sustainability: Modeling and applications. *Sustainability*, 10(5), 1600.
- 29 Shields K. F., Moffa M., Behnke N. L., Kelly E., Klug T., Lee K., Cronk R. & Bartram J. 2021
30 Community management does not equate to participation: fostering community participation in rural
31 water supplies. *Journal of Water, Sanitation and Hygiene for Development* 11 (6), 937–947.
- 32 Silvestri G., Wittmayer J. M., Schipper K., Kulabako R., Oduro-Kwarteng S., Nyenje P., Komakech
33 H. & van Raak R. 2018 Transition management for improving the sustainability of WASH services in
34 informal settlements in Sub Saharan Africa – an exploration. *Sustainability* 10 (4052), 1–19.
- 35 Sim, J., & Waterfield, J. (2019). Focus group methodology: some ethical challenges. *Quality &*
36 *quantity*, 53(6), 3003-3022.
- 37 Simiyu, S., Swilling, M., & Cairncross, S. (2017). Decision-making on shared sanitation in the
38 informal settlements of Kisumu, Kenya. *International journal of environmental health research*, 27(5),
39 377-393.
- 40 Singh, V. K., Singh, P., Karmakar, M., Leta, J., & Mayr, P. (2021). The journal coverage of Web of
41 Science, Scopus and Dimensions: A comparative analysis. *Scientometrics*, 126, 5113-5142.

1 Sinharoy, S., Pittluck, R. E., & Clasen, T. (2019). Review of drivers and barriers of water and
2 sanitation policies for urban informal settlements in low-income and middle-income countries. *Utilities*
3 *Policy*, 60, 100957. <https://doi.org/10.1016/j.jup.2019.100957>

4 Snyder, H. (2019). Literature review as a research methodology: An overview and
5 guidelines. *Journal of Business Research*, 104, 333–339. <https://doi.org/10.1016/j.jbusres.2019.07.039>

6 Solomon, M. (2006). Groupthink versus the wisdom of crowds: The social epistemology of
7 deliberation and dissent. *The Southern journal of philosophy*, 44(S1), 28-42.

8 Sonune, A., & Ghate, R. (2004). Developments in wastewater treatment
9 methods. *Desalination*, 167, 55-63. ISO 690

10 Spinuzzi, C. (2005). *The Methodology of Participatory Design*. *Technical Communication*. 52.
11 163-174.

12 Spuhler, D., & Lüthi, C. (2020). Review of frameworks and tools for urban strategic sanitation
13 planning: considering technology innovations and sustainability. *Journal of Water, Sanitation and*
14 *Hygiene for Development*, 10(4), 768–785. <https://doi.org/10.2166/washdev.2020.062>

15 Spuhler, D., Germann, V., Kassa, K., Ketema, A. A., Sherpa, A. M., Sherpa, M. G., Maurer, M.,
16 Lüthi, C., & Langergraber, G. (2020). Developing sanitation planning options: A tool for systematic
17 consideration of novel technologies and systems. *Journal of Environmental Management*, 271, 111004.
18 <https://doi.org/10.1016/j.jenvman.2020.111004>

19 Stanley-Brown, J., & Weistroffer, H. (2019). *Relevant Participants' Participation in Systems*
20 *Development: When is Participation Irrelevant?*

21 Strande, L., Ronteltap, M. & Brdjanovic, D. (2014). *Faecal Sludge Management: Systems*
22 *Approach for Implementation and Operation*. IWA Publishing

23 Tabios III, G.Q. & de Leon, T. (2020). *Assessing the Resurgent Irrigation Development Program*
24 *of the Philippines - Water Resources Component*. Philippine Institute for Development Studies (PIDS).

25 Tamene, A., & Afework, A. (2021). Exploring barriers to the adoption and utilization of improved
26 latrine facilities in rural Ethiopia: An Integrated Behavioral Model for Water, Sanitation and Hygiene
27 (IBM-WASH) approach. *PLOS ONE*, 16(1), e0245289. <https://doi.org/10.1371/journal.pone.0245289>

28 Tavana, M., Soltanifar, M., & Santos-Arteaga, F. J. (2023). Analytical hierarchy process:
29 Revolution and evolution. *Annals of operations research*, 326(2), 879-907.

30 Tilley, E., Strande, L., Lüthi, C., Mosler, H., Udert, K. M., Gebauer, H., & Hering, J. G. (2014).
31 Looking beyond Technology: An Integrated Approach to Water, Sanitation and Hygiene in Low Income
32 Countries. *Environmental Science & Technology*, 48(17), 9965–
33 9970. <https://doi.org/10.1021/es501645d>

34 Tolich, M. (2009). The principle of caveat emptor: Confidentiality and informed consent as
35 endemic ethical dilemmas in focus group research. *Journal of Bioethical Inquiry*, 6, 99-108.

36 Tolksdorf, J., & Cornel, P. (2017). Semicentralized greywater and blackwater treatment for fast
37 growing cities: how uncertain influent characteristics might affect the treatment processes. *Water*
38 *Science and Technology*, 75(7), 1722-1731.

1 Trimmer, J. T., Miller, D. C., Byrne, D. M., Lohman, H. A., Banadda, N., Baylis, K., ... & Guest, J.
2 S. (2020). Re-envisioning sanitation as a human-derived resource system. *Environmental Science &*
3 *Technology*, 54(17), 10446-10459.

4 Trischler, J., Dietrich, T., & Rundle-Thiele, S. (2019). Co-design: from expert-to user-driven ideas
5 in public service design. *Public Management Review*, 21(11), 1595-1619.

6 Tsekles, E., Fonseca Braga, M., Abonge, C., Santana, M., Pickup, R., Yongabi Anchang, K., de
7 Pippo, T., Semple, K., & Roy, M. (2022). Community engagement in water, sanitation and hygiene in sub-
8 Saharan Africa: does it WASH? *Journal of Water, Sanitation and Hygiene for Development*, 12(2), 143–
9 156. <https://doi.org/10.2166/washdev.2022.136>

10 Uddin, I., & Rahman, K. U. (2023). Impact of corruption, unemployment and inflation on
11 economic growth evidence from developing countries. *Quality & Quantity*, 57(3), 2759-2779.

12 United Nations. (2015). Transforming our World: the 2030 agenda for sustainable development
13 A/RES/70/1.

14 United Nations. (2023). Water and Sanitation - United Nations Sustainable Development.
15 United Nations Sustainable Development. [https://www.un.org/sustainabledevelopment/water-and-](https://www.un.org/sustainabledevelopment/water-and-sanitation/)
16 [sanitation/](https://www.un.org/sustainabledevelopment/water-and-sanitation/)

17 UPM. (2021a). Anaerobic Baffled Reactor (ABR) Design Considerations for Faecal Sludge.
18 Umwelt-Projekt-Management GmbH.

19 UPM. (2021b). Anaerobic Filter (AF) Design Considerations for Faecal Sludge. Umwelt-Projekt-
20 Management GmbH.

21 Usamah, M., Handmer, J., Mitchell, D., & Ahmed, I. (2014). Can the vulnerable be resilient? Co-
22 existence of vulnerability and disaster resilience: Informal settlements in the Philippines. *International*
23 *journal of disaster risk reduction*, 10, 178-189.

24 van Buuren, J. C. L. (2010). SANitation CHoice Involving Stakeholders : a participatory multi-
25 criteria method for drainage and sanitation system selection in developing cities applied in Ho Chi Minh
26 City, Vietnam. [internal PhD, WU, Wageningen University]. <https://edepot.wur.nl/157236>

27 Van Laarhoven, P. J., & Pedrycz, W. (1983). A fuzzy extension of Saaty's priority theory. *Fuzzy*
28 *sets and Systems*, 11(1-3), 229-241.

29 Van Vliet, B. J., Spaargaren, G., & Oosterveer, P. (2011). Sanitation under challenge:
30 contributions from the social sciences. *Water Policy*, 13(6), 797-809.

31 Vásquez, W. F., & Alicea-Planas, J. (2018). Unbundling household preferences for improved
32 sanitation: A choice experiment from an urban settlement in Nicaragua. *Journal of environmental*
33 *management*, 218, 477-485.

34 Vaughn, L. M., & Jacquez, F. (2020). Participatory Research methods – choice points in the
35 research process. *Journal of Participatory Research Methods*, 1(1). <https://doi.org/10.35844/001c.13244>

37 Verganti, R., Dell’Era, C., & Swan, K. (2021). Design thinking: Critical analysis and future
38 evolution. *Journal of Product Innovation Management*, 38(6), 603–
39 622. <https://doi.org/10.1111/jpim.12610>

- 1 Vidal, B., Hedström, A., Barraud, S., Kärrman, E., & Herrmann, I. (2019). Assessing the
2 sustainability of on-site sanitation systems using multi-criteria analysis. *Environmental Science: Water
3 Research & Technology*, 5(9), 1599-1615.
- 4 Vohs, K. D., Baumeister, R. F., Twenge, J. M., Schmeichel, B. J., Tice, D. M., & Crocker, J. (2005).
5 Decision fatigue exhausts self-regulatory resources—But so does accommodating to unchosen
6 alternatives. Manuscript submitted for publication, 1-55.
- 7 Wang, J. (2014). Decentralized biogas technology of anaerobic digestion and farm ecosystem:
8 Opportunities and challenges. *Frontiers in Energy
9 Research*, 2. <https://doi.org/10.3389/fenrg.2014.00010>
- 10 Wang, M., Zhu, J., & Mao, X. (2021). Removal of pathogens in onsite wastewater treatment
11 systems: A review of design considerations and influencing factors. *Water*, 13(9), 1190.
12 <https://doi.org/10.3390/w13091190>
- 13 Waqas, S., Harun, N. Y., Sambudi, N. S., Abioye, K. J., Zeeshan, M. H., Ali, A., Abdulrahman, A.,
14 Alkhattabi, L., & Alsaadi, A. S. (2023). Effect of operating parameters on the performance of integrated
15 Fixed-Film Activated sludge for wastewater treatment. *Membranes*, 13(8),
16 704. <https://doi.org/10.3390/membranes13080704>
- 17 WHO; UNICEF. (2015). Update and MDG Assessment; WHO/UNICEF Joint Monitoring
18 Programme for Water Supply and Sanitation; WHO: Geneva, Switzerland; UNICEF: New York, NY,
19 USA, 2015.
- 20 Wilderer, P. A., & Schreff, D. (2000). Decentralized and centralized wastewater management: a challenge
21 for technology developers. *Water Science and Technology*, 41(1), 1-8.
- 22 Williams, L., Arguillas, M. J. B., & Arguillas, F. (2020). Major storms, rising tides, and wet feet:
23 Adapting to flood risk in the Philippines. *International Journal of Disaster Risk Reduction*, 50,
24 101810. <https://doi.org/10.1016/j.ijdr.2020.101810>
- 25 World Bank. (2019). Evaluating the potential of container-based sanitation. Retrieved June 19,
26 2021 from [https://openknowledge.worldbank.org/bitstream/handle/10986/31292/134664-
27 WPP165603-W.pdf?](https://openknowledge.worldbank.org/bitstream/handle/10986/31292/134664-WPP165603-W.pdf?)
- 28 World Bank. (2023). World Development Indicators: Unemployment rate of 9 countries in
29 South-East Asia [data file]. Retrieved from [https://databank.worldbank.org/Unemployment-rate-of-9-
30 countriesin-South-East-Asia/id/1d34dbab](https://databank.worldbank.org/Unemployment-rate-of-9-countriesin-South-East-Asia/id/1d34dbab)
- 31 Wurtsbaugh, W. A., Paerl, H. W., & Dodds, W. K. (2019). Nutrients, eutrophication and harmful
32 algal blooms along the freshwater to marine continuum. *Wiley Interdisciplinary Reviews: Water*, 6(5),
33 e1373.
- 34 Yang, J., Rahardja, S., & Fränti, P. (2019). Outlier detection: how to threshold outlier scores?.
35 In Proceedings of the international conference on artificial intelligence, information processing and
36 cloud computing (pp. 1-6).
- 37 Yang, J., Shen, L., Jin, X., Hou, L., Shang, S., & Yan, Z. (2019). Evaluating the quality of simulation
38 teaching in Fundamental Nursing Curriculum: AHP-Fuzzy comprehensive evaluation. *Nurse Education
39 Today*, 77, 77–82. <https://doi.org/10.1016/j.nedt.2019.03.012>

1 Yayla, A. Y., Oztekin, A., Gumus, A. T., & Gunasekaran, A. (2015). A hybrid data analytic
2 methodology for 3PL transportation provider evaluation using fuzzy multi-criteria decision
3 making. *International Journal of production research*, 53(20), 6097-6113.

4 Yeh, C. T. (2017). Existence of interval, triangular, and trapezoidal approximations of fuzzy
5 numbers under a general condition. *Fuzzy Sets and Systems*, 310, 1-13.

6 Yu, D., Kou, G., Zhang, X., & Shi, S. (2021). Analysis of collaboration evolution in AHP Research:
7 1982–2018. *International Journal of Information Technology and Decision Making*, 20(01), 7–
8 36. <https://doi.org/10.1142/s0219622020500406>

9 Zadeh, L. A. (1978). Fuzzy sets as a basis for a theory of possibility. *Fuzzy sets and systems*, 1(1),
10 3-28.

11 Zamenopoulos, T., Lam, B., Alexiou, K., Kelemen, M., De Sousa, S., Moffat, S., & Phillips, M.
12 (2019). Types, obstacles and sources of empowerment in co-design: the role of shared material objects
13 and processes. *CoDesign*.

14 Zellner, M. L., Milz, D., Lyons, L., Hoch, C. J., & Radinsky, J. (2022). Finding the Balance Between
15 Simplicity and Realism in Participatory Modeling for Environmental Planning. *Environmental Modelling*
16 & Software, 157, 105481.

17 Zhang, F., Wang, P., Mu, P., Wang, M., Han, L., & Sun, J. (2022). A comprehensive evaluation
18 method for the service status of groins in waterways based on an AHP-improved CRITIC combination
19 weighting optimization model. *Sustainability*, 14(17), 10709.

20 Zhang, X. (2015). Deviation square priority method for distinct preference structures based on
21 generalized multiplicative consistency. *IEEE Transactions on Fuzzy Systems*, 23(4), 1164–
22 1180. <https://doi.org/10.1109/tfuzz.2014.2346794>

23 Zheng, J., Egger, C., & Lienert, J. (2016). A scenario-based MCDA framework for wastewater
24 infrastructure planning under uncertainty. *Journal of environmental management*, 183, 895-908.

25 Zhou, Y., Meng, J., Zhang, M., Chen, S., He, B., Zhao, H., Li, Q., Zhang, S., & Wang, T. (2019).
26 Which type of pollutants need to be controlled with priority in wastewater treatment plants: Traditional
27 or emerging pollutants? *Environment International*, 131, 104982.
28 <https://doi.org/10.1016/j.envint.2019.104982>

29 Zimmer, K., Fröhling, M., Breun, P., & Schultmann, F. (2017). Assessing social risks of global
30 supply chains: A quantitative analytical approach and its application to supplier selection in the German
31 automotive industry. *Journal of Cleaner Production*, 149, 96-109.

32 Zyoud, S. H., Kaufmann, L. G., Shaheen, H., Samhan, S., & Fuchs-Hanusch, D. (2016). A
33 framework for water loss management in developing countries under fuzzy environment: Integration of
34 Fuzzy AHP with Fuzzy TOPSIS. *Expert Systems With Applications*, 61, 86–
35 105. <https://doi.org/10.1016/j.eswa.2016.05.016>

1	Overview Appendices	
2	A – Review Planning Tools	106
3	B – Results Search Query Design Criteria	116
4	C – Overview Substantiation Design Criteria	120
5	D – Graphical Overview Merges Design Criteria	135
6	E – Definitions, Scenarios, and Examples to Design Criteria	137
7	F – Background Information Hagonoy	139
8	G – Mathematical Substantiation	146
9	H – Python Script FAHP	151
10	J – Focus Group Discussions Guiding Presentation	158
11	J – Design Variables Substantiation	167
12	K – Technical Drawings Sanitation Design	179

Appendix A – Review Planning Tools

Source	Description of tool	Design criteria	Advantages	Disadvantages	Participation	Conclusion
[1]	Through consultation of experts (sanitation experts, economists, and behavioural scientists) and end-users, the desires and preferences of all parties are explored, resulting in the selection of feasible alternatives. The alternatives are picked from nine possible technologies through a decision tree. Both the interpretation of input and the decision-making are done by the facilitator.	Climatic conditions, site conditions, population served, state of existing facilities, sociocultural factors, and the in-place institutional framework. Within this framework, this <i>“essentially reduces to the question of which is the cheapest, technically feasible technology that the users can afford, maintain, and prefer to cheaper alternatives” (P.46).</i>	Easy to use decision tree for selection of sanitation technology.	Limited to only nine sanitation technologies. Only includes toilet- and storage systems, no treatment technologies. The community takes on an advisory role but is not a decision-maker.	Limited to consultation of community regarding current practices and preferences, during needs/demands phase. In other phases of the design, participation is restricted to informing the community.	Preselected design options limiting solution space
[2]	The framework uses a decision tree with simple yes/no questions to come to a proposal for a sanitation system. For every decision, the framework states which of the design principles has to be taken into account by the decision-maker to come to a final decision.	Considers four principles: human health, affordability, environmental sustainability, and institutional appropriateness.	Easy to use decision tree for selection of sanitation technology.	Limited to ten sanitation technologies. Only includes toilet- and storage systems, with no secondary treatment technologies. The community is not involved in the decision process.	Stakeholders are solely informed.	Preselected design options limiting solution space
[3]	Feasible technologies are selected from an Excel file, containing an assessment sheet of technology characteristics for prespecified primary treatment technologies deemed. The technologies are proposed in pairs to FGDs consisting of community members, from which they have to pick the preferred technology. Additionally, the FGDs scored the importance of design criteria on a scale of 1-5. Experts determine the weight of each criterion, after which the final ranking is determined by combining the score assigned by experts with the normalized score assigned by community members.	Sustainability criteria, social acceptance, technological and physical applicability, economic and institutional aspects, and the need to protect human health and the environment.	The framework allows for the inclusion of local conditions when determining feasibility technologies. FGDs and the weighting system ensure a participatory approach.	Proposed complex sanitation technologies to end-users without technical knowledge. Only includes toilet- and storage systems, with no secondary treatment technologies.	Community members were consulted to understand the in-place sanitary system. They were not included in defining the design criteria or the idea generation. During the final selection from the set of proposed ideas, the community collaborated as equal decision-makers with the experts.	Preselected design options limiting solution space

Source	Description of tool	Design criteria	Advantages	Disadvantages	Participation	Conclusion
[4]	Decision tree focussing on the type of toilet (dry or wet), costs, and the soil conditions. The framework is presented as a simple flow diagram, leading to 11 possible types of sanitation.	Criteria used are soil conditions (permeability, soil type), affordability, and toilet practices in place.	Easy to use decision tree for selection of sanitation technology.	Limited to eleven sanitation technologies. Only includes toilet- and storage systems, with no secondary treatment technologies. The community is not involved in the decision process.	Stakeholders are solely informed.	Preselected design options limiting solution space
[5]	Decision tree focussing on a “ <i>context-appropriate combination of fecal sludge treatment technologies</i> ”. The diagram mainly focuses on the characteristics of the to-be-treated sludge. Based on the characteristics of the sludge, treatment technologies are proposed. The diagram also defines the end product of the treatment system.	Dewaterability, stability, pathogen reduction, and solid-liquid separation.	The decision tree defines both the technology required to treat the sludge and the potential end product.	Limited to only sludge treatment technologies, neglecting the wastewater. The community is not involved in the decision process.	Solely consultation of end-users during assessment of needs/demands, otherwise participation is limited to informing.	Preselected design options limiting solution space
[6]	Digital decision tree, which through binary choices leads to a subset of solutions. These solutions are obtained from an elaborate database, in which the technologies are explained by their technical, environmental, and cultural aspects. The subset of solutions and design aspects (sizing, location, acceptance, etc.) is discussed with stakeholders through an undefined participatory approach, allowing them to influence the final decision.	Criteria in the decision tool: geographical setting, centralization, toilet system, water use, groundwater table	Elaborate decision tree, proposing subsets of technologies with detailed information. The subsets of technologies include both toilet systems and treatment technologies.	The tool is designed to be used by and for experts, due to its complexity.	During the design of the sanitation system, end-users are only involved in the final selection of the sanitation system.	Only usable by experts due to complexity or limited to expert input

Source	Description of tool	Design criteria	Advantages	Disadvantages	Participation	Conclusion
[7]	Decision support system for selecting sanitation systems that cover low-end facilities such as latrines and batch composting toilets, addressing the problem in developing countries. The system screens 83 predetermined treatment trains for feasibility, after which the alternatives left are evaluated using a multicriteria evaluation model. A set of questions is asked to the user, after which an algorithm determines the suitability of the feasible treatment trains. The best-scoring alternatives are then scored for facilitation, sustainability, and implementation. The scores are aggregated, using assigned weights, from which a final judgment is derived. Lastly, the alternatives are assessed for their projected costs, using estimates derived from cost-capacity relationships.	Criteria determining feasibility: Project context, settlement characteristics, soil characteristics, quality of water supply, demographics, community requirements, effluent quality, greywater. Criteria determining implementability are project facilitation and construction. Criteria determining project facilitation are community involvement and community motivation. Criteria determining sustainability are project facilitation, community needs, operation, and maintenance.	During nine case studies, the system made sensible recommendations for treatment trains. The decision support system is customized for low-cost technologies in developing countries.	Judgments are expressed on a qualitative scale, causing difficulties for users to score some of the questions. The model is not transparent, as it does not show how the input affects the output.	Information about the current situation, the needs, and the preferences is recommended to be gathered through consultation of the community. However, the input and input format are predefined. The decision system itself does not allow participation of the end-user, as the system makes use of an algorithm and can be run by only one user.	Predetermined design trade-offs limiting design freedom
[8]	Manual for the planning and implementation of sanitation projects based on sanitation system function requirements rather than sanitation technologies. In each phase, stakeholders are to be involved. The process starts with a workshop to identify the problem. Subsequently, the boundary conditions are determined, after which the terms of requirements are developed. Using the gathered information, the facilitator in collaboration with sanitation specialists identifies a minimum of three appropriate sanitation systems, which are proposed for the community to choose from.	The requirements for a system are determined by the facilitator in collaboration with stakeholders. A list of possible criteria is added as possible inspiration.	The manual allows future users to provide input and make decisions regarding their future sanitation system.	The manual proposes a process rather than a tool. It does not provide a rigid structure for the evaluation of trade-offs or the evaluation of technologies.	End-users are involved in both problem comprehension and the definition of needs and demands. The resulting set of requirements is proposed to the stakeholders. End-users are only informed on the selection of ideas, while they are the final decision-makers on the most appropriate solution from this selection.	Manual proposes sequential process steps, but does not provide a tool or framework assisting in this.

Source	Description of tool	Design criteria	Advantages	Disadvantages	Participation	Conclusion
[9]	The technology database contains 58 drainage and sanitation systems, composed of 5 different building blocks with the functions of toilets, on-site storage and treatment, transport, off-site treatment, and reuse/disposal. From these 58 systems, the feasible systems are selected by applying predetermined screening criteria to them. The remaining systems are assessed by experts on the performance criteria for each individual building block in a system, for which the required information is included in the database.	The used criteria were grouped under technical functionality, protection of health, environmental protection and material resources conservation, social manageability, and economic desirability.	The framework allows for the inclusion of local conditions when determining feasibility technologies. The database contains elaborate information on the included sanitation options.	The decision process regarding picking the sanitation system is based on the performance criteria, which require expertise to be interpreted, hence excluding end-users from the decision-making process. It is unclear how the performance criteria are used to determine the score of the sanitation system.	End-users are only informed throughout the process.	Only usable by experts due to complexity or limited to expert input
[10]	The Technology Acceptability Framework (TAF) is a decision support tool on the applicability, scalability and sustainability of a specific WASH technology to provide lasting services in a specific context and on the readiness for its introduction. The assessment of a technology is based on a set of questionnaires considering 18 indicators, posing around 3-7 guiding questions and one scoring question per indicator.	Six sustainability dimensions are considered: social, economic, environmental, institutional and legal, skills and knowhow and the technical dimension.	Information gathering through easy questionnaires.	The framework has to be repeated for every single technology. The proposed guidelines set out the trade-offs to be considered by the facilitator.	This framework is strictly technology driven, hence participation is limited to informing end-users on technological choices and trade-offs, while only consulting end-users regarding their needs and demands.	Evaluating the suitability of only one specific technology

Source	Description of tool	Design criteria	Advantages	Disadvantages	Participation	Conclusion
[11]	The developed planning tool contains five steps: first, the stakeholders and current policy are analyzed. Afterward, the target sanitation level is established. Next, the local conditions (both physical and socio-economical) are assessed, before assessing technologies on their applicability in this setting. Lastly, the technologies are also assessed for sustainability.	The criteria used to assess technologies are Health risks caused by systems, compatibility with the existing system, investment cost, operational and maintenance cost, technical skills required, availability of materials, land required, resource consumption, energy, resource recovery, system performance, and public acceptance.	The framework allows for the inclusion of local conditions when determining feasibility technologies.	The tool does not make use of a technology database, which causes the selection of possible technologies to depend on the knowledge and preference of the facilitator. The absence of weights for indicators and not aggregating the obtained scores obstruct facilitators from interpreting the data easily.	The community is consulted in the determination of the local conditions. Otherwise, the community was only informed on the made decision and the selected technology.	Evaluating the suitability of only one specific technology
[12]	The Sanitation 21 framework consists of three parts to reach effective sanitation planning: defining the context; identifying technical options and determining the feasibility of the options. The technologies are identified and listed based on their treatment capacity and level of management required. In the last step, these technologies are assessed on their ability to meet the objectives defined by stakeholders (in the first step).	Criteria are defined through discussions with stakeholders	The framework promotes a discussion between stakeholders in different contexts and domains.	The manual proposes a process rather than a tool. It does not provide a rigid structure for the evaluation of trade-offs or the evaluation of technologies.	The framework recommends involvement of stakeholders and community in the need assessment. The design scope is developed in collaboration with stakeholders, while the design itself is developed by the facilitator. Feedback on the design is only asked after ideation.	Manual proposes sequential process steps, but does not provide a tool or framework assisting in this.
[13]	Planning tool focussing on the comparison of different water and sanitation systems based on their net present value. The tool is based on numbers of simplifying assumptions, allowing planners to use the tool in early stages of a project while only having limited information.	The tool focuses on the determination of the net present value. Other criteria are not considered.	Only limited amount of input data is required.	The model is solely expert-based. The tool is heavily based on simplifying assumptions, increasing the uncertainty in the eventual cost estimate. The tool only considers costs as a decision criterion.	Stakeholders are solely informed.	Focussing on only financial or technical design criteria

Source	Description of tool	Design criteria	Advantages	Disadvantages	Participation	Conclusion
[14]	The framework applies a stochastic model of the sanitation system and a probabilistic analysis of remote sensing data. The developed model focuses on the cost and capacity of a system. The values of input parameters are initially based on literature and expert judgment.	Used input parameters are distance to facility, transport costs, product accumulation rate, and transport capacity.	The computational nature of the model allows tweaking of the numbers, enabling the development of multiple scenarios fairly easily.	The model is solely expert-based. The developed model focuses on the sanitation service system (collection, distribution, etc.), instead of the treatment technologies itself.	Stakeholders are solely informed.	Focussing on only financial or technical design criteria
[15]	The developed program is a decision support platform to assist planners in selecting suitable water and wastewater treatment processes appropriate to the material and manpower resource capabilities of particular countries at particular times. The main use of the tool is for people with a technical background to screen and research possible water treatment options. Through 53 predetermined questions, information about the target location is gathered. Afterward, the user of the tool is expected to construct treatment trains with the building blocks provided by the database.	The required input parameters are grouped into: demographics, resources (both construction and operation), hydrological/meteorological, finances, and on-site (geographical characteristics, cultural practices).	The program contains an elaborate technology database. Users can flexibly choose from sanitation technologies integrated into software and combine them for customized situations.	Users are required to have expertise in water treatment technologies to use the tool.	Stakeholders are solely informed.	Only usable by experts due to complexity or limited to expert input
[16]	The framework combines resource flux modelling, simulations, visualizations, life cycle assessments and life cycle costing. The framework aims to aid in the decision-making process regarding sanitation systems from a perspective of sustainability. The built-in evaluation function allows for analysis of sustainability criteria of both individual treatment units and the total system.	The decision criteria for sustainability included in the framework are: ecology (Eutrophication Potential, Energy Input, Greenhouse Gas Emissions, Organic Matter, Organic micropollutants, Physical footprint), economy (Life Cycle Costs), social issues (Social Acceptance) and flexibility.	Users can flexibly choose from sanitation technologies integrated in software and combine them for customized situations, while allowing new technologies to be added.	Users are required to have expertise on water treatment technologies to use the tool. The community is not involved in the decision process.	Stakeholders are solely informed.	Only usable by experts due to complexity or limited to expert input

Source	Description of tool	Design criteria	Advantages	Disadvantages	Participation	Conclusion
[17]	The framework makes use of a custom library containing 41 sanitation technologies. An algorithm generates all possible sanitation systems, using screening criteria based on predefined design objectives to select only appropriate technologies for the specified case study. The algorithm then calculates the appropriateness score of the proposed treatment trains, identifying the most appropriate option. In addition, the algorithm quantifies resource recovery potentials and environmental emissions.	Evaluation criteria for sustainable sanitation are: Water requirements, Energy requirements, Water supply stability, Energy supply stability, Operation and Maintenance frequency, Climate type, Temperature, Flooding tolerance, Vehicle access, Slope requirements, Soil type, Groundwater depth, Excavation, Population size, Population density, Construction skills, Design skills, Operation and Maintenance skills, Management required, Construction materials, Spare parts requirements, Chemical requirements, Area requirements, Influent volume stability, Pollution stability, Religious constraints, Cultural constraints, User awareness, Cleansing method, Odour, Design participation, Effluent quality, Solid residue quality, Investment costs, Annual costs.	The algorithm combines and evaluates all possible technologies based on user selected design objectives, while allowing the user to add new technologies. The framework provides a reproducible method to systematically assess and compare the available options.	The derived sanitation system configuration can be inefficient from an engineering perspective. Translation of design objectives into design criteria and selection of appropriate criteria is carried out by facilitator/expert.	The set of screening criteria is to be determined in collaboration with local stakeholders, assessing the demands of stakeholders. Empowerment is not reached as the format of the design scope is predetermined by the facilitator. Both the ideation and selection of possible sanitation systems is executed by the algorithm, hence stakeholders are solely informed.	Predetermined design trade-offs limiting design freedom

Source	Description of tool	Design criteria	Advantages	Disadvantages	Participation	Conclusion
[18]	The Citywide Inclusive Sanitation (CWIS) focuses on service provisioning and the suitable management structure, instead of the construction of sanitation itself. CWIS proposes guidelines and principles that have to be taken into account when a sanitation design process is started.	Principles included: Equal benefits for all affected by sanitation system, social and gender equity included in design process, safely managed human waste, transparently acting authorities, engaged authorities, long term planning based on analysis of needs and resources, political willingness.	Emphasizes the role of the institutions in sanitation planning	The framework proposes considerations within a process rather than a tool/process. It does not provide a rigid structure for the evaluation of trade-offs nor for the evaluation of technologies.	Role of end-users in design process is not defined.	Does not provide concrete input for sanitation design process
[19]	The framework makes use of the diffusion of innovations (TDI) and the theory of planned behaviour (TPB). The framework focuses on analysing the theoretical adoption of a sanitation system. Based on the findings from this framework, the sanitation system can be changed to improve the adoption and sustainability in the model's simulated output.	Model factors: Population awareness of resource recovery systems, Persuasion rate, Adoption rate, Design scale, Capital Cost, Available budget, Operation and maintenance costs, Education level, Sludge production, Hydraulic retention time, TSS performance, BOD performance, Level of sustainability.	The model includes the perception of end-users, assessing the projected adoption.	The framework provides feedback on a design, but no design is generated.	Role of end-users in design process is not defined.	Does not provide concrete input for sanitation design process
[20]	The framework distinguishes between contextual factors and procedural elements influencing participatory sanitation design. The framework provides principles and proposes boundary conditions that are required for a participatory process. The framework itself however does not develop tangible design input.	No design criteria were provided.	Promotes improved stakeholder participation in the design process.	The framework proposes a process rather than a tool. It does not provide a rigid structure for the evaluation of trade-offs nor for the evaluation of technologies.	Does not link participation to design cycle.	Does not provide concrete input for sanitation design process

Bibliography Appendix A – Review Planning Tools

- [1] Kalbermatten, J. M. (1982). *Appropriate Sanitation Alternatives: A Planning and Design Manual*. Johns Hopkins University Press, London. Available from: <http://documents.worldbank.org/curated/en/701511468740361506/Appropriate-sanitation-alternatives-a-planning-and-design-manual>
- [2] Mara, D. D., Drangert, J., Nguyen, V. A., Tonderski, A., Gulyas, H., & Tonderski, K. (2007). Selection of sustainable sanitation arrangements. *Water Policy*, 9(3), 305–318. <https://doi.org/10.2166/wp.2007.009>
- [3] Katukiza, A., Ronteltap, M., Oleja, A., Niwagaba, C., Kansiime, F., & Lens, P. N. (2010). Selection of sustainable sanitation technologies for urban slums — A case of Bwaise III in Kampala, Uganda. *Science of the Total Environment*, 409(1), 52–62. <https://doi.org/10.1016/j.scitotenv.2010.09.032>
- [4] Franceys, R., Shaw, R., & Davey, K. (2013). Poster 021: A guide to sanitation selection. Water, Engineering and Development Centre (WEDC). Loughborough University, Loughborough UK.
- [5] Strande, L., Ronteltap, M. & Brdjanovic, D. (2014). *Faecal Sludge Management: Systems Approach for Implementation and Operation*. IWA Publishing.
- [6] Filho, F. J. C. M., De Queiroz, A. a. F. S. L., Machado, B. S., & Paulo, P. L. (2019). Sustainable sanitation management tool for decision making in isolated areas in Brazil. *International Journal of Environmental Research and Public Health*, 16(7), 1118. <https://doi.org/10.3390/ijerph16071118>
- [7] Loetscher, T., & Keller, J. (2002). A decision support system for selecting sanitation systems in developing countries. *Socio-economic Planning Sciences*, 36(4), 267–290. [https://doi.org/10.1016/s0038-0121\(02\)00007-1](https://doi.org/10.1016/s0038-0121(02)00007-1)
- [8] Kvarnstrom, E. & Petersens, E. A. (2004). Open planning of Sanitation systems. EcoSanRes Programme. Available from: http://www.ecosanres.org/pdf_files/ESR_Publications_2004/ESR3web.pdf
- [9] van Buuren, J. C. L. (2010). *SANitation CHoice Involving Stakeholders : a participatory multi-criteria method for drainage and sanitation system selection in developing cities applied in Ho Chi Minh City, Vietnam*. [internal PhD, WU, Wageningen University]. <https://edepot.wur.nl/157236>
- [10] Olschewski, A. (2013). *Technology Applicability Framework (TAF) Manual*. WASHTech Project, St. Gallen.
- [11] Nayono, S. (2014). *Development of a sustainability-based sanitation planning tool (SusTA) for Developing Countries*. Ingenieurwissenschaften, Weimar.
- [12] IWA. (2014). *Sanitation 21: A Planning Framework for Improving City-wide Sanitation Services*. International Water Association.
- [13] Langergraber G. Ketema A. A. Casielles Restoy R. Lechner L. 2015 *CLARA Simplified Planning Tool v1.6*. User Manual. CLARA M4 – Citavi.
- [14] Schmitt, R. J., Morgenroth, E., & Larsen, T. A. (2017). Robust planning of sanitation services in urban informal settlements: An analytical framework. *Water Research*, 110, 297–312. <https://doi.org/10.1016/j.watres.2016.12.007>

- [15] Finney, Brad A., Robert Gearheart, Andrew Salverson, George Zhou, Mary Burke, and Jong Chan Ly. 2009. WAWTTAR, A planning tool for selecting wastewater treatment technologies. *Water, Environment, and Technology*, Water Environment Federation, Vol. 21, No. 10, pp. 51-54
- [16] Schütze, M., Wrieger-Bechtold, A., Zinati, T., Söbke, H., Wißmann, I., Schulz, M., Vesper, S., Londong, J., Barjenbruch, M., & Alex, J. (2019). Simulation and visualization of material flows in sanitation systems for streamlined sustainability assessment. *Water Science and Technology*, 79(10), 1966–1976. <https://doi.org/10.2166/wst.2019.199>
- [17] Spuhler, D., Germann, V., Kassa, K., Ketema, A. A., Sherpa, A. M., Sherpa, M. G., Maurer, M., Lüthi, C., & Langergraber, G. (2020). Developing sanitation planning options: A tool for systematic consideration of novel technologies and systems. *Journal of Environmental Management*, 271, 111004. <https://doi.org/10.1016/j.jenvman.2020.111004>
- [18] Schrecongost, A., Pedi, D., Rosenboom, J. W., Shrestha, R. R., & Ban, R. (2020). Citywide Inclusive Sanitation: A public service approach for reaching the urban Sanitation SDGs. *Frontiers in Environmental Science*, 8. <https://doi.org/10.3389/fenvs.2020.00019>
- [19] Prouty, C., Mohebbi, S., & Zhang, Q. (2018). Socio-technical strategies and behavior change to increase the adoption and sustainability of wastewater resource recovery systems. *Water Research*, 137, 107–119. <https://doi.org/10.1016/j.watres.2018.03.009>
- [20] Jiménez, A., LeDeunff, H., Giné, R., Sjödin, J., Cronk, R., Murad, S., Takane, M., & Bartram, J. (2019). The Enabling Environment for Participation in Water and Sanitation: A Conceptual Framework. *Water*, 11(2), 308. <https://doi.org/10.3390/w11020308>

Appendix B - Result Search Query Design Criteria

Authors	Article Title	Publication Year	Bundle name discard reason
Akhoundi, A; Nazif, S	Sustainability assessment of wastewater reuse alternatives using the evidential reasoning approach	2018	
Aubert, AH; Schmid, S; Beutler, P; Lienert, J	Innovative online survey about sustainable wastewater management: What young Swiss citizens know and value	2022	
Capell, R; Bartosova, A; Tonderski, K; Arheimer, B; Pedersen, SM; Zilans, A	From local measures to regional impacts: Modelling changes in nutrient loads to the Baltic Sea	2021	Not sanitation
Bao, PN; Aramaki, T; Hanaki, K	Assessment of stakeholders' preferences towards sustainable sanitation scenarios	2013	
Ben Brahim-Neji, H; Ruiz-Villaverde, A; Gonzalez-Gomez, F	Decision aid supports for evaluating agricultural water reuse practices in Tunisia: The Cebala perimeter	2014	
Wooten, MS; Hawley, RJ; Rust, C	Optimizing stormwater management to facilitate urban stream restoration via a science-based approach	2022	Not sanitation
Buzuku, S; Kraslawski, A	APPLICATION OF MORPHOLOGICAL ANALYSIS TO POLICY FORMULATION FOR WASTEWATER TREATMENT	2015	
Li, YR; Zhang, XC; Cao, Z; Liu, ZJ; Lu, Z; Liu, YS	Towards the progress of ecological restoration and economic development in China's Loess Plateau and strategy for more sustainable development	2021	Not sanitation
Chamberlain, BC; Carenini, G; Oberg, G; Poole, D; Taheri, H	A Decision Support System for the Design and Evaluation of Sustainable Wastewater Solutions	2014	
Routray, P; Torondel, B; Clasen, T; Schmidt, WP	Women's role in sanitation decision making in rural coastal Odisha, India	2017	Not treatment process
Meerholz, A; Brent, AC	ASSESSING THE SUSTAINABILITY OF WASTEWATER TREATMENT TECHNOLOGIES IN THE PETROCHEMICAL INDUSTRY	2013	Not domestic wastewater
Chirgwin, H; Cairncross, S; Zehra, D; Waddington, HS	Interventions promoting uptake of water, sanitation and hygiene (WASH) technologies in low- and middle-income countries: An evidence and gap map of effectiveness studies	2021	
Curiel-Esparza, J; Cuenca-Ruiz, MA; Martin-Utrillas, M; Canto-Perello, J	Selecting a Sustainable Disinfection Technique for Wastewater Reuse Projects	2014	
Delea, MG; Sclar, GD; Woreta, M; Haardorfer, R; Nagel, CL; Caruso, BA; Dreibelbis, R; Gobezyehu, AG; Clasen, TF; Freeman, MC	Collective Efficacy: Development and Validation of a Measurement Scale for Use in Public Health and Development Programmes	2018	
Narayanamoorthy, S; Annapoorani, V; Kang, D; Ramya, L	Sustainable Assessment for Selecting the Best Alternative of Reclaimed Water Use Under Hesitant Fuzzy Multi-Criteria Decision Making	2019	Not treatment process
Sztraicher, J; Morgan, L; Okaygun, E; Terrell, M; Fry, A; Pailla, S; Louis, G	Iterative Design and Information Communication Technology for Community Development	2014	Not sanitation
Furness, M; Bello-Mendoza, R; Dassonville, J; Chamy-Maggi, R	Building the 'Bio-factory': A bibliometric analysis of circular economies and Life Cycle Sustainability Assessment in wastewater treatment	2021	
Garrido-Baserba, M; Hospido, A; Reif, R; Molinos-Senante, M; Comas, J; Poch, M	Including the environmental criteria when selecting a wastewater treatment plant	2014	
Roskosky, M; Acharya, B; Shakya, G; Karki, K; Sekine, K; Bajracharya, D; von Seidlein, L; Devaux, I; Lopez, AL; Deen, J; Sack, DA	Feasibility of a Comprehensive Targeted Cholera Intervention in The Kathmandu Valley, Nepal	2019	Not sanitation
Habib, MA; Soofi, S; Sadiq, K; Samejo, T; Hussain, M; Mirani, M; Rehmatullah, A; Ahmed, I; Bhutta, ZA	A study to evaluate the acceptability, feasibility and impact of packaged interventions (Diarrhea Pack) for prevention and treatment of childhood diarrhea in rural Pakistan	2013	Not sanitation
Rahmayati, Y; Parnell, M; Himmayani, V	Understanding community-led resilience: the Jakarta floods experience	2017	Not sanitation
Salisbury, F; Brouckaert, C; Still, D; Buckley, C	Multiple criteria decision analysis for sanitation selection in South African municipalities	2018	Not treatment process
Gherghel, A; Teodosiu, C; Notarnicola, M; De Gisi, S	Sustainable design of large wastewater treatment plants considering multi-criteria decision analysis and stakeholders' involvement	2020	
Blanco, C; Wall, MM; Olfson, M	Data needs and models for the opioid epidemic	2022	Not sanitation
Haag, F; Aubert, AH; Lienert, J	ValueDecisions, a web app to support decisions with conflicting objectives, multiple stakeholders, and uncertainty	2022	
Dias, LC; Cunha, MC; Watkins, E; Triantaphyllidis, G	A multi-criteria assessment of policies to achieve the objectives of the EU marine litter strategy	2022	Not sanitation
Silva, JIAO; Melo, AP	The Brazilian Water Management System and public participation: the case of the Paraíba River basin	2020	Not sanitation
Hadipour, A; Rajaei, T; Hadipour, V; Seidrad, S	Multi-criteria decision-making model for wastewater reuse application: a case study from Iran	2016	

Harris-Lovett, S; Lienert, J; Sedlak, DL	Towards a New Paradigm of Urban Water Infrastructure: Identifying Goals and Strategies to Support Multi-Benefit Municipal Wastewater Treatment	2018	
Tuhebewe, D; Babirye, S; Ssendagire, S; Ssengooba, F	The extent to which the design of available reproductive health interventions fit the reproductive health needs of adolescents living in urban poor settings of Kisenyi, Kampala, Uganda	2021	Not sanitation
Kalbar, PP; Karmakar, S; Asolekar, SR	The influence of expert opinions on the selection of wastewater treatment alternatives: A group decision-making approach	2013	
Heberling, MT; Thurston, HW; Nietch, CT	Exploring Nontraditional Participation as an Approach to Make Water Quality Trading Markets More Effective	2018	Not treatment process
Kanda, A; Ncube, EJ; Voyi, K	Selection of appropriate on-site household sanitation options for rural communities of Zimbabwe - case of Mbire district, Zimbabwe	2023	
Kanda, A; Ncube, EJ; Voyi, K	Adapting Sanitation Needs to a Latrine Design (and Its Upgradable Models): A Mixed Method Study under Lower Middle-Income Rural Settings	2021	
Krause, A; Koppel, J	A Multi-Criteria Approach for Assessing the Sustainability of Small-Scale Cooking and Sanitation Technologies	2018	
Lee, EJ; Criddle, CS; Geza, M; Cath, TY; Freyberg, DL	Decision support toolkit for integrated analysis and design of reclaimed water infrastructure	2018	
Ndeketeya, A; Dundu, M	Urban Rainwater Harvesting Adoption Potential in a Socio-economically Diverse City Using a GIS-based Multi-criteria Decision Method	2022	Not sanitation
Opher, T; Shapira, A; Friedler, E	A comparative social life cycle assessment of urban domestic water reuse alternatives	2018	Not treatment process
Edalat, FD; Abdi, MR	Constraints on the Adoption of Adaptive Water Management Principles: the Case of Greater Tehran	2015	Not treatment process
Aralp, CL; Scheri, JJ; O'Sullivan, K	Recovering Sandy: Rehabilitation of Wastewater Pumping Stations after Superstorm Sandy	2016	Not treatment process
Li, YL; Zhang, XY; Morgan, VL; Lohman, HAC; Rowles, LS; Mittal, S; Kogler, A; Cusick, RD; Tarpeh, WA; Guest, JS	QSDsan: an integrated platform for quantitative sustainable design of sanitation and resource recovery systems	2022	
Mautner, MRL; Foglia, L; Herman, JD	Coupled effects of observation and parameter uncertainty on urban groundwater infrastructure decisions	2022	Not sanitation
Martin, DW; Sloan, ML; Gleason, BL; de Wit, L; Vandt, MA; Kargbo, DK; Clemens, N; Kamara, A; Njuguna, C; Sesay, S; Singh, T	Implementing Nationwide Facility-based Electronic Disease Surveillance in Sierra Leone: Lessons Learned	2020	Not sanitation
Nguyen, NBT; Lin, GH; Dang, TT	A Two Phase Integrated Fuzzy Decision-Making Framework for Green Supplier Selection in the Coffee Bean Supply Chain	2021	Not sanitation
Chassalevris, T; Chaintoutis, SC; Koureas, M; Petala, M; Moutou, E; Beta, C; Kyritsi, M; Hadjichristodoulou, C; Kostoglou, M; Karapantsios, T; Papadopoulos, A; Papaioannou, N; Dovas, CI	SARS-CoV-2 wastewater monitoring using a novel PCR-based method rapidly captured the Delta-to-Omicron ??1 transition patterns in the absence of conventional surveillance evidence	2022	Not treatment process
de Faria, ABB; Besson, M; Ahmadi, A; Udert, KM; Sperandio, M	Dynamic Influent Generator for Alternative Wastewater Management with Urine Source Separation	2020	Not treatment process
McGranahan, G; Mitlin, D	Learning from Sustained Success: How Community-Driven Initiatives to Improve Urban Sanitation Can Meet the Challenges	2016	
Bichai, F; Smeets, PWMH	Using QMRA-based regulation as a water quality management tool in the water security challenge: Experience from the Netherlands and Australia	2013	Not treatment process
Setty, K; Jimenez, A; Willetts, J; Leifels, M; Bartram, J	Global water, sanitation and hygiene research priorities and learning challenges under Sustainable Development Goal 6	2020	Not sanitation
Nguyen, HT; Safder, U; Nguyen, XQN; Yoo, C	Multi-objective decision-making and optimal sizing of a hybrid renewable energy system to meet the dynamic energy demands of a wastewater treatment plant	2020	Not sanitation
MacRobert, CJ	A review of impacts associated with infrastructure news coverage in South Africa	2020	Not sanitation
Sepulveda, CDI; Perez, RAO; Salazar, TB; Ayon, YPI	Classification of Urban Water Management in Mid-Sized Sinaloa Cities in Mexico (2010-2012)	2015	Not sanitation
Grover, P; Kar, AK; Gupta, S; Modgil, S	Influence of political leaders on sustainable development goals - insights from twitter	2021	Not sanitation
Addis, M; Worku, W; Bogale, L; Shimelash, A; Tegegne, E	Hygienic Child Feces Disposal Practice and Its Associated Factors among Mothers/Caregivers of Under Five Children in West Armachiho District, Northwest Ethiopia	2022	Not treatment process
Ugwu, CLJ; Zewotir, TT	Using mixed effects logistic regression models for complex survey data on malaria rapid diagnostic test results	2018	Not sanitation
Victral, DM; Heller, L	The Human Rights to Water and Sanitation in Policy Responses to the COVID-19 Pandemic: An Analysis of Brazilian States	2021	Not sanitation
Moosavian, SF; Borzuei, D; Ahmadi, A	Cost Analysis of Water Quality Assessment Using Multi-Criteria Decision-Making Approach	2022	
Nunbogu, AM; Harter, M; Mosler, HJ	Factors Associated with Levels of Latrine Completion and Consequent Latrine Use in Northern Ghana	2019	

Nyoka, R; Foote, AD; Woods, E; Lokey, H; O'Reilly, CE; Magumba, F; Okello, P; Mintz, ED; Marano, N; Morris, JF	Sanitation practices and perceptions in Kakuma refugee camp, Kenya: Comparing the status quo with a novel service-based approach	2017	
MacDonald, DH; Ardeshiri, A; Rose, JM; Russell, BD; Connell, SD	Valuing coastal water quality: Adelaide, South Australia metropolitan area	2015	Not sanitation
Freire-Gormaly, M; Bilton, AM	OPTIMIZATION OF RENEWABLE ENERGY POWER SYSTEMS FOR REMOTE COMMUNITIES	2016	Not sanitation
Agarwal, S; Singh, AP	Performance evaluation of textile wastewater treatment techniques using sustainability index: An integrated fuzzy approach of assessment	2022	Not domestic wastewater
Szabo, L; Gyenes, O; Szabo, J; Kovacs, K; Kovacs, A; Kisko, G; Belak, A; Mohacsi-Farkas, C; Takacs, E; Wojnarovits, L	Electron beam treatment for eliminating the antimicrobial activity of piperacillin in wastewater matrix	2018	Not relevant for design criteria
Omran, II; Al-Saati, NH; Al-Saati, HH; Hashim, KS; Al-Saati, ZN	Sustainability assessment of wastewater treatment techniques in urban areas of Iraq using multi-criteria decision analysis (MCDA)	2021	
Liao, JJ; Zhen, JN; Zhang, L; Metternicht, G	Understanding Dynamics of Mangrove Forest on Protected Areas of Hainan Island, China: 30 Years of Evidence from Remote Sensing	2019	Not sanitation
Opher, T; Friedler, E; Shapira, A	Comparative life cycle sustainability assessment of urban water reuse at various centralization scales	2019	
Okyerere, CY; Pangaribowo, EH; Gerber, N	Household Water Quality Testing and Information: Identifying Impacts on Health Outcomes and Sanitation- and Hygiene-Related Risk-Mitigating Behaviors	2019	Not treatment process
Watson, SS; Ferraris, CF; Averill, JD	Role of materials selection in the resilience of the built environment	2018	Not sanitation
Mwai, J; Njenga, S; Barasa, M	Knowledge, attitude and practices in relation to prevention and control of schistosomiasis infection in Mwea Kirinyaga county, Kenya	2016	Not sanitation
Zagonari, F; Rossi, C	A spatial decision support system for optimally locating treatment plants for safe wastewater reuse: an application to Saudi Arabia	2020	Not treatment process
Paulo, PL; Galbiati, AF; Magalhaes, FJC; Bernardes, FS; Carvalho, GA; Boncz, MA	Evapotranspiration tank for the treatment, disposal and resource recovery of blackwater	2019	
Storey, HL; Agarwal, N; Cantera, J; Golden, A; Gallo, K; Herrick, T; Belizario, V; Kihara, J; Mwandawiro, C; Cadwallader, B; de los Santos, T	Formative research to inform development of a new diagnostic for soil-transmitted helminths: Going beyond the laboratory to ensure access to a needed product	2019	Not sanitation
Fick, DR; Gribb, MM; Tinant, CJ	The Impact of Project-Based Service Learning in a Native American Community on Student Performance in Civil Engineering Capstone Design	2013	Not sanitation
Ramezaniipour, M; Sivakumar, M	MULTI-OBJECTIVE ANALYSIS FOR THE SELECTION OF A SUSTAINABLE GREYWATER TREATMENT SYSTEM	2019	
Rupf, GV; Bahri, PA; de Boer, K; McHenry, MP	Development of a model for identifying the optimal biogas system design in Sub-Saharan Africa	2016	
Salamirad, A; Kheybari, S; Ishizaka, A; Farazmand, H	Wastewater treatment technology selection using a hybrid multicriteria decision-making method	2023	
Ozturk, S; Tonuk, GU	STAKEHOLDER PARTICIPATION AS A MEANS FOR RIVER BASIN MANAGEMENT PLAN	2013	Not sanitation
Hwangbo, S; Heo, S; Yoo, C	Network modeling of future hydrogen production by combining conventional steam methane reforming and a cascade of waste biogas treatment processes under uncertain demand conditions	2018	Not sanitation
Sapkota, M; Arora, M; Malano, H; Sharma, A; Moglia, M	Integrated Evaluation of Hybrid Water Supply Systems Using a PROMETHEE-GAIA Approach	2018	
Scholz, M	Sustainable Water Systems	2013	
Sucu, S; van Schaik, MO; Esmeli, R; Ouelhadj, D; Holloway, T; Williams, JB; Cruddas, P; Martinson, DB; Chen, WS; Cappon, HJ	A conceptual framework for a multi-criteria decision support tool to select technologies for resource recovery from urban wastewater	2021	
Mishra, NR; Mohanty, SK; Mittra, D; Shah, M; Meitei, WB	Projecting stunting and wasting under alternative scenarios in Odisha, India, 2015-2030: a Lives Saved Tool (LiST)-based approach	2019	Not sanitation
De Feo, G; De Gisi, S; De Vita, S; Notarnicola, M	Sustainability assessment of alternative end-uses for disused areas based on multi-criteria decision-making method	2018	Not sanitation
Temesgen, A; Adane, MM; Birara, A; Shibabaw, T	Having a latrine facility is not a guarantee for eliminating open defecation owing to sociodemographic and environmental factors: The case of Machakel district in Ethiopia	2021	
Alencar, MH; Priori, L; Alencar, LH	Structuring objectives based on value-focused thinking methodology: Creating alternatives for sustainability in the built environment	2017	Not sanitation
Faia, HB	INFRASTRUCTURAL ECOLOGY AS A PLANNING PARADIGM: TWO CASE STUDIES	2018	Not sanitation
Tepong-Tsinde, R; Crane, R; Noubactep, C; Nassi, A; Ruppert, H	Testing Metallic Iron Filtration Systems for Decentralized Water Treatment at Pilot Scale	2015	
Shen, Z; Song, X; Li, Y; Gu, MY; Yu, YB; Miao, J; Zhu, H; Zhou, XF; Zhang, YL	Particle size distribution characterization of swine wastewater using membrane treatment process for resource recovery	2021	Not relevant for design criteria

Tjandraatmadja, G; Sharma, AK; Grant, T; Pamminger, F	A Decision Support Methodology for Integrated Urban Water Management in Remote Settlements	2013	
Sandoval-Herazo, LC; Alvarado-Lassman, A; Marin-Muniz, JL; Mendez-Contreras, JM; Zamora-Castro, SA	Effects of the Use of Ornamental Plants and Different Substrates in the Removal of Wastewater Pollutants through Microcosms of Constructed Wetlands	2018	Not relevant for design criteria
Tumwebaze, IK; Rose, JB; Hofstra, N; Verbyla, ME; Okaali, DA; Katsivelis, P; Murphy, HM	Bridging Science and Practice-Importance of Stakeholders in the Development of Decision Support: Lessons Learned	2021	
Duppati, GR; Hailemariam, S; Murray, R; Kivell, J	Electricity access and green financing in the African region	2022	Not sanitation
Wells, EC; Zarger, RK; Whiteford, LM; Mihelcic, JR; Koenig, ES; Cairns, MR	The impacts of tourism development on perceptions and practices of sustainable wastewater management on the Placencia Peninsula, Belize	2016	
Bukhary, S; Batista, J; Ahmad, S	Design Aspects, Energy Consumption Evaluation, and Offset for Drinking Water Treatment Operation	2020	Not treatment process
Younes, MK	Integration of Mathematical Median Ranked Set Sample and Decision Making AHP Tools to Enhance Decentralized Wastewater Treatment System	2020	
Odhiambo, GO; Musuva, RM; Atuncha, VO; Mutete, ET; Odier, MR; Onyango, RO; Alaii, JA; Mwinzi, PNM	Low Levels of Awareness Despite High Prevalence of Schistosomiasis among Communities in Nyalenda Informal Settlement, Kisumu City, Western Kenya	2014	Not sanitation
Gautam, M; Wankhade, K; Sarangan, G; Sudhakar, S	Framework for addressing occupational safety of de-sludging operators: A study in two Indian cities	2021	Not treatment process
Andre, A; Nagy, T; Toth, AJ; Haaz, E; Fozer, D; Tarjani, JA; Mizsey, P	Distillation contra pervaporation: Comprehensive investigation of isobutanol-water separation	2018	Not relevant for design criteria
Roodsari, BN; Nowicki, EP; Freere, P	The Distributed Electronic Load Controller: A New Concept for Voltage Regulation in Microhydro Systems with Transfer of Excess Power to Households	2014	Not sanitation
Reid, J; Zeng, C; Wood, D	Combining Social, Environmental and Design Models to Support the Sustainable Development Goals	2019	Not sanitation
Zheng, J; Egger, C; Lienert, J	A scenario-based MCDA framework for wastewater infrastructure planning under uncertainty	2016	

Appendix C - Overview Substantiation Design Criteria

Acceptability Recovered Resources

Sucu et al. (2021)
Furness et al. (2021)
Lee et al. (2018)
Hadipour et al. (2015)
Nyoka et al. (2017)
Akhoundi and Nazif (2018)
Wells et al. (2016)

Acceptability Technology

Tjandraatmadja et al. (2012)
Chamberlain et al. (2014)
Zheng et al. (2016)
Younes (2020)
Ramezaniapour and Sivakumar (2019)
Nyoka et al. (2017)
Curiel-Esparza et al. (2014)
Kanda et al. (2023)
Omran et al. (2021)
Wells et al. (2016)
Kalbar et al. (2013)
Haag et al. (2022)
Salamirad et al. (2021)

Clean/Dirty

Nunbogu et al. (2019)
Temesgen et al. (2021)
Nyoka et al. (2017)

Collective Efficacy

Delea et al. (2018)

Community Safety and Wellbeing

Tjandraatmadja et al. (2012)
Krause and Koppel (2018)
Zheng et al. (2016)
Kanda et al. (2021)
Lee et al. (2018)
Nunbogu et al. (2019)
Aubert et al. (2022)
Younes (2020)
Hadipour et al. (2015)
Ramezaniapour and Sivakumar (2019)
Nyoka et al. (2017)
Curiel-Esparza et al. (2014)
Kanda et al. (2023)
Akhoundi and Nazif (2018)
Wells et al. (2016)

Haag et al. (2022)

Competition

Furness et al. (2021)

Demographics

Tjandraatmadja et al. (2012)

Bao et al. (2012)

Nunbogu et al. (2019)

Omran et al. (2021)

End-user Behaviour

Tjandraatmadja et al. (2012)

Delea et al. (2018)

Temesgen et al. (2021)

Kalbar et al. (2013)

Environmental Friendly

Tjandraatmadja et al. (2012)

Krause and Koppel (2018)

Zheng et al. (2016)

Bao et al. (2012)

Furness et al. (2021)

Lee et al. (2018)

Younes (2020)

Hadipour et al. (2015)

Li et al. (2022)

Curiel-Esparza et al. (2014)

Kanda et al. (2023)

Akhoundi and Nazif (2018)

Gherghel et al. (2020)

Haag et al. (2022)

Salamirad et al. (2021)

Expertise Required

Tjandraatmadja et al. (2012)

Kanda et al. (2021)

Bao et al. (2012)

Rupf et al. (2016)

Paulo et al. (2019)

Nunbogu et al. (2019)

Temesgen et al. (2021)

Younes (2020)

McGranahan and Mitlin (2016)

Hadipour et al. (2015)

Curiel-Esparza et al. (2014)

Kanda et al. (2023)

Akhoundi and Nazif (2018)

Omran et al. (2021)

Tepong-Tsinde et al. (2015)

Salamirad et al. (2021)

Fly Nuisance

Kanda et al. (2021)

Nunbogu et al. (2019)

Nyoka et al. (2017)

Akhoundi and Nazif (2018)

Geographical Limitations

Tjandraatmadja et al. (2012)

Chamberlain et al. (2014)

Lee et al. (2018)

Garrido-Baserba et al. (2014)

Omran et al. (2021)

Tepong-Tsinde et al. (2015)

Kalbar et al. (2013)

Salamirad et al. (2021)

Government Capacity

Chamberlain et al. (2014)

Hadipour et al. (2015)

Income Recovered Resources

Sucu et al. (2021)

Job Creation

Chamberlain et al. (2014)

Lee et al. (2018)

Rupf et al. (2016)

Nyoka et al. (2017)

Akhoundi and Nazif (2018)

Omran et al. (2021)

Haag et al. (2022)

Labour Intensity

Tjandraatmadja et al. (2012)

Krause and Koppel (2018)

Lee et al. (2018)

Kanda et al. (2023)

Akhoundi and Nazif (2018)

Omran et al. (2021)

Salamirad et al. (2021)

Low Maintenance

Tjandraatmadja et al. (2012)
Paulo et al. (2019)
Temesgen et al. (2021)
Aubert et al. (2022)
Hadipour et al. (2015)
Ramezaniyanpour and Sivakumar (2019)
Nyoka et al. (2017)
Akhoundi and Nazif (2018)
Tepong-Tsinde et al. (2015)
Kalbar et al. (2013)
Salamirad et al. (2021)

Market Readiness

Chamberlain et al. (2014)
Lee et al. (2018)

Market Value

Chamberlain et al. (2014)
Furness et al. (2021)
Lee et al. (2018)
Akhoundi and Nazif (2018)
Wells et al. (2016)

No Interference with users' activities

Tjandraatmadja et al. (2012)
Zheng et al. (2016)
Kanda et al. (2021)
Rupf et al. (2016)
Nunbogu et al. (2019)
Aubert et al. (2022)
Kanda et al. (2023)
Omran et al. (2021)
Wells et al. (2016)

Policy Alignment

Tjandraatmadja et al. (2012)
Krause and Koppel (2018)
Furness et al. (2021)
Nunbogu et al. (2019)
Garrido-Baserba et al. (2014)
McGranahan and Mitlin (2016)
Hadipour et al. (2015)
Kanda et al. (2023)
Scholz (2013)
Kalbar et al. (2013)
Salamirad et al. (2021)

Privacy

Kanda et al. (2021)
Bao et al. (2012)
Nunbogu et al. (2019)
Temesgen et al. (2021)
McGranahan and Mitlin (2016)

Protection

Kanda et al. (2021)
Nunbogu et al. (2019)
McGranahan and Mitlin (2016)

Regulations

Chamberlain et al. (2014)
Lee et al. (2018)

Reliability

Tjandraatmadja et al. (2012)
Krause and Koppel (2018)
Rupf et al. (2016)
Curiel-Esparza et al. (2014)
Wells et al. (2016)

Replicability

Kalbar et al. (2013)

Shared Users

Kanda et al. (2021)
Bao et al. (2012)
Nunbogu et al. (2019)
Temesgen et al. (2021)
McGranahan and Mitlin (2016)
Li et al. (2022)
Nyoka et al. (2017)

Social Control

Delea et al. (2018)
Nunbogu et al. (2019)
McGranahan and Mitlin (2016)

Social Norms

Delea et al. (2018)
Nunbogu et al. (2019)
Temesgen et al. (2021)
McGranahan and Mitlin (2016)
Nyoka et al. (2017)
Akhoundi and Nazif (2018)

Adaptability to Influent Quality

Sucu et al. (2021)
Tjandraatmadja et al. (2012)
Zheng et al. (2016)
Rupf et al. (2016)
Paulo et al. (2019)
Garrido-Baserba et al. (2014)
Ramezaniyanpour and Sivakumar (2019)
Li et al. (2022)
Akhoundi and Nazif (2018)
Tepong-Tsinde et al. (2015)

Capital Expenditure

Sucu et al. (2021)
Tjandraatmadja et al. (2012)
Chamberlain et al. (2014)
Krause and Koppel (2018)
Zheng et al. (2016)
Kanda et al. (2021)
Bao et al. (2012)
Furness et al. (2021)
Lee et al. (2018)
Rupf et al. (2016)
Paulo et al. (2019)
Temesgen et al. (2021) Garrido-Baserba et al. (2014)
Younes (2020)
Hadipour et al. (2015)
Ramezaniyanpour and Sivakumar (2019)
Li et al. (2022)
Curiel-Esparza et al. (2014)
Kanda et al. (2023)
Akhoundi and Nazif (2018)
Omran et al. (2021)
Gherghel et al. (2020)
Tepong-Tsinde et al. (2015)
Kalbar et al. (2013)
Haag et al. (2022)
Salamirad et al. (2021)

Centralized/Decentralized

Sucu et al. (2021)
Zheng et al. (2016)
Bao et al. (2012)
Tumwebaze et al. (2021)
Lee et al. (2018)
Temesgen et al. (2021)
Aubert et al. (2022)
Younes (2020)
McGranahan and Mitlin (2016)
Li et al. (2022)
Akhoundi and Nazif (2018)

Tepong-Tsinde et al. (2015)

Climate Independency

Tjandraatmadja et al. (2012)

Bao et al. (2012)

Rupf et al. (2016)

Paulo et al. (2019)

Garrido-Baserba et al. (2014)

Akhoundi and Nazif (2018)

Scholz (2013)

Tepong-Tsinde et al. (2015)

Salamirad et al. (2021)

Energy Use

Chamberlain et al. (2014)

Zheng et al. (2016)

Furness et al. (2021)

Lee et al. (2018)

Rupf et al. (2016)

Garrido-Baserba et al. (2014)

Aubert et al. (2022)

Li et al. (2022)

Curiel-Esparza et al. (2014)

Akhoundi and Nazif (2018)

Omran et al. (2021)

Gherghel et al. (2020)

Fit for Environment

Sucu et al. (2021)

Chamberlain et al. (2014)

Kanda et al. (2021)

Bao et al. (2012)

Rupf et al. (2016)

Nunbogu et al. (2019)

Garrido-Baserba et al. (2014)

Younes (2020)

McGranahan and Mitlin (2016)

Kanda et al. (2023)

Akhoundi and Nazif (2018)

Scholz (2013)

Tepong-Tsinde et al. (2015)

Kalbar et al. (2013)

Flexibility

Sucu et al. (2021)

Zheng et al. (2016)

Bao et al. (2012)

Lee et al. (2018)

Akhoundi and Nazif (2018)

Omran et al. (2021)

Tepong-Tsinde et al. (2015)
Kalbar et al. (2013)

Lifetime

Sucu et al. (2021)
Kanda et al. (2021)
Younes (2020)
Kanda et al. (2023)
Omran et al. (2021)
Kalbar et al. (2013)
Salamirad et al. (2021)

Locally Available Construction Resources

Kanda et al. (2021)
Rupf et al. (2016)
Nunbogu et al. (2019)
Temesgen et al. (2021)
Garrido-Baserba et al. (2014)
Li et al. (2022)
Kanda et al. (2023)
Tepong-Tsinde et al. (2015)
Salamirad et al. (2021)

Monitoring Capability

Tjandraatmadja et al. (2012)
Salamirad et al. (2021)

Net Water Use

Tjandraatmadja et al. (2012)
Furness et al. (2021)
Ramezaniapour and Sivakumar (2019)
Haag et al. (2022)

Noise Potential

Sucu et al. (2021)
Tjandraatmadja et al. (2012)
Chamberlain et al. (2014)
Salamirad et al. (2021)

Odour Emission

Sucu et al. (2021)
Tjandraatmadja et al. (2012)
Chamberlain et al. (2014)
Kanda et al. (2021)
Nunbogu et al. (2019)
Younes (2020)
Nyoka et al. (2017)
Akhoundi and Nazif (2018)
Omran et al. (2021)
Salamirad et al. (2021)

Operational Expenditure

Sucu et al. (2021)
Tjandraatmadja et al. (2012)
Chamberlain et al. (2014)
Krause and Koppel (2018)
Zheng et al. (2016)
Bao et al. (2012)
Furness et al. (2021)
Lee et al. (2018)
Rupf et al. (2016)
Younes (2020)
McGranahan and Mitlin (2016)
Hadipour et al. (2015)
Ramezaniapour and Sivakumar (2019)
Li et al. (2022)
Curiel-Esparza et al. (2014)
Kanda et al. (2023)
Akhoundi and Nazif (2018)
Omran et al. (2021)
Gherghel et al. (2020)
Tepong-Tsinde et al. (2015)
Haag et al. (2022)
Salamirad et al. (2021)

Product Disposal

Tjandraatmadja et al. (2012)
Chamberlain et al. (2014)
Furness et al. (2021)
Lee et al. (2018)
Garrido-Baserba et al. (2014)
McGranahan and Mitlin (2016)
Ramezaniapour and Sivakumar (2019)
Nyoka et al. (2017)
Akhoundi and Nazif (2018)
Omran et al. (2021)
Gherghel et al. (2020)
Haag et al. (2022)
Salamirad et al. (2021)

Product Use

Furness et al. (2021)
Garrido-Baserba et al. (2014)
Ramezaniapour and Sivakumar (2019)
Li et al. (2022)
Curiel-Esparza et al. (2014)
Omran et al. (2021)
Tepong-Tsinde et al. (2015)
Kalbar et al. (2013)
Salamirad et al. (2021)

Reliability

Tjandraatmadja et al. (2012)
Zheng et al. (2016)
Bao et al. (2012)
Ramezaniapour and Sivakumar (2019)
Curiel-Esparza et al. (2014)
Akhoundi and Nazif (2018)
Omran et al. (2021)
Kalbar et al. (2013)

Removal Efficiency

Sucu et al. (2021)
Tjandraatmadja et al. (2012)
Zheng et al. (2016)
Tumwebaze et al. (2021)
Lee et al. (2018)
Rupf et al. (2016)
Garrido-Baserba et al. (2014)
Aubert et al. (2022)
Younes (2020)
Ramezaniapour and Sivakumar (2019)
Curiel-Esparza et al. (2014)
Akhoundi and Nazif (2018)
Omran et al. (2021)
Tepong-Tsinde et al. (2015)
Salamirad et al. (2021)

Resource Recovery Potential

Sucu et al. (2021)
Chamberlain et al. (2014)
Zheng et al. (2016)
Kanda et al. (2021)
Bao et al. (2012)
Furness et al. (2021)
Lee et al. (2018)
Rupf et al. (2016)
Garrido-Baserba et al. (2014)
Hadipour et al. (2015)
Li et al. (2022)
Nyoka et al. (2017)
Kanda et al. (2023)
Akhoundi and Nazif (2018)
Gherghel et al. (2020)
Kalbar et al. (2013)
Haag et al. (2022)
Salamirad et al. (2021)

Robustness

Lee et al. (2018)
Rupf et al. (2016)
Kanda et al. (2023)
Scholz (2013)
Wells et al. (2016)

Surface Area

Sucu et al. (2021)
Tjandraatmadja et al. (2012)
Lee et al. (2018)
Rupf et al. (2016)
Paulo et al. (2019)
Garrido-Baserba et al. (2014)
Ramezaniyanpour and Sivakumar (2019)
Li et al. (2022)
Curiel-Esparza et al. (2014)
Omran et al. (2021)
Gherghel et al. (2020)
Tepong-Tsinde et al. (2015)
Kalbar et al. (2013)
Salamirad et al. (2021)

Sustainability

Sucu et al. (2021)
Tjandraatmadja et al. (2012)
Zheng et al. (2016)
Furness et al. (2021)

Toxicity of Products

Sucu et al. (2021)
Tjandraatmadja et al. (2012)
Chamberlain et al. (2014)
Bao et al. (2012)
Rupf et al. (2016)
Paulo et al. (2019)
Garrido-Baserba et al. (2014)
Akhoundi and Nazif (2018)
Omran et al. (2021)
Gherghel et al. (2020)
Kalbar et al. (2013)
Salamirad et al. (2021)

Treatment Capacity

Sucu et al. (2021)
Tjandraatmadja et al. (2012)
Chamberlain et al. (2014)
Zheng et al. (2016)
Lee et al. (2018)
Paulo et al. (2019)
Garrido-Baserba et al. (2014)
McGranahan and Mitlin (2016)
Li et al. (2022)
Curiel-Esparza et al. (2014)
Omran et al. (2021)
Salamirad et al. (2021)

Upgrade Potential

Tjandraatmadja et al. (2012)
Kanda et al. (2021)
Lee et al. (2018)
Younes (2020)
Ramezaniapour and Sivakumar (2019)
Akhoundi and Nazif (2018)
Omran et al. (2021)
Salamirad et al. (2021)

Wastewater Produced

Sucu et al. (2021)
Tjandraatmadja et al. (2012)
Bao et al. (2012)
Lee et al. (2018)
Garrido-Baserba et al. (2014)
Younes (2020)
Hadipour et al. (2015)
Ramezaniapour and Sivakumar (2019)
Li et al. (2022)
Curiel-Esparza et al. (2014)
Akhoundi and Nazif (2018)
Tepong-Tsinde et al. (2015)
Salamirad et al. (2021)

Water Use

Zheng et al. (2016)
Bao et al. (2012)
Furness et al. (2021)
Rupf et al. (2016)
Paulo et al. (2019)
Temesgen et al. (2021)
Kanda et al. (2023)

Bibliography Appendix C - Overview Substantiation Design Criteria

Akhoundi, A. H., & Nazif, S. (2018). Sustainability assessment of wastewater reuse alternatives using the evidential reasoning approach. *Journal of Cleaner Production*, 195, 1350–1376. <https://doi.org/10.1016/j.jclepro.2018.05.220>

Aubert, A. H., Schmid, S., Beutler, P., & Lienert, J. (2022). Innovative online survey about sustainable wastewater management: What young Swiss citizens know and value. *Environmental Science & Policy*, 137, 323–335. <https://doi.org/10.1016/j.envsci.2022.08.018>

Báo, P. N., Aramaki, T., & Hanaki, K. (2012). Assessment of stakeholders' preferences towards sustainable sanitation scenarios. *Water and Environment Journal*, 27(1), 58–70. <https://doi.org/10.1111/j.1747-6593.2012.00327.x>

Chamberlain, B. C., Carenini, G., Öberg, G., Poole, D., & Taheri, H. (2014). Chamberlain et al. (2014) for the design and evaluation of sustainable wastewater solutions. *IEEE Transactions on Computers*, 63(1), 129–141. <https://doi.org/10.1109/tc.2013.140>

Curiel-Esparza, J., Cuenca-Ruiz, M. A., Martin-Utrillas, M., & Canto-Perello, J. (2014). Selecting a sustainable disinfection technique for wastewater reuse projects. *Water*, 6(9), 2732–2747. <https://doi.org/10.3390/w6092732>

Delea, M. G., Sclar, G. D., Woreta, M., Haardörfer, R., Nagel, C., Caruso, B. A., Dreibelbis, R., Gobeze, A. G., Clasen, T., & Freeman, M. C. (2018). Collective Efficacy: Development and validation of a measurement scale for use in public health and development programmes. *International Journal of Environmental Research and Public Health*, 15(10), 2139. <https://doi.org/10.3390/ijerph15102139>

Furness, M. F., Bello-Mendoza, R., Dassonville, J., & Chamy-Maggi, R. (2021). Building the 'Bio-factory': A bibliometric analysis of circular economies and Life Cycle Sustainability Assessment in wastewater treatment. *Journal of Cleaner Production*, 323, 129127. <https://doi.org/10.1016/j.jclepro.2021.129127>

Garrido-Baserba, M., Hospido, A., Reif, R., Molinos-Senante, M., Comas, J., & Poch, M. (2014). Including the environmental criteria when selecting a wastewater treatment plant. *Environmental Modelling and Software*, 56, 74–82. <https://doi.org/10.1016/j.envsoft.2013.11.008>

Gherghel, A., Teodosiu, C., Notarnicola, M., & De Gisi, S. (2020). Sustainable design of large wastewater treatment plants considering multi-criteria decision analysis and stakeholders' involvement. *Journal of Environmental Management*, 261, 110158. <https://doi.org/10.1016/j.jenvman.2020.110158>

Haag, F., Aubert, A. H., & Lienert, J. (2022). ValueDecisions, a web app to support decisions with conflicting objectives, multiple stakeholders, and uncertainty. *Environmental Modelling and Software*, 150, 105361. <https://doi.org/10.1016/j.envsoft.2022.105361>

Hadipour, A., Rajaei, T., Hadipour, V., & Seidirad, S. (2015). Multi-criteria decision-making model for wastewater reuse application: a case study from Iran. *Desalination and Water Treatment*, 57(30), 13857–13864. <https://doi.org/10.1080/19443994.2015.1060905>

Harris-Lovett, S., Lienert, J., & Sedlak, D. L. (2018). Towards a new paradigm of urban water infrastructure: Identifying goals and strategies to support Multi-Benefit municipal wastewater treatment. *Water*, 10(9), 1127. <https://doi.org/10.3390/w10091127>

Kalbar, P. P., Karmakar, S., & Asolekar, S. R. (2013). The influence of expert opinions on the selection of wastewater treatment alternatives: A group decision-making approach. *Journal of Environmental Management*, 128, 844–851. <https://doi.org/10.1016/j.jenvman.2013.06.034>

Kanda, A., Ncube, E. J., & Voyi, K. (2021). Adapting Sanitation Needs to a Latrine Design (and Its Upgradable Models): A Mixed Method Study under Lower Middle-Income Rural Settings. *Sustainability*, 13(23), 13444. <https://doi.org/10.3390/su132313444>

Kanda, A., Ncube, E. J., & Voyi, K. (2023). Selection of appropriate on-site household sanitation options for rural communities of Zimbabwe – case of Mbire district, Zimbabwe. *International Journal of Environmental Health Research*, 1–13. <https://doi.org/10.1080/09603123.2023.2166021>

Krause, A., & Köppel, J. (2018). A Multi-Criteria approach for assessing the sustainability of Small-Scale cooking and Sanitation technologies. *Challenges in Sustainability*, 6(1). <https://doi.org/10.12924/cis2018.06010001>

Lee, E. J., Criddle, C. S., Geza, M., Cath, T. Y., & Freyberg, D. L. (2018). Decision support toolkit for integrated analysis and design of reclaimed water infrastructure. *Water Research*, 134, 234–252. <https://doi.org/10.1016/j.watres.2018.01.037>

Li, Y., Zhang, X., Morgan, V. L., Lohman, H. a. C., Rowles, L. S., Mittal, S., Kogler, A., Cusick, R. D., Tarpeh, W. A., & Guest, J. S. (2022). QSDsan: an integrated platform for quantitative sustainable design of sanitation and resource recovery systems. *Environmental Science*, 8(10), 2289–2303. <https://doi.org/10.1039/d2ew00455k>

McGranahan, G., & Mitlin, D. (2016). McGranahan and Mitlin (2016) Success: How Community-Driven Initiatives to Improve Urban Sanitation Can Meet the Challenges. *World Development*, 87, 307–317. <https://doi.org/10.1016/j.worlddev.2016.06.019>

Nunbogu, A. M., Harter, M., & Mosler, H. (2019). Factors Associated with Levels of Latrine Completion and Consequent Latrine Use in Northern Ghana. *International Journal of Environmental Research and Public Health*, 16(6), 920. <https://doi.org/10.3390/ijerph16060920>

Nyoka, R., Foote, A. M., Woods, E., Lokey, H., O'Reilly, C. E., Magumba, F., Okello, P., Mintz, E. D., Marano, N., & Morris, J. (2017). Sanitation practices and perceptions in Kakuma refugee camp, Kenya: Comparing the status quo with a novel service-based approach. *PLOS ONE*, 12(7), e0180864. <https://doi.org/10.1371/journal.pone.0180864>

Omran, I. I., Al-Saati, N. H., Al-Saati, H. H., Hashim, K., & Al-Saati, Z. N. (2021). Sustainability assessment of wastewater treatment techniques in urban areas of Iraq using multi-criteria decision analysis (MCDA). *Water Practice & Technology*, 16(2), 648–660. <https://doi.org/10.2166/wpt.2021.013>

Paulo, P. L., Galbiati, A. F., Filho, F. J. C. M., Bernardes, F. S., Carvalho, G. A., & Boncz, M. Á. (2019). Evapotranspiration tank for the treatment, disposal and resource recovery of blackwater. *Resources, Conservation and Recycling*, 147, 61–66. <https://doi.org/10.1016/j.resconrec.2019.04.025>

Ramezaniapour, M., & Sivakumar, M. (2019). Multi-objective analysis for the selection of a sustainable greywater treatment system. *Environmental Engineering and Management Journal*, 18(1), 159–170. <https://doi.org/10.30638/eemj.2019.016>

Rupf, G. V., Bahri, P. A., De Boer, K., & McHenry, M. P. (2016). Development of a model for identifying the optimal biogas system design in Sub-Saharan Africa. In *Computer-aided chemical engineering* (pp. 1533–1538). <https://doi.org/10.1016/b978-0-444-63428-3.50260-5>

Salamirad, A., Kheybari, S., Ishizaka, A., & Farazmand, H. (2021). Wastewater treatment technology selection using a hybrid multicriteria decision-making method. *International Transactions in Operational Research*, 30(3), 1479–1504. <https://doi.org/10.1111/itor.12979>

Scholz, M. (2013). Sustainable water systems. *Water*, 5(1), 239–242. <https://doi.org/10.3390/w5010239>

Sucu, S., Van Schaik, M. O., Esmeli, R., Ouelhadj, D., Holloway, T. G., Williams, J., Cruddas, P., Martinson, B., Chen, W., & Cappon, H. (2021). A conceptual framework for a multi-criteria decision support tool to select technologies for resource recovery from urban wastewater. *Journal of Environmental Management*, 300, 113608. <https://doi.org/10.1016/j.jenvman.2021.113608>

Temesgen, A., Adane, M. M., Birara, A., & Shibabaw, T. (2021). Having a latrine facility is not a guarantee for eliminating open defecation owing to socio-demographic and environmental factors: The case of Machakel district in Ethiopia. *PLOS ONE*, 16(9), e0257813. <https://doi.org/10.1371/journal.pone.0257813>

Tepong-Tsindé, R., Crane, R. A., Noubactep, C., Nassi, A., & Ruppert, H. (2015). Testing metallic iron filtration systems for decentralized water treatment at pilot scale. *Water*, 7(12), 868–897. <https://doi.org/10.3390/w7030868>

Tjandraatmadja, G., Sharma, A., Grant, T., & Pamminer, F. (2012). Tjandraatmadja et al. (2012) for integrated urban water management in remote settlements. *Water Resources Management*, 27(2), 433–449. <https://doi.org/10.1007/s11269-012-0195-x>

Tumwebaze, I. K., Rose, J. B., Hofstra, N., Verbyla, M. E., Okaali, D. A., Katsivelis, P., & Murphy, H. M. (2021). Bridging Science and Practice-Importance of Stakeholders in the development of decision Support: Lessons learned. *Sustainability*, 13(10), 5744. <https://doi.org/10.3390/su13105744>

Wells, E. C., Zarger, R. K., Whiteford, L. M., Mihelcic, J. R., Koenig, E. S., & Cairns, M. R. (2016). The impacts of tourism development on perceptions and practices of sustainable wastewater management on the Placencia Peninsula, Belize. *Journal of Cleaner Production*, 111, 430–441. <https://doi.org/10.1016/j.jclepro.2014.08.050>

Younes, M. K. (2020). Integration of mathematical median ranked set sample and decision making AHP tools to enhance decentralized wastewater treatment system. *Journal of Water Chemistry and Technology*, 42(6), 472–479. <https://doi.org/10.3103/s1063455x20060132>

Zheng, J., Egger, C., & Lienert, J. (2016). A scenario-based MCDA framework for wastewater infrastructure planning under uncertainty. *Journal of Environmental Management*, 183, 895–908. <https://doi.org/10.1016/j.jenvman.2016.09.027>

Appendix D - Graphical Overview Merges Design Criteria

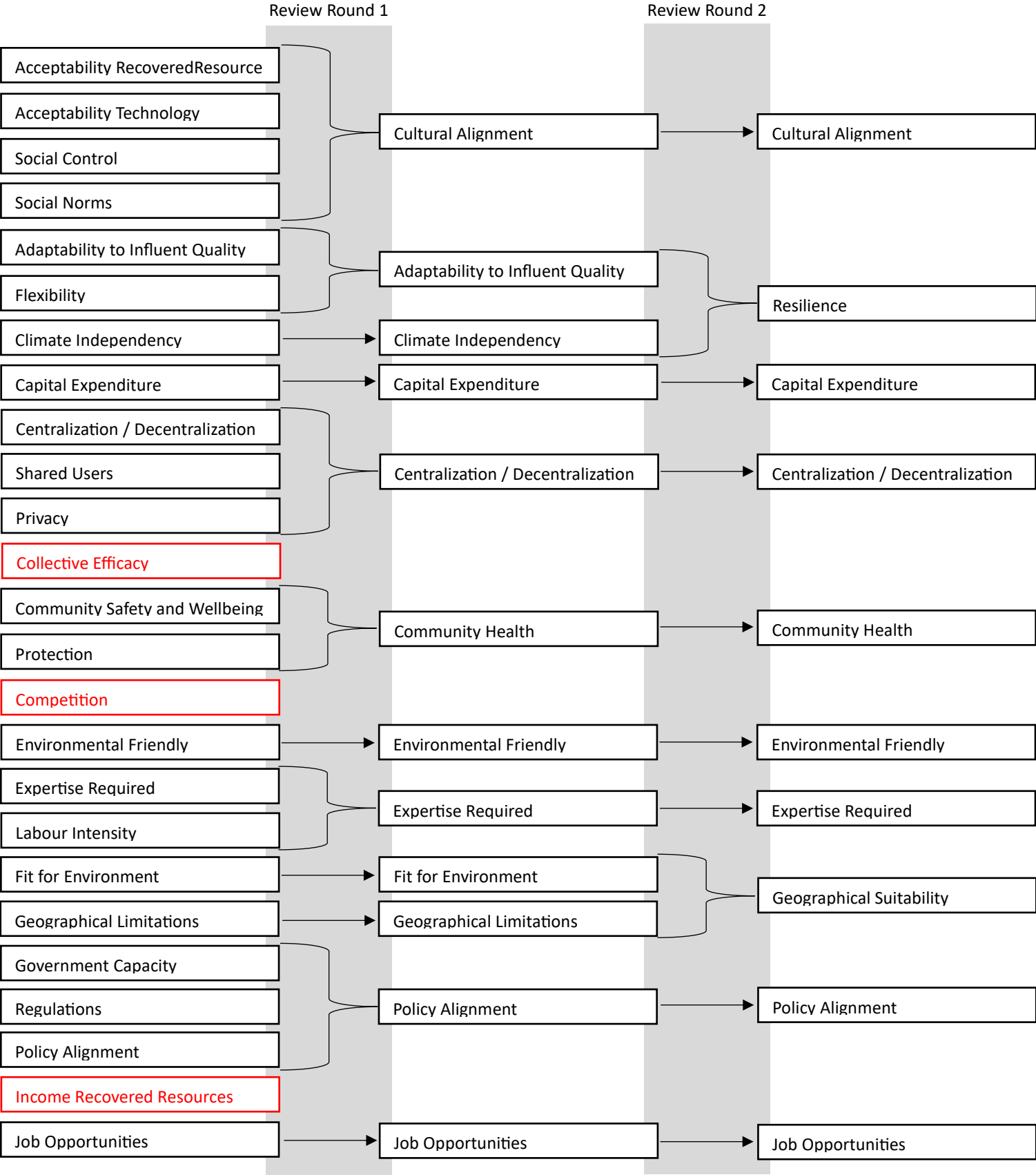

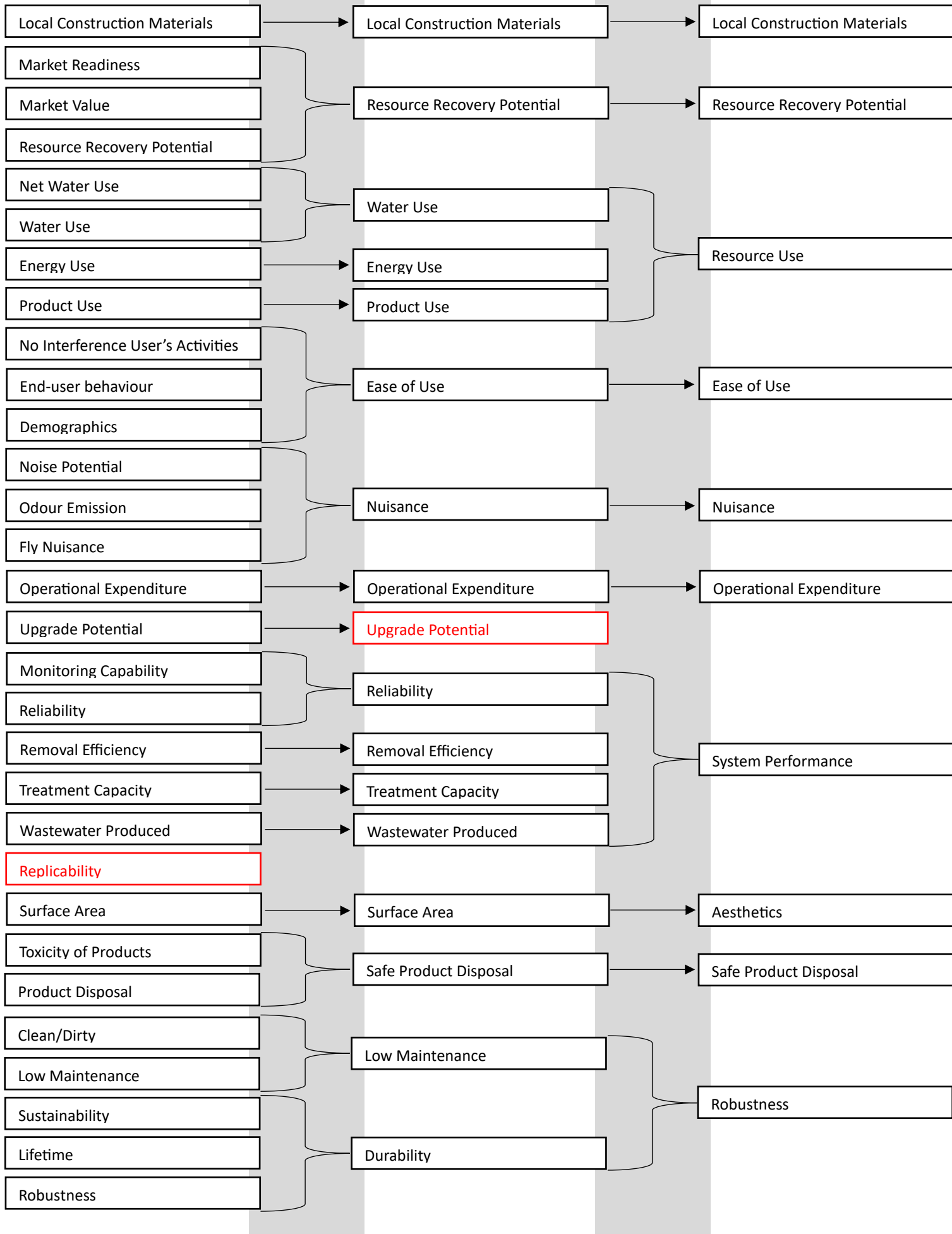

Appendix E – Definitions, Scenarios, and Examples to Design Criteria

Tag	Design criteria	Description	Category
S.1	Centralization/Decentralization	Centralization/Decentralization refers to the degree to which wastewater treatment facilities and their management are shared among its users	Definition
		In the context of this project, decentralized sanitation refers to a sanitation system on an individual household level, while centralized sanitation refers to a sanitation system on the neighbourhood level	Scenario
		Every family is responsible for treating their own wastewater versus the neighbourhood shares the facilities and the responsibilities	Example
S.2	Community Health	Community Health refers to promoting and maintaining the health and well-being of a community as a whole through the practice of sanitation	Definition
		The sanitation system should improve the overall health and cleanliness of the community	Scenario
		The spread of diseases such as diarrhoea, cholera, and typhoid are decreased because of the implementation of the sanitation system	Example
S.3	Cultural Alignment	Cultural Alignment refers to the degree of approval and satisfaction that various stakeholders, including the public, regulatory agencies, householders, and other community members, have towards a sanitation technology or treatment train based on their current values, beliefs, and ideologies	Definition
		The use of the sanitation system aligns with values, beliefs, and ideologies present in the community	Scenario
		The toilet allows people to rinse themselves with water after use	Example
S.4	Ease of Use	Ease of Use refers to a system's ability to minimize interference with users' activities, including low time investment, user-friendly features, and convenience in their daily routine	Definition
		The sanitation system is accessible and convenient in its use	Scenario
		The sanitation system can be used by elderly and less mobile community members as well	Example
S.5	Environmental Friendly	Environmental Friendly refers to wastewater treatment solutions, practices, or actions that prioritize protecting and conserving the local environment	Definition
		The (by-)products of the wastewater treatment system should not affect the health of the local environment in the vicinity of the treatment system	Scenario
		Flora and fauna are not negatively influenced by treating the wastewater	Example
S.6	Expertise Required	Expertise Required refers to the specific set and amount of skills, knowledge, and experience necessary to successfully perform a task or achieve a specific goal.	Definition
		The sanitation system should be simple and easy to construct, maintain and use	Scenario
		The community is able to install and operate the sanitation system itself, without external help	Example
S.7	Job Opportunities	Job Opportunities refers to the process of generating new employment opportunities through activities aimed at improving sanitation conditions.	Definition
		Implementation of the sanitation system creates job opportunities for members of the local community	Scenario
		Community members operate the system and are paid for their efforts	Example
S.8	Nuisance	Nuisance in the context of wastewater treatment refers to any unpleasant or irritating aspect resulting from the operation of the sanitation system, including the presence of pests, such as flies, rodents, and mosquitos, the release of unpleasant or noxious odours, and the level of noise generated.	Definition
		The sanitation system causes no pest, noise, or odour nuisance	Scenario
		Operating the sanitation system causes no bad smell, does not generate irritating noises and attracts no (unwanted) animals	Example
S.9	Policy Alignment	Policy Alignment refers to the extent to which a governmental organization establishes and enforces institutional arrangements and regulatory frameworks regarding sanitation.	Definition
		The sanitation system complies with the regulations and policies installed by the government	Scenario
		The local government supports the sanitation system by granting help, permits, and subsidies	Example
S.10	Aesthetics	Appearance refers to the visual aspects of the design of sanitation facilities, including their form, size, colour, texture	Definition
		The sanitation system is aesthetically pleasing	Scenario
		The size of the toilet is small and fits the existing design of the house	Example

Tag	Design Criteria	Description	Category
T.1	Capital expenditure	Capital expenditure refers to the total amount of money that is spent on the initial acquisition, construction, and installation of sanitation units	Definition
		The required initial investment to develop and construct the sanitation system is low	Scenario
		The construction of the sanitation system fits well within the budget of the local government	Example
T.2	Geographical suitability	Geographical suitability refers to the evaluation of a location's physical and environmental characteristics to determine its suitability - including topography, groundwater flow, soil conditions, and hydrogeological risks - to identify the most appropriate sanitation technology and system design for the specific site	Definition
		The sanitation system is tailored for the environmental conditions present at the targeted location	Scenario
		The sanitation system is able to operate in flood-prone areas	Example
T.3	Locally available construction resources	Locally available construction resources refer to the materials and resources that are readily accessible within a specific region or area and that can be used in the construction of wastewater treatment systems	Definition
		The sanitation system can be constructed with resources available at the targeted location	Scenario
		The construction of the sanitation system only requires wood, clay, and bricks	Example
T.4	Operational expenditure	Operational expenditure refers to the ongoing costs associated with the operation and maintenance of a sanitation unit process or system, such as personnel costs, energy costs, chemical costs, and maintenance and repair costs	Definition
		Operating the sanitation system is cheap	Scenario
		To operate the sanitation system, no expensive chemicals are required	Example
T.5	Resilience	Resilience refers to the ability of a wastewater treatment system to maintain consistent and effective performance despite variations in both influent quality and climatic conditions	Definition
		Changes in the local conditions of the treatment system do not affect the performance of the system	Scenario
		The treatment system is able to handle concentration peaks in the influent	Example
T.6	Resource recovery potential	Resource recovery potential refers to the ability of a process or technology to recover valuable resources from waste(water) – such as energy, nutrients, and water – suitable for local use	Definition
		The sanitation system allows the recovery of resources from domestic wastewater, such as biogas, fertilizer and/or water	Scenario
		The clean water produced by the treatment system is used for the irrigation of crops	Example
T.7	Resource use	Resource use refers to the amount of energy, water, and chemicals required to operate the wastewater treatment system	Definition
		The sanitation system requires little additional resources to operate	Scenario
		No extra chemicals are required to treat the wastewater	Example
T.8	Robustness	Robustness refers to remain operationally effective over its expected lifetime while requiring minimal upkeep, cleaning, or repairs	Definition
		The materials used for the sanitation system require little cleaning and maintenance to remain functional	Scenario
		The system does not contain compartments vulnerable for corrosion by wastewater	Example
T.9	Safe product disposal	Safe product disposal refers to the production, handling and disposal of potentially harmful waste products generated by a sanitation system	Definition
		The sanitation system does not produce harmful or toxic (by-) products	Scenario
		The treatment system does not concentrate heavy metals in the wastewater effluent up to toxic levels	Example
T.10	System performance	System performance refers to the effectiveness and consistency of a wastewater treatment process in achieving the desired effluent quality	Definition
		The quality of the wastewater produced by the sanitation system is consistently sufficient	Scenario
		The water is treated sufficiently to allow discharge of the wastewater produced	Example

Appendix F - Background Information Hagonoy

Topographical conditions

The Philippines is an archipelagic country, comprising over 7000 islands, located in Southeast Asia (). The location of interest is the municipality of Hagonoy, located in the southwest of the province of Bulacan on the main island of Luzon and approximately 54 kilometers from the Philippine capital Manila (Schaik, 2016; Abenir et al., 2022). The municipality of Hagonoy is located at 14°50'N, 120°44'E (PhilAtlas, 2021). The municipality spans 103.10 km² and is divided into 26 sub-municipalities: so-called barangays (Follosco-Aspiras & Santiago, 2016).

The municipality of Hagonoy is located in the North Manila Bay Delta, which is the connection between the Pampanga River Basin – a catchment area of 10,000 km² – and Manila Bay itself (JICA, 2011). The Delta's elevation ranges from 0-1 meters above Manila Sea Level (MSL) at the river outflow to 9 meters above MSL at 30 kilometers from the river outflow, causing the topography of Hagonoy to be relatively flat (RHDHV, 2022).

The Pampanga River Basin contains two 'main' river systems, the Pampanga River System in the West and the Angat River System in the East, which both pass Hagonoy before discharging in Manila Bay (Tabios III & de Leon, 2020). At the lower sections of the basin, the rivers are divided into relatively small branches and filled with fish ponds (PAGASA, n.d.). The province of Bulacan houses three dams, which are all constructed in the Angat River and serve as a water source for agricultural and domestic water use. The river source is located in the Sierra Madre mountain range, after which it consecutively passes the Angat dam, the Ipo dam, and the Bustos dam, with reservoir capacities of 7.5M m³, 850M m³, and 17M m³ respectively (PDRRMO Bulacan, n.d.; Philippine Star, 2014). During heavy rain, these dams discharge into the Pampanga River.

Climatic conditions

The Philippines is located close to the equator, resulting in a humid equatorial climate. Three seasons are distinguished, with the cool dry season between December and February, the hot dry season between March and May, and the rainy season between June and November (World Bank, 2021). The average temperature in the Philippines is 27 degrees Celsius, ranging between average temperatures of 21 and 32 degrees Celsius (PAGASA, 2015). The rainfall in central Luzon (the main island) averages an annual 4050 millimetres and the average humidity is 82% (CCKP, 2021; World Bank, 2021).

The Philippines was appointed as one of the most disaster-prone countries in the world by the United Nations University World Risk Report in 2014 (UNU, 2014). The severity and frequency of natural hazards in the Philippines have been increasing and are expected to increase in the upcoming years because of climate change (GFDRR, 2011; IPCC, 2019). According to the IPCC report from 2019 on the ocean and cryosphere in a changing climate, sea level rise causes submergence of land, increased flooding, coastal erosion, loss/change of coastal ecosystems, salinization of soils and waterbodies, and impeded drainage (IPCC, 2019; Williams et al., 2020).

According to the World Bank, 60% of the land surface and 74% of the population of the Philippines is exposed to natural hazards (CCKP, n.d.). The country is located on the tectonic Philippine Sea Plate, which is positioned in the convergence zone of the Eurasian Plate, the Pacific Plate, and the Indo-Australian Plate (Zhang et al., 2022). This meeting point of tectonic plates causes the country to contain multiple active volcanoes and the Philippines to be prone to earthquakes ().

The equatorial location of the Philippines makes the country prone to cyclones, with a yearly average of 19.4 tropical cyclones entering the country's area of responsibility (Cinco et al., 2016). While only 7-9 cyclones reach landfall, they provide approximately 40% of the annual rainfall, offsetting landslides and causing flooding (Yumul et al., 2010; Holden & Marshall, 2018). The geographical location of the Philippines have caused the country to be heavily affected by hydro-meteorological events, leading to floods, typhoons, monsoons, and thunderstorms to cause 80% of the natural disasters in the Philippines in the last 50 years (UNDRR, 2019).

Because of its location, the municipality of Hagonoy is subdued to pluvial, fluvial, and coastal flooding. The tide is diurnal and ranges between 1.2 meters during spring tide to 0.4 meters during

neap tide (Jacinto et al., 2006). Additionally, the tide can be increased by up to 80% during monsoons (June – September), or due to wind waves (Rodolfo & Siringan, 2016). The fluvial flood in Hagonoy is caused by the tide in Manila Bay, forcing the Pampanga River, the Hagonoy River, and the Labangan Floodway to overflow (Williams et al., 2020).

While the described problems are already occurring, Manila Bay is experiencing an additional 1.5 to 2.5 cm relative annual sea level rise (Mialhe et al., 2016, Morin et al, 2016). The deltaic location of Hagonoy causes natural ground subsidence, which is in turn increased by groundwater extraction, leading to observed ground subsidence of 2.5 – 5 cm per year in these areas (Rodolfo et al., 2003; Lagos et al., 2022). The increased land subsidence at the coast of Manila Bay is experienced as a relative sea level rise, enhancing the tidal floods in the coastal areas (Rodolfo and Siringan, 2006). Altogether, the tidal cycle results in five to seven floodings of Hagonoy per month on average (Van 't Veld, 2015). In a survey among 25 tricycle drivers in Hagonoy focussing on the effect of floods on their work, 56% of the tricycle drivers mentioned a frequency of seven floodings per week, while 20% and 24% of the interviewed tricycle drivers observed five to six and three to four floodings per week respectively (Umali et al., 2023). While efforts have been made by the municipality and the local government, neighborhoods in Hagonoy are still experiencing regular flooding. Although roads are elevated and hence usable again, many alleyways and homes are frequently or permanently flooded (Hiwasaki et al., 2015; Williams et al., 2020).

Demographical conditions

The Philippine Statistics Authority determined the number of inhabitants of Hagonoy at 133,448 in 2020 (PSA, 2020a). In 2015, the number of households in Hagonoy was established at 30,208 households, averaging 4.29 members per household. Within the same statistical analysis of the population, the average age was determined as 27 years (PSA, 2015). Of the entire population in Hagonoy in 2015, 28.61% (37,133 individuals) were aged under 14 and hence deemed directly depending on others. 5.56% (7,211 individuals) are older than 65, hence also dependent, resulting in an economically active population of 65.84% (85,463) (PSA, 2015).

The majority of the inhabitants belong to the ethnic group Tagalog, originating from the similarly named Tagalog region on the island of Luzon. The main language, both in Bulacan and the Philippines, is also called Tagalog (Centeno Savella, n.d.). The religious affiliation of the population of the Philippines is mainly Roman Catholic (78.8% of total individuals), followed by Islam (6.4%) and Iglesia ni Cristo (2.6%) (PSA, 2023).

The municipality of Hagonoy houses 29 public elementary schools, 10 private elementary schools, 4 public high schools, 4 private high schools, and two institutes for higher education: Bulacan State University and Hagonoy Institute of Technology (van Schaik, 2016).

Socio-economic conditions

The main economic driver in Hagonoy is the fishing industry, as Hagonoy serves as one of the main suppliers of fish to Metropolitan Manila (Province of Bulacan, n.d.). Over 70% of the municipal area is devoted to the aquaculture industry, with fish farming being the main driver of the local economy (Hagonoy Water District, 2016). The province of Bulacan is one of the largest producers of shrimp and fish, having adopted a polyculture farming strategy focusing on shrimps, milkfish, tilapia, and mudcrab (David et al., 2019). The frequency of flooding of the fish ponds has however led to the abandoning of some fish ponds, thereby causing large flooded areas to be without any spatial function (Ham, 2018). Besides fishermen, other main occupations concern taxi drivers, local business owners, and social workers (Juradoz, 2021).

The employment rate in the Philippines in 2022 was estimated at 95.6 percent, causing 4.4 percent of the population available for labor to be unemployed (PSA, 2023a). Nevertheless, the Philippine Statistics Authority (2022) concluded that approximately 20 million Filipinos (18.1% of the total population) live below the poverty threshold of 12,030 Philippine Pesos (PHP), causing them to be unable to foresee their basic food and non-food needs. An analysis of the Philippine Statistics Authority in 2023 showed a relationship between the labor sector and possible poverty, concluding

that 30.6% of the fisherfolks belong to families with income below the poverty threshold (PSA, 2023b).

People in Hagonoy live in a variation of concrete, bamboo, and mixed concrete-bamboo structures. The majority of the houses have been affected by storms and ground subsidence, with the ground floor of houses being flooded by water (Abenir et al., 2022). Moreover, the annual typhoons in the Philippines cost the country around 2% of the annual GDP on average, with an additional 2% of the GDP being spent on recovery activities (Vidal, 2013). According to Luna (2007), Antilla-Hughes and Hsiang (2013), and Abdenir et al. (2022), marginalized communities in Bulacan, the Philippines are most affected by the natural hazards striking their local community, as their socio-economic status restricts them from improving their resilience and hence leads to a depriving vulnerability in the long-term.

Sanitation conditions

In the Philippines, the main sanitation system is a combination of flush toilets connected to a septic tank (Bergkamp and Lim, 2018). To flush the toilet, water is poured into the toilet using a small bucket, which is called the 'tabo' (Tan, 2011). Floods can negatively affect large and small scale sewage treatment systems, by causing the effluent of insufficient sanitation solutions to spread over the surrounding premises (Pedro et al., 2020). Consequentially, the pathogens present in the spread excreta grow and pose health risks to the population in this area (Levy et al., 2016). Frequent flooding in combination with insufficient sanitation systems negatively affect the population, due to the increased spread of diarrheal diseases, cholera, typhoid fever, leptospirosis, and Hepatitis A (WHO, 2011; Levy et al., 2016; Pruss-Ustun et al., 2019). Williams et al. carried out Focus Group Discussions on the effects of flooding on the well-being of inhabitants of Hagonoy, in which participants confirmed the spread of contaminated water in their neighborhood (Williams et al., 2020).

Already in 1975, the Filipino government mandated a presidential decree on sanitation, requiring those filing for a building permit to also take sanitation into account (Pres. Decree No. 856, 1975). Moreover, in 2016 and in 2021 the Water Quality Guidelines (WQG) and General Effluent Standards (GES) were issued, stating restrictions for effluent water parameters (DENR Adm. Order No.2016-08, 2016; DENR Adm. Order No.2021-19; 2021). Both the Pampanga River and the fish ponds adjacent to Hagonoy belong to the water body class C, as determined by section 5 of the GES, hence any (waste-)water discharged into these water bodies is required to comply with these guidelines (Roon, 2022; DENR Adm. Order No.2016-08, 2016).

In 2019, the Department of Health (DOH) of the Filipino government stated annual targets for improved sanitation, in an attempt to ban open defecation completely by 2025 (DOH Adm. Order No.2019-0054, 2019). Aligned with this vision and perceiving septic tanks as "*the major component of basic sanitation facilities and other alternative sanitation technology design*" (P.1), the DOH issued a National Standard prescribing the design of septic tanks (DOH Adm. Order No.2019-0047, 2019). However, in the same Standard they state the low groundwater tables and the absence of soil erosion as prerequisites for the suitable application of septic tanks (DOH Adm. Order No.2019-0047, 2019). Moreover, a septic tank is only a form of primary treatment and does not suffice to reduce the health and environmental risks related to wastewater effluent, hence only offering a partial solution to the sanitation problem existing in the Philippines (Baltazar et al., 2021).

Survey data from the Hagonoy Water District, the party in Hagonoy responsible for drinking- and waste-water infrastructure, states that the only wastewater treatment system encountered in households is the septic tank or a variation to the septic tank (19625 households), while 1055 (5.1%) households do not have a septic tank at all (Hagonoy Water District, personal communication, June 8, 2023). The municipality of Hagonoy provided similar figures, by stating that 90% of the houses contain a septic tank, while the other 10% directly discharges into the environment (Engineering Office Municipality Hagonoy, personal communication, May 26, 2023).

Bibliography Appendix G – Background Information Hagonoy

Abenir, M. A. D., Manzanero, L. I. O., & Bollettino, V. (2022). Community-based leadership in disaster resilience: The case of small island community in Hagonoy, Bulacan, Philippines. *International Journal of Disaster Risk Reduction*, 71, 102797. <https://doi.org/10.1016/j.ijdr.2022.102797>

Anttila-Hughes, J., & Hsiang, S. (2013). Destruction, disinvestment, and death: Economic and human losses following environmental disaster. Available at SSRN 2220501.

Baltazar, D. E., Harada, H., Fujii, S., Tan, M. F. O., & Akib, S. (2021). A comparative analysis of septage management in five cities in the Philippines. *Eng*, 2(1), 12–26. <https://doi.org/10.3390/eng2010002>

Bergkamp, G. and Lim, J. (2018). Wastewater management and resource recovery in the Philippines: current status and opportunities. ARCOWA.

Centeno Savella, M.T. (n.d.). Tagalog (Filipino) | Department of Asian Studies. Retrieved from: <https://asianstudies.cornell.edu/research/tagalog-filipino#:~:text=Tagalog%20is%20one%20of%20the,the%20Commonwealth%20Republic%2C%20Manuel%20L>

Cinco, T. A., De Guzman, R. G., Ortiz, A. M. D., Delfino, R. J., Lasco, R. D., Hilario, F. D., Juanillo, E. L., Barba, R., & Ares, E. D. (2016). Observed trends and impacts of tropical cyclones in the Philippines. *International Journal of Climatology*, 36(14), 4638–4650. <https://doi.org/10.1002/joc.4659>

David, P. N. F., Manipol, N. E. P., Madamba, J. A. B., & Mariano, R. A. (2019). Good Aquaculture Practices Adoption and Certification of Shrimp Aquaculture Farms in Bulacan, Philippines: Status, Issues and Prospects. *J. Glob. Bus. Trade*, 15(2), 11-36.

DENR Administrative Order No. 2021-19. (2021). Updated water quality guidelines (WQG) and general effluent standards (GES) for selected parameters. Department of Environment and Natural Resources – Government of the Philippines.

DENR Administrative Order No.2016-08. (2016). Water Quality Guidelines and General Effluent Standards of 2016. Department of Environment and Natural Resources – Government of the Philippines.

DOH Adm. Order No.2019-0047. (2019). National Standard on the Design, Construction, Operation and Maintenance of Septic Tank Systems. Department of Health - Republic of the Philippines.

DOH Adm. Order No.2019-0054. (2019). Guidelines on the Implementation of the Philippine Approach to Sustainable Sanitation (PhATSS). Department of Health - Republic of the Philippines.

F. Mialhe, Y. Gunnell, C. Mering, J. C. Gaillard, J. G. Coloma and L. Dabbadie, “The development of aquaculture on the northern coast of Manila Bay (Philippines): an analysis of long-term land-use changes and their causes,” *Journal of Land Use Science*, vol. 11, no. 2, pp. 236-256, 2016.

Follosco-Aspiras, K., & Santiago, A. D. R. (2016). Assessing the Effectiveness of the Decentralisation Policy on Disaster Risk Reduction and Management: The Case of Hagonoy, Bulacan, Philippines. *Springer Geography*, 131–153. https://doi.org/10.1007/978-3-319-29367-7_8

G. S. Jacinto, I. B. Velasquez, C. L. Villanoy and F. B. Siringan, “Biophysical environment of Manila Bay—then and now,” *The Environment in Asia Pacific Harbours*, pp. 293-307, 2006.

GFDRR. (2011). *Vulnerability, Risk Reduction, and Adaptation to Climate Change: Philippines*. URL: <https://www.gfdrr.org/sites/default/files/publication/climate-change-country-profile-2011-philippines.pdf>

Hagonoy Water District. (2016). *Water Safety Plan*.

Ham, P. (2018). *Vernacular architecture inspires flood-proof housing*. TU Delft DeltaLinks.

Hiwasaki, L., Luna, E., Syamsidik, & Marçal, J. A. (2015). Local and indigenous knowledge on climate-related hazards of coastal and small island communities in Southeast Asia. *Climatic Change*, 128, 35-56.

Holden, W.H. and Marshall, S. (2018). *Climate Change and Typhoons in the Philippines: Extreme Weather Events in the Anthropocene. Integrating Disaster Science and Management*. 407–421. URL: <https://www.sciencedirect.com/science/article/pii/B9780128120569000245?via%3Dihub>

IPCC, 2019: *IPCC Special Report on the Ocean and Cryosphere in a Changing Climate* [H.-O. Pörtner, D.C. Roberts, V. Masson-Delmotte, P. Zhai, M. Tignor, E. Poloczanska, K. Mintenbeck, A. Alegria, M. Nicolai, A. Okem, J. Petzold, B. Rama, N.M. Weyer (eds.)]. Cambridge University Press, Cambridge, UK and New York, NY, USA, 755 pp. <https://doi.org/10.1017/9781009157964>

Japan International Cooperation Agency (JICA). (2011). *The study on integrated water resources management for poverty alleviation and economic development in the Pampanga River Basin. Final Report. Volume 1: Summary*

Juradoz, A. E. (2021). *Designing resilient coastal neighbourhoods. Co-creating a hybrid settlement framework for the city of Hagonoy, Philippines*. [MSc-thesis]. TU Delft.

K. Rodolfo and F. Siringan, “Global sea-level rise is recognised, but flooding from anthropogenic land subsidence is ignored around northern Manila Bay, Philippines,” *Disaster*, vol. 30, no. 1, pp. 118139, 2016.

Lagos, D. T., Eco, R. C., Rebadolla, L. J., Farin, F. A. B. (2022) *Flooding and Subsidence Research: Bulacan Province, Northern Manila Bay Area, Philippines. Diamonds in the Delta, Technical Report*.

Lévy, K., Woster, A. P., Goldstein, R. S., & Carlton, E. J. (2016). Untangling the Impacts of Climate Change on Waterborne Diseases: a Systematic Review of Relationships between Diarrheal Diseases and Temperature, Rainfall, Flooding, and Drought. *Environmental Science & Technology*, 50(10), 4905–4922. <https://doi.org/10.1021/acs.est.5b06186>

Luna, E. M. (2007). *Mainstreaming community-based disaster risk management in local development planning*. In *Forum on Framework-Building for Investigation of Local Government Settlement Planning Responses to Disaster Mitigation* (Vol. 17). Quezon City: Alternative Planning Initiatives (ALTERPLAN)

Morin, V. M., Warnitchai, P., & Weesakul, S. (2016). Storm surge hazard in Manila Bay: Typhoon Nesat (Pedring) and the SW monsoon. *Natural Hazards*, 81(3), 1569–1588. URL: <https://doi.org/10.1007/s11069-016-2146-y>

Pedro, J. P. B., Da Silva Oliveira, C. A., De Lima, S. C. R. B., & Von Sperling, M. (2020). A review of sanitation technologies for flood-prone areas. *Journal of Water Sanitation and Hygiene for Development*, 10(3), 397–412. <https://doi.org/10.2166/washdev.2020.019>

PhilAtlas. (2021). Hagonoy - Province of Bulacan. Obtained from <https://www.philatlas.com/luzon/r03/bulacan/hagonoy.html>

Philippine Atmospheric, Geophysical and Astronomical Services Administration (PAGASA). (n.d.). Flood Forecasting and Warning System for River Basin. Pampanga River Basin. Retrieved from <https://www.pagasa.dost.gov.ph/information/flood-forecasting-and-warning-system-river-basins>

Philippine Statistics Authority (PSA). (2015). Census of Population "Region III (Central Luzon)". Total Population by Province, City, Municipality and Barangay. Retrieved 24th of December 2022

Philippine Statistics Authority (PSA). (2020a). Census of Population "Region III (Central Luzon)". Total Population by Province, City, Municipality and Barangay. Retrieved 24th of December 2022

Philippine Statistics Authority (PSA). (2022). Proportion of Poor Filipinos was Recorded at 18.1 Percent in 2021.

Philippine Statistics Authority (PSA). (2023). Labor Force Survey: Employment Rate in August 2023 was Estimated at 95.6 percent.

Philippine Statistics Authority (PSA). (2023). Poverty Statistics: Fisherfolks and Farmers Remain to Have the Highest Poverty Incidences Among the Basic Sectors in 2021.

Philippine Statistics Authority (PSA). (2023). Religious Affiliation in the Philippines (2020 Census of Population and Housing).

Presidential Decree No.856 December 23. (1975). As mandated in the Code on Sanitation of the Philippines.

Province of Bulacan. (n.d.). Hagonoy – Provincial Government of Bulacan. Province of Bulacan. Geraadpleegd op 23 december 2022, van <https://bulacan.gov.ph/cities-and-municipalities/hagonoy/>

Provincial Disaster Risk Reduction and Management Office (PDRRMO). (n.d.). The Hydrological Area: Bulacan Province. Retrieved from <https://pdrmo.bulacan.gov.ph/programs-and-services/cbfmmp/the-hydrological-area-bulacan-province/>

Prüss-Üstün, A., Wolf, J., Bartram, J., Clasen, T., Cumming, O., Freeman, M. C., Gordon, B., Hunter, P. R., Medlicott, K., & Johnston, R. B. (2019). Burden of disease from inadequate water, sanitation and hygiene for selected adverse health outcomes: An updated analysis with a focus on low- and middle-income countries. *International Journal of Hygiene and Environmental Health*, 222(5), 765–777. <https://doi.org/10.1016/j.ijheh.2019.05.004>

Rodolfo KS, Siringan FP, Remotigue CT, Lamug CB. Worsening floods around northern Manila Bay, Philippines: Research-based analysis from physical and social science perspectives. *Philippine Sociological Review*. 2003; 51: 17-40.

Rodolfo, K. S., & Siringan, F. P. (2006). Global sea-level rise is recognised, but flooding from anthropogenic land subsidence is ignored around northern Manila Bay, Philippines. *Disasters*, 30(1), 118–139. <https://doi.org/10.1111/j.1467-9523.2006.00310.x>

Roon, S. van. (2022). Designing a sanitation system for floating communities [MSc thesis]. TU Delft.

Royal HaskoningDHV (RHDHV). (2022). North Manila Bay Flood Protection Strategy.

Schaik, J. W. J. van. (2016). Finch Philippines: An economical prefabricated residence for Hagonoy, a typhoon prone municipality in the Philippines: analysis, design and implementation [MSc-thesis]. TU Delft.

Tabios III, G.Q., & de Leon, T. (2020). Assessing the Resurgent Irrigation Development Program of the Philippines – Water Resources Component. Discussion Paper Series No. 2020-11. Philippine Institute for Development Studies (PIDS).

Tan, M. L. (2011). 'Tabo' culture. Retrieved from <https://opinion.inquirer.net/5401/%E2%80%98tabo%E2%80%99-culture>

The Philippine Star. (2014). NIA to bid out Bustos Dam rehab. Retrieved from <https://www.philstar.com/business/2014/05/18/1324328/nia-bid-out-bustos-dam-rehab>

Umali, L. A. R., Recto, I. C., Lansangan, R. S., Torres, L. D. G., & Basilio, E. R. (2023). Modified Tricycles as Public Transport during Tidal Flooding Events: The Case of Tikling in Hagonoy, Bulacan, Philippines. *International Journal of Environment, Engineering and Education*, 5(2), 45-55.

UNDRR, A. (2019). Disaster Risk Reduction in the Philippines, Status Report 2019.

United Nations University – Institute for Environment and Security. 2014. World risk report 2014. <http://ehs.unu.edu/news/news/world-risk-report-2014.html>

Van 't Veld, A.C. (2015). Potential Measures to reduce Fluvial and Tidal Floods in the Pampanga Delta, Philippines [MSc Thesis]. TU Delft.

Vidal, J. (2013). Typhoon Haiyan: what really alarms Filipinos is the rich world ignoring climate change. *The Guardian*, 8.

WBG Climate Change Knowledge Portal (CCKP). (2021). Philippines Climate Data: Historical. URL: <https://climateknowledgeportal.worldbank.org/country/philippines/climate-data-historical>

WHO. (2011). Guidance on Water Supply and Sanitation in Extreme Weather Events. World Health Organization. Regional Office for Europe, Copenhagen.

Williams, L., Arguillas, M. J. B., & Arguillas, F. (2020b). Major storms, rising tides, and wet feet: Adapting to flood risk in the Philippines. *International Journal of Disaster Risk Reduction*, 50, 101810. <https://doi.org/10.1016/j.ijdrr.2020.101810>

World Bank. (2021). Climate Risk Country Profile – Philippines. World Bank Group.

Yumul, G.P., Cruz, N.A, Servando, N. T and Dimalanta, C.B. (2010). Extreme weather events and related disasters in the Philippines, 2004–08: A sign of what climate change will mean? *Disasters*. 35. 362–82. URL: <https://pubmed.ncbi.nlm.nih.gov/21073508/>

Zhang, T. Y., Li, P. F., Shang, L. N., Cong, J. Y., Li, X., Yao, Y. J., & Zhang, Y. (2022). Identification and evolution of tectonic units in the Philippine Sea Plate. *China Geology*, 5(1), 96-109.

Appendix G - Mathematical substantiation

During the exercises, pairs of design criteria were posed to the participants. Participants had to compare the two criteria, before picking the criterion that they perceived as most important when designing a sanitation system. In case one of the two criteria was deemed more important, the relative importance was scored on a 9-point Likert scale (1 being 'equally important', 9 being 'extremely more important').

Within this research, participants were asked to compare 20 criteria spread across two separate categories, each containing 10 criteria. The assigned scores were then transformed into a Pairwise Comparison Matrix (PCM).

Definition 1 (Pairwise Comparison Matrix):

The number of criteria to be compared in this decision problem is denoted by n . Matrix A with size $n \times n$ is called a pairwise comparison matrix if all values a_{ij} ($i, j = 1, 2, 3 \dots n$) > 0 and satisfy

$$a_{ij} = \begin{cases} 1/a_{ji} & i \neq j \\ 1 & i = j \end{cases}$$

Where a_{ij} represents the relative importance of criterion x_i over x_j as scored by a participant

For each participant t , two PCMs (one for each category of design criteria) were constructed. With $n = 10$, each PCM was sized 10x10 entries.

$$A_t(n \times n) = \begin{bmatrix} a_{11} & \dots & a_{1n} \\ \vdots & \ddots & \vdots \\ a_{n1} & \dots & a_{nn} \end{bmatrix}, \text{ for participant } t$$

Following Definition 1, the number of unique entries in a Pairwise Comparison Matrix is specified by:

$$\text{Unique Entries} = \frac{n(n-1)}{2}$$

Using $n = 10$, the number of unique entries per PCM equals 45. To derive the weights of the two categories, each containing 10 criteria, participants hence had to fill in 90 pairwise comparisons. In order to decrease the workload of participants, it was decided to only ask 30 comparisons per PCM and calculate the remaining entries through the DEMATEL-method (Zhou et al., 2016).

Definition 3 (Incomplete Pairwise Comparison Matrix)

Matrix $A = [a_{ij}]$ is an incomplete pairwise comparison matrix if $a_{ij} \in \mathbb{R}_+ \cup \{*\}$ such that for all $1 \leq i, j \leq n$, $a_{ij} \in \mathbb{R}_+$ implies $a_{ji} = 1/a_{ij}$ and $a_{ij} = *$ implies $a_{ji} = *$

To be able to deal with the impreciseness of the opinion of humans and the participants in particular, the use of fuzzy numbers was introduced to AHP (Chang, 1996). The scores on the 9-point Likert-scale assigned by the participants are related to linguistic terms describing the relative importance of one criterion over the other (e.g. 'equally important', 'slightly more important', 'extremely more important'). Because of the vagueness and freedom for interpretation that these terms possess, fuzzy AHP expresses such values as elements x with membership function $\mu(x)$.

Definition 3: (Fuzzy number)

Let $M \in F(R)$, with $F(R)$ representing all fuzzy sets and R being the set of real numbers, be called a fuzzy number if:

- 1) $x_0 \in R$ exists such that $\mu_M(x_0) = 1$
- 2) For any $a \in [0,1]$, $A_a = [x, \mu_{A_a}(x) \geq a]$ is a closed interval

The value assigned by the participant is called the ‘crisp’ value. The fuzzy element relating to this crisp value is probably close to the crisp value itself, hence the membership function here is 1. The bigger the difference between a fuzzy element and the crisp value, the less probable it becomes that this element provides a good representation of the crisp value, hence decreasing the membership function (Liu et al., 2020). A widely used membership function is the Triangular Fuzzy Number, which is known for its relatively simple and accessible mathematical operations (Yeh, 2017).

Definition 4: (Triangular fuzzy number)

A fuzzy number M on R is called a triangular fuzzy number if its membership function $\mu_M(x): R \rightarrow [0,1]$ is equal to

$$\mu_M(x) = \begin{cases} \frac{x-l}{m-l} - \frac{l}{m-l}, & x \in [l, m] \\ \frac{x-u}{m-u} - \frac{u}{m-u}, & x \in [m, u] \\ 0, & \text{otherwise} \end{cases}$$

where $l \leq m$

$\leq u$, representing the lower, modal and upper value respectively. The triangular fuzzy number \tilde{A} can be denoted by (l, m, u) .

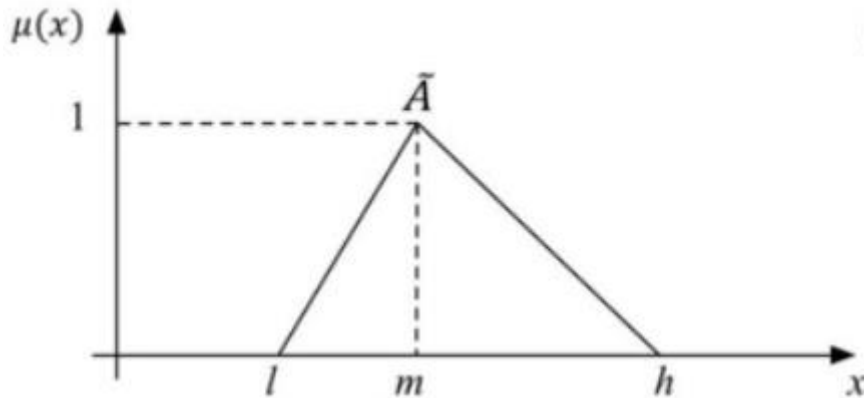

Figure 1| Graphical representation of triangular fuzzy number

To transform the linguistic variables into fuzzy numbers, Table 1 as used by Kannan et al. (2013) was used.

Linguistic variable	Fuzzy numbers
Extremely strong	(9,9,9)
Intermediate	(7,8,9)
Very strong	(6,7,8)
Intermediate	(5,6,7)
Strong	(4,5,6)
Intermediate	(3,4,5)
Moderately strong	(2,3,4)
Intermediate	(1,2,3)
Equally strong	(1,1,1)

Table 1| Linguistic variables for pair-wise comparisons of each criterion

Hence, every entrance a_{ij} in \tilde{A} can be written as $(a_{ijlow}, a_{ijmed}, a_{ijup})$, respectively representing the lower, modal and upper value. Consequentially, the fuzzy matrix \tilde{A} can be rewritten into the three separate matrices $\tilde{A}_{low}, \tilde{A}_{med}, \tilde{A}_{up}$.

To obtain the missing values in an fuzzy IPCM, while restoring the consistency of the matrix, the Decision-Making Trial and Evaluation Laboratory (DEMATEL) was implemented as proposed by Mohamad and Zainuddin (2021).

The missing values in $\tilde{A}_{low}, \tilde{A}_{med}, \tilde{A}_{up}$ were replaced with 0, obtaining the direct relation matrices denoted as D_{low}, D_{med}, D_{up} . The direct relation matrices were normalized using definition:

Definition 5 (Normalized direct relation matrix)

The normalized matrix N_k of direct relation matrix $D_k = (d_{ij})_{n \times n}$ ($i, j = 1, 2, \dots, n$) with $k = low, med, up$ can be calculated through

$$N_k = \frac{D_k}{\max(\sum_{j=1}^n d_{ij}^k, \sum_{i=1}^n d_{ij}^k)} \text{ with } k = low, med, up$$

The sub-stochastic (every row in the matrix adds up to a maximum 1) total relation matrix can be derived using a combination of the normalization and the absorbing state of Markov chain matrices. The normalized direct relation matrices hence were converted into total relation matrices using the following definition, replacing the assigned 0s by non-zero values:

Definition 6 (Total Relation matrix)

Assuming $N_k = (n_{ij})_{n \times n}$ ($i, j = 1, 2, \dots, n$) with $k = low, med, up$ is the normalized direct relation matrix, the total relation matrix T is defined as

$$T_k = \lim_{p \rightarrow \infty} (N_k + N_k^2 + \dots + N_k^p) = N_k(I - N_k)^{-1}, \text{ where } I \text{ is the } n \times n \text{ identity matrix}$$

The obtained matrix T_k only shows values between 0 and 1, which strokes with definition ... requiring the multiplication of symmetric values in a matrix to equal 1. By applying the following transformation, a complete pairwise comparison matrix M_k was obtained:

$$M_k[i, j] = \sqrt{\frac{T_k[i, j]}{T_k[j, i]}}, \text{ with } (i, j = 1, 2, \dots, n) \text{ and } k = low, med, up$$

Through using the abovementioned formula, the fuzzy PCMs per decisionmaker were obtained. The aggregated score of the individual decisionmakers was determined following the Geometric Mean method as described by Zimmer et al. (2017).

Definition 7 (Geometric Mean method)

$$GM^k = \left(\prod_{t=1}^q a_{tij}^k \right)^{\frac{1}{q}}, (\forall i, j = 1, 2, \dots, n), k = low, med, up$$

where q is the number of experts and $(a_{tij}^{low}, a_{tij}^{med}, a_{tij}^{up})$ is the fuzzy number of the comparison between criteria i and j of expert t

As fuzzy numbers are hard to interpret, the aggregated matrices were defuzzified using the Centroid method (Maheswari et al., 2019; Yayla et al., 2015; Calabrese et al, 2019).

Definition 8 (Centroid Method Triangular Fuzzy Number)

$$S[i, j] = \frac{GM^{low}[i, j] + GM^{med}[i, j] + GM^{up}[i, j]}{3}, (\forall i, j = 1, 2, \dots, n)$$

The obtained matrix contains only crisp values, with all values nonzero.

Of the crisp complete matrices, the consistency of the judgements was determined through the use of the Consistency Ratio (Saaty, 1977; Mohamad and Zainuddin, 2021; Sato and Tan, 2023).

Definition 9 (Consistent Pairwise Comparison Matrix)

Let A

$= (a_{ij})_{n \times n}$ be a filled in pairwise comparison matrix. If the following condition is satisfied

$$a_{ij} = a_{ik} * a_{kj}, \forall i, j, k = 1, 2, 3 \dots n$$

then A is called a consistent pairwise comparison matrix, otherwise it is called inconsistent.

Definition 10 (Consistency Ratio)

The consistency ratio of an $n \times n$ matrix may be calculated by

$$CR = \frac{CI}{RI}$$

with $CI = \frac{\lambda_{max} - n}{n - 1}$ where λ_{max} is the largest eigenvalue of the matrix and the Random Indices (RI) is determined from table X

N	1	2	3	4	5	6	7	8	9	10
RI	0	0	0.52	0.89	1.11	1.25	1.35	1.40	1.45	1.49

To calculate the weight vector, containing the relative weights (on a scale of 1) of the judged criteria, the Logarithmic Least Squares Method was applied (Crawford and Williams, 1985; Gyarmati et al., 2023).

Definition 11 (Logarithmic Least Squares Method)

Let A be an $n \times n$ PCM. The weight vector \underline{w} of A determined by the LLSM is given as follows:

$$\min_{\underline{w}} \sum_{i=1}^n \sum_{j=1}^n \left(\ln(a_{ij}) - \ln\left(\frac{w_i}{w_j}\right) \right)^2$$

where w_i is the i -th element of \underline{w} , $0 < w_i$ and $\sum_{i=1}^n w_i = 1$

Which reduces to

$$w_i^{LLSM}(A) = \frac{\prod_{j=1}^n a_{ij}^{\frac{1}{n}}}{\sum_{k=1}^n \prod_{j=1}^n a_{kj}^{\left(\frac{1}{n}\right)}}$$

Bibliography Appendix G – Mathematical Substantiation

- Calabrese, A., Costa, R., Levialedi, N., & Menichini, T. (2019). Integrating sustainability into strategic decision-making: A fuzzy AHP method for the selection of relevant sustainability issues. *Technological Forecasting and Social Change*, 139, 155-168.
- Chang, D. Y. (1996). Applications of the extent analysis method on fuzzy AHP. *European journal of operational research*, 95(3), 649-655.
- Crawford, G., & Williams, C. (1985). A note on the analysis of subjective judgment matrices. *Journal of mathematical psychology*, 29(4), 387-405.
- Gyarmati, L., Orbán-Mihálykó, É., Mihálykó, C., Szádóczki, Z., & Bozóki, S. (2023). The incomplete analytic hierarchy process and Bradley–Terry model: (In)consistency and information retrieval. *Expert Systems With Applications*, 229, 120522. <https://doi.org/10.1016/j.eswa.2023.120522>
- Kannan, D., Khodaverdi, R., Olfat, L., Jafarian, A., & Diabat, A. (2013). Integrated fuzzy multi criteria decision making method and multi-objective programming approach for supplier selection and order allocation in a green supply chain. *Journal of Cleaner production*, 47, 355-367.
- Liu, Y., Eckert, C. M., & Earl, C. (2020). A review of fuzzy AHP methods for decision-making with subjective judgements. *Expert Systems with Applications*, 161, 113738.
- Maheswari, S. U., Shalini, M., & Yookesh, T. L. (2019). Defuzzification Formula for Modelling and Scheduling A Furniture Fuzzy Project Network. *International Journal of Engineering and Advanced Technology*, 9(1s5), 279–283. <https://doi.org/10.35940/ijeat.a1048.1291s519>
- Mohamad, D., & Zainuddin, N. S. (2021). Solving incomplete fuzzy pairwise comparison matrix using fuzzy DEMATEL. *Journal of Physics*, 1988(1), 012058. <https://doi.org/10.1088/1742-6596/1988/1/012058>
- Saaty, T. L. (1997). That is not the analytic hierarchy process: What the AHP is and what it is not. *Journal of Multi-Criteria Decision Analysis*, 6(6), 324–335.
- Sato, Y., & Tan, K. H. (2023). Inconsistency indices in pairwise comparisons: An improvement of the consistency index. *Annals of Operations Research*, 326(2), 809-830.
- Yayla, A. Y., Oztekin, A., Gumus, A. T., & Gunasekaran, A. (2015). A hybrid data analytic methodology for 3PL transportation provider evaluation using fuzzy multi-criteria decision making. *International Journal of production research*, 53(20), 6097-6113.
- Yeh, C. T. (2017). Existence of interval, triangular, and trapezoidal approximations of fuzzy numbers under a general condition. *Fuzzy Sets and Systems*, 310, 1-13.
- Zhou, X., Hu, Y., Deng, Y., Chan, F. T., & Ishizak, A. (2016). A DEMATEL-Based completion method for incomplete pairwise comparison matrix in AHP. *arXiv (Cornell University)*. <https://doi.org/10.48550/arxiv.1607.08116>
- Zimmer, K., Fröhling, M., Breun, P., & Schultmann, F. (2017). Assessing social risks of global supply chains: A quantitative analytical approach and its application to supplier selection in the German automotive industry. *Journal of Cleaner Production*, 149, 96-109.

Appendix H – Python Script

```
import numpy as np
import pandas as pd
import matplotlib.pyplot as plt
from numpy import linalg

#This file currently analysed 30 interviews and uses a .csv file as input.
Only completely filled in rows can be analyzed. The input file used
contains the pairwise comparison for social design criteria.
```

```
df = pd.read_csv(r'C:\Users\sande\OneDrive\Documenten\TU\Thesis\Floating
Homes\Data veldwerk\Python\Pairwise comparisons exercise end-users
technical.csv', na_values = '#DIV/0!')
# dfc = df.drop([0,1],axis=0)
dfc = df.head()
# dfc = dfc.filter(regex='Q')
# dfc = dfc.iloc[:, 3:]
dfc = df.drop(['Interviewee', 'Neighborhood', 'Gender', 'Age', 'Educational
Level', 'Income', 'Household Size', 'Toilet system', 'Start', 'End',
'Unnamed: 55',
'Counter N/A', 'Unnamed: 57', 'Unnamed: 58', 'Unnamed: 59',
'Unnamed: 60', 'Data distribution', 'Unnamed: 62'], axis=1)
dfc = dfc.drop([0], axis=0)
#row 22 is currently empty
dfc = dfc.iloc[:60,: ]
#all rows after line 31 are empty, only completely filled in rows can be
analyzed
dfc.head()
```

```
dfcnm = dfc.fillna(0)
#dfcnm = dfcnm([])
#print(dfcnm)
dfcnm = dfcnm.to_numpy()
mask = np.ones(dfcnm.shape[1], dtype=bool)
mask[:,3] = False

dfcnm = dfcnm.astype(float)
# delete the selected columns from the matrix
#dfcnm = dfcnm[:, mask].astype(int)
#print(dfcnm)

# print('number of respondents =', len(dfcnm))
# print('number of questions asked', np.shape(dfcnm)[1])
```

```
def matrixbuilder(data, criteria):
    ansmatr2 = []

    for row in data:
        ansmatr2.append(row)

    matrices = []

    for arr in ansmatr2:
        matric = np.zeros((criteria,criteria))
        k = 0
        for i in range(0, criteria):
```

```

        for j in range(i+1, criteria):
            matrix[i][j] = arr[k]
            k += 1
        matrices.append(matrix)
#print(matrices)

for matrix in matrices:
    for i in range(0, criteria, 1):
        for j in range(0, criteria, 1):
            if i == j:
                matrix[i,j] = 1
#print(matrices[1])

for matrix in matrices:
    for i in range(0, criteria, 1):
        for j in range(0, criteria, 1):
            if matrix[i,j] != 0:
                matrix[j,i] = round((1 / matrix[i,j]), 3)

for matrix in matrices:
    for i in range(0, criteria, 1):
        for j in range(0, criteria, 1):
            if matrix[i,j] > 1:
                matrix[i,j] = round(matrix[i,j])

return matrices

matrices = matrixbuilder(dfcm, 10)
#print(matrices)
# print(len(dfcm))

```

```

def lowbounderybuilder(medianmatrix, criteria):
    matriceslow = []
    for matrix in medianmatrix:
        matrix = np.zeros((criteria, criteria))
        k = 0
        for i in range(0, criteria, 1):
            for j in range(0, criteria, 1):
                if matrix[i,j] > 1 and matrix[i,j] < 9:
                    matrix[i,j] = matrix[i,j] - 1
                elif matrix[i,j] == 1:
                    matrix[i,j] = 1
                elif matrix[i,j] < 1 and matrix[i,j] > 0 and matrix[j,i] !=
9:
                    matrix[i,j] = round((1 / (matrix[j,i] - 1)), 3)
                elif matrix[i,j] == 9:
                    matrix[i,j] = 9
                    matrix[j,i] = round((1 / 9), 3)
                k += 1
            matriceslow.append(matrix)
    return matriceslow

def upbounderybuilder(medianmatrix, criteria):
    matricesup = []
    for matrix in medianmatrix:
        matrix = np.zeros((criteria, criteria))
        k = 0
        for i in range(0, criteria, 1):
            for j in range(0, criteria, 1):
                if matrix[i,j] > 1 and matrix[i,j] < 9:

```



```

        matrix[i,j] = matrix[i,j] + 1
    elif matrix[i,j] == 1 or matrix[i,j] == 9:
        matrix[i,j] = matrix[i,j]
        matrix[j,i] = matrix[j,i]
    elif matrix[i,j] < 1 and matrix[i,j] > 0 and matrix[j,i] !=
9:
        matrix[i,j] = round((1 / (matrix[j,i] + 1)), 3)
    k += 1
    matricesup.append(matrix)
return matricesup

matriceslow = lowboundarybuilder(matrices, 10)
matricesup = upboundarybuilder(matrices, 10)

```

```

def DEMATEL(callmatrix):
    matrix = []
    for matrix in callmatrix:
        rowsum=matrix.sum(axis=1)
        #print(rowsum)
        colsum=matrix.sum(axis=0)
        normalizationfactor = np.max(np.maximum(rowsum,colsum))
        #print(normalizationfactor)
        normalizedmatrix = matrix / normalizationfactor

        A = np.subtract(np.identity(len(matrix)), normalizedmatrix)
        #print(A)
        Ainverse = np.linalg.inv(A)
        Totalrelationmatrix = np.matmul(normalizedmatrix, Ainverse)

        matrix.append(Totalrelationmatrix)
    return matrix

#print(matrices[0])
#normalizationmatrix(matriceslow)
#Nlow = normalizationmatrix(matriceslow)
Tlow = DEMATEL(matriceslow)
Tmed = DEMATEL(matrices)
Tup = DEMATEL(matricesup)

```

```

def completecomparison(callmatrix):
    matrix = []
    #print(callmatrix)
    for matrix in callmatrix:
        compmatrix = np.zeros((len(matrix), len(matrix)))

        for i in range(0, len(matrix), 1):
            for j in range(0, len(matrix), 1):
                compmatrix[i,j] = np.sqrt(matrix[i,j] / matrix[j,i])
        matrix.append(compmatrix)
    return matrix

complow = completecomparison(Tlow)
compmed = completecomparison(Tmed)
compup = completecomparison(Tup)

```

```

def vertexmethod(matrixlow, matrixmed, matrixup):
    matrix = []
    for matrixA, matrixB, matrixC in zip(matrixlow, matrixmed, matrixup):

```

```

cleanarray = np.zeros(9)
cleanmatrix = np.zeros((len(matrixA), len(matrixA)))
trialmatrix = np.zeros((len(matrixA), len(matrixA)))
linguisticnumber = np.arange(1, 10, 1)
for i in range(0, len(matrixA), 1):
    for j in range(0, len(matrixA), 1):
        for t in range(0, len(cleanarray), 1):
            cleanarray[t] = np.sqrt((1/3) * ((matrixA[i,j] -
linguisticnumber[t])**2) + ((matrixB[i,j] - linguisticnumber[t])**2) +
((matrixC[i,j] - linguisticnumber[t])**2))
            min = np.min(cleanarray)
            cleanmatrix[i,j] = np.where(cleanarray == min)[0] + 1
            if cleanmatrix[i,j] != 1:
                trialmatrix[i,j] = cleanmatrix[i,j]
                trialmatrix[j,i] = 1 / cleanmatrix[i,j]
            trialmatrix[trialmatrix == 0] = 1
        matric.append(trialmatrix)
return matric

linguisticmed = vertexmethod(compLOW, compMED, compUP)

```

```

def consistencycheck(medianmatrix, treshold):
    matric = []
    count = 0
    for matrix in medianmatrix:
        eigenvalues = np.linalg.eigvals(matrix)
        lambdamax = round(np.max(np.abs(eigenvalues)), 10)
        CI = ((lambdamax - len(matrix)) / (len(matrix) - 1))
        RI = np.array([0, 0, 0.52, 0.89, 1.12, 1.26, 1.36, 1.41, 1.46,
1.49])
        CR = CI / RI[len(matrix)-1]
        matric.append(CR)
    for i in range(0, len(matric)):

        if matric[i] > treshold:
            count += 1
            print('interviewee', i+1, 'has provided inconsistent pairwise
comparison')
        print('number of inconsistent matrices', count, 'total number of
matrices', len(medianmatrix))
    return matric

```

```

def defuzzifierperdecisionmaker(lowermatrix, medianmatrix, uppermatrix):
    matric = []
    for matrixA, matrixB, matrixC in zip(lowermatrix, medianmatrix,
uppermatrix):
        cleanmatrix = np.zeros((len(matrixA), len(matrixA)))
        for i in range(0, len(matrixA)):
            for j in range(0, len(matrixA)):
                cleanmatrix[i,j] = (matrixA[i,j] + matrixB[i,j] +
matrixC[i,j]) / 3
                if cleanmatrix[i,j] < 1:
                    cleanmatrix[i,j] = 1 / cleanmatrix[j,i]
                if cleanmatrix[i,j] > 1:
                    cleanmatrix[j,i] = 1 / cleanmatrix[i,j]
            matric.append(cleanmatrix)
    return matric

defuzzifiedmmatrix = defuzzifierperdecisionmaker(compLOW, compMED, compUP)

```

```
# print(defuzzifiedmatrix)
# defuzzifiedmatrix[53]

consistencycheck(defuzzifiedmatrix, 0.1)
```

```
def weightvectorcalculator(singlematrix):
    combweightvector = []
    for matrix in singlematrix:
        A = np.prod(matrix, axis=1)**(1/len(matrix))
        B = np.sum(A)
        Weight = A/B
        combweightvector.append(Weight)
    return combweightvector

vectorind = weightvectorcalculator(defuzzifiedmatrix)
# print(vectorind)
# vectorind[0][0]

def vectorcleaner(weightvectors, value):
    matic = []
    cleanmatrix = np.zeros(60)
    for i in range(0,60):
        cleanmatrix = weightvectors[i][value]
        matic.append(cleanmatrix)
    return matic

cleanvector = vectorcleaner(vectorind, 9)
cleanvector
```

```
def fuzzygeometricmean(matrixcollection):
    matric = []
    cleanmatrix = np.zeros((len(matrixcollection[0]),
len(matrixcollection[0])))
    matrixcollection = np.array(matrixcollection)
    for i,j in np.ndindex(np.shape(matrixcollection)[1:]):
        matric.append(matrixcollection[:,i,j])
    A = np.stack(matric)
    B = np.prod(A, axis=1)**(1/np.shape(A)[1])
    aggregatedmatrix = np.reshape(B, np.shape(matrixcollection)[1:])
    return aggregatedmatrix

agglow = fuzzygeometricmean(compLOW)
aggmed = fuzzygeometricmean(compMED)
aggup = fuzzygeometricmean(compUP)
```

```
def defuzzifieragg(lowermatrix, medianmatrix, uppermatrix):
    aggmatrix = np.zeros((len(lowermatrix), len(lowermatrix)))
    for i in range(0, len(lowermatrix)):
        for j in range(0, len(lowermatrix)):
            aggmatrix[i,j] = (lowermatrix[i,j] + medianmatrix[i,j] +
uppermatrix[i,j]) / 3
            if aggmatrix[i,j] < 1:
                aggmatrix[i,j] = 1 / aggmatrix[j,i]
            if aggmatrix[i,j] > 1:
                aggmatrix[j,i] = 1/ aggmatrix[i,j]
    #print(aggmatrix)
    return aggmatrix
```

```

defuzzifiedmmatrix = defuzzifieragg(aggflow, aggmed, aggup)
print(defuzzifiedmmatrix)
def consistencychecksinglet(aggdefuzmatrix, treshold):
    eigenvalues = np.linalg.eigvals(aggdefuzmatrix)
    lambdamax = round(np.max(np.abs(eigenvalues)), 10)
    CI = ((lambdamax - len(aggdefuzmatrix)) / (len(aggdefuzmatrix) - 1))
    RI = np.array([0, 0, 0.52, 0.89, 1.12, 1.26, 1.36, 1.41, 1.46, 1.49])
    CR = CI / RI[len(aggdefuzmatrix)-1]
    print(CR)
    if CR > treshold:
        print('aggregation has provided inconsistent pairwise comparison')

#used the modulus (calculated by np.abs()) of eigenvalues to compare
complex eigenvalues to real eigenvalues

consistencychecksinglet(defuzzifiedmmatrix, 0.1)

```

```

def weightvectorcalculator(singlematrix):
    A = np.prod(singlematrix, axis=1)**(1/len(singlematrix))
    B = np.sum(A)
    Weight = A/B
    return Weight

vector = weightvectorcalculator(defuzzifiedmmatrix)
print(vector)

```

```

def weightvectorcalculator(singlematrix):
    A = np.prod(singlematrix, axis=1)**(1/len(singlematrix))
    B = np.sum(A)
    Weight = A/B
    return Weight

vector = weightvectorcalculator(defuzzifiedmmatrix)
print(vector)
#%#%
vectorind
criteriasocial = np.array(['Centralization', 'Community Health', 'Cultural
Alignment', 'Ease of Use',
    'Environmental Friendly', 'Expertise Required',
'Job Opportunities', 'Nuisance', 'Policy Alignment', 'Aesthetics'])
criteriatechnical = np.array(['Capital Expenditure', 'Geographical
Suitability', 'Local Construction Resources', 'Operational Expenditure',
    'Resilience', 'Resource Recovery Potential',
'Resource Use', 'Robustness', 'Safe Product Disposal', 'System
Performance'])

def biggestvaluemeasure(vectorcollection, criteria):
    counter = np.zeros(len(criteria))
    for array in vectorcollection:
        result = np.where(array == np.amax(array))
        if result[0] == 6:
            print(array)
            #print(result[0])
            for i in range(0, len(counter)):
                if result[0] == i:
                    counter[i] += 1
            # for k in range(0, len(vectorcollection)):
            #     #print(result)

```

```

#     if result[0] == 6:
#         print(k)
# if result[0] == 7:
#     counter[6] += 1
for j in range(0, len(criteria)):
    print('criteria', criteria[j], 'is appointed as the most important
criterion by', counter[j], 'interviewees')

```

```

def smallestvaluemeasure(vectorcollection, criteria):
    intcounter = 0
    counter = np.zeros(len(criteria))
    for array in vectorcollection:
        intcounter += 1
        result = np.where(array == np.amin(array))
        for i in range(0, len(counter)):
            if list(result[0].shape)[0] > 1:
                print('matrix of interviewee', intcounter, 'contains too
little variance to point out minimum')
                break
            elif result[0] == i:
                counter[i] += 1
        # if result[0] == 7:
        #     counter[6] += 1
    for j in range(0, len(criteria)):
        print('criteria', criteria[j], 'is appointed as the least important
criterion by', counter[j], 'interviewees')

smallestvaluemeasure(vectorind, criteriiatechnical)

```

Design session

EXPERTS



Agenda

Introduction
 Explanation Phase 1
 Explanation Phase 2
 Exercise



Introduction

End-user involved design process for sanitation systems in flood-prone areas
 Involving inhabitants in the design process

Academic focus: additional value of involving end-users

Practical focus: improved sanitation design



Phase I – Pairwise Comparison

Interviews with 60 inhabitants, 7 experts

Rank	Criteria
1	Community Health
2	Policy Alignment
3	Expertise Required
4	Environmental Friendly
5	Ease of Use
6	Centralization
7	Nuisance
8	Aesthetics
9	Job Opportunities
10	Cultural Alignment

Rank	Criteria
1	Safe Product Disposal
2	Resilience
3	Geographical Suitability
4	System Performance
5	Robustness
6	Resource Recovery Potential
7	Operational Expenditure
8	Resource Use
9	Local Construction Resources
10	Capital Expenditure



Phase 2 – Design sessions

Purpose: filling in design requirements

Focus on discussions

All answers provided remain confidential and completely anonymous

Questions?

Start of the exercise

What is a sanitation system?

What is the purpose of sanitation systems?

Resilience

What do you perceive as the biggest threat to a functioning sanitation/toilet system?

- Earthquake
- Land Subsidence
- Flooding
- Temperature Rise
-
-

The current problem

- Bad sanitation can lead to:
- Contamination of groundwater
 - Spread of diseases (diarrhoea, typhoid)
 - Degradation of open water bodies
 - Degradation of fishponds

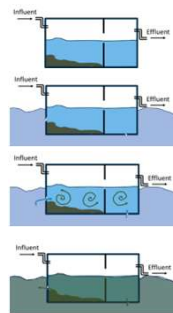

Centralization

Where do you place the sanitation system?

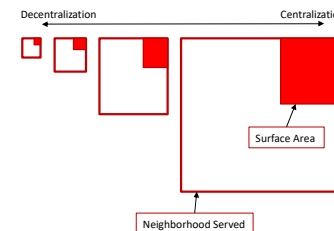

Roles and Expertise Required

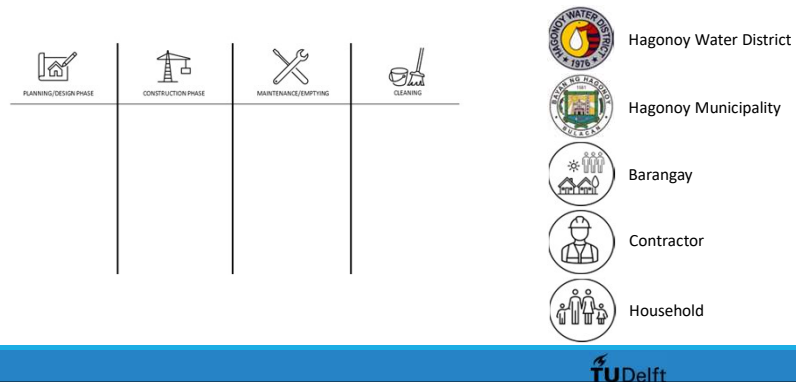

Materials

What material would you preferably use for a sanitation system? Why?

Take risks into account



Robustness

What is the targeted frequency of replacement, maintenance and cleaning?



Capital Expenditure

What should be the maximum initial costs per household of a sanitation system?

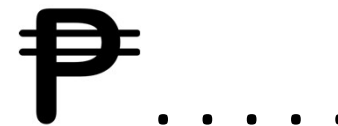

Cultural Alignment

What is the favoured position for the toilet?



Cultural Alignment

What is the favoured way of flushing?



Cultural Alignment

What is the favoured anal cleansing method?

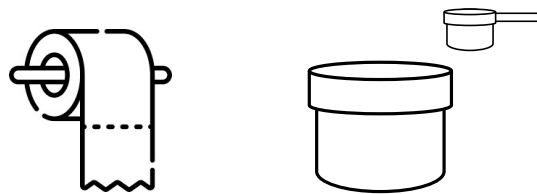

Resource Use

How much water can be used?

How much energy can be used?

How much of other resources can be used (coconut fibers, ash, sawdust)?



Operational Expenditure

What amount are people willing to pay on a monthly basis for wastewater treatment?

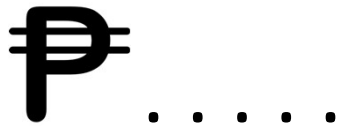

Resource Recovery Potential

Are you willing to reuse materials recovered from wastewater treatment?

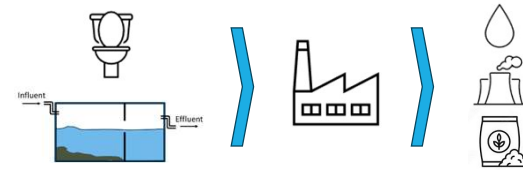

Thank you for your attendance!

SPECIAL THANKS TO:



How to proceed from here

Possible Solutions

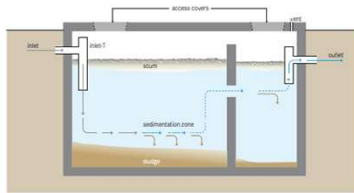

50% solids, 30-40%BOD, 1-log Ecoli removal
 1* chamber >0.67L (2chambers), >0.5L (>2chambers)
 HRT 48 hrs
 Sludge removal required
 No discharge of harsh chemicals allowed
 Contains high level of pathogens

- + Simple and robust technology
- + No electrical energy is required
- + Low operating costs
- + Long service life
- + Small land area required (can be built underground)
- Low reduction in pathogens, solids and organics
- Regular desludging must be ensured
- Effluent and sludge require further treatment and/or appropriate discharge



Possible Solutions

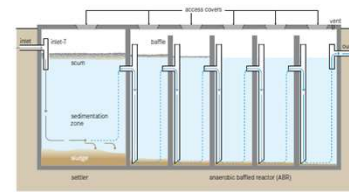

Inflow 2 to 200m³ per day
 90% BOD removal
 HRT 48-72 hrs
 Upflow velocity <0.6 m/h
 Upflow chambers 3 – 6
 Requires ventilation for harmful gases
 Sludge removal required

- + Resistant to organic and hydraulic shock loads
- + No electrical energy is required
- + Low operating costs
- + Long service life
- + High reduction of BOD
- + Low sludge production; the sludge is stabilized
- + Moderate area requirement (can be built underground)
- Requires expert design and construction
- Low reduction of pathogens and nutrients
- Effluent and sludge require further treatment and/or appropriate discharge



Possible Solutions

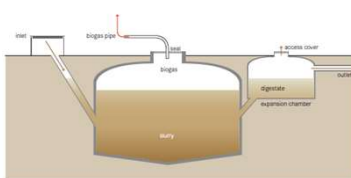

HRT 15 days (highly pathogenic >60 days)
 Operated at 30-38 C (mesophilic temperature)
 Size 1000L (household) – 100.000L (public toilet)
 Greywater should not be added (increases HRT)
 For gas production, additional manure needed

- + Generation of renewable energy
- + Small land area required (most of the structure can be built underground)
- + No electrical energy required
- + Conservation of nutrients
- + Long service life
- + Low operating costs
- Requires expert design and skilled construction
- Incomplete pathogen removal, the digestate might require further treatment
- Limited gas production below 15 °C



Possible Solutions

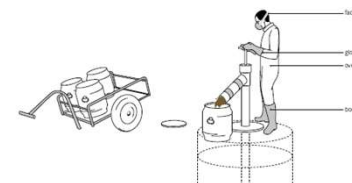

Can be constructed with local materials
 Alternative for areas not accessible to trucks
 Alternative for informal settlements
 Workers should wear protection
 Addition of chemicals to reduce odours not recommended

- + Potential for local job creation and income generation
- + Simple hand pumps can be built and repaired with locally available materials
- + Low capital costs; variable operating costs depending on transport distance
- + Provides services to areas/communities without sewers
- Spills can happen which could pose potential health risks and generate offensive smells
- Time consuming; emptying pits out can take several hours/days depending on their size
- Garbage in pits may block pipe
- Some devices may require specialized repair (welding)



Possible Solutions

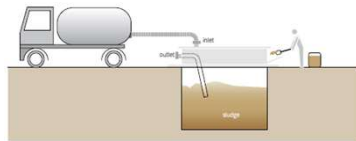

Design must prevent leaching and/or surface water infiltration
 Solution in case of no alternative discharge points for sludge
 Depending on maintenance, odours can become problem

- + Makes sludge transport to the treatment plant more efficient, especially where small-scale service providers with slow vehicles are involved
- + May reduce the illegal dumping of faecal sludge
- + Costs can be offset with access permits
- + Potential for local job creation and income generation
- Requires expert design and construction
- Can lead to odours if not properly maintained



Possible Solutions

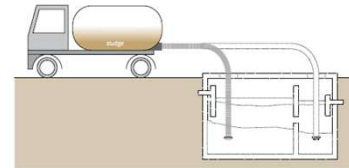

Storage capacity 3-12 m³ (vacuum truck)
 Modified pick-ups /trailers capacity 0.5 - 1.5 m³
 Capital costs are too high for small-scale vehicles

- + Fast, hygienic and generally effective sludge removal
- + Efficient transport possible with large vacuum trucks
- + Potential for local job creation and income generation
- + Provides an essential service to unsewered areas

- Cannot pump thick, dried sludge (must be thinned with water or manually removed)
- Garbage in pits may block hose
- Cannot completely empty deep pits due to limited suction lift
- Very high capital costs; variable operating costs depending on use and maintenance
- Hiring a vacuum truck may be unaffordable for poor households
- Not all parts and materials may be locally available
- May have difficulties with access



Possible Solutions

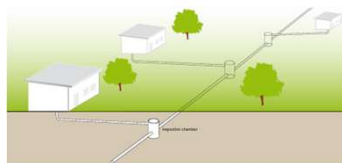

Routed in access ways or under sidewalks (no heavy loads)
 Minimum peak flow 1.5 L/s
 Minimum sewer diameter 100mm
 Gradient >0.5 %
 PVC or HDPE pipes
 Cover of 40-65 cm under sidewalks
 Installation of grease traps recommended (greywater)
 Considered when >150Pers/hect and 60L/pers/day

- + Can be laid at a shallower depth and flatter gradient than Conventional Sewers
- + Lower capital costs than Conventional Sewers; low operating costs
- + Can be extended as a community grows
- + Greywater can be managed concurrently
- + Does not require onsite primary treatment units
- Requires repairs and removals of blockages more frequently than a Conventional Gravity Sewer
- Requires expert design and construction
- Leakages pose a risk of wastewater exfiltration and groundwater infiltration and are difficult to identify



Possible Solutions



Final treatment step (polishing)
 Depth 0.5 – 1.5m
 In combination with algae / fish harvesting:
 high removal nitrogen and phosphorus
 AE ponds in series provide pathogen removal
 Pre-treatment to prevent solids
 Liner to prevent leaching to groundwater
 Berm to prevent run-off / erosion

- + Resistant to organic and hydraulic shock loads
- + High reduction of solids, BOD and pathogens
- + High nutrient removal if combined with aquaculture
- + Low operating costs
- + No electrical energy is required
- + No real problems with insects or odours if designed and maintained correctly
- Requires a large land area
- High capital costs depending on the price of land
- Requires expert design and construction



Possible Solutions

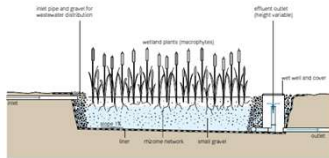

Surface area of 5-10m² per PE
 Inlet cascade to support oxygen dependent process (BOD reduction and nitrification)
 Impermeable liner at bottom to prevent leaching
 Evenly sized gravel 3-32 mm diameter, free of fines
 Bed depth 0.5 – 1 m
 Water level 5 – 15cm below surface
 Native plants with wide deep roots (reed)
 Filter material replaced every 10-15 years

- + High reduction of BOD, suspended solids and pathogens
- + Does not have the mosquito problems of the Free-Water Surface Constructed Wetland
- + No electrical energy is required
- + Low operating costs
- Requires a large land area
- Little nutrient removal
- Risk of clogging, depending on pre- and primary treatment
- Long start-up time to work at full capacity
- Requires expert design and construction



Possible Solutions



Urine stored > 6months is applicable in agriculture
 Urine virtually free of pathogens
 Not applied directly (high pH)
 1m² of cropland can receive 1.5L of urine per grow season
 Urine PE suffices to fertilize 300-400 m² cropland
 Social acceptance might be difficult
 Regular cleaning equipment is required

- + May encourage income generation (improved yield and productivity of plants)
- + Reduces dependence on costly chemical fertilizers
- + Low risk of pathogen transmission
- + Low costs
- Urine is heavy and difficult to transport
- Smell may be offensive
- Labour intensive
- Risk of soil salinization if the soil is prone to the accumulation of salts
- Social acceptance may be low in some areas



Possible Solutions

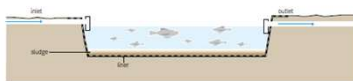

Under ideal circumstances 10.000 kg/ha fish harvested
 Living conditions: low ammonium, required water temp
 BOD influent < 1 g/m²/d
 Oxygen > 4 mg/L
 Fishes to be used: carp, milkfish, tilapia
 Advised to move fish for several weeks before harvesting

- + Can provide a cheap, locally available protein source
- + Potential for local job creation and income generation
- + Relatively low capital costs; operating costs should be offset by production revenue
- + Can be built and maintained with locally available materials
- Requires abundance of fresh water
- Requires a large land (pond) area
- May require expert design and installation
- Fish may pose a health risk if improperly prepared or cooked
- Social acceptance may be low in some areas



Parameter	Unit	Sewerage	Effluent Standard
BOD	mg/L	70 - 240	50
Fecal Coliform	MPN/100mL	10E7 - 50E8	400 ²
Ammonia	mg/L	41.3 - 45	4 ¹
Nitrate	mg/L	0.1 - 2.7	14
Phosphate	mg/L	3.7 - 8	4 ¹
Oil and Grease	mg/L	20 - 60	5
Surfactants (MBAS)	mg/L	-	15
Sulfate	mg/L	-	550

Appendix J – Design Variables Substantiation

Variable	Range	Unit	Source	Picked	Unit	Remarks
Water used per flush	1-3	L/flush	Cairncross and Feachem (1993)			
	1-2	L/flush	Neethling et al. (2020)			
				1	L/flush	
Suspended Solids per COD ratio	0.42	[-]				
				0.42	[-]	
Methane production per COD ratio	0.35	m ³ CH ₄ / kgCOD	Van Lier et al. (2023)			
				0.35	m ³ CH ₄ / kgCOD	
Blackwater						
Variable	Range	Unit	Source	Picked	Unit	Remarks
Defecation frequency	0.74-1.97	per day	Rose et al. (2015)			Range of 39 studies
				1.1	per day	Median
Wet weight feces	75-520	g/cap/day	Rose et al. (2015)			Range of 17 studies
				250	g/cap/day	Median
Density feces				1.06		
Anal cleansing water	0.35-3	L/flush	Cairncross and Feachem (1993)			
				0.35	L/flush	
Phosphorus in feces	0.35	g/cap/day	Vinneras et al. (2006)			
	0.5	g/cap/day	Czemiel (2000)			
	0.5	g/cap/day	Vinneras (2002)			
	0.5	g/cap/day	Meinzinger and Oldenburg (2009)			
				0.5	g/cap/day	

Variable	Range	Unit	Source	Picked	Unit	Remarks
COD in feces	36-55	g/cap/day	Kujawa-Roeleveld and Zeeman (2006)			
	50	g/cap/day	Choi et al. (2004)			
	96	g/cap/day	Meinzinger and Oldenburg (2009)			
				52	g/cap/day	
Ammonia in feces	0.051-0.102	g/cap/day	Silvester et al. (1998)			
				0.102	g/cap/day	
Urination frequency	8	Urinations/day	Clare et al. (2009)			17 studie subjects
				8	Urinations/day	
Volume urine	0.6-2.6	L/cap/day	Rose et al. (2015)			Range of 14 studies
				1.4	L/cap/day	Median
Phosphorus in urine	800-2500	mg/L	Wignarajah et al. (2003)			
	1800	mg/L	Ban and Dave (2004)			
				1400	mg/L	
COD in urine	6270-10600	mg/L	Putnam (1971)			
	17500	mg/L	Almeida et al. (1997)			
				11000	mg/L	
Total Nitrogen in urine	2-35	g/cap/day	Van de Walle et al. (2023)			Range of 8 studies
				11	g/cap/day	Median
Ammonia in urine	300	mg/L	Tilley et al. (2008a)			
	480	mg/L	Tilley et al. (2008b)			
				400	mg/L	
Nitrate in urine	1.07-2.06	mmol/day	Silvester et al. (1998)			
				2.06	mmol/day	High protein meal
Urea per Total Nitrogen	75-90	%	Lentner (1981)			
				90	%	

Greywater						
Variable	Range	Unit	Source	Picked	Unit	Remarks
Volume greywater	72-225	L/cap/day	Morel and Diener (2006)			
				150	L/cap/day	
Phosphorus in greywater	0.9-11	mg/L	Van de Walle et al. (2023)			
				5.5	mg/L	Mean
COD in greywater	92-682	mg/L	Van de Walle et al. (2023)			
				394	mg/L	Mean
Total Nitrogen in greywater	8-11	mg/L	Van de Walle et al. (2023)			
				9.7	mg/L	Mean
Septic Tank						
Variable	Range	Unit	Source	Picked	Unit	Remarks
Scum Accumulation	30-40	% of sludge accumulation	Adm Order 2019-0047 (2019)			
				35	%	
Phosphorus removal	33-40	%	Rahman et al. (1998)			
				20	%	
COD removal	53-54	%	Rahman et al. (1998)			
TN removal	21-25	%	Costa et al. (2002)			
				20	%	
Nitrate removal	20-40	%	Rahman et al. (1998)			
				20	%	

Anaerobic Biodigester						
Variable	Range	Unit	Source	Picked	Unit	Remarks
HRT	8-100	Days	Wang (2014)			
	20	Days	Ruffino et al. (2019)			
	23	Days	Pera et al. (2022)			
				20	Days	
Biodegradability COD	0.5	%	Kumar et al. (2010)			
	0.51	%	How et al. (2019)			
	0.57	%	Campo et al. (2020)			
				50	%	
Sludge Yield	0.11-0.15	mgVSS / mgCOD	Novak et al. (2007)			
	0.16	mgVSS / mgCOD	Chon et al. (2011)			
	0.19-0.26	gMLSS/ gCOD	Kong et al. (2021)			
				10	%	
Treatment Efficiency	84	%	Campo et al. (2020)			
	75-95	%	Lettinga et al. (1993)			
	90	%	Mahendra and Patil (2013)			
	92-97	%	Lou et al. (2012)			
	70-80	%	Barros et al. (2008)			
				80	%	
Solids Concentration Sludge	2.5	gTSS/L	Mori et al. (2006)			
	10	gCOD/L	Barakwan et al. (2019)			
	3.74-5.71	gCOD/L	Ferreiro and Soto (2003)			
				5	kgCOD/m ³	
Total Nitrogen	31	%	Barros et al. (2008)			
				20	%	
Ammonia	22	%	Barros et al. (2008)			
				20	%	
Phosphorus	35	%	Barros et al. (2008)			

				20	%	
Anaerobic Filter						
Variable	Range	Unit	Source	Picked	Unit	Remarks
Specific Surface of Filter Medium	90-300	m ² /m ³	Gutterer et al. (2009)			
	100	m ² /m ³	Young (1991)			
				100	m ² /m ³	
Voids filter mass	30-45	%	Gutterer et al. (2009)			
				35	%	
TN	23.2	%	Merino-Solís et al. (2015)			
	<15	%	Tilley et al. (2014)			
				20	%	
TP	35.4		M Merino-Solís et al. (2015)			
				20	%	
Ammonia removal	<10	%	De Oliveira Cruz et al. (2019)			
				20	%	
Slow Sand Filter						
Variable	Range	Unit	Source	Picked	Unit	Remarks
D10 Picked sand	0.15	mm	Jenkins et al. (2011)			
	0.11	mm	Romero et al. (2020)			
	0.15-0.20	mm	Freitas et al. (2022)			
	0.15-0.30	mm	Guchi (2015)			
	0.45	mm	Leverenz et al. (2009)			
				0.2	mm	
Porosity	0.45	[-]	Jenkins et al. (2011)			
				0.45	[-]	
Darcy Flow	0.1-0.4	m/h	Verma et al. (2017)			
	0.01-0.41	m/h	Jenkins et al. (2011)			
				0.1	m/h	

Variable	Range	Unit	Source	Picked	Unit	Remarks
Skimming layer thickness	5	cm	Guchi (2015)			
	2-5	cm	Trikanad et al. (2023)			
				5	cm	
Skimming frequency	0.5	per year	Trikanad et al. (2023)			
				0.5	per year	
COD removal	90	%	Verma et al. (2017)			
	77	%	Tyagi et al. (2009)			
				80	%	
Phosphorus removal	24.9	%	Hang (2023)			
	14	%	Zhang et al. (2019)			
				20	%	
Nitrate	30-53	%	Romero et al. (2020)			
	45-67.5	%	Verma et al. (2017)			
				20	%	
TN	21.7	%	Hang (2023)			
				20	%	
Horizontal SubSurface Flow						
Variable	Range	Unit	Source	Picked	Unit	Remarks
Water depth	0.27-0.5	m	García et al. (2005)			
	0.3-0.6	m	Reed et al. (1995)			
	0.2	m	Albuquerque et al. (2009)			
				0.6	m	
Root penetration of filter bed	0.5-0.6	[-]	Reed et al. (1995)			
	0.5-0.6	[-]				
				0.6	[-]	
Porosity	40	%	García et al. (2005)			
	40	%	Albuquerque et al. (2009)			
				40	%	

First Order Rate constant P removal	2.73	cm/d	Reed et al. (1995)			
				2.73	cm/d	
Anaerobic Baffled Reactor						
Variable	Range	Unit	Source	Picked	Unit	Remarks
Upflow velocity	2	m/h	Yulistyorini et al. (2022)			
	1	m/h	Gutterer et al. (2009)			
				1	m/h	
Phosphorus removal	51-58	%	Saif et al. (2021)			
				20	%	
TP	21	%	Yulistyorini et al. (2022)			
	43	%	Yulistyorini et al. (2020)			
	33	%	Zha et al. (2019)			
				20	%	
TN removal	28-31	%	Saif et al. (2021)			
	72	%	Yulistyorini et al. (2020)			
	29	%	Zha et al. (2019)			
				20	%	
Ammonia removal	43	%	Yulistyorini et al. (2022)			
	14	%	Zha et al. (2019)			
				20	%	

Bibliography Appendix L – Design Variables Substantiation

Administrative Order 2019-0047 – Republic of the Philippines Department of Health. (2019). National standard on the Design, Construction, Operation and Maintenance of Septic Tank Systems.

Al-Amshawee, S. K. A., & Yunus, M. Y. B. M. (2019). A review on possible approaches of anaerobic biological processes for palm oil mill effluent: Process, quality, advantages, and limitations. *IOP Conference Series*, 702(1), 012058. <https://doi.org/10.1088/1757-899x/702/1/012058>

Albuquerque, A., Oliveira, J., Semitela, S., & Amaral, L. (2009). Influence of bed media characteristics on ammonia and nitrate removal in shallow horizontal subsurface flow constructed wetlands. *Bioresource technology*, 100(24), 6269-6277.

Almeida, M. C., Butler, D., and Friedler, E. (1999). At-source domestic wastewater quality. *Urban Water*, 1(1), 49–55.

Ban, Z. S., and Dave, G. (2004). Laboratory studies on recovery of n and p from human urine through struvite crystallisation and zeolite adsorption. *Environmental Technology*, 25(1), 111–121

Barakwan, R. A., Trihadiningrum, Y., & Bagastyo, A. Y. (2019). Characterization of alum sludge from Surabaya water treatment plant, Indonesia. *Journal of Ecological Engineering*, 20(5).

Barros, P., Ruiz, I., & Soto, M. (2008). Performance of an anaerobic digester-constructed wetland system for a small community. *Ecological engineering*, 33(2), 142-149.

Cairncross, S., and Feachem, R. (1993). *Environmental health engineering in the tropics: An introductory text*. Chichester: Wiley.

Campo, R., Sguanci, S., Caffaz, S., Mazzoli, L., Ramazzotti, M., Lubello, C., & Lotti, T. (2020). Efficient carbon, nitrogen and phosphorus removal from low C/N real domestic wastewater with aerobic granular sludge. *Bioresource technology*, 305, 122961.

Choi, E., Eum, Y., Gil, K. I., and Oa, S. W. (2004). High strength nitrogen removal from nightsoil and piggery wastes. *Water Science and Technology*, 49(5–6), 97–104.

Chon, D. H., Rome, M., Kim, Y. M., Park, K. Y., & Park, C. (2011). Investigation of the sludge reduction mechanism in the anaerobic side-stream reactor process using several control biological wastewater treatment processes. *Water Research*, 45(18), 6021-6029.

Clare, B. A., Conroy, R. S., and Spelman, K. (2009). The diuretic effect in human subjects of an extract of *Taraxacum officinale* folium over a single day. *The Journal of Alternative and Complementary Medicine*, 15(8), 929–934

Costa, J. E., Heufelder, G., Foss, S., Milham, N. P., & Howes, B. (2002). Nitrogen removal efficiencies of three alternative septic system technologies and a conventional septic system. *Environment Cape Cod*, 5(1), 15-24.

Czemiel, J. (2000). Phosphorus and nitrogen in sanitary systems in Kalmar. *Urban Water*, 2(1), 63–69.

De Oliveira Cruz, L. M., Gomes, B. G. L. A., Tonetti, A. L., & Figueiredo, I. C. S. (2019). Using coconut husks in a full-scale decentralized wastewater treatment system: The influence of an anaerobic filter on maintenance and operational conditions of a sand filter. *Ecological Engineering*, 127, 454–459. <https://doi.org/10.1016/j.ecoleng.2018.12.021>

Díez, V., Iglesias, A. B., Cámara, J., Ruiz, M. O., & Ramos, C. (2018). A novel anaerobic filter membrane bioreactor: prototype start-up and filtration assays. *Water Science and Technology*, 78(9), 1833–1842. <https://doi.org/10.2166/wst.2018.309>

Ferreiro, N., & Soto, M. (2003). Anaerobic hydrolysis of primary sludge: influence of sludge concentration and temperature. *Water Science and technology*, 47(12), 239-246.

Freitas, B., Terin, U.C., Fava, N., Maciel, P., Garcia, L., Medeiros, R.C., Oliveira, M., Fernandez-Ibanez, P., Byrne, J.A. and Sabogal-Paz, L.P. (2022) A critical overview of household slow sand filters for water treatment. *Water Research* 208, 117870.

García, J., Aguirre, P., Barragán, J. M., Mujeriego, R., Matamoros, V., & Bayona, J. M. (2005). Effect of key design parameters on the efficiency of horizontal subsurface flow constructed wetlands. *Ecological Engineering*, 25(4), 405–418. <https://doi.org/10.1016/j.ecoleng.2005.06.010>

Guchi, E. (2015) Review on slow sand filtration in removing microbial contamination and particles from drinking water. *American Journal of Food and Nutrition* 3(2), 47-55

Gutterer, B., Sasse, L., Panzerbieter, T., & Reckerzügel, T. (2009). Decentralised wastewater treatment systems (DEWATS) and sanitation in developing countries. BORDA, Bremen.

Hang, Y. (2023). DOC and Ammonium Removal Processes in Slow Sand Filters – Influence of Grain Size and Flow Rate (MSc Thesis). Delft University of Technology.

Heang, B., Bun, S., Chan, R., & Ham, P. (2023). Comparative study of septic tank, anaerobic filter, and anaerobic baffled reactor for treating domestic wastewater. *Nucleation and Atmospheric Aerosols*. <https://doi.org/10.1063/5.0148133>

How, S. W., Chua, A. S. M., Ngoh, G. C., Nittami, T., & Curtis, T. P. (2019). Enhanced nitrogen removal in an anoxic-oxic-anoxic process treating low COD/N tropical wastewater: low-dissolved oxygen nitrification and utilization of slowly-biodegradable COD for denitrification. *Science of the Total Environment*, 693, 133526.

Jenkins, M. W., Tiwari, S. K., & Darby, J. (2011). Bacterial, viral and turbidity removal by intermittent slow sand filtration for household use in developing countries: Experimental investigation and modeling. *Water research*, 45(18), 6227-6239.

Karczmarczyk, A. (2004). Phosphorus removal from domestic wastewater in horizontal subsurface flow constructed wetland after 8 years of operation—a case study. *Journal of Environmental Engineering and Landscape Management*, 12(4), 126-131.

Kong, Z., Wu, J., Rong, C., Wang, T., Li, L., Luo, Z., ... & Li, Y. Y. (2021). Sludge yield and degradation of suspended solids by a large pilot-scale anaerobic membrane bioreactor for the treatment of real municipal wastewater at 25° C. *Science of The Total Environment*, 759, 143526.

Kujawa-Roeleveld, K., & Zeeman, G. (2006). Anaerobic treatment in decentralised and Source-Separation-Based sanitation concepts. *Reviews in Environmental Science and Bio/Technology*, 5(1), 115–139. <https://doi.org/10.1007/s11157-005-5789-9>

Kumar, A., Dhall, P., & Kumar, R. (2010). Redefining BOD: COD ratio of pulp mill industrial wastewaters in BOD analysis by formulating a specific microbial seed. *International Biodeterioration & Biodegradation*, 64(3), 197-202.

Kuruti, K., Begum, S., Ahuja, S., Anupoju, G. R., Juntupally, S., Gandu, B., & Ahuja, D. K. (2017). Exploitation of rapid acidification phenomena of food waste in reducing the hydraulic retention time

(HRT) of high rate anaerobic digester without conceding on biogas yield. *Bioresource Technology*, 226, 65–72. <https://doi.org/10.1016/j.biortech.2016.12.005>

Lentner, C. (1981). *Geigy scientific tables:-1: Units of measurement, body fluids, composition of the body* (8th ed.). Basle: CIBA-Geigy

Lettinga, G., De Man, A., Van der Last, A. R. M., Wiegant, W., Van Knippenberg, K., Frijns, J., & Van Buuren, J. C. L. (1993). Anaerobic treatment of domestic sewage and wastewater. *Water Science and Technology*, 27(9), 67-73.

Leverenz, H. L., Tchobanoglous, G., & Darby, J. L. (2009). Clogging in intermittently dosed sand filters used for wastewater treatment. *Water research*, 43(3), 695-705.

Lou, X. F., Nair, J., & Ho, G. (2012). Field performance of small scale anaerobic digesters treating food waste. *Energy for Sustainable Development*, 16(4), 509–514. <https://doi.org/10.1016/j.esd.2012.06.004>

Mahendra, B. G., & Patil, S. (2013). Anaerobic digestion of domestic wastewater. *Int. J. Res. Eng. Technol*, 2, S283-S287.

Meininger, F., and Oldenburg, M. (2009). Characteristics of source-separated house-hold wastewater flows: A statistical assessment. *Water Science and Technology*, 59(9), 1785–1791.

Merino-Solís, M. L., Villegas, E., De Anda, J., & López-López, A. (2015). The Effect of the Hydraulic Retention Time on the Performance of an Ecological Wastewater Treatment System: An Anaerobic Filter with a Constructed Wetland. *Water*, 7(12), 1149–1163. <https://doi.org/10.3390/w7031149>

Morel, A., Diener, S. (2006) Greywater management in low and middle-income countries, review of different treatment systems for households or neighbourhoods. Swiss Federal Institute of Aquatic Science and Technology (EAWAG)

Mori, M., Seyssiecq, I., & Roche, N. (2006). Rheological measurements of sewage sludge for various solids concentrations and geometry. *Process Biochemistry*, 41(7), 1656-1662.

Neethling, J., Kubheka, N., Majozi, S., & Still, D. (2020). Longterm monitoring and assessment of pour flush technology in South Africa. Water Research Commission, Pretoria.

Novak, J. T., Chon, D. H., Curtis, B. A., & Doyle, M. (2007). Biological solids reduction using the cannibal process. *Water Environment Research*, 79(12), 2380-2386.

Pera, A. L., Sellaro, M., Bianco, M., & Zanardi, G. (2022). Effects of a temporary increase in OLR and a simultaneous decrease in HRT on dry anaerobic digestion of OFMSW. *Environmental Technology*, 43(28), 4463-4471.

Putnam, D. F. (1971). *Composition and concentrative properties of human urine* (CR-1802). Washington, DC: NASA

Rahman, M. M., Shahidullah, A. H. M., & Ali, M. A. (1999). An Evaluation of septic tank performance.

Reed, S. C., Crites, R. W., & Middlebrooks, E. J. (1995). *Natural systems for waste management and treatment* (No. Ed. 2). McGraw-Hill, Inc..

Romero, D. a. D., De Almeida Silva, M. C., Chaúque, B. J. M., & Benetti, A. D. (2020). Biosand Filter as a Point-of-Use Water Treatment Technology: Influence of turbidity on microorganism removal Efficiency. *Water*, 12(8), 2302. <https://doi.org/10.3390/w12082302>

Rose, C., Parker, A., Jefferson, B., & Cartmell, E. (2015). The characterization of feces and urine: a review of the literature to inform advanced treatment technology. *Critical reviews in environmental science and technology*, 45(17), 1827-1879.

Ruffino, B., Cerutti, A., Campo, G., Scibilia, G., Lorenzi, E., & Zanetti, M. (2019). Improvement of energy recovery from the digestion of waste activated sludge (WAS) through intermediate treatments: The effect of the hydraulic retention time (HRT) of the first-stage digestion. *Applied Energy*, 240, 191-204.

Saif, Y., Ali, M., Jones, I. M., & Ahmed, S. (2021). Performance evaluation of a Field-Scale anaerobic baffled reactor as an economic and sustainable solution for domestic wastewater treatment. *Sustainability*, 13(18), 10461. <https://doi.org/10.3390/su131810461>

Silvester, K. R., Bingham, S. A., Pollock, J. R. A., Cummings, J. H., and O'Neill, I.K. (1997). Effect of meat and resistant starch on fecal excretion of apparent N-nitroso compounds and ammonia from the human large bowel. *Nutrition and Cancer*, 29(1), 13–23.

Tilley, E., Atwater, J., and Mavinic, D. (2008a). Recovery of struvite from stored human urine. *Environmental Technology*, 29(7), 797–806.

Tilley, E., Supply, W., and Council, S. C. (2008b). *Compendium of sanitation systems and technologies* (1st ed.). Geneva: Swiss Federal Institute of Aquatic Science and Technology

Tilley, E., Ulrich, L., Lüthi, C., Reymond, P., & Zurbrügg, C. (2014). *Compendium of sanitation systems and technologies*.

Trikannad, S. A., Van Halem, D., Foppen, J. W., & Van Der Hoek, J. P. (2023). The contribution of deeper layers in slow sand filters to pathogens removal. *Water Research*, 237, 119994. <https://doi.org/10.1016/j.watres.2023.119994>

Tyagi, V. K., Khan, A. A., Kazmi, A. A., Mehrotra, I., & Chopra, A. K. (2009). Slow sand filtration of UASB reactor effluent: A promising post treatment technique. *Desalination*, 249(2), 571–576. <https://doi.org/10.1016/j.desal.2008.12.049>

U. Berg, D. Donnert, P. G. Weidler, E. Kaschka, G. Knoll, , and R. Nüesch, "Phosphorus removal and recovery from wastewater by tobermorite-seeded crystallisation of calcium phosphate," *Water Sci. Technol.*, 2006, pp.131–138.

Van De Walle, A., Kim, M., Alam, M. K., Wang, X., Wu, D., Dash, S., Rabaey, K., & Kim, J. (2023). Greywater reuse as a key enabler for improving urban wastewater management. *Environmental Science and Ecotechnology*, 16, 100277. <https://doi.org/10.1016/j.es.2023.100277>

van Lier, J.B., Mahmoud, N., & Zeeman, G. (2023). "Anaerobic wastewater treatment", *Biological Wastewater Treatment: Principles, Modelling and Design*. IWA.

Verma, S., Daverey, A. and Sharma, A. (2017) Slow sand filtration for water and wastewater treatment-a review. *Environmental Technology Reviews* 6(1), 47-58. <https://doi.org/10.1016/j.watres.2011.09.022>

Vinneras, B. (2002). Possibilities for sustainable nutrient recycling by faecal separation with urine diversion (Doctoral thesis). Swedish University of Agricultural Sciences, Uppsala, Sweden.

Vinneras, B., Palmquist, H., Balmér, P., and Jönsson, H. (2006). The characteristics of household wastewater and biodegradable solid waste—A proposal for new Swedish design values. *Urban Water Journal*, 3(1), 3–11.

Vymazal, J., & Kröpfelová, L. (2008). *Wastewater treatment in constructed wetlands with horizontal sub-surface flow* (Vol. 14). Springer science & business media.

Wang, J. (2014b). Decentralized biogas technology of anaerobic digestion and farm ecosystem: Opportunities and challenges. *Frontiers in Energy Research*, 2. <https://doi.org/10.3389/fenrg.2014.00010>

Wignarajah, K., Pisharody, S., and Fisher, J. W. (2003). Investigating the partitioning of inorganic elements consumed by humans between the various fractions of human wastes: An alternative approach (2003-01-2371). Moffett Field, CA: SAE International.

Xu, R., Zhang, Y., Liu, R., Cao, Y., Wang, G., Ji, L., & Xu, Y. (2019). Effects of different substrates on nitrogen and phosphorus removal in horizontal subsurface flow constructed wetlands. *Environmental Science and Pollution Research*, 26, 16229-16238.

Young, J. C. (1991). Factors affecting the design and performance of upflow anaerobic filters. *Water Science and Technology*, 24(8), 133–155. <https://doi.org/10.2166/wst.1991.0222>

Yulistyorini, A., Cayarini, F. D., Mujiyono, Suryoputro, N., & Sukarni, S. (2020). Enhanced treatment performance of an anaerobic baffled filter reactor for domestic wastewater. *Nucleation and Atmospheric Aerosols*. <https://doi.org/10.1063/5.0008421>

Yulistyorini, A., Sunaryo, K., Mujiyono, & Camargo-Valero, M. A. (2022). Hybrid anaerobic baffled reactor and upflow anaerobic filter for domestic wastewater purification. In *Water science and technology library* (pp. 149–164). https://doi.org/10.1007/978-3-030-95542-7_7

Zha, X. X., Ma, J., Tsapekos, P., & Lü, X. (2019). Evaluation of an anaerobic baffled reactor for pretreating black water: Potential application in rural China. *Journal of Environmental Management*, 251, 109599. <https://doi.org/10.1016/j.jenvman.2019.109599>

Zhang, W., Gago-Ferrero, P., Gao, Q., Ahrens, L., Blum, K., Rostvall, A., ... & Renman, G. (2019). Evaluation of five filter media in column experiment on the removal of selected organic micropollutants and phosphorus from household wastewater. *Journal of environmental management*, 246, 920-928.

Appendix K – Technical Drawings Sanitation Design

Overall Design parameters			
Description	Value	Unit	Reference
Water used per flush	1.00		
BW - peak factor concentrations	1.50		
BW - peak factor volume	1.00	[> 1 is more concentrated]	
GW - peak factor concentrations	1.50		
GW - peak factor volume	1.00	[> 1 is more concentrated]	
PE	X	persons	
Bypass greywater	50%		
Average Temperature	22.00	Celcius	
time of most wastewater flow	10.00h		
ss/cod	0.42	ratio	
CH4/COD	0.35	m ³ CH ₄ /kgCOD	
Produced effluent variables			
Flush water	1.00L/flush		
NH ₃ / Total N greywater	50%		
NO ₃ / Total N greywater	40%		

Septic Tank (5 persons)

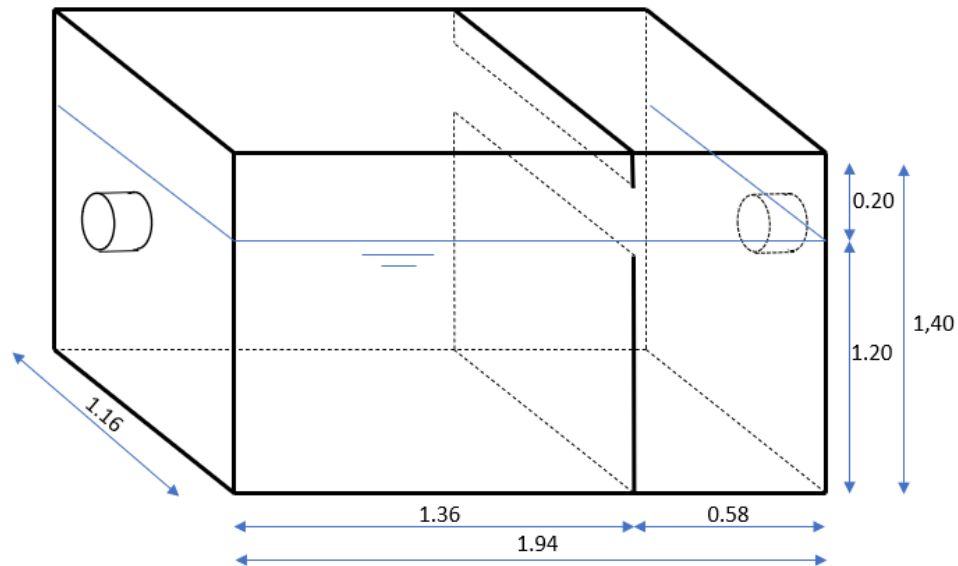

Design variables			
Description	Value	Unit	Remarks
Desludging frequency	5	years	
Scum accumulation	35%		between 30-40%
Free board	0.2	m	
Min depth	1.2	m	
First compartment	70%		of total volume
Width to Length ratio	0.6		
Removal nutrients	20%		
Safety Factor Volume	20%		

Design output		
Description	Value	Unit
Volume	3.15	m ³
Depth	1.40	m
Area	2.25	m ²
Length	1.94	m
Width	1.16	m

Anaerobic Biodigester (5 persons)

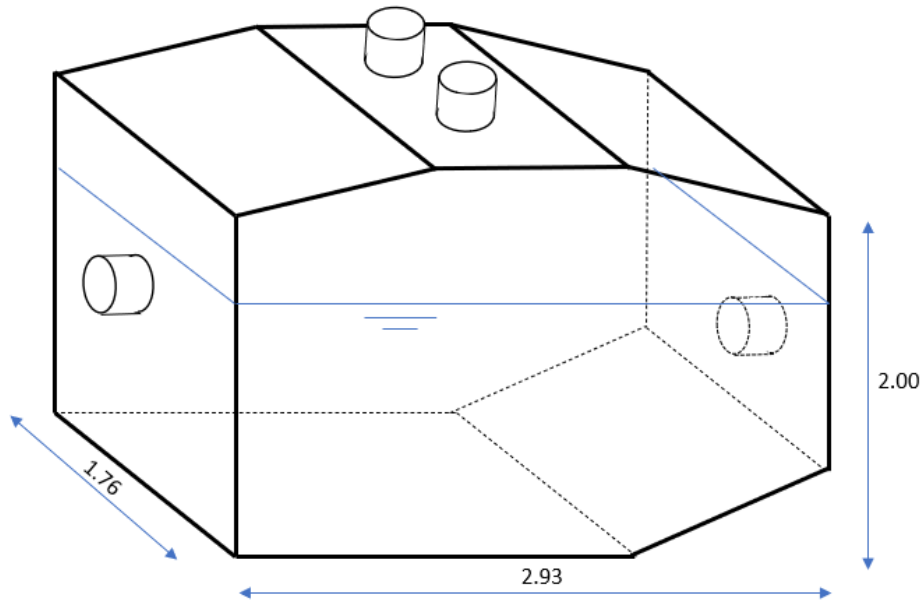

Design variables			
Description	Value	Unit	Remarks
HRT	20	days	
Biodegradability COD	50%		
Sludge Yield	10%		
Treatment Efficiency	80%		
Solids Concentration Sludge	5.00	kgCOD/m ³	
Nutrient removal	20%		
Safety factor	20%		
Reactor height	2.00	m	
Width to Length ratio	0.60		

Design output		
Description	Value	Unit
Sludge production	0.03	kgCOD/day
Biogas production	0.09	m ³ CH ₄ /dag
Volume (including safety factor)	10.33	m ³
Surface	5.17	m ²
Length	2.93	m
Width	1.76	m
SRT	4.87	years

Anaerobic Filter (5 persons)

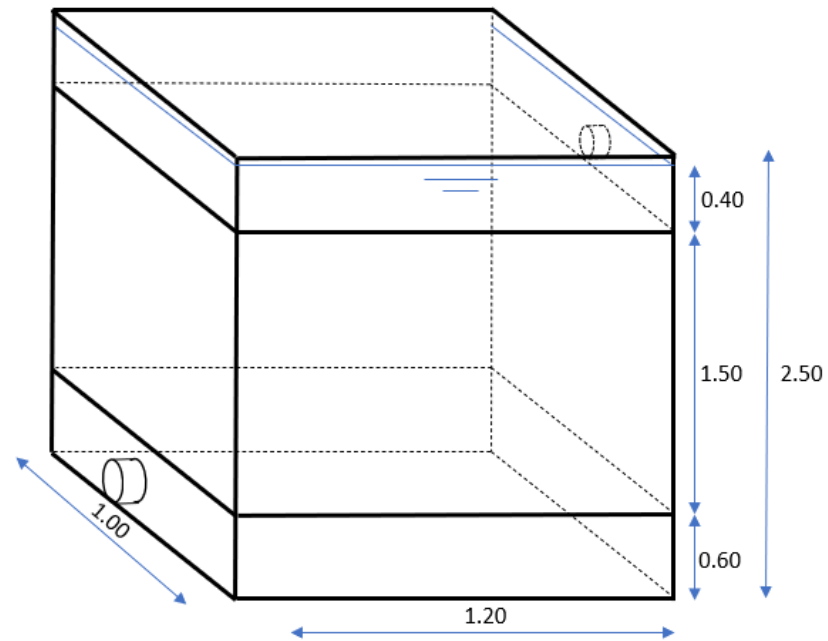

Design variables			
Description	Value	Unit	Remarks
specific surface of filter medium	100.00	m ² /m ³	80-120
voids in filter mass	35%		35-45
depth of filter tank	2.50	m	
space below perforated slabs	0.60	m	
water level on top of filter	0.40	m	
Length tank	1.00	m	
Width tank	1.00	m	
number of filter tanks in serie	1.00	no	
Safety factor	20%		
Nutrient removal	20%		

Design output			
Description	Value	Unit	Remarks
Volume filterbed	1.50	m ³	
Porous volume filterbed	0.53	m ³	
HRT filterbed	29.26	hours	24-48
org load on filter volume cod	831.00	kg/(m ³ *d)	
Max upflow velocity	0.12	m/h	
Volume reactor			
Total depth	2.50	m ³	
Total width	1.00	m	
Total length (incl safety)	1.20	m	
Total volume (incl safety)	3.00	m ³	

Slow Sand Filter (5 persons)

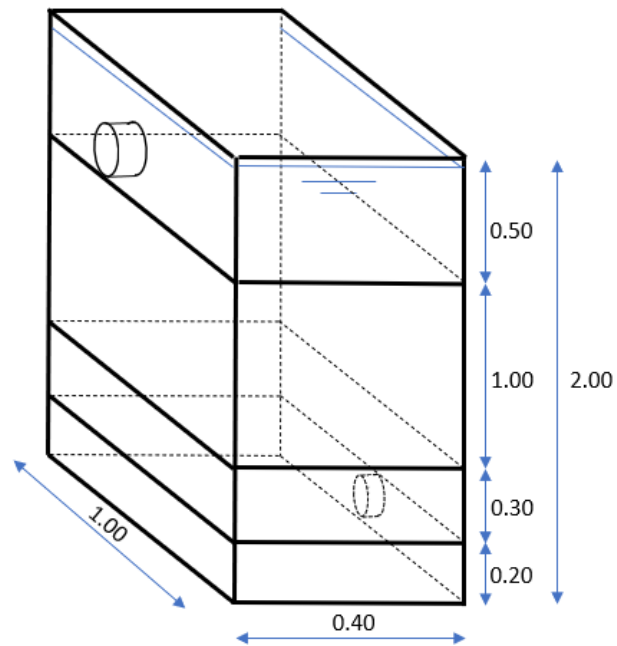

Design variables			
Description	Value	Unit	Remarks
Porosity	0.45		
D10 value sand	2.00E-04m		
Darcy flow (HLR)	0.10m/h		
Initial sand bed height	1.00m		
Minimum sand bed height	0.60m		
Skimming layer thickness	5.00cm		
Skimming frequency	0.50per year		
Desired width	1.00m		
COD removal	80%		
Nutrient removal	20%		
Safety factor	20%		

Design output		
Description	Value	Unit
Sand volume (end of lifetime)	0.20m ³	
HRT (end of lifetime)	2.70hours	
Years of operation	16.00years	
Reactor height	2.00m	
Reactor width	1.00m	
Reactor Length	0.40m	
Volume (incl safety)	0.81m ³	

Horizontal Subsurface Flow Filter (5 persons)

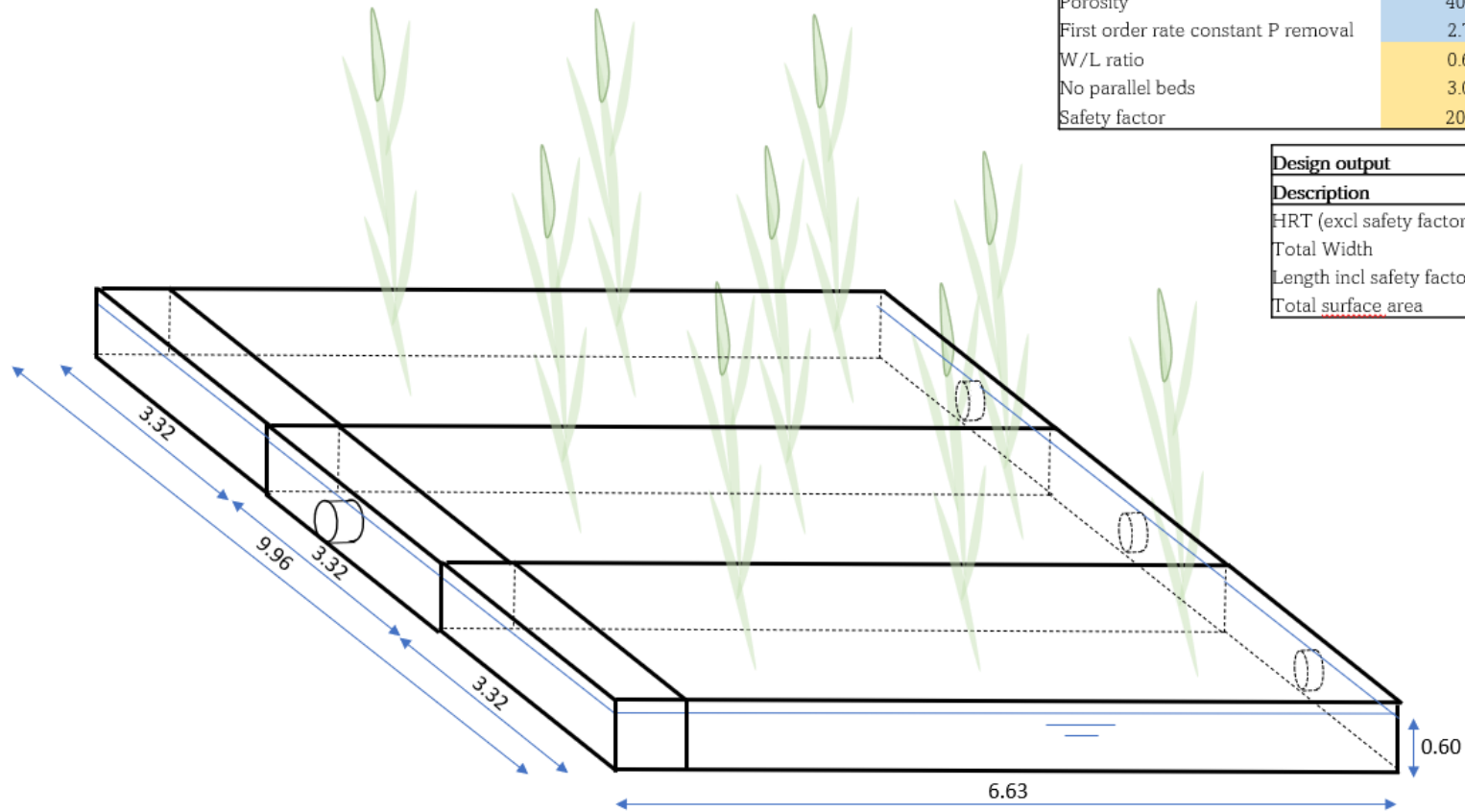

Design variables			
Description	Value	Unit	Remarks
Root penetration of filter bed	50%		
Depth bed	0.60m		
Porosity	40%		
First order rate constant P removal	2.73cm/d		
W/L ratio	0.60		
No parallel beds	3.00		
Safety factor	20%		

Design output		
Description	Value	Unit
HRT (excl safety factor)	16.38	days
Total Width	9.95	m
Length incl safety factor	6.63	m
Total surface area	65.98	m ²

Anaerobic Baffled Reactor (20 persons)

Design variables			
Description	Value	Unit	Remarks
BOD/COD ratio	0.50	ratio	
desludging interval	60.00	months	
HRT settler	2.50	h	
width	1.00	m	
desired width baffle	0.00	m	
max upflow	1.00	m/h	
number upflow chambers	4.00		between 3 and 6 chambers
height outlet	1.00	m	height settler and baffle assumed to be the same
width downflow shaft	0.00	m	
length/depth ratio	0.50		between 50 and 60% of height
Safety factor	20%		
Nutrient removal	20%		

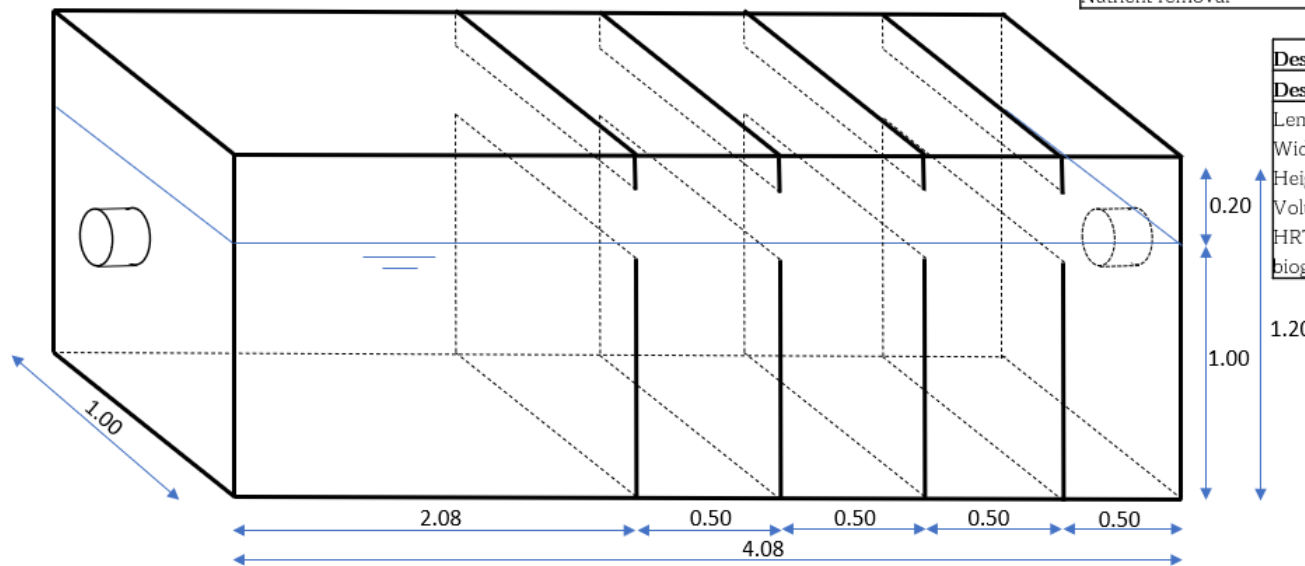

Design output			
Description	Value	Unit	Remarks
Length	4.08	m	
Width	1.00	m	
Height	1.20	m	
Volume	4.89	m ³	
HRT	26.17	hours	24-48
biogas	0.68	m ³ /day	

Anaerobic Filter (20 persons)

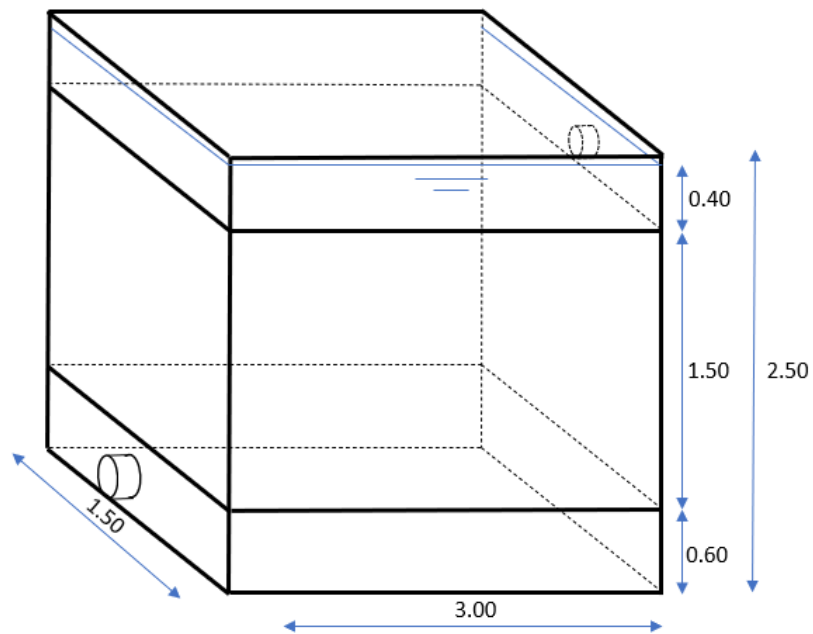

Design variables			
Description	Value	Unit	Remarks
specific surface of filter medium	100.00	m ² /m ³	
voids in filter mass	35%		
depth of filter tank	2.50	m	
space below perforated slabs	0.60	m	
water level on top of filter	0.40	m	
Length tank	2.50	m	
Width tank	1.50	m	
number of filter tanks in serie	1.00	no	
Safety factor	20%		
Nutrient removal	20%		

Design output		
Description	Value	Unit
Volume filterbed	5.63	m ³
Porous volume filterbed	1.97	m ³
HRT filterbed	27.43	hours
org load on filter volume cod	154.49	kg/(m ³ *d)
max upflow velocity	0.13	m/h
Volume reactor		
Total depth	2.50	m ³
Total width	1.50	m
Total length (incl safety)	3.00	m
Total volume (incl safety)	11.25	m ³

Horizontal Subsurface Flow Filter (20 persons)

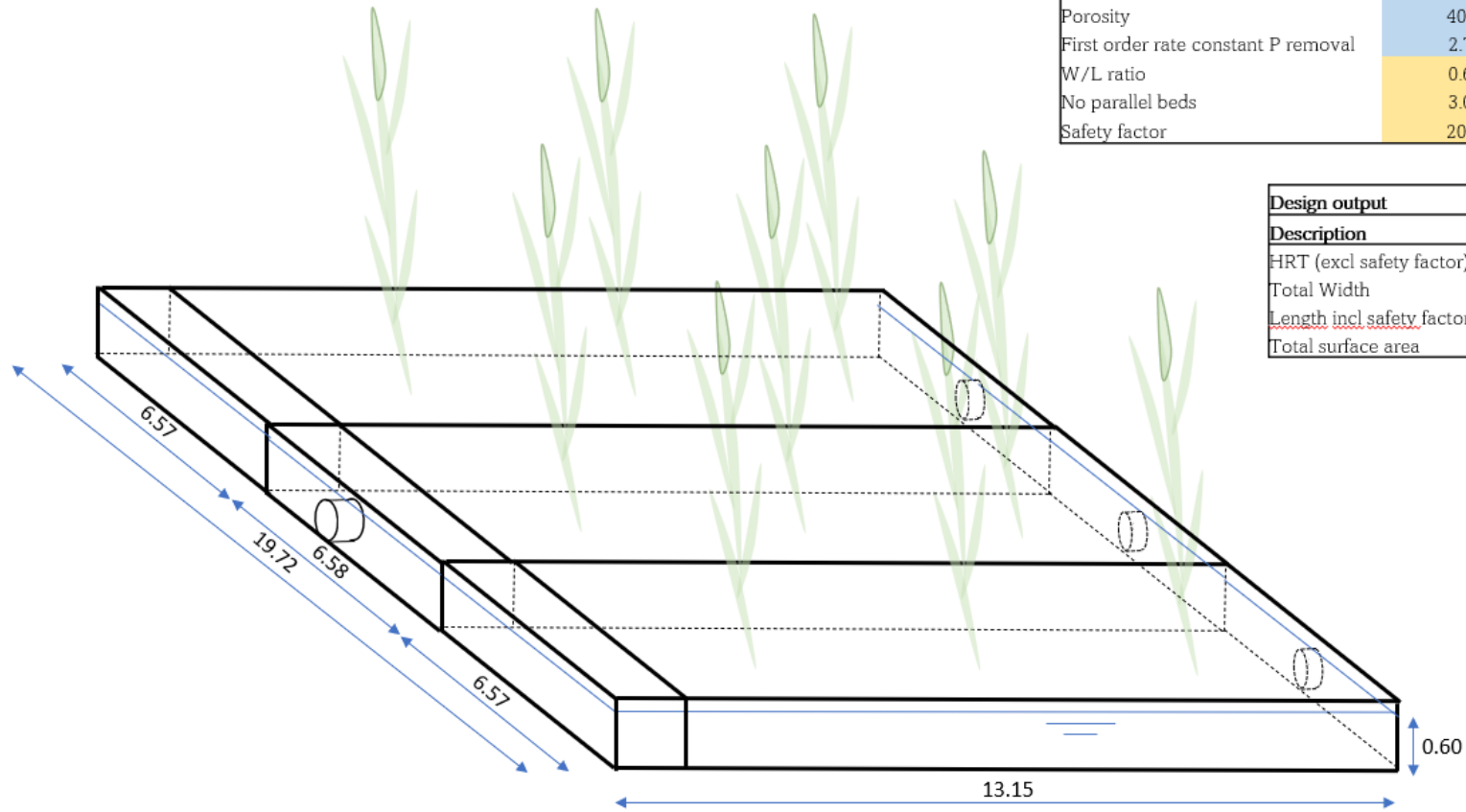

Design variables			
Description	Value	Unit	Remarks
Root penetration of filter bed	50%		
Depth bed	0.60m		
Porosity	40%		
First order rate constant P removal	2.73cm/d		
W/L ratio	0.60		
No parallel beds	3.00		
Safety factor	20%		

Design output		
Description	Value	Unit
HRT (excl safety factor)	16.09	days
Total Width	19.72	m
Length incl safety factor	13.15	m
Total surface area	259.20	m ²

Fishpond

