



# Towards circular EV chargers

Assessing and improving the circularity of  
EVBox's commercial AC chargers

Isabelle Laros  
4306465  
31-08-2021

---

# Colophon

## **Master thesis**

Towards circular EV chargers: Assessing and improving the circularity of EVBox's commercial AC chargers

## **Graduation student**

Isabelle Laros  
Integrated Product Design

## **Graduation date**

31-08-2021

## **Institute**

Delft University of Technology  
Faculty of Industrial Design Engineering

## **Supervisory team**

Prof. dr. ir. C.A. Bakker (TU Delft)  
MSc. ir. S. Dungal (TU Delft)

## **Internship company**

VanBerlo, part of Accenture  
B. Sené  
L. Roseillier

## **Client**

EVBox  
W. Diemer



---

# Acknowledgements

Before you lies my graduation project, the result of half a year's worth of effort and my last accomplishment as a student. It was an exciting, educational and at times challenging journey which would not have been possible without the help of many people. I would hereby like to dedicate special thanks to them.

Conny and Sagar, thank you for your kind understanding, your critical feedback and advise throughout this project.

Baptiste, arigatou for all the fun and inspiring meetings and your active input to continuously help me better the quality of my work.

Lineke, thank you for sharing your knowledge and expertise with me.

Wijnand, thank you for enabling me to make the most of this opportunity and your consistent and quick answers and input.

Olivier, thank you for being my biggest supporter and taking care of me. Thank you for being there for me even on my worst days.

Pak Long, thank you for being by my side during some of the most important moments in the past 8 years, including now.

Rosa, thank you for picking me up when I was down and your solution-oriented attitude.

Céline and Mooijman, thank you for giving me your objective opinions and letting me see things from a different perspective when I needed it.

My dear roommates Jolien and Tisja, thank you for making home a comfortable and safe place to come back to after every day of hard work.

Papa, mama, Felix, thank you for making it possible for me to achieve this. Now I can finally also be a part of the master degree club.

My VanBerlo colleagues and fellow interns, thank you for making me feel at ease at the studio and all the fun and insightful experiences.

All EVBox employees that have helped me with disassembling Iqon and evaluating the redesigns, thank you for your help and enthusiasm.



---

# Executive summary

Over the past years, electric vehicle charging company EVBox has, in collaboration with design agency VanBerlo made the first steps in becoming more circular. Within this project further steps have been explored on both strategic- and product level of EVBox's commercial AC chargers.

First, an analysis on the EV context led to the conclusion that there are many stakeholders involved that need to be included in the value retention process and that EVBox could strengthen its market position by differentiating by becoming circular rather than just sustainable.

Secondly, through a method dubbed reverse logistics mapping the economic viability of implementing maintenance and repair-, remanufacturing-, recycling- and component harvesting strategies was explored. A cascading strategy where all benefits of the aforementioned strategies can be added up, was chosen as the most fruitful.

Thirdly, by disassembling two chargers Disassembly Maps (De Fazio, 2018) could be made where areas of improvement were found. The EVBox Iqon was chosen as the focus product and redesigns were proposed based on the areas of improvement and priority components, namely the charger cables, side panels and kWh-meter.

Through Disassembly Map-guided brainstorm sessions multiple redesign proposals were developed within the solution spaces of a redesigned installerbox that allows for the harvesting of the kWh-meter; mechanical fastening of the PMMA plates to completely liberate the side panels for reconditioning; and a modified stopper mechanism to allow easier replacement of the cables.

The chosen redesign is a custom installerbox which allows for a decrease of disassembly time of 76% compared to the original design.

Furthermore, this project has proven that the Disassembly Map is a suitable tool to evaluate and guide redesign sessions for EV chargers.

This project resulted in a proposal for EVBox's future approach to circular design:

- Standard definitions of circular jargon have to be implemented throughout the whole company to facilitate communication and avoid miscommunication on the topic.
- The tools used in this project, namely the Disassembly Map and Reverse Logistics Mapping can be used to guide future circular design activities. The tools can be used on other products within the portfolio or to develop the focus strategy and product further.
- It is preferable to take circularity into account from the earliest stages of development, as it is difficult to optimise a product for circularity that is already on the market.
- When optimising a product for circularity that is already on the market, it is advised to focus on optimising 1 area of the product per time.
- The actual implementation of circular strategies goes much further than calculations and redesigns; the structure of a company has to be adapted too.
- If EVBox manages to successfully implement a cascading strategy both in- and outside the company, it can become one of the sustainable frontrunners in the EVSE market.
- In the long term it might be worthwhile to change to a subscription model, also known as 'charging as a service'.



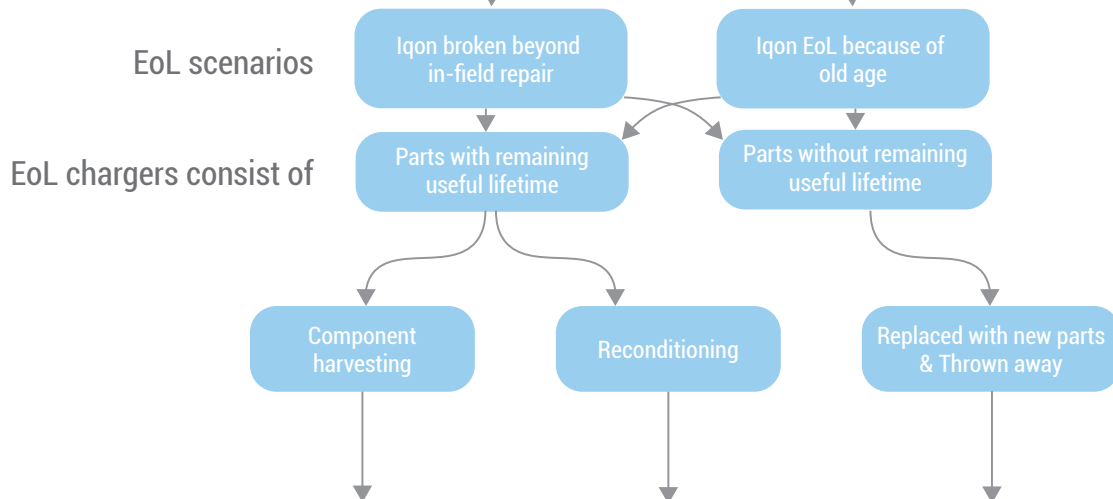
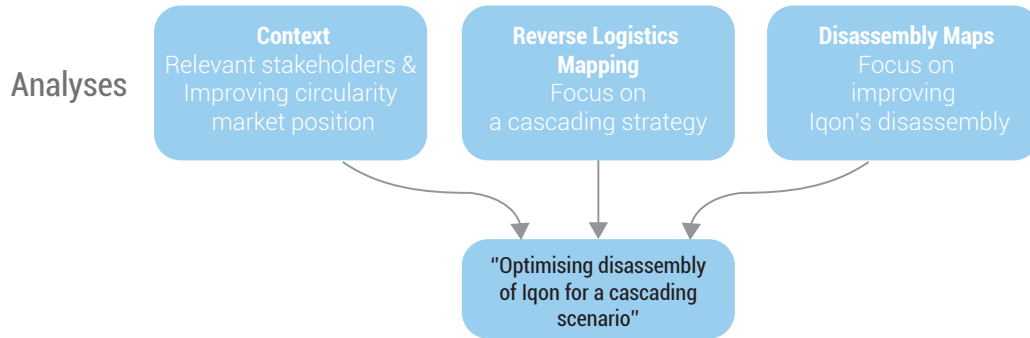

**Integration**  
Solution spaces & Redesigns

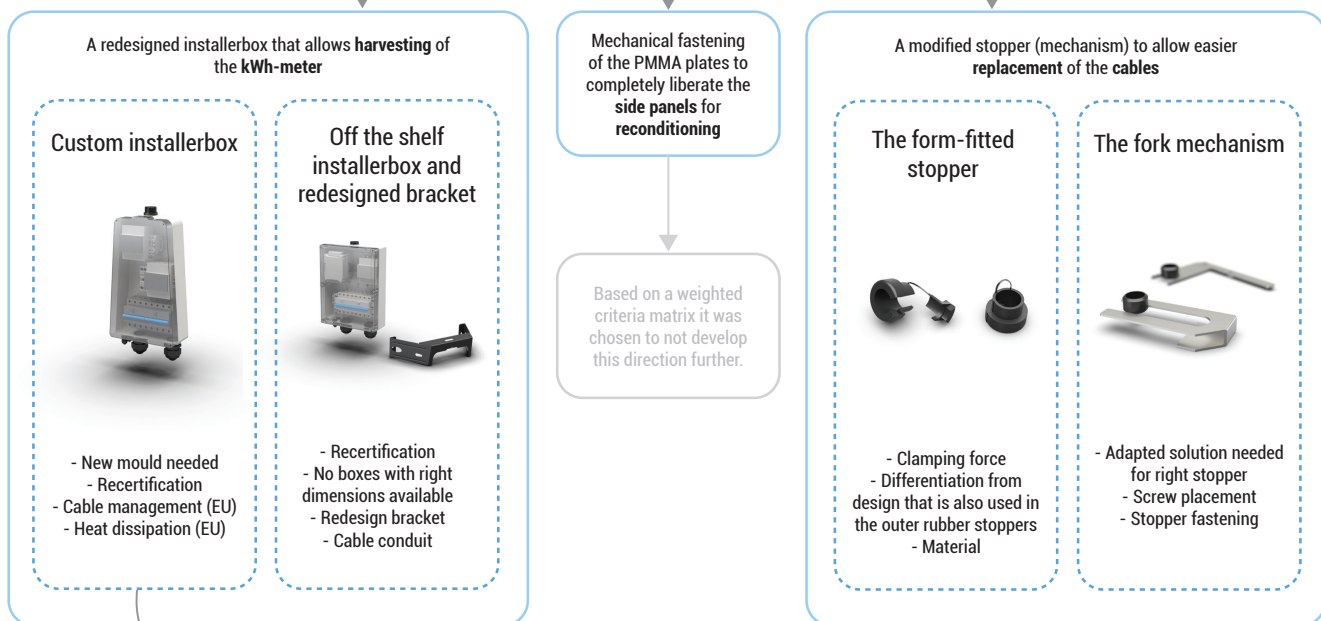

**Final redesign**

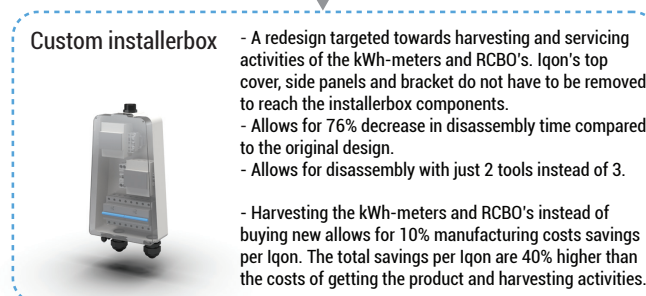

---

# Contents

Acknowledgements	4
Executive summary	6
Contents	8
1. General introduction	10
2. Approach and methods	12
3. Analyses	14
3.1. Context	16
3.2. Current situation regarding circularity	24
3.3. Reverse Logistics Mapping	34
3.3.1. <i>Maintenance and Repair</i>	36
3.3.2. <i>Remanufacturing</i>	38
3.3.3. <i>Recycling</i>	40
3.3.4. <i>Component harvesting</i>	42
3.4. Assessing disassembly	48
3.4.1. <i>Disassembly Iqon</i>	52
3.4.2. <i>Disassembly BusinessLine G4</i>	62
4. Integration	72
4.1. List of requirements and wishes	72
4.2. Illustrative redesign	74
4.2.1. <i>Ideation</i>	76
4.2.2. <i>Redesign proposals</i>	88
5. Evaluation	114
5.1. Redesign evaluation	116
5.2. Proposal for Disassembly Map improvement	120
5.3. Proposal for EVBox's future approach to circular design engineering	124
5.4. Conclusion	126
5.5. Further recommendations	127
6. References	130







# General introduction

"The world is on fire" are the famous words Bill Nye used in 2019 to describe the current state of our planet. As the depletion of our finite supply of natural resources is drawing closer and closer, humanity has to shift from the current linear 'take-make-waste' economy to a circular economy. The circular economy is regenerative and restorative by design and is based on the following three principles: designing out waste and pollution, keeping products and materials in use and regenerating natural systems, (Ellen MacArthur Foundation, 2021). This circular approach enables the capture and retention of value of products for longer periods of time.

Electric vehicle charging company EVBox has, in collaboration with design agency VanBerlo, made the first steps in becoming more circular. The goal of this joint research project between TU Delft, EVBox and VanBerlo is to explore further steps in EVBox's circularity journey. Therefore, the main research question of this project is:

**MRQ. How can the circularity of EVBox's commercial AC chargers be assessed and improved?**

Application of circular value retention strategies, namely reuse, repair, refurbish, remanufacture and recycle, are tightly connected to ease of product disassembly: disassemblability. The better a product can be disassembled, the better it can be reused, repaired, refurbished, remanufactured and recycled (Vanegas et al., 2017). To answer the main research question, several subquestions focusing on the current and future situation have been defined as follows:

**RQ1. How well can EVBox's commercial AC chargers currently be disassembled?**

**RQ2. How can circularity be implemented in future EVBox product development?**

- RQ2.1. What circular strategy is most favourable to implement on EVBox's commercial AC chargers?
- RQ2.2. How can the disassembly of EVBox's commercial AC chargers be improved for the chosen strategy?
- RQ2.3. How can the findings of this thesis contribute to future circular development for EVBox?

**RQ3. Is the Disassembly Map a suitable tool for guiding redesign activities of EV chargers?**





Finding answers to these questions and subquestions is done through analyses of the EV charger context and stakeholders. Then, by identifying target components and using a new tool called the Disassembly Map, (De Fazio, 2019) EVBox's AC charger disassemblability is assessed. Furthermore, this thesis will assess the suitability of the Disassembly Map tool by using it on a new and complex product category.

Through reverse logistics mapping potential strategies are analysed and the most fruitful strategy for future implementation is selected.

Combining the findings from the analyses results in the definition of design requirements which are implemented in illustrative redesigns. These serve as a showcase of what solutions can look like when a circular design approach is followed.

All findings and insights are distilled into an approach for circular product development to be implemented by EVBox in the future.

# Approach and methods

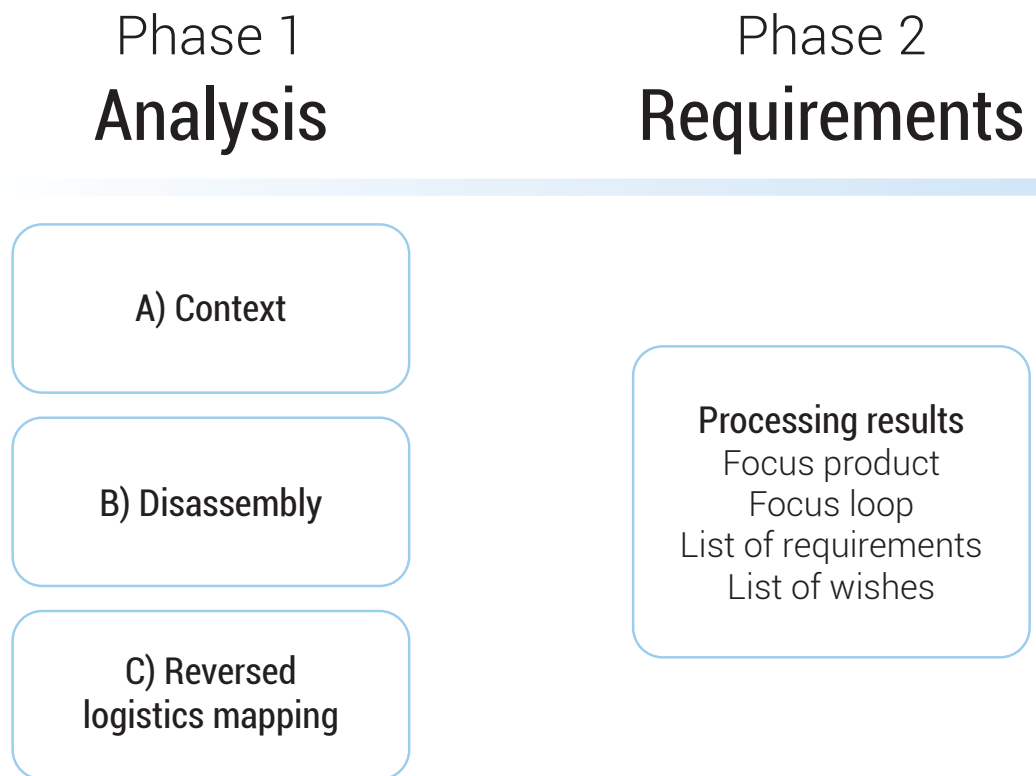

This project followed the basic design cycle shown in figure 1, flowing through the stages of analysing, defining requirements, synthesising and evaluating, (Van Boeijen, A., Daalhuizen, J., 2013). Throughout the whole process close contact was kept with experts and stakeholders, enabling the co-creation of value.

The Disassembly Map is used on EVBox's commercial AC chargers to answer research question 1, because it provides insights in the current state of affairs regarding disassembly and the product's potential for lifetime extension strategies. The Disassembly Map tool is ideal for making the disassembly (improvements) of these complex types of products visually comprehensible. The product's target components are identified, as well as product architecture and tools needed for disassembly. This way opportunities for improvement become clear, after which the tool can be used to guide and support redesign activities.

Improving ease of disassembly will only help when the envisioned activities are truly undertaken. Through reverse logistics mapping, which is the identification and visualisation of necessary steps and processes in the ecosystem to take back the products, the economic viability of implementing one or more of the value retention strategies is identified. Different value retention strategies and relevant context- and stakeholder touchpoints are identified to make a cost calculation disclosing the

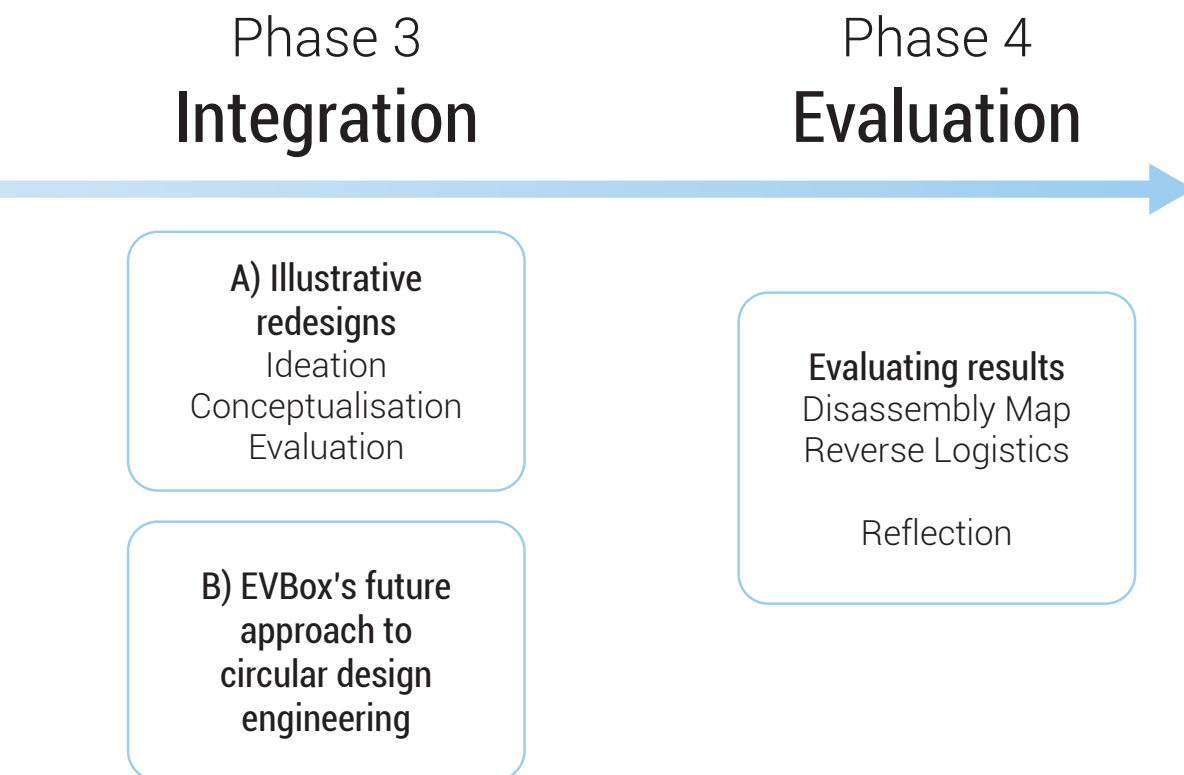

most fruitful approach, answering research question 2.1.

▲ Figure 1. Process.

Redesign directions and ideas have been developed using the Disassembly Map in 2 brainstorm sessions. After which the ideas were evaluated using a weighted criteria matrix. The final redesign proposals have been evaluated with the list of requirements and discussions with EVBox and VanBerlo engineers, grading them on feasibility, viability and desirability. The illustrative redesign process serves as an example on how to answer research question 2.2.

By assessing the activities undertaken to answer research question 1 and 2.2, research question 3 is answered. For research question 1 the Disassembly Map tool is used during analysis and for research question 2.2 the tool is used during ideation. The tool is assessed on both aspects and changes on how to improve the Disassembly Map are proposed.

Finally, research question 2.3. is answered by collecting all the project experiences, positive and negative, and convert them into an overarching approach for future circular product development for EVBox. An explanation of the circular economy, why EVBox should want to go circular, the use of tools such as the Disassembly Map and reverse logistics mapping and circularity goals are combined in a booklet that can be used for reference by EVBox employees.

# Analyses

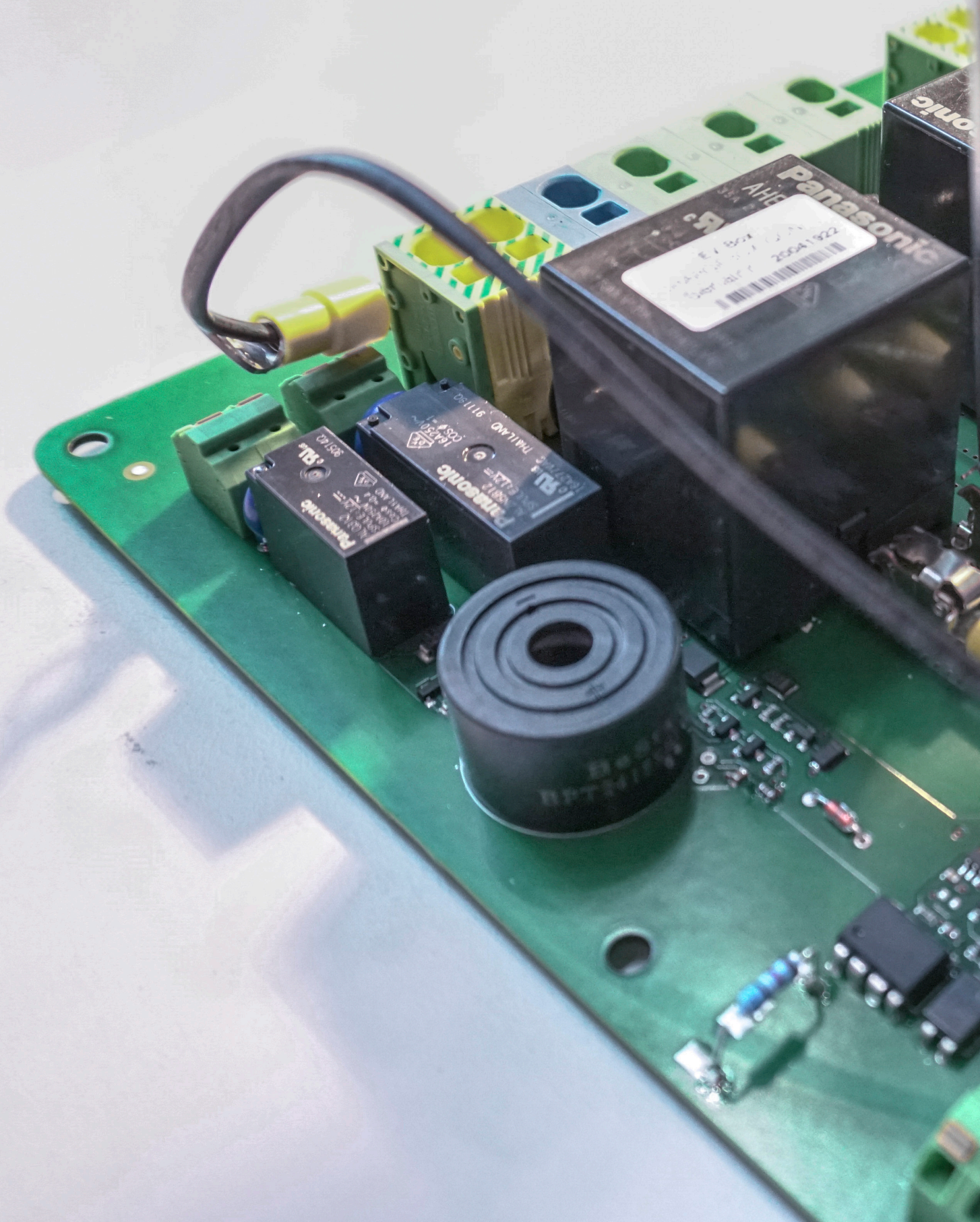

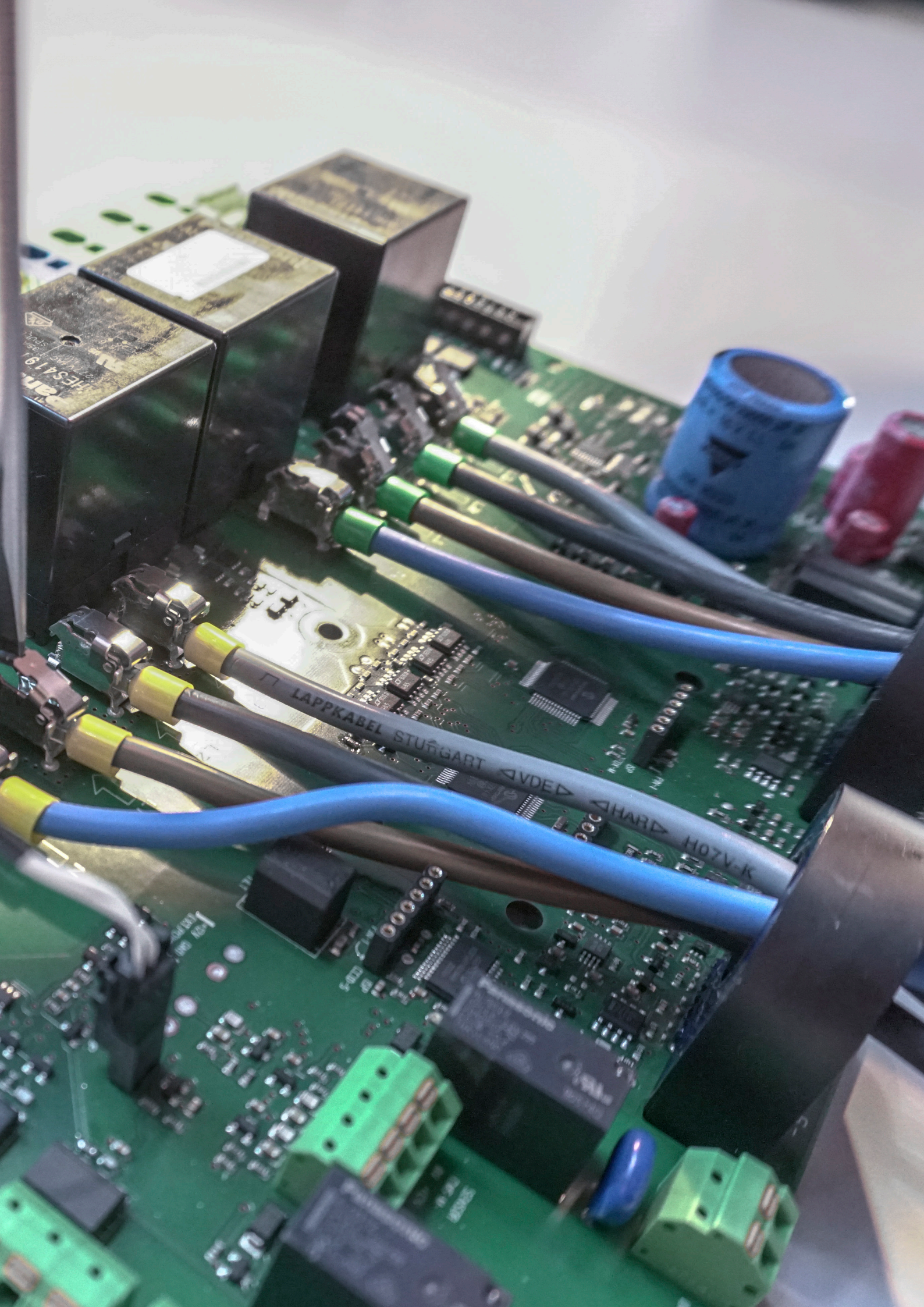

MS 4 19  
MS 4 19  
MS 4 19

LAPPKABEL STUßGART  
VDE  
HARD  
H07V-K

12V  
12V  
12V

# 3.1 Context

This chapter provides a basic understanding of EV chargers and the project context by describing the EV- and EVSE (Electric Vehicle Supply Equipment) ecosystem and its stakeholders. Furthermore, EVBox's role within this ecosystem and relations to other stakeholders are explained.

## EV chargers

Electric vehicle (EV) chargers are products which, as the name suggests, enable users to charge their electric vehicle batteries. Two types of chargers are distinguished: alternating current (AC) chargers and direct current (DC) chargers. This thesis focuses on AC chargers, on the grounds that in 2020 EVBox production volumes per product line for AC chargers were in the range of 10.000 to 100.000 units and for DC chargers in the range of 100 to 2500 units, (EVBox, 2021). According to the Transport and Environment Infrastructure Report (2020) tri-phase and one-phase AC chargers account for respectively 61% and 33% of the total power supply for EV's. DC chargers make up 4%

and 0,5% respectively. Therefore, it is at this moment more valuable to look at the impact of AC chargers rather than DC chargers.

In the case of AC chargers an onboard charger is used; it will convert the AC from the external charger to a DC inside the car to charge the battery pack. However, due to weight and size restrictions these types of on-board vehicle chargers only have a power range of around 2 kW to 22 kW. These types of external AC chargers can be found at, for example, homes, offices and public spaces. The intended use scenario consists of the car being parked and connected to a charger for 1 to 6 hours, but

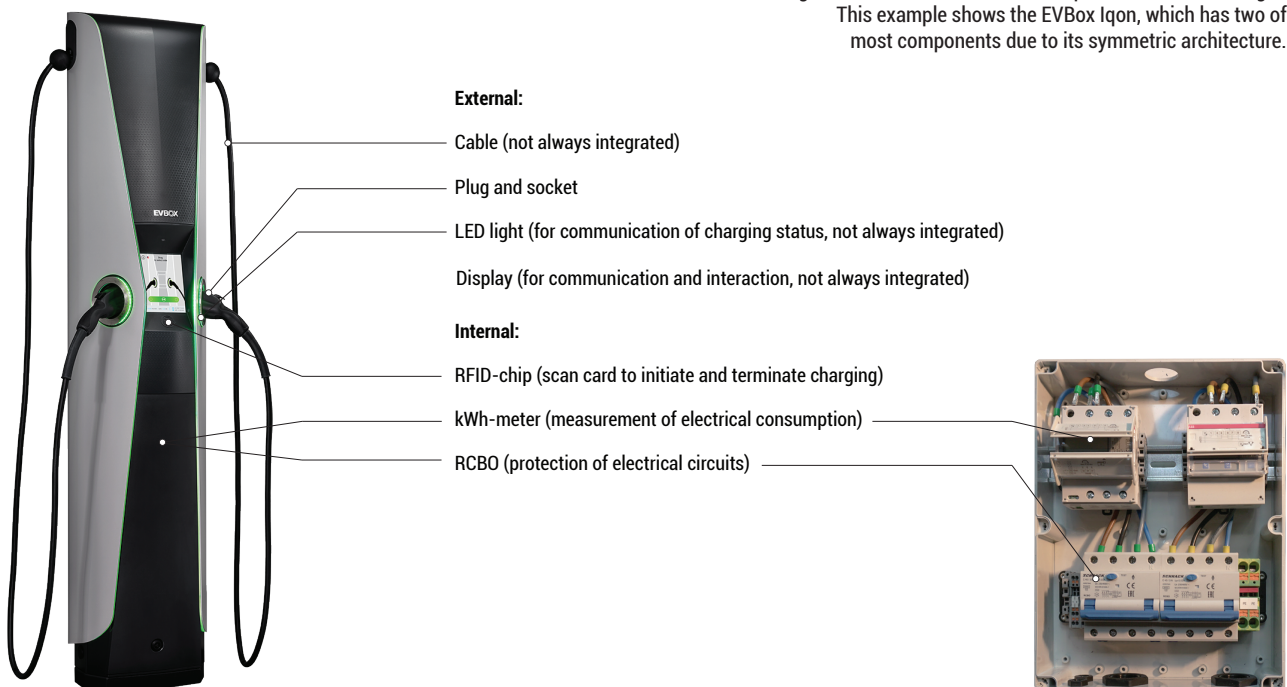

▼ Figure 2. External and internal components in an AC charger. This example shows the EVBox Iqon, which has two of most components due to its symmetric architecture.





this is dependent on charging speed. Figure 2 shows and explains the basic elements of an AC charging station.

### Market

Since 2008 the global EV market is rapidly developing due to technological advancements, supportive policies and growing customer awareness, (EVVolumes, 2020). See figure 3. Looking at Rogers' Innovation Adoption Curve in figure 4, EV adoption is well progressing into the

early adopters segment and expected to reach the early majority segment in the upcoming 1 to 3 years, (EVBox, 2021). With EV sales at an all-time high, the need for charging stations to power these vehicles is soaring as well.

Because the market is still in its infancy, there are multiple parties trying to profit from the situation. The stakeholder map for the EV market is therefore quite complicated, with sometimes overlapping responsibilities.

Figure 4. The Innovation Adoption Curve: EV adoption is progressing into the early adopters segment. ▶

Figure 3. EV sales are at an all-time high, resulting in a rapidly growing EVSE market (EVVolumes, 2020) ▼

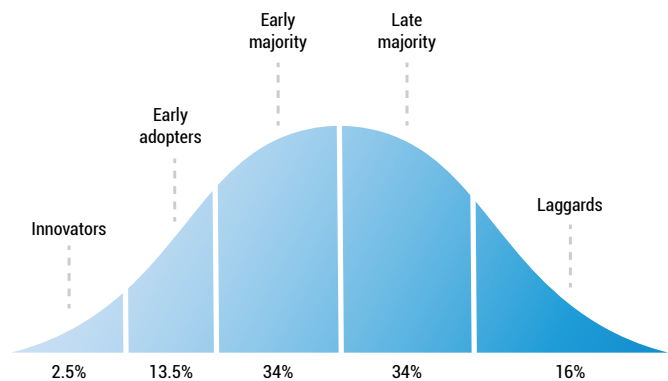

### GLOBAL PLUG-IN VEHICLE MARKETS BEV & PHEV - Light Vehicles

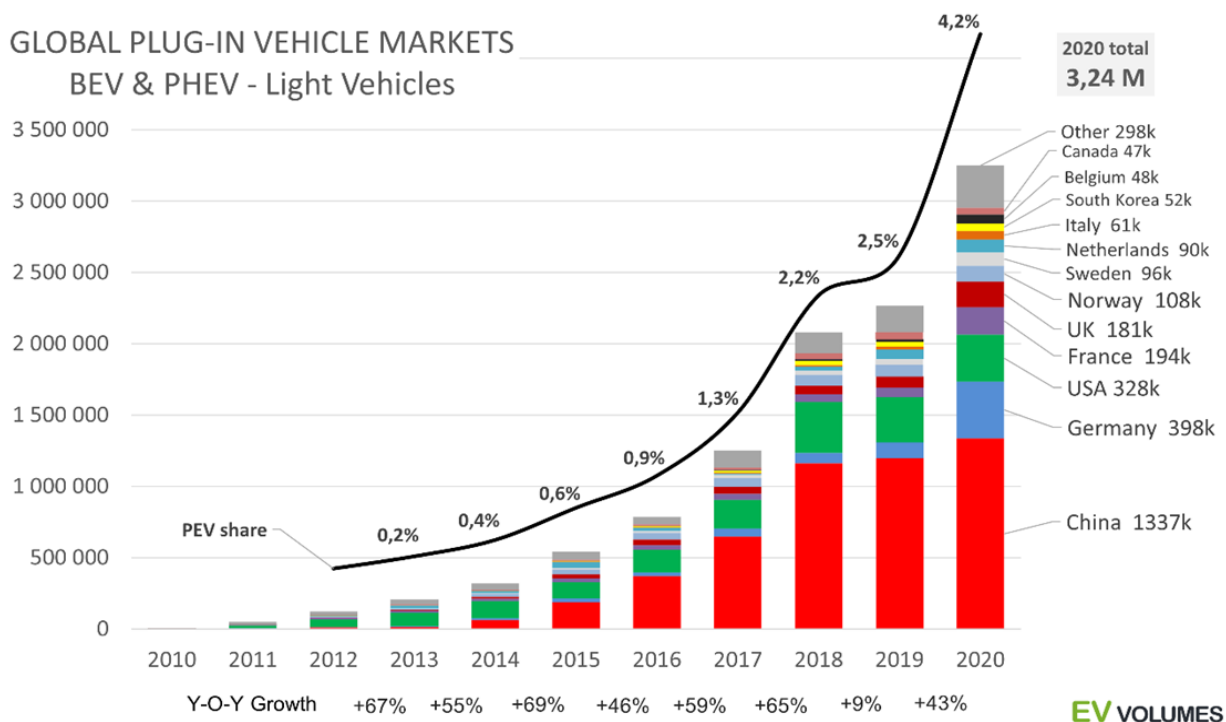

## EV ecosystem and stakeholders

The EV ecosystem shown in figure 5 shows how EV charging is currently structured in the European market, (EVBox, 2021).

- The EV driver is the user of the chargers, requiring easy access to charging points and hassle-free charging.
- The mobility service provider has a contract with the EV driver for all services concerning charging. Oftentimes the mobility service provider also acts as energy provider or charge port operator. The mobility service provider verifies contract ID's of customers that are sent through the mobility service provider clearing house, other mobility

service providers or other charge point operators.

- The charge port operator is responsible for management, maintenance and operation of charging stations, technically as well as administratively.
- The charging station owner is often also the owner of the property the charger is placed on (also known as a facility manager). Based on the location (public or private) electricity is provided by the location owner or charge port operator. The location owner can be, for example, a municipality, parking garage owner or homeowner.
- The roaming platform enables stakeholders to create a digital and efficient charging network for communication.

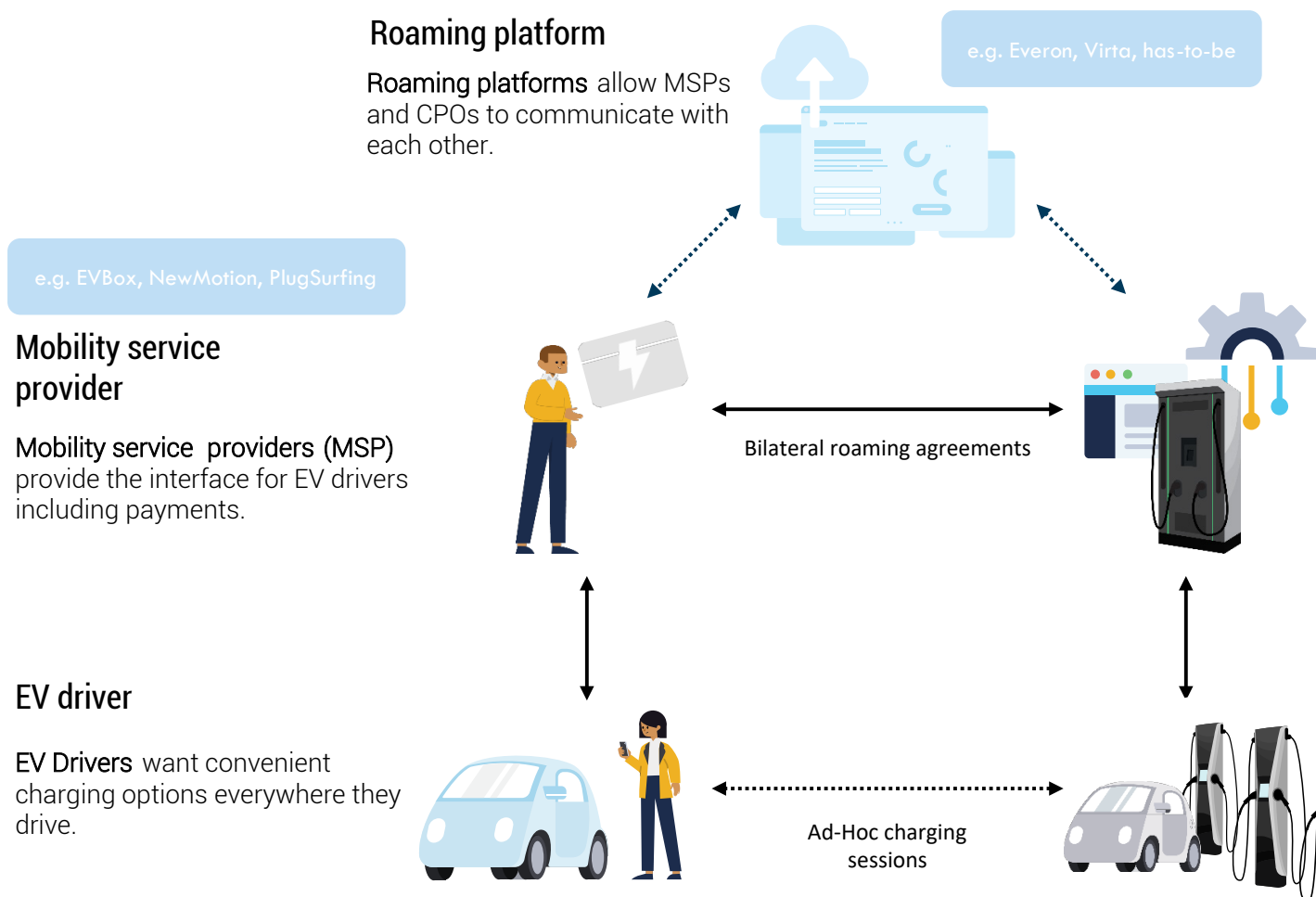

## EVBox

Since its foundation in 2010, EVBox has empowered forward-thinking businesses to build a sustainable future by providing flexible and scalable electric vehicle charging solutions. The company has experienced astonishing success and is growing rapidly, being dubbed market leader in the Navigant Research Leadership Board Report in 2019. Currently, EVBox is focused on the European and North American markets.

The key to EVBox's success is the complementarity of their solutions, providing a combination of hardware, software and services to fit customer needs. EVBox acts as a charge port operator, mobility service provider

and roaming platform operator (through their platform called Everon), offering products for operation, a software platform, mobility service, energy management and hardware. EVBox does not hold ownership of assets: the upkeep and commercialization of chargers is mainly left to their clients and partners, such as municipalities, car manufacturers and fleet operators. See figure 6 and 7. EVBox provides trainings for installers to become a certified EVBox installation partner who will then bridge the gap between EVBox and the EV driver. These installation partners will also be the ones to de-install and properly dispose the chargers after serving their commercial lifetime of 8 years, rendering them an important facet in taking back the products for applying potential EoL strategies.

▼ Figure 5. The European EV ecosystem with stakeholders. EVBox acts as a charge port operator, mobility service provider and roaming platform operator.

▼ Figure 6. Customised public EV charger for the municipality of Amsterdam.

### Charge port operator

e.g. EVBox, Allego, "Reseller"

Charge port operators (CPO) provide the platform for charging stations to interface with the EV charging network.



▼ Figure 7. Customised EV charger for the Algemene Nederlandsche Wielrijders-Bond.

### Charging station owner

e.g. Hilton, PWC, IKEA, Amazon

Charging station owners purchase, install, and maintain EV charging stations.



EVBox categorises their chargers into three segments: residential-, commercial and community- (including workplace) and on the go charging (public/fast charging). AC chargers focus on the residential, commercial and community segments. The focus of this project will be on AC chargers used in commercial scenarios. As of now, around 60% of charging sessions happen in a domestic environment.

Research has shown that this will decrease to 45% because more EV drivers will be living in shared apartment buildings. By 2030 there will be an increase in the need to charge in public or at workplaces to about 55%, (Transport & Environment, 2020).

EVBox offers two AC chargers for commercial scenarios. These are the BusinessLine and



Iqon both based on EVBox' 4th generation electronics platform, see figure 8. These are the products that are analysed in the first part of the project. Both are high-quality products, consisting of electronics inside a housing. Iqon is much larger than and more than twice as expensive as BusinessLine due to the embedded cable management system and the use of higher quality materials such as stainless

steel. However, as it is a new product there are currently only about 20 in the field whereas BusinessLine counts approximately 30.000 in the Netherlands, (Diemer, 2021). However, the number of Iqons in the field is expected to grow due to the upscaling of production.

▼ Figure 8. Iqon (left) and BusinessLine 4 (right) are EVBox's commercial AC chargers.



# Summary

- There are two types of charging: AC and DC charging. Charging with an AC charger means that conversion from AC to DC happens inside the car. Through DC charging this conversion happens in a DC charger.
- The EV and EV supply equipment markets are rapidly developing due to technological drivers, beneficial policies and customer demand. EVBox is one of the biggest charging solution companies, (EVVolumes, 2020).
- The EV charging ecosystem consists of the following stakeholders: EV driver, mobility service provider, roaming platform operator, charge point operator and the charging station owner. EVBox takes on the roles of mobility service provider, charge point operator, roaming platform operator and hardware supplier.
- EV charger sales in a business market are done either directly to facility managers, through resellers, CPO's or MSP's. 75% of sales is done B2B2B, (VanBerlo, 2018)
- EVBox sells chargers for residential-, commercial and community- and on the go scenarios.
- The focus of this project is on EVBox's commercial AC chargers, for the reason that AC chargers make up 94% of the total energy supply for EV's (Transport & Environment, 2020) and the fact that EVBox production volumes are higher for AC chargers than DC chargers. Additionally, an increase in commercial charging points is expected; by 2030 around 55% of charging sessions will happen in a public- or workspace environment (Transport & Environment, 2020).



# Conclusion

Because of the higher production volumes, more impact can be created during this project by focusing on AC chargers in the commercial segment. EVBox currently has two chargers within the commercial AC segment in their portfolio: Iqon and BusinessLine 4. Further disassembly activities within this project focus on these two products. Based on its sheer size and materials used in the product, Iqon could be an interesting choice for the redesign activities. The bigger components made from high-quality materials such as stainless steel have more embedded value that could be interesting to capture, especially considering that production is being upscaled. However, as there are currently more BusinessLines in the market (30.000 versus 20 (Diemer, 2021)), a final decision between these products is made based on the findings from the reverse logistics mapping calculations and the Disassembly Maps further on in the project.

The developing market with many stakeholders means that responsibility of the product after sale is given away, making it difficult to reclaim the product with the intend of applying R-strategies. As there are many different sales flows for EVBox products, the responsibility and ownership of the product differs largely. From a circular perspective, one would want to keep ownership of assets to facilitate the return of products for R-strategy implementation. As this is not the case, old and potentially new stakeholder partnerships would have to be clearly defined and strengthened, since all need to be aligned on the correct and most efficient return of the products.

Typically, product responsibility is passed on from an EVBox assembly partner (such as CMM) to a reseller (such as CoolBlue) to an in-house installer party (CoolBlue) or an external installer party (such as VeBe) to a facility manager (at for example a parking garage), with logistics party Kuehne+Nagel handling the transportation in between. This means that taking back the product from the field could entail the reversal of such a sales channel. In that case, once a product has reached its end of life, the facility manager will notify a (de-)installer party which will de-install the charger and have it transported back to a (dis-)assembly partner. Every (extra) step and thus stakeholder in this process could pose a barrier in the efficient take back of the chargers and thus the number of steps needs to be kept to a minimum. It would, for example, be redundant to take the product back to a reseller party before returning it to an assembly partner when inspection and disassembly activities can all be done at one facility. Furthermore, all parties would have to be financially compensated for the additional product return activities, further emphasising the need for efficiency in this process. If EVBox wants to make a successful business case, these activities should not cost more than the potential benefits that going circular could bring.

This means that these potential barriers and opportunities in the reverse logistics chain need to be further explored and defined, as well as research into the feasibility of reversing the sales channel. The following chapters will provide more details on the reverse logistics of potential circular strategies for EVBox's chargers.

## 3.2 Current situation regarding circularity

**This chapter clarifies the principles of the circular economy and the value hill, explaining and providing definitions of terms that will be used throughout the thesis. Afterwards, EVBox practices and intentions related to the circular economy are analysed.**

### The circular economy

Currently, the global economy is based on a linear take-make-use-dispose system, which means that resources are taken from the Earth, made into products, used for a certain amount of time, and then thrown away. The linear economy draws from finite resources and is destructive to the Earth's ecosystems. Consequently, the linear economy is not sustainable.

A solution to the current linear economic system can be found in transitioning to the circular economy, which is restorative and regenerative by design. As stated below by the Ellen MacArthur Foundation, (2021):

The circular economy proposes a loop-based system visualised in the Butterfly Diagram, where product life is extended through repair, reuse, refurbishment and recycling. These methods are only applicable for technical nutrients which are finite and man-made. As EV chargers are completely made from technical nutrients, the focus will be on this side of the Butterfly diagram. The other side concerning the cycles of biological nutrients is not relevant for this research. The technical cycles are shown in figure 9.

The definitions for the technical cycle strategies in this thesis are described on the next page.

**"A circular economy is based on the principles of designing out waste and pollution, keeping products and materials in use, and regenerating natural systems."**

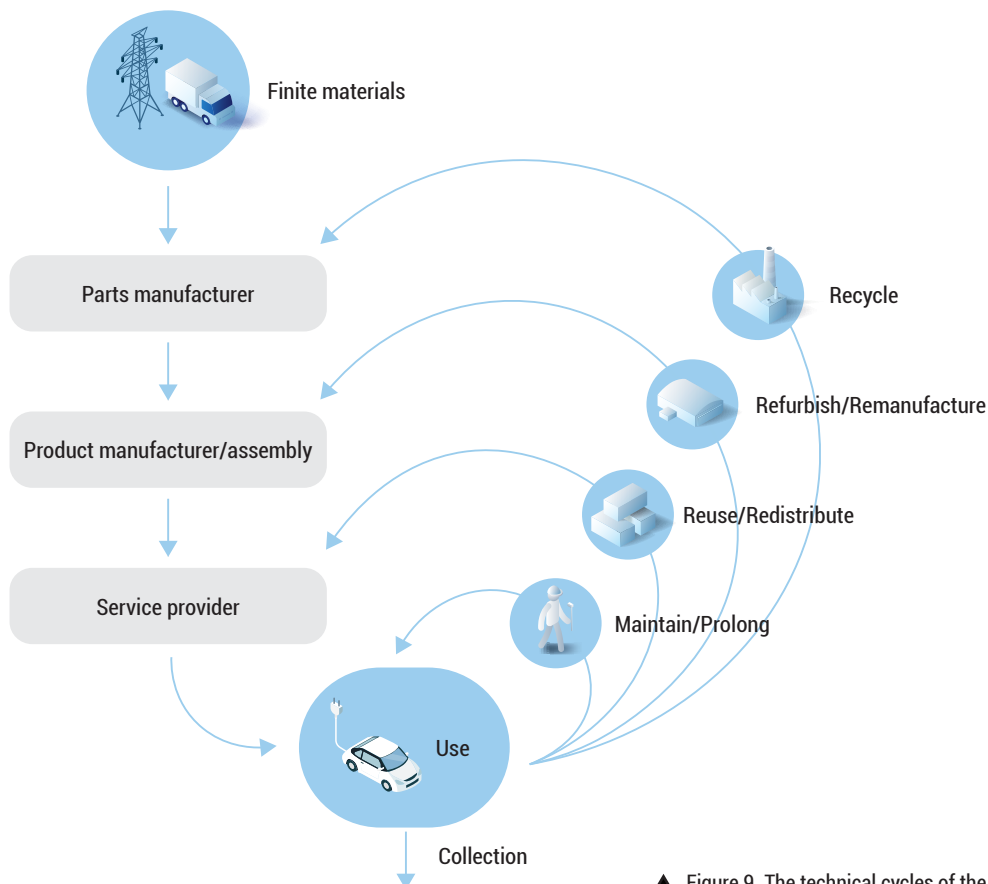

▲ Figure 9. The technical cycles of the Butterfly Diagram.



**Maintain/Prolong** is defined as “the performance of inspection and/or servicing tasks that have been preplanned for accomplishment at specific points in time to retain the functional capabilities and cosmetic condition of products or systems.” (Flipsen et al., 2016).

**Repair** is defined as “repairability is the ability to bring a product back to working condition after failure in a reasonable amount of time and for a reasonable price.” (Flipsen et al., 2016).

**Reuse/Redistribute** is defined as “The use of a product again for the same purpose in its original form or with little enhancement or change.” (Ellen MacArthur Foundation, 2013).

**Refurbishing** is defined as “A process of returning a product to good working condition by replacing or repairing major components that are faulty or close to failure, and making ‘cosmetic’ changes to update the appearance of a product, such as cleaning, changing fabric, painting or refinishing. Any subsequent warranty is generally less than issued for a new or a remanufactured product, but the warranty is likely to cover the whole product (unlike repair). Accordingly, the performance may be less than as-new.” (Ellen MacArthur Foundation, 2013).

**Remanufacturing** is defined as “A standardized industrial process that takes place within industrial or factory settings, in which cores are restored to original as-new condition and performance or better. The remanufacturing process is in line with specific technical specifications, including engineering, quality, and testing standards, and typically yields fully warranted products. Firms that provide remanufacturing services to restore used goods to original working condition are considered producers of remanufactured goods.” (International Resource Panel, 2018).

**Recycling** is defined as

- “Functional recycling. A process of recovering materials for the original purpose or for other purposes, excluding energy recovery.
- Downcycling. A process of converting materials into new materials of lesser quality and reduced functionality.
- Upcycling. A process of converting materials into new materials of higher quality and increased functionality.” (Ellen MacArthur Foundation, 2013).

## The value hill

The Value Hill is a means of showing the addition and loss of value of products pre- and post-use, see figure 10, (Hinfelaar et al., 2016). On the left side the basic steps of product manufacturing are shown: raw material extraction, component manufacturing, product assembly and retail. In a linear economy this value is completely destroyed once products are disposed of and incinerated or landfilled (figure 10 A). By implementing the strategies mentioned on the previous page value can be retained post-use. The value hill visualises how the most value can be retained on top of the hill by implementing strategies from the smallest loops where product and component integrity are maintained the most (figure 10 B).

## The circular economy and EVBox

Over the past years EVBox has developed an interest in implementing circular practices within the company. A logical development because sustainability is at EVBox's core as an E-mobility actor. Combined with the effects of the customer pull and legislative push from both European and national authorities, EVBox has the ambition of becoming a sustainable EV charger market leader. Not only from an ethical standpoint, but also from a business standpoint.

Research into several EV supply equipment manufacturers reveals a general message: all advocate sustainability by reducing carbon emissions in the mobility industry, but almost none make notion of circularity or the circular

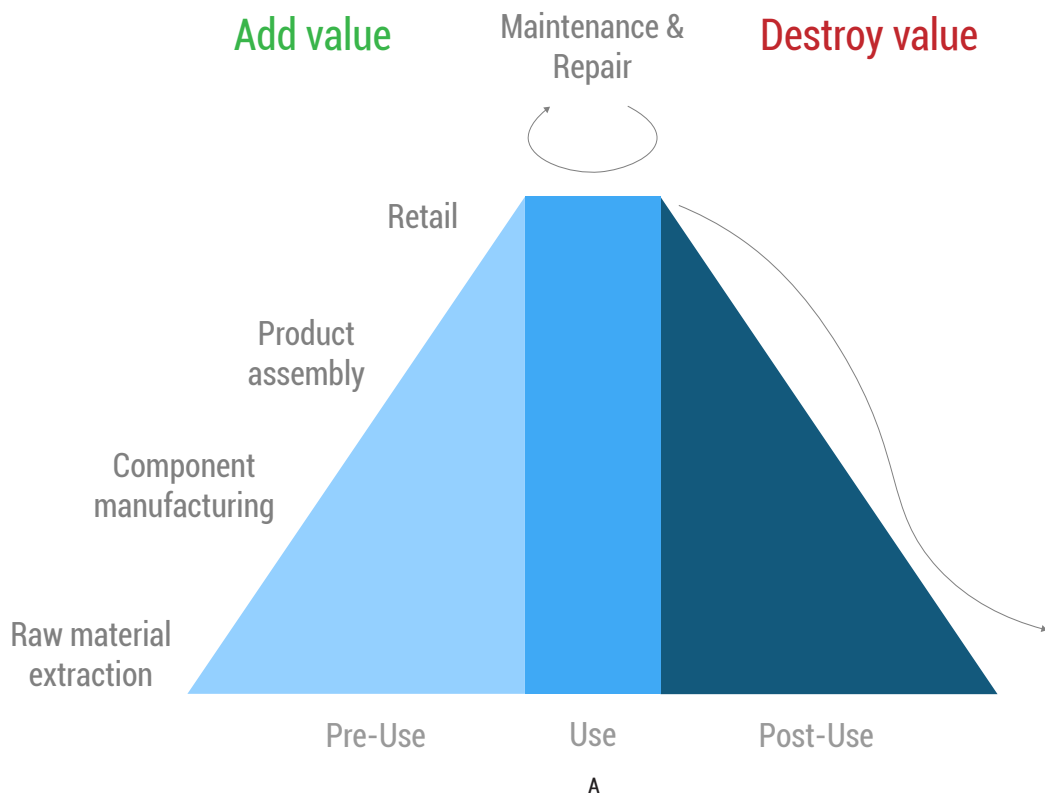

economy. For example, one of EVBox's main competitors ChargePoint states on their website that 'EV's drive a sustainable future', later adding that 'reducing greenhouse gas emissions is key to slowing climate change'. No information on circularity can be found on their website, but they do offer charging as a service, which is a subscription-based model. See figure 11. Within such as model customers pay a monthly fee in return for a monitored and properly functioning charger. After the subscription has ended, ChargePoint will take back the chargers as it has kept ownership over the product. Such a subscription model is an excellent example of keeping product ownership and is highly compatible with circular businesses.

A big competitor in Southern Europe and the

US that does display knowledge of the circular economy is Enel X, stating to 'boost circularity for a sustainable world'. Enel X is not only active within the EV supply equipment market, but also within the field of public lighting, home boilers and general consultancy for businesses on how to go circular. Their domestic EV chargers are made from recycled plastics and their chargers for urban areas are made using renewable energy. Furthermore, parts of the public chargers can be recovered and reused, providing it with a self-proclaimed circularity score of 3 out of 5 as shown in figure 13.

EVBox is 'advocating for a zero-emission future' and takes part in many initiatives such as the Global Climate Action Summit, believing that it is beneficial to have many perspectives

▼ Figure 10. A. The value hill in a linear economy. B. The value hill in a circular economy.

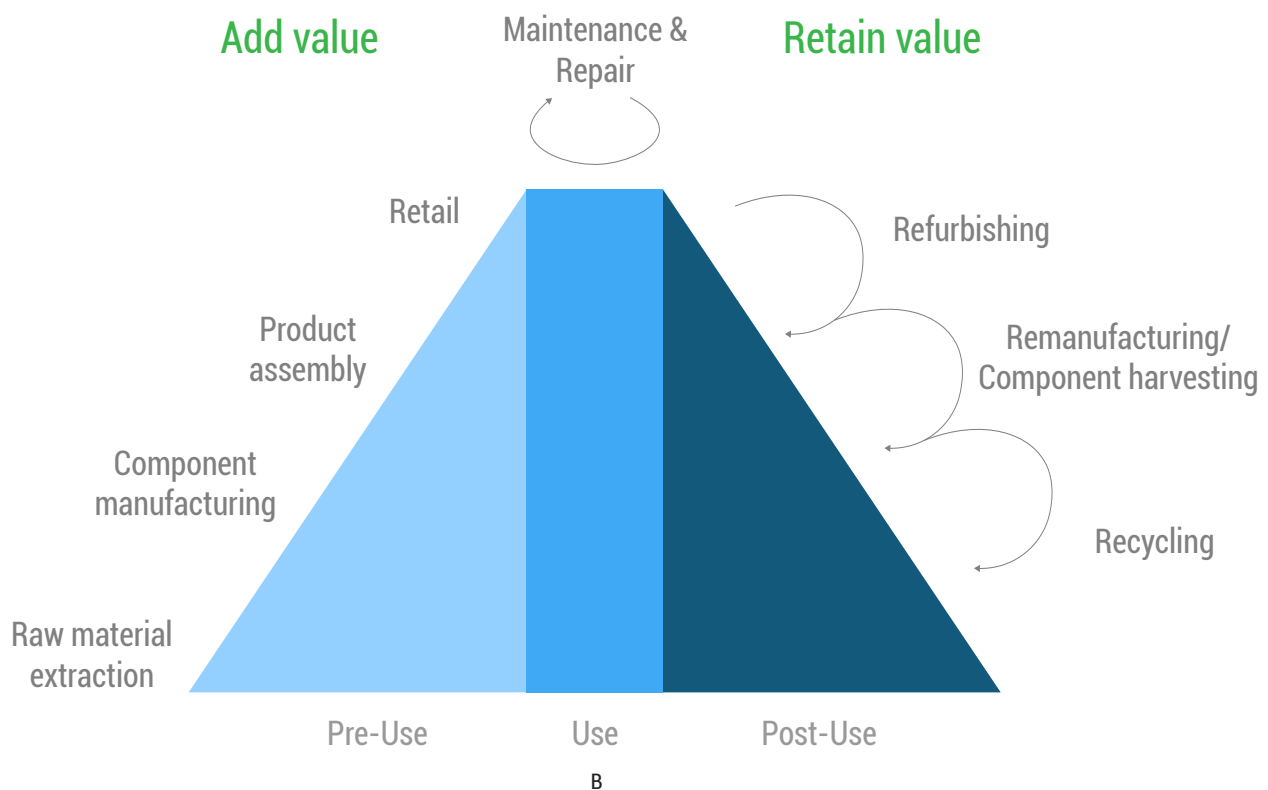

on solving the intricate problem of climate change. Through multiple posts on their blog it becomes clear that EVBox is aware that 'emission-free' should not just apply to the end product, but to the whole lifecycle of the product. Compensations through the planting of trees for every charging port sale are made to cover for excess emissions. Furthermore, manufacturing is done locally in the US and the Netherlands, mitigating long distance transport by container ships.

There is currently, however, a discrepancy in the company's claim and execution. Selling products through resellers means most

control and responsibility after product sale is given away. As of now, all EVBox products are decommissioned by either the user in a domestic scenario or an external party in a commercial scenario, the products will then be collected and treated as electronic waste following the WEEE directive (in the EU) by unknown third parties. Therefore, it is difficult to completely close loops and retain and capture value of products.

As a result, EVBox is exploring opportunities for applying circular strategies. Since the start of their collaboration in 2016, design agency VanBerlo has done several projects concerning

▼ Figure 11. Chargepoint offers charging as a service subscription models.

Figure 12. EVBox article that reads 'a sustainable business is a circular business.' ►

Figure 13. Enel X circular public chargers. ◀



## ChargePoint as a Service

### A Solution for Every Business Model

ChargePoint's subscription solution, ChargePoint as a Service™, is an easy way for businesses to offer ChargePoint electric vehicle (EV) charging. You're probably familiar with other "as a Service" models, such as Software as a Service (SaaS), which offer access to smart solutions at a reduced cost through subscription pricing. Choosing to implement your ChargePoint solution as a service brings all the benefits of this popular model to charging solutions.

### The Control You Want, with Less Overhead

- ✔ Choose the term that works for you: 1, 3 or 5 years
- ✔ Conserve CapEx funds and use annual OpEx funds to pay for your charging infrastructure
- ✔ Protect and get the most out of your investment: stations are always proactively monitored and never technically obsolete
- ✔ Save time and money with minimal overhead and predictable operational expenses



circularity and sustainability. Through this collaboration EVBox has made progress in making their product development more sustainable. During the design process the whole lifecycle of the charging station is taken into account. For example, by putting effort in making the chargers more serviceable via a modular setup and by limiting the number of steps that have to be taken to reach failure-prone components or by assessing the possibility of selling refurbished products. An EVBox blog post in 2018 provides a glimpse into a potential service model where users can subscribe to make use of a charging station, eliminating the need to buy chargers. See figure 12. Upon

ending the subscription, the chargers are taken back by EVBox for refurbishing and recycling. Currently, the subscription model development has been put on hold, but it is promising to know EVBox seems to have considered this.

EVBox could differentiate in the EV supply equipment market by going circular, being able to show that they are not just a sustainable business, but a circular business.



[← Back to articles](#)

## SUSTAINABILITY

# A sustainable business is a circular business



### CIRCULARITY SCORE

Sustainable inputs, sharing platform, product-as-a-service, life extension.



## Circular Product

The Enel X series of electric vehicle chargers for urban areas are made using renewable energy and their parts can be recovered and reused. They power sustainable mobility for private individuals and public administrations alike, making cities more circular, comfortable and clean.

[FIND OUT MORE >](#)

Countries



## Current life cycle map and End of Life

The life cycle map in figure 14 visually represents the stages a charger will go through during its life. Beginning with raw material extraction and component manufacturing. Component manufacturing and assembly is outsourced to multiple third parties.

Product assembly is done by assembly partners and potentially disassembly partners such as CMM in Amersfoort and VDL in Eersel, after which the products are stored and transported to resellers by EVBox's third party logistics provider Kuehne+Nagel. Installation is done by a third party or by the reseller themselves in case they offer installation services.

EVBox's AC chargers have an estimated commercial lifetime of 8 years, after which they will be de-installed and brought to special waste collection points by an installer party. Then, they will be disposed of following the WEEE directive, for which EVBox pays a tax. Eventually, this still means that the products are shredded. Valuable materials such as copper in the cables and metal parts are collected and recycled, but other less valuable components will be incinerated.

As can be seen in the figure, the life cycle map of EVBox's chargers is linear, which means that potential value is lost as shown in the value hill in figure 10A. Through application of one or more value retention strategies from the butterfly diagram in figure 9 the value of these products can be captured. They are represented in figure 14 by arrows that loop back to earlier stages in the charger lifecycle. In the next chapter the options of maintenance and repair, remanufacturing, recycling and component harvesting are presented and evaluated through reverse logistics mapping.

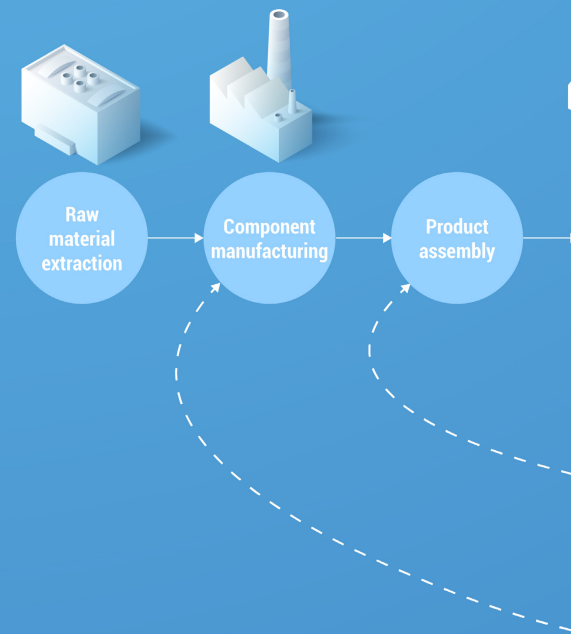
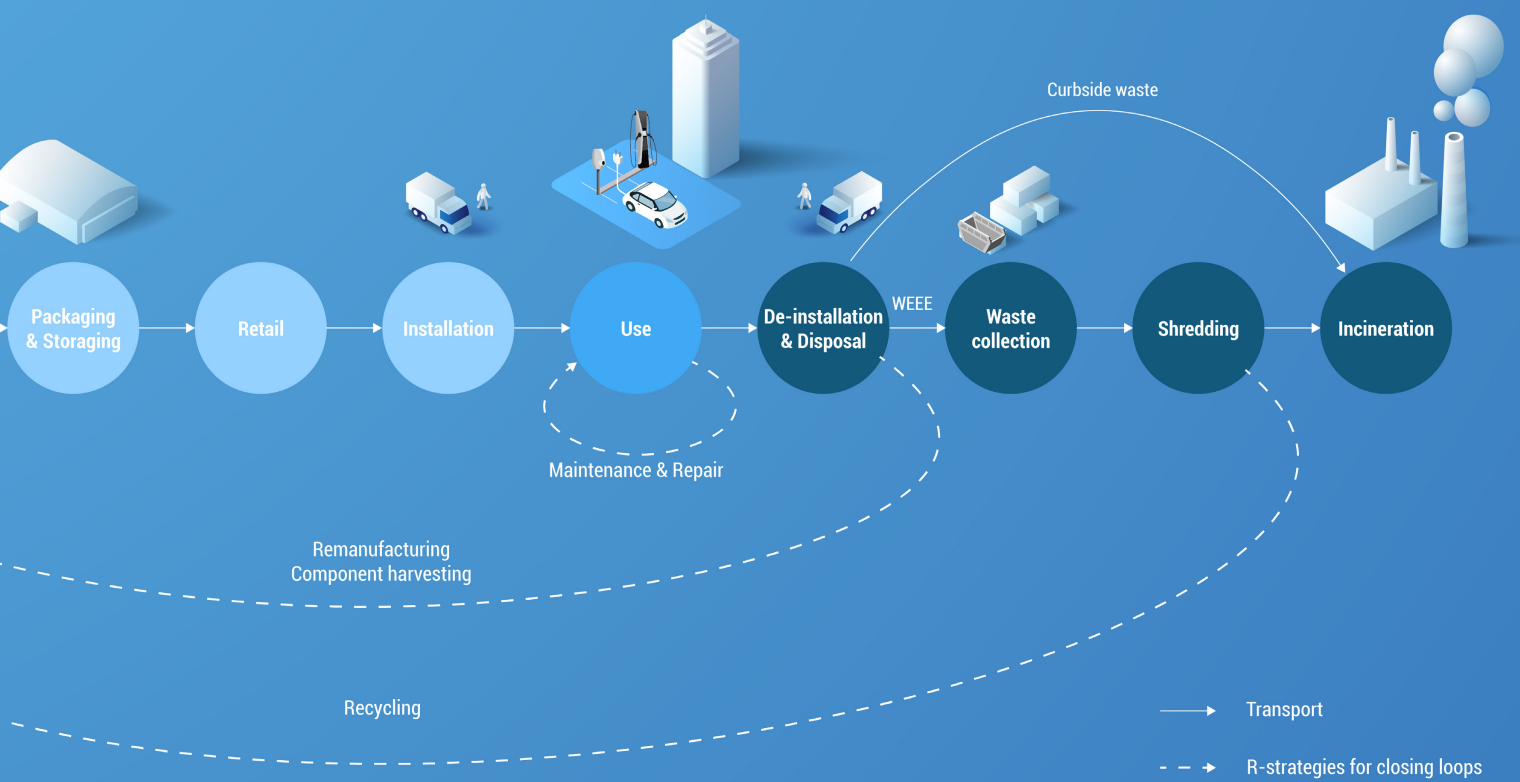

Figure 14. The linear life cycle map of EVBox's chargers. ►



# Summary

- In a circular economy product value is retained and captured through closing loops. This can be done by maintaining/prolonging product life, reusing, refurbishing, remanufacturing and recycling. They are listed here in order of least product integrity loss to the most product integrity loss. EVBox is looking for new ways to implement circularity on both product- and strategic level.
- The life cycle map of EVBox's EV chargers shows a linear flow where the products are eventually disposed and treated as electronic waste by unknown third parties. Partnerships with current or new third-party installers/servicers/logistics providers have to be defined or set up in order to bring back the products to (dis-)assembly partners.
- In general, EV supply equipment manufacturers contribute to tackling climate change by providing the chargers that are needed to electrify the mobility sector, leading to reduced carbon emissions. Almost no competitor makes notion of the circular economy. EVBox seems to be one of the few parties that is aware of the fact that sustainability applies to more than just the end product and instead on the whole product lifecycle and the way business can be done.





## Conclusion

To differentiate from other EV supply equipment manufacturers and recapture the value of their EoL products, EVBox could go circular by applying one of the loop closing strategies proposed in the butterfly diagram. Being able to present the company as circular instead of just sustainable would show customers that EVBox holds the upcoming changes imposed by European and national law in high regard. By being one of the first companies to implement these changes, EVBox could become a front-runner and expert on the development of circular EV chargers. The first step of becoming aware has already been taken, but there still is a way to go when it comes to mastering and implementing circular business models.

Going circular, however, means a thorough change in the way business is done is necessary. As mentioned before, one or more strategies from the butterfly diagram should be implemented which requires, among other undertakings, the additional setup of a reverse logistics infrastructure. To facilitate this, charging as a service could be an outcome as product ownership is retained throughout and after the subscription period. However, exploration into a subscription model in 2018 has been put on hold by EVBox for now.

Taking this into account, the further analyses will not be on a subscription-based model, but on the current business model where product ownership is given away after sales. This means that EVBox's de-installer-, logistics- and disassembly partners should agree to the changes that closing loops will bring.

De-installation is something that would happen at EoL in all cases, the difference is that in a circular construct a charger is send back to a (dis-)assembly partner instead of a waste manager. Furthermore, de-installation has to be non-destructive to keep the product in the best shape possible. EVBox should align with all de-installation parties concerning these changes, of which implementation appears to be plausible.

Reverse logistics could be handled by EVBox's current logistics partner Kuehne+Nagel. As mentioned on their website, the company has experience with aftermarket services that can be tailored to specific needs. It is promising to see that one of the major stakeholders in the (reverse) logistics of EVBox products is already taking part in initiatives for recapturing value by reusing products and materials. This should make an extension on the current partnership for transportation, warehousing and other specifics concerning logistics plausible as well.

Non-destructive disassembly of the chargers and sorting of components could be done at current assembly partners, but the necessary tools for applying more extensive R-strategies such as remanufacturing are unavailable at these facilities. This means that, in case there is enough space available, they should either be bought (and covered by EVBox) as an investment for upgrading the current facilities or disassembly and more extensive reconditioning could be outsourced to other parties. If either or both are done, disassembly and reconditioning of EVBox chargers are plausible too. During the Reverse Logistics Mapping activities the assumption was made that remanufacturing will happen at a (dis-)assembly partner.

In this chapter it became clear that applying value retention processes seems to be plausible for EVBox products, thus the next chapter explores the possibility of creating successful business models from closing loops through maintenance and repair, remanufacturing, recycling and component harvesting.

## 3.3 Reverse logistics mapping

**This chapter aims to provide a detailed overview of EoL strategies and what potential implementation would mean for EVBox. The focus of this analysis is on economic factors: through costs calculations a decision for the most fruitful business model scenario is chosen. After all, making a product easier to disassemble does not provide guarantee that it is actually worth it.**

### Potential business model scenario's

There is a genuine interest in closing and slowing loops from EVBox's side. A visit to assembly partner CMM has also indicated that there is interest in going circular. As mentioned before, closing loops will strengthen EVBox's market position as a sustainable EV charging solution provider. Additionally, the customer pull and legislative push are making changes in the way businesses operate necessary. Furthermore, CMM's CEO Hans Lamme indicated and showed that there is a possibility of adding a designated disassembly line in the assembly hall during a company visit.

Reverse logistics is defined as 'moving goods from their place of use, back to their place of manufacturing for re-processing, re-filling, repairs or recycling/waste disposal' (Deloitte Consulting, 2014).

The Ellen MacArthur Foundation stated the following on reverse logistics, (2016):

"Just as important as forward logistics, which powers global trade through the transport of materials, goods and information from start to (literally) finish, is reverse logistics. It is a key step in capturing the value of end-of-life goods and facilitating the reuse and recycle pillars of the circular model. This covers not only the collection and transport of materials

and products but value-added activities such as testing, sorting, refurbishing, recycling and redistribution."

This thesis aims to add a 'mapping' activity to the identification of reverse logistics steps which entails visually representing all steps, stakeholders and related costs and benefits. It can be considered a tool for finding and communicating fruitful circular strategies to stakeholders.

By visually mapping the reverse logistics steps and calculating the costs connected to its activities it is possible to estimate which value retention strategy can be best implemented by EVBox in the future as a potential business plan. Combined with the product-based Disassembly Map findings, guidelines for improvement can be made for the redesign for this specific strategy.

The four potential strategies that are considered in this analysis are:

- Maintenance and repair
- Remanufacturing
- Recycling
- Component harvesting

Refurbishing is left out of this analysis as prior research by EVBox has already indicated that this could be a feasible strategy.



*Note: all developed scenarios on the following pages are hypothetical and serve as examples of strategical possibilities. The business models still need to be further developed.*

### 3.3.1. Maintenance and repair

Product life extension is a means to keep products in use for longer periods of time. This can be done by servicing activities such as repair, replacement and cleaning. EVBox chargers have an average commercial lifetime of 8 years, of which 3 years are covered by legal warranty. This warranty can be extended to 5 years. The warranty implies that the product should be functioning normally within this period of time and, in case parts failure and errors due to wrong assembly occur, it will be covered by EVBox. Labour costs of the repair professionals are not covered by EVBox. EVBox will be influenced if products are designed badly for repair, since the products have a warranty: customer satisfaction might decrease since customers do not expect the product to break within this period and repair costs will increase. An additional reason for wanting better repairable chargers came to surface through conversations with the EVBox Product Management Department: products that are more serviceable are more attractive to installers and repair professionals. These are often part of the reseller company and influence the purchase of a specific EV charger brand. In short: EV chargers that are easy to service are preferred over other chargers.

EVBox does not have in-house (de-)installation- and service technicians. After the products are sold to charging port owners maintenance is done by EVBox trained installation parties such as ENGIE affiliates or other installers such as Laadpunt.nl, Justplugin and VeBe in the Netherlands. For big contracts EVBox cooperates with third parties for service and maintenance to be able to offer one turn-key solution to customers.

Only when issues appear to be too complex to resolve on-site, the faulty components or station are disassembled and taken back to CMM or another assembly partner.

Additionally, CMM takes back faulty products through Return Merchandise Authorization (RMA) orders. The most common reasons for sending a product back are 'wrong item delivered' and 'wrong item ordered'. CMM does

not take back products that need to be repaired; this is done on-site by the aforementioned third-party specialists. The CEO of CMM explained that in case of an RMA, products will undergo a physical quick check and be reboxed and re-sent when the box is unopened upon arrival. When the box is opened by a customer, the products will undergo a full check, including cleaning and replacement of parts where needed. Then the products will be reboxed and re-sent.

These and the aforementioned efforts indicate the possibility of a larger-scale repair service where more components are available as spare parts and a continuous in- and outflux of to be repaired and repaired products is constituted.

Product life extension in itself may not provide any extra income, as product sale is still just once per product. Extra income may come through increased customer loyalty, sales and the reduction of servicing costs under warranty. Servicing and repair packages can be provided to customers for a certain price guaranteeing product repair within a certain number of days. Maintenance and repair can be a lucrative strategy when the income made from selling these servicing and repair packages to customers exceeds the servicing and repair costs. A calculation was done based on collected data and assumptions which can be seen in the reverse logistics map in figure 15 and found in appendix A1. The complete Excel calculation sheet can also be found in appendix A1. Figure 15 shows the benefits versus costs regarding this scenario: it is estimated that profits in a maintenance and repair scenario are equal to 8% of the costs. The calculation shows that transport costs are low compared to the labour costs. The biggest expenses come from labour and spare parts. The latter being heavily dependent on which part(s) needs to be replaced. For example, the replacement of the entire installer- and chargerbox assembly is roughly ten times more expensive than the replacement of the kWh-meter alone. The yearly servicing of all stations amounts to the biggest expenses. As of now, there are only about 20 Iqons in the field; this number is expected to grow. Which means more servicing and repair has to be done for this product, and more servicing and repair packages can be sold.

Figure 15. Reverse logistics map of a maintenance and repair scenario. ►



## Maintenance and repair scenario

An Iqon/BLG4 at the parking lot on the ILSY-plantsoen in Ypenburg is serviced by Engie services located at the Oude Middenweg in Den Haag.

## Key assumptions

- All servicing and repair is done on-site.
- Servicing is done once a year (VeBe, 2021).
- Transport happens with a Diesel van with fuel consumption ratio 1:10.
- There are currently 30.000 BLG4 and 20 Iqons in the Netherlands (Diemer, 2021).
- Benefits are created by the sales of maintenance- and repair packages to clients.
- Other assumptions can be found in appendix A1.

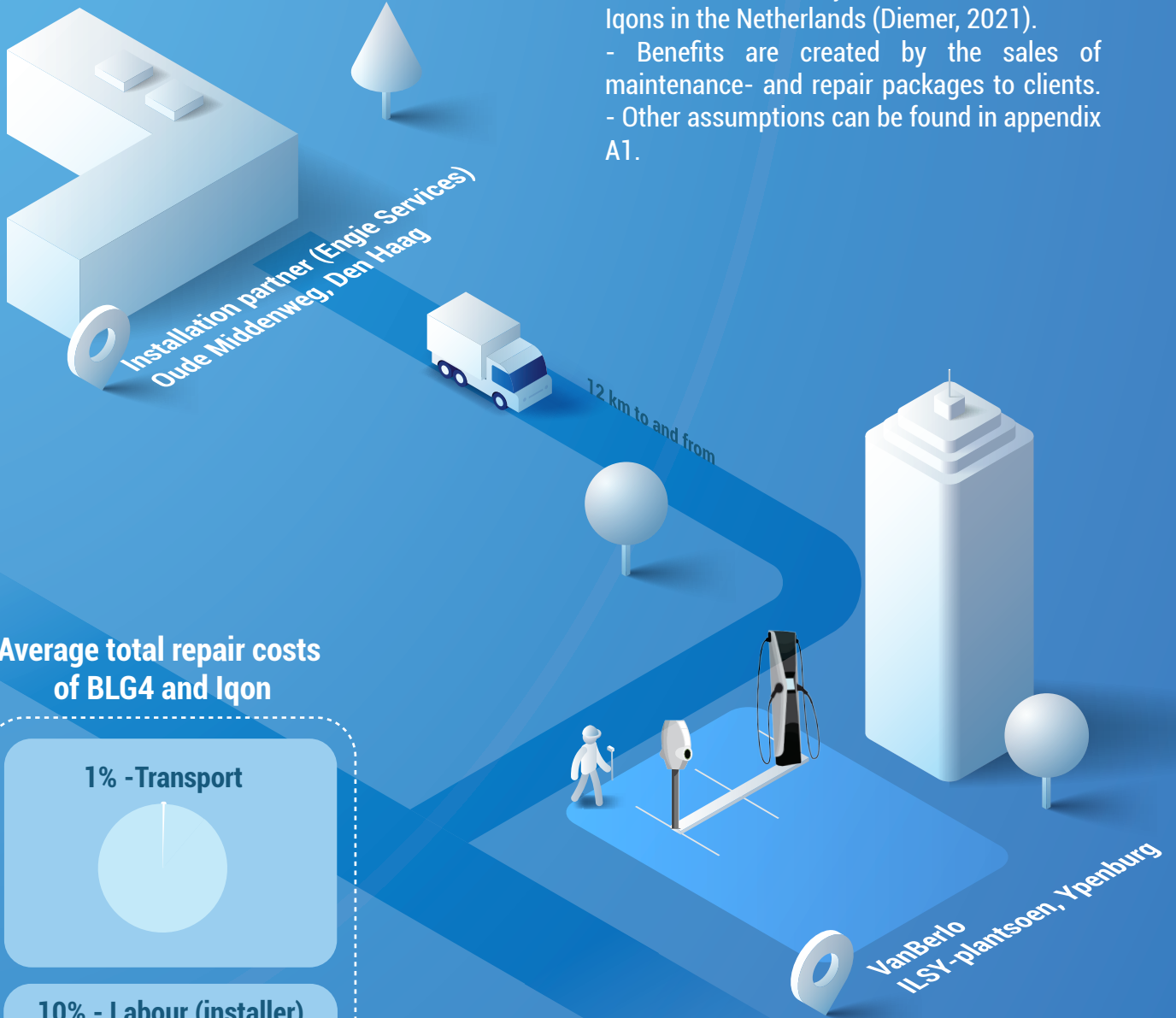

## Average total repair costs of BLG4 and Iqon

1% - Transport



10% - Labour (installer)



89% - Spare parts



## Costs versus benefits per year

Profits equal 8% of costs

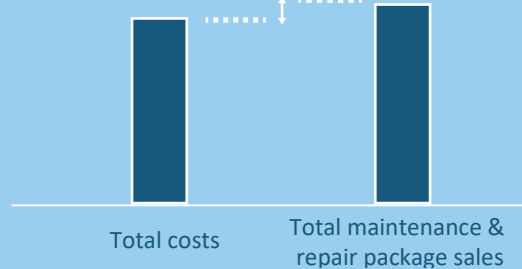

### 3.3.2. Remanufacturing

Remanufacturing is a potentially valuable strategy for EVBox, as their products are durable and made of high-end materials, (Gray, C, Charter, M., 2007; Hatcher, Ijomah, Windmill, 2011). Additionally, as EVSE sales are growing and EVBox production is being upscaled the reverse flow of used products will also grow, which can enable sufficient product inflow for remanufacturing (Gray, C, Charter, M., 2007; Ayres, R. et al., 1997).

Applying a remanufacturing strategy would mean taking back products from the field to CMM or another (re)manufacturing partner which will be done by an installer party and Kuehne+Nagel. Upon arrival, the process of running entrance diagnostics on electronics, disassembling the products, thorough cleaning of parts, inspecting and sorting parts, remanufacturing suitable components/ replacing components that are unsuitable for remanufacturing, reassembling products, final testing and finally selling the reassembled products is done (Steinhilper, R., Butzer, S., 2016). Reassembled products consist of a combination of new and remanufactured parts.

From a financial perspective, this could be a viable strategy when the benefits made from selling remanufactured products is higher than the costs of taking back the chargers and remanufacturing them. Additionally, remanufacturing would lead to material and cost savings.

A scenario calculation was done based on the assumptions shown in the reverse logistics map in figure 16 and appendix A1. The complete calculation can be found in appendix A1. In this scenario it becomes clear that transport costs amount very little to the overall costs. De-installation of all stations is expensive due to the labour costs of installers.

Components have been divided into three groups: wear parts/obsolete parts, reconditionable parts and harvestable parts which can be seen in Appendix A1. The component category percentages are visualised under the 'Component harvesting' subchapter. In case the main frame, top frame, CMS guide frame, side panels, pulley system, aluminium heatsink and DIN rails in Iqon are reconditioned, 35% of the total production costs can be saved. It is estimated that 48% of total production costs needs to be invested in replacing wear parts with spare parts, which amounts to 88% of the total costs of remanufacturing. Overall, it is estimated that profits in a remanufacturing strategy amount to 54% of the costs, rendering remanufacturing a lucrative strategy.

As of now, there are only about 20 Iqons in the field; this number is expected to grow, which means more remanufacturing has to be done and more remanufactured products can be sold.

Figure 16. Reverse logistics map of a remanufacturing scenario. ►



## Remanufacturing scenario

An Iqon/BLG4 at the parking lot on the ILSY-plantsoen in Ypenburg is at its EoL. It is de-installed by an EVBox partner and stored at a Kuehne+Nagel warehouse. Then it is brought to CMM, where it will go through the remanufacturing process. Afterwards, the remanufactured product will be remarketed and sold as new.

## Key assumptions

- Transport happens with a Diesel van with fuel consumption ratio 1:10.
- There are currently 30.000 BLG4 and 20 Iqons in the Netherlands (Diemer, 2021).
- 50% of brought back Iqons and 25% of BLG4's will be remanufactured and resold.
- Remanufactured products are sold for 2/3rd of the original price, business model still to be further developed.
- Remanufacturing consists of disassembly, inspection and sorting, cleaning, reconditioning (resetting), replacement with spare parts quality control, assembly, end of line testing (Steinhilper R.; Butzer S., 2016).
- Storage costs, tooling costs and remarketing costs have been left out of the calculation.
- Other assumptions can be found in appendix A1.

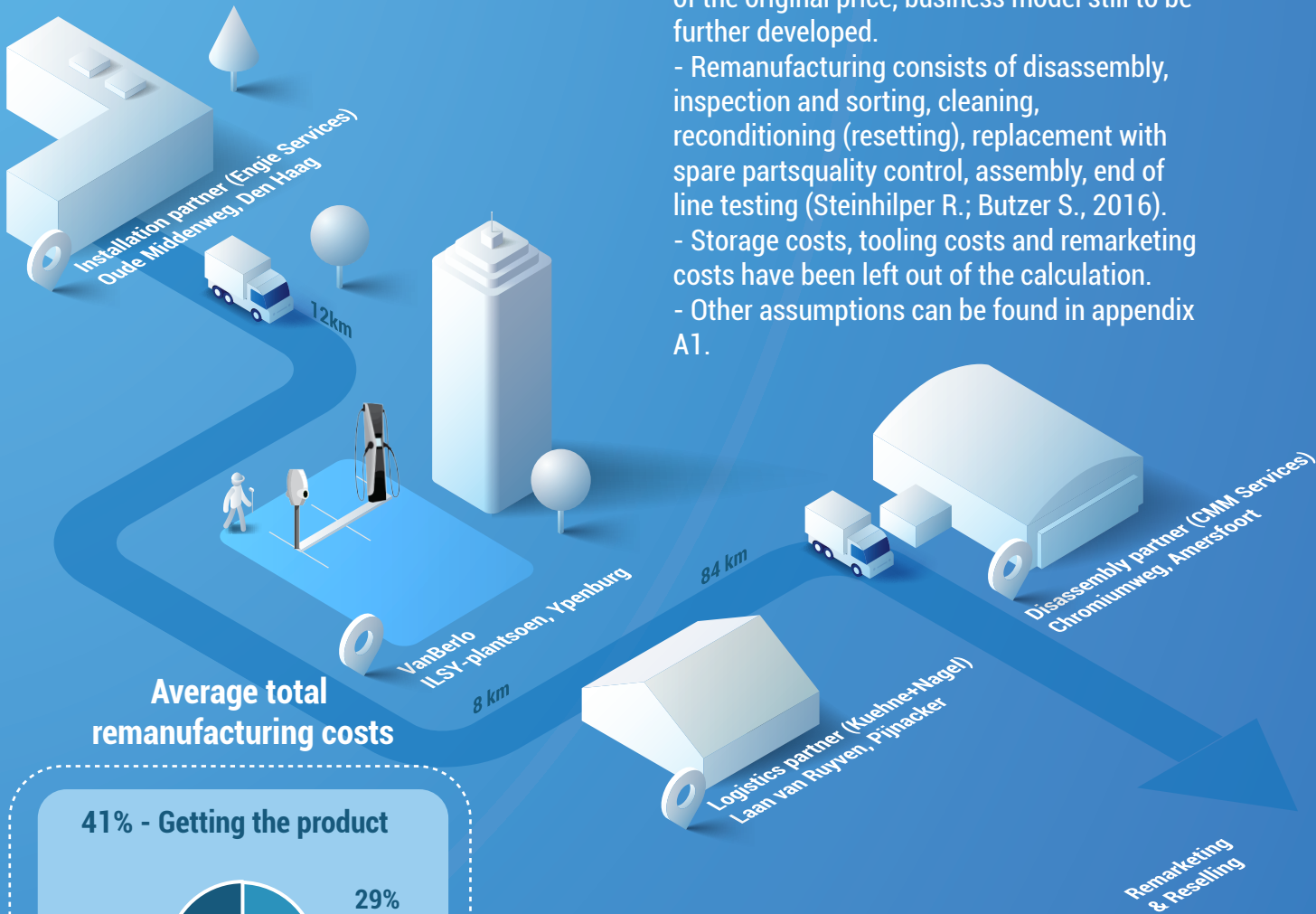

### Average total remanufacturing costs

41% - Getting the product



71% De-installation

59% - Remanufacturing\*



~88% Spare parts

~12% Reman proces

\*BLG4 & Iqon average

### Costs versus benefits

Profits equal 54% of costs

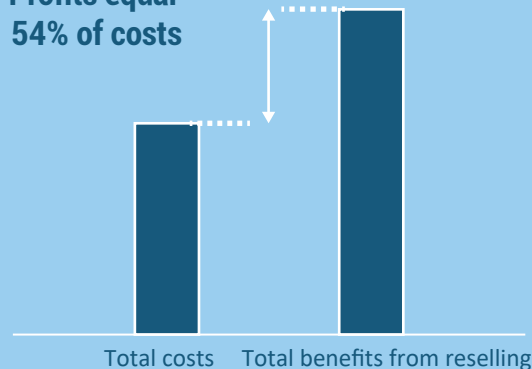

### 3.3.3. Recycling

Recycling is a strategy that affects component integrity the most: components are collected, liberated, concentrated and reprocessed, (Tempelman, 2014). After reprocessing, the materials can be reused in other applications. Recycling should only be done when other strategies that better preserve product/component integrity are not viable. A recycling strategy should therefore only be chosen as a last resort.

The correct collection of chargers that have reached EoL is the first step in this process. In a business scenario, the facility manager is responsible for the disposal of the charger. He or she would have to call an installer to de-install the charger, who would then transport or send the charger to a specific collection point. From there on the charger will have to be transported to a special sorting centre, where the product will be disassembled and separated into specific waste streams to be processed at specialised processing centres, (WEEE Nederland, 2021). There, the streams are separated and shredded as mentioned above resulting in feedstock for new products. Any residual waste is incinerated.

Recycling is an economic activity (Tempelman, 2014). As shown in the reverse logistics map in figure 17, it is unlikely that EVBox will be able to profit from income made from reselling recycled materials, as it will be captured by the recycling centre. Appendix A1 shows an estimated costs overview for a recycling scenario. This calculation does show, however, that EVBox chargers contain lots of precious metals: value which should be captured, rather than given away. This emphasises the importance of implementing other R-strategies before recycling.

It should be noted, however, that upcoming European regulations will make correct recycling of products mandatory as mentioned in the European Green Deal (European Commission, 2019) and the Circular Economy Action Plan, (European Commission, 2020). Producer responsibility will have to be strengthened. Therefore, it could be worthwhile to form one or more partnerships with third-party recycling plants. Assembly partner CMM is currently working with recycling partner HKS, which could perhaps be investigated further to explore possibilities of upscaling recycling activities when reverse logistics activities are upscaled.

Figure 17. Reverse logistics map of a recycling scenario. ►



## Recycling scenario

An BLG4/Iqon at the parking lot on the ILSY-plantsoen in Ypenburg is at its EoL. It is de-installed by a EVBox partner and stored at a Kuehne+Nagel warehouse. Then it is brought to CMM for disassembly and picked up by a recycling partner for further processing.

## Key assumptions

- Transport happens with a Diesel van with fuel consumption ratio 1:10.
- There are currently 30.000 BLG4 and 20 Iqons in the Netherlands (Diemer, 2021).
- 90% of chargers is reclaimed from the field.
- A material recovery rate of 60% is used.
- Shredding costs: €25 / ton for coarse shredding and €50 / ton for fine shredding (Tempelman, 2014).
- Other assumptions can be found in appendix A1.

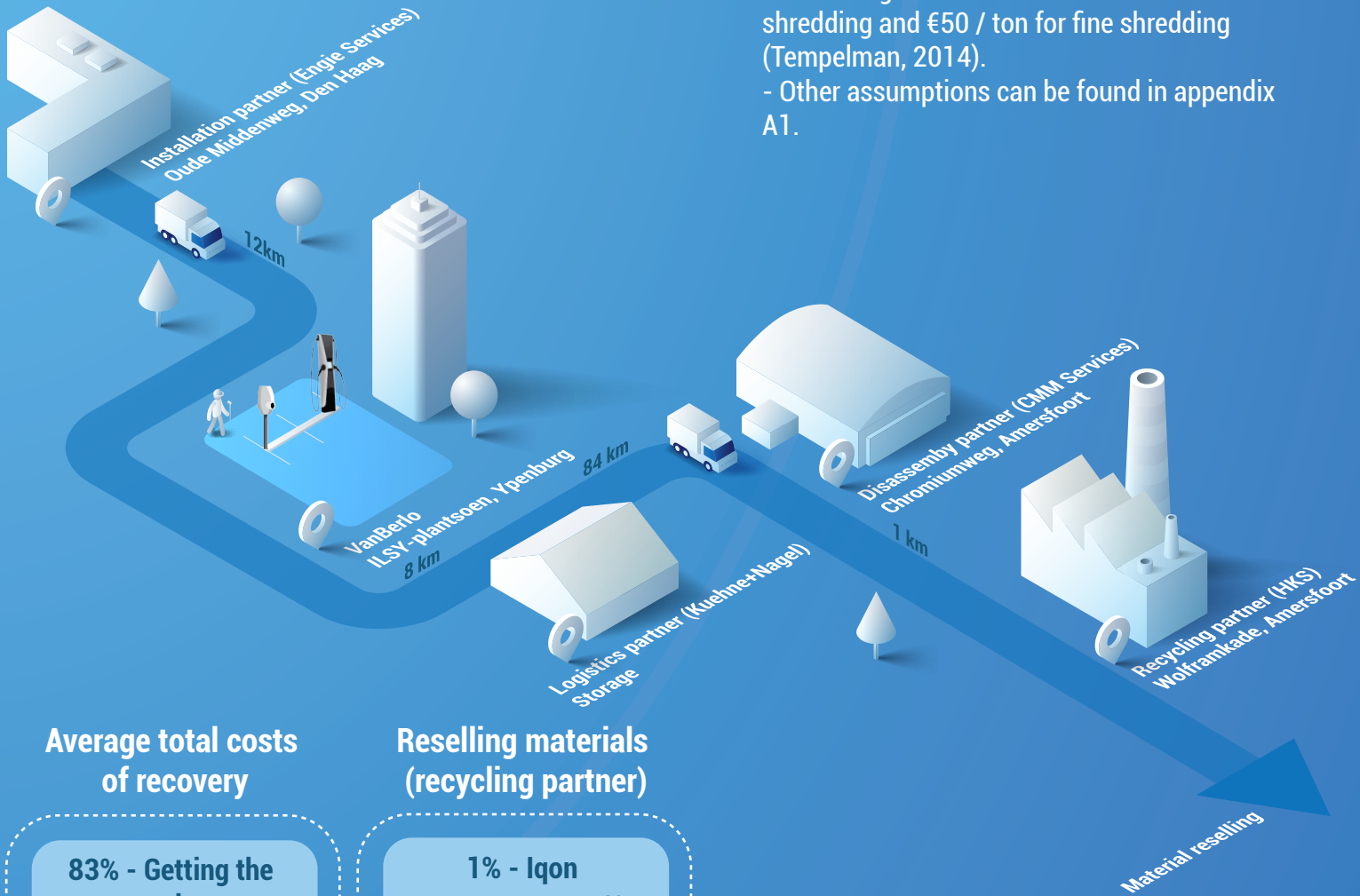

### Average total costs of recovery

83% - Getting the product



17% - Disassembly\*



\*Possibly at recycling center

### Reselling materials (recycling partner)

1% - Iqon

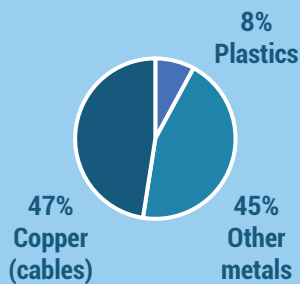

99% - BLG4

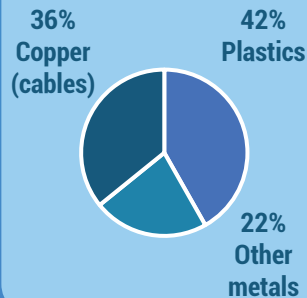

### Costs versus benefits

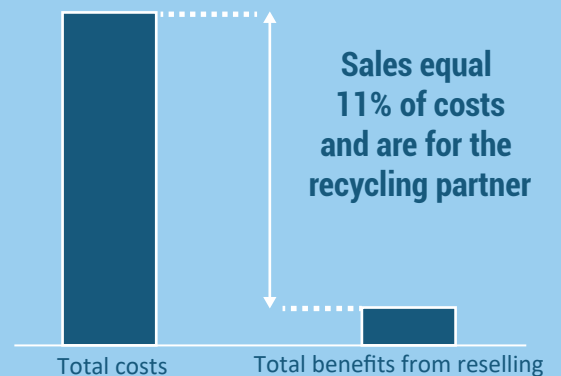

### 3.3.4. Component harvesting

Component harvesting can be implemented for reusing suitable components. It is often done in combination with other strategies such as repair, refurbishing and remanufacturing. Harvested components can be used in new as well as second-hand products, eliminating the need to buy the components as new, resulting in cost savings. Component harvesting can be done instead of manufacturing new parts. This is an interesting strategy when combined with, for example, repair and remanufacturing as the products need to be disassembled anyway to implement those strategies. Furthermore, money can be saved when harvested parts are used instead of new parts.

Previous research by VanBerlo has shown that some parts in the chargers are overengineered and have long shelf lives. It would be a waste to incinerate them when a charger becomes defective or reaches its EoL. One of those parts is the kWh-meter, located in the installerbox. Based on this information, a videocall with two employees of the manufacturer of the kWh-meters (ABB), was set up to further investigate this matter

During the call, the employees indicated that the lifetime of the meters is 7 years longer than the expected 8 years of Iqon, resulting in a total expected lifetime of 15 years. Furthermore, the innovation rate of these meters is slow: the current model was designed in 2012. These factors show there is potential for a second life. However, during the call it also became clear that the meters can not be recalibrated to zero. Within a remanufacturing scenario, this could be problematic as components have to become as new. On the other hand, this does not have to be bad news necessarily. The meter's value could act like the mileage in a second-hand car

and give an indication of past usage, which is also valuable information. A harvested meter that is not recalibrated can not be classified as remanufactured but is classified as refurbished. As mentioned in chapter 3.2, for a component to be remanufactured, it has to be brought back to an as-new state. Thus, for the kWh-meters to be remanufactured, they would have to be recalibrated to zero.

Additionally, kWh-meters have a calibration warranty. When the components are disassembled (for example, for a quality check), the kWh-meter loses its warranty. As far as the ABB employees knew, disassembly of the kWh-meter with the intend of reusing has never been done before. There is a 1 year warranty in the Netherlands on these components.

Based on the abovementioned findings, one could argue that similar electronic components, for example those that also measure and take action based on electric attributes such as current/voltage/power, will have a similar expected lifetime which is longer than the expected lifetime of the charger as a whole. Further research into the harvesting of, for example, the RCBO and solenoids, could substantiate this claim but has not been done due to the timeframe of this thesis.

The reverse logistics map in figure 18 shows that savings created by harvesting suitable components equal 21% of total remanufacturing costs. The Iqon component categories mentioned under 'Remanufacturing' have been used in this calculation. Based on assumptions, the harvestable parts in Iqon amount to 6% of total production costs. The full calculation can be found in appendix A1.

Figure 18. Reverse logistics map of a component harvesting scenario. ►



## Component harvesting scenario

A BLG4/Iqon at the parking lot on the ILSY-plantsoen in Ypenburg is at its EoL. It is de-installed by a EVBox partner and stored at a Kuehne+Nagel warehouse. It is then transported to an assembly partner where functional components are harvested for reuse in refurbished/remanufactured products.



## Key assumptions

- Transport happens with a Diesel van with fuel consumption ratio 1:10.
- There are currently 30.000 BLG4 and 20 Iqons in the Netherlands (Diemer, 2021).
- 50% of brought back Iqons and 25% of BLG4's will be remanufactured and resold with harvested components.
- Component harvesting is done as an additional activity next to refurbishing/remanufacturing, thus disassembly/reconditioning costs have not been taken into account.
- Other assumptions can be found in appendix A1.

## Iqon component categories

% Of total production costs

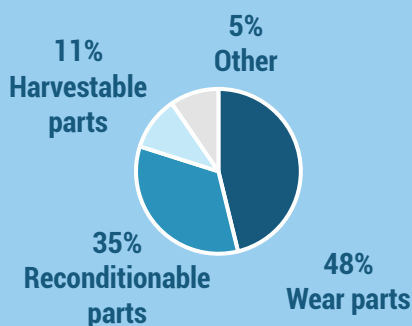

## Iqon costs versus benefits

Savings equal 12% of total remanufacturing costs

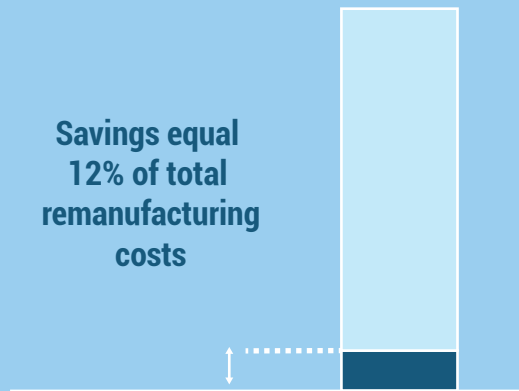

### 3.3.5. Total reverse logistics overview of value retention strategies

#### Maintenance and repair scenario

##### Costs versus benefits per year

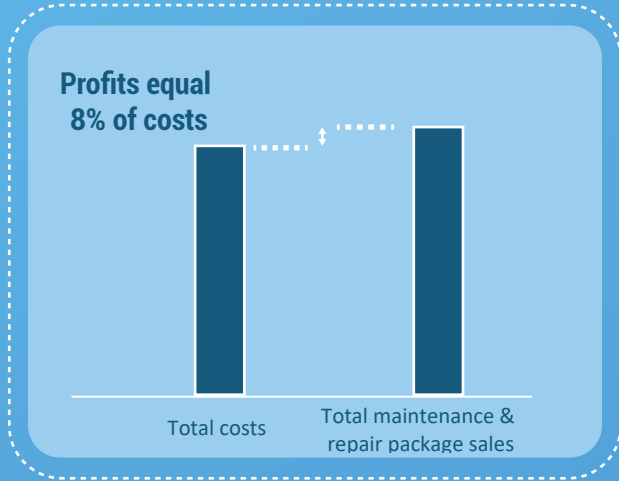

#### Remanufacturing scenario

##### Costs versus benefits

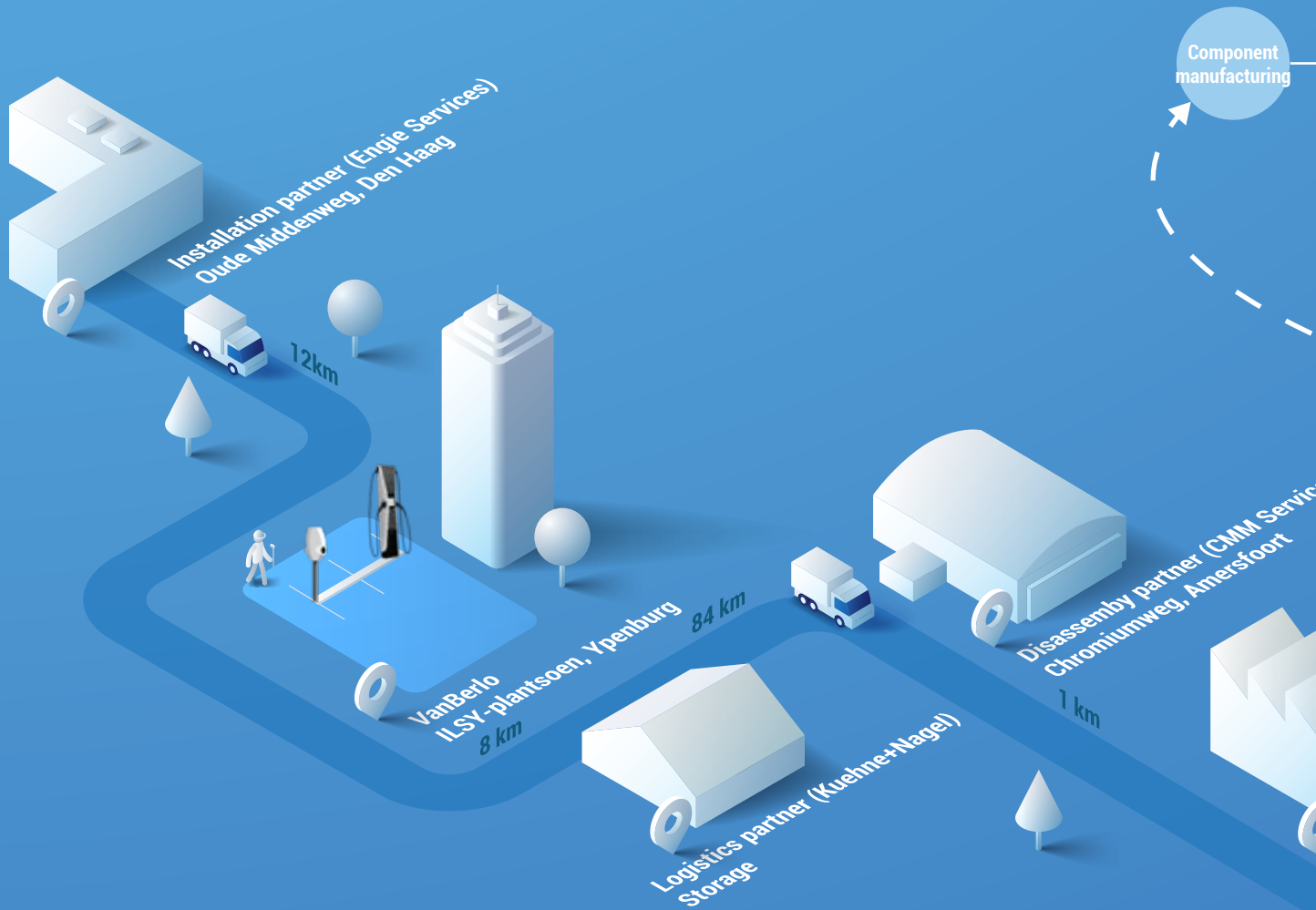
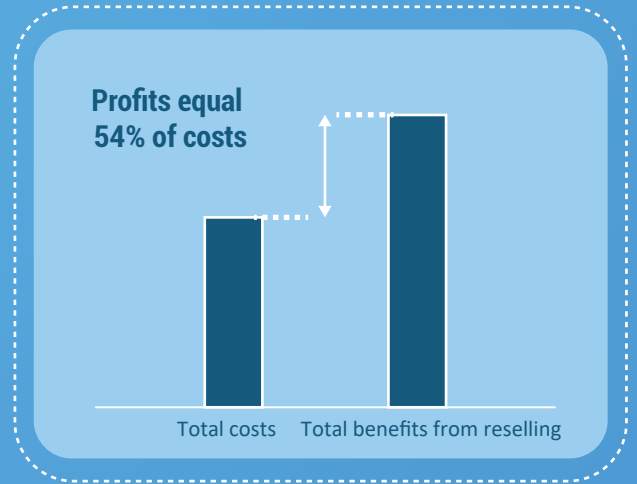

### Component harvesting scenario

#### Icon costs versus benefits

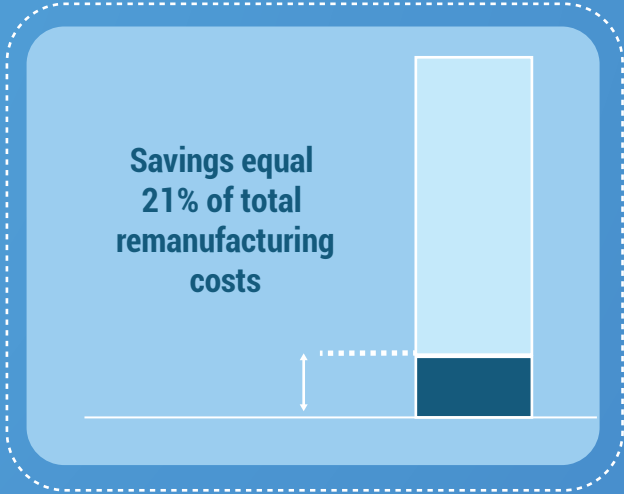

### Recycling scenario

#### Costs versus benefits

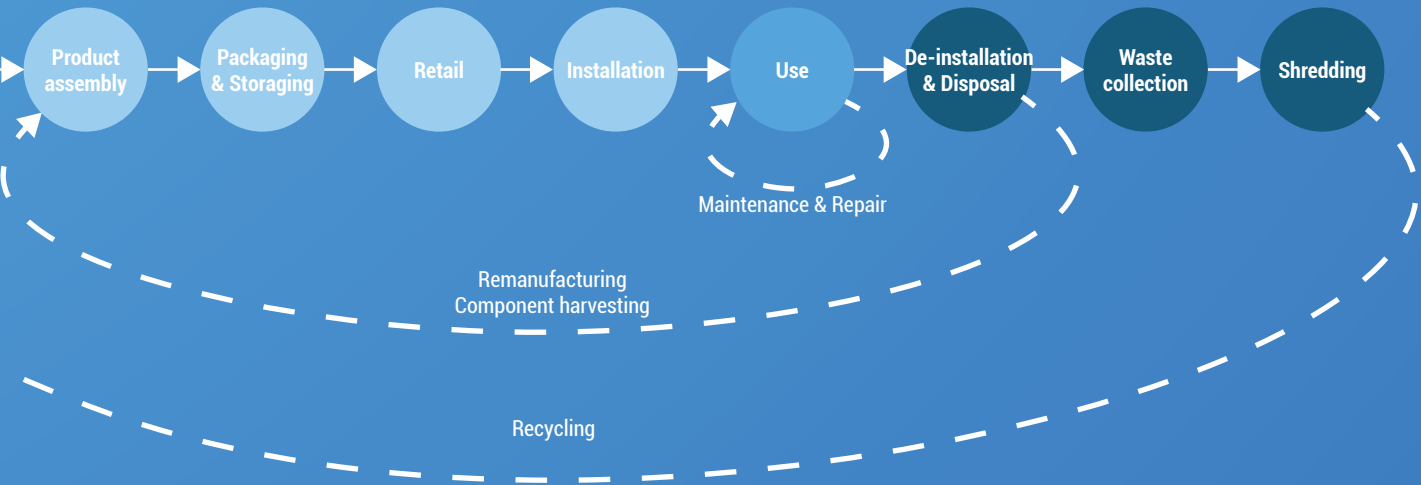
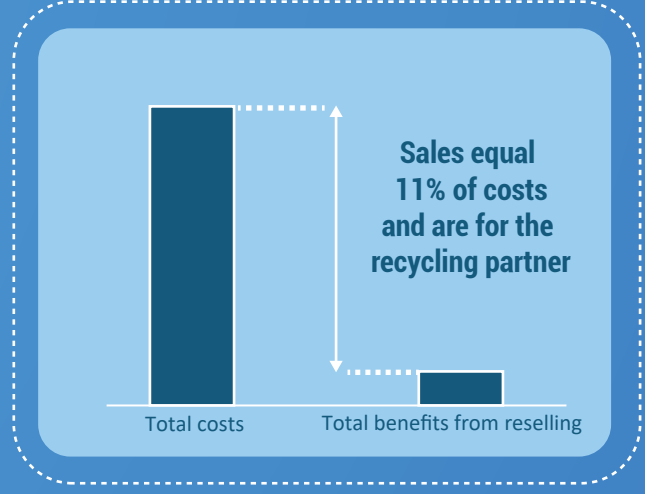

# Summary

- It is estimated that a maintenance and repair strategy can be fruitful for EVBox, based on the costs calculation in appendix A1, increased customer loyalty, sales and the reduction of servicing costs under warranty.
- It is estimated that the economical viability of implementing a remanufacturing strategy is fruitful, based on the costs calculations in appendix A1, as well as the affirmation of CMM's CEO, the growing production of Iqon and the product's suitability for remanufacturing due to durable, high-value components and materials (Hatcher, Ijomah, Windmill, 2011).
- Component harvesting of the kWh-meters is estimated to be a fruitful additional activity which could lead to further savings, (ABB, 2021).
- Recycling is estimated to be the least fruitful of all investigated strategies due to the higher costs than benefits ratio and the lowest preservation of product- and part integrity. Other strategies which better preserve integrity should be prioritised.
- The European Green Deal will oblige extended responsibility on producers. This entails the correct disposal and recycling of products. It is therefore recommended to investigate potential partnerships with recycling centres as soon as possible.



# Conclusion

Applying one of the strategies does not exclude implementation of others; in a truly circular construct products can cascade through multiple loops by being reused, repaired, refurbished, remanufactured and finally, recycled. A cascading strategy would allow EVBox to add up all benefits calculated in this chapter, leading to the most lucrative scenario. Furthermore, once the reversed logistics for one of the strategies has been set up, the step to applying others is relatively easy to make since all strategies consist of partially the same parties.

Additionally, this chapter uncovered that products that are brought back can consist of components that require different treatment. For example, after 8 years the side panels would be suitable for reconditioning in a remanufacturing scenario but the top cover would be more suitable for recycling. Furthermore, the kWh-meters, for example, can not be recalibrated and can thus only be considered refurbished instead of remanufactured after going through a value retention process. These examples show that the distinction between the different strategies can appear to be quite vague and that it might be necessary to apply them in parallel. However, it is important to clearly define the strategies to avoid any miscommunications with stakeholders and to avoid any confusion concerning pricing and warranties of the products. Making a clear distinction between the loops also allows for better manageability in terms of calculations, as was done in this chapter.

## **RQ2.1. What circular strategy is most favourable to implement on EVBox's commercial AC chargers?**

Based on the reversed logistics mapping done in this chapter, it is estimated that applying a maintenance and repair, remanufacturing and component harvesting strategy in parallel can lead to economic benefits. Recycling is the only strategy where the costs appear to weigh more than the benefits. Applying all in a cascading construct could lead to the benefits of all strategies being added up, resulting in the most economically lucrative scenario.

## 3.4 Assessing disassembly

**In this chapter the ease of disassembly of EVBox's commercial AC chargers, the BusinessLine G4 and Iqon, is analysed. Where the previous analysis was done on a strategic level, this analysis is done on product-level. First, the used tool called the Disassembly Map is explained, after which critical components and activities are identified. A description of the disassembly and elements that hampered disassembly is given. Finally, disassembly maps of the products are presented.**

### Tool: the Disassembly Map

A product's ease of disassembly correlates to product lifetime extension strategies. Improved component accessibility facilitates reuse, repair, refurbishment, remanufacturing and recycling, (Vanegas et al., 2017). The Disassembly Map is used on EVBox's commercial AC chargers, because it provides insights in the current state of affairs and the product's potential for lifetime extension strategies. Furthermore, the tool will be ideal for making the disassembly of these complex types of products visually comprehensible.

The Disassembly Map was first created by Francesco de Fazio in 2019. Through the use of the Disassembly Map the ease of disassembly is assessed based on the disassembly depth and sequence, type of tools used, fastener reusability and reversibility and the disassembly time. The method visually maps the disassembly of a product, showing different routes to target components. Stated by De Fazio et al., (2020) and Flipsen, (2020) target components are the components that contain:

- the highest failure rates and functional importance, which is important for product repair and upgradeability;
- the highest economic value, mass and remaining useful life, which is important for components harvesting and refurbishing;
- the most embodied environmental impact, which is important for recycling purposes.

De Fazio's initial research covered the disassembly of multiple vacuum cleaners. The tool has been under development ever since

by, for instance, using it for different product categories such as child car seats (Vermaat, 2020), Pedelec Drive Units (Brimaire, 2020) and more. Further improvements of the tool have been described by De Fazio et al, (2020) and consist of a more comprehensive range of disassembly actions, a more precise representation for the final removal of a component and the use of a grid to facilitate vertical comparison. This thesis will assess the usability of the Disassembly Map on the complex product category of EV chargers, apply changes accordingly and make recommendations for future application.

The Disassembly Mapping methodology is based on standardized logic representations derived from a combination of previously established methods, (Ishii et al., 1996; Vanegas et al., 2016; Zandin, 2003). Relations and dependencies of components are described as either sequence dependency, sequence independency, multiple dependency and components clustering. They are shown in figure 19 A, B, C, D and E, respectively. Once a component has been completely liberated, it is represented in the tool by a light blue component circle. Sequence dependency, as the name suggests, entails the possibility of disassembly of one component after complete disassembly of another. With sequence independency, two components can be disassembled after disassembly of one component. The opposite is true for multiple dependency, which is when two components must be disassembled before another component can be disassembled. Component clustering is represented in the tool by a bigger circle; it entails the disassembly of multiple components at once, for example a subassembly. Such as subassembly can



be further disassembled, which is depicted in figure 19-E.

In between component circles action labels represent the necessary steps to achieve

component liberation. Action labels are either square-shaped in case of a single motion action, or hexagon-shaped in case of a multiple motion action. See figure 20. As the names suggest, single motion actions require

Figure 19. A. Sequence dependency; B. Sequence independency; C. Multiple dependency; D. Components clustering; E. Components declustering; F. An activity label. ▼

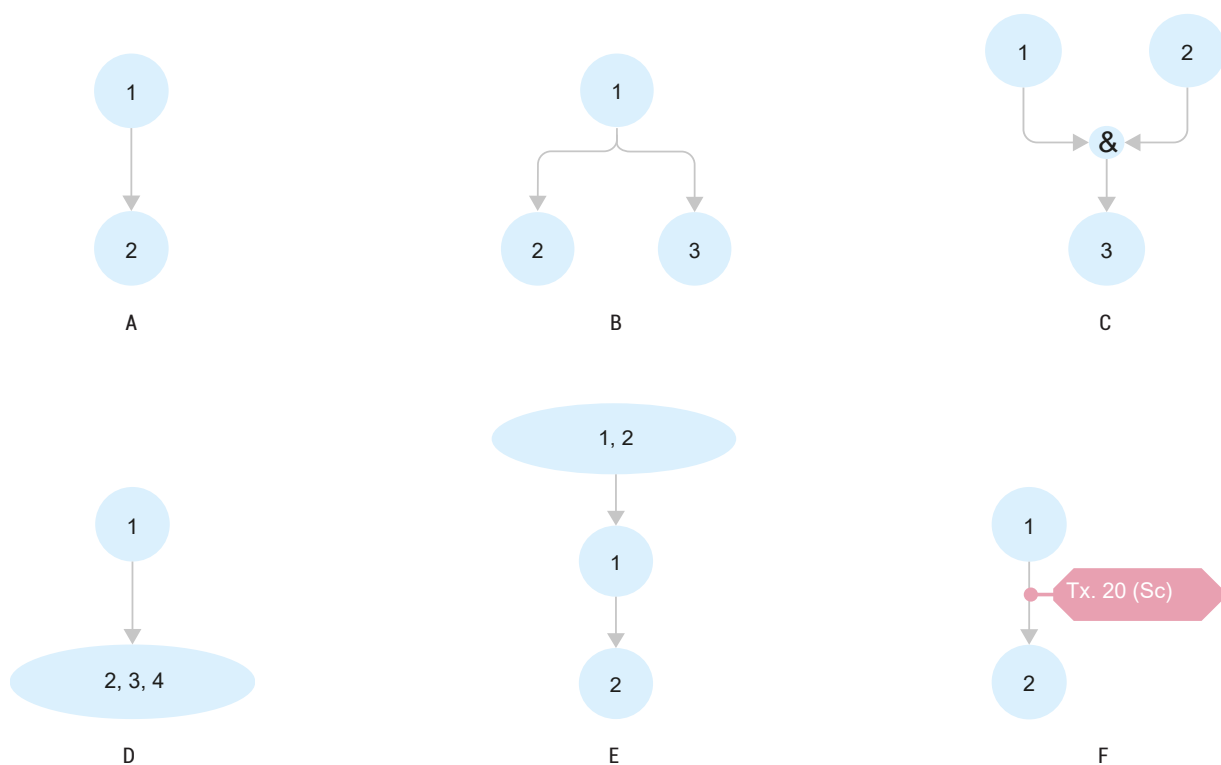

◀ Figure 20. Single motion action (square) and multiple motion action (hexagon).



▶ Figure 21. Green and aqua represent actions by hand, orange and magenta actions with tools. Colour intensity correlates to motion intensity.

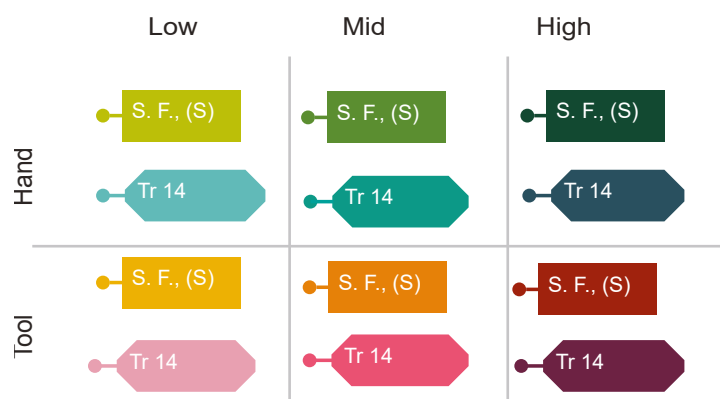

one single loosening or fastening movement, whereas multiple motion actions require multiple loosening or fastening movements, such as unscrewing a screw with a screwdriver. Different colours are used to represent if an action is done by hand (green for single motion actions and aqua for multiple motion actions) or with the use of a tool (orange for single motion actions and magenta for multiple motion actions). Colour intensity correlates to the force intensity needed for completing the action. See figure 21. Text inside the action blocks indicate the type of activity (such as a removal action or unscrewing) and the type of tool used (such as torx or spudger).

### Identification of critical activities and target components

As mentioned before, target components are components that should be prioritised based on failure frequency and functional importance, highest mass and/or cost values in the BOM and remaining useful life, and lastly the highest embedded environmental impact (De Fazio et al., 2020; Flipsen, 2020). Following these guidelines the target components in the Iqon and BusinessLine G4 have been identified before disassembly through a preparation session with product designers and engineers from VanBerlo, data collected from the bills of materials (EVBox Iqon BOM, 2021), failure mode effects analyses (EVBox Iqon/BLG4 FMEA, 2020) and during disassembly by documenting all steps in the HotSpot Mapping Datasheet, (Flipsen, 2020).

Results from the HotSpot Mapping Datasheets have not been prioritised as for unclear reasons economical and environmental flags appeared for every component made from stainless steel and thermoplastic. Furthermore, the datasheets did not flag any target components in BLG4.

See appendix A2 for an overview of the disassembly preparation session.

See appendix A3 and A4 for the BOM analysis and the FMEA analyses, respectively.

The HotSpot Mapping Datasheets can be found in appendix A6.

Table 1 shows all target component outcomes based on the mentioned analyses. Prioritising them has been done based on frequency of

		FM
Iqon	<i>Functional importance and failure frequency</i>	CMS, cables, cooling, lightguide
	<i>High embodied economic value</i>	
	<i>High embodied environmental impact</i>	
BLG4	<i>Functional importance and failure frequency</i>	
	<i>High embodied economic value</i>	
	<i>High embodied environmental impact</i>	

occurrence which can be seen in appendix A5. Additionally, the last column shows the priority components for the redesign activities in chapter 4.2. They are the PMMA lightguides (for complete liberation and reconditioning of the sidepanels), the cables (for replacement) and the kWh-meter (for component harvesting).



FMEA	BOM	Disassembly prep session	Priority components for redesign
connectors, LED- (PMMA)		LED-ring, cables, display, brake wheels, solenoid, holsters	PMMA lightguides, cables, kWh-meter
	<p>Frame assembly: main frame and side panels</p> <p>CMS: top and guide frame, cables</p> <p>Chargerbox: CB heatsink, PCBA Chargepoint PCBA, display, holster assy, LED assy</p> <p>Installerbox: RCBO and kWh-meter</p>	kWh-meter, RCBO, steel frame, display, cables (copper), heatsink	
		PCBA's (rare metals), metal components, plastic covers, lightguide (PMMA)	
		LED-ring, cables	
	kWh-meter, RCBO, LED- & holster assy, heatsink, PCBA's	kWh-meter, RCBO, socket with lockmotor, heatsink, cables (copper)	
		PCBA's (rare metals), heatsink, plastic cover	

▲ Table 1. Critical components based on FMEA and BOM analyses and a preparation session with VanBerlo colleagues.

### 03.4.1. Disassembly Iqon

#### Setup

Disassembly of Iqon was done in a clean environment with plenty of space to construct the final exploded view which can be seen in figure 22 and 24. Component names are based on the BOM from prior research, but have in some cases been changed to names that are easier to understand. A toolbox and a desk were provided, as well as an extra light for better visibility which was of great help.

All activities were done to simulate a scenario that is as close to a factory environment as possible. An attempt was made to simulate a reverse assembly as mentioned in the assembly manual provided on the EVBox website. Disassembly was done with the intent of completely liberating components instead of just servicing purposes, as this would be

done in a realistic scenario. Time was not measured, as the activities were not undertaken by a professional and it would not recreate an authentic scenario. Especially in combination with all documentation activities this would not provide a truthful value. Instead, disassembly time was based on educated estimations.

All activities were recorded with a GoPro camera mounted on a tripod, a Sony a6300 camera and an iPhone for photos of details and further reference after disassembly. All disassembly steps and tools are documented in the detailed HotSpot Mapping Datasheet which can be found in appendix A6. Figure 23 shows the 18 tools that were used for disassembly.

Disassembly of Iqon and documenting all activities were done in two workdays by an unskilled worker.

▼ Figure 22. The setup for the disassembly of Iqon.



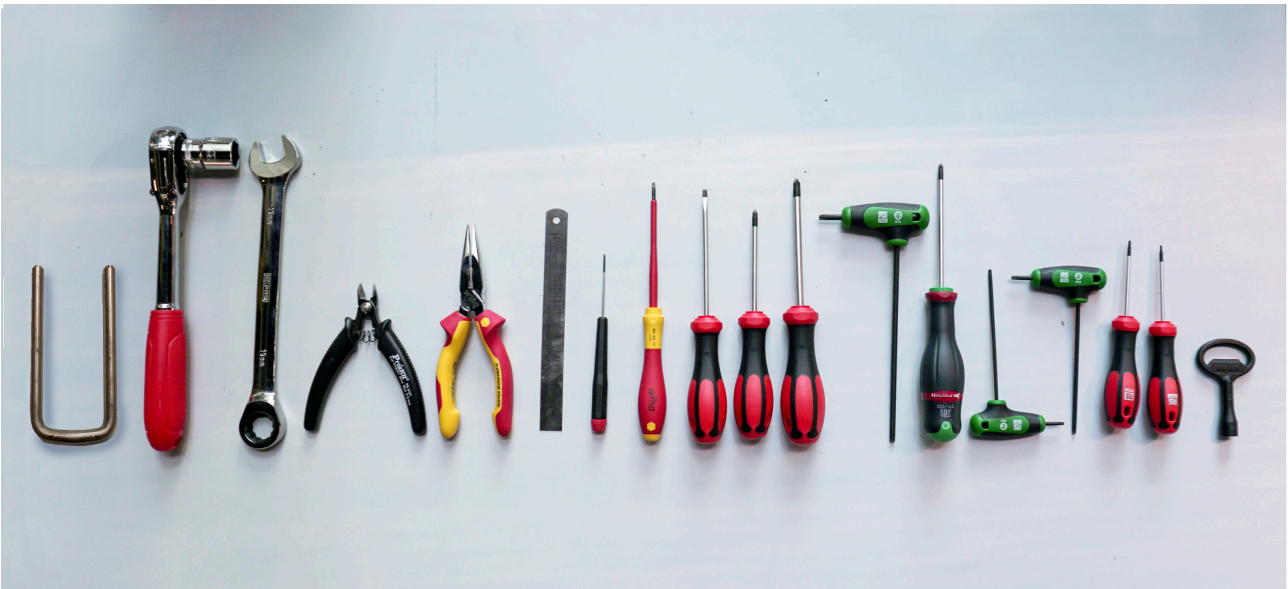

▲ Figure 23. All the tools used for the disassembly of Iqon.

Figure 24. The exploded view of all components after disassembly. ▼



## Disassembly Map Iqon

Some elements had to be added to the Disassembly Map to fully be able to represent the disassembly. For example, the addition of certain tools and the addition of a new penalty point. Symbol 'Ø' indicates a destructive disassembly activity; these activities have not been undertaken.

Iqon's Disassembly map in figure 35 shows that the architecture of the product is rather modular. This can also be seen in figure 25. The product consists of the main frame assembly, in and on

which the side panel assemblies, charger- and installerbox assembly and cable management system assembly are constructed. However, the map clearly shows that before reaching these horizontally placed subassemblies some vertical and thus sequential steps have to be undertaken. Namely, the removal of the top- and bottom covers and side panels. Afterwards multiple loose parts have to be disassembled along with cable unfastening activities.

Several disassembly activities and subassemblies are shown in figure 26 to 34.

Figure 26. To remove the side panels 4 screws have to be removed with a Torx 25 screwdriver, a penalty for low visibility is given here.



Figure 27. Furthermore, to remove the side panels 8 thumb screws have to be unfastened. Another low visibility penalty is given here.



Figure 28. Triangular...

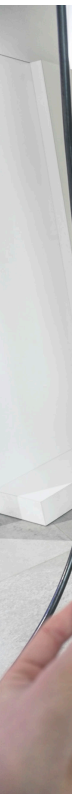

Figure 25. The modular architecture of Iqon becomes visible after removing the top- and bottom cover and the side panels.

Cable management assembly

Chargerbox assembly

Installerbox assembly

Pulley assembly (part of CMS)



Figure 29. Removal of the side panels means manoeuvring them over the charger cables.

To remove the top- and bottom covers, the special key tool is needed.





◀ Figure 30. The charger- and installerbox are handled as one rigid unit. They are connected with a cable tree and a threaded connection which is part of the aluminium chargerbox heatsink/ backplate.

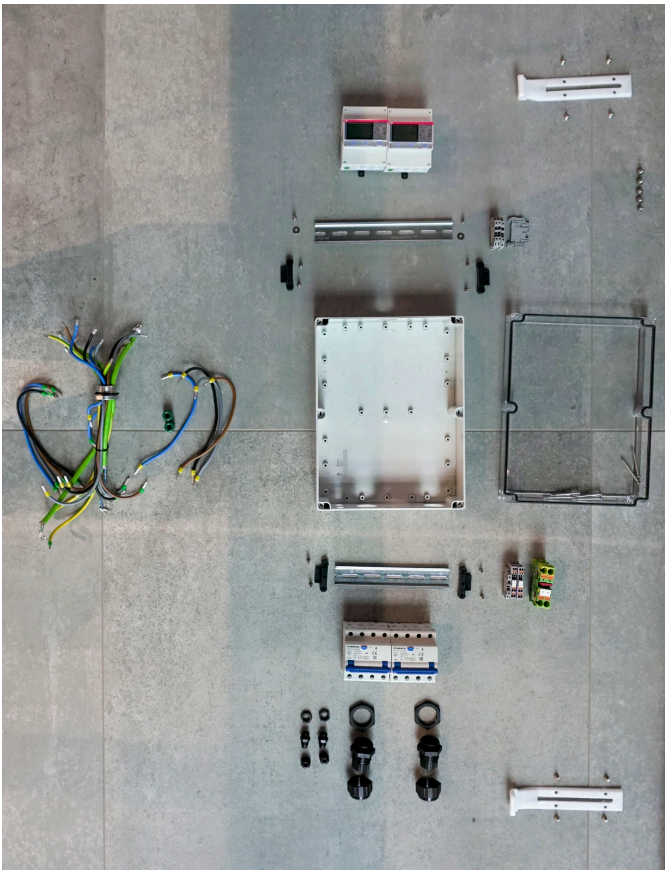

◀ Figure 31. The installerbox fully disassembled: the cable tree (left), kWh-meters (top), RCBO's (bottom).

Figure 32. The chargerbox front assembly (without holsters/ LED-rings). ▼

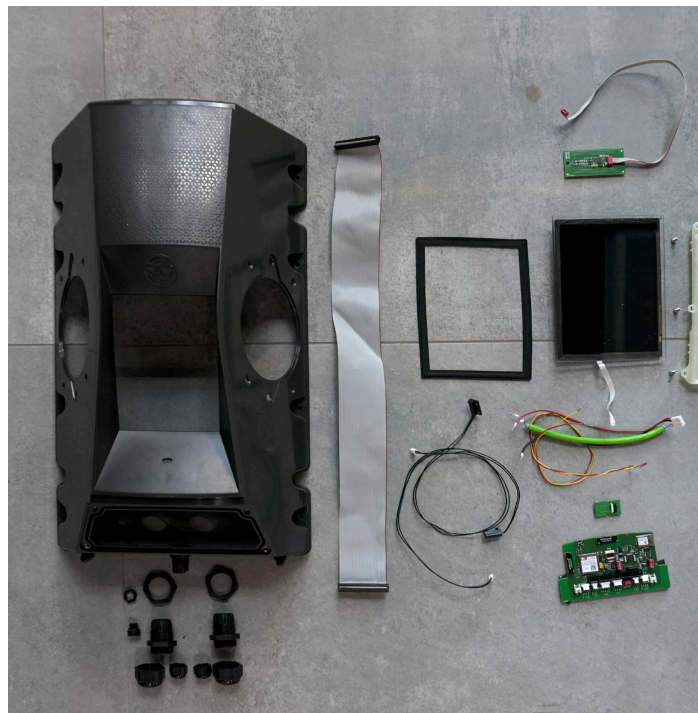



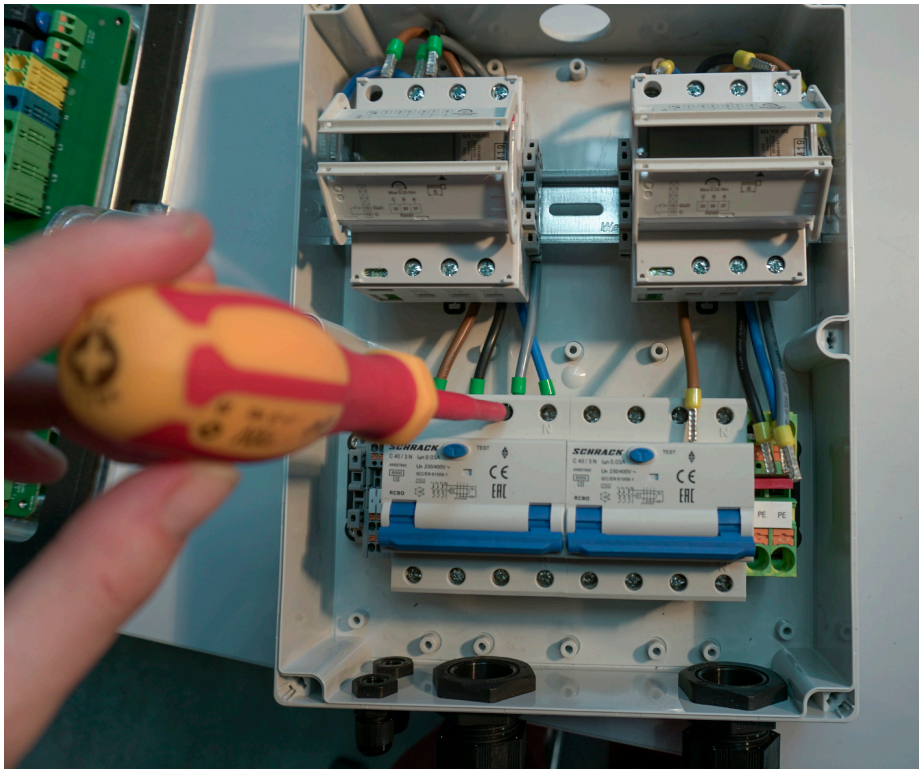
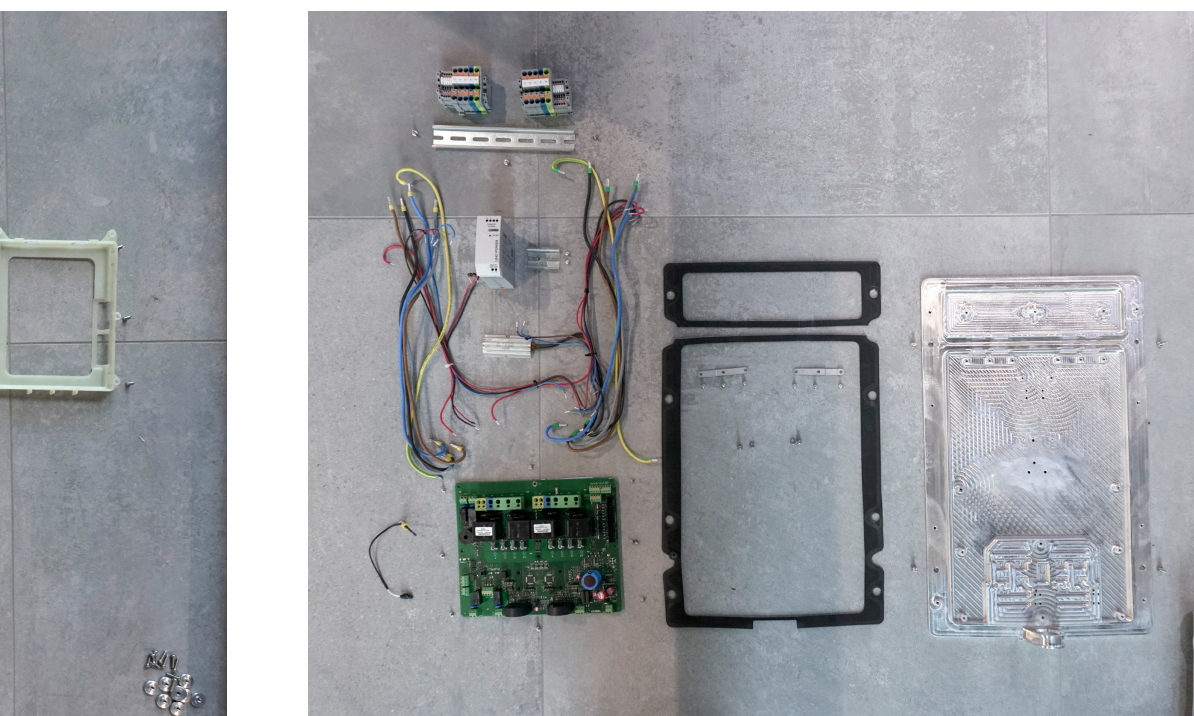

Figure 33. DIN components and -rails are standardised. Wires ▲ can be disassembled by unscrewing (pictured above) or unplugging by pressing the orange buttons (left and right) with a screwdriver. The components themselves can be unfastened by unhooking them from the DIN rail with a screwdriver.

Figure 34. The chargerbox back assembly; the aluminium ▼ heatsink/backplate with threaded connection on the right.



### Motion intensity



### Motion Type



### Connectors

- Tr. 14 = Triangular key 14 mm
- Tx. 6 = Torx 6
- Tx. 8 = Torx 8
- Tx. 10 = Torx 10
- Tx. 15 = Torx 15
- Tx. 20 = Torx 20
- Tx. 25 = Torx 25
- PZ1 = Pozidrive screwdriver size 1
- PZ2 = Pozidrive screwdriver size 2
- N19 = Nut 19
- Hex. = Hex nut
- Th.Scr. = Thumb screw
- 0.5 x 3 = Flat headed screwdriver
- S.F. = Snap fit
- Hk. = Hook
- Hg. = Hinge
- C. Plug = Cable plug
- P. Plug = Pin plug
- Adv. = Adhesive
- Th. = Thread
- Rem. = Removal action (cut, pull)

### Type of tool

- (H) = Hand
- (Sp) = Spudger
- (P) = Pliers
- (Ct.P) = Cutting pliers
- (Sc) = Screwdriver
- (N.Dr) = Nut driver
- (Wr) = Wrench
- (Ret) = Retainer

### Penalties

- ⊗ = Product manipulation
- ⊗ = Identifiability (low visibility)
- ⚠ = Uncommon tool
- ⊗ = Unreusable connector
- ⊗ = Destructive disassembly

### Disassemblability HotSpot Indicators

- Ⓟ = Priority component
- Ⓢ = Economical indicator L.1
- Ⓢ = Economical indicator L.2
- Ⓢ = Environmental indicator L.1
- Ⓢ = Environmental indicator L.2

### Components

1. Top cover
2. Hinges
3. Metal hinge
4. Hinges 2
5. Ring
6. Plastic bolt
7. Plastic thread
8. Bottom cover
9. PMMA lightguide 1
10. Left cover
11. PMMA lightguide 2
12. Right cover
13. See through CB cover
14. IB frame
15. See-through plate
16. Slider guides
17. Bottom frame (optional)
18. Rubber knobs
19. Oval plate
20. Brake disks
21. Plugs
22. Brake balls
23. Brake disks 2
24. Charge cables
25. Front IB cover
26. Cable tree
27. Steel plates
28. Other wheels
29. Wheels
30. Rollers
31. Weights
32. Rail
33. Roller units (right)
34. Axis
35. Metal ring
36. Roller units (left)
37. Small plate
38. Small bars
39. Springs
40. Roller axis
41. Top rollers
42. Plates
43. Small plate
44. Solenoid
45. Bearing
46. lower roller
47. Cables
48. 4 Grey plates
49. kWh-meters
50. DIN-rail
51. Black plastics
52. RCB0's
53. 1 DIN Grey plate
54. DIN - 4 numbers
55. 2 DIN green-yellow
56. DIN rail
57. Black plastics 2
58. Cable guide
59. IB backplate
60. Heating element
61. 2 metal plates
62. Cables
63. Foam
64. PCB
65. UNO power unit
66. DIN rail
67. DIN components
68. DIN rail
69. Alu heatsink
70. Cables
71. Rubber ring
72. Lock motor
73. Metal bar
74. Back part
75. See-through ring
76. LED strip
77. Rubber rings
78. Cables
79. Cable guides
80. PCB1
81. PCB2
82. PCB3
83. CB cover
84. Foam
85. White bracket
86. Display PCB
87. Display
88. Main frame

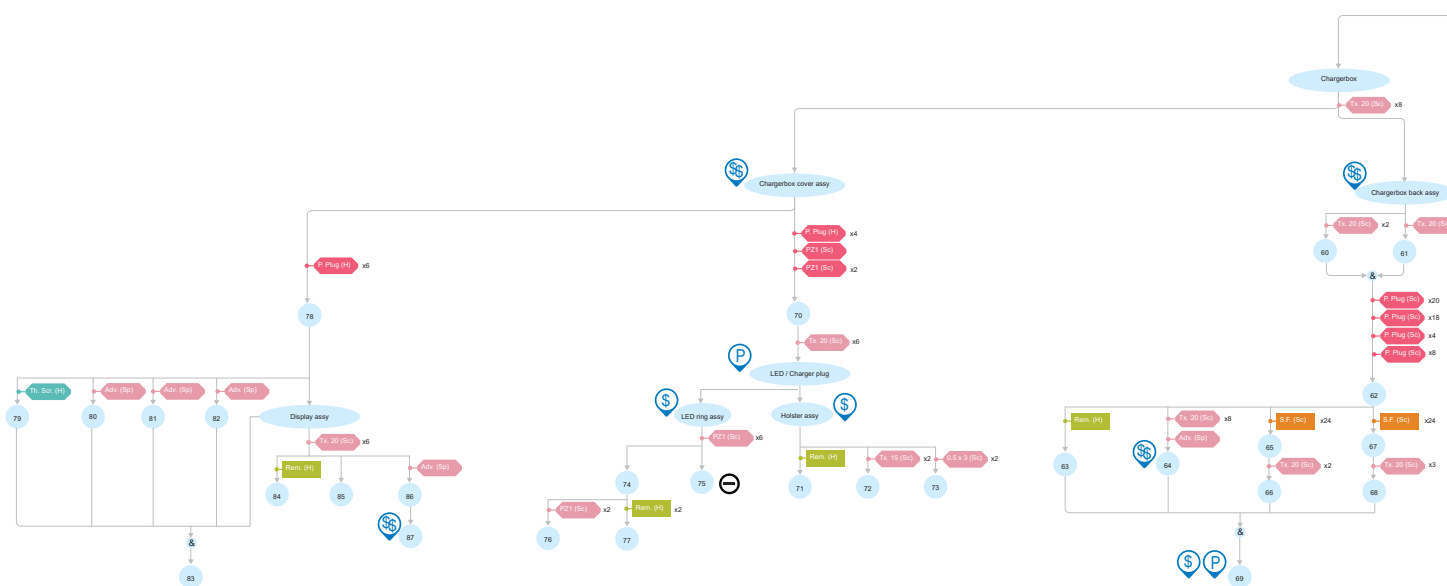
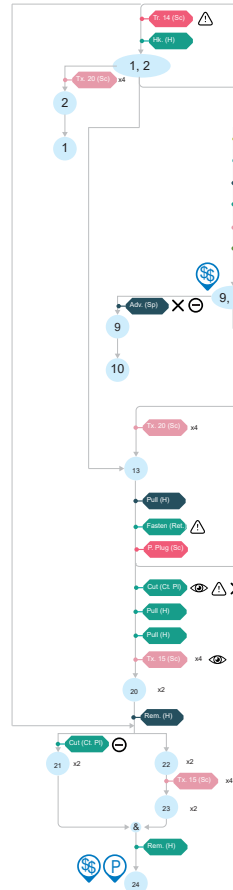

▼ Figure 35. EVBox Iqon Disassembly Map.

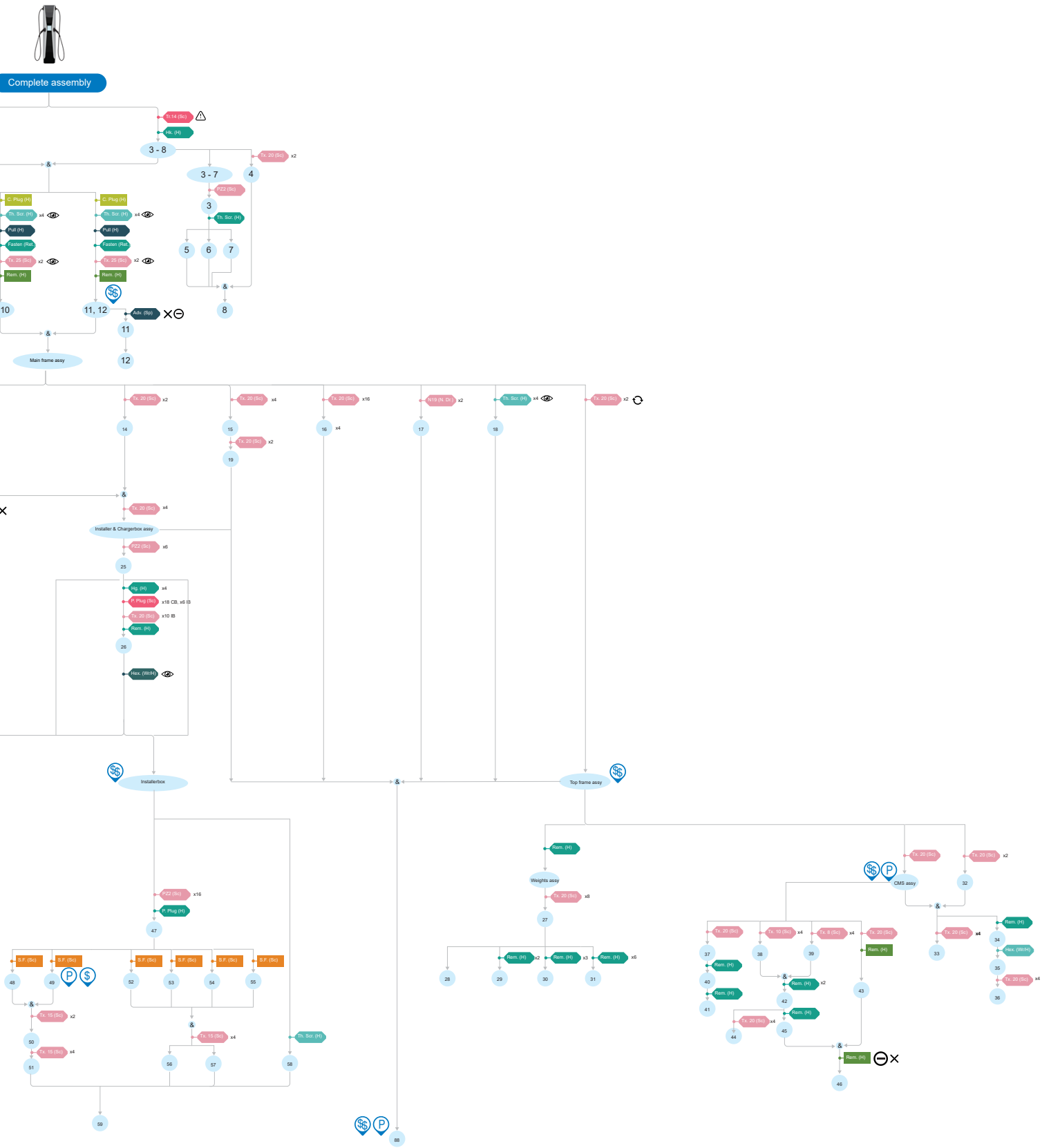

## Design elements hampering disassembly

A few components could not be disassembled without severely damaging the components and have been given a penalty point. They are:

- The plugs at the end of the charger cables. Rubber is moulded over a pre-existing structure as shown in figure 39.
- The PMMA lightguides attached to the stainless steel side panels. They have been fastened with 4 double-sided pieces of very high bond tape on each side. See figure 36.
- Part of the LED-ring subassembly. Two parts in the structure seemed to be fastened using glue or 2K injection moulding. See figure 38.
- Two rollers in the weights assembly. They were too tightly fastened with springs. See figure 37.

For Iqon's disassembly 2 specialty tools were used. They are the triangular key and the

retainer. The triangular 14 mm key is used to open the top- and bottom cover and has to be a specialty tool to ensure only specialists open the product. The retainer is used to retain the weights and prevent them from falling.

During disassembly large amounts of wires had to be removed. These wires connect subassemblies which makes separation of said subassemblies difficult. Standardized DIN parts facilitated unfastening. This becomes especially clear in the charger- and installerbox assembly

The number of- and force needed for sequential steps taken to disassemble the charger cables is problematic.

The Disassembly Map shows that many priority components are situated low in the architecture: the LED/Holster assembly, display, aluminium heatsink, kWh-meter, main frame and CMS assembly.

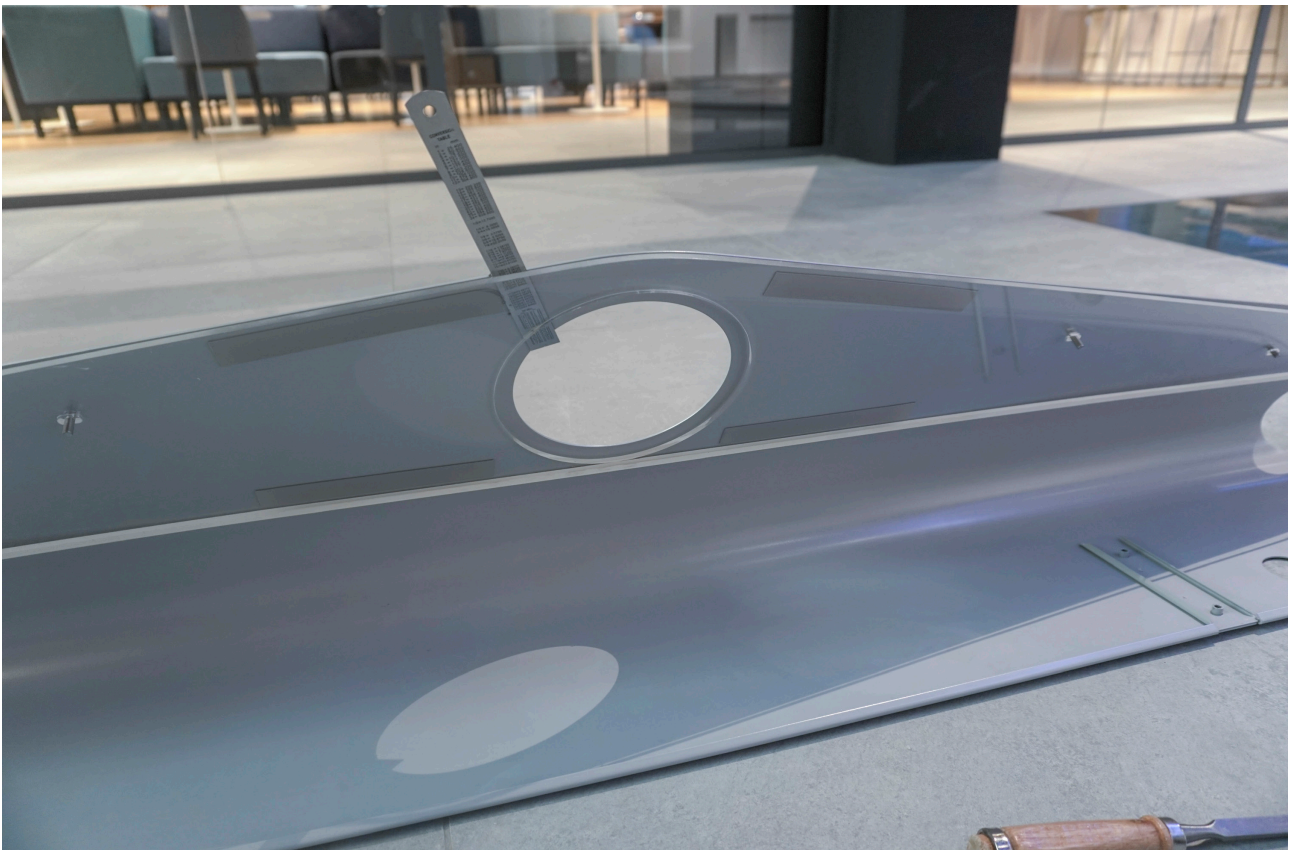

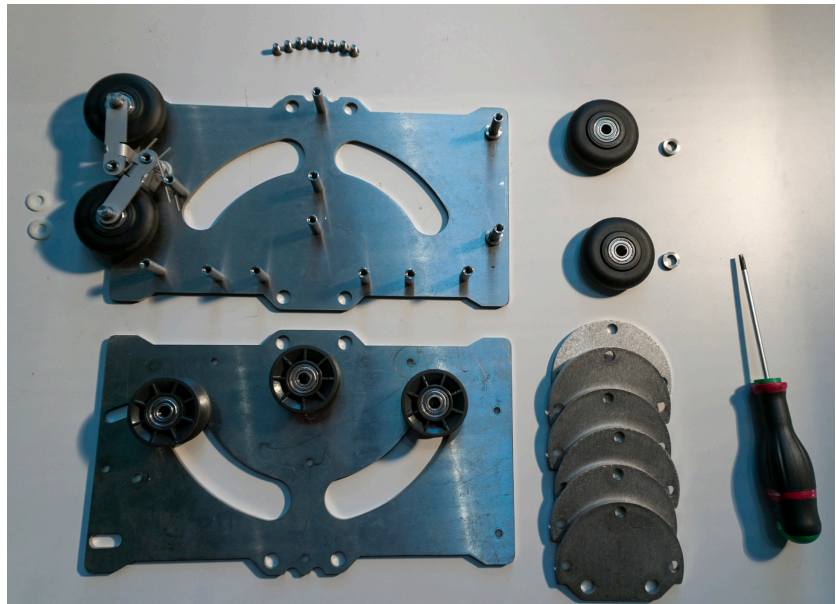

◀ Figure 36. The very high bond tape on the lightguides that could not be disassembled.

Figure 37. The weights assembly, in which two rollers (top left) could not be disassembled. ▲

Figure 38. The LED-ring component that could not be further disassembled. ▼

Figure 39. The plug that could not be further disassembled. ▶

## 03.4.2. Disassembly BusinessLine G4

### Setup

Disassembly of the BusinessLine G4 was done in a workshop with access to a toolbox and a desk, see figure 40. The disassembly was, just like Iqon, recorded with a GoPro, a Sony a6300 camera and an iPhone for photos of details and for further reference after disassembly. Similar to the disassembly of Iqon, all steps were documented in the HotSpot Mapping Datasheet, (Flipsen, 2020). The complete sheets can be found in appendix A6. All 12 tools that were used for this disassembly can be seen in figure 41. For this disassembly it was also attempted to recreate an authentic scenario.

The provided model was a double BLG4, which means that there are two sides of the product connected at the back. One of these two is a hub and the other a satellite. The difference is the addition of an additional PCBA for communication and cables in a hub configuration. For simplicity's sake only one half of the product was disassembled, as disassembly of the other side would be practically the same. Figure 42 shows the exploded view of the BLG4.

The disassembly and documentation for BLG4 took half a workday by an unskilled worker, 4 times less than for Iqon.

▼ Figure 40. The setup for the disassembly of BusinessLine.

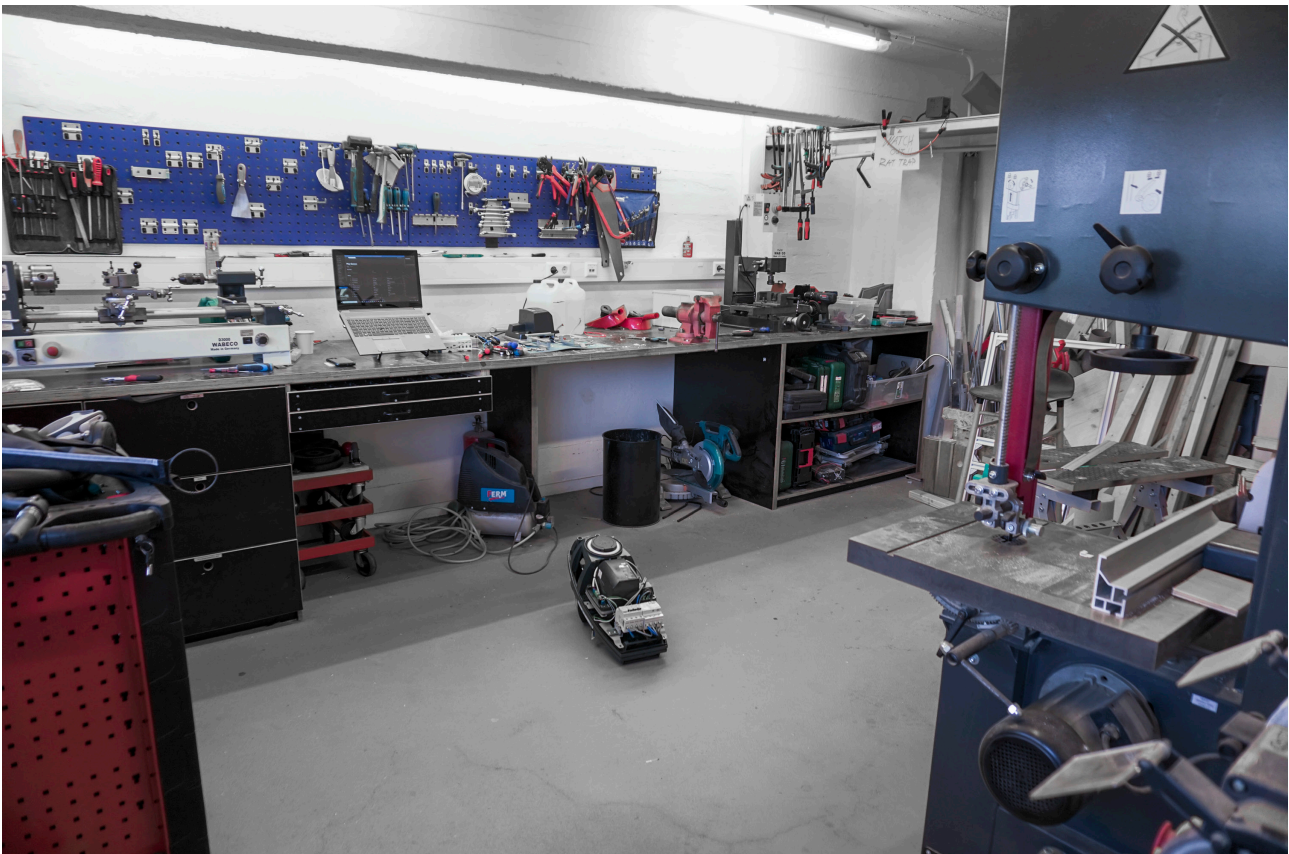



▲ Figure 41. All the tools used for the disassembly of BusinessLine.

Figure 42. The exploded view of all components after disassembly. ▼

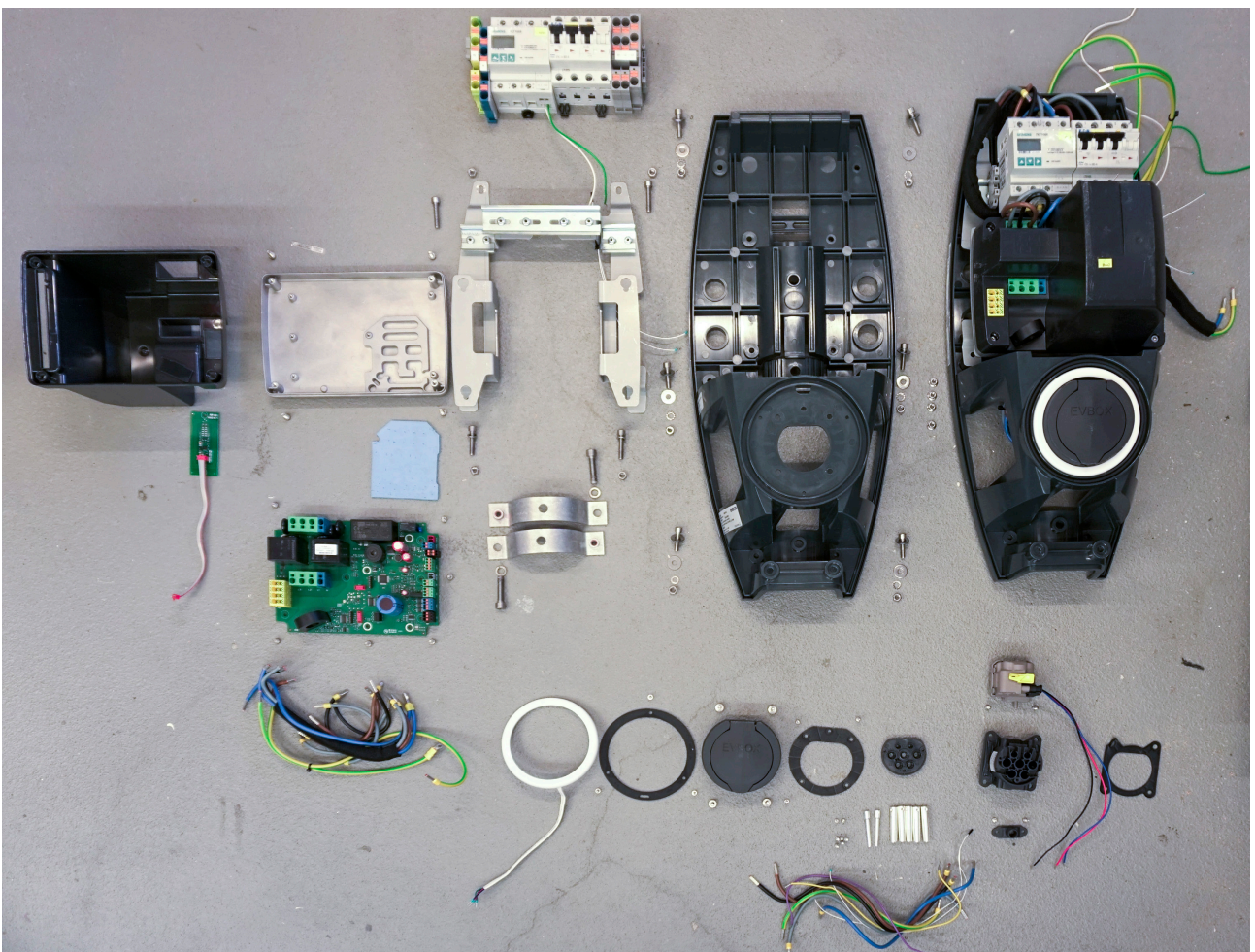

### Disassembly map BLG4

BLG4's Disassembly Map shows a rather vertical and thus sequential architecture, even when at first glance after removing the front cover the product seems to be modular like in figure 46. The three priority components,

namely the kWh-meter, metal heatsink and LED-ring can be accessed quickly. No specialty tools had to be used for disassembly. The full Disassembly Map of BusinessLine can be seen in figure 47. Figures 43 to 45, and 48 show other disassembly activities and subassemblies.

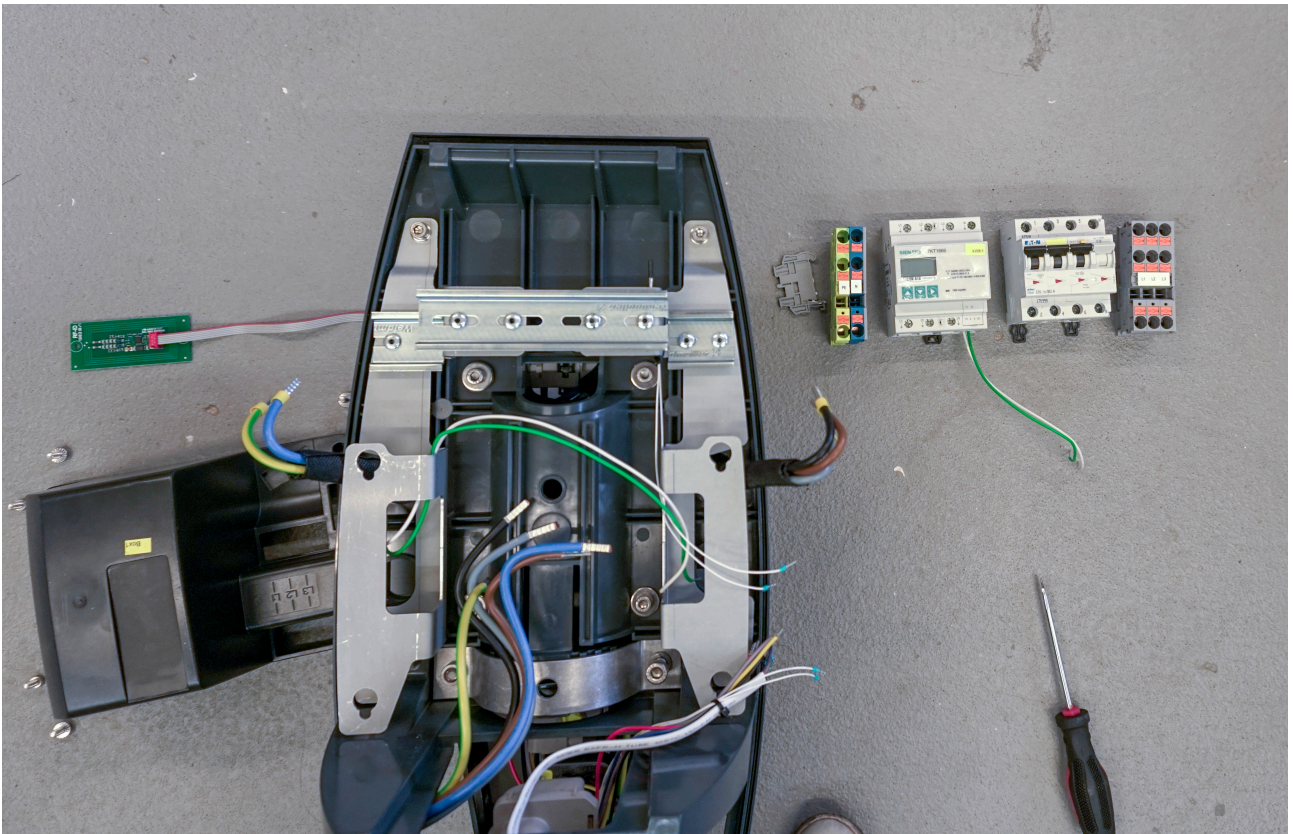
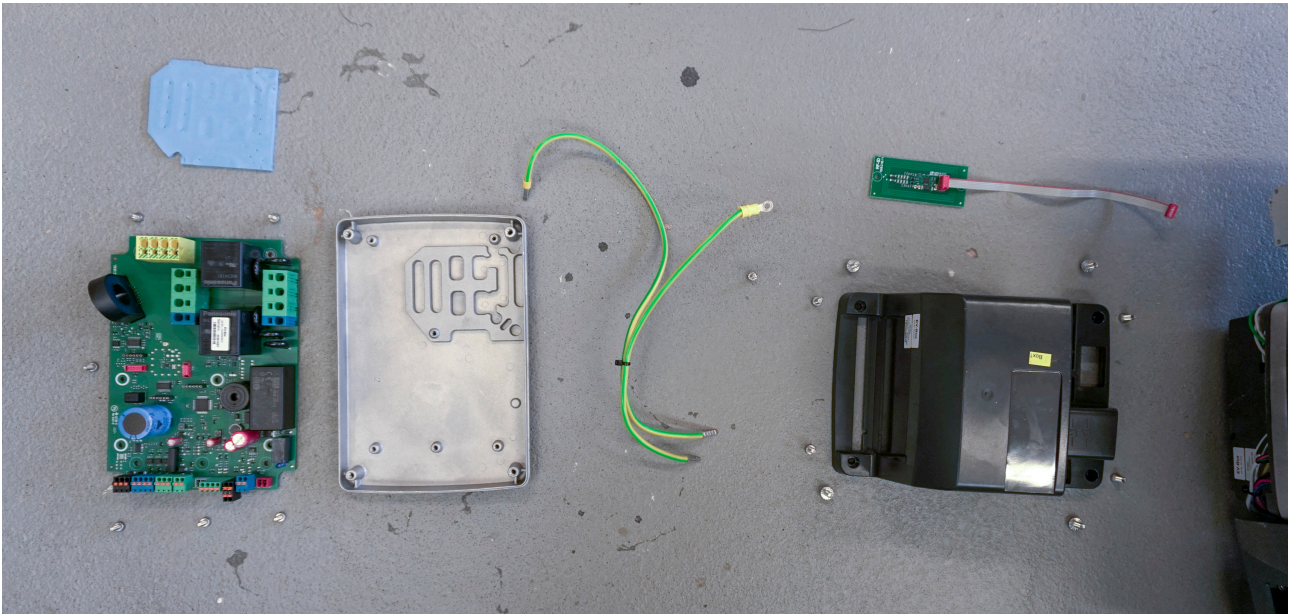



◀ Figure 43. The chargerbox assembly.

Figure 44. After removal of the DIN components it becomes clear that the DIN-rail is riveted on the metal frame.

▶ Figure 45. The standardized DIN components are disassembled like in Iqon.

Figure 46. BusinessLine's modular architecture after disassembling the covers.

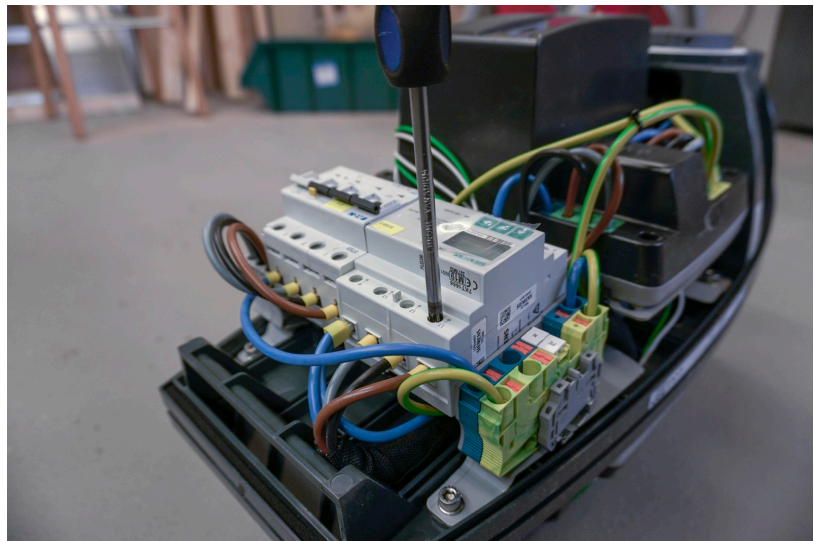

DIN-rail and DIN-components

Chargerbox assembly

LED- and socket assembly

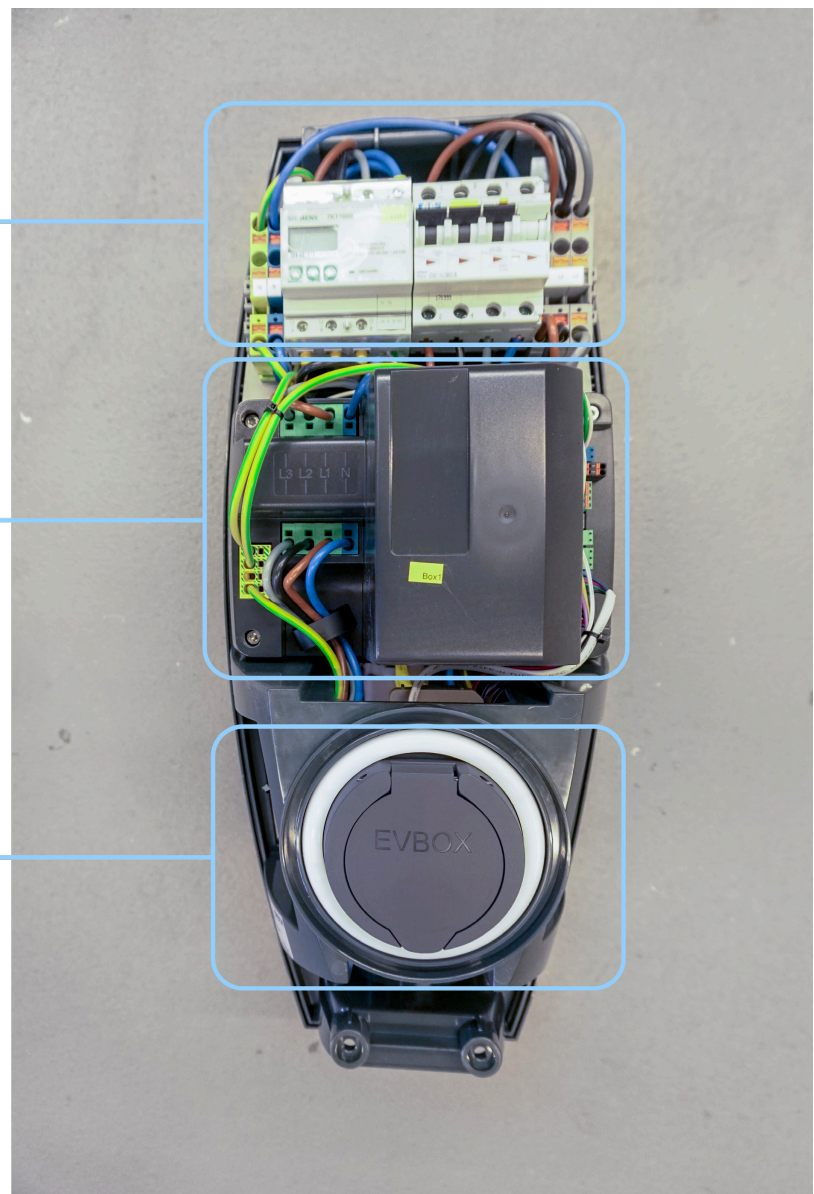

## BLG4 design elements hampering disassembly

In BLG4 it was impossible to separate the DIN-rail from the metal frame as it was riveted in place. This could be problematic when one of the two components is to be reused. In a recycling scenario this would not matter as much, since

both are made from the same material.

Also in this product the amount of cables connecting subassemblies hinders disassembly activities. They were, however, easier to disconnect in BLG4 than in Iqon.

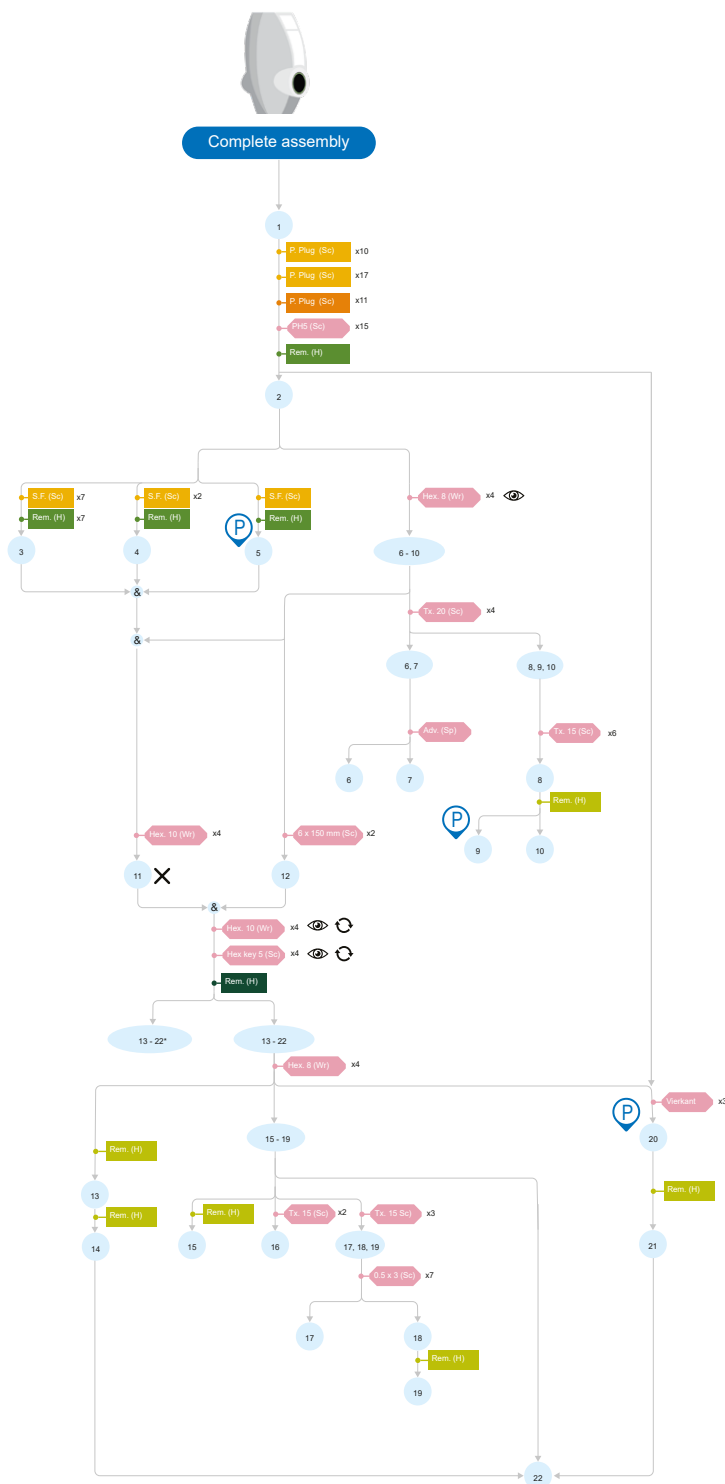

▼ Figure 47. BusinessLine's Disassembly Map.

**Motion intensity**

	Low	Mid	High
Hand	S.F. (S)	S.F. (S)	S.F. (S)
Tool	Tr 14	Tr 14	Tr 14

**Motion Type**

- Single motion action
- Multiple motion action

**Components**

1. Covers	12. Curved metal plates
2. Cables	13. Lid 2
3. Other DIN components	14. Rubber seal
4. RCBO	15. Rubber seal 2
5. kWh-meter	16. Lock motor
6. Lid	17. Metal bars
7. PCB1	18. Cables
8. PCB2	19. Plastic plate
9. Metal backplate	20. LED ring
10. Blue insulator	21. Rubber seal 2
11. Metal frame + DIN rails	22. Plastic main frame

**Connectors**

- Tx. 15 = Torx 15
- Tx. 20 = Torx 20
- PH5 x 100 = Philips crosshead screwdriver
- 0.5 x 3 = Flat headed screwdriver
- S.F. = Snap Fit
- Hex. = Hex nut
- C. Plug = Cable Plug
- Push B. = Push Button
- P. Plug = Pin plug
- Adv = Adhesive
- Th = Thread
- Rem. = Removal action (cut, pull)

**Type of tool**

- (H) = Hand
- (Sp) = Spudger
- (Pl) = Pliers
- (Sc) = Screwdriver
- (Wr) = Wrench

**Penalties**

- Product manipulation
- Identifiability (low visibility)
- Uncommon tool
- Unreusable connector

**Disassemblability HotSpot Indicators**

- Priority component
- Economical indicator L.1
- Economical indicator L.2
- Environmental indicator L.1
- Environmental indicator L.2

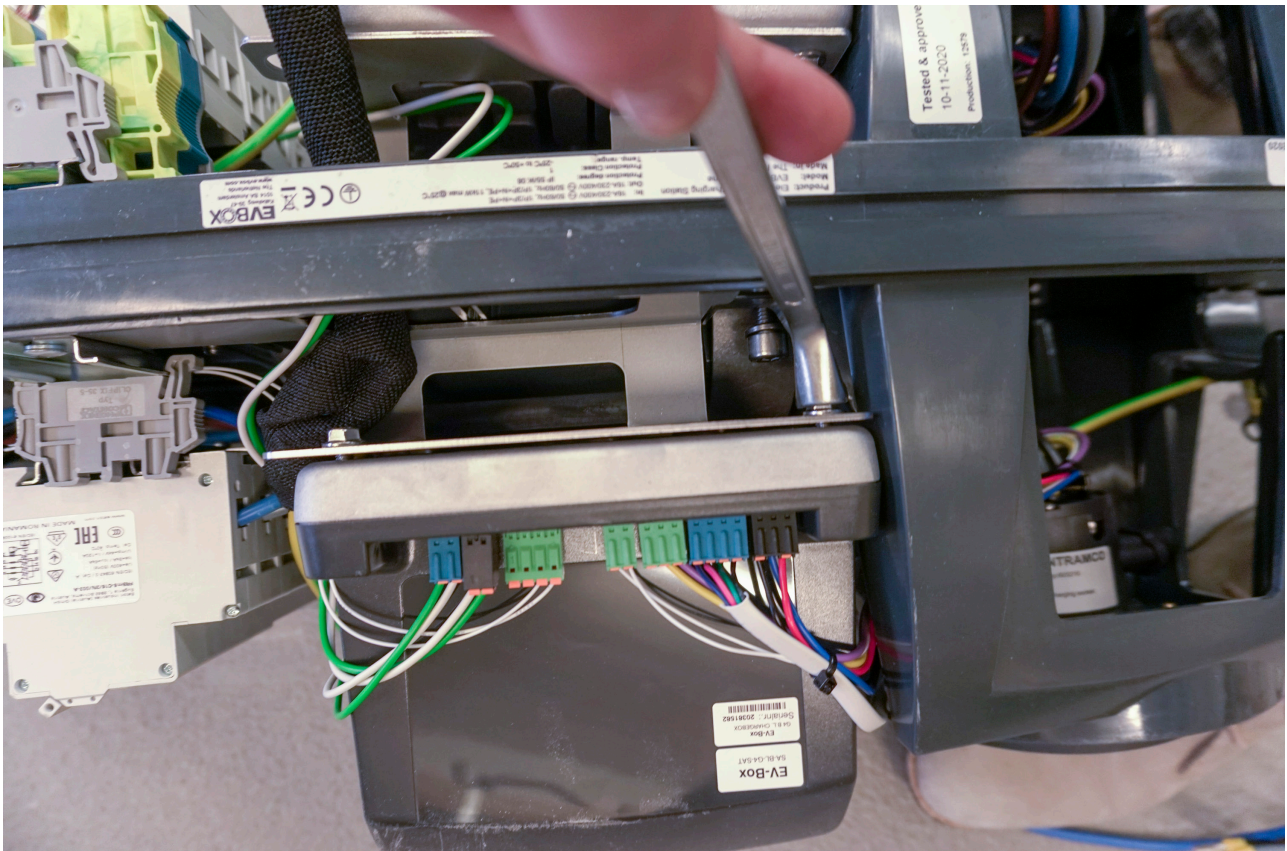

▲ Figure 48. The steel frame is difficult to disassemble due to low visibility and awkward tool positioning.

# Summary

- Based on frequency of occurrence during the preliminary analyses of the BOM, FMEA and preparation session the target components of Iqon are the LED/Holster assembly, display, aluminium heatsink, kWh-meter, main frame, side panels and CMS assembly.
- Based on frequency of occurrence during the preliminary analyses of the BOM, FMEA and preparation session the target components of BLG4 are defined as the kWh-meter, LED- & holster assembly and heatsink.
- The results of the disassembly are visually represented in the Disassembly Maps: it is visible that both products have a modular configuration optimised for servicing activities, which is applauded. Iqon has a horizontal Disassembly Map architecture but only after going through multiple sequential (thus vertical) activities.
- Electronic components are accessible for servicing activities. It takes 1 step in BLG4 (unscrewing the cover), 3 for the Iqon chargerbox (opening the top cover and see-through chargerbox lid) and 21 for the Iqon installerbox (opening the top- and bottom cover, sliding open the side panels, removing the bracket and removing the installerbox lid).
- To completely liberate certain target components in Iqon (such as the heatsinks and kWh-meters), the number of steps is high or the activity was destructive. Especially the cables, installerbox and unremovable PMMA lightguides from the side panels (which are or contain priority components) allow room for improvement.
- In BusinessLine it is impossible to separate the DIN-rail from the metal frame as it was riveted in place. This does not have to be a problem, as both are made from the same material. If the DIN-rail were to be separable, however, they could be used in more applications or products.
- The PMMA plates in Iqon were not separable from the metal covers during disassembly. They were fastened with 4 pieces of very high bonding tape. As PMMA and stainless steel are different material groups and have different expected lifespans, it is advisable to make them separable.
- Two rollers in the cable management system in Iqon were not removable.
- The LED-ring in Iqon was not completely separable.
- The plugs in Iqon were not separable, as rubber is moulded over a pre-existing plastic structure. This could be problematic, as the plugs are the most used components of the products and will most likely need to be replaced at EoL.
- Two special tools were needed for the disassembly of Iqon: the 14 mm triangular key for taking off the top- and bottom covers and the retainer for internally retaining the weights. No specialty tools were needed for the disassembly of BLG4.
- Wires connect all subassemblies and need to be separated before those can be disassembled. This is quite a tedious job, but seeing as the cable connections are already standardised in the field of electronics changing these connections could cause confusion.



# Conclusion

The previous subchapter about the assessment of disassembly show that even though both products already benefit from having a modular setup, there is still room for improvement in lowering the number of steps needed to reach target components and in tackling the penalty points. Iqon is chosen as the focus product for the redesign phase, based on the following arguments:

- An Iqon 2.0 is an option for EVBox's future product roadmap, therefore this project could then be considered as a recommendation for the redesign. Currently it is unclear if a BusinessLine 5.0 would be an option for EVBox's future product roadmap.
- Iqon production is expected to be upscaled, resulting in more potential value to be recaptured.
- There is more to gain in terms of disassemblability due to the products' higher complexity, FMEA and material value per product.
- More penalty points and areas in need of attention are present in the Disassembly Map, which is previously described.

The next chapter describes how some of these findings have been tackled during redesign activities for Iqon, resulting in optimisation for disassembly of the charger cables and kWh-meters in a cascading scenario.

## **RQ1: How well can EVBox's commercial AC chargers currently be disassembled?**

Both Iqon and BusinessLine can be disassembled well for servicing. Both products have a modular setup which allows for parallel disassembly and thus a reduction in disassembly time and steps. In both products covers must be removed with a specialty tool before the subassemblies can be reached, which is necessary to protect the inner components from the weather and unauthorised people. Wiring in between subassemblies makes certain disassembly activities difficult, as the wires first need to be removed completely before subassemblies and/or their components can be completely liberated. However, as this is a highly technical product and the wiring setup is already done following DIN (Deutsches Institut für Normung) electrotechnical standardisation, changing this could lead to confusion amongst professional electricians. The wiring issues are thus not prioritised in this thesis.

BusinessLine can be disassembled in such a way that priority components can be quickly completely liberated: the kWh-meter can be disassembled in 6 steps, the components in the chargerbox and heatsink can be disassembled in 9 steps and the LED-ring can be disassembled in 6 steps. Penalty points are given for low visibility during disassembly of the chargerbox, product manipulation and low visibility penalty points are given for disassembly of the LED-/Holster assembly. Lastly, a penalty point for an un reusable fastener is given for the DIN-rail and metal frame that are riveted together. No specialty tools were needed once the covers of BusinessLine were disassembled.

Iqon's modular subassemblies can be reached once several sequential activities have been completed. They are the removal of the top- and bottom covers, the side panels and detaching the installerbox from the chargerbox by unplugging wires. Removal of all subassemblies

in addition to the disassembly of 8 'loose' parts and the removal of the charger cables will result in the liberation of the stainless steel main frame. This can be done in at least 21 steps. Most of the other priority components are located inside the subassemblies and require many steps before disassembly is possible: the charger cables can be liberated in 28 steps, the top frame assembly can be reached in 18 steps, separating the installerbox from the charger box would mean 28 disassembly steps need to be taken. The installerbox could also be reached in 18 steps, when it is not separated from the chargerbox. From there, it would take an additional 3 steps to liberate the kWh-meter. Liberating the heatsink in the chargerbox would take 32 steps and liberating the LED-/holster assembly would take 28 steps. Either side panel can be reached in 10 steps. Removal of the top- and bottom cover and both side panels would require the completion of 16 steps.

In addition to the earlier mentioned specialty tool needed for disassembling the top- and bottom cover, a second specialty tool is needed for retaining the weights inside the product to ensure the safety of the repair-/installer professionals.

Penalties have been given for low visibility during disassembly of the side panels, cutting tie-wraps, unscrewing the stoppers and unscrewing the installer- and chargerbox fastener. Other penalties that have been given are the destructive disassembly- and un reusable tool penalties for the PMMA lightguides that are attached to the side panels, the cutting of tie-wraps to release the charger cables, the cutting of the plugs to separate them from the charger cables and the disassembly of the LED-ring and rollers in the cable management system.



# Integration

Housing of the plug

B

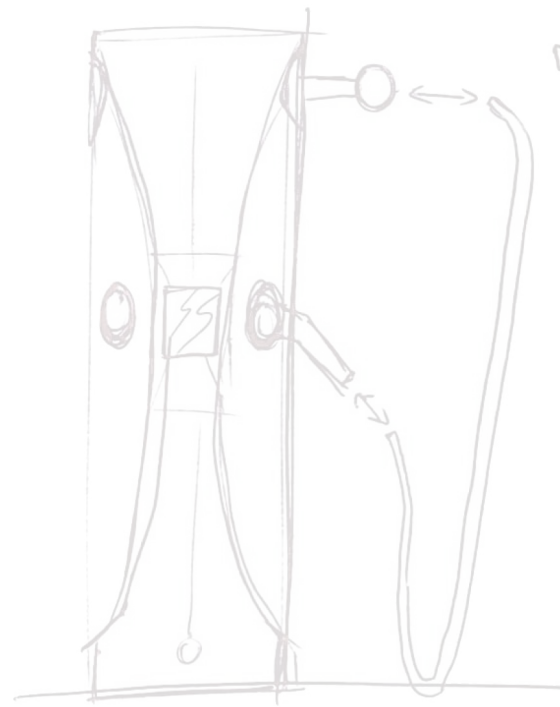
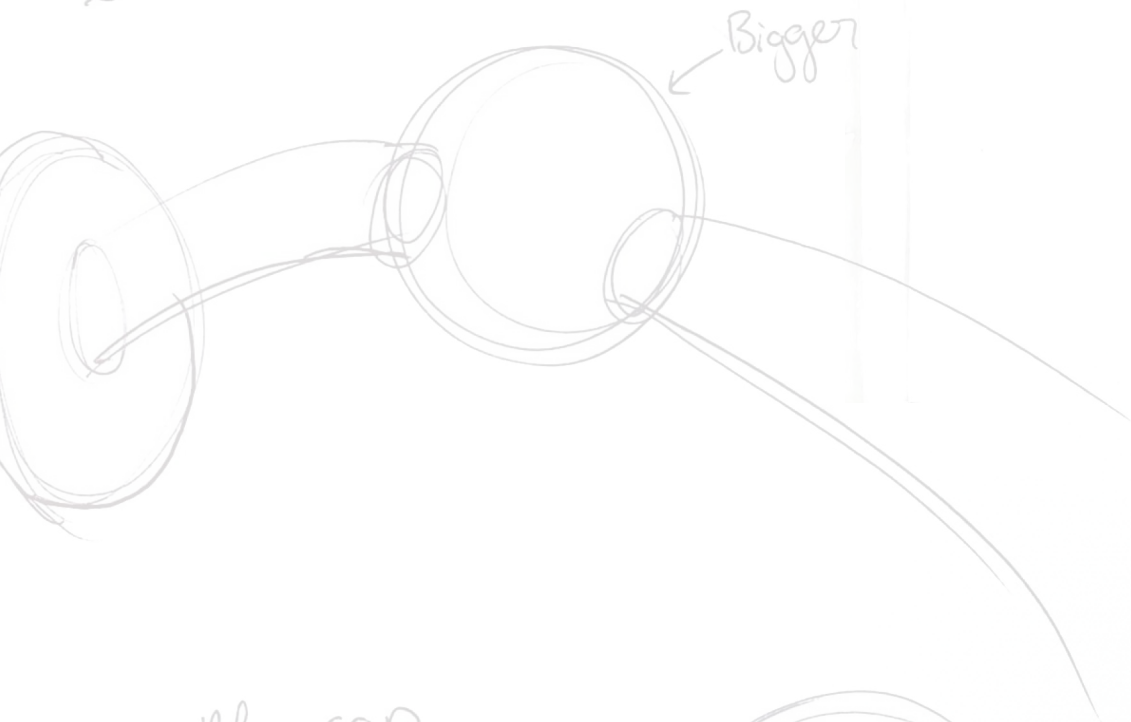

where to split?



Ballpoint principle



Bottle cap



Top & Bottom instead of left & right



push to open stoppers



MODULAR

Modular  
cable  
design?



5 big cables  
2 smaller  
ones

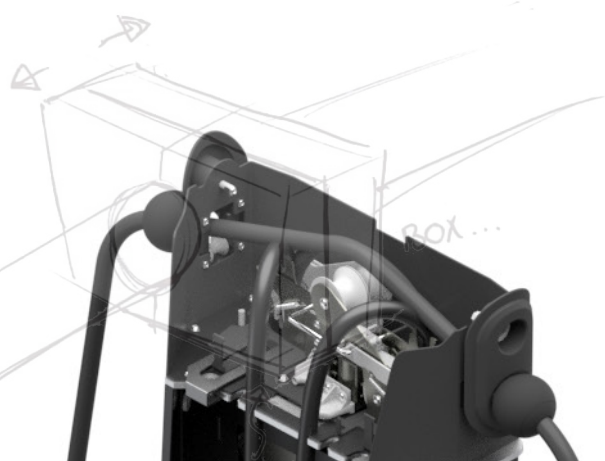

Box...

Simple  
connections  
as DIN components?  
How to nicely integrate?

Round  
connector



## /04.1 List of requirements and wishes

**A list of requirements and wishes has been developed, of which the most important requirements are listed here. The list is based on previous analyses, but has been detailed and defined throughout the redesign activities when more specifications came to surface.**

### Requirements

**For the redesign to be a success** the following requirements have to be met:

- R1. The redesign proposal should conform the PRD (product requirement document) of Iqon 1.0, in which safety specifications and regulations are noted.
- R2. The redesign proposals should be taken into account in the development of Iqon 2.0, which means that the outer aesthetics of the product should not be changed and the redesign should be compliant with the G5+ electronics platform.
- R3. The redesign proposals should decrease disassembly steps and time.
- R4. The redesign proposals should not introduce new tools to the disassembly.
- R5. The redesign proposals should lead to savings or not increase the estimated reverse logistics costs.

### Wishes

**It would be favourable** for the redesign if the following wishes are implemented:

- W1. The redesign proposals should preferably not increase the number of components.
- W2. The redesign proposals should preferably not increase the number of materials.
- W3. The redesign proposal should preferably not increase the production costs of the product.





## /04.2 Illustrative redesign

**The aim of this chapter is to present potential solutions for improving ease of disassembly of Iqon in a cascading scenario. The process serves as an example of how optimisation for circularity can be executed by EVBox if analyses are done on both strategic- and product level. By organising two brainstorm sessions redesign directions and more concrete ideas were found, respectively. They are presented in the first part of this chapter. Afterwards, the final concepts and encountered challenges are presented.**

### 04.2.1. Ideation

#### **Designing for a cascading scenario**

Design for a cascading scenario means design for facilitating the cascading process. As remanufacturing is the most extensive value retention process, it is wise to take this as the baseline: when an extensive process can be done for remanufacturing, a less extensive process can also be done for refurbishing for example. The remanufacturing process consists of disassembling, cleaning, inspecting and sorting, reconditioning, replacing, reassembling and testing (Steinhilper, R., Butzer, S., 2016). Redesign activities in this thesis are done conform the scope of the project and thus the focus is on disassembly (for proper execution of other cascading activities).

A flowchart of product value retention scenarios can be seen in figure 49. In this flowchart a distinction is made between two types of products that can come back to a (dis-)assembly partner of EVBox: products that are too broken to be repaired on-site and products that are returned after serving their

estimated commercial lifetime of 8 years. Both consist of components that do not have remaining useful life and components that do. This leads to components being replaced/ thrown away or components being harvested/ reconditioned, respectively. A distinction is made between 3 types of components: wear parts, reconditionable parts and harvestable parts. Iqon's components are categorized within these groups as shown in figure 49.

Critical components for disassembly for value retention were chosen based on an overlap between component category (wear part, reconditionable part and harvestable part), the disassembly map improvement potential and the critical components mentioned in the 'Disassembly Assessment' chapter. The critical components for the redesign are therefore the charger cables (due to frequent failure and heavy signs of wear and tear), the side panels (due to high value, durable material and aesthetic importance for reconditioning) and the kWh-meter (due to the harvesting potential mentioned in the 'Reverse logistics' chapter).

Figure 49. Flowchart of Iqon within a cascading scenario. ►

Iqon broken beyond in-field repair

Iqon EoL because of old age

These can both consist of

Parts with remaining useful lifetime

Parts without remaining useful lifetime

Component harvesting

Reconditioning

Replaced with new parts & Thrown away

kWh-meters, RCBO's, solenoids

Main frame, side panels, heatsink, DIN rails, pulley system, top frame, CMS guide frame, bracket

Cables, top- and bottom covers, PMMA lightguides, cable outlets, IB housing, CB housing

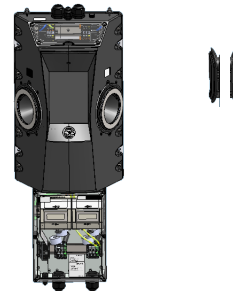
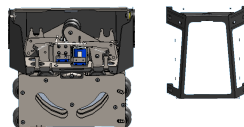
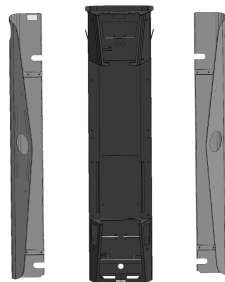

## Finding redesign directions – brainstorm session #1

A brainstorm session was held with VanBerlo employees with prior knowledge of Iqon. The aim of the session was to find solution directions for shortening disassembly time and decreasing the number of disassembly steps to reach the aforementioned critical components. This was done by experimenting with the Disassembly Map to find redesign opportunities for a cascading scenario following the three methods of clumping, surfacing and trimming (Flipsen, 2020).

After an introduction on the topic of cascading and the Disassembly Map, the critical components for the redesign were presented and the methods to follow during the session were explained.

Due to the creative nature of the session, it did not completely go as planned; instead of focusing on a strategy (clumping, surfacing

and trimming) and then focusing on the critical components one by one it was the other way around: per critical component the strategies were applied to find solutions. All frames from the Miro board are presented in appendix C.

In terms of output the session went well and multiple directions have been identified after clustering the ideas for the side panels, charger cables and the installerbox which houses the kWh-meter. Figure 50 shows all the ideas clustered on post-its (most ideas were written down in text) and figure 51 shows the potential redesign directions that are derived from it. These solution spaces are:

- A redesigned installerbox that allows **harvesting** of the **kWh-meter**.
- A modified stopper (mechanism) to allow easier **replacement** of the **cables**.
- Mechanical fastening of the PMMA plates to completely liberate the **side panels** for **reconditioning**.

Figure 50. Clustering of post-its after brainstorm session 1. ▶

Figure 51. The redesign directions/solution spaces derived from brainstorm session 1. ▼

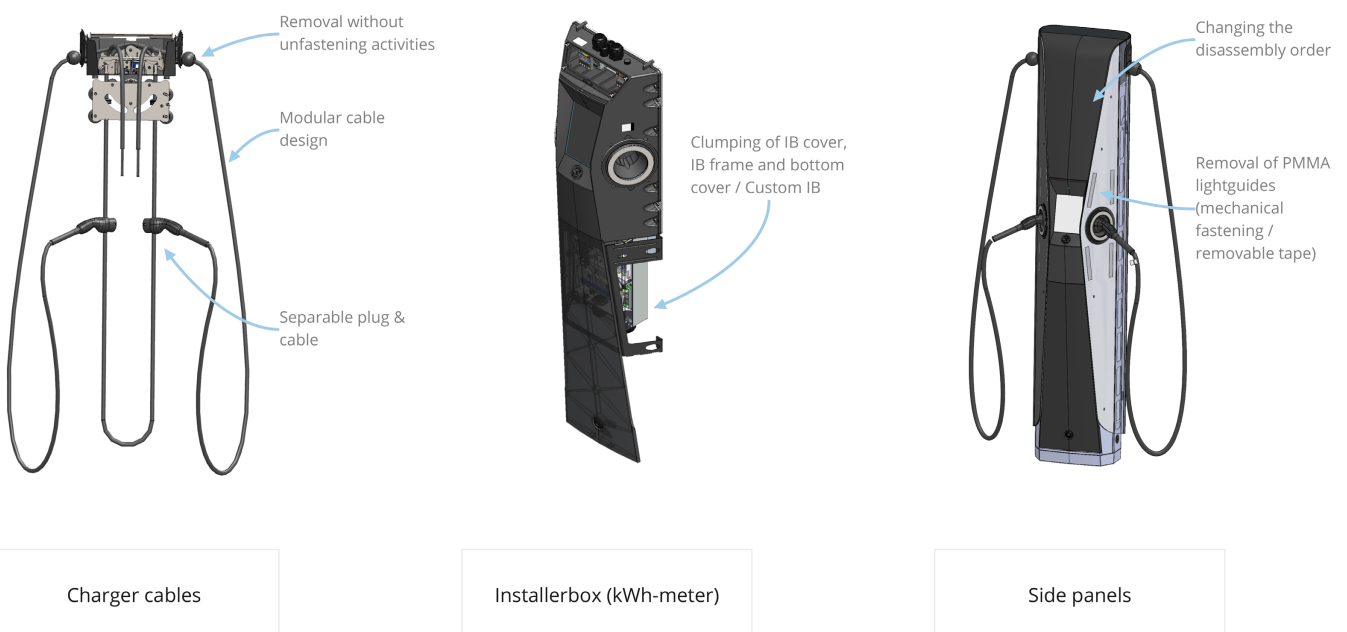

Charger cables

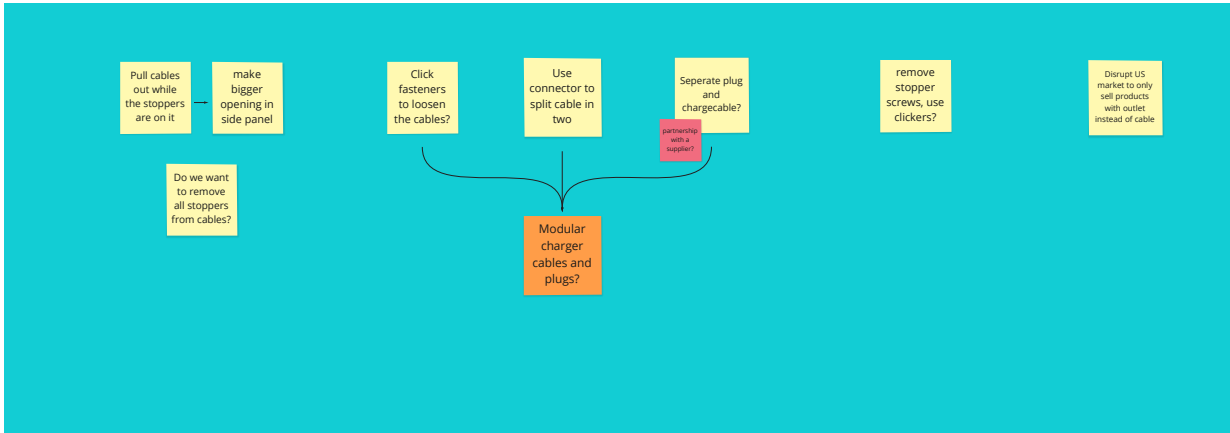

IB

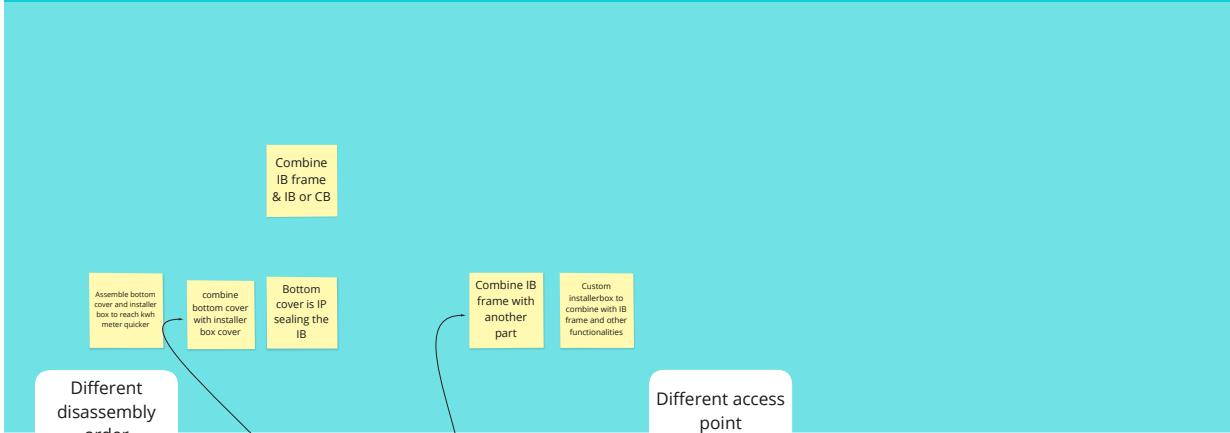

Side panels

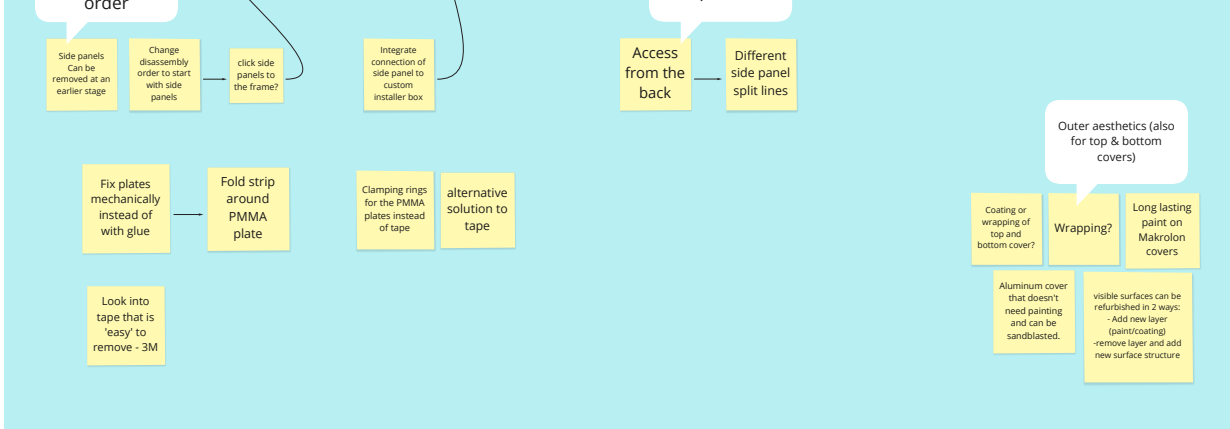

Other

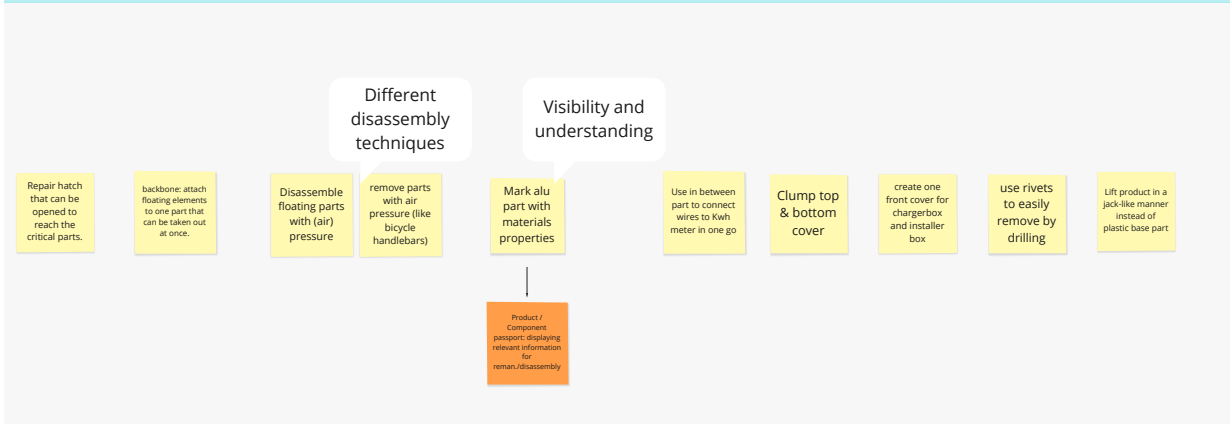

## Disassembly map adjustments

To make the Disassembly Map of Iqon more understandable and usable for the brainstorm participants, the Disassembly Map was simplified and presented on a Miro board where simultaneous collaboration would be possible as shown in figure 52. Visualising the Disassembly Map of Iqon was limited to the possibilities of the software which has its pros and cons. One major benefit of using Miro is the possibility of simultaneous online collaboration with multiple parties. Another benefit is the automatic connection of components once an arrow has been placed; moving one of the components will result in the arrow moving with it. In another software such as Adobe Illustrator the arrows have to be manually reconnected. In this way, Miro facilitates the restructuring of the Disassembly Map.

To enhance understandability, images were added to the Disassembly Map and sub-assemblies were colour coded:

Dark grey	Top- and bottom cover
Light grey	Side panels
Yellow	Cables
Pink	Installer- and chargerbox
Green	CMS
Light blue	Loose parts
Orange	Main frame

Colour coding facilitates the distinction between different component categories and makes it clear where overlap between subassemblies occurs. It stimulates modular thinking. A clear example is the installerbox frame that is part of the 'loose parts' group that has to be removed before the installerbox can be reached.

The addition of component images makes it easier for participants to identify them. To further facilitate component identification in the Disassembly Map numbers were replaced with the component names.

Only after doing the brainstorm sessions it was discovered that Miro offers the possibility of adding more shapes and colours than initially presented, which would have made the adjusted Disassembly Maps more similar to the original map presented in chapter 3.2.1. Instead, for the sessions the hexagon indicating a 'multiple motion action' is replaced with a parallelogram. Furthermore, it was attempted to match the colours indicating the force intensity of activities as much to the original ones as possible with gradations of pink, green and aqua. Black correlates to the darkest tone of aqua in the original map.

Figure 52. The Disassembly Map used during the brainstorm. ►





THE COLLABORATIVE DISASSEMBLY MAP

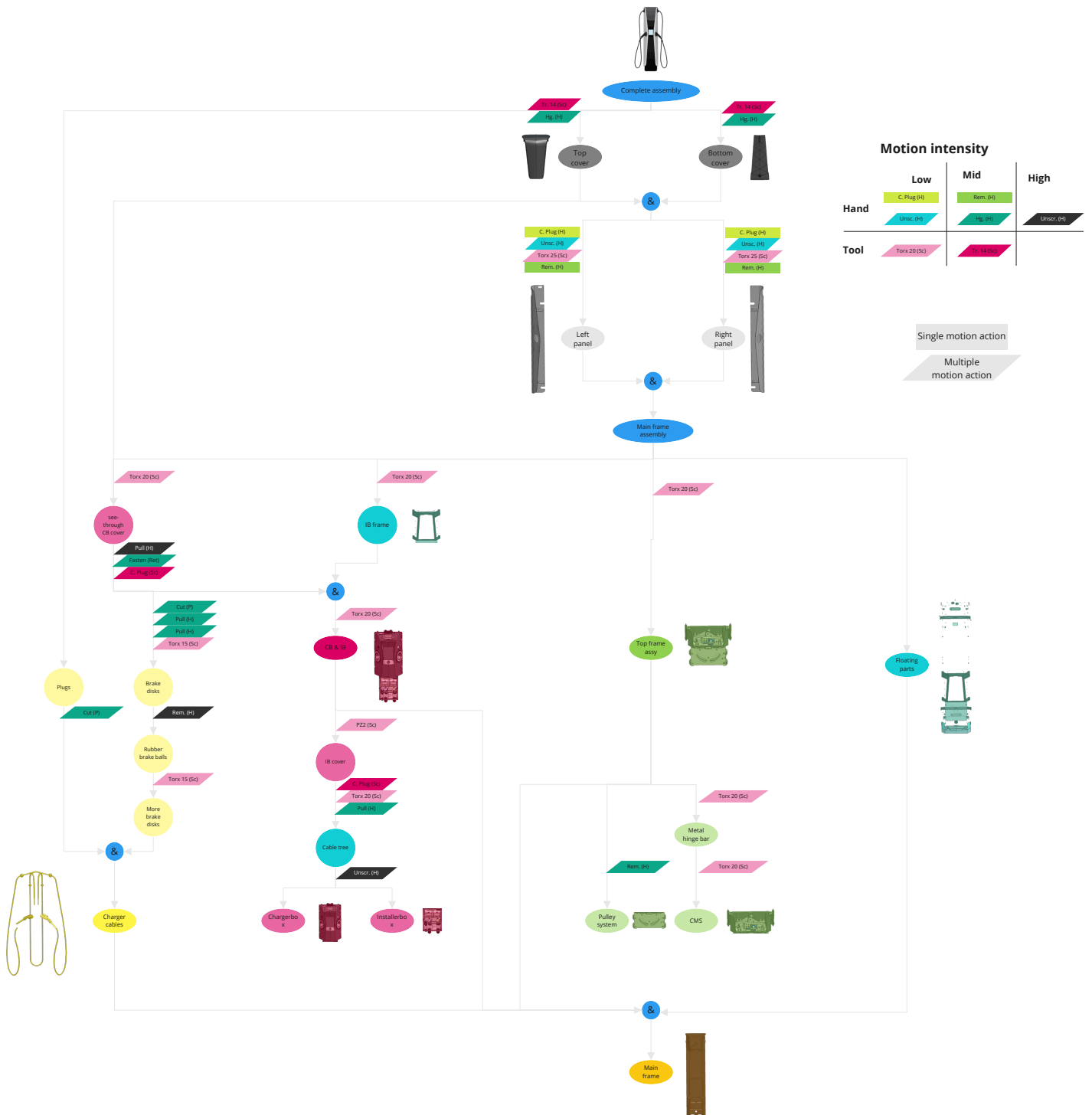

## **Finding concrete solutions – brainstorm session #2**

During a second brainstorm session, solutions within the potential directions developed in session 1 were further defined and detailed. Participants were provided with a simplified CAD model of the product to further clarify principles of this complex product when words would fall short. Initial ideation visualisations were provided to kickstart the brainstorm session and a collaborative highlighted disassembly map was available to explain connections and impact of certain changes. Participants were encouraged to visualise ideas as much as possible. All the frames from the Miro board can be found in appendix D. Some of the ideas and thought processes during the session are shown in figure 53, 54 and 55 on the following pages.

MODULAR |

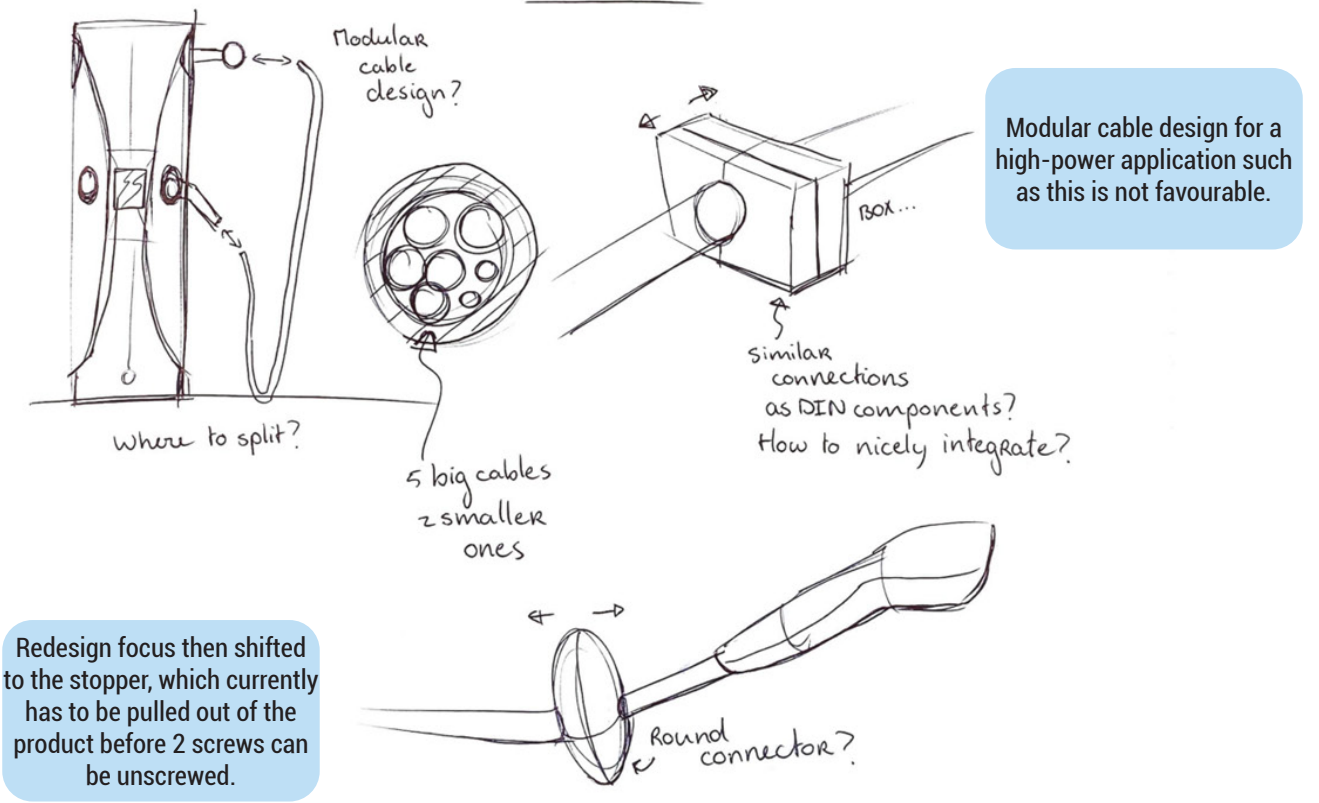

Redesign focus then shifted to the stopper, which currently has to be pulled out of the product before 2 screws can be unscrewed.

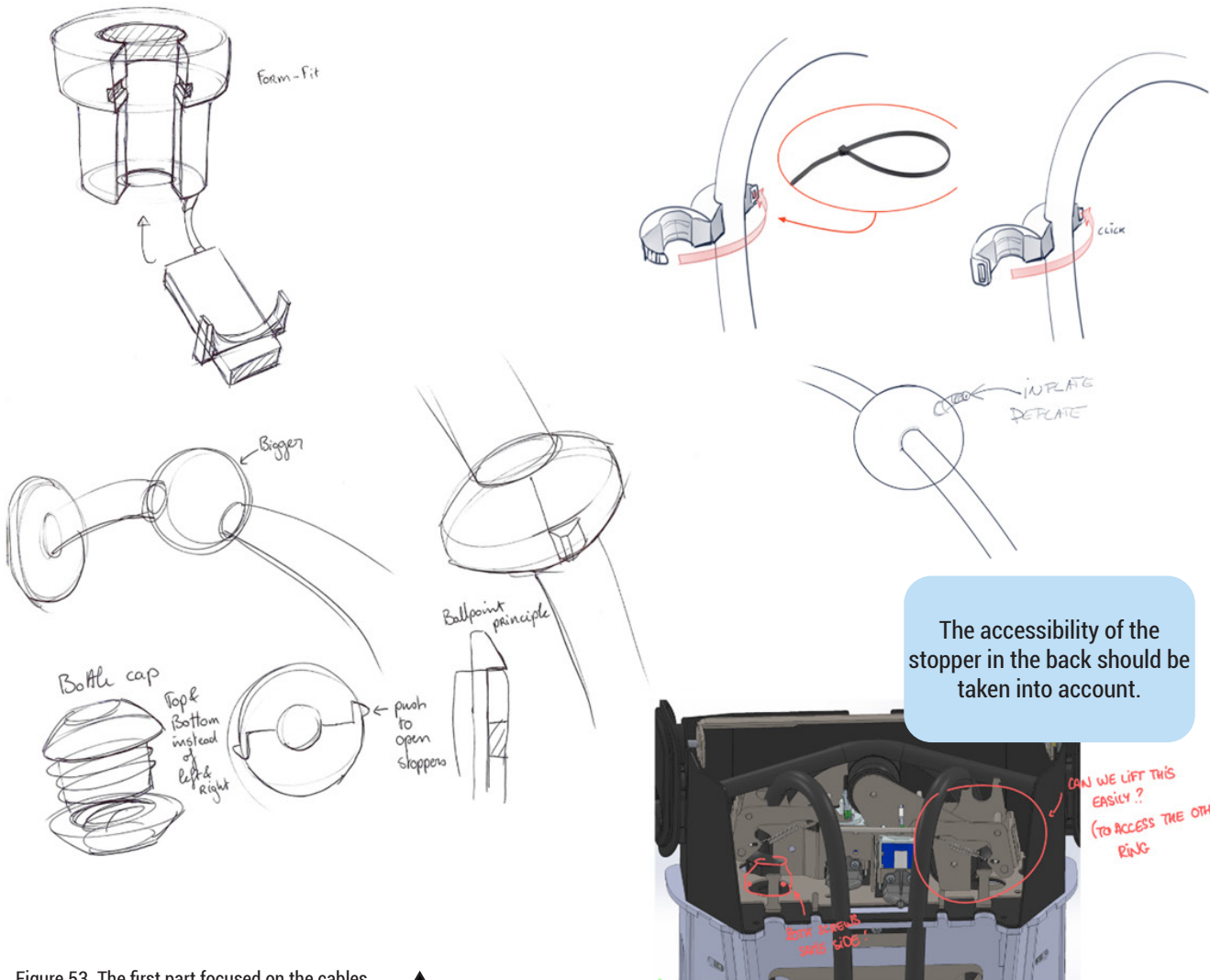

The accessibility of the stopper in the back should be taken into account.

Figure 53. The first part focused on the cables. ▲

INSTALLER BOX

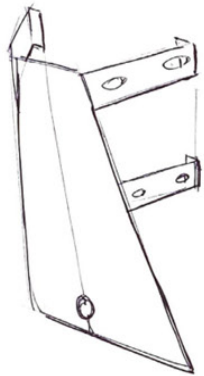

Bottom cover + Bracket?

Big Makrolon part?  
Metal?

Can it be injection moulded?  
(multi plate mould?  
Draft angle?)

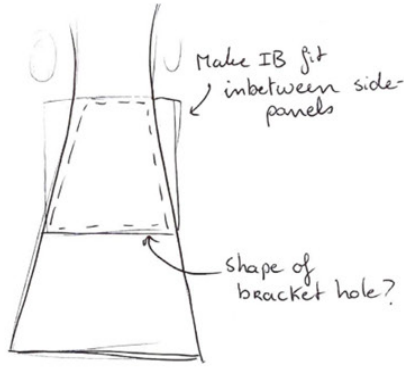

Shape of bracket hole?

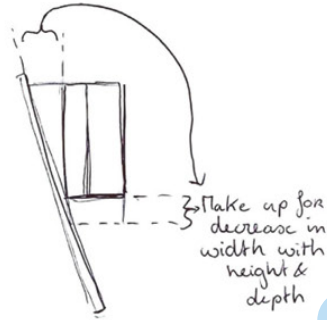

Take up for decrease in width with height & depth



CUSTOM SHAPE

Redesign focus was on accessibility of the installerbox components directly after removing the bottom cover.

Bracket functionalities (holding the side panels and bottom cover) could be integrated in the installerbox (lid) or the bottom cover.

By changing the installerbox shape, it can be reached through the bracket.

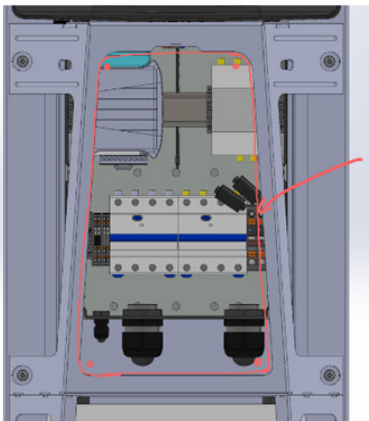
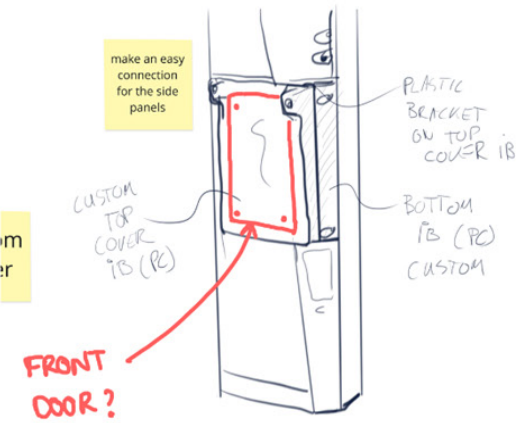
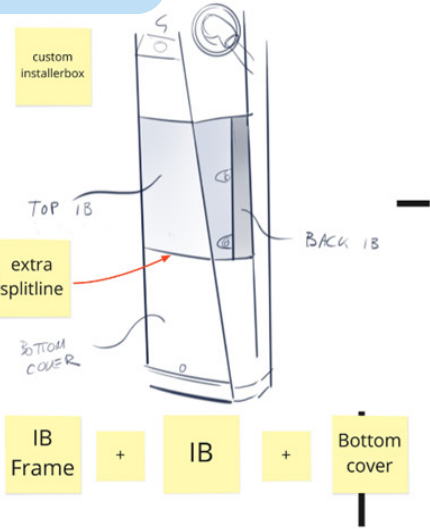

BOX THAT HAS THE SHAPE OF THE HOLE.

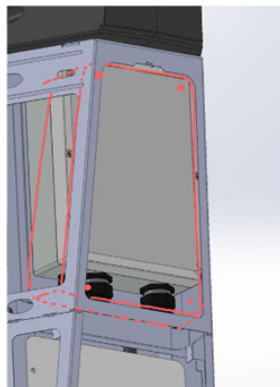

▲ Figure 54. The second part focused on the installerbox.

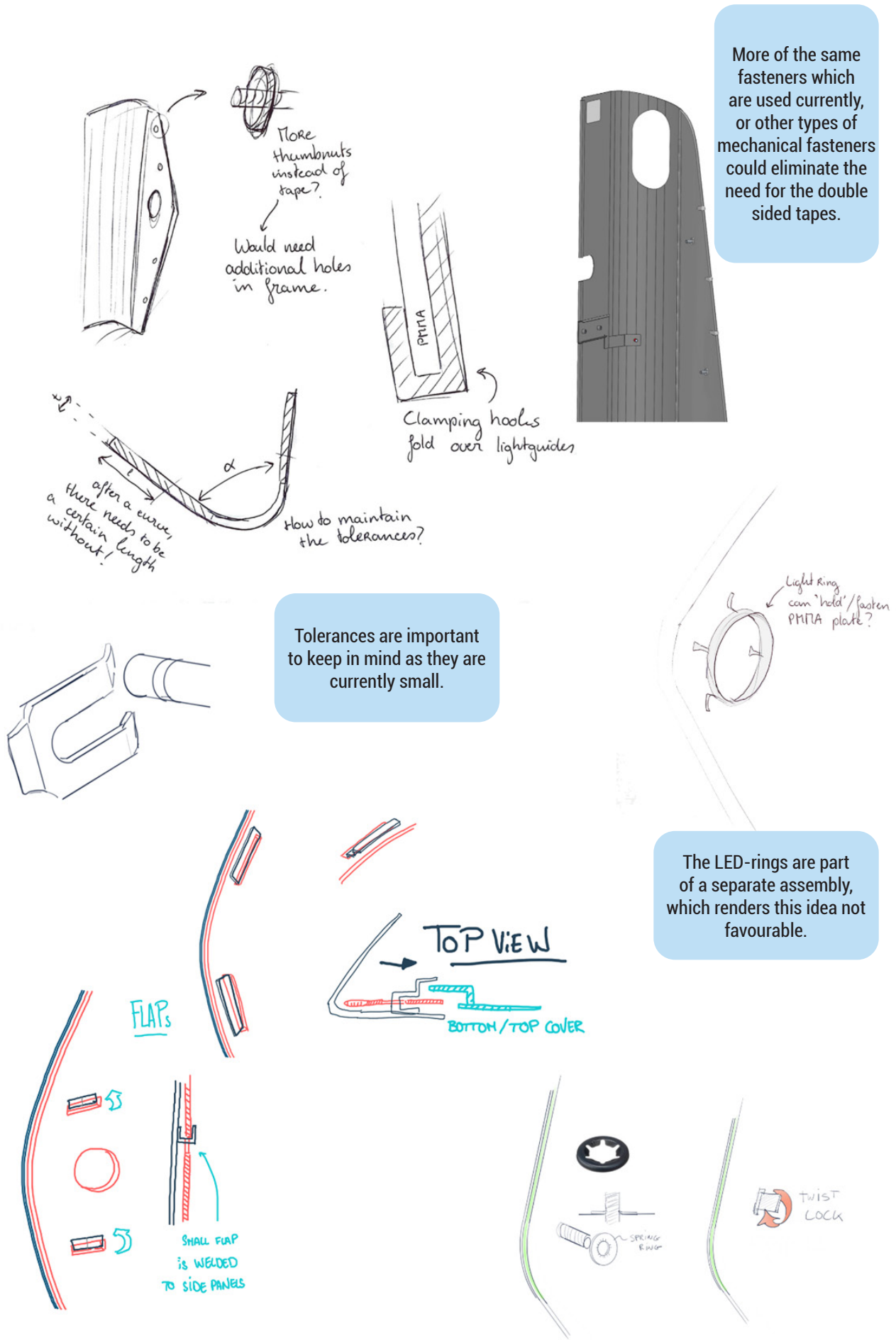

More of the same fasteners which are used currently, or other types of mechanical fasteners could eliminate the need for the double sided tapes.

Tolerances are important to keep in mind as they are currently small.

The LED-rings are part of a separate assembly, which renders this idea not favourable.

Figure 55. The third part focused on the side panels. ▲

## Prioritising solutions

With the help of so-called power dots, a method used by VanBerlo employees to subjectively choose the most fruitful ideas based on design experience, a selection was made in each direction:

- A modified stopper (mechanism) to allow easier retraction of the cables.
- A redesigned installerbox that allows for (lid) removal through the bracket and thus easier access to the kWh-meter.
- Mechanical fastening of the PMMA plates, with for example starlock rings (it was later discovered that these are not easy to remove at all, so the ideation was put on hold).

Then, with the weighted criteria matrix shown in table 3, the ideas were sorted on priority. Table 2 shows the scaling that was used. Conform this matrix the redesign efforts were divided: the most time would be put in the redesign of the installerbox, stopper and side panels, respectively.

The weights of the criteria were chosen based on necessity for succesful project output, thus compliance to the redesign- and project scope which mainly focus on disassembly improvement.

<i>Criterion</i>	<i>Weight</i>	<b>Weighted cri</b>	
		<i>Stopper redesign</i>	<i>Accessible insta</i>
Remanufacturing improvement	20	8	9
Disassembly improvement	20	5	8
Feasibility of implementation	15	6	5
Conform PRD Iqon 1.0	10	6	5
No changes to outer aesthetics	10	9	9
Feasibility for project timeline	10	6	6
Costs of implementation	10	6	2
Applicability on short-term notice	5	5	5
<b>Total</b>	<b>100</b>	<b>51</b>	<b>49</b>



Table 2. Weighted criteria matrix scale. ►

Table 3. Weighted criteria matrix. ▼

Scale	
10	Excellent
9	Very good
8	Good
7	More than satisfactory
6	Satisfactory
5	Nearly satisfactory
4	Unsatisfactory
3	Bad
2	Very bad
1	Poor

Criteria matrix				
Chargerbox	Removable PMMA lightguides	Total Stopper	Total IB	Total PMMA
	8	160	180	160
	2	100	160	40
	8	90	75	120
	8	60	50	80
	4	90	90	40
	8	60	60	80
	8	60	20	80
	8	25	25	40
	54	645	660	640

## 04.2.2. Redesign proposals

Four redesign proposals have been developed; they are shown within the earlier defined solution spaces in figure 56. The following chapters will explain the redesign proposals and challenges that were encountered along the way. Due to the time constraints of this project and the scoring in the aforementioned weighted criteria matrix the further development of the redesign for liberation of the side panels was put on hold.

Figure 56. Redesign proposals in the earlier presented cascading flowchart. ►

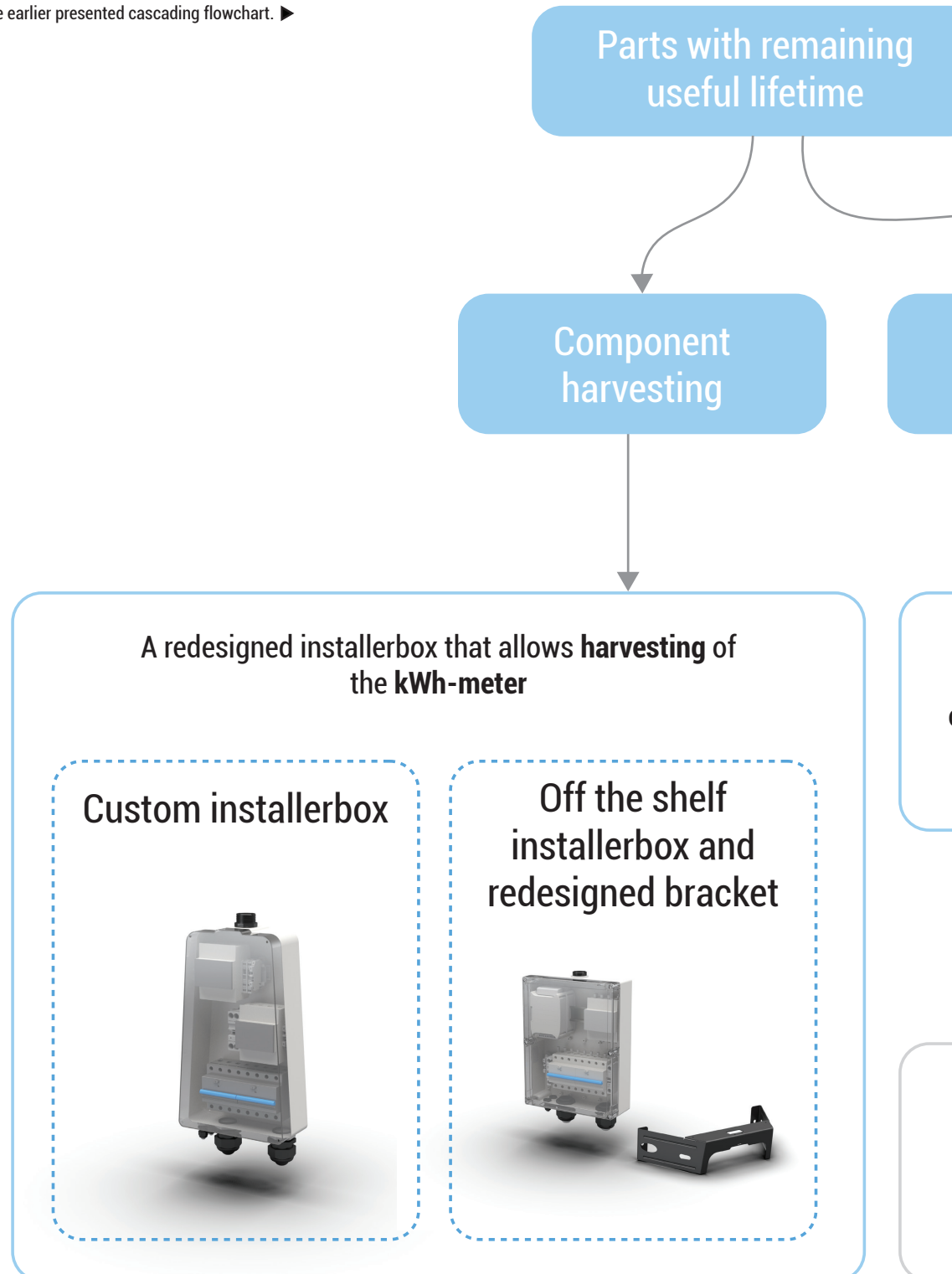



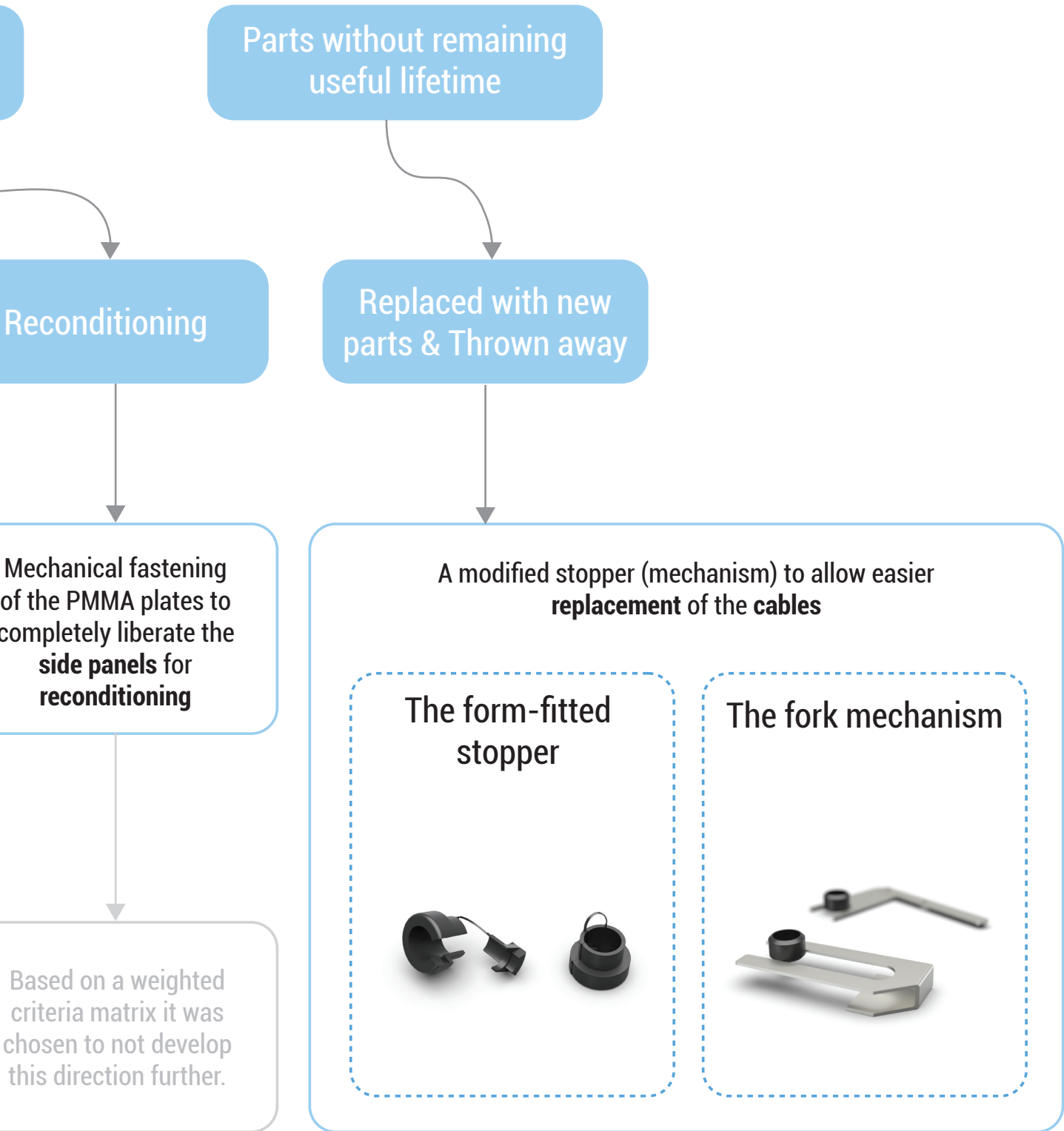

# Proposal 1: the custom installerbox

## Functionality

The installerbox houses and protects the following DIN components: the kWh-meters, RCBO's, ground terminal blocks and the data terminal blocks shown in figure 2. The box has an IP rating of 66 to protect inner components against dust and water and provides space for the excess heat from the RCBO's to dissipate. It is currently designed to be rigidly fastened to the chargerbox with a thread so both can be handled as one unit.

To reach the components inside the installerbox (when it is still mounted on the frame) one first has to remove the bottom cover, slide open the side panels, remove the bracket/frame, unscrew the installerbox lid and unplug the cables that connect it to the chargerbox. The biggest hindrance is the frame blocking the installerbox, as can be seen in figure 58 and 59.

## Redesign proposal

The installerbox is made accessible without having open the top cover, to slide open the side panels and unscrewing the bracket by making the installerbox shape the same as the hole in the bracket in front of it, see figure 57. To provide (de-)installers with enough space to reach the screws, the box is kept at the same depth as before (90 mm). This also ensures the possibility of flipping the RCBO switches.

In the Disassembly Map this would be visualised by an additional arrow going from the bottom cover directly to the installerbox lid, see figure 60 and 61. This could significantly accelerate component harvesting activities.

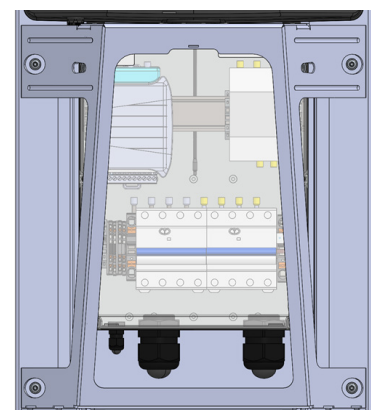
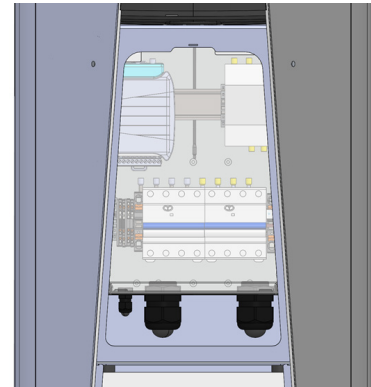
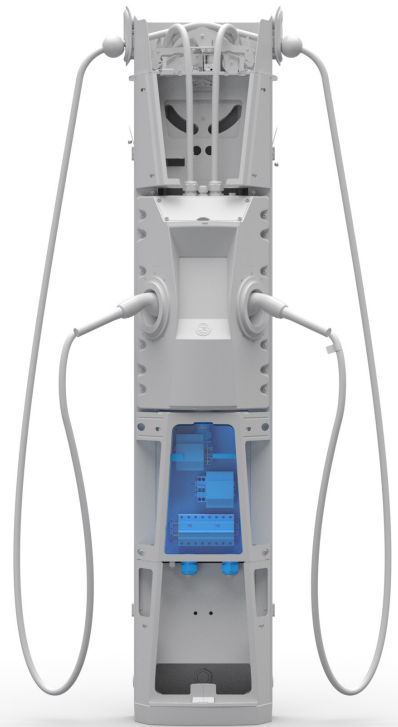
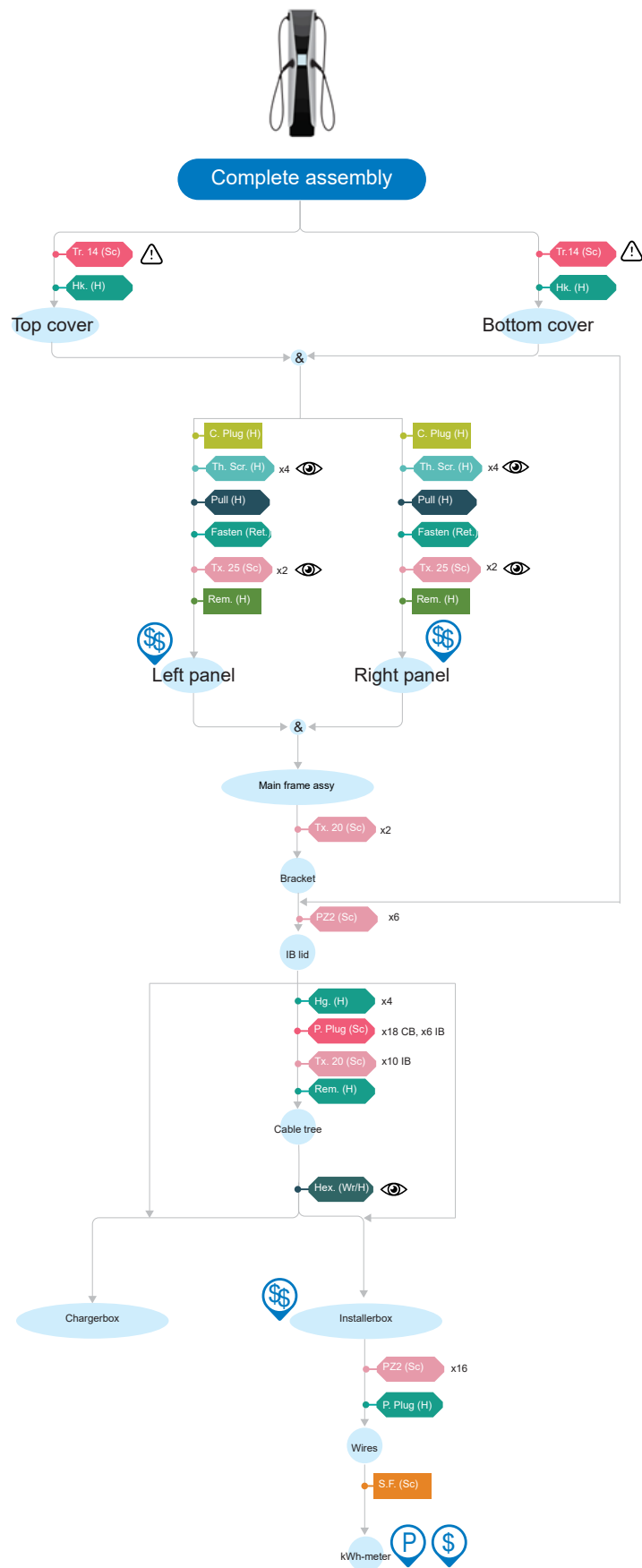
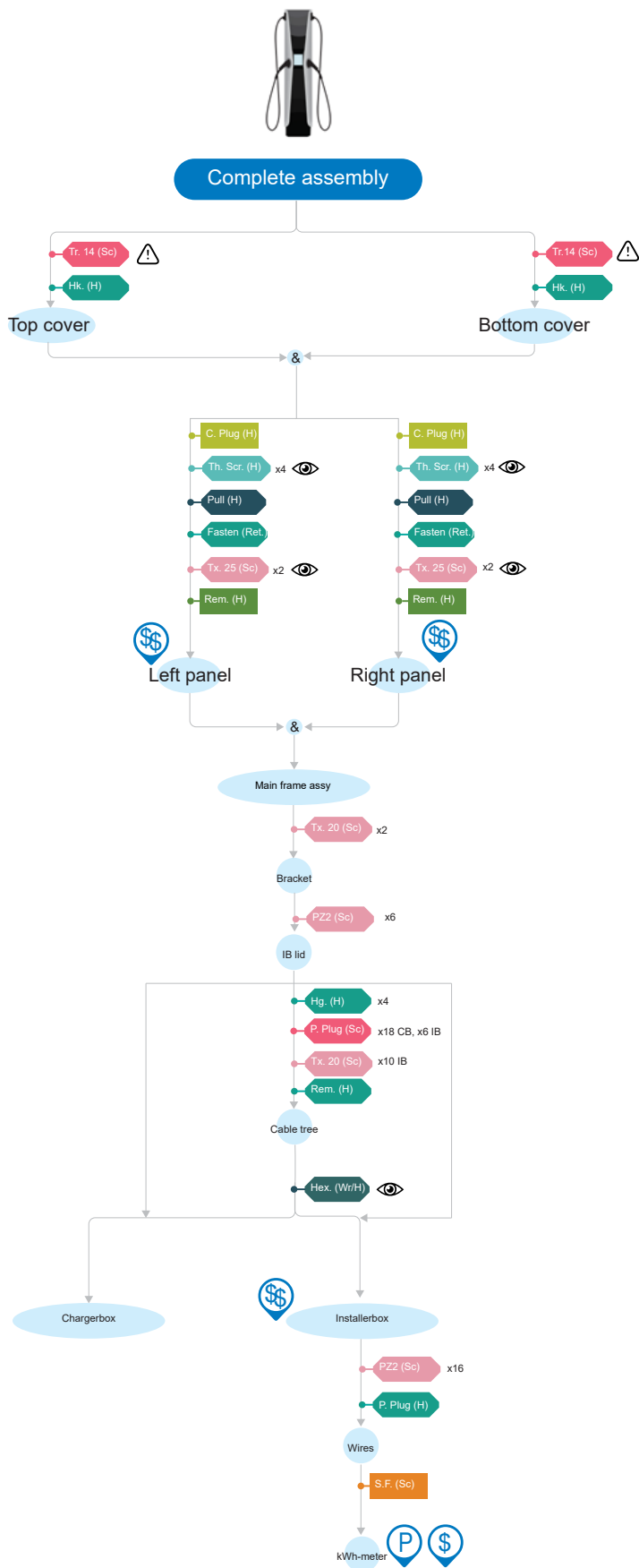

Figure 57. Location of the redesign in product, ▲

Figure 58 & 59. Access of the current installerbox is blocked by the side panels and bracket. ►





▲ Figure 60 & 61. Partial Disassembly Map comparison between the original and redesign. A shortcut from the bottom cover to the IB lid has been created.



## Prototyping and verification

A prototype was made to test whether all components would still fit inside the installerbox and if cables could be managed properly. The challenge is to make all the components fit inside the box and still be accessible for the de-installer's hand, see figures 62 and 63. Through prototyping it was discovered that the new shape can fit through the bracket and that the DIN components can be positioned in such a way they fit and are accessible, as shown in figures 64 and 65. The cables, however, seem to be fitted in too tightly to be realistic for the European version of Iqon. The EVBox Elvi wall dock was used for reference, in which the cable management is designed for in-factory assembly and not for in-field replacement, (Diemer; Kreijne, 2021). See Figure 66. For the US version of Iqon cable management will not be a problem, as the RCBO's are not located inside the product and the kWh-meters are much smaller. This means that there is more room inside the American version of the installerbox which allows for proper cable management.

Another issue that was raised during discussions with the EVBox Engineering Department when asked for their expert opinion on this concept, is maintaining a similar total enclosure volume, which is needed to help manage the heat produced by the RCBO's. Again, this is an issue in the European version of Iqon. The heat-producing RCBO's are not located in the US version of the product, eliminating the heat dissipation problem. In the EU version of Iqon this problem could be mitigated by using an aluminium enclosure which could serve as a heatsink.

Furthermore, a custom part means that a new mould has to be manufactured and recertification has to be done, which combined would cost between €60.000,- and €70.000,-. The discussions with the EVBox Engineering Department highlighted the preference to keep the enclosure an off the shelf part with the same specifications as the current design. The next concept was born from this notion. The complete email conversation can be seen in appendix A7.

Figure 62. Component configuration that would not fit. ▼



Figure 63. Another configuration that would not fit. ▼

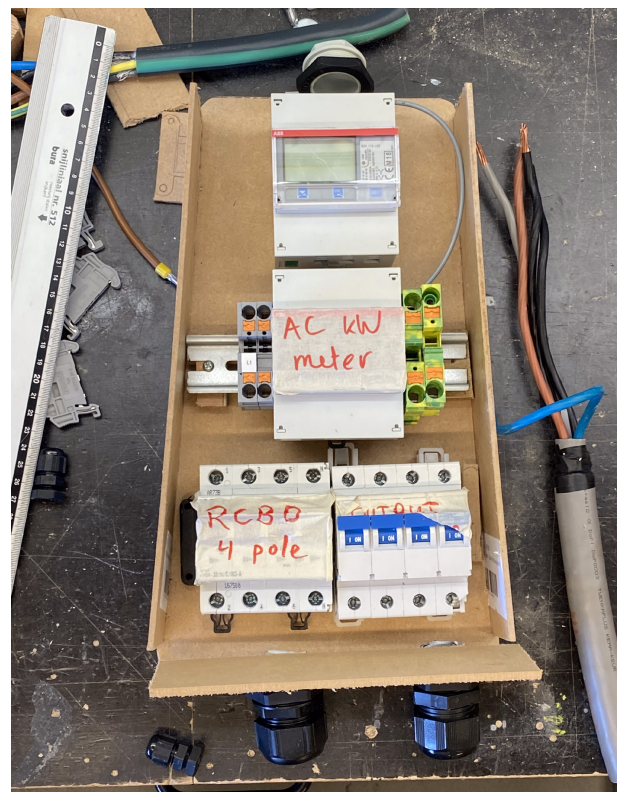

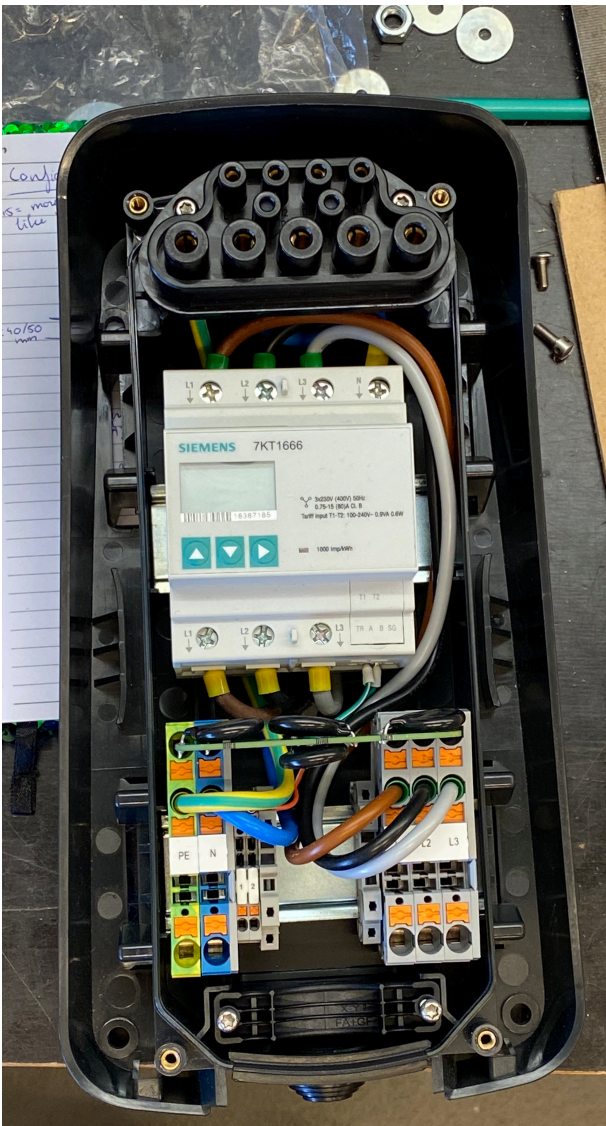
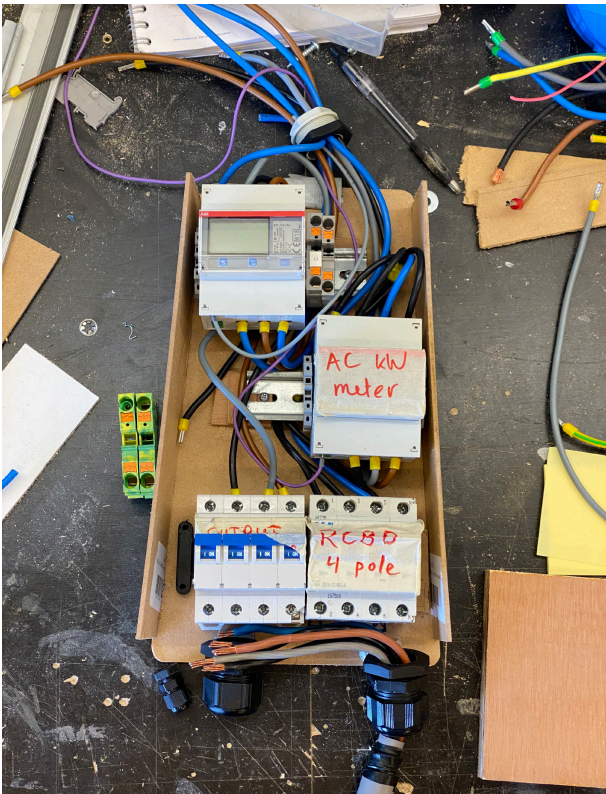

Figure 64. The prototype inside the main frame of the product. ▲

Figure 65. A configuration that fits, but cable management appears to be too tight ▶

◀ Figure 66. The Elvi, in which cable management is designed for in-factory assembly, not for in-field replacement.

## Challenges and optimisation possibilities

Based on the feedback from the EVBox engineers and managers and prototyping the following challenges need to be taken into account for making this redesign feasible, viable and desirable:

- More volume or a metal enclosure is needed for proper heat dissipation in the European version of the installerbox, which houses the RCBO's and bigger versions of the kWh-meters.
- More volume is needed for cable management in the European configuration of the installerbox.
- Redesigning the installerbox to be a custom part means production costs will be higher.
- Redesigning the installerbox to be a custom part means recertification has to be done, increasing costs.
- A redesigned installerbox should have the same electrical, mechanical, material and environmental specifications as the current installerbox, of which the most important ones are an IP rating of 66 or 67, DC breakdown voltage of 1000 V, AC breakdown voltage of 690 V, UL protection class 12 and an operating temperature between -35 and 80 degrees Celsius. The complete list of specifications can be seen in appendix E.

## Proposal 2: the off-the-shelf installerbox and redesigned bracket

### Functionality

The functionality of the installerbox is the same as mentioned before.

The bracket in front of the installerbox is used to fasten the side panels and the bottom cover.

### Redesign proposal

As commented by experts from the EVBox engineering Department, the installerbox is preferred to be an off-the-shelf part. To accommodate to this wish, the second concept was generated. A taller, but narrower installerbox is lowered onto the main frame, making use of the extra space from the angled side panels. The bracket is cut in half; leaving only the part that accommodates its prime functionalities. See figure 67.

Bridging the gap between the installerbox and chargerbox can be done by using a so-called conduit gland as shown in figure 68. These are available in multiple shapes and sizes and come in a variety of IP ratings, (Flexicon, 2021).

The redesign allows for the same shortcut created with proposal 1 which is pictured in figure 60 and 61.

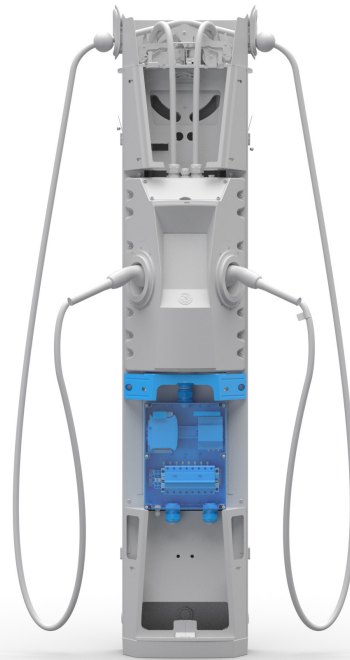
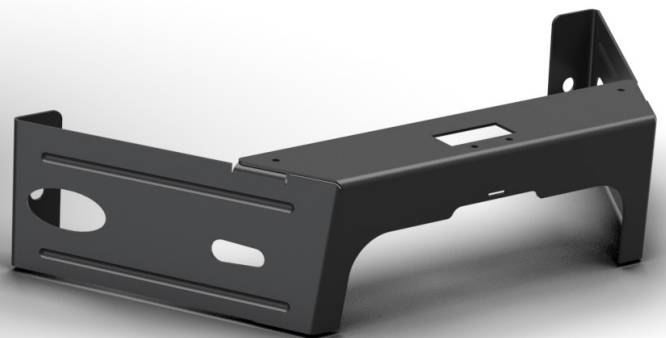
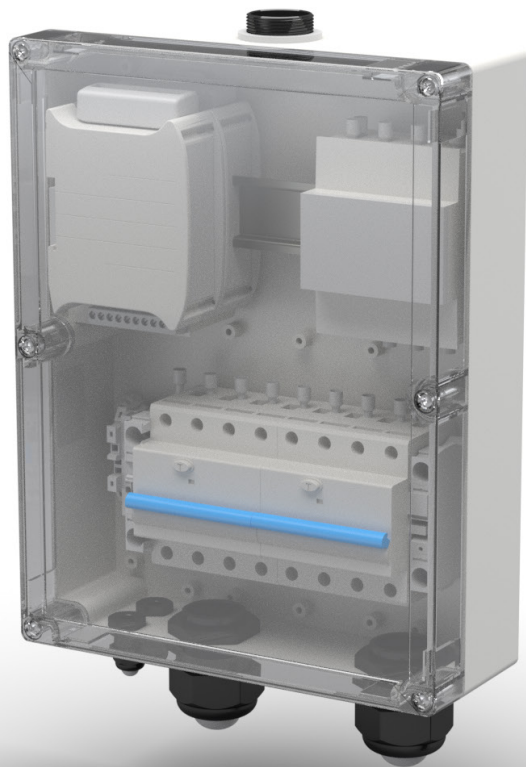

Figure 67. Location of the redesign in product. ▼

Figure 68. A conduit gland with on both ends a nut mechanism that is already used in the current design ▼







## Testing and verification

Through initial testing it was discovered that the presently used installerbox would not fit the redesign purpose. The screws could still not be properly reached when the side panels were closed which can be seen in figure 69 and 70. It was then decided that the installerbox should be narrower and taller than the original box, so screws can be accessed and the lid can be removed.

Research into potential off-the-shelf installerboxes with the same specifications and volume as mentioned in appendix E unfortunately led to no results. It appears no suitable enclosures exist, but the research showed that a lot of customisation is possible. This means that this part could be custom made, in which case concept 1 could be opted for. The complete research into enclosure possibilities can be found in appendix F.

More issues came to surface through e-mail contact with the EVBox Engineering Department. As shown in figure 72 and 73 a gap appears between the lightguide and side panel when the two thumbnuts located lower on the bracket are omitted. The entire side panel also moves a few millimetres away from the centre. This influences EVBox's assurance of consistent quality and fit which is problematic.

Another iteration of the bracket was done by drilling 6 holes in the bracket to allow access to the screws in the installerbox lid. The screws were accessible, but the lid could still not be removed due to lack of space between the installerbox and bracket. See figure 71.

When the cable lengths are increased, this could have consequences for EMI (iNARTE Electromagnetic Compatibility Certification Program) and other certifications. Furthermore, lowering the installerbox could have consequences for flooding certification requirements. However, an expert from the EVBox Certification Department noted that he did not see any initial problems. His only remarks were that it would most likely be needed to repeat at least the radiated tests due to the changes



Figure 69 & 70. The side panels obstruct the installerbox lid. ▼ ▲





▲ Figure 71. The screws are accessible with the addition of 6 holes in the bracket. There is not enough space to remove the lid, however.

▼ Figure 72 & 73. Panels and bracket without nut on the left and with nut on the right.



in cable lengths and to repeat the rain and external icing tests due to mechanical changes. He did not foresee any additional risks when implementing the changes. Recertification is costly and it is therefore preferred to avoid it as much as possible.

Adding a flexible cable conduit in between the chargerbox and installerbox would mean that the way the total assembly is handled would change. As mentioned earlier, due to the rigid connection between the boxes, both can currently be handled as one rigid body. Having the installerbox hang loosely from this conduit would not be ideal for assembly and service. Furthermore, assembly tooling and workstations would have to be changed, adding to the overall costs. The cable conduit would also add two more points for water ingress (Whitacre, 2021). For the complete email conversation see appendix A7.

### Challenges and optimisation possibilities

Challenges complicating redesign feasibility, viability and desirability are the following:

- Off-the-shelf enclosures with the right dimensions and specifications do not seem to readily exist; they would have to be custom made.
- Redesigning the bracket and omitting the thumbnuts would lead to unacceptable gaps appearing between the side panels, PMMA lightguides and frame.
- Certification in terms of flooding requirements, EMI and Safety conditions might need to be rechecked.
- Rain and external icing tests might need to be redone due to mechanical changes.
- Radiated tests might need to be redone due to changes in cable length.
- The cable conduit complicates the way the installerbox and chargerbox are handled.
- The cable conduit adds two extra points for water ingress.
- The longer cable length and cable conduit mean that assembly tooling and workstations need to be changed, leading to extra costs.

## Proposal 3: the form-fitted stopper

### Functionality

The stopper mechanism in Iqon is meant to alleviate stresses on the cables that are caused by the pulley system (the weights) and prevent the cables from damaging the electrical terminations and being pulled out of the chargerbox. This system serves an important role, but hampers disassembly as the cables first need to be pulled towards the de-installer before the screws on both sides of the stoppers can be removed. Removal of the stopper on the right is even more difficult because it has to be pulled from behind the cable management assembly: see images 75 and 76. The stiffness of the cables further complicates positioning the screwdriver in the right angle and decreases visibility.

### Redesign proposal

The redesigned stopper uses a form fitting rather than 2 screws. This allows for easy removal as less time has to be spend on positioning the cables and screwdriver properly. Figure 74 shows the position of the redesigned stopper in the product. It can be seen in open and closed configuration to the right. The stopper is placed around the cable and pushed into the hole in the frame, which ensures the stopper is clamped onto the cable as shown in figure 79.

Figure 77 and 78 shows what this redesign looks like in the Disassembly Map compared to the original design.

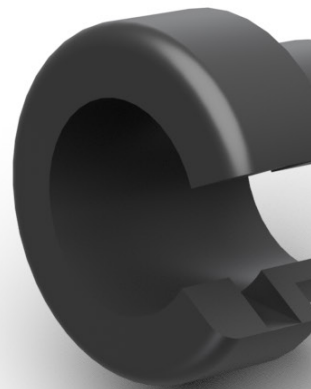
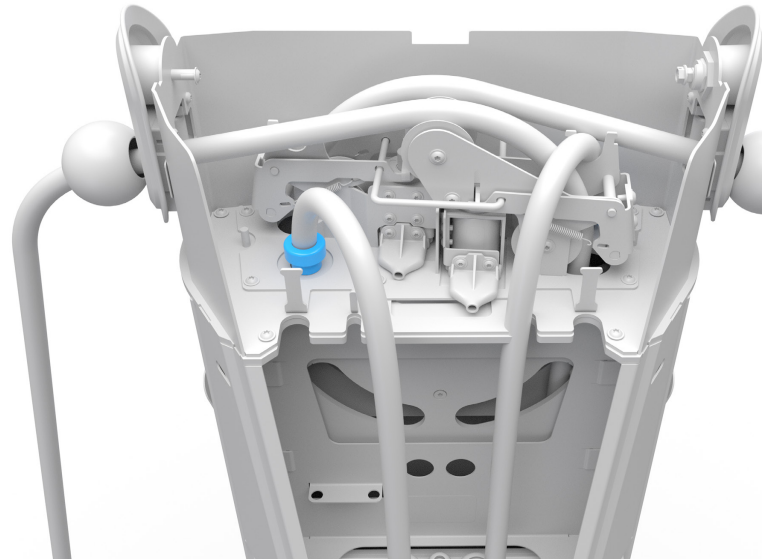
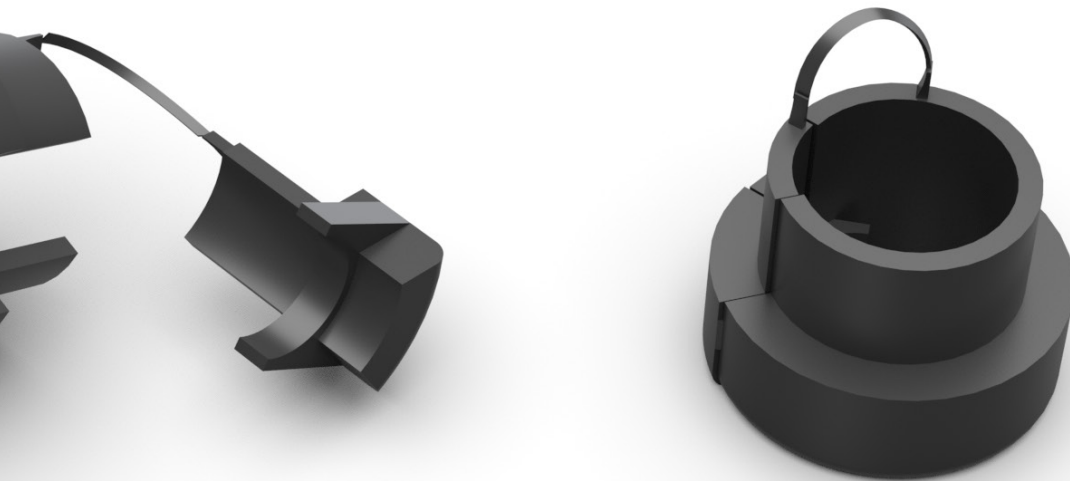
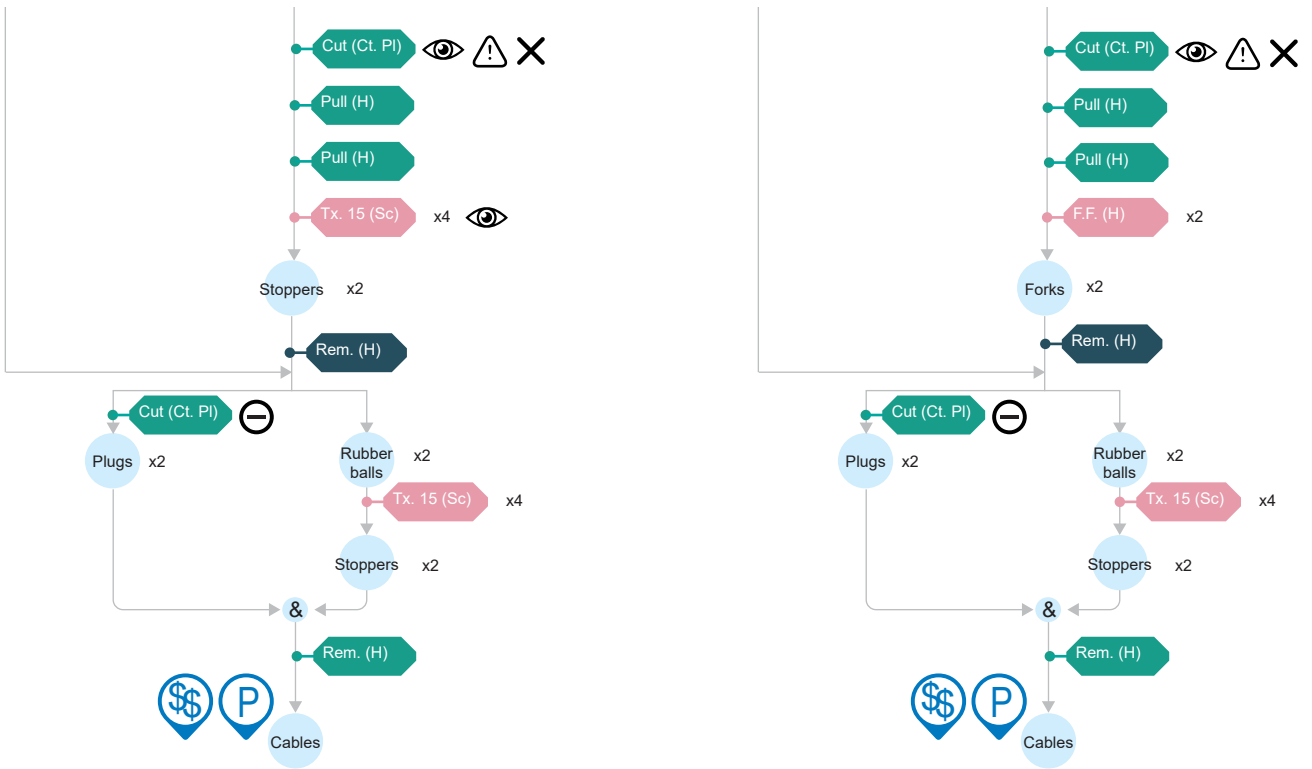

Figure 74. Location of the redesign in product. ▲



▶ ▲ Figure 75 & 76. The stoppers need to be pulled out of the product and towards the de-installer to be disassembled.





▲ Figure 77 & 78. Disassembly Map comparison between the original and redesign.

▼ Figure 79. The strain relief's working principle.

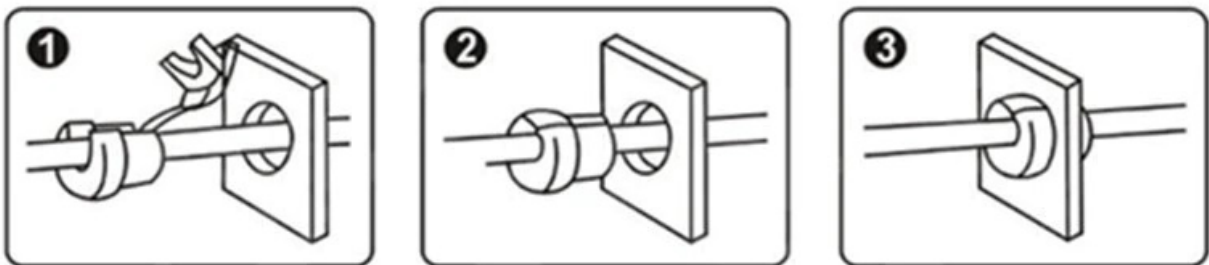

## Testing and verification

This concept has not (yet) been properly tested, but the principle is widely used in smaller scale applications shown in figure 80 and 81. Examples are cabling in lamps, guitar amplifiers and other electronics that need cable strain relief. This could mean that the principle will work well on thicker cables (18 mm) too, (AdvanceComponents; EssentraComponents, 2021).

When discussing the redesign with the EVBox Engineering Department the question was raised if the redesign would provide the needed clamping force to fixate the stopper on the cable. It will be difficult to create enough clamping force with just a couple of millimeters of sheet metal. In the current design this is accomplished by two ridges on both sides that dig into the cable when the screws are tightened.

Another issue is choosing the right material. The current material, namely 15% glass filled nylon, would not provide the needed flexibility for the connector part of the redesign.

## Challenges and optimisation possibilities

For this redesign to become feasible, viable and desirable the following challenges need to be addressed:

- Making sure enough clamping force is exerted on the cables to completely prevent them from moving.
- Certification might be required for the principle to be used on a thicker cable
- The original stopper design is used in the outer rubber stoppers as well. These prevent the cables from going inside the product. Differentiating from this design means there will be extra production costs.

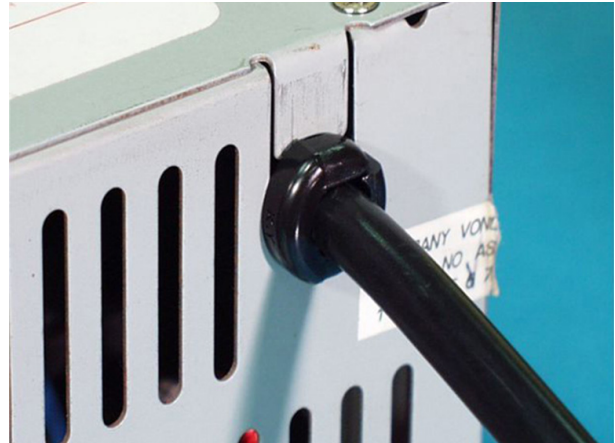

▲ Figure 80. Strain relief in an electronic product.

▼ Figure 81. Strain relief on a thinner cable, hand and tool for scale.



## Proposal 4: the fork mechanism

### Functionality

The functionality of the stopper mechanism is the same as mentioned before.

### Redesign

The redesigned stoppers are smaller and made from the same material as the outer layer of the cable (nylon). The stopper will be small enough to pass through the hole in the frame and is fastened onto the cable with glue. With an extendable stainless steel plate that partly covers the hole the downward movement of the cable is stopped. The plate is fastened into place with a screw. This plate is more visible and easier to remove than the original stoppers. Afterwards, the cable can be completely pulled out of the product. See figure 82 and 83.

This redesign enables disassembly of the stopper without having to pull the rather stiff charger cable towards you and manoeuvring it in such a way that the 2 screws on both sides of the stopper can be reached. These activities would be replaced with unscrewing the fork and pulling the cables out. See figure 84 and 85 for the Disassembly Map comparison.

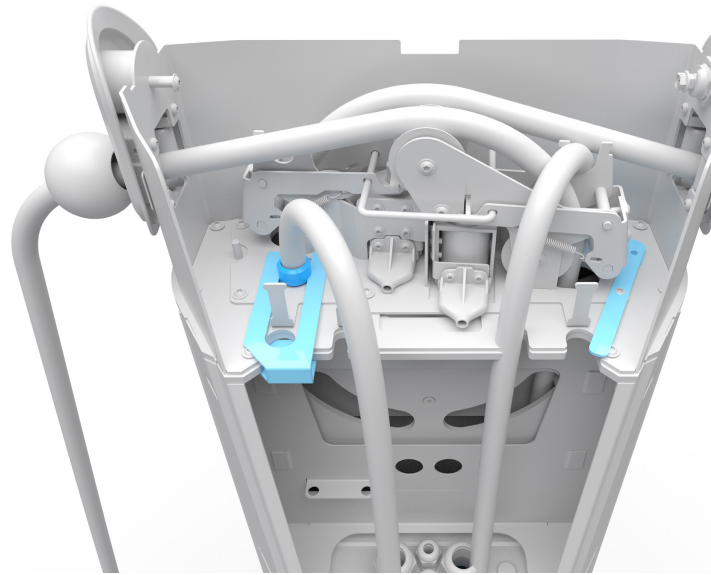
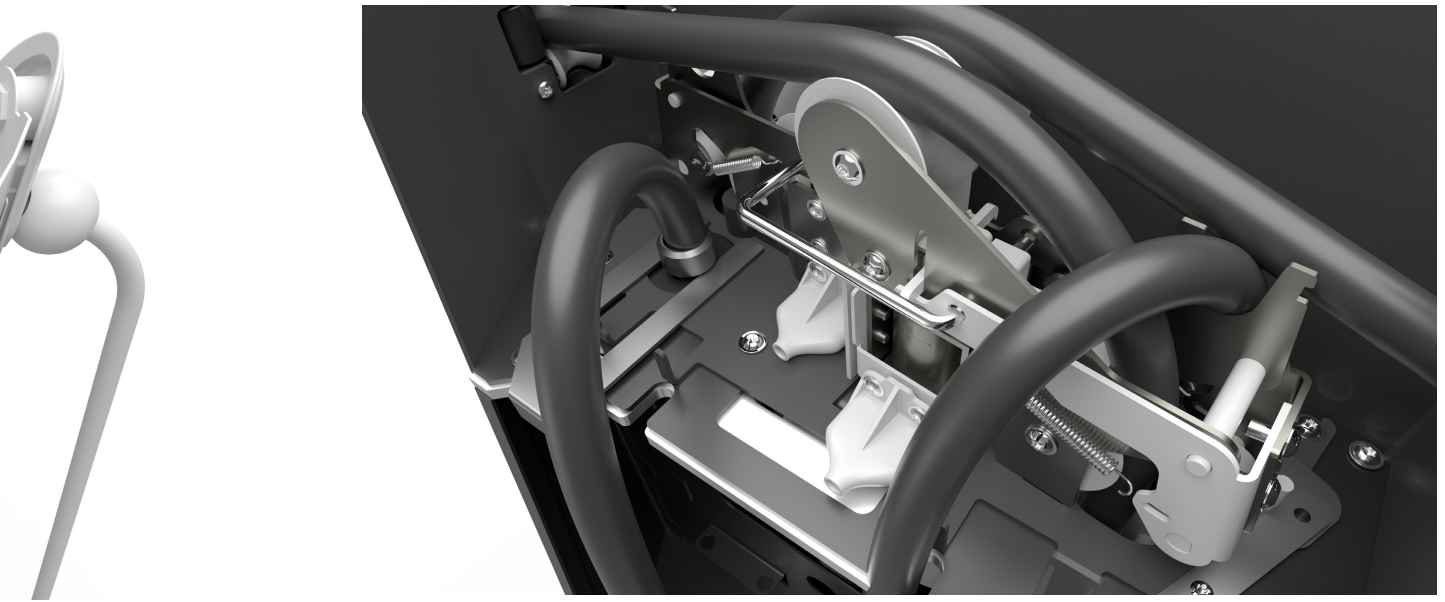

Figure 82. Location of the redesign in product. ▲





▲ Figure 83. Close-up of the envisioned redesign.



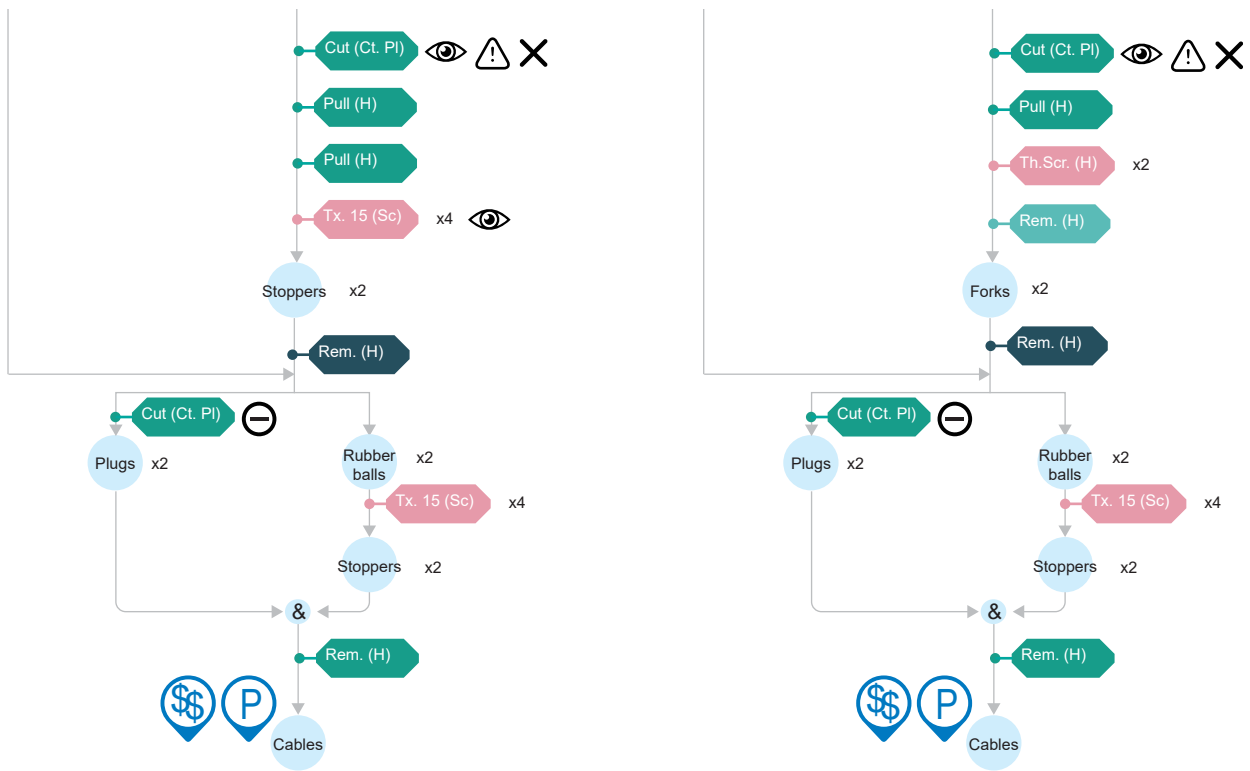

▲ Figure 84 & 85. Disassembly Map comparison between the original and redesign.



## Prototyping and verification

Figure 86 and 87 show the prototype that was made to validate the concept's working principle. The test indicated that it is possible for the partially thickened cable to move through the pulley system and that the fork stops the downward movement of the cable. A tightly fitted rubber ring does not, however, provide the clamping force needed to keep it securely fastened on the cable as it started moving when pulling force was increased.

## Challenges and optimisation possibilities

For this redesign to become feasible, viable and desirable the following challenges need to be addressed:

- A suitable fastening method that secures the stopper on the cable.
- The envisioned fastening of the fork onto the frame is with screws; proper placement of said screws has to be chosen.
- This principle works well for the stopper positioned on the left side of the product. However, since the positioning of the stopper on the right side of the product is much deeper and more difficult to access from the front, a modified solution has to be found.

► ▼ Figure 86 & 87. Prototype to validate the working principle.



Final redesign proposal





## The custom installerbox

is a design that allows for easier servicing and harvesting of the kWh-meters and RCBO's. This redesign makes it possible to skip the steps of opening the top cover, opening the side panels and removing the bracket, because its shape is the same as the shape of the hole of the bracket in front of it.

### USP'S

- Allows for skipping 15 disassembly steps compared to the original design.
- Allows for 76% decrease in disassembly time compared to the original design.
- Allows for disassembly with just 2 tools instead of 3.
- A design targeted towards harvesting and servicing activities of the kWh-meters and RCBO's.

### EVBOX benefits

- Differentiate within the EVSE market by being circular, rather than just sustainable.
- Harvesting the kWh-meters and RCBO's instead of buying new allows for 10% manufacturing costs savings per Iqon. The total savings per Iqon are 40% higher than the costs of getting the product and harvesting activities.
- Easier to service designs are preferred by professionals.

# Summary

- After brainstorm session 1 the following solution spaces have been found for improving disassembly of the redesign critical components, which are the cables, kWh-meter and side panels:
  - Cable removal without unfastening activities (e.g. making the panel holes bigger)
  - Cable removal with unfastening activities (e.g. modular cable design, integration of rubber knobs with cables)
  - Separate plug and cable (partnership with a supplier)
  - Custom installerbox
  - Clumping the installerbox cover, installerbox frame and bottom cover so it can be removed in one go
  - Changing the disassembly order (side panels first, then top and bottom cover)
  - Removal of PMMA lightguides (removable tape or mechanical fastening)
- A second brainstorm resulted in the further development or discontinuation of redesign proposals. The brainstorm resulted in the development of:
  - A modified stopper (mechanism) to allow easier retraction and replacement of the charger cables.
  - A redesigned custom installerbox that allows for (lid) removal through the bracket and thus easier access to its components.
  - Mechanical fastening of the PMMA plates, with for example starlock rings (the idea was later discarded and development in this solution space was put on hold).
- The final redesign proposals, namely a custom installerbox, an off-the-shelf installerbox with redesigned bracket, a redesigned stopper without screws and a redesigned stopper mechanism with a fork have been developed and verified or falsified with the help of the EVBox Engineering Department.
- The custom installerbox is deemed as the most fruitful redesign proposal.



# Conclusion

Based on the discussions and verification/falsification sessions with the EVBox Engineering Department it became clear that the implementation of a custom installerbox would be the most fruitful. A custom installerbox would provide the most improvements in the Disassembly Map and consequently in the reverse logistics calculations.

Throughout the redesign process it became clear that optimising a product for circularity that is already on the market is challenging. Iqon is an award-winning design, which means that changes to the outer aesthetics were not desired and that the redesign space was constricted to the original dimensions of the product. This meant that during the redesign activities special attention had to be given to taking advantage of left-over space within the product, for example in between the bracket and installerbox or in between the components of the top frame assembly. However, in case of the installerbox, exploring possibilities within this extra space also led to the issue of recertification. Changing component dimensions or placement would mean testing for recertification would be necessary for the product to still comply to both US, European and international standards. It is advised to have a complete list of all standards and certifications and what that means for the product readily available before and during the (re)design phase to avoid unexpected requirements.

Furthermore, since multiple parties were involved in the development of Iqon, it is advisable to involve them in the redesign processes too. Not only can they provide their expert opinion on new ideas, but they can provide insights on the initial design process. These insights in the development history of a product can clarify where and why certain decisions were made and if it could be beneficial to revisit some of those choices. It should be noted that involving people without prior knowledge could also lead to fresh insights and can thus be beneficial for the redesign process.

## RQ2.2 How can the disassembly of EVBox's AC chargers be improved for the chosen strategy?

This chapter shows how a redesign process for optimising disassembly can be structured with the use of the Disassembly Map. By identifying the purpose of the redesign, in this case improving disassembly of target components in a cascading scenario, brainstorm sessions can be guided and solution spaces can be found. Within the solution spaces several redesigns have been developed which allow for faster disassembly.

- One option is creating a shortcut. The custom installerbox and off-the-shelf installerbox proposals allow de-installers to skip 15 steps in the disassembly process by making the internal components of the box accessible without having to disassemble the top cover, side panels and bracket. Instead, only the bottom cover and the installerbox lid have to be removed, which means it would only take 3 steps to open the installerbox and an additional 3 steps to liberate the kWh-meter.
- Another option is focusing on improving an activity label. In the case of the redesigned stoppers the activity no longer requires a tool but can be done by hand. Furthermore, the number of times the activity needs to be done is reduced: instead of unscrewing 2 screws per stopper, the 2 stoppers can be removed by unfastening the form fitted part.
- The fork mechanism shows that in order to optimise a system for disassembly the introduction of a new component might be necessary. Because the forks are located at a more accessible place, namely the frame instead of the stiff cables, these components are better identifiable, eliminating the penalty point given for the original design. Moreover, there is no need to pull out the cables to disassemble the stoppers anymore, as these are integrated onto the cable, eliminating a 'pull' activity label.

The solution spaces include, but are not limited to these redesigns. These are examples of how disassembly can be improved for a cascading scenario focusing on the identified priority components. During another (re)design process, other factors might be taken into account or weighed differently, resulting in different priority components and different redesign proposals. Even within the identified solution spaces in this thesis, different redesign proposals could be found but have not been pursued.



### RQ3. Is the Disassembly Map a suitable tool for guiding redesign activities of EV chargers?

Overall, the Disassembly Map has been proven to be a suitable tool for guiding EV charger redesign activities. The fact that fruitful redesign proposals have been developed with the use of the tool is proof of that fact. The tool can be used for finding solution spaces as well as concrete redesign ideas, which is dependent on how the brainstorm session is structured. In the first case it is recommended to use a simplified version of the whole map while applying the clumping, surfacing and trimming strategies and/or focusing on priority components. In the second case, one could use only the focus points of the Disassembly Map, such as certain subassemblies or a certain disassembly sequence.

The Disassembly Map is a tool that displays product components and their disassembly in a detailed manner; product disassembly visualisation goes as far as fastener type and force intensity. Therefore, it can be used on a conceptual level as well as embodiment level. In the latter case it might be difficult to host a collaborative session with people who have no prior knowledge of the product or the Disassembly Map. Especially when it comes to complex products such as EV chargers the amount of information displayed in the map might be more confusing than clarifying. Therefore, the map might need to be simplified by colour coding subassemblies, making black boxes of subassemblies, using images of components and in some cases using component names instead of numbers. Furthermore, it is recommended to host brainstorm sessions with participants with prior knowledge of the product and/or the Disassembly Map.

To facilitate Disassembly Map brainstorm sessions, it is recommended to have a real product or model at hand. This way steps within the Disassembly map can be clearly explained as it has been proven to be difficult to only use words. Here too, it could be more efficient to work with participants with prior knowledge. If a model is not available, it is recommended to provide participants with a CAD-model of the EV charger. Due to product complexity, this CAD-model might also need to be simplified to improve loading time and workability.

Miro was found to be a suitable software to allow online collaboration when a real-life brainstorm session can not be hosted. The software allows detailing of the map to a more than satisfactory level. Additionally, the software allows for easy restructuring of the architecture without having to redraw arrows like with a software like Adobe Illustrator. Exporting images can cause some readability issues, so it is necessary to check the board dimensions before adding things onto them.

Developing requirements and wishes based on the Disassembly Map is difficult for such a complex product unless the requirements can be generic. During this project the Disassembly Map was mostly used to identify areas of improvement. After using it as an analysis tool generic requirements such as 'the redesign must decrease the amount of disassembly steps and time' were set up. Quantifying such requirements could help, but could only be properly done after redesign iterations were made and ideas became more tangible. Setting up proper requirements with the help of the Disassembly Map is therefore an iterative process.

/05

# Evaluation





# /05.1 Redesign evaluation

Primary verification of the redesign proposals has been done with the help of the EVBox Engineering and Product Management Departments. Requirements 1 and 2 have been taken into account throughout the redesign process and have therefore been met. Here, the redesigns are evaluated based on a Disassembly Map comparison and a reverse logistics comparison to evaluate requirements 3, 4 and 5.

## Disassembly Map comparison

A timing test was done with an Iqon and a prototype mounted in the product to make a comparison of the original and proposed redesign based on Disassembly Map features, which can be seen in table 4. These relate to the third and fourth requirements that were set up in chapter 4.1:

- R3. The redesign proposals should decrease disassembly steps and time.
- R4. The redesign proposals should not introduce new tools to the disassembly.

Based on the table features it can be concluded that the redesign improves disassemblability of Iqon within the specific solution space and that the requirements have been met. The custom installerbox allows for 76% faster disassembly of the kWh-meters. Figures 88 and 89 shows a comparison between the Disassembly Maps of the original design and the redesign and the steps that can be skipped thanks to the redesign.

	Original design	Redesign
Number of steps	21	6
Average disassembly time	4m 14s	57 s
Number of tools	3	2

Table 4. Comparison of Disassembly Map features between the original and redesign by timing disassembly with a prototype. ▲

Figure 88 & 89. Partial Disassembly map comparison and the steps that can be skipped thanks to the redesign. ►

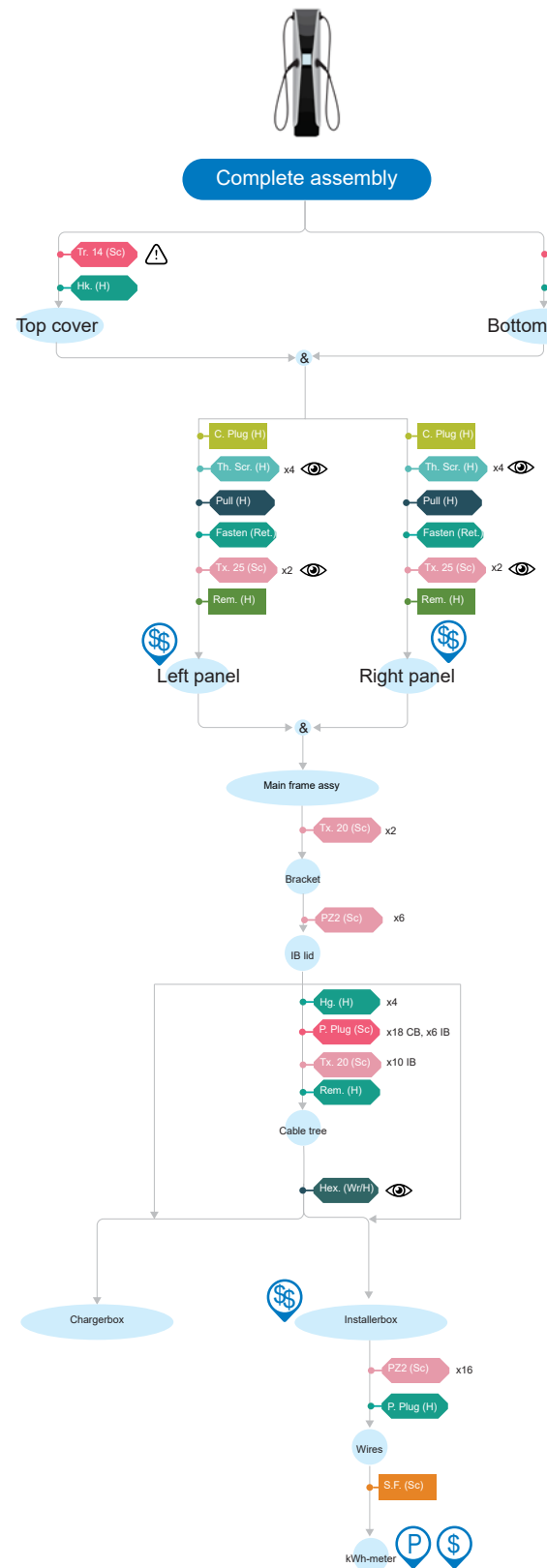

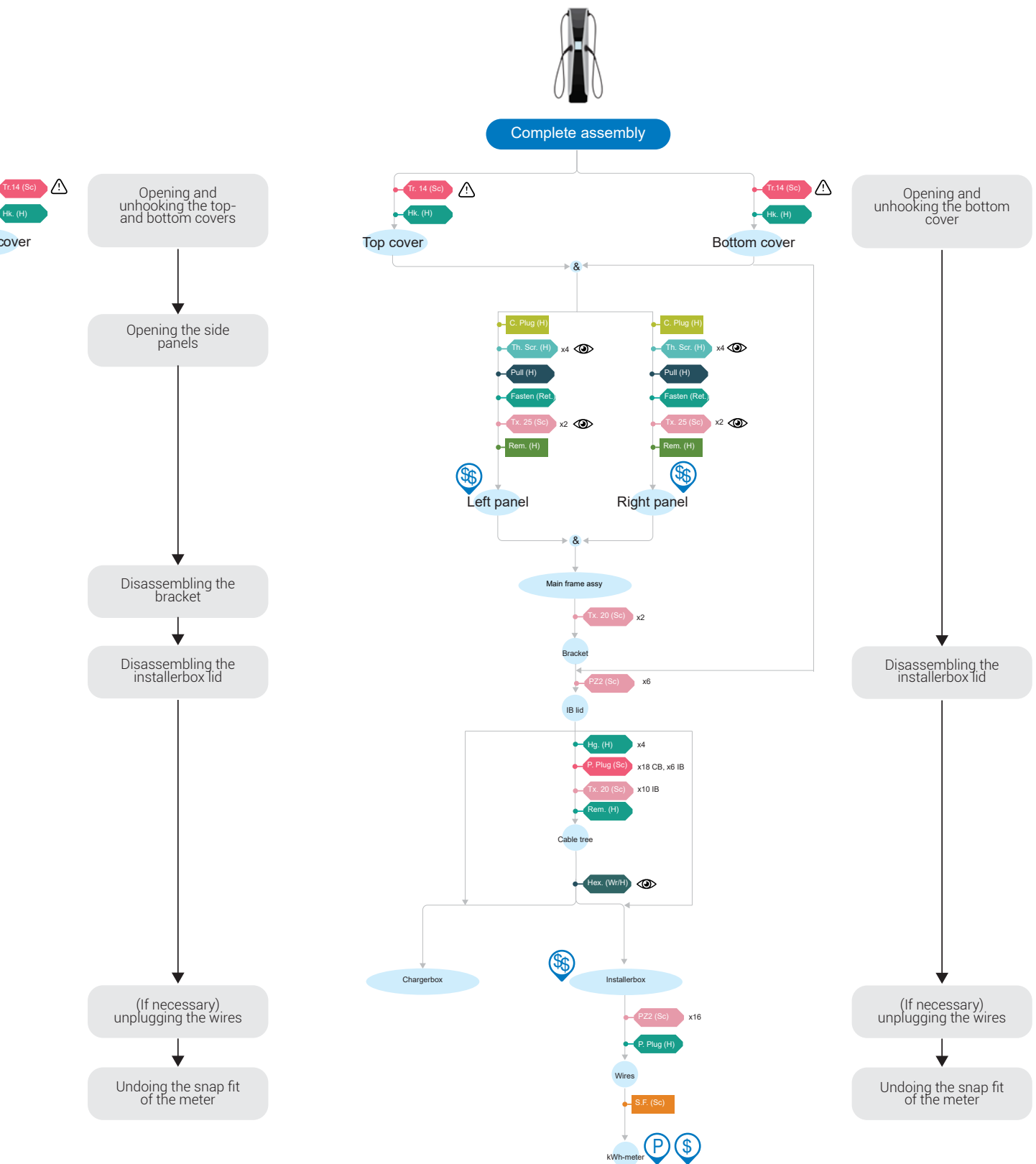

## Reverse Logistics Mapping

The custom installerbox allows for an improvement in disassembly steps and as a result time. This results in a reduction of disassembly time of 76% of the kWh-meter. Because of this, further steps like component reconditioning and quality control of the meter can also be carried out more time efficient.

If both RCBO's and kWh-meters are harvested and reused in other Iqons, it is estimated that 10% of total manufacturing costs can be saved per Iqon. Labour costs have not been included in the calculation.

When comparing the amount of savings per Iqon with the costs of getting an Iqon from the field and harvesting components, it is estimated that this is a profitable activity. Profits equal 68% of the costs of the reverse logistics.

When comparing the benefits the redesign could bring with the cost of investment for recertification and a new mould, it is estimated that investment costs will be returned after harvesting both sets of RCBO's and kWh-meters 314 times. For now, this poses a problem seeing as there are only about 20 Iqons in the field. However, as mentioned a few times before, production will be upscaled. Furthermore, investment costs for setting up the reverse logistics and restructuring the organization have not been taken into account. Figure 90 shows the reverse logistics map of the scenario with the redesign.

Appendix A8 shows the full calculation.

It can be concluded that the redesign has a positive effect on the implementation of a cascading and harvesting strategy. Therefore, the following requirement has been met:

- R5. The redesign proposals should lead to savings or not increase the estimated reverse logistics costs.



Figure 90. The reverse logistics map of the redesign. ▼

## kWh-meters & RCBO's harvesting

### Potential savings

Savings equal  
10% of total Iqon  
manufacturing  
costs



### Costs versus savings

Profits equal  
68% of costs

Total costs of  
harvesting

Total savings  
per Iqon

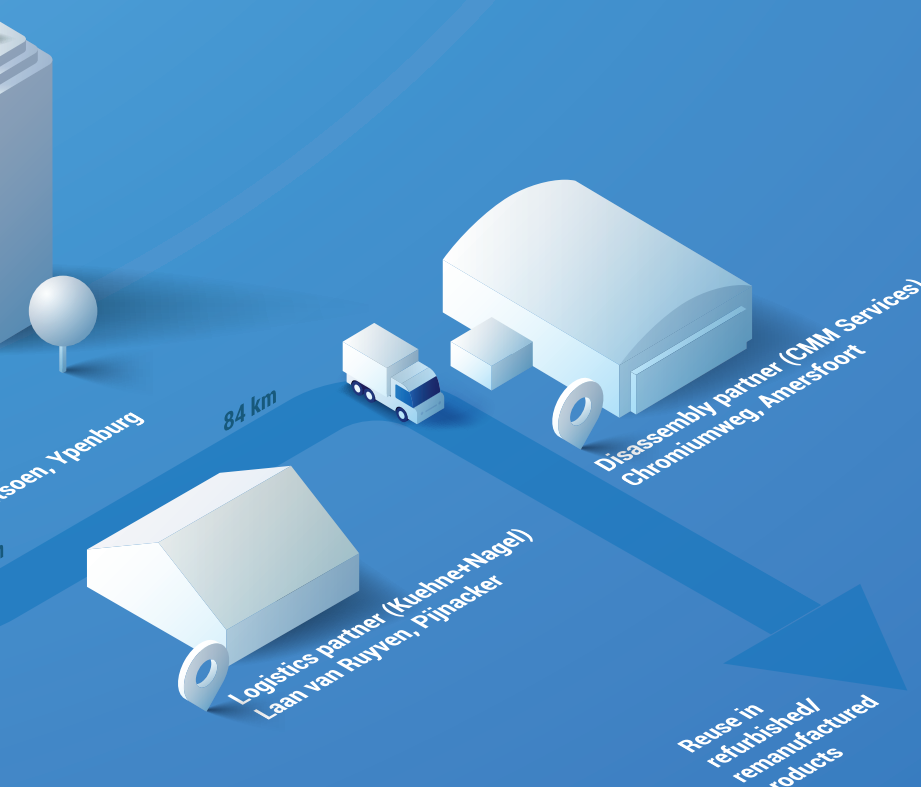
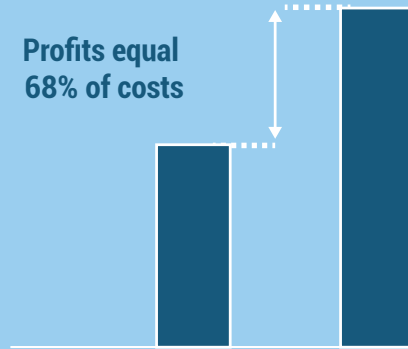

## /05.2 Proposal for Disassembly Map improvement

The Disassembly Map has been used as an analysis tool and an ideation tool during this project. Based on the experiences, a proposal for improving the tool is made.

The purpose of the Disassembly Map is clarity; in case of complex products the Disassembly Map could be simplified by representing subassemblies as 'black boxes' indicated by a square subassembly block. The simplified Disassembly Map of Iqon in figure 91 shows an example of a 'black boxed' subassembly: the installerbox. Elsewhere the detailed version of this subassembly can be presented, see figure 92. Another option would be to use images of components in the map and being consistent in component designation. Adding images of components can greatly improve understandability when using the tool as a way of communicating a disassembly process with others. In figure 91 a combination of CAD images and real life photos was used. The CAD images provide a cleaner look. Colour coding could also help with identification of components and subassemblies. However, this appears to be subjective as some people find it more confusing. Future research could find a way to integrate this well in the Disassembly Map. Providing a CAD-model or real-life product/model during brainstorm sessions can be of great help as explaining the complex workings and disassembly of certain products can not always be properly done with just words. In short, a visual representation of the product and components next to or in the Disassembly Map can greatly improve understandability.

The tool can be used as a guide during ideation sessions, but to completely foster its potential, it is important to structure a Disassembly Map driven session by highlighting critical components, applying the clumping, surfacing and trimming techniques or a combination of the two. For example, my own experience has taught me that the Disassembly Map was not needed to come to certain ideas. Just by disassembling the products a lot of insights on disassemblability were already uncovered, such as the difficulty of removing the cables.

The HotSpot Mapping sheets provided insights in the separate steps that need to be taken for disassembly of a component, but it tells little to nothing about for example the disassembly sequence. The added value of the Disassembly Map is that properties such as the disassembly architecture, type of tool, force intensity and priority components become easier to identify at a glance. It helps with communicating the disassembly process of products to others, for example to brainstorm participants. With the visual aid of the Disassembly Map it became not only easier to communicate which steps made disassembly difficult and where, but also why improvement was needed: for example the cables were labelled as a priority component. To harness the added value of the Disassembly Map, it is therefore needed to utilise these added benefits and make them a guiding part in brainstorm sessions.

An 'ideal Disassembly Map' could be made to guide (re)design efforts. In theory, a product fully optimised for disassembly would consist of components/subassemblies which can be taken out in parallel, resulting in a horizontal architecture in the Disassembly Map. A (re) design process could be guided by placing functionally critical, pre-known components in a Disassembly Map architecture which is as horizontal as possible, see figure 93. From there on additional properties can be explored such as the fastener types. The Disassembly Map and new product design could then 'grow' from this base form while keeping fastener types, force intensity, penalty points, etc to a minimum. This is, however, still just a theory and needs to be verified through testing. Another option would be to use the ideal Disassembly Map as a target to guide redesign efforts of a pre-existing product. Mapping products from competitors has been proven to be a successful means of finding good disassembly practices, but has not been done during this project. It could be worthwhile to do additional research into disassemblability of competitor EV chargers. In this way redesign efforts can be guided by good practices instead of solely the points of improvement found in the analysis phase

Figure 91. The simplified collaborative Disassembly Map with visual support and a black box example made in Miro. ▼



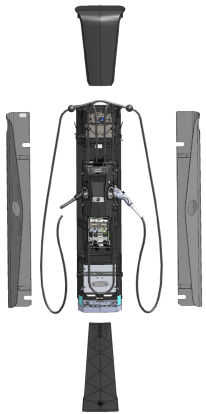

**Motion intensity**

	Low	Mid	High
Hand	C. Plug (H)	Rem. (H)	Rem. (H)
	Unscr. (H)	Hg. (H)	Unscr. (H)
Tool	C. Plug (H)	Rem. (H)	Rem. (H)
	Torx 20 (Sc)	Tr. 14 (Sc)	Tr. 14 (Sc)

Single motion action

Multiple motion action

**THE COLLABORATIVE DISASSEMBLY MAP**



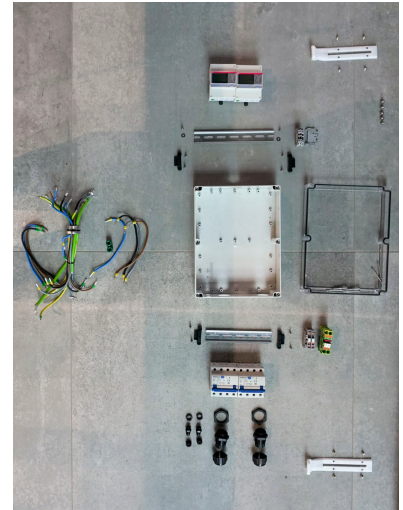
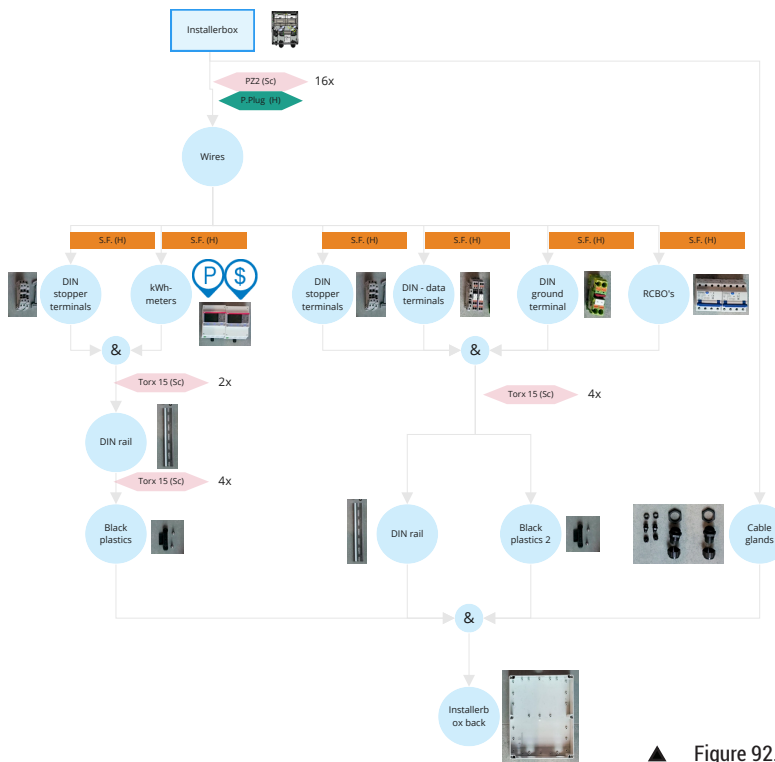

▲ Figure 92. The 'opened' black box where disassembly of the (in this example) installerbox is visualised in detail.

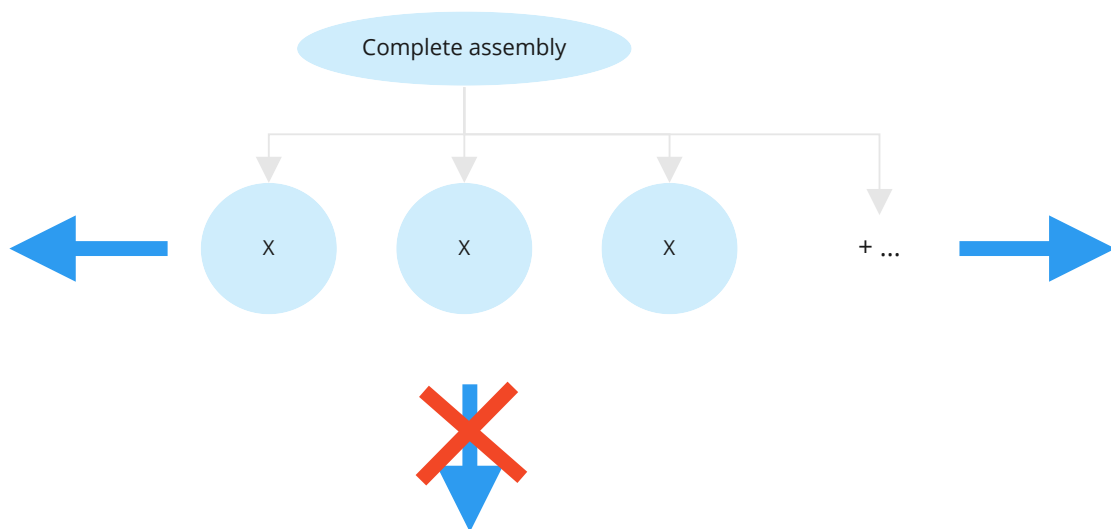

▲ Figure 93. An ideal Disassembly Map is as horizontal as possible.



## /05.3 Proposal for EVBox's future approach to circular design engineering

### **RQ2.3. How can the findings of this project contribute to future circular development for EVBox?**

Through experiencing and managing this project, advice on future implementation of circular product development is provided. The insights and advice are combined in a separate booklet which can be used by EVBox employees during future circular (re)design activities.

The booklet consists of an explanation of the circular economy and definitions, why it is important for EVBox to go circular and how it can be put into practice to reach overarching circularity goals on both a strategic- and product level by using examples from this thesis.

This project has shown how difficult it can be to optimise a product for circularity when it is already on the market. Therefore, one of the main proposals is to include circular design engineering in the earliest stages of product development. Consequently, it is advised to take the EoL scenarios of all newly developed EVBox product components into account. This can be done based on the component categories 'wear part', 'harvestable part' and 'reconditionable part', which was done in this project. Based on the envisioned categories, suitable EoL scenarios can be developed and then proper disassembly of the components can be ensured. Within this project it has been estimated that plastic parts will not preserve the necessary aesthetic and functional properties after serving 8 years of commercial lifetime and will therefore need to be replaced/recycled. Metal parts will retain functional properties but will have to be reconditioned to bring back the necessary aesthetics. Certain electronics such as the kWh-meters, RCBO's and solenoids are estimated to be harvestable. It is advisable to verify these assumptions and make changes accordingly. Based on the envisioned EoL scenarios of components, design for disassembly can be implemented.

When attempting to optimise a product for circularity that is already on the market, it is advised to focus on one area within the product. This will heighten the likeliness of redesign feasibility, as changes on a smaller scale can often be made than changes on a bigger scale. During this project this was done by focusing on the priority components and their estimated EoL scenario.

When shifting to a circular business model it is necessary to determine and maintain standard definitions. The field of circular design has been developing rapidly and so has its jargon. In order to communicate with industry professionals and within EVBox it is necessary to define what certain terms mean. For example, during this project it became clear that circularity is often mistakenly interpreted as recycling, which is ironically the strategy in which the least product value and -integrity is retained. Therefore, employees as well as employers will have to be educated on the terminology and principles of the circular economy so there is little risk of miscommunication. The Circular Design Guide, a website created through a collaboration of the Ellen MacArthur Foundation and IDEO provides handy tools and methods to help teams familiarise themselves with the circular economy. A good starting point could be reading the Ellen MacArthur Foundations 'Towards the circular economy - Economic and business rationale for an accelerated transition'.

The tools used in this project, namely the Disassembly Map and Reverse Logistics Mapping can be used in future circular design activities. They have been proven to be effective for use on EV chargers. The tools can be used on other products within the portfolio in the same way as has been done

during this project. Additionally, the already existing Disassembly Maps and Reverse Logistics Maps can be developed further to optimise Iqon and BusinessLine for circularity. A future goal for EVBox could be to make the whole portfolio properly disassemblable to fit the charger's EoL scenario. Then, Disassembly Maps and Reverse Logistics Maps need to be made for other and future AC chargers and the DC charger portfolio.

If EVBox manages to successfully implement a cascading strategy both in- and outside the company, it can become one of the sustainable frontrunners in the EVSE market. This would require the envisioned strategy and redesign proposals to be developed further. EVBox will need to make agreements with all the parties in the reverse logistics chain and investments for the reverse logistics and redesigns will have to be made. However, the actual implementation of circular strategies goes much further than calculations and redesigns; the structure of the company has to be adapted too. The corporate mindset has to shift from linear to circular. Furthermore, as mentioned earlier, definitions have to be clear to promote efficient communication. Especially for big companies, these steps can be difficult and too drastic to make at once. A solution might be to run separate tests to verify and implement the presented models one step at a time. The establishment of a new circularity branch or startup within EVBox could provide the supervision and execution needed to make the incremental circular changes. Whereas implementing a cascading strategy at once might be too big of a step, trying to refurbish or remanufacture a certain amount of products might be feasible. This way, circularity can be implemented in small increments, eventually fully transforming the company into a circular business.

In the long term it might be worthwhile to change to a subscription-based model, also known as charging as a service. A subscription model fits perfectly within a circular business, as product ownership is kept throughout and after a product's commercial lifetime. This facilitates the take back of products at EoL. Then, EVBox's value proposition to users could be described as 'offering accessibility to EV charging' which does not necessarily include the actual sales of the chargers. It would be interesting to investigate whether users would want a charger or a charged EV. Filling in the Business Model Canvas could provide more insights in the key value propositions of EVBox which could facilitate the shift towards a service-model. This proposal could also come to fruition by establishing a separate branch or startup within EVBox developing and executing it.

## /05.4 Conclusion

The aim of this project was to find ways of assessing and improving the circularity of EVBox's commercial AC chargers. By answering research questions 1, 2 and 3 in the previous chapters this project's main research question can now be answered.

### **MRQ. How can the circularity of EVBox's commercial AC chargers be assessed and improved?**

Implementing circularity is an intricate matter. Circularity itself can consist of many aspects and implementation can look different in various situations. Assessing the current situation and finding good practices and points of improvement is a valuable way of tackling issues and implementing corrections in designs and processes. In this project this was done with the help of the Disassembly Map tool to make an assessment on product level and reverse logistics mapping to make an assessment on a strategic level. This graduation project can be regarded as an exploratory foundation on which can be built in the future.

Ease of disassembly is closely related to the application of circular value retention strategies such as repair, refurbishment, remanufacturing and recycling. One way of assessing the product's ease of disassembly is with the help of the Disassembly Map tool. By mapping the disassembly of both Iqon and BusinessLine 4 areas of improvement have been found and used to guide redesign efforts for improving disassembly. The Disassembly Map has been proven to be a valuable method for assessing the current situation regarding disassemblability of EVBox's commercial AC chargers and it is recommended to use the developed maps in future redesign processes of said products. The maps of Iqon and BusinessLine 4 can be further developed to EVBox's needs if necessary. It will be worthwhile to make Disassembly Maps of other products in EVBox's portfolio too and go

through the same process as in this project in order to find points of improvement.

Currently value is lost as EVBox's chargers are partially recycled or incinerated by unknown third parties. Implementing a cascading strategy by potentially developing one or more of the redesign proposals could be lucrative for EVBox, as was found by doing the reverse logistics calculations. Reversing the currently established logistics has been found to be feasible, viable and desirable and allows for the capturing of value. In order to do this EVBox will have to set up and adapt partnerships with logistics partner Kuehne+Nagel, assembly partners such as CMM, remanufacturing plants and recycling plants, such that there are no or as little unknown parties in the logistics chain as possible. It is advised for EVBox to strengthen their product responsibility after sales through improved partnerships with stakeholders in the EV ecosystem and sales channels. These partners will require a share of the incomes too, which has to be agreed upon beforehand. Another way of retaining product responsibility is to adapt a charging as a service model. Such a subscription model is highly compatible with the circular economy and allows EVBox to keep product ownership even after sales. Shifting to a subscription model could be one of EVBox's future circularity goals.

It is best to take circularity into account from the beginning of the design process. To make a product more circular one must make concessions which has proven to be difficult in some cases. Furthermore, the actual implementation of circular strategies goes much further than calculations and redesigns; the structure of a company, has to be adapted too. If EVBox manages to successfully implement a cascading strategy both in- and outside the company, it can become one of the sustainable frontrunners in the EVSE market.



## /05.5 Further recommendations

The timeline and scope of this project were limited, which means that some issues and questions remain unexplored and unanswered. Recommendations on further research are provided to further encourage the development of circular designs and strategies within EVBox.

### Product

Further exploration of other potential redesign ideas within the found solution spaces, such as an installerbox lid with integrated bracket functionalities or clumping the bottom cover and bracket together is recommended. Ideas that could provide even better disassemblability of the cables and kWh-meter might still be found.

Further exploration of potential redesign ideas for other critical components which have not been taken into account in this project should be explored as well. For example, optimising reconditioning of the main frame in a remanufacturing scenario by trimming or clumping the floating parts attached to it.

Redesigning or replacing wear parts to become reconditionable or harvestable parts could also increase overall product circularity. For example, manufacturing the top- and bottom cover from stainless steel that can be reconditioned after serving their commercial lifetime.

This thesis focused on disassembly, but other product and component features also contribute to the overall circularity. A study into materials, embedded energy and CO<sub>2</sub>-equivalent of components could be explored

to find further areas of improvement. Doing a lifecycle assessment (LCA) could provide such insights.

### Strategy

It is recommended to further investigate the investments necessary to set up the reverse logistics chain. As of now, the cost of investments has not been fully taken into account in the calculations. It is estimated that these costs will include the partnerships with remanufacturing and recycling parties, expansion of the current partnerships with Kuehne+Nagel, installer parties and (dis)-assembly partners, additional disassembly tools and education and the restructuring of EVBox itself, amongst others.

Due to the failed attempts to contact the EVBox supply chain department, the verification of transport costs in Excel sheets has not been done. It is highly recommended to gain this information as it could prove to be a significant part in the cost calculations. Verification with both the EVBox supply chain department and Kuehne+Nagel logistics experts would further improve the quality of the calculations.

Furthermore, implementing a circular strategy is more than a financial model, it requires incorporation throughout the whole (management of a) company (Boorsma, 2020). A new department might need to be established, along with the proper education of employees and employers. Proper (understanding of) definitions need to be established to enable efficient and clear communication both in- and outside the company. This could be an

interesting topic to explore for a strategic product design student, who would have more knowledge on strategic advise.

## Other

Other aspects of circularity could be explored in the future. The three principles of designing out waste and pollution, keeping products and materials in use and regeneration of natural systems all have to be taken into account to achieve true circularity. This thesis focused on keeping products and materials in use by enhancing disassembly of products for reapplication in value retention strategies. Future endeavours of EVBox could focus on designing out waste or finding ways to not just be eco-efficient, but eco-effective as well: not only minimising negative impact but also optimising positive impact. These factors should already be taken into account in the earliest development phases, which is further emphasised by the experience gained from this project.

Applying the Disassembly Map tool on other products within the EVBox portfolio could further broaden the ease of disassembly of other products. Resulting in a disassembly-friendly portfolio. Reverse logistics mapping of these products could further clarify what strategy is favourable to implement.

## DESIGN OUT WASTE AND POLLUTION

Did you know that waste and pollution are largely a result of the way we design things?

Waste and pollution are not accidents, but the consequences of decisions made at the design stage, where around 80% of environmental impacts are determined. By changing our mindset to view waste as a design flaw and harnessing new materials and technologies, we can ensure that waste and pollution are not created in the first place.

## KEEP PRODUCTS AND MATERIALS IN USE

What if we could build an economy that uses things, rather than uses them up?

We can't keep wasting resources. Products and materials must be kept in the economy. We can design some products and components so they can be reused, repaired, and remanufactured. But making things last forever is not the only solution. When it comes to products like food or packaging, we should be able to get the materials back so they don't end up in landfill.





## REGENERATE NATURAL SYSTEMS

What if we could not only protect, but actively improve the environment?

In nature, there is no concept of waste. Everything is food for something else - a leaf that falls from a tree feeds the forest. Instead of simply trying to do less harm, we should aim to do good. By returning valuable nutrients to the soil and other ecosystems, we can enhance our natural resources.

# References

- Achterberg, E., Hinfelaar, J., Bocken, N., (2016). The Value Hill Business Model Tool: identifying gaps and opportunities in a circular network.
- Ayres, R., Ferrer, G., & Leynseele, T.V. (1997). Eco-efficiency, asset recovery and remanufacturing. *European Management Journal*, 15, 557-574.
- van Boeijen, A., Daalhuizen, J., Zijlstra, J., & van der Schoor, R. (2013). *Delft Design Guide: Design strategies and methods*. BIS Publishers.
- Boorsma, N., Balkenende, R., Bakker, C. et al. Incorporating design for remanufacturing in the early design stage: a design management perspective. *Jnl Remanufacture* 11, 25–48 (2021). <https://doi.org/10.1007/s13243-020-00090->
- Brimaire, J., (2020). Disassemblability Evaluation of Pedelec Drive Units in Remanufacturing.
- Butzer, S., Schötz, S., Steinhilpher, R., (2016). Remanufacturing Process Assessment – A Holistic Approach. Retrieved from <https://www.sciencedirect.com/science/article/pii/S2212827116308654>
- CBS, (2020). Bijna 200 duizend stekkerauto's. Retrieved from <https://www.cbs.nl/nl-nl/nieuws/2020/16/bijna-200-duizend-stekkerauto-s>
- Chargepoint, (n.d.). Chargepoint as a service. Retrieved from <https://www.chargepoint.com/products/cpaas/>
- Charter, M., & Gray, C. (2007). Remanufacturing and product design: designing for the 7th generation. Retrieved from [https://www.researchgate.net/publication/247834190\\_Remanufacturing\\_and\\_product\\_design](https://www.researchgate.net/publication/247834190_Remanufacturing_and_product_design)
- De Fazio, F. (August, 2019). Enhancing consumer product repairability - A case study on vacuum cleaners. Retrieved from <https://repository.tudelft.nl/islandora/object/uuid%3A810d-b9a6-9718-4451-8f8f-67ad0cdccad9>
- Deloitte Consulting, (2014). The hidden value of reverse logistics. Retrieved from [https://www2.deloitte.com/content/dam/Deloitte/be/Documents/process-and-operations/BE\\_POV\\_Supply-chain-strategy\\_20140109.pdf](https://www2.deloitte.com/content/dam/Deloitte/be/Documents/process-and-operations/BE_POV_Supply-chain-strategy_20140109.pdf)
- Ellen MacArthur Foundation, (2013). Towards the circular economy - Economic and business rationale for an accelerated transition. Retrieved from <https://www.ellenmacarthurfoundation.org/publications/towards-the-circular-economy-vol-1-an-economic-and-business-rationale-for-an-accelerated-transition>
- Ellen MacArthur Foundation, (). Reverse logistics Maturity Model. Retrieved from <https://ellenmacarthurfoundation.org/assets/downloads/ce100/Reverse-Logistics.pdf>
- Enel X, (n.d.). Charging the e-mobility journey. Retrieved from <https://corporate.enelx.com/en/our-offer/electric-mobility/ev-charging-stations>

EssentraComponents, (n.d.). Guide to cable strain relief and protection. Retrieved from <https://www.essentracomponents.com/en-gb/news/guides/guide-to-cable-strain-relief-and-protection>

European Commission, (2019). The European Green Deal. Retrieved from <https://eur-lex.europa.eu/legal-content/NL/TXT/?qid=1576150542719&uri=COM%3A2019%3A640%3AFIN>

European Commission, (2020). A new Circular Economy Action Plan For a cleaner and more competitive Europe. Retrieved from <https://eur-lex.europa.eu/legal-content/EN/TXT/?uri=CELEX-%3A52020DC0098&qid=1629648179195>

European Federation for Transport and Environment AISBL, (January 2020). Recharge EU: how many charge points will Europe and its Member States need in the 2020s. Retrieved from <https://www.transportenvironment.org/publications/recharge-eu-how-many-charge-points-will-eu-countries-need-2030>

EVVolumes, (2021). Global Plug-in Vehicle Sales Reached over 3,2 Million in 2020. Retrieved from <https://www.ev-volumes.com/country/total-world-plug-in-vehicle-volumes/>

Flexicon, (n.d.). Product brochure. Retrieved from <http://www.flexicon.uk.com/brochures/pg12/#40>

Flipsen, B., (2020). HotSpot Mapping Manual.

Flipsen, B., Bakker, C., & van Bohemen, G. L. A. (2016). Developing a Reparability Indicator for Electronic Products. In Proceedings of Electronic Goes Green 2016+ : Inventing shades of green (pp. 1-9). Fraunhofer IZM Berlin.

Hatcher, G., Ijomah, W., & Windmill, J. (2011). Design for remanufacture: a literature review and future research needs. *Journal of Cleaner Production*, 19, 2004-2014.

IEA, (2020). Global EV outlook 2020. Retrieved from <https://www.iea.org/reports/global-ev-outlook-2020>

IRP (2018). Re-defining Value – The Manufacturing Revolution. Remanufacturing, Refurbishment, Repair and Direct Reuse in the Circular Economy. Nabil Nasr, Jennifer Russell, Stefan Bringezu, Stefanie Hellweg, Brian Hilton, Cory Kreiss, and Nadia von Gries. A Report of the International Resource Panel. United Nations Environment Programme, Nairobi, Kenya

Ishii, K., Burton, L., (1996). Reverse Fishbone Diagram: A Tool in Aid of Design for Product Retirement. Retrieved from [https://www.academia.edu/2247821/Reverse\\_fishbone\\_diagram\\_a\\_tool\\_in\\_aid\\_of\\_design\\_for\\_product\\_retirement](https://www.academia.edu/2247821/Reverse_fishbone_diagram_a_tool_in_aid_of_design_for_product_retirement)

Navigant Research, (2019). Navigant Research Leaderboard: EV Charging Network Companies. Retrieved from <https://guidehouseinsights.com/news-and-views/evbox-and-chargepoint-are-the-leading-providers-of-public-charging-networks-and-electric-vehicle-cha>

Peeters J.R., Tecchio P., Ardente F., Vanegas P., Coughlan D., Duflou J., eDIM: further development of the method to assess the ease of disassembly and reassembly of products – Application to notebook computers, EUR 28758 EN, Publications Office of the European Union, Luxembourg, 2018, ISBN 978-92-79- 73189-1, doi:10.2760/864982, JRC107773

Rijksoverheid, (2021). Overheid stimuleert milieuvriendelijker rijden. Retrieved from <https://www.rijksoverheid.nl/onderwerpen/auto/overheid-stimuleert-milieuvriendelijker-rijden>

RVO, (2021). Laden van elektrische voertuigen: definities en toelichting versie januari 2021. Retrieved from <https://www.rvo.nl/onderwerpen/duurzaam-ondernemen/energie-en-milieu-innovaties/elektrisch-rijden/stand-van-zaken/cijfers>

Tempelman, E., Shercliff, H., Ninaber van Eyben, B., (2014). Manufacturing and design. Elsevier Ltd. Burlington, USA.

Vanegas, P., Peeters, J., Cattrysse, D. et al., (2017). Ease of disassembly of products to support circular economy strategies. Retrieved from <https://www.sciencedirect.com/science/article/pii/S0921344917301763>

VeBe, (n.d.). Service en onderhoud. Retrieved from <https://vebebv.com/#service>

Vermaat, B. (August, 2020). Design for refurbishment of child car seats - Towards circular safety critical products. Retrieved from <https://repository.tudelft.nl/islandora/object/uuid%3A1d77f13b-8005-4cac-aa8d-9350171f158c>

WEEE, (n.d.). Onze aanpak. Retrieved from <https://weee.nl/nl/aanpak#approach-101>



