

Design of Restraint Systems for Reclined Seating in the Automotive Industry.

by **Utkarsh Singh**

for the graduation of MSc. Integrated Product Design

At

Delft University of Technology
Industrial Design Engineering
Landbergstraat 15, 2628CE
Delft, the Netherlands

In collaboration with

BMW Seat Development Department,
Knorrstrabe 147, 80788
Munich, Germany.

SUPERVISORY TEAM

Chair : Dr Peter Vink

Mentor : E.J.J van Ir Breemen

Company Mentor : Dr Maximilian Wegner

Abstract

As the automotive industry advances towards greater autonomy, the landscape of car travel is evolving. The integration of reclined seating within vehicles, made possible without major alterations to traditional layouts, presents a promising avenue for enhancing passenger experiences. This shift, however, comes with unique safety challenges due to the changed seating dynamics.

Research, including insights from General Motors, Volvo & Volkswagen emphasizes the need for innovative safety solutions for reclined seating. Simulations comparing three-point and four-point seat belt configurations, in both upright and reclined positions, reveal advantages for the latter at higher speeds. This configuration produces a more balanced force distribution during impacts, away from vital areas.

While the potential of a four-point restraint system is evident, implementation hurdles arise. Addressing both safety and comfort, a study assesses the user experience for both systems. Building on these insights, a convertible restraint system is proposed, seamlessly transitioning from a three-point to a four-point configuration based on passenger position. This adaptable design merges safety and comfort effectively.

The proposed design requires redesign of certain components of the seat back & headrest. These are provided as recommendations.

Acknowledgement

Hello,

As you read through this section, you might notice that it stands as a unique piece within this report – one that hasn't undergone the usual rounds of refinement that the rest of the content has. It's a little different, a bit more candid, and perhaps a touch more from the heart.

I find myself in a moment of reflection, overwhelmed with gratitude for all those who played a role in bringing this project to fruition

First and foremost, I would like to thank my mentors Peter, Ernest and Maximilian for their unwavering support and guidance throughout this journey. Their expertise and insights were instrumental in shaping the direction of this work.

I would also like to thank the entire BMW team - Sylvia, Andreas Bissinger, Andreas Loecherer and Florian for their inputs in the earlier stages

I extend my heartfelt appreciation to the participants who provided valuable feedback and input, helping to refine the design goals and solutions. Your insights played a crucial role in steering the project in the right direction.

I am also thankful to my colleagues and peers who provided encouragement, shared their knowledge, and engaged in fruitful discussions. Your camaraderie made the process enjoyable and enriched the final outcome.

A big thanks to the PMB crew too. Your expertise during the prototyping

phase meant a lot.

Last but not least, I want to acknowledge my family and friends for their unwavering support, understanding, and motivation. Your encouragement kept me focused and inspired throughout this endeavor.

This project would not have been possible without the collective efforts of all those mentioned above. Thank you for being an integral part of this journey and for contributing to its successful completion.

Table of Content

Abstract	4	5.4 Conceptualisation	100
Acknowledgement	6	Chapter 6 : Final Design	108
Chapter 1 : Introduction	10	6.1 Concept Presentation	110
1.1 Context	12	6.2 Desirability	116
1.2 Seat requirements with NDRA's	14	6.3 Feasibility and Viability	118
1.3 Design goal	18	6.4 Impact of designs on users	120
1.4 Approach & Thesis outline	20	Chapter 7 : Final Thoughts	122
Chapter 2 : Literature Research	22	7.1 Conclusion	124
2.1 invention of modern seatbelt	24	7.2 Reflection	124
2.2 three point system- parts & principle	28		
2.3 Seatbelt safety testing	30	References	128
2.4 Literature on occupant safety in reclined seating	38		
2.5 Alternative safety systems	44	Appendices	
2.6 Looking ahead : Restraint systems for reclined seating	48	Appendix A - FEM steps of occupant safety	136
2.7 Conclusion	50	Appendix B - Safety belt comfort study	150
Chapter 3 : Occupant safety modelling	52	Appendix C - Questionnaires, users test	156
3.1 Methodology	54	during conceptualisation	
3.2 Modelling	56	Appendix D - CAD dimensions of parts in final Design	160
3.3 Procedure	58	Appendix E : Approved Project Brief	164
3.4 Results & Discussion	64		
3.5 Conclusions	66		
Chapter 4 : Comfort modelling	68		
4.1 Comfort models from literature	70		
4.2 Analysing (dis)comfort of restraint systems	72		
4.3 Parameters	76		
4.4 Safety belt Comfort study	84		
Chapter 5 : Ideation & Conceptualisation	86		
5.1 Design Goal	88		
5.2 Design Criterias	90		
5.3 Ideation			

01. Introduction

Car travel has undergone significant evolution over the years, transforming from a basic mode of transportation to a sophisticated and enjoyable experience for users. This introduction explores the various stages of this evolution from a user's point of view, highlighting the advancements that have shaped the car travel experience to reach the context set for this project, the main design challenge forward and its approached.

Invention of Automobiles:

The invention of the automobile marked the beginning of a new era in transportation. With the introduction of mass-produced cars by Henry Ford in the early 20th century, car travel became accessible to the general public, offering a sense of freedom and independence. Users were no longer restricted to fixed routes or schedules, and the ability to travel long distances efficiently was a significant breakthrough. (Wikipedia contributors, 2023)

Comfort and Convenience:

As technology advanced, car manufacturers began to prioritize user comfort and convenience. Features such as adjustable seats, heating and cooling systems, and

improved suspension systems made car travel more enjoyable for users. The inclusion of amenities like cup holders, storage compartments, and power outlets further enhanced the convenience factor, allowing users to have a more pleasant and personalized experience during their journeys. (Wikipedia contributors, 2023)

Safety Innovations:

Safety has always been a paramount concern in car travel, and significant advancements have been made to protect users on the road. The introduction of seatbelts, airbags, and anti-lock braking systems (ABS) played a vital role in minimizing injuries and fatalities. Furthermore, the integration of advanced driver-assistance systems (ADAS) like lane departure warning, adaptive cruise control, and automatic emergency braking has greatly enhanced overall safety, providing users with peace of mind and reducing the risk of accidents. (Howe, 2023)

Infotainment and Connectivity:

The integration of infotainment systems has revolutionized the in-car experience. From traditional AM/FM radios to advanced multimedia systems

with touchscreen displays, Bluetooth connectivity, and smartphone integration, users now have access to a wide range of entertainment options, navigation assistance, and hands-free communication. Additionally, the advent of connected car technology enables real-time traffic updates, remote vehicle monitoring, and access to a host of online services, further enhancing the user experience. (Administrator, 2023)

Electric and Autonomous Vehicles:

The recent emergence of electric and autonomous vehicles represents a significant milestone in the evolution of car travel. Electric vehicles (EVs) offer a sustainable and eco-friendly alternative to traditional combustion engines, reducing emissions and dependence on fossil fuels. The implementation of autonomous driving technology promises to revolutionize the driving experience by offering increased safety, reduced driver fatigue, and enhanced productivity during travel. (Luciaclemares, 2023)

In Conclusion, car travel has become more than just a means of transportation—it has become an immersive and enjoyable experience for users worldwide.

1.1 Context

In recent years, significant progress has been made in developing autonomous vehicles, with level 3 autonomous cars on the roads. Level 3 automation allows the vehicle to handle most driving tasks, but the driver still holds responsibility and requires human override (sou (Chan, 2017)).

The next stage is Level 4 automation, where human interaction is minimal, and the car can handle most driving situations independently. This advancement will redefine car travel, offering new possibilities and experiences.

Level 4 automation provides users with the opportunity to engage in various activities during their journeys. A study by Sun (2021) found that relaxation and entertainment are key activities desired by participants in autonomous vehicles. Wilson (2022) also mentions them as to be the first NDRA's we can witness with autonomous vehicles.

To support these activities, reclined seating positions are often preferred for comfortable viewing or leisurely pursuits. While most car seats have some reclining capability, fully reclined positions are generally considered unsafe for travel. (Emison, 2022)

Automotive manufacturers like BMW are addressing this issue by developing specialized seats that strike a balance between comfort and safety (fig1). These seats allow users to recline to a certain degree, ensuring their well-being during travel while catering to their desire for a relaxed and enjoyable experience.



Fig1 : Comfortable reclined seating
in BMW X7 Zero Lounge

1.2 Seat Requirements associated with NDRA(relaxing, sleeping, & entertainment.

As described in the context, we are heading towards a future with reclined seats. This section summarises the literature with respect to these activities to allow carmakers to optimise future car seats.

Relaxing

To optimize a car seat for relaxing, angles and orientation of body parts with the highest relaxation can be derived from sitting in various environments, such as cars, trains and airplanes.

A study of Hiemstra (2016) into the comfort of train seats during various activities found a comfortable angle of 126° for the backrest and 6° for the seat cushion angle, while some participants preferred a larger seat cushion angle which increases when reclining the backrest (Hiemstra, 2016). During relaxing, the headrest was almost always used (91,7%) and its position preferred behind the backrest (Hiemstra, 2016). In addition, an armrest of 200mm height, covering the entire arm was preferred (Hiemstra, 2016).

Sleeping

To optimize a car seat for sleeping, angles and orientation of body parts during sleeping on a bed can be compared to sleeping in a seat to identify bottlenecks and possibly find an ideal situation for implementation in a car seat.

Sleep posture is one of the most important indicators of determining sleep quality (among sleep stage and difficulty). During sleeping on a bed, common postures are left and right fetus with bent legs and arms (41%), Side log postures with straight legs and arms (28%), Supine (back, 8%) and prone (on belly, 7%) (Idzikowski, 2003). However, sitting on a seat adopting these postures might not be possible.

During sleeping on a bed, recorded pressure values ranged from 0-10 kPa for back and belly posture and 0-17 kPa for side postures (Liu et al., 2014), which is not much different from the values 0-17 kPa found during sitting by Kilincsoy (2011). Dreischarf (2016) found lower spinal pressure between disks (IDP) for lying (< 0.25 MPa) than for sitting (0.3- 0.55 MPa).

When sleeping or relaxing in a train chair, there are often no options to recline the backrest or seat angle. In order to attempt an increase of comfort, the following postures are adopted: Slumped posture, with arms on armrest and head on headrest (29,2%), Straight posture with head and arms free of support (28.8%) and Straight posture using all supports (headrest, backrest and armrest (20%; Kamp, 2012). Tan (2010) found similar postures in aircraft seats with slight reclining option, with the addition of head rotation and the use of small pillows. A sideways rotated posture which was rated the most comfortable (Tan, 2010).

While sleeping in a static train or aircraft seat is apparently possible, it is far from ideal. In an upright position, pressure might be concentrated on the seat, rather than spread over the entire body and the head might not have sufficient support to stay upright when asleep. Changing the seat angles probably would significantly increase the quality and probability to sleep. While sleeping is considered a private activity (Kamp, 2012), more privacy could also be offered in a seat when used for sleeping. Also, vibrations and sometimes unexpected movements should be accounted for.

Goossens (1995) found optimal seat and backrest inclinations during lying that produced no shear force and low pressure. He suggests a maximum seat inclination of 20° at a backrest inclination of 50°. Upper and lower leg inclination should be equal.

Entertainment

To optimize a car seat for entertainment, angles & orientation of the body parts should allow the user to view the entertainment screen with minimal discomfort.

Generally, in car entertainment screens are placed above the eye height. Rosemalen (2009) conducted a comfort experiment with different Backrest angles using LPD method. It was observed that 130° had the highest comfort scores.

Relaxing

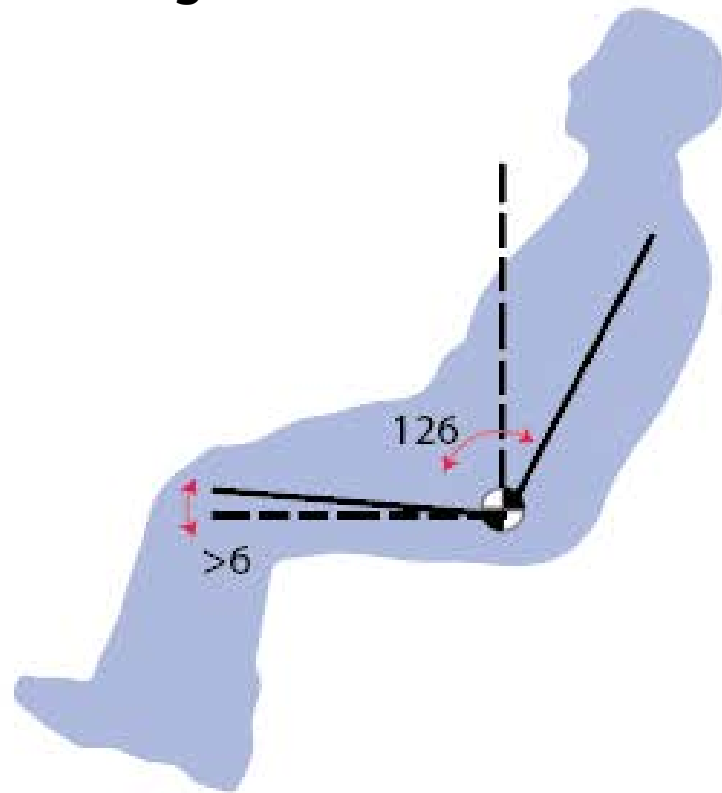

Sleeping

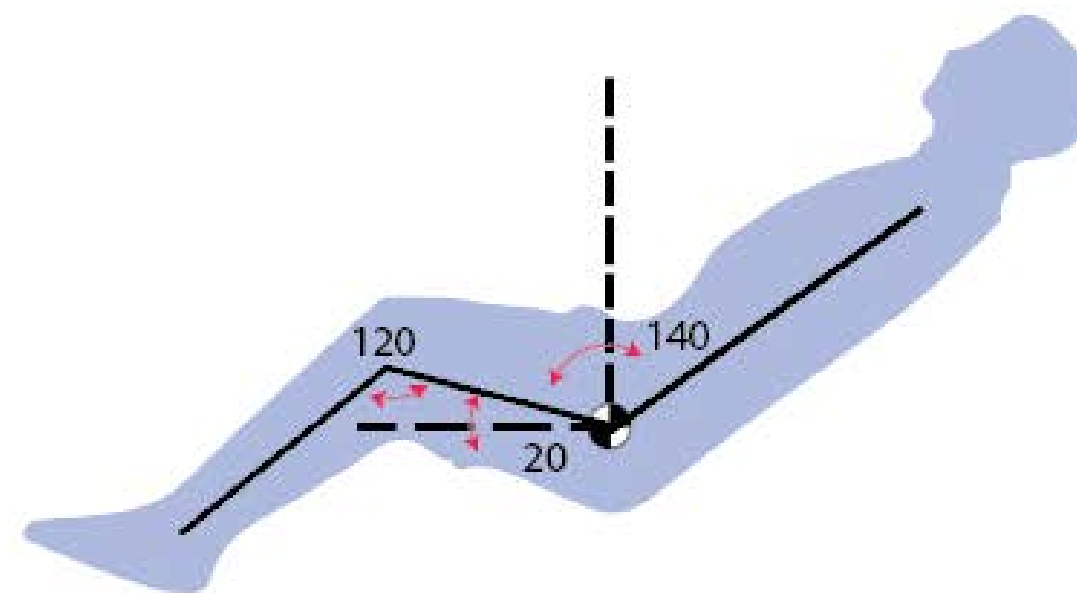

Watching IFE above eye level

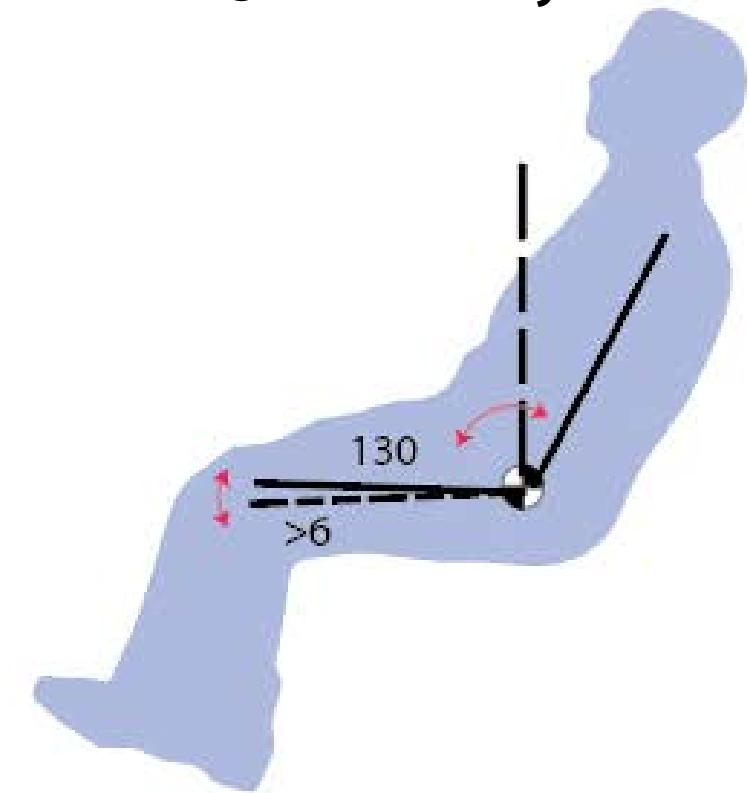

Figure 2: Body postures for different activities according to Hiemstra(2016), Goosens(1995) & Rosmalen(2009) for relaxing, sleeping & In-vehicle entertainment

1.3 Design Challenge

Mostly, occupant safety devices are designed with respect to upright sitting positions. For reclined seats, the three point safety belt installed in most cars, becomes essentially useless because the shoulder harness moves away from the passenger (fig 3), making it useless. Here, the center of gravity shifts below the lap belt, which can glide the occupant out of their seats.

Moreover, it is largely unknown how body kinematics will change for reclined seats.

Although Level 4 autonomy promises to reduce in incidents and collisions from human error, they will still share the roads with conventional vehicles driven by fallible human drivers. For the foreseeable future, there is still a chance of accidents (The Associated Press, 2022), All cars will still require seatbelts and airbags.

The design challenge is to look how the body kinematics changes for reclined seats in the event of collision and design an effective system to reduce injuries in these positions.

Fig 3 : Shoulder harness moving away from the occupant.



1.4 Approach & Outline

Approach

The problem “designing a safe safety belt system for sleeping) is approached from two frames of references; comfort & safety.

As previously stated, there is limited literature available for occupant safety in reclined position. To realise how body kinematics change in case of collisions, a finite element model was constructed with different systems in LS Dyna software.

Based on the evaluation of different systems, further comfort studies are conducted to evaluate concepts from user point of view.

Outline

In this chapter, the context of future road vehicles that enable reclined seating is presented. Extensive literature is gathered to highlight the lack of adequate safety systems for reclined seats. The potential benefits and challenges associated with reclined seating are discussed, emphasizing the need for improved safety measures to protect occupants in this seating configuration.

Chapter 2: Literature
Building upon the introduction, this chapter delves into

how automakers have addressed safety concerns in reclined seating. Various safety systems implemented by automakers are analyzed, shedding light on their effectiveness and limitations. Additionally, a comprehensive review of existing literature on bio kinematics is presented to understand how the human body responds to reclined positions during collisions, providing essential insights into the biomechanical aspects of reclined seating safety.

Chapter 3: Occupant safety modelling

To further explore body kinematics in reclined seating, finite elemental modeling is employed. This chapter explains the methodology and approach used for simulations. The study investigates the effects of different seatbelt configurations on body kinematics during crashes, ultimately revealing that the four-point system outperforms the three-point system in these scenarios.

Chapter 4: Comfort studies

In this chapter, the focus shifts towards the comfort aspect of safety belts. A comfort model is developed, incorporating relevant parameters and criteria. A user study is conducted using a localized postural method to pinpoint discomfort points experienced by occupants specifically in the four-point safety belt system.

Chapter 5: Ideation & Conceptualisation

Drawing from the insights gathered in the previous

chapters, this chapter introduces the design phase of the project. The four-point safety belt system is dissected into its separate components. Different design alternatives for each component are presented and evaluated based on predefined criteria to determine the best alternatives to be taken forward for conceptualization.

Chapter 6: Conceptualization and Evaluation of the Final System

Building upon the selected design alternatives, this chapter showcases the conceptualization of the final system. The integrated design concept is presented and evaluated based on its desirability, feasibility, and viability. The chapter highlights the proposed improvements and contributions of the final system in enhancing safety and comfort for occupants in reclined seating positions.

Chapter 7: Final thoughts Conclusion and Author's Reflection

The project concludes with a summary of the findings from each chapter, emphasizing the significance of the four-point safety belt system in reclined seating scenarios. The conclusion also discusses the implications of the research on the future of occupant safety and reclined seating in road vehicles. Finally, the chapter ends with the author's personal reflections on the research process, its outcomes, and potential future research directions to continue advancing occupant safety in reclined seating.

02. Literature Research

This chapter looks in depth about how safety has been approached in the automotive industry, active and passive devices, introduction of sled tests & recent studies on safety with respect to reclined seats.

2.1 Invention of modern seatbelt

The invention of the seatbelt by Edward J. Claghorn in 1885 was primarily driven by the intention to ensure the safety of tourists and prevent them from falling off vehicles while traveling ((US312085A - Clag-hoen - Google Patents, 1885). However, despite the availability of seatbelt concepts, the widespread use of seatbelts did not become common as cars became more popular in the early 20th century. This lack of safety measures resulted in a significant increase in traffic fatalities during this period ((Bill Loomis, The Detroit News, 2015)).

In 1934, General Motors conducted the first barrier

impact test, indicating a growing awareness of the need for safety measures in automobiles ("A Review of Vehicle Impact Testing," 1970.). Preston Tucker also recognized the importance of seatbelts and incorporated them into the design of the Tucker car in 1946 (Dutton, 2012). However, due to concerns about the perception of safety, seatbelts were later eliminated from the production phase of the Tucker car (Dutton, 2012).

During the 1950s, race car drivers emerged as primary users of seatbelts, given the inherent risks associated with their profession (Society of Automotive Engineers, 1950s). Recognizing the importance of seatbelt usage, the Society of Automotive Engineers established the Motor Vehicle Seat Belt Committee in the mid-1950s (Society of Automotive Engineers, 1959). This committee played a crucial role in promoting the use of seatbelts and advocating for their inclusion in automobiles.

California became the first state to mandate the installation of horizontal lap safety belts in all newly

produced cars (California, n.d.). This legislative action marked a significant milestone in seatbelt regulations and further emphasized the importance of seatbelt usage for enhanced road safety.

Meanwhile, in Sweden, researchers were actively exploring ways to improve vehicle safety. Engineers Bengt Odelgard and Per-Olof Weman conducted studies on protective measures and concluded that a diagonal restraint system would significantly enhance safety compared to lap belts alone (Vattenfall, n.d.). As a result, Vattenfall, the State Power board in Sweden, began using two-point across-the-chest belts in its cars (Vattenfall, n.d.).

Concurrently, Volvo, a Swedish automobile manufacturer, prioritized safety and hired Nils Bohlin as their first safety engineer in 1958 ("Three-point Seatbelt Inventor Nils Bohlin Born," 2010). Bohlin recognized the limitations of the two-point belt design and its potential to cause severe injuries during car crashes. He drew inspiration from Vattenfall's seatbelt implementation and developed the three-point seatbelt, which provided better protection for passengers' torsos and reduced the

2.2 Three point seatbelt - parts & working principle.

A seat belt is a strap or harness, designed to hold a person in a car seat securely and prevent the forward or lateral motion plus sliding forward in case of collision. In the event of a car crash, when the automobile comes to a sudden stop, a person's body's inertia moves it forward at the same speed that the vehicle was travelling at. In today's cars, this momentum is stopped by the combination of seatbelts and air bags.

Seat belt features such as the retractor mechanism, the strap and pretensioners hold back on the firmest parts of the passenger's body, which are the hip bones and shoulders to reduce the motion possibilities that they would have in a moving vehicle and diminish injuries in softer parts of the body. In the event of a car crash, the belt keeps the body strapped to the seat in order to halt the person.

According to NHTSA (Vaca, F., et al., 2005) the basic requirements for the seat belts assemblies put forward are :

1. A seat belt assembly should be designed for use by only one person at one time.
2. A seat belt assembly should ensure upper torso restraint without shifting the pelvic restraint into the abdomen.
3. Vertical forces on the shoulders and spine should be minimized.
4. Hardware parts should not contain burrs or sharp edges.
5. Seat belts should be supplied with the buckle readily

accessible to a person, ensuring quick and easy removal of the seat belt assembly.

6. Buckle release mechanism should exclude the possibility of accidental release.

The current design of the seat belt ensures that your body is kept inside the automobile in case of a car crash, avoiding being thrown out of the vehicle. Airbags are designed to work cohesively with seatbelts, which means they need to be used together to avoid being injured by the airbag itself.

The three-point seat belt has a layout as shown in Figure 2 . The belt runs from the vehicle's B-pillar to the D-ring, it then goes over the torso of the occupant to the buckle, and then to the anchor point. The three belt segments are called pillar belt, shoulder belt and lap belt, as indicated in the figure. An important aspect of the belt is its webbing, which determines the strain behavior under loading conditions. Restraint suppliers express the belt webbing characteristics by the relative percentage of elongation at a tension force of 10 kN. Conventional belt webbing typically has a stiffness between 10-20%, a thickness of 1-1.5 mm and a width of 48-51 mm. (Conventional Seat Belt System [10,11], n.d.)

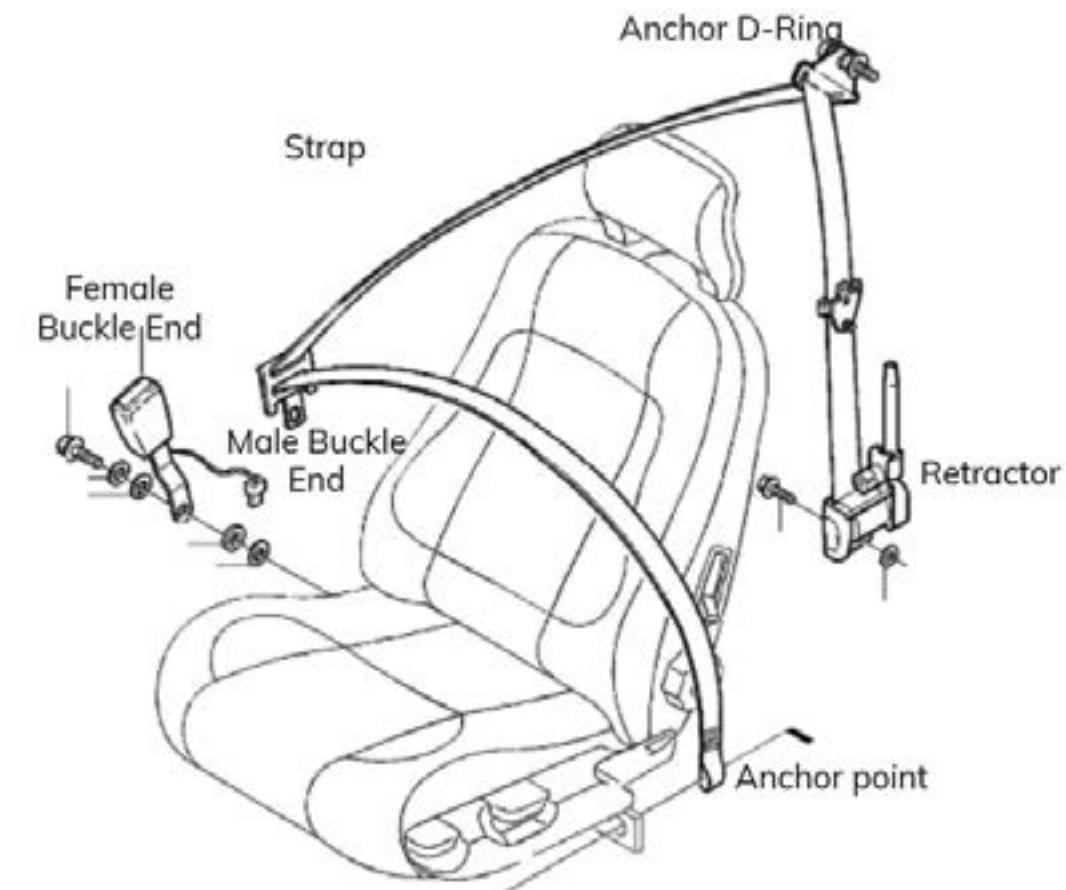

Fig 4 : Components of a three point seatbelt (Conventional Seat Belt System [10,11], n.d.)

Over the years seatbelts have improved, the following components have played a crucial role in this:

2.2.1 The retractor

This part is sometimes known as the inertia-reel, and is located in the lower part of the B-pillar. The function of the retractor is twofold. Firstly, when the belt is unbuckled, the webbing is reeled in by a rewinding spring connected to the retractor spool. This spring also removes the worst slack from the belt when in use, such that the belt aligns properly over the occupant without being uncomfortable. The second function is the locking mechanism. The retractor locks the belt whenever the vehicle senses a crash, for example by acceleration sensors. In addition to this, the locking mechanism is also activated when the occupant pulls the belt faster than normal, which gives the occupant a feeling of confidence in the safety belt.

2.2.2 The load limiter

The load limiter or shoulder belt force limiter has probably been the most important improvement since the introduction of the safety belt. The device is typically integrated within the retractor, and its function is to ensure that the loading forces on the occupant are limited. The load limiting force is typically obtained by torsion of the steel bar. When the belt force is lower than the load limit, there is no pay-out of the belt. Belt forces that are higher than the limit level make the torsion bar twist, and the webbing will unwind from the spool.

The torsion bar characteristics determine the load-deformation profile, which has typically a constant limit level of 2-6 kN in today's passenger vehicles (Håland, 2006). Since the introduction of the load limiter, studies showed that the risk on thoracic injuries is drastically reduced, especially the Dmax IC (Foret-Bruno et al., 2001).

2.2.3 The pretensioner

During the first milliseconds of the crash, it is desirable that as much slack is removed from the belt as possible. Slack in the shoulder belt allows the occupant to move forward at the start of the crash, which limits the available space for the ride-down and complicates airbag trigger timing. Slack in the lap

belt increases the risk of submarining, the phenomenon of sliding underneath the belt. Since the retractor spring force is too weak (for reasons of comfort) to achieve slack removal, pretensioner devices have been developed. Originally, they consisted of mechanical springs, but nowadays, they have a pyrotechnical mechanism. Pretensioners are located in the buckle and/or the retractor, and they apply a restraining force of 1.5-2 kN within milliseconds after the crash. They can retract 100-150 mm of belt, dependent on the amount of initial slack.

2.3 Seatbelt Safety Testing

Ensuring vehicle safety is a top priority for the automotive industry, and comprehensive crash tests play a crucial role in evaluating a car's overall safety performance. In Europe, Euro NCAP conducts a series of rigorous tests, rating vehicles between 1 and 5 stars based on their safety performance. These tests include the Mobile Progressive Deformable Barrier, Full Width Rigid Barrier, Mobile Side Impact Barrier, Side Pole, Far Side Impact, and Whiplash tests. (The European New Car Assessment Programme | Euro NCAP, n.d.)

1. Mobile Progressive Deformable Barrier:

In this test, the car is propelled into a moving deformable barrier at 50 km/h (31 mph), simulating a collision with a mid-size family car. Adult male dummies are seated in the front, and child dummies are placed in the back. The test assesses crumple zones and the compatibility of the test car.

2. Full Width Rigid Barrier:

The car is driven into a rigid barrier at 50 km/h (31 mph) with full overlap. A small 5th percentile dummy is seated in the driving position and rear seat. The aim is to evaluate the car's restraint system, including airbags and seatbelts.

3. Mobile Side Impact Barrier:

A deformable barrier is driven at 60 km/h (37 mph) into the side of the stationary test vehicle at a right angle, representing another vehicle colliding with the side of a car.

4. Side Pole:

The car is propelled sideways at 32 km/h (20 mph)

against a rigid, narrow pole at a small angle away from perpendicular, simulating a vehicle traveling sideways into roadside objects like a tree or pole.

5. Far Side Impact:

This test, introduced in 2020, evaluates far-side injuries where the driver is struck from the opposite side. The vehicle's body is attached to a sled and propelled sideways to measure the dummy's excursion towards the impacted side.

6. Whiplash:

The vehicle seat is rapidly propelled forwards at 16 and 24 km/h (9.9 and 14.9 mph) to assess the seat and head restraint's ability to protect the occupant's head and neck during a rear impact.

All these tests are conducted using a crash test dummy. A crash dummy is an anthropometrically correct representation of a car occupant, designed to mimic the human response in a typical crash. Crash dummies are made from plastics, rubber and metal components and contain measurement instruments in the most important body regions. Crash dummies are regularly recalibrated to ensure that they behave consistently over time. Currently a 50th percentile Male dummy called THOR-50M (Test device for human occupant restraint) is used. (Glossary | Euro NCAP, n.d.)

There are a number of factors related that determine the outcome of collision. These can be differentiated into two different groups as shown in Fig 5. Introducing reclined seats will introduce unique challenges to

occupant safety. With changes in seating angles and positions, the distribution of crash forces on the body may differ, affecting injury risks. Additionally, interactions with seatbelts and airbags in reclined positions can impact their effectiveness in protecting occupants.

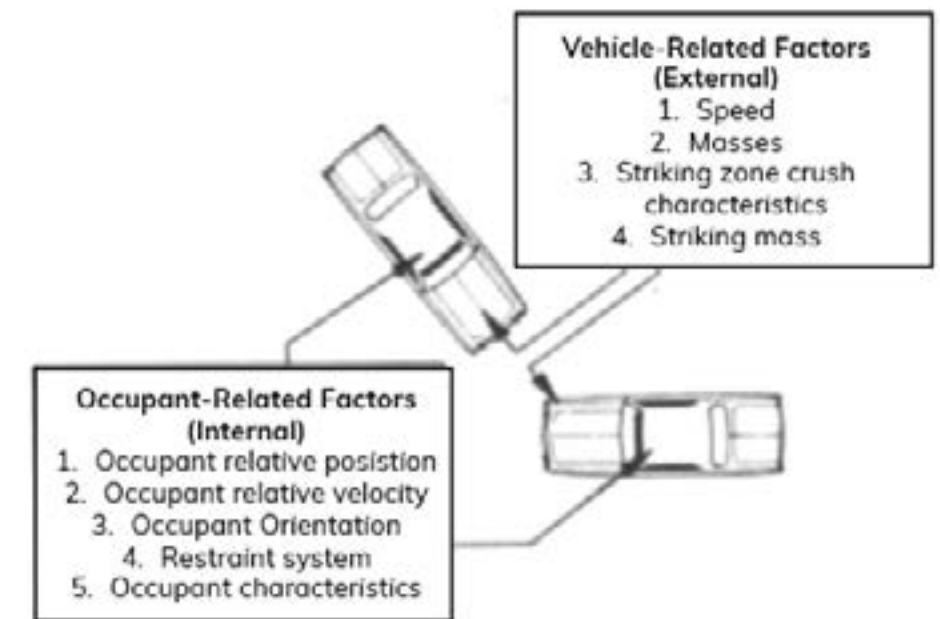

Fig 5: Factors of collision

To study this seatbelt manufacturers have developed cost effective sled tests to study occupant restraint and safety. These tests simulate collisions using crash test dummies, providing valuable data for seatbelt design improvements. In the context of reclined seats, sled tests can help assess the performance of seatbelt configurations and restraint systems specific to this seating configuration.

2.4 Literature on occupant safety in reclined seats

This following section aims to explore the current state of knowledge regarding occupant safety in reclined seats, focusing on the potential risks and the effectiveness of seat and seatbelt designs in mitigating injuries. The review examines relevant studies to provide insights for improving occupant safety in reclined seating positions.

2.4.1 Methodology:

A comprehensive search of electronic databases, including PubMed, IEEE Xplore, and Google Scholar, was conducted using relevant keywords such as “reclined seat safety,” “occupant protection,” and “reclined seatbelt design.” The search was limited to articles published in English between 2017 and 2023. Selected studies were critically evaluated for their contribution to understanding occupant safety in reclined seats, and relevant information was extracted for analysis and synthesis.

Fig 6 : Liturature mapped out using Lite-Map

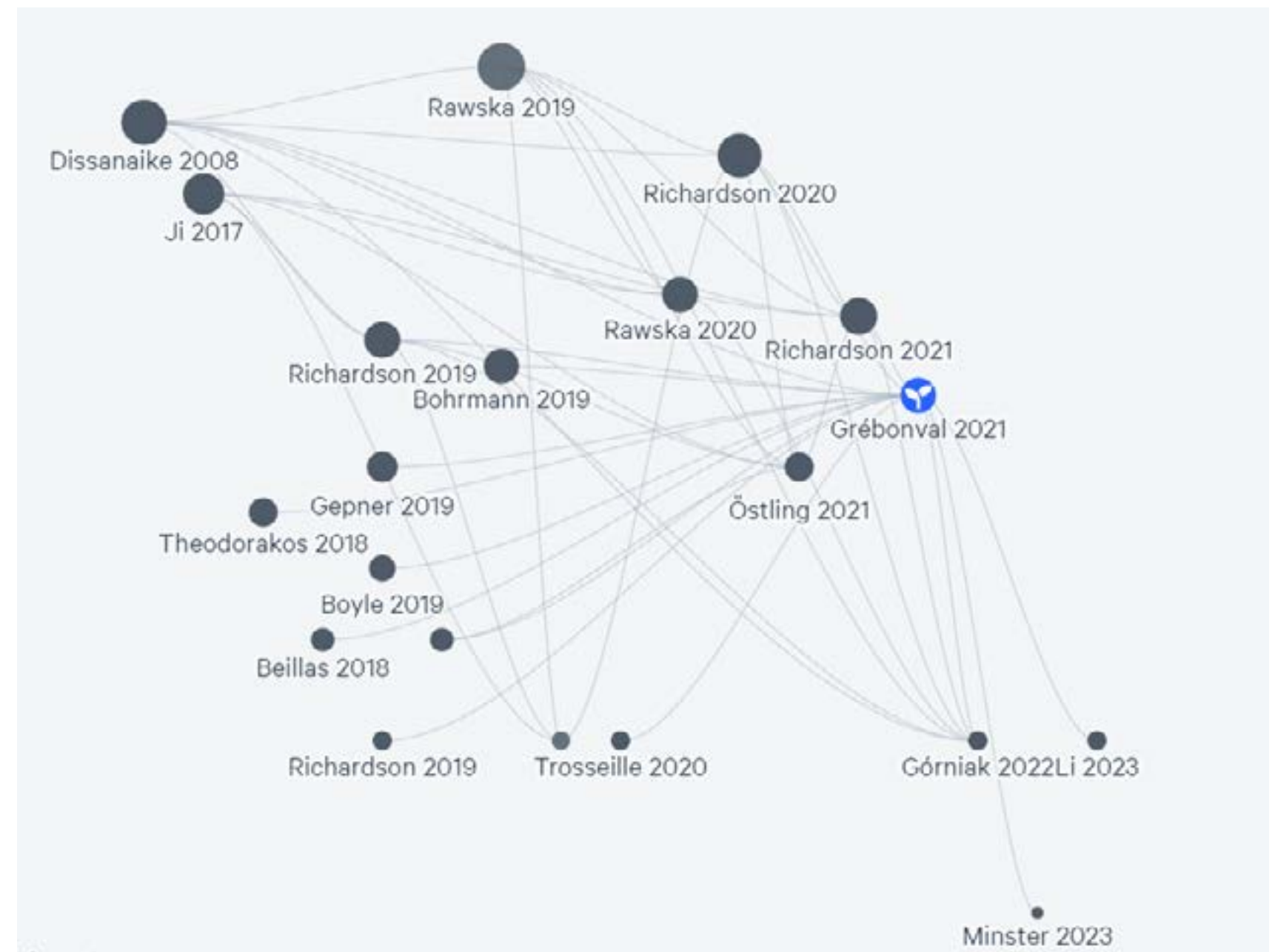

2.4.2 Results and Discussion:

Biomechanical Considerations:

Studies have investigated the biomechanical effects of reclined seats on occupant safety. Klinich et al. (2006) conducted sled tests using anthropomorphic test devices (ATDs) and found that more reclined seatback angles resulted in increased head excursion and a higher likelihood of head contact with vehicle interior components during frontal crashes. Understanding how seatback angle affects occupant kinematics is crucial during collision scenarios. Zuby et al. (2015) demonstrated through computer simulations and real-world crash data that reclined seats could affect head restraint performance and increase the risk of head and neck injuries in rear-end collisions.

Richardson et al, (2021) analysed the body kinematics of five different Post mortem human subjects. The sequence of kinematics occurred was different and followed a similar order:

- (i) pelvis initial forward displacement
- (ii) upper torso initial forward pitch
- (iii) pelvis peak forward displacement followed by pelvis rebound
- (iv) upper torso peak forward displacement followed by upper torso rebound.

Moreover, the body velocities were greater. These findings emphasize the importance of considering the seatback angle while designing occupant safety systems.

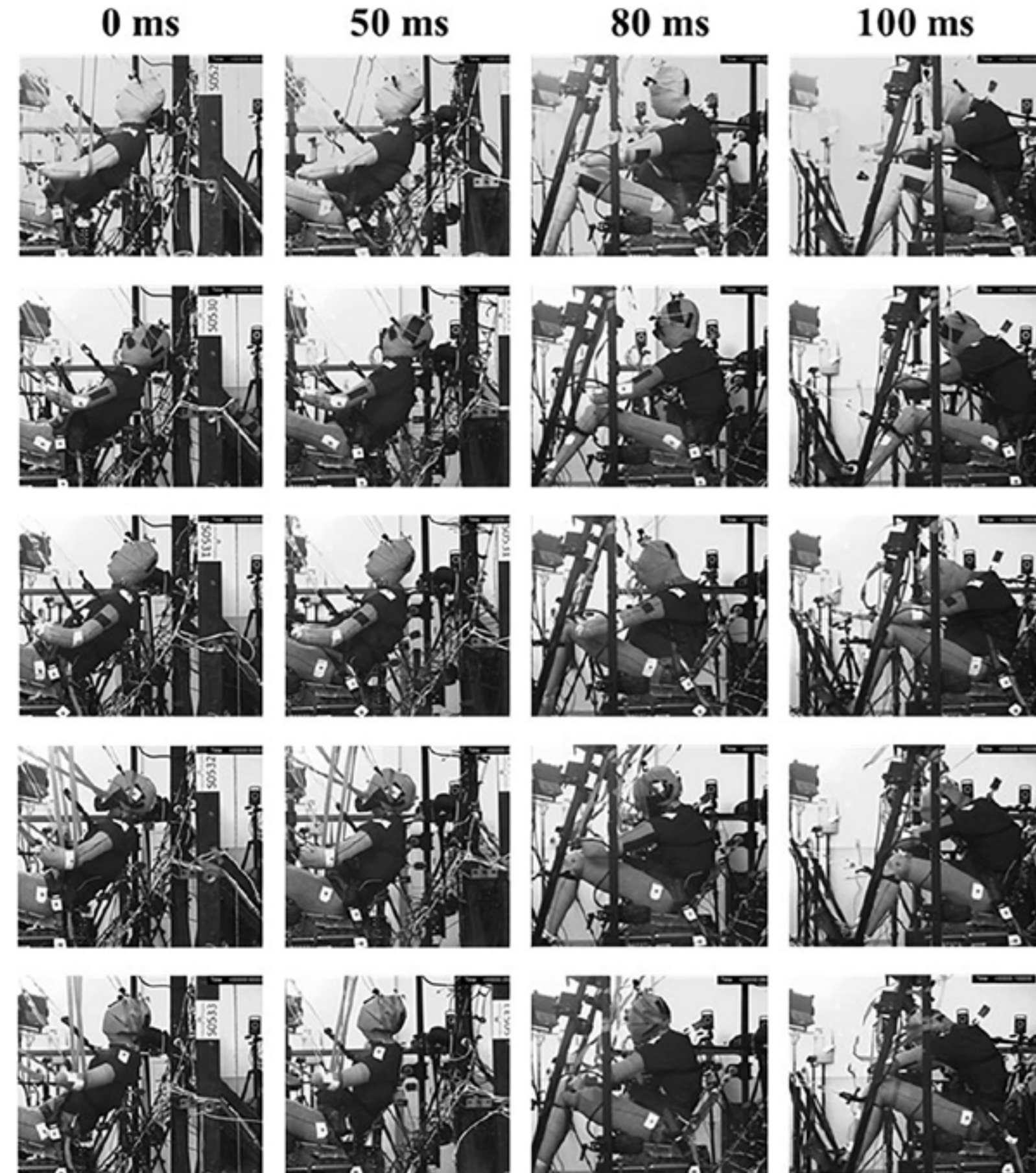

Figure 7 : Body kinematics of 5 PMHS tests by Richardson et al(2021)

Injury Risk Assessment:

Several studies have focused on assessing the specific injury risks associated with reclined seats. Parenteau et al. (2018) analyzed real-world crash data and found an increased risk of head and neck injuries for occupants in reclined seats compared to upright seats. The relaxed posture in the reclined position reduces muscular tension, potentially affecting the occupant's ability to brace for impact. Fredriksson et al. (2014) investigated occupant injuries in frontal crashes and reported a higher risk of serious head and chest injuries for occupants seated in a reclined position compared to an upright position. These studies underscore the importance of considering the increased injury risks associated with reclined seating positions.

Submarning Risk and Injury Criteria:

One of the most severe factors in frontal crashes involving reclined seats is submersion, where the occupant's hips slide under the lap belt, restraining the body at the abdomen. Grébonval et al. (2021) studied the effect of seatpan and pelvis angle on submersion risk and found that lower seatpan angle and higher pelvis angles increased the risk of submarning and associated injuries. This highlights the need for maintaining optimal seatpan angles (atleast 15° from horizontal) and pelvis angle in reclined seat designs to mitigate the risk of submersion.

Head Injuries and Whiplash:

Górniak et al. (2022) studied head-related injuries and whiplash in reclined seats using a 50th percentile anthropomorphic test dummy (ATD). They compared different seat angles and crash pulses and found that greater seat inclinations, particularly around 130° , led to a lower risk of head injuries. However, fully-reclined seats exhibited the highest head accelerations. These findings emphasize the importance of carefully considering seatback angle to mitigate head injuries and whiplash in reclined positions.

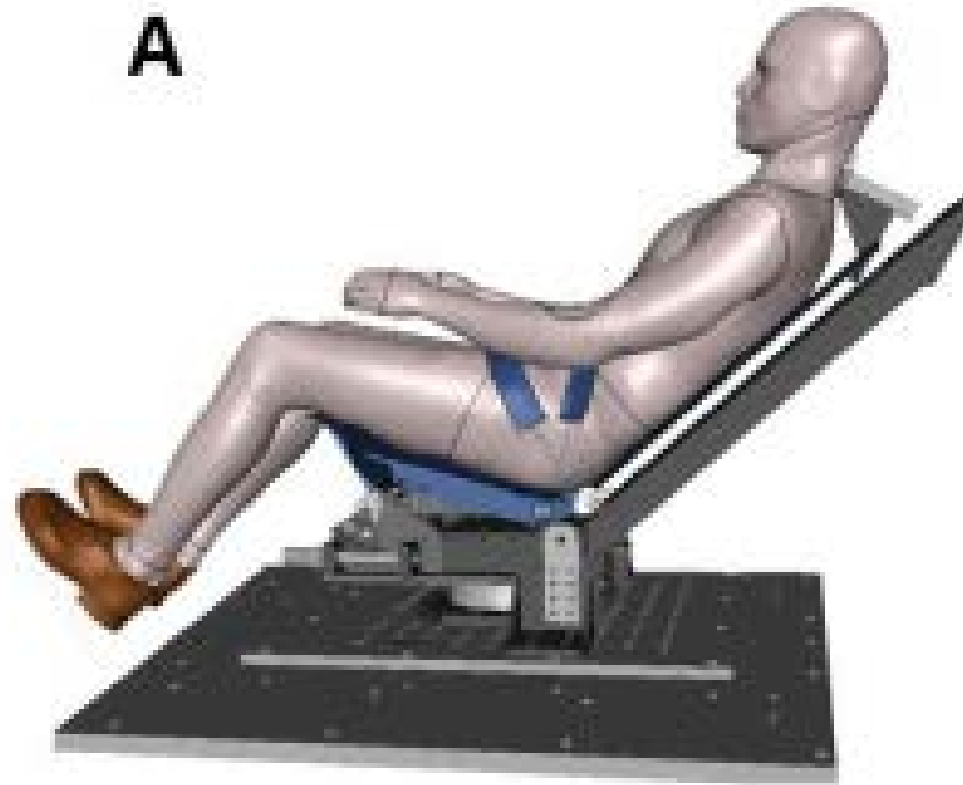

Figure 8: Setup of Grebonval, (2021)

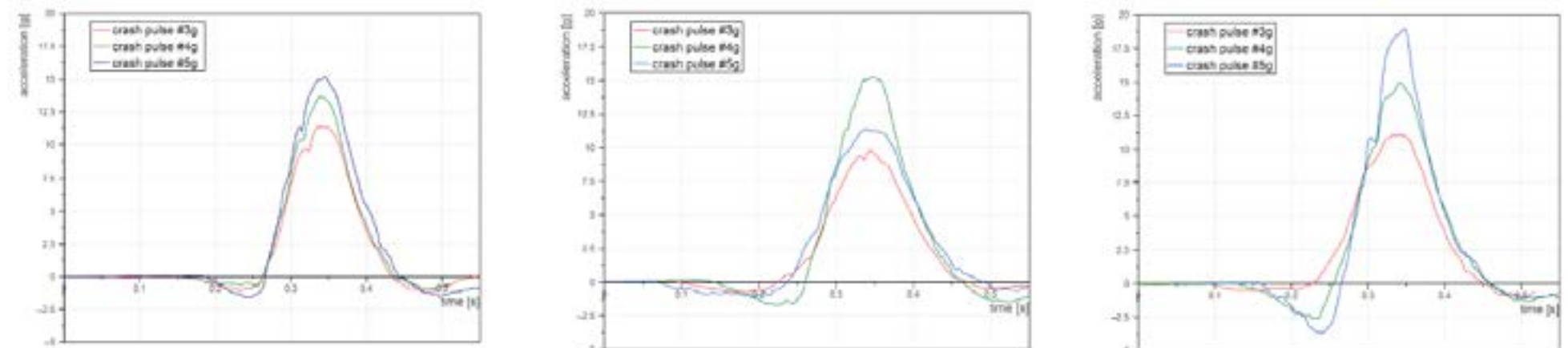

Figure 9: Head acceraltion observed by Gorniak et al, (2022)

Seatbelt Integration:

Forman et al. (2019) compared injury criteria using standard and seat-integrated seatbelts in upright, semi-reclined, and reclined seats. Their simulations demonstrated that seat-integrated D-rings resulted in earlier torso engagement, reduced head motion, and lower head acceleration compared to standard B-pillar mounting D-rings. However, seat-integrated D-rings also increased resultant force and flexion angle in the lumbar spine. These findings emphasize the trade-offs involved in seatbelt integration and the need for optimizing seat and seatbelt designs for occupant safety in reclined positions.

Knee-to-Knee Bolster Interaction:

Proper knee-to-knee bolster interaction plays a substantial role in restraining the pelvis and lower extremities, mitigating the consequences of submarining during frontal crashes. Lin et al. (2017) highlighted the importance of knee bolster design and positioning to enhance occupant safety in reclined seats.

Regulatory Standards:

Researchers have highlighted the absence of specific regulatory standards regarding reclined seats. Current automotive safety standards, such as those established by the National Highway Traffic Safety Administration (NHTSA) and the European New Car Assessment Programme (Euro NCAP), do not specifically address reclined seats. However, incorporating provisions related to seatback angle into safety regulations could promote uniformity and enhance occupant protection. Ekman et al. (2017) argue for the development of specific safety standards for reclined seats based on comprehensive testing protocols and injury criteria.

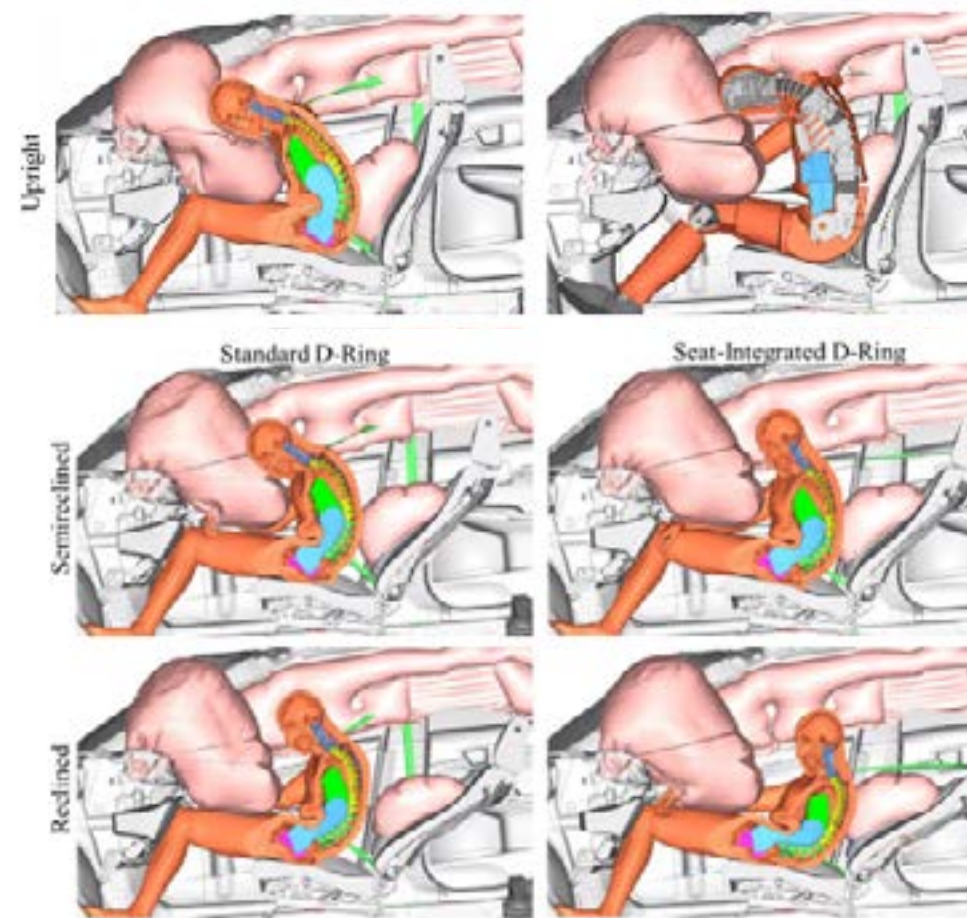

Figure 10: Simulations of Forman et al (2021)

Mitigation Strategies:

Researchers have proposed various mitigation strategies to address the safety concerns associated with reclined seats. One approach involves the use of advanced seatbelt technologies, such as load limiters and pre-tensioners, to optimize seatbelt performance in reclined positions. Chen et al. (2019) demonstrated the potential of load limiters in reducing head and neck injury risks through computer simulations. Additionally, improvements in seat design, including energy-absorbing structures and anti-submarining measures, have been suggested to mitigate injury risks associated with reclined seats (Stammen et al., 2012).

While, the three point system is the norm for cars now, there have been other systems tried out in the past by automakers.

2.5 Alternative Seatbelt Safety Systems

Over the years, automakers and seatbelt manufacturers have continuously explored various configurations and strategies to enhance vehicle safety and protect occupants during accidents. Seatbelts play a vital role in restraining occupants, reducing injury risks, and preventing ejection from the vehicle. In this section, we will delve into four different seatbelt configurations: the Four-Point Seatbelts, Automatic Seatbelt, Y-Yoke Integrated Seatbelt System, and Blanket Airbag, as well as the concept of Automatic Cushion Restraint. We will explore how each system works, their respective advantages and disadvantages, and why some of them were not widely adopted.

Four-Point Seatbelts:

Rouhana et al. (2003) analysed four point seatbelts with traditional three point ones. The Four-Point Seatbelt configuration is a departure from the conventional Three-Point Seatbelt system commonly found in most vehicles. It involves the addition of two more anchor points to secure the occupant in a more comprehensive manner.

How it works:

There are two primary configurations:

X4 configuration: This setup includes an additional shoulder belt that crisscrosses on the occupant's chest, forming an 'X' shape, and a standard lap belt.

V4 configuration: This style features a harness-style belt that secures the occupant diagonally, forming a 'V' shape,

along with the traditional lap belt.

Advantages:

Better body load distribution: The Four-Point Seatbelt system distributes crash forces across the shoulders

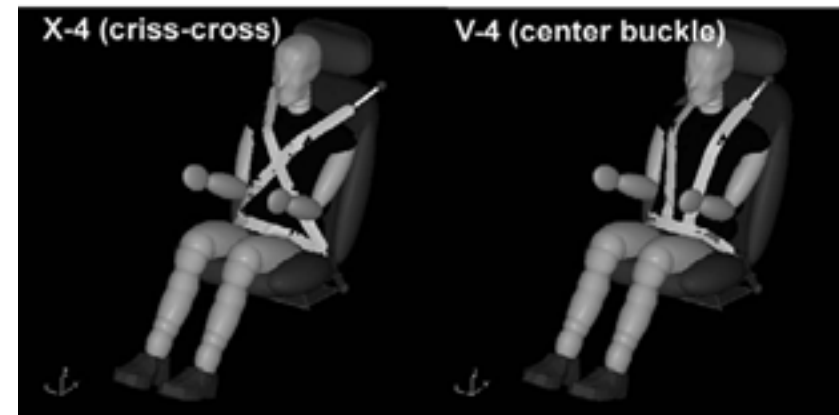

Figure 11: Four point belt configuration by Rouhana et al(2023)

and hips, potentially reducing the risk of thoracic injuries. **Enhanced occupant restraint:** The added anchor points provide a more secure restraint, especially during high-energy impacts, as seen in motorsports.

Disadvantages:

Practicality and comfort: The X4 configuration can be uncomfortable and restrict movement during day-to-day driving.

Interaction issues: In production vehicles, challenges arose in interactions with inboard shoulder belts during side impacts, which needed further resolution.

Automatic Seatbelt:

The Automatic Seatbelt system was a short-lived invention introduced in cars during the early 1990s. It aimed to automate the process of securing the seatbelt across the occupant's chest. (Orlove, 2017)

How it works:

When a vehicle occupant enters the car, the motorized cross-chest belt, mounted to the A-pillar, moves around the door frame and rests by the B-pillar. This automatically draws the seatbelt across the passenger's chest.

Advantages:

Automation: The system eliminated the need for the occupant to manually fasten the seatbelt, encouraging compliance.

Initial restraint: The seatbelt would be in place once the occupant sat down, providing immediate restraint during a collision.

Disadvantages:

Incomplete restraint: The Automatic Seatbelt only secured the upper torso; occupants still needed to manually fasten the lap belt, leading to incomplete restraint.

Mechanical issues: The system was prone to malfunction and breakage, leading to user dissatisfaction.



Figure 12: Automatic seatbelt (Orlove,2017)

Y-Yoke Integrated Seatbelt System:

H McElhaney, (1972) designed the Y-Yoke Integrated Seatbelt System. It was a concept that offered a unique configuration to enhance occupant restraint and reduce motion during crashes.

How it works:

The system consisted of a rigid seat frame with integral lap belt anchors, providing better control of belt slack and angles compared to traditional floor-mounted anchor points. The upper torso restraint included an inverted Y-yoke harness with an inertia reel.

Advantages:

Reduced head and chest acceleration: Analytical models predicted a reduction in head and chest acceleration during crashes.

Controlled occupant motion: The Y-Yoke system offered better control over occupant movement during impacts.

Disadvantages:

Lack of implementation: Despite promising results in simulations, the Y-Yoke system was never introduced in production vehicles, and practical challenges might have prevented its adoption.



Figure 12: Y- yoke integrated system by H McElhaney,(1972)

Blanket Airbag

Developed by the Firestone Tire & Rubber Company, the Blanket Airbag is a unique concept designed to prevent passengers from being hurled forward or sideways during a collision. (Grime, 1972)

How it works:

The system is stored in a compartment at the lower edge of the back seat and in the instrument panel for the front seat. During a collision, the energy-absorbing fabric blanket is automatically deployed to restrain passengers.

Advantages:

Enhanced protection: The Blanket Airbag offers protection for occupants against being thrown forward or sideways during a crash.

Vision not obstructed: The design prevents obstruction of vision while still ensuring occupant restraint.

Disadvantages:

Limited coverage: The blanket covers below the knees but not above the shoulders, leaving some areas less protected.

Practicality concerns: The system might present challenges in terms of deployment speed, reliability, and cost-effectiveness for widespread adoption.



Figure 13: Blanket airbags in the 1970s (Grime, 1972)

Automatic Cushion Restraint:

The concept of Automatic Cushion Restraint involves a pad attached to a movable member alongside the occupant's seat, offering additional restraint during deceleration. (Index of Patents Issued From the United States Patent Office, n.d.)

How it works:

The cushion pad moves between an operative position adjacent to the occupant's chest during normal driving and an inoperative position spaced from the chest during deceleration. The pad is attached to inertia locking means to absorb forward momentum.

Advantages:

Additional restraint: The Automatic Cushion Restraint provides supplementary protection during deceleration events.

Occupant safety: The concept aims to reduce forward motion and potential injury during sudden stops.

Disadvantages:

Limited implementation details: The Automatic Cushion Restraint concept might face practical challenges in terms of feasibility and effectiveness, as its implementation details are not extensively described.

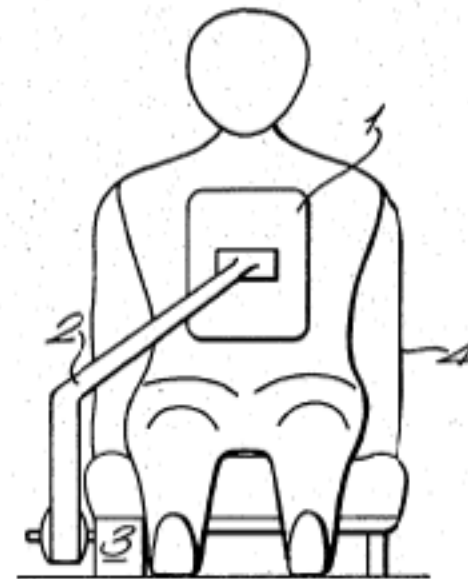

Fig. 1.

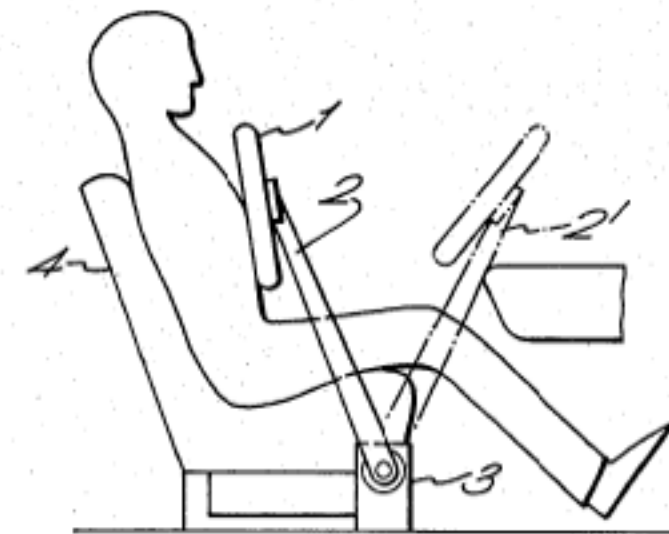

Fig. 2.

Figure 14: Automatic Cushion restraint
(Grime, 1972)

2.6 Looking ahead : Restraint systems for reclined seats

As the automotive industry embraces autonomous driving and long-distance travel, ensuring passenger safety in reclined seats poses unique challenges. Recent developments focus on safety systems for reclined seats, offering comfort and protection during autonomous journeys. In this section, we will explore three notable safety configurations designed for reclined seats: Volvo's Special Safety Blanket, General Motors' Blanket Airbags, and the Seven-Point System studied by Volkswagen. We will discuss how each system works, their potential advantages, and the challenges they face.

Volvo's Special Safety Blanket:

Volvo introduced a pioneering concept in their 360C concept car, focusing on securing passengers while they are reclined in level 5 autonomous cars. The Special Safety Blanket is designed to provide comfort while ensuring protection during collisions or hard braking events. (Gizmodo Australia, 2020)

How it works:

The blanket comprises restraints that tighten around the passenger's shoulders and hip areas when a collision or hard braking occurs. This personalized blanket is intended to offer both comfort and safety during autonomous travel.

Advantages:

Comfort and protection: The Special Safety Blanket aims to balance passenger comfort with safety during reclined travel.

Level 5 autonomous focus: This system is specifically designed to cater to passengers in fully autonomous vehicles where reclined seats might be more common.

Challenges:

Variable passenger sizes: Ensuring the blanket can effectively interact with passengers of different sizes poses challenges in designing a one-size-fits-all solution.

Posture variations: People assume various postures while reclined, introducing another layer of complexity in providing appropriate restraints.



Figure 15 : Safety blanket in fully reclined seats by Volvo. (Gizmodo Australia, 2022)

General Motors' Blanket Airbags:

General Motors filed a patent in 2022 for a new restraint system intended for use in future vehicles featuring reclining seats. (GM Applies for "Blanket Airbag" Safety Restraint System Patent, 2021)

How it works:

The vehicle safety system consists of a seat capable of moving between upright and substantially reclined positions. An enclosure above the headrest stores a blanket airbag in an underdeployed position before collisions. Electromechanical restraint systems, associated with both the seatback and seat bottom, are physically coupled with the blanket airbag. These restraint systems pull the blanket airbag from its underdeployed position to a deployed position, substantially covering the passenger on the seatback and seat bottom.

Challenges:

Complex deployment: Ensuring the blanket airbag deploys effectively and promptly in various collision scenarios requires precise engineering.

Integration with other safety features: Coordination with existing safety systems, such as airbags and seatbelts, is essential for a cohesive safety strategy.

Advantages:

Comprehensive coverage: The blanket airbags provide extensive protection to passengers in reclined positions during collisions.

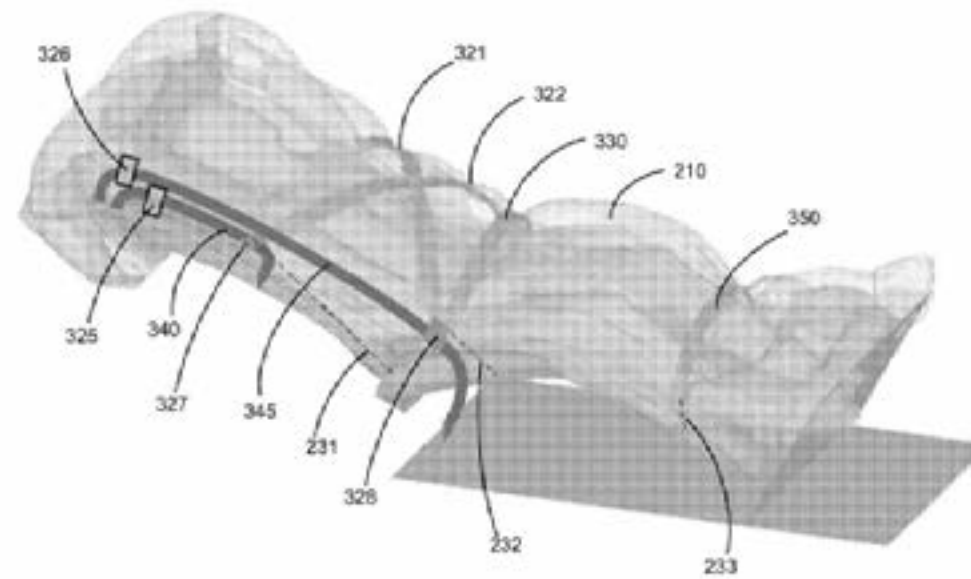

Figure 16: General motors blanket airbag (GM Applies for "Blanket Airbag" Safety Restraint System Patent, 2021)

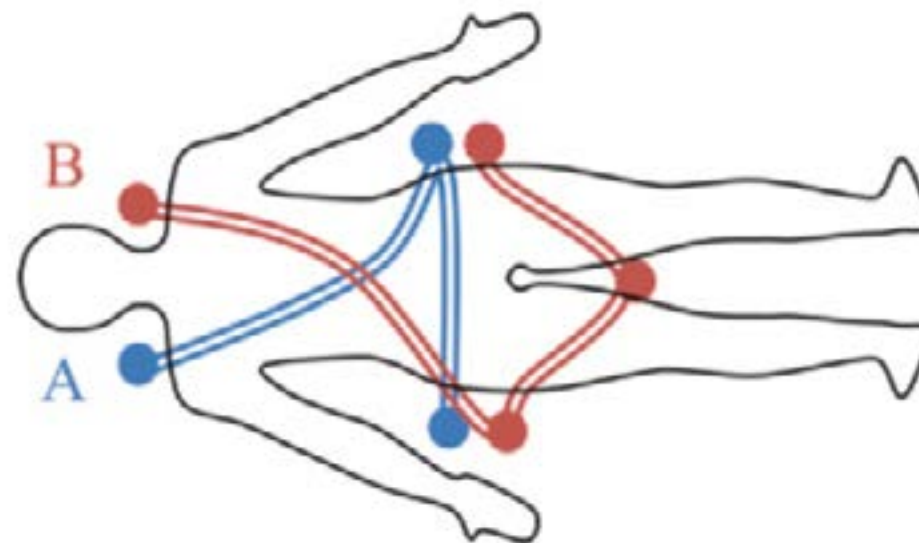

Figure 17: 7-point system by Volkswagen in their study (Caballero-Bruno,2022)

Seven-Point System in Volkswagen Study:

A study conducted by Caballero-Bruno et al. in 2022 aimed to assess sleep comfort and quality at different backrest angles while providing secure restraints.

How it works:

The seven-point seatbelt comprises a combination of a traditional three-point seatbelt and a four-point seatbelt. The traditional three-point belt secures the passenger's torso, while the additional four-point belt offers supplementary restraint.

Advantages:

Enhanced restraint: The seven-point system provides better restraint during dynamic situations compared to traditional three-point seatbelts alone.

Improved safety in reclined positions: The additional points of restraint help address potential discomfort and tightness issues.

Challenges:

Discomfort concerns: Participants in the study reported discomfort, primarily due to tightness and the proximity of shoulder belts to the neck.

Practical implementation: The complexity of the seven-point system may pose challenges in integrating it into production vehicles.

2.7 Conclusion

Occupant safety in reclined seats is a critical consideration in the automotive industry as autonomous travel and long journeys become more prevalent. Biomechanics, seatbelt effectiveness, injury risk assessment, head injuries and submarining risk are among the key factors that influence occupant safety. Various strategies have been adopted by automakers to address these challenges and ensure both comfort and protection.

Volvo's Special Safety Blanket, designed for level 5 autonomous cars, offers personalized restraint by tightening around the shoulders and hips during collisions. Although it strikes a balance between safety and comfort, accommodating different passenger sizes and postures remains a challenge.

General Motors' Blanket Airbags provide comprehensive coverage by deploying from above the headrest during collisions. Integration with seat movement enhances their effectiveness, but further refinement is needed in deployment and integration with other safety features.

Volkswagen's Seven-Point System, combining traditional three-point and four-point seatbelts, enhances restraint during dynamic situations. Despite its benefits, addressing user discomfort and practical implementation complexities is crucial.

In light of these developments, the Four-Point V Belt, proven effective in motorsports like Formula 1, emerges

as an intriguing option for reclined seats. This configuration loads the body differently during high-energy impacts and has a proven safety record in motorsports. As automakers continue to refine safety systems and explore new configurations, the Four-Point V Belt is worth exploring for enhanced occupant safety in reclined seating.

To optimize occupant protection in reclined seats, comprehensive testing protocols, injury criteria, and specific safety standards addressing this seating configuration are necessary. Further research and development are essential to ensure the safety of occupants during autonomous travel and long journeys in reclined seats. Ultimately, by combining biomechanics, innovative safety configurations, and proven motorsport solutions, automakers can advance occupant safety and pave the way for safer reclined seating in the future of automotive travel.

03. Occupant Safety Modelling

In recent years, Finite Element Analysis (FEA) has greatly enhanced occupant safety by improving crash dynamics and vehicle safety. However, FEA has limitations in replicating real-world crashes due to input data quality and assumptions during model development. Despite this, FEA remains valuable for providing insights into safety system effectiveness.

In the previous chapter, it was mentioned that studies have been conducted to understand the biomechanics of occupants in reclined positions using a three-point seatbelt system. However, literature surveys and approaches by other car brands indicate that a three-point system might not be as effective in providing adequate protection in reclined positions. Furthermore, alternative configurations for occupant restraint in reclined positions have not been extensively explored.

Rouhana et al. (2003) demonstrated the effectiveness of four-point seatbelt systems in upright positions. However, there is a lack of comprehensive research comparing the effectiveness of three-point and four-point systems in both upright and reclined positions.

In this chapter, we aim to bridge this gap and conduct a comparative analysis of the effectiveness of three-point and four-point seatbelt systems in both upright and reclined positions. By exploring the biomechanical responses of occupants in various scenarios, we seek to gain valuable insights into the safety implications

of different seatbelt configurations during different driving conditions. This research will contribute to the advancement of occupant safety systems, especially in reclined seating, and guide the automotive industry in adopting more effective restraint systems for enhanced protection of occupants in future vehicles

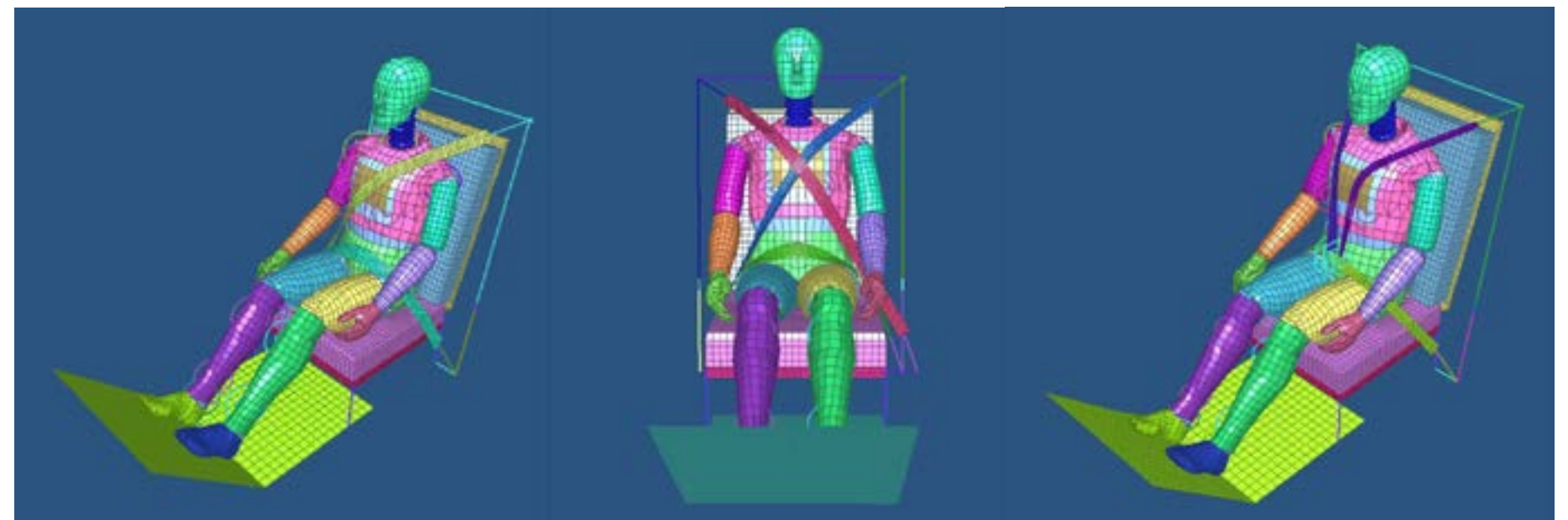

Figure 18 : Traditional three point, X4 & V4 Seatbelt configurations used for crash modelling

3.1 Methodology

To analyse occupant safety, a finite element model was constructed using Altair Hyperworks using a Radioss solverdeck.

Initially, a car seat model was developed to place the passenger (Figure 19). But due to model complexity, high simulation time and system limitation, a simple seat as shown in the next section was adopted.

There were a few challenges with this phase of the project. The software had a steep learning curve, there were next to no resources with respect to four point seatbelt modelling.

With limited time left only frontal collisions at varying speeds were analysed.

After initial runs, the X4 configuration was dropped as it performed worse than the baseline three point system. Rouhana et al. (2003) also had similar results in their research.

Figure 20 shows the overview of the modelling condition.

In total, three different speeds & two seatback angles were considered, bringing a total of twelve runs.

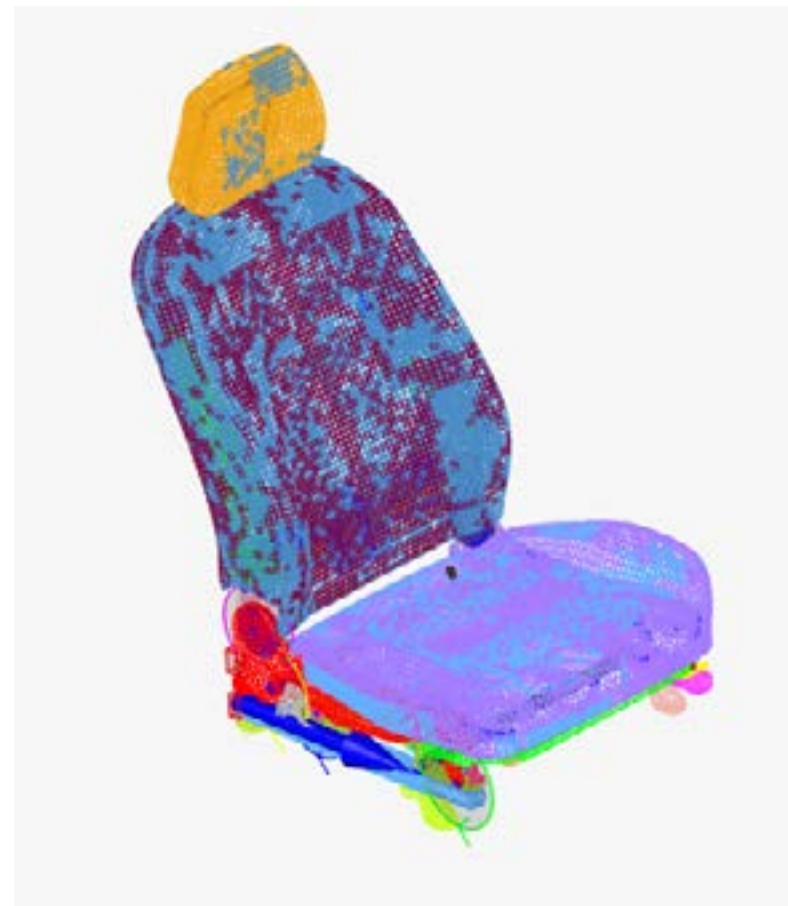

Fig 19 : Detailed car seat model

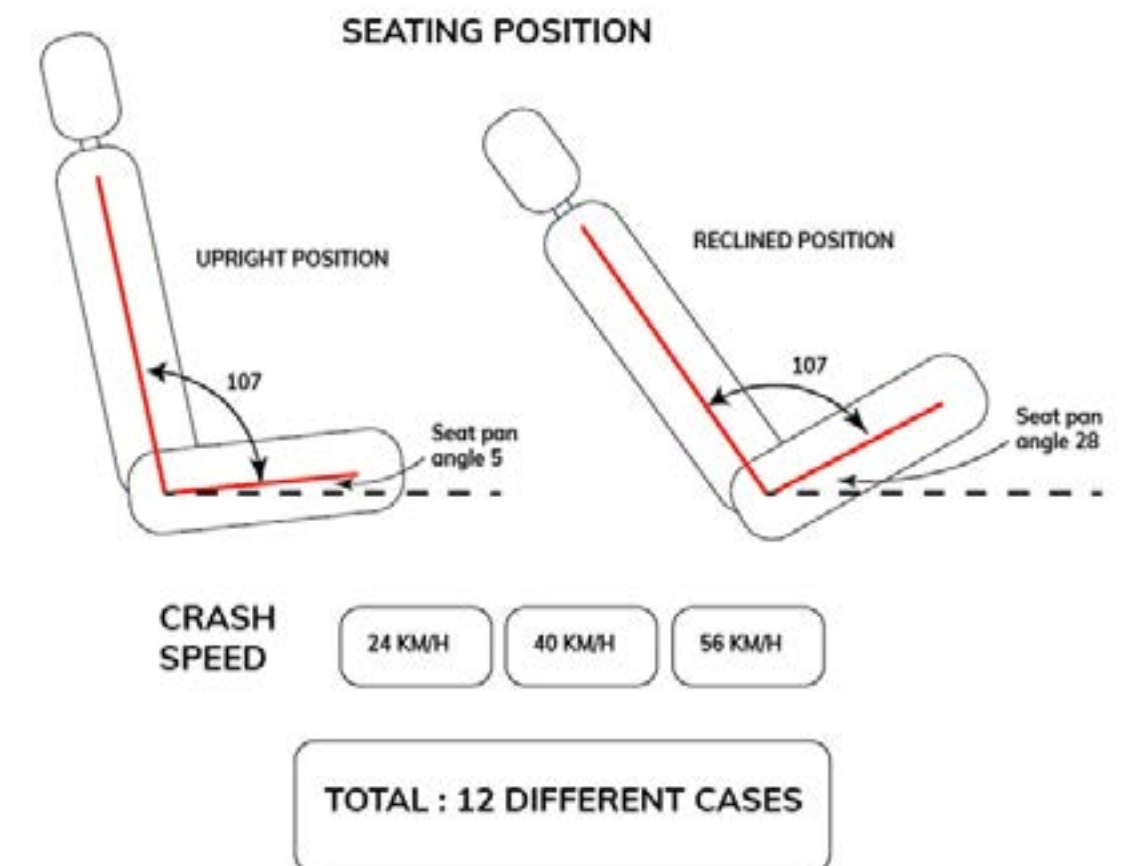

Fig 20 : Overview of modelling condition.

3.2 Modelling

The frontal collision occupant safety model consists of five different parts :

- (i) The Frame of the car seat
- (ii) The seat & seatback cushions
- (iii) The floor of the vehicle
- (iv) The dummy placed on the seat
- (v) Seat belt anchorages & restraint systems.

Let us look at each part, its components, their properties & its function.

(i) The Frame:

The frame consists of a seatplate, seatback plate, seat frame seatback frame and legs. All components have material properties of steel and are made up out of shell elements, except legs which are made up of beam elements.

The angle between the seatback & seatbase is 112 is kept constant.

(ii) Cushions

The cushions consists of four different parts. The seat and seatback cushion made out of foam with the value 1 kpa, And seat & seatback covers made out of fabrics

(iii) Floor

The floor of the model is attached to the front of the frame legs. After a distance of 0.7m, it is inclined at

an angle of 45 to replicate car seat floors for front seat passengers.

(iv) The dummy :

The dummy used was provided by Altair Hyperworks, it is a simplified version of THOR-M50 dummy made up of shell elements. It is positioned on the seat using a dummy positioner tool.

(v) Seat belt Anchorages & restraint systems.

The part consists of four different components; namely the belt anchorage, load limiter and pretensioner. The load limiter & pretensioners limits the maximum load & tightens the belts in an event of collision.

The two different configurations for three and four point systems are shown below. For four point system, in addition a buckle is modeled in Hypercrash

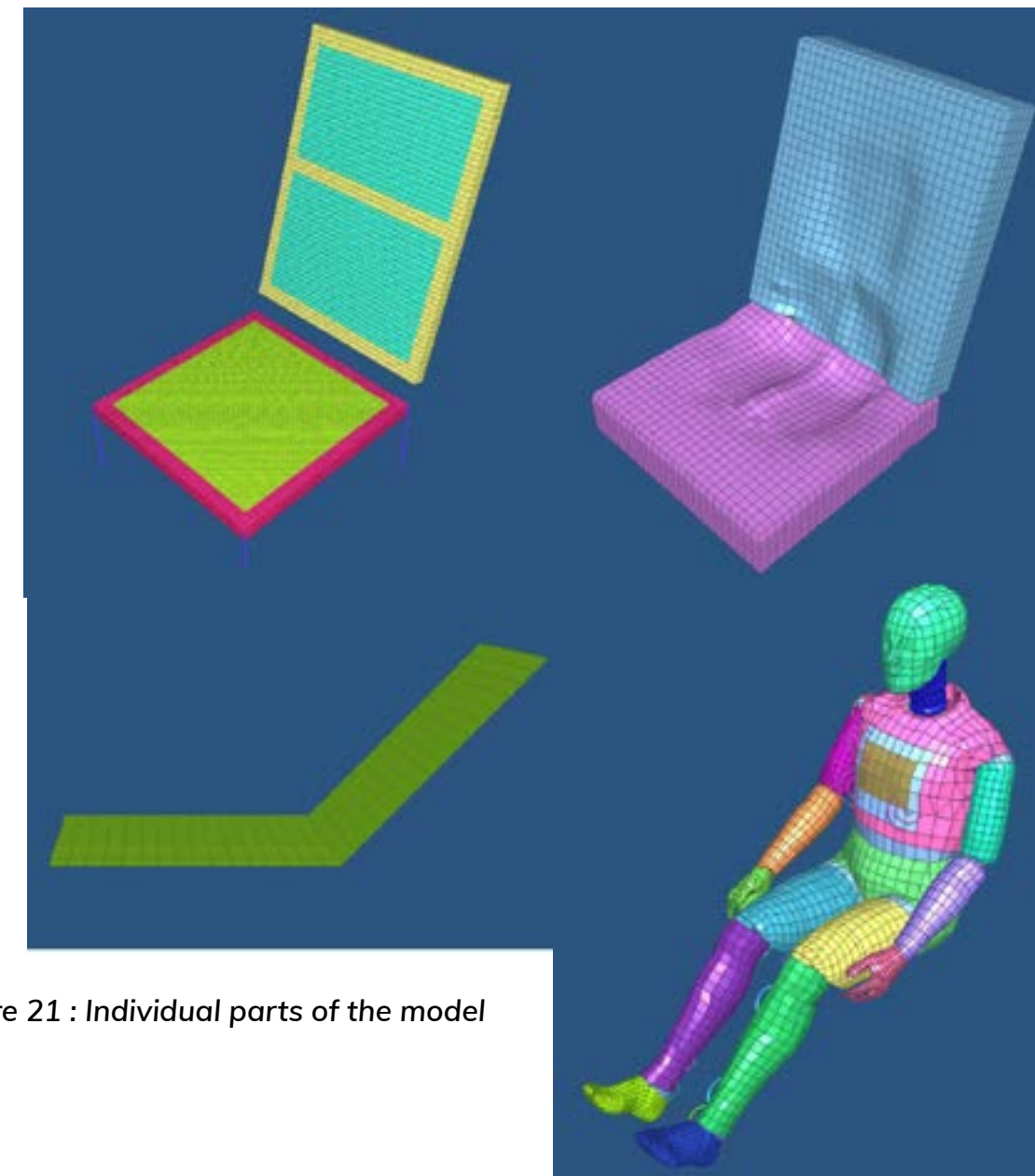

Figure 21 : Individual parts of the model

3.3 Procedure

Detailed procedure is available in appendix A

Initially different solver files were created for each part in Altair Hypermesh. The models were assembled in Hypercrash by importing individual files.

The seat is modified depending on which case is being simulated; upright (112) or reclined (135).

Based on the condition the dummy is positioned using the dummy positioner tool. Once placed on the seat, there are certain elements overlapping. These are removed using a seat deformer tool. Refer Fig 22.

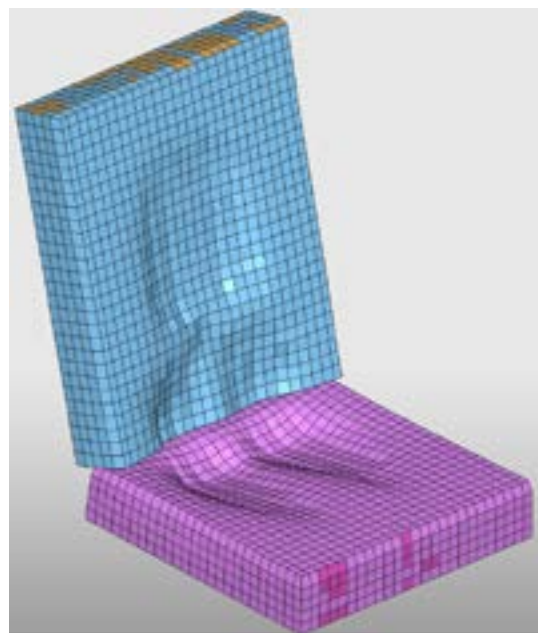

Fig 22 : Seat Deformer tool to remove overlapping elements.

To model the seatbelt, the seatbelt tool is used, at least three nodes are used to define the direction of the belt. All belt webbing was modeled using membrane finite elements. A coefficient of 0.25 was defined between the dummy and the seat. This value is taken from (Test of Friction Coefficient Between Car Seat Fabric and Cloth_ News_Link Testing Instruments Co. ,Ltd, n.d.)

In order to simulate collision, different contacts between parts had to be defined. Following contacts had to be defined:

- (i) Between seatplate & seat cushion
- (ii) Between seaback & setback cushion
- (iii) Dummy to seat
- (iv) Dummy feet to floor
- (v) Seatbelt & Dummy

Finally, the loadcase is defined by defining the acceleration pulse for all the nodes.

Control cards are used to define the parameters for the simulations and output. The parameters analysed throughout the dynamic test were belt contact forces, chest displacement & head accelerations. These parameters are relevant as described in the previous chapter.

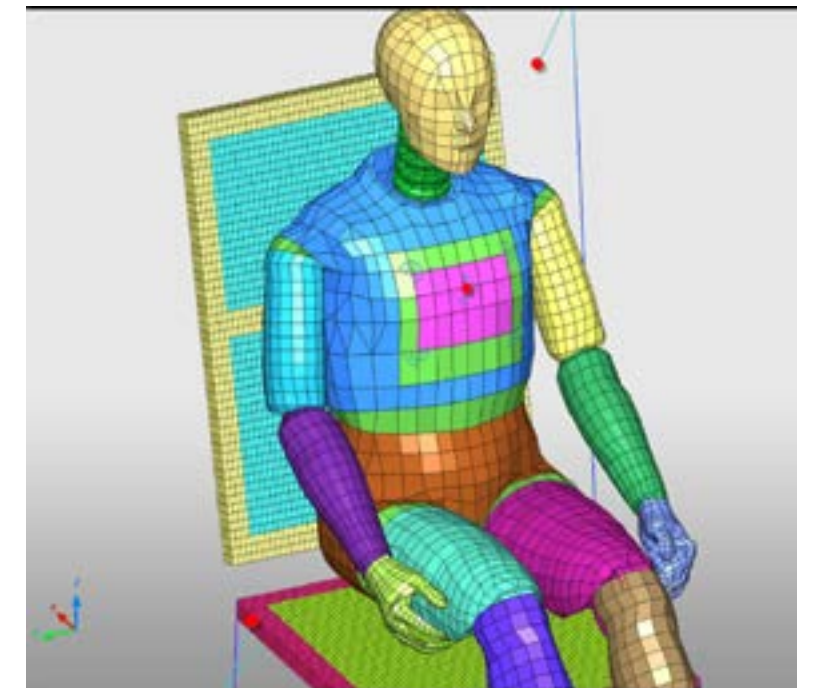

Fig 23 : Three nodes in red to model the seatbelt

3.4 Results & Discussion

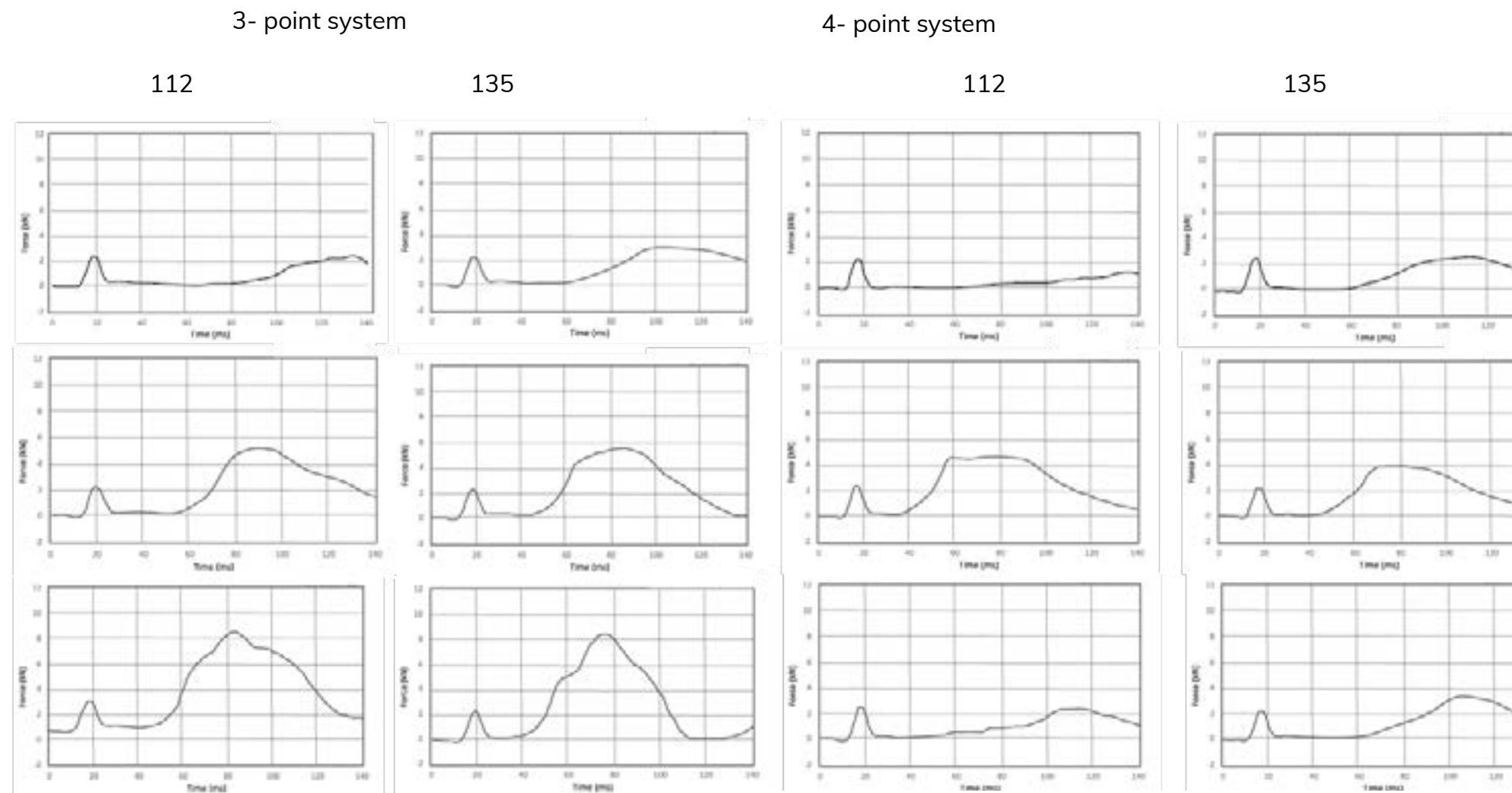

Fig 24 : Belt forces in 24km/h(1st row), 40 km/h (2nd row) & 56 km/h (3rd row)

3.4.1 Maximum Belt Forces

Figure x shows the maximum belt forces in three point and four point V restraint system. An initial peak is observed around 20ms in all cases for both restraint systems, this is due to tightening of the lap belt to secure the pelvis.

The maximum force is observed in the shoulder belt between 80-100 ms for three point & slightly earlier for the four point systems.

It is observed that at lower speeds(24km/h) is the curves are similar but as speed increases the four point effectively distributes the forces on its two belts away from the critical organs.

These forces are observed on the clavicle regions, indication that the body is loaded differently, this will in turn lead to a different set of injuries which needs to be studied further,

In general, it was observed at all speeds for both restraint systems, a greater force is required to control the body excursion in reclined position when compared to an upright position. Comparing the two systems, the four point has lower peaks in reclined positions.

3.4.2 Chest Deflection

In literature, typically four points around the chest are used to determine its injury criteria.

Since our study, does not include evaluating injury criterias, a single node was used to map the response of chest deflection as function of time.

In general, chest deflection increased with an increase of seatback angle. Peak chest deflection occurred between 80-100 & 100-120 ms for three point & four point systems.

Overall, the four point system performed better than three point system. In certain cases reducing it as much as 50 % when compared to the three point system.

The reason for this can be explained from the belt geometry. In the V4 system, the plane of the shoulder belt webbing is essentially vertical from the shoulders to the pelvis. This allows tension to build up in the shoulder belts, but prevents significant transmission of longitudinal forces to the thorax. That is because the belt webbing behaves like a flexible cable.

As described in B Seely and Ensign (1948), a flexible cable offers no resistance to bending and, therefore, “can transmit stress only along its axis, that is, the stress at any point of a flexible cable is tangent to the curve assumed by the cable”. The tension is entirely along the axis of the cable and the normal component of this stress is negligible when the cable is straight. It is only when the cable assumes a curved shape that the normal component becomes significant.

Therefore, if a shoulder belt spans the clavicle and pelvis, and is relatively straight, as in the V4 system, most of the stress will be along the webbing. There will be very little stress transmitted normal to the belt (into the chest), and the chest deflection should be minimal.

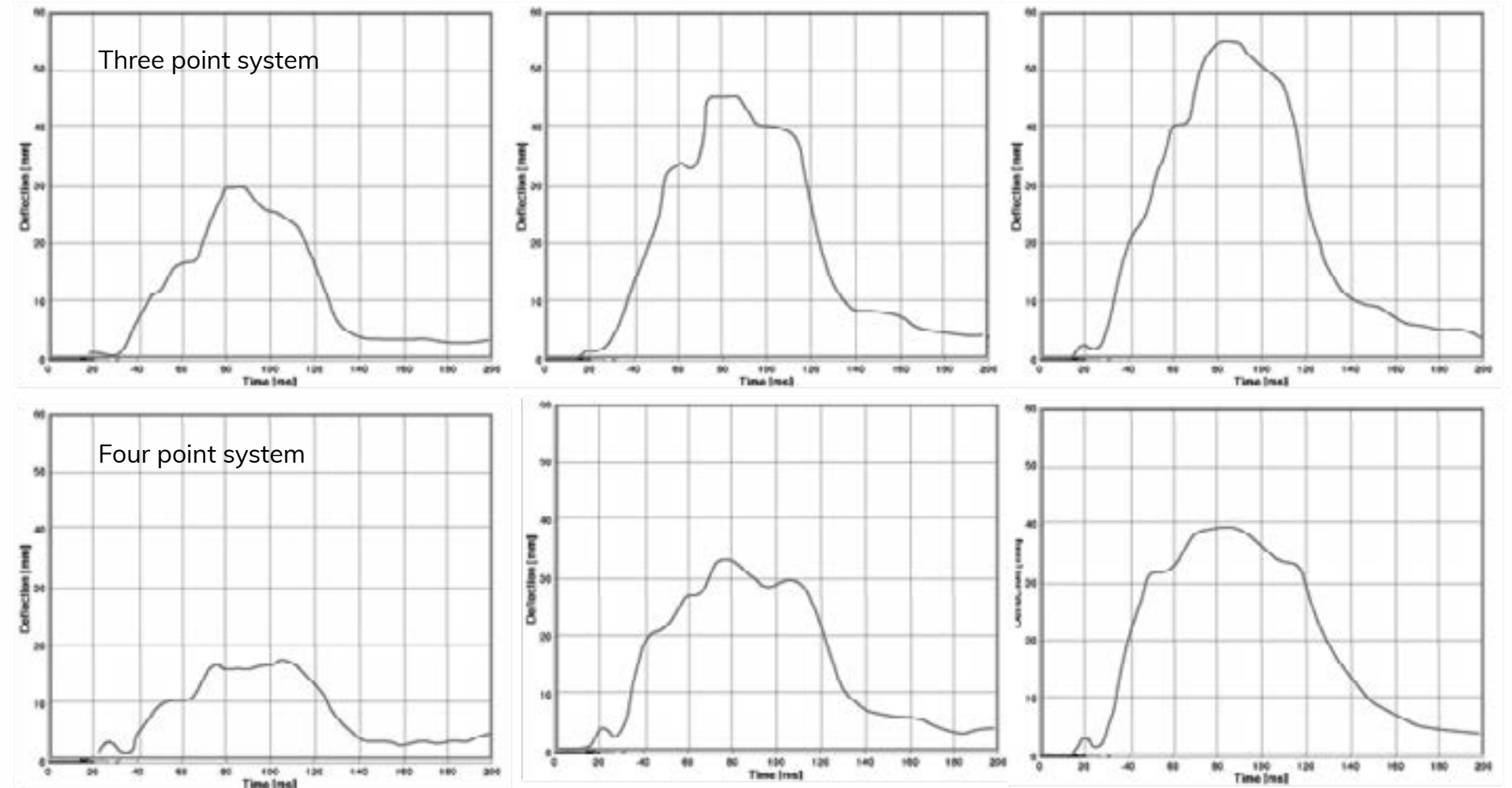

Fig 25 : Chest Deflection in 24km/h(1st column), 40 km/h (2nd column) & 56 km/h (3rd column)

3.4.3 Head Displacement

There was no significant difference between the head displacements between the two restraint systems.

In general, the head displacements increased with increasing the crash pulse. One's the body interacts with the belt system, the forward motion is restricted & a sharp acceleration is observed towards the chest.

In some cases contact is made before the head retracts back.

In reclined positions, the curve stretches out more. It is observed that the rotational value of the head increases, & even for lower speeds the head strikes the chest.

These findings are key for the design of frontal airbags. They need to have a greater volume when triggered in order to engage with the head. Alternatively, the location needs to be shifted from the dashboard to the roof,

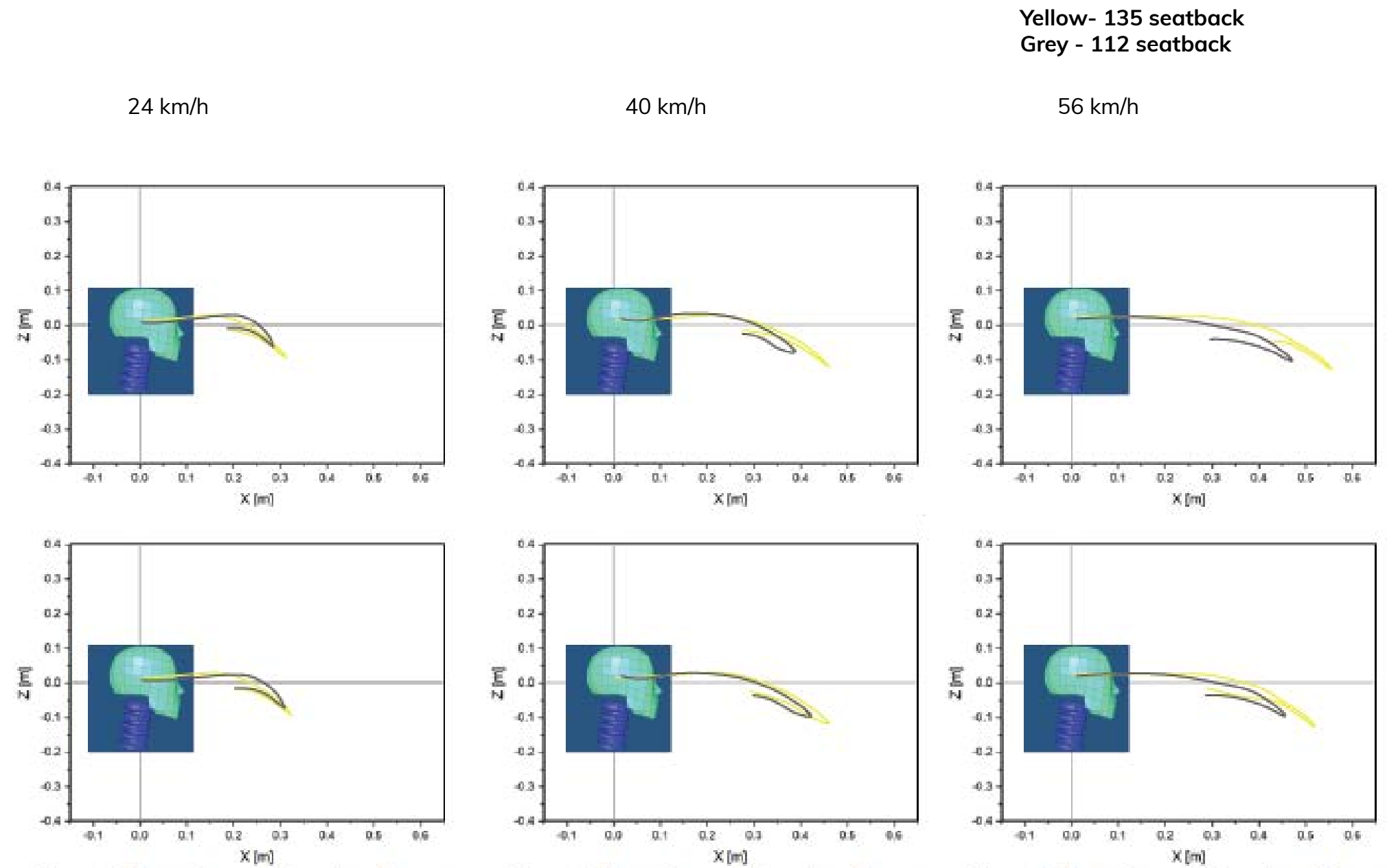

Fig 26 : Head displacement for three point(1st row) & four point system (2nd row)

3.5 Conclusion

The finite elemental simulations of both the three-point and four-point seatbelt systems were extensively analyzed under various seatback angles and multiple impact speeds, with a focus on evaluating belt forces, chest, and head displacements using a 50th percentile dummy.

The findings of the study revealed that at lower impact speeds, both the three-point and four-point systems exhibited similar performance characteristics. However, as the impact speed increased, the four-point system demonstrated superior performance by effectively distributing the forces to the clavicles, thereby diverting them away from critical organs. This even force distribution is a significant advantage of the four-point system over the three-point system, especially in high-speed collisions, where the risk of severe injuries is greater.

Interestingly, the research also highlighted that in general, the belt forces were considerably higher in the reclined seating position compared to the upright seating position. This indicates that the angle of the seatback has a notable impact on the forces experienced by the occupant during a crash.

Additionally, the study observed that with a reclined seating position, the rotational velocity of the head increases during impact, leading to potential collisions between the head and the chest. This highlights the importance of addressing head movements and head-neck interactions in reclined seating scenarios to mitigate the

risk of severe head injuries.

While it's essential to acknowledge the limitations of the modeling used in this study, the results offer valuable insights into the comparative performance of three-point and four-point seatbelt systems, especially in reclined seating situations. The evidence suggests that the four-point system outperforms the three-point system in distributing forces away from critical organs, thereby potentially reducing the severity of injuries during high-speed impacts.

These findings indicate the potential of four point harness style seatbelts to be studied further for different cases & PMHS(Post Mortem Human Surrogates).

04. Comfort Modelling

From previous chapters, it was indicated that the four point V belt configurations secures passengers more effectively than a traditional three point system when reclined. But any system is only good if it is accepted by the end user.

In this chapter, we first look into comfort models present in literature, modify them to present a comfort model for a restraint system.

To improve the user interaction, based on the comfort model a comfort study is conducted to evaluate initial & short term comfort for three & four point seatbelt system.

The results are formulated into design consideration, to be used during ideation & conceptualisation.

4.1 Comfort models from Literature

According to Zhang et al. (1996), comfort and discomfort are two independent factors. Discomfort is associated with the feeling of pain, caused by physical constraints in the design. Unlike comfort, which is associated with feelings of relaxation and well-being. Comfort and discomfort are the outcome of the interaction between seatbelt webbing and human occupant, influenced by parameters and adjustment of the seat and the body position and driving dynamics, of which the last two are known to change over time.

Mergl (2006) defines three time dependant periods of comfort, the initial comfort as the first three minutes, the short-term-comfort lasts up to 30 min and long-term comfort starts after 30 minutes. Hartung (2006) found a significantly higher discomfort.

The comfort model of Vink & Hallbeck (2012), visible in Figure 27, is based on the models of Looze (2003) and Moes (2005), and describes the (dis)comfort as experienced when a person interacts (I) with a certain product by using it (in this case seatbelt webbing). This interaction causes (H) human body effects, like postural changes or muscle activity. The (P) perception of these effects, related to prior (E) expectations, results in a subjective evaluation of (C) comfort or (D) discomfort. It can also result in a (N) neutral experience. Discomfort, over time can cause musculoskeletal complaints (M). The experience can be improved by adjusting the webbing, repositioning seatbelt anchorages, adjusting the posture or changing the one of the seat parameters.

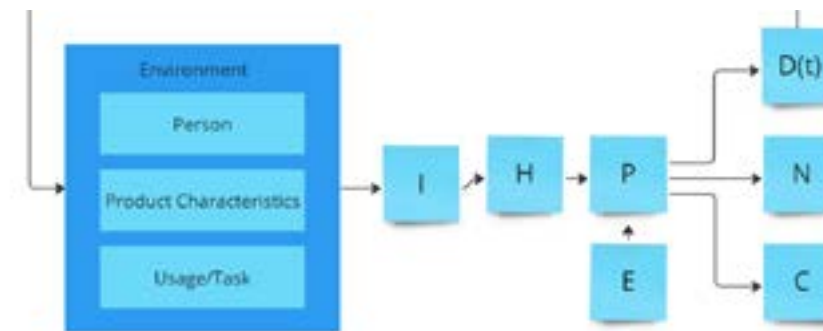

Fig 27 : Comfort model by Vink & Hallbeck

However, in order to use this model for the improvement of seatbelt webbing, it requires certain modifications. Fixed parameters of the human and the seat like body size or seat structure should be separated from variable parameters like seat settings or posture. In addition, driving dynamics should be added as the seat is an important connection between the (driving) car and the human (Bergs & Kanaska, 2012). At last, (dis)comfort improvement measurements should be defined.

The model of Wegner in Figure 28 proposes the addition of the driving dynamics (DD) and an option to adapt the seat (A). For our case driving dynamics can be added.

Naddeo (2014) modified the model of Vink & Hallbeck (2012) to study the upper body and the Range of Motion (ROM) of each joint, see Figure 29. Subjective and objective evaluation instruments were introduced to the

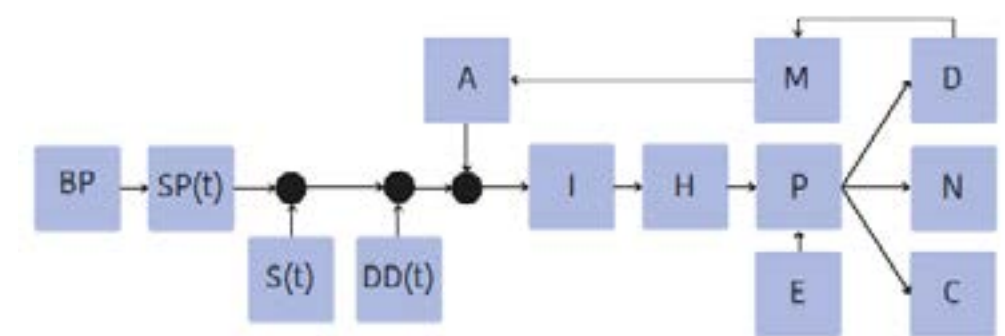

Fig 28 : Comfort model by Vink & Hallbeck

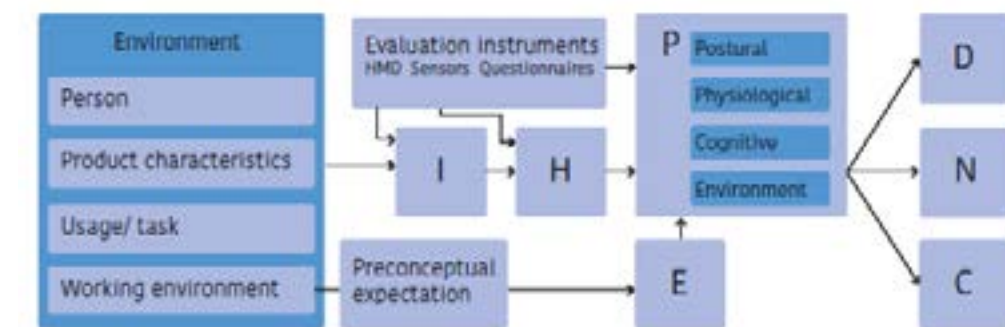

Fig 29 : Model by Naddeo 2021

model to study the interaction and its perception between human and product. In order to optimize this model to the evaluation of seatbelt (dis)comfort, the additions should be more structured and could then be added to the model of Wegner.

4.2 Analysing (Dis)Comfort of restraint systems

When analysing a seatbelt configuration for (dis)comfort, a deeper understanding is required of the variables and parameters at play. The (dis)comfort of a seatbelt webbing is at least influenced by four factors (Le et al. 2014):

- the configuration of seatbelt webbing
- the Seat adjustment angles (Backrest & Seat Pan)
- the Human
- the Interaction between these three element.

The modified comfort model visible in Figure 30; which is profoundly similar to those of Vink & Hallbeck (2012), Naddeo (2014) and Wegner; shows the reactions between the seatbelt and human occupant.

Seatbelt, seat and bodyparameter, both fixed at the moment of use, call for a certain seat adjustment and body position. The interaction (I) between the body position, body and seat webbing, seat adjustment and the addition of driving dynamics affect the human body (H). The way this interaction is perceived (P), combined with prior (E) expectations (car brand image,interior), either results in comfort (C), neutral (N) or discomfort(D). Prolonged discomfortable position of seatbelt webbing can even lead to localised points of discomfort(M).

The model uses both objective measurments & subjective measurments. Based on these, design considerations can be made with respect to location of anchor points moreover, points of discomfort can be identified and worked upon.

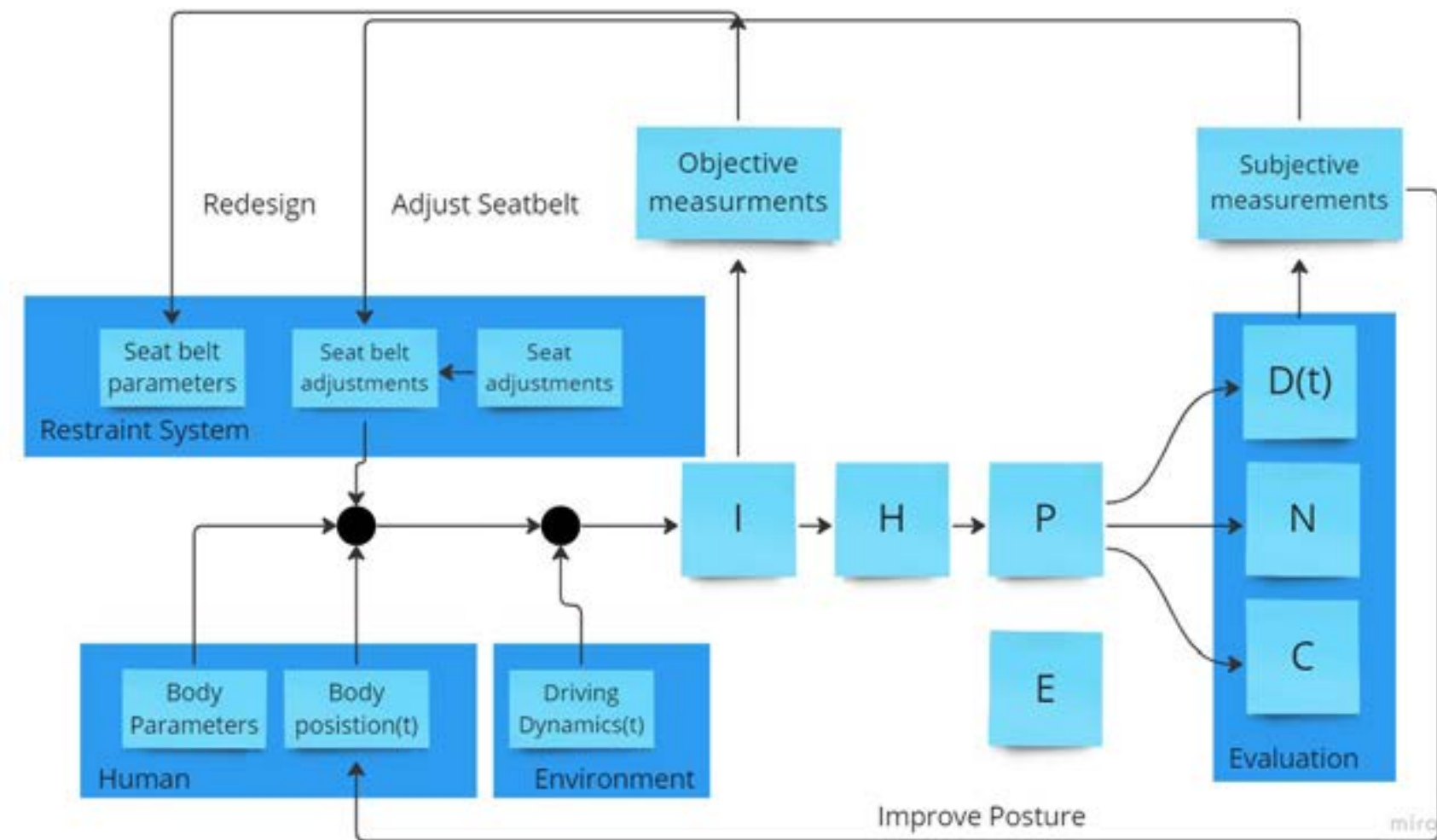

Fig 30 : Comfort model for safety belts

4.3 Parameters

4.3.1 Objective measurements - Contact Pressure

The first and most researched comfort quantifying parameter is pressure. Pressure forces act perpendicular to a surface and are usually expressed in [N, N/ cm² or kPa].

The three point system crosses the middle of the occupants clavicle (the one closest to the shoulder anchorage, crosses the central of the sternum/chest, and extends to the latch plate/buckle that rests lateral to the pelvis & greater trochanter. The lap belt passes over the anterior pelvis at or below the level of the anterior superior iliac spine. (Refer Fig 31)

For the four point system, the lap belt has a similar contact to a three point system, but the shoulder belts pass over the the shoulder blades, passing on each side of the sternum to attach with the lap belts. Refer Fig 32.

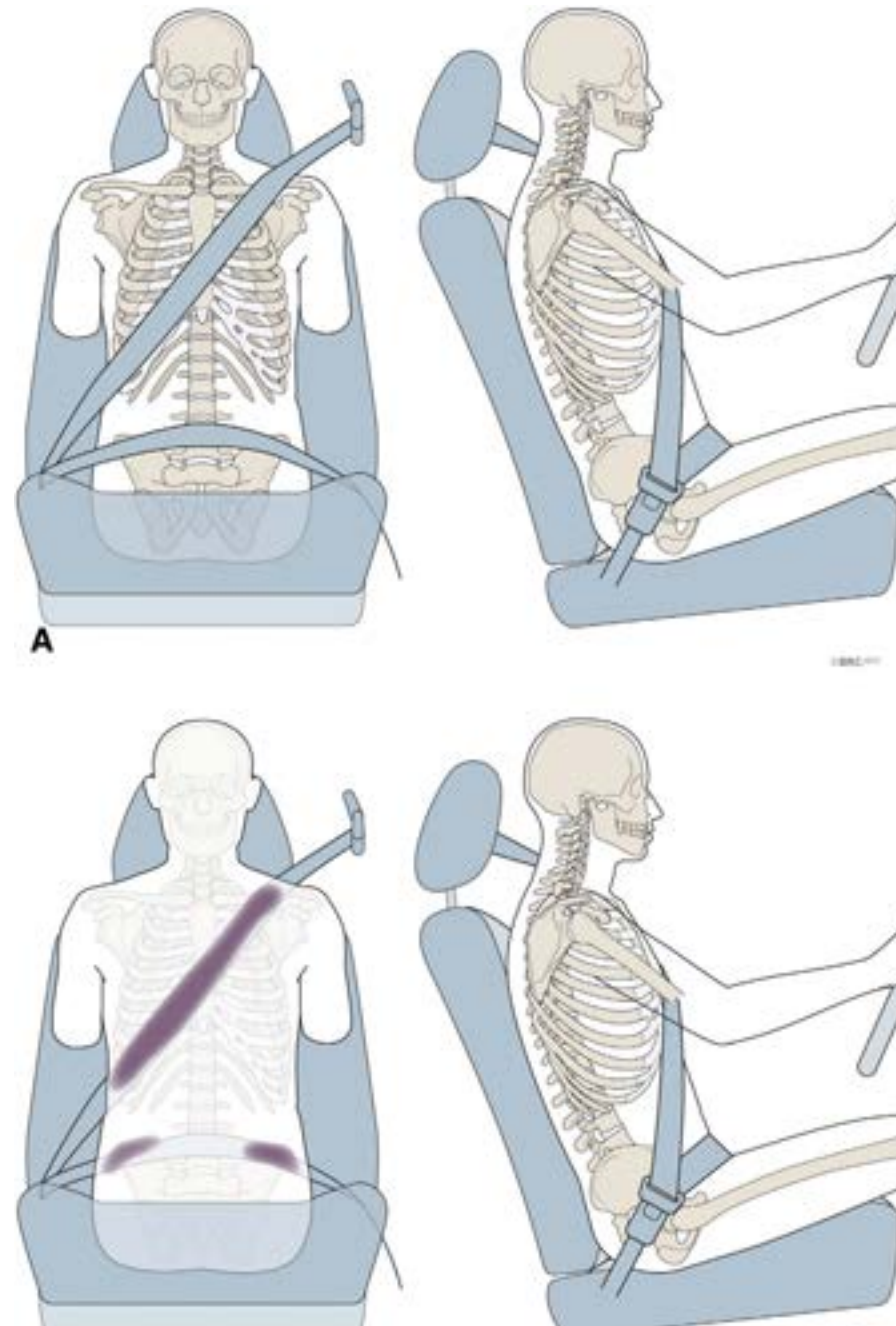

Figure 31 : Contact points for three point belt



Figure 32 : Contact points for four point belt

The position of upper anchorage point also determines the contact pressure. According to Chen et al. (2003), the contact pressure is least when the upper anchorage is closest to the occupant in the fore-aft direction (X axis) & lateral direction (Y axis). The change in pressure with respect to Z axis is not significant, but subjective comfort rating suggested a lower Z point, provided better seatbelt fit. Moreover it reduces the risk of seatbelt rubbing the neck or slipping of the neck.

With respect to Backrest angles, the mean pressure reduced with an increase of backrest angle, though the maximum backrest angle measured was 120.

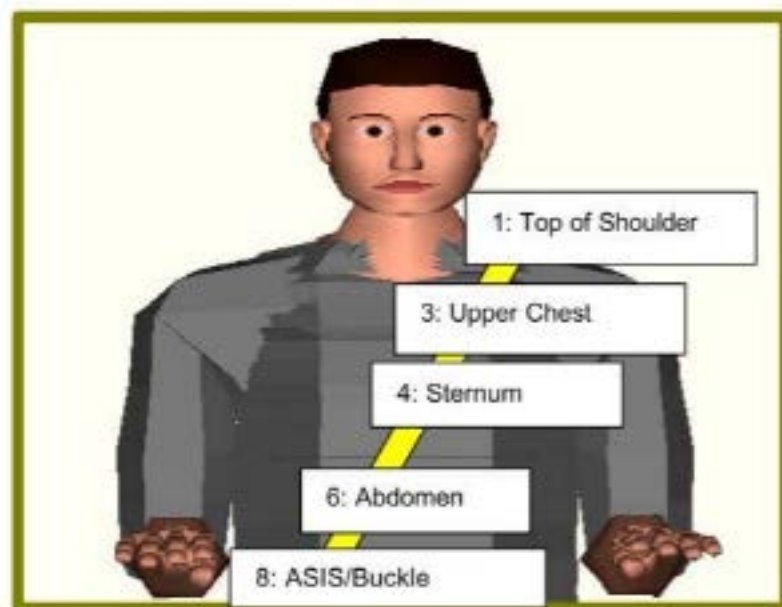

Figure 33 : Reference points used by Chen et al (2003) to study pressure distribution

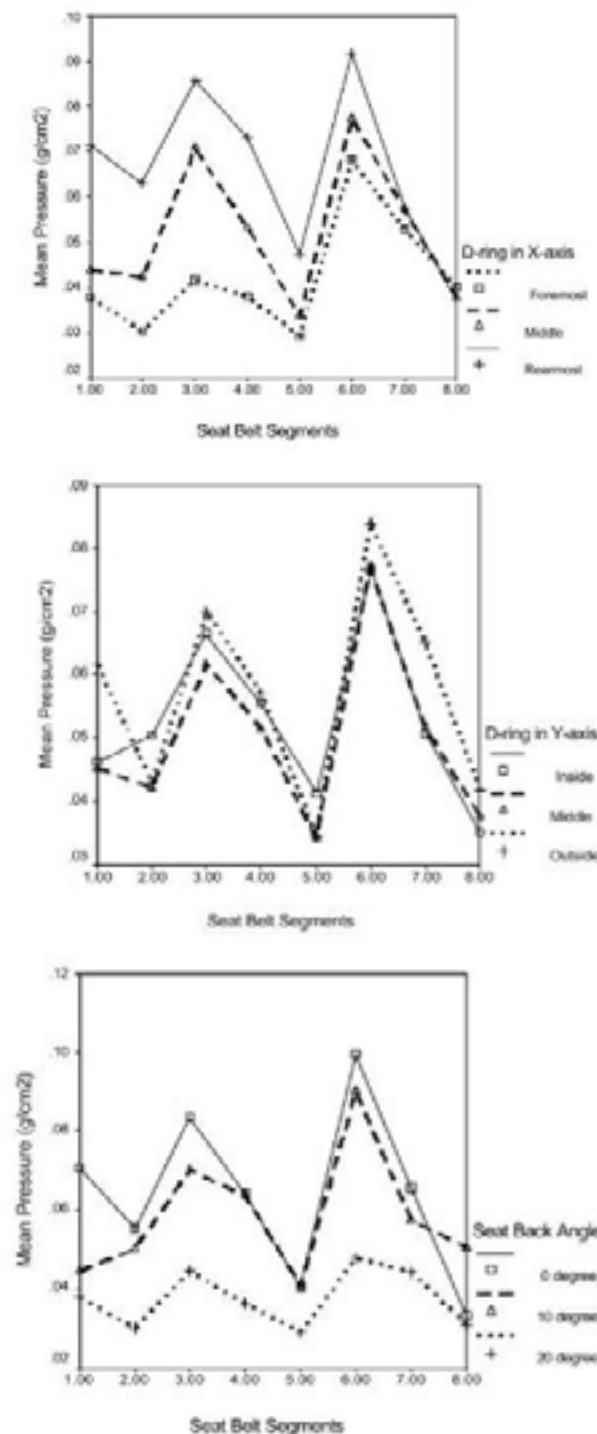

Figure 34 :Pressure change with respect to X, Y & seatback angle

4.3.2 Human parameters

The pressure experienced depend on ones size and weight, Each human individual is unique, therefore each interaction with a seatbelt is unique. Human factors known to influence the (dis)comfort of a beltfit are size, weight, gender and age.

With respect to age, according to Bohmana et al., 2019, the lateral shoulder position differed only slightly between older & younger participants and there was no difference in shoulder belt contact with the clavicle, However, the shoulder belt position on the abdomen was commonly higher for the older adults than for the younger. This resulted in higher lap belt angles, which increases the risk of submarining (Halanf et al, 1991).

No studies could be found in literature with respect four point systems.

4.3.3 Subjective measurements

While objective measurements give indications on what parameters needs to be altered to reduce discomfort. At the end of the day, discomfort can not be objectified.

To analyse the (dis)comfort of safety systems, a study presented in the next section is used to determine the initial and short term discomfort for three & four point belt systems in reclined position.

4.4 Seat Belt Comfort study

4.4.1 Introduction :

As previously stated in the introduction, comfort & short term comfort last up to three & thirty minutes respectively. This section discusses a study evaluating the short-term comfort of three- and four-point restraint systems in reclined positions.

Designing a comfortable product is challenging, as there's no universal concept of comfort. Slater (1985) defines comfort as a pleasant physiological, psychological, and physical harmony between a person and their environment. Richards (1980) emphasizes that comfort is a person's subjective well-being in response to an environment. Looze et al. (2003) highlight accepted points in the literature:

- Comfort is subjectively defined.
- Various factors (physical, physiological, psychological) influence comfort.
- Comfort is a reaction to the environment.

These points guide the procedure framing.

4.4.2 Subjects

About 11 students of Delft university of technology aged between 22 & 28 years old (7 male, 4 female) took part in the study.



Figure 36 : Participants during the comfort study.

4.4.3 Procedure :

Each session accommodated a maximum of two participants. Participants were provided with an informed consent form outlining the study's objectives. This was followed by taking body measurements. Following this they were then guided to their designated seats, where they were instructed to secure their seatbelts and adjust their seats for optimal screen visibility. During a 20-minute television viewing period, participants had the flexibility to adjust their seats, as well as select different television programs. Comfort and discomfort levels were assessed through a questionnaire administered twice: once after securing the seatbelt at the outset and again at the session's conclusion after seatbelt removal.

The procedure was iterated with swapping seats to ensure comprehensive evaluation.

4.4.4 Materials:

Two distinct car seats were utilized, placed on pallet stands to establish a uniform base. To ensure equal seat height, one seat was elevated. A platform was then constructed between the headrest and backrest, serving as the placement for shoulder anchorages of the restraint system (refer to Fig 37).

Conducted at the Faculty of Industrial Design Engineering in Delft, the experiment simulated in-vehicle entertainment with a 32-inch television screen mounted on the forward wall (see Fig 38)

4.4.5 Measurements

The comfort and discomfort levels of systems were assessed via a questionnaire, employing the Localised Postural Discomfort (LPD) method. This technique, as described by Grinten and van der Smitt (1992), gauges



Fig 37 : Prototype for seatbelts

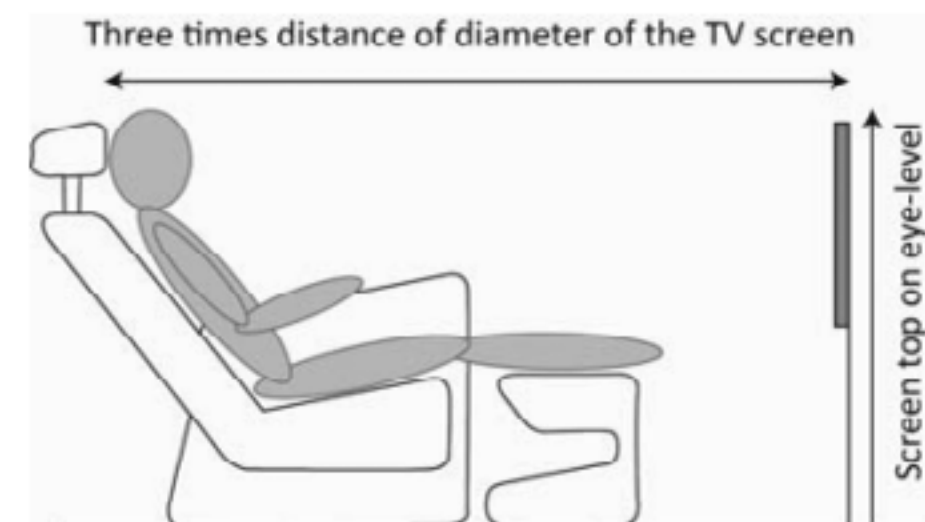

Figure 38 : Test setup

experienced discomfort in specific body regions- head, neck, arms, upper back, lower back, and upper legs. The Borg Category Ratio Scale (Borg, 1990), ranging from 1 to 10, quantifies discomfort intensity, with higher scores indicating greater discomfort. Participants marked numbers on a body map divided into 12 regions (see Fig 40). The method has been used frequently and predicts whether complaints could be found later in the product. (Hamberg-vanReenen, 2008)

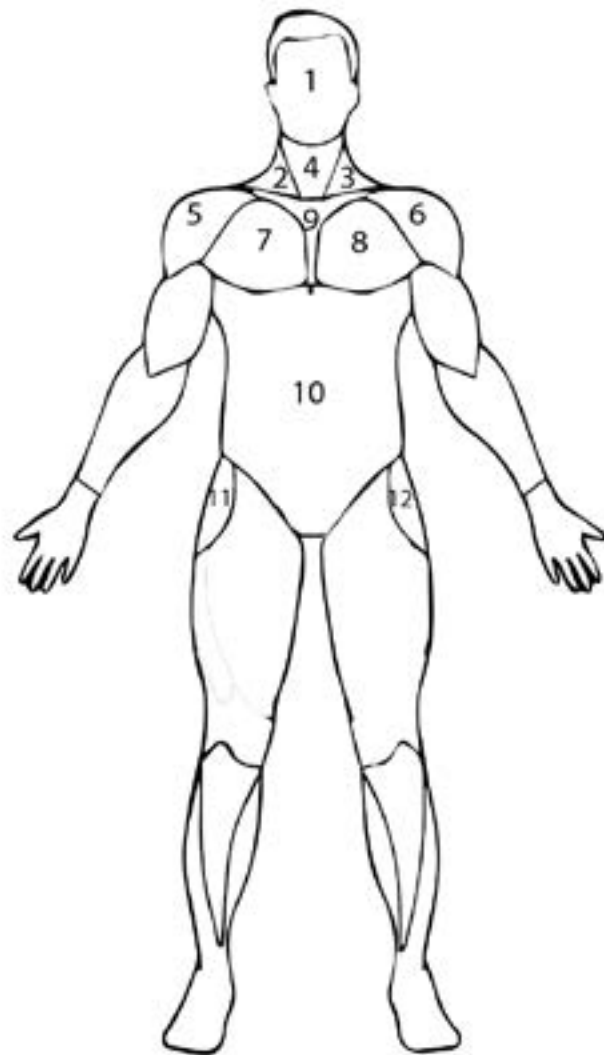

Fig 40 : Body chart for LPD

4.4.6 Analysis :

The average score of participants per measuring moments was calculated. Additionally the change in LPD scores were calculated indicating the change of the locally perceived discomfort while using a particular seatbelt configuration.

From these results insights were generated which can be used in the design phase.

4.4.7 Results :

- (Un)Buckling time : Figure 41 & 42 shows the self reported time to buckle & unbuckle the seatbelts. On average, the four point configuration required more time.
- LPD results : The graph in fig 43 shows the average scores of Locally Perceived Discomfort for all body regions. The graph in fig 44 shows the individual change of the Locally Perceived Discomfort scores per body region.

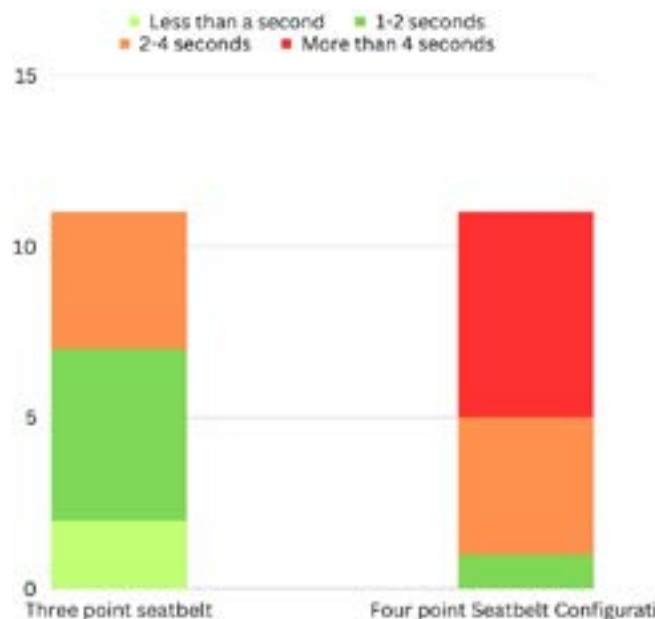

Fig 41 : Buckling time

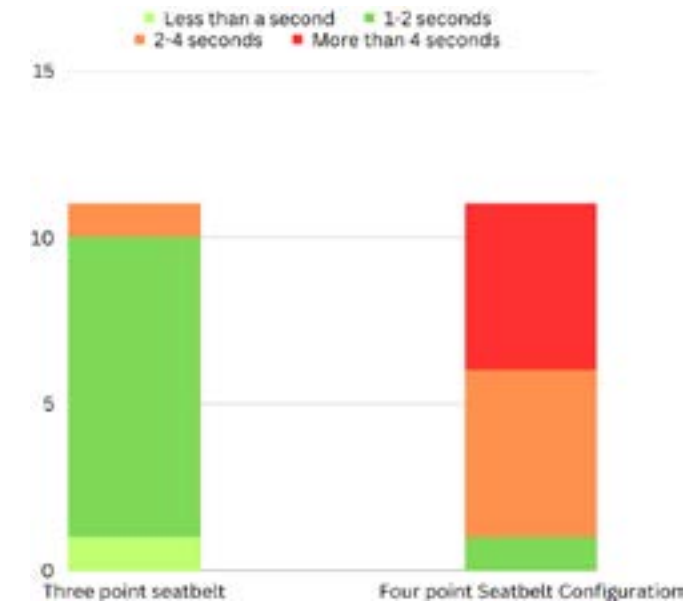

Fig 42 : UnBuckling time

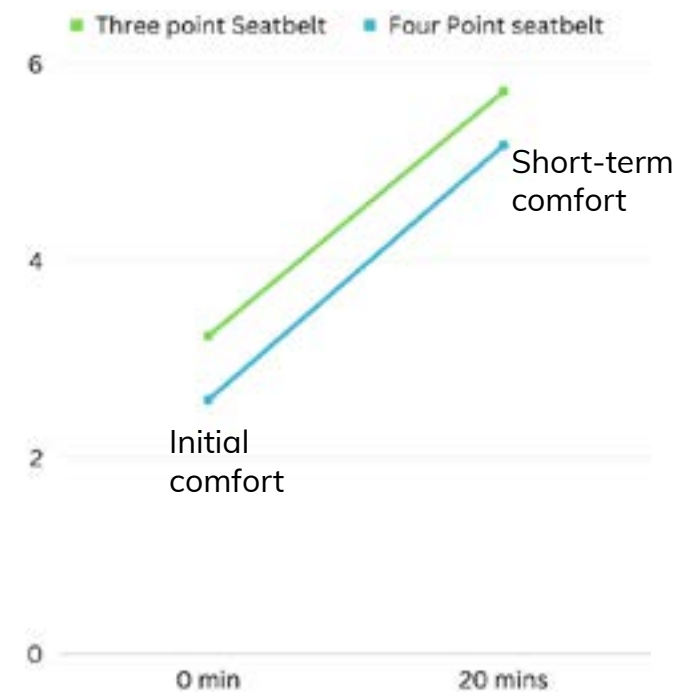

Fig 43 : Comfort over the duration

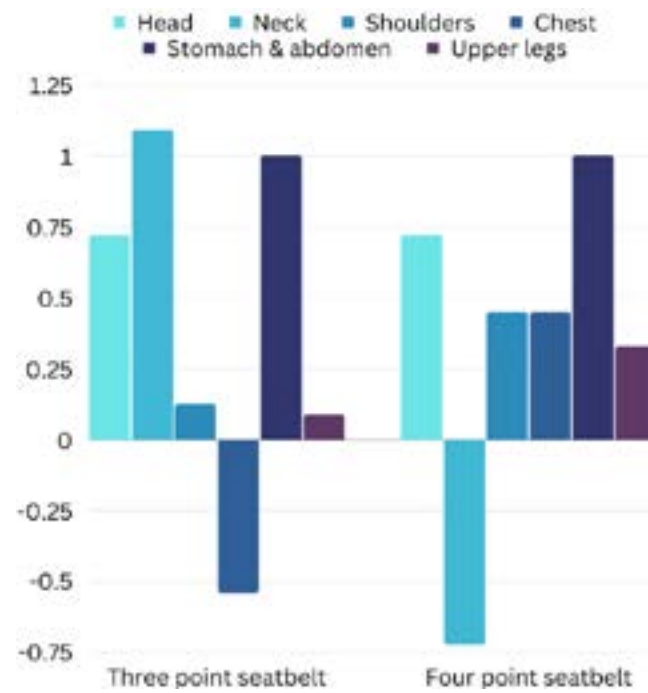

Fig 44 : Change in comfort scores of individual parts

4.4.8 Discussion :

- (Un) Bucking time : Participants took a greater amount of time to buckle & unbuckle the four point seatbelt as they were unsure about the process. Some participants proceeded to fasten from one side similar to the three point system, resulting in a lopsided configuration. Another shortcoming mentioned by most participant included locating both the straps.
- The unbuckling time was also greater as participants needed to remove both the arms , which is an extra action to be performed.
- LPD scores : Participant discomfort was evident in specific body regions. Notably, neck discomfort in

three point system, particularly on the left side, received notably high scores. Participants noted that reclining further back led to the webbing being closer and causing itchiness around the neck. In contrast, the four-point system yielded lower scores in the neck region due to the belt's path over the clavicles.

- Head Discomfort: The head region discomfort primarily stemmed from the headrest. While slightly forward tilting of the headrest suited an upright position, participants expressed a preference for a flatter headrest in reclined positions.
- Stomach and Abdomen Discomfort: In the four-point system, discomfort in the stomach and abdomen regions arose from buckle positioning. As participants shifted forward, the buckle would ascend, resulting in an ill-fitting seatbelt.
- Seat Preferences: Some participants indicated a desire for a flatter backrest to enhance comfort during reclined relaxation or sleep.

Overall, participant feedback highlights the significance of neck comfort, headrest adjustability, buckle placement, and backrest design in optimizing comfort during reclined seating experiences.

4.4.9 Design considerations:

Based on the comfort, the following design considerations can be made.

In Scope (with respect to restraint systems)

- People are unfamiliar with fastening a four point system, any system designed should be intuitive and build up on their existing knowledge of fastening a three point seatbelt.
- For the three point system, the shoulder anchorage should be placed wider than the shoulder. Based

on anthropometric data, this should be greater than 41 mm(DINED).

- In four point position, the buckle should be stationary providing an optimal belt fit.
- Out of Scope (With respect to seat & head rest design)
- People preferred a flatter seatback in reclined positions
 - The seat needs to be wider to accommodate the previous requirement of wider shoulder anchorages.
 - The headrest needs to be flatter.

05. Ideation & Conceptualisation

All chapters leading up to now, have established that in reclined seats the body kinematics changes considerably, requiring automakers to come up with new ways to secure occupants while travelling.

In this chapter, we initially summarise the design considerations collected throughout. This is followed by ideation using a morphological approach to design variations of individual elements.

Different methods involving users like user test, interviews & questionnaires are used to evaluate to come up with the final concept.

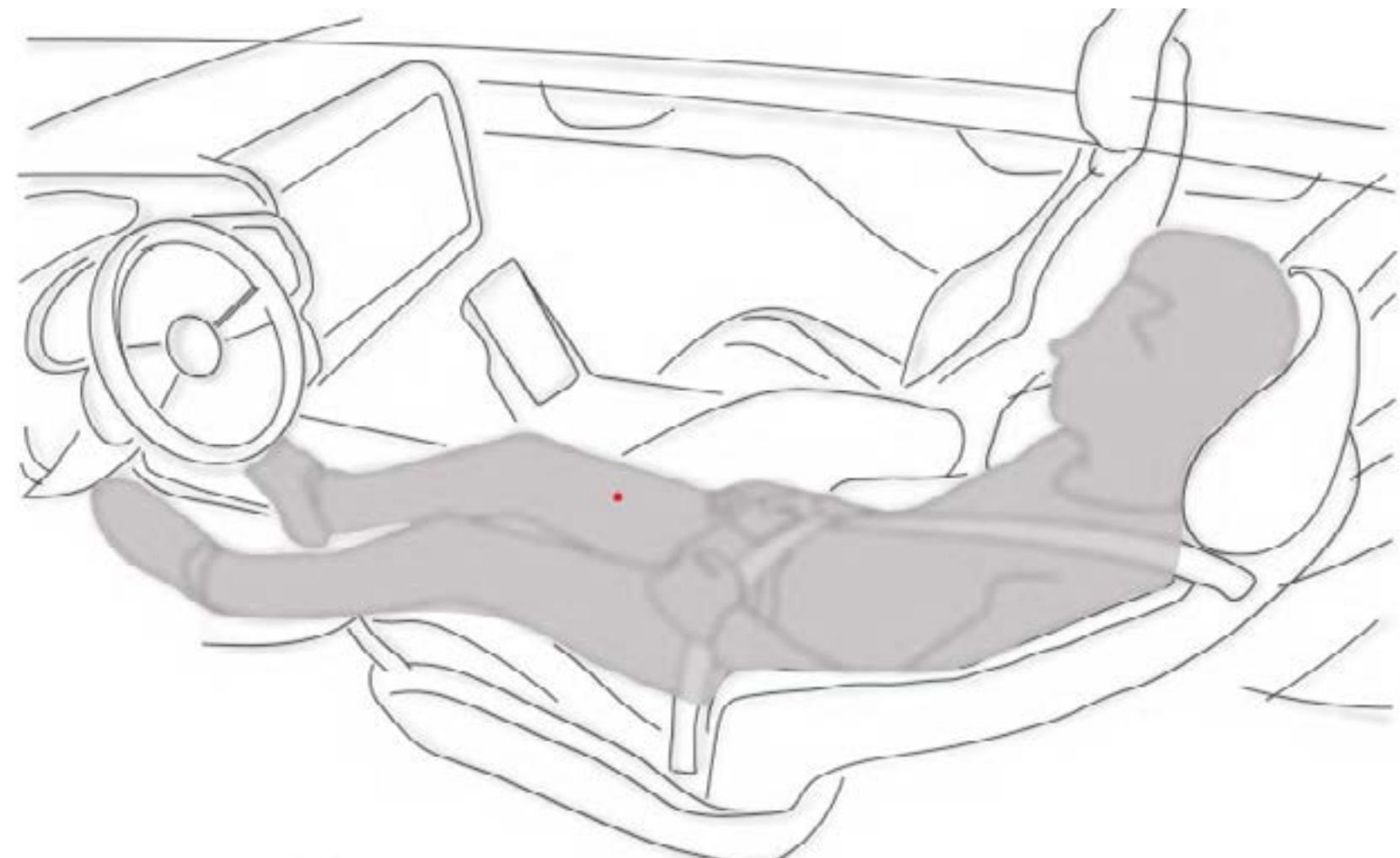

5.1 Design Goal

From chapter 3, it was determined that V4 seatbelt configuration was more effective than a traditional three point system.

The design goal was redefined from chapter 1 to :

“ To create a comfortable four-point restraint system that guarantees occupant safety in both upright and reclined positions. This system should provide optimal support and fit for occupants in various postures without causing discomfort, which is seamlessly integrated within the vehicle without hindering interaction with their surroundings..”

The terms used have the following meaning :

seamlessly integrated within the vehicle :

To maintain a seamless integration with the vehicle interior, the four-point restraint system should be designed in coordination with the overall vehicle design. The system should not interfere with the vehicle's aesthetics, ergonomics, or functionality.

without hindering interaction with their surroundings :

Occupants should be able to reach for items, adjust in-car features, and perform various activities with ease while still being adequately restrained.

5.2 Design Criterias

Design Consideration :

The design recommendation from each chapter along with current legalisation set forward by The United Nations Economic Commissions for Europe in ECE r14(seatbelt anchorages) & ECE R16 (seatbelts) are used to form design criterias.

General :

- All rigid parts of the system should not have sharp edges.
- All parts vulnerable to corrosion should be treated suitably.
- Rigid parts used for energy absorption should not be fragile
- The system should be operational between seatback angles of 110-135.
- The egress time in the event of collision should be less than 7 seconds.

Straps :

- The minimum width of seatbelt webbing should be 46 mm. (ECE 16)
- The strap should have energy absorbing & energy dissipating capacity. (ECE R16)
- The minimum thickness of seatbelt webbing should be 2 mm. (ECE R16)
- No sharp edges should be present on the webbing.
- The material used should be flame resistant.

Seatbelt anchorages :

Anchorage are defined as points of seatbelts attached to

the seat or the vehicle body.

- Should prevent damage to the strap at the point of interaction.
- All anchor points should be atleast 120 mm behind the H point of the seat.
- The upper anchorage point should be between 400 & 1000mm from the center of seat.
- .The anchor plate needs to gave a dimension of atleast 25x25 mm including 6 mm hole to secure it. (ECE R16)

Buckle :

- For buckles in harness styles, the maximum contact area with the occupant should be between 20 & 40 cm².
- The minimum width of the buckle should be 46mm.
- The operating force to lock and unlock the buckle should be between 1-6 daN
- The buckle should be released by pressing either a button or a similar device.
- The surface to which this pressure is applied should atleast have an area of 4.5 cm² with a minimum width of 15 mm
- For non enclosed button, the minimum area should be no less than 2.5 cm² with minimum width of 10 mm
- The buckle release area should be in red colour. No other part of the buckle should be of this colour
- The buckle needs to undergo a dynamic testing of 5000 opening & closing cycles.

Retractor

- The retractor need to undergo certain strength tests.
- Automatic retrsctors should be designed to ensure locking is possible in every 30 mm of webbing.
- They need to undergo dynamic testing of 5000 cycles of extracting and retracting.

From Comfort studies:

In Scope (with respect to restraint systems)

- People are unfamiliar with fastening a four point system, any system designed should be intuitive and build up on their existing knowledge of fastening a three point seatbelt.
- For the three point system, the shoulder anchorage should be placed wider than the shoulder. Based on anthropometric data, this should greater than 61 mm(DINED).
- In four point position, the buckle should be stationary providing an optimal belt fit.

Out of Scope (With respect to seat & head rest design)

- People preferred a flatter seatback in reclined positions
- The seat needs to be wider to accomodate the previous requirement of wider shoulder anchorages.
- The headrest needs to be flatter.

5.3 Ideation

A morphological chart approach is used for ideation. The restraint system is broken down by its key components. For each component multiple designs are ideated. For each component, different design alternatives are evaluated with the best ones considered for conceptualisation.

5.3.1 User Experience with experience with locking procedure

To ensure the successful adoption of a safety system, it is essential to consider not only its technical effectiveness but also its acceptance by users. A safety system can only fulfill its purpose if it is embraced and utilized by occupants consistently. Achieving user acceptance involves various factors, including user-friendliness, ease of operation, comfort, and integration with the overall vehicle design.

In this section, we come up with different alternatives occupants can undergo to fasten a four point system.

Four different procedures were ideated to fasten the system. (Refer Fig 45)

Procedure 1 & 2 were similar in the aspect that both required the shoulder belts to be fastened into the lap belt individually. Only aspect which was different was how the lap belt was fastened.

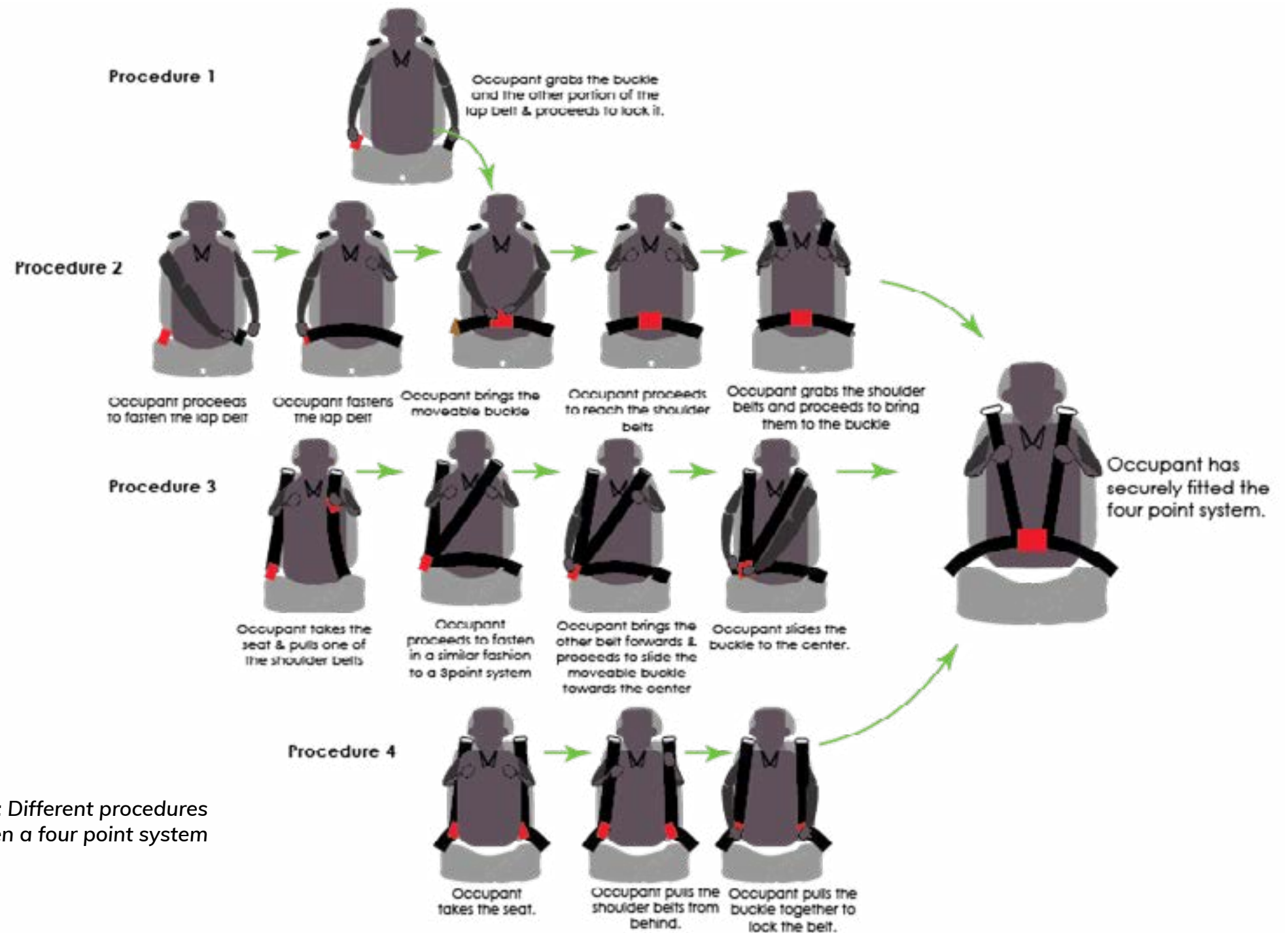

Fig 45 : Different procedures to fasten a four point system

Overall, both the procedures required three fastening points, with procedure 2 requiring the occupant to unlock the buckle from the side and slide it to the center.

Procedure 3 involved the occupant to initially fasten the seatbelt similar to a three point system, followed by bringing the other shoulder belt forward & sliding the buckle to the center.

The system designed for this possible scenario can act as a three point systems in upright & four point system in reclined positions.

In Procedure 4, the occupant needs to bring the shoulder belts from behind & requires occupants to fasten the buckle present at the hip level.

Every procedure had its advantages & flaws. Since the design of the rest of the system components depended on which procedure would be suitable, a questionnaire was shared with users.

Evaluation

To gather insights, a questionnaire was designed, summarizing prior chapters' findings and emphasizing the efficacy of the four-point system in reclined seating scenarios. The questionnaire aimed to gauge participants' perceptions regarding ease of use and their willingness to adopt the system in their daily routines.

A total of 46 responses were collected, providing a comprehensive view.

The general consensus regarding the four-point system was that it impeded occupants' interaction with their surroundings.

Participants ranked Procedure 4 as the most user-friendly, while Procedure 1 and 2 were deemed the least preferable (Fig 46). Interestingly, Procedure 3 received the highest ranking for fitting into participants' existing knowledge (refer Fig 47), indicating a lower barrier for user acceptance. Respondents highlighted

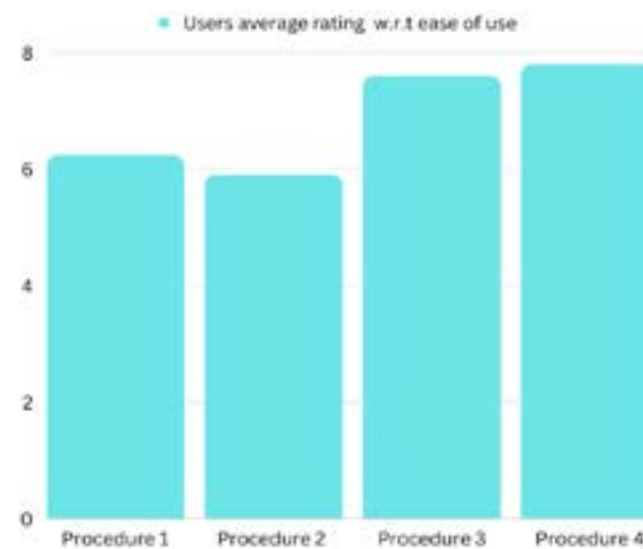

Fig 46 : Average responses w.r.t ease of use



Fig 47 : Average responses w.r.t adaptability

an additional advantage: the potential to use the system as a three-point solution for daily use.

Feasibility concerns were also raised, primarily related to the design of a sliding buckle.

Considering these insights and referencing past failures of companies like Volvo and Ford in introducing four-point systems (The Next Belt for Passenger Safety - 4 - Point Seat Belt Design, n.d.), the design goal was reframed :

“ To create a interchangeable restraint system that guarantees occupant safety in both upright and reclined positions. This system should provide optimal support and fit for occupants in various postures without causing discomfort, which is seamlessly integrated within the vehicle without hindering interaction with their surroundings.

Subsequent ideation and conceptualization efforts are centered around the implementation of Procedure 3.

5.3.2 Retractor

The retractor is a fundamental component of modern seatbelt systems, playing a vital role in occupant safety & comfort during vehicle travel. As a mechanism responsible for controlling the seatbelt's length and tension, the retractor ensures that the seatbelt remains snug and securely restrains the occupant in the event of a collision or sudden deceleration. This section will explore how the position of retractors would influence users' comfort.

Fig 48 shows the different placement retractors. Here R refers to retractor & F refers to fixed anchorage point to the seat/vehicle body.

Each configuration was prototyped in the lab and tested out to realize potential drawbacks.

- Option A involved placing retractors on the end of the lap belt & fixed anchorages for the shoulder belt. The retractors present in the lap belt secured the buckle in its position in both upright & reclined positions. Only drawback observed was that the forward motion to interact with the surroundings was limited due to the fixed shoulder belts.
- Option B, inverted the configuration of option A. It provided more freedom to move forward but had issues with the buckle rising above the abdomen in reclined positions.
- Option C is the combination of A & B. It has a recliner placed on all four belt ends. This was able to mitigate the problems previously faced but increases the overall cost of the system. Furthermore, the lap belt retractors need to be redesigned.

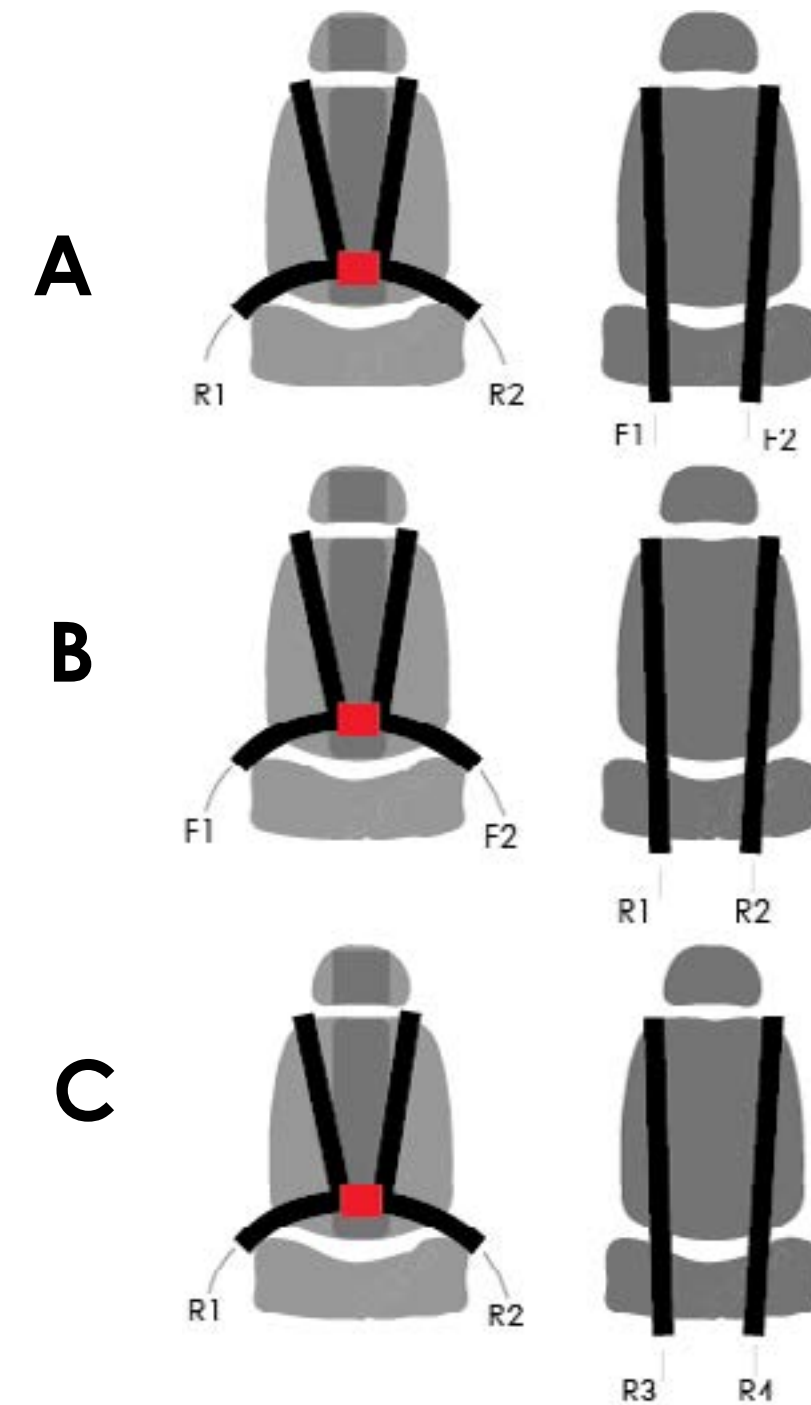

Fig 48 : Different configurations of retractors

5.3.3 Buckle Designs

Seatbelt buckles play an indispensable role within automotive safety systems, guaranteeing both secure and convenient fastening for vehicle occupants.

The design process places considerable emphasis on ergonomics, aiming to create a user-friendly interaction that accommodates various scenarios.

To refine this interaction, a sequence of sketches and prototypes were created, allowing for direct user feedback. Through this iterative process, a prevailing preference for buckles featuring a central trigger for release was evident among participants. This design choice was favored because individuals could access and operate it comfortably, whether in a three-point or four-point configuration.



Fig 49 : Buckle prototypes

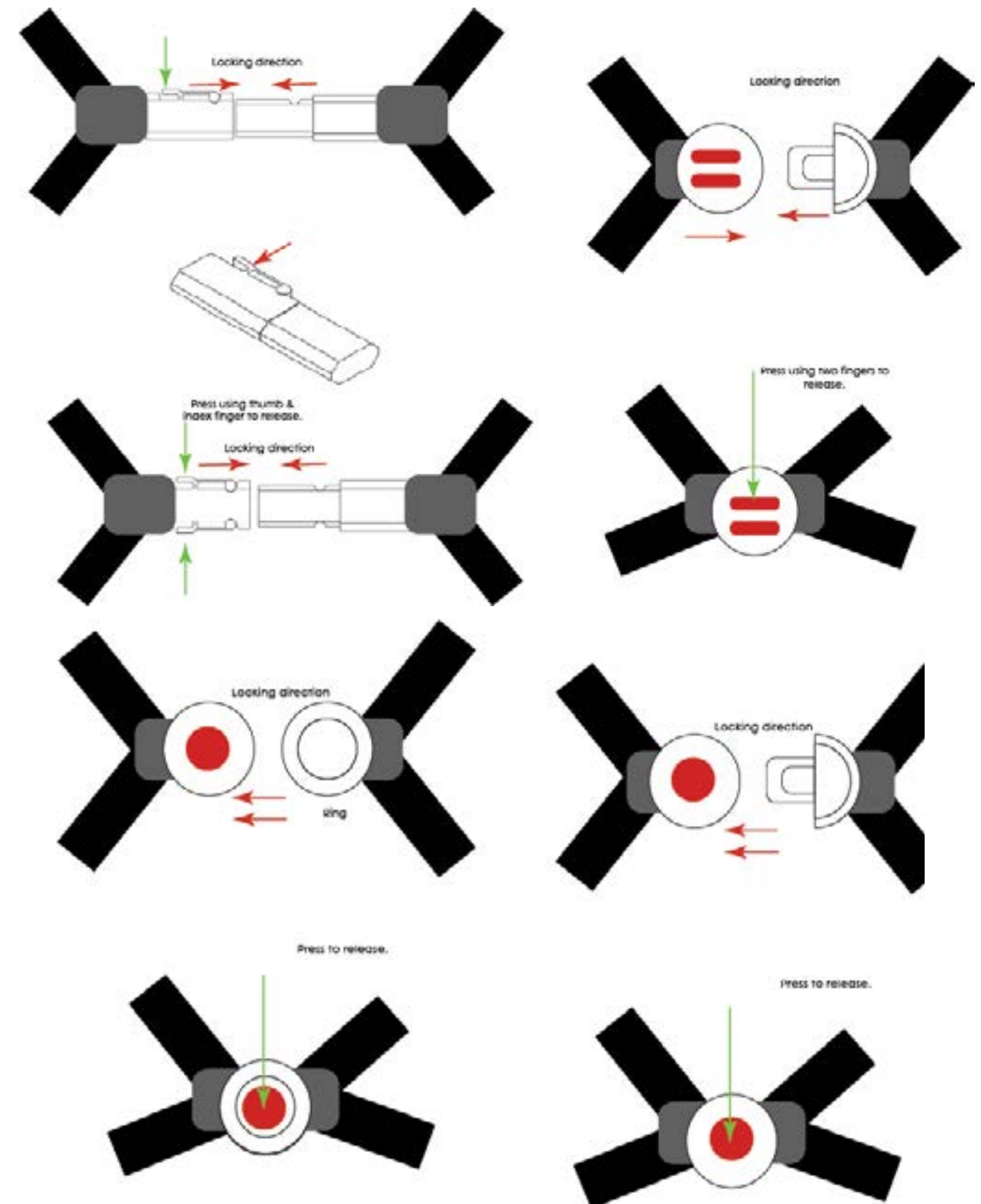

Fig 50: Buckle ideation

5.3.4 Integration of belt & buckle

The integration of the belt and buckle determines whether proper seatbelt fit is achieved or not.

After ideation, it was determined, a slight angled geometry with the buckle & hinge joints on the shoulder belt would provide proper belt fit while also allowing user to adjust to their convenience.

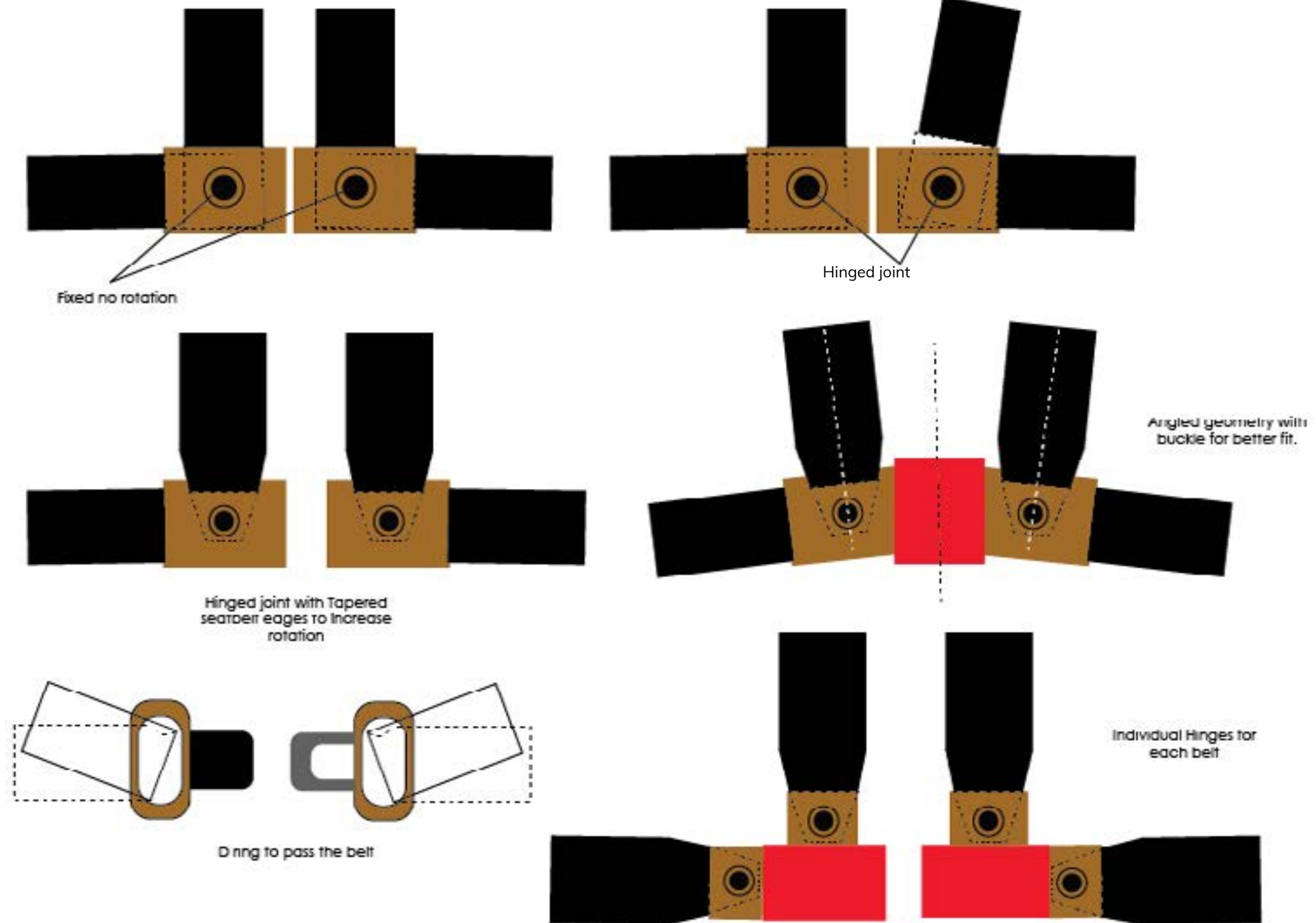

Fig 51: Ideation w.r.t belt and buckle integration.

5.4 Conceptualisation

Having generated a vast number of ideas, different choices were combined to conceptualise solutions. A BMW U06 front seat was used during conceptualisation. These seats are already in series production since 2021 & are used in BMW UKL vehicles.

5.4.1 Version 1 :

The first conceptualisation features having a center release buckle. The shoulder straps are joined to the buckle using a hinge joint. The hinge joint has a 30 degrees range of motion, which helps with better belt fit. (Refer Fig 52)

The retractors for the shoulder belts are placed behind the seats & for the lap belts on the sides.

It was determined to have the tension in the lap belts greater than that of shoulder belts as it will keep the buckle locked securely. This can be seen in Fig 53 & 54.

Though with greater lap belt force the webbing might be outside, to place it on the inside, the structure of the seat might have to be altered.

In an upright position, the user can grab the tongue of the seatbelt and secure himself in a three point configuration. (Refer Fig 55)

When they wish to recline further, they can be alerted to shift to the four point configuration. The alert system is not part of the project but could be as simple as the alert system to fasten your seatbelts.



Fig 52 : Central release buckle

If the tension in the shoulder belt is greater, the buckle will be free to move around.



Fig 53 : Free Configuration with greater shoulder belt tension

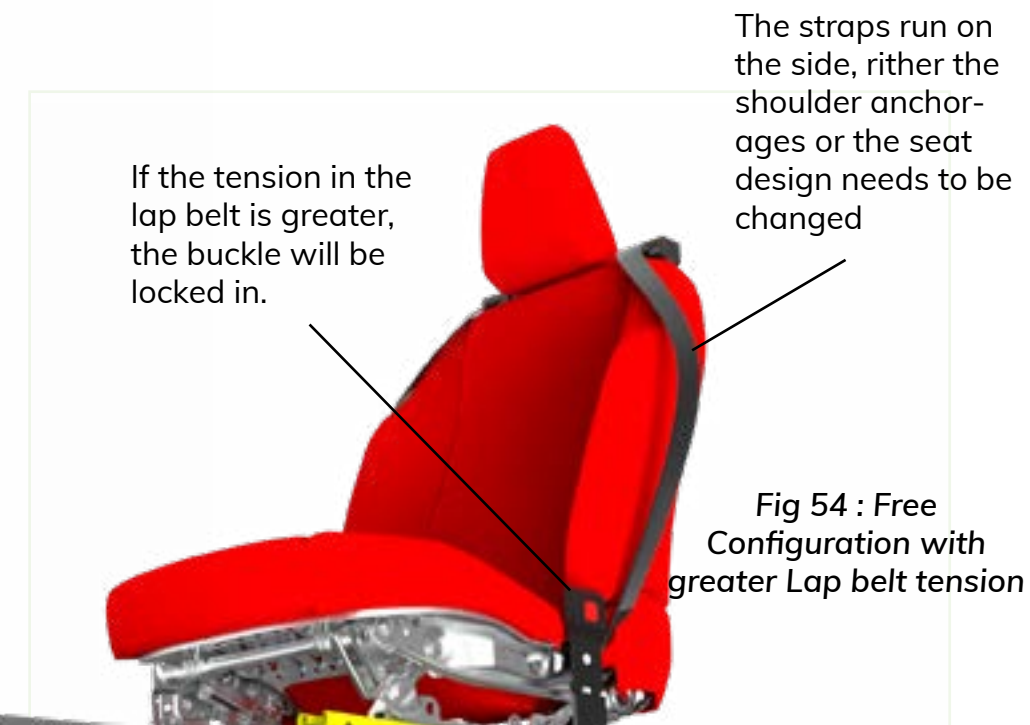

Fig 54 : Free Configuration with greater Lap belt tension

While reclining, the passenger can pull out the shoulder belt from behind him & slide the buckle to the center.
(Refer Fig 56)

Shortcomings :

- In a three point configuration, the hinge of the shoulder belts demands greater rotation.
- During no usage, the buckle does not loct with the retractor connector

Both these problems can be solved by placing the lap retractors at an angle.

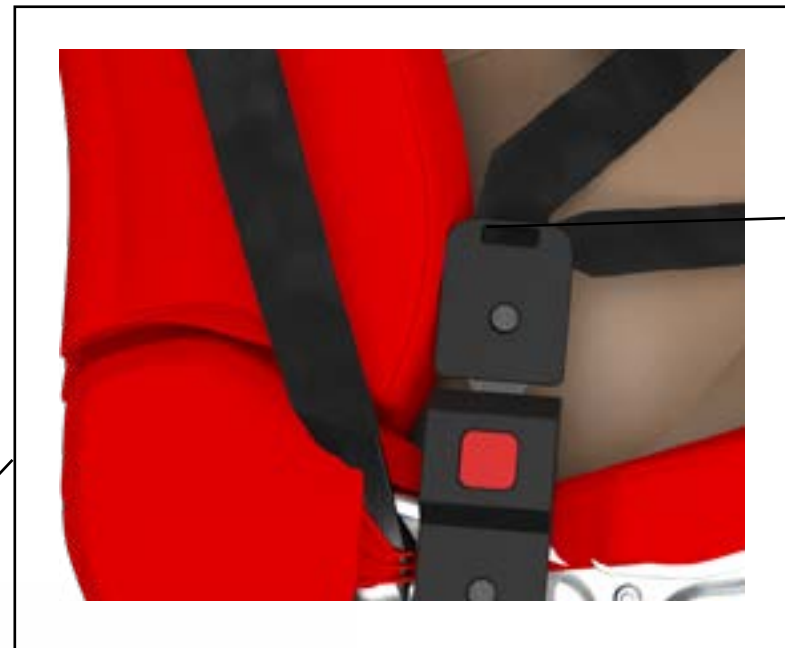

Shoulder belt demands more rotation, either the hinge joint should provide more rotation or the angle to the retractor needs to be changed



Fig 55 : Three point configuration in an upright position

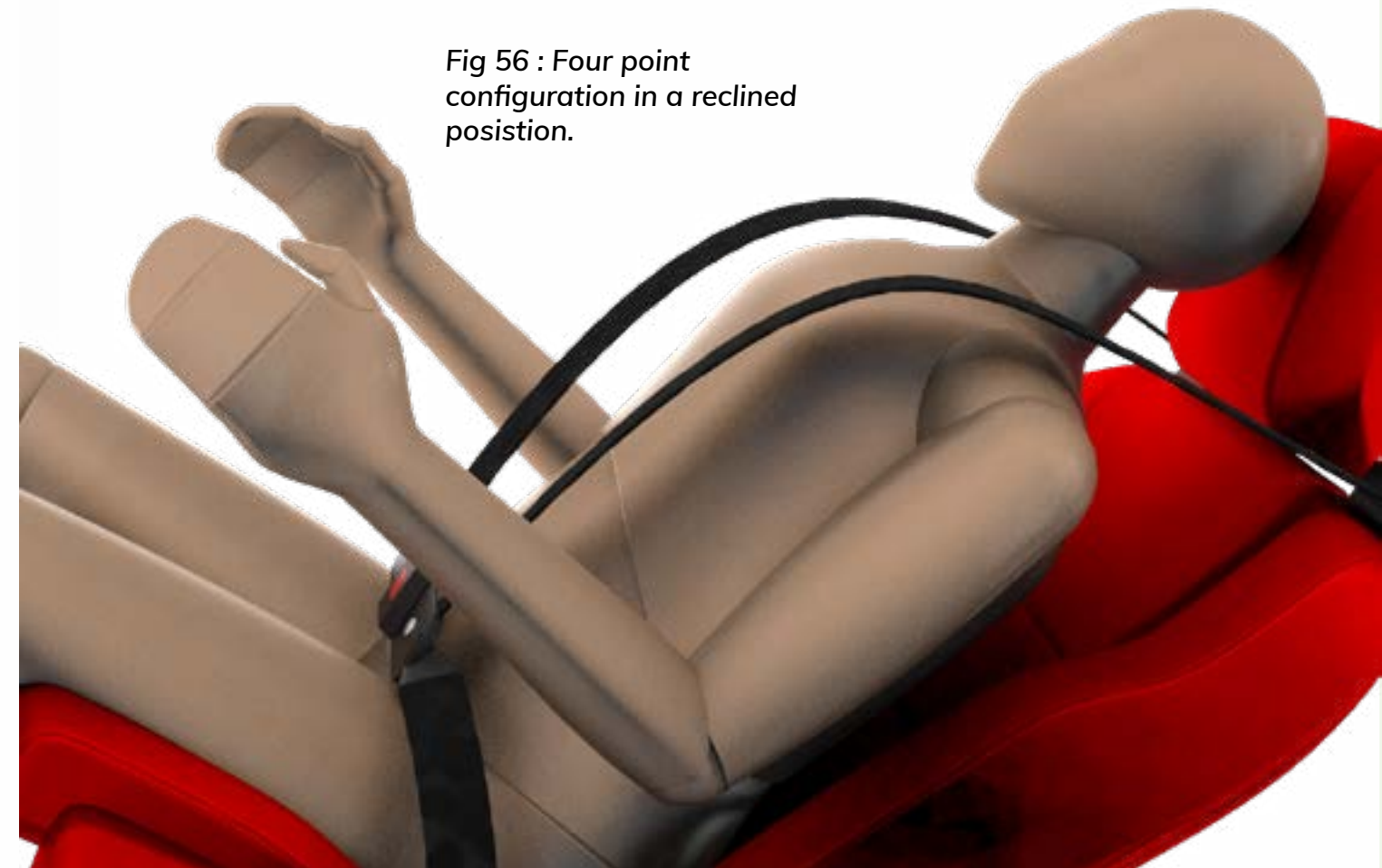

Fig 56 : Four point configuration in a reclined position.

5.4.2 Version 2 :

The version 2 concept also features a central release buckle. It features the belt connectors at angle to provide better user fit.

The lap belt retractors are also placed at angle of 30 degrees.

Similar to the previous case, it can be used in three & four point configuration.

Though functional, when locked in four point configuration it becomes curved rigid structure, this will not fit all users. Moreover, it can be dangerous during collisions.

The hinged connection to the shoulder belt is the reason for this size. It was determined to drop it for conventional loop similar to that of lap belts.

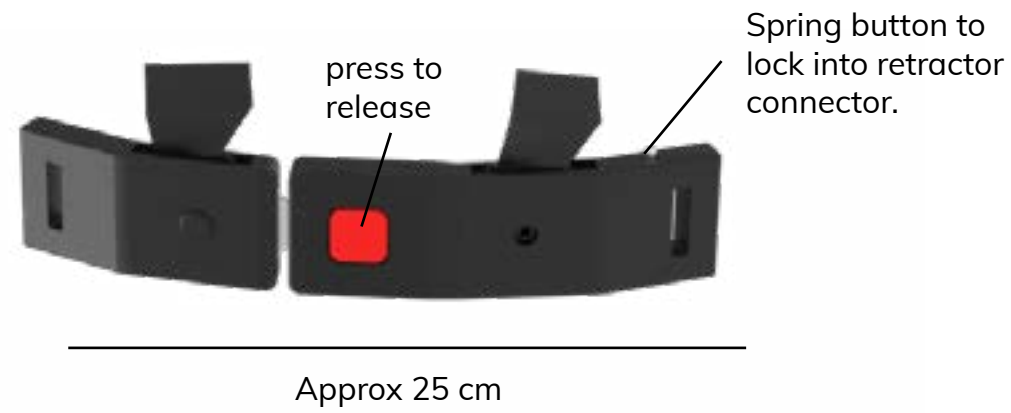

Fig 57 : In a locked position, it becomes one solid structure.



Fig 58 : Free position of the system

Fig 59 : Four point configuration in a reclined position.



5.4.3 Version 3

Taking a step away from conventional buckle designs. A new design with a cylindrical profile was approached. (Refer Fig 60). The curved surface also reduces the contact area with the user in the four point configuration. It still features a central release button

Fig 61 shows how the tongue will be locked & released when pressed.

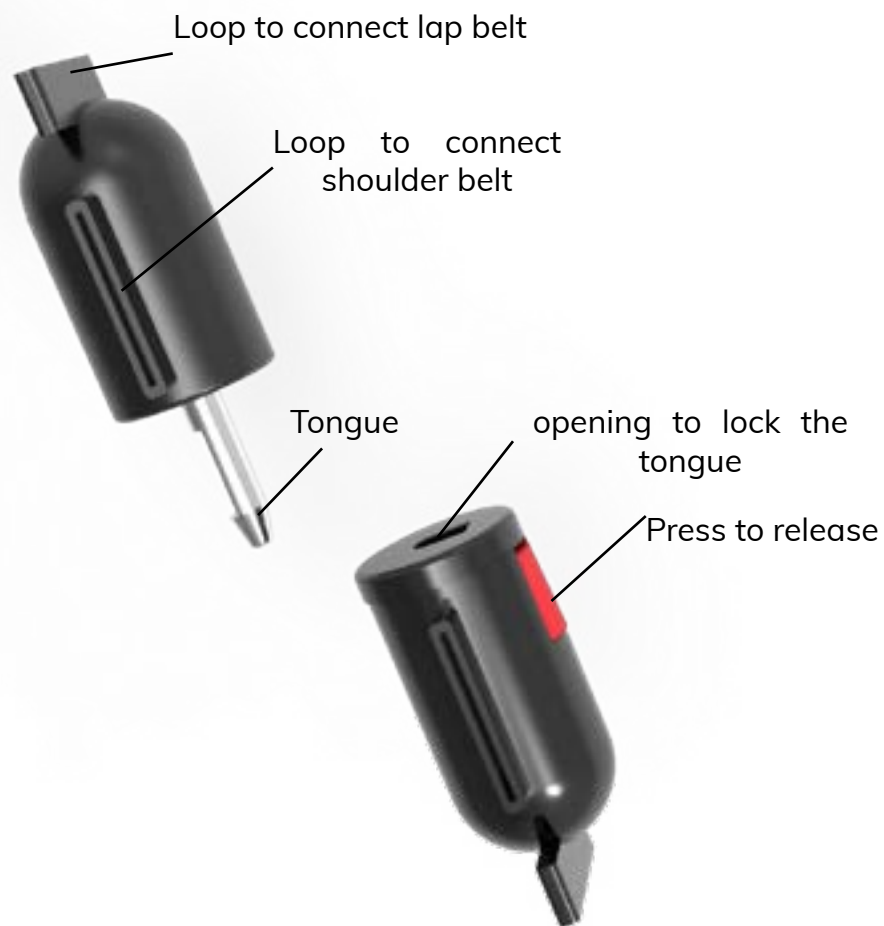

Fig 60 : Cylindrical buckle design

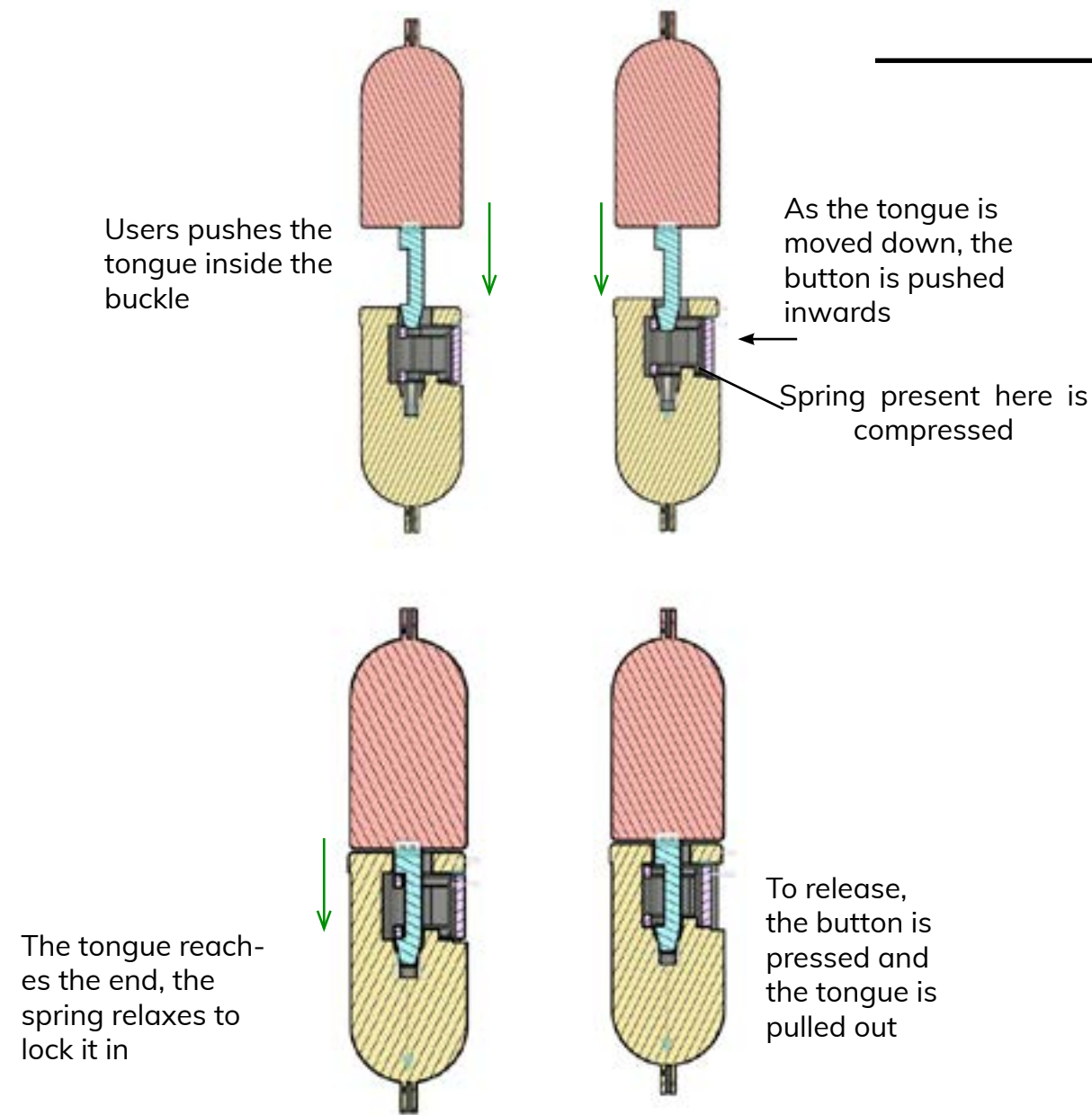

Fig 61 : Step by step locking procedure



Fig 63 : Four point configuration in a reclined position.

06. Conceptualisation & Final Design

This chapter follows the ideation phase where creative concepts were generated for each component of the product were explored. Building on the insights gained during ideation, we now proceed to the critical stage of product conceptualisation and final design.

The chapter begins with the concept presentation showing its user experience and functionality. This will be followed by assessing it in terms of desirability, feasibility & viability.

Finally, the product will be showcased as a poster with a section on what impact would it have on users.

6.1 Concept Presentation

6.1.1 Exploded view

Fig 64 shows the exploded view of the final buckle design. The buckle is made up of for key components, the cap, the press button, the central cylinder & the end connector.

The press button contains for springs of 3 mm diameter and 5 mm length. The end plate also has a spring attached to it. The functionality of these components while (un)locking will be explained in the next section.

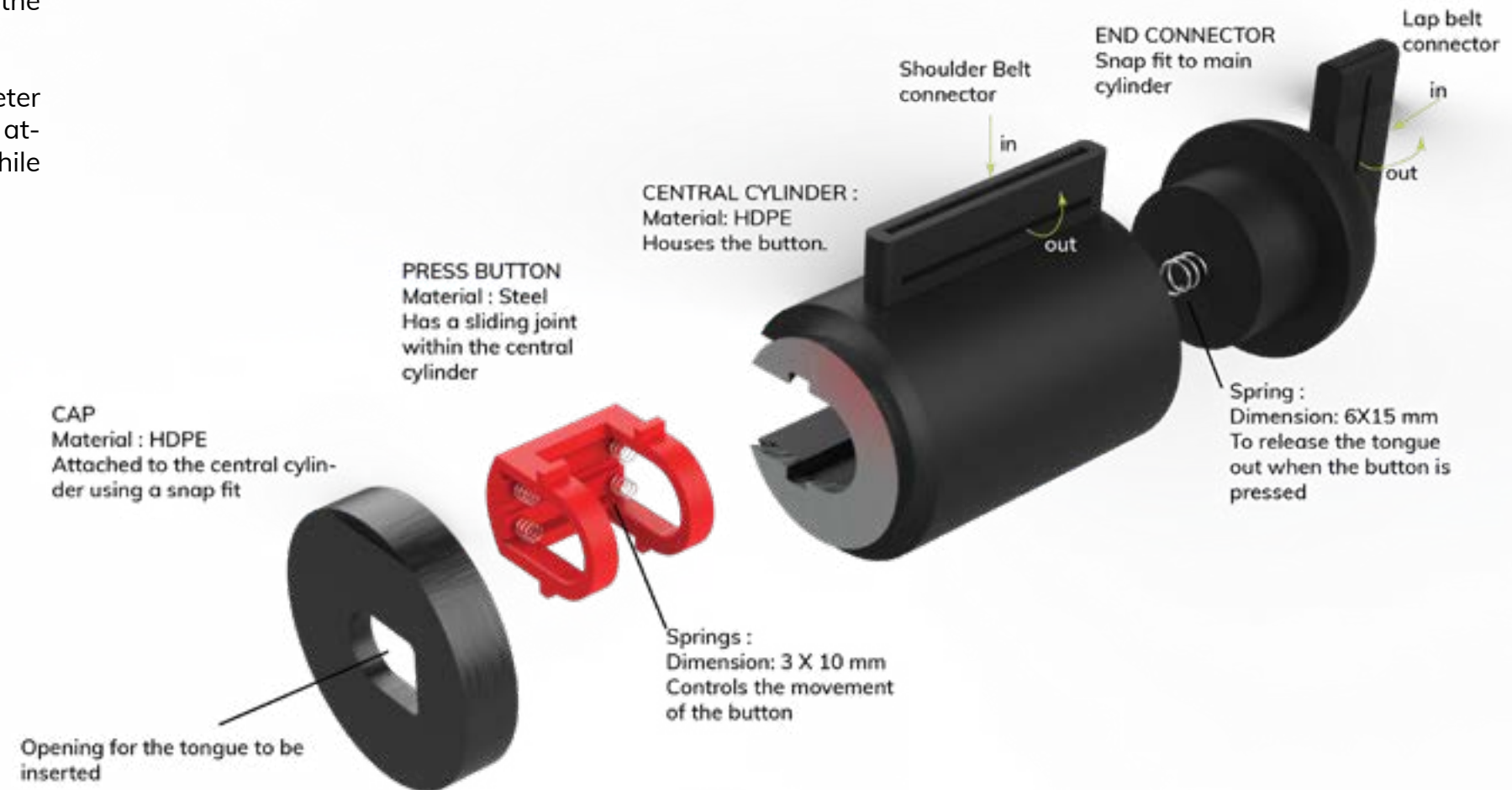

Fig 64 : Exploded of the buckle

6.1.2 Locking & quick release mechanism

Figure 66 shows the crosssectional view of the locking system. In this section we will go step by step to see how the locking & quick release mechanism of the system work

Step 1:

In order to lock, the user proceeds to push the tongue into the central cylinder through the cap. Here it first interacts with the internal parts of the the push button.

Step 2 :

As the tongue is pushed down, the push button moves sideways, the four push (only two here) button springs are compressed

Step 3 :

The tongue continues through the central cylinder, pushing the button sideways and compressing the push button springs.

Step 4:

As the tongue approaches the end of the central cylinder, it is encountered with the end connector spring, it is compressed, the push button springs expands & the button moves outwards engaging with the tongue.

Step 5: This step shows how the tongue is released. When the button is pressed, the push button springs compress and move sideways away from the tongue. Once not engaged, the end connector springs expands pushing the tongue outwards with a force of $k/2 \cdot (x)^2$. Here $x=5\text{mm}$ & k is the spring constant.

The dimensions are kept such that when the button is pressed by 5 mm, the tongue is released. This is similar to what is found in existing belts.

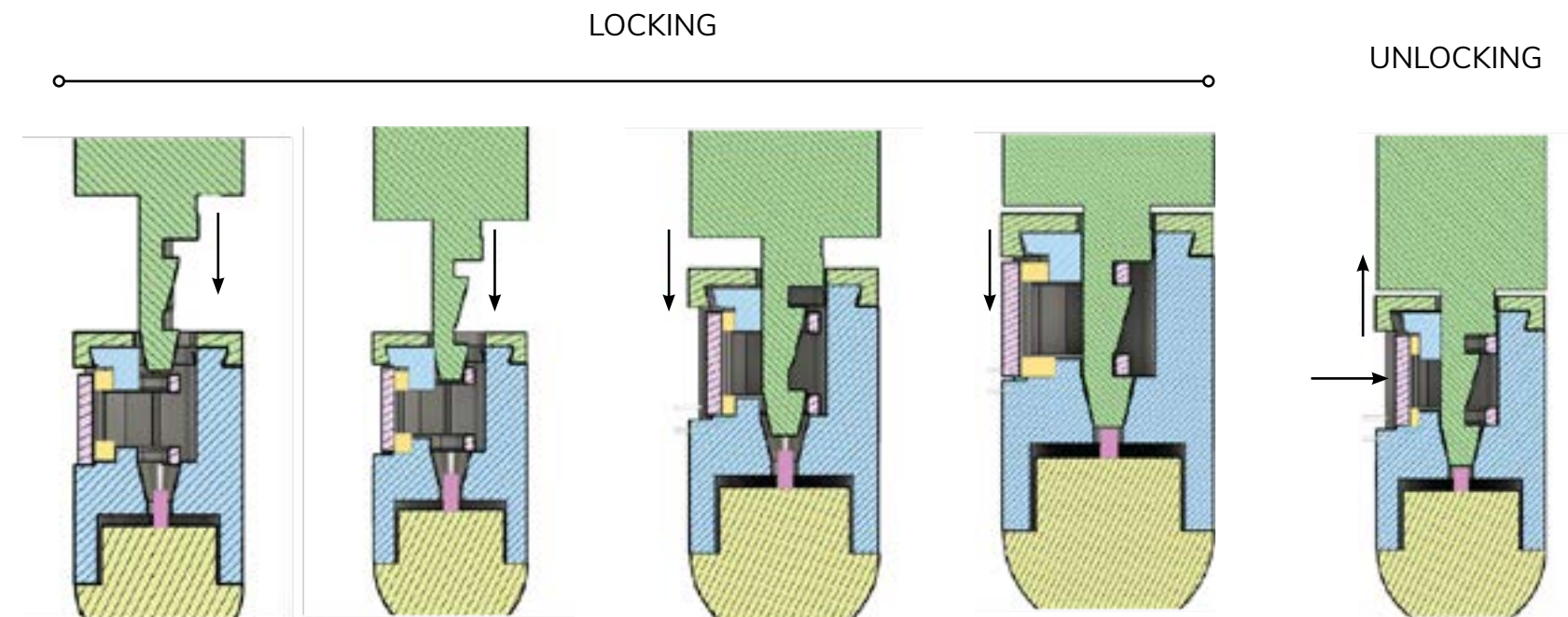
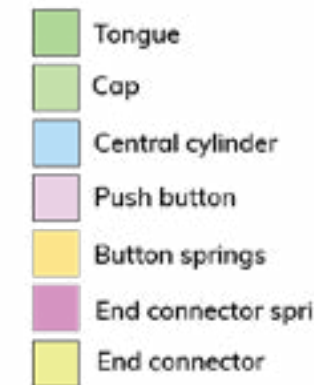

Fig 66 : locking & unlocking procedure

6.1.3 Webbing, retractor casing & connector.

At present, all retractor bodies have the same dimensions. The size of retractor bodies are determined by the torsion bar & amount of webbing it requires in its spool. The lap belts require much less webbing when compared to shoulder belts. In future, a retractor with smaller dimensions can be designed but at present it has a semicircular casing of diameter 100mm.

From the comfort study, it was identified in reclined position, the seatbelt webbing is quite close to the neck. This is not only uncomfortable, but the edges of the seatbelt can be fatal during collision. They can cut into the skin and cause internal injuries. To overcome this a curved configuration is used.

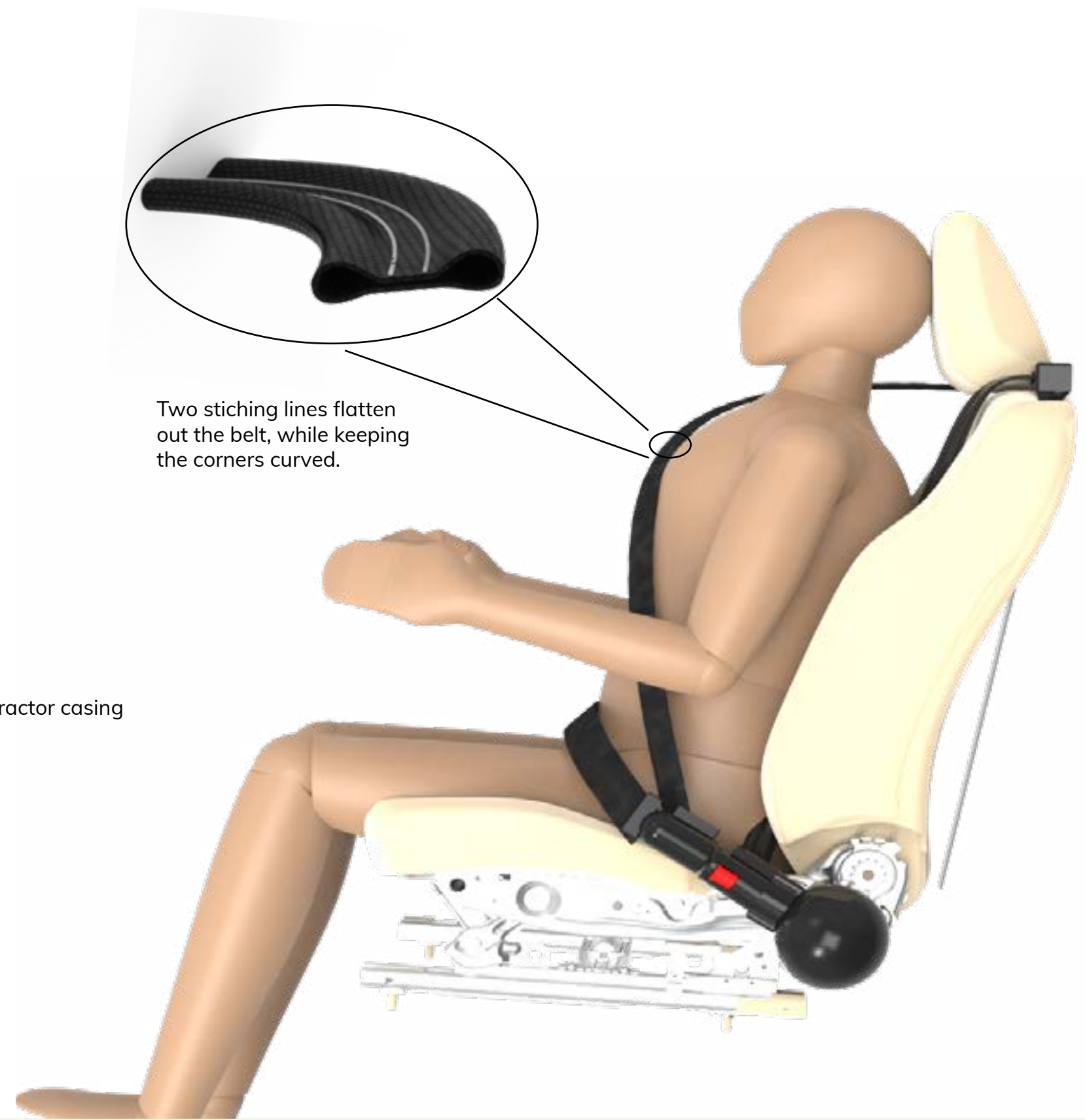

Fig 66 : Webbing & retractor casing

6.2 Desirability

The acceptance of seatbelts by the public took a considerable amount of time and regulatory efforts.

Reluctance Toward 4-Point Seatbelts:

Despite the well-established effectiveness of 4-point seatbelts in distributing crash forces more evenly across the body compared to traditional 3-point seatbelts, their initial adoption faced reluctance due to several factors. These factors included user discomfort, limited adjustability, and unfamiliarity with the design. This reluctance became apparent when leading automakers like Ford and Volvo attempted to introduce 4-point seatbelt systems in the early 2000s. Despite the clear safety benefits, these attempts were met with skepticism and garnered limited consumer acceptance.

Convertible Restraint System: Offering Safety and Versatility:

The concept of a convertible restraint system addresses the concerns tied to both 3-point and 4-point seatbelts. This innovative system empowers users to seamlessly switch between the two configurations based on their preferences and requirements. For daily commutes, users can opt for the familiar 3-point setup that offers comfort and a sense of familiarity. However, when embarking on highway journeys or when individuals wish to recline their seats for relaxation, the system allows for effortless transitioning to the more secure 4-point mode. This mode

spreads impact forces across the body, thereby reducing the risk of injuries.

New webbing design ;

The new ergonomic webbing design considers users comfort & reduces injuries caused by webbing penetration into the body.

Empowerment Through User Choice:

The pivotal advantage of the convertible restraint system lies in its capacity to grant users a choice. Recognizing that safety measures should not feel coercive, the system acknowledges the differing comfort levels and driving contexts of individuals. By permitting users to choose the suitable restraint mode, this system effectively bridges the divide between safety imperatives and user preferences. Consequently, it encourages a heightened adherence to seatbelt usage, while respecting the autonomy of users.

Learning From Past Failures:

The automotive industry's trajectory is punctuated by both successful and unsuccessful safety innovations. The ill-fated attempt with automatic seatbelts during the 1980s stands as a pertinent example. Although the intent was to augment seatbelt usage, this approach backfired as users perceived the automatic nature of the system as intrusive and uncomfortable. In contrast, the

convertible restraint system adopts a different approach, providing alternatives and ensuring that users retain a sense of control over their safety choices.

Though the new concept proposes this approach, only upon implementation will we know if it will be accepted by users.

6.3 Feasibility & Viability

Technical Feasibility:

The proposed concept demonstrates technical feasibility by utilizing existing resources from current restraint systems and modifying them to align with the new design. To unlock the full potential of the concept, the shoulder belt and lap belt retractors necessitate reconfiguration:

The shoulder belt retractor must allow the webbing to be flattened upon retraction.

Lap belt retractors should be adapted to fit seamlessly within the seat structure.

Moreover, it's important to note that the system requires a seat redesign for proper integration.

Safety & Effectiveness:

While initial simulations show promise, the safety and effectiveness of the concept require further investigation. Currently, there is limited research on reclined seating and four-point systems. Initial simulations indicate that four-point systems distribute forces more evenly and away from critical organs, especially in frontal oblique crashes, as demonstrated by J. Hun's work in 2018. However, to conclusively establish its safety benefits, comprehensive simulations and crash testing are imperative.

Economic Viability:

The proposed system's cost is projected to surpass that of a traditional 3-point system due to the requirement of four retractors. Potential cost reduction strategies include emulating J. Hun's design, featuring retractors solely on the shoulder belts and connecting the lap belt to buckle

pretensioners. However, such adjustments might compromise user comfort. Another avenue is utilizing a conventional buckle to mitigate costs.

Regulatory Compliance:

Components related to the buckle have been designed in compliance with regulations. The only deviation from strict adherence is in the configuration where the buckle, in a three-point setup, should be anchored to the vehicle. In the proposed concept, it is secured within the retractor connector.

Conclusion:

The feasibility assessment of the proposed convertible restraint system reveals both potential and challenges. Technical modifications, such as retractor redesigns and seat adaptations, are feasible. Safety and effectiveness hold promise but require rigorous testing to validate assumptions. Economic viability presents cost challenges that may impact user comfort and design choices. Regulatory compliance is generally met, albeit with a minor deviation. In summary, the concept holds great potential but necessitates further research, testing, and potential trade-offs to ensure a well-rounded and successful implementation.

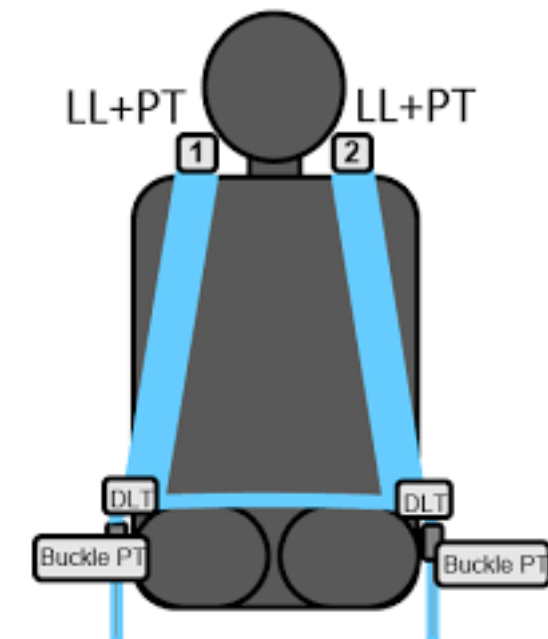

Fig 67 : J.Hun(2018) design. LL- load limiter, PT- pretensioner.

FlexSecure: Your Safety, Your Way –
Four Points of Protection in Recline



FlexSecure Restrain System

Experience Unmatched Safety with FlexSecure Restraint System: Revolutionizing Car Travel. Transforming from three points to a recommended four-point configuration in recline, it adapts to your comfort while prioritizing your security on the road.

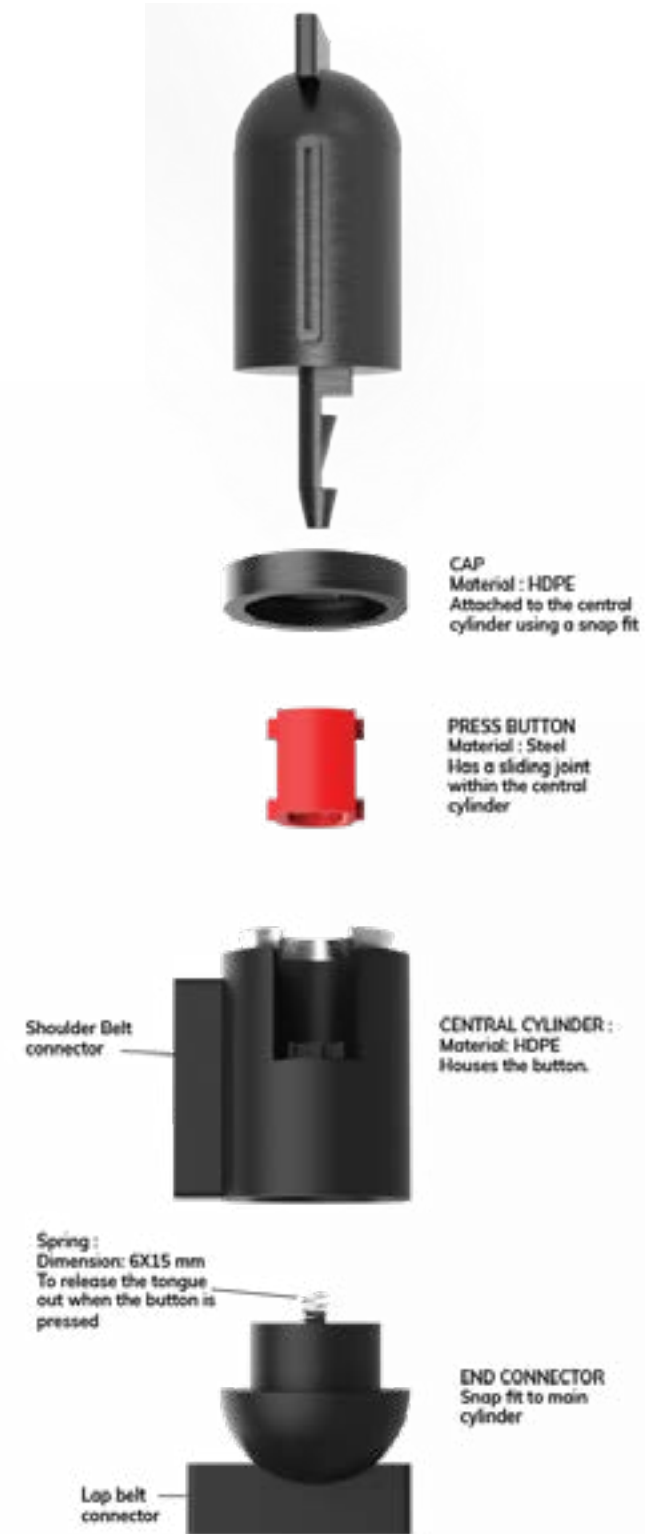

Ergonomic webbing : Two stitching lines flatten out the belt, while keeping the corners curved, which avoids chaffing.



6.5 Impact of design

The proposed concept is meticulously tailored for high-end automobiles that offer in-vehicle entertainment systems and highly reclinable seats. Its application is not intended to disrupt daily routines, but rather to provide an additional layer of safety when passengers are comfortably reclined. This innovation seeks to enhance the safety of such passengers without interfering with their luxurious experience.

Should the concept be fully developed, it operates on an alert-based system. As the seat surpasses a certain recline angle, an alert alarm activates—a functionality similar to existing systems that prompt passengers to fasten their seatbelts. This alert advises users to transition to a four-point restraint system. Crucially, the responsibility for this shift remains with the passengers themselves.

Upon engagement, the concept drastically improves passenger restraint when in a reclined position. This enhancement is particularly significant for the effectiveness of airbags designed to protect occupants. By facilitating proper alignment and restraint even when seats are reclined, the concept maximizes the potential of existing safety features.

However, it's essential to recognize that the proposed concept is not intended as a long-term solution, but rather a transitional one. As the landscape of transportation evolves and autonomous vehicles become more preva-

lent, uncertainty and risk increase in tandem. During this phase of hybrid road environments—where a mix of driver-controlled and autonomous vehicles coexist—the concept plays a crucial role. It bridges the gap by ensuring safety without impeding the transition to newer seat layouts that cater to evolving transportation modes.

A humorous yet enlightening example of this transition phase can be observed in a video featuring a police officer attempting to pull over an autonomous taxi for not adhering to traffic signals. This light-hearted interaction underscores the ongoing adjustments required as autonomous vehicles become a regular sight on the roads. In this context, the proposed concept acts as a safeguard, ensuring passenger safety during these transitional phases marked by a mix of manual and automated driving

07. Final thoughts

The chapter will include the conclusion of the project followed by a reflection by the author.

7.1 Conclusion

As the automotive industry progresses towards higher levels of autonomy, the very essence of car travel is undergoing a transformation. This transition towards greater autonomy is expected to usher in a myriad of non-driver related activities within vehicles. A notable avenue in this regard, achievable without necessitating substantial alterations to the traditional car layout, pertains to reclined seating.

The integration of reclined seating presents a new set of challenges due to the altered bio-kinematics of occupants in such positions. Recent studies and patent filings from companies such as General Motors indicate that addressing safety concerns associated with reclined seating requires innovative solutions. For instance, Rouhana et al. (2003) demonstrated that a four-point harness configuration notably reduced injuries in an upright position.

To delve into the effectiveness of such solutions, a series of simulations were undertaken. These simulations compared the outcomes of three-point and four-point seat belt configurations in both upright and reclined positions. The results revealed that at lower speeds, no substantial differences were observed between the two configurations. However, at higher speeds, the four-point system demonstrated a significant advantage by more evenly distributing the impact forces across the clavicles and away from vital organs.

In light of these findings, while the potential of a four-point restraint system became evident, certain challenges associated with its implementation surfaced. Furthermore, to address the paramount aspect of user comfort, a dedicated study was conducted, evaluating the comfort levels of both three-point and four-point systems.

Building upon the insights garnered from these investigations, a revolutionary convertible restraint system was conceived. This system is uniquely designed to function as a three-point restraint when occupants

are in an upright position, transitioning seamlessly to a four-point configuration when passengers recline. This dual-purpose design optimally combines safety and comfort, making it a versatile solution that effectively accommodates varying occupant positions.

In conclusion, the paradigm shift towards autonomous driving has engendered the exploration of innovative safety solutions, particularly in the context of reclined seating. Through meticulous studies and simulations, the viability of a convertible restraint system that flexibly adapts to occupant positions has been demonstrated. This pioneering system offers both safety benefits and user comfort, marking a significant advancement in the pursuit of safer and more adaptable automotive environments.

7.2 Reflection

I got intrigued by a research paper by Caballero-Bruno et al. (2022) that studied how reclining seats affect sleep quality and comfort. I found it fascinating because they had people sleeping in a moving vehicle, secured with a 7-point seatbelt. The choice of a 7-point system really caught my attention, and it made me want to know why?

So, I decided to dive into this project with big plans, driven by my curiosity. But as I got deeper, I quickly realized there were challenges ahead. The first hurdle was that the regular three-point seatbelt is already a huge safety innovation. Trying to come up with something better and more elegant was quite a challenge.

At the start, I read up on past and current safety ideas related to reclining seats. This gave me a better understanding of how long these projects take and helped me set more realistic goals.

Then came a big obstacle - understanding dynamic crash modeling. It took me a while to grasp how it works. Once I figured out the software, I struggled to model the four-point system because there weren't many tutorials or detailed resources available.

Until I got simulation results, I was stressed since it felt like there was no progress. But having the simulation results validated gave me some relief. Unfortunately, time was short, and I couldn't fully design the final concept. The more I looked into it, the more things I realized needed consideration. Stuff like the seat design and where to anchor the shoulder belts, for instance.

I also noticed that while I was designing, I tend to be overly critical, always spotting potential flaws and ways things could go wrong.

All in all, I put my everything into this project. Even now, I keep getting ideas on how to improve the designs. But I understand that all projects have to come to an end. It's been quite a journey, and while I may keep thinking of ways to make things better, I know that every project has its finish line.

I would also like to thank my mentors throughout the project, who always encouraged me.

References

A review of vehicle impact testing. (n.d.). SAE, 79, 7000398.

Administrator, D. (2023, June 4). Exploring the past, present, and future of automotive infotainment. DataJob Sweden. <https://datajob.se/exploring-the-past-present-and-future-of-automotive-infotainment/>

Ahmadpour, N., Robert, J., & Lindgaard, G. (2016). Aircraft passenger comfort experience: Underlying factors and differentiation from discomfort. *Applied Ergonomics*, 52, 301–308. <https://doi.org/10.1016/j.apergo.2015.07.029>

B Seely, F., & Ensign, N. (1948). *Analytical Mechanics for Engineers*. (Vol. 3).

Bergs, J., & Kanaska, D. (2012). MOTOR VEHICLE SEATS AND THEIR DEFECT CLASSIFICATION. *Engineering for Rural Development*.

Bill Loomis, The Detroit News. (2015, April 26). The Detroit News. The Detroit News. <https://eu.detroitnews.com/story/news/local/michigan-history/2015/04/26/auto-traffic-history-detroit/26312107/>

Bohman, K., Osvalder, A., Ankartoft, R., & Alfredsson, S. (2019). A comparison of seat belt fit and comfort experience between older adults and younger front seat passengers in cars. *Traffic Injury Prevention*, 20(sup2), S7–S12. <https://doi.org/10.1080/15389588.2019.1639159>

Borg, G. (1990) Psychophysical Scaling with Applications in Physical Work and the Perception of Exertion. *Scandinavian Journal of Work Environment and Health*, 16, 55–58. - References - Scientific Research Publishing. (n.d.). [https://www.scirp.org/\(S\(oyulxb452alnt1aej1nfow45\)\)/reference/ReferencesPapers.aspx?ReferenceID=1980586](https://www.scirp.org/(S(oyulxb452alnt1aej1nfow45))/reference/ReferencesPapers.aspx?ReferenceID=1980586)

Caballero-Bruno, I., Wohllebe, T., Töpfer, D., & Castellano, P. M. H. (2022). The effect of seating recline on sleep quality, comfort and pressure distribution in moving autonomous vehicles. *Applied Ergonomics*, 105, 103844. <https://doi.org/10.1016/j.apergo.2022.103844>

California, S. O. (n.d.). Click it or ticket | Office of Traffic Safety. <https://www.ots.ca.gov/media-and-research/campaigns/click-it-or-ticket/> Chan, C. (2017). Advancements, prospects, and impacts of automated driving systems. *International Journal of Transportation Science and Technology*, 6(3), 208–216. <https://doi.org/10.1016/j.ijtst.2017.07.008>

Conventional seat belt system and BIS system [10,11]. (n.d.). ResearchGate. https://www.researchgate.net/figure/Conventional-seat-belt-system-and-BIS-system-10-11_fig1_221818182

De Looze, M., Kuijt-Evers, L., & Van Dieën, J. H. (2003). Sitting comfort and discomfort and the relationships with objective measures. *Ergonomics*, 46(10), 985–997. <https://doi.org/10.1080/0014013031000121977>

Emission, M. (2022). Unknown Danger: Why Reclined Car Seats can be Deceptively Unsafe. Langdon & Emission. [https://www.langdonemission.com/blog/reclined-car-seats-can-be-deceptively-unsafe#:~:text=If%20your%20car%20seat%20is,%E2%80%9D\)%20or%20not%20properly%20worn.](https://www.langdonemission.com/blog/reclined-car-seats-can-be-deceptively-unsafe#:~:text=If%20your%20car%20seat%20is,%E2%80%9D)%20or%20not%20properly%20worn.)

Evans, A., Polak, C., Neuroth, L. M., Smith, G. A., & Zhu, M. (2022). Trends in Passenger Seat belt Use Among High School Students—United States, 1991–2019. *Journal of Adolescent Health*, 71(6), 761–763. <https://doi.org/10.1016/j.jadohealth.2022.07.005>

Fig 2. Cappetti and Naddeo comfort perception model. (n.d.). ResearchGate. https://www.researchgate.net/figure/Cappetti-and-Naddeo-comfort-perception-model_fig2_282315499

Fig. 3. A part of the comfort model of Moes (2005). (n.d.). ResearchGate. https://www.researchgate.net/figure/A-part-of-the-comfort-model-of-Moes-2005_fig3_51462478

FROM THE ARCHIVE: 1st day of driving when wearing seat belts became CA law in 1986. (2021, January 1). ABC7 San Francisco. <https://abc7news.com/seat-belts-law-california-wearing/9207393/#:~:text=Wearing%20seat%20belts%20became%20California,driving%20in%20the%20Bay%20Area>. Gizmodo Australia. (2020, November 29). Here's How Volvo's 'Special Safety Blanket' Would Work.

Gizmodo Australia. <https://gizmodo.com.au/2018/09/heres-how-volvos-special-safety-blanket-would-work/>

Glossary | Euro NCAP. (n.d.). <https://www.euroncap.com/en/vehicle-safety/glossary/#compatibility>

GM applies for "Blanket Airbag" Safety Restraint System patent. (n.d.). <https://www.gm.com.cn/en/home/commitments/sustainability.detail.html/Pages/news/cn/en/gm-comm/newsletter/2022/spring/blanket-airbag.html>

.H McElhaney, J. (1972). Biomechanics of seatbelt design. SAE, 81, 720756.

How can automated and connected cars improve road safety? | RoadSafetyFacts.eu. (2019, April 15). RoadSafetyFacts.eu. <https://roadsafetyfacts.eu/how-can-automated-and-connected-vehicles-improve-road-safety/#:~:text=Self%2Ddriving%20vehicles&text=Removing%20the%20driver%20from%20the,influence%20of%20alcohol%20or%20drugs>.

Howe, J. (2023, May 3). A brief history of car safety innovations - Classics World. Classics World. <https://classicsworld.co.uk/guides/a-brief-history-of-car-safety-innovations/>

Index of Patents Issued from the United States Patent Office. (n.d.). Google Books. https://books.google.nl/books?id=FYAS-lqYgPYC&pg=PA734&lpg=PA734&d-q=restraining+device+for+vehicle+passenger+3811701&source=bl&ots=_dURvMlif0&sig=ACfU3U1IskLGxt_HTI5oHjgwzlocbTJWLg&hl=en&sa=X&ved=2a-hUKEwjD88DR4e2AAxUn3wIHHcFRCAMQ6AF6BAgJEAM#v=onepage&q=restraining%20device%20for%20vehicle%20passenger%203811701&f=false

Kempf, B., & Kongsted, A. (2012). Association between the side of unilateral shoulder pain and preferred sleeping position: a Cross-Sectional study of 83 Danish patients. *Journal of Manipulative and Physiological Therapeutics*, 35(5), 407–412. <https://doi.org/10.1016/j.jmpt.2012.04.015>

Luciaclemares. (2023, June 1). Autonomous car and the future of road safety. Telefónica. <https://www.telefonica.com/en/communication-room/blog/autonomous-car-and-the-future-of-road-safety/>

Mastrigt, S. H., Groenesteijn, L., Vink, P., & Kuijt-Evers, L. (2016). Predicting passenger seat comfort and discomfort on the basis of human, context and seat characteristics: a literature review. *Ergonomics*, 60(7), 889–911. <https://doi.org/10.1080/00140139.2016.1233356>

Nederlands Instituut voor Praeventieve Gezondheidszorg TNO. (1992). Development of a practical method for measuring body part comfort. TNO Publications. <https://repository.tno.nl/islandora/object/uuid%3A4b0deda8-cde3-48cb-baed-23f81f3ac4f6>

Orlove, R. (2017, January 31). Seatbelts In The 1990s Were Completely Absurd. Jalopnik. <https://jalopnik.com/seatbelts-in-the-1990s-were-completely-absurd-1791819322>

Publications Office of the European Union. (2007, November 30). CELEX1, Regulation No 16 of the Economic Commission for Europe of the United Nations (UN/ECE) — Uniform provisions concerning the approval of: I. safety-belts, restraint systems, child restraint systems and Isofix child restraint systems for occupants of power-driven vehicles II. vehicles equipped with safety-belts, restraint systems, child restraint systems and Isofix child restraint systems. Publications Office of the EU. <https://op.europa.eu/en/publication-detail/-/publication/d13b01c3-4962-478b-a710-215ee6dae2cb/language-en>

Reenen, H. H. H., Van Der Beek, A. J., Blatter, B., Van Der Grinten, M., Van Mechelen, W., & Bongers, P. (2008). Does musculoskeletal discomfort at work predict future musculoskeletal pain? *Ergonomics*, 51(5), 637–648. <https://doi.org/10.1080/00140130701743433>

Rohlmann, A., Zander, T., Graichen, F., Dreischarf, M., & Bergmann, G. (2011). Measured loads on a vertebral body replacement during sitting. *The Spine Journal*, 11(9), 870–875. <https://doi.org/10.1016/j.spinee.2011.06.017>

Rouhana, S. W., Bedewi, P. G., Kankanala, S. V., & Schneider, L. W. (2003). Biomechanics of 4-Point seat belt systems in frontal impacts. ResearchGate. https://www.researchgate.net/publication/6701669_Biomechanics_of_4-Point_Seat_Belt_Systems_in_Frontal_Impacts

SAE MOBILUS. (2003, January 9). <https://saemobilus.sae.org/content/2003-01-0954/>

Safety in early years. (1959). SAE, 67.

Slater, K. (1986). DISCUSSION PAPER THE ASSESSMENT OF COMFORT. *Journal of the Textile Institute*, 77(3), 157–171. <https://doi.org/10.1080/00405008608658406>

Tan, C. (2009). Sleeping Posture Analysis of Economy Class Aircraft seat. <https://www.semanticscholar.org/paper/Sleeping-Posture-Analysis-of-Economy-Class-Aircraft-Tan-Chen/2f85f7fddcb8612534a2b41e9a6995a1d8afb7f2>

Test of friction coefficient between car seat fabric and cloth_News_Link Testing Instruments co. ,Ltd. (n.d.). <https://www.linktesting.org/1626.html/>

The Associated Press. (2022, June 15). Nearly 400 car crashes in 11 months involved automated tech, companies tell regulators. NPR. <https://www.npr.org/2022/06/15/1105252793/nearly-400-car-crashes-in-11-months-involved-automated-tech-companies-tell-regul>

The European New Car Assessment Programme | Euro NCAP. (n.d.). <https://www.euroncap.com/en>

The next belt for passenger safety - 4 – point seat belt design. (n.d.). Volvo Car USA Newsroom. <https://www.media.volvocars.com/us/en-us/media/pressreleases/365>

Three-point seatbelt inventor Nils Bohlin born. (2010, January 27). HISTORY. <https://www.history.com/this-day-in-history/three-point-seatbelt-inventor-nils-bohlin-born>

Two types of four-point safety belt. (n.d.). Volvo Cars Global Media Newsroom. [https://www.media.volvocars.com/global/en-gb/media/pressreleases/5275US312085A-clag-hoen-Google-Patents-\(1885,-February-10\)-https://patents.google.com/patent/US312085A/en](https://www.media.volvocars.com/global/en-gb/media/pressreleases/5275US312085A-clag-hoen-Google-Patents-(1885,-February-10)-https://patents.google.com/patent/US312085A/en)

Van Kamp, I., Kilincsoy, U., & Vink, P. (2011). Chosen postures during specific sitting activities. *Ergonomics*, 54(11), 1029–1042. <https://doi.org/10.1080/00140139.2011.618230>

Vink, P., & Hallbeck, M. S. (2012). Editorial: Comfort and discomfort studies demonstrate the need for a new model. *Applied Ergonomics*, 43(2), 271–276. <https://doi.org/10.1016/j.apergo.2011.06.001>

Wikipedia contributors. (2023). History of transport. Wikipedia. https://en.wikipedia.org/wiki/History_of_transport

Wilson, C. (2022). Non-Driving Related tasks and journey types for future autonomous vehicle owners. <https://www.semanticscholar.org/paper/Non-Driving-Related-tasks-and-journey-types-for-Wilson-Gyi/15ef7f458500472c7914408cb-2653ca439659294>

Zenk, R., Mergl, C., Hartung, J., Sabbah, O., & Bubb, H. (2006). Objectifying the comfort of car seats. SAE Technical Paper Series. <https://doi.org/10.4271/2006-01-1299>

APPENDIX - A

Procedure of FEM modelling

STEP 1 :Start HyperCrash

1. Open HyperCrash.
2. Set the User profile to RadiossV2021 and the Unit system to N_mm_s_T.
3. Set User Interface style as New.
4. Set the working directory to <install_directory>/tutorials/hwsolvers/radioss.
5. Click Run.
6. Click File > Import > Radioss.
7. In the input window, select SEAT__00D00.rad.
8. Click OK.

STEP 2 : Merge Models

1. Click File > Import > Radioss.



2. Click Merge.
3. Select the file FLOORD00.rad.
4. Click OK.
5. In the Set all to field, enter the value 100000.
6. Click the Set all to button to offset the numbering of

all the entities

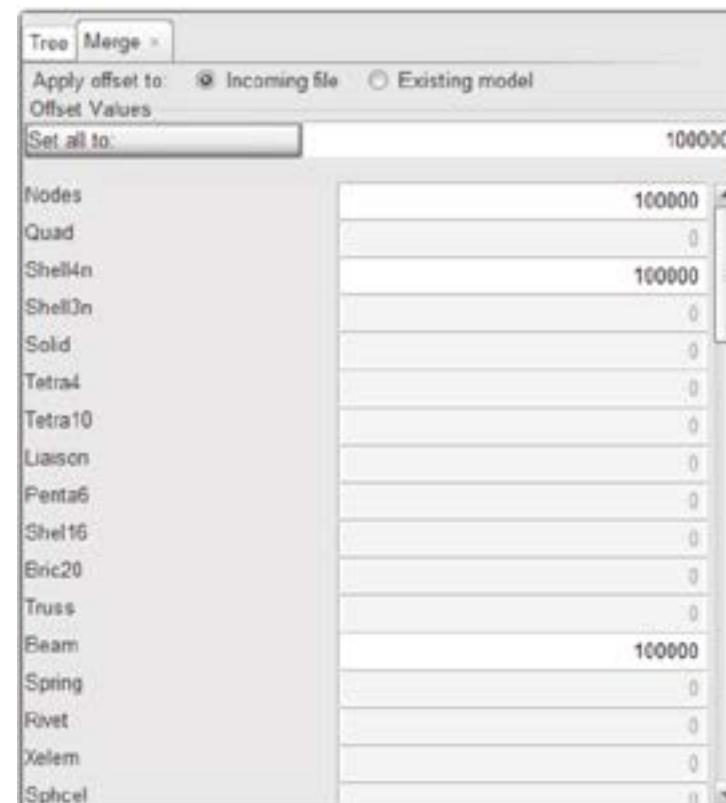

7. Click Merge to merge the floor model.
8. Redo the steps 1 to 7 for the cushion model:
 - File:
 - FOAMD00.rad
 - Set all to offset: 200000
9. Redo the steps 1 to 7 for the seatbelt model:
10. File:

- BELTD00.rad
- Set all to offset: 300000

STEP 3. Set Model Heirarchy

1. Click the Tree tab and select the subset of the seat named Seat model (300005).
2. Right-click and select Change Name

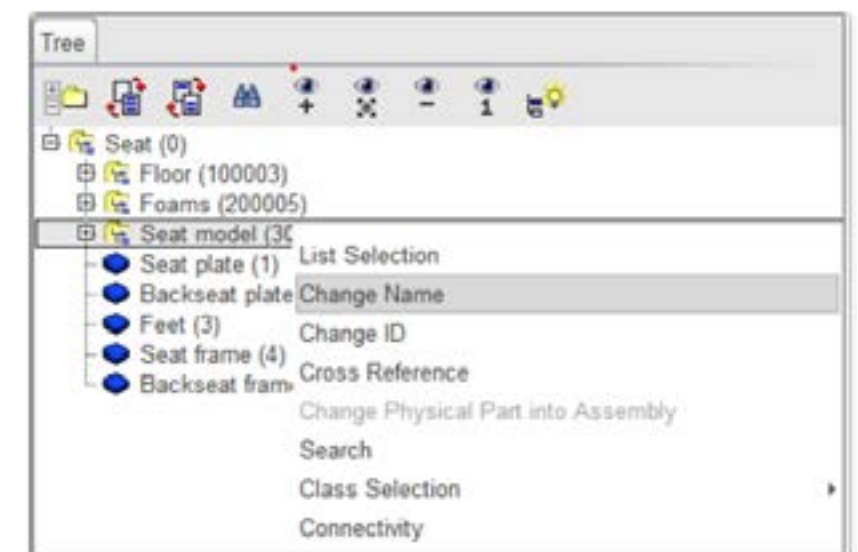

3. In the Change Name window, enter the name Seatbelt.
4. Click Ok.
5. Click any item on the tree, right-click and select New Assembly.
6. Enter the name Frame and click Ok.
7. Select the parts Seat plate, Backseat plate, Feet, Seat frame, and Backseat frame using the Shift or Ctrl

keys.

8. Press and hold the middle mouse button and drag the selected parts into the new assembly Frame.
9. Select the Tree root (Seat) and right-click.
10. In the pop-up menu, select List Selection.

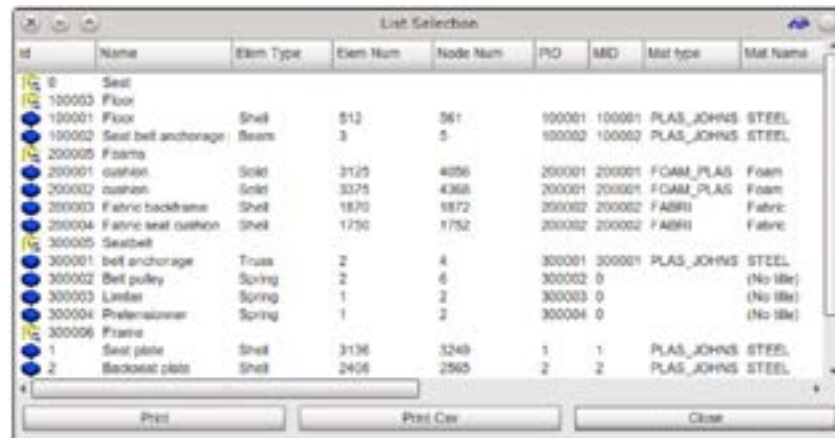

11. The List Selection dialog opens.
12. In the displayed window, check if all parts have properties (PID) and materials (MID).
13. Click Close > Export the model to save.

STEP 4: Connect Models

To add the feet of the seat and the seatbelt anchorage point to the floor rigid body:

1. Click Mesh Editing > Rigid Body.

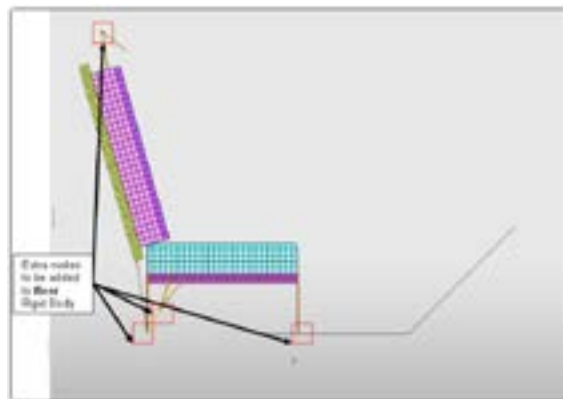

2. Select the rigid body: Floor.
3. Click See selected rigid bodies (reviewgeneral-24).
4. Click Display All07_display and then Left View (F11).
5. Right-click in the Grnod_Id entry box and click Select in graphic, click selectbyboxadd-24Add nodes by box selection and select all the nodes of the seat, feet and the anchorage points of the seatbelt.
6. Right-click to validate.
7. Select the Floor rigid body in the list, right-click and add the rigid body and main node to time history.

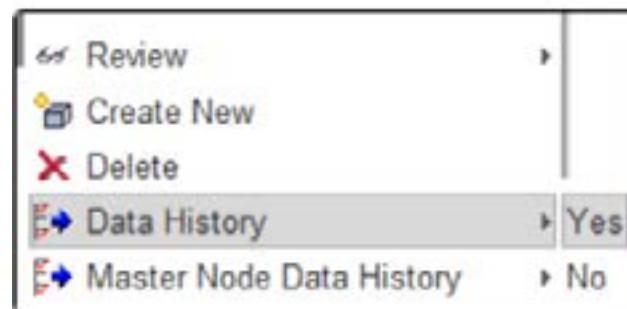

STEP 5 : Connect Cushion to the Seat Frame

1. Click LoadCase > Contact Interface.
2. Right-click in the window and select Create New > Kinematic condition (Type 2).
3. Display only the cushion parts. Press F11 for XZ view, select Secondary nodes section, and click box tool to add nodes by box selection.
4. Holding down the Shift key, click to draw a polygon window around nodes on the backside of cushion of the nodes.

Tip: Press the letter P for non-perspective view, if needed. Press Shift and draw a closed polygon window around the nodes to select. When finished, release the Shift key.

5. Display Frame Assembly in the Tree, pick Main surface section, click arrow_upAdd/Remove a face and pick one element on each part of the frame facing the cushion. Then select the Expand option on the lower right corner to pick select all.
6. Select the Expand option on the lower right corner to select all the elements of the seat assembly facing the seat cushions.
7. Click Yes or Enter on the keyboard to end the

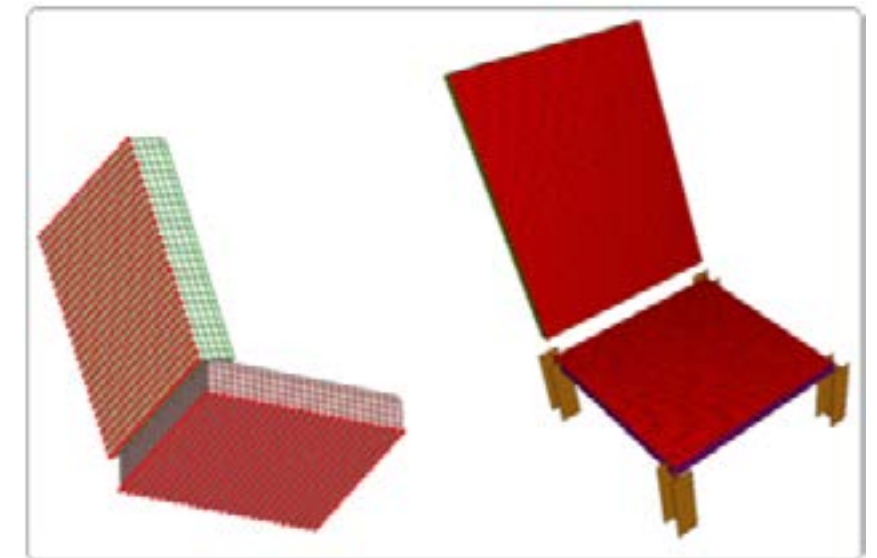

8. selection For the Title of the contact, enter seat cushion fixation.
9. Click Save.
10. Click the check icon at the top of the interface panel, to check the interface. The created interface should be displayed with green text. Otherwise, the interface has to be modified.
11. Click Close.
12. Click Export to save the model.

STEP 6 Positioning the Dummy

1. Click Safety > Dummy Positioner

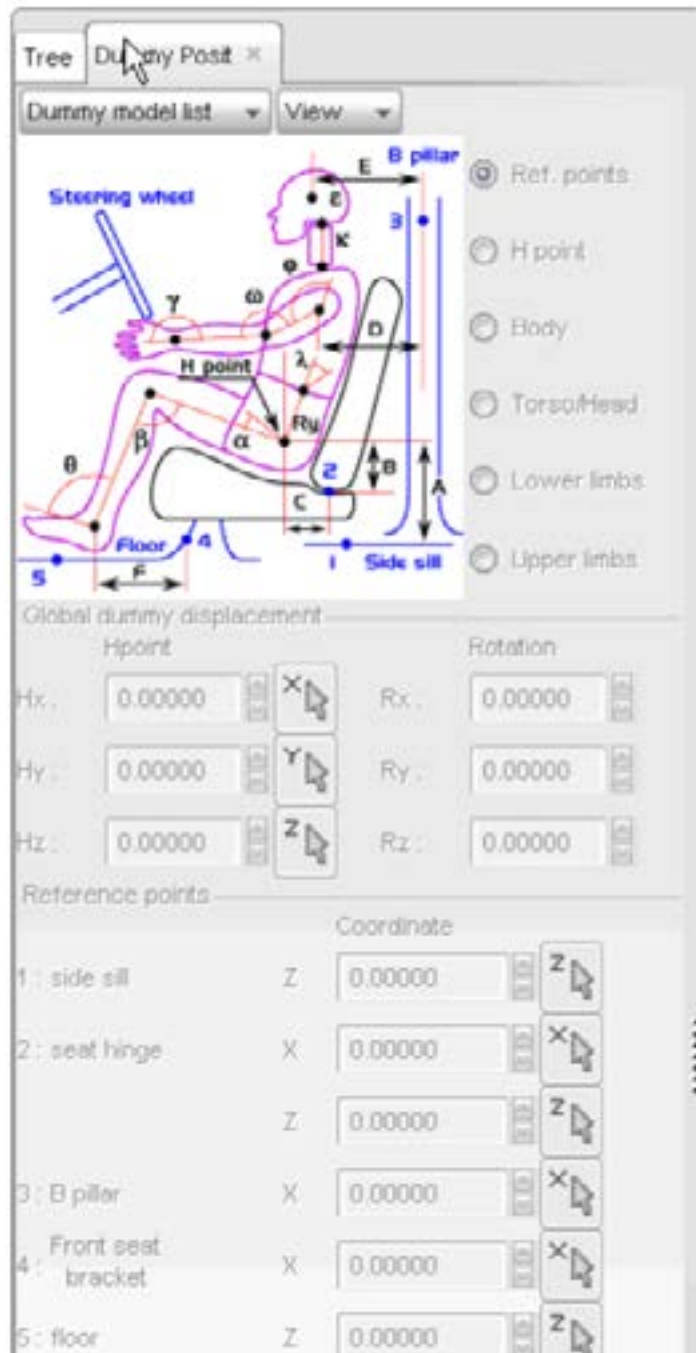

2. From the Dummy model list menu, select New dummy.

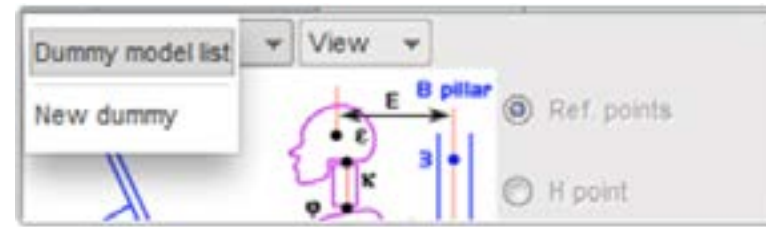

A DummyMng panel opens.

3. Select the File subpanel.
4. Import the Dummy
5. Click Validate.
6. Set Set all to value to 400000.
7. Click the Set all to button to offset the numbering of all entities.
8. Click OK to merge the Dummy model.
9. Position the dummy on the seat using the move tool.
10. Close the Dummy positioner and click Export to save the model.

Step 7 : Add the Safetybelt

1. Click Safety > Belt Generator.
2. Enter the name Upper belt and click OK to validate



3. Click Seat belt reference points
4. Click Add nodes by picking and select three nodes, as shown in the following image (red dots)

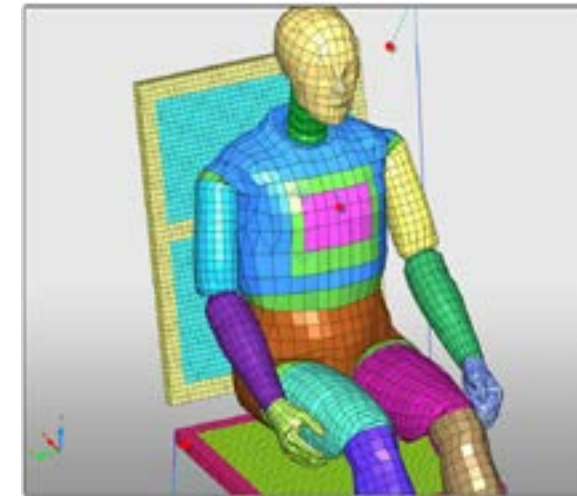

5. Click Yes on the right corner and OK to validate the node selection.
6. Click Add/Remove body parts (and select the parts: torso, pelvis, upper legs, and the seat cushion fabric, as shown in red in the image Click Yes to validate the selection.

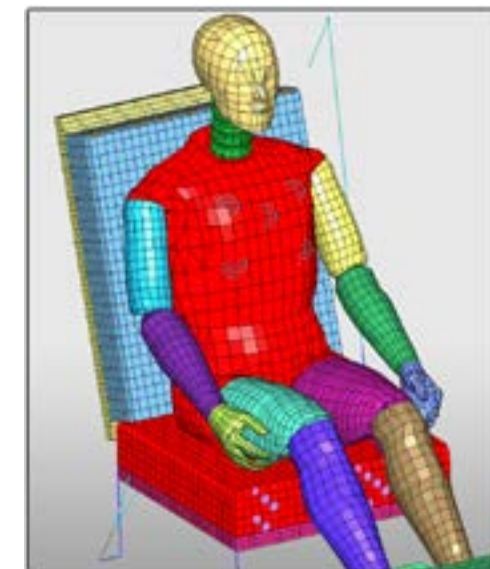

7. Set the Gap value to 5.00 mm.
8. Set the Belt geometric width to 40.
9. Set the Element Size to 8.
10. Click Material and select the material properties
11. Click OK.
12. Click Property and select the property filebelt properties
13. Click OK.
14. Click Preview to display the proposed seat belt. Some intersections may exist between the seat cushion and the seat belt.
15. Use the orientation tools to modify the angle of the Rigid Body 2

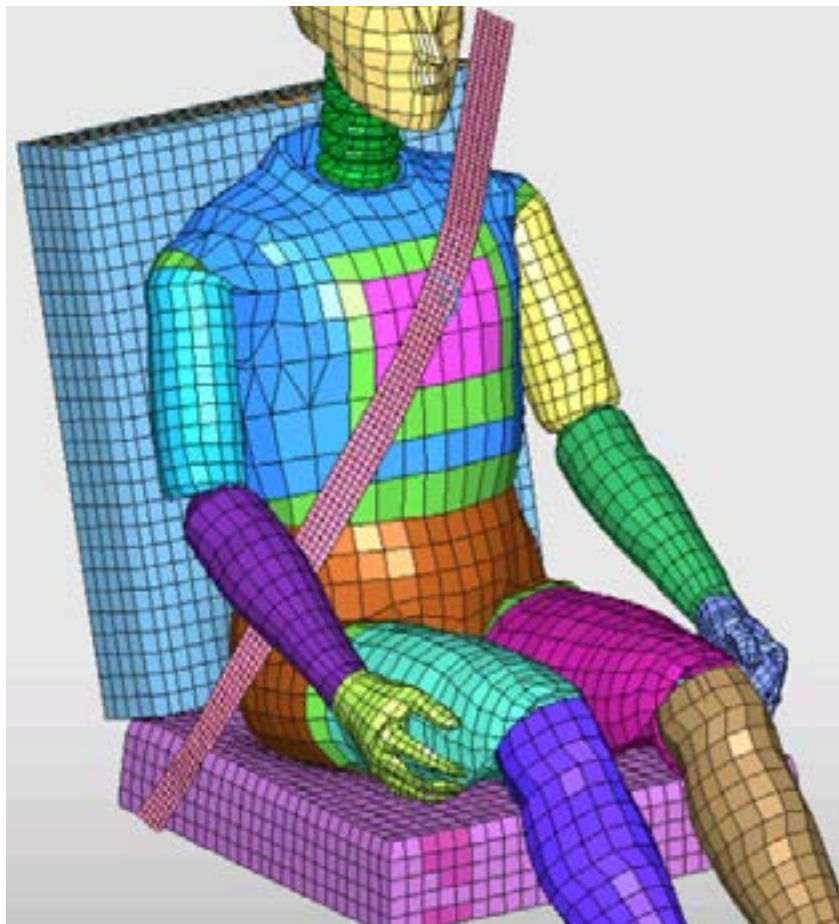

16. Click Save to save the belt definition.
17. Redo the same operations in order to create the lower belt. Select nodes, as shown below

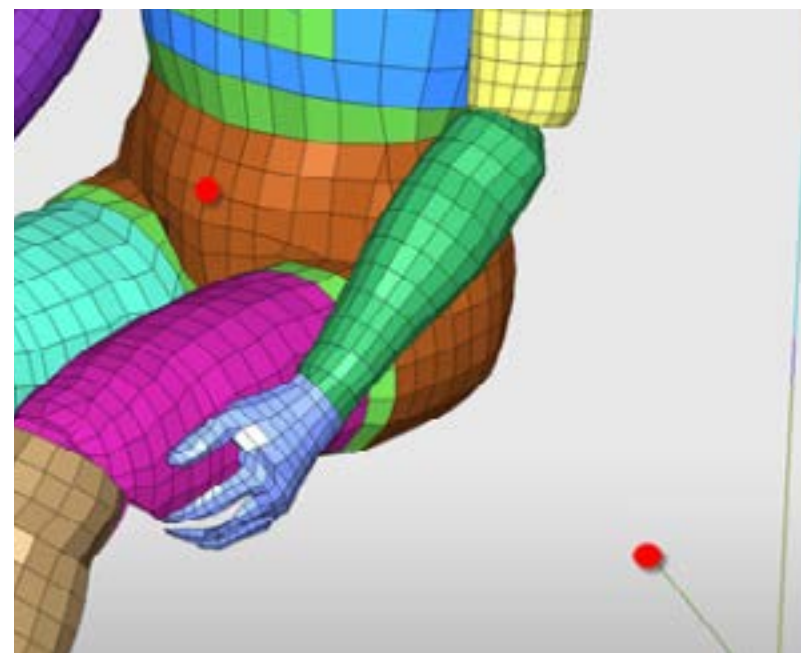
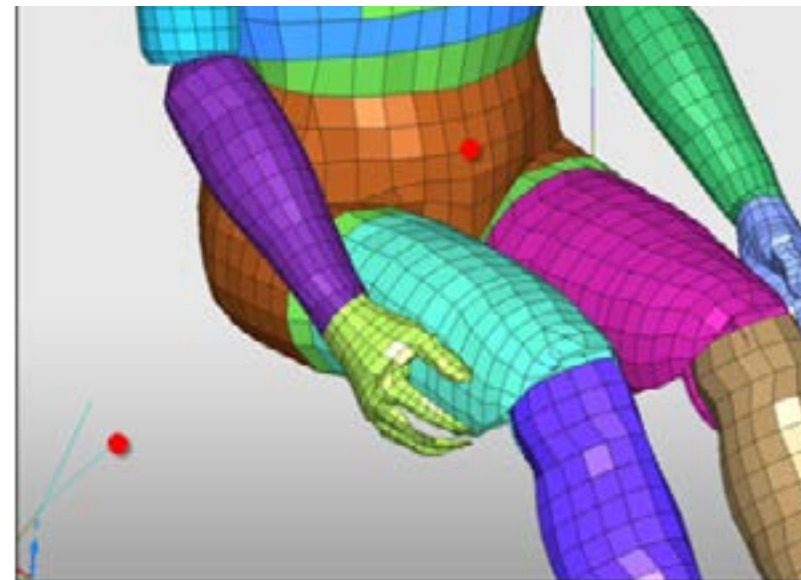

18. Select the parts: pelvis, upper legs and seat cushion fabric.
19. Click Preview > Save > Close

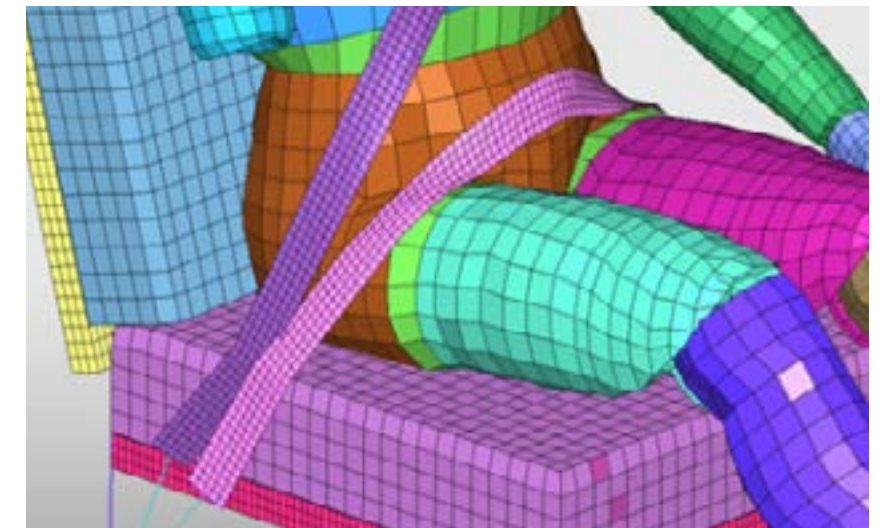

STEP 8 : Seatbelt & Dummy

8.1 Create Contact Interfaces

During the seatbelt creation, two contact interfaces between the seatbelt and the dummy have been created. You will need to check and remove any remaining intersections and penetrations.

1. Click LoadCase > Contact Interface.
2. Select interface BELT ID 400038.
3. Click See selected icon to display.
4. Click in Main Surface, right-click in the modeling window, and click blue icon to include picked parts to select the Fabric backframe and the Backseat frame as they may come into contact with the shoulder belt during the analysis.

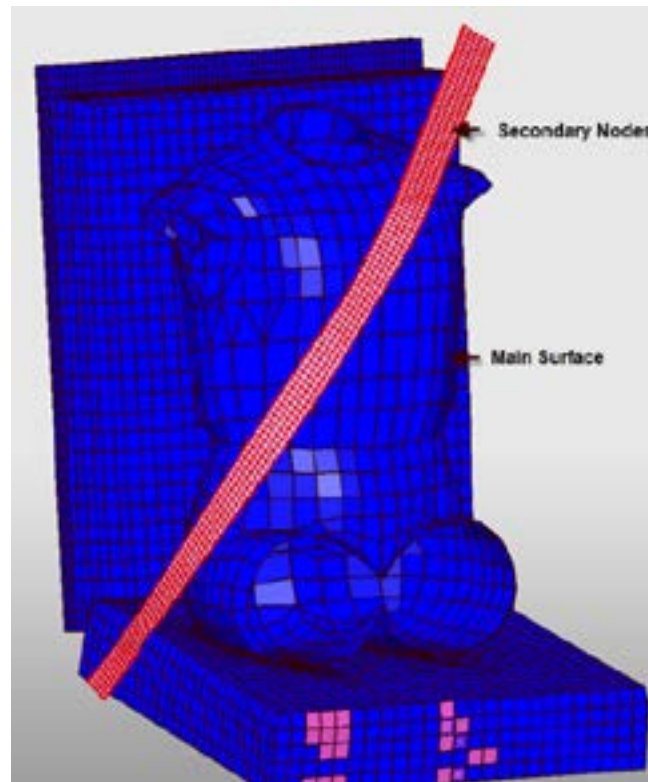

5. Click Save.
6. Select interfaces BELT ID 400038 and BELT ID 400039.
7. Click See selected (reviewgeneral-24) to display.
8. Set Coulomb friction to 0.3.
9. Set Friction penalty formulation to 2.
10. Click Save.
11. Select interfaces BELT ID 400038 and BELT ID 400039.
12. Click Check penetration selected interfaces.
13. In the Quality panel, remove the intersections and penetrations using the De penetrate Auto (depenetratesauto).
14. Click Close in order to come back to the Contact Interface panel.
15. Click Export to save the model.

8.2 Create Seat Structure

Creation of Self-Impact between different parts of the Seat.

1. In the Tree window, select subsets Frame, Floor and Foam.
2. Click the Isolate icon .
3. Right-click in the Contact list and select Create New Multi-usage (Type 7).
4. Click Self impact.
5. Set the Title to Self impact seat structure.
6. Set Gap/element option to Variable gap.
7. Set Coulomb friction to 0.2.
8. Set Friction penalty formulation to 2.
9. Right-click in the Main Surface entry box and click Select in graphics > Add selected parts of tree
10. Click Save.
11. Select the self impact seat structure interface in the list.
12. Click Check penetration selected interfaces. Some penetrations exist between the seat cushion and the seat structure.
13. Switch to the Tree window, and select the subset named Frame.
14. Switch to the Quality window and click the Fixed part icon. Press the Esc key to remove all selected parts.
15. Click Add selected parts of tree.
16. Click De penetrate Auto. Note: Only the nodes of the seat cushion are moved. The seat parts are fixed.
17. Click Close twice.
18. Click Export to save the model.

8.3 Create the Interface between Dummy feet & Floor

Creation of an interface between dummy feet and the floor.

1. Right-click in the Contact list and select Create New > Tied with void (Type 10).
2. Set the dummy feet as secondary nodes.
3. Set the floor as main surface.

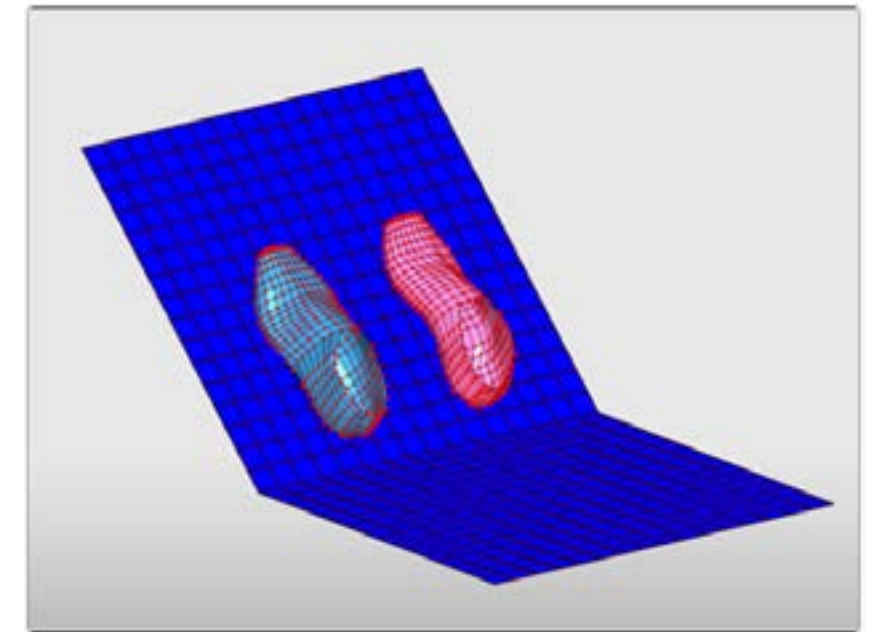

4. Set the interface Title to Feet - Floor.
5. Set Gap for impact activation to 3.0 mm.
6. Click Save > Close.
7. Click Export to save the model

Step 9 : Seat Deformer tool

As the dummy is placed on the seat , there are elements overlapping. If not dealt with, this will cause the model to crash.

This can be fixed by the following tool :

Click Safety > Seat Deformer > Pre-simulation (new) and click Add selected parts of Tree

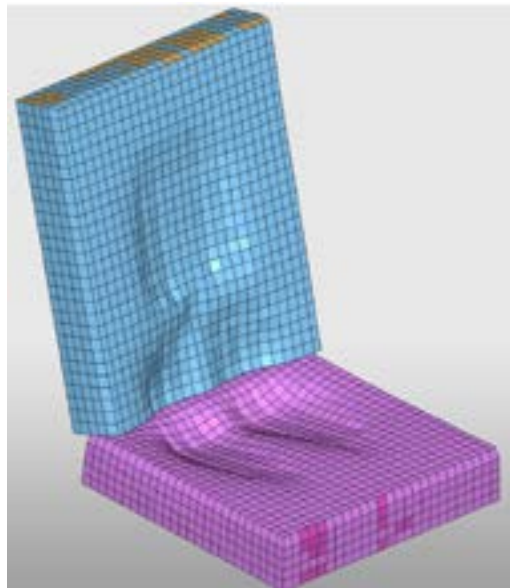

Above is the seat after the seat deformer tool.

Step 10 : Loadcase Settings

10.1 Set the velocity

1. Click LoadCase > Initial Velocity to open the Initial Velocity tab.
2. Select the initial velocity All in the list.
3. Click See selected initial velocity
4. Right-click in the Support entry box and click Select in graphics > Add all nodes
5. Change [Vx] X Velocity from -10000 to -13000 mm/s
6. Update Imposed Velocity
7. Update the imposed velocity on the floor to decelerate the car.

10.2 Set Imposed velocity

1. Click LoadCase > Imposed > Imposed Velocity.
2. Select Imposed velocity in the list.
3. Click See selected imposed velocity. The floor rigid body is displayed on the screen. The imposed velocity is defined on its main node.
4. Click Save > Close.

5. Click Export to save the model.

10.3 Set Boundary Conditions

To simulate the Sled Test, you need to constrain all degrees of freedom on the floor except X-direction.

1. Click LoadCase > Boundary Condition.
2. Select Floor in the list.
3. Click See selected boundary condition. The floor rigid body is displayed on the screen. The boundary condition is defined on its main node.
4. Verify that the degree of freedom for Ty, Tz, Rx, Ry, and Rz are fixed

Step 11. Set Time History Data

1. Select Nodes
2. Click Data History > Time History.
3. Select the node group associated with the dummy
4. Click See selected nodes. These are the nodes of the dummy rigid bodies.
5. For the first 5 nodes of the group:
 - Select the node in the list.
 - Click See selected node.
 - Enter a name in the field Node name, with the associate body part of the dummy.
 - Click Ok.

Repeat the process for all parts.

Step 12. Clean the model

1. Go to Quality Module.
2. Select Check All Solver Contact Interfaces.
3. Make sure there are no intersections and initial penetrations; if so, fix them.
4. Click Close.
5. Go to Mesh Editing and clean so that all the unused materials and properties are removed

Step 13 Create Control Cards

1. Click Model > Control Cards to create the Control Cards in the images below

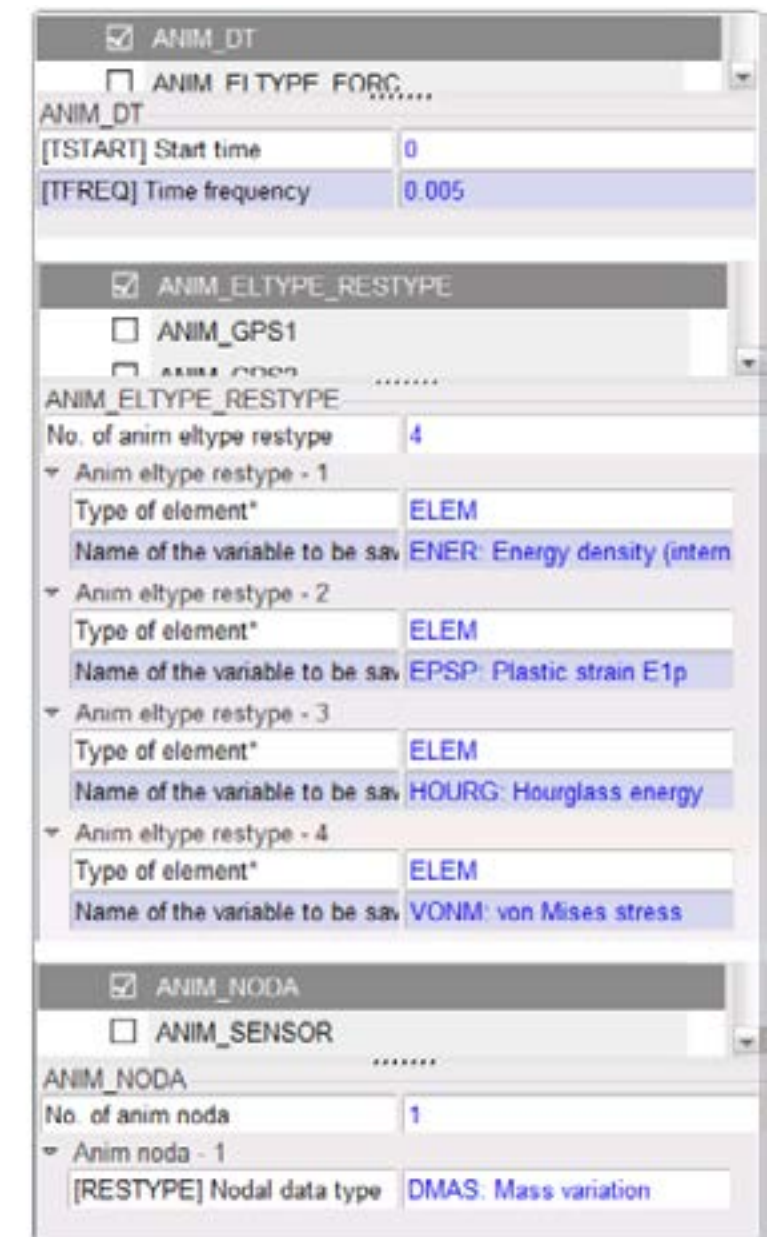

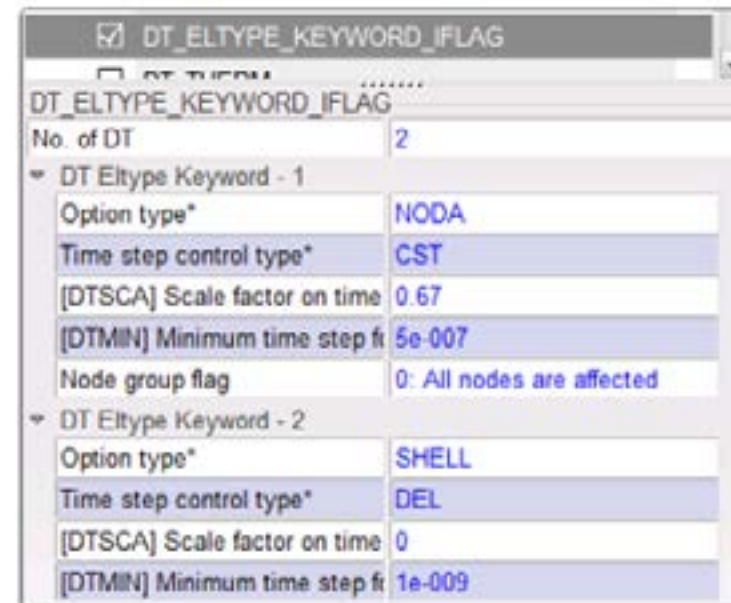
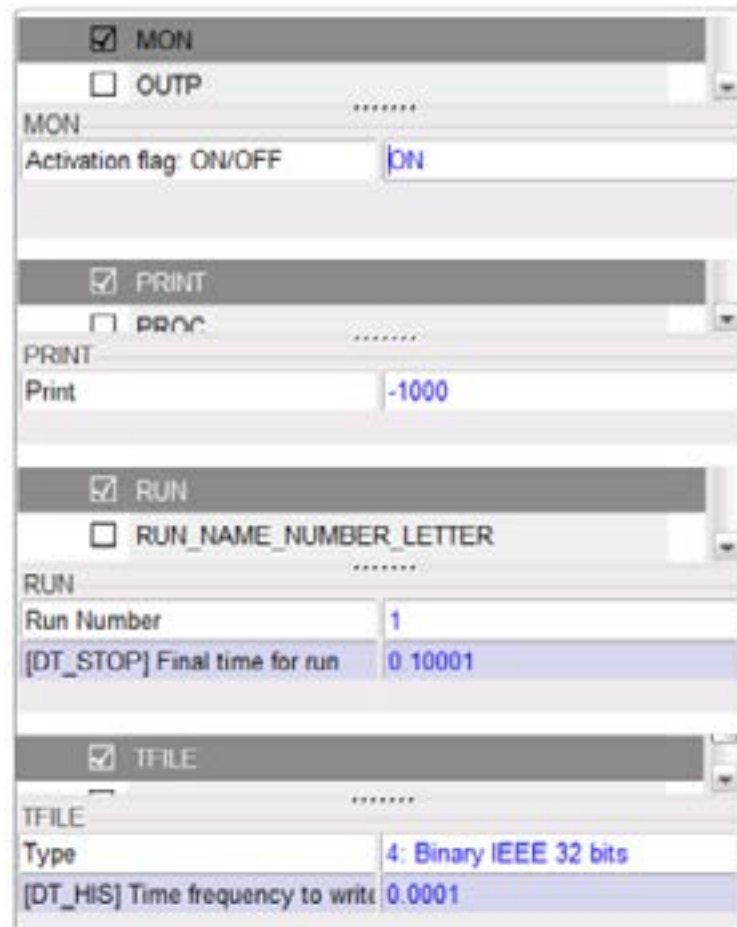

2. Click File > Export > Radioss.
3. Enter a name for the model in the file output window and click OK.
4. Click Save Model.
5. The model is now ready to be computed

Open the model in Altair Hypermesh to compute. The results can be generated in Hyperview. This is the complete procedure for three point seatbelt in upright position with an impact speed of 56km/h.

For reclined seating, the model has to be rotated. For four point system an additional buckle should be created. Speeds can be varied in loadcase settings.

APPENDIX B

Seatbelt Comfort Study

The study is conducted to evaluate the comfort & usability of three-point & four-point seatbelts in upright & reclined positions in the context of in-vehicle entertainment.

* Required

* This form will record your name, please fill your name.

General Information

1

Name of the participant *

2

Age *

3

Height in Cms *

4

Weight in Kgs *

8/22/23, 2:16 AM

Seatbelt Comfort Study

Seatbelt Comfort measurements

In this section, you will evaluate the point of discomfort, perceived value of safety & usability of the seatbelt mechanism.

5

Which seatbelt comfort did you use *

Three-point seatbelt

Four-point seatbelt

Seatbelt Comfort measurements

In this section, you will evaluate the point of discomfort, perceived value of safety & usability of the seatbelt mechanism.

5

Which seatbelt comfort did you use *

Three-point seatbelt

Four-point seatbelt

6

Time of evaluation of seatbelt comfort *

Before the start of the study

At the end of the study

Initial Comfort Evaluation

7

Give an estimated time to fasten the seatbelt

- less than a second
- 1-2 seconds
- 2-4 seconds
- More than 4 seconds

8

Describe any shortcomings experienced with respect to fastening the seatbelt

Final Comfort Evaluation

9

Give an estimated time to unfasten the seatbelt *

- less than a second
- 1-2 seconds
- 2-4 seconds
- More than 4 seconds

10

Describe any shortcomings experienced with respect to the seatbelt.

11

Rate your perceived value of safety with respect to the seatbelt configuration in all seating configurations? *

- Very safe
- Somewhat safe
- Safe
- Neither safe nor unsafe
- Somewhat unsafe

12

Would you use this seatbelt configuration on a day-to-day basis? (applicable only for four-point seatbelt)

Localised postural discomfort

Based on the experienced (dis)comfort evaluate the (dis)comfort experienced in the different regions of the body.
Refer to the scale (1- no discomfort to 10- unbearable).

13

Localized body parts

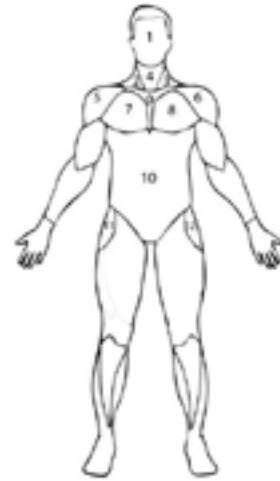

Upload file

File number limit: 1 Single file size limit: 10MB Allowed file types: Word, Excel, PPT, PDF, Image, Video, Audio

14

Upper Head (Region 1) *

1	2	3	4	5	6	7	8	9	10
---	---	---	---	---	---	---	---	---	----

15

Left side neck (Region 2) *

1	2	3	4	5	6	7	8	9	10
---	---	---	---	---	---	---	---	---	----

16

Right side neck (Region 3) *

1	2	3	4	5	6	7	8	9	10
---	---	---	---	---	---	---	---	---	----

17

Upper neck (Region 4) *

1	2	3	4	5	6	7	8	9	10
---	---	---	---	---	---	---	---	---	----

18

Left shoulder (Region 5) *

1	2	3	4	5	6	7	8	9	10
---	---	---	---	---	---	---	---	---	----

19

Right shoulder (Region 6) *

1	2	3	4	5	6	7	8	9	10
---	---	---	---	---	---	---	---	---	----

20

Left upper chest(Region 7) *

1	2	3	4	5	6	7	8	9	10
---	---	---	---	---	---	---	---	---	----

21

Right Upper Chest (Region 8) *

1	2	3	4	5	6	7	8	9	10
---	---	---	---	---	---	---	---	---	----

22

Sternum(Region 9) *

1	2	3	4	5	6	7	8	9	10
---	---	---	---	---	---	---	---	---	----

23

Stomach & abdomen (Region 10) *

1	2	3	4	5	6	7	8	9	10
---	---	---	---	---	---	---	---	---	----

24

Left upper thigh (Region 11) *

1	2	3	4	5	6	7	8	9	10
---	---	---	---	---	---	---	---	---	----

25

Right upper thigh (Region 12) *

1	2	3	4	5	6	7	8	9	10
---	---	---	---	---	---	---	---	---	----

APPENDIX C

Preferred procedure for fastening seatbelt

Hello, my name is Utkarsh Singh. I'm currently working on my graduation titled "Design of Restraint Systems for reclined seating. So far, I have conducted research and modeled crash simulations that indicate that four-point systems might be safer for reclined seating. To build a product out of it I have a quick survey to see what would be the preferred position of fastening four point systems.

* Required

* This form will record your name, please fill your name.

1

Name *

2

Email address *

3

How often do you travel with a car?

4

How often do you travel with a car

- Every day
- A few times a week
- Once a week
- Once a month

4

How often do you travel with a car

- Every day
- A few times a week
- Once a week
- Once a month

5

Rate procedure 1 based on ease of use *

6

Please find the various procedures below



7

Rate procedure 1 based on how adaptable it is to your existing routine *

8

Rate procedure 2 based on how adaptable it is to your existing routine *

9

6

Please find the various procedures below



7

Rate procedure 1 based on how adaptable it is to your existing routine *

8

Rate procedure 2 based on how adaptable it is to your existing routine *

9

Rate procedure 3 based on how adaptable it is to your existing routine *

Rate procedure 4 based on how adaptable it is to your existing routine *

11

Rate procedure 1 based on ease of use *

12

12

Rate procedure 2 based on ease of use *

13

Rate procedure 3 based on ease of use *

14

Rate procedure 4 based on ease of use *

15

What is your take on having four-point seatbelts in commercial vehicles? *

16

Any other questions *

APPENDIX D - Buckle CAD model

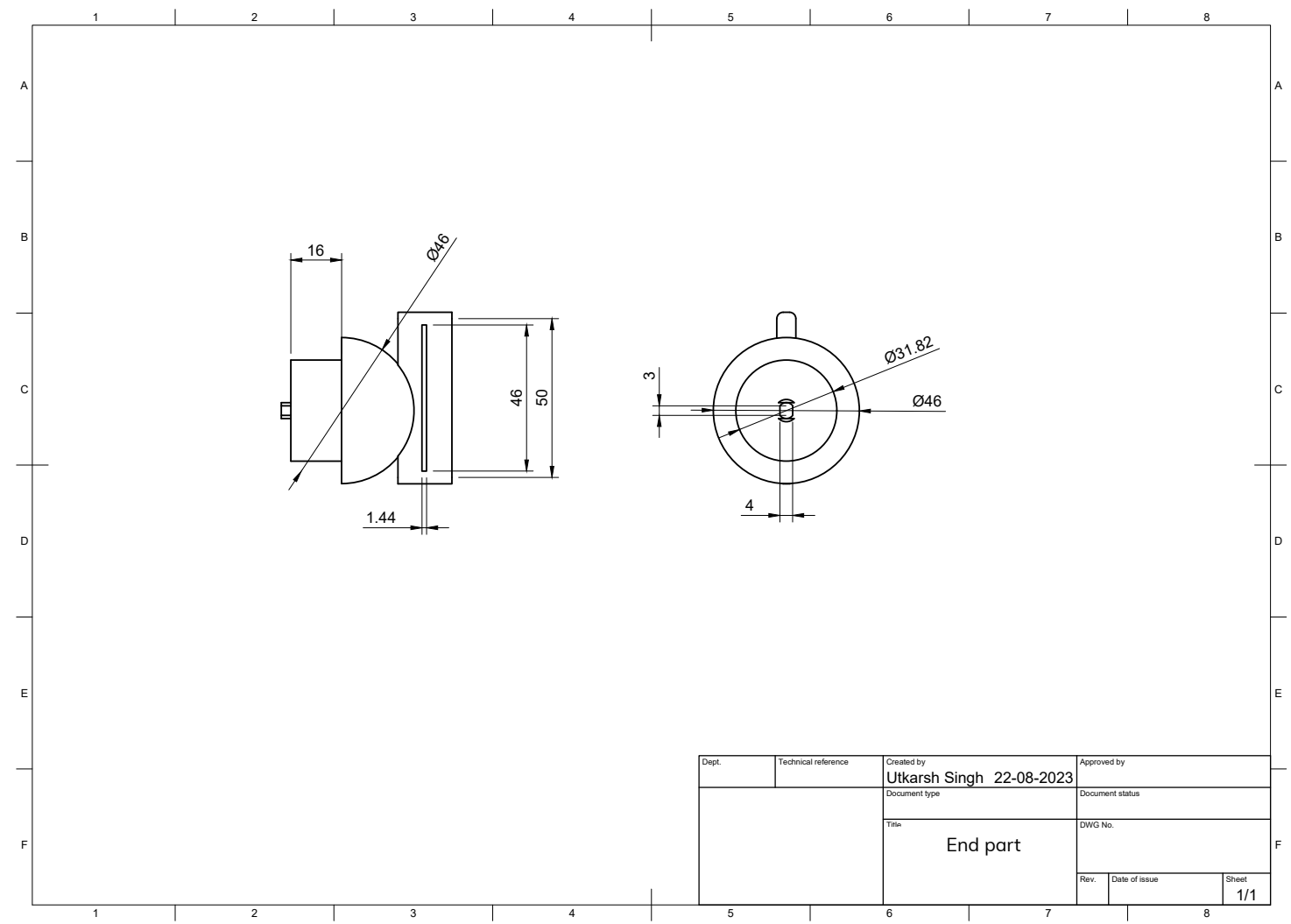
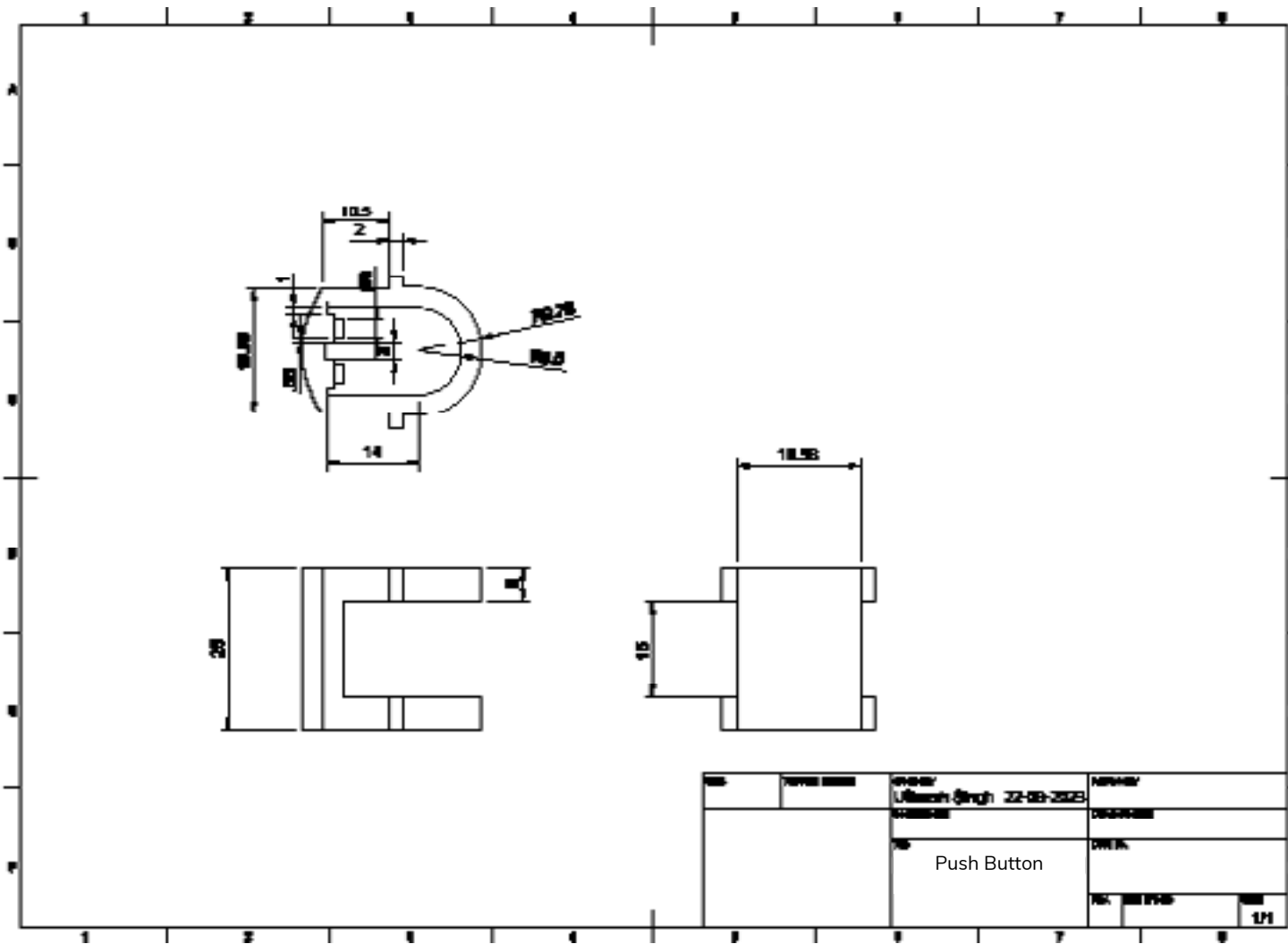

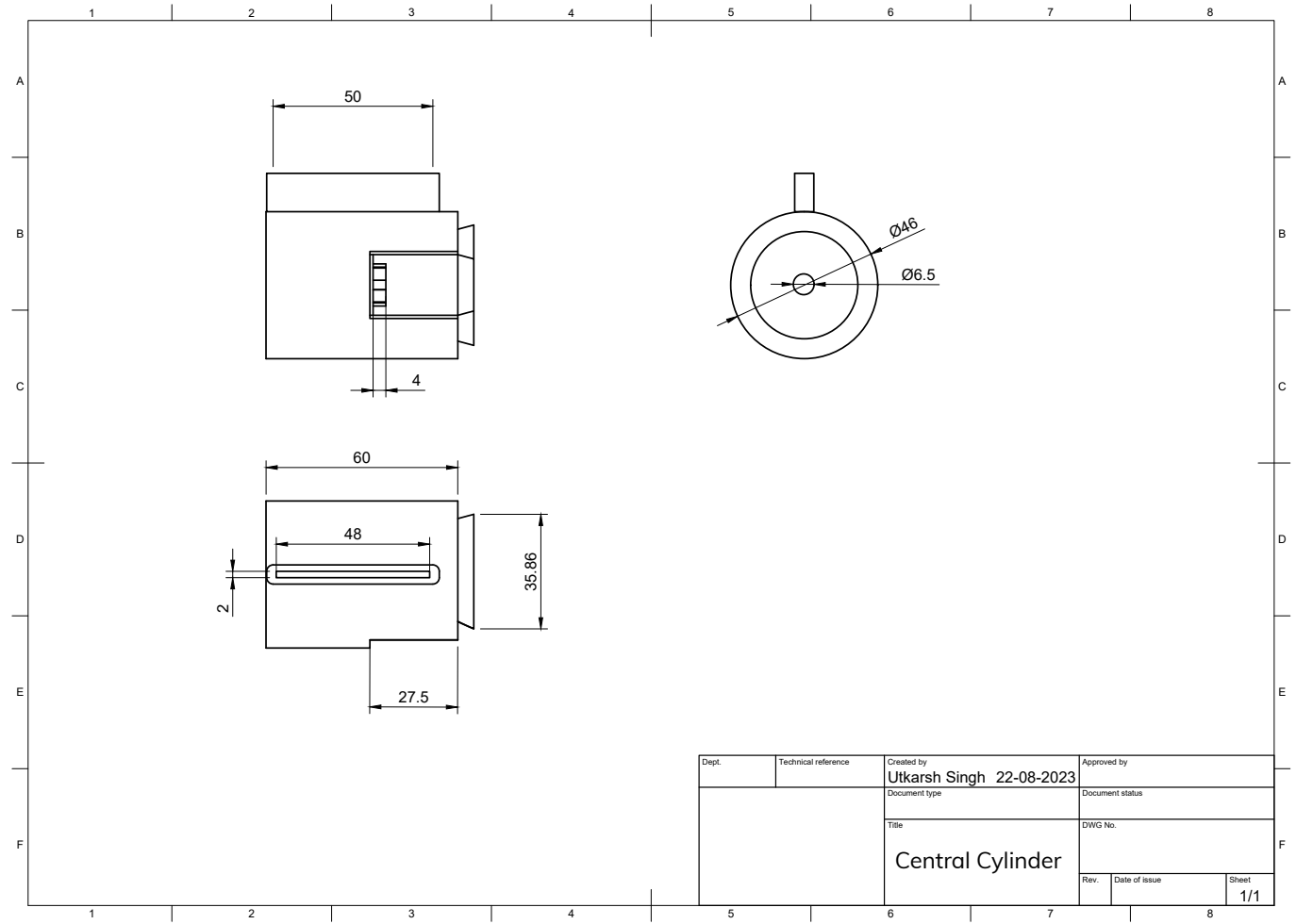
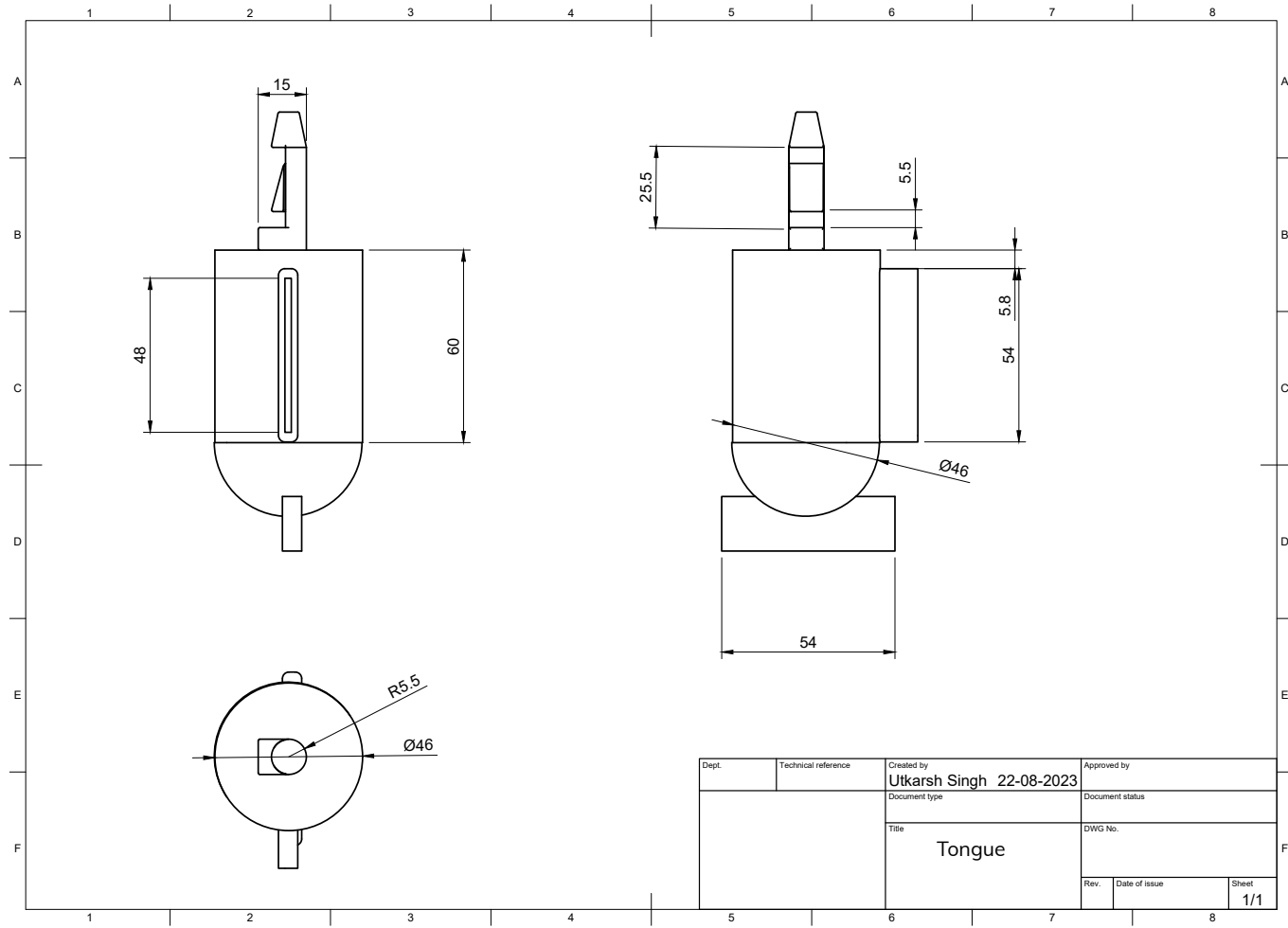

APPENDIX E - Graduation Brief

Procedural Checks - IDE Master Graduation

APPROVAL PROJECT BRIEF

To be filled in by the chair of the supervisory team.

chair P. Vink date 28-3-2023 signature 

CHECK STUDY PROGRESS

To be filled in by the SSC E&SA (Shared Service Center, Education & Student Affairs), after approval of the project brief by the Chair. The study progress will be checked for a 2nd time just before the green light meeting.

Master electives no. of EC accumulated in total: 30 EC YES all 1st year master courses passed

Of which, taking the conditional requirements into account, can be part of the exam programme 30 EC NO missing 1st year master courses are:

List of electives obtained before the third semester without approval of the BoE

Variant for Engineers

ID4070 IDE Academy (4,0)

name Robin den Braber date 30 - 03 - 2023 signature RdB

FORMAL APPROVAL GRADUATION PROJECT

To be filled in by the Board of Examiners of IDE TU Delft. Please check the supervisory team and study the parts of the brief marked **. Next, please assess, (dis)approve and sign this Project Brief, by using the criteria below.

- Does the project fit within the (MSc)-programme of the student (taking into account, if described, the activities done next to the obligatory MSc specific courses)?
- Is the level of the project challenging enough for a MSc IDE graduating student?
- Is the project expected to be doable within 100 working days/20 weeks ?
- Does the composition of the supervisory team comply with the regulations and fit the assignment ?

Content: APPROVED NOT APPROVED

Procedure: APPROVED NOT APPROVED

the missing course ID4070 should be finished before the green light meeting

comments

name Monique von Morgen date 4/4/2023 signature MvM

introduction (continued): space for images

image / figure 1: _____

image / figure 2: _____

PROBLEM DEFINITION **

Limit and define the scope and solution space of your project to one that is manageable within one Master Graduation Project of 30 EC (= 20 full time weeks or 100 working days) and clearly indicate what issue(s) should be addressed in this project.

Area for writing the Problem Definition. A vertical dashed line is on the left side.

ASSIGNMENT **

State in 2 or 3 sentences what you are going to research, design, create and / or generate, that will solve (part of) the issue(s) pointed out in "problem definition". Then illustrate this assignment by indicating what kind of solution you expect and / or aim to deliver, for instance: a product, a product-service combination, a strategy illustrated through product or product-service combination ideas, In case of a Specialisation and/or Annotation, make sure the assignment reflects this/these.

Area for writing the Assignment. A vertical dashed line is on the left side.

PLANNING AND APPROACH **

Include a Gantt Chart (replace the example below - more examples can be found in Manual 2) that shows the different phases of your project, deliverables you have in mind, meetings, and how you plan to spend your time. Please note that all activities should fit within the given net time of 30 EC = 20 full time weeks or 100 working days, and your planning should include a kick-off meeting, mid-term meeting, green light meeting and graduation ceremony. Illustrate your Gantt Chart by, for instance, explaining your approach, and please indicate periods of part-time activities and/or periods of not spending time on your graduation project, if any, for instance because of holidays or parallel activities.

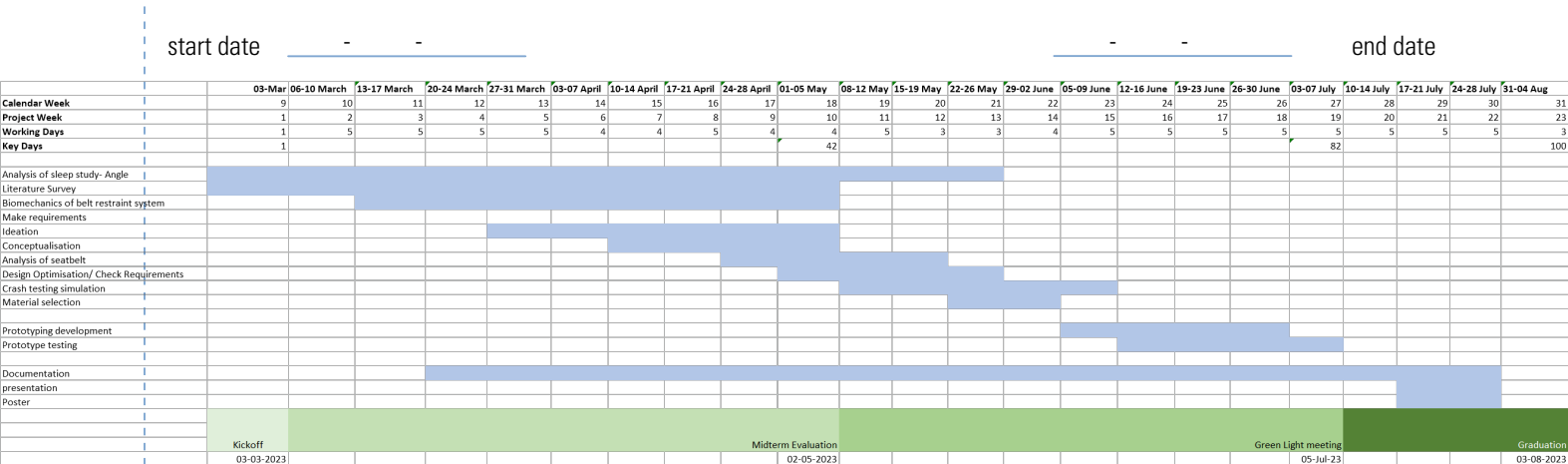

MOTIVATION AND PERSONAL AMBITIONS

Explain why you set up this project, what competences you want to prove and learn. For example: acquired competences from your MSc programme, the elective semester, extra-curricular activities (etc.) and point out the competences you have yet developed. Optionally, describe which personal learning ambitions you explicitly want to address in this project, on top of the learning objectives of the Graduation Project, such as: in depth knowledge a on specific subject, broadening your competences or experimenting with a specific tool and/or methodology, Stick to no more than five ambitions.

Vertical dashed line on the left side of the page.

FINAL COMMENTS

In case your project brief needs final comments, please add any information you think is relevant.

Vertical dashed line on the left side of the page.