



DESIGN STUDY FOR THE CREATION OF LOTIC HABITATS AT THE WEIR COMPLEXES IN THE RIVER MEUSE

MASTER THESIS

by

T.L. Rahan

Delft University of Technology
In collaboration with Royal HaskoningDHV

August 2024

[Blank page]

DESIGN STUDY FOR THE CREATION OF LOTIC HABITATS AT THE WEIR COMPLEXES IN THE RIVER MEUSE

by

Tyra Lee Rahan

to obtain the degree of Master of Science at
Delft University of Technology

To be defended publicly on Wednesday 14 August, 2024 at 15:00.

Student number: 4448499

Project duration: February 13, 2023 – August 14, 2024

Thesis committee:

Dr. ing. M. Z. Voorendt
Prof. Dr. Henk Jonkers
Ir. Floris van der Ziel
Ir. Rick Delbressine

Committee chair and TU Delft supervisor
TU Delft Supervisor
Royal HaskoningDHV Supervisor
Rijkswaterstaat Advisor



Preface

This report serves as the master thesis for the final graduation project for the master's program Structural engineering, with a Specialization in Hydraulic Structures, at Delft University of Technology. This project is in collaboration with Royal HaskoningDHV and Rijkswaterstaat to achieve a concept design for an optimized ecological route for lotic habitat formation (in Dutch: 'Stromende habitats') at the weir complexes in the Dutch part of the river Meuse.

My interest has always been on the environmental aspects of the civil engineering field. Specifically, I am interested in exploring how we can reduce the negative impact of civil engineering projects on the environment and how these projects can enhance existing environmental conditions, benefitting the surrounding species. This interest is rooted in my upbringing in Suriname, a country in South America that values its beautiful natural environment. Given my desire to contribute to designs that support both infrastructure for society and reduce the negative impact on the surrounding environments, I chose to focus on this topic for my thesis. I believe that by combining engineering expertise with a commitment to environmental issues, we can create structures and systems that benefit both society and the natural environment. This thesis represents my contribution to that goal.

I would like to sincerely thank my supervisor and committee chair, Mark Voorendt from TU Delft, for all his support, advice, and motivation during my entire thesis. I would also like to thank my other supervisors, Henk Jonkers from TU Delft, Rick Delbressine from Rijkswaterstaat, and Floris van der Ziel from Royal HaskoningDHV, for their valuable feedback and support during this process. In addition, I want to thank Robert Jan Labeur from TU Delft for his advice during the design process. Lastly, I want to thank my parents, brothers, and close friends for their support and advice throughout my entire study period. My accomplishments would not have been possible without them.

Tyra Rahan
Delft, August 2024

Abstract

Water levels in the river Meuse drop during periods of low river discharges, making it unnavigable for shipping. To maintain navigability in the Dutch part of the river Meuse, seven weir complexes were constructed in the river. These complexes regulate the river and maintain target water levels to allow for shipping throughout the entire year. The complexes were constructed in the early 20th century and are all reaching the end of their technical lifetime. Therefore, they require replacement or renovation. This provides the opportunity to explore ecosystem restoration at these complexes.

The seven weir complexes are located at Borgharen, Linne, Roermond, Belfeld, Sambeek, Grave, and Lith. Each complex consists of weirs, locks, and fish ladders. These complexes act as barriers to fish migration, the river's sediment transport, and reduce the lotic habitats in the river (in Dutch: 'Stromende habitats'). The reduction of lotic habitats leads to a decline in species that depend on these environments.

The objective of this report is to study the possibility of creating an optimized ecological route at conceptual level for the weir complexes in the Dutch part of the river Meuse to create environmental conditions for the formation of lotic habitats. This optimized ecological route is referred to as an ecological channel. The channel was designed to support specific endangered river species, referred to as the target river species.

The channel was initially designed for weir complex Sambeek, which serves as the case study location. This complex was selected as it has the most available space, which provides more flexibility for the channel's design. Subsequently, an assessment was conducted to determine whether the channel could be applied to the other complex locations. To form lotic habitats, the channel must meet certain environmental conditions that are based on the needs of the target river species. These conditions must be achieved during the critical reproductive months of these species. The environmental conditions primarily consist of varying flow conditions, which are achieved by varying inflow rates, indicating the need of an intake structure.

The ecological channel was designed through an iterative process, as its dimensions and flow conditions have interdependent relationships. These parameters had to be iteratively adjusted until a suitable combination was found that met the required conditions. To streamline the process and reduce the number of possible combinations, the design of the channel's intake structure and the channel's dimensions were done separately.

The final ecological channel design includes an intake structure consisting of a flap gate and vertical-slot fish passage. An impression of the final channel design at weir complex Sambeek is shown in the figure on the following page. The channel design meets the required environmental conditions for habitat formation for river discharges up to 500 m³/s for weir complex Sambeek, Linne, Roermond, and Grave, and for discharges up to 250 m³/s at complex Borgharen, Belfeld, and Lith. Both discharge ranges include the critical reproductive months of the target river species, as was required. The final design shows that the required environmental conditions for lotic habitat formation can be achieved at the weir complexes in the Dutch part of river Meuse, potentially leading to an increase in the populations of the target river species.

The channel design may not accurately represent reality due to uncertainties in the estimations and limitations of the channel's boundary conditions, available space, and simplifications of its hydraulic processes. In addition, even if the required environmental conditions are achieved, it does not guarantee that the river species will utilize the channel, as their behaviours can be unpredictable, and their response may not be as anticipated. To develop a more realistic and detailed design, it is recommended to construct a hydraulic model and conduct further research on the behaviours of the river species.

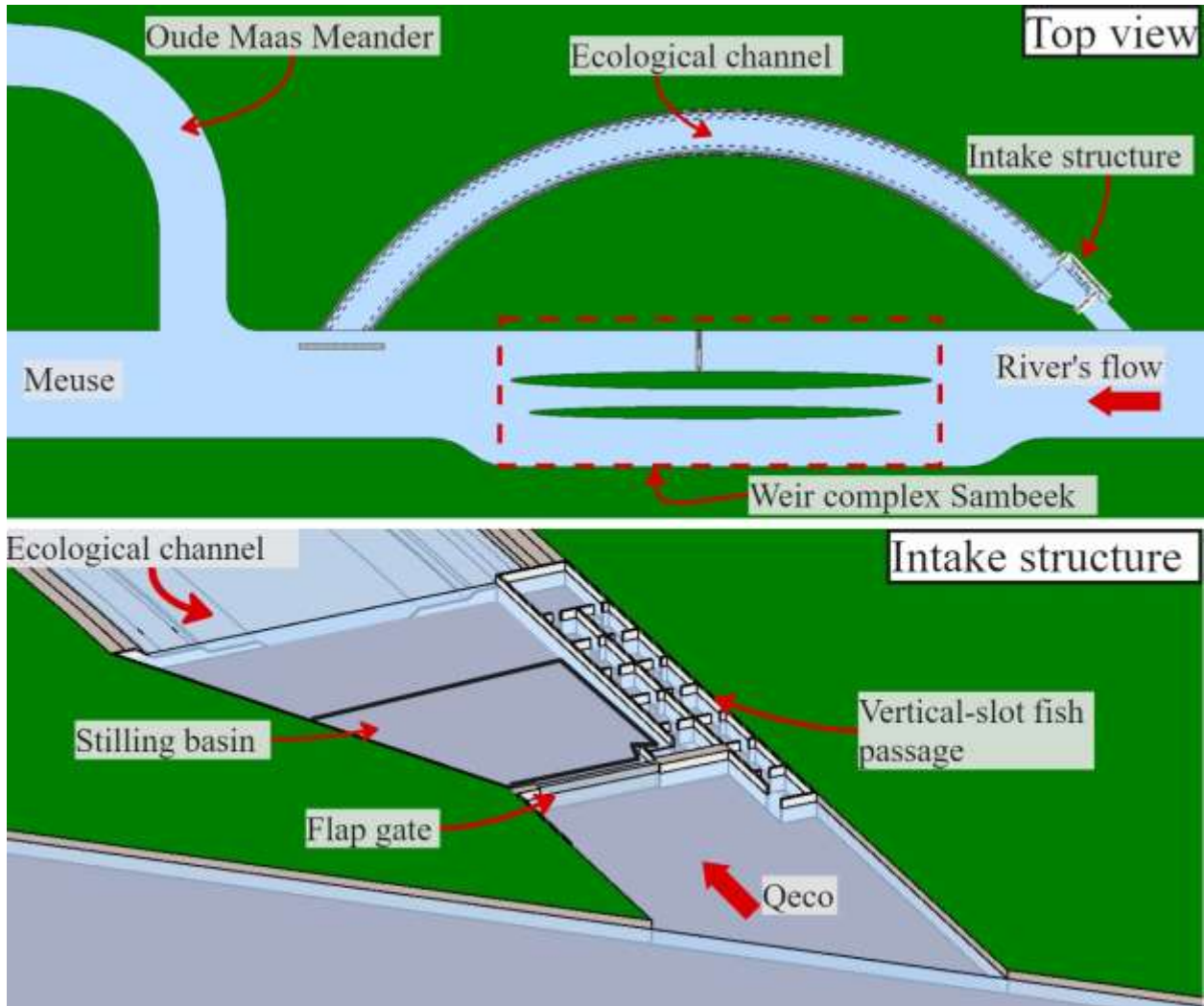

Impression of the ecological channel's final design.

Preface	iii
Abstract	iv
1. Introduction.....	1
1.1 Motivation for the project	1
1.2 Problem analysis	2
1.3 Project’s objective and scope.....	8
1.4 Approach and report outline	9
2. System analysis.....	11
2.1 Selection of the case study location	11
2.2 Area description of complex Sambeek	12
2.3 Weir management of complex Sambeek.....	12
2.4 River species at complex Sambeek.....	15
2.5 Functional analysis for complex Sambeek.....	17
3. Basis of design	19
3.1 Functional requirements.....	19
3.2 Evaluation criteria.....	23
3.3 Boundary conditions at complex Sambeek	24
4. Functional-spatial design	27
4.1 Design of the ecological channel for lotic habitat formation	27
4.2 Design of the fish passable intake structure.....	47
4.3 Final combined design of the ecological channel	62
4.4 Evaluation of the ecological channel’s function as a fish passage.....	64
5. Generalization.....	67
5.1 Identifying boundary conditions for the other weir complexes	67
5.2 Assessing the ecological channel design at the other weir complexes	68
6. Discussion, Conclusions, and Recommendations	70
6.1 Discussion	70
6.2 Conclusions.....	73
6.3 Recommendations.....	75
References.....	77
Appendices.....	80
Appendix A Area analysis of the weir complex locations.....	81
Appendix B General information about weir complex Sambeek.....	88

B.1.	Combined Poirée and Stoney weir.....	88
B.2.	Locks with mooring areas.....	89
B.3.	Fish ladder.....	90
B.4.	Process analysis	91
Appendix C	Required habitats of the target river species	94
C.1.	Aquatic plants species.....	94
C.2.	Macro-fauna species	94
C.3.	Fish species	97
Appendix D	Fish passage’s target and required flow conditions	100
D.1.	Findability conditions for the fish passage.....	100
D.2.	Passability conditions for the fish passage.....	102
Appendix E	Equations describing the channel’s hydraulic processes.....	105
Appendix F	Determining the channel’s flow conditions for uniform flow.....	108
F.1.	Calculating the flow conditions for uniform flow.....	108
F.2.	Estimating the occurrence of river discharges below 30 m ³ /s	120
Appendix G	Impact of each channel parameter on the flow conditions.....	122
Appendix H	Discharge distribution of the river’s flow	136
Appendix I	Determining the channel’s flow conditions for quasi-uniform flow.....	138
I.1.	Calculating the backwater curves	138
I.2.	Calculating the flow conditions in the thalweg and bank areas	145
I.3.	Overview of the flow conditions in the channel’s thalweg and bank areas	151
Appendix J	Determining the flow conditions for the design alternatives of the intake structure	152
J.1.	Determining the flow conditions for the first design alternative	152
J.2.	Determining the flow conditions for the second design alternative.....	156
Appendix K	Estimating the number of days river discharges between 400 and 500 m ³ /s occur	160
Appendix L	Boundary conditions and flow conditions for the other complex locations.....	161
L.1.	Estimated channel lengths.....	161
L.2.	Measured river water levels at each complex location	163
L.3.	Channel’s flow conditions for quasi-uniform flow	164
L.4.	Vertical-slot fish passage’s flow conditions	183

1. Introduction

1.1 Motivation for the project

The discharge of the river Meuse in the Netherlands primarily relies on precipitation, leading to significant fluctuations in the river's flow rates. During periods of low river discharges, the river's water levels become insufficient, making the river unnavigable for shipping. To address this issue and enable the continuation of shipping during varying river discharges, seven weir complexes were constructed along the river. These weir complexes regulate the river by raising the river's water levels during low river discharges. Figure 1 gives an aerial view for one of these weir complexes. Constructed in the early 20th century, these weir complexes are all reaching the end of their technical lifetime. Therefore, replacement or renovation of the weir complexes is essential, considering their crucial role in facilitating shipping on the river Meuse.

Rijkswaterstaat, the organization responsible for managing all seven weir complexes, is tasked with their replacement or renovation. This replacement or renovation process aligns with their 'Vervanging en Renovatie programma' (Rijkswaterstaat, 2022). The program describes various ambitions, including striving for greater climate neutrality and exploring opportunities to restore disrupted ecosystems. This master thesis aims to explore these opportunities for ecosystem restoration at the weir complexes while ensuring the preservation of their primary function in supporting shipping activities.



Figure 1: Aerial view of weir complex Sambeek in the river Meuse (Rijkswaterstaat, n.d.)

1.2 Problem analysis

This section provides an overview of the river Meuse and the existing weir complexes. It then proceeds to discuss the ecological shortcomings of these complexes to identify areas for potential ecological improvements. It aims at pinpointing a concise problem statement.

1.2.1 The river Meuse's network

The river Meuse originates from the Langres Plateau in France and flows through Belgium and the Netherlands before reaching the North Sea. It can be divided into three parts: the French, Belgian, and Dutch part, as shown in Figure 2. The primary tributaries of the river Meuse are the river Ourthe, Semois and Rur, which are indicated in Figure 2. The river Meuse enters the Netherlands at Eijsden and passes through Maastricht and 's-Hertogenbosch before flowing into the river Hollandsch Diep, Haringvliet, and eventually the North Sea. The Dutch part of the river, known as the Maas, is supported by vital tributaries such as the river de Voer, Jeker, Geul, Geleenbeek, de Roer, Swalm, Niers, Dommel, Aa and de Dieze (Ankum, Delbressine, Kurvers, & Maes, 2023).

During the industrialization era, the Netherlands required reliable transportation routes, for which the river Meuse was considered. However, the river's discharge primarily relied on precipitation, resulting in unreliable shipping conditions due to inadequate water levels during low river discharges. To ensure a consistent and reliable transportation system on the river, plans were formulated to canalize the river Meuse. Following the successful canalization project, the Dutch part of the river Meuse can be divided into six distinct sections, namely the Bovenmaas, Grensmaas, Plassenmaas, Zandmaas or Terrassenmaas, Bedijktemaas, and Getijdenmaas, as shown in shown in Figure 2. The canalization plans and the river sections are elaborated in the report (Ankum, Delbressine, Kurvers, & Maes, 2023).



Figure 2: The river Meuse with its main tributaries flowing through France, Belgium, and the Netherlands to the North Sea (Ankum, Delbressine, Kurvers, & Maes, 2023) [left]. The Dutch sections of the river Meuse [right].

1.2.2 Overview of the existing weir complexes

The seven weir complexes are located at Borgharen, Linne, Roermond, Belfeld, Sambeek, Grave, and Lith as shown in Figure 3. Each weir complex is named after its corresponding location and is composed of multiple subsystems. Table 1 gives an overview of the main subsystems at each location. The subsystems at each complex location are elaborated in the report by (Ankum, Delbressine, Kurvers, & Maes, 2023).

Table 1: Overview of the subsystems at each complex location

Subsystems	Type	Weir complex location
Weirs	Combined Poirée and Stoney weir	Linne, Roermond, Belfeld, and Sambeek
	Wheel gates weir with control valve	Borgharen and Lith
	Bridge weir with frames and panels	Grave
Locks and mooring areas		All
Fish passage	V-shaped pool-and-weir fish ladder	All
Hydropower plants		Linne and Lith



Figure 3: Overview of the weir complex locations in the river Meuse with corresponding aerial views (Rijkswaterstaat, n.d.)

General functioning of the weirs and locks

The main purpose of the seven weir complexes is to ensure the continuity of shipping on the river Meuse, particularly during low river discharges when insufficient water levels for navigation occurs. When the river experiences low river discharges, the weirs control and restrict the river's flow, thereby achieving the desired water levels upstream of the complexes. The closed weirs create a water level difference between the upstream and downstream sides of the weir complex. The ships navigate this water level difference by

utilizing the locks. Mooring areas are located upstream and downstream of the locks, providing anchoring points for ships.

As the river discharge increases, the weirs gradually open to maintain the desired upstream water levels. This process continues until the water level difference between the upstream and downstream sides of the complex becomes negligible. At this point, the weirs can be fully opened, and the river operates as a free-flowing river, where the water levels depend on the river's discharge, gradient and cross-section. This situation occurs during high river discharges, which result in high-water levels that cause the locks to become partially submerged, making them non-operational. Currently, ships can pass the weir complex by navigating through the fully open weirs at weir complex Roermond, Belfeld, Sambeek, Grave and Lith (Ankum, Delbressine, Kurvers, & Maes, 2023). Figure 4 shows a schematization of the weirs during low and high river discharges.

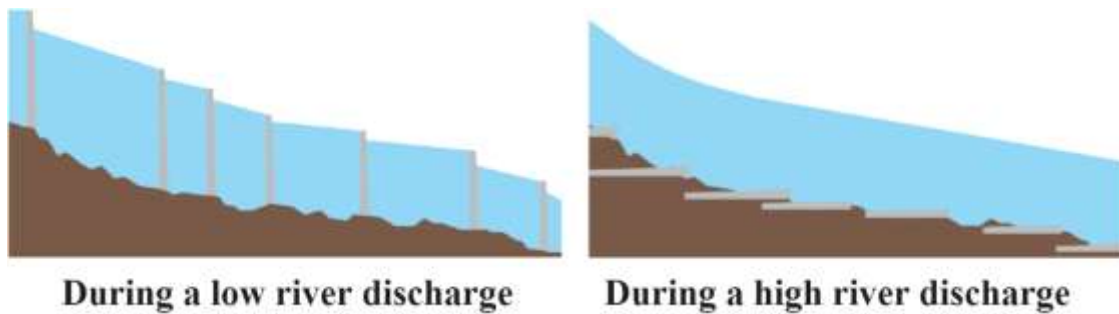

Figure 4: Schematization of the weir during low and high river discharges (Ankum, Delbressine, Kurvers, & Maes, 2023)

Apart from ensuring sufficient water levels for shipping, the river Meuse also plays a crucial role in providing water for industrial and drinking water purposes. As a result of the river regulation, the surrounding environment has been arranged to align with the target water levels (Dutch: 'stuwpeilen'). This includes the intake and drainage systems of the region, and maintaining the desired groundwater table. Therefore, having sufficient water levels in the river is essential to support these activities. The target water levels are determined through various agreements, such as the WATAK (water agreement between Rijkswaterstaat and the water boards of Brabant and Limburg) (Ankum, Delbressine, Kurvers, & Maes, 2023).

Fish ladders

The river Meuse supports various fish species that freely move between the different habitats in the river. However, the closed weirs and locks form a barrier to fish movement, particularly hindering the upstream migrating fish. To address this, fish passages were constructed at all seven weir complex locations. Each fish passage is a V-shaped pool-and-weir fish ladder, which consists of consecutive pools and weirs that divide the total water level over the complex into smaller more navigable steps for the fish. The fish ladders have an adjustable intake weir (most upstream weir) to regulate the inflow rates. Figure 5 shows the fish ladder at Borgharen. For the fish ladder to effectively support fish migration, it must provide adequate flow velocities, water levels, and luring currents.



Figure 5: V-shaped pool-and-weir fish ladder at weir complex Borgharen (Rijkswaterstaat, n.d.) and (Vriese, et al., 2021)

1.2.3 Ecological shortcomings of the weir complexes

The current ecological shortcomings of the weir complexes are described in the report (Vriese, et al., 2021) and outlined in the remainder of this section.

Inadequate fish passability

The fish passability of the weir complexes refers to the longitudinal upstream and downstream movement or migration of fish through the complexes. When the weirs are closed the upstream migrating fish use the fish ladders, while the downstream migrating fish mostly move with the river's flow over the weirs. When the weirs are fully opened the fish can move freely through them.

Upstream fish migration

The fish ladders have several structural issues that reduces their proper functioning. These are:

- High water level differences over the individual weirs, making the fish passage less passable for weaker swimming fish
- High turbulence intensities in the individual pools, which reduces the passability for weaker swimming fish
- Insufficient dimensions of the weirs and pools, hindering the passage for larger fish. It also leads to increased turbulence intensities in the pools, reducing the passability for weaker swimming fish
- Improper placement or subsidence of the fish passage components, which decreases its passability
- Inadequate maintenance, resulting in clogging of the fish passage

The primary issue with the fish ladders is their luring current. This current must attract the fish for them to locate the outlet of the fish passage (downstream entrance), which is crucial for the upstream migrating fish. The fish ladders are designed for the maximum water level difference over the weir complex. This results in the submergence of the downstream side of the fish passage, which reduces its luring current.

The effectiveness of the luring current is also influenced by the other subsystems, as upstream migrating fish are naturally drawn toward the largest flow current in the river due to their rheotaxis orientation sense. This is typically the flow over the weirs or the hydropower plants. According to the report by (Vriese, et al., 2021), fish then follow an imaginary migration line along the downstream flow (downstream turbulent zones) of the weirs to navigate the weir complex. For an adequate findability of the fish passage's outlet (downstream entrance), the report recommends aligning it with the migration line. However, the position of the migration line varies based on the flow rate over the weirs, making it challenging to determine the optimal position of the fish passage. Figure 6 also shows that improper placement of the fish ladder can reduce its findability due to the misalignment with the migration line.



Figure 6: The fish migration line (pink line) along the downstream turbulent zones of the weirs [left]. Zooming in on the downstream turbulent zones [right] (Vriese, et al., 2021)

Downstream fish migration

The water level difference over the weirs results in flows with significant energy as they pass over them. This results in high turbulence intensities downstream of the weirs, as shown in Figure 6. The downstream migrating fish typically pass over the weirs with the river's flow. They can suffer direct injuries from collision or abrasions with the weirs, as well as indirect injuries due to these high turbulence intensities. The turbulence intensity can suppress the fish's predator reflex for up to 24 hours, making them vulnerable to predators. Therefore, to minimize these indirect injuries, a proper stilling basin must be added downstream of the weirs to effectively dissipate the flow's energy.

In addition, at weir complex Linne and Lith, the downstream migration fish also end up at the hydropower plants, which can lead to direct injuries the fish. The mortality rate for fish passing through the hydropower plants is higher than those passing over the weirs.

Reduction of the river's natural habitats

The river Meuse is home to various river species. The presence of the dikes, weir complexes, and other hydraulic structures disrupt the river's natural landscapes and flow patterns, resulting in a loss of gradual transitions between high and low water levels and flow velocities, see Figure 7 (Rijkswaterstaat, 2022). These gradual transitions are crucial for the river's biodiversity, as different species prefer different habitats (Keizer, 2016). Their disappearance has led to a decline of certain river species, reducing the overall biodiversity in the river. The weirs regulate the river to maintain the target water levels, this primarily reduces habitats dependent on continuous and fluctuating flow conditions, known as lotic habitats. Reduction of these lotic habitats, and consequently the species dependent on them, has serious implications for the river's ecosystem health and water quality (Rijkswaterstaat, n.d.). Therefore, it is crucial to explore options for restoring the river's lotic habitats.

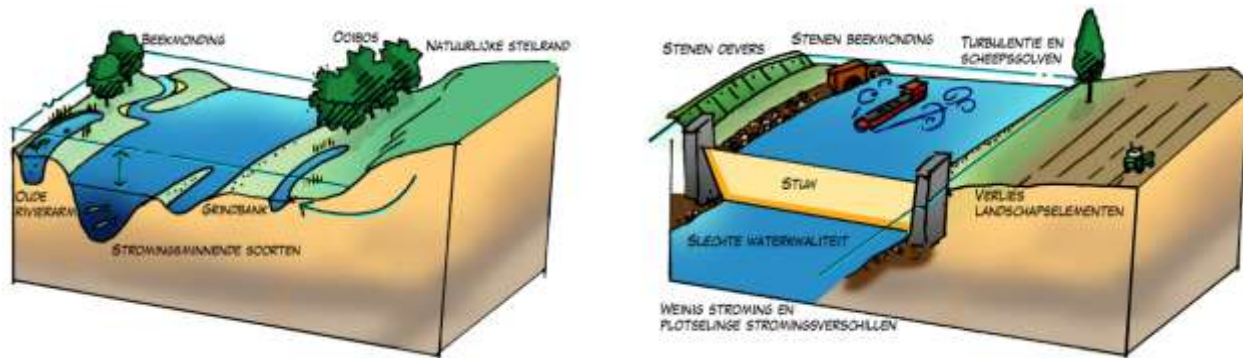

Figure 7: River with natural gradients [left] and a regulated river with low velocities and high-water levels [right]

Disruption of the river's sediment balance

The natural sediment transport of sludge, sand and gravel in the river is obstructed by the weir complexes. The retaining nature of the weirs and locks disrupts the movement of sediment, leading to sludge sedimentation upstream of the complexes. This sludge covers the gravel bed, reducing the oxygen supply to the riverbed and resulting in reduced spawning grounds for Salmonidae species (Vercrujssse, et al., 2021).

The sedimentation of sludge also reduces variations in the riverbed types, leading to a loss of habitats for certain fish species. Over the years, changes in weir management have increased the effects of sedimentation. In the past, the weirs were opened for river discharges between 500 – 700 m³/s, allowing natural sediment transport to occur over several weeks or months per year. However, currently, the weirs are opened for discharges between 1000 m³/s - 1600 m³/s, leading to prolonged closures of several months or years.

In addition, erosion occurs downstream of the complexes, increasing the holding capacity of the river and reducing flooding of the floodplains, which reduces the habitats of certain plant species. The lack of sediment transport towards the coastal zone, reduces the necessary sediment compensation for sea level rise, potentially leading to submergence of coastal habitats. Therefore, it is interesting to exploring ways that restore the river's natural sediment balance.

1.2.4 Problem statement

The previously stated shortcomings of the weir complexes in the river Meuse, are summarized below:

- Disruption of the river's natural sediment transport due to the retaining nature of the weirs
- Inadequate fish passability at the weir complexes due to insufficient passability and findability of the fish ladders
- Degradation of the river's lotic habitats due to the reduced fluctuation of flow velocities and water levels

1.3 Project's objective and scope

1.3.1 Objective

The objective of this graduation report is to study the possibility of creating an optimized ecological route at conceptual level for the weir complexes in the Dutch part of the river Meuse to create environmental conditions for the formation of lotic habitats.

1.3.2 Scope

Several measures are available that potentially lead to lotic habitat formation in the river Meuse, such as the implementation of a by-pass channel (Dutch: 'nevengeul'), a weir channel (Dutch: 'stuwgeul': a channel that runs parallel to the river and is separated from it by a longitudinal dam), dynamic weir management, and lowering of the target water levels. These specific measures are not elaborated in this report. A detailed description of each measure is provided in the report by (Vriese, et al., 2021).

This report specifically focusses on creating the environmental conditions necessary for lotic habitat formation in an optimized ecological route, similar to the by-pass and weir channel concepts. This optimized ecological route is referred to as an ecological channel for the remainder of this report. The channel is designed to support specific river species that are endangered due to the reduction of the lotic habitats in the river. The ecological channel is initially designed for one weir complex location. Subsequently, it is examined whether the channel can be applied to the other complex locations to determine the feasibility of forming lotic habitats at all complex locations.

The existing fish ladders, weirs, navigation locks, and mooring areas remain unchanged and are therefore not assessed. Only the effects on their functionality are examined. As a result, the inadequate fish passability of the existing fish ladders is not considered. However, it is examined whether the ecological channel can potentially function as a fish passage and improve the fish passability of the entire weir complex. In addition, the disruption of the river's natural sediment transport is not considered in this report.

The design of the ecological channel does not include:

- A morphological study
- A hydraulic model
- A structural design

Deepening questions

To achieve the objective of this report, the following deepening questions are formulated:

1. How are the suitable dimensions of the ecological channel determined?
2. Can the ecological channel function as a fish passage?
3. Can the ecological channel be applied to all weir complex locations in the Dutch part of the river Meuse?

1.4 Approach and report outline

1.4.1 Methodology: The civil engineering design method

To achieve the objective, a form of system engineering is applied, specifically the civil engineering design method. The method, outlined in Figure 8, consists of seven phases and follows a constant iterative process, until the final required design is reached. The method is detailed in the lecture notes (Molenaar & Voorendt, 2023). The method is applied to the functional-spatial design loop. The approach is presented in the following subsection.

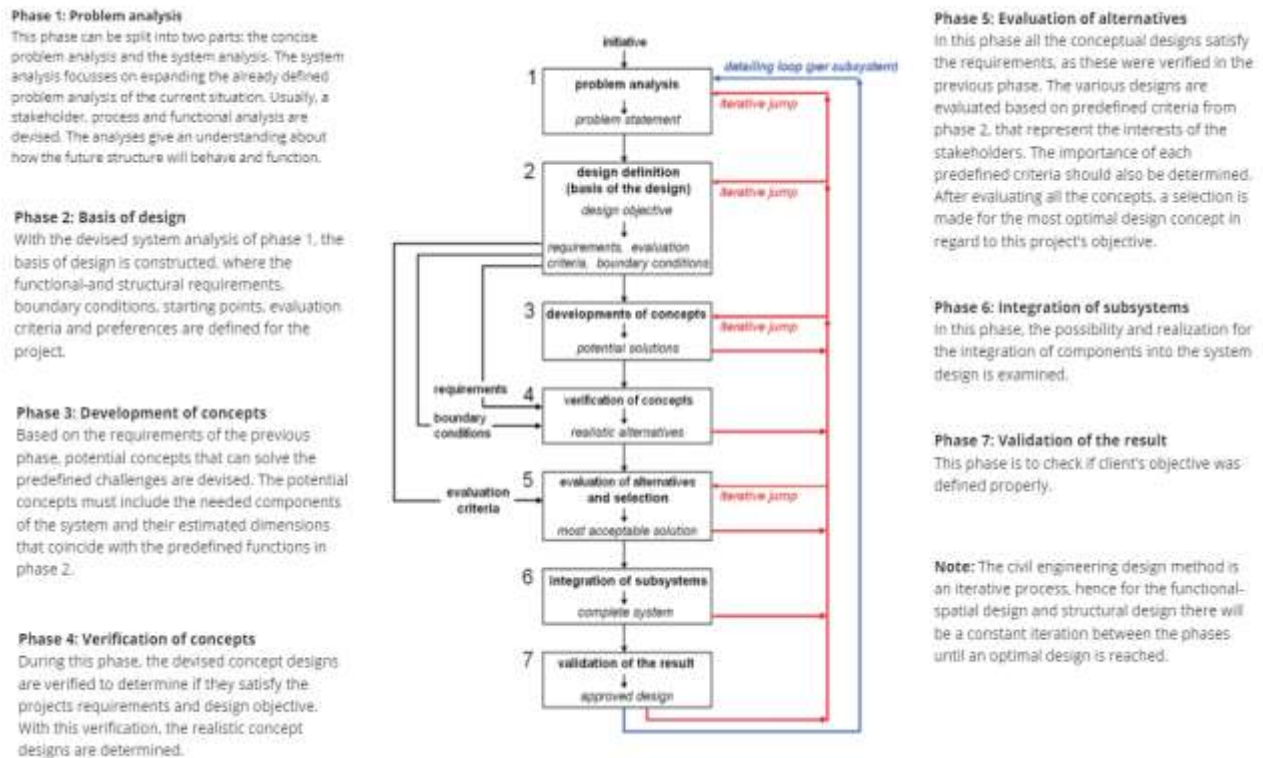

Figure 8: Overview of the civil engineering design method (Molenaar & Voorendt, 2023)

1.4.2 Approach and report outline

System analysis

The ecological channel is designed for one of the seven weir complex locations in the river Meuse. The selected weir complex serves as the case study location for this report. The analysis then provides general information about the case study location, along with a stakeholder analysis and a functional analysis.

The stakeholder analysis identifies the interests of all parties that are (in)directly involved or affected by the ecological channel design. The functional analysis provides a functional overview of the entire weir complex. The analysis categorizes functions into principal, persevering, and additional functions. The principal function describes the motivation for the existence of the weir complex, persevering functions are those inherited from the existing weir complex, and the additional functions represent the opportunities the weir complex can provide to the surrounding environment (Molenaar & Voorendt, 2023). The system analysis is presented in Chapter 2.

Basis of design

The basis of design provides the functional requirements which the final design must satisfy. It also provides the boundary conditions for the case study location, and the evaluation criteria with which potential design concepts are evaluated. The basis of design is presented in Chapter 3.

Functional-spatial design

The functional-spatial design is made for the ecological channel and its intake structure, considering the functional requirements and boundary conditions described in the basis of design. The flow conditions of the ecological channel and intake structure are verified with analytical calculations based on basic hydraulic principles. The design process answers the deepening question:

'1. How are the suitable dimensions of the ecological channel determined?'

Furthermore, whether the ecological can function as a fish passage is examined, which answers the deepening question:

'2. Can the ecological channel function as a fish passage?'

The functional-spatial design gives the final design of the ecological channel, including its intake structure, and the integration of it into the existing weir complex of the case study location. The design includes global dimensions and operational considerations. The functional-spatial design is presented in Chapter 4.

Generalization

The final design of the ecological channel and its intake structure is generalized for the boundary conditions of the other weir complex locations in the Dutch part of the river Meuse. Whether the design can be applied to the other complex locations answers the last deepening question:

'3. Can the ecological channel be applied to all weir complex locations in the Dutch part of the river Meuse?'

The generalization is elaborated in Chapter 5.

Discussions, conclusions, and recommendations

The discussion evaluates the approaches, methods, simplifications, and assumptions used. The conclusion provides descriptions and illustrations of the final design of the ecological channel and its integration into the existing weir complex of the case study location. It also answers all the deepening questions. The recommendations indicate setbacks, limitations, and suggest areas that can be further explored. These items are presented in Chapter 6.

2. System analysis

This chapter presents the selection of the case study location and provides general information about it. After which the stakeholder and functional analyses are conducted. The aim of this chapter is to formulate the basis for Chapter 3.

2.1 Selection of the case study location

One of the seven weir complexes in the river Meuse is selected as the case study location for the ecological channel design. The selection is based on the location with the most available space. This criteria is used as locations with more available space provide more flexibility for the design process. More space allows for larger channel dimensions, which can be beneficial for achieving the necessary flow conditions.

Available space at each complex location

The available space around all seven weir complex locations is determined by conducting an area analysis using Google Earth. The analysis includes the surrounding areas where there is no significant development and excludes the influence of proprietors. The area analysis of each complex location and the estimation of the available area is shown in Appendix A and outlined in Table 2. It shows that weir complex Sambeek has the largest available space. Therefore, weir complex Sambeek is selected as the case study location for this report. Figure 9 shows the area analysis for complex Sambeek.

Table 2: Estimated available area for each weir complex location, see Appendix A for the corresponding figures.

Weir complex	Estimated available area	
	North side of complex [km ²]	South side of complex [km ²]
Borgharen	0.41	0.24
Linne	0.43	0.13
Roermond	0.75	0.22
Belfeld	0.05	0.52
Sambeek	2.18	1.33
Grave	0.21	0.26
Lith	0.79	0.14



Figure 9: Area analysis of weir complex Sambeek (Google earth, 2022) [right] and complex Sambeek (Rijkswaterstaat, sd) [left]

2.2 Area description of complex Sambeek

Weir complex Sambeek is located in the Zandmaas or Terrassenmaas section of the river Meuse, at the border of the provinces Limburg and North Brabant, as shown in Figure 10. The figure shows that the area north of the complex lies in the province Limburg, while the area south of the complex lies in the province North Brabant. Therefore, flood protection along the river is managed by the respective waterboards in each province. The weirs at Sambeek regulate the river segment between complex Sambeek and Belfeld, see Figure 10. The complex is surrounded by the river's floodplains, known as its winter bed. These floodplains function as natural reservoirs, providing additional width to the river's flow to decrease the flood risk of the surrounding hinterlands without increasing the height of the winter dikes. According to the Water Act (Dutch: 'Waterwet'), Rijkswaterstaat is responsible for managing the floodplains of the entire river Meuse.

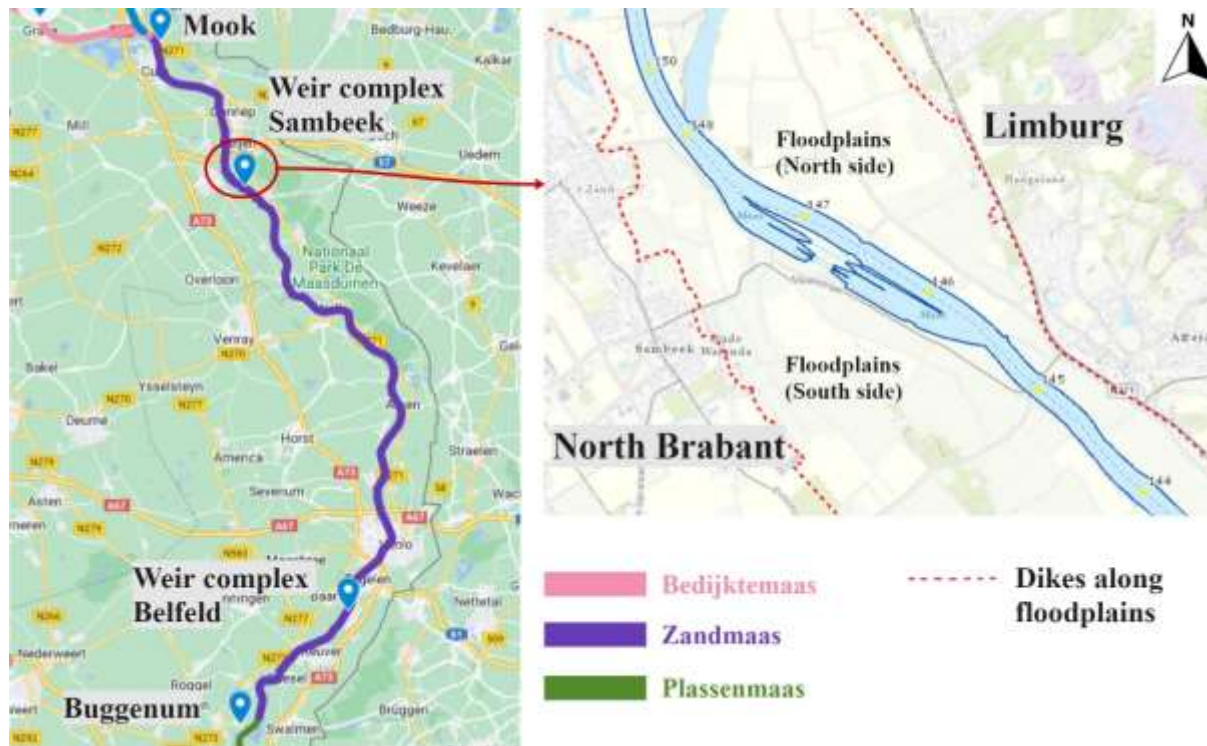

Figure 10: Location of weir complex Sambeek in the river Meuse [left] and its surrounding floodplains [right]

The assessment of the available space for weir complex Sambeek shows that the area south of the complex (referred to as 'C') is known as the Maasheggen, see Figure 9. This area is recognized by UNESCO as a Biosphere area (Maasheggen, sd). As a result, restrictions are in place to prevent negative impacts within this area. Therefore, it is assumed that no interventions are permitted in the Maasheggen area. The focus remains solely on the area's 'A' and 'B'.

2.3 Weir management of complex Sambeek

Weir complex Sambeek consists of the following main subsystems: the combined Poirée and Stoney weir, three lock chambers, and one fish passage, as shown in Figure 11. The locks and weirs accommodate shipping on the river and operate according to a certain weir management. This weir management is described in following subsection. General information about the subsystems is indicated in Appendix B.

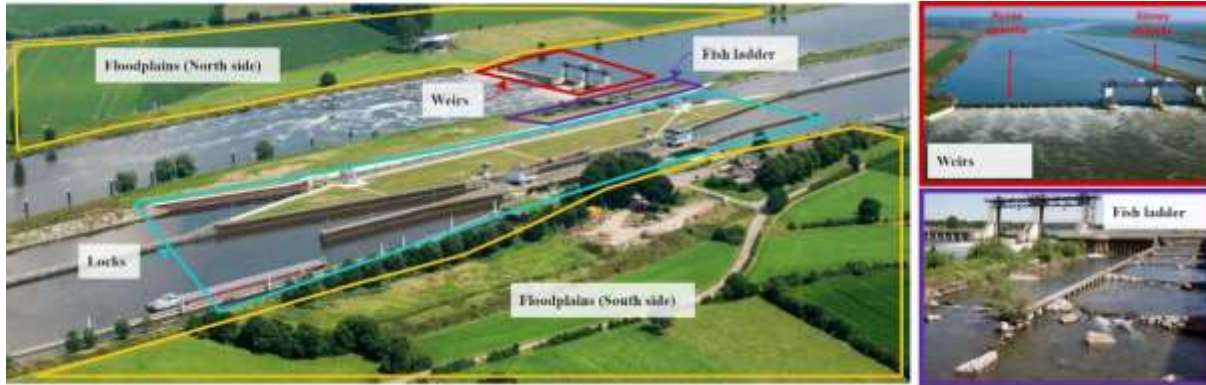

Figure 11: Overview of weir complex Sambeek and its main subsystems (Biezen, sd) [left]. Aerial overview of the combined Poirée and Stoney weirs (Heer, 2020) [upper right]. Aerial overview of the fish ladder (Buiter, 2020) [lower right]

2.3.1 Target water levels

The weir management of complex Sambeek involves two measurements points: Sambeek-Boven and Well-Dorp, between which the control point for the weir management shifts. This shift is based on the water levels at these points and ensures suitable water levels in the river, which mitigates the risk of flooding along the river segment between weir complex Sambeek and Belfeld. The weir management is elaborated in the report by (Aubel, 2023) and outlined in Figure 12. It results in a water level differences of 3-4 meters between the upstream and downstream sides of the weir complex during low river discharges (Vercrujssse, et al., 2021). The weir management at the other weir complex locations is similar. The target water levels (Dutch: ‘stuwpeilen’) for each complex location is given Figure 13.

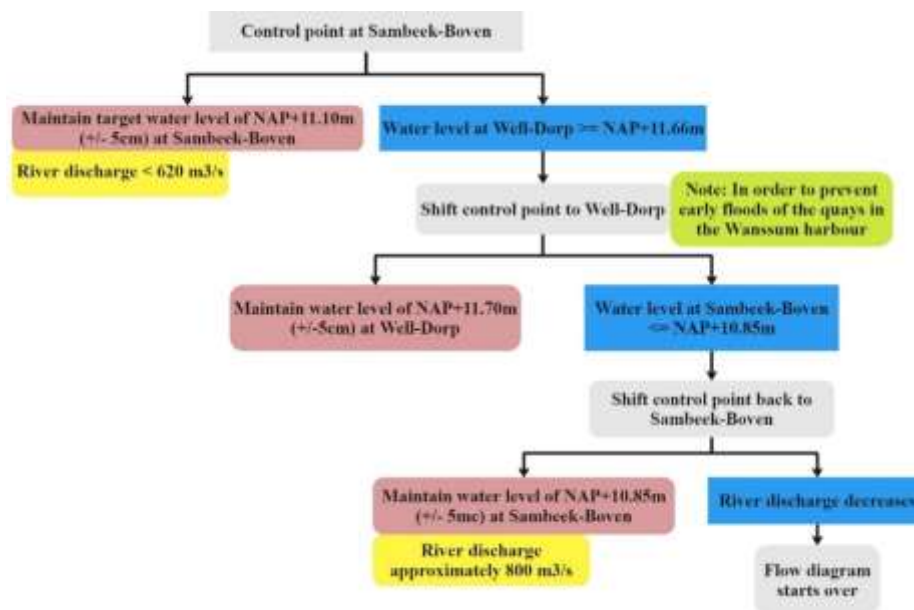

Figure 12: Flow diagram of the current weir management at complex Sambeek based on the report (Vercrujssse, et al., 2021)

2. System analysis

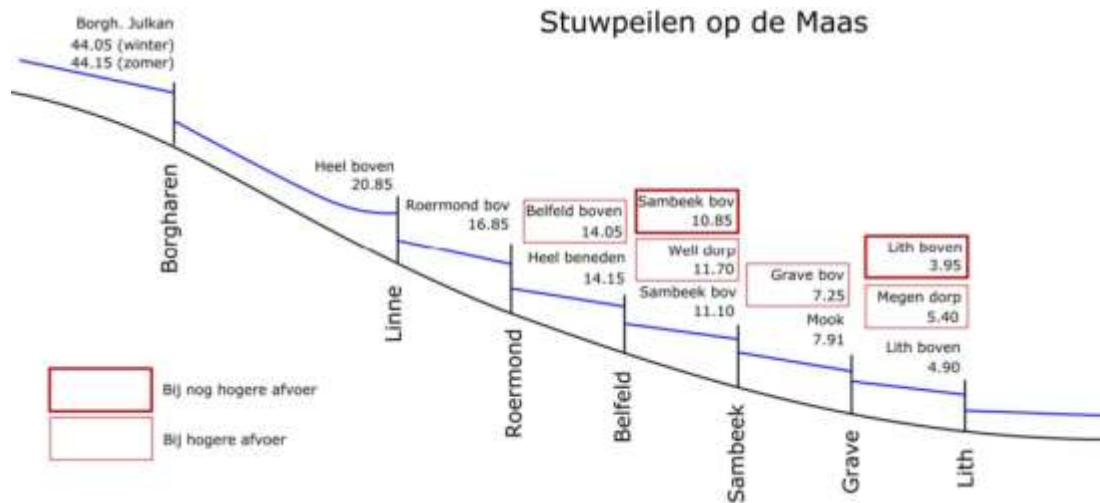

Figure 13: Target water levels of the seven weir complexes in the river Meuse (Ruijgh, de Jong, & Kramer, 2021)

2.3.2 Fully opening the weirs

The weirs at Sambeek are fully opened when there is a minimal water level difference of 50 cm between the downstream and upstream side of the river (Ruijgh, de Jong, & Kramer, 2021). This occurs for river discharges of above 1300 m³/s and above (measured at Sint Pieter). The fully open weirs allow for ships to pass the complex via the open Poirée weirs, as the locks are (partially) submerged during this discharge (Aubel, 2023). The river discharge for which the weirs at each complex location fully opened is shown in Table 3.

Table 3: Overview of the river discharges when the weirs of each complex location fully opens and its occurrence per year (Ankum, Delbressine, Kurvers, & Maes, 2023)

Stuw	Rivierkilometer	Strijkdebiet m ³ /s (circa)	Gem. aantal dagen per jaar gestreken (Antea, 2020)	
			Na Maaswerken	Voor Maaswerken
Borgharen	15.4	1600	1x per 3 tot 5 jaar	4
Linne	68.2	1350-1400	4	9
Roermond	80.9	1000-1100	8	20
Belfeld	100.8	1000-1100	20	20
Sambeek	146.6	1300	6	20
Grave	175.6	1300-1500	4	9
Lith	200.9	1200	4	4

Furthermore, for river discharges between 1000 and 1600 m³/s, the project area experiences flooding (DLG, 2007). In this report, it is assumed that the floodplains surrounding the complex are flooded (not fully inundated) for river discharges above 1600 m³/s. Figure 14 gives an impression of the flooding of the floodplains. It is also assumed that shipping is impeded at the complex during flood river discharges, indicating that the weir complex is no longer operational. At this discharge level, the areas protected by the winter dikes are not susceptible to flooding, as weir complex Sambeek is designed with for a larger peak discharge, see Subsection 2.3.3.



Figure 14: Floodplains surrounding weir complex Sambeek during flood river discharges ($Q_{river} > 1600 \text{ m}^3/\text{s}$). This image was taken during the floods of 2021, which was an exceptional situation (Heijligers).

2.3.3 Extreme river discharges

According to the report by (Ankum, Delbressine, Kurvers, & Maes, 2023), the governing flood discharge is based on a probability of flooding of 1/1250 per year. For the river section between Eijsden and Mook, this results in an extreme high discharge of $3275 \text{ m}^3/\text{s}$, while for the river section downstream of Mook (Bedijktemaas), it results in an extreme discharge of $3800 \text{ m}^3/\text{s}$. Therefore, for complex Sambeek the extreme discharge of $3275 \text{ m}^3/\text{s}$ is considered. In addition, the report by (Bruggeman, Haasnoot, Hommes, Linde, & Brugge, 2011) indicates that the extreme low river discharge of the river Meuse is $25 \text{ m}^3/\text{s}$.

2.3.4 Retaining current the weir management

As part of the of the Zandmaas/Maasroute project, a water level increase of 25 cm was applied at complex Sambeek to accommodate deeper vessels passing through the locks and to mitigate the drying effects on the natural environment caused by the summer bed deepening activities. This resulted in a change of the weir management, requiring the weirs at Sambeek to be fully opened with a greater water level difference over the weir compared to before. To compensate this, temporary water level increases at Grave are required, creating a strong dependency between the weir management of Grave and Sambeek (Ankum, Delbressine, Kurvers, & Maes, 2023). Considering this dependency, along with several others, such as water intake, drainage, and the groundwater table of the surrounding area, it is decided to keep the existing target water levels the same (see Figure 13).

2.4 River species at complex Sambeek

The river Meuse supports various river species. As mentioned in Subsection 1.2.3, the presence of the weir complexes reduces the lotic habitats in the river. This reduction impacts various river species, with some more severely affected than others, which can lead to their disappearance from the river. Therefore, the Kaderrichtlijn Water Leidraad (KRW-leidraad) identified which river species are most endangered by the reduced lotic habitats in the river Waal, IJssel, and Nederrij-Lek (Vriese, et al., 2021). It is assumed that these target river species also apply for the river Meuse. The ecological channel is designed to form lotic habitats suitable for these target species.

2.4.1 Target river species

The target river species for design of the ecological channel consists of macrofauna, and aquatic plants, macro-fauna, and fish species. These target species and there preferred habitats are described in Appendix C. The target species are shown in Table 4.

2. System analysis

Table 4: Overview of the target river species for which the ecological channel is designed (Vriese, et al., 2021)

Target aquatic plants	
1. Rivierfonteinkruid (<i>Potamogeton nudosus</i>)	2. Slijkgroen (<i>Limosella aquatica</i>)
Target macro-fauna species	
1. Bataafse stroommossel (<i>Unio crassus</i>)	5. Schoraas (<i>Ephoron virgo</i>)
2. Bolle stroommossel (<i>Unio tumidus</i>)	6. Vierlijnseeendagsvlieg (<i>Ephemera glaucops</i>)
3. Kokerjuffer (<i>Hydropsyche contubernalis</i>)	7. Zandslurfje (<i>Propappus volki</i>)
4. Rivierrombout (<i>Gomphus flavipes</i>)	
Target fish species	
5. Barbeel (<i>Barbus Barbus</i>)	5. Serpeling (<i>Leuciscus Leuciscus</i>)
2. Kwabaal (<i>Lota lota</i>)	6. Sneep (<i>Chondrostoma nasus</i>)
3. Riviergrondel (<i>Gobio Gobio</i>)	7. Winde (<i>Leuciscus idus</i>)
4. Rivierprik (<i>Lampetra fluviatilis</i>)	

2.4.2 Reproductive months

The ecological channel supports the target river species during various different stages of their life cycle, which occur during different periods of the year. Table 5 shows the periods when several macro-fauna species emerge from their pupal stage and the spawning periods of the fish species.

Table 5: Overview of the reproductive months for the target macro-fauna and fish species (Vriese, et al., 2021)

Marco-fauna species	Emergence period
Kokerjuffer (<i>Hydropsyche contubernalis</i>)	End of April – end of September
Rivierrombout (<i>Gomphus flavipes</i>)	July – end of September
Schoraas (<i>Ephoron virgo</i>)	end of July – start of September
Vierlijnseeendagsvlieg (<i>Ephemera glaucops</i>)	June - August
Fish species	Spawning period
Barbeel (<i>Barbus barbuis</i>)	May – July
Kwabaal (<i>Lota lota</i>)	November - March
Riviergrondel (<i>Gobio Gobio</i>)	April – August
Rivierprik (<i>Lampetra fluviatilis</i>)	March - May
Serpeling (<i>Leuciscus leuciscus</i>)	March - May
Sneep (<i>Chondrostoma nasus</i>)	March – May
Winde (<i>Leuciscus idus</i>)	March - April

The growth period for the fish species during their juvenile stage occurs between March and July. Considering this, along with the periods shown in Table 5, the majority of the reproductive activities of the target species takes place in the months March – September. Therefore, this period is crucial, and the ecological channel must achieve the required flow conditions during this time. This period is referred to as the critical reproductive months.

2.4.3 Fish species for the fish passage

As mentioned in Subsection 1.3.2, the possibility of the ecological channel functioning as a fish passage is examined. In the Netherlands, the starting point is that a fish passage should be able to accommodate all the fish species present in the waterway, in this case the river Meuse (Coenen, Antheunisse, Beekman, & Beers). Therefore, unlike for the creation of lotic habitats, there are no specific target fish species for the fish migration. Instead, the fish passage is designed with general dimensions and hydraulic parameters that aim to meet the needs for most of the fish species in the river.

The fish species can be categorized into six main fish types, as shown in Table 6. See the report by (Vriese, et al., 2021) for a full elaboration on the fish species. The functioning of the fish passage has a more significant effect on the potamodromous and diadromous fish species, as their migration is necessary for completing their lifecycles and maintaining their populations. The potamodromous fish species typically migrate from March to June, while the anadromous fish species typically migrate from October to December.

These two periods have different average river discharges and water levels, making it difficult to design a fish passage with dimensions and hydraulic parameters that meet the needs of the fish species in both periods. Therefore, the primary migration period for which the fish passage must effectively function is taken as the spring period, from March to June (Coenen, Antheunisse, Beekman, & Beers)

Table 6: The fish types in the river Meuse (Vriese, et al., 2021)

Fish types	Description
Rheophilic	The lifecycle of these species depends on the presence of running water conditions, in other words lotic habitats. Different life stages are spent in different flow conditions
Diadromous	This species migrates during its entire lifecycle between saltwater and freshwater. It uses the entire river system, meaning migration to various habitats is important for the species populations. The diadromous can be divided into two groups: <ul style="list-style-type: none"> Anadromous: This group breeds in fresh water and matures in salt water Catadromous: This group breeds in salt water and matures in fresh water
Limnophile	This species prefers stagnant water and can complete its entire lifecycle in one habitat. The species is rarely found in the river's main flow, usually after floods or high-water levels. This species is strongly associated with the river's vegetation, which is used for food and breeding areas.
Eurytopic	This species does not require specific habitats. Their lifecycle is not dependent on certain habitats or vegetation.
Exotics	This species presents the non-native fish that can potentially harm the native fish species
Potamodromous	This species spends its entire lifetime in freshwater and migrates within river networks to breed and develop

2.5 Functional analysis for complex Sambeek

The functional analysis provides a complete functional overview of complex Sambeek with an ecological channel. It shows which subsystem performs which required function and forms the basis for the functional requirements in Section 3.1.

2.5.1 Identification of the weir complex's functions

According to the Dutch National Water Program, wet infrastructures in the Netherlands have four primary purposes: (1) ensuring sufficient water, (2) flood risk reduction, (3) clean and healthy water, and (4) efficient and safe water transport, each with specific usage functions. Understanding how the weir complex fulfils these purposes allows for the identification of its principal, preserving, and additional functions. For a general overview of the primary purposes and their functions, see the report (Ruijgh, de Jong, & Kramer, 2021). The primary purposes and their corresponding functions at complex Sambeek are explained below.

(1) Ensuring sufficient water (Dutch: 'Voldoende water')

The motivation behind the construction of the weir complexes was to ensure sufficient water levels for navigation. This function aligns with the primary purpose 'ensuring sufficient water'. Additionally, over time, other systems have become dependent on the current target water levels, which contributes to the necessity of ensuring sufficient water levels. Hence, the principal function of the weir complex is:

Principal function

- Maintain sufficient river water levels for navigation, industrial, and drinking water purposes, as well as maintaining the intake, drainage, and groundwater table of the surrounding region

(2) Flood risk reduction (Dutch: ‘Waterveiligheid’)

The weir complex does not directly fulfil the primary purpose of ‘Flood risk reduction’. However, the surrounding dike infrastructure does so, and these infrastructures are designed for the current weir management. Therefore, the flow capacity of the weir complex must be sufficient to accommodate the river’s current flow during normal, high, and peak river discharges. Given that the existing combined Poirée and Stoney weirs and the dike infrastructure remain unchanged in this report, the weir complex has the following preserving functions:

Preserving functions related to flood protection:

- Enable the passage of non-flood river discharges
- Enable the passage of peak river discharges

(3) Clean and Healthy water (Dutch: ‘Schoon en gezond water’)

This purpose refers to the water quality of the river, the habitats of the river species, and the fish migration routes. The ecological channel aims to fulfil this purpose by creating lotic habitats at the weir complex, and, if impossible, accommodating fish migration. The existing fish passage contributes to this purpose by enabling semi-natural fish migration through the weir complex. The existing weirs contribute to this purpose by periodically opening and allowing sediment transport through the weir complex, which aids in maintaining the river’s sediment balance. The sediment balance is crucial for the ‘Clean and Healthy water’ purpose, as its disruption leads to the ecological shortcomings described in Subsection 1.2.3.

Since the ecological channel is a new addition to the existing weir complex, its functions are categorized as additional functions, while the functions of the fish passage are categorized as preserving functions. The functions are shown below.

Preserving functions related to fish migration

- Accommodate the upstream migrating fish through the weir complex for non-flood river discharges
- Accommodate the downstream migrating fish through the weir complex for non-flood river discharges

Preserving functions related to sediment transport

- Enable the periodic passage of sediment through the weir complex.

Additional functions

- Create lotic habitats along the river, which can facilitate the growth of the target river species during the critical reproductive months of the river species

Purpose 4: Efficient and safe water transport (Dutch: ‘Vlot en veilig verkeer over het water’)

The weir complex, particularly the navigation locks and the Poirée weir, contribute to the primary purpose of ‘Ensuring safe water transport’. These subsystems enable the passage of ships through the weir complex. Given that the existing Poirée weir and navigation locks remain unchanged in this report, the weir complex has the following preserving functions:

Preserving functions related to navigation

- Enable the passage of ships through the weir complex for non-flood river discharges

3. Basis of design

Based on the system analysis, the basis of design is constructed for the case study location Sambeek. This chapter forms the basis for the functional-spatial design in Chapter 4.

3.1 Functional requirements

Based on the functional analysis in Section 2.5, the functional requirements are divided into six categories: weir management, navigation, flood protection, fish migration, lotic habitats, and sediment transport. However, as stated in Subsection 1.3.2, the river's sediment transport is not considered in this report, indicating that no sediment transport requirements are needed. Therefore, the remaining requirements that will be taken into account for the weir complex design are divided into five categories: weir management, navigation, flood protection, fish migration, and lotic habitats.

3.1.1 Weir management requirement

The *principal function* of the weir complex is to maintain sufficient water levels in the river for various systems during the river discharges when regulation is needed. This is achieved by maintaining the current target water levels in the river, as shown in Section 2.3. The corresponding requirement is:

- The current target river water levels (Dutch: 'stuwpeilen') at the measurement points Sambeek-Boven and Well-Dorp must remain unchanged.

3.1.2 Navigation requirements

The navigational *preserving functions* refer to the safe passage of the ships on the river and through the weir complex during non-flood river discharges. This is achieved by ensuring suitable flow conditions in the river and at the weir complex. The flow conditions are based on a representative reference vessel and the design rules outlined in the waterway guidelines report (Rijkswaterstaat, 2020). The navigation requirements are:

1. The reference vessel must safely pass the weir complex for discharges below 1300 m³/s using the locks.
2. The reference vessel must safely pass the weir complex for river discharges between 1300 m³/s and 1600 m³/s using the fully opened Poirée weir.
3. The reference vessel must safely navigate the river for river discharges below 1600 m³/s.

The guidelines specify dimensional and hydraulic requirements for the river, weirs, navigation locks, and mooring areas to ensure safe passage for ships. Since these subsystems and the current target water levels remain unchanged in this report, it is assumed that these requirements are met for the new situation, as they are already satisfied for the existing situation. Therefore, the navigation requirements are not verified in this report, provided that the implementation of the ecological channel does not influence any of these subsystems.

3.1.3 Flood protection requirements

The *preserving functions* related to the flood protection of the weir complex refer to providing sufficient flow capacity for the river discharges. The governing extreme discharge for the weir complex is 3800 m³/s. The flood protection requirements are:

3. Basis of design

1. The total flow capacity of the weir complex must be sufficient to accommodate non-flood river discharges ($Q_{river} < 1600 \text{ m}^3/\text{s}$) without using the surrounding floodplains.
2. The total flow capacity of the weir complex, including the surrounding floodplains, must be sufficient to accommodate the governing extreme flood discharge of $3800 \text{ m}^3/\text{s}$.

Since the river, weirs, flood plains, and the current target water levels remain unchanged in this report, it is assumed that the flow capacity requirements of the weir complex are met for the new situation, as they are already satisfied for the existing situation. Therefore, the flood protection requirements are not verified in this report, provided that the implementation of the ecological channel does not influence the river's water levels.

3.1.4 Fish migration requirements

The *preserving functions* of the weir complex related to fish migration refer to a fish passage that enables fish to safely navigate the water level difference between the upstream and downstream side of the weirs during river discharges when they are closed. Fish can pass through the open weirs during higher river discharges. This is achieved with a findable and passable fish passage (Coenen, Antheunisse, Beekman, & Beers). The corresponding requirements to achieve such a passage are:

1. The findability of the fish passage's inlet and outlet (upstream and downstream entrances) must be sufficient for upstream and downstream migrating fish species for river discharges below $1300 \text{ m}^3/\text{s}$.
2. The passability of the fish passage and its entrances must facilitate free, continuous, and safe upstream and downstream movement of the fish species for river discharges below $1300 \text{ m}^3/\text{s}$.

There are no strict flow or dimensional requirements to achieve a findable and passable fish passage. Instead, the report (Ghodrati, 2021) provides optimal target values to maximize the efficiency of the fish passage. However, it indicates that deviating from these values does not necessarily result in a non-functional fish passage, rather it reduces its efficiency while still maintaining its functionality. At a certain point, when the efficiency reaches a minimum threshold, the fish passage is considered non-functional in this report due to its poor condition. These minimum threshold values are considered strict requirements, while the most optimal values are taken as the ideal target values.

Overview of the fish passage's findability conditions

The main criteria for the fish passage's findability depend on the positioning of its outlet and its luring current. The criteria are described in Appendix D.1 and the corresponding strictly required and striving target values are summarized in Table 7. It should be noted that both the geometrical and hydraulic target values in the report (Ghodrati, 2021) are constructed for pool-and-weir/slot fish passages (Dutch: 'Bekken vispassages'). However, for this report these values are applied to all considered fish passage types.

Table 7: Findability requirements and target values for the fish passage's inlet and outlet (Ghodrati, 2021). * (Coenen, Antheunisse, Beekman, & Beers)

Parameters	Target values	Required values
Outlet's position downstream of barriers with turbulence intensities below $1300 \text{ W}/\text{m}^3$	$L_{outlet,distance} \approx 0 \text{ m}$	$L_{outlet,distance} \leq 10 \text{ m}$
Outlet's position downstream of barriers with turbulence intensities above $1300 \text{ W}/\text{m}^3$	In line with the fish migration line	
Outflow velocity	$u_{outflow} \approx 1.0 \text{ m}/\text{s}^*$	$0.25 < u_{outflow} < 1.75 \text{ m}/\text{s}$

3. Basis of design

Outflow rate	$Q_{\text{outflow}} = 5\text{-}10\%$ of the river's discharge during the fish migration period *	
Direction luring current	Parallel to river's flow or 0° to river's flow	$< 90^\circ$ to the river's flow
Transition of the fish passage to riverbed and vice-versa	Should be a gradual transition with a maximum slope ratio of 1:2	

*Applies if the fish passage does not have the highest flow rate at the complex

Overview of the fish passage's passability conditions

The passability of the fish passage depends on the flow conditions within it, which are determined by the geometrical and hydraulic dimensions of the passage. These dimensions are described in Appendix D.2. The corresponding required and target values are summarized in Table 8 and Table 9.

Table 8: Minimum geometrical target values for the representative European Meerval fish (Ghodrati, 2021)

Parameters	Target values for European Meerval	Required values for European Meerval
Water depth in flow openings	$h_{\text{min,opening}} \geq 2 \cdot H_{\text{vis}} = 0.52 \text{ m}$	$> 0.26 \text{ m}$
Width of flow openings	$B_{\text{min,opening}} \geq 3 \cdot D_{\text{vis}} = 0.72 \text{ m}$	$> 0.36 \text{ m}$
Water depth in pools	$h_{\text{min,pool}} \geq 2 \cdot H_{\text{vis}} = 0.52 \text{ m}$	$> 0.26 \text{ m}$
Length of the pools	$L_{\text{min,pool}} \geq 3 \cdot L_{\text{vis}} = 4.8 \text{ m}$	$> 2.4 \text{ m}$

Table 9: Target hydraulic dimension values for the Braseem fish zone (Ghodrati, 2021).

Parameters	Target values for Braseem fish zone	Required values for Braseem fish zone
Water level difference over weir/slot	$\Delta h \leq 0.10 \text{ m}$	$< 0.15 \text{ m}$
Maximum flow velocity over weir/slot	$u_{\text{max,weir}} \leq \sqrt{2 \cdot g \cdot \Delta h} = 1.4 \text{ m/s}$	$< 1.7 \text{ m/s}$
Maximum flow velocity in fish passage	$u_{\text{max,passage}} \leq 1.0 \text{ m/s}$	
Minimum flow velocity in fish passage	$u_{\text{min,passage}} \geq 0.2 \text{ m/s}$	
Average flow velocity in the fish passage	$u_{\text{avg,passage}} = \frac{Q}{A} \approx 0.5 \frac{\text{m}}{\text{s}}$	$\leq 1.0 \text{ m/s}$
Bottom substrate layer thickness	20 cm of rough substrate layer	
Maximum bottom flow velocity over weir/slot	$u_{\text{bottom,max}} = \frac{u_{\text{max}}}{3} \leq 0.45 \text{ m/s}$	$< 0.7 \text{ m/s}$
Energy dissipation the fish passage	$\varepsilon = \frac{\rho \cdot g \cdot Q \cdot \Delta h}{V_{\text{pool-like structure}}} \leq 100 \text{ W/m}^3$	$\leq 150 \text{ W/m}^3$

3.1.5 Lotic habitat requirements

The additional function of the weir complex is to restore lotic habitats in the river Meuse, which can enable the growth of the target river species. This is achieved by creating suitable water depths, flow velocities, bed compositions, and water temperatures within the channel. (Vriese, et al., 2021) provide a general list of the required values of these criteria. Temperature is not considered in this report due to certain challenges in practical implementation. Thus, the requirements to restore lotic habitats in the ecological channel are:

1. The channel must provide a continuously available range of suitable water depths during the critical reproductive months of the target river species.

3. Basis of design

2. The channel must provide a continuously available range of suitable flow velocities during the critical reproductive months of the target river species.
3. The channel's bed composition must consist of sand, gravel, stones, and (submerged) vegetation.
4. The channel must maintain a stable bed, ensuring no excessive erosion or sedimentation.

The required flow conditions

The required flow conditions are divided into three groups. The first group focuses on the requirements for the aquatic plants, macro-fauna, and adult fish. The second group focusses on the requirements of fish during their spawning and larval stage, while the third group focusses on fish during their juvenile stage. To simplify the design of the channel, the conditions for the first group are primarily met in the thalweg of the ecological channel, while the conditions of the other groups are primarily met in the bank area. Figure 15 provides an impression of channel's thalweg and bank area. The required flow conditions for the channel's thalweg and bank area are given in Table 10.

Table 10: The required flow conditions for the ecological channel's thalweg and bank area (Vriese, et al., 2021)

Parameters	Required flow conditions for the channel's thalweg
Minimum water depth	$d_{min,thalweg} = 0.80$ m
Minimum flow velocity	$u_{min,thalweg} = 0.10$ m/s
Maximum flow velocity	$u_{max,thalweg} = 1.0$ m/s
	Required flow conditions for the channel's bank area
Minimum water depth	$d_{min,bankarea} = 0.2$ m
Maximum water depth	$d_{max,bankarea} = 1.5$ m
Minimum flow velocity	$u_{min,bankarea} = 0.0$ m/s
Maximum flow velocity	$u_{max,bankarea} = 0.5$ m/s
	Required bed composition for entire channel
Bed composition	must consist of sand, gravel, stones, and (submerged) vegetation

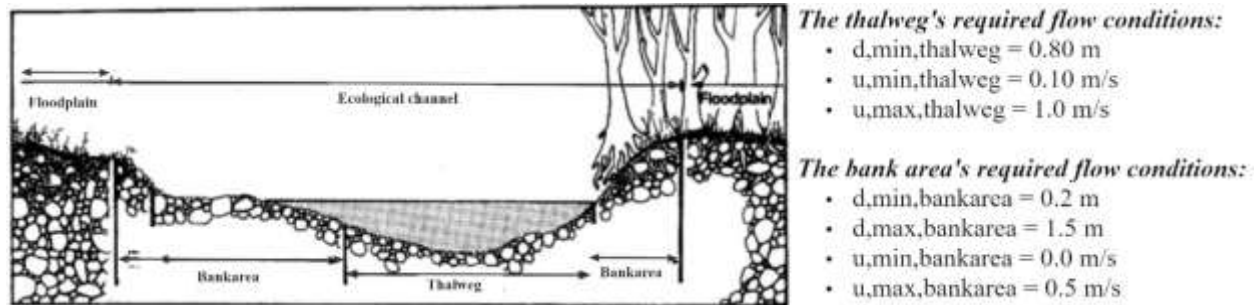

Figure 15: Impression of the ecological channel's thalweg and bank area (Sullivan, Lisle, Dolloff, & Reid, 1986)

The channel's inlet and outlet requirements

To achieve a variety of flow conditions within the channel, a variable inflow rate is required. This necessitates the use of an adjustable intake structure at the channel's inlet, especially since the river water levels upstream of the channel remain relatively consistent during lower river discharges ($Q_{river} \leq 1000$ m³/s, see Table 11). Accommodating fish passage through both the channel's inlet and outlet is beneficial, as this can support a larger fish population in the channel, which can contribute to a more diverse ecosystem. Accommodating fish passage through the channel's inlet can be achieved by either making the intake structure fish passable or by constructing a separate fish passage. Both options must meet fish passability requirements as shown in Table 8 and Table 9. For accommodating fish passage through the channel's outlet, it must also meet the passability requirements as shown in these two tables.

Furthermore, it is crucial to ensure that the functioning of the channel does not negatively impact the navigability of the weir complex, the local water levels, or the distribution of the available river discharge. The navigability of weir complex can be influenced by the position of the channel's outlet and its outflow velocity, which can lead to unwanted cross-currents. The local water levels at the weir complex can be elevated by the backwater effects of the intake structure, which can have negative consequences for the current elevations of the surrounding area. The discharge distribution is influenced by the intake structure's ability to limit its flow capacity when needed. These considerations lead to the following requirements:

1. An adjustable intake structure is required to provide continuously varying inflow rates within the channel
2. The channel's inlet must accommodate free, continuous, and safe upstream and downstream movement of the fish species during the critical reproductive months
3. The channel's outlet must accommodate free, continuous, and safe upstream and downstream movement of the fish species during the critical reproductive months
4. An adjustable intake structure is required to regulate the inflow rate during low river discharges, ensuring consistent and sufficient flow rates for the lock management, potential leakage losses, and the existing fish passage
5. Cross-currents resulting from the outflow rate and velocity of the channel must be minimized to ensure the navigability of the weir complex and the river
6. The intake structure must not result in unwanted river water elevations that can reduce the current discharge capacity of the weir complex

3.2 Evaluation criteria

The evaluation criteria are used to select the most optimal design concept for the project's objective, which in this case is to choose the intake structure that best facilitates the passage of fish. The determined criteria directly indicate the intake structure's ability to safely and effectively accommodate all the present fish species.

Efficiency in accommodating fish passage

The descriptions of the fish passages indicate that the technical fish passages are more resistant to varying water levels and require less space compared to semi-natural fish passages. This makes them more efficient, as their resistance ensures suitable flow conditions for longer periods, and their shorter length reduces the distance fish must travel, potentially lowering their required effort. In contrast, semi-natural fish passages are susceptible to water level variations, which reduces their reliability and thus efficiency. In addition, their effectiveness is sensitive to their execution, especially for the V-shaped and cascade passages.

Ability to accommodate a range of fish species

The vertical-slot fish passage accommodates fish throughout the water column, allowing them to move at their preferred depth. The De-wit fish passage operates closer to the bed of the passage. The fish slope with setting stones is more suitable for larger and stronger swimmers. The shape of the V-shaped pool-and-weir passage provides better swimming opportunities for the smaller and weaker swimmers compared to the cascade passage.

Maintainability

Technical fish passages are easier to maintain compared to semi-natural fish passages. The V-shaped pool-and-weir and the cascade fish passages require significant maintenance and monitoring to maintain its functionality, while the vertical-slot and De-Wit fish passage are easily monitored and maintained.

3.3 Boundary conditions at complex Sambeek

This section provides the physical and hydraulic boundaries of weir complex Sambeek, which serve as design parameters during the functional-spatial design process. The boundary conditions include the (1) ground levels of the surrounding floodplains, the (2) river's bed elevations, (3) flow rate, and (4) water levels.

(1) Ground level of the project area

The Zandmaas or Terrassenmaas consists of terraces of varying heights, separated by terrace edges. The project area and the river's floodplains lie in the most recently formed terraces, the Holocene riverplain, which has a ground level of approximately NAP+12.0 m, see Figure 16. The east border of the project area is a trench-shaped path with a ground level of roughly NAP+11.0 m, which is known as the Heijense Leijgraaf channel. The inlet of this channel lies upstream of complex Sambeek and its outlet lies in the Oude Maas meander, which was formed during the canalisation of the river Meuse. Currently, the meander is only connected to the river Meuse on its upstream side, while the downstream side is dammed and reserved for recreational use. East of this channel lies the edge for one of the older terraces, on top of which river dunes are located (DLG, 2007). This area has a ground level between NAP+14 m and NAP+16 m, see Figure 16. For more detailed information of the project area, see the report (DLG, 2007).

Based on the topography description, it is assumed that average ground level of the surrounding floodplains, both north and south of the complex, are equivalent to the Holocene riverplain, which is NAP+12.0 m. Similarly, it is assumed that the average crest level of the winter dikes along the floodplains are equivalent to the older terraces, which is NAP+14.0 m.



Figure 16: Topography map [left] and elevation map [right] of the floodplains north of complex Sambeek (DLG, 2007)

3. Basis of design

(2) River's bed elevations

The river's bed elevations at potential locations for the inlets and outlets of the ecological channel are critical parameters for its design. These bed elevations are estimated from the longitudinal profile of the river Meuse, shown in Figure 17. Using this figure, it is estimated that the riverbed just upstream of the combined Poirée and Stoney weirs until the position RKM 145 has an average bed elevation of NAP+3.5 m, while the riverbed just downstream of the weirs until RKM 150 has an average bed elevation of NAP+2.4 m. It is assumed that this estimated average bed elevation downstream of the weirs also applies in the Oude Maas meander. The areas with these estimated bed elevations, both upstream and downstream, are shown in Figure 18. These are the only areas considered for potential inlet and outlet locations for the ecological channel.

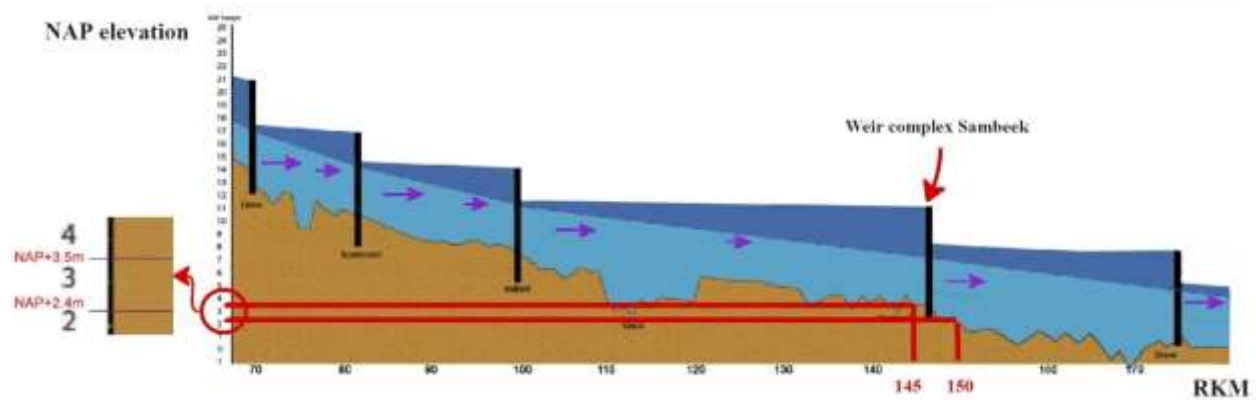

Figure 17: Longitudinal profile of the river Meuse from which the riverbed elevations upstream and downstream of weir complex are estimated (waterpeilen.nl, 2021)

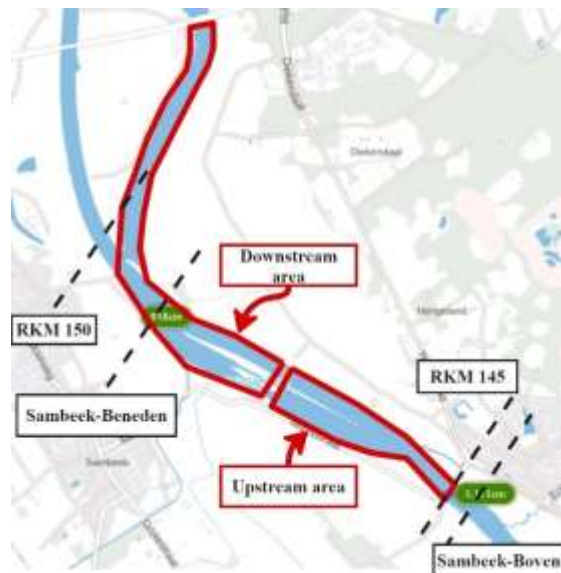

Figure 18: The considered upstream and downstream areas for potential inlet and outlet locations of the ecological channel and fish passage (Rijkswaterstaat, 2023)

(3) River's flow rate

During the critical reproductive months of the target river species

The river's flow rate, in combination with the weir management, determines the water levels in the river. These two factors are critical parameters for the design of the ecological channel, especially during the critical reproductive months (March to September).

According to the report by (Vriese, et al., 2021), the river Meuse has an average discharge of approximately 100 m³/s during the months April to October. This period includes the summer months (June to October), during which river discharges often drop to 50 m³/s and reach critically low levels of 25 m³/s. Despite these low levels, during this period river discharges can typically reach up to 250 m³/s and may even have extreme peaks of 3300 m³/s. However, these extreme peaks are not considered for the design of the channel, as the entire weir complex is non-operational during such discharges. Therefore, the river's discharge range for which the ecological channel must be functional is 25 – 250 m³/s.

However, a continuous discharge is required for the lock management and the fish passage at the weir complex. Lock management requires a minimum discharge of 20 m³/s. During a critical low river discharge of 25 m³/s, it can suffice with a discharge of 15 m³/s (Vercrujisse, et al., 2021). The fish passage is designed for an inflow rate of 4 m³/s, yet 5 m³/s is kept available for it. Thus, the minimum available discharge for the ecological channel is 5 m³/s.

During the non-critical reproductive months

Aside from the critical reproductive months, the required flow conditions of the ecological channel are aimed to be continuously maintained. The entire weir complex becomes non-operational for river discharges exceeding 1600 m³/s. Thus, the design of the entire weir complex is described until this point.

(4) River's water levels

The measured river water levels are a critical parameter in the design of the ecological channel, as it influences its inflow rates, water depths, and flow velocities. The specific water levels used in the design process depends on the location of the inlet and outlet of the ecological channel. It is assumed that the water levels in the upstream area of potential inlet locations for the ecological channel and fish passage corresponds to the water levels measured at Sambeek-Boven (first upstream publicly known measurement point), while the water levels in the downstream area of potential outlet locations correspond to the water levels measured at Sambeek-Beneden (first downstream publicly known measurement point).

Table 10 shows the measured water levels at these two points for various river discharges. These water levels are used for the design of the ecological channel. The table also shows the percentage with which these water levels are exceedance per year. The available discharge refers to the river discharge after subtracting the reserved discharge for the lock management, the existing fish ladder, and potential leakage losses.

Table 11: The measured flow rates and water levels at Sambeek-Boven and Sambeek-Beneden (measurements provided by Royal HaskoningDHV). The frequency for which the water levels are exceed is expressed in the total numbers of days per year and the total percentage per year.

River's discharge Q_{river} [m ³ /s]	Reserved discharge [m ³ /s]	Available discharge Q [m ³ /s]	Water levels at Sambeek-Boven	Water levels at Sambeek-Beneden	Δh [m]	#Days water levels exceeded	% days water levels exceeded
25	20	5	NAP+10.85m	NAP+7.76m	3.09	272	75%
<50	25	25	NAP+10.85m	NAP+7.76m	3.09	272	75%
125	25	100	NAP+10.87m	NAP+7.82m	3.05	188	52%
250	25	225	NAP+10.86m	NAP+8.0m	2.86	109	30%
500	25	475	NAP+10.82m	NAP+8.62m	2.2	47	13%
1000	25	975	NAP+10.85m	NAP+10.27m	0.58	9	3%
1250	25	1225	NAP+11.57m	NAP+11.08m	0.49	4	1%
1627	25	1602	NAP+12.44m	NAP+12.16m	0.28	-	-

4. Functional-spatial design

This chapter develops the functional-spatial design of the ecological channel, including its intake structure and fish passage. The main goal of the ecological channel and its intake structure is to create lotic habitats at the weir complex, while the goal of the fish passage is to enable fish movement through the channel's inlet. To simplify the design process, the chapter is divided into four sections:

Section 4.1. Design of the ecological channel for lotic habitat formation:

This section provides the necessary channel dimensions and parameters for creating lotic habitats.

Section 4.2. Design of the fish passable intake structure:

This section focuses on designing the intake structure that enables the required inflow rates, as determined in the previous step, while also facilitating upstream and downstream fish movement.

Section 4.3. Final combined design of the ecological channel (including the intake structure)

In this section, the channel design and selected intake structure design are integrated with the existing navigation locks, mooring areas, and combined Poirée and Stoney weirs to form a cohesive weir complex design for the creation of lotic habitats

Section 4.4. Evaluation of the ecological channel's function as a fish passage:

This section evaluates whether the ecological channel can effectively serve as a fish passage for the entire weir complex by fulfilling the fish migration requirements shown in Subsection 3.1.4 and potentially reducing the number of subsystems at the complex.

4.1 Design of the ecological channel for lotic habitat formation

4.1.1 Approach for the design of the ecological channel

This section provides the necessary channel dimensions and parameters for creating lotic habitats. The channel dimensions and parameters have interdependent relationships. One channel design is developed by adjusting these parameters until a combination is found that meets the required flow conditions shown in Subsection 3.1.5. Due to the interdependent relationships between the channel parameters, this adjustment process is iterative and is achieved with the following steps:

Step 1: Describing the channel's hydraulic processes with equations

The channel's parameters have interrelated relationships, particularly in determining the water depths and flow velocities. This step provides the hydraulic equations used to describe these relationships.

Step 2: Inventorying the channel's parameters

The hydraulic equations used to design the ecological channel incorporate various channel parameters. This step provides an inventory of these parameters.

Step 3: Selection of the initial channel parameters

The parameters require several initial values, to start the iterative adjustment process between the equations and channel parameters.

Step 4: Verifying the initial flow conditions

In this step, the initial channel parameters are used to determine the initial flow conditions, which are then verified against the flow requirements.

Step 5: Determining the most impactful channel parameters (Sensitivity analysis)

The initial channel parameters are iteratively adjusted to find a parameter combination that best meets the required flow conditions. These adjustments are based on a sensitivity analysis that identifies the most impactful parameters, which are prioritized for adjustment. This step provides the sensitivity analysis

Step 6: Determining the final channel parameters values

After iteratively adjusting the most impactful channel parameters, the final parameter combination is determined. This step provides these final parameter values.

Step 7: Verifying the final flow conditions

In this step, the identified parameter combination is used to determine the channel's flow conditions. These flow conditions are then verified against the flow requirements.

Step 8: Developing the final ecological channel design

This step provides a visual overview of the channel's final conceptual design.

4.1.2 Step 1+2: Inventorying the channel parameters used in the hydraulic equations

The relationships between the channel's parameters are described by three fundamental hydraulic equations, which are outlined in Appendix E. These equations determined the following parameters:

- The channel's water depth is determined with the Belanger equation.
- The channel's bed roughness is determined with the White-Colebrook equation using the channel's bed material.
- The critical flow velocity, indicating the start of the sediment transport for the channel's bed material, is determined with the Shields equation.

These equations incorporate various channel parameters, an overview is given in Table 12.

Table 12: Simplified overview of the channel parameters and their dependencies.

Channel's parameters	Symbol	Dimensions	Depends on
Flow conditions			
Water depth	d_s	m	$Q_{eco}, L_{channel}, \Delta z, A, P, B_c, c_f, d_{n50}$
Inflow rate	Q_{eco}	m^3/s	$d_s, C_d, p_{weir}, B_{weir}, d_{river}$
Depth averaged flow velocity	u_{avg}	m/s	Q_{eco}, A
Longitudinal dimensions			
Channel's length	$L_{channel}$	m	Available space of the project area
Channel's bed level difference	Δz	m	Channel's inlet and outlet bed levels
Bed slope	i_b	-	$L_{channel}, \Delta z$
Cross-sectional dimensions			
Channel's bottom width	B_{bottom}	m	-
Channel's height	y	m	-
Wet cross-sectional area	A	m^2	d_s, B_{bottom}, y
Wet perimeter	P	m	d_s, B_{bottom}, y
Channel's water surface width	B_c	m	d_s, B_{bottom}, y

Hydraulic radius	R	m	d_s, B_{bottom}, y
Bed parameters			
Nominal diameter of bed material	d_{n50}	m	Bed material
Friction coefficient	c_f	-	d_s , cross-sectional dimensions, d_{n50}
Critical flow velocity of the channel's bed material	$\overline{u_c}$	m/s	$d_{n50}, \psi_c, c_f, \Delta$
Relative submerged density	Δ	-	Bed material
Critical Shields parameter	ψ_c	-	Value based on literature
River parameters			
River's downstream water level	d_{BC}	m	Project's boundary conditions

4.1.3 Step 3: Selection of initial channel parameters

This subsection focuses on determining initial channel parameters to form the initial channel design. These values are selected based on engineering judgement to reduce the number of parameter combinations that need to be evaluated in the following subsection. The channel parameters for which initial values are selected, are:

1. Channel's inlet and outlet location
2. Nominal diameter of the channel's bed material
3. Channel's length
4. Channel's cross-sectional shape and dimensions
5. Channel's inlet and outlet bed levels
6. Channel's inflow rate

1. Initial channel's inlet and outlet location

The locations of the channel's inlet and outlet position are crucial for its design, as they affect the findability of the ecological channel by the fish species. As stated in Section 2.2, the ecological channel can be located either north of the weir complex (area next to the Poirée weir) or south of the weir complex (area next to the navigation locks). Typically, the flow over the weirs is larger compared to the flow through the navigation locks, meaning the fish are primarily attracted to the weirs. Therefore, the ecological is located in the project area north of the weir complex (next to the Poirée weir), see Figure 19.

Outlet locations

Outlet location 1

For optimal findability, the outlet of the ecological channel should align with the weirs, see Table 7. If this is achieved, it can be assumed that the fish are naturally drawn towards the weirs and, consequently, towards the outlet of ecological channel. This makes the target ratio between the fish passage's outflow rate and river's flow rate less crucial, given there is a sufficient outflow velocity. Thus, aligning the outlet with the weirs leads to a potential outlet location, see Figure 19.

Outlet location 2

Aligning the outlet with weirs may limit the channel's length. Hence, the channel's outlet can be situated further downstream. To ensure an adequate findability for the fish, the channel's outflow must maintain the target outflow rate of 5-10% of the river's flow during the migration period and an outflow velocity of approximately 1.0 m/s. In addition, the channel's outlet should be located within the main flow of the river. Therefore, for a potential location, the outlet can be positioned along the north bank of the river. The outermost location just before the Oude Maas Meander is chosen as a potential outlet location, as it allows for a longer channel length, see Figure 19.

Outlet location 3

Having a sizeable channel length is favourable, as it allows for more space for habitat formation. By prioritizing a larger channel over providing an adequate findable outlet for fish, the channel's outlet can be

4. Functional-spatial design

positioned along the bank of the Oude Maas Meander. In the (DLG, 2007) report, the outlet of the Afferden by-pass channel, which focusses on habitat creation, is located just south of the outlet of the Heijense Leijgraaf stream. Using this as a reference, the location is chosen as a potential outlet location, as shown in Figure 19.



Figure 19: Potential outlet locations for the ecological channel (Google earth, 2022)

Inlet location

There is no specified inlet distance from the weirs to ensure a findable inlet for the fish. Therefore, potential locations include one that aligns with the current inlet distance, which is 60 m upstream of the weirs. Another potential location aligns with the inlet of the Afferden by-pass channel, which is situated just upstream of the ferry-way. Both inlet locations are shown in Figure 20.



Figure 20: Potential inlet locations for the ecological channel (Google earth, 2022)

2. Initial channel's length

The channel length refers to the distance along the channel's path, including any meandering. Using the potential channel inlet and outlet locations defined earlier results in six potential channel lengths. A sizeable channel length is favourable, as it allows for more space for habitat formation. Considering this, inlet location 2 and outlet location 3 would be selected, resulting in a channel length of 4 km. However, outlet location 3 has a poor findability for the fish, which could negatively affect the fish population within the channel. Therefore, to ensure adequate outlet findability while still maintaining a sizeable channel length, inlet location 2 and outlet location 2 are chosen. The channel length is estimated using Google Earth, as shown in Figure 21. This estimated length is 3.5 km. The channel's path is arbitrarily chosen and includes some meandering.

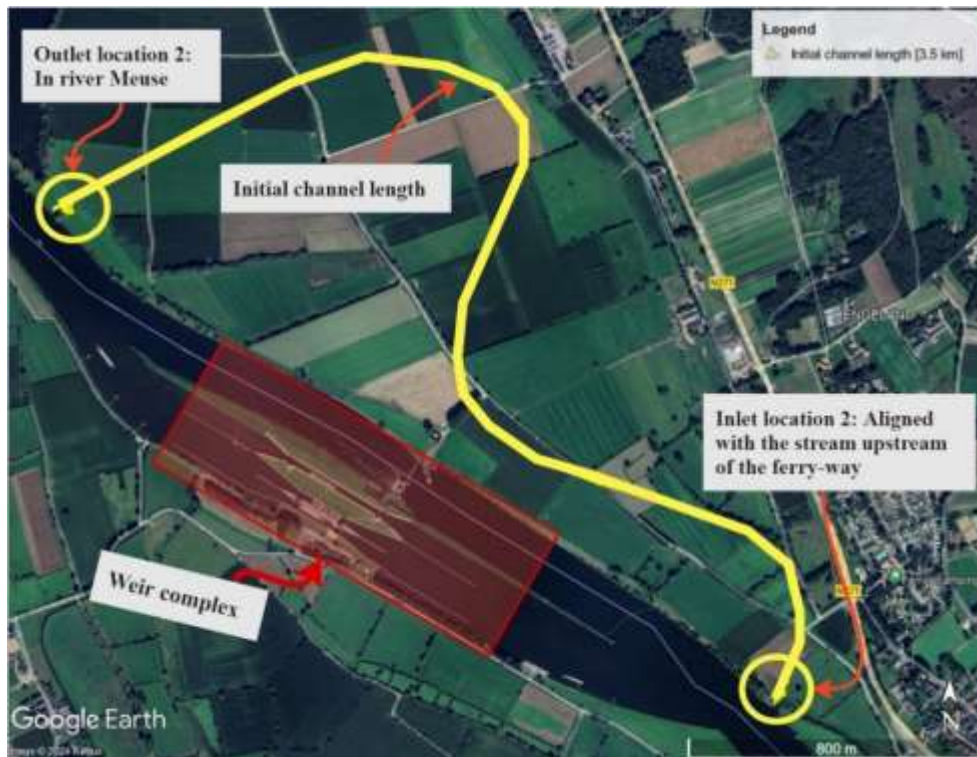

Figure 21: An approximation of the initial maximum channel length (Google earth, 2022)

3. Initial channel's inlet and outlet bed elevations

The bed elevations at the channel's inlet and outlet determine the total bed level difference (Δz) between these two points. This bed level difference, along with the channel's length, determines the channel's bed slope, which is a critical channel parameter. A steeper slope results in higher flow velocities, which must be limited. Due to the natural slope of the channel, the channel's bed is higher at the inlet and lower at the outlet. To compensate for this elevation difference, the inlet's bed elevation is positioned 1.5 m below the lowest upstream river water level. The outlet's bed elevation is positioned 0.55 m below the lowest downstream river water level, as this is the minimum target water depth, including some margin for error, for a passable fish passage (see Table 8). This results in a bed elevation of NAP+9.35 m at the channel's inlet and a bed elevation of NAP+7.21 m at the channel's outlet. Additionally, to improve the channel's findability, there should be a gradual transition from the riverbed to the channel's bed and vice-versa, see Table 7. An impression of the channel's longitudinal bed profile is shown in Figure 22.

4. Functional-spatial design

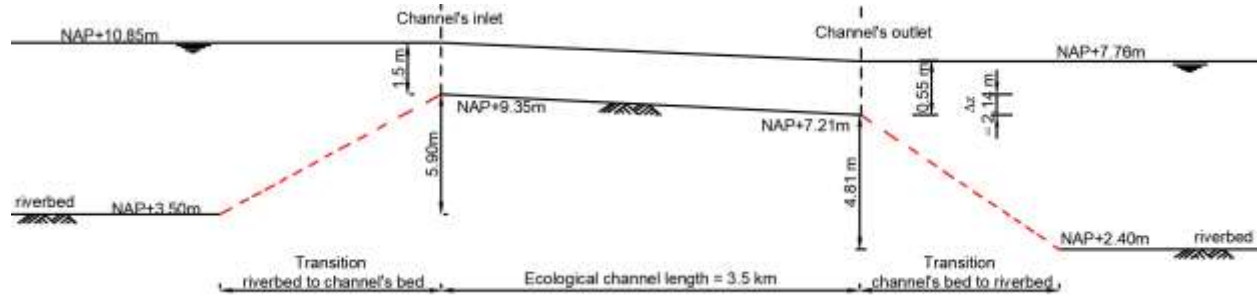

Figure 22: Impression of the ecological channel's initial longitudinal bed profile

4. Initial nominal diameter of the channel's bed material

The bed materials refers to the composition of the channel's entire bed, which is used to determine its nominal diameter (d_{n50}). This is a critical parameter since it determines the channel's bed resistance (bed friction), which is crucial to determine the channel's flow conditions. The project area lies in the Holocene riverplain, which typically consists of a 2- to 3-meter-thick layer of silty to sandy clay, underneath which a layer of medium-coarse sand to coarse sand with gravel lies (DLG, 2007). The initial inlet and outlet bed elevations lie in the medium-coarse to coarse sand with gravel layer, see Figure 23. This indicates that the entire channel lies in this layer.

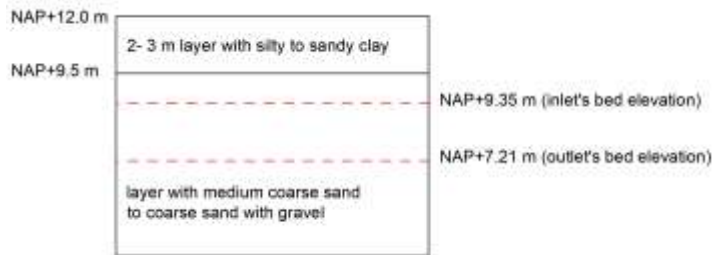

Figure 23: The natural bed composition of the channel's inlet and outlet location

The medium-coarse sand to coarse sand with gravel layer is divided into three groups. Group 1 consists of the medium-coarse sand. The coarse sand with gravel is divided into group 2 and 3, where group 2 contains coarse sand and group 3 contains medium coarse gravel. The nominal diameter for this layer is calculated by finding the average particle diameter across all three groups. The particle size ranges for the different types of sediment are given in the report (Voorendt, 2023). The nominal diameter calculation is shown in Figure 24.

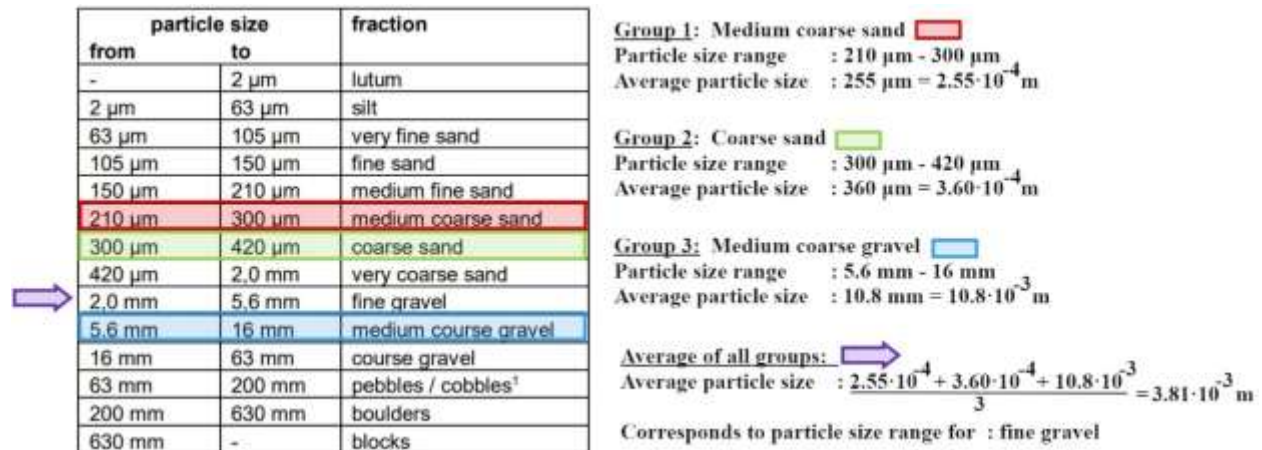

Figure 24: Determination of the average particle diameter for the channel's bed composition (Voorendt, 2023)

4. Functional-spatial design

The nominal diameter (d_{n50}) is 1.2 times smaller than the average diameter (d_{50}) (Schiereck & Verhagen, 2019). Therefore, the estimated nominal diameter for the ecological channel's bed material is:

$$d_{n50} = \frac{d_{50}}{1.2} = \frac{3.81 \cdot 10^{-3}}{1.2} = 3.18 \cdot 10^{-3} \text{ m}$$

5. Channel's initial cross-sectional shape and dimensions

Cross-sectional shape

The ecological channel aims to replicate natural river dynamics, which is best achieved with a natural channel, as this maintains natural flow patterns. A natural channel is non-prismatic, resulting in varying cross-sectional shapes and dimensions. For design purposes, the natural cross-section is simplified to a standard shape, such as rectangular, trapezoidal, or semi-circular. Among these shapes, the semi-circular shape has the highest hydraulic efficiency but is also the hardest to construct. The trapezoidal shape, while slightly less efficient, is much easier to construct. Therefore, a compound trapezoidal shape is selected to approximate a natural channel shape. Figure 25 shows this approach of a compound trapezoidal shape approximating a natural channel shape.

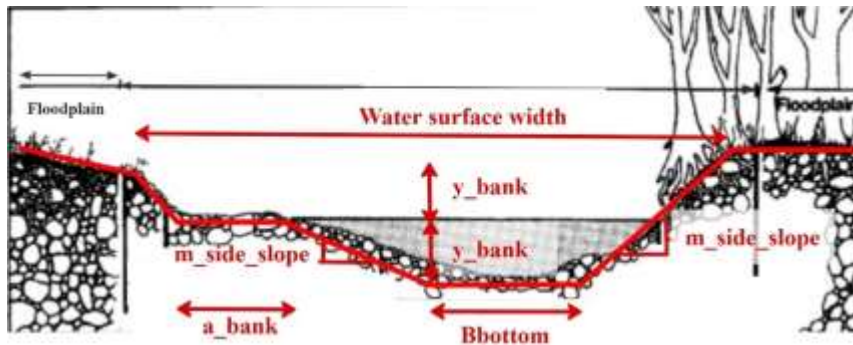

Figure 25: A compound trapezoidal cross-section shape approximating a natural channel cross-sectional shape (Sullivan, Lisle, Dolloff, Grant, & Reid, 1987)

Cross-sectional dimensions

The compound trapezoidal cross-section is divided into three steps with heights of 0.5 m, since it can give more opportunity of exposed bank areas. With these step heights and the selected channel bed elevations, there is still an area between the channel and the surrounding flood plains. The depth of this area depends on the channel's elevation and the ground elevation of the surrounding floodplains. This area is referred to as 'bank area extra'. In addition, limiting the thalweg's height to 0.5 m results in a water depth of 0.3 m on the first bank area step for the minimum water depth of 0.8 m, which satisfies the minimum bank area water depth requirement.

The initial bottom width (B_{bottom}) of the channel is set at 20 m. The bank area's step width have a width of 5 m (a_{bank}). These values are arbitrarily chosen. In addition, the side slopes of the compound trapezoidal channel are all equal and have a ratio of 1:2. This is based on the Afferden by-pass channel. Figure 26 shows the channel's initial cross-sectional dimensions.

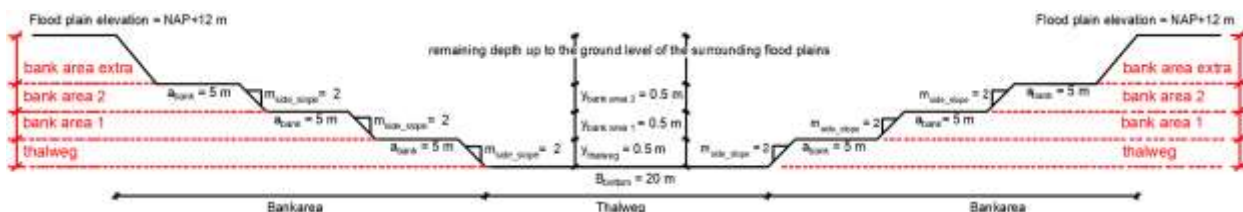

Figure 26: Initial compound trapezoidal cross-sectional dimensions

6. Channel's initial inflow rate

Using the concept description of the 'stuwgeul' in the report by (Vriese, et al., 2021), an initial inflow rate range of 5 to 50 m³/s is selected (Q_{eco}) for the ecological channel. The dimensions and type of the intake structure determines its inflow rate. However, in determining the optimal parameter combination for the channel that leads to the required flow conditions, only inflow rates are considered and not the intake structure itself. This approach is taken to simplify the iterative process, as focussing only on the inflow rate reduces the number of parameters. The intake structure is designed in Section 4.2.

Overview of the initial channel parameters

An overview of the initial channel parameters is shown in Table 13.

Table 13: Overview of the initial channel parameters values

Chosen parameters	Symbol	Value
Inflow rate range	Q_{eco}	5 – 50 m ³ /s
Channel's length	$L_{channel}$	3500 m
Bed level at channel's inlet		NAP+9.35 m
Bed level at channel's outlet		NAP+7.21 m
Bed level difference between channel's inlet and outlet	Δz	2.14 m
Nominal diameter of project's area bed material	d_{n50}	$3.18 \cdot 10^{-3}$ m
Channel bottom width	B_{bottom}	20 m
Thalweg's step height	$y_{thalweg}$	0.5 m
Bank area's step width	a_{bank}	5 m
Bank area's step height	y_{bank}	0.5 m
Channel's side slope	m_{side_slope}	2
Channel's bed slope	$i_b = \frac{\Delta z}{L_{channel}}$	$7.725 \cdot 10^{-4}$

4.1.4 Step 4: Verifying the initial flow conditions

The initial channel parameters are used to determine its initial flow conditions, which are then verified against the flow requirements of Subsection 3.1.5. The flow conditions are first determined for uniform flow, which represent a simplified ideal situation where the channel's flow depth, flow velocity, and flow rate are constant throughout the channel. In reality, the channel experiences non-uniform flow due to external influences of the river, variations in the channel's geometry, and variations of the channel's bed material (bed friction). It is assumed that if the flow conditions are not achieved for the simplified ideal situation (uniform flow), they most likely cannot be achieved for the actual more complex flow situation in the channel. Hence, the channel parameter combination is first analysed for uniform flow conditions.

Calculating the initial flow conditions for uniform flow

The water levels in the channel are calculated using the equilibrium flow equation. The bed friction and critical flow velocity are determined using the White-Colebrook and Shields equation, respectively. These equations are described in Appendix E and outlined below:

Equilibrium flow depth:
$$\frac{dd}{ds} = \frac{i_b - i_f}{1 - F_r^2} = 0 \rightarrow \frac{A^3}{P} = \frac{c_f \cdot Q_{eco}^2}{i_b \cdot g}$$

White-Colebrook equation:
$$\frac{1}{\sqrt{c_f}} = 5.75 \cdot \log \left(\frac{12 \cdot R}{k_s} \right)$$

Shields equation:

$$\bar{u}_c = \frac{\sqrt{\frac{g}{c_f}} \cdot \sqrt{d_{n50} \cdot \Delta \cdot \Psi_c \cdot K_s}}{K_v}$$

The equilibrium flow depth equation is a non-linear equation that is solved using the Newton-Raphson numerical method (Schoups, 2023). For this method, the equation is rewritten as $F(x) = 0$. An initial guess (x_0) is made for the solution. The solution is iteratively updated by finding the intersection between the x-axis (x_1) and the tangent of the function ($F'(x_0)$) at the current guess:

$$x_1 = x_0 - \frac{F(x_0)}{F'(x_0)}$$

This new solution (x_1) is then used as the current guess to find the next intersection:

$$x_2 = x_1 - \frac{F(x_1)}{F'(x_1)}$$

This cycle is repeated until the function $F(x_n)$ is close to zero. For example, until $|F(x_n)| < 10^{-10}$. For the equilibrium flow depth, the cycle is shown below

$$F(d_e) = 0 \rightarrow \frac{dd}{ds} = 0 \qquad F(d_e) = \frac{i_f}{i_b} - 1 = 0$$

$$F'(d_e) = -i_b \cdot i_f^{-2} \cdot \frac{di_f}{dd_e} \qquad i_f = \frac{c_f \cdot Q_{eco}^2 \cdot P}{g \cdot A^3}$$

Using these equations, the equilibrium flow depth is calculated using Python. The Python code iterates until convergence is achieved with $|F(d_e)| < 10^{-10}$. The calculated equilibrium flow depths are then used to determine the flow velocities, the friction coefficients, and the critical flow velocities. The Python code and the initial flow conditions are provided in Appendix F. The flow conditions and whether these satisfy the flow requirements are summarized in Table 14.

Table 14: Overview of the channel's initial flow conditions for uniform flow and whether these satisfy the flow requirements. The bold highlighted values indicate the conditions that meet requirements.

Inflow rate Q_{eco} [m ³ /s]	Flow depth d_e [m] $0.8 \text{ m} \leq d_e \leq 2 \text{ m}$	Flow velocity u [m/s]			Critical flow velocity u_{crit} [m/s]		
		Thalweg $\leq 1.0 \text{ m/s}$ and u_{crit}	Bank area 1 $\leq 0.5 \text{ m/s}$ and u_{crit}	Bank area 2 $\leq 0.5 \text{ m/s}$ and u_{crit}	Thalweg	Bank area 1	Bank area 2
5	0.36	0.68	-	-	0.58	-	-
10	0.59	0.91	0.26	-	0.63	0.44	-
20	0.8	1.12	0.59	-	0.66	0.56	-
30	1.05	1.33	0.77	0.17	0.68	0.6	0.39
40	1.18	1.44	0.89	0.42	0.69	0.62	0.51
50	1.3	1.53	1.0	0.58	0.70	0.64	0.56

Concluding remarks

Table 14 shows that neither the flow depth nor flow velocity requirements are simultaneously satisfied, and that the critical flow velocity is not met for any of the inflow rates. Hence, the initial channel parameter

4. Functional-spatial design

combination results in a channel design that does not meet the flow requirements for the considered inflow range. These parameters are adjusted in the following subsection.

4.1.5 Step 5: Determining the most impactful channel parameters

In this subsection, a sensitivity analysis is conducted on the channel's initial parameters to assess the impact of each parameter on the flow conditions. The aim is to identify the most impactful parameters and primarily adjust these, while also making minor adjustments to the remaining parameters, to find a parameter combination that meets the required flow conditions. The analysis is prompted by Subsection 4.1.4, which shows that for the initial parameters, there is no combination where both the equilibrium flow depth and velocity requirements are met within the considered discharge range.

Conducting the sensitivity analysis

The impact of each channel parameter on the equilibrium flow depth and average flow velocity is determined by varying each parameter individually while keeping the initial values of the remaining parameters constant. The response of the equilibrium flow depth and flow velocity are plotted, showing their rate of change for each parameter. By comparing the plots, the parameters with the largest impact on the flow conditions are identified. The graphs are generated using Python for four discharge values. An overview of the impact of each channel parameter on the channel's flow depth and average flow velocity is shown in Figure 27. Each graph and the influence of each parameter are explained in Appendix G.

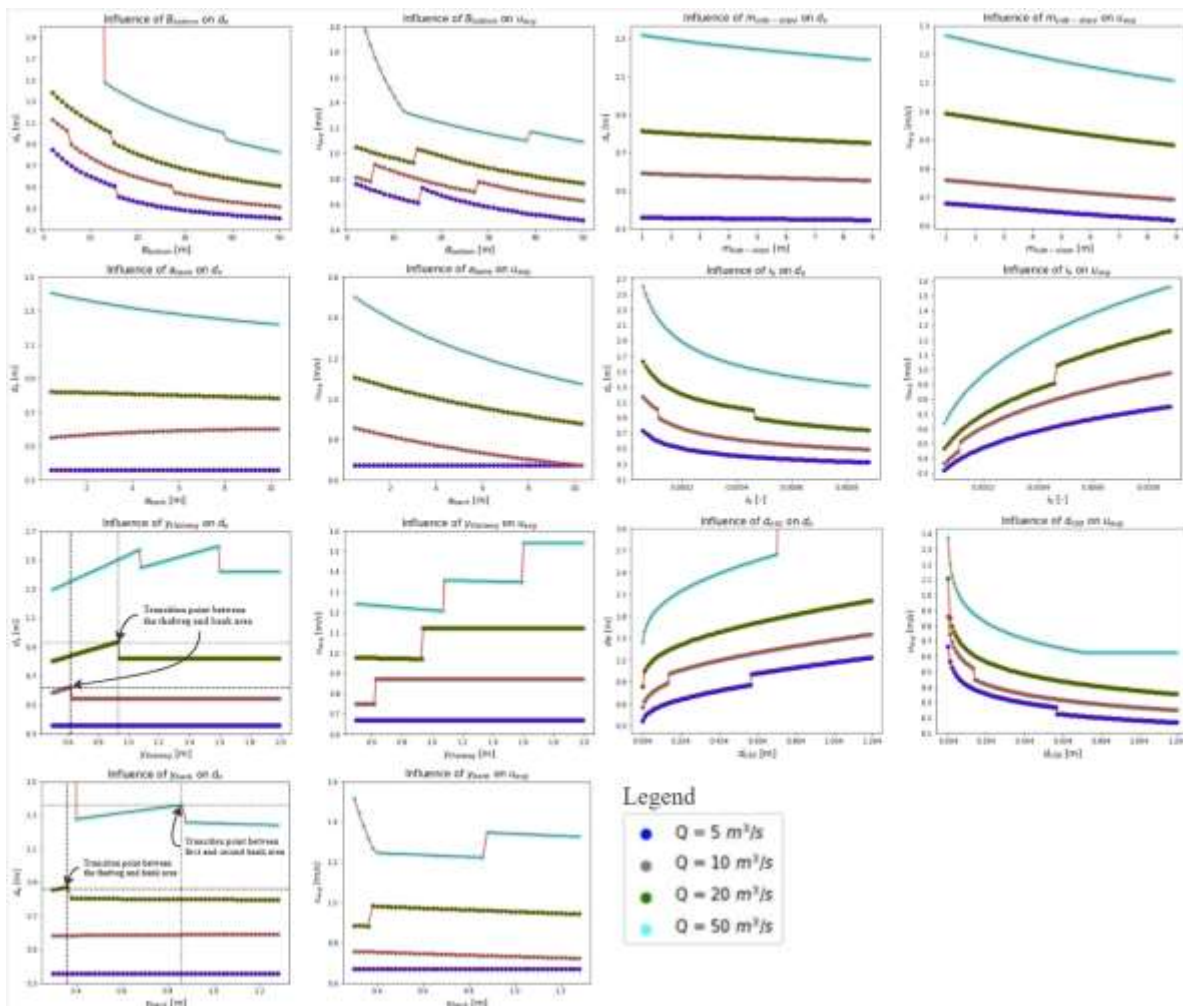

Figure 27: Visual influence of the channel's parameters on the channel's equilibrium flow depth and average flow velocity.

Conclusion of the sensitivity analysis

Considering the influence of each parameter, the parameters m_{side_slope} , y_{bank} , $y_{thalweg}$, and a_{bank} result in graphs with gentle slopes, especially for the lower inflow rates. This indicates that these parameters have a low impact on the flow conditions, especially compared to the impact of the parameters d_{n50} , i_b , B_{bottom} , and Q_{eco} . Hence, due to their low influence, several of these parameters remain unchanged for the final design.

The parameters d_{n50} , i_b , B_{bottom} , and Q_{eco} have higher rates of change, as can be seen from their non-linear form and the range of the flow conditions values. Therefore, these parameters are primarily adjusted to achieve the required flow conditions.

Hence, to improve the initial flow conditions, the equilibrium flow depth must be increased, while the flow velocity must decrease. This can primarily be achieved by:

- increasing the channel's bed friction (d_{n50}) / (c_f)
- decreasing the channel's bed slope (i_b)
- balancing the channel's bottom width (B_{bottom})
- limiting the inflow rate range (Q_{eco})

Increasing the channel's bed friction ($d_{n50} \gg$) / ($c_f \gg$)

The friction coefficient cannot be increased randomly, as it may result in a channel bed that is unrealistic or unsuitable for lotic habitat formation. Thus, the friction coefficient must be determined based on the required bed composition for creating lotic habitats, while still corresponding to a realistic and suitable physical channel bed. Additionally, increasing the bed friction also increases the channel's critical flow velocity (u_{crit}), which helps prevent excessive erosion.

Decreasing the channel's bed slope ($i_b \ll$)

The channel's bed slope is lowered by decreasing the bed level difference (Δz), since the maximum channel length for an adequate outlet findability is already considered. This is achieved by adjusting the channel's inlet and/or outlet bed elevation. Specifically, by lowering the inlet's bed elevation, as the outlet bed elevation is already set to the minimum required water depth to accommodate fish movement. However, this leads to a deeper excavation and more ground work, which may result in higher excavation costs, longer construction time, and a larger environmental footprint. Since there are no limits for the excavation depth of the channel, this remains a viable option. Additionally, decreasing the bed level difference also increases the channel's critical flow velocity (u_{crit}), which helps prevent excessive erosion.

Balancing the channel's bottom width (B_{bottom})

Decreasing the channel's bottom width (B_{bottom}) increases the flow depth and the flow velocity, which is not favourable. Therefore, adjusting the bottom width must be done carefully in combination with the other channel parameters to avoid negatively impacting the flow conditions.

Limiting the channel's inflow rate (Q_{eco})

Increasing the channel's inflow rate results in an increase of the flow depths and flow velocities, as shown in Figure 27. Therefore, if the flow conditions are met for lower discharge limits, it is unlikely that they will be met for the upper discharge limits, especially if there is a significant value difference between the lower and upper limits. Hence, limiting the inflow rate range is favourable for the channel's design, as it leads to a higher probability that the flow conditions are met for both the upper and lower limit.

4.1.6 Step 6: Determining the final channel parameters

The parameter combination that achieves the required flow conditions is determined in this subsection. The parameters m_{side_slope} , y_{bank} , $y_{thalweg}$ remain unchanged. The friction coefficient and inflow rate are determined

analytically. With these values, the remaining parameters (i_b , B_{bottom} , and a_{bank}) are iteratively adjusted until the required flow conditions are achieved. This iteration is done in Python using the code provided in Appendix F. The iteration themselves are not shown.

It is important to note, that the process of determining a working channel design that meets the required conditions is not straightforward. It involves systematically changing the parameters one by one and observing their effects on the channel's flow conditions. This is an iterative process since numerous theoretical parameter combinations are possible.

Calculating the Friction coefficient (c_f) and (d_{n50})

The nominal diameter and the corresponding friction coefficient for the required bed composition of sand, gravel, stones, and (submerged) vegetation is calculated in this subsection. An indication of the required friction coefficient determined with the friction slope equation:

$$i_f = \frac{Q^2 \cdot c_f \cdot P}{g \cdot A^3} \rightarrow c_f = \frac{i_f \cdot g \cdot R}{u^2}$$

For uniform flow the friction slope (i_f) is equal to the bed slope (i_b). With $d_{emin} = 0.8\text{m}$ and $B_{bottom} = 20\text{ m}$, leads to a hydraulic radius of $R_{min} = 0.60\text{ m}$. The maximum flow velocity of step is used for calculation, $u_{target} = 0.5\text{ m/s}$. Substituting this all into the friction slope equation gives an indication of the required friction coefficient. The corresponding nominal diameter (d_{n50}) is determined with the White-Colebrook equation:

$$c_f = \frac{i_b \cdot g \cdot R}{u^2} = \frac{7.725 \cdot 10^{-4} \cdot 9.81 \cdot 0.60}{0.5^2} = 0.018$$

This value is rounded down to be more conservative and prevent large sediment diameters: $c_f = 0.015$

$$\frac{1}{\sqrt{c_f}} = 5.75 \cdot \log\left(\frac{12 \cdot R}{3.5 \cdot d_{n50}}\right) \rightarrow d_{n50} = \frac{10 \cdot \frac{12 \cdot R}{\left(\frac{1}{\sqrt{c_f}}\right)^{5.75}}}{3.5} = 0.078\text{ m}$$

This sediment size corresponds to the lower limits of pebbles/cobbles (Voorendt, 2023). It can be argued that this is a realistic value since the ecological channel bed must ultimately consist of sand, gravel, stones, and (submerged) vegetation. Naturally, not all these elements will be present along the full length of the channel, as variations in the bed composition along the channel will occur due to the presence of natural or deliberately placed obstruction, such as boulders, (dead) tree trunks, (aquatic) plants. This is favourable for habitat creation, as it creates spawning grounds, hiding areas, and resting areas for the river species.

It is assumed that these local variations do not influence the overall average friction coefficient of the channel. Therefore, the friction coefficient at specific locations in the channel are not determined. To determine a realistic average channel friction coefficient, a comparison is made between the friction coefficient and Manning coefficient (n), as the Manning coefficient is empirically determined for various channel layouts.

The ecological channel friction coefficient is comparable with the manning coefficient for natural river channel with winding, pools, and shoals, resulting in a range $n = 0.033 - 0.040\text{ m}^{-1/3}\text{s}$ (Battjes & Labeur, 2017). For the ecological channel the average manning value of this range is taken, $n = 0.037\text{ m}^{-1/3}\text{s}$. The relation between the manning coefficient and the friction coefficient is:

$$\frac{1}{n} \cdot R^{\frac{1}{6}} = C = \sqrt{\frac{g}{c_f}} \rightarrow c_f = \frac{g}{\left(\frac{1}{n} \cdot R^{\frac{1}{6}}\right)^2}$$

For the calculation, the hydraulic radius for d_{emax} is used since a higher hydraulic radius leads to a lower friction coefficient.

$$d_{emax} = 1.5 \text{ m} \rightarrow R = 1.06 \text{ m} ; n = 0.037 \text{ m}^{-1/3} \text{ s} \rightarrow c_f = 0.013$$

Thus, the calculated d_{n50} of 0.078 m is kept for the design of the ecological channel. Local variations in the channel's bank area or bed material will occur. However, it is assumed that these local effects have no significant influence on the overall friction and flow conditions of the channel and are not examined in this report.

Calculating the inflow rate range (Q_{eco})

This paragraph discusses the optimal channel inflow rate that maintains fluctuating flows rates in the channel while ensuring sufficient outflow rates. The fluctuating flow rates aim to mimic the natural flow variations in lotic habitats, and a sufficient outflow rate helps improve the channel's outlet findability. To maintain the natural fluctuations of the river's flow, the channel's inflow rate is set as a percentage of the river's flow rate. To achieve a sufficient outflow rate, it can be set to the target outflow rate for fish passages, which 5-10% of the river's flow during the migration period, see Table 8. As stated, the critical months of the river species have typical flow rate of 25 to 125 m³/s, with peak flows reaching up to 250 m³/s.

Factoring in the required discharge for the lock management and the fish passage, this results in an available discharge of 5 m³/s for a river discharge of 25 m³/s. For the remaining river discharges, 25 m³/s should be available (see Table 11). Hence, the minimum inflow rate is set at 5 m³/s, and from there, it gradually increases to 12.5 m³/s until the river's flow rate reaches 125 m³/s. This indicates that for river discharges below 125 m³/s, the inflow rate is higher than 10% of the main flow.

The maximum inflow rate is set at 20 m³/s to avoid a broad inflow rate range. To maintain a sufficient outflow rate, this maximum value corresponds to 5% of the river's main flow, which is 400 m³/s. Thus, the channel's inflow rate continuously rises until this maximum value is reached, resulting in inflow rates higher than 5% of the river's flow.

For river discharges above 400 m³/s the inflow rate is less than 5% of the river's main flow and it remains constant (no fluctuations). It is assumed that river discharges above 400 m³/s occur approximately 13% of the year (this value is chosen similar to the river discharge 500 m³/s, see Table 11). Therefore, fluctuating flow rates are achieved 87% of the year, with the crucial aspect being their 100% presence during the critical reproductive of the river species. It is important to note that these percentages are not fixed and can vary, introducing some uncertainty.

Hence, the inflow rate range of the ecological channel is set to 5 – 20 m³/s. The flow distribution of the river's flow to the lock management, fish passage, and ecological channel is shown in Appendix H.

The final parameter combination

The parameters m_{side_slope} , y_{bank} , $y_{thalweg}$, and a_{bank} remain unchanged from their initial values. The channel's friction coefficient (c_f) and inflow rate range (Q_{eco}) are determined above. After iterating with these values, it appears that the channel's bottom width (B_{bottom}) and bank area's step width (a_{bank}) are decreased to increase the channel's flow depth. The bed level difference is also reduced to achieve suitable flow

conditions. This is accomplished by lowering the inlet’s bed level to NAP+8.95 m, a decrease of 0.4 m. The final channel parameters are shown in Table 15.

Table 15: Overview of the final channel parameters for uniform flow

Chosen parameters	Symbol	Value
Inflow rate range	Q_{eco}	5 – 20 m ³ /s
Channel’s length	$L_{channel}$	3500 m
Bed level at channel’s inlet		NAP+8.95 m
Bed level at channel’s outlet		NAP+7.21 m
Bed level difference between channel’s inlet and outlet	Δz	1.74 m
Nominal diameter of project’s area bed material	d_{n50}	0.078 m
Channel bottom width	B_{bottom}	12 m
Thalweg’s step height	$y_{thalweg}$	0.5 m
Bank area’s step width	a_{bank}	4 m
Bank area’s step height	y_{bank}	0.5 m
Channel’s side slope	m_{side_slope}	2
Channel’s bed slope	$i_b = \frac{\Delta z}{L_{channel}}$	$4.97 \cdot 10^{-4}$

4.1.7 Step 7: Verifying the final flow conditions

The final channel parameters are used to determine its final flow conditions, which are verified against the flow requirements of Subsection 3.1.5. Similar to Subsection 4.1.4, the flow conditions are first verified for uniform flow. Then, quasi-uniform flow effects, such as the influence of the river’s water levels, effects are taken into account since these influence the flow conditions in the channel. The flow conditions for quasi-uniform flow are then verified against the flow requirements.

It is assumed that only gradual deviations occur in the channel, as there are no abrupt changes in the channel’s geometry or bed material. Given that quasi-uniform flow accounts for gradual deviations, it is considered unnecessary to determine the channel’s flow conditions for non-uniform flow. However, local changes in the channel’s outlet and inlet will most likely result in abrupt deviations, for which non-uniform flow effects should be considered. These are examined in Subsection 4.1.8 and Section 4.2, respectively.

Calculating and verifying the final flow conditions for uniform flow

Calculating the channel’s flow conditions using the final parameters for uniform flow uses the same method described in Subsection 4.1.4 and the same Python code provided in Appendix F. The flow conditions and whether these satisfy the flow requirements are summarized in Table 16. The flow depth for an inflow rate of 5 m³/s is 0.76m, which rounds to the minimum required flow depth of 0.8 m. Without rounding, the water depth is 3 cm too low. However, it is assumed that this depth difference poses no issue, as an inflow rate of 5 m³/s occurs only approximately 5% percent of the year (when $Q_{river} < 30$ m³/s). Therefore, all the flow conditions for uniform flow meet the flow requirements.

This estimation is based on the measured river discharges at the measurement point Venlo over the past 27 years. The discharge values at Venlo are used, as it is the closest publicly available discharge measurement point. It is located further upstream near weir complex Belfeld. The measurements are extracted from the Waterinfo website from Rijkswaterstaat (Rijkswaterstaat, 2023). Using Python, the total discharge measurements and the number of measurements less than 30 m³/s per year are determined. The percentage of these low discharges per year is calculated, from which the average is determined to be 3.22%. This rough estimation is shown in Appendix F.2.

4. Functional-spatial design

Table 16: Overview of the channel's final flow condition for uniform flow.

Inflow rate Q_{eco} [m ³ /s]	Flow depth d_e [m]	Flow velocity u [m/s]			Critical flow velocity u_{crit} [m/s]		
		Thalweg ≤ 1.0 m/s and u_{crit}	Bank area 1 ≤ 0.5 m/s and u_{crit}	Bank area 2 ≤ 0.5 m/s and u_{crit}	Thalweg	Bank area 1	Bank area 2
5	0.76	0.49	0.21	-	1.65	1.16	-
6.6	0.86	0.54	0.26	-	1.71	1.29	-
12.5	1.19	0.70	0.39	0.16	1.87	1.52	1.01
16	1.31	0.75	0.45	0.23	1.92	1.60	1.22
20	1.43	0.80	0.50	0.30	1.96	1.67	1.37

Calculating and verifying the final flow conditions for quasi-uniform flow

The river's water levels, in combination with the channel's outlet bed elevation, establish the downstream boundary conditions of the channel, which are the water depths at channel's outlet. The Belanger equation uses these downstream water depths to determine the backwater curves and consequently the flow depths in the channel. The flow depths are used to determine the bed friction and critical flow velocities using the White-Colebrook and Shields equation, respectively. These equations are described in Appendix E and outlined below:

Belanger equation:
$$\frac{dd}{ds} = \frac{i_b - i_f}{1 - F_r^2} \quad ; \quad i_f = \frac{c_f \cdot Q_{eco}^2 \cdot P}{g \cdot A^3} \quad ; \quad F_r^2 = \frac{Q_{eco}^2 \cdot B_c}{g \cdot A^3}$$

White-Colebrook equation:
$$\frac{1}{\sqrt{c_f}} = 5.75 \cdot \log \left(\frac{12 \cdot R}{k_s} \right)$$

Shields equation:
$$\overline{u}_c = \frac{\sqrt{\frac{g}{c_f}} \cdot \sqrt{d_{n50} \cdot \Delta \cdot \Psi_c \cdot K_s}}{K_v}$$

Setting up the boundary conditions

The river's water levels and the corresponding downstream water depths for the outlet bed elevation of NAP+7.21 m are shown in Table 17. Using the flow distribution of the weir complex, as shown in Appendix H, the channel's inflow rates for each of these downstream water depths are also shown in Table 17 as these influence the backwater curves. The river's water levels are considered up to a discharge of 1600 m³/s, as from this point on flooding of the floodplains occurs, and the entire weir complex, including the ecological channel, becomes non-operational.

Table 17: The channel's inflow rates and downstream water depths (downstream boundary conditions)

River's discharge Q_{river} [m ³ /s]	Water levels upstream of the channel	Water levels downstream of the channel	Channel's inflow rate Q_{eco} [m ³ /s]	Downstream water depth (d_{BC}) [m]
< 50	NAP+10.85m	NAP+7.76m	5 – 6.6	0.55 m
125	NAP+10.87m	NAP+7.82m	12.5	0.61 m
250	NAP+10.86m	NAP+8.0m	16	0.79 m
500	NAP+10.82m	NAP+8.62m	20	1.41 m
1000	NAP+10.85m	NAP+10.27m	20	3.06 m
1250	NAP+11.57m	NAP+11.08m	20	3.87 m
1627	NAP+12.44m	NAP+12.16m	20	4.95 m

Calculating the backwater curves

The backwater curves are calculated for each downstream boundary condition and inflow rate shown in Table 17. The backwater curve equation is a non-linear differential equation that is solved using Euler’s Method (Schoups, 2023). This method approximates the actual backwater curves by first defining the channel’s initial condition (the downstream water depth) and dividing the channel into small intervals (Δs).

With the known water depth (d_{BC}) at the initial interval (s_0), the derivative of the function representing the water depth (the backwater curve $\frac{dd}{ds}$) is determined. By multiplying the derivative with the interval size (Δs), the change in the water depth (Δd) over this interval is estimated. Adding this estimated change to the initial water depth provides the approximate water depth ($d_{.1}$) at the next interval ($s_{.1}$). The next interval is upstream of the downstream water depth, hence the negative interval value.

$$d_{-1} = d_{BC} + \left(\frac{dd}{ds}\right)_{BC} \cdot \Delta s$$

The water depth ($d_{.1}$) at $s_{.1}$ becomes the known value for the new interval, and its derivate is used to estimate the water depth at the next interval ($s_{.2}$). This process is repeated for the entire channel length until the last interval (s_n).

$$d_n = d_{n-1} + \left(\frac{dd}{ds}\right)_{n-1} \cdot \Delta s$$

The intervals start at the channel’s outlet and extend to just downstream of the channel’s intake structure, as the intake structure itself is determined in the following section. The calculation is performed using Python, which results in six separate calculations since six river discharges are considered. The Python code is provided once in Appendix I.1. The appendix also shows the calculated values and backwater curves for each boundary condition.

The figures in Appendix I.1 show that for river discharges up to 500 m³/s, the upstream water depths roughly align with the uniform flow depth, which reinforces the reasoning for first analysing the channel dimensions for uniform flow. For discharges starting from 1000 m³/s, the water depths lie significantly higher than these equilibrium flow depths. The backwater curves for both these inflow rates are shown in Figure 28.

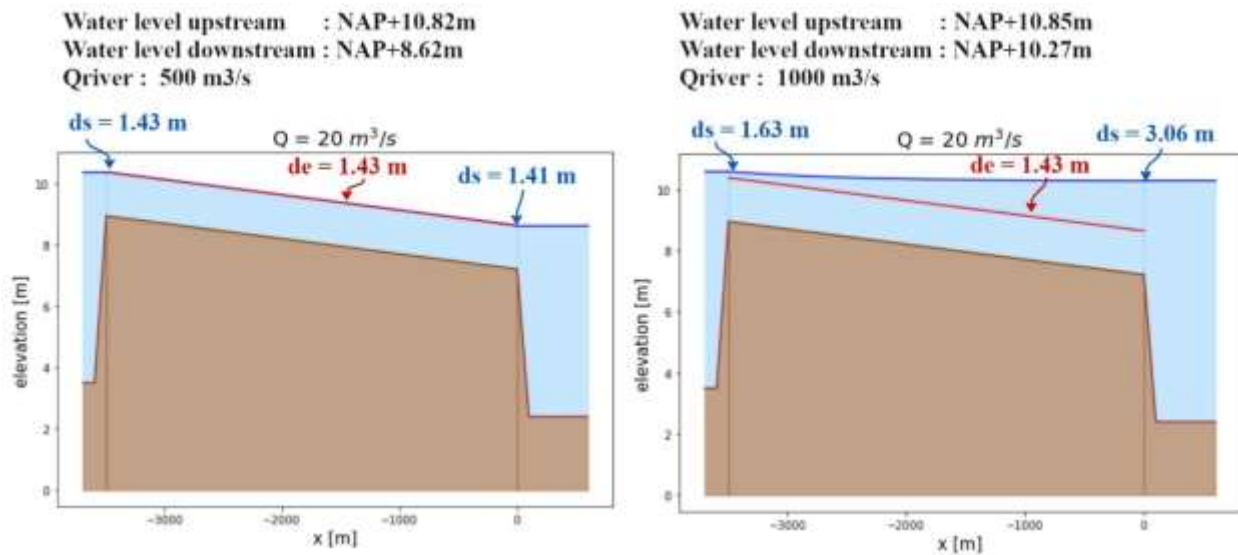

Figure 28: Backwater curve for $Q_{eco} = 500 \text{ m}^3/\text{s}$ [left] and $Q_{eco} = 1000 \text{ m}^3/\text{s}$ [right]

The water depth for the river discharges starting from 1000 m³/s exceeds the total depth of the channel. However, there is still an area between the channel and the floodplains. The depth of this area naturally depends on the channel's elevation and the elevation of the surrounding floodplains, which is assumed to have an average elevation of NAP+12 m. This area is referred to as the 'bank area extra'. This area is shown in Figure 29 for the channel's outlet, middle, and inlet.

Calculating the flow conditions in the thalweg and bank areas

The backwater curves give an indication of the overall flow conditions. The flow conditions in thalweg and the bank areas are calculated to determine whether these satisfied the flow conditions. These flow conditions are determined by considering each section (thalweg, bank area 1, and bank area 2) separately and calculating the cross-sectional dimensions, flow rate, flow velocity, and friction coefficients in each section. This calculation is done in Python, the code is provided in Appendix I.2.

Calculating the flow velocities per section

To determine the flow velocities of each section, the flow rate (Q) through each section must be known. The flow rate depends on the flow velocity itself, water depth, and the friction slope (S_f). The friction slope is also unknown and also depends on the flow conditions. Therefore, for an estimation the friction slope of each section assumed equal to the bed slope of that section, which is the situation for uniform flow.

This is a reasonable estimation for river discharges below 1000 m³/s, as the flow conditions on the upstream side of the channel are almost identical to those for uniform flow. The water depths on the downstream side of the channel lie lower than for uniform flow (M2- backwater curve), resulting in higher flow velocities. See the backwater curves in Appendix I.1. Therefore, the calculated flow velocities at the channel's outlet are in reality higher. However, since the water levels are not much higher than uniform flow, the estimation is still reasonable, given that the calculated flow velocities lie well below the required flow conditions. With this assumption, the flow rate, flow velocity, and the remaining parameters per section are determined.

Verification of the flow conditions per section

The flow conditions in the channel's thalweg and bank areas at the channel's outlet, the middle of the channel, and just downstream of the channel's inlet are individually shown in Appendix I.2. The figures show that for river discharges up to 500 m³/s, the flow conditions in both the thalweg and bank areas are met. However, for river discharges starting from 1000 m³/s, the flow conditions are not met in either the thalweg or bank areas, as the flow depths and flow velocities are too high. The flow conditions for both these inflow rates are shown in Figure 29. A summary of all the flow conditions in the thalweg and bank areas for the channel's outlet, middle, and outlet are shown in Table 40 of Appendix I.3. The table also shows the flow conditions that do not satisfy the flow requirements, these are highlighted.

The bed of the extra bank area consists of the existing floodplain bed material. Considering Figure 23, the extra bank area section of the channel partly lies in the bed layer consisting of medium-coarse sand to coarse sand with gravel, while the remaining part lies in the bed layer consisting of silty to sandy clay. The bed material is not reinforced, and sediment transport is not examined, as this area's purpose is to accommodate higher inflow rates and not create lotic habitats, similar to the surrounding floodplains.

4. Functional-spatial design

Flow conditions met

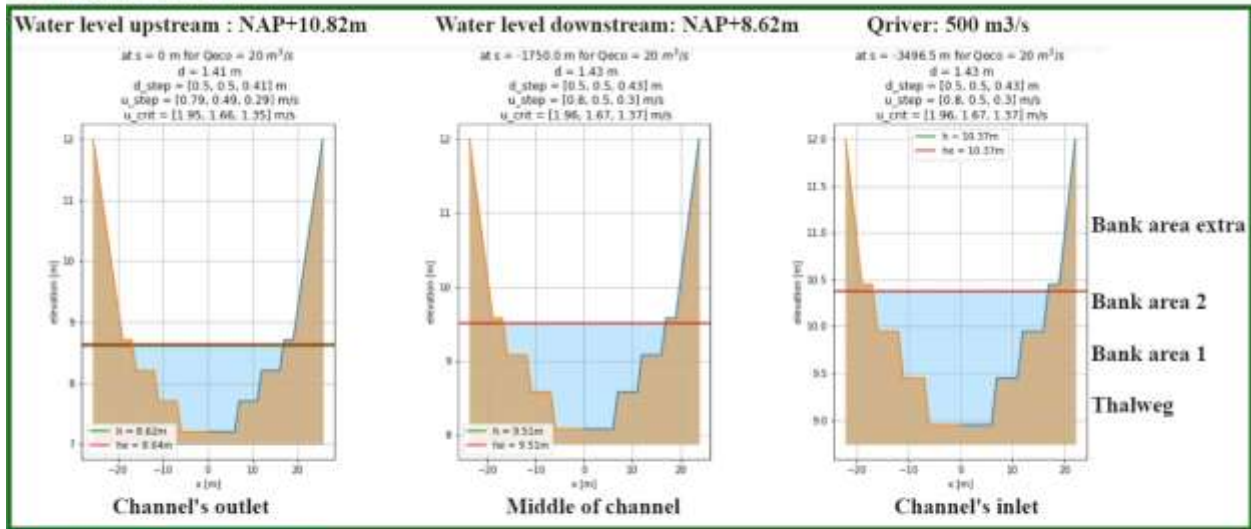

Flow conditions not met

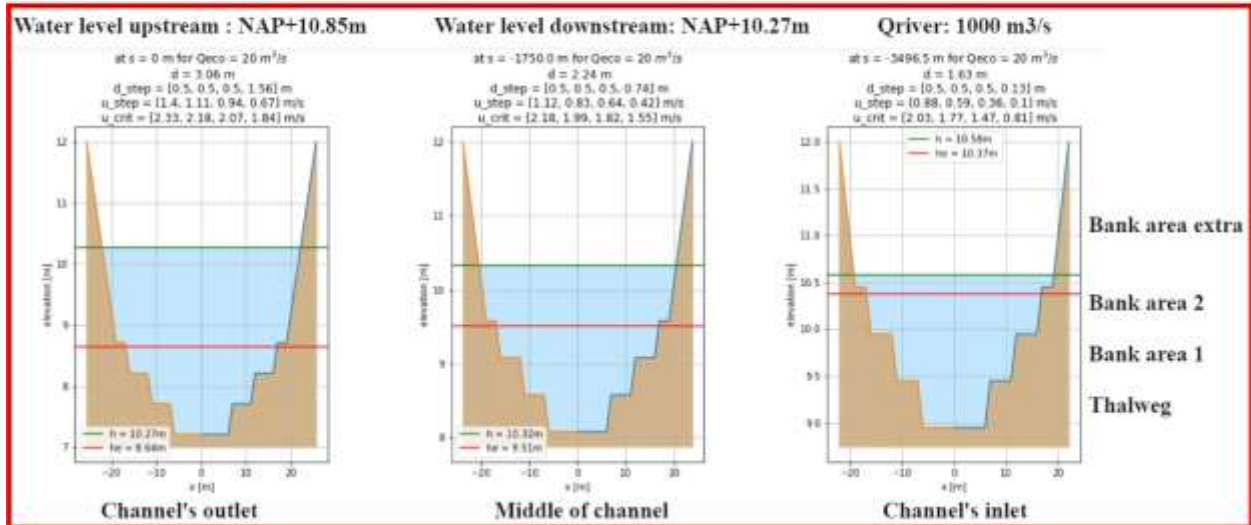

Figure 29: The flow conditions in the channel's thalweg and bank areas for $Q_{eco} = 500$ m³/s and $Q_{eco} = 1000$ m³/s

Concluding remarks

The channel must primarily function during the critical reproductive months of the target river species. During this period, river discharges range between 25 and 250 m³/s (not including extreme peaks) (see Section 3.3). The channel's flow conditions are suitable for this discharge range, as they are suitable up to a discharge of 500 m³/s. It is important to note that the channel can effectively function for higher river discharges. However, as the river's water levels for discharges between 500 m³ and 1000 m³/s are unknown, it is conservatively assumed to effectively function up to a river discharge of 500 m³/s, which is exceeded approximately 13% of the year (see Table 11). Therefore, with the current channel parameters, the channel effectively functions approximately 87 % of the year, by meeting the required flow conditions for habitat formation described in Subsection 3.1.5.

4.1.8 Step 8: Developing the final ecological channel design

This subsection develops a visual overview of the channel's final conceptual design. It outlines the channel's outlet design, the required bed and bank protection, and the design of the transition zones from the channel's bed to the riverbed, and vice-versa.

Design of the channel's outlet structure

As stated in Subsection 3.1.5, the outflow from the ecological channel must not create cross-currents that hinder the navigability of the river. According to the waterway guidelines, for weir complex Sambeek, the cross-currents must be limited to 0.3 m/s (Rijkswaterstaat, 2020). This limit is exceeded for all inflow rates of the ecological channel (see Appendix I). Therefore, the channel's outlet is realigned to have an outflow parallel to the river's flow, preventing unwanted cross-currents. This adjustment also enhances the fish findability of the channel's outlet, as the report by (Ghodrati, 2021) indicates that a luring current parallel to the river's main flow has a better attraction than a luring current at an angle.

Therefore, realigning the channel's outflow to be parallel with the river's flow is achieved by implementing a flow guide structure. The structure is similar to a longitudinal dam (in Dutch: 'langsdam'). Figure 30 gives an impression of this structure. The structure's dimensions are typically determined during the structural design phase. Additionally, the required distance of the structure from the riverbank to realign the channel's outflow is best determined using a hydraulic model, as it can include flow interactions effects. However, both the structural design phase and constructing a hydraulic model lie beyond the scope of this report. Therefore, the dimensions of this structure and its distance from the riverbank are not determined. It is assumed that the required distance does not significantly reduce the river's flow width, thereby posing no issue for shipping.



Figure 30: The figure on the left gives an impression of the flow guiding structure at the channel's outlet (it is not drawn to scale). The figure on the right shows a longitudinal dam on which the flow guiding structure is based (Siebe Swart, 2020)

The bed and bank protection for the entire channel

Similar to the Afferden by-pass channel, lateral erosion of the channel can cause unwanted meandering or shifting of the channel, leading to erosion of critical areas. The report (DLG, 2007) describing the Afferden by-pass channel recommends establishing intervention lines to control the meandering within acceptable limits. The report states that the Afferden by-pass channel will experience minor shifting (decimetres per year). However, the ecological channel is designed for higher inflow rates, which could result in larger movement rates. Therefore, a morphological study is required to assess the channel's shifting rate and develop strategies, such as intervention lines, to limit excess shifting.

Establishing conducting a morphological study lies beyond the scope of this report. Hence, the bed and banks of the ecological channel remain natural for now, as it is calculated that the considered bed materials

4. Functional-spatial design

will not lead to excessive erosion. Sedimentation is also expected to not pose a problem, as the intake structure restricts the influx of non-suspended sediment (bed load). The bed protection for the intake structure is determined in following section.

Design of the transition from the channel's bed to the riverbed and vice-versa

The recommended transition from the waterway to fish passage's inlet, and from the fish passage's outlet to the waterway, is a gradual slope with a maximum slope 1:2, consisting of stones to enhance its findability for bottom-dwelling fish species (Ghodrati, 2021). This recommendation is applied to the ecological channel to enhance its findability. The recommended transition is shown in Figure 31.

The bed level difference between the channel's inlet and the river bed elevation is 5.45 m ($\text{NAP}+8.95 - \text{NAP}+3.5\text{m} = 5.45\text{ m}$), and the bed level difference between the channel's outlet and the river bed elevation is 4.81 m ($\text{NAP}+7.21\text{m} - \text{NAP}+2.4\text{m} = 4.81\text{m}$). Therefore, the minimum lengths of these transition zones are approximately 11 m and 10 m, respectively.

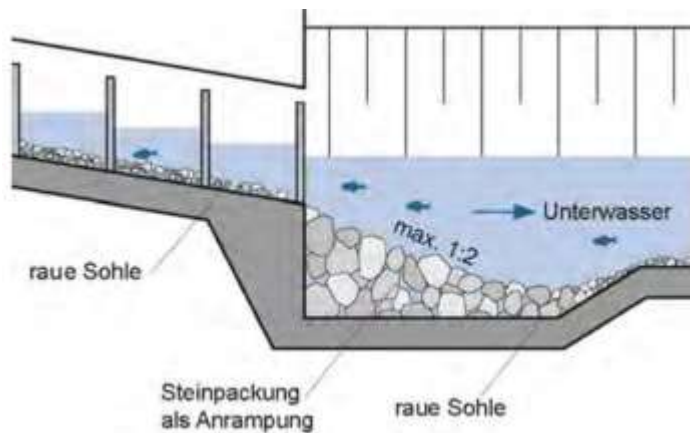

Figure 31: Gradual transition with a maximum slope of 1:2 from the fish passage's outlet to the riverbed (Ghodrati, 2021)

Final design of the ecological channel

The channel's cross-section is shown in Figure 32, and the top view of the channel's final conceptual design at weir complex Sambeek is given in Figure 33. In reality, the channel has a more natural shape, however due to limitations of the drawing program, an unnatural curved shaped is used.

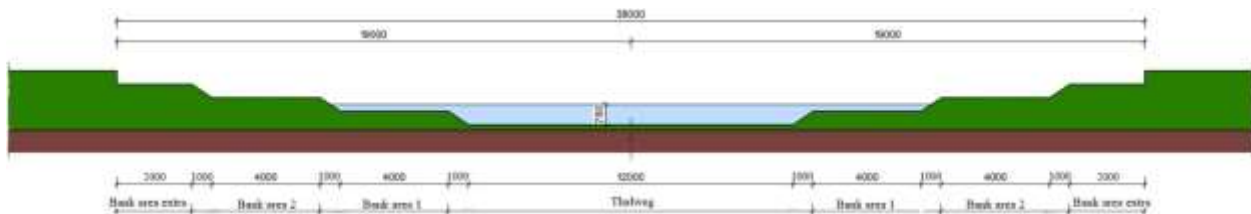

Figure 32: Cross-section of the ecological channel

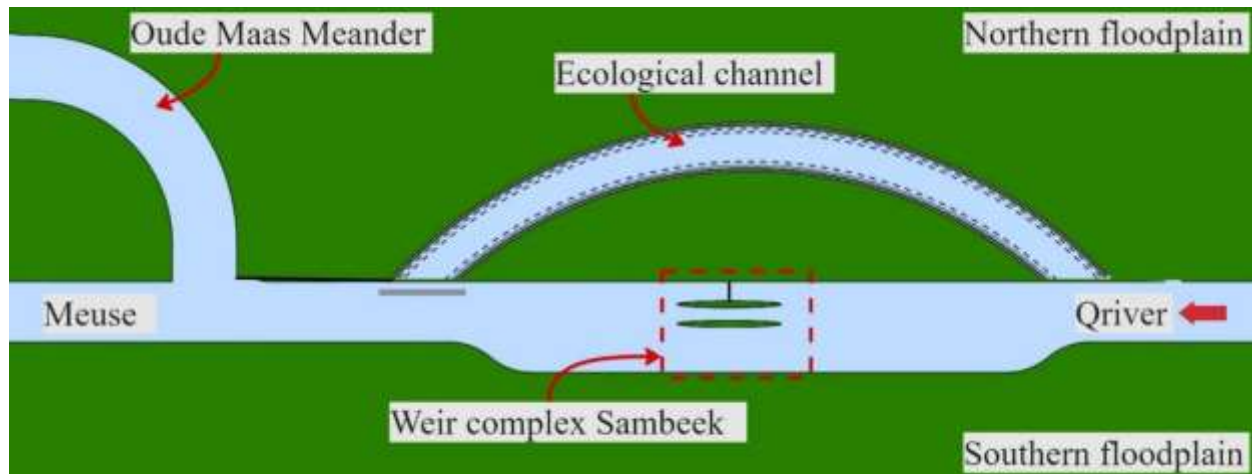

Figure 33: Top view of ecological channel at weir complex Sambeek. Upstream of the channel the river has an estimated average width of 140 meters (Heer, 2020).

4.2 Design of the fish passable intake structure

4.2.1 Approach for the design of the intake structure

This section focuses on designing the intake structure that enables the required inflow rates, as determined in Subsection 4.1.6, while also accommodating upstream and downstream fish movement according to the requirements of Subsection 3.1.4. The following steps are followed to achieve this design:

Step 1: Listing design alternatives for a fish passable intake structure

This step determines potential design alternatives for the fish passable intake structure that accommodates both the inflow rates and fish movement. This can be achieved either by the design of the intake structure itself or by incorporating a fish passage.

Step 2: Evaluating suitable intake structure and fish passage types

In this step, various intake structure and fish passage types are evaluated to identify the most suitable ones for the previously determined design alternatives. This ensures that only structures appropriate for the situation are included in the design process.

Step 3: Developing and verifying the design alternatives for the fish passable intake structure

Using the suitable intake structure and fish passage types, the design alternatives are developed and verified.

Step 4: Developing the final fish passable intake structure design

This step selects the most optimal design alternative and provides a visual overview of the final conceptual design for the fish passable intake structure.

4.2.2 Step 1: Listing design alternatives for a fish passable intake structure

The intake structure must accommodate the required inflow rates and accommodate upstream and downstream fish movement. This can be achieved either by the design of the intake structure itself or by incorporating a fish passage, both of which must meet the fish migration requirements described in Subsection 3.1.4. Therefore, two design alternative are developed for the intake structure. The boundary conditions for which the intake structure is designed is provided below.

Inventorizing the boundary conditions

The intake structure must accommodate the inflow rate range of 5 – 20 m³/s. The water level’s just upstream of the intake structure (river’s water levels) and the water levels just downstream of the intake structure (determined in Subsection 4.1.7) are shown in Table 18. These two values are both measured from the channel’s bed elevation of NAP+8.95m, and determine the water level difference over the intake structure, which is a critical parameter for its design, as it influences its inflow rate, flow velocity, and water depth. Table 18 gives an overview of these parameters.

The ecological channel is effectively functional up to, but not including, the river discharge 1000 m³/s. Therefore, the intake structure must effectively be functional up to the same river discharge. This indicates that the fish passable intake structure must satisfy the target and required flow conditions for fish movement (see Table 8) until this point. The inflow rate must still be limited even if the ecological channel does not function properly. Hence, the intake structure is designed until a river discharge of 1600 m³/s, as higher river discharges result in inundated floodplains making the entire weir complex, including the ecological channel, non-operational.

Table 18: Overview of the intake structure’s boundary conditions. Δh is the water level difference over the intake structure

River’s discharge Q_{river} [m ³ /s]	River’s water levels h_{inlet}	River’s water depth d_{inlet} [m]	Channel’s inflow rate Q_{eco} [m ³ /s]	Channel’s water levels h_s	Channel’s water depth d_s [m]	Δh [m]
25	NAP+10.85 m	1.90	5	NAP+9.71 m	0.76	1.14
<50	NAP+10.85 m	1.90	6.6	NAP+9.81 m	0.86	1.04
125	NAP+10.87 m	1.92	12.5	NAP+10.14 m	1.19	0.73
250	NAP+10.86 m	1.91	16	NAP+10.26 m	1.31	0.60
500	NAP+10.82 m	1.87	20	NAP+10.37 m	1.43	0.45
1000	NAP+10.85 m	1.90	20	NAP+10.58 m	1.63	0.27
1250	NAP+11.57 m	2.62	20	NAP+11.15 m	2.20	0.42
1627	NAP+12.44 m	3.49	20	NAP+12.18	3.23	0.26

Design alternative 1: Intake structure with a separate fish passage

The first alternative has an intake structure with a separate fish passage. The intake structure focusses on accommodating the inflow rates, while the fish passage allows fish to navigate the intake structure. The fish passage can completely by-pass the intake structure (typically semi-natural fish passages) or can be incorporated into the intake structure itself (typically technical fish passages). An intake structure with a separate fish passage is visualized in Figure 34.

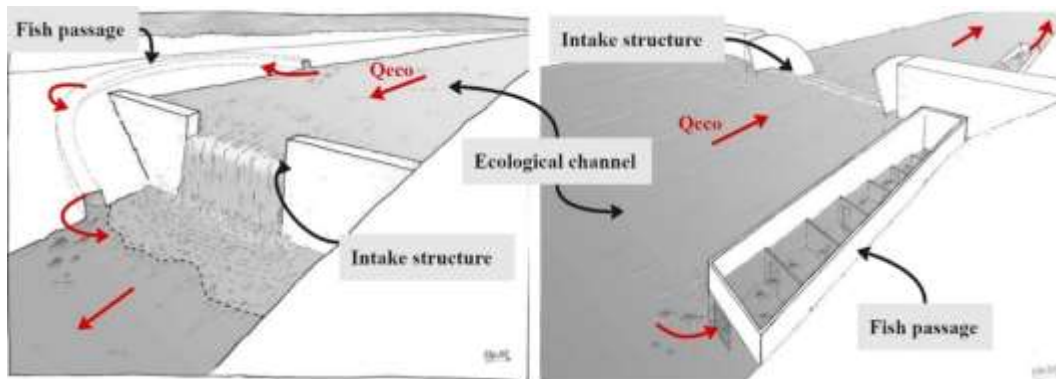

Figure 34: Visual representation of an intake structure with a separate fish passage (Coenen, Antheunisse, Beekman, & Beers)

Design Alternative 2: Intake structure without a separate fish passage

The second alternative involves designing the intake structure itself to accommodate the inflow rates and fish movement, eliminating the need for a separate fish passage. However, this cannot be achieved with a standard intake structure, as it must accommodate a range of inflow rates, while limiting the flow velocities and achieving sufficient water depths, which are contradictory needs.

Therefore, for this design alternative, the intake structure consists of consecutive weirs and pools that divide the total water level difference into smaller navigable steps for the fish. The most upstream weir regulates the channel's inflow rate. This is comparable with the pool-and-weir fish passage design. A visual representation of this intake structure is visualized in Figure 35.

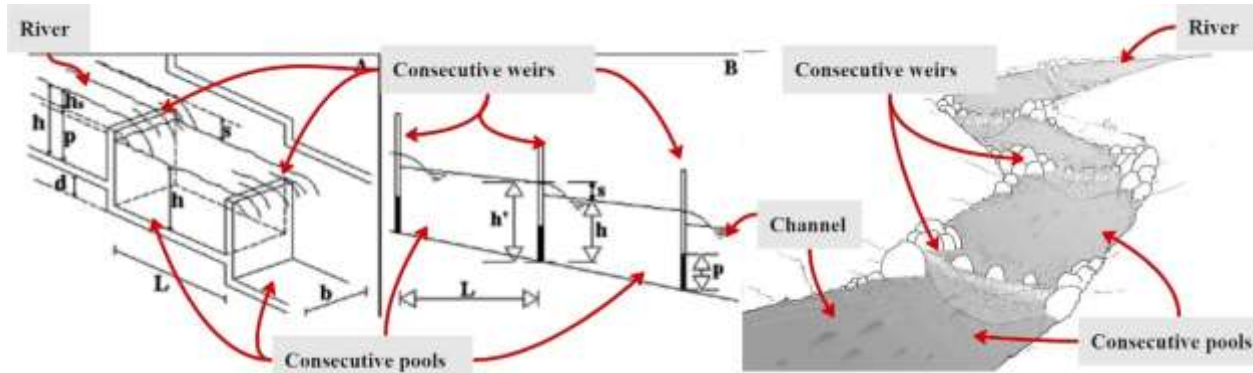

Figure 35: Visual representation of the first design alternative (Vincenzo & Caricato, 2006) [left] (Coenen, Antheunisse, Beekman, & Beers) [right]

4.2.3 Step 2: Evaluating suitable intake structure and fish passage types

There are various types of intake structures and fish passages, each with certain advantages and disadvantages. This subsection identifies the most suitable types by evaluating them based specific criteria. The intake structures are compared with each other, while the fish passages are evaluated with a multi-criteria analysis (MCA), which quantitatively assesses their effectiveness.

Type of intake structures

The intake structure is a discharge-regulating structure that must regulate and maintain various inflow rates for different river discharges. The intake structure must be adjustable to accommodate these varying inflow rates. Since these adjustments are continuously required, the considered intake structures are automated gated structures with accurate flow regulation. Gated structures can either have overflow, underflow, or a flow that directly passes through the flow opening. This direct flow occurs for gates with horizontal opening mechanisms, such as horizontal rotating tainter gates, horizontal sliding gates, and mitre gates. These gates are not considered since they offer less control over the inflow rate compared to overflow and underflow gates. The considered gate types are shown in Figure 36. For a detailed description of each gate type, see the report (Novak, Moffat, Nalluri, & Narayanan, 2007) and (Erbisti, 2014). Each option is briefly discussed below to determine which gate types are suitable for the design alternatives.

Narrowing down the number of potential gate types

Vertical lift gate

The vertical lift gate is a relatively simple and inexpensive structure that operates with an underflow (Ankum P. , 2002). It is operated by lifting or lowering the gate using a slide or wheeled support. This gate is typically used for by-pass channels by operating with an underflow. A disadvantage of these supports is that they can jam during operation due to floating debris (Lewin, 2001), which can reduce its reliability.

4. Functional-spatial design

However, typically the gate can be fully lifted out the waterway, making maintenance and repairs easier compared to submerged gates.

Radial gate

The radial gate (or vertical rotating tainter gate) operates similarly, with the main difference being that it is lifted or lowered by rotating around a pivot point, rather than being lifted or lowered vertically. Radial gates are easier to automate, despite generally having a more complex design (Novak, Moffat, Nalluri, & Narayanan, 2007). A more complex design usually leads to higher construction costs.

Flap gate

Flap gates are known for their fine regulation and are generally more cost-effective and environmentally friendly compared to the other gate types (Novak, Moffat, Nalluri, & Narayanan, 2007). They can operate independently or in combination with other gate types, such as vertical lift gates. Flap gates can operate with either overflow or underflow. Depending on the type of flow, the moving mechanism of a flap gate can either be submerged or lie above the water surface (Erbisti, 2014).

Inflatable gate

Inflatable gates (or rubber gates) have no lifting mechanism, instead their desired crest heights are achieved by being filled with both water and air. These gates are generally low in cost and require little maintenance. However, they can be easily damaged and typically have a shorter lifespan compared to other gate types (Novak, Moffat, Nalluri, & Narayanan, 2007).

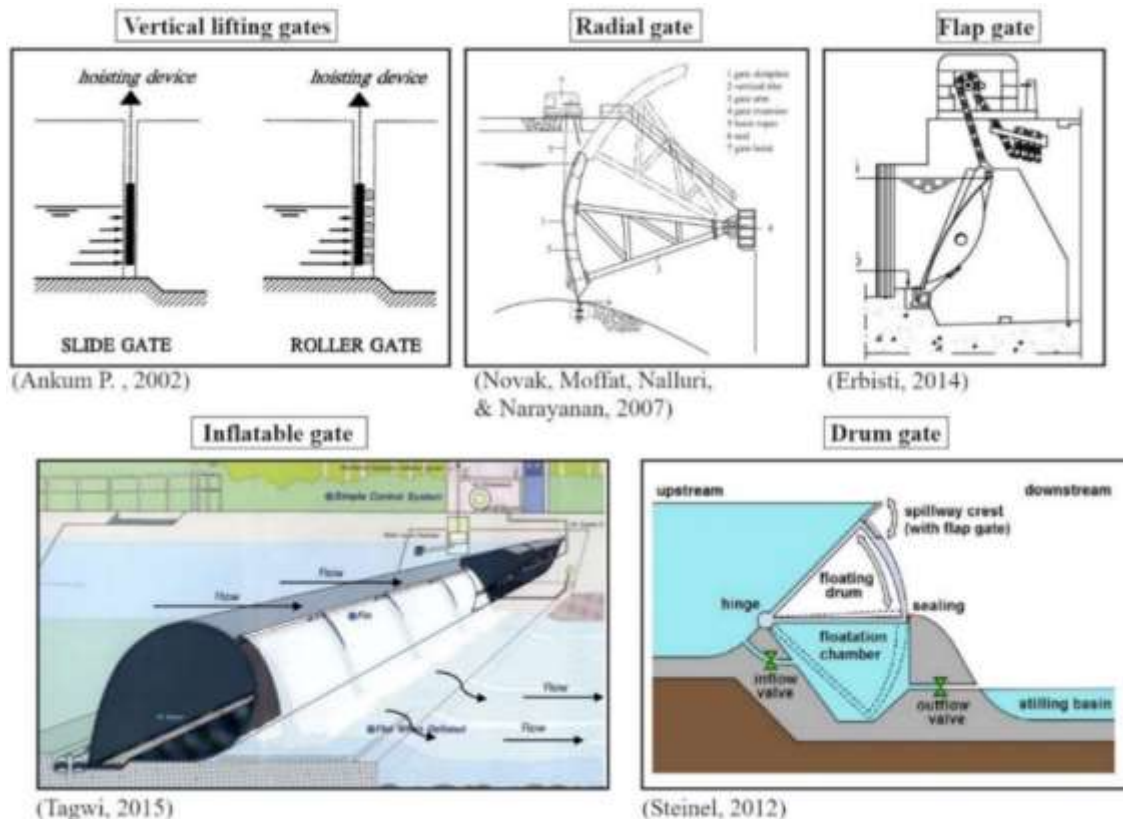

Figure 36: Overview of the considered gate options

The selected types of gated intake structures

Considering the cost-effectiveness of each gate, the gate options are narrowed down to a vertical lift gate, flap gate, and inflatable gate. However, due to the lower durability of the inflatable gate compared to the other two options, the selection is further narrowed down to the vertical lift gate and flap gate. For the ecological channel fine regulation is preferable to achieve the inflow rates shown in Appendix H. This fine regulation is achievable with overflow rather than underflow (Erbisti, 2014). Therefore, the flap gate is the optimal choice, as it is also known for its fine regulation.

Type of fish passages

Fish passage designs can be categorized as natural, semi-natural, or technical. A natural passage functions as a by-pass channel that mimics natural river dynamics with minimal artificial components. This passage requires a significant amount of space to achieve suitable flow conditions for fish movement (Coenen, Antheunisse, Beekman, & Beers). Therefore, it is not considered a suitable fish passage type.

A semi-natural passage uses some artificial components, such as sills, baffles, etc., to help fish overcome the water level difference by dividing it into smaller manageable steps that the fish can navigate. A technical passage operates similarly, with the main difference being that it entirely consists of artificial components.

The considered fish passages for both passage types are shown in Figure 37. More recently designed fish passages, such as the Schutte fish passage, De-Wit fish passage, are not considered due to limited literature and experience with their design. For a detailed description of all the fish passages, see the report (Coenen, Antheunisse, Beekman, & Beers). Each option is briefly discussed below to determine which fish passages are suitable for the design alternatives.

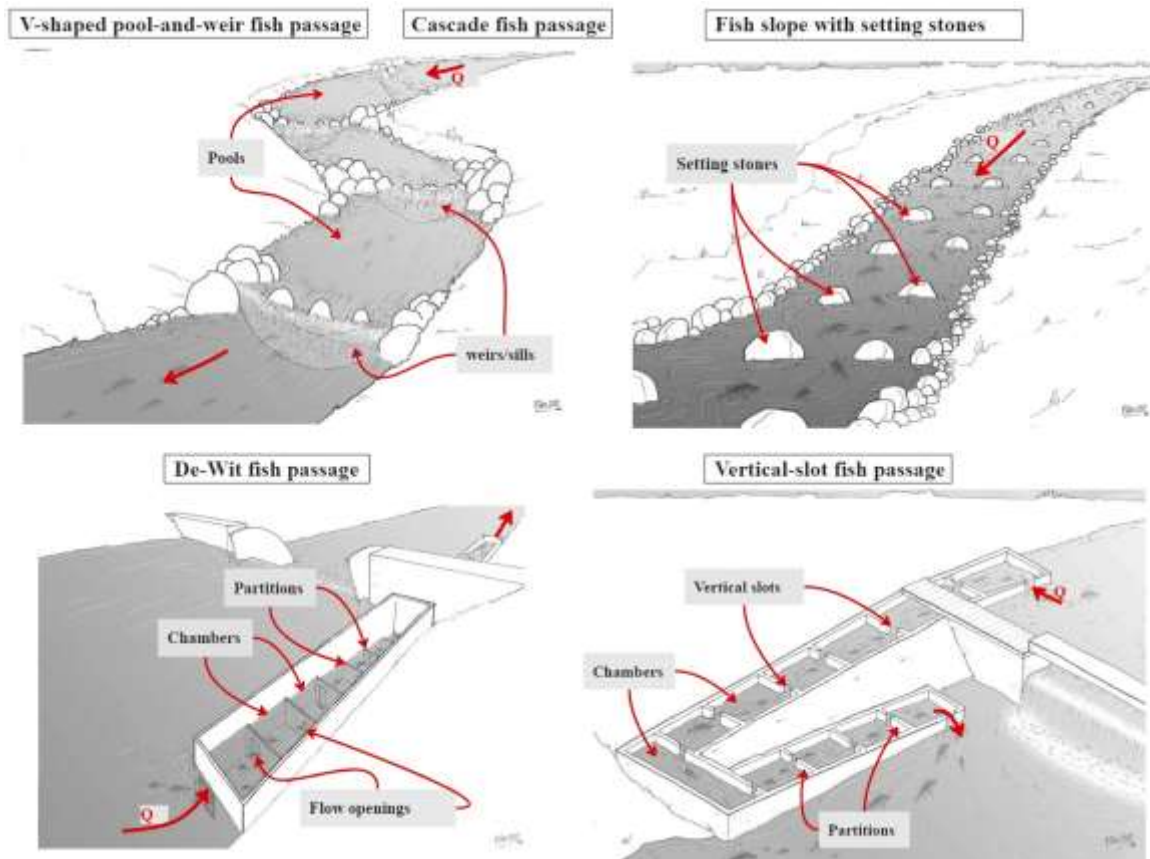

Figure 37: Overview of the considered fish passage type options (Coenen, Antheunisse, Beekman, & Beers)

Narrowing down the number of potential fish passage types

Semi-natural V-shaped pool-and-weir fish passage

A pool-and-weir passage consists of a series of weirs and pools that divide the total water level difference into smaller more navigable steps for the fish. These weirs can have various flow opening shapes, which are selected based on factors such as the present hydraulic conditions, available space, and design preferences. This passage type uses weirs with V-shaped flow openings that are constructed from wood covered with natural rocks. This shape is selected, as it provides better upstream swimming conditions compared to flat weirs. The passage also contributes to habitat formation, which gives added value to the surrounding environment. However, this fish passage type requires significant maintenance and monitoring to maintain its functionality. It is also susceptible to varying water levels, and its flow conditions are sensitive to its execution, as incorrect placement of components can lead to significant deviations from the calculated flow conditions, reducing the channel's efficiency (Coenen, Antheunisse, Beekman, & Beers). Figure 37 gives an impression of this fish passage.

Semi-natural cascade fish passage

This fish passage operates similarly to the V-shaped pool-and-weir passage, with the difference being that the sills are entirely constructed from stones and its roughly rectangular flow opening shape. Additionally, the sill can have multiple flow openings (Kroes & Monden). The remainder of this passage is similar to the V-shaped pool-and-weir fish passage. Figure 37 gives an impression of this fish passage.

Semi-natural fish slope with setting stones fish passage

This fish passage uses strategically placed boulders to assist fish in navigating the water level difference between the upstream and downstream sides of the weirs. These boulders disrupt the flow, creating calmer flow areas behind them. Fish can use these calmer areas as resting zones before navigating between the boulders. The boulders are placed alternately to prevent the flow from short-circuiting, which could lead to high flow velocities that might hinder fish movement. This passage is functional for natural water level variations and is a relatively inexpensive fish passage. However, according to the report (Coenen, Antheunisse, Beekman, & Beers), this passage is more suitable for stronger swimmers and bottom dwelling fish species, which reduces its suitability for smaller weaker swimmers. Figure 37 gives an impression of fish slope with setting stones fish passage.

Vertical-slot fish passage

The vertical-slot fish passage consists of a tank with multiple consecutive partitions, which divide the tank into several pools. Vertical slots in these partitions act as flow openings, extending from the bottom to the water surface (see Figure 37). This design allows fish to move throughout the entire water column, accommodating their preferred depth. The fish passage has an inclined bedding to ensure a stepless passage bed. By alternating the flow openings, a meandering flow pattern is created, which helps increase the energy dissipation and reduce the flow velocity, enhancing its suitability for smaller and weaker fish. Typically, the top of the fish passage is at ground level and is covered with a removable metal mesh, allowing for easy access and maintenance. The fish passage is resistant to water level variation and can maintain desired water levels. However, it does not contribute to habitat formation and has no added value to the surrounding environment (Coenen, Antheunisse, Beekman, & Beers).

De-Wit fish passage

This fish passage is derived from the vertical-slot fish passage, resulting in a similar operation. Like the vertical-slot fish passage, it consists of a tank with multiple consecutive partitions that divide it into several pools. However, unlike the vertical-slot passage, the flow openings in the partitions remain fully submerged rather than extending to the water surface (see Figure 37), allowing fish movement only at this depth. The

4. Functional-spatial design

remainder of the passage is similar to the vertical-slot fish passage, with the difference being that its construction and maintenance are more affordable (Coenen, Antheunisse, Beekman, & Beers)

Evaluating the fish passage types

The fish passages are evaluated using a multi-criteria analysis (MCA) to determine the optimal one. This approach allows for qualitative consideration of the passage types. The MCA evaluates their efficiency in accommodating fish passage, their ability to accommodate a range of fish species, and their maintainability. These criteria directly indicate the fish passage's ability to safely and effectively accommodate all the present fish species. The criteria are elaborated in Section 3.2. The impact of each criteria is determined by a weight factor.

The efficiency and accommodation range are the most critical criteria, as they are the primary purposes of the fish passage. The maintainability is also crucial, as inadequate upkeep can reduce the fish passage's efficiency and functionality. The weight factor for each criterion is shown in Table 19, ranging from 1 to 5. A higher weight indicates a higher the score. The fish passage with the highest score is considered the most optimal.

Table 19: Weight factors for the evaluation criteria of the fish passages

Evaluation criteria	Weight factor
Efficiency in accommodating fish passage	5
Ability to accommodate range of fish species	5
Maintainability	4

Selected fish passage types

The fish passages are scored for each criterion. The most suitable fish passages are the technical fish passages due to their higher efficiency and maintainability. The vertical-slot fish passage received the highest score and is selected as the most optimal fish passage for the design alternatives.

Table 20: MCA for the considered fish passages

	V-shaped pool-and-weir passage	Cascade passage	Fish slope with setting stones passage	Vertical-slot passage	De-Wit passage
Efficiency for accommodating fish passage	2	2	3	4	4
Ability to accommodate range of fish species	4	2	2	5	4
Maintainability	2	2	3	5	5
Total score	8	6	8	14	13

4.2.4 Step 3: Developing and verifying the design alternatives for the fish passable intake structure

In this subsection, designs for each design alternative are developed and verified using the most suitable intake structure types and fish passage types determined in Subsection 4.2.3.

Design alternative 1: Intake structure with a separate fish passage

This design alternative has an intake structure with a separate fish passage. The intake structure focusses on accommodating the inflow rates, while the fish passage allows fish to navigate the intake structure. The most suitable intake structure and fish passage were determined to be a flap gate and vertical-slot fish

passage, respectively (see Subsection 4.2.3). This choice is further supported, as it is similar to the intake structure of the Afferden by-pass channel, which incorporates a flap gate with a De-Wit fish passage (DLG, 2007). The dimensions and operation of both structures are determined below.

Design of the flap gate

The flap gate is fixed with a bottom hinge on top of a concrete sill. The moving mechanism, which pivots the gate around this hinge, is located above the water surface, as shown in Figure 38. This positioning improves the maintainability and ease of repair of the moving mechanism. The gate typically consists of steel and has a thickness ranging between 6.5 – 40 mm (Ryszard & Paulus, 2019). This results in a sharp crest, as the ratio between the water depth over the gate and the gate thickness exceeds 2.0 for the small water depths over the gate (see Figure 41). This value is the minimum ratio for a crest to be classified as sharp (Azimi, Rajaratnam, & Zhu, 2013). A floating beam is added to the flap gate to reduce the amount of floating debris in the ecological channel.

The dimensions of the sill, thickness of the gate, and the details of the moving mechanisms are determined during the structural design of the intake structure, which is not covered in this report. Only the retaining height, width, and the angle of the gate to the channel's bottom are determined in this report. The gates angle with the channel's bed level typically lies between $0^\circ - 70^\circ$ (Erbisti, 2014).

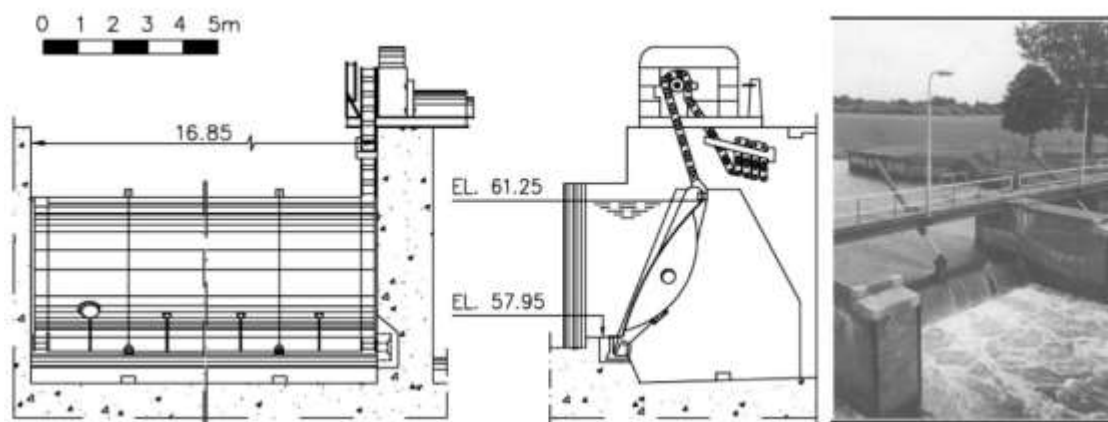

Figure 38: Flap gate fixed with a bottom hinge on top of a sill, with its moving mechanism situated above the water surface (Erbisti, 2014) and (Ryszard & Paulus, 2019)

Determining and verifying the dimensions of the flap gate

The required retaining height and gate angle (flow opening) to achieve the necessary inflow rates for the measured river discharges are determined with the discharge water level relation (Q-h relation) for gated structures.

The gated structure can either have submerged-overflow or free-overflow. The main distinction between these two flow types is their influence on the discharge over the gate. For submerged flow, both the upstream and downstream water levels of the gate influence the discharge, while for free-flow, only the upstream water levels influence it (Voorendt, 2023). In this case, the upstream water depths are the upstream river's water levels relative to the channel bed elevation of NAP+8.95m, and the downstream water levels are assumed to be equal to the channel's water levels determined just downstream of the inlet (d_{inlet}) (see Subsection 4.1.7).

4. Functional-spatial design

The inflow rate for both flow types are described by the weir equations for broad-crested weirs. It is assumed that the equations for sharp-crested weirs are similar, differing only in the discharge coefficients. These equations are based on the energy, mass, and momentum balance principles. Typically, the inflow from the river to the channel experiences energy loss. However, for an initial design, this energy loss is neglected, as it is assumed that it is insignificant compared to the channel's friction loss. The weir equations for both flow types are shown below.

$$Q_{eco} = C_d \cdot B_{gate} \cdot h_3 \cdot \sqrt{2g \cdot (h_1 - h_3)}$$

Where:

Q_{eco} = inflow rate [m³/s]

C_d = discharge coefficient [-]

B_{gate} = flow width of the gate [m]

h_1 = upstream water depth relative to gate crest [m]

h_3 = downstream water depth relative to gate crest [m]

$$Q_{eco} = C_d \cdot B_{gate} \cdot \frac{2}{3} \cdot \sqrt{\frac{2}{3} \cdot g \cdot h_1^{\frac{3}{2}}}$$

Where:

Q_{eco} = inflow rate [m³/s]

C_d = discharge coefficient [-]

B_{gate} = flow width of the gate [m]

h_1 = upstream water depth relative to gate crest [m]

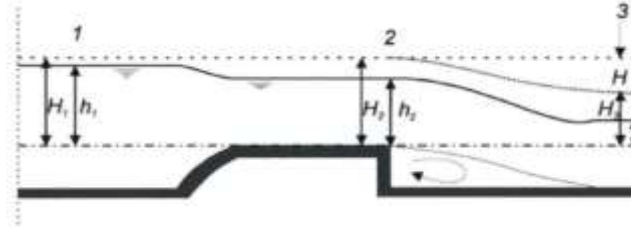

Figure 39: Figure 46: Flow conditions for broad-crested weir with free-flow (Voorendt, 2023)

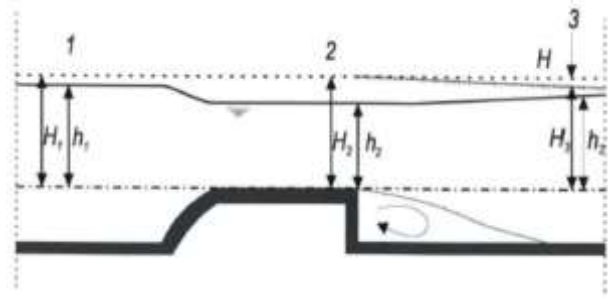

Figure 40: Flow conditions for broad-crested weir with submerged flow (Voorendt, 2023)

The inflow rates that the flap gate must accommodate for the various river discharges is shown in Appendix H. The sharp-crested flap gate operates with free-overflow when the downstream water level is sufficiently low ($h_3 \ll p_{gate}$) and with submerged-overflow for higher downstream water levels.

Using the above-mentioned equations, the retaining height of the gate is determined by iteratively adjusting the gate dimensions until the necessary inflow rates are achieved for the measured water levels. The recommended discharge coefficients for submerged-overflow and free-overflow, 1.1 and 1.0, respectively, are used as initial values. According to the report by (Arvanaghi & Oskeui, 2013), the actual discharge coefficient for rectangular sharp-crested weirs/gates is determined with the following equation:

$$C_d = 0.611 + 0.08 \cdot \frac{d_2}{p_{gate}}$$

Therefore, the discharge coefficients are iteratively calculated until convergence is reached. The calculation to determine the combination of the discharge coefficient and gate dimensions that lead to the required inflow rates is performed in Python and shown in Appendix J. The sharp-crested flap gate operates with free-overflow for $Q_{eco} \leq 6.6$ m³/s and submerged-flow for the higher downstream water levels ($Q_{eco} > 6.6$ m³/s). The resulting width of gate is 10 m and total height is 1.9 m. The retaining height of the gate and the angle it makes with the channel bed to allow the various inflow rates is shown in Figure 41.

4. Functional-spatial design

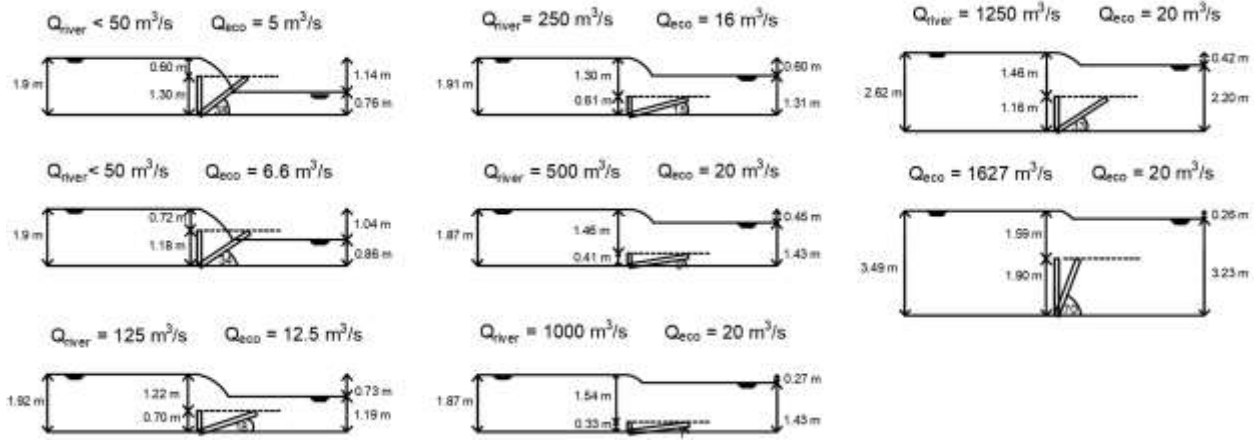

Figure 41: The water levels upstream and downstream of the flap gate and its retaining height

Furthermore, the river's target water levels remain unchanged. The flap gate will likely cause a localized increase in the water levels just upstream of it due its retaining nature. However, the channel's capacity is small compared to the river. Therefore, it is assumed that this increase has an insignificant impact on the river's target water levels, even during high river discharges when the flap gate has a higher submergence level.

Desing of the stilling basin

A stilling basin is added downstream of the flap gate to prevent the formation of scour holes, which can negatively impact the stability of intake structure. To sufficiently dissipate the flow's energy, the report by (Vercrujse, et al., 2021) recommends the following dimensions for the stilling basin:

- The stilling basin must have a depth (d_{basin}) of $\frac{1}{4}$ the water level difference over the structure, with a minimum depth of 0.9 m.
- The stilling basin must have a volume (V_{basin}) of 10 m^3 for every $1 \text{ m}^3/\text{s}$ discharge over the structure.

These stilling basin dimensions also reduces the indirect injuries to the downstream migrating fish moving with the flow over the flap gate. With the maximum water level difference of 1.14 m and maximum inflow rate of $20 \text{ m}^3/\text{s}$, the stilling basin has the following dimensions:

$$d_{basin} = \min\left(\frac{1}{4} \cdot \Delta h_{max}; 0.9 \text{ m}\right) = \min(0.29 \text{ m}; 0.9 \text{ m}) = 0.9 \text{ m}$$

$$V_{basin} = 20 \cdot 10 = 200 \text{ m}^3$$

$$V_{basin} = L_{basin} \cdot B_{basin} \cdot d_{basin}$$

$$L_{basin} \cdot B_{basin} = 222.22 \text{ m}^2$$

The minimum width of the stilling basin is taken to be equal to the flap gate width, which is 10 m. This results in a stilling basin length of 22.22 m, which is rounded up to 25 m.

Design of the Vertical-slot fish passage

The overflow over the flap gate mimics a river's natural flow, which attracts the fish due to their rheotaxis orientation sense. The flap gate forms a barrier for fish movement, which is navigated using the vertical-slot fish passage. By attracting fish towards the gate, they are positioned near the fish passage outlet (downstream entrance). By properly designing the fish passage and its luring current to the conditions of Table 7 and Table 8, the fish can effectively navigate the flap gate.

Fish passage's inlet and outlet

The transition from the channel to the fish passage inlet and from the fish passage outlet to the channel follows the same gradual transition slope for the ecological channel described in Subsection 4.1.8, which improves the findability for bottom-dwelling fish species. With these rock-filled slopes (see Figure 31, it is assumed that the inflow of the fish passage pose no issue to the bed stability of the ecological channel. With the downstream stilling basin, the outflow velocity of the fish passage also pose no issue to the bed stability. In addition, gates are added to both the inlet and outlet to fully close the fish passage for required maintenance and repairs. The fish passage is susceptible to floating debris. Therefore, to reduce the inflow of floating debris, the inlet is positioned perpendicular to the channel's flow and a floating beam is added to it (Coenen, Antheunisse, Beekman, & Beers).

Fish passage's bed material

To achieve suitable bottom flow velocities for bottom-dwelling, smaller, and weaker swimming fish species, the report by (Ghodrati, 2021) recommends adding a 20 cm thick substrate layer to the fish passage bottom (see Table 9). This layer consists of a mixture of limestones with gradings of 100/200mm for base stones and 400/500m for resting stones (Dutch: 'ruststenen'). Figure 42 gives an impression of this substrate layer. With this layer, it is estimated that the bottom flow velocity is a third of the average flow velocity in the fish passage. Therefore, if the flow velocities in the fish passage meet the required flow conditions, it is assumed that the bottom flow velocity described in Table 9 is achieved with this substrate layer. In addition, due to the design of fish passage, erosion and sedimentation within the passage itself poses no issue (Coenen, Antheunisse, Beekman, & Beers), especially with the added substrate layer.



Figure 42: The advised 20 cm thick substrate layer for fish passages (Ghodrati, 2021)[left] and the Meandering flow pattern of the fish passage (Coenen, Antheunisse, Beekman, & Beers)

Determining the dimensions of the fish passage

The fish passage tank and partitions typically made of concrete, which is also the chosen material for this passage. The vertical slots in the partitions are alternately placed to create meandering main flow pattern, as shown in Figure 42. This pattern creates calmer flow areas along the meander, which serves as resting zones for the fish before they navigate the slots.

The report by (Coenen, Antheunisse, Beekman, & Beers) recommends a water level difference 0.05-0.08 m (Δh) over each pool. However, to reduce the overall length of the fish passage, the maximum target value of 0.10 m is selected. With this elevation difference and a maximum water level difference of 1.14 m (for an inflow rate of 5 m³/s), 11.4 drops are required ($\frac{1.14 \text{ m}}{0.10 \text{ m}} = 11.4$). This results in 12 pools, each with a water level difference of 0.095 m ($\frac{1.14 \text{ m}}{12} = 0.095 \text{ m}$). The report (Coenen, Antheunisse, Beekman, & Beers) recommends to add resting pools for every seven pools. Therefore, one resting pools is added after the 7th pool. The resting pool has a length 1.5 times the normal pool, and a width twice the normal pools. The

4. Functional-spatial design

selected fish passage dimension values are the minimum target values with some margin for error. These values are shown in Table 21. With the selected pool length, the fish passage has a total length of roughly $(5m \cdot 12) + 7.5m = 67.5m$. A top view of the fish passage is shown in Figure 43, and its longitudinal profile is shown in Figure 44.

Table 21: The selected dimensions for the vertical-slot fish passage

Fish passage dimension	Symbol	Value
Slot dimensions		
Number of slots		13
Water level difference over pool	Δh	0.095 m
Slot width	B_{slot}	0.75 m
Pool dimensions		
Number of pools		12
Pool length	L_{pool}	5.0 m
Pool width	B_{pool}	2.5 m
Resting pool length	$L_{resting-pool}$	7.5 m
Resting pool width	$B_{resting-pool}$	2.5 m

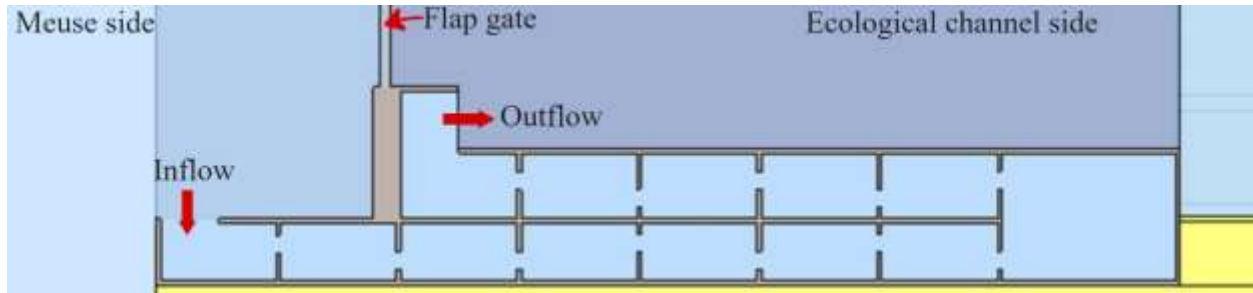

Figure 43: Top view of the vertical-slot fish passage

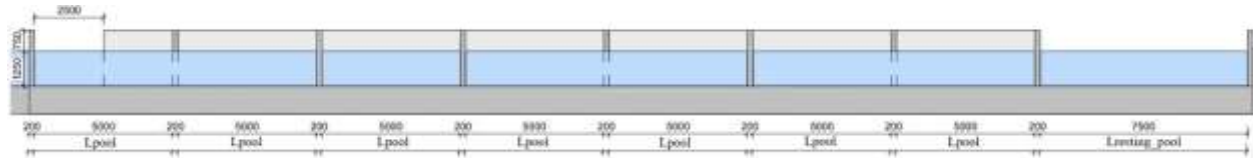

Figure 44: Longitudinal profile of the vertical-slot fish passage

Verifying the flow conditions

The flow conditions are estimated using simplified equations and coefficient recommended in the fish passage handbook. It is assumed that the fish passage pools and slots are identical, leading to similar water level differences over each pool. The flow conditions, such as the fish passage's inflow rate, flow velocity, and energy dissipation are calculated with the equations shown in Table 22.

Table 22: Hydraulic equations to determine the flow conditions in the vertical-slot fish passage (Coenen, Antheunisse, Beekman, & Beers)

Equations	Parameters
$Q_{fish} = C \cdot B_{slot} \cdot y_0 \cdot \sqrt{2 \cdot g \cdot \Delta h_{pool}}$	Q = inflow rate fish passage [m^3/s] u_{avg} = average flow velocity through the slots [m/s] ε = energy dissipation in the pools [W/m^3] C = discharge coefficient [-] b = width of the vertical slot width [m] y_0 = water depth upstream of the vertical slot fish passage [m]
$\Delta h_{pool} = \frac{\Delta h_{tot}}{\text{number of pools}}$	

4. Functional-spatial design

$u_{avg} = C \cdot \sqrt{2 \cdot g \cdot \Delta h}$ $\varepsilon = \frac{\rho \cdot g \cdot Q \cdot \Delta h}{L_{pool} \cdot B_{pool} \cdot d_{pool}}$	d_{pool} = water depth in the pools [m] Δh_{pool} = water level difference between two pools [m] Δh_{tot} = water level difference over fish passage [m]
--	--

According to the report (Kroes & Monden), the discharge coefficient ranges between $0.72 < C_d < 0.82$ for water depths ranging from $0.40 < y_0 < 2.0$ m. However, for simplicity, a discharge coefficient of 0.7 across the entire water depth, which is used for this passage. The inlet of the vertical-slot fish passage is located at the channel's bed elevation of NAP+8.95m. Therefore, the water depths upstream of the passage (y_0) are the same as those upstream of the channel, as shown in Table 18 (d_{inlet}). The inflow rates and flow velocities for each upstream water level is calculated using Python. The code is provided in Appendix J and the values are outlined in Table 23. The table shows that the flow velocities satisfy the flow velocity requirements of Table 9 and that the outflow rates have sufficient ratios with the flow over the flap gate (see Table 7).

In addition, the table also shows the energy dissipation across the pools. The energy dissipation is assessed for the pool with the lowest water level, as it results in the maximum energy dissipation. The smallest water depth occurs in the last pool (pool 12) by adding the water level difference to the downstream water depths. Table 23 shows that the maximum allowable energy dissipation condition is satisfied for each inflow rate. However, the target energy dissipation is not met for the inflow rate of $1.36 \text{ m}^3/\text{s}$. This is not a significant issue, as this low inflow rate occurs only a small percentage of the year.

Table 23: Flow conditions of the Vertical-slot fish passage

Driver [m ³ /s]	Q _{eco} [m ³ /s]	Δh _{total} [m]	y ₀ [m]	C	B _{slot} [m]	Δh _{pool} [m]	Q _{inflow} [m ³ /s]	Q _{flap-gate} [m ³ /s]	discharge ratio [%]	v _{avg} [m/s]	ε [Watt/m ³]
50	5.0	1.14	1.90	0.7	0.75	0.095	1.36	3.84	37.43	0.96	116.75
50	6.6	1.04	1.90	0.7	0.75	0.087	1.30	5.30	24.55	0.91	93.45
125	12.5	0.73	1.92	0.7	0.75	0.061	1.10	11.40	9.66	0.76	42.03
250	16.0	0.60	1.91	0.7	0.75	0.050	0.99	15.01	6.62	0.69	28.66
500	20.0	0.45	1.87	0.7	0.75	0.038	0.84	19.16	4.40	0.60	16.89
1000	20.0	0.27	1.90	0.7	0.75	0.023	0.66	19.34	3.43	0.47	7.08
1250	20.0	0.42	2.62	0.7	0.75	0.035	1.14	18.86	6.04	0.58	14.01
1627	20.0	0.26	3.49	0.7	0.75	0.022	1.19	18.81	6.35	0.46	6.25

Design alternative 2: Intake structure without a separate fish passage

For this design alternative, the intake structure consists of consecutive weirs and pools that divide the total water level difference into smaller navigable steps for the fish. The most upstream weir regulates the channel's inflow rate.

Determining the dimensions of the intake structure

Similar to the pool-and-weir fish passage, the weirs have submerged overflow, which decreases the occurrence of air nappe and thus increasing the passability of the weirs (Coenen, Antheunisse, Beekman, & Beers). This indicates that the water levels downstream of the weir influences its flow conditions. The inflow rate over the weir is described with the weir equation for submerged-overflow, see Figure 45 and the equation below.

$$Q_{eco} = C_d \cdot B_{weir} \cdot h_1 \cdot \sqrt{2g \cdot (h_1 - h_3)}$$

Where:

Q_{eco} = inflow rate [m³/s]

C_d = discharge coefficient [-]

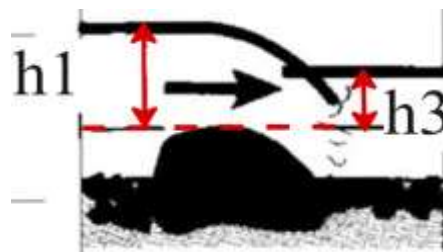

Figure 45: The upstream and downstream water levels of the weirs in a V-shaped pool-and-weir fish passage to determine the inflow rates (Kroes & Monden)

4. Functional-spatial design

B_{weir} = flow width of the weir [m]

h_1 = water level upstream of the weir [m]

h_3 = water level downstream of the weir [m]

Initial dimensions for this intake structure are estimated using simplified equations and coefficients. The water level downstream of the weir are the water levels calculated for the channel's inlet in Subsection 4.1.7. In reality, the water levels downstream of the weir (h_3) are determined with the energy balance and impulse balance. However, for an estimation it is assumed that the water levels downstream of the weir (h_3) are equal to the calculated water levels for the channel's inlet (d_s) in Subsection 4.1.7. The report by (Coenen, Antheunisse, Beekman, & Beers) recommends a water level difference 0.08 m (Δh) over each weir and a minimum pool length of 10 m to properly dissipate the water's energy. With this elevation difference and a maximum water level difference of 1.14 m (for an inflow rate of 5 m³/s), 14.25 drops are required ($\frac{1.14 \text{ m}}{0.08 \text{ m}} = 14.25$). This results in 15 pools.

Simplified calculation for determining the dimensions of the most downstream weir

Since the weirs have submerged overflow, they theoretically cannot be considered separately, as they influence each other. However, for an estimation, the dimensions of the most downstream weir are calculated to provide an indication of the required weir dimensions, given the desired flow conditions. A typical value for the discharge coefficient for submerged overflow is used, which is 1.1 (Voorendt, 2023). With the water level difference ($\Delta h = 0.08$ m) and the known inflow rate ($Q_{eco} = 5$ m³/s), the required weir width (B_{weir}) and height (p_{weir}) are determined by iteratively adjusting each parameter until the required flow conditions are met. After the iteration, the weir width is determined to be 6.5 m and the height of the most downstream weir is 0.29 m above the channel's bed elevation, resulting in a crest elevation of NAP+9.24m. An overview of these dimensions is given in Figure 46 and their calculations are given below.

Water depth over the weir: $d_2 = d_4 + \Delta h - p_{weir} = 0.76 + 0.08 - 0.29 \approx 0.55 \text{ m} \geq 0.52 \text{ m}$, satisfied

Width of the weir crest: $B_{weir} = \frac{Q_{eco}}{C_d \cdot d_2 \cdot \sqrt{2 \cdot g \cdot \Delta h}} = \frac{5.0}{1.1 \cdot 0.55 \cdot \sqrt{2 \cdot g \cdot 0.08}} \approx 6.5 \text{ m} \geq 0.72 \text{ m}$, satisfied

Flow velocity over the weir: $u_2 = \frac{Q_{eco}}{B_{weir} \cdot d_2} = \frac{5}{6.5 \cdot 0.55} = 1.40 \frac{\text{m}}{\text{s}} \leq 1.40 \frac{\text{m}}{\text{s}}$, satisfied

Water depth upstream of the weir: $d_1 = d_4 + \Delta h = 0.76 + 0.08 = 0.84 \text{ m} \geq 0.52 \text{ m}$, satisfied

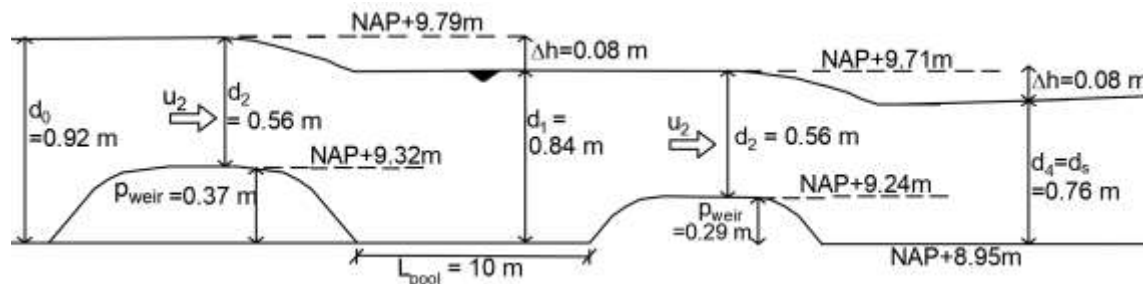

Figure 46: The dimensions of the most downstream weir for first design alternative of the intake structure

Dimensions of the remaining weirs and pools

The remaining weirs have a similar design, each with a consecutive elevation increase of 0.08m. The most upstream weir has an elevation of NAP+10.28m. The longitudinal profile of the intake structure is shown in Figure 47. The width of the pools is set slightly larger than the weir width (B_{pool}) at 7 m. The pool length (L_{pool}) is set at 10 m, which satisfies the recommendation that the pool width should be $\frac{1}{2} - \frac{2}{3}$ times the pool

4. Functional-spatial design

length (Ghodrati, 2021). The verification of the drowning rate and energy dissipation over the second most downstream weir is shown below

$$\text{Drowning rate over the weir: } S = \frac{d_0}{d_1} = \frac{0.92-0.2}{0.84-0.2} = 0.91 \geq 0.5, \text{ satisfied}$$

$$\text{Energy dissipation over the weir: } \varepsilon = \frac{\rho \cdot g \cdot Q \cdot \Delta h}{L_{pool} \cdot B_{pool} \cdot d_1} = \frac{1000 \cdot 9.81 \cdot 5 \cdot 0.08}{10 \cdot 7 \cdot 0.84} = 66.73 \frac{\text{Watt}}{\text{m}^3} \leq 100 \frac{\text{Watt}}{\text{m}^3}, \text{ satisfied}$$

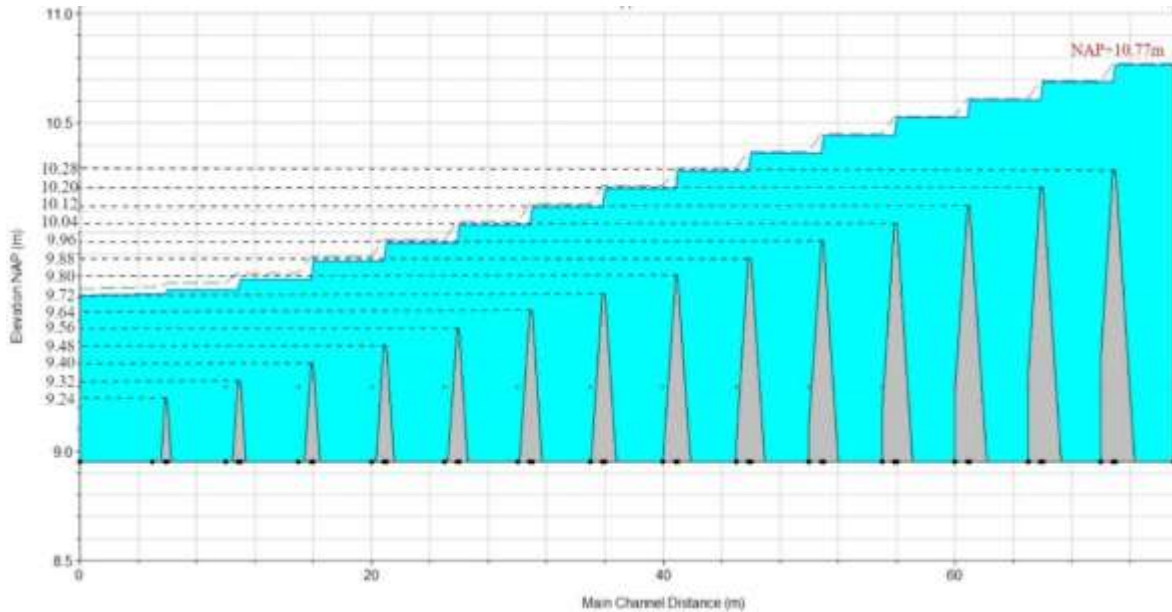

Figure 47: Longitudinal profile of the intake structure for the first design alternative

Verification of the intake structure

With these dimensions, the intake structure is modelled using HEC-RAS. The flow conditions calculated using this program are only estimations, as HEC-RAS is not entirely suitable for this type of structure, given the calculations are made for uniform flow conditions, which is not the case in reality. The HEC-RAS inputs and outputs are shown in Appendix J. For an inflow rate of 5 m³/s, the water level upstream of the most upstream weir is NAP+10.77 m (see Figure 47). This lies lower than the river's water level (NAP+10.85m), indicating no unwanted water elevation upstream of the intake structure.

To accommodate larger inflow rates, the most upstream weir must be lowered. For a maximum inflow rate of 20 m³/s, the weir must be lowered to an elevation of NAP+9.24m. However, doing this without adjusting the remaining weirs results in increased water levels upstream of the intake structure (positive backwater curves), which can lead to premature local flooding of the floodplains. In addition, for this inflow rate, the flow velocities in the fish passage exceed the allowable maximum value (see Appendix J). Hence, the intake structure does not satisfy the requirements. One solution is to make all the weirs adjustable. However, this would result in roughly 14 adjustable weirs that need to be constructed, maintained, and monitored, leading to high costs.

4.2.5 Step 4: Developing the final fish passable intake structure design

This subsection selects the most optimal design alternative and provides a visual overview of the final conceptual design for the fish passable intake structure.

Selecting the optimal design alternative

For the second design alternative to meet the flow conditions for the various inflow rates, it would require 14 adjustable weirs. This would lead to high construction and maintenance costs compared to the first design alternative. Therefore, the first design alternative, consisting of the flap gate and vertical-slot fish passage, is selected as the optimal design alternative.

Final design of the intake structure

The front view of the intake structure is shown in Figure 48, and a visual impression of its final conceptual design is given in Figure 49.

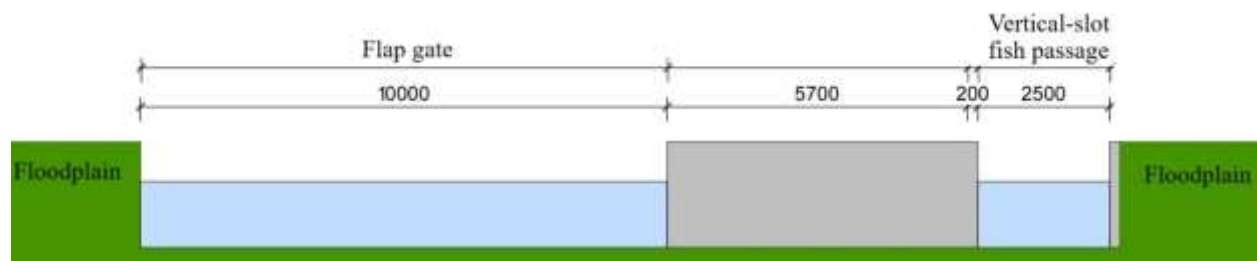

Figure 48: Front view of the final intake structure

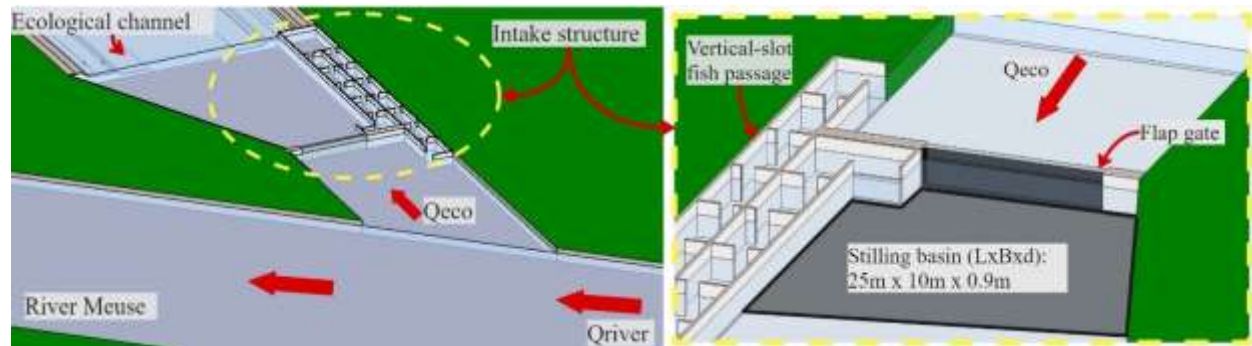

Figure 49: Impression of the final intake structure

4.3 Final combined design of the ecological channel

In this section, the channel design and selected intake structure design are integrated with the existing navigation locks, mooring areas, and combined Poirée and Stoney weirs to form a cohesive weir complex design for the formation of lotic habitats. This represents the final design of the ecological channel that meets all lotic habitat requirements described in Subsection 3.1.5. Figure 50 provides a top view of the weir complex, Figure 51 shows the intake structure, and Figure 52 shows the channel's cross-section.

4. Functional-spatial design

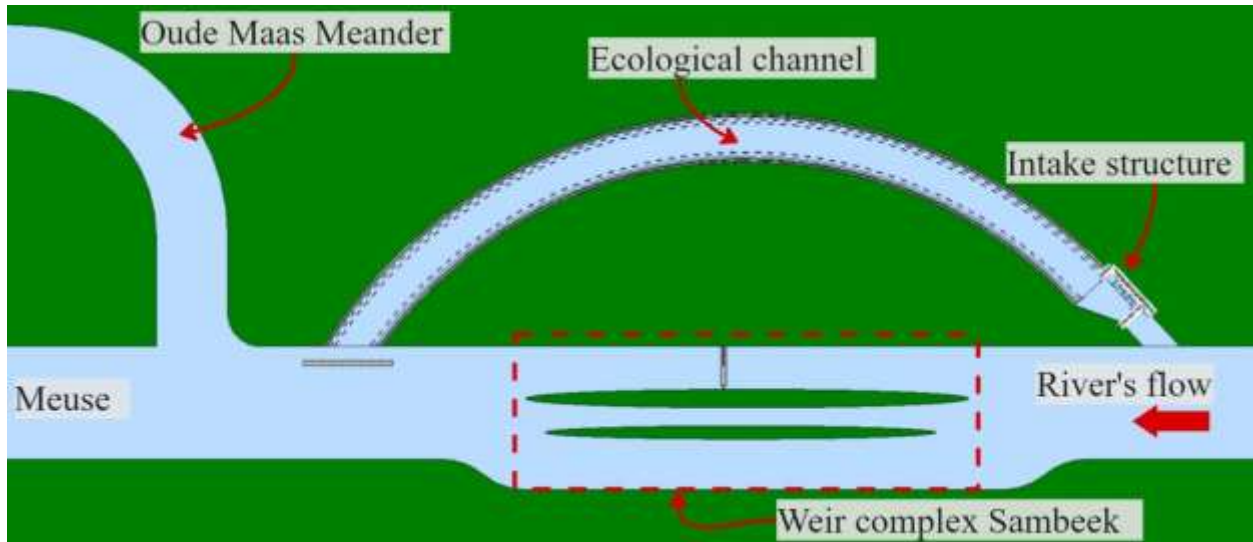

Figure 50: Top view of the final design of the ecological channel at weir complex Sambeek

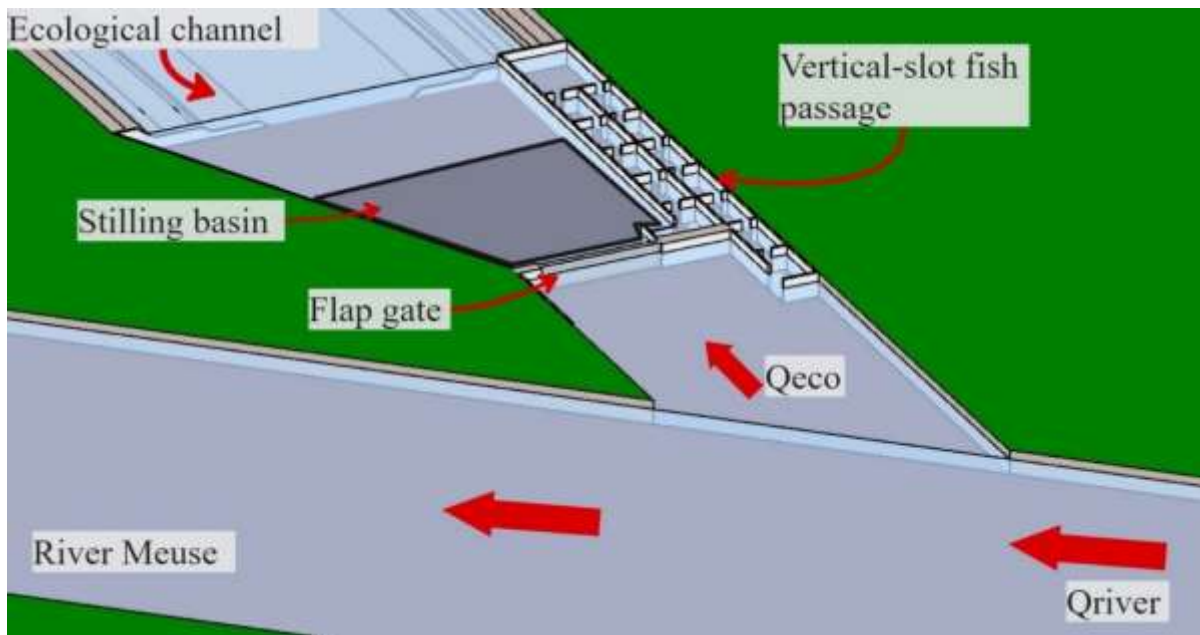

Figure 51: The design of the ecological channel's intake structure.

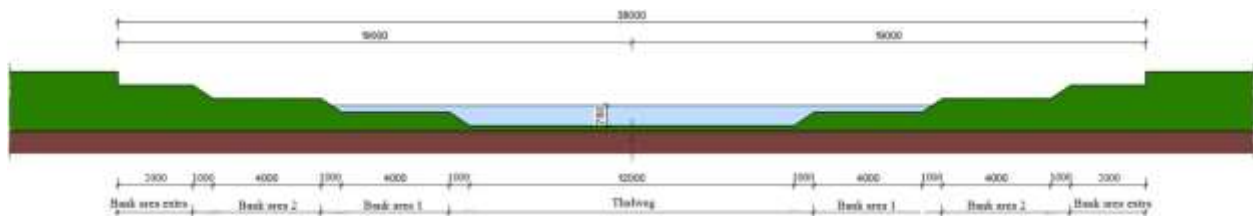

Figure 52: Cross-section of the ecological channel

4.4 Evaluation of the ecological channel's function as a fish passage

This section evaluates whether the ecological channel can effectively serve as a fish passage by satisfying the fish migration requirements shown in Subsection 3.1.4 and potentially improving the fish passability of the complex.

Evaluating the ecological channel against the fish migration requirements

The ecological channel is fish passable due to the vertical-slot fish passage bypassing the flap gate at the channel's inlet and the adequate flow conditions within the channel for river discharges up to 500 m³/s. The channel's flow conditions satisfy the passability requirements for a fish passage (see Table 8 and Table 9). However, the findability requirements for a fish passage (see Table 7) are not met, specifically the outlet location and the outflow velocity (luring current).

The outflow velocities are calculated in Appendix I.3 and shown in Table 24. The outlet location lies approximately 1.2 km downstream of the weirs (see Figure 53), while the requirement is that it must be placed within 10 meters downstream of the weirs for energy dissipation levels below 1300 W/m³ or in-line with the fish migration line. Therefore, for the ecological channel to function as the fish passage, an additional fish passage must be added to achieve these findability requirements.

Table 24: Outflow velocities of the ecological channel for the various inflow rates

	h_BC	y_BC[m]	Qinflow [m ³ /s]	A_outlet [m ²]	P_outlet [m]	R_outlet [m]	L [m]	ib	u_outlet [m/s]	v_crit [m/s]	y_outlet [m]	h_outlet [m]	cf	de [m]	he [m]
0	7.76	0.55	5.0	7.6	22.46	0.34	-3500	0.000497	0.66	1.31	0.55	7.76	0.02	0.76	7.97
1	7.76	0.55	6.6	7.6	22.46	0.34	-3500	0.000497	0.87	1.31	0.55	7.76	0.02	0.86	8.07
0	7.82	0.61	12.5	8.94	22.73	0.39	-3500	0.000497	1.40	1.39	0.61	7.82	0.02	1.19	8.40
0	8.0	0.79	16.0	13.05	25.53	0.55	-3500	0.000497	1.23	1.55	0.79	8.0	0.02	1.31	8.52
0	8.62	1.41	20.0	31.46	34.31	0.92	-3500	0.000497	0.64	1.8	1.41	8.62	0.01	1.43	8.64
0	10.27	3.06	20.0	98.65	45.68	2.16	-3500	0.000497	0.20	2.21	3.06	10.27	0.01	1.43	8.64
0	11.08	3.87	20.0	136.79	49.31	2.75	-3500	0.000497	0.16	2.33	3.87	11.08	0.01	1.43	8.64
0	12.16	4.96	20.0	181.17	53.42	3.39	-3500	0.000497	0.11	2.43	4.96	12.16	0.01	1.43	8.64

Operational window of the additional fish passage

The optimal location for the fish passage in the weir complex is next to the Stoney weirs, as these primarily accommodate the river's flow during the migration period of the fish species. Hence, the existing fish ladder is located there. The ecological channel is situated in the flood plains next to Poirée weir, and therefore, the additional fish passage is also located there. Fish are attracted to the Poirée weir when it has the largest flow rate at the weir complex. This occurs above river discharges of 400 m³/s, as the Stoney weirs have a capacity of 200 m³/s. This is the same river discharge for which the existing fish ladder's findability decreases, due to the submergence of the downstream pools (Vriese, et al., 2021).

Therefore, with the additional fish passage, the ecological channel could function as the primary fish passage for discharges between 400 m³/s and 1000 m³/s. A fish passage is no longer required for river discharges above 1250 m³/s, as both the Stoney and Poirée weir are fully opened. Therefore, the additional fish passage would be operational for flow rates above 400 m³/s, which occurs approximately 13% of the year (exceedance percentage for a river flow rate of 500 m³/s is used, see Table 11).

Location of the additional fish passage

The additional fish passage is located next to the Poirée weir. To maintain the structural integrity of the structural wall of the crane rail and its storage area, the fish passage outlet is positioned as shown in Figure 53. The figure shows that the fish passage outlet lies approximately 40 m downstream of the Poirée weir.

4. Functional-spatial design

It is assumed that this location roughly aligns with the fish migration line of the fish species, as the energy dissipation likely exceeds 1300 m³/s.

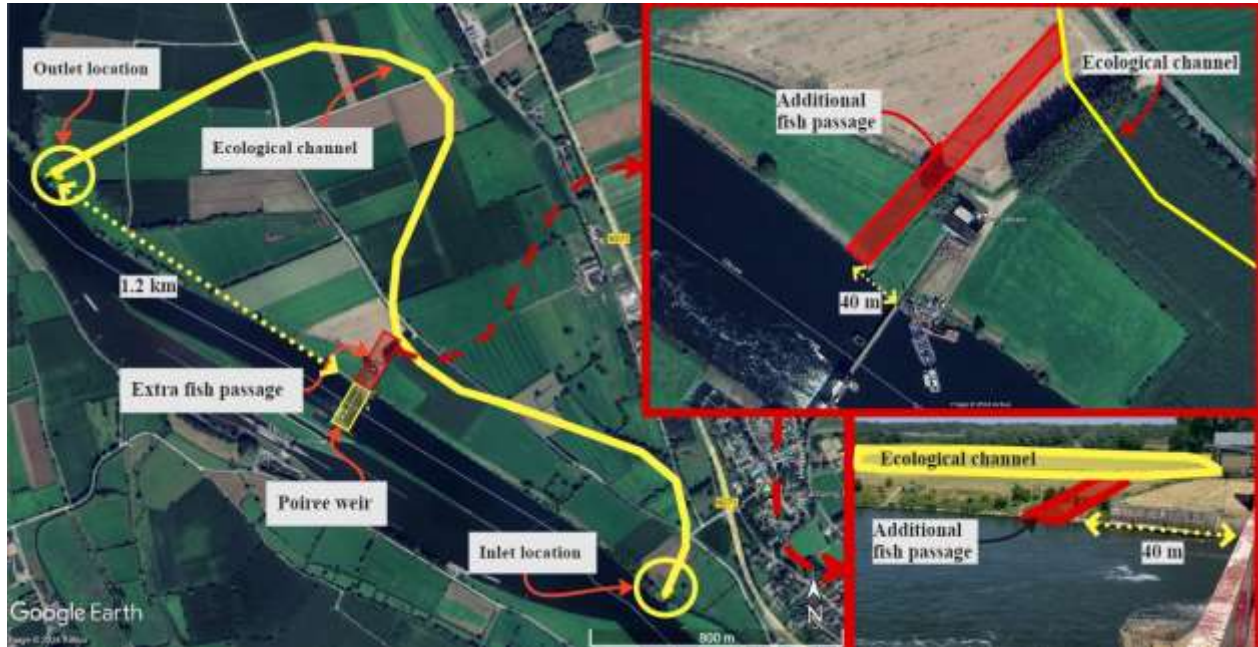

Figure 53: Location of the additional fish passage for the ecological channel

Luring current of the additional fish passage

The luring current consists of the outflow rate and outflow velocity. Similar to the channel's inlet, the most suitable fish passage is the vertical-slot fish passage. The outflow rate ratio of the ecological channel for river discharges above 400 m³/s is less than 5 % (see Appendix H). This indicates that the outflow rate ratio of the additional fish passage is even lower, meaning the target outflow ratio is not met (see Table 7). With a simple calculation, the outflow velocity over the last slot of the fish passage is determined for the river discharges 500 and 1000 m³/s, using the equation and parameters of the vertical-slot fish passage shown in Subsection 4.2.4. The water levels upstream of the additional fish passage are assumed to be the water levels in the middle of the channel (see Table 40), and the downstream water levels are the water levels measured at Sambeek-Beneden (see Table 11). The outflow velocities for both river discharges are estimated below.

$$u_{avg} = C \cdot \sqrt{2 \cdot g \cdot \frac{\Delta h_{tot}}{\text{number of pools}}}$$

$$Q_{river} = 500 \text{ m}^3/\text{s}: u_{avg} = 0.7 \cdot \sqrt{2 \cdot g \cdot \frac{(NAP+9.51 - NAP+8.62m)}{18}} = 0.97 \text{ m/s}$$

$$Q_{river} = 1000 \text{ m}^3/\text{s}: u_{avg} = 0.7 \cdot \sqrt{2 \cdot g \cdot \frac{(NAP+10.32 - NAP+10.27m)}{18}} = 0.41 \text{ m/s}$$

The outflow velocities satisfy the luring current requirements, and assuming the outlet location of the fish passage aligns with the migration line, the findability requirements are met.

Concluding remarks

The ecological channel cannot function as the sole fish passage for the weir complex. It can only satisfy the fish passage requirements for river discharges between 400 m³/s and 500 m³/s, which occurs approximately

31 days of the year. This approximation is shown in Appendix K. This discharge range excludes the migration period of the fish species, which is the critical period when the fish passage must effectively function, as the river typically has flow rates between 25 and 250 m³/s during this period (see Section 3.3). Additionally, whether the additional fish passage is findable for all the various fish species is uncertain, as the fish migration line differs for the various flow rates over the Poirée weir, different river species, and their life stages (Vriese, et al., 2021).

Furthermore, adding an additional fish passage, along with the required fish passage for the channel's inlet, increases the construction, maintenance, and monitoring costs. It is uncertain whether this temporary effectiveness can contribute to improvement of the fish passability of the weir complex and whether it is

5. Generalization

This chapter assesses whether the final design of the ecological channel can be applied to the other weir complex locations in the Dutch part of the river Meuse. Implementing this channel design at these locations can potentially increase the overall lotic habitats in the river and ensure relatively consistent performances, maintenance processes, and monitoring procedures across the different locations. The channel design is generalized for the critical boundary conditions of these locations. These boundary conditions are used to verify the channel's flow conditions against the lotic habitat requirements, assessing its suitability at these locations. Additionally, the flow conditions of the vertical-slot fish passage of the intake structure are verified against the fish migration requirements.

5.1 Identifying boundary conditions for the other weir complexes

The boundary conditions are considered critical as they directly influence the flow conditions within the channel. These are the:

1. Maximum estimated channel length in the surrounding area
2. Measured river water levels upstream and downstream of the complex for various river discharges

1. The maximum estimated channel length in the surrounding area

Using the area analysis for the complex locations in Appendix A, the maximum channel length is estimated for each complex location using Google Earth. The estimation focuses on the floodplain with the most available area, see Appendix L.1. The floodplain south of complex Borgharen is not considered, as the Bosscherveld nature park is situated there. Similarly, the floodplain north of complex Linne is not considered, as the Linne overflow is situated there. Although the area north of complex Roermond already has a by-pass channel, the possibility of an ecological channel is still examined. The maximum estimated channel length for each complex location is shown in Table 25.

Table 25: Maximum estimated channel length for each complex location

Weir complex	Maximum estimated channel length
Borgharen	1 km
Linne	2 km
Roermond	2.5 km
Belfeld	2 km
Grave	2 km
Lith	2.5 km

2. Measured river water levels upstream and downstream of the complex for various river discharges

As stated in Subsection 3.3, Royal HaskoningDHV provided the measured water levels for various measurement points along the river Meuse, meaning the measured water levels for all the complex locations are known. Similar to complex Sambeek, the upstream water levels of each complex are taken from the first publicly known upstream measurement point, while the downstream water levels are taken from the first publicly known downstream measurement point. These measured water levels and the corresponding water level differences over the weirs is shown in Appendix L.2.

5.2 Assessing the ecological channel design at the other weir complexes

5.2.1 Flow conditions within the channel

For the ecological channel's design to achieve the required flow conditions, the channel's bed slope (i_b) of $4.97 \cdot 10^{-4}$ must remain unchanged. The bed slope depends on the channel's length ($L_{channel}$) and bed level difference (Δz). Since the channel's lengths at the other complex locations are shorter than that of complex Sambeek, the bed level difference at each location must be decreased to achieve the same bed slope. The required bed level difference for complex location is determined by multiplying the bed slope by the estimated channel length.

This decrease in the bed level difference can be achieved by either lowering the channel's inlet bed elevation or by raising its outlet bed elevation. However, as the channel's outlet bed elevation is set to 0.55 m below the lowest target water level downstream of the complex, which is the minimum target water depth for adequate fish passability, it remains unchanged. Therefore, the required channel's inlet bed elevation is determined by adding the outlet bed elevation and required bed level difference. These values are shown in Table 26.

Table 26: The required bed elevation of each weir complex location

Target downstream water depth = 0.55 m						
Weir complex	Downstream water level [NAP+m]	Outlet's bed elevation [NAP+m]	Required bed slope [-]	Channel length [m]	Required bed level difference [m]	Inlet's bed elevation [NAP+m]
Sambeek	7.76	7.21	0.000497	3500	1.74	8.95
Borgharen	38.04	37.49	0.000497	1000	0.50	37.99
Linne	16.86	16.31	0.000497	2000	0.99	17.30
Roermond	14.15	13.60	0.000497	2500	1.24	14.84
Belfeld	10.98	10.43	0.000497	2000	0.99	11.42
Grave	4.93	4.38	0.000497	2000	0.99	5.37
Lith	0.65	0.10	0.000497	2500	1.24	1.34

Using the bed elevations and the dimensions of the ecological channel, the flow conditions in the thalweg and bank areas are calculated for quasi-uniform flow conditions in Appendix L.3, using the same Python code provided in Appendix I. The ecological channel is considered suitable for the complex locations if it meets the flow requirements during the critical reproductive period of the target river species, which has a typical discharge range of 25 – 250 m³/s. Based on the calculated flow conditions, the ecological channel is applicable at all weir complex locations. Similar to complex Sambeek, complexes Linne, Roermond, and Grave are functional up to a river discharge of 500 m³/s, while complex Borgharen, Belfeld, and Lith are functional until a river discharge of 250 m³/s.

In addition, the gradual transition from the river bed to channel bed, and vice-versa, as well as the channel's outlet, remain unchanged for the other complex locations.

5.2.2 Vertical-slot fish passage

The dimensions of the vertical-slot fish passage remain unchanged, except for the number of pools. The number of pools depends on the maximum water level difference over the intake structure, which is the difference between the upstream river water levels and the water levels just downstream of the intake

structure, as calculated in Appendix L.3. The upstream and downstream water depths are both relative to the inlet's bed elevation determined in Table 26. Similar to complex Sambeek, the maximum water level difference over each pool is set to 0.10 m (Δh_{pool}). Based on this, the number of pools for each complex location is determined for the total maximum water level difference over the fish passage. This is shown in Table 27.

Table 27: The required number of pools for a maximum water level difference of 0.10 m (Δh_{pool}) over each pool at each complex location

Weir complex	River's discharge Q_{river} [m ³ /s]	Upstream water levels	Downstream water levels	Δh_{tot} [m]	Number of pools
Borgharen	25	NAP+44.08m	NAP+38.75m	5.33	54
Linne	25	NAP+20.86m	NAP+18.06m	2.80	28
Roermond	25	NAP+16.85m	NAP+15.60m	1.25	13
Belfeld	25	NAP+14.14m	NAP+12.18m	1.96	20
Grave	25	NAP+7.69m	NAP+6.13m	1.56	16
Lith	25	NAP+4.89m	NAP+2.10m	2.79	28

Using the fish passage's dimensions, upstream and downstream water levels, and number of pools, the flow conditions are calculated in Appendix L.4 using the same Python code provided in Appendix J.1. The calculation shows that fish passage meets the maximum flow velocities through the slots. However, the maximum energy dissipation criteria are not met in the following situations:

- At complex Borgharen for $Q_{river} \leq 125$ m³/s
- At complex Belfeld for $Q_{river} \leq 25$ m³/s
- At complex Lith for $Q_{river} \leq 50$ m³/s

The energy dissipation can be reduced by increasing the volume of the pools. For complex Borgharen, the pool can be increased to 7.5 m and the width to 3.5 m. For complex Belfeld, the pool length can remain the same and the width can be increased to 3.5 m. For complex Lith, the pool length can be increased to 6.0m and the width to 3.5 m. The corresponding flow conditions are shown in Appendix L.4. Naturally, various configurations are possible, this is just one option. The optimal dimensions are not determined in this report, as they have no added value for the for-habitat formation.

5.2.3 Flap gate

The flap gate does not have to meet fish migration requirements, it just needs to accommodate the required inflow rates. The required flow openings at each complex location does not provide additional insights into the efficiency of the ecological channel. The situation at each complex location is conventional, suggesting that the required flow openings are also conventional.

6. Discussion, Conclusions, and Recommendations

6.1 Discussion

Deepening question 1: How are the suitable dimensions of the ecological channel determined?

Determining the dimensions of the ecological channel that satisfy the required flow conditions for habitat formation is an iterative process, as the channel's dimensions and parameters have interdependent relationships. Due to these dependencies, they must be iteratively adjusted until a suitable combination is found that meets the required flow conditions.

1. Uncertainty of the boundary conditions

The ecological channel is initially designed for the boundary conditions at weir complex Sambeek. These boundary conditions include the ground levels of the surrounding floodplains and the river's measured inflow rates and corresponding water levels. It is assumed that the surrounding floodplains have a ground elevation of NAP+12m. However, a more accurate determination of the actual elevations is needed to ensure that the water levels in the channel do not exceed these elevations during non-flood river discharges ($Q_{river} < 1600 \text{ m}^3/\text{s}$). This issue can be addressed by, for example, locally raising the ground level.

In addition, the channel's design is based on measured river discharges and water levels from 2007 to 2008, which may be insufficient data for verifying the ecological channel's dimensions. This data may not be representative of the river's flow conditions over the past years, as these can change due to global warming or other factors. The uncertainty of the boundary conditions may result in a different channel design. However, the channel's design is robust within the known boundary conditions, as the required flow conditions are met for river discharges above the required range of 25 to 250 m^3/s . Therefore, if the river's flow conditions do not significantly differ from the known values, it can be assumed that the channel's design will maintain the required performance within the required discharge range. In contrast, designing with boundary conditions that significantly differ from the known values may result in a different channel design.

2. Uncertainty of the estimated available space in the surrounding floodplains

The ecological channel's design is based on the estimated available space in the surrounding floodplains. The maximum length and path of the channel are estimated without considering underground structures such as pipes and wiring, or the challenges of crossing certain road and areas. Therefore, the actual channel length may need to be shorter than estimated. However, the current performance of the ecological channel is still achievable with a shorter channel length, provided the current channel bed slope (i_b) remains unchanged. This means that the channel's bed level difference (Δz) must be reduced to compensate for the shorter length. If the shorter channel length significantly differs from the current estimated value and the bed level difference cannot compensate for it, it will likely result in a different channel design.

3. Taking non-uniform conditions into account

The iterative adjustment process for determining the channel's dimensions uses the Belanger, White-Colebrook, and Shields equations to describe the hydraulic processes in the channel. These processes assume uniform conditions, such as quasi-uniform flow conditions, uniform channel cross-section, bed composition, and bed slope. However, in reality, these conditions will not occur due to natural morphological changes over time and both natural and human interventions in the channel. These factors

lead to non-uniform conditions that can significantly impact the flow conditions in the channel and lead to a different channel design.

The determined nominal diameter for the channel bed will not be present along the full length of the channel, as variations in the bed composition will naturally occur, which is favourable for habitat formation. These variations can include:

- areas with different bed compositions due to sediment transport (erosion and sedimentation), or deliberate placement
- deliberate placement of elements, such as boulders and dead tree trunks, to create spawning, hiding, and resting areas for the river species,
- occurrence of natural elements such as tree trunks and (aquatic) plants
- unintentional human interventions

These variations result in non-uniform bed compositions throughout the channel, which locally affects the flow conditions. Depending on the severity of these variations, they can impact the overall flow conditions in the channel. In addition, these variations, along with the natural channel banks and the initial winding path of the channel, results in lateral erosion, leading to meandering or shifting of the channel. This leads to variations in the channel's cross-section and bed slope, which is also favourable for the river species. However, it locally effects the channel's flow conditions, which can lead to unsuitable flow conditions for habitat formation. Depending on the severity of the lateral erosion, unwanted meandering can occur, which can impact the overall flow conditions in the channel or lead to excessive erosion of critical areas.

Furthermore, the channel is designed for quasi-uniform flow conditions, which considers gradual variations in the flow. The above-mentioned variations can lead to local and abrupt changes in the flow conditions, energy levels, and turbulence intensities, which can significantly impact the local flow dynamics and potentially effect the functioning of the ecological channel.

4. Limitation of the channel's design

The combination of the channel parameters that meets the required environmental conditions for uniform and quasi-uniform flow establishes the dimensions of the channel. These conditions are designed to meet the needs of specific river species that are endangered by the reduction of lotic habitats in the river. Consequently, the channel theoretically supports this specific group. However, considering other river species for lotic habitat formation may require different environmental conditions, which the current channel design does not meet. Therefore, considering river species outside the scope of this report (see Subsection 2.4.1) may lead to a different channel design.

5. Uncertainty of the ecological channel's design

The required flow conditions for the target river species are derived from recommendations in conducted studies and practical experience (Vriese, et al., 2021). However, there is no guarantee that the river species will utilize the channel even with these preferred flow conditions, as their behaviours can be unpredictable, and their responds may not be as anticipated.

Deepening question 2: Can the ecological channel function as a fish passage?

The ecological channel can function as a fish passage by satisfying the fish migration requirements, which consists of findability and passability requirements based on recommended values in the fish passage handbooks by (Coenen, Antheunisse, Beekman, & Beers), (Kroes & Monden), and (Ghodrati, 2021).

1. Uncertainty of the required findable and passable conditions for a fish passage

All these reports recommend target values for the dimensions and flow conditions of fish passages where they are most efficient. The handbook by (Ghodrati, 2021) also provides values where the fish passage's efficiency decreases, while still remaining functional. However, none of the reports specify conditions indicating when the fish passages become non-functional.

Achieving these recommended target values for various upstream and downstream boundary conditions is challenging. Therefore, in addition to these target values where the fish passage is most efficient, required values are established. It is assumed that failure to meet these required values results in a non-functional fish passage design. This approach of categorizing target and required values provides more structure for determining when the fish passage is functional or non-functional, and allows for more flexibility in designing the fish passage for various upstream and downstream boundary conditions. However, these required values are based on recommendations from the fish passage handbooks, which have limitations and uncertainties, especially in aspects that differ between the handbooks, such as the fish passage's outlet location and the outflow orientation.

In addition, there is no guarantee that the fish species will utilize the channel even with the optimal conditions to achieve a passable and findable fish passage, as their behaviours can be unpredictable, and their responses may not be as anticipated. The presence of optimal conditions does not guarantee that the fish will find and/or pass the fish passage as anticipated.

2. Temporary effectiveness of the ecological channel as fish passage

The ecological channel's flow conditions satisfy the passability requirements for a fish passage up to a river discharge of 500 m³/s. However, the findability requirements are not met, specifically the outlet location and the outflow velocity (luring current). To address these issues, an additional fish passage can be incorporated. The inlet of the additional fish passage is situated approximately in the middle of the channel and the outlet is situated just downstream of the Poirée weir.

The upstream migrating fish are expected to follow the imaginary migration line along the downstream turbulent zones of the weir to navigate it. Aligning the additional fish passage's outlet (downstream entrance) with this migration line is expected to enhance its findability (Vriese, et al., 2021). However, the path of the migration lines differs for the various flow rates over the Poirée weir, the different fish species, and their life stages. Hence, the findability of this additional fish passage remains uncertain.

The fish are naturally attracted to the largest occurring flow rate in the river due to their rheotaxis orientation sense, which primarily occurs over the Stoney weirs. The Poirée weir, has larger flow rates starting from 400 m³/s, meaning the additional fish passage's findability requirements are likely satisfied from this point on. However, the ecological channel can only serve as a fish passage up to a river discharge of 500 m³/s, as it meets the passability requirements up to this point. Therefore, the ecological channel with an additional fish passage can only meet the fish passage requirements for river discharges from 400 m³/s up to 500 m³/s, which occurs approximately 31 days of the year. It is uncertain whether this temporary effectiveness can contribute to improvement of the fish passability of the weir complex and whether it is worthwhile to have this improvement for the increased costs.

Deepening question 3: Can the ecological channel be applied to all weir complex locations in the Dutch part of the river Meuse?

The channel's design is applicable at the other complex locations if it meets the requirements during the critical reproductive months. Compared to complex Sambeek, the other complex locations have less available space, resulting in shorter channel lengths. To ensure the required flow conditions are achieved

in the channel at these complex locations, its bed slope (i_b) must remain unchanged. Therefore, the channel's bed level difference (Δz) must be decreased to compensate for the shorter channel lengths. This is achieved by lowering the channel's inlet bed elevation, while maintaining the outlet bed elevation of 0.55 m below the minimum target river water level downstream of the complex to ensure adequate water depths for fish passability. With these adjustments, the design of the ecological channel is applicable at all the weir complex locations.

The discussions points described for the first deepening question regarding the design of the ecological channel at weir complex Sambeek apply to all the other complex locations. The estimated available space, boundary conditions, and simplifications of the hydraulic processes may not accurately represent reality. A more detailed consideration of these factors makes them more representative of reality, which may result in a different channel design.

Similar to complex Sambeek, the required environmental conditions at each complex location are designed to meet the needs of specific river species. Considering other river species may require different environmental conditions, which may result in a different channel design. In addition, even if the required environmental conditions are met, there is no guarantee that the river species will utilize the channel, as their behaviours can be unpredictable, and their responds may not be as anticipated.

6.2 Conclusions

This section provides the conclusion of the design process aimed at achieving the objective of determining whether the ecological channel can create environmental conditions for the formation of lotic habitats in the Dutch part of river Meuse. This section includes a general conclusion and the answers to the deepening questions.

General conclusion

The final ecological channel design includes an intake structure consisting of a flap gate and vertical-slot fish passage. Figure 54 gives an impression of the final design at weir complex Sambeek. The design is assessed for river discharges up to 1627 m³/s, as the weir complex becomes non-operational beyond this point. The channel design meets the required environmental conditions for habitat formation for river discharges up to 500 m³/s for weir complex Sambeek, Linne, Roermond, and Grave, and for discharges up to 250 m³/s at complex Borgharen, Belfeld, and Lith. Both discharge ranges include the critical reproductive months of the target river species, as was required. The final design shows that the required environmental conditions for lotic habitat formation can be achieved in a regulated river, such as the river Meuse.

However, the channel design may not accurately represent reality due to uncertainties in the estimations and limitations of the channel's boundary conditions, available space, and simplifications of its hydraulic processes. In addition, even if the required environmental conditions are achieved, it does not guarantee that the river species will utilize the channel, as their behaviours can be unpredictable, and their response may not be as anticipated. Nonetheless, the final design of the ecological channel shows that the required environmental conditions for lotic habitat formation can be achieved at the weir complexes in the Dutch part of river Meuse, potentially leading to an increase in the populations of the target river species.

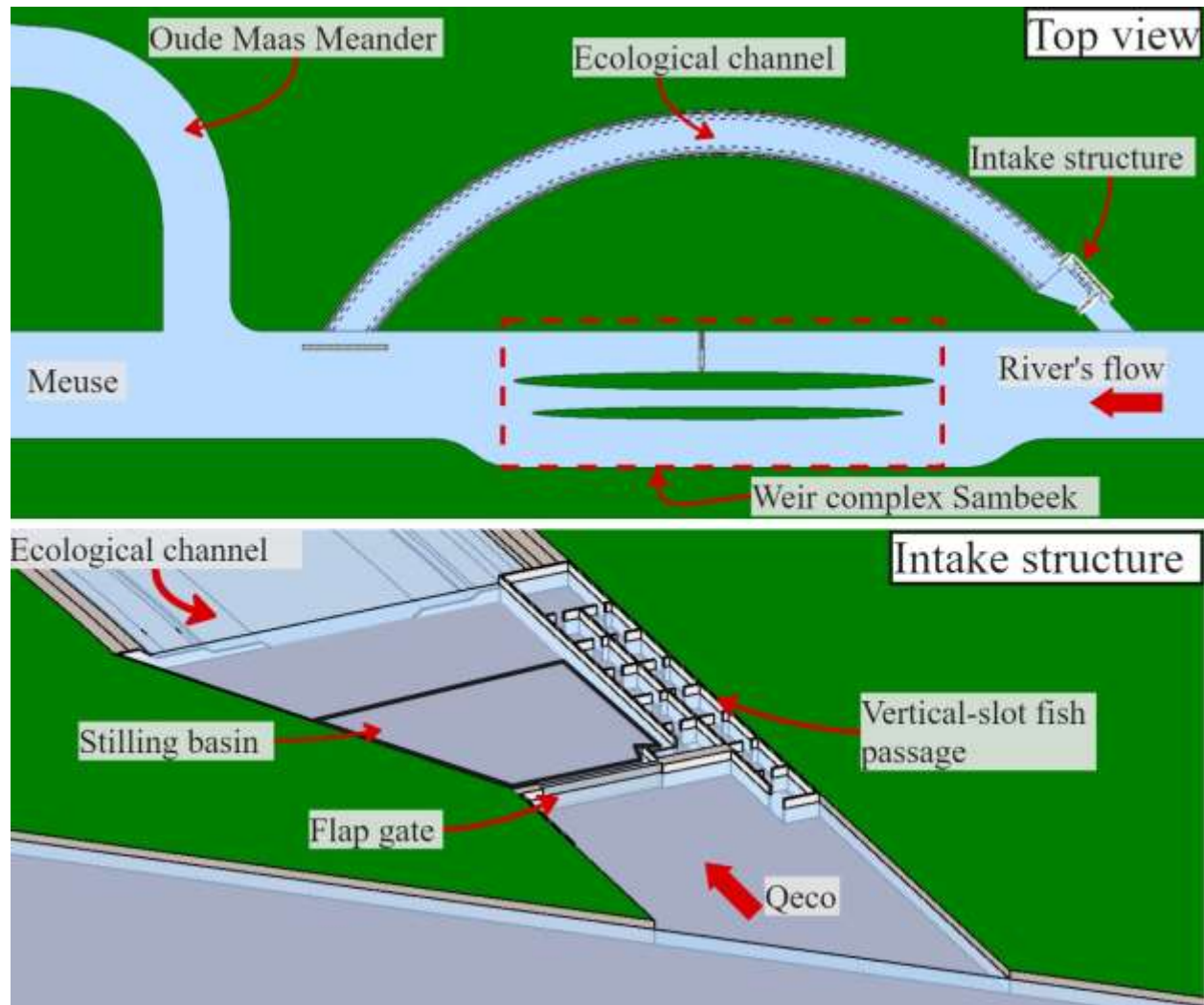

Figure 54: The ecological channel's final design

Answer to deepening question 1: How are the suitable dimensions of the ecological channel determined?

Determining the dimensions of the ecological channel that satisfy the required environmental conditions for habitat formation is an iterative process, as the channel's dimensions and parameters have interdependent relationships. Due to these dependencies, they must be iteratively adjusted until a suitable combination is found that meets the required conditions. To streamline the process and reduce the number of possible combinations, the design of the channel's intake structure and the channel's dimensions are done separately.

The iterative process for determining the channel's dimensions starts by constructing an initial design. The initial channel parameters are iteratively adjusted until a parameter combination is found that meets the conditions for uniform and quasi-uniform flow. This combination establishes the dimensions of the channel. The intake structure is then designed to accommodate the established channel dimensions and parameters. It must continuously accommodate varying inflow rates and ensure fish passability. This is achieved with a flap gate and vertical-slot fish passage.

Answer to deepening question 2: Can the ecological channel function as a fish passage?

The ecological channel can function as a fish passage if it meets the established fish migration requirements, which consists of findability and passability requirements. With these conditions, it is determined that the ecological channel can function as a fish passage for river discharges between 400 m³/s and 500 m³/s by incorporating an additional fish passage, as the channel itself does not meet the findability requirements. The incorporating of an additional fish passage, increases the construction, maintenance, and monitoring costs. It is uncertain whether the presence of an additional fish passage, which potentially functions for approximately 31 days of the year outside the main fish migration period, improves the fish passability of the weir complex and whether it is worthwhile to have this improvement for the increased costs.

Answer to deepening question 3: Can the ecological channel be applied to all weir complex locations in the Dutch part of the river Meuse?

The channel design is applicable at the other complex locations if the required environmental conditions for the formation of lotic habitats are met during the critical reproductive months. Although these other complex locations have less available space and consequently shorter channel lengths, the final channel design is applicable at all complex locations, provided the bed slope at each complex location is equal to that of complex Sambeek. The channel's cross-sectional dimensions remain unchanged at all complex locations, while the channel's length and bed level difference vary.

Weir complex Linne, Roermond, and Grave are functional up to a river discharge of 500 m³/s, while Borgharen, Belfeld, and Lith are functional until a river discharge of 250 m³/s. The vertical-slot fish passages meet the fish migration requirements for these discharge ranges if minor adjustments are made, such as increasing the number of pools in the fish passages. Additionally, for complex Borgharen, Belfeld, and Lith, the pool dimensions must also be slightly increased.

6.3 Recommendations

1. Verify the channel's design for additional measured data

The ecological channel's design is based on the available measured river discharges and water levels from 2007 to 2008, which may be insufficient data for verifying the ecological channel's dimensions, as this data may not accurately represent the river's flow conditions in recent years. Therefore, it is of interest to verify the channel's design using measured data from recent years to determine whether it still meets the required environmental conditions for lotic habitat formation.

2. Conduct a more detailed area analysis

A more accurate area analysis of the surrounding flood plains at each complex location is necessary to ensure that the path of the ecological channel avoids unnecessary crossing of cables, pipes, trees, buildings, roads, historical areas, or other important elements. This area analysis can provide a better estimation of the channel's length, which can impact the channel's design. Lastly, the influence on the groundwater table of the surrounding floodplains should be assessed, as the channel may drain groundwater toward it, potentially lowering the local groundwater table.

3. Conduct a morphological study

The severity of the channel's lateral erosion (meandering), can be estimated with a morphological study. The morphological study examines the channel's shape and its changes over time by estimating the sediment transport and predicating how the channel bed will change. With this study, strategies can be developed to limit excessive erosion and assess the overall sediment transport of the channel and its influence on habitat formation. It can also provide insights to possible sediment transport blockage at the flap gate of the intake structure.

4. Construct a hydraulic model

Constructing a hydraulic model of the ecological channel allows for the consideration of non-uniform aspects, such as non-uniform cross-sections, bed slopes, bed compositions, energy losses, and turbulence intensities. This model helps assess the complexities of the local flow variations and the overall flow conditions in the channel, and their effects on the habitat formation. The hydraulic model should include the intake structure, flap gate and vertical-slot fish passage, to assess the local flow conditions and their impact on the fish passability. With this model a more realistic ecological channel design can be developed.

5. Conduct research on the preferred environmental conditions for other river species

The ecological channel is designed to meet the needs of specific river species. Considering other river species for lotic habitat formation may require different environmental conditions, which may lead to a different channel design. Therefore, it is of interest to determine the required environmental conditions for other river species that also rely on lotic habitats in the river Meuse. This assessment can evaluate the suitability of the current channel design and identify necessary adjustments to achieve these preferred environmental conditions. This can lead to a channel design that supports a larger group of river species. However, identifying the necessary environmental conditions for other river species falls in the domain of ecology and not civil engineering.

6. Conduct further research on the river species

Further studies are necessary to address the uncertainties whether the river species will utilize the ecological channel when optimal flow conditions are present. This is necessary as it ensures that the channel does not only satisfy the requirements but also the objective. The uncertainty mainly lies in the unpredictable behaviour of the various river species. It seems interesting to quantify this uncertainty to take into account during the design process of the ecological channel. However, this research falls in the domain of ecology and not civil engineering.

7. Conduct further research on the temporary effectiveness of the ecological channel

The ecological channel can function as a fish passage for river discharges between 400 m³/s and 500 m³/s by incorporating an additional fish passage. Further research is needed to determine whether the presence of an additional fish passage, which potentially functions for approximately 31 days of the year outside the main fish migration period, improves the fish passability of the weir complex and whether it is worthwhile to have this improvement for the increased costs.

8. Compare the channel with a standard by-pass channel

Both the ecological channel and the standard by-pass channel aim to form lotic habitats for various species. The main difference being the order of magnitude of the channel's dimensions and inflow rates. Comparing these two channels on their effectiveness and resilience can help identify ecological advantages and disadvantages, which can potentially lead to a more optimal design.

9. Conduct a flood scenario analysis

The final design is assessed up to a river discharge of 1627 m³/s, as the weir complex becomes non-operational beyond this point. Analyzing the channel during and after higher river discharges can indicate whether the channel remains operational after a flood or requires maintenance measures. Considering the ecological channel's entire lifetime provides a clearer indication of when the environmental conditions for the formation of lotic habitats are achieved.

References

- Ankum, A. v., Delbressine, R., Kurvers, S., & Maes, B. (2023). *Stuwen in de Maas Systeembeschouwing*. Rijkswaterstaat Zuid-Nederland (RWS ZN). Retrieved from <https://open.rws.nl/open-overheid/onderzoeksrapporten/@257020/stuwen-maas-systeembeschouwing/>
- Ankum, P. (2002). *Design of Open-Channels and Hydraulic Structures*. Delft University of Technology, Faculty of Civil Engineering and Geosciences. Delft: Delft University of Technology.
- Arvanaghi, H., & Oskeui, N. N. (2013). *Sharp-Crest Weir Discharge Coefficient*. Journal of Civil Engineering and Urbanism.
- Aubel, P. v. (2023). *Objectbeschrijving sluis- en stuwcomplex Sambeek*. Ministerie van Infrastructuur.
- Azimi, A. H., Rajaratnam, N., & Zhu, D. Z. (2013). *Discharge Characteristics of Weirs of Finite Crest Length with Upstream and Downstream Ramps*. Research Gate. Retrieved from https://www.researchgate.net/publication/273746899_Discharge_Characteristics_of_Weirs_of_Finite_Crest_Length_with_Upstream_and_Downstream_Ramps
- Battjes, J., & Labeur, R. (2017). *Unsteady Flow in Open Channels*. Cambridge University Press.
- Biezen, B. v. (n.d.). *Sambeek - Luchtfoto sluizencomplex Sambeek*. Retrieved from <http://www.hollandluchtfoto.nl/media/1675a10b-2e16-4da6-a27b-9af66b994644-sambeek-luchtfoto-sluizencomplex-sambeek>
- Blom, A. (2021). River Dynamics 1 CIE4345. *Course Slides*. Delft University of Technology. Retrieved from brightspace.tudelft.nl: https://brightspace.tudelft.nl/d21/e/content/399264/Home
- Bruggeman, W., Haasnoot, M., Hommes, S., Linde, A. t., & Brugge, R. v. (2011). *Deltascenario's : Verkenning van mogelijke fysieke en sociaaleconomische ontwikkelingen in de 21ste eeuw op basis van KNMI'06 en WLO-scenario 's, voor gebruik in het Deltaprogramma 2011-2012*. Deltares.
- Buiter, R. (2020). *Voor een beetje stroom vermalen we vis tot sushi*. Retrieved from Trouw: <https://www.trouw.nl/duurzaamheid-economie/voor-een-beetje-stroom-vermalen-we-vis-tot-sushi~b3852cab/>
- Coenen, J., Antheunisse, M., Beekman, J., & Beers, M. (n.d.). *Handreiking vispassages in Noord-Brabant (Waterschap De Dommel, Waterschap Aa en Maas en Waterschap Brabantse Delta)*. Waterschap De Dommel, Waterschap Aa en Maas en Waterschap Brabantse Delta.
- DLG. (2007). *Inrichtingsplan nevengeul Afferden*. Roermond: Dienst Landelijk Gebied (DLG).
- Erbisti, P. C. (2014). *Design of hydraulic gates* (2nd Edition ed.). CRC Press, Taylor & Francis group.
- Geest, G. v., Dorenbosch, M., Collas, F., Kessel, N. v., & Achterkamp, B. (2020). *Oost- Nederland KRW Leidraad*. Rijkswaterstaat Oost-Nederland. Rijkswaterstaat.
- Ghodrati, G. (2021). *Handreiking voor de bepaling van de technisch-hydraulische streefwaarden van vispassages*. Royal HaskoningDHV.

- Google earth. (2022, 08 07). *Google earth*. Retrieved from Google earth:
<https://earth.google.com/web/@51.6379136,5.98857151,13.33316821a,8013.75852966d,30y,0h,0t,0r>
- Heer, D. d. (2020). *Nieuwe generatie Maasstuwen: Een geschikte uitvoeringsoplossing voor een nieuwe stuw in de Maas bij Linne*. Delft University of Technology.
- Heijligers, J. (n.d.). NOS.
- Hensen, M. (n.d.). *Sluis Sambeek*. Retrieved from Binnenvaartinbeeld:
https://www.binnenvaartinbeeld.com/nl/maas/sluis_sambeek
- Keizer, K. (2016). *Determination whether a large scale Tesla valve could be applicable as a fish passage*. Delft University of Technology, Civil Engineering.
- Kranenbarg, J., & Kemper, J. (2006). *Efficiëntere vismigratie bij vistrappen: Onderzoek op vismigratie gericht stuwbeheer in de Maas bij Sambeek*. Rijkswaterstaat.
- Kroes, M., & Monden, S. (n.d.). *Vismigratie een handboek voor herstel in Vlaanderen en Nederland*. Ministerie van de Vlaamse Gemeenschap. AMINAL, Afdeling Water.
- Lewin, J. (2001). *Hydraulic gates and valves: In free surface flow and submerged outlets*. London: Thomas Telford Publishing.
- Maasheggen. (n.d.). *Maasheggen, het oudste cultuurlandschap van Nederland*. Retrieved from [maasheggenunesco.com](https://www.maasheggenunesco.com/): <https://www.maasheggenunesco.com/>
- Martin, P., & Boughrous, A. (2012). *Guide taxonomique des oligochetes dulcanquicoles du Maghreb*. Researchgate.
- Molenaar, W., & Voorendt, M. (2023). *Hydraulic Structures: General lecture notes*. Delft University of Technology, Faculty of Civil Engineering and Geosciences. Delft University of Technology.
- NDFD & FLORON. (2015). *FLORON Verspreidingsatlas*. Retrieved from [verspreidingsatlas.nl](https://www.verspreidingsatlas.nl/): <https://www.verspreidingsatlas.nl/>
- Novak, P., Moffat, A., Nalluri, C., & Narayanan, R. (2007). *Hydraulic Structures* (4 ed.). New York, New York, USA and Canada: Taylor & Francis.
- Observation.org. (2004). *Waarneming.nl*. Retrieved from Observation.org:
<https://waarneming.nl/species/search/>
- Rijkswaterstaat. (2020). *Richtlijnen Vaarwegen 2020*. BNSV. Rijkswaterstaat Water, Vekeer en Leefomgeving (WVL). Retrieved from <https://standaarden.rws.nl/index.html>
- Rijkswaterstaat. (2022). *Vervanging en Renovatie*. Rijkswaterstaat. Retrieved from <https://open.overheid.nl/documenten/ronl-4f136573fd73e0e65d504fd377e70e0eed77be3d/pdf>
- Rijkswaterstaat. (2023, 08 22). *Rijkswaterstaat waterinfo*. Retrieved from Rijkswaterstaat waterdata:
[https://waterinfo.rws.nl/#!/details/publiek/waterhoogte/Sambeek-boven\(SAMB\)/Waterhoogte__20Oppervlaktewater__20t.o.v.__20Normaal__20Amsterdams__20Peil__20in__20cm](https://waterinfo.rws.nl/#!/details/publiek/waterhoogte/Sambeek-boven(SAMB)/Waterhoogte__20Oppervlaktewater__20t.o.v.__20Normaal__20Amsterdams__20Peil__20in__20cm)

- Rijkswaterstaat. (n.d.). *De 7 Maasstuwen*. Retrieved from Rijkswaterstaat.nl:
<https://www.rijkswaterstaat.nl/water/waterbeheer/bescherming-tegen-het-water/waterkeringen/dammen-sluizen-en-stuwen/de-7-maasstuwen>
- Rijkswaterstaat. (n.d.). *Doelen en resultaten*. Retrieved from Rijkswaterstaat.nl:
<https://www.rijkswaterstaat.nl/water/projectenoverzicht/maas-natuurvriendelijke-oevers-en-uiteerwaarden/doelen-en-resultaten>
- Rijkswaterstaat. (n.d.). *vispassage Borgharen*. Retrieved from Rijkswaterstaat.nl:
<https://www.rijkswaterstaat.nl/leefomgeving/leefbaarheid-en-milieu/natuur-en-biodiversiteit/ruim-baan-voor-vis/vispassage-borgharen>
- Ruijgh, E., de Jong, J., & Kramer, N. (2021). *Vispasseerbaarheid stuwcomplexen: Kennisvragen beantwoorden en Analysetool ontwikkelen*. Deltares.
- Ryszard, D., & Paulus, T. (2019). *Lock gates and other closures in hydraulic objects*. Butterworth-Heinemann.
- Schierreck, G. J., & Verhagen, H. (2019). *Introduction to Bed, Bank and shore protection* (Vol. 2nd edition). Delft Academic Press / VSSD.
- Schoups, G. (2023). Water system analysis CTB3360. Delft University of Technology.
- Siebe Swart. (2020, 05 27). *Luchtfoto Waal met langsdammen*. Retrieved from www.siebeswart.nl:
<https://www.siebeswart.nl/image/I0000FUts5oG0zlo>
- Sullivan, K., Lisle, T., Dolloff, C., Grant, G., & Reid, L. (1987). *Stream Channels: The Link Between Forests and fishes. Chapter three*. Washington: Forest Service: U.S. Department of Agriculture. Retrieved from Forest Service: <https://research.fs.usda.gov/treesearch/3603>
- USACE Hydrolic Engineering Center. (n.d.). *Weir flow coefficient*. Retrieved from HEC-RAS hydraulic reference manual:
<https://www.hec.usace.army.mil/confluence/rasdocs/ras1dtechref/6.5/modeling-culverts/culvert-data-and-coefficients/weir-flow-coefficient>
- Vercruisje, W., Wezenberg, S., Frings Roy, van Rossum, M., Muller, M., Bellert, B., & Collas, F. (2021). *Memorandum: Ecologische aandachtspunten en ontwerpeisen voor vervangen en renoveren van stuwen in de Maas*. Rijkswaterstaat.
- Vincenzo, A. d., & Caricato, G. (2006). *Fishways: The case of the Trivigno weir (Potenza, Southern Italy)*. ResearchGate.
- Voorendt, M. (2023). *Manual Hydraulic Structures*. Faculty of Civil Engineering and Geosciences. Delft: Delft University of Technology.
- Vriese, F., Hop, J., Reeze, B., de la Haye, M., van Kessel, N., Claus, M., & van Winden, A. (2021). *Stromend habitat en connectiviteit in de Maas*. Rijkswaterstaat. Retrieved from <https://open.rws.nl/open-overheid/onderzoeksrapporten/@158244/stromend-habitat-connectiviteit-maas/>

Appendices

Appendix A Area analysis of the weir complex locations

This appendix provides the area analysis of each weir complex location. It includes aerial overviews with the surrounding dikes (including their failure probabilities), other hydraulic structures, and an estimation of the available areas. This appendix supports Chapter 2.

Weir complex Borgharen

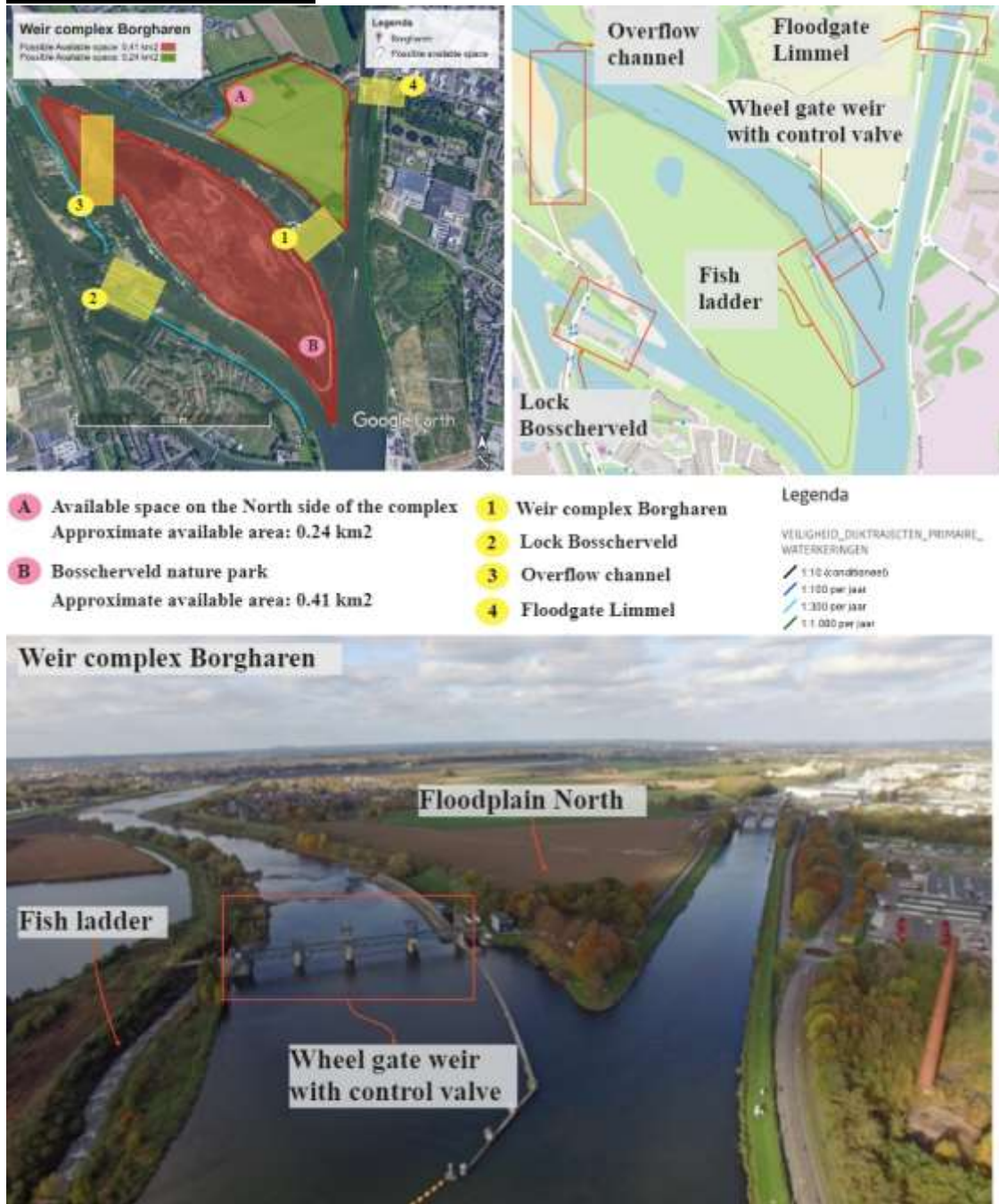

Figure 55: Aerial overview of weir complex Borgharen and its possible available space for interventions

Weir complex Linne

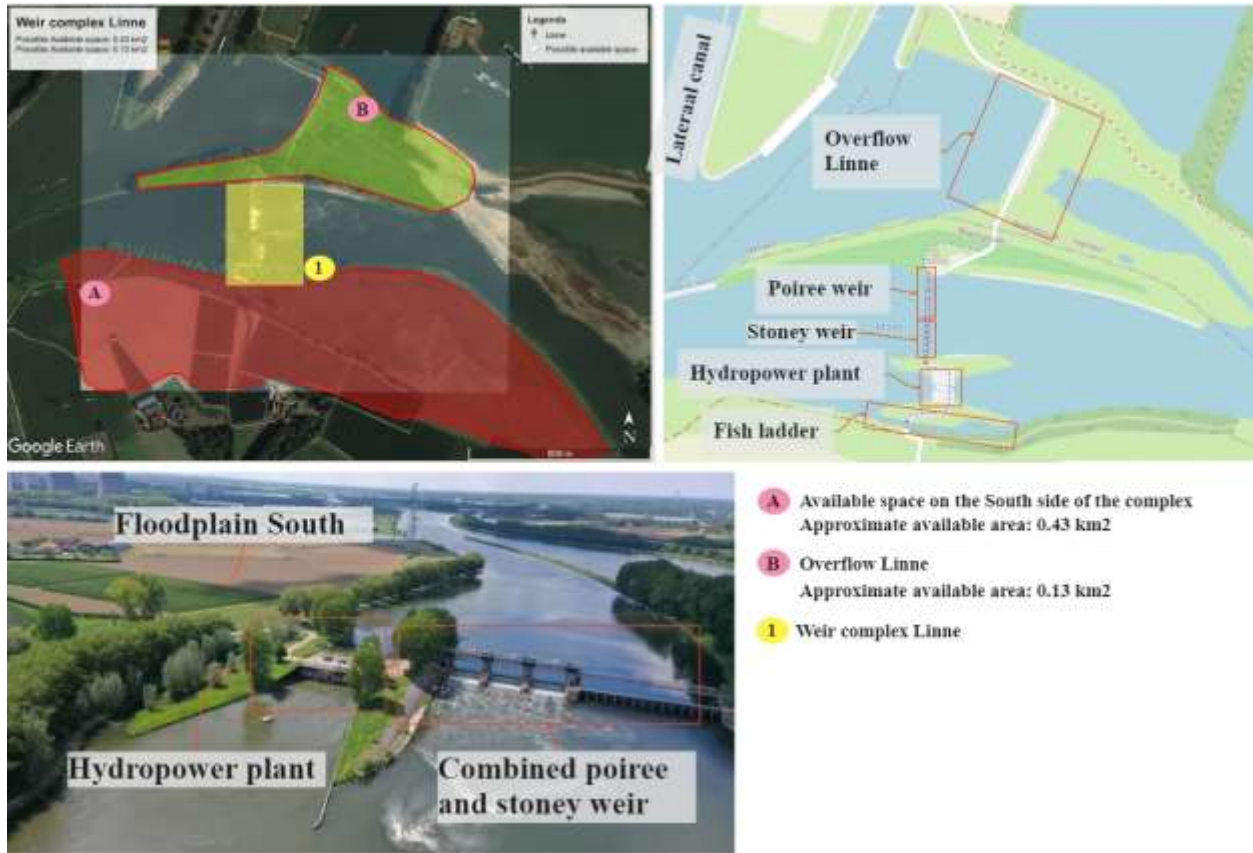

Figure 56: Aerial overview of weir complex Linne and its possible available space for interventions

Weir complex Roermond

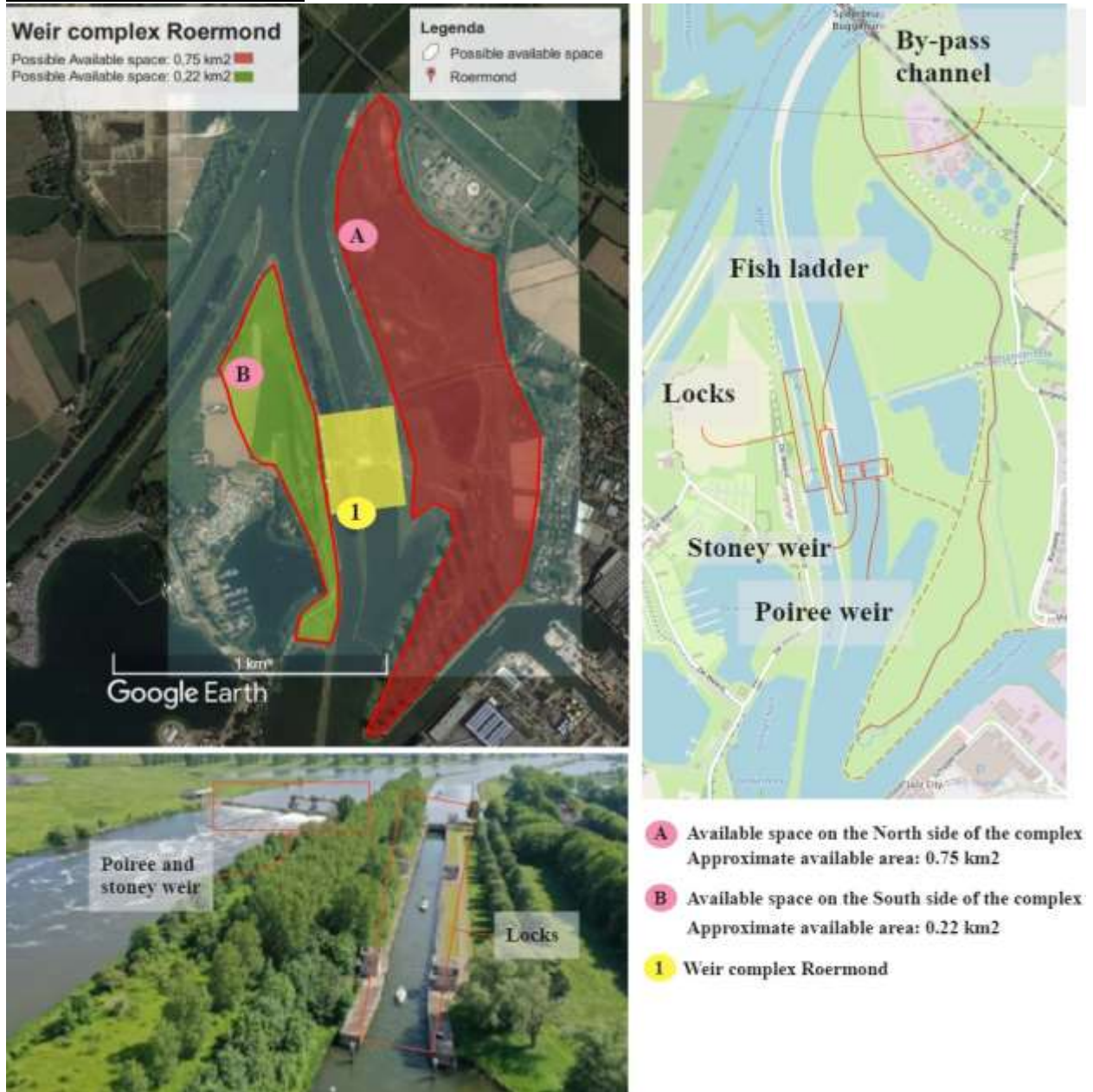
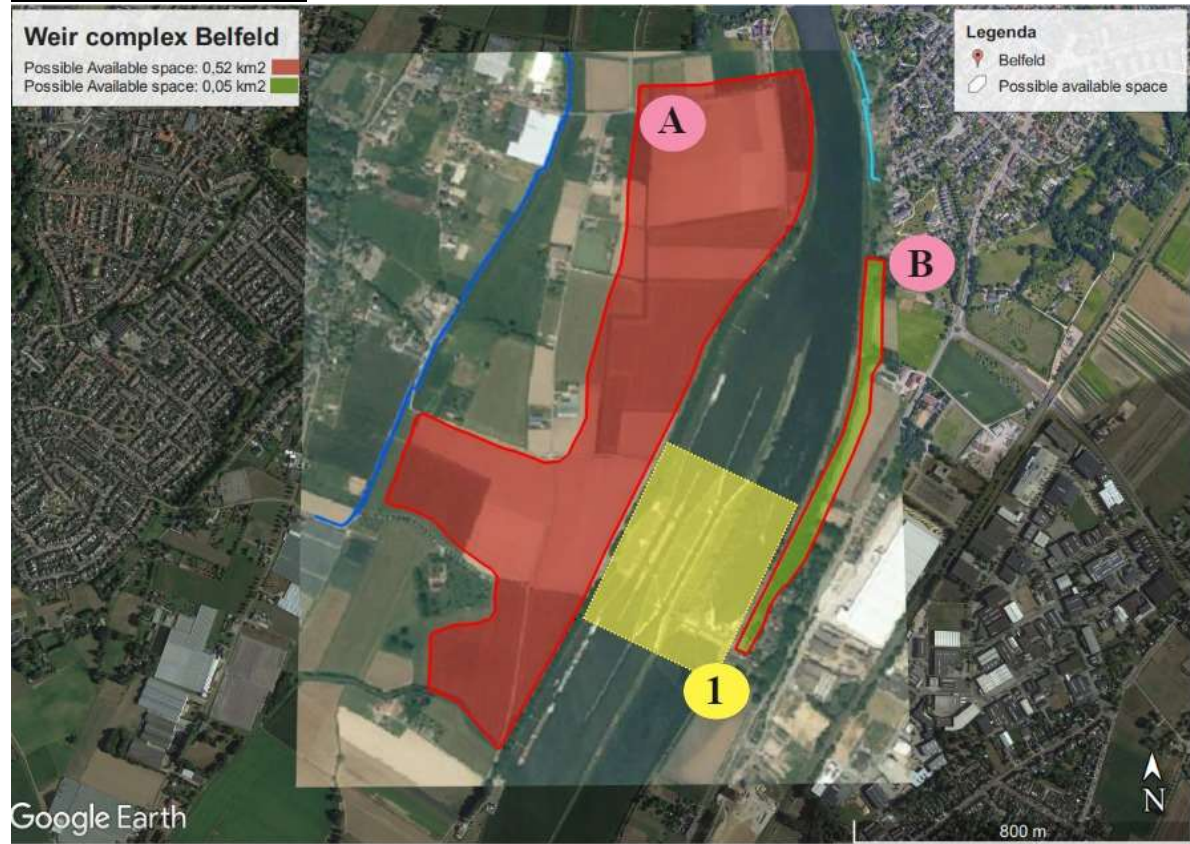

Figure 57: Aerial overview of weir complex Roermond and its possible available space for interventions

Weir complex Belfeld



VEILIGHEID_DIJKTRAJECTEN_PRIMAIRE_WATERKERINGEN

- 1:10 (conditioneel)
- 1:100 per jaar
- 1:300 per jaar
- 1:1.000 per jaar

- A** Available space on the North side of the complex
Approximate available area: 0.52 km²
- B** Available space on the South side of the complex
Approximate available area: 0.05 km²
- 1** Weir complex Belfeld

Figure 58: Aerial overview of weir complex Belfeld and its possible available space for interventions

Weir complex Sambeek

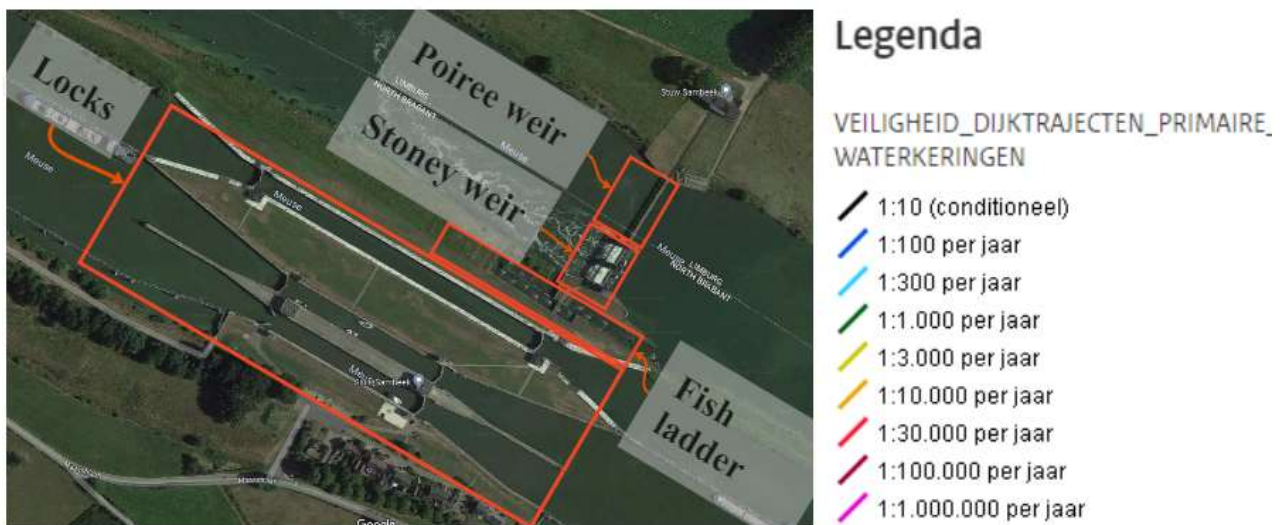
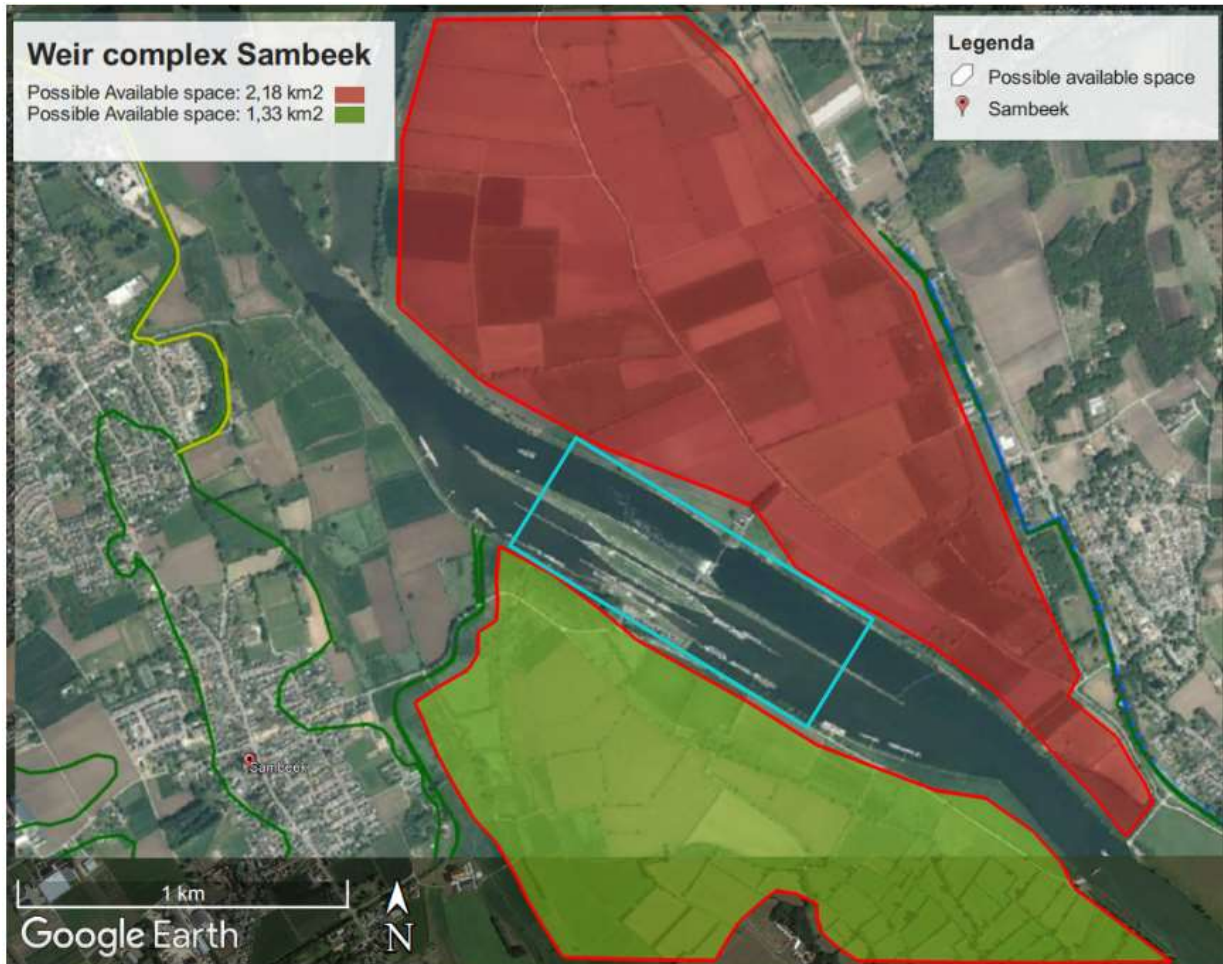

Figure 59: Aerial overview of weir complex Sambeek and its possible available space for interventions

Weir complex Grave

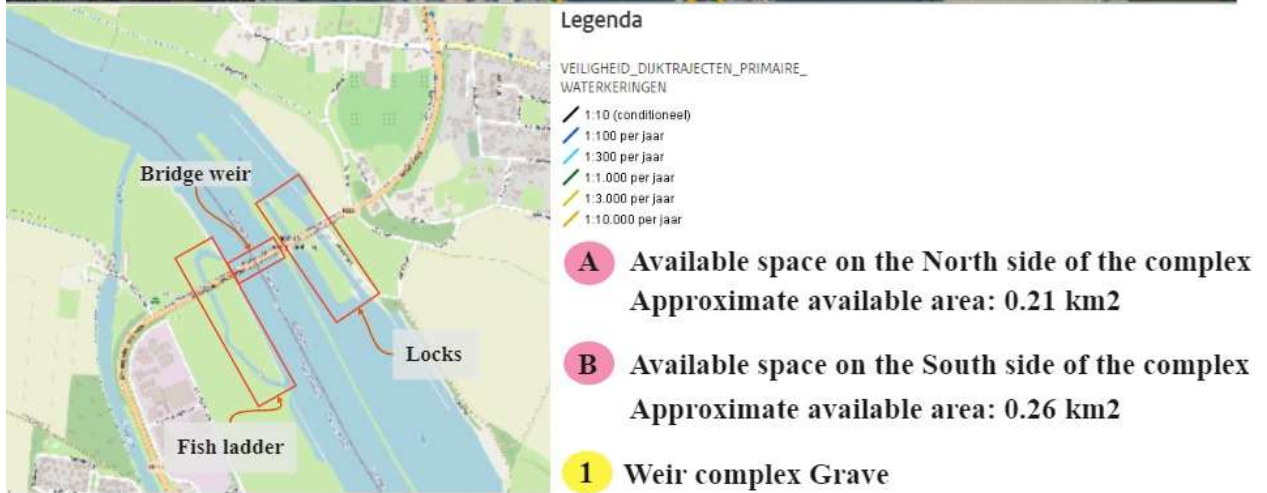

Figure 60: Aerial overview of weir complex Grave and its possible available space for interventions

Weir complex Lith

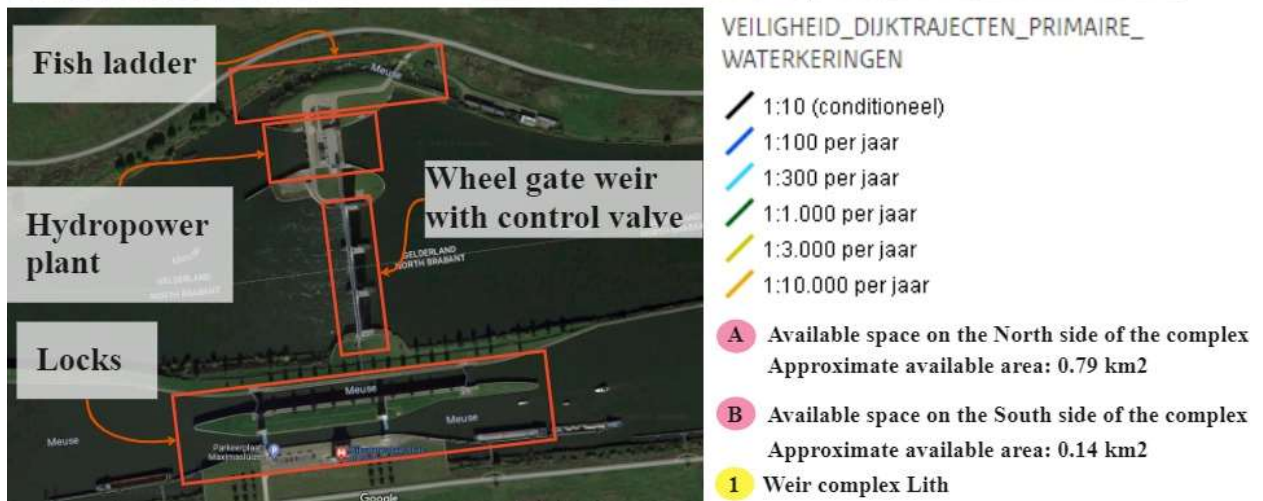
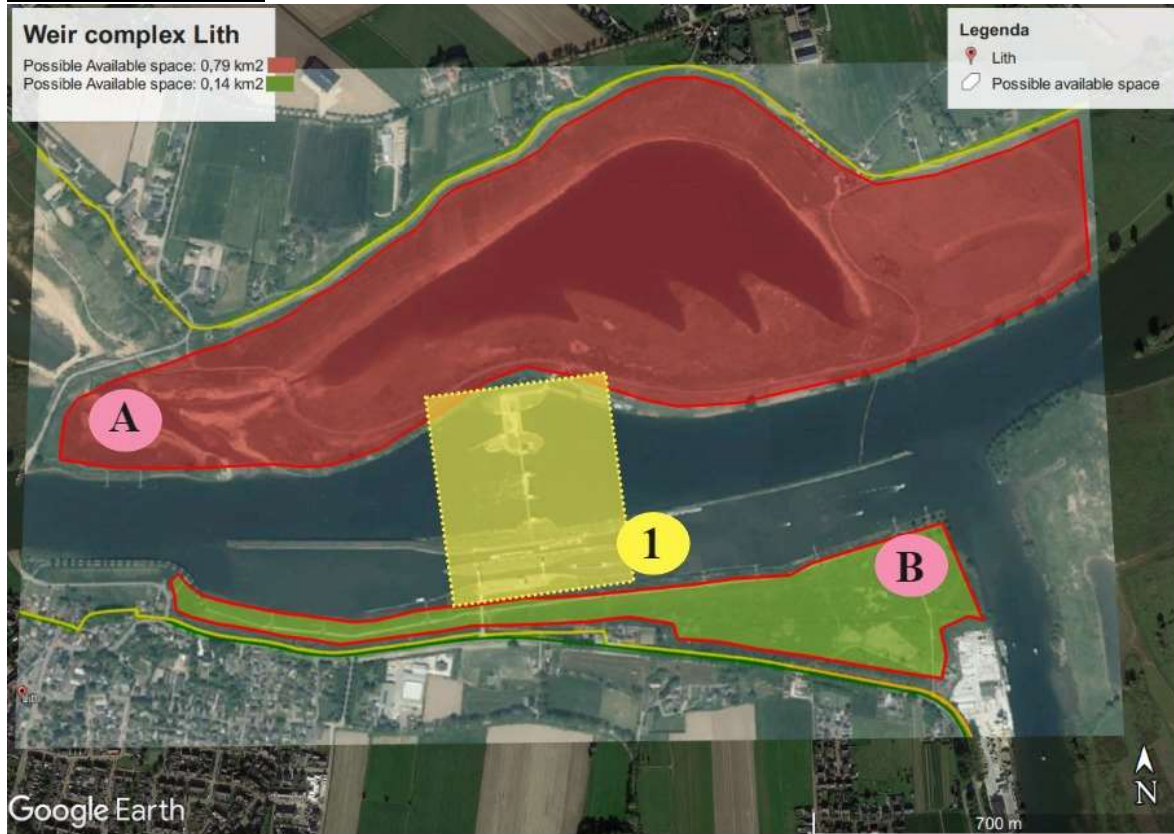

Figure 61: Aerial overview of weir complex Lith and its possible available space for interventions

Appendix B General information about weir complex Sambeek

This appendix provides the current layout and functioning of complex Sambeek. The overall functioning of the complex is described with a process analysis. The complex mainly consists of a combined Poirée and Stoney weir, three lock chambers, and one fish passage. This appendix support Section 2.3.

B.1. Combined Poirée and Stoney weir

The weir complex consists of a combined Poirée and Stoney weir, which can be divided into a navigation and discharge part, see Figure 63. The navigation part is the Poirée section of the weir, consisting of frames with panel-gates attached to them. Each panel-gate consists of three panel rows that can be removed separately. The discharge part is the Stoney section of the weir, which consists of two openings with two vertically moveable gates placed back-to-back on a sequence of roller carriages. Figure 62 shows the main components of both the Poirée and Stoney weirs.



Figure 62: Main components of the combined Poirée and Stoney weir (Ankum, Delbressine, Kurvers, & Maes, 2023)

Both weirs regulate the river’s water level. The Stoney weir operates with both an overflow and underflow and is responsible for the fine water regulation. For low river discharges the Poirée weir is fully closed and the Stoney weirs regulates the river with the overflow. From a river discharge of about 200 m³/s and onwards, panels from the Poirée weir are removed to help regulate the river. All the panel-gates of the Poirée weir are removed for a river discharge of 1300 m³/s. Starting from this discharge the Poirée weir is fully opened, allowing for ships to pass through the flow opening. In this case the Stoney weirs are also fully opened and underflow occurs when both the gates are lifted from the riverbed (Kranenbarg & Kemper, 2006). The opening sequence of the weirs are presented in the report (Aubel, 2023). An overview of the general parameters for both weirs is shown in Table 28.

Table 28: General parameters of the weirs at complex Sambeek (Ankum, Delbressine, Kurvers, & Maes, 2023) and (Aubel, 2023)*

Poirée weir section		Stoney weir section	
Number of frames	12	Number of Concrete pillars*	3
Number of panel sections	13	Number of gates	2
Total flow opening	63.05m	Total flow opening	34 m
Width of one panel	4.85 m	Width steel gate*	17.0 m
Height of upper panel (highest level of retaining element)**	NAP+11.10m	Depth steel gate*	1.70 m
Height of middle panel**	NAP+9.20m	Length steel gate**	2.95 m

Height of lower panel**	NAP+7.30m	Highest level of gate*	NAP+11.10m
Sill height**	NAP+4.20m	Lowest level of gate*	NAP+8.40m
		Sill height*	NAP+5.45m



Figure 63: Overview of the combined Poirée and Stoney weir at complex Sambeek (Heer, 2020)

B.2. Locks with mooring areas

The weir complex consists of three navigation locks: the twin-locks (Dutch: ‘Tweelingsluizen’) that have identical designs and the original lock. In that time, it was normal for a tugboat to tug two Rijnships through locks, which resulted in the original lock to have a length of 260 meters (Ankum, Delbressine, Kurvers, & Maes, 2023). The locks are locally operated from the control house located between the twin-locks. An overview of the locks is given in Figure 64. Table 29 gives general parameters of all three locks.

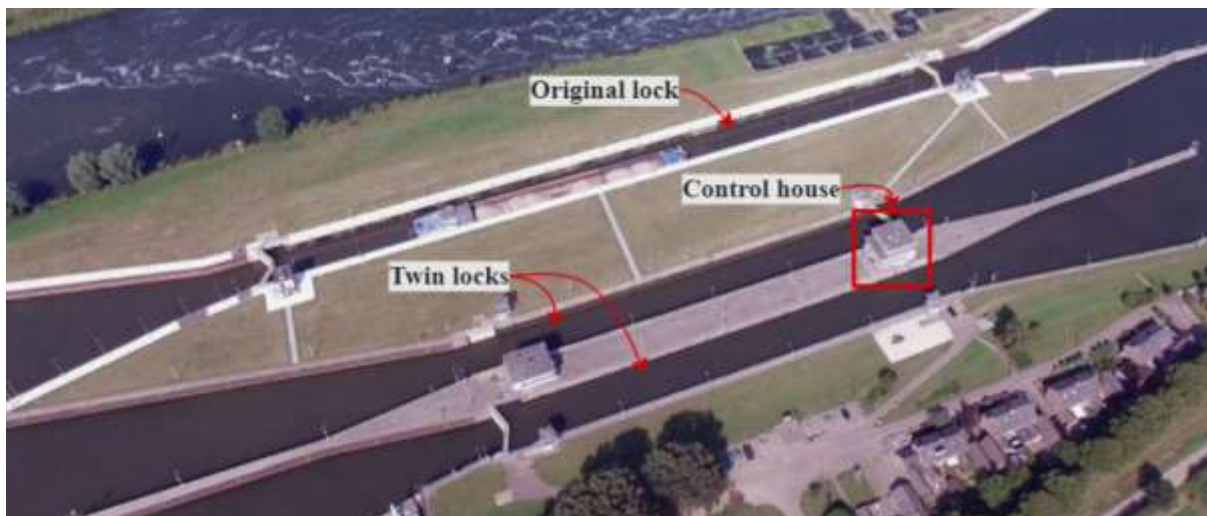

Figure 64: Overview of three lock chambers at complex Sambeek (Hensen, sd)

The ships use the locks to pass through the weir complex for discharges lower than 1300 m³/s (measured at Sint Pieter) due to the existing water level difference between the upstream and downstream side of the complex. However, when the river’s discharge exceeds 1300 m³/s and the Poirée weirs need to be fully opened, the locks become (partially) submerged and lose their functionality. In such cases, the ships navigate the weir complex by passing through the open Poirée weirs (Aubel, 2023).

Table 29: General parameters of the locks at complex Sambeek (Ankum, Delbressine, Kurvers, & Maes, 2023)

	Twin-locks	Older lock
Length lock chamber	142 meters	260 meters
Width lock chamber	16 meters	16 meters
Sill height upstream side	NAP+4.0m	NAP+6.40m
Sill height downstream side	NAP+4.0m	NAP+3.70m

B.3. Fish ladder

The fish ladder at weir complex Sambeek is located on the island between the locks and Stoney weirs. It is a V-shaped pool-and-weir fish passage that consists of a series of pools and slots to divide the total water difference at the complex into smaller more navigable steps for the fish. The fish ladder is shown in Figure 65. Fish are attracted to the highest occurring flow rate due to their rheotaxis orientation sense (Vriese, et al., 2021). For most of the year, the largest flow rate is through the Stoney weirs, which is why the fish ladder is positioned next to them, to bring the fish near its outlet (downstream entrance). However, in order for the fish to find the outlet it requires a suitable luring current.

The current fish ladder is designed with a maximum inflow rate of 4 m³/s and a total maximum water level difference of 3-4 meters between the downstream and upstream side of the complex (Vercruijssse, et al., 2021). With this design, the outlet of the fish ladder becomes submerged for river discharges above 400 m³/s, as this results in rising water levels downstream of the complex (Kranenbarg & Kemper, 2006). The submerging of the fish ladder’s outlet reduces its luring current, and consequently its findability. Therefore, it is assumed that for river discharges below 400 m³/s, the findability of the fish passage is adequate.



Figure 65: Overview of the fish ladder at Sambeek (Buiter, 2020)

B.4. Process analysis

The process analysis presents the operational sequence of events and their corresponding consequences for the current layout of complex Sambeek. The operational scheme is described below and presented in a flow scheme in Figure 66. It is important to note that the maintenance of the weir complex is not included in this flow scheme.

Describing the operational scheme

For river discharges below $1300 \text{ m}^3/\text{s}$, water level regulation using the combined Poirée and Stoney weirs is required to elevate the river's water level for navigation. Initially, the Stoney weirs primarily regulate the river until a discharge of $200 \text{ m}^3/\text{s}$. From this point, the Poirée also start to regulate the river. The closed weirs form a barrier for the passage of the river's flow, sediment transport, vessels, and fish. Both upstream and downstream migrating fish use the fish ladder to traverse the closed weirs. The fish ladder is primarily used by the upstream migrating fish, while downstream migrating fish mainly pass over the weirs. Shipping utilizes the locks to traverse the closed weirs.

As the river discharge increases, the Poirée weirs are gradually opened until the water level difference between the upstream and downstream side of the complex becomes insignificant and regulation is no longer necessary ($1300 \text{ m}^3/\text{s} \leq Q_{river} < 1600 \text{ m}^3/\text{s}$). At this stage, the Poirée and Stoney weirs are fully opened, allowing the river to flow freely. In this case, vessels pass through the open Poirée weir instead of the locks, as these are (partially) submerged. The fish can also freely pass the complex through the open weirs.

During flood river discharges ($Q_{river} \geq 1600 \text{ m}^3/\text{s}$), the floodplains surrounding complex Sambeek become (partially) inundated, and all the subsystems are (partially) submerged. During these discharges, it is assumed that shipping on the river is inhibited. Following a flood, remediation is required due to potential accumulated sediment and debris at the weirs, fish ladders and locks.

Flow scheme of weir complex Sambeek

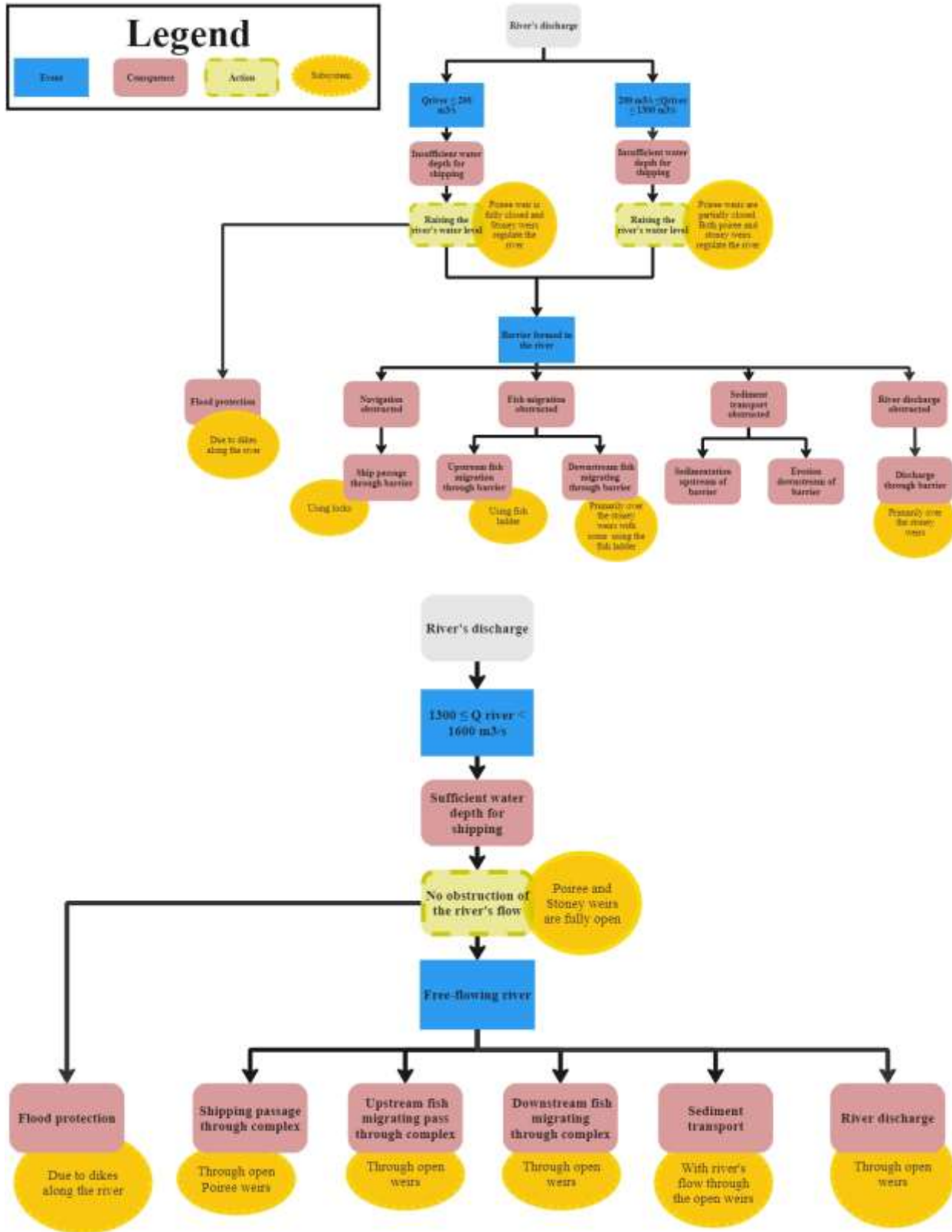

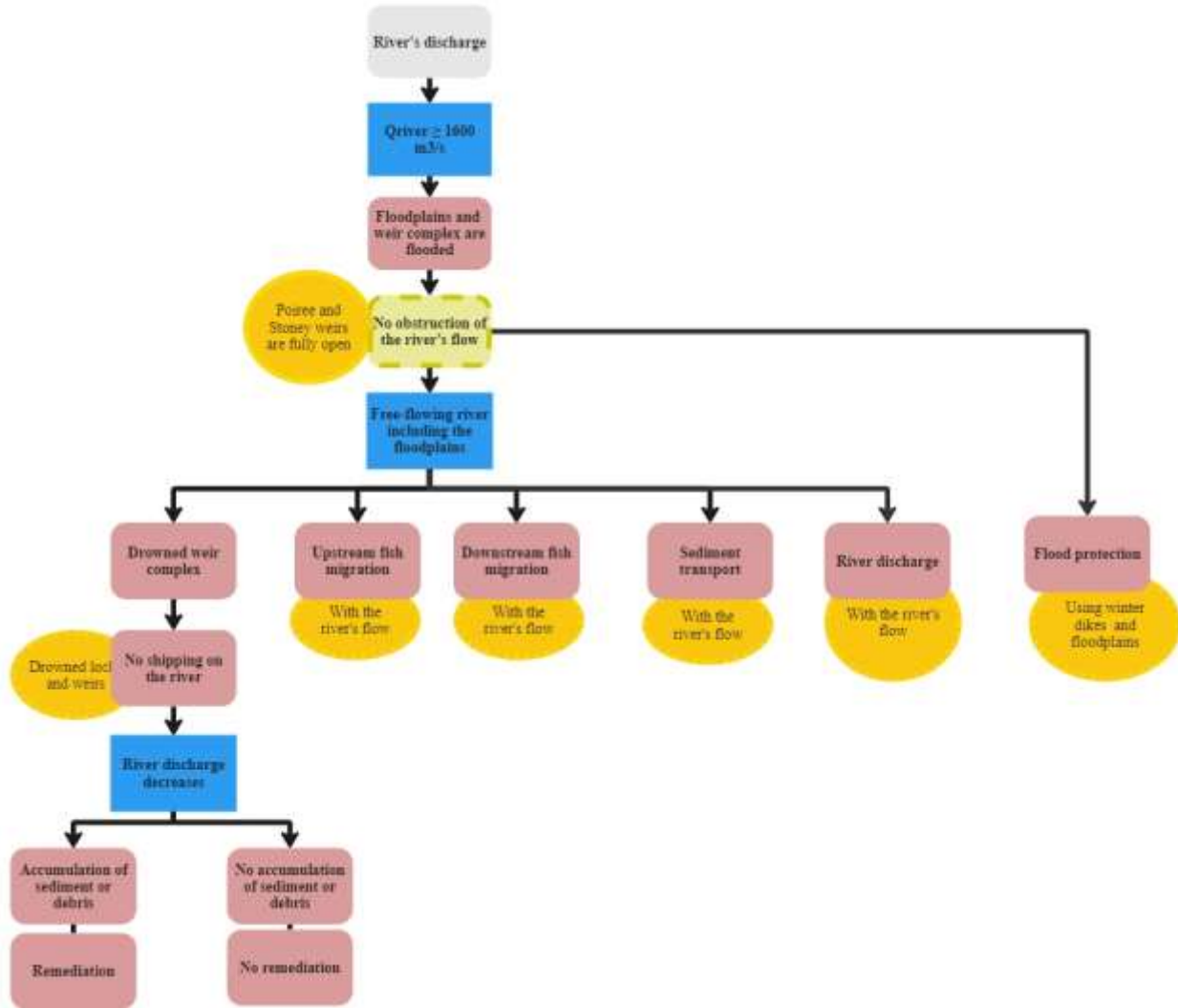

Figure 66: Flow scheme of complex Sambek operational sequence

Appendix C Required habitats of the target river species

This appendix provides the preferred habitats of the target aquatic plants, macro-fauna, and fish species. This appendix supports Section 2.4.

C.1. Aquatic plants species

For aquatic plants, those in the main stream and along the banks, it is important to have fluctuating water levels (Vriese, et al., 2021). The target aquatic plants are shown below, and their required habitats are given in Table 30. See the report by (Geest, Dorenbosch, Collas, Kessel, & Achterkamp, 2020) for an elaboration on the aquatic plant species.

Rivierfonteinkruid (*Potamogeton nodosus*)



Figure 67: Rivierfonteinkruid (*Potamogeton nodosus*) (NDFP & FLORON, 2015)

Slijkgroen (*Limosella aquatica*)



Figure 68: Slijkgroen (*Limosella aquatica*) (NDFP & FLORON, 2015)

Table 30: Ecological requirements for the target aquatic plants according to KRW-leidraad (Vriese, et al., 2021)

Soort	Stroomsnelheid (m/s)	Substraat bodem	Diepte mei (m)	Droogval tolerant
Rivierfonteinkruid (<i>Potamogeton nodosus</i>) (N2000)	0,05 – 0,75	klei en tussen stenen	0,7 – 1,5	nee
Slijkgroen (<i>Limosella aquatica</i>) (N2000)	≤ 0,3	klei of slib op zand- of grindbodems	droogvallend	ja

C.2. Macro-fauna species

The target macro-fauna species are shown below, and their required habitats are given in Table 31. The life cycle stages of the target macro-fauna are shown in Figure 76. It indicates that, aside from the suitable flow conditions within the channel, tree and other flora are required along the banks of the channel. See the report by (Geest, Dorenbosch, Collas, Kessel, & Achterkamp, 2020) for an elaboration on the macro-fauna species.

Bataafse stroommossel (*Unio crassus*)



Figure 69: Bataafse stroommossel (*Unio crassus*) (NDFP & FLORON, 2015)

Bolle stroommossel (*Unio tumidus*)



Figure 70: Bolle stroommossel (*Unio tumidus*) (NDFP & FLORON, 2015)

Kokerjuffer (*Hydropsyche contubernalis*)



Figure 71: Kokerjuffer (*Hydropsyche contubernalis*) (Observation.org, 2004)

Rivierrombout (*Gomphus flavipes*)



Figure 72: Rivierrombout (*Gomphus flavipes*) (NDFP & FLORON, 2015)

Schoraas (*Ephoron virgo*)

Vierlijnseendagsvlieg (*Ephemera glaucops*)



Figure 73: Schoraas (*Ephoron virgo*) (Observation.org, 2004)



Figure 74: Vierlijnseendagsvlieg (*Ephemera glaucops*) (Observation.org, 2004)

Zandslurfje (*Propappus volki*)

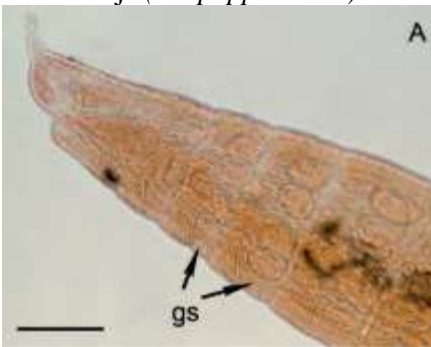

Figure 75: Zandslurfje (*Propappus volki*) (Martin & Boughrous, 2012)

Table 31: Ecological requirements for target macro-fauna according to KRW-leidraad (Vriese, et al., 2021)

Soort	Stroomsnelheid (m/s)	Substraat bodem	Diepte (m)	Temperatuur (°C)
Bataafse stroommossel (<i>Unio crassus</i>)	≤ 1,40	slib, zand, grind	0,1 - 10	7,5 - 20,0
Bolle stroommossel (<i>Unio tumidus</i>)	≤ 1,30	slib, zand, grind	0,2 - 9,2	10,0 - 24,2
Kokerjuffer (<i>Hydropsyche contubernalis</i>)	≤ 0,95	hout, grind, stenen, slib, klei, zand tussen waterplanten	≥ 0,5	0,0 - 21,0
Rivierrombout (<i>Gomphus flavipes</i>)	≤ 0,26	slib, klei, zand, stenen, waterplanten	0,3 - 3,0	1,2 - 23,5
Schoraas (<i>Ephoron virgo</i>)	≤ 1,60	slib, klei, zand, grind	n.b.	9,0 - 26,0
Vierlijnseendagsvlieg (<i>Ephemera glaucops</i>)	≤ 0,20	slib, zand, grind	≤ 9,2	n.b.
Zandslurfje (<i>Propappus volki</i>)	≥ 0,30	zand, grind, stenen	≥ 0,2	2,0 - 23,6

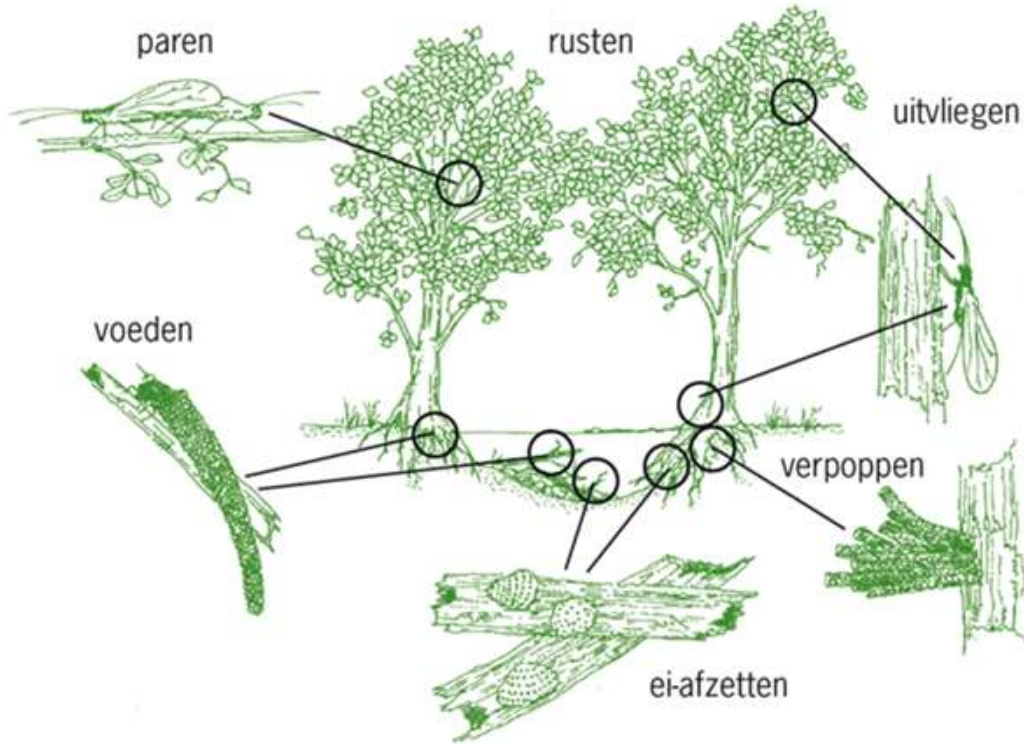

Figure 76: The different life stages of the target macro-fauna species (Vriese, et al., 2021)

C.3. Fish species

Naturally, the target fish species consists of rheophilic and rheophilic diadromous fish types, as they require lotic habitats. The target fish species are shown below, and their required habitats during different life stages is given in Table 32. See the report by (Geest, Dorenbosch, Collas, Kessel, & Achterkamp, 2020) for an elaboration on the fish species.

Barbeel (*Barbus barbus*)



Figure 77: Barbeel (*Barbus barbus*) (NDFP & FLORON, 2015)

Kwabaal (*Lota lota*)



Figure 78: Kwabaal (*Lota lota*) (NDFP & FLORON, 2015)

Riviergrondel (*Gobio Gobio*)

Rivierprik (*Lampetra fluviatilis*)



Figure 79: Riviergrondel (*Gobio gobio*) (NDF & FLORON, 2015)



Figure 80: Rivierprik (*Lampetra fluviatilis*) (NDF & FLORON, 2015)

Serpeling (*Leuciscus leuciscus*)



Figure 81: Serpeling (*Leuciscus leuciscus*) (NDF & FLORON, 2015)

Sneep (*Chondrostoma nasus*)



Figure 82: Sneep (*Chondrostoma nasus*) (NDF & FLORON, 2015)

Winde (*Leuciscus idus*)



Figure 83: Winde (*Leuciscus idus*) (NDF & FLORON, 2015)

Table 32: Ecological requirements for target fish species according to KRW-leidraad (Vriese, et al., 2021)

Soort	Stroomsnelheid (m/s)	Substraat bodem	Diepte (m)	Temp (°C)
Habitat (adulten)				
Barbeel (<i>Barbus barbus</i>)	0,16 - 1,8	zand, grind, stenen*	0,8 - 5,0	4,0 - 30,0
Kwabaal (<i>Lota lota</i>)	0,0 - 0,5	zand, grind, stenen*	1,0 - >100	0,0 - 23,3
Riviergrondel (<i>Gobio gobio</i>)	0,1 - 0,8	slib, zand, grind*	0,1 - 1,5	2,0 - 36,7
Rivierprik (<i>Lampetra fluviatilis</i>)	1,0 - 2,8	n.v.t.	0,1 - 5,0	5,0 - 18,0
Serpeling (<i>Leuciscus leuciscus</i>)	0,1 - 0,8	slib, zand, grind*	0,5 - 5,0	4,0 - 32,0
Sneep (<i>Chondrostoma nasus</i>)	0,2 - 1,1	grind, stenen*	0,3 - 1,5	4,0 - 29,0
Winde (<i>Leuciscus idus</i>)	0,05 - 1,5	slib, zand, grind, stenen*	0,3 - 5,0	4,0 - 36,0
Voortplantingshabitat (adulten)/ Opgroei habitat (eieren en larven)				
Barbeel (<i>Barbus barbus</i>)	0,2 - 1,2	grind	< 1,0	8,0 - 25,0
Kwabaal (<i>Lota lota</i>)	0,0 - 0,1	zand, grind, geïnundeerde vegetatie	0,2 - 0,8	0,0 - 5,0
Riviergrondel (<i>Gobio gobio</i>)	0,1 - 0,3	zand, grind, stenen, geïnundeerde vegetatie	0,1 - 0,5	ca. 13,0
Rivierprik (<i>Lampetra fluviatilis</i>)	0,5 - 1,0	zand, grind, stenen/ fijn organisch materiaal	0,2 - 1,5	> 9,0
Serpeling (<i>Leuciscus leuciscus</i>)	0,02 - 0,5	zand, grind, stenen	0,18 - 0,30	7,0 - 10,0
Sneep (<i>Chondrostoma nasus</i>)	0,5 - 1,0	grind	ca. 0,30	8,0 - 14,0
Winde (<i>Leuciscus idus</i>)	0,05 - 0,5	zand of grind, geïnundeerde vegetatie	0,5 - 1,5	8,0- 10,0
Opgroei habitat (juвениel)				
Barbeel (<i>Barbus barbus</i>)	0,2 - 1,2	zand, grind, stenen*	0,2 - 0,75	< 25,0
Kwabaal (<i>Lota lota</i>)	0,0 - 0,15	zand, grind, stenen*	0,2 - 0,3	< 25,5
Riviergrondel (<i>Gobio gobio</i>)	0,0 - 0,2	zand, grind*	< 0,5	
Serpeling (<i>Leuciscus leuciscus</i>)	0,0 - 0,5	slib, zand, grind*	0,18 - 0,3	< 15,0
Sneep (<i>Chondrostoma nasus</i>)	0,2 - 1,1	grind, stenen*	0,05 - 1,5	
Winde (<i>Leuciscus idus</i>)	0,0 - 1,5	slib, zand, grind, stenen*	0,2 - 5,0	

* Adulten en juvenielen zoeken (tevens) beschutting in grind/stenen, diepe kommen, holle oever, overhangende vegetatie, boomwortels, obstakels en/of vegetatie.

Appendix D Fish passage's target and required flow conditions

The appendix provides the quantification of the fish passage's findability and passability requirements and target values. This appendix supports Subsection 3.1.4.

D.1. Findability conditions for the fish passage

The findability refers to whether the target fish can easily locate the fish passage's inlet (upstream entrance) and outlet (downstream entrance). This makes the inlet and outlet design of the fish passage critical for its findability. The main conditions for the fish passage's findability depend on the following:

1. Placement of the outlet location
2. The luring current's magnitude
 - a. The outflow rate
 - b. The outflow velocity
3. Direction of the luring current
4. Transition of the fish passage's outlet to the riverbed
5. Placement of the inlet location
6. Transition of the fish passage's inlet to the riverbed

1. Placement of the outlet location

Fish are attracted to the largest occurring flow rate in the waterway due to their rheotaxis orientation sense. Therefore, it is advised to position the fish passage next to the structure with the largest flow rate to increase its findability (Coenen, Antheunisse, Beekman, & Beers). At weir complex Sambeek, this is typically the flow over the Stoney weirs, which is why the existing fish passage is placed next to them.

Position downstream of the weirs

The report (Vriese, et al., 2021) states that upstream migrating fish tend to follow an imaginary migration line along the downstream turbulent zones of the weirs, to find alternative ways to navigate further upstream, see Subsection 1.2.3. However, the report (Ghodrati, 2021) indicates that the downstream turbulent zones and the migration line itself do not form a barrier for the upstream migrating fish.

This conclusion stems from hydraulic tests conducted to determine whether upstream migrating fish stop at the downstream turbulent zones of the weirs or continue swimming until reaching the weirs themselves. The tests involved multiple fish passage outlets (downstream entrances) located 0 – 7.5 m downstream of a weir with downstream turbulence intensities up to 1300 W/m^3 , all with the same luring current. The test showed that various fish species (both bottom dwelling and non-bottom dwelling species) passed the turbulent zones, with the entrance located 0 meters downstream of the weir being the most easily found by the fish.

Therefore, the report recommends locating the fish passage outlet (downstream entrance) aligned with the weir itself or, if necessary, at a less efficient but still acceptable location less than 5 meters downstream of the weirs. Anything further than 10 meters downstream of the weirs is considered non-findable, provided the flow rate over the weirs is higher than that of the fish passage.

Hence, the recommendations by the report (Ghodrati, 2021) is taken into account for hydraulic structures with energy dissipations below 1300 W/m^3 , and the recommendation by the report (Vriese, et al., 2021) is taken into account for higher energy dissipation levels.

Luring current magnitude

With the fish passage positioned just downstream of the highest occurring flow rate, the fish are in proximity to the fish passage's outlet. However, the outlet is only findable if the luring current is detected by the fish. The detectability of the luring current depends on the fish passage's outflow velocity and outflow rate (Ghodrati, 2021).

Outflow velocity

Higher outflow velocities are more detectable for the fish and thus increase the fish passage's outlet findability. However, high flow velocities form a barrier for weaker swimmers. Therefore, it is recommended to maintain an outflow velocity of 1.0 m/s (Ghodrati, 2021). This flow velocity is considered a flow requirement. It should be noted that this requirement only applies if the fish passage does not have the highest flow rate at the weir complex.

Outflow rate

As a rule of thumb, it is advised to have a discharge through the fish passage that is a minimum of 5-10% of the river's discharge during the fish's migration period (Coenen, Antheunisse, Beekman, & Beers). This discharge range is taken as a target flow condition and not as a requirement.

Direction of the luring current

The report (Coenen, Antheunisse, Beekman, & Beers) and (Kroes & Monden) states that the fish passage's luring current should be perpendicular to the river's flow to increase its findability, as this positioning allows the luring current to have the largest reach and pulling force. However, the report (Ghodrati, 2021) indicates that the fish passage outlet is more easily located if the luring current is parallel to the main flow. This conclusion stems from hydraulic tests conducted to determine which luring current direction is most easily found by the fish. The considered directions were 0° , 45° , or 90° to main flow, see Figure 84. Seeing that the advised luring current direction in the report (Ghodrati, 2021) is supported by hydraulic tests, it is considered as a flow requirement in this report. Hence, the luring current of the fish passage must be parallel to the river's flow.

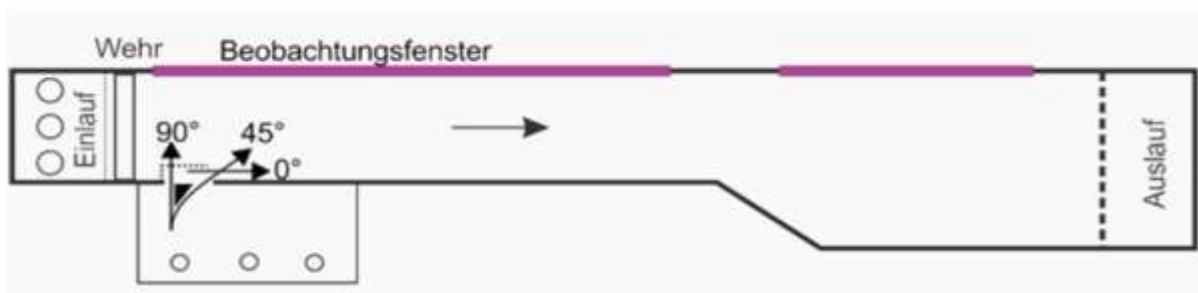

Figure 84: Overview of the hydraulic test to determine the most optimal luring current angle (Ghodrati, 2021)

Placement of the inlet location

The fish passage's inlet (upstream entrance) must not be positioned too close to the weirs, as fish may abandon the fish passage and approach the weirs or be swept away by the flow of the weirs (Coenen, Antheunisse, Beekman, & Beers). There is no advised distance for the placement of the fish passage's inlet.

D.2. Passability conditions for the fish passage

The passability of the fish passage depends on the geometrical and hydraulic dimensions of the fish passage. The geometrical dimensions refer to the water depths and widths of the flow openings within the fish passage. The hydraulic dimensions refer to the flow conditions within the fish passage, such as flow velocities, water depths, and energy dissipation. These conditions must be limited to ensure safe passage for all target fish species (Ghodrati, 2021).

Target Geometrical dimensions

The required geometrical dimensions to achieve the necessary flow conditions in the fish passage are based on the representative fish expected to use the fish passage. For the river Meuse, the representative fish is the Europe Meerval. The size of the fish is shown in Figure 85. The required ratio between the geometrical dimensions and the fish's size is described in the report (Ghodrati, 2021) and shown in Table 8.

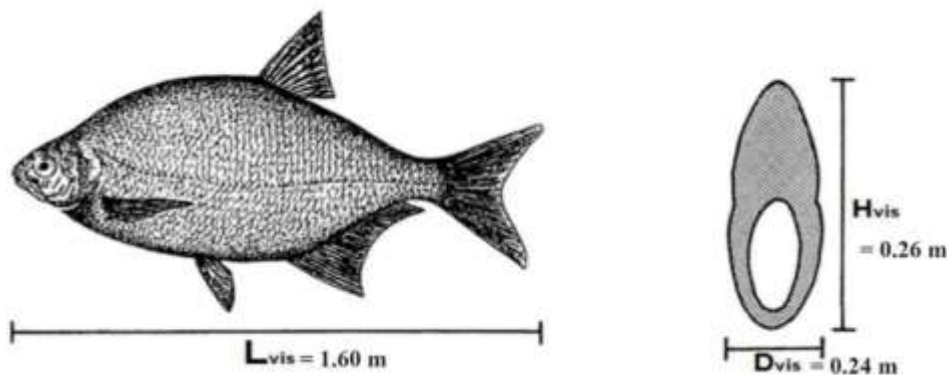

Figure 85: Size of representative European Meerval fish (Ghodrati, 2021)

Target Hydraulic dimensions

The required hydraulic dimensions to achieve the necessary flow conditions in the fish passage are based on the representative fish expected to use the fish passage are based on the characteristics of the fish zone the passage is in. This ensure suitable flow conditions for all fish species within this fish zone. Weir complex Sambek lies in the Brasem fish zone. The corresponding hydraulic dimensions are described in the report (Ghodrati, 2021) and outlined below.

Water level difference and maximum flow velocity over weir/slot

The water level difference (Δh) over the weir/slot is the difference between the water level upstream (h_1) and downstream water level (h_3) relative to the deepest part of the weir/slot, as shown in Figure 86. This water level difference determines the flow velocity and turbulence intensity over the weir/slot. Larger water level differences lead to higher flow velocities and turbulence intensities. Therefore, it is crucial to limit the water level difference to control these values. According to the report by (Coenen, Antheunisse, Beekman, & Beers), the water level difference should be limited to 0.08 m, especially as inaccuracies occur during the construction of the fish passage, which can lead to higher water level differences in practice.

According to the report by (Ghodrati, 2021), water level differences below 0.10 m create passable flow conditions for the fish species in the Brasem fish zone, while differences above 0.15m likely makes the fish passage impassable for several fish species. Therefore, water level difference below 0.10 m are taken as the target values, and a difference of 0.15 m is taken as the maximum acceptable value.

In addition, the water level difference in combination with the upstream water level of the weir also determines the drowning rate for the weir (S), which can determine whether a weir is fish passable (Coenen,

Antheunisse, Beekman, & Beers). The minimum value for the drowning rate (S) is 0.5. The equation to determine the drowning rate is:

$$S = \frac{h_3}{h_1} = \frac{h_1 - \Delta h}{h_1} \geq 0.5$$

Where:

S = drowning rate of the weir [-]

h_1 = water level upstream of the weir [m]

h_3 = water level downstream of the weir [m]

Δh = water level difference over the weir structure [m]

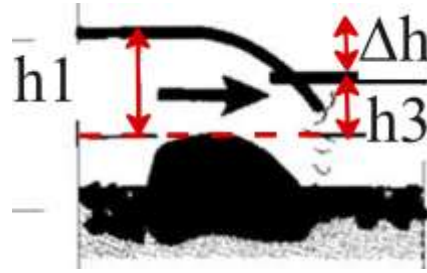

Figure 86: The water level upstream and downstream of a weir

Maximum flow velocities

The maximum allowable flow velocity in the fish passage is set to 1.0 m/s to ensure it is passable for smaller and weaker swimming fish. It also limits to occurrence of excessive erosion in the fish passage. The flow velocity over/through the weirs/slots can be higher, as fish can sprint over a short distance. This is known as their sprint swimming speed (Dutch: ‘Sprintsnelheid’), which they can maintain over a distance of 1.0 m (Ghodrati, 2021). This maximum flow velocity over/through the weirs/slots depends on the water level difference and is calculated with the following equation

$$u_{max,opening} = \sqrt{2 \cdot g \cdot \Delta h}$$

Where:

$u_{max,opening}$ = maximum flow velocity over the weir/slot [m/s]

g = gravitational acceleration [m/s²]

Δh = water level difference over the weir/slot [m/s]

With the target water level differences of ≤ 0.10 m, the target flow velocity is ≤ 1.4 m/s. With the maximum water level difference of 0.15 m, the maximum allowable flow velocity is 1.7 m/s.

Maximum flow velocity at fish passage bottom

It is important to have lower flow velocities at the bottom of the fish passage to accommodate the weaker swimming fish and bottom-dwelling fish species. According to the report by (Ghodrati, 2021), this can be achieved by adding a 20 cm thick rough substrate layer to the bottom of the fish passage. It has been empirically determined that this reduces the bottom flow velocity to one-third of the average flow velocity of the fish passage. Therefore, the maximum target bottom flow velocity over/through a weir/slot is 0.45 m/s, which is one-third of the target flow velocity. The maximum allowable bottom flow velocity over/through a weir/slot is 1.0 m/s.

Energy dissipation the fish passage

The turbulence intensity over a weir/slot corresponds to the energy dissipation over it. This energy dissipation must be limited to the amount of energy a fish can produce in one second per cubic meter (m³) to navigate the flow (Ghodrati, 2021). The energy dissipation depends on the flow’s energy and the volume of the pools. The flow’s energy is determined by the flow rate and the water level difference over the weir/slot. This energy must be fully dissipated in the pools, meaning the pool must have sufficient volume to achieve this. The energy dissipation over a weir/slot structure is determined with the Larinier equation:

$$\varepsilon = \frac{\rho \cdot g \cdot Q_{inflow} \cdot \Delta h}{L_{pool} \cdot B_{pool} \cdot h_2}$$

Where:

ε = energy dissipation

ρ = water density [kg/m³]

Q = flow rate [m³/s]

Δh = Water level difference over the weir/slot [m]

L_{pool} = length of the pools [m]

B_{pool} = width of the pools [m]

h_3 = water depth downstream of the slot relative to fish passage bottom [m]

The target energy dissipation is $\leq 100 \frac{W}{m^3}$, and the maximum allowable value is $\leq 150 W/m^3$ (Ghodrati, 2021).

Appendix E Equations describing the channel's hydraulic processes

This appendix provides a brief overview of the concept of equilibrium flow depth and the four fundamental hydraulic equations used to describe the relationships between the channel's parameters. The appendix supports Section 4.1.

General simplifications

Since these equations have interrelated relationships, they are solved iteratively until a convergence is reached between the parameters. In addition, several general simplifications are made to enable an analytical determination of the channel's design. These simplifications include that the channel has:

- Gradually varying flow
- Quasi-uniform flow
- Hydrostatic pressure
- Subcritical flow
- Turbulent flow
- Incompressible fluid

Equilibrium flow depth concept

As stated, uniform flow is initially assumed in the channel based on which the corresponding equilibrium flow depths and depth average flow velocities are determined. These are constant throughout the channel and indicate the stable equilibrium state the channel gradually adjusts to. This adjustment occurs over a certain length, known as the adaptation length (Blom, 2021). If the ratio between the adaptation length and the channel's length is small, then a significant portion of the channel's water depth closely approximates the equilibrium flow depth. Hence, the equilibrium flow depth is used to establish initial channel parameters.

The equilibrium flow depth occurs when the channel's bed slope and friction slope are equal ($i_b = i_f$), resulting in a water depth gradient of zero ($\frac{dd}{ds} = 0$). Substituting this water depth gradient into the Belanger equation leads to a non-linear equation, as the wet perimeter (P), wet cross-sectional area (A), and friction coefficient (c_f) depend on the channel's water depth. This relationship is shown in Table 33. The equilibrium flow depth is approximated by iteratively solving the non-linear equation.

Equation 1. Belanger equation (Backwater curve equation)

The Belanger equation is used to determine the water depth profiles, also known as the Backwater curves, of the channel. The equation describes the gradual water depth variation upstream of the channel's downstream boundary condition. For the ecological channel, this downstream boundary condition corresponds to the water depth at the channel's outlet (d_{BC}), where the channel's cross-section remains uniform. Given that the Belanger equation applies to flows with gradual variations (quasi-uniform flow), any abrupt change in the channel's geometry, such as narrowing the channel's outlet, would shift the boundary condition upstream of this variation. The Belanger equation and its corresponding parameters are shown in Table 33 and Figure 87. The channel's depth averaged flow velocity is determined by the channel's flow rate and wet cross-sectional area: $u_{avg} = \frac{Q_{eco}}{A}$.

Typically, the outflow from the channel to the river experiences energy loss, resulting in a lower water depth at channel's outlet (d_{BC}). However, for an initial channel design, this energy loss is neglected, as it is assumed that it is insignificant compared to the channel's friction loss.

Table 33: The Belanger equation and its parameters (Battjes & Labeur, 2017)

Belanger equation and its parameters	
$\frac{dd}{ds} = \frac{i_b - i_f}{1 - F_r^2}$	d_s/d_s : water surface slope variation [-] i_b : channel's bed slope [-] i_f : channel's friction slope [-] F_r : Froude number [-]
$i_f = \frac{c_f \cdot Q_{eco}^2 \cdot P}{g \cdot A^3}$	Q_{eco} : channel's flow rate [m ³ /s] c_f : Channel's bed friction coefficient (roughness coefficient) [-] A : channel's wet cross-sectional area [m ²] P : channel's wet perimeter [m]
$F_r^2 = \frac{Q_{eco}^2 \cdot B_c}{g \cdot A^3}$	Q_{eco} : channel's flow rate [m ³ /s] B : Channel's top width [m] A : channel's wet cross-sectional-area [m ²]
$i_b = \frac{\Delta z}{L_{channel}}$ $\Delta z = z_{inlet} - z_{outlet}$	$L_{channel}$: channel's length [m] Δz : difference between the channel's inlet and outlet bed levels [m] z_{inlet} : the bed level at the channel's inlet [m] z_{outlet} : the bed level at the channel's outlet [m]
$d_e \rightarrow \frac{dd}{ds} = 0$ $\frac{A^3}{P} = \frac{c_f \cdot Q_{eco}^2}{i_b \cdot g}$	d_e : equilibrium flow depth [m] Q_{eco} : channel's flow rate [m ³ /s] c_f : Channel's bed friction coefficient (roughness coefficient) [-] A : channel's wet cross-sectional area [m ²] P : channel's wet perimeter [m]

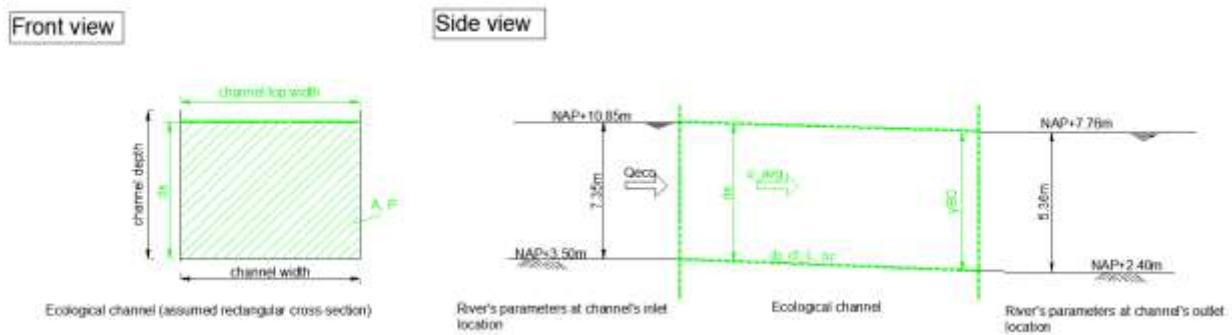

Figure 87: Overview of the channel parameter's influencing the Belanger equation.

Equation 2: The White-Colebrook equation

The channel's bed roughness is described by the friction coefficient (c_f) instead of the Manning or Strickler coefficients. This choice is made because the friction coefficient accounts for effects, such as the channel's water depth and bed roughness height, allowing for a more accurate representation of the channel's bed roughness. The channel's friction coefficient is determined with the White-Colebrook equation. For an initial channel design, it is assumed that the channel has fully turbulent and hydraulically rough flow conditions. Table 34 shows the White-Colebrook equation and its corresponding parameters for these flow conditions.

Table 34: The White-Colebrook equation for turbulent and rough flow conditions (Blom, 2021)

White-Colebrook equation	
$\frac{1}{\sqrt{c_f}} = 5.75 \cdot \log \left(\frac{12 \cdot R}{k_s} \right)$	c_f : channel's friction coefficient [-] R : channel's hydraulic radius [m] A : channel's wet cross-sectional area [m ²]

$R = \frac{A}{p}$ $k_s = 3.5 \cdot d_{n50}$	<p>P: channel's wet perimeter [m] k_s: channel's equivalent bed roughness height [m] d_{n50}: nominal diameter of the channel's bed material [m] <i>*The factor 3.5 is an empirically determined factor</i></p>
---	---

Equation 3: Shields equations

In addition to the required water depths and flow velocities, the ecological channel must have a stable channel bed, meaning there is no excessive erosion in the channel. This stability is achieved by establishing a channel bed with a critical flow velocity that is higher than the occurring flow velocities. The critical flow velocity indicates the point where the bed material starts moving. This critical flow velocity is determined with the Shields equation, see Table 35. The Shields equation assumed deep-water conditions ($\frac{\text{water depth}}{\text{grain diameter}} > 5$). For an initial channel design, the slopes and turbulence effects are neglected.

Table 35: The adapted Shields equation and its parameters (Schierreck & Verhagen, 2019)

<p>Shields equation</p> $\bar{u}_c = \frac{C \cdot \sqrt{d_{n50} \cdot \Delta \cdot \Psi_c \cdot K_s}}{K_v}$ $C = \sqrt{g/c_f}$ $\Delta = \frac{\rho_{bedmaterial}}{\rho_{water}} - 1$	<p>\bar{u}_c: critical mean depth average flow velocity [m/s] Ψ_c: critical Shields parameter [-] Δ: relative submerged density of the bed material [-] C: Chézy coefficient [$\sqrt{\text{m/s}}$] c_f: friction coefficient [-] d_{n50}: nominal diameter [m] K_s: slope effects that decreases the channel bed's strength [-] K_v: turbulence effects that increases the load on the channel bed [-]</p>
---	--

Appendix F Determining the channel's flow conditions for uniform flow

This appendix provides the Python code used to iteratively determine the channel's uniform flow conditions. Comments are provided throughout the Python code to help follow the process. The channel parameters and average flow conditions are shown in Table 36. The flow conditions in the channel's thalweg and bank areas are shown Table 37, Figure 88 and Figure 89. This appendix supports both Subsections 4.1.4 and 4.1.7. The values that support these subsections are referred to as the initial values and final values, respectively. In addition, this appendix also provides the Python code used to estimate the occurrence of river discharges below 30 m³/s.

F.1. Calculating the flow conditions for uniform flow

Importing the required libraries

```
In [1]: import numpy as np
import matplotlib.pyplot as plt
import matplotlib
%matplotlib inline
import pandas as pd
from pandas import read_csv
from scipy.stats import norm
import matplotlib.cm as cm
import cmath
import math

g = 9.81
rho = 1000 #kg/m3
```

Ecological channel's parameters

```
In [2]: ##### CHANNEL'S BED ELEVATION #####
z_inlet_end = 9.35 #NAP+ #<-----the channel's initial inlet bed elevation
z_outlet_start = 7.21 #<-----the channel's initial outlet bed elevation

z_inlet_end = 8.95 #NAP+ #<-----the channel's final inlet bed elevation
z_outlet_start = 7.21 #<-----the channel's final outlet bed elevation

dz = z_inlet_end - z_outlet_start #channel's bed level difference (Δz)

##### CHANNEL'S LENGTH #####
L = [3500]
ib_list = []

for j in range(len(L)):
    ib = dz/L[j]
    ib_list.append({'L [m]': L[j], 'Δz [m]': dz, 'ib': ib})

df_slope = pd.DataFrame(ib_list) # add the above parameters into a dataframe
display(df_slope.head(20))

##### CHANNEL'S INFLOW RATE #####
one_weir = []
Q_ain = [5, 10, 20, 30, 40, 50] #<----- the initial inflow rate range
Q_afe = [5, 6.6, 12.5, 16, 20] #<----- final inflow rate range

for i in range(len(Q_ain)):
    Qweir_inflow = Q_ain[i]
    one_weir.append({'Qweir [m3/s]': Qweir_inflow})

df_weir = pd.DataFrame(one_weir)
display(df_weir.head(20))
```

L [m]	Δz [m]	ib
0	3500	2.14
0	3500	0.000611

L [m]	Δz [m]	ib
0	3500	1.74
0	3500	0.000497

Qweir [m ³ /s]	
0	5
1	10
2	20
3	30
4	40
5	50

Qweir [m ³ /s]	
0	5.0
1	6.6
2	12.5
3	16.0
4	20.0

Channel's cross-section: compound trapezoidal

```
In [3]: bottom_level = z_outlet_start #using the cross-section at the channel's outlet for the calculations
floodplain_level = 12 #MHP+ #c-----ground elevation of the surrounding floodplains

##### INITIAL CHANNEL PARAMETER VALUES #####
b_bottom = 20 #c-----Initial bottom width of the channel
y_step = 0.5 #c-----Initial thalweg and bank area step height
a_step = 5.0 #c-----Initial bank area's step width
m_step = 2 #c-----Initial channel's bed slopes

##### FINAL CHANNEL PARAMETER VALUES #####
b_bottom = 12 #c----- the final bottom width
y_step = 0.5 #c-----Initial thalweg and bank area step height
a_step = 4.0 #c-----Initial bank area's step width
m_step = 2 #c-----Initial channel's bed slopes

a_thalweg = b_bottom/2 #dividing the channel into two halves to simplify the plot of the cross-section
step_height_a_m = [(0.5, a_thalweg, m_step), (y_step, a_step, m_step), (y_step, a_step, m_step)] #thalweg, bank area 1, 2.
N = len(step_height_a_m) # the number of steps; thalweg, bank area 1 and 2

# parameter for the area remaining between the channel and the floodplains.
a_over = 2
m_over = 0

# drawing the channel's cross sectional shape
def draw_empty_trap(N, bottom_level, step_height_a_m, b_bottom, level_floodplain, a_over, m_over):
    x_cor = [0]
    y_cor = [bottom_level]

    step_a = step_height_a_m[0][1]
    b_thalweg = b_bottom - (2*step_a) #ensures that the thalweg's bottom aligns with the channel's bottom
    w_list = [b_thalweg]
    b_list = []

    d_list = []
    a_list = []
    m_list = []

    for i in range(N):
        d_list.append(step_height_a_m[i][0])
        a_list.append(step_height_a_m[i][1])
        m_list.append(step_height_a_m[i][2])

        x0 = x_cor[-1]
        y0 = y_cor[-1]

        x1 = x0 + a_list[i]
        y1 = y0 + 0

        x_cor.append(x1)
        y_cor.append(y1)
        x2 = x1 + (m_list[i] * d_list[i])
        y2 = y1 + d_list[i]

        x_cor.append(x2)
        y_cor.append(y2)

        b = (2 * a_list[i]) + w_list[i]
        w = b + (m_list[i] * d_list[i] * 2)

        b_list.append(b)
        w_list.append(w)

    #remaining depth between the channel and floodplains
    y_over = level_floodplain - np.sum(d_list) - bottom_level
    d_list.append(y_over)

    m_list.append(m_over)
    a_list.append(a_over)

    x1_over = x_cor[-1] + a_over
    y1_over = y_cor[-1] + 0

    x_cor.append(x1_over)
    y_cor.append(y1_over)

    x2_over = x1_over + (m_over * y_over)
    y2_over = y1_over + y_over
```

← Initial values

← Final values

```

x_cor.append(x2_over)
y_cor.append(y2_over)

b_over = (2 * a_over) + w_list[-1]
w_over = b_over + (n_over * y_over * 2)

b_list.append(b_over)
w_list.append(w_over)

w_list = w_list[1:]

y_tot = np.sum(d_list)

x_cor_spiegel = [-x for x in x_cor]

plt.plot(x_cor, y_cor)
plt.plot(x_cor_spiegel, y_cor)
plt.xlim(-x2_over - 5, x2_over + 5)

plt.xlabel('x [m]')
plt.ylabel('elevation [m]')
plt.title('front view of the compound trapezoidal cross-section')
plt.grid()
plt.show()

return d_list, a_list, m_list, b_list, w_list, y_over, y_tot
d_list, a_list, m_list, b_list, w_list, y_over, y_tot = draw_empty_trap(N = N, bottom_level = bottom_level,
    stop_height_a_m = stop_height_a_m, b_bottom = b_bottom, level_floodplain = floodplain_level,
    a_over = a_over, n_over = n_over)

print(f"the total depth of the channel (at the outlet) is: {np.round(y_tot, 3)} m")
print(f"the channel bottom bed is: {b_bottom} m")
print(f"the channels area top width is: {np.round(w_list[-1],3)} m")

```

Initial values

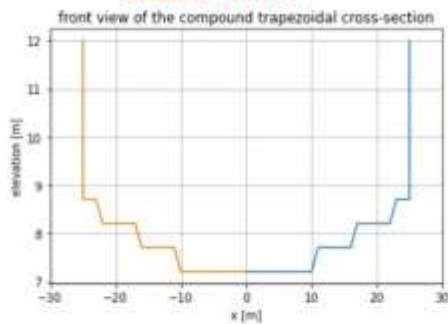

the total depth of the channel (at the outlet) is: 4.79 m
the channel bottom bed is: 20 m
the channels area top width is: 50.0 m

Final values

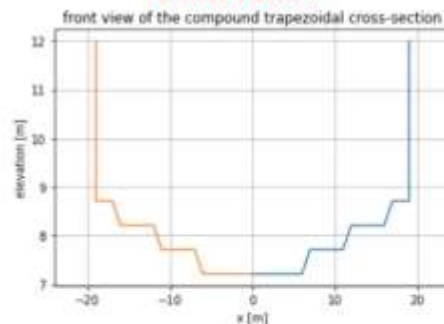

the total depth of the channel (at the outlet) is: 4.79 m
the channel bottom bed is: 12 m
the channels area top width is: 38.0 m

```

In [4]: ##### MAKING LISTS OF THE CROSS-SECTIONAL DIMENSIONS #####
breedte_hoogte_slope = []
for i in range(len(b_list)):
    breedte_hoogte_slope.append((b_list[i], d_list[i], m_list[i]))

print(breedte_hoogte_slope)
# print('d', sum([d for b,d,m in breedte_hoogte_slope]))

```

Calculating the channel's flow conditions for uniform flow

```

In [5]: def NewtonIteration_de(intervals, de_0, Q, breedte_hoogte_slope, So, dn50, l_channel, z_outlet_start): #iterative process
#uniform flow -> friction slope = bed slope (Sf = So)
de_list = [de_0]
delta = 1.65 # used in shields equation-----
shields = 0.03 ## used in shields equation-----

Sf_list = []
cf_list = []
Fy_list = []
u_list = []
difference_list_de = []

Rtot_list = []
Atot_list = []
Ptot_list = []

u_critical_list = []

breedte_hoogte_hoek = breedte_hoogte_slope
for i in range(intervals):
    x = 0
    Atot = 0
    Ptot = 0
    top_width = 0
    for b,d,m in breedte_hoogte_hoek: #loop for determining A, P, B, and the topwidth
        if de_list[i] > dx: #d is for the depth of the channel not the water depth
            x = dx

            Atot = Atot + (b * d) + (m * (d**2))
            dAdy = b + (2*m*d)

            Ptot = Ptot + (b + (2*d*np.sqrt(1+(m**2)))) - top_width
            dPdy = 2*np.sqrt(1+(m**2)) #does not include top width, as it is a constant

            top_width = b + (2 * m * d)
            top_width_dy = 2 * m

        else:
            Atot = Atot + (b * (de_list[i]-x)) + (m * ((de_list[i]-x)**2))
            dAdy = b + (2*m*de_list[i]) - (2*x*m)

            Ptot = Ptot + b + (2*(de_list[i]-x) * np.sqrt(1+(m**2))) - top_width
            dPdy = 2*np.sqrt(1+(m**2)) #does not include top width, as it is a constant

            top_width = b + (2 * m * (de_list[i] - x))
            top_width_dy = 2 * m

        break

    Atot_list.append(Atot)
    Ptot_list.append(Ptot)

    #From this point the calculations are performed for the total cross-sectional area, wet perimeter and hydraulic radius
    Rtot = Atot/Ptot
    Rtot_list.append(Rtot)

    ##### WHITE COLEBROOK EQUATION #####
    ks = 3.5 * dn50 #assumed dn50 constant throughout the channel
    cf = (1/(5.75*np.log10((12*Rtot)/ks))) ** 2
    cf_list.append(cf)

    Sf = (cf * (Q**2) * Ptot) / (g*(Atot**3)) #friction slope
    Sf_list.append(Sf)

    Fy = ((So / Sf) - 1) #Function of de (F(de))
    Fy_list.append(Fy)

    dSf_dy = ((Q**2) * ((cf*Atot*dPdy) - (3*cf*Ptot*dAdy))) / (g * (Atot**4)) #derivative of the friction slope
    dFy_de = -So * (Sf**-2) * dSf_dy #derivative of the function F(de)

    de = (de_list[i] - (Fy/dFy_de)) #new depth
    de_list.append(de)

    u = Q / Atot # flow velocity
    u_list.append(u)

```



```

difference_de = de_list[i+1] - de_list[i]
difference_list_de.append(difference_de)

##### SHIELDS EQUATION #####
#critical flow velocity where sediment transport occurs (most critical at lowest water depth)
C = np.sqrt(g/cf)
u_critical = C * np.sqrt(shields * delta * dn50)
u_critical_list.append(u_critical)

if np.abs(Fy) < 10**-10: # check whether F(de) is close to zero
# print('converged')
break

return de_list, Sf_list, Fy_list, difference_list_de, cf_list, u_list, Rtot_list, Atot_list, Ptot_list, u_critical_list

de_results = []
de_print = []

de_0 = 3.0 # <-----de_0 = initial guess for the equilibrium water depth

dn50 = 3.18 * (10 **3) #<----- the initial friction coefficient
dn50 = 0.078 #<----- the final friction coefficient

for k in range(len(df_weir['Qweir [m3/s]'))):
for j in range(len(df_slope['L [m]'))):
de_list, Sf_list, Fy_list, diff_list, cf_list, u_list, R_e, A_e, P_e, u_crit = NewtonIteration_de(intervals = 1000,
de_0 = de_0, Q = df_weir['Qweir [m3/s]'][k], breedte_hoogte_slope = breedte_hoogte_slope,
So = df_slope['ib'][j],dn50 = dn50, L_channel = df_slope['L [m]'],
z_outlet_start = z_outlet_start)

de_results.append({'Qweir': df_weir['Qweir [m3/s]'][k], 'L': df_slope['L [m]'][j], 'dz [m]': dz,
'ib': df_slope['ib'][j], 'A':A_e, 'P_e': P_e, 'R': R_e,'cf': cf_list, 'cf_final': cf_list[-1],
'de': de_list, 'u': u_list, 'de_final': de_list[-1], 'u_e': u_list[-1], '< u_crit': u_crit[-1]})

de_print.append({'Qeco [m3/s]': df_weir['Qweir [m3/s]'][k], 'Lchannel [m]': df_slope['L [m]'][j], 'dz [m]': dz,
'ib': df_slope['ib'][j], 'B_bottom [m]': b_bottom, 'y_bank [m]': y_step, 'a_bank [m]': a_step,
'm_side_slope': m_step, 'dn50 [m]': dn50, 'A [m2]': np.round(A_e[-1],2), 'P [m]': np.round(P_e[-1],2),
'R [m]': np.round(R_e[-1],2), 'cf(de)': cf_list[-1], 'de [m]': np.round(de_list[-1],2),
'u_avg [m/s]': np.round(u_list[-1],2), 'u_crit [m/s]': np.round(u_crit[-1],2)})

df_de = pd.DataFrame(de_results)
# display(df_de.head(30)) #<----- this dataframe shows the lists with all the iteration values

for p in range(len(df_de['cf'])):
print(f"number of iterations for each inflow rate: {len(df_de['cf'][p])}")

df_de_print = pd.DataFrame(de_print)
display(df_de_print.head(30)) #<----- this dataframe shows the final values after iterating

```

Table 36: Overview of the channel's initial and final average flow conditions for uniform flow

Initial flow conditions																
number of iterations for each inflow rate: 19																
number of iterations for each inflow rate: 16																
number of iterations for each inflow rate: 16																
number of iterations for each inflow rate: 14																
number of iterations for each inflow rate: 14																
number of iterations for each inflow rate: 13																
Qeco [m ³ /s]	Lchannel [m]	Δz [m]	ib	B_bottom [m]	y_bank [m]	a_bank [m]	m_side_slope	dn50 [m]	A [m ²]	P [m]	R [m]	ch(de)	de [m]	u_avg [m/s]	u_crit [m/s]	
0	5	3500	2.14	0.000811	20	0.5	5.0	2	0.00318	7.44	21.61	0.34	0.004580	0.36	0.67	0.58
1	10	3500	2.14	0.000811	20	0.5	5.0	2	0.00318	13.30	32.63	0.41	0.004329	0.59	0.75	0.60
2	20	3500	2.14	0.000811	20	0.5	5.0	2	0.00318	20.44	33.60	0.61	0.003812	0.90	0.98	0.84
3	30	3500	2.14	0.000811	20	0.5	5.0	2	0.00318	29.24	44.70	0.65	0.003728	1.05	1.03	0.84
4	40	3500	2.14	0.000811	20	0.5	5.0	2	0.00318	34.99	45.28	0.77	0.003546	1.18	1.14	0.86
5	50	3500	2.14	0.000811	20	0.5	5.0	2	0.00318	40.24	45.80	0.88	0.003414	1.30	1.24	0.67
Final flow conditions																
number of iterations for each inflow rate: 20																
number of iterations for each inflow rate: 18																
number of iterations for each inflow rate: 17																
number of iterations for each inflow rate: 15																
number of iterations for each inflow rate: 17																
Qeco [m ³ /s]	Lchannel [m]	Δz [m]	ib	B_bottom [m]	y_bank [m]	a_bank [m]	m_side_slope	dn50 [m]	A [m ²]	P [m]	R [m]	ch(de)	de [m]	u_avg [m/s]	u_crit [m/s]	
0	5.0	3500	1.74	0.000487	12	0.5	4.0	2	0.078	12.47	23.42	0.63	0.016135	0.76	0.40	1.53
1	6.6	3500	1.74	0.000487	12	0.5	4.0	2	0.078	14.65	23.84	0.61	0.014760	0.66	0.45	1.60
2	12.5	3500	1.74	0.000487	12	0.5	4.0	2	0.078	24.25	33.34	0.73	0.013356	1.19	0.52	1.68
3	16.0	3500	1.74	0.000487	12	0.5	4.0	2	0.078	28.04	33.85	0.83	0.012408	1.31	0.57	1.75
4	20.0	3500	1.74	0.000487	12	0.5	4.0	2	0.078	32.02	34.38	0.83	0.011638	1.43	0.62	1.80

Depth average flow velocity

Equilibrium flow depth

Critical flow velocity

Checking that only sub-critical flow occurs in the channel

```
In [6]: ##### CHANNEL'S FRICTION COEFFICIENT, SEE IF CF > IB #####
for n in range(len(df_de['Qweir'])):
    df_slope['cf'] = df_de['cf_final'][n]
    df_slope['Qweir'] = df_de['Qweir'][n]
    df_slope['de'] = df_de['de_final'][n]

    #Only sub-critical flow (cf > ib)
    requirement = df_slope['ib'] - df_slope['cf'] #super a/c cf < ib ; df_slope['cf'] < df_slope['ib']
    super_critical_flow = df_slope['ib'] > df_slope['cf'] # super_critical_flow = requirement > -0.002
    df_slope = df_slope.drop(df_slope[super_critical_flow].index)
    df_slope = df_slope.reset_index(drop=True)

# display(df_slope.head(20))
```

Determining the flow depth and flow velocity in the thalweg and bank areas

```
In [7]: ##unifor flow -> friction slope = bed slope (Sf = So)
b_hoogte_slope = []
for i in range(len(a_list)): #making a list where the thalweg and bank area dimensions are separate
    if i == 0:
        b_hoogte_slope.append((a_list[i] * 2, d_list[i], m_list[i]))
    else:
        b_hoogte_slope.append((a_list[i], d_list[i], m_list[i]))

def InfoPerStep(ylist, b_hoogte_slope, dn50, So):
    g = 9.81
    b_hoogte_hoek = b_hoogte_slope #chosen parameter's cross-section
    ds_step = []

    intervals = 1000
    delta = 1.65 # used in shields equation-----
    shields = 0.03 ## used in shields equation-----

    ylist = [ylist] * intervals

    for i in range(len(ylist)):
        #info per step
        which_step = []
        A_step_list = []
        P_step_list = []
        R_step_list = []

        d_step_list = []
        u_step_list = []

        cf_step_list = []
        Q_step_list = []
        Sf_step_list = []
        u_critical_list = []

        x = 0

        for index, (a,d,m) in enumerate(b_hoogte_hoek):
            if ylist[i] > d+x:

                # cross-section parameters for half the step
                A_section = (a * d) + ((1/2) * a * (d**2)) + ((a + (n * d)) * (ylist[i] - (d + x)))
                P_section = (a + (2*d*np.sqrt(1+(n**2))))
                R_section = A_section / P_section

                ##### WHITE COLEBROOK EQUATION #####
                #flow parameters per section
                ks = 3.5 * dn50
                cf_section = (1/(5.75*np.log10((12*R_section)/ks))) ** 2 ## determine cf for each hydraulic radius of each step

                #####SHIELDS EQUATION #####
                #critical flow velocity where sediment transport occurs (most critical at lowest water depth)
                C_section = np.sqrt(g/cf_section)
                u_critical_section = C_section * np.sqrt(shields * delta * dn50)
```

```

# Sf = So (uniform flow)
Sf_section = So

Q_section = (np.sqrt(g/cf_section)) * (A_section) * ((A_section/P_section) ** (1/2)) * (Sf_section ** (1/2))
u_section = Q_section / A_section

which_step.append(index+1)
A_step_list.append(A_section)
P_step_list.append(P_section)

R_step_list.append(R_section)

cf_step_list.append(cf_section)
Sf_step_list.append(Sf_section)
u_critical_list.append(u_critical_section)

Q_step_list.append(Q_section)
u_step_list.append(u_section)

x = dex

d_step_list.append(x) #water depth in each section

else:
# cross-section parameters for half the step
A_section = (a * (ylist[i] - x)) + ((1/2) * m * ((ylist[i] - x)**2))
P_section = (a * ((ylist[i] - x)*np.sqrt(1+(m**2))))

R_section = A_section / P_section

d_step_list.append(ylist[i]-x) #water depth in each section

##### WHITE COLEBROOK EQUATION #####
ks = 3.5 * dn50
cf_section = (1/(5.75*np.log10((12*R_section)/ks))) ** 2 ## determine cf for each hydraulic radius of each step

#####SHIELDS EQUATION #####
#critical flow velocity where sediment transport occurs (most critical at lowest water depth)
C_section = np.sqrt(g/cf_section)
u_critical_section = C_section * np.sqrt(shields * delta * dn50)

# for now Sf = So
Sf_section = So

Q_section = (np.sqrt(g/cf_section)) * (A_section) * ((A_section/P_section) ** (1/2)) * (Sf_section ** (1/2))
u_section = Q_section / A_section

which_step.append(index+1)
A_step_list.append(A_section)
P_step_list.append(P_section)

R_step_list.append(R_section)

cf_step_list.append(cf_section)
Sf_step_list.append(Sf_section)

u_critical_list.append(u_critical_section)

Q_step_list.append(Q_section)
u_step_list.append(u_section)

break

Q_step_total = Q_step_list[0] + (2 * sum(Q_step_list[1:]))
u_step_total = sum(u_step_list) / len(u_step_list)

ds_step.append({'Q [m3/s]': df_de['Q weir'][j], 'L [m]': df_de['L'][j], 'de [m]': np.round(ylist[i],2),
               'step': which_step, 'd_step [m]': np.round(d_step_list,2),
               'cf_step': np.round(cf_step_list, 6), 'u_step [m/s]': np.round(u_step_list,2),
               'u_crit [m/s]': np.round(u_critical_list, 2)})

return ds_step

total_step_data = []

for j in range(len(df_de['de_final'])):
    ds_step = InfoPerStep(ylist = df_de['de_final'][j], b_hoogte_slope = b_hoogte_slope, dn50 = dn50,
                        So = df_slope['th'][0])

#print each dataframe separately, each step has the iteration value, so it is a dataframe with a 1000 values
#each dataframe corresponds to a channel length and inflow rate combination
df_ds_step = pd.DataFrame(ds_step)

#show the first value of each dataframe
display(df_ds_step.head(1))

```

Table 37: Overview of the channel's initial and final flow conditions per section for uniform flow

Initial flow conditions per section

Q [m³/s]	L [m]	de [m]	step	d_step [m]	cf_step	u_step [m/s]	u_crit [m/s]
0	1	3000	0.36	0	0.36	0.006548	0.00
0	10	3000	0.09	1	2	0.003048	0.003942
0	20	3800	0.8	1	2	0.088279	0.09889
0	30	3000	1.00	1	2	0.003307	0.00428
0	40	3000	1.00	1	2	0.003307	0.00428
0	50	3500	1.3	1	2	0.003194	0.003778

Final flow conditions per section

Q [m³/s]	L [m]	de [m]	step	d_step [m]	cf_step	u_step [m/s]	u_crit [m/s]
0	0.0	3000	0.36	0	0.36	0.013802	0.0208
0	0.0	3000	0.09	1	2	0.013802	0.0208
0	0.0	3000	0.09	1	2	0.013802	0.0208
0	12.5	3000	1.19	1	2	0.013802	0.0208
0	18.0	3000	1.31	1	2	0.013802	0.0208
0	20.0	3000	1.42	1	2	0.013802	0.0208

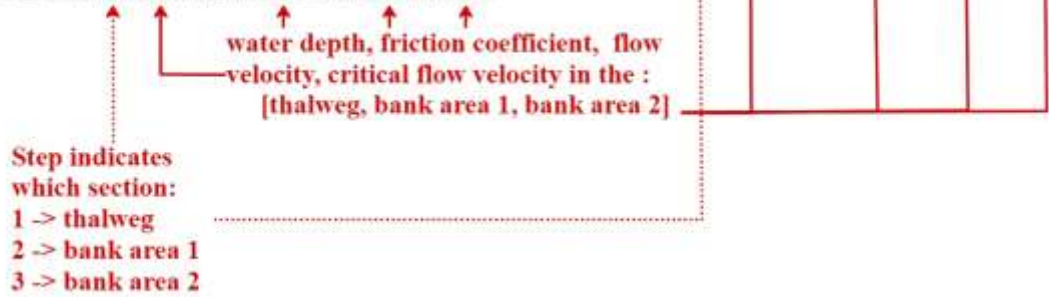

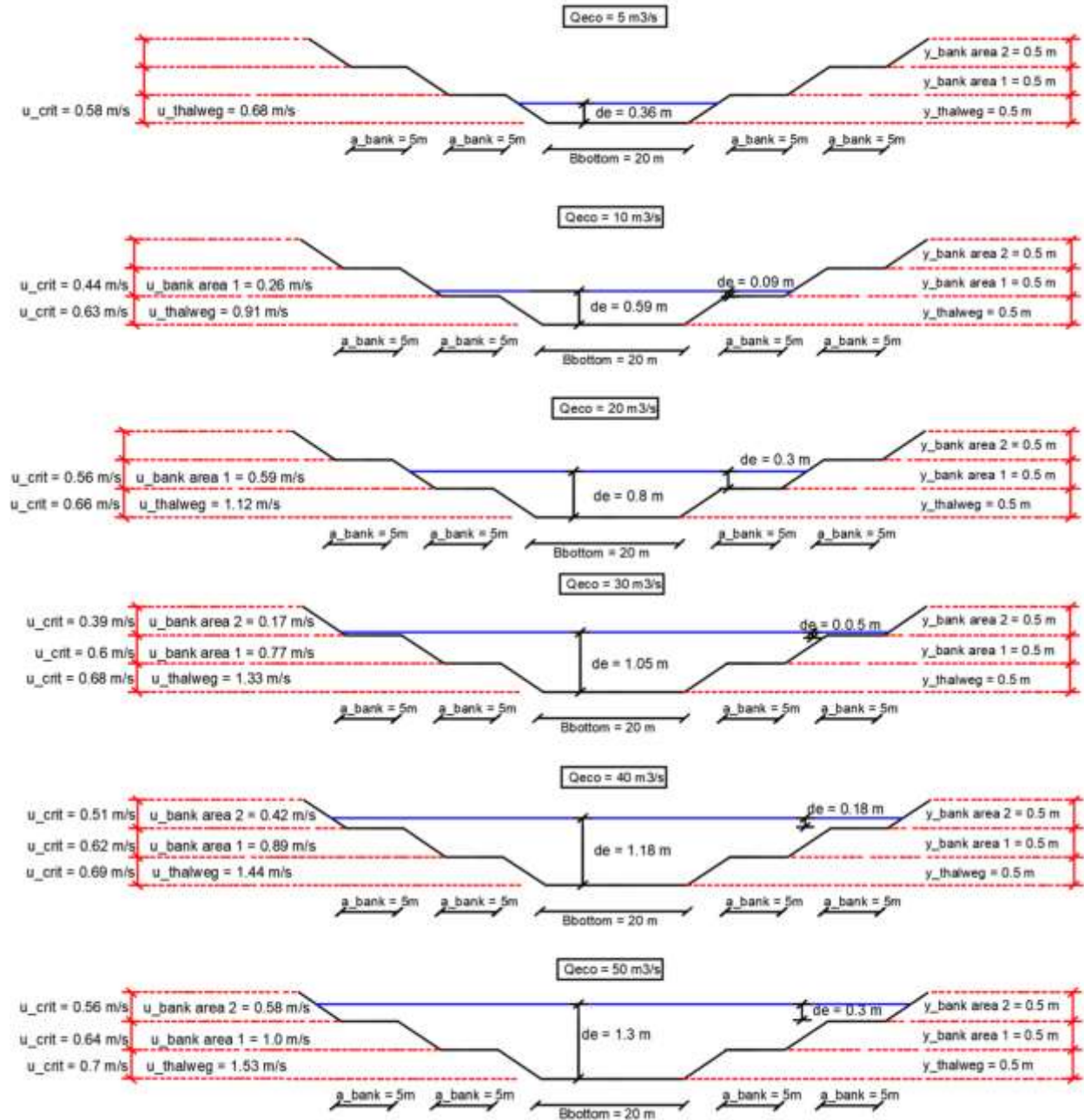

Figure 88: Cross-sectional view of the channel's initial flow conditions for uniform flow

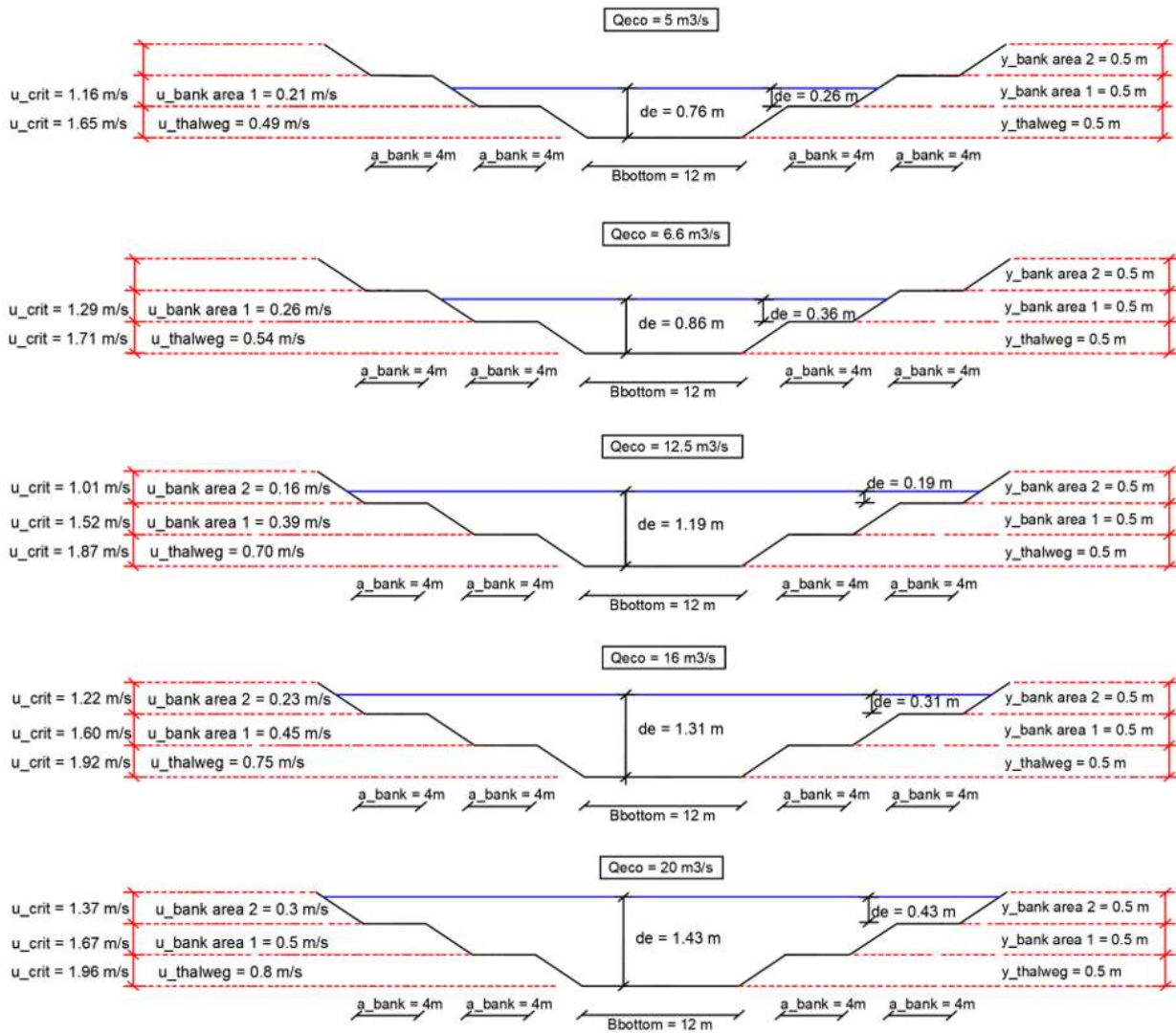

Figure 89: Cross-sectional view of the channel's final flow conditions for uniform flow

F.2. Estimating the occurrence of river discharges below 30 m³/s

Discharge at Venlo

```
In [2]: #importing the discharge data from the Rijkswaterstaat waterinfo website at VENLO
data_discharge = pd.read_csv('20230907_042.csv', encoding = 'unicode_escape', delimiter = ';')
# data_discharge.head()
# data_discharge.info()
```

```
In [20]: #Manually removing the column with NAN values and column with undeeded information for the merging
df_VENLO = data_discharge.drop(['MONSTER_IDENTIFICATIE', 'TYPERING_OMSCHRIJVING', 'TYPERING_CODE', 'GROOTHEID_CODE',
                                'PARAMETER_OMSCHRIJVING', 'PARAMETER_CODE', 'CAS_NR', 'ORGAAN_OMSCHRIJVING', 'ORGAAN_CODE',
                                'GROEPERING_OMSCHRIJVING', 'GROEPERING_CODE', 'GROEPERING_KANAAL', 'GROEPERING_TYPE',
                                'EPSG', 'X', 'Y', 'TAXON_NAME', 'REFERENTIEVLAK', 'BEMONSTERINGSSOORT_OMSCHRIJVING',
                                'BEMONSTERINGSAPPARAAT_CODE', 'PLAATSBEPALINGSAPPARAAT_OMSCHRIJVING', 'PLAATSBEPALINGSAPPARAAT_CODE',
                                'BEMONSTERINGSHOOGTE', 'WAARDEBEWERKINGSMETHODE_OMSCHRIJVING', 'WAARDEBEWERKINGSMETHODE_CODE',
                                'COMPARTIMENT_CODE', 'NOTITIE_OMSCHRIJVING', 'NOTITIE_CODE', 'REFERENTIE', 'BEMONSTERINGSSOORT_CODE',
                                'LIMIETSYMBOOL', 'STATUSWAARDE', 'OPDRACHTGEVENDE_INSTANTIE', 'MEETAPPARAAT_CODE',
                                'BEMONSTERINGSAPPARAAT_OMSCHRIJVING', 'HOEDANIGHEID_CODE', 'WAARDEBEPALINGSMETHODE_CODE',
                                'KVALITEITSOORDEEL_CODE', 'MEETAPPARAAT_OMSCHRIJVING', 'COMPARTIMENT_OMSCHRIJVING',
                                'HOEDANIGHEID_OMSCHRIJVING', 'WAARDEBEPALINGSMETHODE_OMSCHRIJVING',
                                'WAARNEMINGTIJD (MET/CET)', 'LOCATIE_CODE', 'ALFANUMERIEKEWAARDE', 'EENHEID_CODE',
                                'MEETPUNT_IDENTIFICATIE', 'GROOTHEID_OMSCHRIJVING'], axis = 1)

#make copies of the data to remove warning message
df_VENLO = df_VENLO.copy()

#replacing the comma separation with a dot
df_VENLO['NUMERIEKEWAARDE'] = df_VENLO['NUMERIEKEWAARDE'].str.replace(r',(?=[^,]*)$', '.', regex=True).astype(float)

#converting the date into the panda datetime format, to properly use the data
df_VENLO['WAARNEMINGDATUM'] = pd.to_datetime(df_VENLO['WAARNEMINGDATUM'], format = '%d-%m-%Y')

# rename the columns
df_VENLO = df_VENLO.rename(columns={'NUMERIEKEWAARDE': 'NUMERIEKEWAARDE [m3/s]'})

#if you want to see the first 5 columns of the data with only Venlo
display(df_VENLO.head(20))
```

```
In [30]: # number of discharge measurements less than 30 m3/s
df_discharge_below_30 = df_VENLO[df_VENLO['NUMERIEKEWAARDE [m3/s]' ] < 30]

#group the count per year (data over 27 years)
df_discharge_below_30['Year'] = df_discharge_below_30['WAARNEMINGDATUM'].dt.year
count_per_year = df_discharge_below_30.groupby('Year').size()

#total measurements for each year
total_measurements_per_year = df_VENLO.groupby(df_VENLO['WAARNEMINGDATUM'].dt.year).size()

#percentage discharge < 30 m3/s per year
percentage_per_year = (count_per_year / total_measurements_per_year) * 100

results_30 = pd.DataFrame({'Total measurements per year': total_measurements_per_year,
                           'measurements < 30 m3/s': count_per_year,
                           'percentage < 30 m3/s [%]': np.round(percentages_per_year,2)})

print('average percentage:', np.round(results_30['percentage < 30 m3/s [%]'].mean(),2))

display(results_30);

average percentage: 3.22
```

	Total measurements per year	measurements < 30 m3/s	percentage < 30 m3/s [%]
1996	31842	3972	12.47
1997	52560	1556	2.96
1998	52560	467	0.89
1999	52453	250	0.48
2000	52704	21	0.04
2001	52925	93	0.18
2002	52925	241	0.46
2003	52925	1611	3.04
2004	53070	305	0.57
2005	52925	1027	1.94
2006	52925	440	0.83
2007	52925	16	0.03
2008	53070	31	0.06
2009	52925	345	0.65
2010	52925	763	1.44
2011	52925	942	1.78
2012	53070	64	0.12
2013	52925	70	0.13
2014	52925	77	0.15
2015	52925	589	1.11
2016	53436	340	0.64
2017	53290	2861	5.37
2018	53290	8010	15.03
2019	53290	6795	12.75
2020	53436	6487	12.14
2021	52925	1	0.00
2022	52836	7241	13.70
2023	28065	303	1.16

Appendix G Impact of each channel parameter on the flow conditions

This appendix provides an analysis of the impact of each channel parameter on the channel's flow conditions. The appendix supports Subsection 4.1.5.

Influence of the channel's bottom width (B_{bottom})

Interpreting the graphs

Figure 90 shows that increasing the channel's bottom width leads to a decrease in the channel's equilibrium flow depth and flow velocity. This occurs as an increasing bottom width results in a higher wet cross-sectional area (A) and wet perimeter (P). However, the wet perimeter increases significantly more than the wet cross-sectional area, resulting in a decrease of the hydraulic radius (R). An increase in the wet cross-sectional area leads to lower flow velocities, while a decrease in the hydraulic radius leads to lower flow depths. Increasing the channel's bed width leads to a decrease in the channel's critical flow velocity (u_{crit}). Naturally, decreasing the channel's bottom width has the opposite effect.

The kinks in the graphs occur where the channel's water level transitions from the thalweg to the first bank area, and from the first bank area to the second bank area. This happens as the channel's width used in the calculations suddenly increases. For an inflow rate of $50 \text{ m}^3/\text{s}$, the channels has very large water depths and flow velocities for the narrow bottom widths. This is not shown in the figure, as the y-axis values are limited to properly display the flow conditions for the other inflow rates. These large values indicate that the channel's capacity is exceeded, leading to spilling onto the surrounding floodplains.

Conclusion

To improve the initial flow conditions, the equilibrium flow depth must be increased, while the flow velocity must be decreased. Decreasing the bottom width increases the flow depth in both the thalweg and bank areas, which leads to higher flow velocities in both areas. Naturally, increasing the bottom width has the opposite effect. Therefore, adjusting the bottom width must be done carefully in combination with the other channel parameters, as it can negatively influence the flow conditions due to its significant impact on both the water depths and flow velocities.

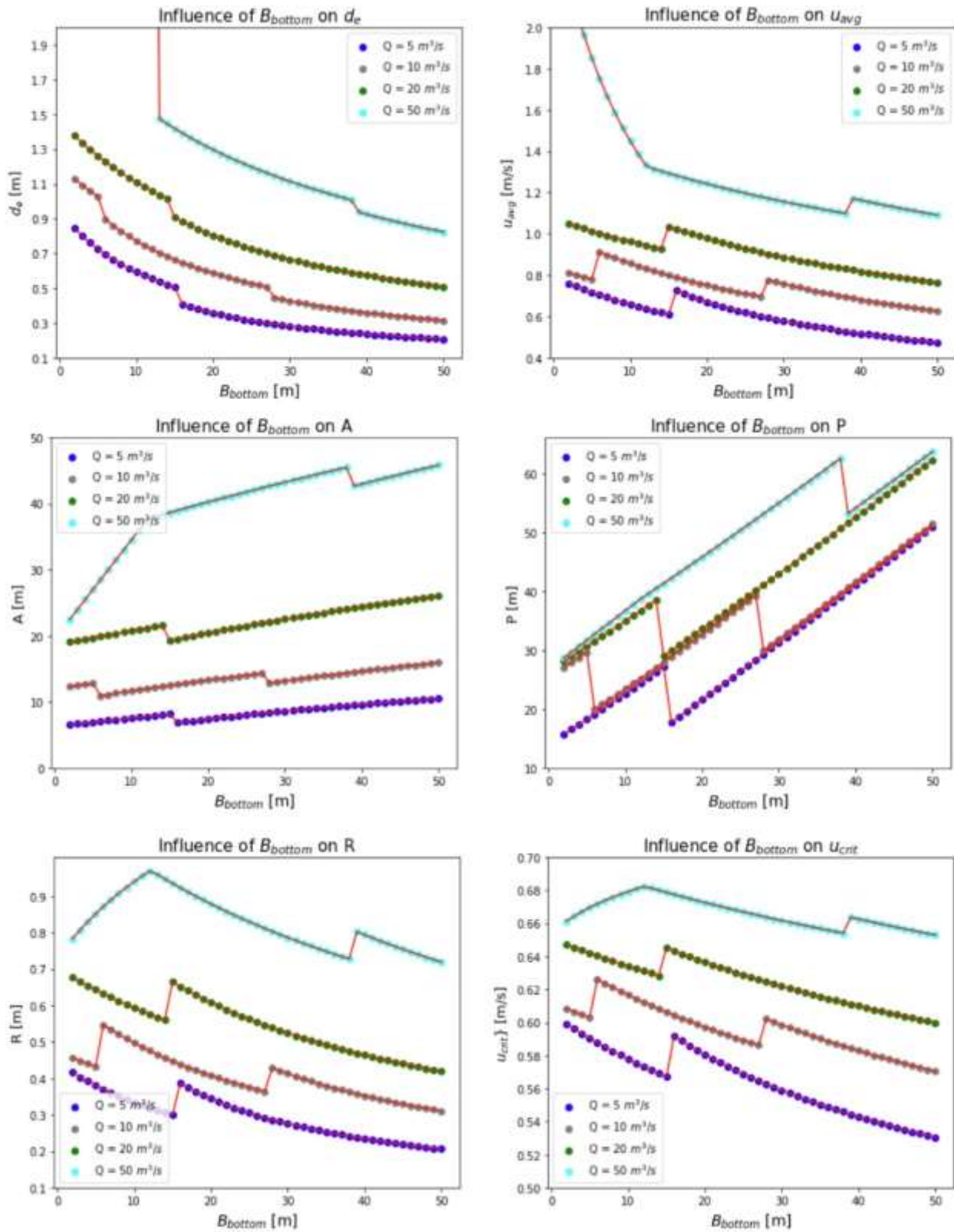

Figure 90: Visual influence of the channel's bottom width on the channel's flow conditions.

Influence of the bank area's step width (a_{bank})***Interpreting the graphs***

Figure 91 shows that, similar to the channel's bottom width, increasing the bank area's step width increases the channel's wet perimeter (P) more than the wet cross-sectional area (A), resulting in a decrease of the hydraulic radius (R) and consequently the flow depths and flow velocities. For an inflow rate of $5 \text{ m}^3/\text{s}$, the channel's equilibrium flow depth lies within the channel's thalweg, thus the bank area's step width has no influence on it. For $Q_{eco} = 10 \text{ m}^3/\text{s}$ and $20 \text{ m}^3/\text{s}$, the graphs show gentle slopes, indicating low rates of change for both the flow depth and flow velocity. The rate of change for the inflow rate of $50 \text{ m}^3/\text{s}$ is greater. However, even with larger step widths, this inflow rate does not lead to the required flow velocities. Increasing the bank area's step width leads to a decrease in the channel's critical flow velocity (u_{crit}).

Conclusion

The figures above show that the bank step width has no significant impact on either the flow depths or flow velocities. A larger step width can provide more opportunities for habitat formation in the bank area. However, it also requires more excavation, which can result in a higher environmental footprint. Therefore, a minimum step width of 2.5 m is maintained for habitat formation, while a maximum value of 5 m is set to reduce the overall width of the channel. The minimum value is loosely based on the minimum required pool length for fish passages (see Table 8) and the maximum value is based on engineering judgement.

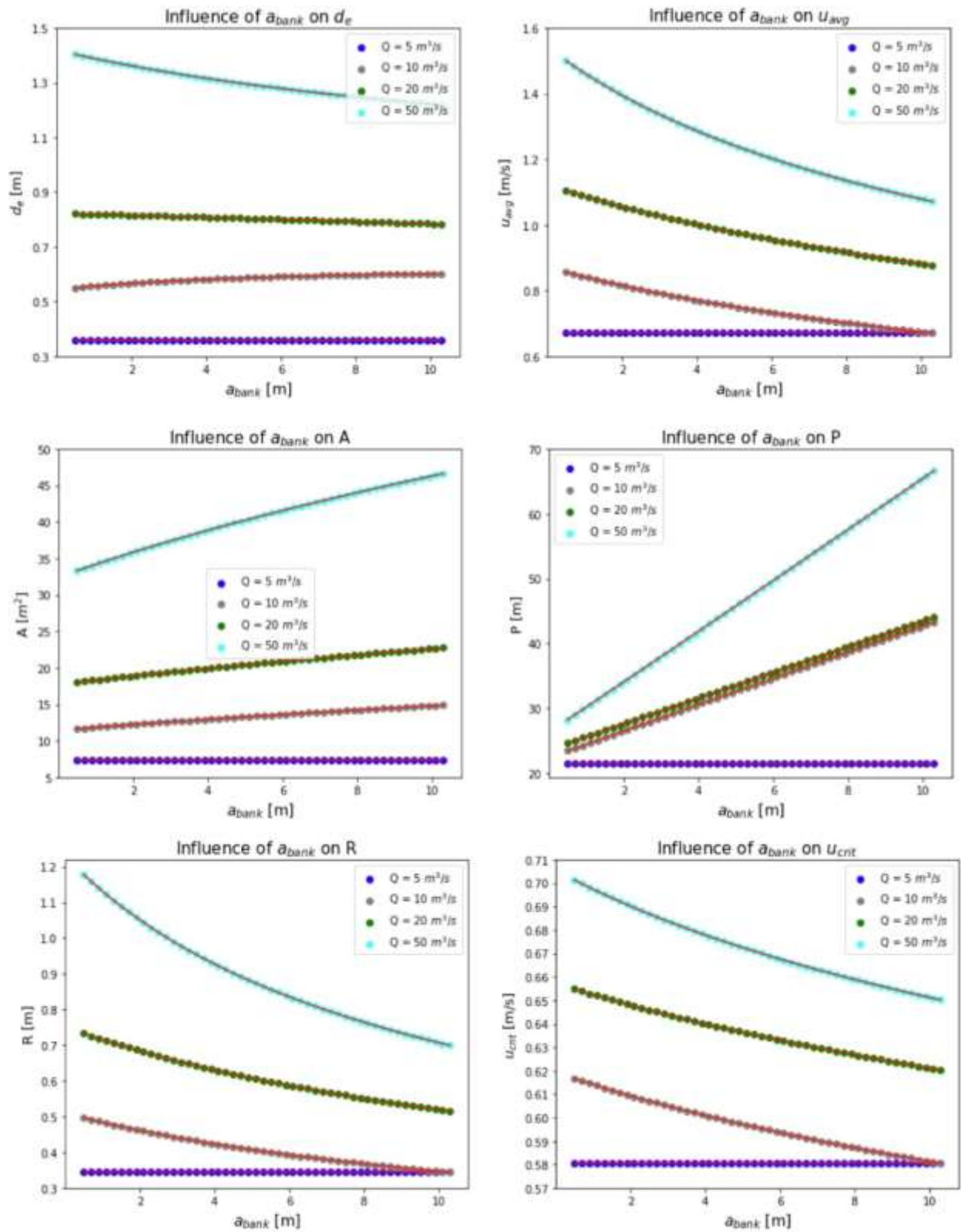

Figure 91: Visual influence of the bank area's step width on the channel's flow conditions.

Influence of the thalweg's step height ($y_{thalweg}$)

Interpreting the graphs

Figure 92 shows that increasing the step height of the channel's thalweg results in a narrower channel. This leads to a slight increase of the channel's wet cross-sectional area (A) and a slight decrease of the channel's wet perimeter (P), resulting in an increase of the channel's hydraulic radius (R) and consequently the channel's flow depth. The increase in the channel's wet cross-sectional area also results in a decrease of the channel's flow velocity.

The influence on the flow conditions is noticeable when the water level lies below the thalweg's step height. This is observed at the transition point between the thalweg and bank area for $Q_{eco} = 10, 20,$ and $50 \text{ m}^3/\text{s}$. The equilibrium flow depth gradually increases until it equals the thalweg's step height, which is 0.62 m for $Q_{eco} = 10 \text{ m}^3/\text{s}$. At this point, a kink appears in the graph, as the width used in the calculations suddenly increases. Beyond this point, the water level lies above the thalweg's step height, causing the flow conditions and cross-sectional dimension to remain almost constant. This most likely occurs due to the inclusion of the wet cross-sectional area and wet perimeter of the bank area, reducing the thalweg's influence. The transition points are indicated with black lines in Figure 92.

Conclusion

The figures above show that the thalweg's step height has no significant impact on either the flow depths or flow velocities. In addition, it is assumed that increasing or decreasing the step height does not lead to any ecological benefits, as there is no evidence about this. Therefore, the initial thalweg's step height of 0.5 m remains unchanged.

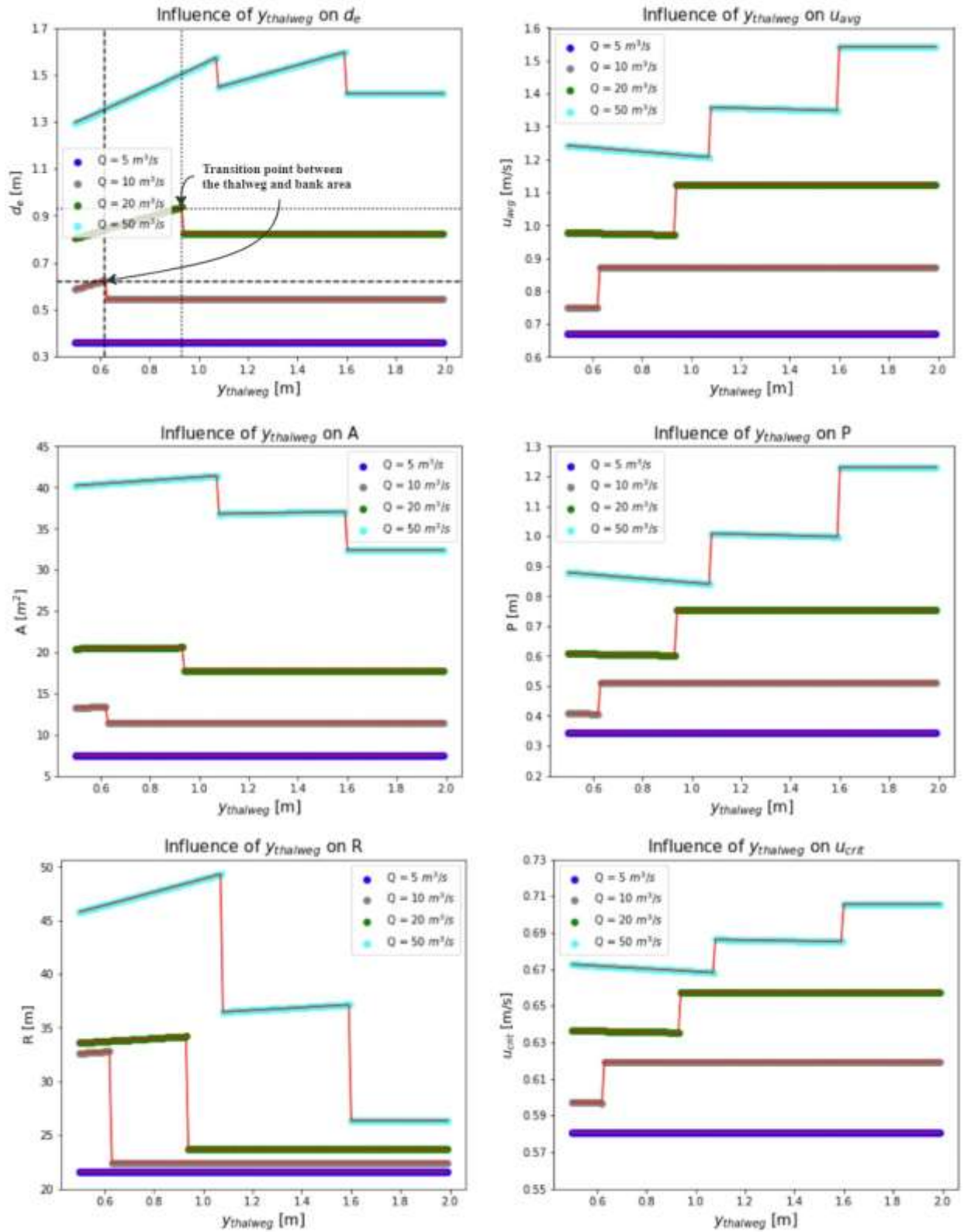

Figure 92: Visual influence of the thalweg's step height on the channel's flow conditions

Influence of the bank area's step height (y_{bank})

Interpreting the graphs

Figure 93 shows increasing the step height of the bank area has the same influence as increasing the thalweg's step height. The kinks in the graphs represent the transition points between the channel's first and second bank area. When the water level lies in the thalweg, as for $Q_{eco} = 5 \text{ m}^3/\text{s}$, the bank area's step height has no influence on the flow conditions. When the channel's water level lies above the thalweg and below the step height of the first bank area (before the kinks for $Q_{eco} = 20$ and $50 \text{ m}^3/\text{s}$), the flow depth increases and the flow velocity decreases. Once the water level rises above the step height of the second bank area, the graphs for the flow conditions and cross-sectional dimensions become gentler, resulting in low rates of change. The large flow depths for $Q_{eco} = 50 \text{ m}^3/\text{s}$ and the small bank area step heights most likely occur as the shallow channel capacity is exceeded, resulting to spilling onto the floodplains.

Conclusion

The figures above show that the bank area's step height has no significant impact on either the flow depths or flow velocities. In addition, it is assumed that increasing or decreasing the step height does not lead to any ecological benefits, as there is no evidence about this. Therefore, the initial bank area's step height of 0.5 m remains unchanged.

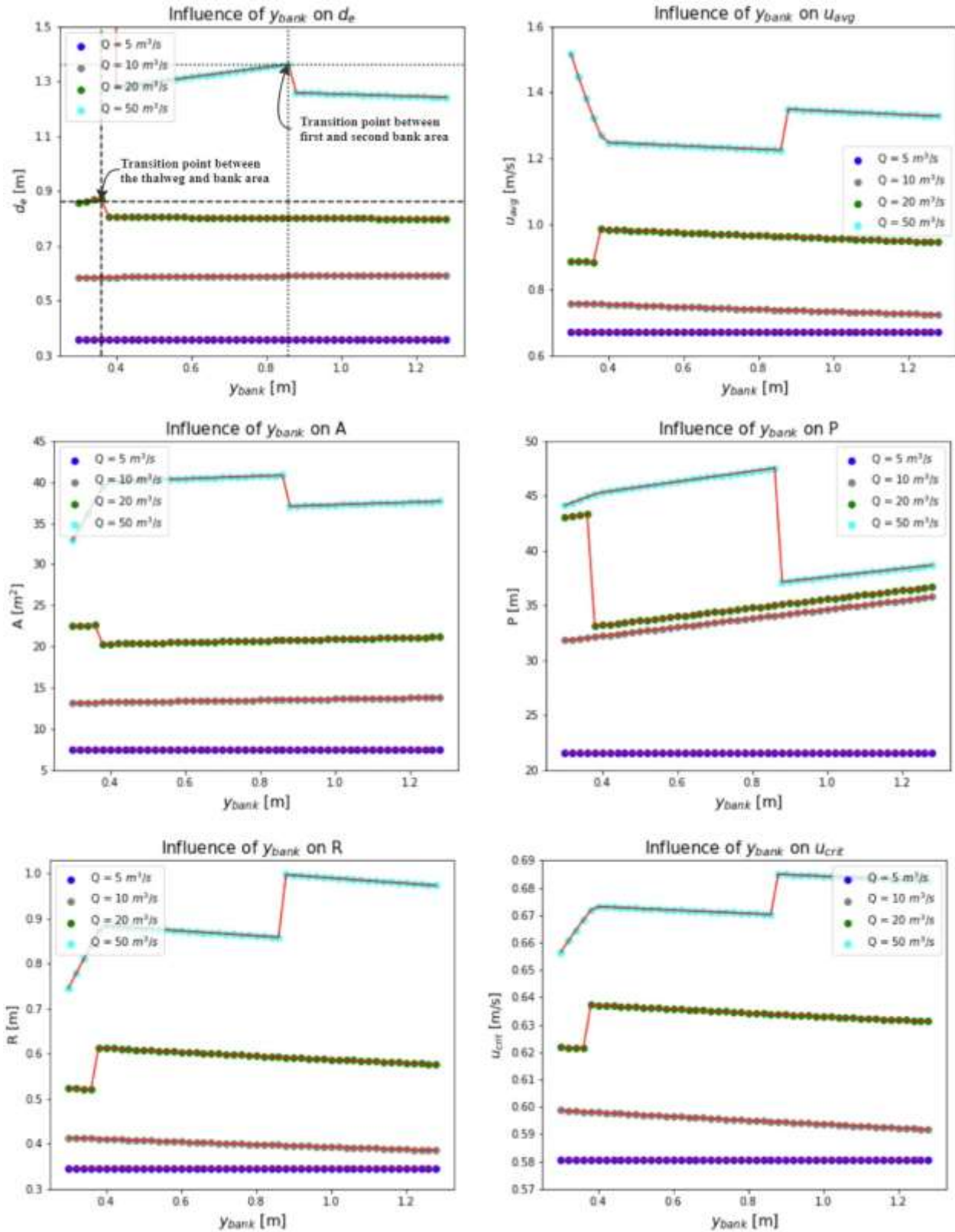

Figure 93: Visual influence of the bank area's step height on the channel's flow conditions

Influence of the channel's side slopes ($m_{side\ slope}$)

Interpreting the graphs

Figure 94 shows that increasing the channel's side slopes increases the channel's wet cross-sectional area and wet perimeter. However, the wet perimeter increases more than the wet cross-sectional area, resulting in a decrease of the hydraulic radius and consequently the flow depth. An increase of the wet cross-sectional area leads to a decrease of the channel's flow velocity. Nevertheless, the graphs indicate that the side slopes have an insignificant impact on both the flow conditions.

Conclusion

For guiding bottom dwelling fish over the sills of pool-and-weir fish passage, it is advised to maintain a maximum slope ratio of 1:1 (angle of 45°). Assuming this guideline is applicable to the channel, this ratio would be favourable for fish movement. However, a steeper side slope can lead to soil instability in the channel. Therefore, after observing that reducing the side slope ratio from 1:2 to 1:1 has no significant impact on the flow conditions, the initial side slope ratio of 1:2 is remains unchanged.

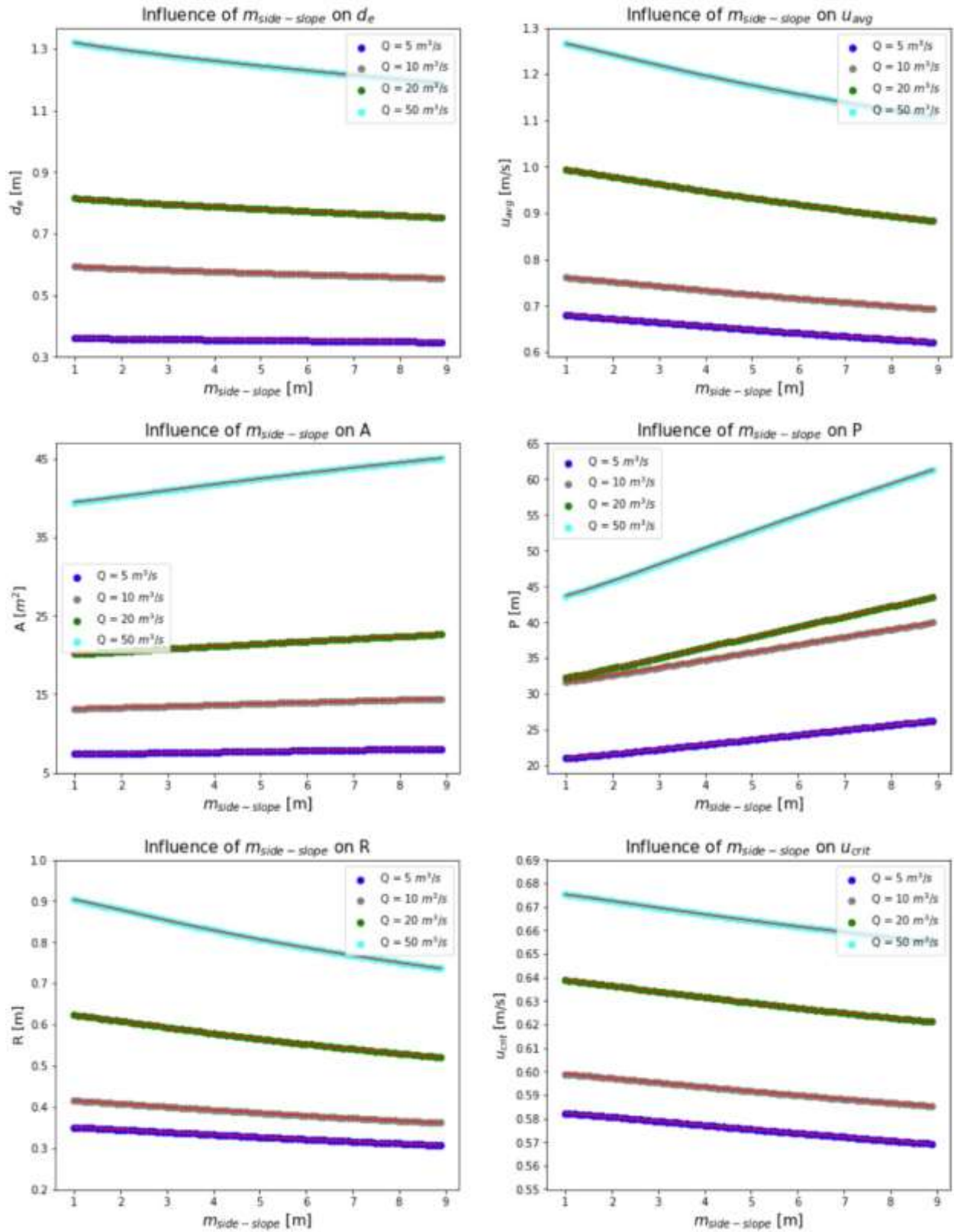

Figure 94: Visual influence of the channel's side slopes on the channel's flow conditions

Influence of the channel's bed slope (i_b)

Interpreting the graphs

Figure 95 shows that increasing the channel's bed level difference (Δz) increases the channel's bed slope (i_b). This leads to a decrease of the channel's wet cross-sectional area (A) and wet perimeter (P), resulting in a decrease of the hydraulic radius (R) and consequently the flow depth. A decrease of the channel's wet cross-sectional area leads to an increase of the channel's average flow velocity. Increasing the channel's bed width leads to a decrease in the channel's critical flow velocity (u_{crit}). The kinks in the graphs occur where the channel's water level transitions from the thalweg to the first bank area, and from the first bank area to the second bank area. This happens as the channel's width used in the calculations suddenly increases.

Conclusion

To improve the initial flow conditions, the equilibrium flow depth must be increased, while the flow velocity must be decreased. Decreasing the channel's bed slope leads to this improvement. The channel's bed slope (i_b) can be decreased by either increasing the channel's length ($L_{channel}$) and/or decreasing the channel's bed level difference (Δz).

Given that 3.5 km is already considered the maximum channel length that allows for an adequate outlet findability, the bed slope must be reduced by decreasing Δz . This can be achieved by adjusting the channel's inlet and/or outlet bed elevations. Since the outlet is positioned 0.55 m below the lowest downstream water level, increasing the outlet bed level is not favourable. Therefore, it remains unchanged to ensure adequate fish passability. Decreasing the channel's inlet bed level lowers the bed level difference. However, this leads to a deeper excavation and more ground work, which can result in higher excavation costs, longer construction times, and a larger environmental footprint. Since there are no limits for the excavation depth of the channel, this remains a viable option.

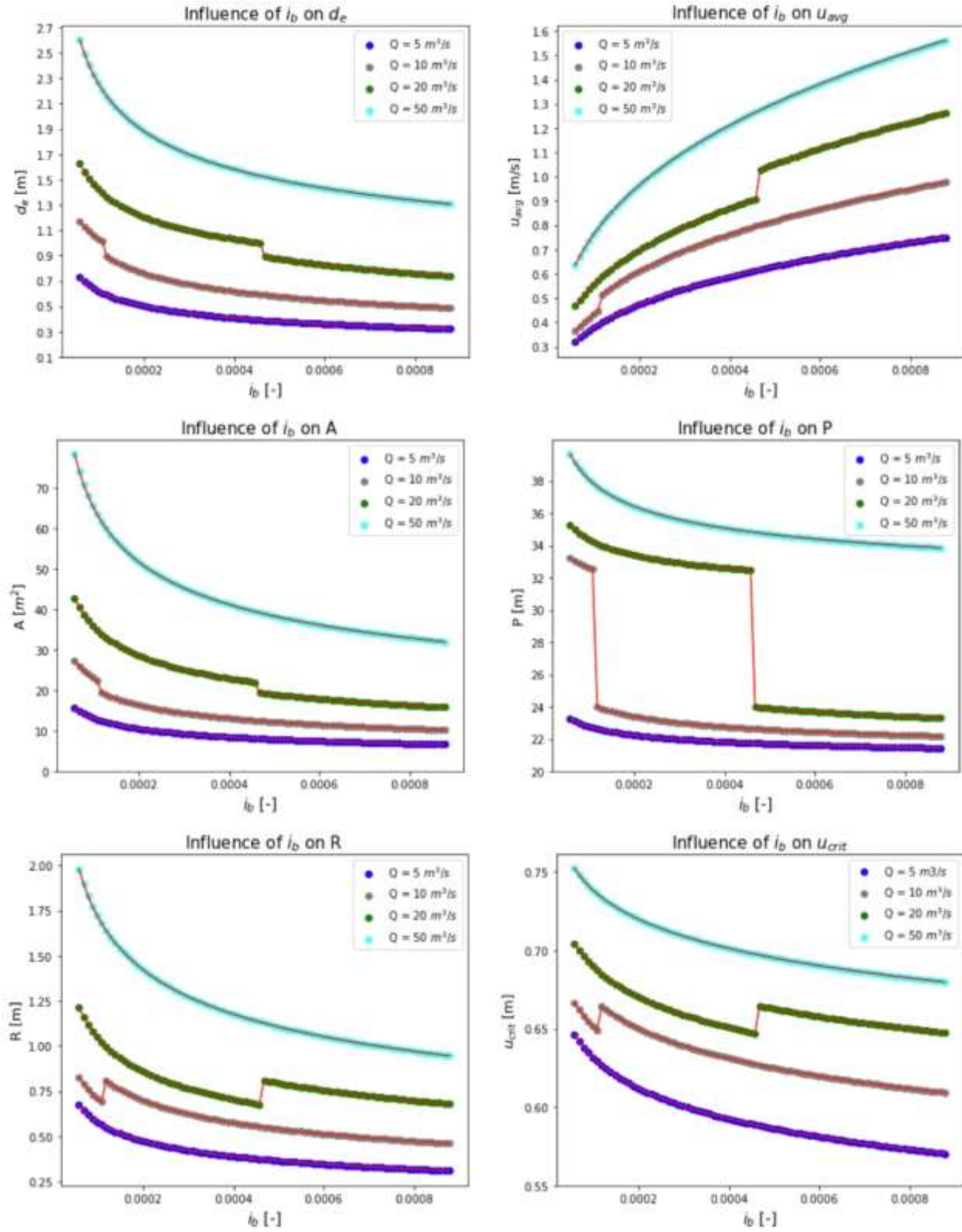

Figure 95: Visual influence of the channel's bed slope on the channel's flow conditions

Influence of the channel's friction coefficient (c_f)

Interpreting the graphs

The channel's friction coefficient is varied by varying the equivalent roughness height of the bed (k_s). In other words, varying the nominal diameter (d_{n50}) of the channel's bed material by applying different sediment sizes or materials. Figure 96 shows that increasing the channel's nominal diameter (d_{n50}) leads to an increase of the channel's wet cross-sectional area, wet perimeter, hydraulic radius, and consequently, the flow depth. An increase of the wet cross-sectional area results in a decrease of the flow velocity. Increasing the channel roughness coefficient width leads to an increase in the channel's critical flow velocity (u_{crit}). The kinks in the graphs occur where the channel's water level transitions from the thalweg to the first bank area, and from the first bank area to the second bank area. This happens as the channel's width used in the calculations suddenly increases.

Conclusion

To improve the initial flow conditions, the equilibrium flow depth must be increased, while the flow velocity must be decreased. Increasing the channel's nominal diameter and consequently the bed friction leads to this improvement. In addition, increasing the bed friction results in an increase of the channel's critical flow velocity, which is beneficial for preventing excessive erosion. The channel's friction coefficient is increased by raising the equivalent roughness height of the bed (k_s). This is achieved by applying sediments with a larger size or by implementing vegetation, boulders, or dead timber in the channel.

The friction coefficient cannot be increased randomly, as it may result in a channel bed that is unrealistic or unsuitable for lotic habitat formation. It is also assumed that increasing the friction coefficient at specific locations in the channel does not provide an indication of its average value. Thus, the friction coefficient must be determined based on the required bed composition for creating lotic habitats, while still corresponding to a realistic and suitable physical channel bed.

Increasing the channel's inflow rate (Q_{eco})

Naturally, increasing the channel's inflow rate results in an increase of the flow depths and flow velocities, as shown in all the figures above. Therefore, if the flow conditions are met for lower discharge limits, it is unlikely that they will be met for the upper discharge limits, especially if there is a significant discharge difference between the lower and upper limits. Given there are no requirements for the discharge range, only target values, changing the channel's inflow rate is a viable option. Hence, limiting the inflow rate range is favourable for the channel's design.

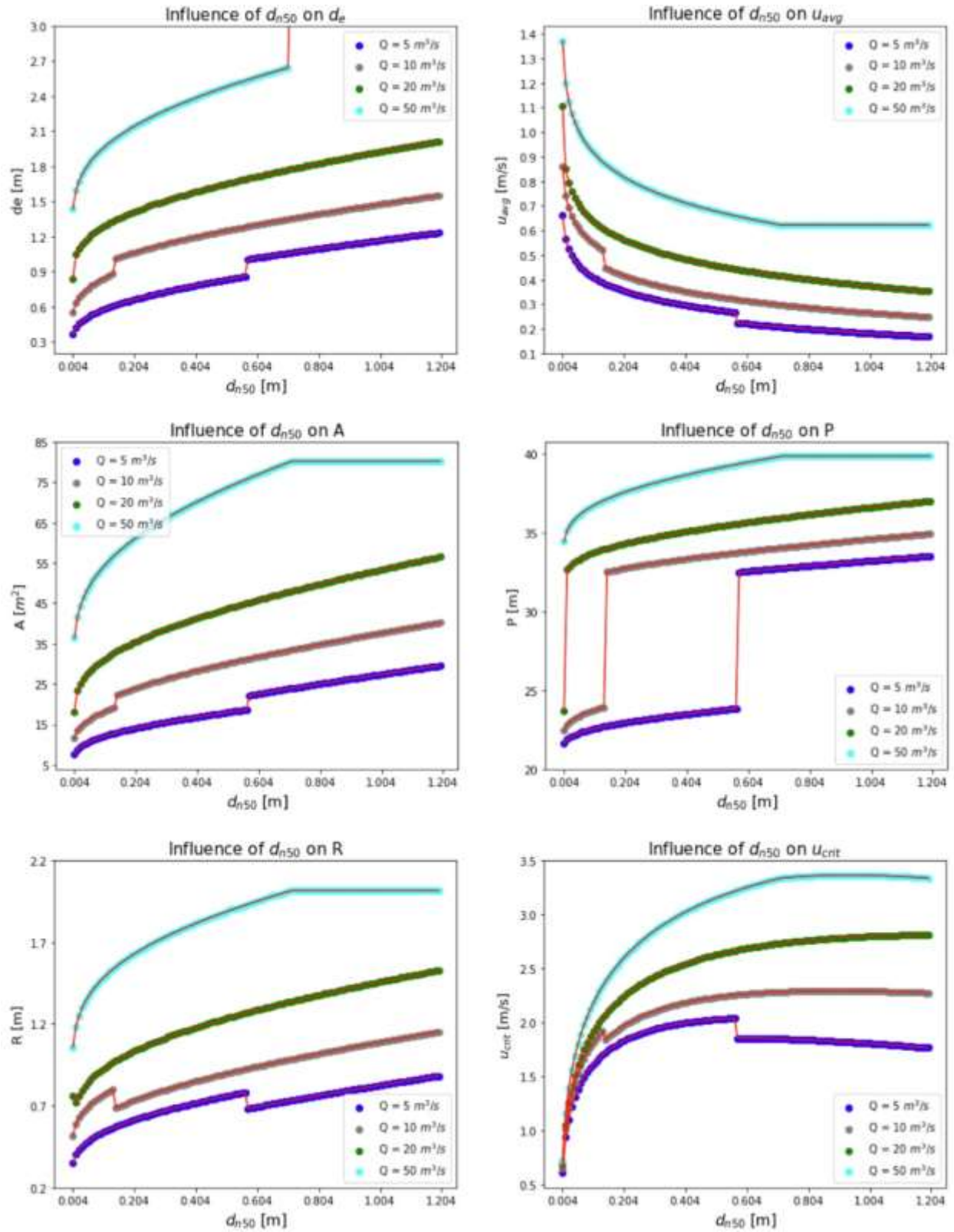

Figure 96: Visual influence of the channel's bed friction on the channel's flow conditions

Appendix H Discharge distribution of the river's flow

This appendix provides an overview of the river's discharge distribution subsystems of the weir complex. This appendix supports Subsection 4.1.5. The highlighted rows are the river discharges for which the water levels in the river are measured.

Table 38: The distribution of the river's discharge to the subsystems of the weir complex

River's discharge [m ³ /s]	Discharge for lock management [m ³ /s]	Discharge for the fish passage [m ³ /s]	Available river discharge [m ³ /s]	Inflow rate ecological channel [m ³ /s]	% of the river's discharge through ecological channel	Discharge over weirs of the river [m ³ /s]
25	15	5	5	5	20.0%	0.0
30	20	5	5	5	16.7%	0.0
35	20	5	10	5.4	15.4%	4.6
40	20	5	15	5.8	14.5%	9.2
45	20	5	20	6.2	13.7%	13.8
50	20	5	25	6.6	13.2%	18.4
55	20	5	30	7.0	12.7%	23.0
60	20	5	35	7.4	12.3%	27.6
65	20	5	40	7.8	11.9%	32.2
70	20	5	45	8.2	11.7%	36.8
75	20	5	50	8.6	11.4%	41.4
80	20	5	55	8.9	11.2%	46.1
85	20	5	60	9.3	11.0%	50.7
90	20	5	65	9.7	10.8%	55.3
95	20	5	70	10.1	10.7%	59.9
100	20	5	75	10.5	10.5%	64.5
105	20	5	80	10.9	10.4%	69.1
110	20	5	85	11.3	10.3%	73.7
115	20	5	90	11.7	10.2%	78.3
120	20	5	95	12.1	10.1%	82.9
125	20	5	100	12.5	10.0%	87.5
130	20	5	105	12.8	9.8%	92.2
140	20	5	115	13.0	9.3%	102.0
150	20	5	125	13.3	8.9%	111.7
160	20	5	135	13.6	8.5%	121.4
170	20	5	145	13.8	8.1%	131.2
180	20	5	155	14.1	7.8%	140.9
190	20	5	165	14.4	7.6%	150.6
200	20	5	175	14.6	7.3%	160.4

Appendices

210	20	5	185	14.9	7.1%	170.1
220	20	5	195	15.2	6.9%	179.8
230	20	5	205	15.4	6.7%	189.6
240	20	5	215	15.7	6.5%	199.3
250	20	5	225	16.0	6.4%	209.0
260	20	5	235	16.2	6.2%	218.8
270	20	5	245	16.5	6.1%	228.5
280	20	5	255	16.8	6.0%	238.2
290	20	5	265	17.1	5.9%	247.9
300	20	5	275	17.3	5.8%	257.7
310	20	5	285	17.6	5.7%	267.4
320	20	5	295	17.9	5.6%	277.1
330	20	5	305	18.1	5.5%	286.9
340	20	5	315	18.4	5.4%	296.6
350	20	5	325	18.7	5.3%	306.3
360	20	5	335	18.9	5.3%	316.1
370	20	5	345	19.2	5.2%	325.8
380	20	5	355	19.5	5.1%	335.5
390	20	5	365	19.7	5.1%	345.3
400	20	5	375	20.0	5.0%	355.0
410	20	5	385	20	4.9%	365.0
420	20	5	395	20	4.8%	375.0
430	20	5	405	20	4.7%	385.0
440	20	5	415	20	4.5%	395.0
450	20	5	425	20	4.4%	405.0
460	20	5	435	20	4.3%	415.0
470	20	5	445	20	4.3%	425.0
480	20	5	455	20	4.2%	435.0
490	20	5	465	20	4.1%	445.0
500	20	5	475	20	4.0%	455.0
600	20	5	575	20	3.3%	555.0
700	20	5	675	20	2.9%	655.0
800	20	5	775	20	2.5%	755.0
900	20	5	875	20	2.2%	855.0
1000	20	5	975	20	2.0%	955.0
1250	20	5	1225	20	1.6%	1205.0
1627	20	5	1602	20	1.2%	1582.0

Appendix I Determining the channel's flow conditions for quasi-uniform flow

This appendix provides the Python code used to iteratively determine the channel's quasi-uniform flow conditions. Comments are provided throughout the Python code to help follow the process. The channel's flow conditions just downstream of the inlet are shown in Table 39, the backwater curves are shown in Figure 97, and the flow conditions in channel's thalweg and bank areas is shown in Figure 98 and Figure 99. This appendix supports Subsection 4.1.7.

I.1. Calculating the backwater curves

Importing the required libraries

```
In [1]: import numpy as np
import matplotlib.pyplot as plt
import matplotlib
%matplotlib inline
import pandas as pd
from pandas import read_csv
from scipy.stats import norm
import matplotlib.cm as cm
import cmath
import math

g = 9.81
rho = 1000 #kg/m3
```

Ecological channel's parameters

```
In [2]: ##### RIVER'S BOUNDARY CONDITIONS #####
Qriver = [50, 125, 250, 500, 1000, 1250, 1627] #m3/s
h_SAMBV = [10.85, 10.87, 10.86, 10.82, 10.85, 11.57, 12.44] #NAP+m
h_SAMBH = [7.76, 7.82, 8.00, 8.62, 10.27, 11.08, 12.16] #NAP+m

z_river_inlet = 3.5 #NAP+m #c-----
z_river_outlet = 2.4 #NAP+m #c-----

##### CHANNEL'S BED LEVELS #####
z_inlet_start = z_river_inlet
z_inlet_end = 8.95 #NAP+ #c-----

z_outlet_start = 7.21 #NAP+m #c-----
z_outlet_end = z_river_outlet

dz = z_inlet_end - z_outlet_start #channel's bed level difference
print(f"the channel's total bed level difference {np.round(dz,2)} m")

##### CHANNEL'S LENGTHS #####
#channel's length is between the inlet and outlet ramp
L = [3500]
ib_list = []

for j in range(len(L)):
    ib = dz/L[j]
    ib_list.append({'L [m]': L[j], 'dz [m]': dz, 'ib': ib})

df_slope = pd.DataFrame(ib_list)
display(df_slope.head(20))
```

```

##### WATER LEVELS DOWNSTREAM OF THE CHANNEL #####
## the calculation done for each water level
h_BC = h_SAMBN[0] # boundary condition 0 ; Qriver < 50 m3/s
h_BC = h_SAMBN[1] # boundary condition 1 ; Qriver = 125 m3/s
h_BC = h_SAMBN[2] # boundary condition 2 ; Qriver = 250 m3/s
h_BC = h_SAMBN[3] # boundary condition 3 ; Qriver = 500 m3/s
h_BC = h_SAMBN[4] # boundary condition 4 ; Qriver = 1000 m3/s
h_BC = h_SAMBN[5] # boundary condition 5 ; Qriver = 1250 m3/s
h_BC = h_SAMBN[6] # boundary condition 6 ; Qriver = 1627 m3/s

#(it is assumed there is not outflow energy loss)
y_BC = h_BC - z_outlet_start #c----- #downstream boundary condition is the water depth at the channel's outlet location

print(f'water level at the channels outlet location: h_BC = {h_BC} m')
print(f'water depth at the channels outlet location: y_BC = {np.round(y_BC,2)} m')

##### CHANNEL'S INFLOW RATE #####
one_weir = []

Q_aim = [6.6] # boundary condition 0 ; Qriver < 50 m3/s
Q_aim = [12.5] # boundary condition 1 ; Qriver = 125 m3/s
Q_aim = [16] # boundary condition 2 ; Qriver = 250 m3/s
Q_aim = [20] # boundary condition 3 ; Qriver = 500 m3/s
Q_aim = [20] # boundary condition 4 ; Qriver = 1000 m3/s
Q_aim = [20] # boundary condition 5 ; Qriver = 1250 m3/s
Q_aim = [20] # boundary condition 6 ; Qriver = 1627 m3/s

for i in range(len(Q_aim)): #adding the inflow rates to a dataframe
    Qweir_inflow = Q_aim[i]

    one_weir.append({'Qweir [m3/s]': Qweir_inflow})

df_weir = pd.DataFrame(one_weir)
display(df_weir.head(20))

```

Calculating the channel's flow conditions for quasi-uniform flow

```
In [7]: # this is not an iteration, as the downstream water depth is a known value
#the flow conditions are determined per interval; the smaller the intervals, the more accurate the results
def BackwardDifference(intervals, Q_inflow, y_BC, L_channel, breedte_hoogte_slope, So, z_outlet_start, z_inlet_end, de_final,
                      dn50):
    q1 = 0 #no Lateral flow
    g = 9.81
    L0 = 0
    delta = 1.65 # used in shields equation<-----
    shields = 0.03 # used in shields equation<-----

    #Inflow rate iteration List, starting from inflow rate
    Qlist = [Q_inflow] #constant because no lateral inflow or outflow

    # water depth iteration List, starting at the downstream boundary
    ylist = [y_BC]

    #s positions at each interval
    slist = [L0]

    #bed level List at each interval
    zlist = [z_outlet_start]

    #flow velocity at each interval
    ulist = []

    #water level List at each interval
    hlist = []

    Fr_2_list = []
    Sf_list = []
    cf_list = []

    delist = [de_final] * intervals
    helist = []

    #critical flow velocity at each interval; determined with the hydraulic radius and friction coefficient at each interval
    #u_crit Largest for Largest cf -> at smallest water depth
    u_critical_list = []

    #####
    #cross-sectional dimensions
    Atot_list = [] #wet-crosstional area at each interval
    Ptot_list = [] #wet perimeter at each interval
    Rtot_list = [] #hydraulic radius at each interval
    top_width_list = []

    #width, height, side_slope for the thalweg and bank areas
    breedte_hoogte_hoek = breedte_hoogte_slope

    for i in range(intervals):
        x = 0
        Atot = 0
        Ptot = 0
        top_width = 0

        #Loop for determining A, P, R, topwidth
        for index, (b,d,m) in enumerate(breedte_hoogte_hoek):
            if ylist[i] > d+x:
                x = d+x
                Atot = Atot + (b * d) + (m * (d**2))
                Ptot = Ptot + (b + (2*d*np.sqrt(1+(m**2)))) - top_width

                top_width = b + (2 * m * d)
            else:
                Atot = Atot + (b * (ylist[i]-x)) + (m * ((ylist[i]-x)**2))
                Ptot = Ptot + b + (2*(ylist[i]-x) * np.sqrt(1+(m**2))) - top_width

                top_width = b + (2 * m *(ylist[i] - x))

            break

        #From this point the calculations are performed for the total cross-sectional area, wet perimeter and hydraulic radius
        Atot_list.append(Atot)
        Ptot_list.append(Ptot)
        top_width_list.append(top_width)

        Rtot = Atot / Ptot
        Rtot_list.append(Rtot)

    # print(Rtot)
```

```
##### INLET (L1)BC (L2)QUITIN #####
ks = 1.9 * dn50 #m/s #constant throughout the channel
cf = (1/(5.75*rs*log10((12*ktot)/ks))) ** 2 # determine cf for each hydraulic radius of each interval
cf_list.append(cf)

#friction slope of ecological channel with cf
SF = cf * ((Qlist[i] ** 2) * Ptot) / (g * (Atot**3))
SF_list.append(SF)

#Frude number of ecological channel (already squared)
Fr_2 = ((Qlist[i] ** 2) * top_width) / (g * (Atot**3)) #Fr_top tot use de dam
Fr_2_list.append(Fr_2)

#delta s in longitudinal direction
dl = L_channel/intervals
s_newpoint = slist[i] + dl
slist.append(s_newpoint)
z_newpoint = zlist[i] + (-So * dl)
zlist.append(z_newpoint)

#flow velocity
u_newpoint = Qlist[i] / Atot
ulist.append(u_newpoint)

#discharge
Q_newpoint = Qlist[i] - (dl * q)
Qlist.append(Q_newpoint) #discharge upstream is the same as downstream because qL = 0

#water depth
y_newpoint = ylist[i] + (dl * ((So - SF) / (1 - Fr_2)))
ylist.append(y_newpoint)

#water level
hs_newpoint = slist[i] + ylist[i]
hlist.append(hs_newpoint)

#equilibrium water level
he = slist[i] + delect[i]
he_list.append(he)

##### INLET (L1)BC (L2)QUITIN #####
#critical flow velocity where sediment transport occurs (most critical at lowest water depth)
c = np.sqrt(g/df)
u_critical = c * np.sqrt(helect * delta * dn50)
u_critical_list.append(u_critical)

return ylist, Qlist, ulist, Atot_list, Ptot_list, Rtot_list, slist, slist, SF_list, Fr_2_list, hlist, delect,
he_list, cf_list, u_critical_list
```

Visual representation of the backwater curve calculation process

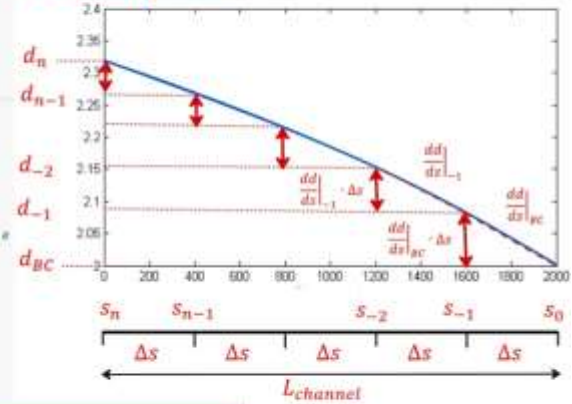

```
##### subst the initial values #####
intervals = 1000 #-----

ds_results_y3 = []
ds_plot = {}
ds_results_outlet = []

for k in range(len(df_weir['Qweir [m3/s]'])):
    for j in range(len(df_slope['L [m]'])):
        aantal = len(df_slope['L [m]'])
        index_de = (k*aantal) + j
        d_s, Q_s, u_s, A_s, P_s, R_s, z_s, s_s, SF_s, Fr_s, h_s, de_s, he_s, cf_s, ucrit_s = BackwardDifference(intervals = inter
        Q_inflow = df_weir['Qweir [m3/s]'][k], y_BC = y_BC, L_channel = -df_slope['L [m]'][j],
        breedte_hoogte_slope = breedte_hoogte_slope,
        So = df_slope['ib'][j], z_outlet_start = z_outlet_start, z_inlet_end = z_inlet_end,
        de_final = df_de['de_final'][index_de], dn50 = dn50)

##### #results at just after the channel's inlet
ds_results_y3.append({'h_BC': h_BC, 'y_BC[m]': y_BC, 'Qinflow [m3/s]': Q_s[-1], 'A_inlet [m2]': np.round(A_s[-1],2),
                    'P_inlet [m]': np.round(P_s[-1],2), 'R_inlet [m]': np.round(R_s[-1],2),
                    'L [m]': -df_slope['L [m]'][j], 'ib': df_slope['ib'][j],
                    'u_inlet [m/s]': np.round(u_s[-1],2), 'ucrit [m/s]': np.round(ucrit_s[-1],2),
                    'y_inlet [m]': np.round(d_s[-1],2), 'h_inlet [m]': np.round(h_s[-1],2),
                    'cf': np.round(cf_s[-1],2), 'de [m]': np.round(de_s[-1],2), 'he [m]': np.round(he_s[-1],2)})

##### #results for each interval
ds_plot.append({'Qweir': df_weir['Qweir [m3/s]'][k], 'L [m]': -df_slope['L [m]'][j], 's [m]': s_s,
                'd(s) [m]': d_s, 'u(s) [m/s]': u_s, 'ucrit(s)': ucrit_s, 'A(s) [m2]': A_s, 'P(s) [m]': P_s, 'R(s) [m]':
                'Fr(s)': Fr_s, 'SF(s)': SF_s, 'cf(s)': cf_s, 'z(s) [m]': z_s, 'h(s) [m]': h_s,
                'de(s)': de_s, 'he(s)': he_s})

##### #results at the channel's outlet
ds_results_outlet.append({'h_BC': h_BC, 'y_BC[m]': y_BC, 'Qinflow [m3/s]': Q_s[-1], 'A_outlet [m2]': np.round(A_s[0],2),
                        'P_outlet [m]': np.round(P_s[0],2), 'R_outlet [m]': np.round(R_s[0],2),
                        'L [m]': -df_slope['L [m]'][j], 'ib': df_slope['ib'][j],
                        'u_outlet [m/s]': np.round(u_s[0],2), 'ucrit [m/s]': np.round(ucrit_s[0],2),
                        'y_outlet [m]': np.round(d_s[0],2), 'h_outlet [m]': np.round(h_s[0],2),
                        'cf': np.round(cf_s[0],2), 'de [m]': np.round(de_s[0],2), 'he [m]': np.round(he_s[0],2)})

##### #the iteration list for s[m], d(x) [m], z(s) have an extra interval (-1). They have a larger length than the other parameters
##### #the other parameters iteration lists have a length (l). Keep in mind for the graphs
df_ds = pd.DataFrame(ds_results_y3)
display(df_ds.head(30)) #----- this dataframe shows the flow condition just after the inlet

df_ds_plot = pd.DataFrame(ds_plot)
display(df_ds_plot.head(20)) #----- this dataframe shows the lists with all the iteration values
```

Table 39: The flow conditions just downstream of the channel's inlet and at the channel's outlet

	h_{BC}	y_{BC} [m]	Q_{inflow} [m ³ /s]	A_{inlet} [m ²]	P_{inlet} [m]	R_{inlet} [m]	L [m]	ib	u_{inlet} [m/s]	ω_{crit} [m/s]	y_{inlet} [m]	h_{inlet} [m]	cf	d_e [m]	h_e [m]
0	7.76	0.55	5.0	12.47	23.42	0.53	-3500	0.000497	0.4	1.53	0.76	9.71	0.02	0.76	9.71
0	7.76	0.55	6.6	14.65	23.84	0.61	-3500	0.000497	0.45	1.6	0.86	9.81	0.01	0.86	9.81
0	7.82	0.61	12.5	24.25	33.34	0.73	-3500	0.000497	0.52	1.68	1.19	10.14	0.01	1.19	10.14
0	8.0	0.79	16.0	28.04	33.85	0.83	-3500	0.000497	0.57	1.75	1.31	10.26	0.01	1.31	10.26
0	8.62	1.41	20.0	32.02	34.38	0.93	-3500	0.000497	0.62	1.8	1.43	10.37	0.01	1.43	10.37
0	10.27	3.06	20.0	39.45	39.29	1.0	-3500	0.000497	0.51	1.64	1.63	10.58	0.01	1.43	10.37
0	11.08	3.87	20.0	62.22	41.85	1.49	-3500	0.000497	0.32	2.03	2.2	11.15	0.01	1.43	10.37
0	12.16	4.95	20.0	106.18	46.44	2.29	-3500	0.000497	0.19	2.24	3.23	12.16	0.01	1.43	10.37
	h_{BC}	y_{BC} [m]	Q_{inflow} [m ³ /s]	A_{outlet} [m ²]	P_{outlet} [m]	R_{outlet} [m]	L [m]	ib	u_{outlet} [m/s]	ω_{crit} [m/s]	y_{outlet} [m]	h_{outlet} [m]	cf	d_e [m]	h_e [m]
0	7.76	0.55	5.0	7.6	22.46	0.34	-3500	0.000497	0.66	1.31	0.55	7.76	0.02	0.76	7.97
1	7.76	0.55	6.6	7.6	22.46	0.34	-3500	0.000497	0.87	1.31	0.55	7.76	0.02	0.86	8.07
0	7.82	0.61	12.5	8.94	22.73	0.39	-3500	0.000497	1.40	1.39	0.61	7.82	0.02	1.19	8.40
0	8.0	0.79	16.0	13.05	23.53	0.55	-3500	0.000497	1.23	1.55	0.79	8.0	0.02	1.31	8.52
0	8.62	1.41	20.0	31.46	34.31	0.92	-3500	0.000497	0.64	1.8	1.41	8.62	0.01	1.43	8.84
0	10.27	3.06	20.0	98.65	45.66	2.16	-3500	0.000497	0.20	2.21	3.06	10.27	0.01	1.43	8.84
0	11.08	3.87	20.0	135.79	49.31	2.75	-3500	0.000497	0.15	2.33	3.87	11.08	0.01	1.43	8.84

Plot the backwater curves

```

In [9]: fig, ax = plt.subplots(ncols=len(df_weir['Qweir [m3/s']']), nrows= len(df_slope["L [m]"]),sharey=True, figsize=(15,10))
fig.tight_layout()

ncol = 0
if len(df_slope["L [m]"]) == 1:
    for Q in df_weir['Qweir [m3/s']']:
        nrow = 0
        ax.set_title("#Q = {round(Q,2)} $m^3/s$", fontsize = 18)
        for i in range(len(df_ds_plot)):
            if df_ds_plot['Qweir'][i] == Q:
                #z and s have length [i+1]; hs has length [i]. Remove last value of z and s.
                #It has no influence on final values
                z = df_ds_plot['z(s) [m]'][i][-1]
                s = df_ds_plot['s [m]'][i][-1]
                hs = df_ds_plot['h(s) [m]'][i]

                he_s = df_ds_plot['he(s)'][i]
                _a, _b, _c, _d = 100, 500, 100, 100
                ax.set_xlabel('x [m]', fontsize = 15)
                ax.set_ylabel('elevation [m]', fontsize = 15)

                ax.plot(s, z, color = "saddlebrown", label = "z")
                ax.plot(s, hs, 'blue')

                ax.plot(s, he_s, 'red')

                ax.fill_between(s, z, hs, color = "lightskyblue", alpha = 0.5)
                ax.fill_between(z, z, color = "saddlebrown", label = "z", alpha = 0.5)
                end = s[-1]
                ax.plot([0, _a, _b + _a], [z[0], 2.4, 2.4], color = "brown")
                ax.fill_between([0, _a, _b + _a], [z[0], 2.4, 2.4], color = "saddlebrown", alpha = 0.5)
                ax.plot([0, _a, _b + _a], [hs[0], hs[0], hs[0]], color = "blue")
                ax.fill_between([0, _a, _b + _a], [hs[0], hs[0], hs[0]], [z[0], 2.4, 2.4], color = "lightskyblue", alpha = 0.5)

                ax.plot([end, end - _c, end - _d - _c], [z[-1], 3.5, 3.5], color = "brown")
                ax.fill_between([end, end - _c, end - _d - _c], [z[-1], 3.5, 3.5], color = "saddlebrown", alpha = 0.5)
                ax.plot([end, end - _c, end - _d - _c], [hs[-1], hs[-1], hs[-1]], color = "blue")
                ax.fill_between([end, end - _c, end - _d - _c], [hs[-1], hs[-1], hs[-1]], [z[-1], 3.5, 3.5], color = "lightskyblue",
                    alpha = 0.5)

            nrow += 1
        ncol += 1
plt.show()

```

Flow conditions satisfied

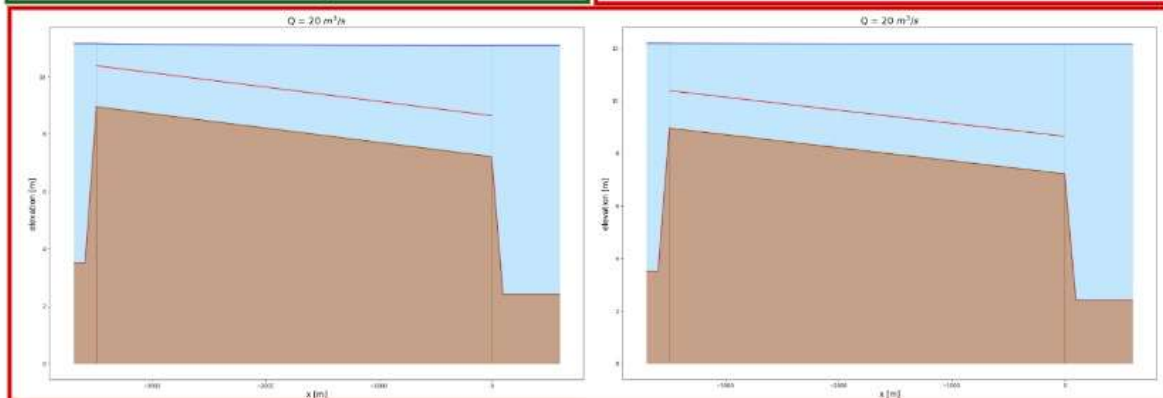
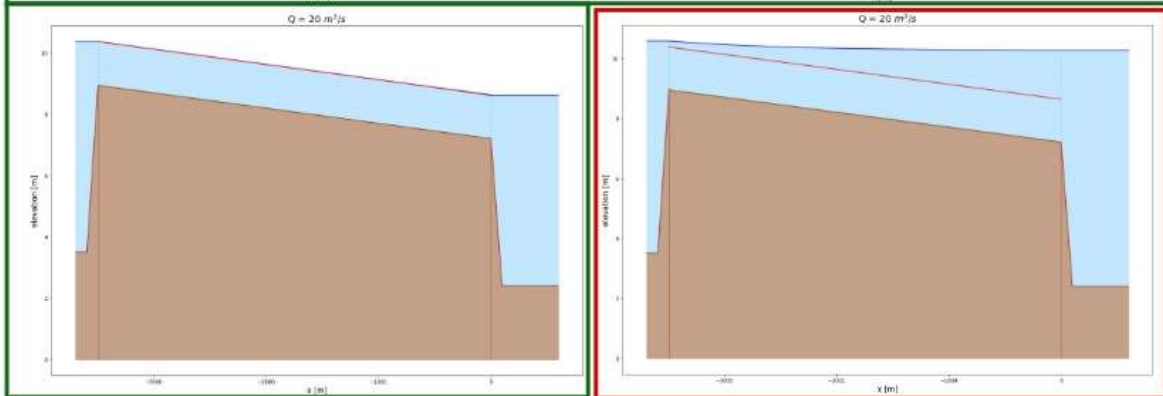
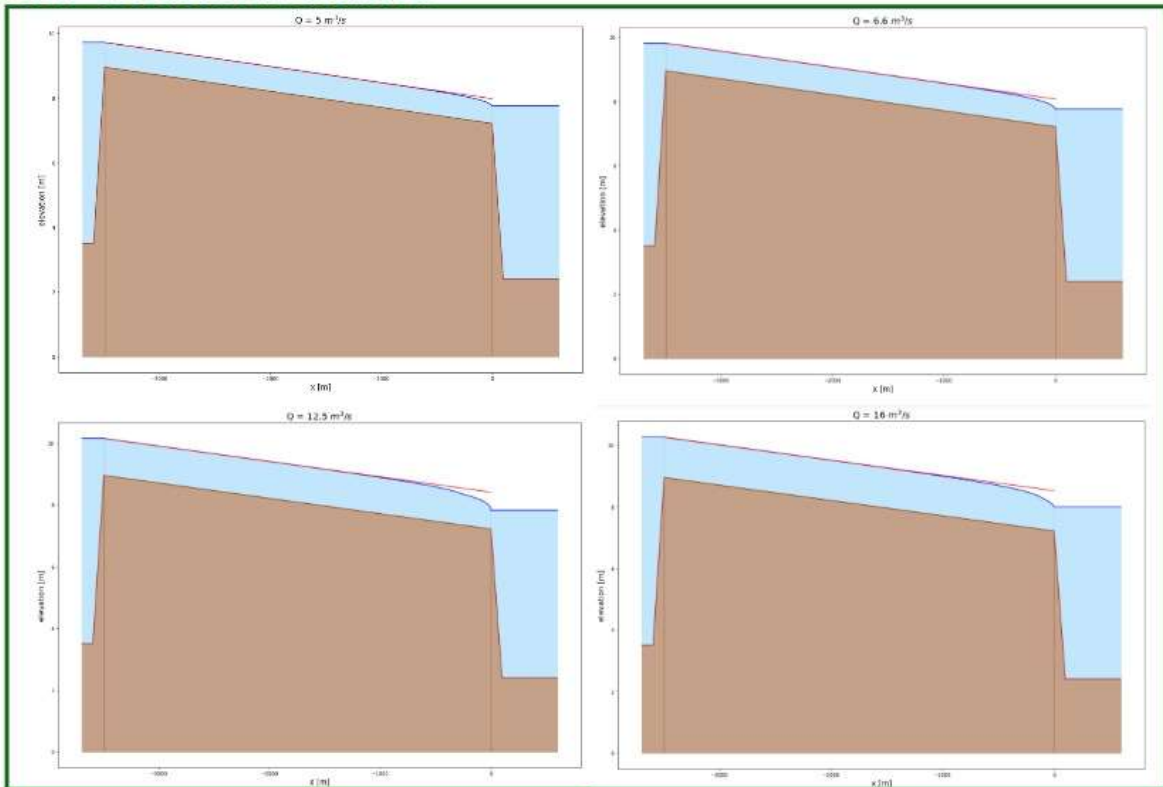

Flow conditions not satisfied

Figure 97: The backwater curves for the various inflow rates

I.2. Calculating the flow conditions in the thalweg and bank areas

Determining the flow depth and flow velocity in the thalweg and bank areas

```
In [8]: # To simplify the calculation it is assumed that the friction slope = bed slope. This results in flow velocities
# That are higher than the ones for quasi-uniform flow velocities, as the M1-backwater curve results in larger water depths
# and thus lower flow velocities

b_hoogte_slope = []
for i in range(len(a_list)):
    if i == 0:
        b_hoogte_slope.append((a_list[i] ** 2, d_list[i], m_list[i]))
    else:
        b_hoogte_slope.append((a_list[i], d_list[i], m_list[i]))

print(b_hoogte_slope)
print('d', sum([d for b,d,m in b_hoogte_slope]))

def InfoPerStep(ylist, b_hoogte_slope, dn50, So):
    g = 9.81
    delta = 1.65 # used in shields equation<-----
    shields = 0.03 ## used in shields equation<-----

    b_hoogte_hoek = b_hoogte_slope #chosen parameters cross-section

    ds_step = []

    ylist = ylist[:-1] # does not include the last value to have the same length as the other parameters.
    #It has no influence on te final flow conditions

    for i in range(len(ylist)):
        #info per step
        which_step = []
        A_step_list = []
        P_step_list = []

        d_step_list = []
        u_step_list = []
        u_critical_list = []

        cf_step_list = []
        Q_step_list = []
        Sf_step_list = []

        x = 0

        for index, (a,d,m) in enumerate(b_hoogte_hoek):
            if ylist[i] > d+x:

                # cross-section parameters for half the step
                A_section = (a * d) + ((1/2) * m * (d**2)) + ((a + (m * d)) * (ylist[i] - (d + x)))
                P_section = (a + (2*d*np.sqrt(1+(m**2))))

                R_section = A_section / P_section

                ##### WHITE COLEBROOK EQUATION #####
                #flow parameters per section
                ks = 3.5 * dn50
                cf_section = (1/(5.75*np.log10((12*R_section)/ks))) ** 2 ## determine cf for each hydraulic radius of each step

                #####SHIELDS EQUATION #####
                #critical flow velocity where sediment transport occurs (most critical at lowest water depth)
                C_section = np.sqrt(g/cf_section)
                u_critical_section = C_section * np.sqrt(shields * delta * dn50)

                # for now Sf = So
                Sf_section = So
                Q_section = (np.sqrt(g/cf_section)) * (A_section) * ((A_section/P_section) ** (1/2)) * (Sf_section ** (1/2))
                u_section = Q_section / A_section

                which_step.append(index+1)

                A_step_list.append(A_section)
                P_step_list.append(P_section)

                cf_step_list.append(cf_section)
                Sf_step_list.append(Sf_section)
                u_critical_list.append(u_critical_section)

                Q_step_list.append(Q_section)
                u_step_list.append(u_section)

                x = d+x

                d_step_list.append(d) #water depth in each section

            else:
                # cross-section parameters for half the step
                A_section = (a * (ylist[i] - x)) + ((1/2) * m * ((ylist[i] - x)**2))
                P_section = (a + ((ylist[i] - x)*np.sqrt(1+(m**2))))

                R_section = A_section / P_section

                d_step_list.append(ylist[i]-x) #water depth in each section

                ##### WHITE COLEBROOK EQUATION #####
                #flow parameters per section
                ks = 3.5 * dn50
                cf_section = (1/(5.75*np.log10((12*R_section)/ks))) ** 2 ## determine cf for each hydraulic radius of each step
```

```
#####SHIELDS EQUATION#####
#critical flow velocity where sediment transport occurs (most critical at lowest water depth)
C_section = np.sqrt(g/cf_section)
u_critical_section = C_section * np.sqrt(shields * delta * dn50)

# for now Sf = So
Sf_section = So

Q_section = (np.sqrt(g/cf_section)) * (A_section) * ((A_section/P_section)** (1/2)) * (Sf_section ** (1/2))
u_section = Q_section / A_section

which_step.append(index+1)
A_step_list.append(A_section)
P_step_list.append(P_section)

cf_step_list.append(cf_section)
Sf_step_list.append(Sf_section)
u_critical_list.append(u_critical_section)

Q_step_list.append(Q_section)
u_step_list.append(u_section)

break

Q_step_total = Q_step_list[0] + (2 * sum(Q_step_list[1:]))
u_step_total = sum(u_step_list) / len(u_step_list)

ds_step.append({'Q': df_ds_plot['Qweir'][j], 'L': df_ds_plot['L [m]'][j], 'd(s)': ylist[i],
'de(s)': df_ds_plot['de(s)'][i]-1,
'step': which_step, 'd_step': d_step_list, 'A_step': A_step_list,
'P_step': P_step_list, 'cf_step': cf_step_list, 'Sf_step': Sf_step_list,
'Q_step': Q_step_list, 'Q_check': Q_step_total,
'u_step': u_step_list, 'u_check': u_step_total,
'u_crit': u_critical_list})

return ds_step

total_step_data = []

for j in range(len(df_ds_plot['d(s) [m]'))):
    ds_step = InfoPerStep(ylist = df_ds_plot['d(s) [m]'][j], b_hoogte_slope = b_hoogte_slope, dn50 = dn50,
                        So = df_slope['ib'][0])

    #print each dataframe separately, each step has the iteration value, so it is a dataframe with a 1000 values
    #each dataframe corresponds to a channel length and inflow rate combination
    df_ds_step = pd.DataFrame(ds_step)

    ##show the x values of each dataframe
    # display(df_ds_step.head(1000))

    ##combine all the dataframes, to better select specific values for making graphs
    total_step_data.append({'dataframe_n': df_ds_step})

dfs = [data['dataframe_n'] for data in total_step_data] #the combined dataframe
df_combined_step_data = pd.concat(dfs, ignore_index=True) # Concatenate the list of dataframes into one
# display(df_combined_step_data.head(5))
# the combined dataframe is a combination of 4 dataframes, each with 1000 values. Hence, the dataframe has 4000 rows.

print('number of rows combined dataframe', len(df_combined_step_data['Q']))
print('number of rows combined dataframe', len(df_combined_step_data['L']))
# print('number of rows combined dataframe', len(df_combined_step_data['d(s)'])')

# print(df_combined_step_data[df_combined_step_data['L'] == -4000])

#the final values of the list are similar to that of the uniform flow
#the first values differ, as the water level differs more from the uniform flow situation
```

Cross-sectional plots at three channel locations, including the flow conditions

```
In [11]: # draw the empty cross-sectional shape
def draw_trap(N, L_interval, Q_interval, s_pos, step_height_a_m, b_bottom, level_floodplain, a_over, m_over, plt):
    # plot the water depth in the cross-section
    _h = 0
    _d = 0
    for i in range(len(df_ds_plot['Qweir'])):
        for j in range(len(df_ds_plot['h(s) [m]'][i])):
            if df_ds_plot['Qweir'][i] == Q_interval and df_ds_plot['L [m]'][i] == L_interval
            and df_ds_plot['s [m]'][i][j] == s_pos:
                #
                plt.axhline(df_ds_plot['d(s) [m]'][i][j], color = 'green', label = f"y = {df_ds_plot['d(s) [m]'][i][j]}m")
                plt.axhline(df_ds_plot['h(s) [m]'][i][j], color = 'green',
                    label = f"h = {round(df_ds_plot['h(s) [m]'][i][j],2)}m")
                _h = df_ds_plot['h(s) [m]'][i][j]
                _d = df_ds_plot['d(s) [m]'][i][j]

                #####
                plt.axhline(df_ds_plot['he(s)'][i][j], color = 'red', label = f"he = {round(df_ds_plot['he(s)'][i][j],2)}m")
                _he = df_ds_plot['he(s)'][i][j]

                bottom_level = df_ds_plot['z(s) [m]'][i][j]

                x_cor = [0]
                y_cor = [bottom_level]

                step_a = step_height_a_m[0][1]
                b_thalweg = b_bottom - (2*step_a)
                u_list = [b_thalweg]
                b_list = []

                d_list = []
                a_list = []
                m_list = []
```

Flow conditions satisfied

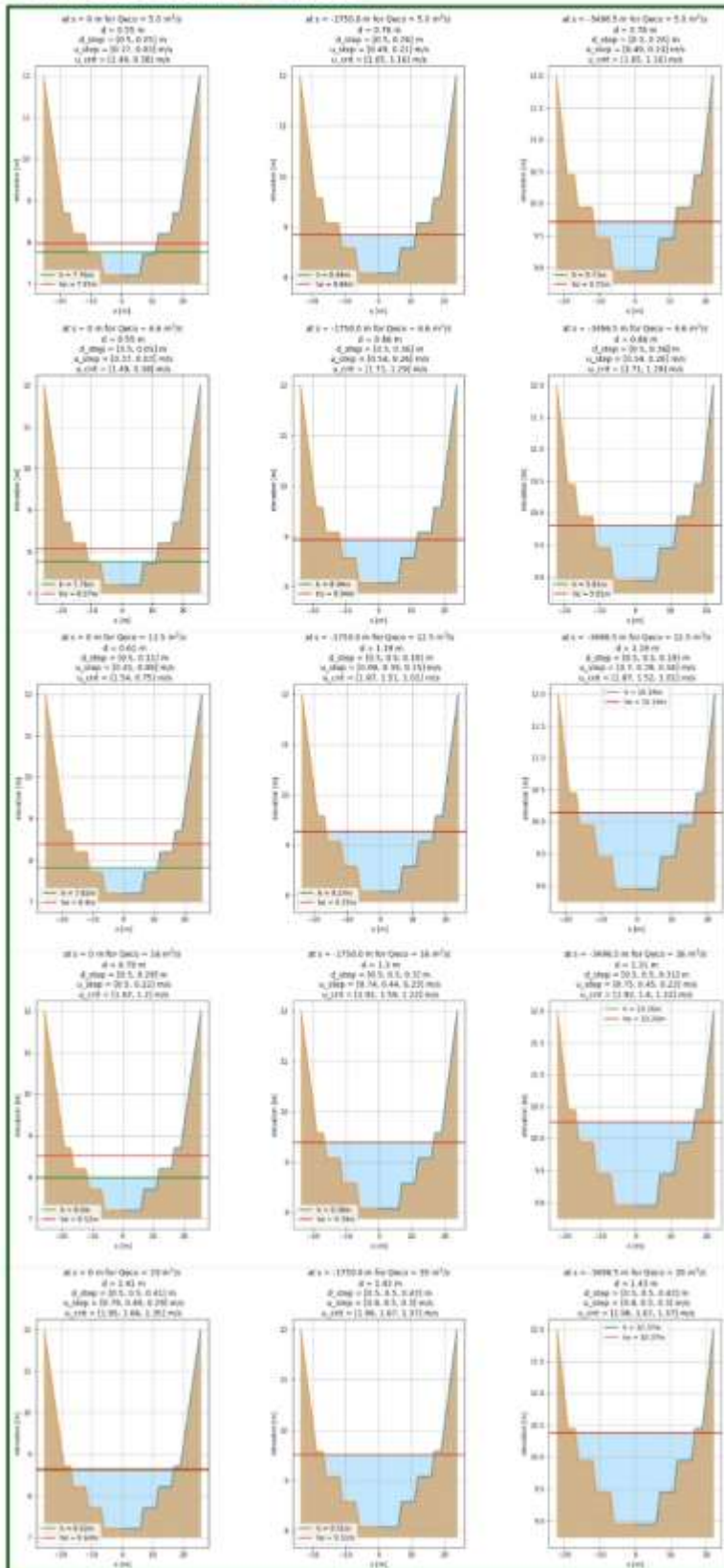
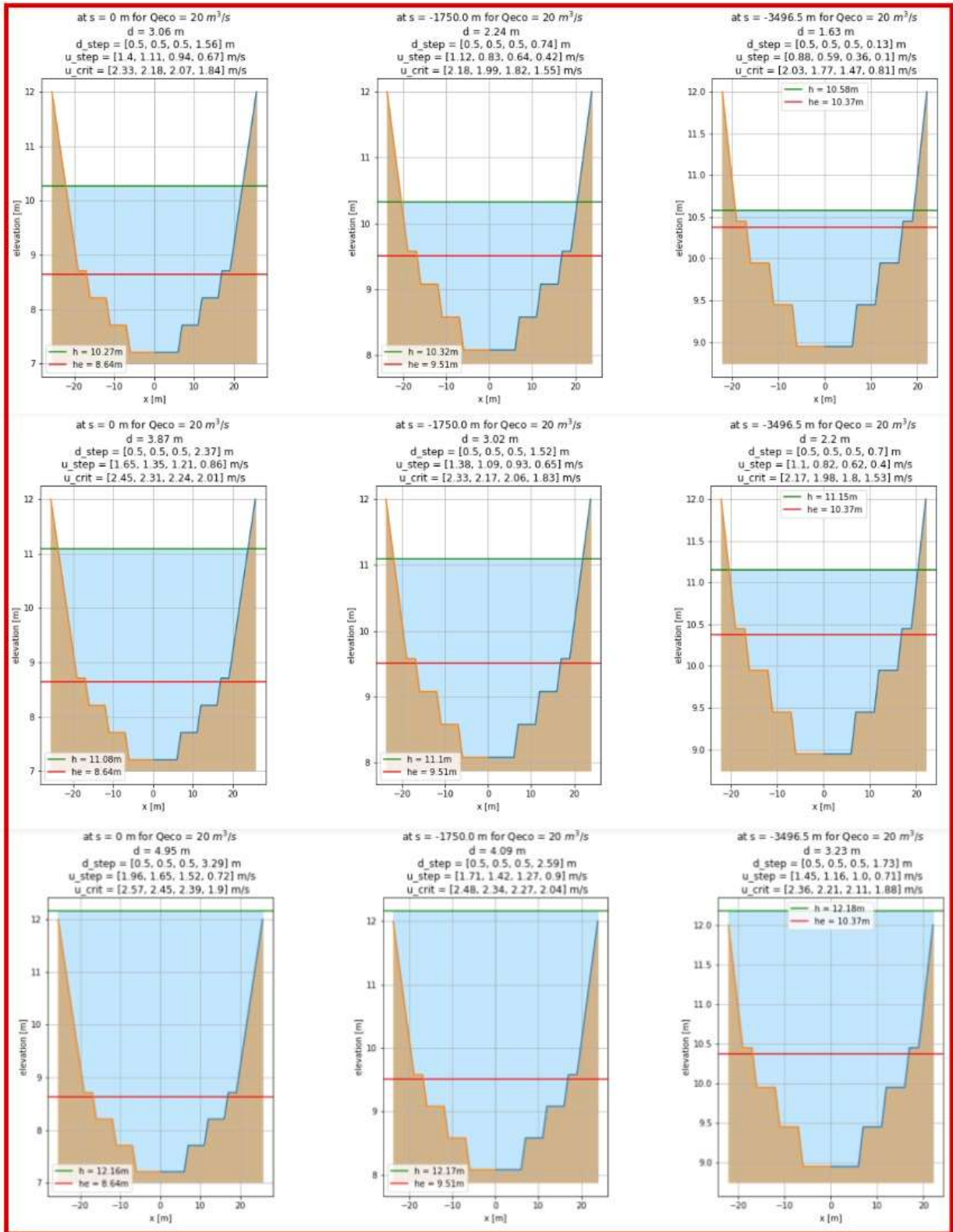

Figure 98: The flow conditions in the channel's thalweg and bank areas that satisfy the required flow conditions



Flow conditions not satisfied

Figure 99: The flow conditions in the channel's thalweg and bank areas that do not satisfy the required flow conditions

I.3. Overview of the flow conditions in the channel's thalweg and bank areas

Table 40: Flow conditions in the channel's thalweg and bank areas at the outlet, middle, and inlet for quasi-uniform flow (bold highlighted values do not meet the flow requirements)

Channel's outlet									
River's discharge	Inflow rate	Flow depth d_s [m]	Flow velocity u [m/s]				Critical flow velocity u_{crit} [m/s]		
Q_{river} [m ³ /s]	Q_{eco} [m ³ /s]	$0.8 \text{ m} \leq d_s \leq 2 \text{ m}$	Thalweg $\leq 1.0 \text{ m/s}$ and u_{crit}	Bank area $1 \leq 0.5 \text{ m/s}$ and u_{crit}	Bank area 2 $\leq 0.5 \text{ m/s}$ and u_{crit}	Bank area extra	Thalweg	Bank area 1	Bank area 2
25	5	0.55	0.37	0.03	-	-	1.49	0.38	-
50	6.6	0.55	0.37	0.03	-	-	1.49	0.38	-
125	12.5	0.61	0.41	0.09	-	-	1.54	0.75	-
250	16	0.79	0.50	0.22	-	-	1.67	1.20	-
500	20	1.41	0.79	0.49	0.29	-	1.95	1.66	1.35
1000	20	3.06	1.40	1.11	0.94	0.67	2.33	2.18	2.07
1250	20	3.87	1.65	1.35	1.21	0.86	2.45	2.31	2.24
Middle of the channel									
River's discharge	Inflow rate	Flow depth d_s [m]	Flow velocity u [m/s]				Critical flow velocity u_{crit} [m/s]		
Q_{river} [m ³ /s]	Q_{eco} [m ³ /s]	$0.8 \text{ m} \leq d_s \leq 2 \text{ m}$	Thalweg $\leq 1.0 \text{ m/s}$ and u_{crit}	Bank area $1 \leq 0.5 \text{ m/s}$ and u_{crit}	Bank area 2 $\leq 0.5 \text{ m/s}$ and u_{crit}	Bank area extra	Thalweg	Bank area 1	Bank area 2
25	5	0.76	0.49	0.21	-	-	1.65	1.16	-
50	6.6	0.86	0.54	0.26	-	-	1.71	1.29	-
125	12.5	1.19	0.69	0.39	0.15	-	1.87	1.51	1.01
250	16	1.30	0.74	0.44	0.23	-	1.92	1.59	1.22
500	20	1.43	0.80	0.50	0.30	-	1.96	1.67	1.37
1000	20	2.24	1.12	0.83	0.64	0.42	2.18	1.99	1.82
1250	20	3.02	1.38	1.09	0.93	0.65	2.33	2.17	2.06
Channel's inlet									
River's discharge	Inflow rate	Flow depth d_s [m]	Flow velocity u [m/s]				Critical flow velocity u_{crit} [m/s]		
Q_{river} [m ³ /s]	Q_{eco} [m ³ /s]	$0.8 \text{ m} \leq d_s \leq 2 \text{ m}$	Thalweg $\leq 1.0 \text{ m/s}$ and u_{crit}	Bank area $1 \leq 0.5 \text{ m/s}$ and u_{crit}	Bank area $2 \leq 0.5 \text{ m/s}$ and u_{crit}	Bank area extra	Thalweg	Bank area 1	Bank area 2
25	5	0.76	0.49	0.21	-	-	1.65	1.16	-
50	6.6	0.86	0.54	0.26	-	-	1.71	1.29	-
125	12.5	1.19	0.70	0.39	0.16	-	1.87	1.52	1.01
250	16	1.31	0.75	0.45	0.23	-	1.92	1.60	1.22
500	20	1.43	0.80	0.50	0.30	-	1.96	1.67	1.37
1000	20	1.63	0.88	0.59	0.36	0.1	2.03	1.77	1.47
1250	20	2.20	1.10	0.82	0.62	0.40	2.17	1.98	1.80

Appendix J Determining the flow conditions for the design alternatives of the intake structure

This appendix provides the Python code used to calculate the required flow openings to achieve the necessary inflow rates for the flap gate and the flow conditions of the vertical-slot fish passage for the first design alternative. It also provides the inputs and outputs of the HEC-RAS hydraulic program used to estimate the flow conditions for the intake structure that consists of consecutive pools and weirs, the second design alternative. This appendix supports Subsection 4.2.4.

J.1. Determining the flow conditions for the first design alternative

Determining the flow opening and flow conditions for the flap gate

The flap gate accommodates both free-overflow and submerged overflow. The calculations for the flow opening and the flow conditions for both flow types is shown below.

Flap gate flow conditions at complex Sambeek

```
In [4]: ### Sambeek data
upstream_water_level = [10.85, 10.85, 10.87, 10.86, 10.82, 10.85, 11.57, 12.44] # water levels just upstream of fish passage
downstream_water_level = [9.71, 9.81, 10.14, 10.26, 10.37, 10.58, 11.15, 12.18] #water levels just downstream of fish passage
inlet_bed_elevation = 8.95
Bgate = 10
pgate = [1.3, 1.18, 0.695, 0.61, 0.41, 0.33, 1.155, 1.905]

# hydraulic data
Qriver = [25, 50, 125, 250, 500, 1000, 1250, 1627] #river's flow rate
Qgate_flow = []
Q_eco = []

Cd_overflow = [1.1] #initial value for submerged flow
Cd_freeflow = [1.0] #initial value for free-flow
Cd_list = []

# determining the water depths upstream and downstream of the flap gate and the water level difference
for j in range(len(upstream_water_level)):
    d1 = upstream_water_level[j] - inlet_bed_elevation #upstream water depth relative to bottom
    d3 = downstream_water_level[j] - inlet_bed_elevation # downstream water depth relative to bottom

    h1 = d1 - pgate[j] #upstream water depth relative gate crest
    h3 = d3 - pgate[j] # downstream water depth relative gate crest
    dh = d1 - d3

    for i in range(10):
        ## Submerged- overflow calculation
        if d3 > pgate[j]: #if the downstream water depth lies above the gate crest
            Qinflow = Cd_overflow[i] * Bgate * h3 * np.sqrt(2 * g * (h1 - h3))
            Q_eco.append(Qinflow)

            h2 = h3 #estimated water depth above gate
            u2 = Qinflow/(Bgate * h2) #estimated water depth above gate

            Cd = 0.611 + 0.08 * (h2/pgate[j])
            Cd_overflow.append(Cd)
            Cd_list.append(Cd)

            dif = Cd_overflow[i+1] - Cd_overflow[i]
            if abs(dif) < 10**-10:
                print('converged for submerged flow')
                break

        ###free-overflow calculation
        else:
            Qinflow = Cd_freeflow[i] * Bgate * (2/3) * np.sqrt((2/3)*g) * ((h1)**(3/2))
            Q_eco.append(Qinflow)

            h2 = (2/3) * h1 #water depth above gate
            u2 = Qinflow/(Bgate * h2) #flow velocity above gate

            Cd = 0.611 + 0.08 * (h2/pgate[j])
            Cd_freeflow.append(Cd)
            Cd_list.append(Cd)

            dif = Cd_freeflow[i+1] - Cd_freeflow[i]

            if abs(dif) < 10**-10:
                print('converged for free-flow')
                break

    Qgate_flow.append({'Qriver [m3/s]': Qriver[j], 'h1 [m]': h1, 'h3 [m]': h3,
                      'dh [m]': dh, 'Cd': np.round(Cd_list[-1],2),
                      'Bgate [m]': Bgate, 'p_gate [m]': np.round(pgate[j],2), 'd1 [m]': d1,'d3 [m]': d3,
                      'Qinflow [m3/s]': np.round(Q_eco[-1],1),
                      'h2 [m]': np.round(h2,2), 'u2 [m/s]': np.round(u2,2)})

df_gate_flow = pd.DataFrame(Qgate_flow)
display(df_gate_flow.head(30))
```

converged for free-flow
 converged for free-flow
 converged for submerged flow
 converged for submerged flow
 converged for submerged flow
 converged for submerged flow
 converged for submerged flow
 converged for submerged flow

	Qriver [m3/s]	h1 [m]	h3 [m]	dh [m]	Cd	Bgate [m]	p_gate [m]	d1 [m]	d3 [m]	Qinflow [m3/s]	h2 [m]	u2 [m/s]
0	25	0.600	-0.540	1.14	0.64	10	1.30	1.90	0.76	5.0	0.40	1.26
1	50	0.720	-0.320	1.04	0.64	10	1.18	1.90	0.86	6.6	0.48	1.38
2	125	1.225	0.495	0.73	0.67	10	0.70	1.92	1.19	12.5	0.50	2.53
3	250	1.300	0.700	0.60	0.70	10	0.61	1.91	1.31	16.0	0.70	2.29
4	500	1.460	1.010	0.45	0.81	10	0.41	1.87	1.42	20.0	1.01	1.98
5	1000	1.570	1.300	0.27	0.93	10	0.33	1.90	1.63	20.0	1.30	1.54
6	1250	1.465	1.045	0.42	0.68	10	1.16	2.62	2.20	20.0	1.05	1.92
7	1627	1.585	1.325	0.26	0.67	10	1.90	3.49	3.23	20.0	1.33	1.51

The negative values indicate free-flow, as the downstream water depth lies below the gate height.

Determining the flow conditions for the Vertical-slot fish passage

The calculation to determine the flow conditions in the fish passage is shown below

Vertical-slot fish passage flow conditions

```
In [2]: ### SAMBEK
upstream_water_level = [10.85, 10.85, 10.87, 10.86, 10.82, 10.85, 11.57, 12.44] # water levels just upstream of fish passage
downstream_water_level = [9.71, 9.81, 10.14, 10.26, 10.37, 10.58, 11.15, 12.18] #water levels just downstream of fish passage
inlet_bed_elevation = 8.95
number_of_pools = 12

#####
# Hydraulic data
Qriver = [25, 50, 125, 250, 500, 1000, 1250, 1627] #river's flow rate
Qeco = [5, 6.6, 12.5, 16, 20, 20, 20, 20] #inflow rate to the ecological channel

# Dimensions of the fish passage
Bslot = 0.75
Cfish = 0.7 #discharge coefficient of the fish passage's slots
Lpool = 5.0
Bpool = 2.5

Q_fish_list = []
total_dh = []
y0_list = []
d_downstream_list = []

# determining the water depths upstream and downstream of the fish passage and the water level difference
for j in range(len(upstream_water_level)):
    y0 = upstream_water_level[j] - inlet_bed_elevation
    d_downstream = downstream_water_level[j] - inlet_bed_elevation
    dh = y0 - d_downstream

    y0_list.append(y0)
    d_downstream_list.append(d_downstream)
    total_dh.append(dh)

for i in range(len(total_dh)):
    dh_each_pool = total_dh[i] / number_of_pools

    Q_fish = Cfish * Bslot * y0_list[i] * np.sqrt(2*g*dh_each_pool) #inflow rate of the fish passage
    Q_flap_gate = Qeco[i] - Q_fish
    Q_ratio = (Q_fish/ Q_flap_gate) * 100 #the discharge ratio between the ecological channel and fish passage

    v_slot = Cfish * np.sqrt(2*g*dh_each_pool) #flow velocity through the slot
    d_pool = d_downstream_list[i] + dh_each_pool #water depth in the pool
    energy = (rho * g * Q_fish * dh_each_pool) / (Lpool * Bpool * d_pool) # energy dissipation over the pools

    Q_fish_list.append({'Qriver [m3/s]': Qriver[i], 'Qeco [m3/s]': Qeco[i], 'dh_total [m]': total_dh[i],
                       'y0 [m]': y0_list[i], 'y1 [m]': d_downstream_list[i], 'C': Cfish, 'Bslot [m]': Bslot,
                       'dh_pool [m]': np.round(dh_each_pool,3), 'Qpassage [m3/s]': np.round(Q_fish,2),
                       'Qflap-gate [m3/s]': np.round(Q_flap_gate,2), "discharge ratio [%]": np.round(Q_ratio,2),
                       'v_avg [m/s]': np.round(v_slot,2), 'ε [W/m3]': np.round(energy,2)})

df_fish_passage = pd.DataFrame(Q_fish_list)
display(df_fish_passage.head(20))
```

	Qriver [m3/s]	Qeco [m3/s]	Δh_total [m]	y0 [m]	y1 [m]	C	Bslot [m]	Δh_pool [m]	Qpassage [m3/s]	Qflap-gate [m3/s]	discharge ratio [%]	v_avg [m/s]	ε [W/m3]
0	25	5.0	1.14	1.90	0.76	0.7	0.75	0.095	1.36	3.64	37.43	0.86	118.75
1	50	6.6	1.04	1.90	0.66	0.7	0.75	0.087	1.30	5.30	24.55	0.91	93.45
2	125	12.5	0.73	1.92	1.19	0.7	0.75	0.061	1.10	11.40	9.66	0.76	42.03
3	250	16.0	0.60	1.91	1.31	0.7	0.75	0.050	0.99	15.01	6.62	0.69	26.66
4	500	20.0	0.45	1.87	1.42	0.7	0.75	0.038	0.84	19.16	4.40	0.60	17.00
5	1000	20.0	0.27	1.90	1.63	0.7	0.75	0.022	0.66	19.34	3.43	0.47	7.08
6	1250	20.0	0.42	2.62	2.20	0.7	0.75	0.035	1.14	18.66	6.04	0.58	14.01
7	1627	20.0	0.26	3.49	3.23	0.7	0.75	0.022	1.19	18.81	6.35	0.46	6.25

J.2. Determining the flow conditions for the second design alternative

This appendix provides inputs and outputs of the HEC-RAS hydraulic program used to estimate the flow conditions for the intake structure that consists of consecutive pools and weirs. This appendix supports Subsection 4.2.4.

Input of the model

Constructing the model of the intake structure starts by defining the dimensions of the passage's total length, pool length, and pool width. With the estimated values for an inflow rate of 5 m³/s in Subsection 4.2.4, these dimensions are set to 150 m, 10 m, and 7 m, respectively. Next, the dimensions of the weirs are defined in the model. The weir has a width of 6.5 m and a recommended weir length of 0.15 m (Kroes & Monden). For simplicity, a rectangular shape is taken for both the pools and weir's flow opening. The first weir has a crest elevation of NAP+9.24 m (most downstream weir), and the consecutive weirs each increase by 0.08 m. The last weir (most upstream weir) has a crest elevation of NAP+10.28m. The program's windows showing the weirs at the start, middle, and end of the passage are shown in Figure 100.

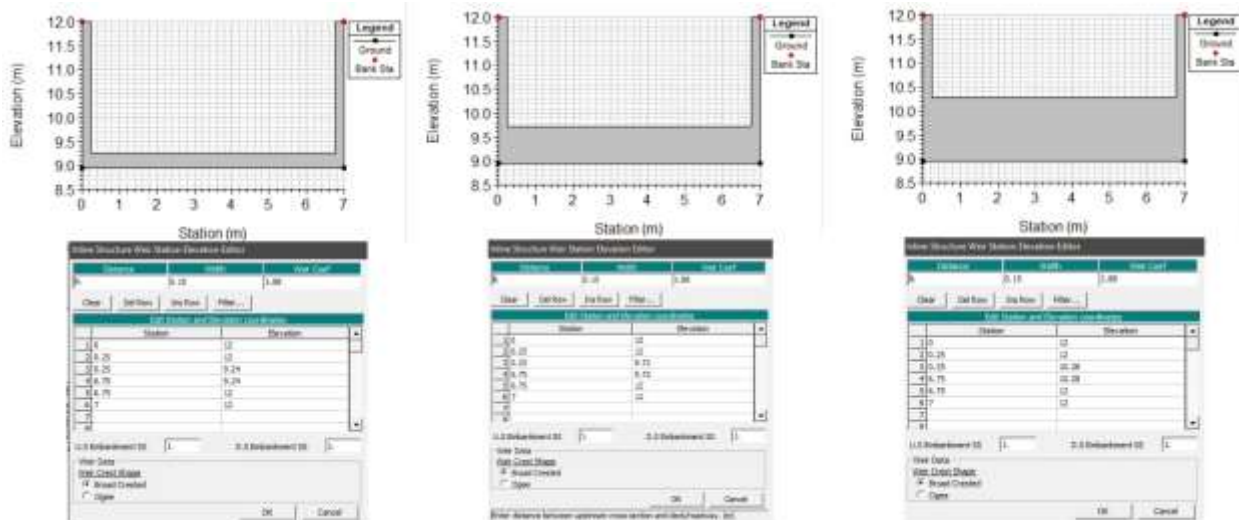

Figure 100: Dimensions inputs of the HEC-RAS program

The figure shows a weir discharge coefficient of 1.88, even though it was stated that the calculation uses a discharge coefficient of 1.1. This occurs, as the HEC-RAS program calculates for free-flow and automatically takes the submergence of the weirs into account. According to the HEC-RAS manual (USACE Hydraulic Engineering Center, n.d.), the weir equation used in the model is:

$$Q = C \cdot B \cdot H^{\frac{3}{2}}$$

Where:

Q : flow rate [m³/s]

C : weir flow coefficient

B : weir width [m]

H : weir energy head [m]

Comparing this to the weir equation for free-flow shows that the weir flow coefficient is equal to 1.705 times the discharge coefficient (C_d). The comparison is shown below. The weir flow coefficient is 1.88.

$$Q = C_d \cdot B \cdot \frac{2}{3} \cdot \sqrt{\frac{2}{3}g} \cdot h_1^{\frac{3}{2}} \quad \rightarrow \quad Q = \frac{2}{3} \cdot \sqrt{\frac{2}{3}g} \cdot C_d \cdot B \cdot h_1^{\frac{3}{2}} \quad \rightarrow \quad Q = 1.705 \cdot C_d \cdot B \cdot h_1^{\frac{3}{2}}$$

Next, the minimum and maximum required inflow rates of the intake structure, 5 m³/s and 20 m³/s, are added in the model. The water depths downstream of the intake structure (determined in Subsection 4.1.7) are added to the model. The windows for these inputs are shown in Figure 101. The calculation is performed for uniform flow.

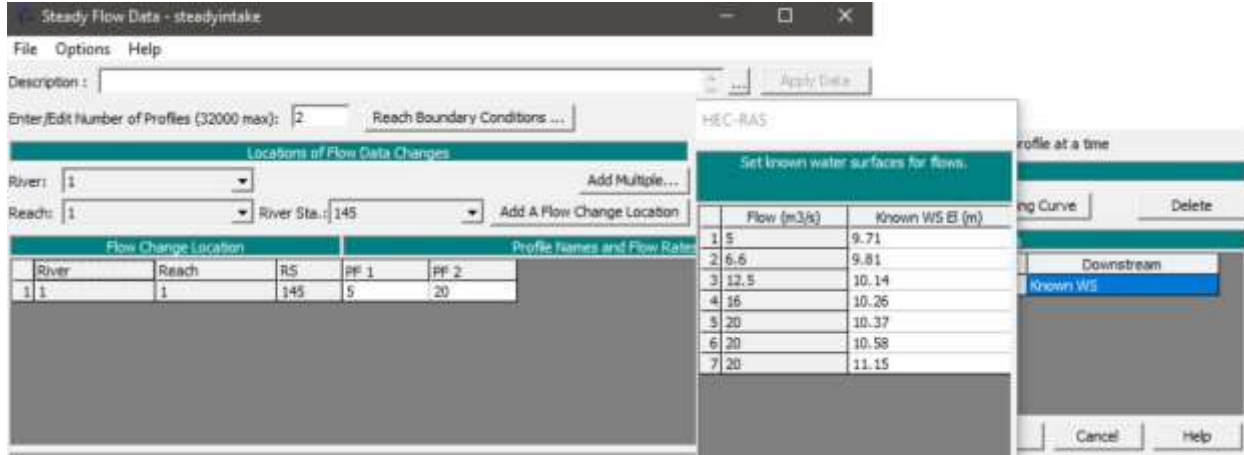

Figure 101: The input windows for the flow rates and downstream water levels

Output of the model

The program calculates the water depths above the weirs and flow velocities in the pools. The flow conditions at the start, middle, and end of the intake structure for the flow rate 5 m³/s are shown in Figure 102, and the longitudinal profile is shown in Figure 103. The figures show that the flow conditions are met for this flow rate. To accommodate a flow rate of 20 m³/s, the most upstream weir must be lowered to an elevation of NAP+9.24m. If only the most upstream weir is lowered and the remaining weirs are not, it leads to increased water levels upstream of the intake structure, which can lead to premature flooding of the floodplains. The flow conditions at the start, middle, and end of the intake structure for a flow rate 20 m³/s is shown in Figure 104 and the longitudinal profile in Figure 105.

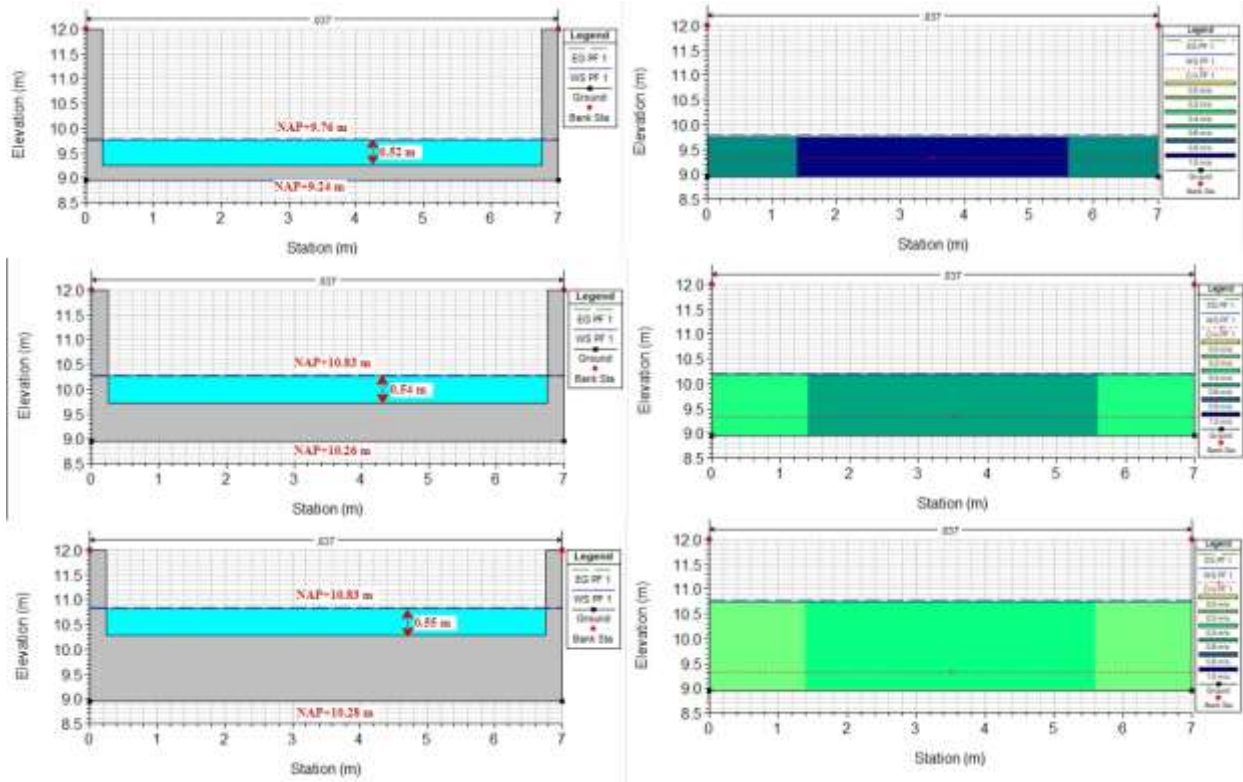

Figure 102: The water depths above the weir and the flow velocities in the pool for a flow rate of $5 \text{ m}^3/\text{s}$

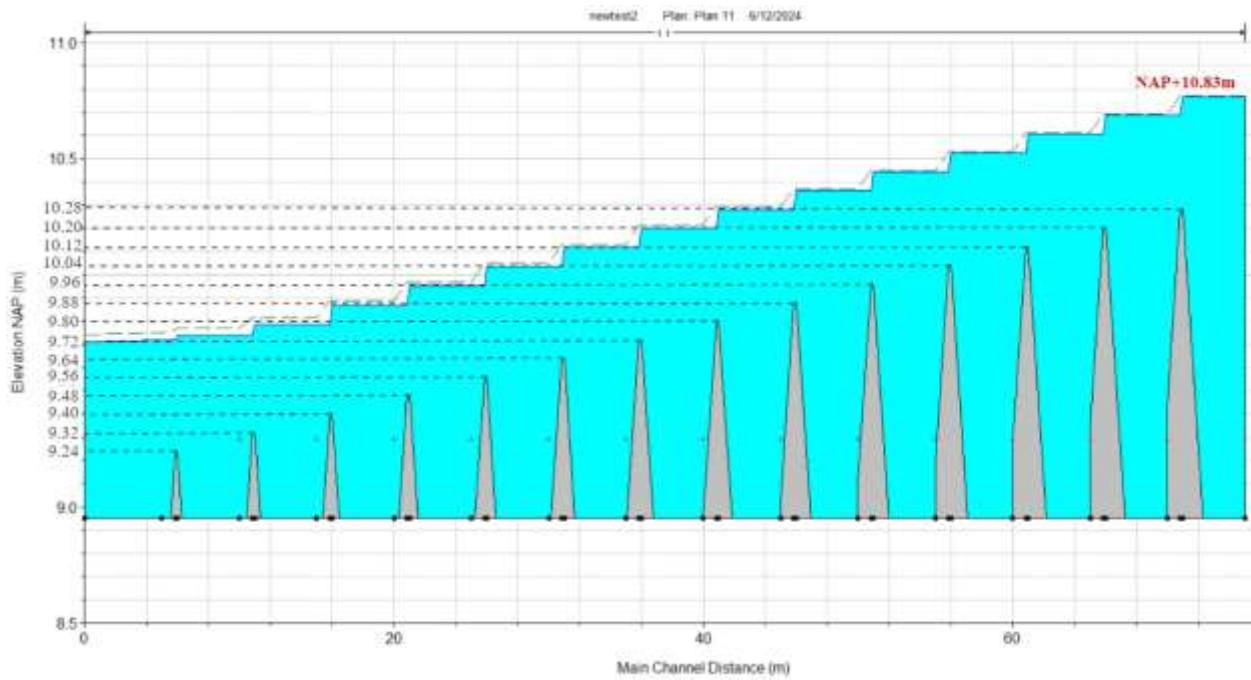

Figure 103: Longitudinal profile of the intake structure for flow rate of $5 \text{ m}^3/\text{s}$

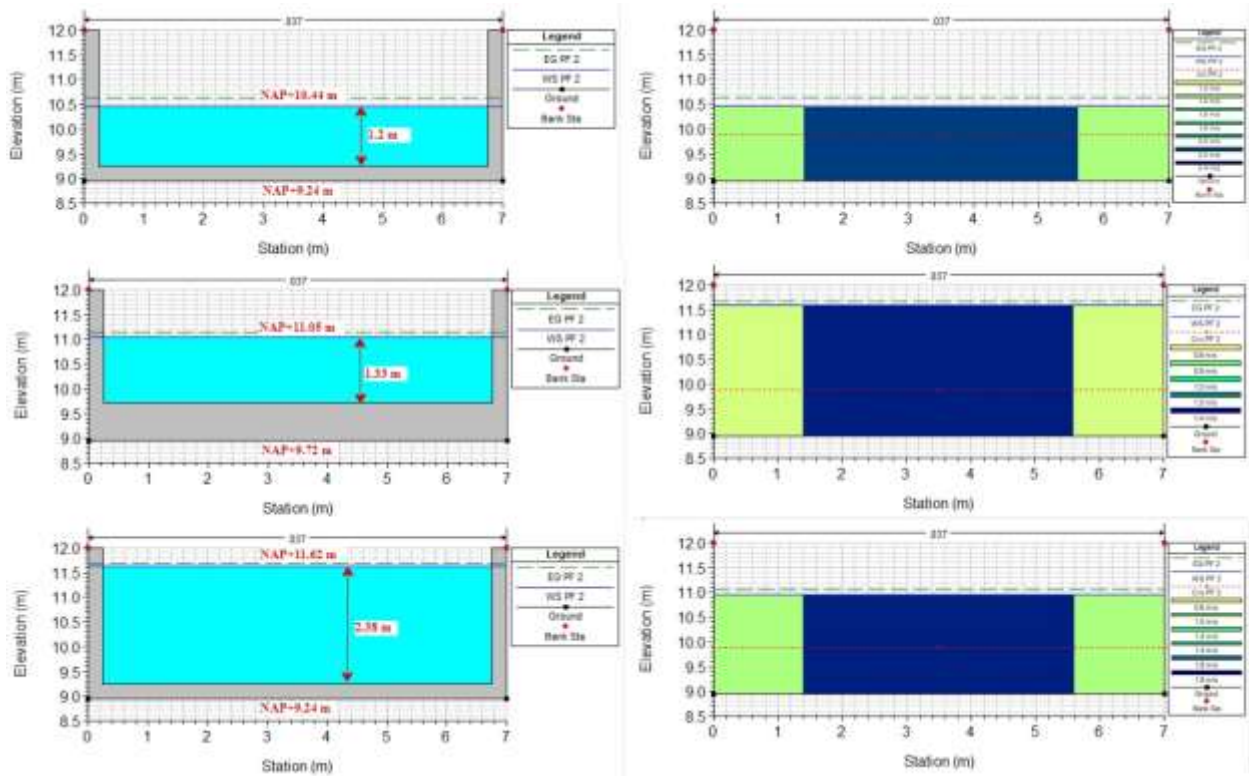

Figure 104: The water depths above the weir and the flow velocities in the pool for a flow rate of $20 \text{ m}^3/\text{s}$

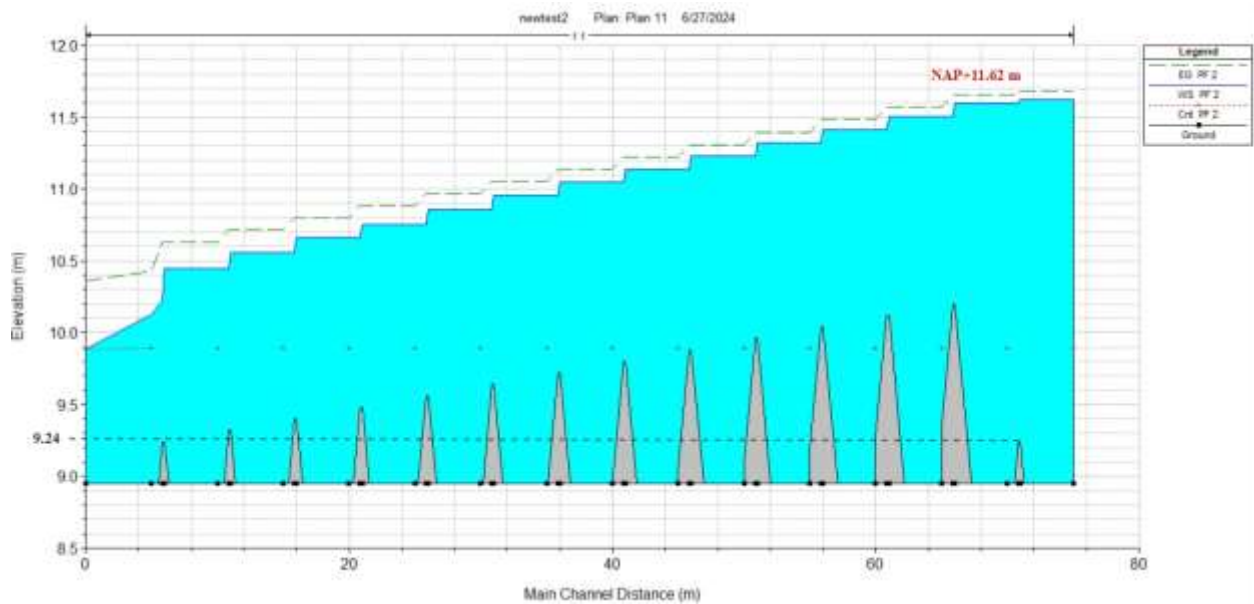

Figure 105: Longitudinal profile of the intake structure with the lowered upstream weir for flow rate of $20 \text{ m}^3/\text{s}$

Appendix K Estimating the number of days river discharges between 400 and 500 m³/s occur

The number of days a river discharge between 400 m³/s and 500 m³/s occurs is estimated using the measured discharge data from the measurement point Venlo. This data is used as it is the closest publicly available source. The data is extracted from the Waterinfo website from Rijkswaterstaat (Rijkswaterstaat, 2023). Using the Python code given below, the total number of days in the measured years that exceed a river discharge of 400 m³/s is determined. The average of these values is used as the final estimated total number of days, which is 78 days. The values are given in Table 41.

A river discharge of 500 m³/s is exceeded roughly 47 days year per, see Table 11. The number of days a discharge occurs between 400 m³/s and 500 m³/s is the difference between these values, which is 31 days.

```
#Importing the discharge data from the Rijkswaterstaat waterinfo website at VENLO
data_discharge = pd.read_csv('D:\Rijkswaterstaat\waterinfo\VENLO\discharge_data.csv', encoding = 'unicode_escape', delimiter = ';')
# data_discharge.head()
# data_discharge.info()

#Removing the column with NaN values and column with unnecessary information for the merging
df_VENLO = data_discharge.drop(['MONSTER_IDENTIFICATIE', 'TYPERING_OMSCHRIJVING', 'TYPERING_CODE', 'GROOTHEID_CODE',
'PARAMETER_OMSCHRIJVING', 'PARAMETER_CODE', 'CAS_NR', 'ORGAN_OMSCHRIJVING', 'ORGAN_CODE',
'GROEPERING_OMSCHRIJVING', 'GROEPERING_CODE', 'GROEPERING_KANAAL', 'GROEPERING_TYPE',
'TYPE', 'E', 'F', 'TRAILNAME', 'REFERENTIEVAAL', 'MONSTERINGSDIET_OMSCHRIJVING',
'BEWEGINGSRIJESAPPARAAT_CODE', 'PLAATSAPPARAAT_OMSCHRIJVING', 'PLAATSAPPARAAT_CODE',
'BEWEGINGSRIJESHOOFD', 'WAARDENBESCHRIJVING_OMSCHRIJVING', 'WAARDENBESCHRIJVING_CODE',
'COMPARTMENT_CODE', 'NOTITIE_OMSCHRIJVING', 'NOTITIE_CODE', 'REFERENTIE', 'MONSTERINGSDIET_CODE',
'LIJNTEGROEP', 'STATUSWAARD', 'OPDRACHTVENDE_INSTANTIE', 'METAPARAAT_CODE',
'BEWEGINGSRIJESAPPARAAT_OMSCHRIJVING', 'METSANID_CODE', 'WAARDENBESCHRIJVING_CODE',
'QUALITEITSCORREL_CODE', 'METAPARAAT_OMSCHRIJVING', 'COMPARTMENT_OMSCHRIJVING',
'METSANID_CODE', 'WAARDENBESCHRIJVING_CODE', 'METSANID_CODE', 'METSANID_CODE', 'BEWEGINGSRIJESAPPARAAT_CODE', 'STATUSWAARD',
'METAPARAAT_CODE', 'GROOTHEID_OMSCHRIJVING'], axis = 1)

#Make copies of the data to remove warning message
df_VENLO = df_VENLO.copy()

#Replacing the comma separator with a dot
df_VENLO['WAARDENBESCHRIJVING'] = df_VENLO['WAARDENBESCHRIJVING'].str.replace(',', '.', regex=True).astype(float)

#Converting the date into the pandas datetime format, to properly use the date
df_VENLO['WAARDENBESCHRIJVING'] = pd.to_datetime(df_VENLO['WAARDENBESCHRIJVING'], format = '%d-%m-%Y')

#Remove the columns
df_VENLO = df_VENLO.rename(columns={'WAARDENBESCHRIJVING': 'WAARDENBESCHRIJVING (m3/s)'})

#If you want to see the first 5 columns of the data with only Venlo
display(df_VENLO.head(20))

df_dh_Q['WAARDENBESCHRIJVING'] = pd.to_datetime(df_dh_Q['WAARDENBESCHRIJVING'], format='%Y-%m-%d')

average_value_per_year = []

for i in range(len(df_dh_Q['WAARDENBESCHRIJVING'])):
    #which year
    df_dh_Q_year = df_dh_Q[df_dh_Q['WAARDENBESCHRIJVING'].dt.year == 2000]

    # Calculate daily averages of the downstream water levels and discharges
    daily_avg_df = df_dh_Q_year.groupby(df_dh_Q_year['WAARDENBESCHRIJVING'].dt.date).agg({
        'SAPBESCHRIJVING': 'mean',
        'discharge [m3/s]': 'mean'}).reset_index()

    # filtering the data based on criterion value
    filtered_df = daily_avg_df[daily_avg_df['discharge [m3/s]'] >= 400]

    display(filtered_df.head(50))
    print(len(filtered_df['discharge [m3/s]'])) #number of rows
    filtered_df.describe()
```

Table 41: Estimated number of days exceeding a river discharge of 400 m³/s

Year	Number of days exceeding Q _{river} = 400 m ³ /s
2000	81
1999	123
1998	120
1997	42
1996	23
Average value	78

Appendix L Boundary conditions and flow conditions for the other complex locations

This appendix provides the estimated channel lengths and the measured river water levels upstream and downstream of each weir complex location. In addition, it provides the flow conditions in the channel's thalweg and bank area for each complex location. This appendix supports Chapter 5.

L.1. Estimated channel lengths

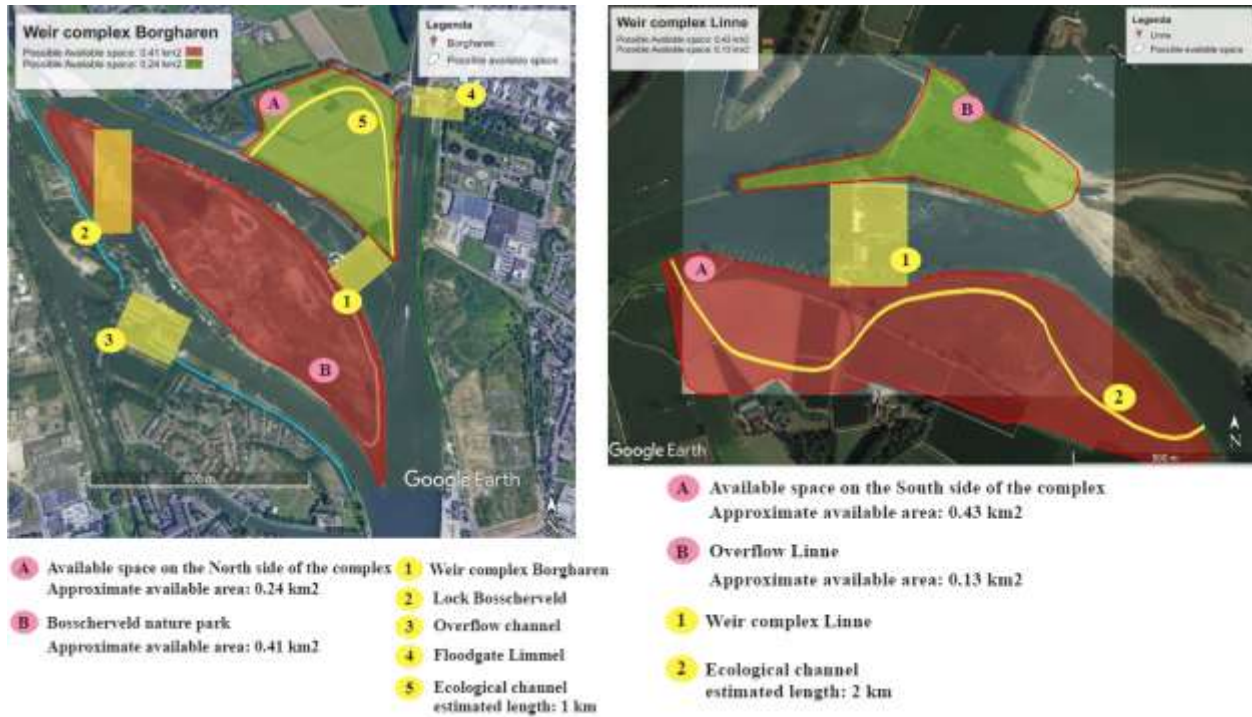

Figure 106: Estimated channel length for weir complex Borgharen and Linne (Google earth, 2022)



Figure 107: Estimated channel length for weir complex Roermond and Belfeld (Google earth, 2022)

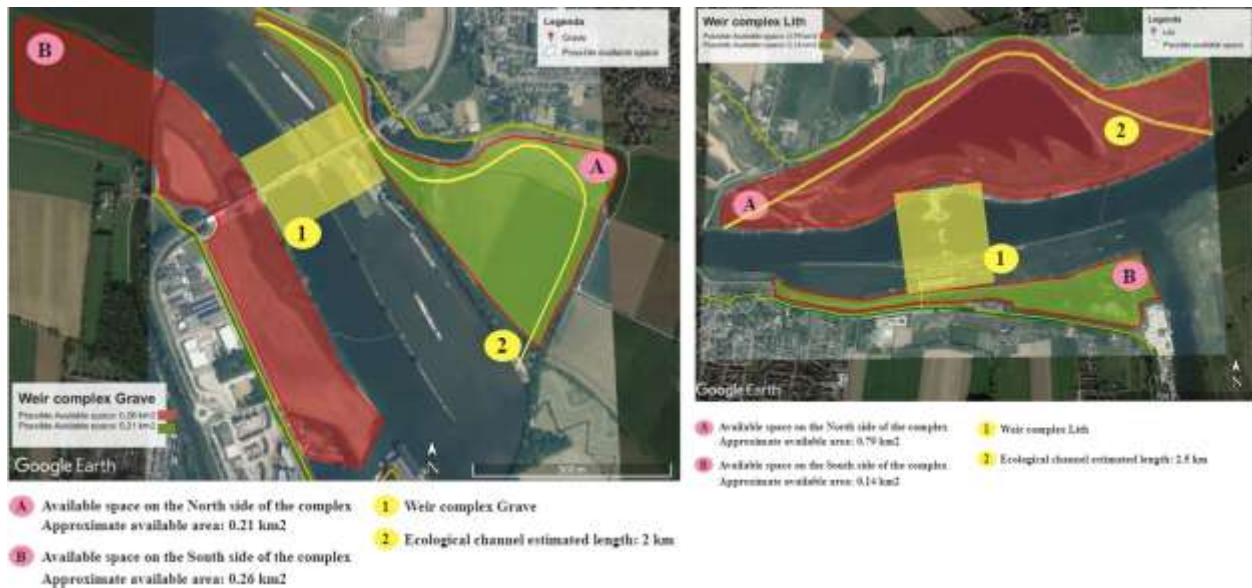

Figure 108: Estimated channel length for weir complex Grave and Lith (Google earth, 2022)

L.2. Measured river water levels at each complex location

Table 42: The measured flow rates and water levels at the first measurement point upstream and downstream the weir complexes (measurements provided by Royal HaskoningDHV). The frequency for which the water levels are exceeded is expressed in the total numbers of days per year and the total percentage per year.

Weir complex Borgharen							
River's discharge Q_{river} [m ³ /s]	Reserved discharge [m ³ /s]	Available discharge Q [m ³ /s]	Water levels at Borgharen JK	Water levels at Borgharen dorp	Δh [m]	#Days water levels exceeded	% days water levels exceeded
25	20	5	NAP+44.08m	NAP+38.04m	6.04	272	75%
<50	25	25	NAP+44.08m	NAP+38.04m	6.04	272	75%
125	25	100	NAP+44.10m	NAP+38.70m	5.40	188	52%
250	25	225	NAP+44.09m	NAP+39.51m	4.58	109	30%
500	25	475	NAP+44.03m	NAP+40.74m	3.29	47	13%
1000	25	975	NAP+44.05m	NAP+42.62m	1.43	9	3%
1250	25	1225	NAP+44.05m	NAP+43.42m	0.63	4	1%
1627	25	1602	NAP+44.83m	NAP+43.93m	0.90		
Weir complex Linne							
River's discharge Q_{river} [m ³ /s]	Reserved discharge [m ³ /s]	Available discharge Q [m ³ /s]	Water levels at Heel-Boven	Water levels at Linne-Beneden	Δh [m]	#Days water levels exceeded	% days water levels exceeded
25	20	5	NAP+20.86m	NAP+16.86m	4.0	272	75%
<50	25	25	NAP+20.86m	NAP+16.86m	4.0	272	75%
125	25	100	NAP+20.85m	NAP+16.92m	3.93	188	52%
250	25	225	NAP+20.84m	NAP+17.09m	3.75	109	30%
500	25	475	NAP+20.81m	NAP+17.59m	3.22	47	13%
1000	25	975	NAP+20.92m	NAP+18.93m	1.99	9	3%
1250	25	1225	NAP+20.85m	NAP+19.60m	1.25	4	1%
1627	25	1602	NAP+21.43m	NAP+20.55m	0.88		
Weir complex Roermond							
River's discharge Q_{river} [m ³ /s]	Reserved discharge [m ³ /s]	Available discharge Q [m ³ /s]	Water levels at Roermond-Boven	Water levels at Heel-Beneden	Δh [m]	#Days water levels exceeded	% days water levels exceeded
25	20	5	NAP+16.85m	NAP+14.15m	2.7	272	75%
<50	25	25	NAP+16.85m	NAP+14.15m	2.7	272	75%
125	25	100	NAP+16.85m	NAP+14.20m	2.65	188	52%
250	25	225	NAP+16.83m	NAP+14.32m	2.51	109	30%
500	25	475	NAP+16.79m	NAP+14.75m	2.04	47	13%
1000	25	975	NAP+16.85m	NAP+16.22m	0.63	9	3%
1250	25	1225	NAP+17.61m	NAP+17.10m	0.51	4	1%
1627	25	1602	NAP+18.61m	NAP+18.32m	0.29		
Weir complex Belfeld							
River's discharge Q_{river} [m ³ /s]	Reserved discharge [m ³ /s]	Available discharge Q [m ³ /s]	Water levels at Belfeld-Boven	Water levels at Belfeld-Beneden	Δh [m]	#Days water levels exceeded	% days water levels exceeded
25	20	5	NAP+14.14m	NAP+10.98m	3.16	272	75%

<50	25	25	NAP+14.14m	NAP+10.98m	3.16	272	75%
125	25	100	NAP+14.12m	NAP+11.18m	2.94	188	52%
250	25	225	NAP+14.07m	NAP+11.59m	2.48	109	30%
500	25	475	NAP+14.07m	NAP+12.57m	1.50	47	13%
1000	25	975	NAP+14.89m	NAP+14.64m	0.25	9	3%
1250	25	1225	NAP+15.63m	NAP+15.56m	0.07	4	1%
1627	25	1602	NAP+17.06m	NAP+16.81m	0.25		
Weir complex Grave							
River's discharge Q_{river} [m ³ /s]	Reserved discharge [m ³ /s]	Available discharge Q [m ³ /s]	Water levels at Grave-Boven	Water levels at Grave-Beneden	Δh [m]	#Days water levels exceeded	% days water levels exceeded
25	20	5	NAP+7.69m	NAP+4.93m	2.76	272	75%
<50	25	25	NAP+7.69m	NAP+4.93m	2.76	272	75%
125	25	100	NAP+7.69m	NAP+4.96m	2.73	188	52%
250	25	225	NAP+7.62m	NAP+5.09m	2.53	109	30%
500	25	475	NAP+7.45m	NAP+5.55m	1.90	47	13%
1000	25	975	NAP+7.40m	NAP+6.76m	0.64	9	3%
1250	25	1225	NAP+7.84m	NAP+7.37m	0.47	4	1%
1627	25	1602	NAP+8.50m	NAP+8.14m	0.36		
Weir complex Lith							
River's discharge Q_{river} [m ³ /s]	Reserved discharge [m ³ /s]	Available discharge Q [m ³ /s]	Water levels at Lith-Boven	Water levels at Lith-Beneden	Δh [m]	#Days water levels exceeded	% days water levels exceeded
25	20	5	NAP+4.89m	NAP+0.65m	4.24	272	75%
<50	25	25	NAP+4.89m	NAP+0.65m	4.24	272	75%
125	25	100	NAP+4.90m	NAP+0.73m	4.17	188	52%
250	25	225	NAP+4.90m	NAP+0.99m	3.91	109	30%
500	25	475	NAP+4.90m	NAP+1.76m	3.14	47	13%
1000	25	975	NAP+4.90m	NAP+3.35m	1.55	9	3%
1250	25	1225	NAP+4.12m	NAP+3.95m	0.17	4	1%
1627	25	1602	NAP+4.89m	NAP+4.64m	0.25		

L.3. Channel's flow conditions for quasi-uniform flow

The flow conditions are determined with the Python code provided in Appendix I. The upstream and downstream water levels, the inlet and outlet bed elevations, and channel length values are adjusted in the code, while the remainder of the calculation remains unchanged. The input values and flow conditions for each complex location are shown below.

Weir complex Borgharen

Weir complex Borgharen

```
In [37]: ##### RIVER'S BOUNDARY CONDITIONS #####
Qriver = [50, 125, 250, 500, 1000, 1250, 1627] #m3/s
h_SAMBV = [44.08, 44.10, 44.09, 44.03, 44.05, 44.05, 44.83] #NAP+m
h_SAMBN = [38.04, 38.70, 39.51, 40.74, 42.62, 43.42, 43.93] #NAP+m

##### CHANNEL'S BED LEVELS #####
z_inlet_end = 37.99 #NAP+
z_outlet_start = 37.49 #NAP+m
dz = z_inlet_end - z_outlet_start #channel's bed level difference

print(f"the channel's total bed level difference {np.round(dz,2)} m")

##### CHANNEL'S LENGTHS #####
L = [1000]
ib_list = []

for j in range(len(L)):
    ib = dz/L[j]
    ib_list.append({'L [m]': L[j], 'Δz [m]': dz, 'ib': ib})

df_slope = pd.DataFrame(ib_list)
display(df_slope.head(20))

##### WATER LEVELS DOWNSTREAM OF THE CHANNEL #####
## the calculation done for each water level
h_BC = h_SAMBN[0] # boundary condition 0 ; Qriver < 50 m3/s
h_BC = h_SAMBN[1] # boundary condition 1 ; Qriver = 125 m3/s
h_BC = h_SAMBN[2] # boundary condition 2 ; Qriver = 250 m3/s
h_BC = h_SAMBN[3] # boundary condition 3 ; Qriver = 500 m3/s
h_BC = h_SAMBN[4] # boundary condition 4 ; Qriver = 1000 m3/s
h_BC = h_SAMBN[5] # boundary condition 5 ; Qriver = 1250 m3/s
h_BC = h_SAMBN[6] # boundary condition 6 ; Qriver = 1627 m3/s

y_BC = h_BC - z_outlet_start #<----- #downstream boundary condition is the water depth at the channel's outlet location
```

Flow conditions satisfied

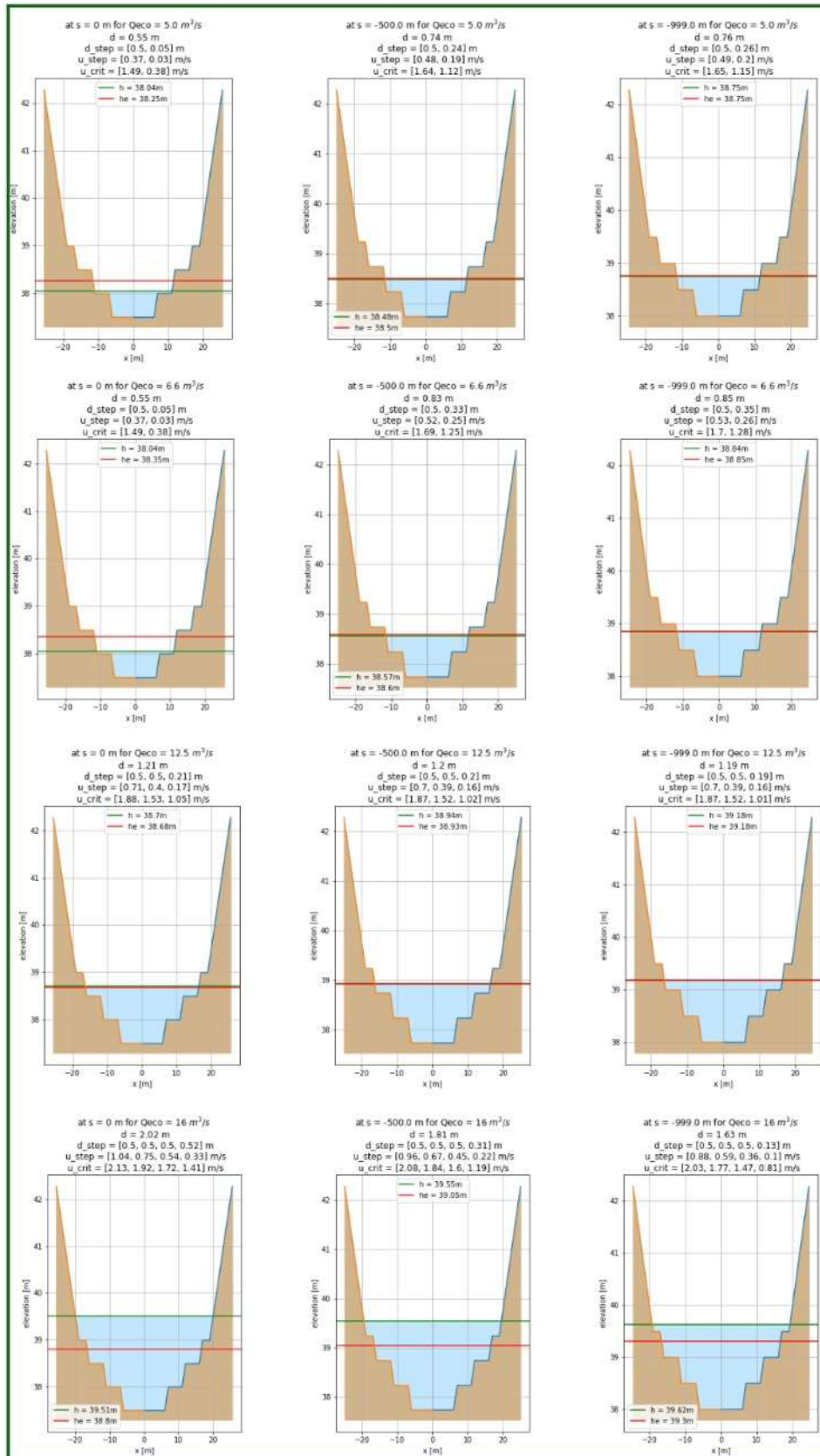

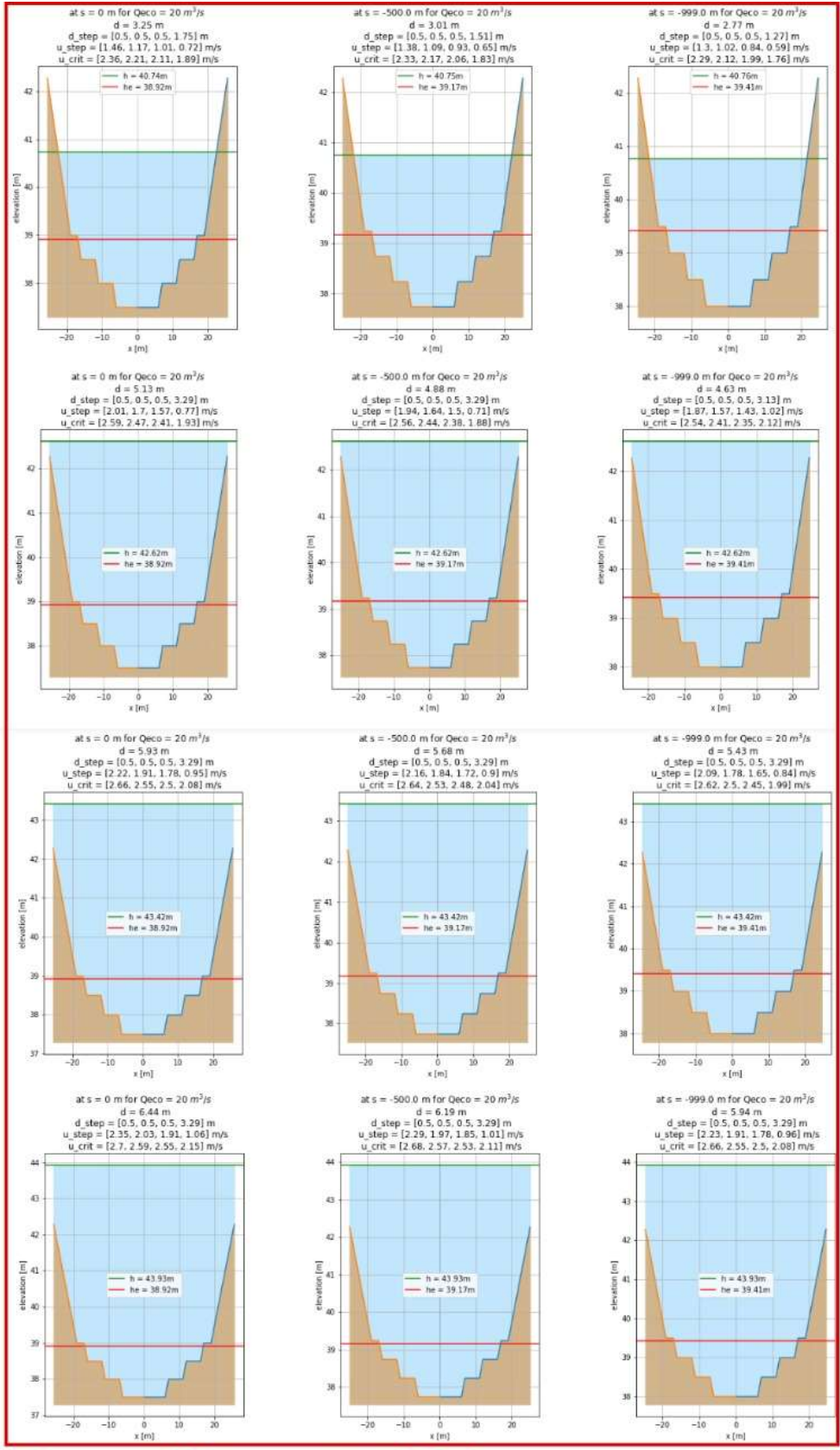

Flow conditions not satisfied

Weir complex Linne

Weir complex Linne

```
In [38]: ##### RIVER'S BOUNDARY CONDITIONS #####
Qriver = [50, 125, 250, 500, 1000, 1250, 1627] #m3/s
h_SAMBV = [20.86, 20.85, 20.84, 20.81, 20.92, 20.85, 21.43] #NAP+m
h_SAMBN = [16.86, 16.92, 17.09, 17.59, 18.93, 19.60, 20.55] #NAP+m

##### CHANNEL'S BED LEVELS #####
z_inlet_end = 17.30 #NAP+
z_outlet_start = 16.31 #NAP+m
dz = z_inlet_end - z_outlet_start #channel's bed level difference

print(f"the channel's total bed level difference {np.round(dz,2)} m")

##### CHANNEL'S LENGTHS #####
L = [2000]
ib_list = []

for j in range(len(L)):
    ib = dz/L[j]
    ib_list.append({'L [m]': L[j], 'Δz [m]': dz, 'ib': ib})

df_slope = pd.DataFrame(ib_list)
display(df_slope.head(20))

##### WATER LEVELS DOWNSTREAM OF THE CHANNEL #####
## the calculation done for each water level
h_BC = h_SAMBN[0] # boundary condition 0 ; Qriver < 50 m3/s
h_BC = h_SAMBN[1] # boundary condition 1 ; Qriver = 125 m3/s
h_BC = h_SAMBN[2] # boundary condition 2 ; Qriver = 250 m3/s
h_BC = h_SAMBN[3] # boundary condition 3 ; Qriver = 500 m3/s
h_BC = h_SAMBN[4] # boundary condition 4 ; Qriver = 1000 m3/s
h_BC = h_SAMBN[5] # boundary condition 5 ; Qriver = 1250 m3/s
h_BC = h_SAMBN[6] # boundary condition 6 ; Qriver = 1627 m3/s

y_BC = h_BC - z_outlet_start #<----- #downstream boundary condition is the water depth at the channel's outlet location
```

Flow conditions satisfied

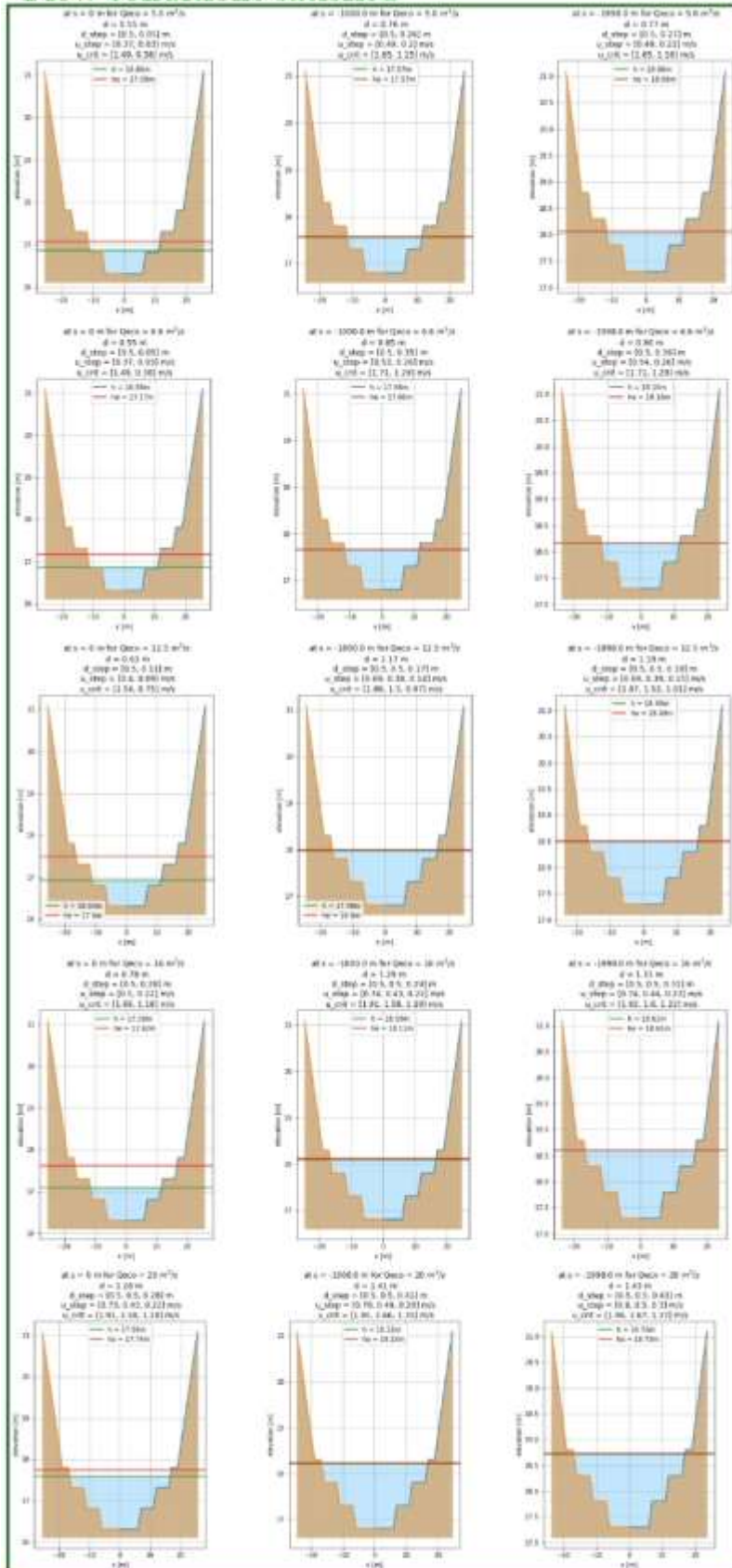

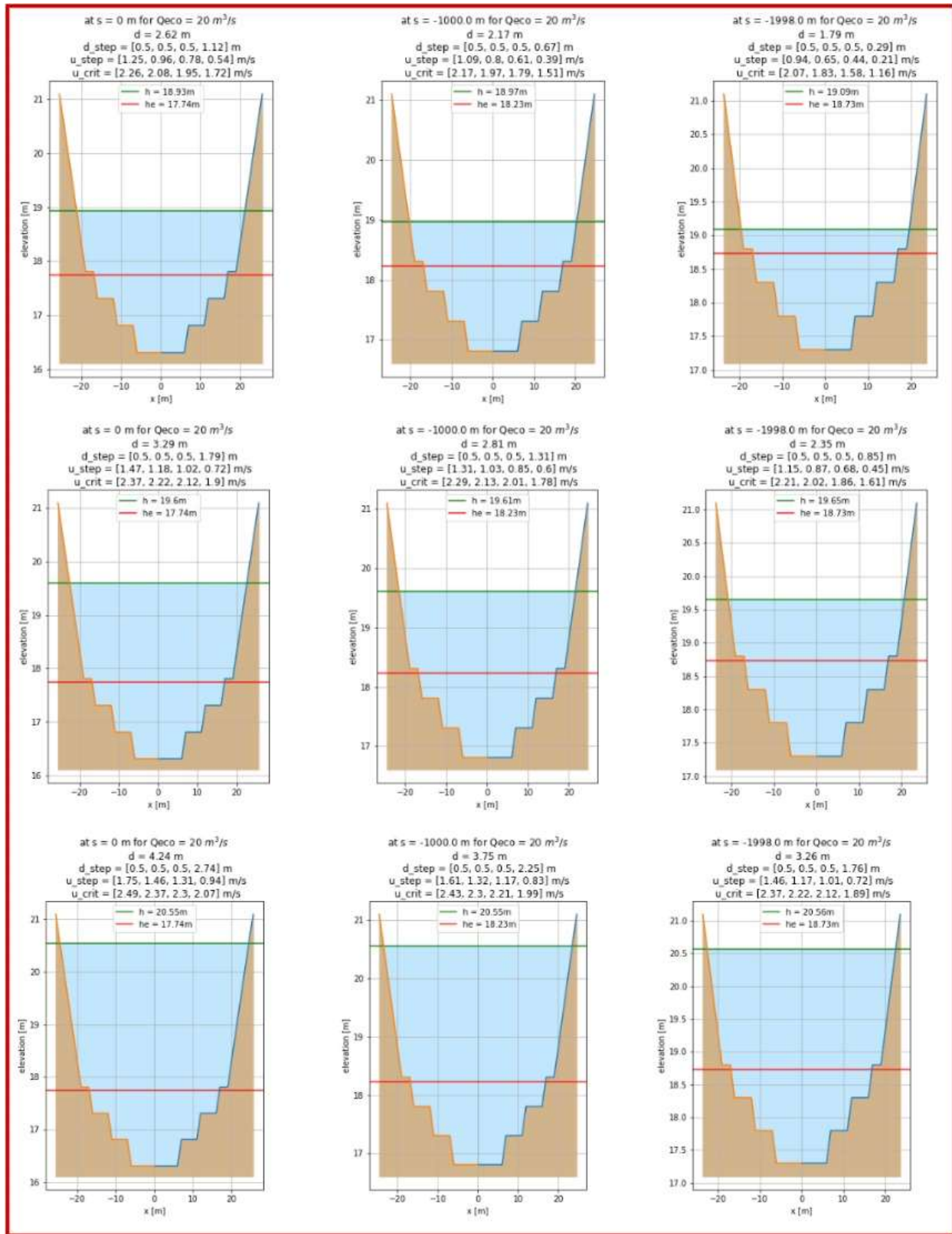

Flow conditions not satisfied

Weir complex Roermond

Weir complex Roermond

```
In [39]: ##### RIVER'S BOUNDARY CONDITIONS #####
Qriver = [50, 125, 250, 500, 1000, 1250, 1627] #m3/s
h_SAMBv = [16.85, 16.85, 16.83, 16.79, 16.85, 17.61, 18.61] #NAP+m
h_SAMBN = [14.15, 14.20, 14.32, 14.75, 16.22, 17.10, 18.32] #NAP+m

##### CHANNEL'S BED LEVELS #####
z_inlet_end = 14.84 #NAP+
z_outlet_start = 13.60 #NAP+m
dz = z_inlet_end - z_outlet_start #channel's bed level difference

print(f"the channel's total bed level difference {np.round(dz,2)} m")

##### CHANNEL'S LENGTHS #####
L = [2500]
ib_list = []

for j in range(len(L)):
    ib = dz/L[j]
    ib_list.append({'L [m]': L[j], 'Δz [m]': dz, 'ib': ib})

df_slope = pd.DataFrame(ib_list)
display(df_slope.head(20))

##### WATER LEVELS DOWNSTREAM OF THE CHANNEL #####
## the calculation done for each water level
h_BC = h_SAMBN[0] # boundary condition 0 ; Qriver < 50 m3/s
h_BC = h_SAMBN[1] # boundary condition 1 ; Qriver = 125 m3/s
h_BC = h_SAMBN[2] # boundary condition 2 ; Qriver = 250 m3/s
h_BC = h_SAMBN[3] # boundary condition 3 ; Qriver = 500 m3/s
h_BC = h_SAMBN[4] # boundary condition 4 ; Qriver = 1000 m3/s
h_BC = h_SAMBN[5] # boundary condition 5 ; Qriver = 1250 m3/s
h_BC = h_SAMBN[6] # boundary condition 6 ; Qriver = 1627 m3/s

y_BC = h_BC - z_outlet_start #<----- #downstream boundary condition is the water depth at the channel's outlet location
```

Flow conditions satisfied

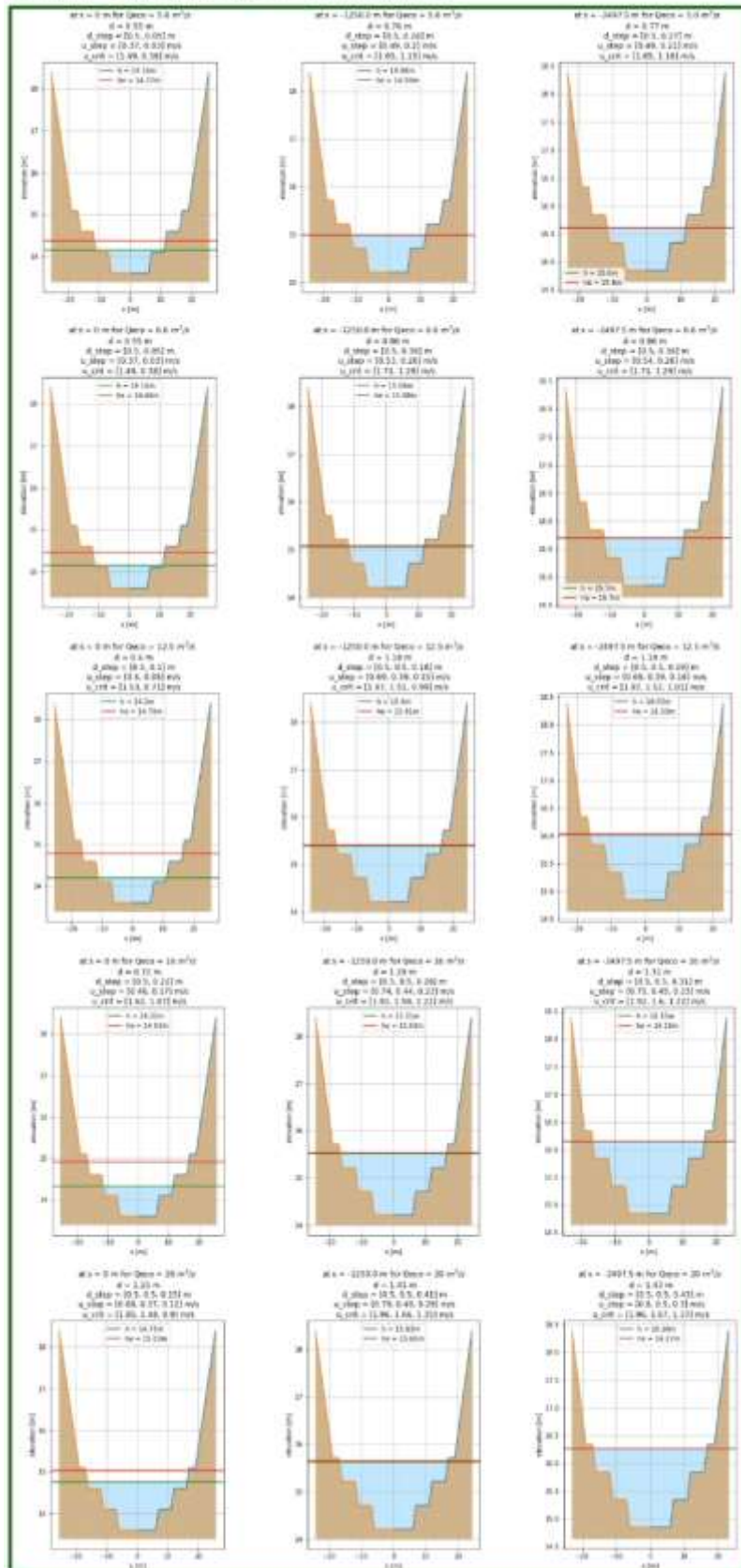

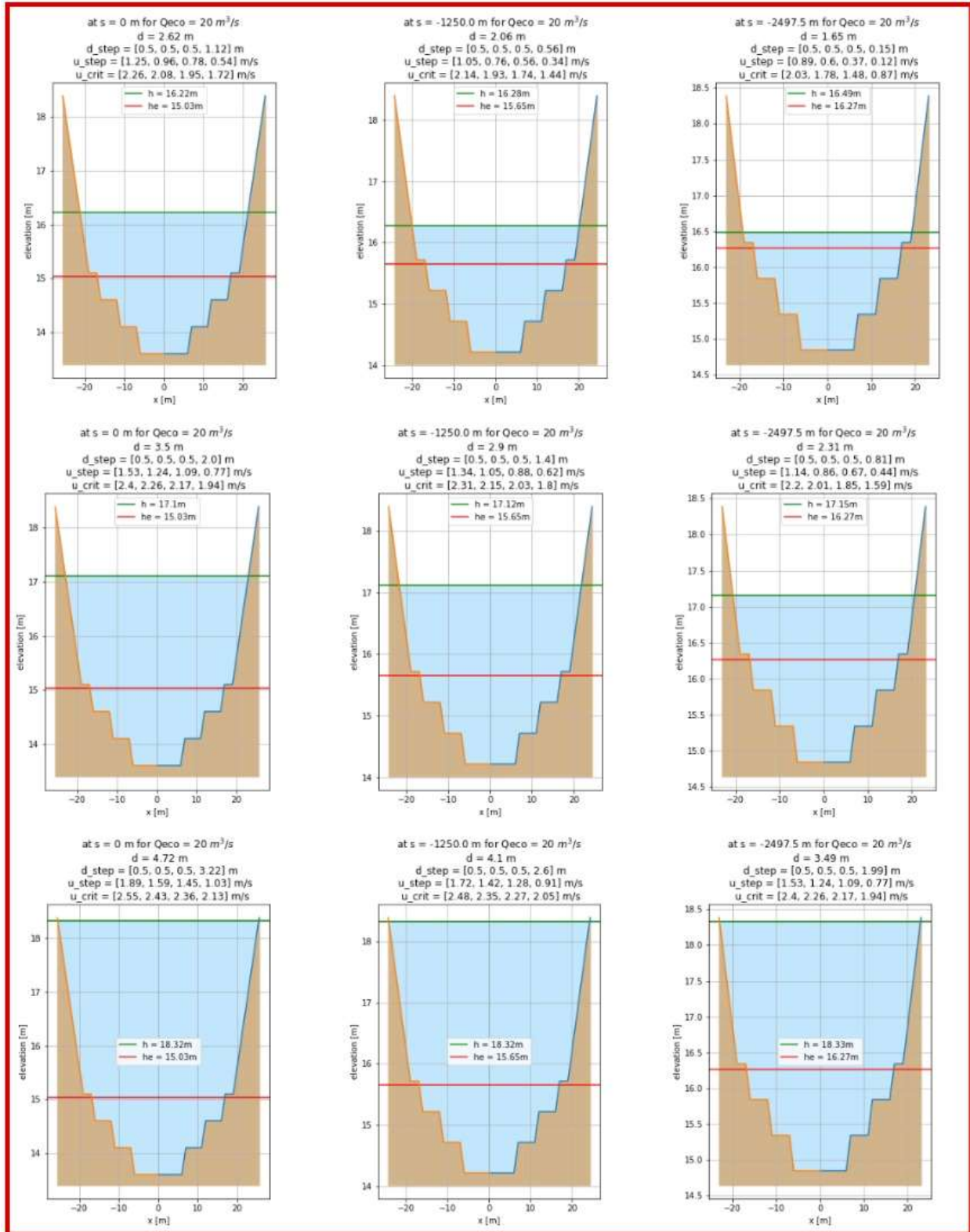

Flow conditions not satisfied

Weir complex Belfeld

Weir complex Belfeld

```
In [40]: ##### RIVER'S BOUNDARY CONDITIONS #####
Qriver = [50, 125, 250, 500, 1000, 1250, 1627] #m3/s
h_SAMBN = [14.14, 14.12, 14.07, 14.07, 14.89, 15.63, 17.06] #NAP+m
h_SAMBN = [10.98, 11.18, 11.59, 12.57, 14.64, 15.56, 16.81] #NAP+m

##### CHANNEL'S BED LEVELS #####
z_inlet_end = 11.42 #NAP+
z_outlet_start = 10.43 #NAP+m
dz = z_inlet_end - z_outlet_start #channel's bed level difference

print(f"the channel's total bed level difference {np.round(dz,2)} m")

##### CHANNEL'S LENGTHS #####
L = [2000]
ib_list = []

for j in range(len(L)):
    ib = dz/L[j]
    ib_list.append({'L [m]': L[j], 'Δz [m]': dz, 'ib': ib})

df_slope = pd.DataFrame(ib_list)
display(df_slope.head(20))

##### WATER LEVELS DOWNSTREAM OF THE CHANNEL #####
## the calculation done for each water level
h_BC = h_SAMBN[0] # boundary condition 0 ; Qriver < 50 m3/s
h_BC = h_SAMBN[1] # boundary condition 1 ; Qriver = 125 m3/s
h_BC = h_SAMBN[2] # boundary condition 2 ; Qriver = 250 m3/s
h_BC = h_SAMBN[3] # boundary condition 3 ; Qriver = 500 m3/s
h_BC = h_SAMBN[4] # boundary condition 4 ; Qriver = 1000 m3/s
h_BC = h_SAMBN[5] # boundary condition 5 ; Qriver = 1250 m3/s
h_BC = h_SAMBN[6] # boundary condition 6 ; Qriver = 1627 m3/s

y_BC = h_BC - z_outlet_start #<----- #downstream boundary condition is the water depth at the channel's outlet location
```

Flow conditions satisfied

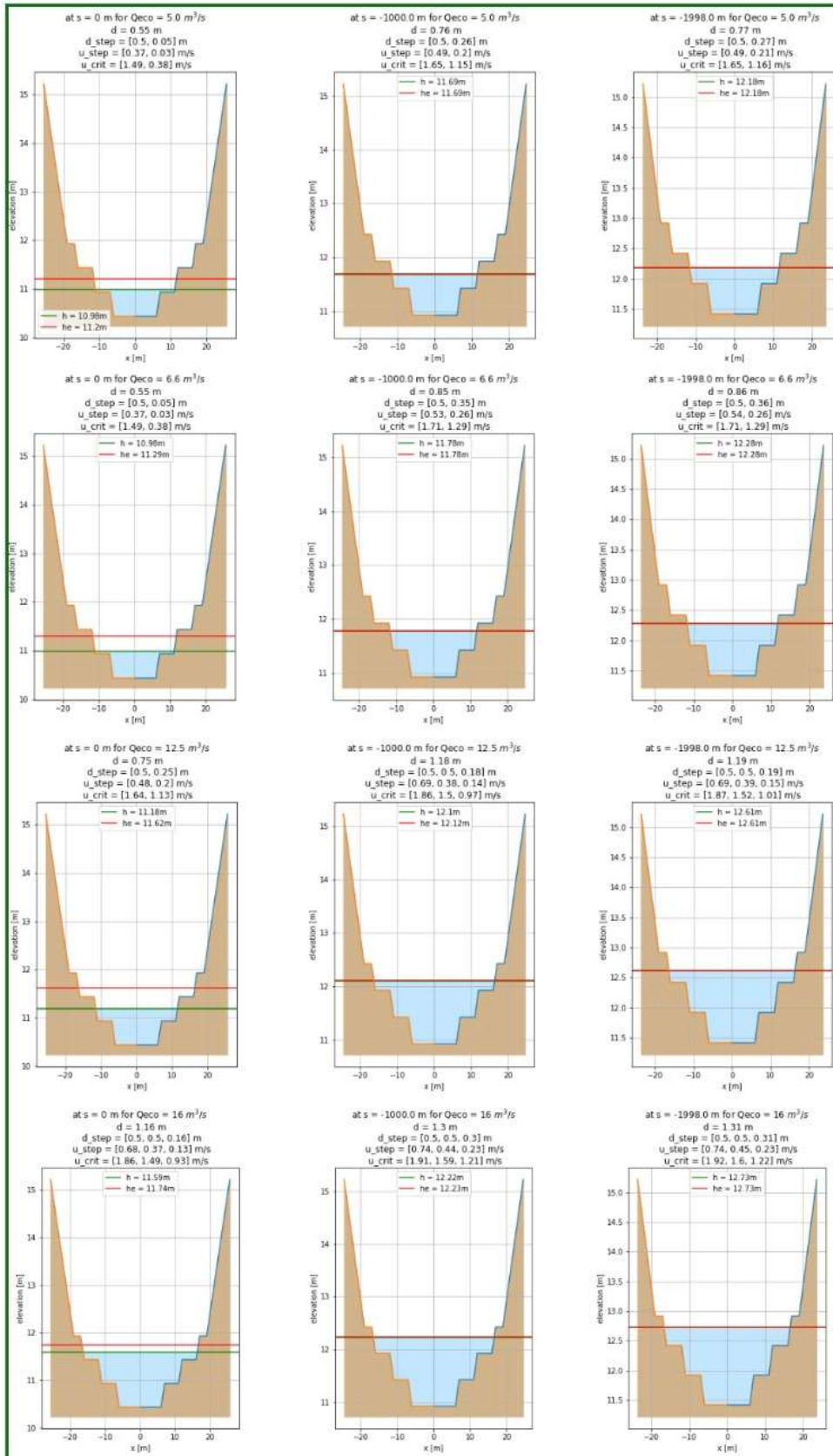

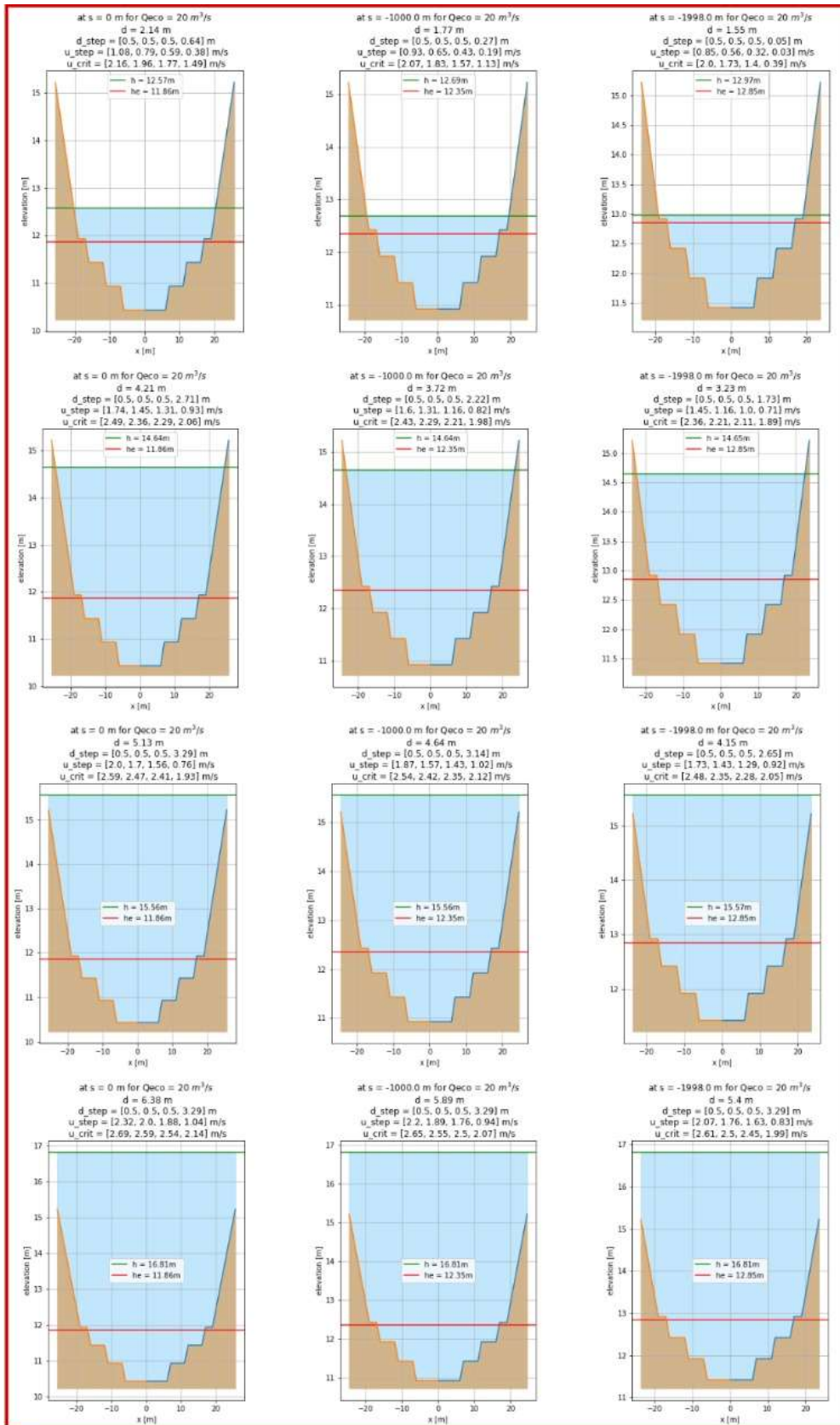

Flow conditions not satisfied

Weir complex Grave

Weir complex Grave

```
In [41]: ##### RIVER'S BOUNDARY CONDITIONS #####
Qriver = [50, 125, 250, 500, 1000, 1250, 1627] #m3/s
h_SAMBV = [7.69, 7.69, 7.62, 7.45, 7.40, 7.84, 8.5] #NAP+m
h_SAMBN = [4.93, 4.96, 5.09, 5.55, 6.76, 7.37, 8.14] #NAP+m

##### CHANNEL'S BED LEVELS #####
z_inlet_end = 5.37 #NAP+
z_outlet_start = 4.38 #NAP+m
dz = z_inlet_end - z_outlet_start #channel's bed level difference

print(f"the channel's total bed level difference {np.round(dz,2)} m")

##### CHANNEL'S LENGTHS #####
L = [2000]
ib_list = []

for j in range(len(L)):
    ib = dz/L[j]
    ib_list.append({'L [m]': L[j], 'Δz [m]': dz, 'ib': ib})

df_slope = pd.DataFrame(ib_list)
display(df_slope.head(20))

##### WATER LEVELS DOWNSTREAM OF THE CHANNEL #####
## the calculation done for each water level
h_BC = h_SAMBN[0] # boundary condition 0 ; Qriver < 50 m3/s
h_BC = h_SAMBN[1] # boundary condition 1 ; Qriver = 125 m3/s
h_BC = h_SAMBN[2] # boundary condition 2 ; Qriver = 250 m3/s
h_BC = h_SAMBN[3] # boundary condition 3 ; Qriver = 500 m3/s
h_BC = h_SAMBN[4] # boundary condition 4 ; Qriver = 1000 m3/s
h_BC = h_SAMBN[5] # boundary condition 5 ; Qriver = 1250 m3/s
h_BC = h_SAMBN[6] # boundary condition 6 ; Qriver = 1627 m3/s

y_BC = h_BC - z_outlet_start #<----- #downstream boundary condition is the water depth at the channel's outlet location
```

Flow conditions satisfied

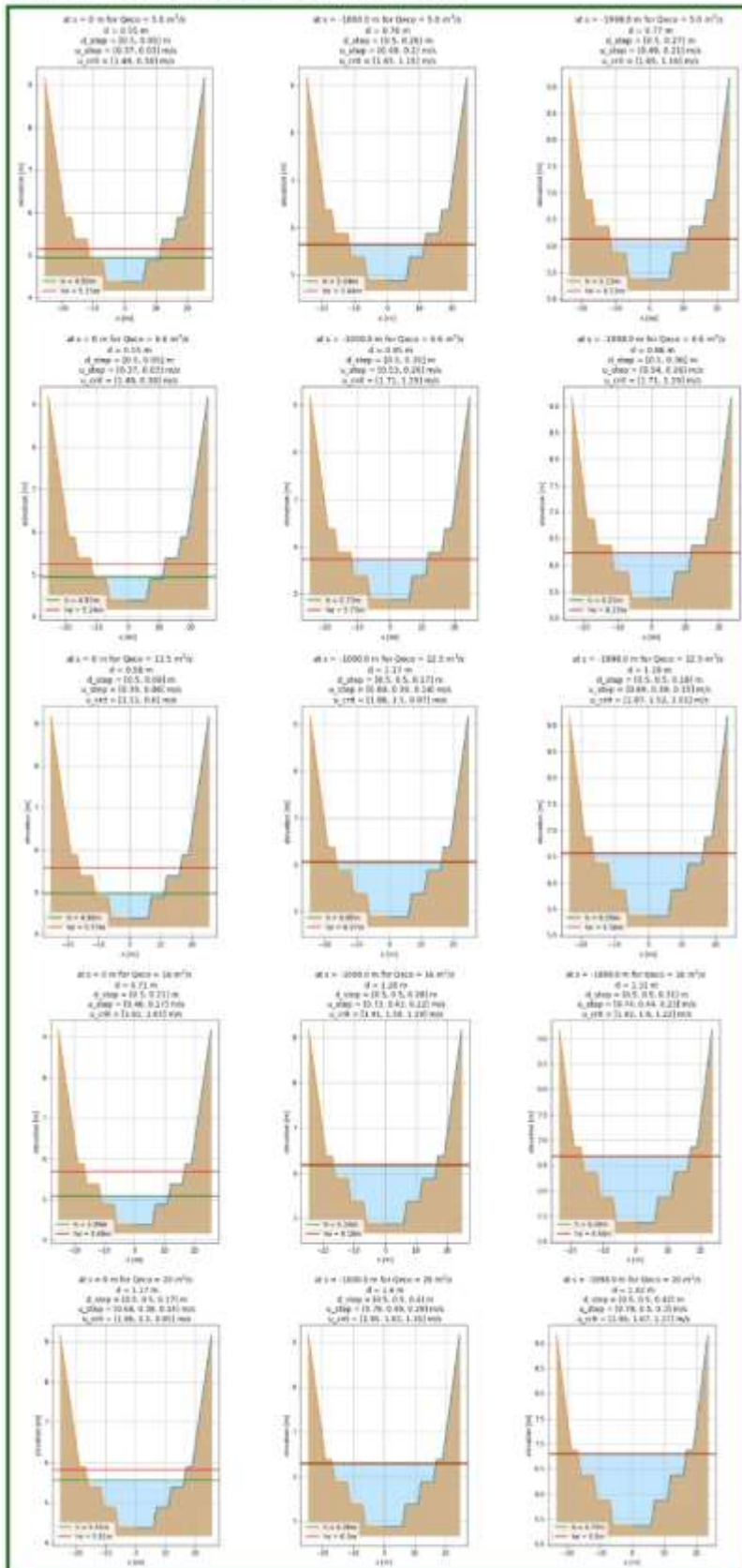

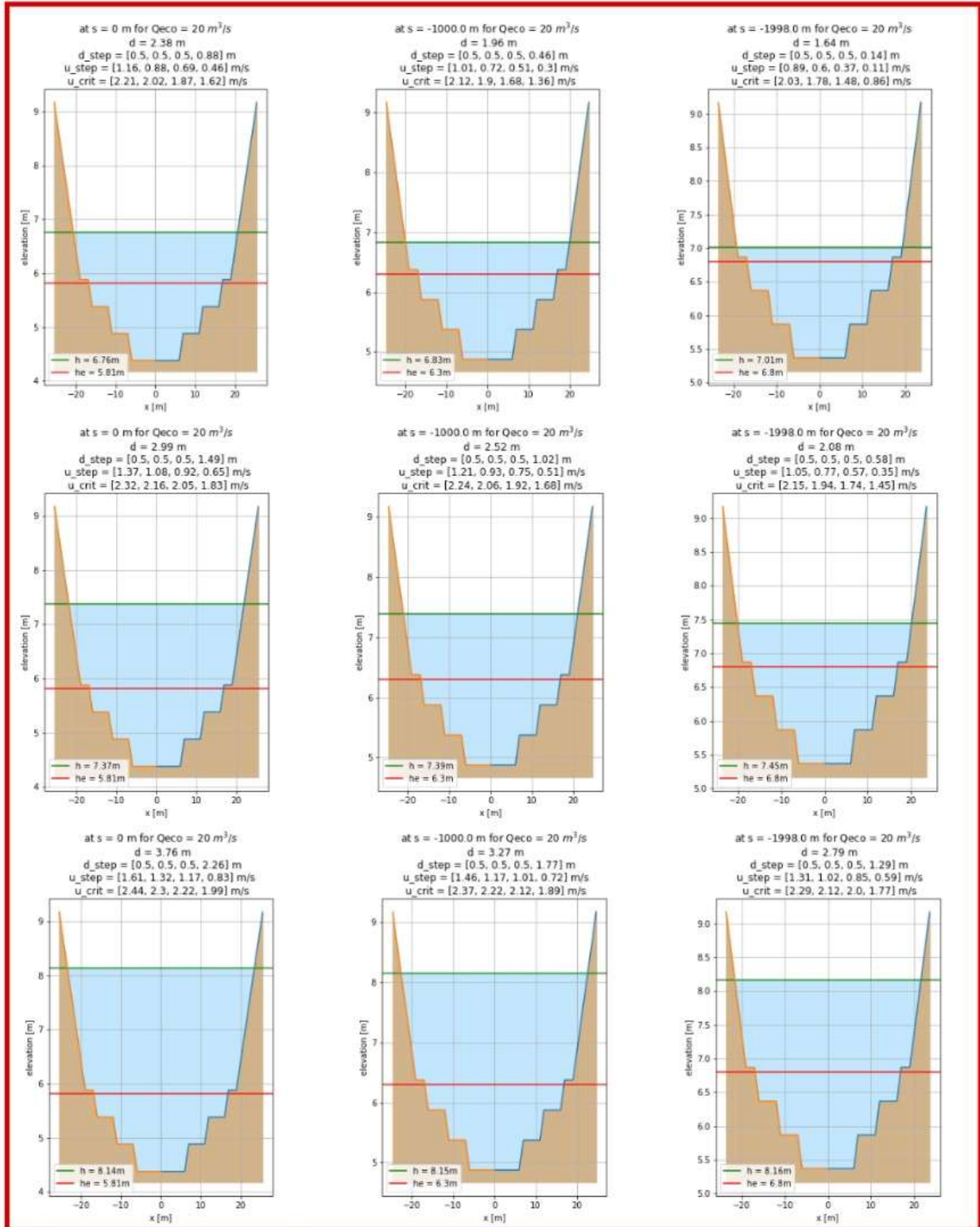

Flow conditions not satisfied

Weir complex Lith

Weir complex Lith

```
In [42]: ##### RIVER'S BOUNDARY CONDITIONS #####
Qriver = [50, 125, 250, 500, 1000, 1250, 1627] #m3/s
h_SAMBV = [4.89, 4.90, 4.90, 4.90, 4.90, 4.12, 4.89] #NAP+m
h_SAMBN = [0.65, 0.73, 0.99, 1.76, 3.35, 3.95, 4.64] #NAP+m

##### CHANNEL'S BED LEVELS #####
z_inlet_end = 1.34 #NAP+
z_outlet_start = 0.10 #NAP+m |
dz = z_inlet_end - z_outlet_start #channel's bed level difference

print(f"the channel's total bed level difference {np.round(dz,2)} m")

##### CHANNEL'S LENGTHS #####
#channel's length is between the inlet and outlet ramp
L = [2500]
ib_list = []

for j in range(len(L)):
    ib = dz/L[j]
    ib_list.append({'L [m]': L[j], 'Δz [m]': dz, 'ib': ib})

df_slope = pd.DataFrame(ib_list)
display(df_slope.head(20))

##### WATER LEVELS DOWNSTREAM OF THE CHANNEL #####
## the calculation done for each water level
h_BC = h_SAMBN[0] # boundary condition 0 ; Qriver < 50 m3/s
h_BC = h_SAMBN[1] # boundary condition 1 ; Qriver = 125 m3/s
h_BC = h_SAMBN[2] # boundary condition 2 ; Qriver = 250 m3/s
h_BC = h_SAMBN[3] # boundary condition 3 ; Qriver = 500 m3/s
h_BC = h_SAMBN[4] # boundary condition 4 ; Qriver = 1000 m3/s
h_BC = h_SAMBN[5] # boundary condition 5 ; Qriver = 1250 m3/s
h_BC = h_SAMBN[6] # boundary condition 6 ; Qriver = 1627 m3/s

y_BC = h_BC - z_outlet_start #<----- #downstream boundary condition is the water depth at the channel's outlet location
```

Flow conditions satisfied

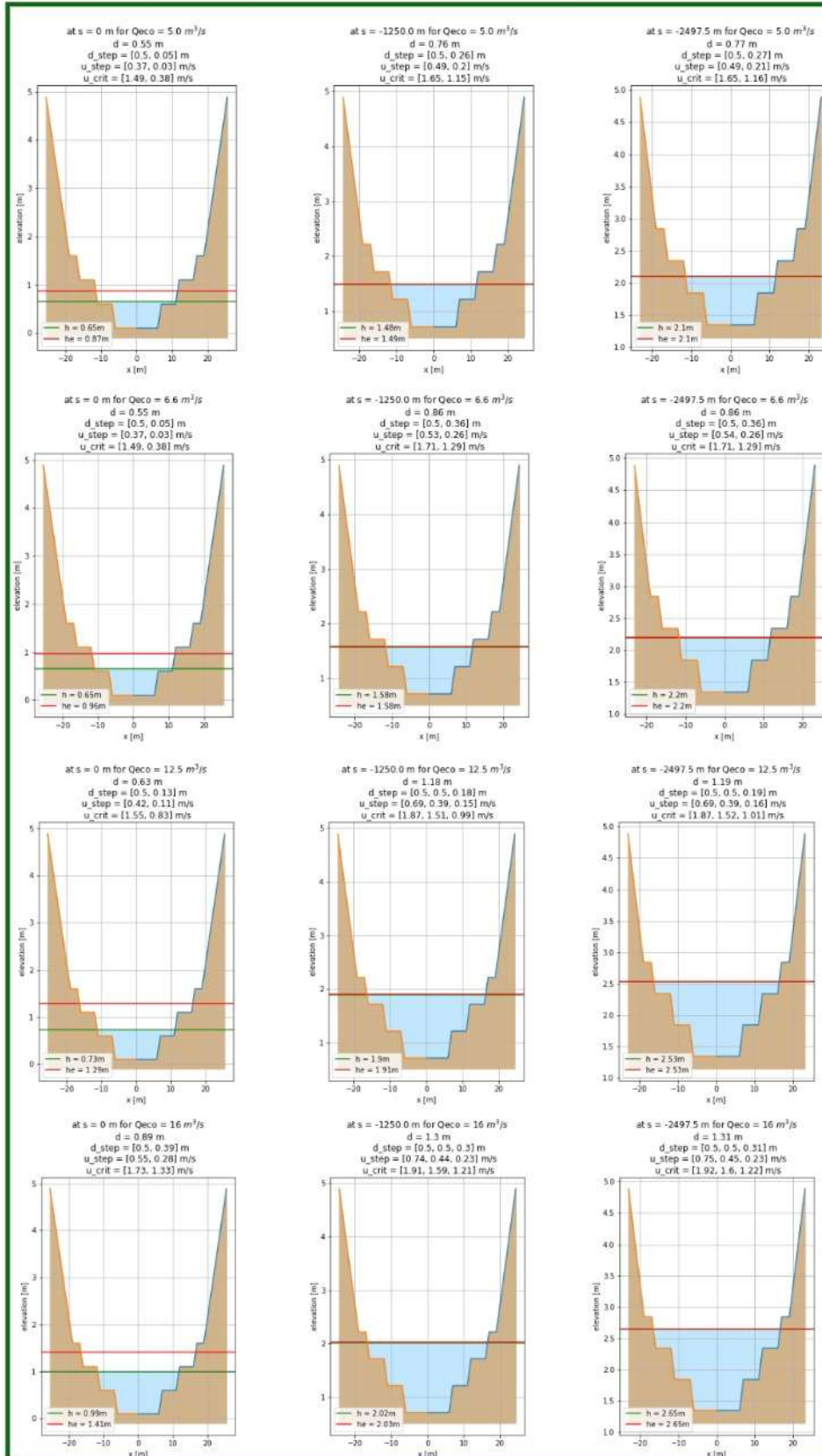

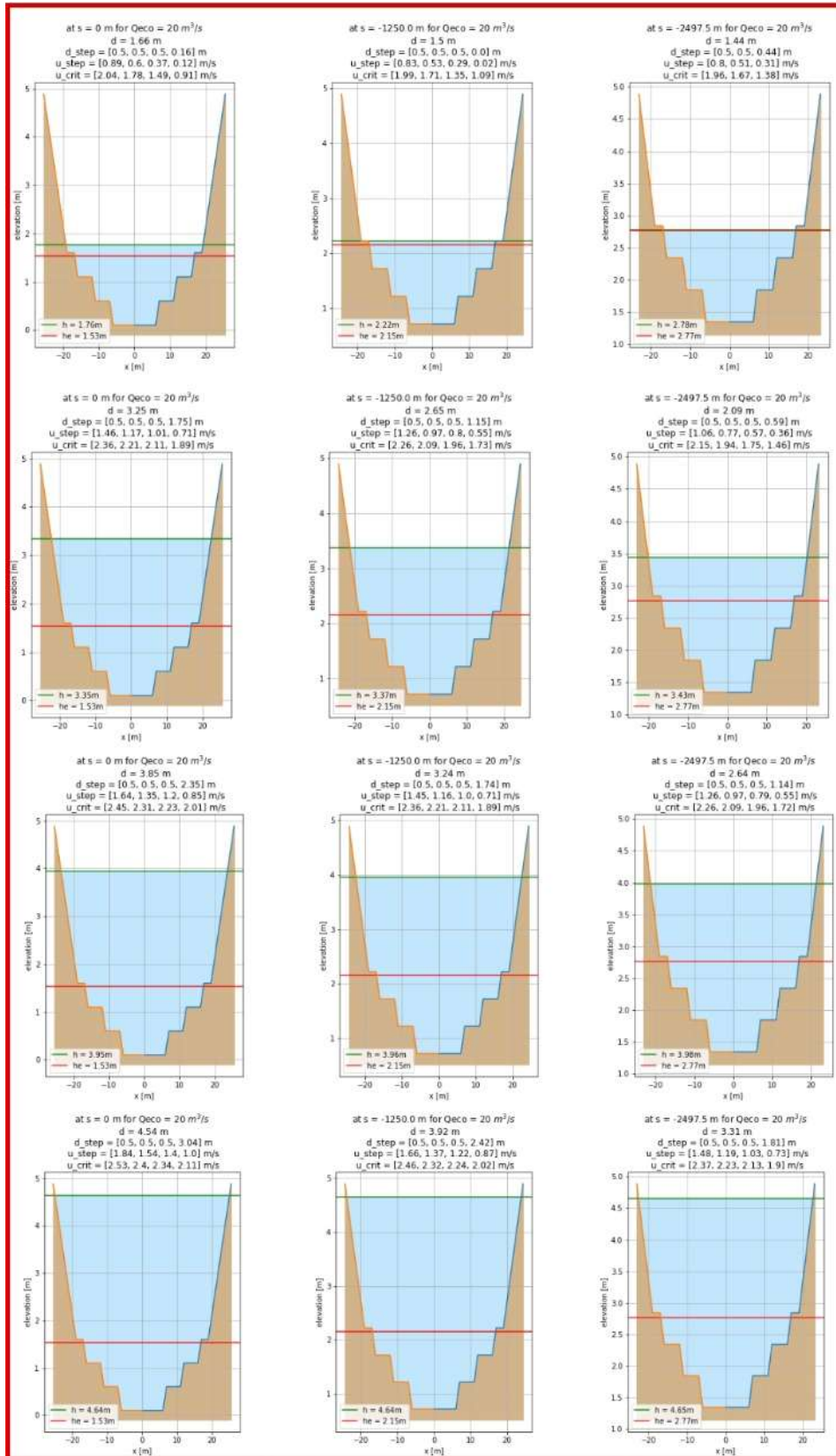

Flow conditions not satisfied

	Q_{river} [m ³ /s]	Q_{eco} [m ³ /s]	Δh_{total} [m]	y_0 [m]	y_1 [m]	c	B_{slot} [m]	Δh_{pool} [m]	$Q_{passage}$ [m ³ /s]	$Q_{flap-gate}$ [m ³ /s]	discharge ratio [%]	v_{avg} [m/s]	ϵ [W/m ³]
0	25	5.0	2.79	3.55	0.76	0.7	0.75	0.100	2.61	2.39	108.85	0.98	237.05
1	50	6.6	2.89	3.55	0.86	0.7	0.75	0.096	2.56	4.04	63.32	0.96	201.79
2	125	12.5	2.37	3.56	1.19	0.7	0.75	0.085	2.41	10.09	23.87	0.90	125.52
3	250	16.0	2.25	3.56	1.31	0.7	0.75	0.080	2.35	13.65	17.19	0.88	106.45
4	500	20.0	2.12	3.56	1.44	0.7	0.75	0.076	2.28	17.72	12.85	0.85	89.30
5	1000	20.0	1.47	3.56	2.09	0.7	0.75	0.053	1.90	18.10	10.48	0.71	36.48
6	1250	20.0	0.14	2.78	2.64	0.7	0.75	0.005	0.46	19.54	2.34	0.22	0.68
7	1627	20.0	0.24	3.55	3.31	0.7	0.75	0.009	0.76	19.24	3.97	0.29	1.55

L.4. Vertical-slot fish passage’s flow conditions

The flow conditions are determined with the Python code provided in Appendix J.1. The upstream and downstream water levels, the inlet bed elevation, and number of pools values are adjusted in the code. These input values are shown in Table 43. The remainder of the calculation remains unchanged, and the flow conditions of each complex location is shown in the tables below.

Input values

Table 43: The flow parameters at each complex location for the fish passage calculation

	Weir complex Borgharen inlet’s bed elevation NAP+37.99m number of pools: 54			Weir complex Linne; inlet’s bed elevation NAP+17.30m number of pools: 28		
River’s discharge Q_{river} [m ³ /s]	Upstream water levels	Downstream water levels	Δh [m]	Upstream water levels	Downstream water levels	Δh [m]
25	NAP+44.08m	NAP+38.75m	5.33	NAP+20.86m	NAP+18.06m	2.80
<50	NAP+44.08m	NAP+38.84m	5.24	NAP+20.86m	NAP+18.16m	2.70
125	NAP+44.10m	NAP+39.10m	4.92	NAP+20.85m	NAP+18.49m	2.36
250	NAP+44.09m	NAP+39.62m	4.47	NAP+20.84m	NAP+18.61m	2.23
500	NAP+44.03m	NAP+40.76m	3.27	NAP+20.81m	NAP+18.72m	2.09
1000	NAP+44.05m	NAP+42.62m	1.43	NAP+20.92m	NAP+19.09m	1.83
1250	NAP+44.05m	NAP+43.42m	0.63	NAP+20.85m	NAP+19.65m	1.20
1627	NAP+44.83m	NAP+43.93m	0.90	NAP+21.43m	NAP+20.56m	0.87
	Weir complex Roermond; inlet’s bed elevation NAP+14.84m number of pools: 13			Weir complex Belfeld; inlet’s bed elevation NAP+11.42m number of pools: 20		
River’s discharge Q_{river} [m ³ /s]	Upstream water levels	Downstream water levels	Δh [m]	Upstream water levels	Downstream water levels	Δh [m]
25	NAP+16.85m	NAP+15.60m	1.25	NAP+14.14m	NAP+12.18m	1.96
<50	NAP+16.85m	NAP+15.70m	1.15	NAP+14.14m	NAP+12.28m	1.86
125	NAP+16.85m	NAP+16.03m	0.82	NAP+14.12m	NAP+12.61m	1.51
250	NAP+16.83m	NAP+16.15m	0.70	NAP+14.07m	NAP+12.73m	1.34
500	NAP+16.79m	NAP+16.26m	0.53	NAP+14.07m	NAP+12.97m	1.10
1000	NAP+16.85m	NAP+16.49m	0.36	NAP+14.89m	NAP+14.65m	0.24
1250	NAP+17.61m	NAP+17.15m	0.46	NAP+15.63m	NAP+15.57m	0.06
1627	NAP+18.61m	NAP+18.33m	0.28	NAP+17.06m	NAP+16.81m	0.25
	Weir complex Grave; inlet’s bed elevation NAP+5.37m number of pools: 16			Weir complex Lith inlet’s bed elevation NAP+1.34m number of pools: 28		

River's discharge Q_{river} [m ³ /s]	Upstream water levels	Downstream water levels	Δh [m]	Upstream water levels	Downstream water levels	Δh [m]
25	NAP+7.69m	NAP+6.13m	1.56	NAP+4.89m	NAP+2.10m	2.79
<50	NAP+7.69m	NAP+6.23m	1.46	NAP+4.89m	NAP+2.20m	2.69
125	NAP+7.69m	NAP+6.56m	1.13	NAP+4.90m	NAP+2.53m	2.37
250	NAP+7.62m	NAP+6.68m	0.94	NAP+4.90m	NAP+2.65m	2.25
500	NAP+7.45m	NAP+6.79m	0.66	NAP+4.90m	NAP+2.78m	2.12
1000	NAP+7.40m	NAP+7.01m	0.39	NAP+4.90m	NAP+3.43m	1.47
1250	NAP+7.84m	NAP+7.45m	0.39	NAP+4.12m	NAP+3.98m	0.14
1627	NAP+8.50m	NAP+8.16m	0.34	NAP+4.89m	NAP+4.65m	0.24

Weir complex Borgharen

Table 44: Flow conditions for the vertical-slot fish passage at complex Borgharen

	Qriver [m ³ /s]	Qeco [m ³ /s]	Δh_{total} [m]	y0 [m]	y1 [m]	C	Bslot [m]	Δh_{pool} [m]	Qpassage [m ³ /s]	Qflap-gate [m ³ /s]	discharge ratio [%]	v_avg [m/s]	ϵ [W/m ³]
0	25	5.0	5.33	6.59	1.26	0.7	0.75	0.099	4.81	0.19	2506.99	0.97	274.49
1	50	8.6	5.24	6.59	1.35	0.7	0.75	0.097	4.77	1.83	261.40	0.87	251.23
2	125	12.5	4.92	6.61	1.69	0.7	0.75	0.091	4.64	7.86	59.03	0.94	180.27
3	250	16.0	4.47	6.60	2.13	0.7	0.75	0.083	4.42	11.58	38.12	0.89	129.64
4	500	20.0	3.27	6.54	3.27	0.7	0.75	0.061	3.74	16.26	23.02	0.76	53.40
5	1000	20.0	1.43	6.56	5.13	0.7	0.75	0.026	2.48	17.52	14.17	0.50	10.01
6	1250	20.0	0.63	6.56	5.93	0.7	0.75	0.012	1.65	18.35	8.98	0.33	2.54
7	1627	20.0	0.90	7.34	6.44	0.7	0.75	0.017	2.20	17.80	12.38	0.40	4.46

Energy dissipation requirement not satisfied

The flow conditions for the increased pool volume ($L_{pool} = 7.5$ m and $B_{pool} = 3.5$ m) is shown in the Table 45.

Table 45: Flow conditions for the vertical-slot fish passage at complex Borgharen with adjusted dimensions

	Qriver [m ³ /s]	Qeco [m ³ /s]	Δh_{total} [m]	y0 [m]	y1 [m]	C	Bslot [m]	Δh_{pool} [m]	Qpassage [m ³ /s]	Qflap-gate [m ³ /s]	discharge ratio [%]	v_avg [m/s]	ϵ [W/m ³]
0	25	5.0	5.33	6.59	1.26	0.7	0.75	0.099	4.81	0.19	2506.99	0.97	140.05
1	50	8.6	5.24	6.59	1.35	0.7	0.75	0.097	4.77	1.83	261.40	0.97	128.18
2	125	12.5	4.92	6.61	1.69	0.7	0.75	0.091	4.64	7.86	59.03	0.94	95.03
3	250	16.0	4.47	6.60	2.13	0.7	0.75	0.083	4.42	11.58	38.12	0.89	66.14
4	500	20.0	3.27	6.54	3.27	0.7	0.75	0.061	3.74	16.26	23.02	0.76	27.25
5	1000	20.0	1.43	6.56	5.13	0.7	0.75	0.026	2.48	17.52	14.17	0.50	5.10
6	1250	20.0	0.63	6.56	5.93	0.7	0.75	0.012	1.65	18.35	8.98	0.33	1.30
7	1627	20.0	0.90	7.34	6.44	0.7	0.75	0.017	2.20	17.80	12.38	0.40	2.28

Weir complex Linne

Table 46: Flow conditions for the vertical-slot fish passage at complex Linne

	Qriver [m ³ /s]	Qeco [m ³ /s]	Δh_{total} [m]	y0 [m]	y1 [m]	C	Bslot [m]	Δh_{pool} [m]	Qpassage [m ³ /s]	Qflap-gate [m ³ /s]	discharge ratio [%]	v_avg [m/s]	ϵ [W/m ³]
0	25	5.0	2.80	3.56	0.76	0.7	0.75	0.100	2.62	2.38	100.90	0.88	238.90
1	50	8.6	2.70	3.56	0.86	0.7	0.75	0.096	2.57	4.83	83.88	0.96	203.41
2	125	12.5	2.36	3.55	1.19	0.7	0.75	0.094	2.40	10.10	23.72	0.90	124.41
3	250	16.0	2.23	3.54	1.31	0.7	0.75	0.089	2.32	13.68	16.99	0.88	104.49
4	500	20.0	2.09	3.51	1.42	0.7	0.75	0.075	2.23	17.77	12.55	0.85	87.40
5	1000	20.0	1.83	3.62	1.79	0.7	0.75	0.065	2.15	17.85	12.08	0.78	59.50
6	1250	20.0	1.20	3.55	2.36	0.7	0.75	0.043	1.71	18.29	9.34	0.64	24.02
7	1627	20.0	0.87	4.13	3.26	0.7	0.75	0.031	1.69	18.31	9.25	0.55	12.54

Weir complex Roermond

Table 47: Flow conditions for the vertical-slot fish passage at complex Roermond

	Qriver [m ³ /s]	Qeco [m ³ /s]	Δh _{total} [m]	y ₀ [m]	y ₁ [m]	C	Bslot [m]	Δh _{pool} [m]	Q _{passage} [m ³ /s]	Q _{flap-gate} [m ³ /s]	discharge ratio [%]	v _{avg} [m/s]	ε [W/m ³]
0	25	5.0	1.25	2.01	0.76	0.7	0.75	0.098	1.45	3.55	40.82	0.96	127.75
1	50	8.8	1.15	2.01	0.88	0.7	0.75	0.088	1.39	5.21	26.68	0.92	101.75
2	125	12.5	0.82	2.01	1.19	0.7	0.75	0.063	1.17	11.33	10.36	0.78	48.38
3	250	16.0	0.78	2.01	1.31	0.7	0.75	0.054	1.08	14.92	7.27	0.72	33.61
4	500	20.0	0.53	1.95	1.42	0.7	0.75	0.041	0.92	19.06	4.80	0.63	20.05
5	1000	20.0	0.38	2.01	1.65	0.7	0.75	0.028	0.78	19.22	4.05	0.52	10.08
6	1250	20.0	0.40	2.77	2.31	0.7	0.75	0.035	1.21	10.79	6.45	0.58	14.35
7	1627	20.0	0.28	3.77	3.40	0.7	0.75	0.022	1.29	10.71	6.88	0.48	8.19

Weir complex Belfeld

Table 48: Flow conditions for the vertical-slot fish passage at complex Belfeld

	Qriver [m ³ /s]	Qeco [m ³ /s]	Δh _{total} [m]	y ₀ [m]	y ₁ [m]	C	Bslot [m]	Δh _{pool} [m]	Q _{passage} [m ³ /s]	Q _{flap-gate} [m ³ /s]	discharge ratio [%]	v _{avg} [m/s]	ε [W/m ³]
0	25	5.0	1.98	2.72	0.76	0.7	0.75	0.098	1.98	3.62	65.57	0.97	177.50
1	50	8.8	1.86	2.72	0.86	0.7	0.75	0.093	1.93	4.67	41.30	0.95	147.73
2	125	12.5	1.51	2.70	1.19	0.7	0.75	0.075	1.73	10.77	16.01	0.85	80.78
3	250	16.0	1.34	2.65	1.31	0.7	0.75	0.067	1.60	14.40	11.07	0.80	60.91
4	500	20.0	1.10	2.65	1.55	0.7	0.75	0.055	1.45	18.55	7.79	0.73	38.87
5	1000	20.0	0.24	3.47	3.23	0.7	0.75	0.012	0.88	19.12	4.62	0.34	2.57
6	1250	20.0	0.06	4.21	4.15	0.7	0.75	0.003	0.54	19.46	2.76	0.17	0.20
7	1627	20.0	0.25	5.64	5.39	0.7	0.75	0.012	1.47	18.53	7.91	0.35	2.66

Energy dissipation requirement not satisfied

The flow conditions for the increased pool volume ($B_{\text{pool}} = 3.5 \text{ m}$) is shown in the Table 49.

Table 49: Flow conditions for the vertical-slot fish passage at complex Belfeld for the adjusted dimensions

	Qriver [m ³ /s]	Qeco [m ³ /s]	Δh _{total} [m]	y ₀ [m]	y ₁ [m]	C	Bslot [m]	Δh _{pool} [m]	Q _{passage} [m ³ /s]	Q _{flap-gate} [m ³ /s]	discharge ratio [%]	v _{avg} [m/s]	ε [W/m ³]
0	25	5.0	1.96	2.72	0.76	0.7	0.75	0.098	1.98	3.02	65.57	0.97	147.91
1	50	8.8	1.86	2.72	0.86	0.7	0.75	0.093	1.93	4.67	41.30	0.95	123.11
2	125	12.5	1.51	2.70	1.19	0.7	0.75	0.075	1.73	10.77	16.01	0.85	67.31
3	250	16.0	1.34	2.65	1.31	0.7	0.75	0.067	1.60	14.40	11.07	0.80	50.76
4	500	20.0	1.10	2.65	1.55	0.7	0.75	0.055	1.45	18.55	7.79	0.73	32.39
5	1000	20.0	0.24	3.47	3.23	0.7	0.75	0.012	0.88	19.12	4.62	0.34	2.14
6	1250	20.0	0.06	4.21	4.15	0.7	0.75	0.003	0.54	19.46	2.76	0.17	0.25
7	1627	20.0	0.25	5.64	5.39	0.7	0.75	0.012	1.47	18.53	7.91	0.35	2.22

Weir complex Grave

Table 50: Flow conditions for the vertical-slot fish passage at complex Grave

	Qriver [m ³ /s]	Qeco [m ³ /s]	Δh _{total} [m]	y ₀ [m]	y ₁ [m]	C	Bslot [m]	Δh _{pool} [m]	Q _{passage} [m ³ /s]	Q _{flap-gate} [m ³ /s]	discharge ratio [%]	v _{avg} [m/s]	ε [W/m ³]
0	25	5.0	1.50	2.32	0.76	0.7	0.75	0.088	1.66	3.32	50.81	0.97	150.32
1	50	8.8	1.48	2.32	0.88	0.7	0.75	0.091	1.83	4.97	32.79	0.94	122.89
2	125	12.5	1.13	2.32	1.19	0.7	0.75	0.071	1.43	11.07	12.96	0.82	83.84
3	250	16.0	0.94	2.25	1.31	0.7	0.75	0.059	1.27	14.73	8.81	0.75	42.72
4	500	20.0	0.66	2.08	1.42	0.7	0.75	0.041	0.98	19.02	5.17	0.63	21.78
5	1000	20.0	0.39	2.93	1.84	0.7	0.75	0.024	0.74	19.26	3.83	0.48	8.47
6	1250	20.0	0.38	2.47	2.66	0.7	0.75	0.024	0.90	18.10	4.69	0.48	8.15
7	1627	20.0	0.34	3.13	2.79	0.7	0.75	0.021	1.06	19.04	5.60	0.45	6.29

The value exceeds 150 W/m³. However, the difference is small, so the flow conditions are considered satisfied

Weir complex Lith

Table 51: Flow conditions for the vertical-slot fish passage at complex Lith

	Qriver [m ³ /s]	Qeco [m ³ /s]	Δh _{total} [m]	y ₀ [m]	y ₁ [m]	C	Bslot [m]	Δh _{pool} [m]	Q _{passage} [m ³ /s]	Q _{flap-gate} [m ³ /s]	discharge ratio [%]	v _{avg} [m/s]	ε [W/m ³]
0	25	5.0	2.79	3.55	0.76	0.7	0.75	0.100	2.61	2.39	108.85	0.98	237.05
1	50	8.6	2.69	3.55	0.88	0.7	0.75	0.096	2.56	4.04	63.32	0.98	201.79
2	125	12.5	2.37	3.56	1.19	0.7	0.75	0.085	2.41	10.09	23.87	0.90	125.52
3	250	16.0	2.25	3.56	1.31	0.7	0.75	0.080	2.35	13.65	17.19	0.88	106.45
4	500	20.0	2.12	3.56	1.44	0.7	0.75	0.076	2.28	17.72	12.85	0.85	89.30
5	1000	20.0	1.47	3.56	2.09	0.7	0.75	0.053	1.90	18.10	10.48	0.71	36.48
6	1250	20.0	0.14	2.78	2.64	0.7	0.75	0.005	0.46	19.54	2.34	0.22	0.88
7	1627	20.0	0.24	3.55	3.31	0.7	0.75	0.009	0.76	19.24	3.97	0.29	1.55

Energy dissipation requirement not satisfied

The flow conditions for the increased pool volume ($L_{pool} = 6.0$ m and $B_{pool} = 3.5$ m) is shown in the Table 52.

Table 52: Flow conditions for the vertical-slot fish passage at complex Lith with the adjusted dimensions

	Qriver [m ³ /s]	Qeco [m ³ /s]	Δh _{total} [m]	y ₀ [m]	y ₁ [m]	C	Bslot [m]	Δh _{pool} [m]	Q _{passage} [m ³ /s]	Q _{flap-gate} [m ³ /s]	discharge ratio [%]	v _{avg} [m/s]	ε [W/m ³]
0	25	5.0	2.79	3.55	0.76	0.7	0.75	0.100	2.61	2.39	108.85	0.98	141.10
1	50	8.6	2.69	3.55	0.88	0.7	0.75	0.096	2.56	4.04	63.32	0.98	120.11
2	125	12.5	2.37	3.56	1.19	0.7	0.75	0.085	2.41	10.09	23.87	0.90	74.71
3	250	16.0	2.25	3.56	1.31	0.7	0.75	0.080	2.35	13.65	17.19	0.88	63.36
4	500	20.0	2.12	3.56	1.44	0.7	0.75	0.076	2.28	17.72	12.85	0.85	53.16
5	1000	20.0	1.47	3.56	2.09	0.7	0.75	0.053	1.90	18.10	10.48	0.71	21.71
6	1250	20.0	0.14	2.78	2.64	0.7	0.75	0.005	0.46	19.54	2.34	0.22	0.40
7	1627	20.0	0.24	3.55	3.31	0.7	0.75	0.009	0.76	19.24	3.97	0.29	0.92