

Assessment of Sub-scale Designs for Scaled Flight Testing

Raju Kulkarni, Akshay; Varriale, Carmine; Voskuil, Mark; la Rocca, Gianfranco; Veldhuis, Leo

DOI

[10.2514/6.2019-3089](https://doi.org/10.2514/6.2019-3089)

Publication date

2019

Document Version

Final published version

Published in

AIAA Aviation 2019 Forum

Citation (APA)

Raju Kulkarni, A., Varriale, C., Voskuil, M., la Rocca, G., & Veldhuis, L. (2019). Assessment of Sub-scale Designs for Scaled Flight Testing. In *AIAA Aviation 2019 Forum* (pp. 1-21). Article AIAA-2019-3089 (AIAA Aviation 2019 Forum). American Institute of Aeronautics and Astronautics Inc. (AIAA).
<https://doi.org/10.2514/6.2019-3089>

Important note

To cite this publication, please use the final published version (if applicable).
Please check the document version above.

Copyright

Other than for strictly personal use, it is not permitted to download, forward or distribute the text or part of it, without the consent of the author(s) and/or copyright holder(s), unless the work is under an open content license such as Creative Commons.

Takedown policy

Please contact us and provide details if you believe this document breaches copyrights.
We will remove access to the work immediately and investigate your claim.



Assessment of Sub-scale Designs for Scaled Flight Testing

Akshay Raju Kulkarni*, Carmine Varriale[†]
Delft University of Technology, Kluyverweg 1, 2629HS Delft

Mark Voskuijl[‡]
Netherlands Defence Academy, 1781 AC Den Helder

Gianfranco La Rocca[§] and Leo L.M. Veldhuis[¶]
Delft University of Technology, Kluyverweg 1, 2629HS Delft

Sub-scale Flight Testing (SFT) is potentially useful in predicting aircraft flight behaviour, especially in the case of unconventional designs for which legacy information is unavailable and wind tunnel tests are unable to predict aircraft dynamics. A necessary condition for SFT is the design of properly scaled models. However, even in case of perfect scaling, the sub-scale model needs adequate flight performance and handling qualities to enable the execution of flight tests. Thus, the (static and dynamic) stability and control (S&C) and handling qualities (HQ) of sub-scale designs should be evaluated accurately as well as quickly, to allow conceptual design iterations. To this purpose, we propose the use of a 3D panel method (3DPM) for the generation of the non-linear aerodynamic database, in combination with a non-linear flight dynamics analysis. Two main challenges affect the proposed approach. The first concerns the validity of the low-fidelity 3DPM data for the assessment of the sub-scale design S&C and HQ. The second is about the time consuming and error-prone pre/post-processing activity demanded by the hundreds of analysis cases for the aerodynamic database generation. The first issue is investigated by predicting the longitudinal S&C performance and HQ of a sub-scale design using 3DPM analysis and comparing them with the prediction from wind-tunnel test (static) data supplemented by (dynamic) data from 3DPM. Both models appear trimmable and stable and the difference in their HQ are quantified, thus verifying the suitability of 3DPM analysis for sub-scale design assessment. The pre/post-processing challenge is tackled by the development of a knowledge-based engineering application to automate the aerodynamics database generation, reducing the time needed for geometry modeling, discretization and post-processing of hundreds of cases from weeks to hours. The proposed methodology and its flexibility are demonstrated in this paper, where a commercial 3DPM code and an in-house developed non-linear flight dynamics analysis tool have been used to assess two sub-scale designs, one conventional and one based on the box-wing configuration.

I. Nomenclature

Φ	=	velocity potential [-]
V	=	velocity [m s^{-1}]
u	=	velocity along x body axis [m s^{-1}]
v	=	velocity along y body axis [m s^{-1}]
w	=	velocity along z body axis [m s^{-1}]

*PhD Candidate, Faculty of Aerospace Engineering, Delft University of Technology, AIAA Student Member

[†]PhD Candidate, Faculty of Aerospace Engineering, Delft University of Technology

[‡]Professor, Faculty of Military Sciences, Netherlands Defence Academy

[§]Assistant Professor, Faculty of Aerospace Engineering, Delft University of Technology

[¶]Professor, Faculty of Aerospace Engineering, Delft University of Technology

p	=	angular velocity about x body axis [rad s ⁻¹]
q	=	angular velocity about y body axis [rad s ⁻¹]
r	=	angular velocity about z body axis [rad s ⁻¹]
ψ	=	heading angle [rad]
θ	=	longitudinal attitude angle [rad]
ϕ	=	roll angle [rad]
X_E	=	position along x Earth axis [m]
Y_E	=	position along y Earth axis [m]
Z_E	=	position along z Earth axis [m]
δ_a	=	aileron deflection angle [rad]
δ_e	=	elevator deflection angle [rad]
δ_r	=	rudder deflection angle [rad]
δ_T	=	normalized throttle command [-]
\ddot{u}	=	acceleration along x body axis [m s ⁻²]
\ddot{v}	=	acceleration along y body axis [m s ⁻²]
\ddot{w}	=	acceleration along z body axis [m s ⁻²]
W	=	weight of the aircraft [N]
\dot{p}	=	angular acceleration about x body axis [rad s ⁻²]
\dot{q}	=	angular acceleration about y body axis [rad s ⁻²]
\dot{r}	=	angular acceleration about z body axis [rad s ⁻²]
C_L	=	Lift coefficient of the aircraft [-]
C_D	=	Drag coefficient of the aircraft [-]
C_M	=	Moment coefficient of the aircraft [-]
ω	=	natural frequency [rad s ⁻¹]
ζ	=	damping ratio [-]
I	=	inertia matrix [kg m ²]

II. Introduction

There has been a tremendous growth in air traffic in the last decade and in the next two it is expected to double. [1] Fossil fuel scarcity and environmental impact are two fundamental challenges requiring immediate attention. [2–4] Many studies claim that unconventional aircraft designs, incorporating novel technologies, can offer a solution towards a sustainable air-traffic growth. [5–7]

These claims are mostly based on "paper designs" and not demonstrated in flight yet. However, the actual performances of an aircraft, such as its dynamics stability and controllability and, eventually, its flying and handling qualities are difficult to predict, especially in the case of unconventional configurations, for which the use of semi-empirical or statistics based methods are limited or impossible. This poses a major obstacle in the transition of many novel designs from conceptual studies to production and operation.

Diverse approaches are typically used to assess the aforementioned flight performances of a given design. Computational Fluid Dynamics (CFD) or CFD-based surrogate models are used to predict the aerodynamic aircraft behaviour with the highest fidelity, but are still limited by uncertainties and errors.[8, 9] Wind-tunnel Testing (WT) on sub-scale models is performed to validate and correct numerical simulations. [8, 10] Still, this testing method has limitations. First, the commonly used geometrically scaled models have different aerodynamics than the full-scale design. Second, WT is mostly limited to the study of static behaviour, whereas the evaluation of dynamic behaviour, when even possible, would require sophisticated and expensive experimental setup. This raises the question: how can we reliably predict the flight dynamic behaviour of a design concept in the absence of a full-scale flying model?

Sub-scale Flight Testing (SFT) has the potential to answer the question. It allows studying both the static and dynamic behaviour of the aircraft, it is far cheaper than full-scale flight testing (which is generally impossible during design), it can complement WT and feature lower uncertainties than virtual testing (i.e., computer simulations). Similar to WT, the lower development cost and larger flexibility offered by sub-scale testing come with the challenges of identifying adequate scaling techniques, essential to build a representative model, and scale-up methods, to map the test results on the full scale design.

The problem of scaling and enhancing similitude between full-scale and sub-scale designs has been specifically addressed in a previous work. [11] Nevertheless, even if we were to achieve perfect similitude between a sub-scale model and full-scale design, the sub-scale model would also need to take-off, perform the required testing mission and land safely. Thus, while designing a representative sub-scale model, it is necessary to address also its flying quality (i.e. static and dynamic stability, controllability, flying and handling qualities), accurately and quickly, to make SFT feasible in practice. [11–13]

An adequate trade-off between simulation accuracy and time is important in sub-scale model design, because the SFT results should be fed back to the designer for further iterations on the full scale aircraft design. While, conventional CFD methods such as the Euler method, Reynolds Averaged Navier Stokes method or Direct Numerical Solution methods can provide the best accuracy for what concerns the assessment of the aerodynamic derivatives, they are too time expensive: few days per case, whereas, at least a few hundred cases must be analyzed to build up the necessary aerodynamic dataset to assess the sub-scale vehicle flight performance. Low fidelity methods like 2D panel codes are very fast (few seconds per case) but inaccurate.

This paper proposes a methodology that is based on the combination of a medium fidelity 3D Panel Method (3DPM) for the generation of the aerodynamic database of scaled aircraft (i.e., forces and moments acting on the aircraft at varying flight conditions and combinations of control surface deflections), and a non-linear flight dynamics model to simulate the six degrees of freedom aircraft motion. Section III describes the 3DPM and the non-linear flight dynamics models selected for this work and their integration approach for the assessment of sub-scale designs.

Although 3DPM simulations take a few minutes per case, the preparation of the analysis input models is generally very time expensive. For each case, a few hours are needed to manually prepare the model, i.e. to model the geometry at the required level of fidelity, apply the necessary discretization and generate the analysis input file according to the prescribed format. This can be a critical bottleneck when hundred of cases must be evaluated. To solve this problem, we developed an aircraft configuration-agnostic design automation tool, which can prepare the input model and trigger its analysis within a few seconds, for each control-surfaces arrangement. This was achieved by the development of a Knowledge Based Engineering (KBE) application, as described in Section III.

In addition to being time efficient, the method must also be accurate to ensure a successful and safe SFT campaign. To validate the proposed approach, the handling qualities predicted on the sole basis of 3DPM analysis are compared with those estimated using static aerodynamic data from wind-tunnel test supplemented by dynamic aerodynamic data from 3DPM. The comparison is presented in Section IV. In this section the flexibility of the proposed methodology is demonstrated, by showing the prediction of the S&C characteristics and HQ of a 10% scaled Prandtl-plane (a novel aircraft configuration based on the box-wing system) design and an 8.8% sub-scale model of the Cessna Citation II 550. Section V draws conclusions on the applicability of the proposed methodologies and tools.

III. S&C and HQ assessment using 3DPM and non-linear flight dynamics analysis

The combination of a 3D panel method (3DPM) with non-linear flight dynamics analysis is the solution proposed by the authors to achieve the previously addressed balance between computational time and accuracy. Section III.A discusses the requirements for the construction of the aerodynamic database. Section III.B provides background on 3DPMs and their application in view of satisfying the given requirements. Some information on the specific 3DPM code used in this work is provided here as well. Section III.C introduces the in-house developed non-linear flight dynamics analysis tool used to assess the S&C characteristics and HQ of the given sub-scale designs. Finally, Section III.D describes how S&C and HQ assessment can be automated using a KBE application.

A. Construction of the aerodynamic database

The aerodynamic database needed for the non-linear flight dynamics analysis can be structured into a clean-aerodynamic database and a control-surface database. The clean-aerodynamics database contains the forces and moments experienced by the aircraft in clean configuration (i.e., no control surfaces deflected), defined in the body-axis, at different flight conditions: varying angles of attack, side-slip angles, Mach numbers and pitch, roll and yaw rates. The control-surface database contains the change in forces and moments with respect to the clean configuration due to control surface deflection, at different flight conditions.

The clean-aerodynamic database should at least contain forces and moments at three angles of attack, three side-slip angles, two Mach numbers, two pitch rate, two yaw rates and two roll rates, to allow the non-linear flight dynamics analysis to interpolate through the database. Similarly, the control surface database should contain the change in forces and moments due to two different deflections of each one of the control surfaces, at the same angles of attack, side-slip angles and Mach numbers as in the clean-aerodynamic database.

B. 3D panel method

Panel methods have been used since 1960s. The panel methods which are in use today were introduced in the late 1970s thanks to the increase in computing power. After a few decades, the use of CFD programs that employ finite volume methods became widespread. Such methods are precise but are computationally expensive and not suitable when a lot of cases need to be simulated. Given the large amount of analysis cases necessary for the aerodynamic database described in Section III.A, fast 3DPMs are way more convenient than CFD.

3DPM calculates the potential flow external to a body or internal to a duct when normal velocity on the surfaces bounding the flow is specified. The potential flow is described by velocity potential, Φ , whose gradient is equal to flow velocity, V , and is mathematically expressed as follows:

$$\nabla\Phi = V \quad (1)$$

The velocity potential can be used to evaluate the velocity of the flow at different locations and thereby the forces, moments and pressures acting on the body. These can then be used to evaluate the S&C characteristics and HQ of a given model when combined with weight and balance data and propulsion system characteristics.

In order to calculate the velocity potential, the body and its wake are discretized using a quadrilateral or triangular mesh. Series of singularities such as source and doublets are associated with each mesh panel. The strength of each of the singularities is calculated by applying the Neumann condition to the Laplace equation.[14]

In this paper, VSAERO*, a commercial 3D panel code is used to determine the aerodynamics and control-surface database necessary for use in a non-linear flight dynamics analysis. VSAERO can determine the forces and moments acting on any given body, thus any arbitrary aircraft configuration can be analyzed, including fuselage(s), engine nacelles, etc. Furthermore, it corrects for boundary layer effects using integral boundary layer equations and corrects for compressibility effects using the Karman-Tsien rule or the Prandtl-Glauert equation. [14]

Despite these advantages, VSAERO has some disadvantages. First, it is only applicable to inviscid flow. Thus, for cases where boundary layer effects are dominant, this method is ineffective, despite the use of the integral boundary layer equations. Secondly, VSAERO cannot predict the interference drag accurately, thus it tends to underestimate the drag of complete vehicle configurations. Thereby it should be chosen to study only those phenomena which are not significantly influenced by drag. Finally, results from VSAERO are only valid for low angles of attack (under 7° angle of attack). It is unable to model the non-linear flow behaviour in those regimes where flow separation occurs. Nevertheless, since most of the S&C and HQ analyses are performed in a regime which is not close to stall, VSAERO can be used for such studies.

*<https://starkaerospace.com/products-services/ami/software/>

C. Non-linear Flight Dynamics Analysis (PHALANX)

The aerodynamic data-set generated by VSAERO must be used to estimate the trim conditions, the static and dynamic stability and the handling qualities of a given sub-scale aircraft. To this end, an in-house developed, non-linear flight dynamics analysis tool called PHALANX (Performance, HANDling qualities and Loads ANalysis toolbOX) is used. PHALANX is a data-driven, selective-fidelity, modelling and analysis toolbox, which gathers data and models from different aeronautical disciplines (aerodynamics, weight and balance, propulsion, etc.) to create a non-linear aircraft dynamics simulation model. This serves as a virtual flight test vehicle, and can be used to:

- evaluate aircraft performance characteristics such as equilibrium trust, rate of climb, cruise efficiency and maximum mission range;
- assess static and dynamic stability in different flight conditions;
- perform handling qualities assessments;
- model automatic flight control systems; and
- estimate flight loads resulting from both intentional maneuvers and atmospheric disturbances.

PHALANX is developed in MATLAB/Simulink® and is centered around the SimScape™ Multibody Dynamics core for modeling and simulation of complex physical systems. This allows PHALANX to model relative motion of aircraft parts (e.g. center of gravity shift due fuel consumption, wings flexibility) and monitor local flight parameters at prescribed locations (e.g. angle of attack at the horizontal tail) [15]. The data from different disciplinary analyses can have different fidelity levels, which allows PHALANX to operate consistently at various design phases and also in Multi-disciplinary Design Optimization (MDO) environment. [16, 17]

PHALANX can be used for both aircraft and rotorcraft configurations. It has been used in a variety of research studies to investigate the flight mechanics of novel aircraft configurations such as a blended wing body [6, 7, 18], a box-wing aircraft [19, 20] and a propulsive tail empennage concept [15]. Studies have been performed to assess the loads encountered during advanced take-off and landing procedures [21, 22]. Finally, in case real-time simulations are required with a pilot in the loop, the simulation output can be cast to the Flight Gear open-source simulator[†] visual display system.

The following sections provide an insight into the working of PHALANX. The trim algorithm is explained in Section III.C.1, the extraction of handling qualities is discussed in Section III.C.2.

1. Equation of motion and trim algorithm

The sub-scale aircraft models addressed in this study are considered rigid, with constant mass and inertia. In such a case, the aircraft equations of motion reduce to the following system of coupled, non-linear, first-order ordinary differential equations:

$$\dot{x}_{\text{dynamic}} = f_{\text{dynamic}}(x_{\text{dynamic}}, x_{\text{kinematic}}, \delta) \quad (2)$$

$$\dot{x}_{\text{kinematic}} = f_{\text{kinematic}}(x_{\text{dynamic}}, x_{\text{kinematic}}) \quad (3)$$

where,

$$x_{\text{dynamic}} = \{u, v, w, p, q, r\} \quad (4)$$

$$x_{\text{kinematic}} = \{\psi, \theta, \phi, X_E, Y_E, Z_E\} \quad (5)$$

$$\delta = \{\delta_a, \delta_e, \delta_r, \delta_T\} \quad (6)$$

The dynamic equations can be explicitly written as,

$$\begin{pmatrix} \dot{u} \\ \dot{v} \\ \dot{w} \end{pmatrix} = - \begin{pmatrix} p \\ q \\ r \end{pmatrix} \times \begin{pmatrix} u \\ v \\ w \end{pmatrix} + \frac{g}{W} \begin{pmatrix} X(\alpha, \beta, \theta, W, \delta) \\ Y(\alpha, \beta, \theta, \phi, W, \delta) \\ Z(\alpha, \beta, \theta, \phi, W, \delta) \end{pmatrix} \quad (7)$$

$$\begin{pmatrix} \dot{p} \\ \dot{q} \\ \dot{r} \end{pmatrix} = [I]^{-1} \left(- \begin{pmatrix} p \\ q \\ r \end{pmatrix} \times [I] \begin{pmatrix} p \\ q \\ r \end{pmatrix} + \begin{pmatrix} \mathcal{L}(\alpha, \beta, \theta, \phi, \delta) \\ \mathcal{M}(\alpha, \beta, \theta, \phi, \delta) \\ \mathcal{N}(\alpha, \beta, \theta, \phi, \delta) \end{pmatrix} \right) \quad (8)$$

[†]<https://www.flightgear.org/>

This system is closed by 6 additional kinematic equations which relate the speed in body axes to the position in Earth axes, and the rotational rates to the Euler angles (gimbal equations). In case the aerodynamic data is available only for the longitudinal characteristics, the system of equations 7 - 8 is reduced to equations for \dot{u} , \dot{w} and \dot{q} and the others are assumed as automatically satisfied. The only auxiliary kinematic equation simplifies to $\dot{\theta} = q$.

Trimming the aircraft means finding the combination of inputs δ and states $[x_{\text{dynamic}}, x_{\text{kinematic}}]$ that result in a steady flight, i.e. $f(x_{\text{tr}}, u_{\text{tr}}) = \dot{x}_{\text{tr}} = 0$. A subset of these parameters (i.e., states and inputs) must be assigned explicitly in the equations of motion (for example, trim speed, altitude, flight path orientation or thrust setting). The remaining parameters are called trim controls κ and have to be determined. This is obtained as a solution to an optimization problem, which is formulated as:

minimize

$$\|\dot{x}_{\text{dynamic}} - f_{\text{dynamic}}(\kappa)\|^2 \quad (9)$$

subject to the condition,

$$\kappa_{\text{lower-bound}} \leq \kappa \leq \kappa_{\text{upper-bound}} \quad (10)$$

where the objective function is the sum of squared residual accelerations in aircraft body axes. A fixed-step, line-search algorithm is used first to solve the problem. This disregards the boundary constraints. In case this algorithm is unable to find the trim condition within the boundaries or leads to controls saturation, a more robust interior-point method is deployed through the MATLAB function `fmincon`. In both cases, the gradient of the objective function with respect to the trim controls is calculated numerically by means of simulation. The stopping criterion for each acceleration component is set to 10^{-6}m s^{-2} , and therefore the demanded objective function value is below $6 \times 10^{-12} \text{m s}^{-2}$.

2. Handling qualities prediction

The system of equations of motion can be numerically linearized about a trimming point by perturbing the inputs and calculating the rate of change of the states. This is done automatically through the MATLAB function `linmod`. If a set of output variables is chosen, the system can be represented with the state-space notation. The full order linearized model consists of the 12 rigid aircraft states shown in Equations 5 and 4 (of which ψ , X_E and Y_E have no effect on the dynamics), plus the actuator dynamics. The bare airframe linear model only retains the rigid body states, i.e. the ones on the left-hand side of in equations 7 and 8.

The longitudinal linearized model can be extracted from the full order linearized model by selecting the suitable states, inputs and outputs. In this study, the following longitudinal linear system is adopted:

$$\begin{Bmatrix} \dot{u} \\ \dot{w} \\ \dot{\theta} \\ \dot{q} \end{Bmatrix} = A \begin{Bmatrix} u \\ w \\ \theta \\ q \end{Bmatrix} + B\delta_e \quad (11)$$

where the A and B matrices are populated by the linearization algorithm. This fourth order system is representative of the two characteristic longitudinal eigenmotions: the short period and the phugoid. The eigenvalues of the dynamic matrix are extracted and processed to obtain dynamic parameters such as damping ratio and natural frequency of the eigenmotions.

Handling qualities are used to quantify the aircraft response for the required pilot workload. HQ can be of two types, namely, predicted handling qualities (i.e., offline computer simulations or tests without a pilot) and assigned handling qualities (i.e., based on pilot rating).

For a full-scale aircraft, the pilot assigns a HQ rating (using the Cooper Harper rating scale [23]) which is based on the task performance (for example, trajectory tracking precision) and the piloting effort required. This process is repeated with many pilots and many different aircraft to arrive at a certain HQ metric such as Level 1/2/3. Each of this metrics is aircraft size and task dependent.

For sub-scale flight testing, currently, there are no clear assigned HQ requirements because the size and task requirements of sub-scale models are different from those of full-scale aircraft. Thus, the assigned HQ criteria must be developed for sub-scale designs. However, this is beyond the scope of this work. For the remainder of this paper, reference to the HQ implies predicted HQ.

Within the same level of dynamic approximation (e.g. non-linear dynamics, fourth-order linearized longitudinal dynamics, second-order "coarse" short period or phugoid approximation), the fidelity of the flight mechanics simulation is tied to the fidelity of the datasets used to build the aircraft model. The HQs and S&C assessment is therefore strongly influenced by the aerodynamic dataset provided as input to the flight mechanics toolbox. A relatively fast and accurate approach based on 3D panel methods allows to build a large aerodynamic dataset that includes unsteady and control derivatives for a large number of flight conditions. By making use of this, the aircraft dynamic model can be linearized in each of this conditions, retaining the properties of local aerodynamic phenomena. An aerodynamic dataset based on constant stability and control derivatives would not give the same possibility.

D. Automated S&C and HQ assessment using KBE

The capabilities and limitations of VSAERO and PHALANX are discussed in the preceding sub-sections. This section describes the steps that must be taken to combine the two methods to generate the aerodynamic database that is necessary for assessment of S&C characteristics and HQ.

In one run of VSAERO, forces and moments are determined for one control-surface arrangement (i.e., clean or control surface deflected) at one flight condition. Thus, at least 144 runs (i.e., 3 angle of attack x 3 side-slip angles x 2 Mach numbers x 2 pitch rates x 4 for each of p,q,r and clean configuration) must be executed to generate the clean-aerodynamic database. For each control surface, VSAERO must be run at least 36 times (i.e., 3 angles of attack x 3 side-slip angles x 2 Mach numbers x 2 control surface deflections). Symmetry conditions can be exploited to reduce the number of computational runs. For example, an aircraft with five control surfaces of which two symmetric, requires 252 VSAERO runs (i.e., 144 + 3 x 38). For a conventional aircraft configuration with 3 control surfaces (1 elevator, 1 rudder, 1 pair of ailerons), modelled using 12500 panels, one iteration takes approximately five minutes. Thus, requiring approximately 21 hours to generate the complete database (see the design case in Section IV).

There are two points of attention. First, the number of runs indicated in this section is the minimum requirement. For finer data-sets, more runs must be performed. Second, only the convergence time of the VSAERO has been considered when describing the time requirements. However, the time need to pre- and post process models manually is not included, which is typically 3-5 times larger than the computation time for the whole database. Furthermore, model preparation is laborious and error-prone.

Figure 1 shows the data that must be provided to PHALANX based on the results obtained from VSAERO. Two main blocks are shown, namely, the aerodynamics database and the control-surface database.

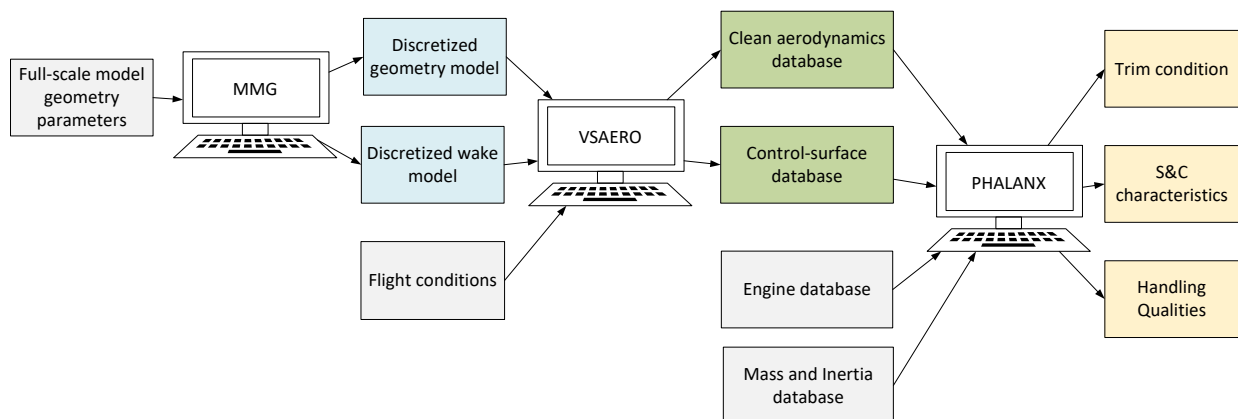

Fig. 1 Schematic of information exchange between MMG, VSAERO and PHALANX

Three main pre-processing tasks must be performed to use VSAERO (see Figure 1):

- 1) discretize the aircraft model;

- 2) generate a preliminary wake emanating from the aircraft components and discretize it
- 3) determine the flight conditions for which VSAERO simulation must be performed.

Furthermore, VSAERO requires the information on the body and wake discretization and the flight conditions in the form of a specifically formatted input file. Although very time consuming when done manually, these steps are repetitive and rule based, thus suitable for automation using KBE.

In this work, all VSAERO input files are automatically generated by means of a Knowledge Based Engineering (KBE) tool called the Multi-model Generator (MMG) under development at TU Delft, using the ParaPy[‡] commercial KBE platform. Designers can use the MMG to model diverse aircraft configurations and their variants.[24] These models can be modified/discretized to generate dedicated disciplinary models for various analysis tools. In this research work, two main MMG capabilities are used and/or extended to generate the large number of input files required to build the aerodynamics database, namely the aircraft model discretization and the wake model generation. Next to that dedicated reporting capabilities and post-processing capabilities have been developed to write properly formatted VSAERO input files and to post-process the analysis results.

E. Geometry generation of sub-scale aircraft

Subs-scale designs are assessed at the end of the conceptual design phase, where the available full-scale design information is still coarse. The MMG generates the full-scale geometry with the available information and allows the designer to fine tune and enrich this geometry for further analysis. The MMG has been developed such that it allows the generation of both conventional and unconventional designs (i.e., it is aircraft configuration agnostic). This is possible because the underlying object oriented modelling approach in MMG allows modeling virtually any type of aircraft configurations as a combination of lifting surfaces and bluff bodies class instances, whose number, position and shape can be changed as required.

The fine-tuned full-scale design is then used to generate two types of sub-scale designs:

- Geometrically scaled designs: Linear transformation of the aircraft shape that enlarges or shrinks objects by one factor that is same in all directions.
- Aerodynamically scaled designs: Sub-scale design is modified to simulate the aerodynamics of the full-scale design, which can be done in three different ways:
 - 1) using different scaling factors per axis of the full-scale design
 - 2) using different cross-sectional shapes such as changing airfoils or fuselage cross-sections
 - 3) using different relative distances between different components of the aircraft (for example, changing the tail volume coefficient)

F. Geometry discretization process

VSAERO requires a discretized sub-scale geometry (preferably structured mesh [14]) in its input file for analysis. Generating a structured mesh for an aircraft geometry which has faces with more than four edges is difficult (unless it is split into four sided faces). To this purpose, an algorithm is developed and incorporated in the MMG, which automatically splits the geometry of any given conventional/unconventional aircraft into four sided faces (see Figure 2a and 2c).

The aircraft model with split faces is used to automatically generate a structured mesh by placing equal number of nodes on all the opposite faces of a quadrilateral. The embedded grid generation methods provided by the ParaPy KBE system are used to this purpose. Screen-shots of two automatically meshed aircraft models for VSAERO analysis are shown in Figure 2b and 2d.

During the generation of the meshed model, the MMG guarantees the correct orientation of the body normal vectors into the flow field, which is a critical requirement for VSAERO and known to be a tedious and error-prone issue affecting the manual meshing approach.

G. Wake model generation

As discussed in Section III.B, a discretized wake model is needed in addition to the geometry model. The MMG can automatically generate a wake model based on the model mesh and its "understanding" of the aircraft topology (fixed and movable trailing edges, wing-fuselage intersections, etc.). It can generate both flexible and rigid wakes. In case of flexible wakes, the wake model generated by the MMG is an initial estimate, which is then modified by VSAERO during

[‡]<https://www.parapy.nl/>

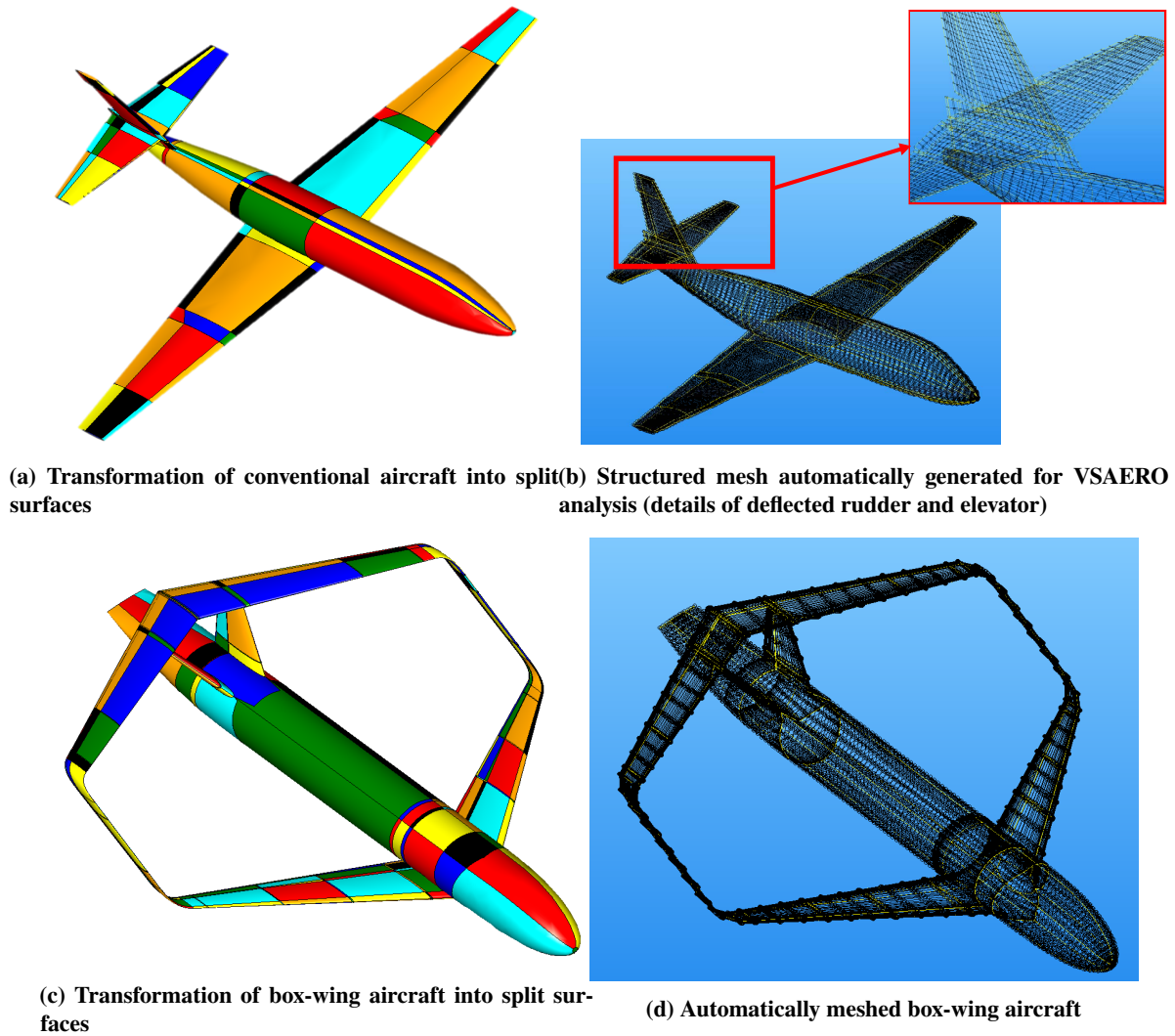

Fig. 2 Automatically pre-processed and discretized model for VSAERO analysis

the computation of the flow field. In case of rigid wakes, VSAERO does not modify the wake model, which could lead to fluctuations in results in case of incorrect wake model definition. For all the results provided in this paper, a flexible wake model is used. An example of flexible wake model used for a conventional aircraft and its modification after the VSAERO simulation is shown in Figure 3

The discretized body and wake information is automatically compiled by the MMG in the format required by VSAERO. Furthermore, the designers can either modify the geometry via the graphical user interface of the MMG to perform what-if studies or execute scripts to interact with live instance of the MMG (e.g., during an optimization study, with the optimizer perturbing the MMG model), thereby making use of the native features of a KBE tool, such as dependency tracking, lazy evaluation and run-time caching, which makes the MMG a more efficient and powerful solution than using a conventional CAD tool in a loop [25].

IV. Results and discussion

As discussed in Section 1, there are two main problems with the use of the 3D panel code. First, the time needed to prepare the model is too long to use the 3D panel code in the conceptual design phase. Second, the accuracy of the 3D panel code to estimate S&C characteristics and HQ is unknown.

In Section III, a methodology to automate the design process to quickly assess a given sub-scale model was described.

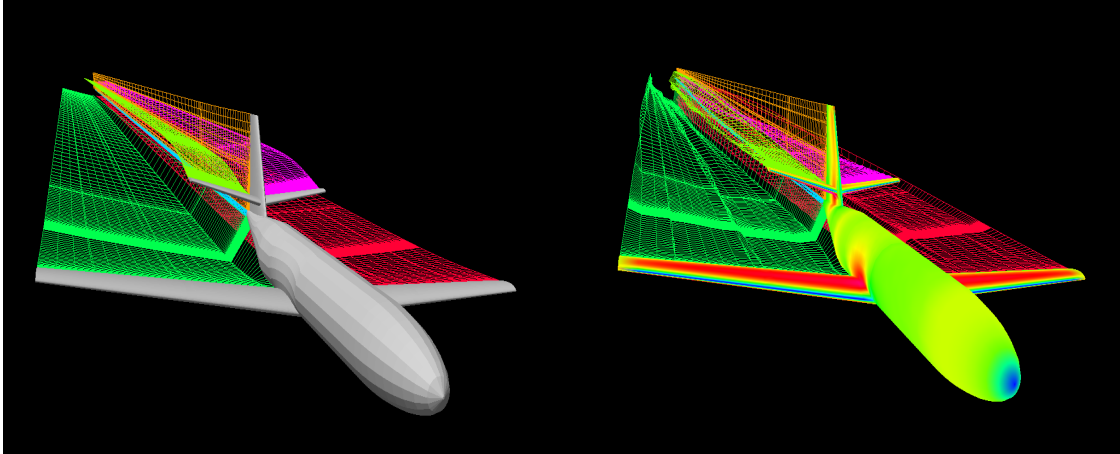

Fig. 3 Wake models before and after VSAERO analysis

Section IV.A, discusses the accuracy of 3D panel code to estimate the S&C and HQ of a sub-scale design. Section IV.A.2 presents a use-case where the S&C and HQ of a sub-scale box-wing aircraft is estimated using the 3D panel code. Section IV.B demonstrates the implementation of the proposed methodology to a box-wing aircraft and Section IV.C elaborates on the time gains obtained using the MMG. Finally, Section IV.D discusses the potential for future research based on the results achieved in this work.

A. Verification and validation

The accuracy of the 3D panel code can be studied in two ways. The first method directly compares the aerodynamic coefficients obtained from the 3D panel code with those of a higher fidelity test such as RANS CFD or wind-tunnel testing. The second method compares two flight dynamics models constructed using aerodynamic database generated by analyses of different fidelity levels. In this section, we quantify the accuracy of 3D panel code using both methods.

1. Comparison of aerodynamic derivatives

First, the results from the 3D panel code (VSAERO) are compared with the results of Wind-tunnel Test (WT) for an 8.8% aerodynamically scaled model of the Cessna Citation II 550 (the dimensions of the model can be found in the previous work by the authors [11]). The rationale of aerodynamic scaling of this sub-scaled model is to match the lift coefficient with the full-scale Cessna Citation 550. The wind-tunnel test was conducted at the Low Turbulence Tunnel (LTT) of Delft University of Technology. It is a low-speed, closed return wind-tunnel. At the test Reynolds number of 3×10^5 and 5×10^5 , the turbulence is less than 0.1%. The test-section has the dimension of 1.80 X 1.25m.

The WT model was tested at varying angles of attack, from -5 to 14 degrees, with a step size of 1 degree. Testing beyond 14 degrees was not possible due to physical limits of the wind-tunnel setup. For each of the test points, balance readings for forces and moments on the model were acquired using an external six-component balance. All results presented in this paper are corrected for blockage effects (i.e. wake blockage and solid blockage) and streamline curvature. However, the results do not account for the forces and moments due the presence of support stings.

Figure 4 shows the lift polar gathered from the wind tunnel test and the 3D panel code (VSAERO). This graph shows that VSAERO analysis and the wind-tunnel results have a good match up to 7 degrees angle of attack. Beyond this, VSAERO follows a linear slope (because of its inability to predict any separation phenomena) whereas the wind-tunnel results display the stall behaviour. The effect of the elevator deflection on the lift curve is shown in Figure 5.

The drag polar is plotted for both the wind-tunnel test and the VSAERO analysis in Figure 6. The drag calculated from the viscous calculation in VSAERO is significantly lower (approximately 50% lower) than the wind-tunnel test. This is because VSAERO does not account for interference drag. In addition, the separation is not included in the VSAERO model. The lower drag has a significant effect on the phugoid motion. This is studied further in Section IV.A.2. On the other hand, the drag estimated by WT might be higher than in reality, because the interference drag due to the presence of support stings has not be removed from the displayed WT results. Thus, the actual drag difference between

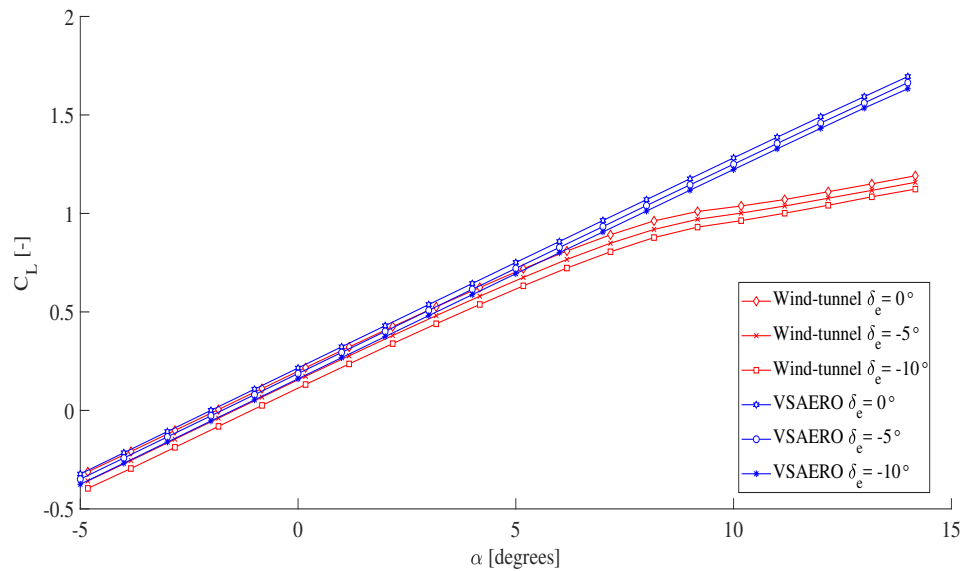

Fig. 4 Lift polar obtained from VSAERO and wind-tunnel test for different elevator deflections at $Re = 5 \times 10^5$

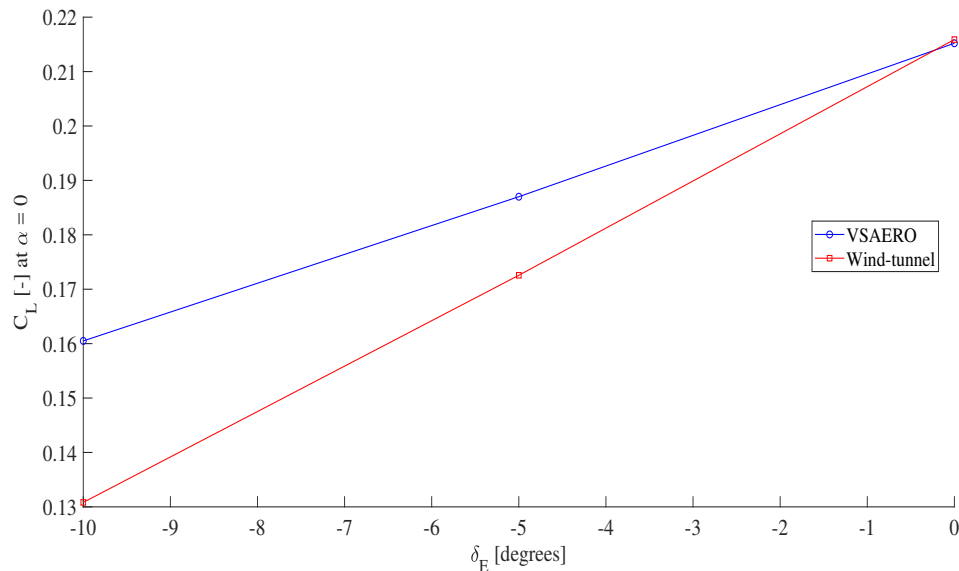

Fig. 5 Lift versus the elevator deflection at 0° angle of attack and $Re = 5 \times 10^5$

VSAERO analysis and the actual sub-scale flight test might be lower than that indicated in Figure 6.

Figure 7 shows the moment polars. The moment estimated by VSAERO is lower than WT at low angles of attack and high elevator deflection angles. This can be explained by the lower effectiveness of the elevator predicted by VSAERO as compared to WT. This can be seen in Figure 4, where, the reduction in lift due to elevator deflection is lower in case of VSAERO than WT. This could be due to VSAERO's inability to accurately model separation and non-linearities which occur due to elevator deflection.

At high angles of attack, the difference in the moments is due to the discrepancies in lift due to the separation at the wing, which increases the tail effectiveness thereby increasing pitch-down tendency.

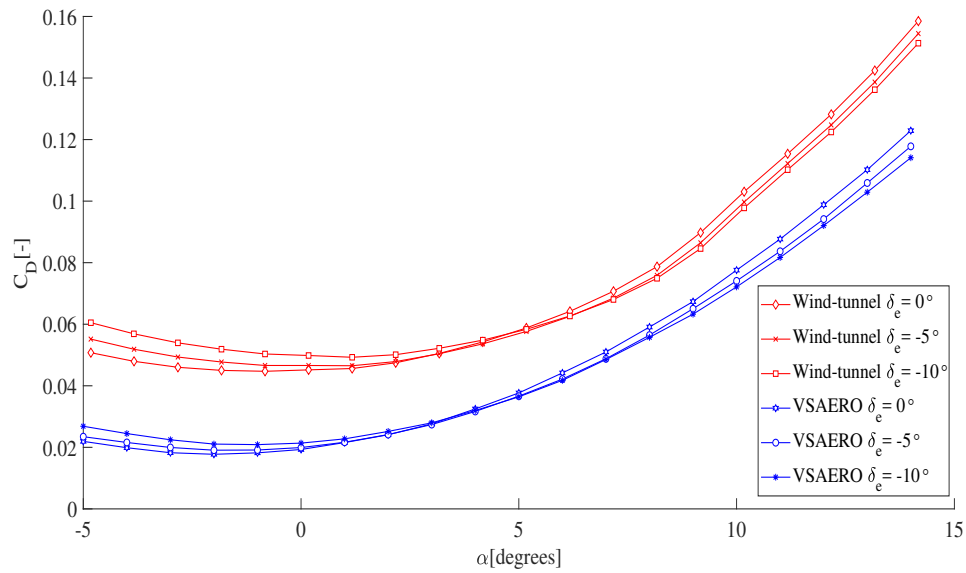

Fig. 6 Drag polar obtained from VSAERO and wind-tunnel test for different elevator deflections at $Re = 5 \times 10^5$

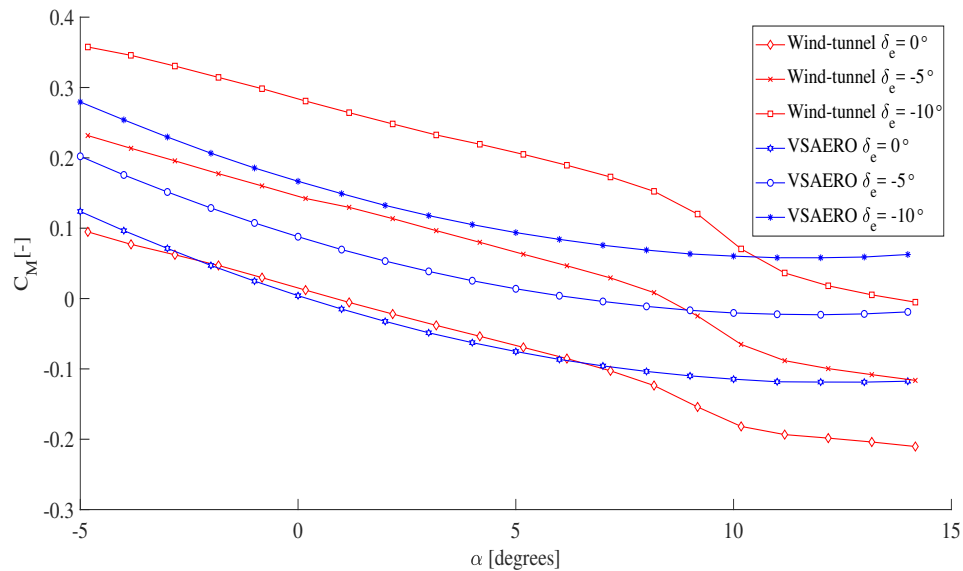

Fig. 7 Moment polar obtained from VSAERO and wind-tunnel test for different elevator deflections at 5×10^5

2. Comparison of flight dynamics model

Section IV.A compared the static aerodynamic derivatives obtained from WT and VSAERO analysis. There were discrepancies in the aerodynamic results obtained using VSAERO. However, the aim of this research is to predict the S&C and HQ of a given sub-scale design. Thus, the aerodynamic database must be used in conjunction with PHALANX, whose results are the ones to be compared, eventually.

This is done by generating and comparing two flight dynamics model (see Figure 8). The first model is built using the static aerodynamic derivatives from WT and the dynamic aerodynamic derivatives based on VSAERO analysis, as the WT that was performed does not capture the dynamic derivatives. This model is called Hybrid WT Flight Dynamics Model (HWFDM). The second model used both static and aerodynamic derivatives from VSAERO analysis. This model is called VSAERO Flight Dynamics Model (VFDM). Both models had the same engine and mass and inertia

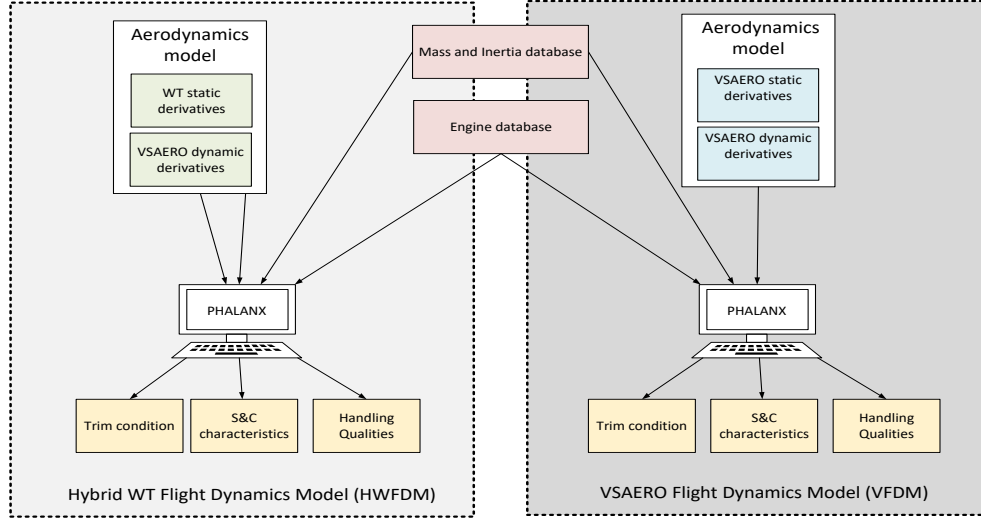

Fig. 8 Schematic of the two flight dynamics model used in this study

model. Where, the inertia of the wing and fuselage were scaled using the method proposed by Wolowicz et.al. [26]. The masses of commercial off the shelf engines[§] and landing gear are added to the mass of wing and fuselage. The mass and the inertia values used in this analysis are:

$$mass = 12.5\text{kg} \quad (12)$$

and the inertia values in the study of longitudinal behaviour were as follows,

$$I_{xx} = 0.253\text{kg m}^2 \quad (13)$$

$$I_{yy} = 0.312\text{kg m}^2 \quad (14)$$

$$I_{zz} = 0.560\text{kg m}^2 \quad (15)$$

$$I_{xz} = 0.026\text{kg m}^2 \quad (16)$$

the remaining inertia values were set to zero as they do not influence the longitudinal S&C.

Investigations showed that both models could be trimmed. Furthermore, the static-stability of both models were directly compared using the results from WT with the results from VSAERO as no dynamic derivatives were needed. The results of this study are shown in Figure 9. It can be seen that for both WT data and VSAERO data, at the center of gravity location (i.e., 0.64m behind the nose), the trim elevator deflection reduces as the velocity increases. Moreover, the location of the center of gravity is ahead of the neutral point. This shows that both models are statically stable. Finally, the computed neutral point for both models are comparable. Thus, VSAERO analyses can be used to study the static stability of sub-scale designs.

Both models were also dynamically stable. For the short period motion, the predicted HQ of HWFDM and VFDM for damping and frequency criteria are shown in Figure 10. The difference between the two models is due to the different C_{M_α} values that can be seen in Figure 7. Nevertheless, the results are comparable and the proposed approach can be used to estimate the short period HQs. As described in Section III, for sub-scale designs, the assigned HQ are unclear. Thus, the workload of the pilot cannot be estimated in the current study.

The phugoid motion HQ showed the most difference when VFDM was compared with HWFDM. This is shown in Figure 11. While the frequency of phugoid motion is comparable, the damping ratio is approximately 6 times higher for HWFDM as compared to VFDM. The main difference comes from the higher lift-to-drag ratio of VFDM as compared to HWFDM. Since the models had similar lift forces at low angles of attack, the difference is caused by drag. Therefore, in the future, when phugoid HQ is determined using VSAERO, appropriate corrections must be made to the predicted drag either using empirical methods or by performing high fidelity simulations.

[§]<https://www.schuebeler-jets.de/de/produkte/hds>

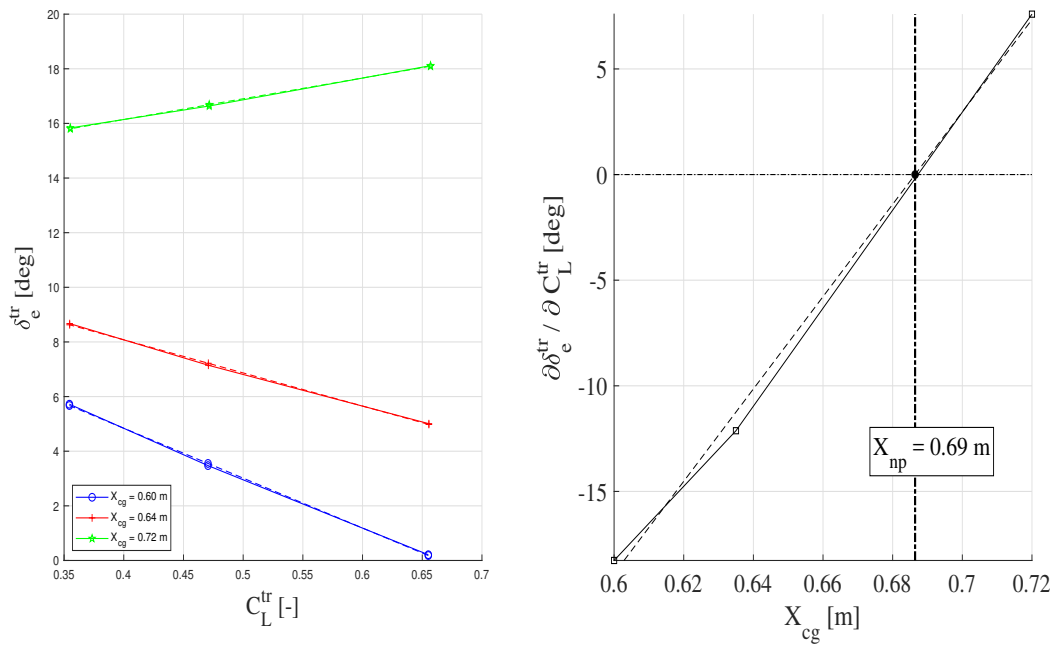

(a) WT static stability

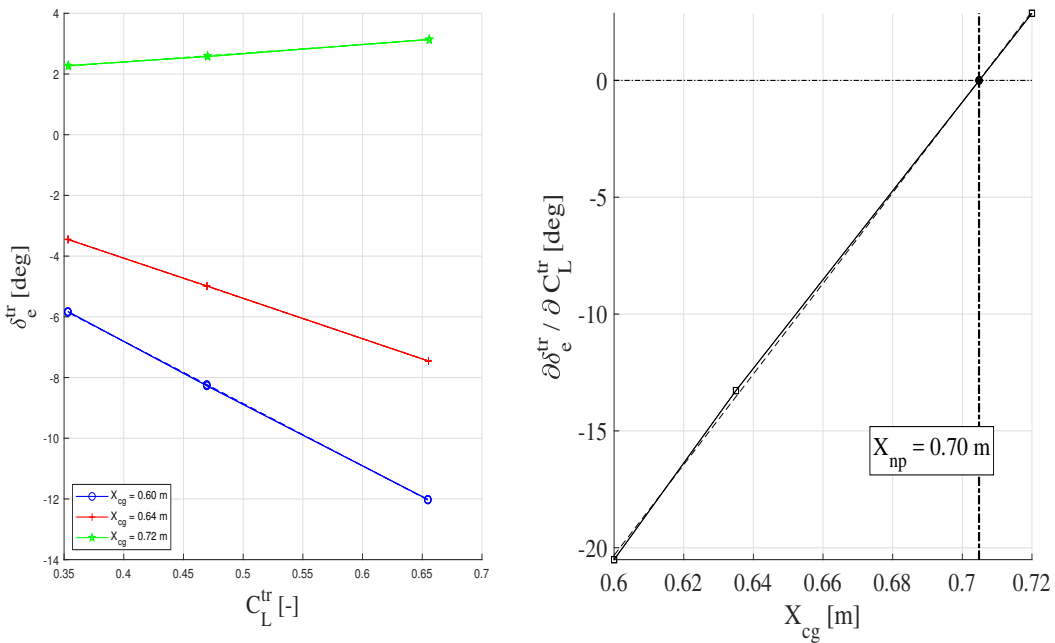

(b) VSAERO static stability

Fig. 9 Comparison of static stability of WT and VSAERO static aerodynamics model (the center of gravity (cg) location is the distance from the center of the nose of fuselage)

B. Assessment of S&C and HQ of box-wing aircraft

Section IV.A shows the implementation of the proposed method using MMG for conventional aircraft and its applicability when compared to high fidelity testing such as WT. However, the original aim of this approach is to use it for unconventional aircraft. This section studies the stability and control of a 10% scaled model of a box wing aircraft

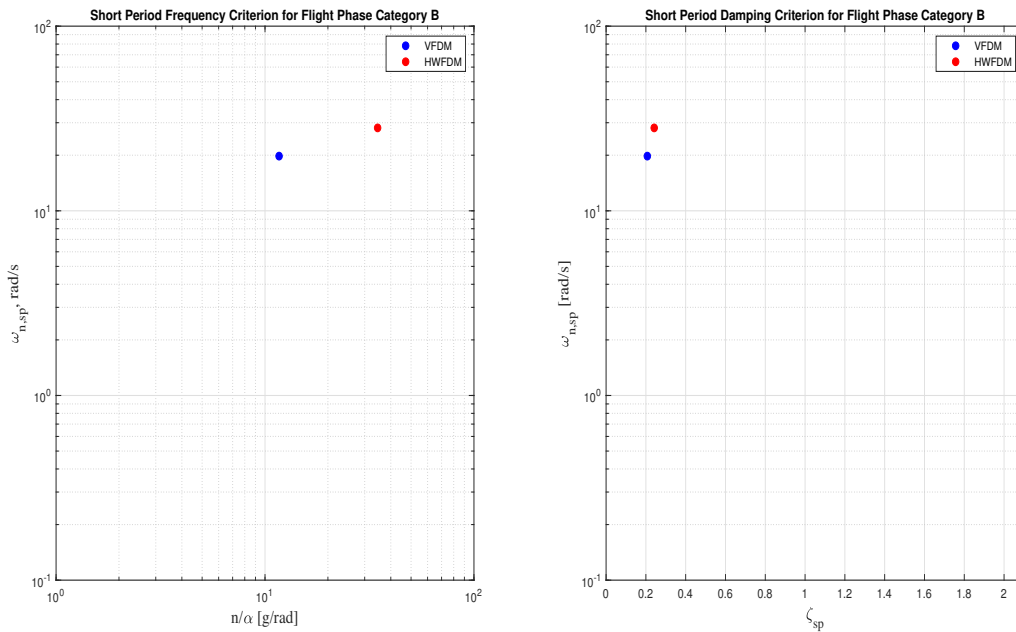

Fig. 10 Handling qualities: short period motion

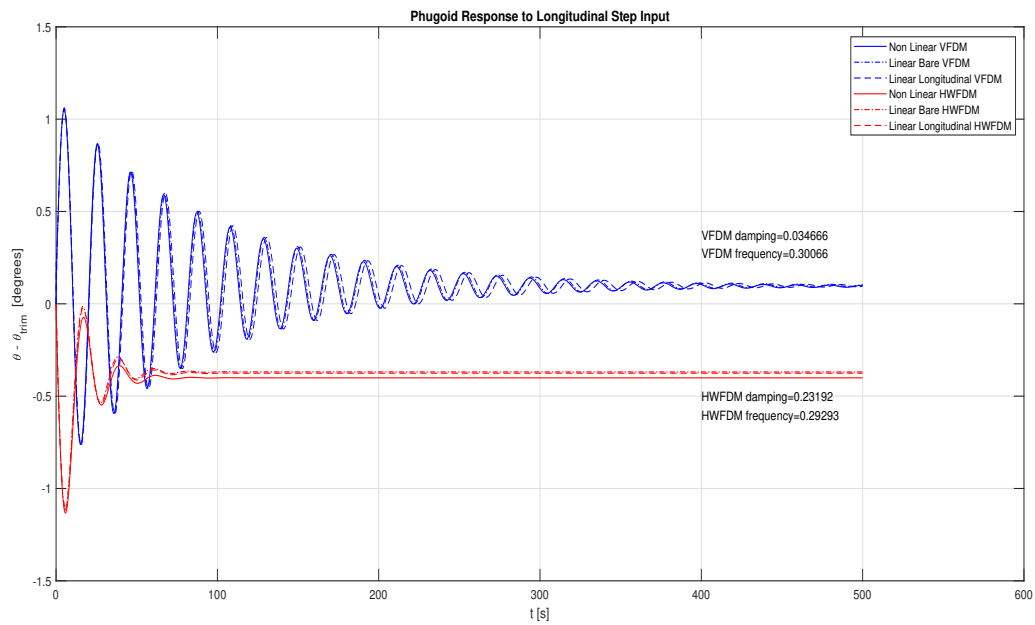

Fig. 11 Phugoid Response to Longitudinal Step Input

design. The main dimensions of the sub-scale model are shown in Figure 12. The mass, inertias and the engine model are used in the same way as described for previous study case in Section IV.A. The mass and inertia values used in this analysis were:

$$mass = 125\text{kg} \quad (17)$$

and the inertia used for the study of longitudinal characteristics were

$$I_{xx} = 64.9\text{kg m}^2 \quad (18)$$

$$I_{yy} = 129.8\text{kg m}^2 \quad (19)$$

$$I_{zz} = 129.1\text{kg m}^2 \quad (20)$$

$$I_{xz} = -17.9\text{kg m}^2 \quad (21)$$

the remaining inertia values were set to zero as they do not influence the longitudinal S&C.

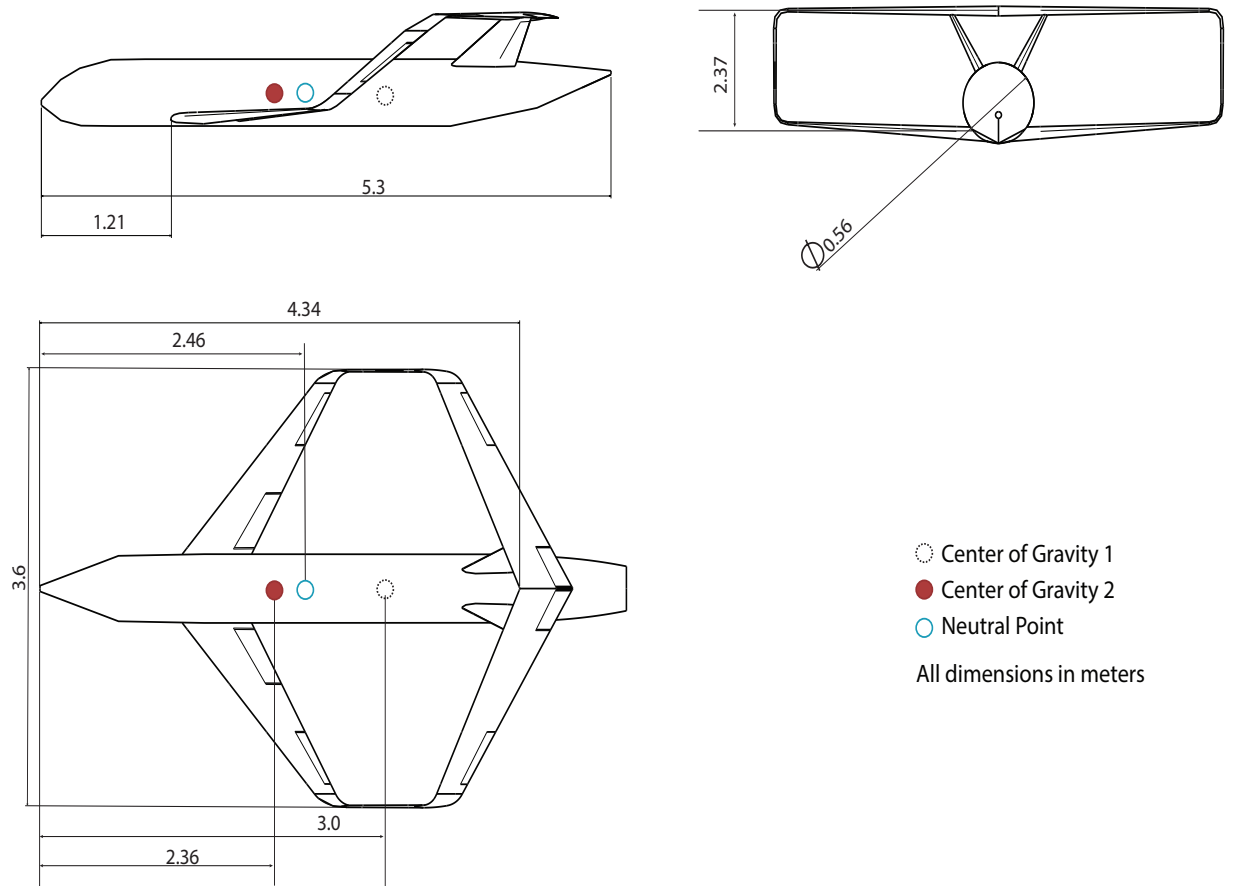

Fig. 12 Important dimensions of the sub-scale box wing aircraft

The centre of gravity location was selected by geometrically scaling the center of gravity location of the full-scale aircraft. This is shown with a red circle in Figure 12. With this information, the aerodynamic database and the flight dynamics model were generated. The model was trimmable. However, the model was found to be statically unstable which can be seen from 13 where, the perturbation causes a diverging angle of attack after 2 seconds. Furthermore, the model was stable in short-period motion (see Figure 14) but unstable in phugoid motion where it constantly diverged (see Figure 15).

Since the center of gravity location was determined by geometric scaling, re-positioning it could improve the stability of the sub-scale model. Thus, neutral point was determined using the untrimmed aerodynamic data (see Figure 16). This was found to be at 2.46 meters behind the nose as shown in Figure 12.

In order to ensure static stability, a new center of gravity location was chosen 10 cm ahead of the neutral point (see Figure 12). At this location of center of gravity, the aircraft was statically stable. However, due to insufficient control power, the sub-scale design could no longer be trimmed. Furthermore, attempts were made to trim the aircraft by moving the center of gravity closer to neutral point. However, in all the cases, the control power was insufficient. It can thus be concluded that this sub-scale model is unstable in flight and thus cannot be used for SFT. Nevertheless, increasing the control power could be a solution to make this sub-scale model fly. Alternatively, the model must be aerodynamically scaled, as against the geometrical scaling performed in this paper, to ensure that it has sufficient handling qualities.

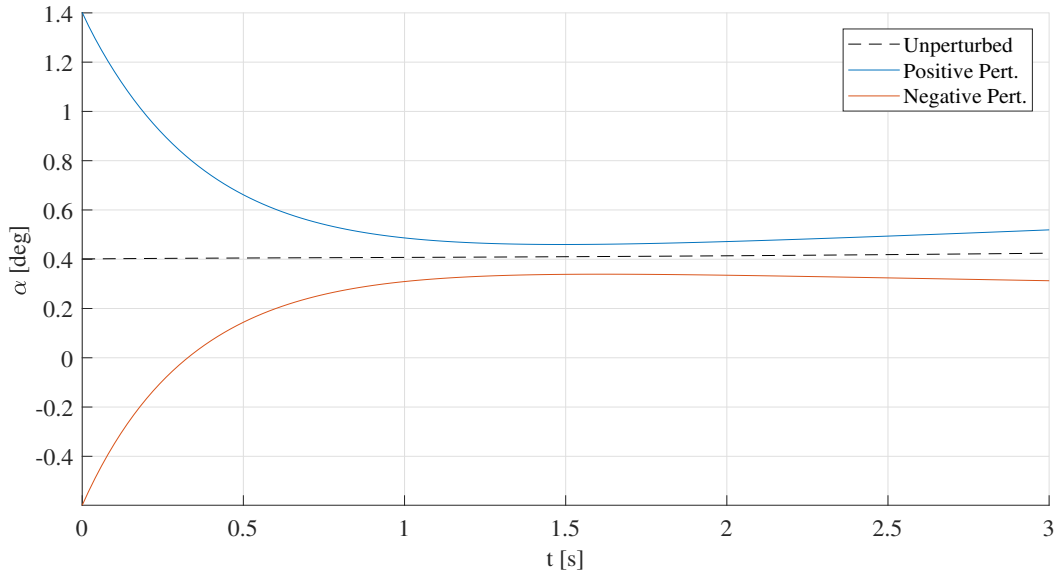

Fig. 13 Static behaviour of sub-scale box-wing aircraft to perturbations in angle of attack

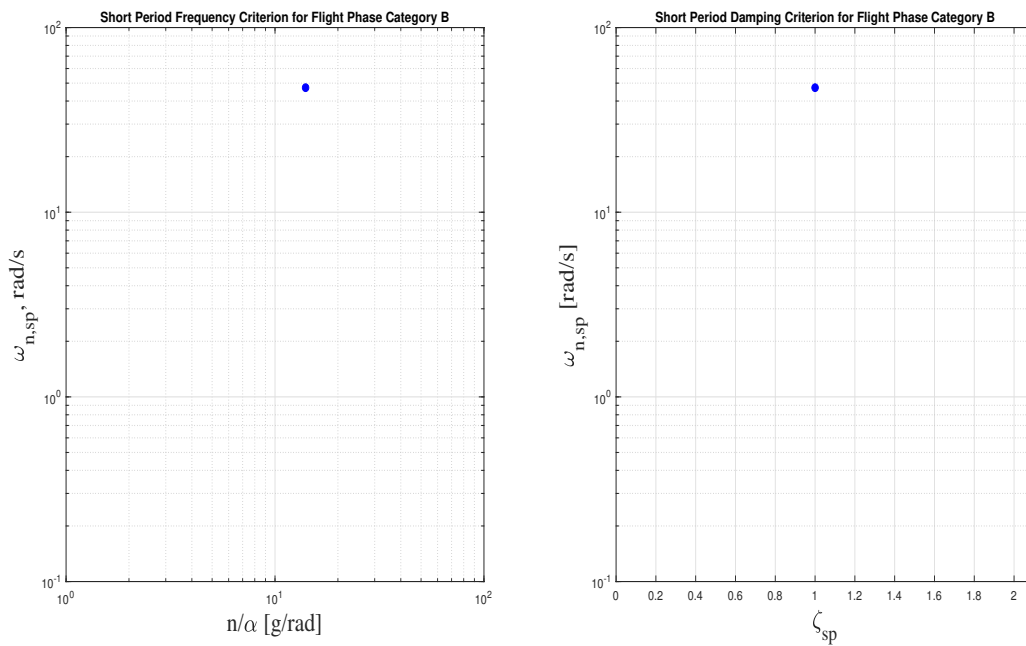

Fig. 14 Short-period HQ of box-wing aircraft

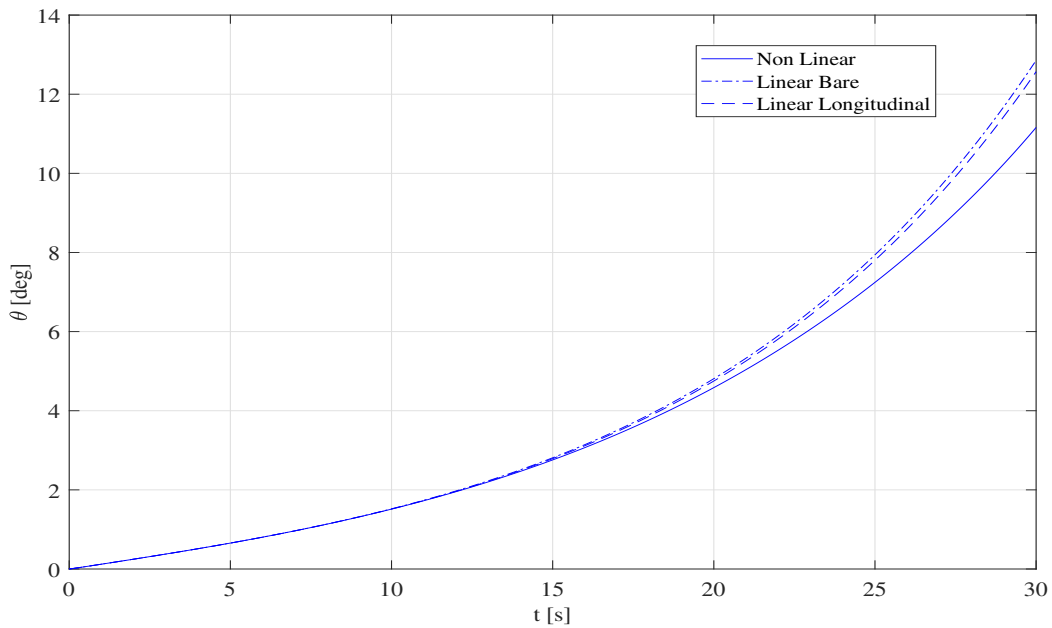

Fig. 15 Phugoid response of box-wing aircraft to longitudinal step input

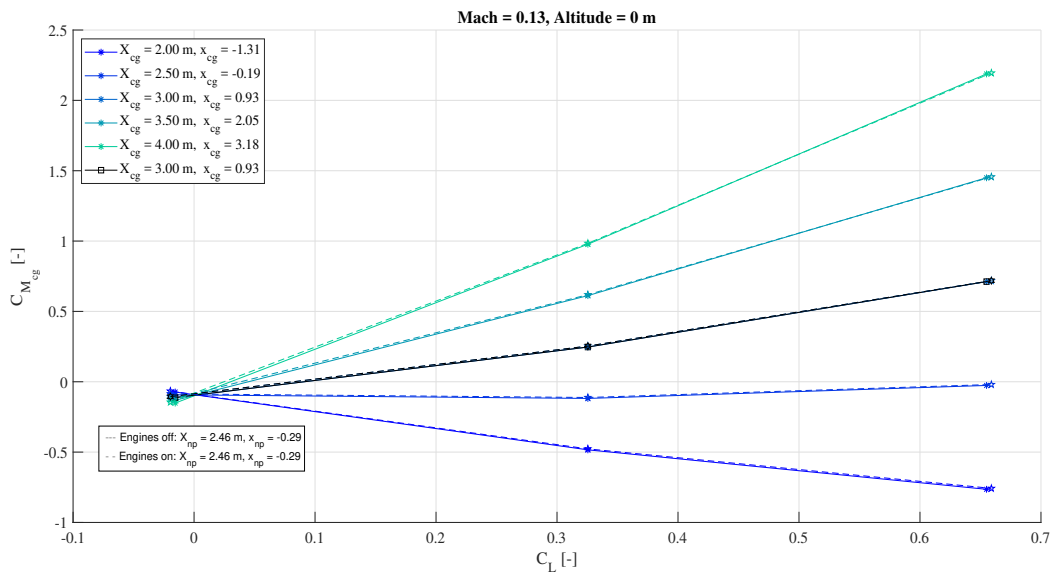

Fig. 16 Plot of variation of pitching moment with increasing lift coefficient to determine the neutral point (the center of gravity (cg) location is the distance from the center of the nose of fuselage)

C. Time studies

Section IV.A and IV.B discuss the results obtained using 3DPM and its effect on S&C and HQ of both conventional and unconventional designs. However, a key challenge in the use of this approach is the time needed to pre/post process the models such that it can be effectively used in the time available at the end of the conceptual design phase. This was solved by the development of the MMG discussed in Section III.D. Here the effectiveness of the MMG as compared to

manual model generation is evaluated.

For the generation of VFDM, VSAERO was executed 900 times. Where, each run took about 4 minutes. Furthermore, the model preparation time was 55 minutes. Thus, a total time for generation of aerodynamic database was 61 hours (i.e., 60 hours for VSAERO analysis + 1 hour for input file generation).

In order to make a fair comparison, an attempt was made to generate this database manually. There are two types of changes that must be made in the VSAERO input-file. The first being the flight conditions and the second, changes in control surface deflection (i.e., geometry and wake manipulation). The first is rather straight forward and can be accomplished easily with simple file-parsing scripts. Therefore this is neglected and only the time needed for geometry and wake changes are compared.

After symmetry simplification, there are 5 movable surfaces on the Cessna Citation sub-scale model (i.e., 2 on main wing, 2 on vertical tail and 1 on horizontal tail). For each movable, a positive deflection and negative deflection must be considered. Thus, including clean configuration, 11 variants must be built. For each geometry, manually generating error input-file free took 30 hours which requires two weeks of 24 hour work days or 6 work weeks. Thus, in the time frame required for the manual generation of the input files, 5 different sub-scale designs can be studied using the MMG, thereby offering the opportunity to perform MDO studies.

For the case of scaled box wing aircraft, VSAERO was iterated 375 times. The total model preparation time was 1 hour and the execution time per run was 7 minutes per iteration. Thus consuming 45 hours for the complete generation of the database. This study shows the time gains obtained from the development of the MMG and how it can enable the efficient assessment of the S&C and HQ of any given sub-scale design.

D. Outlook

The results demonstrated in this section open up the possibility of interesting future research. Some of these are discussed below:

- 1) **Mass and inertia calculation:** The mass and inertia used in this research was based on simplified scaling laws. However, the actual design can have significantly different mass and inertia depending on the material of construction and internal structure. Thus, a bottom-up approach must be developed which considers different internal structural elements and commercial-off-the-shelf equipment for sub-scale models. These actual masses and locations should be used to determine the mass, inertia and associated center of gravity of the sub-scale model.
- 2) **Lateral S&C and HQ studies:** In this paper, only the longitudinal S&C characteristics and HQ are considered. However, this approach can also be applied directly to the study of the lateral behaviour of sub-scale aircraft.
- 3) **Higher fidelity aerodynamics analysis:** The current study only uses the 3DPM to determine the aerodynamic database. However, as shown with validation study, 3DPM displays a discrepancy when compared with WT. Higher fidelity CFD methods such as RANS could be used to fine-tune the the aerodynamic database generated by 3DPM, thereby improving the aircraft assessment, while keeping the computational effort within the time constraints of conceptual design.
- 4) **Including the nacelle and pylon aerodynamics:** The current aerodynamic database does not consider the effect of pylons and nacelles. In future studies, these effects can be included to improve the S&C and HQ assessment.

V. Conclusions

This paper introduced the need to assess the S&C characteristics and HQs of sub-scale designs in order to ensure successful and safe SFT. The proposed approach to achieve this objective is based on combining 3DPM and non-linear flight dynamics analysis. Two main challenges are associated to the proposed approach. First, the validity of results from 3DPM for assessment of S&C and HQ was unknown. This was addressed by performing high-fidelity WT and comparing the results with 3DPM, which showed that the results from 3DPM were conservative and adequate for sub-scale design assessment. Second, the time needed to pre/post process hundreds of models was a critical bottle-neck. This was solved by using a KBE application to automate the repetitive, time-consuming and error-prone tasks, which lead to 90% reduction of the pre/post processing times .

In addition to assessing sub-scale designs, this integrated and automated work-flow combining the 3DPM and non-linear flight dynamics analysis opens up opportunities for improvements in sub-scale design and testing. For example, this work-flow can be included in an optimization loop to maximize similarity between sub-scale design

and their corresponding full-scale design, where, constraints can be imposed on the S&C characteristics and HQ of sub-scale design. Furthermore, the non-linear flight dynamics analysis can be used to construct a simulator which can be used by pilots to practice and assess the flying qualities of the design. Thus, the combination of 3DPM, non-linear flight dynamics analysis and KBE can effectively improve the sub-scale aircraft design process and ensure successful and safe sub-scale flight testing.

Acknowledgments

The research presented in this paper has been performed part in the framework of the Clean Sky 2 Large Passenger Aircraft (CS2-LPA-GAM-2018) project and part in the PARSIFAL project (Prandtlplane ARchitecture for the Sustainable Improvement of Future AirLanes). It has received funding from the European Union's Horizon 2020 research and innovation program under grant agreement H2020-MG-2016-2017/H2020-MG-2016-Two-Stages and No 723149, respectively. The authors would like to thank the partners of the two projects for their feedback, discussion and technical insight.

References

- [1] "IATA - IATA Forecasts Passenger Demand to Double Over 20 Years," , 2017. URL <http://www.iata.org/pressroom/pr/Pages/2016-10-18-02.aspx>.
- [2] IATA, "2036 Forecast Reveals Air Passengers Will Nearly Double to 7.8 Billion," , 2018. URL <https://www.iata.org/pressroom/pr/pages/2017-10-24-01.aspx>.
- [3] "IATA - Environmental Policy," , 2017. URL <http://www.iata.org/policy/environment/Pages/default.aspx>.
- [4] "IATA - Environment," , 2017. URL <http://www.iata.org/whatwedo/environment/Pages/index.aspx>.
- [5] Frediani, A., "The prandtl wing," *VON KÁRMAN INSTITUTE FOR FLUID DYNAMICS: VKI Lecture Series: Innovative Configurations and Advanced Concepts for Future Civil Transport Aircraft. Rhode St-Genèse: Von Kármán Institute for Fluid Dynamics*, 2005.
- [6] Prakasha, P. S., Della Vecchia, P., Ciampa, P., Ciliberti, D., Charbonnier, D., Jungo, A., Fioriti, M., Boggero, L., Mirzoyan, A., and Anisimov, K., "Model Based Collaborative Design & Optimization of Blended Wing Body Aircraft Configuration: AGILE EU Project," *2018 Aviation Technology, Integration, and Operations Conference*, 2018, p. 4006.
- [7] Kok, H., Voskuil, M., and van Tooren, M., "Distributed propulsion featuring boundary layer ingestion engines for the blended wing body subsonic transport," *51st AIAA/ASME/ASCE/AHS/ASC Structures, Structural Dynamics, and Materials Conference 18th AIAA/ASME/AHS Adaptive Structures Conference 12th*, 2010, p. 3064.
- [8] Greenwell, D., "A review of unsteady aerodynamic modelling for flight dynamics of manoeuvrable aircraft," *AIAA Atmospheric Flight Mechanics Conference and Exhibit*, 2004, p. 5276.
- [9] Ghoreyshi, M., Badcock, K. J., Ronch, A. D., Marques, S., Swift, A., and Ames, N., "Framework for establishing limits of tabular aerodynamic models for flight dynamics analysis," *Journal of Aircraft*, Vol. 48, No. 1, 2011, pp. 42–55.
- [10] Jouannet, C., and Krus, P., "Lift coefficient predictions for delta wing under pitching motions," *32nd AIAA Fluid Dynamics Conference and Exhibit*, 2002, p. 2969.
- [11] Raju Kulkarni, A., La Rocca, G., and Veldhuis, L., "Degree of similitude estimation for sub-scale ight testing," AIAA, San Diego, USA, 2019.
- [12] Vahora, M., Ananda, G. K., and Selig, M. S., "Design Methodology for Aerodynamically Scaling of a General Aviation Aircraft Airfoil," *2018 AIAA Aerospace Sciences Meeting*, 2018, p. 1277.
- [13] Chambers, J., *Modeling Flight NASA Latest Version: The role of dynamically scale Free Flight Models in support of NASA aerospace programs.*, Vol. 3, Joseph Chambers, 2015.
- [14] Nathman, J. K., *VSAERO User's manual*, Vol. 6.1, Remond Washington, 1999.
- [15] Varriale, C., Hameeteman, K., Voskuil, M., and Veldhuis, L., "A Thrust-Elevator Interaction Criterion for Aircraft Optimal Longitudinal Control," AIAA, Dallas, 2019.

- [16] Pfeiffer, T., Nagel, B., Böhnke, D., Rizzi, A., and Voskuijl, M., "Implementation of a heterogeneous, variable-fidelity framework for flight mechanics analysis in preliminary aircraft design," *60th German Aerospace Congress (DLRK)*, 2011.
- [17] Tian, F., and Voskuijl, M., "Automated generation of multiphysics simulation models to support multidisciplinary design optimization," *Advanced Engineering Informatics*, Vol. 29, No. 4, 2015, pp. 1110–1125.
- [18] Voskuijl, M., La Rocca, G., and Dircken, F., "Controllability of blended wing body aircraft," *Proceedings of the 26th International Congress of the Aeronautical Sciences, ICAS 2008, including the 8th AIAA Aviation Technology, Integration and Operations (AIO) Conference, Anchorage, Alaska, September 14-19,(2008)*, Optimage Ltd., 2008.
- [19] Voskuijl, M., de Klerk, J., and van Ginneken, D., "Flight mechanics modeling of the PrandtlPlane for conceptual and preliminary design," *Variational analysis and aerospace engineering: Mathematical challenges for aerospace design*, Springer, 2012, pp. 435–462.
- [20] van Ginneken, D., Voskuijl, M., van Tooren, M., and Frediani, A., "Automated control surface design and sizing for the prandtl plane," *51st AIAA/ASME/ASCE/AHS/ASC Structures, Structural Dynamics, and Materials Conference 18th AIAA/ASME/AHS Adaptive Structures Conference 12th*, 2010, p. 3060.
- [21] Wu, P., Voskuijl, M., and Veldhuis, L. L. M., "An approach to estimate aircraft touchdown attitudes and control inputs," *Aerospace Science and Technology*, Vol. 71, 2017, pp. 201–213.
- [22] Wu, P., Voskuijl, M., Van Tooren, M. J. L., and Veldhuis, L. L. M., "Take-off and landing using ground-based power-simulation of critical landing load cases using multibody dynamics," *Journal of Aerospace Engineering*, Vol. 29, No. 3, 2015, p. 04015070.
- [23] Cooper, G. E., and Harper Jr., R. P., "The Use of Pilot Rating in the Evaluation of Aircraft Handling Qualities," Tech. Rep. NASA TN D-5153, NASA, Washington D. C., 1969.
- [24] La Rocca, G., and Van Tooren, M. J. L., "Enabling distributed multi-disciplinary design of complex products: a knowledge based engineering approach," *Journal of Design Research*, Vol. 5, No. 3, 2007, pp. 333–352.
- [25] La Rocca, G., "Knowledge based engineering: Between AI and CAD. Review of a language based technology to support engineering design." *Advanced Engineering Informatics*, Vol. 26(2), 2012, pp. 159–179.
- [26] Wolowicz, C. H., Brown Jr, J. S., and Gilbert, W. P., "Similitude requirements and scaling relationships as applied to model testing," 1979.