

3D Printing Wood for Custom-design Window Frames

Aut, Serdar; Alberts Coelho, A.; Turrin, M.; Knaack, U.

Publication date

2024

Document Version

Final published version

Published in

AM Perspectives

Citation (APA)

Aut, S., Alberts Coelho, A., Turrin, M., & Knaack, U. (2024). 3D Printing Wood for Custom-design Window Frames. In P. L. Rosendahl, B. Figueiredo, M. Turrin, U. Knaack, & P. J. S. Cruz (Eds.), *AM Perspectives: Research in additive manufacturing for architecture and construction* (pp. 139-148). SOAP | Stichting OpenAccess Platforms.

Important note

To cite this publication, please use the final published version (if applicable).
Please check the document version above.

Copyright

Other than for strictly personal use, it is not permitted to download, forward or distribute the text or part of it, without the consent of the author(s) and/or copyright holder(s), unless the work is under an open content license such as Creative Commons.

Takedown policy

Please contact us and provide details if you believe this document breaches copyrights.
We will remove access to the work immediately and investigate your claim.

AM

1

Perspectives

Editors

Philipp L. Rosendahl

Bruno Figueiredo

Michela Turrin

Ulrich Knaack

Paulo J. S. Cruz



AM Perspectives
Research in additive manufacturing
for architecture and construction

AM Perspectives results from a collaboration between the Landscapes, Heritage and Territory Laboratory, University of Minho (Lab2PT); Architecture, Construction and Technology Hub, University of Minho (ACTech Hub); Institute of Structural Mechanics + Design, TU Darmstadt (ISM+D); the Generative Design Lab, TU Darmstadt (GDL); Faculty of Architecture and the Built Environment, TU Delft; Stichting OpenAccess Platforms (SOAP).

Editors

Philipp L. Rosendahl
Bruno Figueiredo
Michela Turrin
Ulrich Knaack
Paulo J. S. Cruz

Design and layout

Joana Lourencinho Carneiro

Publishers

Lab2PT – Landscapes, Heritage and Territory Laboratory,
University of Minho, Guimarães.
ISM+D – Institute of Structural Mechanics + Design,
TU Darmstadt, Darmstadt.
SOAP – Stichting OpenAccess Platforms, Rotterdam.

© 2024, by Editors, authors and Lab2PT, ISM+D and SOAP.

AM Perspectives is published under a CC-BY-4.0 licence.

You are free to:

Share – copy and redistribute the material in any medium or format for any purpose, even commercially. Adapt – remix, transform, and build upon the material for any purpose, even commercially. The licensor cannot revoke these freedoms as long as you follow the license terms.

Under the following terms:

Attribution – You must give appropriate credit, provide a link to the license, and indicate if changes were made. You may do so in any reasonable manner, but not in any way that suggests the licensor endorses you or your use.
No additional restrictions – You may not apply legal terms or technological measures that legally restrict others from doing anything the license permits.

For general questions, please contact SOAP | Stichting OpenAccess directly at admin@openaccess.ac or visit www.openaccess.ac for further information.

ISBN/EAN 978-90-833861-8-8
e-ISBN 978-989-8963-91-8
DOI 10.47982/a82n7r50

Financial support

AM Perspectives has been made possible by financial support of the Multiannual Funding of the Landscape, Heritage and Territory Laboratory (Lab2PT), Ref. UID/04509/2020, financed by national funds (PIDDAC) through the FCT/MCTES.

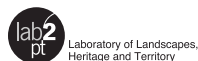

SOAP | Stichting OpenAccess Platforms



3D PRINTING WOOD FOR CUSTOM-DESIGN WINDOW FRAMES

Christopher Bierach

Serdar Aşut

Alexsander Alberts Coelho

Michela Turrin

Ulrich Knaack

Given the urgent sustainability goals, the construction industry is actively seeking renewable and recyclable biobased materials. In this research, cellulose and lignin, the most abundant biopolymers on earth, were studied as fundamental building blocks to create an innovative bio-based material to 3D print elements for the construction industry. Having obtained a 3D printable paste, the study presented in this paper delved into the 3D printing possibilities by using a clay extruder mounted on a robotic arm. A window frame was used as test case, addressing the existing gap in replacing or enhancing current window frames. To better understand the printing process and explore various geometric configurations, a section of a window frame was printed as proof of the concept.

Given the expected population growth to 10 billion by 2050 according to the United Nations [2], alongside the pressing issues of global warming and resource depletion, it's crucial for the built environment to act promptly. This sector is a significant source of human-made greenhouse gas emissions, as highlighted by Pablo Van der Lugt [3]. Buildings globally consume 30% of energy [2] and produce 27% of CO2 emissions, including those from materials like concrete, steel, and aluminum. These materials also contribute to 4% of energy use and 6% of emissions. Overall, the building sector is accountable for a significant 37% of global energy consumption and process-related emissions [4]. To reach global zero net carbon emissions by 2050, utilizing low-car-

bon materials like wood, including hardwood, softwood, and bamboo, is a viable option [3]. These natural materials are anticipated to remain abundant in the next century.

Nevertheless, there are benefits and drawbacks to utilizing wood. Trees take a long time to grow, and wood production generates waste and CO2 emissions from processing and transportation. While wood is valuable, it strains wood resources and forests [5]the current waste wood and paper recycling practices (S1. Timber harvesting requires careful management to avoid overexploitation [6] and Russia boasts the largest forested area in the world. Economic development entails various challenges for the environment, including a lack of forestry legislation or

compliance, poor governance and unrestrained privatisation. This study investigates the role of institutional quality in explaining deforestation using panel-time series data for 75 Russian regions from 2009 to 2019. We apply a one-way autoregressive fixed-effect model with Driscoll-Kraay standard errors due to spatial dependence and time lags across Russian regions. The findings affirm the hypothesis of the environmental Kuznets curve for deforestation, implying that after surpassing a threshold point of gross regional product per capita, deforestation decreases. Poor institutional quality significantly increases the deforestation rate, which remains robust when considering the timber harvesting volume. The results affirm our proposition that the Russian forestry preservation policy is somewhat effective in reducing the deforestation rate. The empirical findings reinforce the importance of improving institutional quality for preserving forest areas toward carbon sequestration and overall Sustainable Development Goal agendas.”,“container-title”:“Forest Policy and Economics”,“DOI”:“10.1016/j.forpol.2023.102949”,“ISSN”:“1389-9341”,“journalAbbreviation”:“Forest Policy and Economics”,“page”:“102949”,“source”:“ScienceDirect”,“title”:“Economic growth, institutional quality and deforestation: Evidence from Russia”,“title-short”:“Economic growth, institutional quality and deforestation”,“volume”:“150”,“author”:“{{“family”:“Sohag”,“given”:“Kazi”},{{“family”:“Gainetdinova”,“given”:“Anna”},{{“family”:“Mariev”,“given”:“Oleg”}}”,“issued”:“{{“date-parts”:“[[“2023”,5,1]]}”}”,“schema”:“https://github.com/citation-style-language/schema/raw/master/csl-citation.json”} . Thus, the construction industry needs alternative bioresources alongside wood. This research paper explores a new wood-like biocomposite using cellulose and lignin from local biomass waste streams through 3D printing, suitable for the building industry.

Cellulose and lignin are the most abundant natural biopolymers on earth, with cellulose known for its mechanical strength and reinforcement potential included in the 3D printing [7] including 4D (responsive/smart [8]). Lignin, the second most abundant natural material globally [9], holds potential for novel materials [10]. Together, cellulose and lignin mimic timber’s characteristics without relying on trees. 3D printing can allow adjustable mechanical properties and complex structures, offering a renewable, recyclable biocomposite from local biomass for the building industry. Within this overarching research line, that focuses on 3D printed window frames, whether to refurbish existing frames or fabricate new ones for complex buildings. The research follows a bottom-up approach, from developing a biocomposite through blending powder-base cellulose and lignin, to reassembling its structure into a window frame through 3D printing. After conducting tests and experiments with the materials and processes, the results inform and guide the window frame’s design, considering the limitations and advantages of 3D printing with wood waste.

MATERIAL AND PRINTING PROCESS

Various combinations of cellulose and lignin in different proportions with different binders were studied for use in 3D printing. Among the binders, Methylcellulose outstand in delivering the most promising properties when combined with lignin and cellulose [11]. It formed a consistent paste, exhibiting the adhesion and viscosity needed for cold paste extrusion 3D printing (Figure 1).

With the resulting paste, various 3D printing tests were performed at LAMA (Laboratory for Additive Manufacturing in Architecture), at the TU Delft Architectural Engineering and Technology Department. An LDM WASP extruder XL 3.0 [12] was custom-built to be mounted onto a UR5. To evaluate the potentials and limitations of the cold extrusion 3D printing process multiple factors were considered when designing a set of experiments and tests. Various geometric shapes, including overhangs, overlapping layers, infills, and different forms, were modelled using Rhinoceros (McNeel). Additionally, ‘Robots’ a Grasshopper plug-in was employed to program and simulate the robotic arm [13]. Separately, a slicing software was used to control the rotation of the extruder. The desired shapes were printed using a pressurized system for material extrusion, with a nozzle diameter of 4 mm, a pressure of 2 bar, and a print speed of 2000 mm/s (Figure 2).

First, printing straight and curved elements at a specific height was investigated, while progressively tuning printing parameters and paste formulation. The challenges of printing extruded polygons such as squares, and diamonds were analyzed, including based on their tendency to buckle and eventually collapse during printing. Extruding the paste with 4 mm wide nuzzles at 2000 mm/s allowed producing elements up to 30 mm high, where the structural stability of models with a circular boundary was higher, as expected (examples in Figure 3).

Structural stability during printing increased also based on the design of the infill. Wider layers and reduced layer heights improved stability but obviously came at the cost of increased weight, reduced corner resolution, and a tendency for straight walls to buckle and collapse (Figure 4).

Additionally, studying the overlapping of a single tool-path to connect all its edges enhanced stability. The geometry was contoured at a 3 mm height with a 1 mm overlapping between edges (Figure 5).

Lastly, overhangs were tested to allow more geometrical freedom for the desired printed shape but failed at a 20-degree angle. Despite these failures, a custom infill design was made to provide adequate support without adding extra load on the inclined walls (Figure 6).

These preliminary tests proceeded in parallel with initial mechanical characterization of the 3D printed material, part of which is published in [11], and served to address the research on material development and 3D printing, which



Figure 1: Preliminary studies on extrusion of Methylcellulose with lignin and cellulose using a syringe.

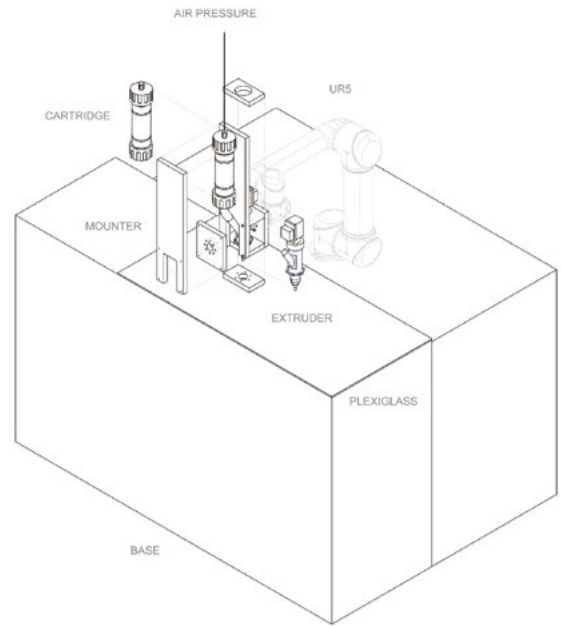

Figure 2: Printing setup with customized tool.



Figure 3: Preliminary geometry testing.



Figure 4: Toolpath testing.



Figure 5: Infill testing.



Figure 6: Overhand testing.

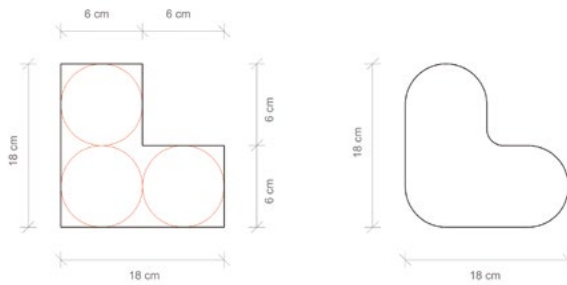

Figure 7: Plan view of straight vs curved edges.

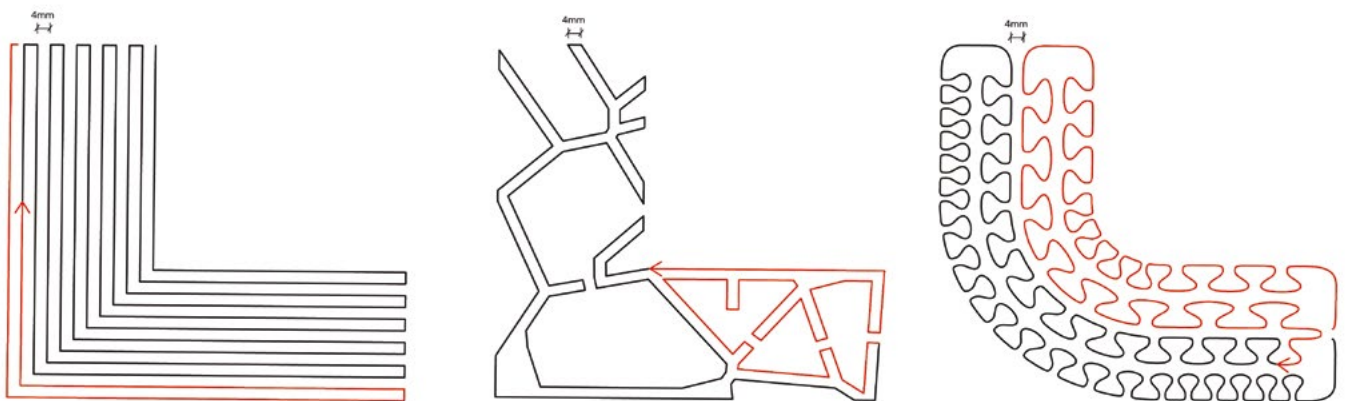

Figure 8: Toolpath restriction [drawing made by author].

proceeded based on iterative loops of testing and reformulating the material and process. They served also to indicate the preliminary boundaries of a design grammar, then used in a design exercise, for which the 3D printing logic was key. Along with the advantages of 3D printing in terms of geometric freedom, the considerations on the better stability of curved structures compared to deformations of straight walls; on the limits of overhang angles; on the shape proportions to facilitate shape stability during printing; on the importance of infills' design to prevent overloading inclined surfaces; and on similar aspects tuned to the specificities of the new material were considered.

DESIGN CONTEXT

The design exercise is contextualized in a broader vision. The overall context regards the potentials for (i) refurbishment of wooden window frames, and (ii) new window frames for 3DP buildings.

The issue of decaying wooden window frames due to water exposure and other aging factors is a prevalent concern in building maintenance and renovation. When focusing on automation, renovating a decaying wooden window frame with 3DP presents several compelling advantages. Firstly, it can allow preserving the window's original aesthetics with precise replication of intricate details. Additionally, 3D printing offers customization to fit specific dimensions and design preferences, which can ensure a perfect fit as mass-produced frames fail to address individual needs. Moreover, it promotes sustainability and minimizes waste as it can preserve the original frame while only replacing the deteriorated sections. Utilizing 3D printed customized elements with wood can provide effective solutions for the existing building stock, heritage projects and building renovations, where custom solutions are beneficial.

3D printing offers potentials also for new windows frames, for example when including complex geometries or when interfacing complex geometries. This latter occurs for example in 3D printed buildings [14], which currently make use of conventional and standard components. Applying conventional components on 3D printed (concrete) structures sometimes implies a misalignment in architectural language and a technically challenging interface with the surface texture of 3D printed walls [15]. These issues encompass design compatibility, structural integration, waterproofing, insulation, and aesthetics. The intricate, often curved designs of 3D printed walls may not align seamlessly with traditional flat window frames, where a poor connection potentially causes leaks and reduced insulation. A reason for this is that typical elements such as window frames are fabricated via traditional manufacturing processes that lack the advanced construction technology necessary for

producing complex shapes at competitive costs. The tectonics of 3D printed structures invites rethinking traditional components, creating innovative design options for windows and openings too [16]. As 3D printed walls are being increasingly investigated, exploring options to incorporate components like 3D printed window frames can open beneficial avenues.

With this context in mind, the design exercise regarded 3D printed wood in building construction with focus on window frames.

DESIGN EXPLORATION: LIMITATIONS & ADVANTAGES

The design exercise experimented on a corner part of a window frame, which was designed and fabricated as a proof of concept for the "3D printing wood" process. The first aspect that required reconsideration was the boundary shape of the frame. Reflecting on our earlier tests involving various geometric shapes, it became evident that using straight lines would increase the challenges, for which the use of curved shapes was maximized, in the attempt to distribute stresses evenly during printing and maintaining a consistent material flow. Figure 7 shows an example of the design logic.

As the design exercise was conducted in a preliminary stage of the material development, when exceeding 4 cm in height could have easily resulted in buckling and collapse during printing, the overall height of the printed structure was set to a max of 4 cm per piece. Taller objects were designed by considering the assembling of multiple sections, by first splitting the complete piece into smaller segments later integrated to form a unified whole. At this stage of the material development, another challenge related to the shape fidelity, with the difficulty to predict the deformations during printing, for example due to shrinkage when drying. While research on morphological characterization of the 3D printed material is needed, this preliminary exercise coped with it in an empiric manner. The exercise dealt also with the weight of the overall structure, aiming to minimize the use of material. While in a more advanced phase of the research (when material properties are characterised) computational (topology) optimization opens clear avenues, at this stage the exercise considered general geometric features with focus on printability of elements with inner cavities. The main objective was to create a single and continuous toolpath that could be printed without interruptions. The designed geometry should provide the necessary support for the overall structure, necessitating the path to overlap with itself. A preliminary study was conducted, comparing straight, curved, and Voronoi shapes (Figure 8). The path including most curved elements resulted prefer-

able not only for stability during printing but also to facilitate the inclusion of other printed elements toward minimization of assembling and of use of e.g. adhesives. Consequently, the final toolpath for the cavities was designed by maximizing the use of curved elements.

While the exercise did not aim to technically address the inclusion of sealing gaskets and other needed features, yet it intended to speculate on future approaches for their integration. In this light, it was important to account for the sill, frame, sash, gasket, and glass in the design and printing process (Figure.9). When utilizing a 3D printing approach to wood construction, integrating crucial features that a window frame necessitates, like a sealing gasket, calls for a thoughtful approach to implementing for example locking mechanism using a suitable infill pattern. The frame and sill could potentially be combined into a single printed element. The sash could be excluded since the gasket could be directly integrated into the curved infill of the frame. In this scenario, the single frame and sill would be printed as one piece, and a separate material, semi-flexible, would be employed to print the gasket. At this preliminary stage, this line of thoughts allowed for easy insertion and locking of the gasket into the frame. The glass sheet would then be carefully fitted and held in place by the gasket. Given that window frames required precision between elements and typically had a standard size, considering the nozzle diameter was important. Hence, a 4 mm nozzle was utilized to ensure a higher definition and an accurate model.

PROOF OF CONCEPT

After studying the parameters for 3D printing with methylcellulose in combination with lignin and cellulose, encountered challenges and potentials became the central driving force to design and fabricate the window frame as a proof of concept (Figure.10). Another limitation is regarding the maximum payload of the robotic arm, which was 5 kg. Consequently, with the custom-built holder weighing 4 kg, there was a small margin of 800 g of material to be used in one single print. Therefore, the design exercise considered these limitations to understand the possibilities of printing a 180x180x100 mm object. Thus, four different parts were printed and later combined. One printed section for one full cartridge would take 40 min to print 21 m of material. After 7 days, the four separate elements were dry and had shrunk by approximately 10 to 15 percent. As expected, the shrinkage of the material challenged the assembling for large objects, resulting in misalignments between the previous and ongoing printed layers, yet offered a test case to better understand the material behaviour. Lastly, it was observed that the printed infill was too dense, affecting the drying time of the pieces as air could not flow easily inside

the cavities. Nevertheless, the curved infill system demonstrated the feasibility of connecting and receiving other components, such as a gasket, without the need for additional sealants or adhesives.

DESIGN VISION

As the material development proceeds, this design exercise showcased the potential for 3D printing a window frame – for example to replace specific components of a wooden window frame (Figure 11).

Considering the broader context of 3D printed a single window frame, two distinct scenarios are noted, on-site printing and off-site printing. Printing in a facility offered the advantage of a controlled environment, simplifying the printing process. The frame could be easily integrated into the house, either during or after the printing phase, providing better control over material shrinkage, geometrical complexity, and finishing. However, the challenge lay in maintaining the overall quality of the frame while avoiding staggered parts. The integral printing of the frame was pivotal in achieving a satisfactory result. The printed parts, initially done on a flat surface, would later be flipped to a ninety-degree angle for integration into a wall (Figure 12, Figure 14).

This orientation could introduce thermal bridges due to the exposed cavities. Solutions may include filling the cavities with additional material or 3D-printed gaskets, although the airtightness of the printed layers might remain a challenge. On the other hand, printing frames on-site (Figure.13, Figure.15) allowed greater flexibility for 3D printed habitats.

An enhanced recipe, enhancing printability capabilities, could potentially enable printing at greater heights and varied inclinations. In an ideal scenario, the wooden frame would serve as scaffolding for the wall, allowing synchronized printing with two distinct materials. On-site printing permitted staggered printing between both materials, ensuring a perfect fit between components in a wet state (Figure. 16).

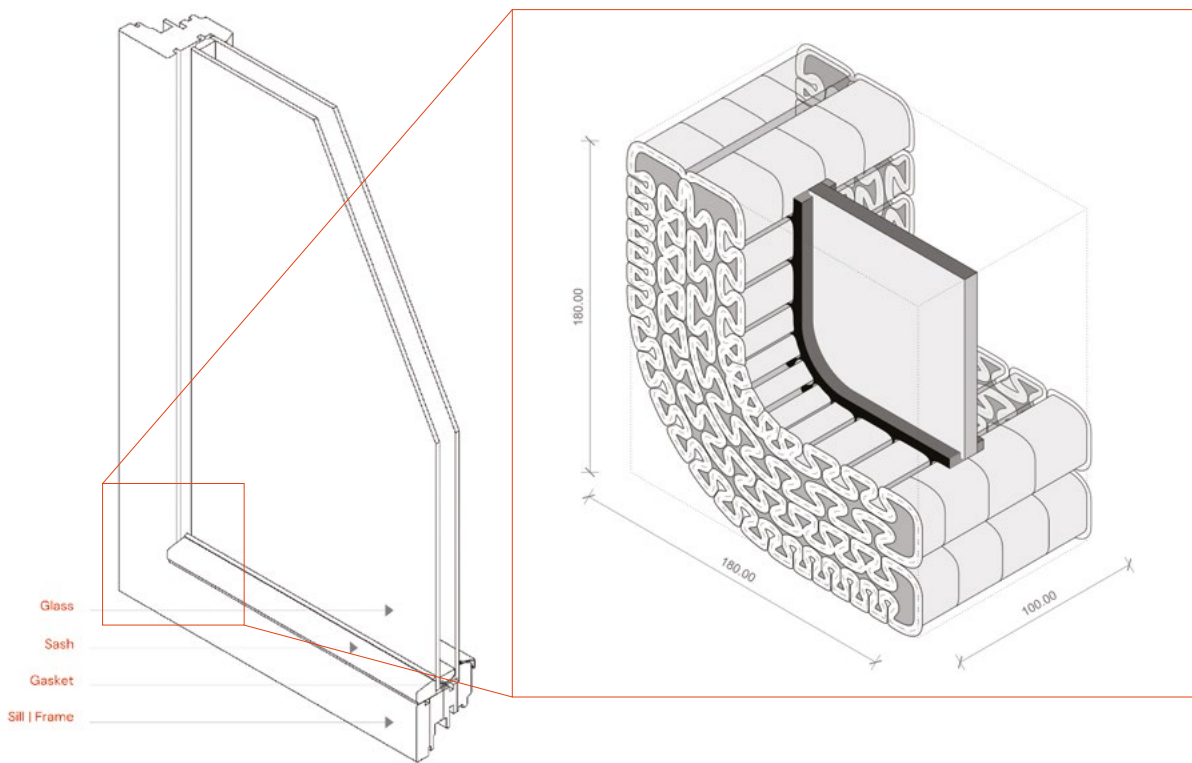

Figure 9: Axonometric view of typical wooden window frame vs 3DP optimized corner of a window frame.



Figure 10: Final 3D-printed window frame.

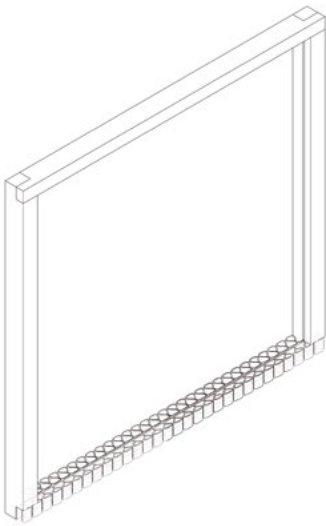

Figure 11: Replace part of the existing window frame with 3DP wood.



Figure 12: 3D printing a window frame horizontally in the factory.



Figure 13: Construction process when placing dried frame to wet printed wall.

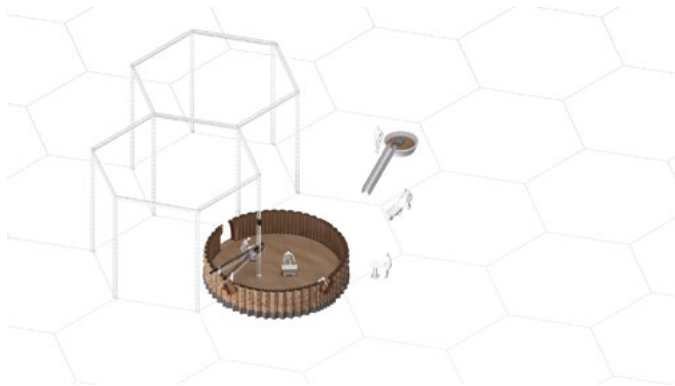

Figure 14: Vertical 3D-printed window frame printed on-site.



Figure 15: Construction process, printing wooden window frame and 3DP wall simultaneously.

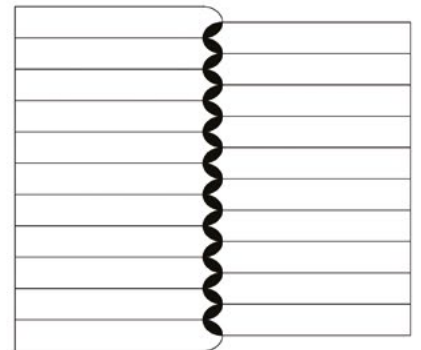
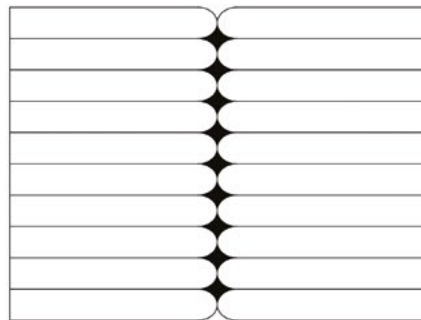
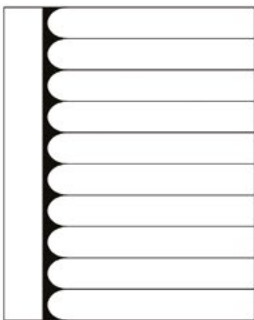

Figure 16: Diagram to describe the connection between flat and 3D-printed elements to 3DP elements when printed separately, and 3D-printed elements when printed together.

CONCLUSION

The objective of this research was to develop an application as a proof of concept towards using wood-like natural material sourced from recycled materials, customized for 3D printing. This includes preserving existing constructions through non-destructive techniques and employing low-carbon construction methods utilizing natural materials that can be recycled into building components. The main outcome of the material research was a fully bio-based composite using a natural binding agent—methylcellulose—mixed with cellulose and lignin, resulting in a smooth and well-structured paste with viscosity and adherence suitable for 3D printing.

During the printing phase, it was observed that the challenges lay in balancing material behaviour with printability. Design decisions and extrusion parameters played a significant role in addressing these challenges. Curvilinear structures were more stable compared to straight walls, which tended to buckle. Overhang angles were limited, and heavy geometries tended to collapse. Infills needed careful design to avoid overloading inclined surfaces.

These challenges influenced the design and fabrication of a 3D-printed window frame, showcasing the potential for replacing or customizing window frames in 3D-printed buildings. The printed frame was exhibited at the Built Environment Additive Manufacturing (BE-AM) symposium of 2022 [17]. The technology and material are envisioned to be used to replace or create customized window frames. However, it's important to note that the material is still in development, also toward improvements of its structural properties, needed for applications demanding higher strength and stiffness.

Although promising proof of concepts were created, further research and refinement of the material properties are necessary. If the current composite is improved to enhance printability, it could enable printing at different inclinations and offer customization. On-site printing is another potential application, enabling staggered printing with different 3D-printed materials for a perfect fit between components. However, it requires investigation into various printing orientations for 3D printed window frames and their implications on load-bearing capacities. These considerations set the stage for future research into optimal integration scenarios and effective treatment of 3D printed window frames for the building industry.

ACKNOWLEDGMENT

The “Wood Without Trees” research initiative is an ongoing research line involving the Digital Technologies Section and the Architectural Technology Section of the Architectural Engineering & Technology department at the TU Delft Faculty of Architecture and the Built Environment. The article is based on the master's thesis of the alumni Christopher Bierach and alumni Alexsander Alberts Coelho, supervised by the co-authors. D. Richard Gosselink, the Coordinator of Wageningen UR Lignin Platform, provided valuable guidance and support in sourcing lignin and cellulose materials. The authors appreciate the equipment provided by ir. Paul De Ruiter for 3D printing at LAMA, the TU Delft Laboratory for Additive Manufacturing in Architecture.

REFERENCES

- [1] "Architectural Engineering and Technology." Accessed: Oct. 10, 2023. [Online]. Available: <https://www.tudelft.nl/bk/over-faculteit/afdelingen/architectural-engineering-and-technology>
- [2] "2022 Global Status Report for Buildings and Construction | UNEP - UN Environment Programme." Accessed: Oct. 02, 2023. [Online]. Available: <https://www.unep.org/resources/publication/2022-global-status-report-buildings-and-construction>
- [3] Pablo Van der Lugt, *Tomorrow's Timber*. Material District, 2020.
- [4] "IEA - International Energy Agency - IEA." Accessed: Oct. 02, 2023. [Online]. Available: <https://www.iea.org/reports/tracking-buildings-2021>
- [5] A. L. Bais, R. Sikkema, M. Vis, P. Reumerman, M. Theurl, and K. Erb, "Assessing wood use efficiency and greenhouse gas emissions of wood product cascading in the European Union," JRC Publications Repository. Accessed: Oct. 02, 2023. [Online]. Available: <https://publications.jrc.ec.europa.eu/repository/handle/JRC103048>
- [6] K. Sohag, A. Gainetdinova, and O. Mariev, "Economic growth, institutional quality and deforestation: Evidence from Russia," *Forest Policy and Economics*, vol. 150, p. 102949, May 2023, doi: 10.1016/j.forpol.2023.102949.
- [7] C. Gauss, K. L. Pickering, and L. P. Muthe, "The use of cellulose in bio-derived formulations for 3D/4D printing: A review," *Composites Part C: Open Access*, vol. 4, p. 100113, Mar. 2021, doi: 10.1016/j.jcomc.2021.100113.
- [8] J. Yang *et al.*, "Cellulose, hemicellulose, lignin, and their derivatives as multi-components of bio-based feedstocks for 3D printing," *Carbohydrate Polymers*, vol. 250, p. 116881, Dec. 2020, doi: 10.1016/j.carbpol.2020.116881.
- [9] D. S. Bajwa, G. Pourhashem, A. H. Ullah, and S. G. Bajwa, "A concise review of current lignin production, applications, products and their environmental impact," *Industrial Crops and Products*, vol. 139, p. 111526, Nov. 2019, doi: 10.1016/j.indcrop.2019.111526.
- [10] S. Bertella and J. S. Luterbacher, "Lignin Functionalization for the Production of Novel Materials," *Trends in Chemistry*, vol. 2, no. 5, pp. 440-453, May 2020, doi: 10.1016/j.trechm.2020.03.001.
- [11] C. Bierach, A. A. Coelho, M. Turrin, S. Asut, and U. Knaack, "Wood-based 3D printing: potential and limitation to 3D print building elements with cellulose & lignin," *Archit. Struct. Constr.*, vol. 3, no. 2, pp. 157-170, Jun. 2023, doi: 10.1007/s44150-023-00088-7.
- [12] "Extruder for ceramics - LDM WASP Extruder XL 3.0," Shop | WASP | 3D printer sales. Accessed: Oct. 08, 2023. [Online]. Available: <https://www.3dwasp.shop/en/prodotto/extruder-for-ceramics-ldm-wasp-extruder-xl/>
- [13] "Home," GitHub. Accessed: Oct. 08, 2023. [Online]. Available: <https://github.com/visose/Robots/wiki/Home>
- [14] "First resident of 3D-printed concrete house in Eindhoven receives key." Accessed: Oct. 02, 2023. [Online]. Available: <https://www.witteveenbos.com/news/first-resident-of-3d-printed-concrete-house-in-eindhoven-receives-key/>
- [15] "Qatar // Expo 2022 Floriade – Expo Pavilion Group." Accessed: Oct. 02, 2023. [Online]. Available: <https://www.expopaviliongroup.com/dubai-expo-2020-algeria-1>
- [16] "OPENINGS IN 3D PRINTING WITH EARTH," IAAC Blog. Accessed: Oct. 02, 2023. [Online]. Available: <https://www.iaac-blog.com/programs/openings-3d-printing-earth/>
- [17] "Booklet 2022," BE-AM. Accessed: Oct. 08, 2023. [Online]. Available: <https://be-am.de/booklet-2022/>