

## A method to find the 50-year extreme load during production

Bos, Rene; Veldkamp, D.

**DOI**

[10.1088/1742-6596/753/4/042021](https://doi.org/10.1088/1742-6596/753/4/042021)

**Publication date**

2016

**Document Version**

Final published version

**Published in**

Journal of Physics: Conference Series

**Citation (APA)**

Bos, R., & Veldkamp, D. (2016). A method to find the 50-year extreme load during production. *Journal of Physics: Conference Series*, 753, Article 753. <https://doi.org/10.1088/1742-6596/753/4/042021>

**Important note**

To cite this publication, please use the final published version (if applicable).  
Please check the document version above.

**Copyright**

Other than for strictly personal use, it is not permitted to download, forward or distribute the text or part of it, without the consent of the author(s) and/or copyright holder(s), unless the work is under an open content license such as Creative Commons.

**Takedown policy**

Please contact us and provide details if you believe this document breaches copyrights.  
We will remove access to the work immediately and investigate your claim.

## A method to find the 50-year extreme load during production

This content has been downloaded from IOPscience. Please scroll down to see the full text.

2016 J. Phys.: Conf. Ser. 753 042021

(<http://iopscience.iop.org/1742-6596/753/4/042021>)

View [the table of contents for this issue](#), or go to the [journal homepage](#) for more

Download details:

IP Address: 131.180.130.242

This content was downloaded on 03/02/2017 at 14:01

Please note that [terms and conditions apply](#).

You may also be interested in:

[A simple model of suppressing stimulated Brillouin scattering in optical fiber with frequency-modulated laser](#)

Hu Xiao-Yang, Chen Wei, Tu Xiao-Bo et al.

[19-fs pulse generated by supercontinuum compression](#)

Hua-Qiang Zhang, Peng Wang, Wen-Jun Liu et al.

[Fabrication of High-Resolution and High-Aspect-Ratio Patterns on a Stepped Substrate by Using Scanning Probe Lithography with a Multilayer-Resist System](#)

Masayoshi Ishibashi, Nami Sugita, Seiji Heike et al.

[Correlation between electrical, mechanical and chemical properties of fresh and used aircraft engine oils](#)

Juliusz B Gajewski, Marek J Gogowski, Maciej Paszkowski et al.

[Monte Carlo Simulation of InP/InGaAs Heterojunction Bipolar Transistors Considering Quantum Effects through an Effective Potential](#)

Eiichi Sano

# A method to find the 50-year extreme load during production

René Bos<sup>1</sup> and Dick Veldkamp<sup>2</sup>

<sup>1</sup>TU Delft, Aerospace Department, Wind Energy Section, Kluyverweg 1, 2629 HS Delft, The Netherlands; email: [r.bos-1@tudelft.nl](mailto:r.bos-1@tudelft.nl)

<sup>2</sup>Suzlon Energy Ltd. Netherlands Branch, Aero & Loads Dept, Jan Tinbergenstraat 290. 7559 ST Hengelo, The Netherlands; email: [h.f.veldkamp@suzlon.com](mailto:h.f.veldkamp@suzlon.com)

**Abstract.** An important yet difficult task in the design of wind turbines is to assess the extreme load behaviour, most notably finding the 50-year load. Where existing methods often focus on ways to extrapolate from small sample sizes, this paper proposes a different approach. It combines generating constrained gusts in turbulence fields, Delaunay tessellation to assign probabilities and a genetic algorithm to find the desired load in an efficient way. The individual parts of the method are verified and the results are compared to both crude Monte Carlo and importance sampling. We found that using a genetic algorithm is a promising approach to find the 50-year load, with only a small number of load cases ( $\sim 10^3$ ) to be evaluated and requiring no user input but an appropriate fitness function.

## 1. Introduction

The wind turbine standard IEC 61400-1 requires that the 50-year extreme load during production (for example the blade tip deflection) is established [1]. If a reference simulation period of 10 minutes is used, the exceedance probability of the desired load is  $P = 3.8 \times 10^{-7}$ , which means that millions of simulations with different turbulent wind fields are required to find it. It is possible to do this [2][3][4], but because of the cost one normally reverts to simulating  $\sim 1,000$  load cases and extrapolating from those. Various extrapolation schemes have been proposed; but their accuracy remains doubtful because there are insufficient data to support a good distribution fit [5]. Finding the 50-year extreme load is especially problematic during the conceptual design phase or when designing a controller. This is because the uncertainty surrounding this load may easily be larger than what is gained by moving to a new design.

The problem in determining the 50-year load by brute force (e.g. crude Monte Carlo) is that much computational effort is wasted on simulating uninteresting events. By definition extreme loads occur rarely, as they are triggered by freak events (gusts) in the wind field. However this also means that simulating *only those events* should yield the 50-year load. The groundwork for such a procedure was done in the *NewGust* project [6], which resulted in the basic recipe to generate constrained wind fields with embedded rare events. This opened the door to the use of weighted sampling methods where the simulation campaign is concentrated on severe gusts instead of ordinary 10-minute wind fields [7].

However, a problem is that a designer needs to know in advance which events are related to extreme loads. This is straightforward when only the wind speed is involved, but is more complex for 3D wind fields where gust events are described by five or more variables (e.g., wind speed, amplitude, location of peak, etc.) [8]. In order to solve this problem, we propose to derive the extreme load distribution and the 50-year return level using a genetic algorithm. The gusts that are relevant to the 50-year load are found iteratively instead of from a predefined sampling distributions.

In the paper we describe how to generate constrained gusts, and present evidence that the method of constrained gusts produces turbulence fields that would have been found if many random fields had been generated instead. The new extreme finding method with the genetic algorithm is applied to find



the 50-year blade deflection. To test the method’s validity, results are compared to the large set of calculations previously done by NREL [3].

## 2. Approach

### 2.1. Generation of wind fields with embedded gusts

Stochastic wind fields are commonly generated using Fourier series, which yield a 3D matrix of velocities that are superimposed on the mean wind speed profile:

$$\mathbf{u}(\mathbf{x}) = \sum_{\boldsymbol{\kappa}} \mathbf{C}(\boldsymbol{\kappa}) \mathbf{n}(\boldsymbol{\kappa}) e^{i\boldsymbol{\kappa} \cdot \mathbf{x}}, \quad (1)$$

where  $\mathbf{u} = [u, v, w]^T$  is the turbulent velocity vector (i.e., the deviation from the mean),  $\mathbf{x} = [x, y, z]^T$  the position vector,  $\boldsymbol{\kappa} = [\kappa_x, \kappa_y, \kappa_z]^T$  the wave number vector, and  $\mathbf{C}$  a correlation matrix that follows from the Cholesky decomposition of the spectral tensor [9]. Moreover,  $\mathbf{n}$  is a complex white noise vector used to randomise the harmonics. This ensures that each realisation of (1) yields a different, but statistically similar, velocity field.

We are interested in specific gust events that are described by a position vector,  $\mathbf{x}_0 = [x_0, y_0, z_0]^T$ ; an ellipsoidal volume  $V$ , with a length  $U$  and lateral diameter  $\bullet$ , and a velocity amplitude averaged over that volume,  $A$  (see figure 1). A velocity field containing such a gust is described by:

$$\mathbf{u}_c(\mathbf{x}) = \{ \mathbf{u}(\mathbf{x}) \mid \bar{\mathbf{u}}(\mathbf{x}_0) = A, \nabla \bar{\mathbf{u}}(\mathbf{x}_0) = 0 \}, \quad (2)$$

where

$$\bar{\mathbf{u}}(\mathbf{x}_0) = \int \mathbf{u}(\mathbf{x}_0 + \mathbf{r}) g(\mathbf{r}) d\mathbf{r} \quad (3)$$

describes averaging over the ellipsoidal volume:

$$g(\mathbf{r}) = \begin{cases} 1/\text{vol}(V), & \text{for } \mathbf{r} \in V, \\ 0, & \text{for } \mathbf{r} \notin V. \end{cases} \quad (4)$$

The field  $\mathbf{u}_c$  (2) can be obtained from a combination of linear constraints in Fourier space, using a conditional white noise vector  $\mathbf{n}_c$ .

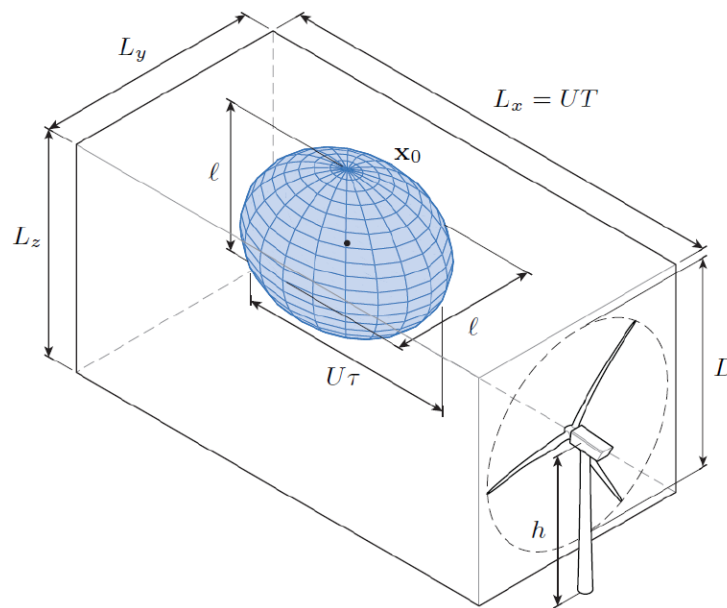

**Figure 1.** Sketch of a gust embedded in a rectangular turbulence field with mean wind speed  $U$ . Its amplitude,  $A$ , is the average wind speed excursion over the ellipsoid, described by a time scale,  $\tau$ , and a lateral length scale,  $\bullet$ .

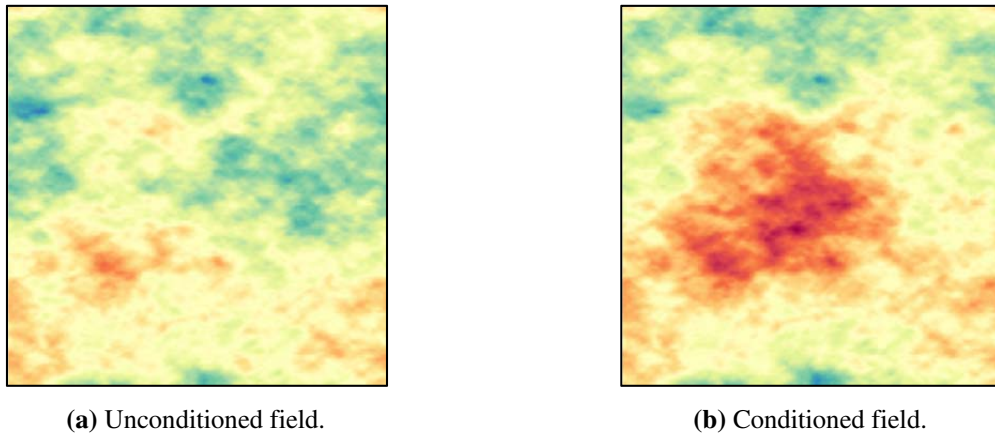

**Figure 2.** Comparison of velocity fields produced from unconditioned vector  $\mathbf{n}$  and conditioned vector  $\mathbf{n}_c$ .

$$\mathbf{n}_c(\boldsymbol{\kappa}) = \{ \mathbf{n}(\boldsymbol{\kappa}) \mid \mathbf{Y}\mathbf{n} = \mathbf{b} \}, \quad (5)$$

where

$$\mathbf{Y} = \begin{bmatrix} \dots, & G(\boldsymbol{\kappa}_j) [C_{uu}(\boldsymbol{\kappa}_j), C_{uv}(\boldsymbol{\kappa}_j), C_{uw}(\boldsymbol{\kappa}_j)], & \dots \\ \dots, & i\boldsymbol{\kappa}_{x,j} G(\boldsymbol{\kappa}_j) [C_{uu}(\boldsymbol{\kappa}_j), C_{uv}(\boldsymbol{\kappa}_j), C_{uw}(\boldsymbol{\kappa}_j)], & \dots \\ \dots, & i\boldsymbol{\kappa}_{y,j} G(\boldsymbol{\kappa}_j) [C_{uu}(\boldsymbol{\kappa}_j), C_{uv}(\boldsymbol{\kappa}_j), C_{uw}(\boldsymbol{\kappa}_j)], & \dots \\ \dots, & i\boldsymbol{\kappa}_{z,j} G(\boldsymbol{\kappa}_j) [C_{uu}(\boldsymbol{\kappa}_j), C_{uv}(\boldsymbol{\kappa}_j), C_{uw}(\boldsymbol{\kappa}_j)], & \dots \end{bmatrix} \quad (6)$$

is a matrix containing the 0<sup>th</sup>- and 1<sup>st</sup>-order derivatives and:

$$\mathbf{b} = [A, 0, 0, 0]^T \quad (7)$$

is a constraint vector specifying the values of those derivatives. The function  $G(\cdot)$  is the Fourier transform of the kernel  $g(\mathbf{r})$ , which in the case of an ellipsoidal volume is given by:

$$G(\boldsymbol{\kappa}) = \frac{3}{\boldsymbol{\kappa}'^3} (\sin(\boldsymbol{\kappa}') - \boldsymbol{\kappa}' \cos \boldsymbol{\kappa}'), \quad (8)$$

With:

$$\boldsymbol{\kappa}' = \frac{1}{2} \sqrt{(\boldsymbol{\kappa}_x U \tau)^2 + (\boldsymbol{\kappa}_y \ell)^2 + (\boldsymbol{\kappa}_z \ell)^2}. \quad (9)$$

Any field obeying the constraints set in (2) can be straightforwardly obtained by conditional sampling:

$$\mathbf{n}_c(\boldsymbol{\kappa}) = \mathbf{n} + \mathbf{Y}^* (\mathbf{Y}\mathbf{Y}^*)^{-1} (\mathbf{b} - \mathbf{Y}\mathbf{n}), \quad (10)$$

where  $\mathbf{Y}^*$  denotes the Hermitian transpose of  $\mathbf{Y}$ . A comparison of the fields resulting from the unconditioned vector,  $\mathbf{n}$ , and the conditioned vector,  $\mathbf{n}_c$ , is shown in Figure 2.

The probability of such gust events occurring in three-dimensional velocity fields cannot be computed directly, but can be closely approximated by the Euler-characteristic heuristic [10][11]. In the case that  $L_x \gg L_y, L_z$ , the probability that a level  $A$  is exceeded somewhere in a domain  $B$  is approximately equal to:

$$P(u(\mathbf{x}) \geq A : \mathbf{x} \in B) \approx L_x L_y L_z \frac{\sqrt{|\Lambda_2|}}{4\pi^2 \Lambda_0^{3/2}} \left( \frac{A^2}{\Lambda_0} - 1 \right) e^{-\frac{A^2}{2\Lambda_0}}, \quad (11)$$

where  $\Lambda_0$  and  $\Lambda_2$  are the 0<sup>th</sup>- and 2<sup>nd</sup>-order spectral moments; i.e.,

$$\Lambda_0 = \int G^2(\boldsymbol{\kappa}) \Phi_{uu}(\boldsymbol{\kappa}) d\boldsymbol{\kappa}, \quad (12)$$

$$\Lambda_2 = \int \boldsymbol{\kappa} \boldsymbol{\kappa}^T G^2(\boldsymbol{\kappa}) \Phi_{uu}(\boldsymbol{\kappa}) d\boldsymbol{\kappa}, \quad (13)$$

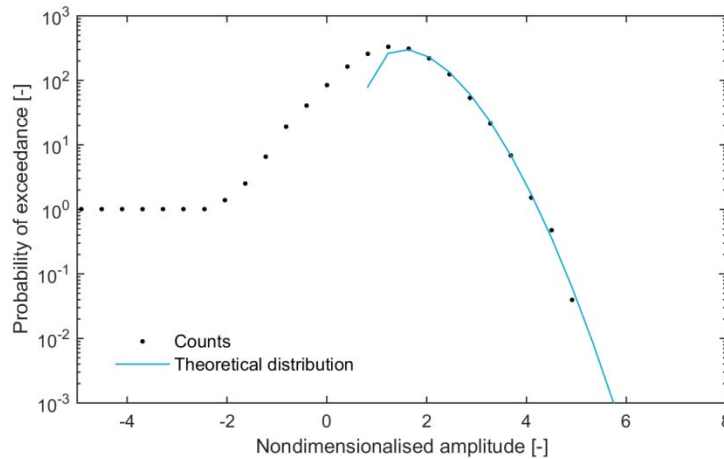

**Figure 3.** Theoretical probability of exceedance for non-dimensionalised amplitudes,  $A / \Lambda_0^{1/2}$ , within a  $600 \text{ s} \times 200 \text{ m} \times 200 \text{ m}$  wind field, adhering to the IEC class 1A normal turbulence model, compared to actual counts.

where  $\xi_{uu}$  is the  $u$ -component of the spectral tensor. To illustrate, Figure 3 shows a comparison of the theoretical probability with gusts in 10-minute velocity fields counted by brute force.

### 2.2. Finding the 50-year deflection by crude Monte Carlo

The straightforward way of finding the 50-year load is by using the *crude Monte Carlo* method:  $N$  10-minute wind fields are generated using the mean wind speed distribution  $f(U)$ , and fed to an aero-elastic code such as Bladed, FAST, or Flex5 (see Figure 4a). The result is a set of 10-minute extreme loads,  $\xi_1, \dots, \xi_N$ , from which the extreme load distribution can be estimated:

$$\hat{F}(L) = \frac{1}{N+1} \sum_{i=1}^N \mathbf{1}(\xi_i \leq L). \tag{14}$$

The 50-year load is found by finding the load  $L$  for which the probability of non-exceedance matches the 50-year level; i.e.,

$$F_{50} = 1 - \frac{1}{50 \cdot 365.25 \cdot 24 \cdot 6} = 1 - 3.8 \cdot 10^{-7}. \tag{15}$$

By drawing samples directly from the parent mean wind speed distribution, the crude Monte Carlo method is the most natural way of determining extreme loads. However, it is also one of the most expensive, with over  $2.6 \times 10^6$  10-minute wind fields being required to reach the 50-year period. This is why one usually tries to obtain the 50-year load by extrapolation, which however brings considerable uncertainty (see [2]).

### 2.3. Finding the 50-year deflection by importance sampling

An improvement over the crude Monte Carlo method is *importance sampling* (see Figure 4b). In that case, samples are being drawn from a sampling distribution,  $w(\mathbf{k})$ , and weighted by the likelihood ratio  $f(\mathbf{k})/w(\mathbf{k})$ :

$$\hat{F}(L) \approx \frac{\sum_{i=1}^N \mathbf{1}(\xi_i \leq L) \frac{f(\mathbf{k}_i)}{w(\mathbf{k}_i)}}{\sum_{i=1}^N \frac{f(\mathbf{k}_i)}{w(\mathbf{k}_i)}}, \tag{16}$$

where  $\mathbf{k}$  represents a point in sample space.

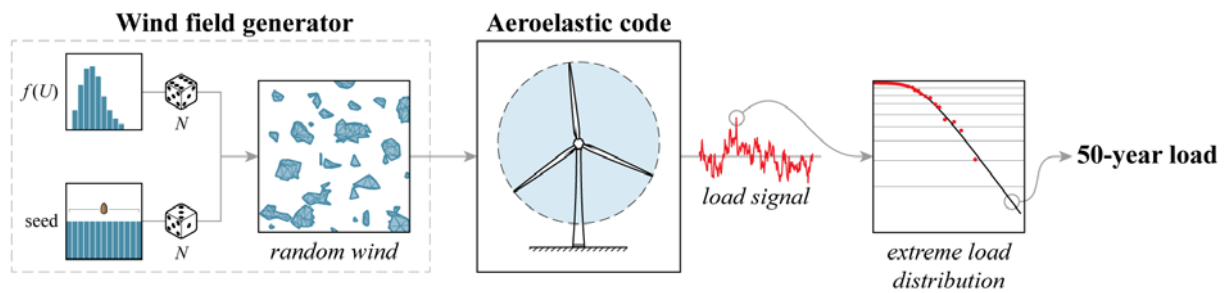

(a) Workflow of a crude Monte Carlo method. Here,  $N$  ten-minute wind fields are fed to an aero-elastic code, producing an extreme load distribution that can be extrapolated to find the 50-year return level.

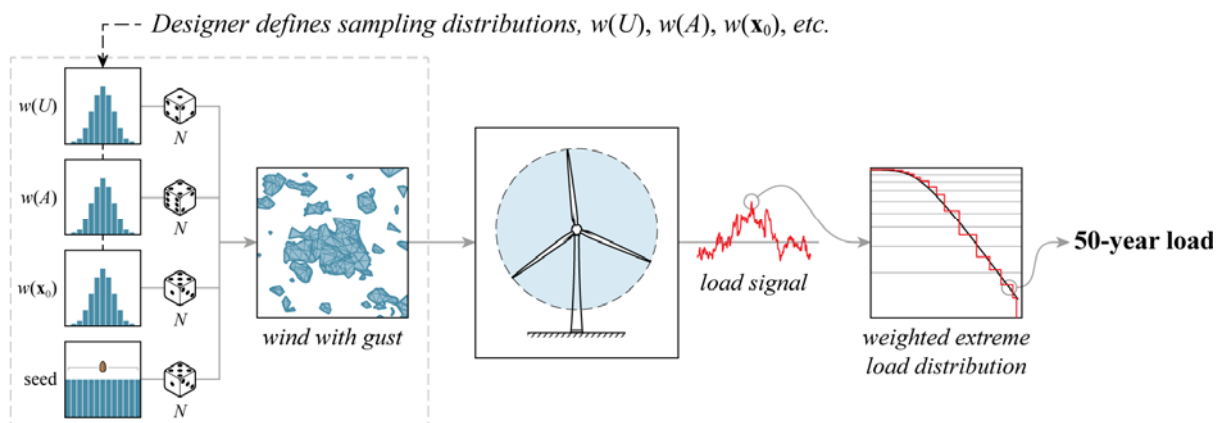

(b) Workflow of a Monte Carlo method with importance sampling. Instead of directly from the probability density function, samples are drawn from sampling distributions,  $w(U)$ ,  $w(A)$ , and  $w(\mathbf{x}_0)$ . The extreme load distribution is then constructed by weighting with the likelihood ratio,  $f(U, A, \mathbf{x}_0)/w(U, A, \mathbf{x}_0)$ .

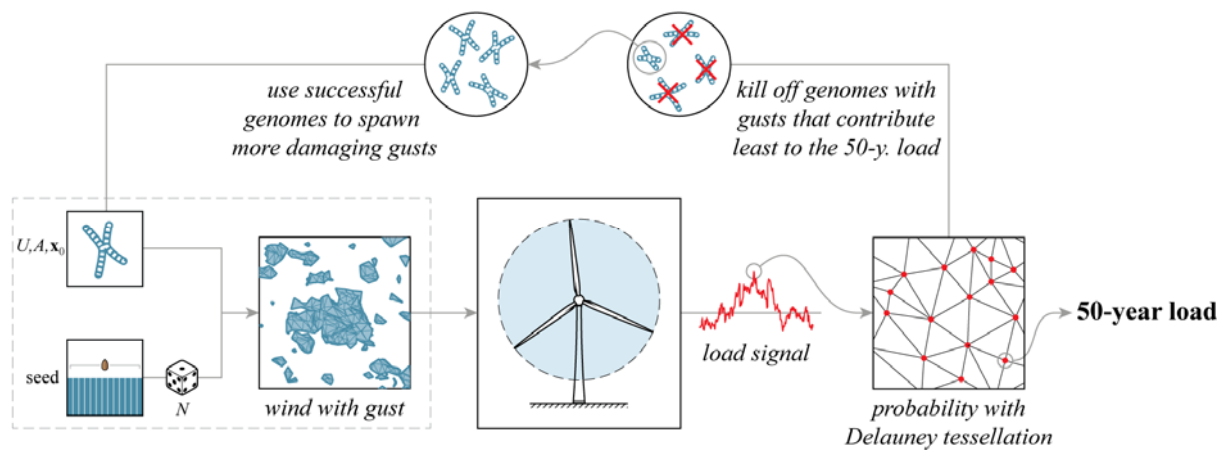

(c) Workflow for sampling with genetic algorithm

**Figure 4.** Three methods for finding the 50-year load.

Importance sampling becomes interesting if the designer knows which parameter value ranges are relevant to the problem. The method explained in Section 2.1 allows the generation of pseudo-random wind fields with gusts that would otherwise occur naturally in 10-minute wind fields. This means that the amplitude and the position of extreme gusts of a certain size can be introduced as stochastic variables:

$$f(A) \approx L_x L_y L_z \frac{A \sqrt{|\Lambda_2|}}{2\pi^2 \Lambda_0^2} \left( \frac{A^2}{\Lambda_0} - 2 \right) e^{-\frac{A^2}{2\Lambda_0}}, \quad (17)$$

$$f(\mathbf{x}_0) = \begin{cases} 1/\text{vol}(B), & \text{for } \mathbf{x}_0 \in B, \\ 0, & \text{for } \mathbf{x}_0 \notin B, \end{cases} \quad (18)$$

where Equation (17) is obtained from differentiating Equation (11). The idea is to find a suitable sampling distribution  $w(U, A, \mathbf{x}_0)$ , to produce gust events comparable to those triggering the 50-year load. If that is the case, the cumulative load distribution (16) equals that of the crude Monte Carlo method (14), irrespective of the length of the time series that includes the gust (this could be much shorter than 10 minutes, as long as the relevant wave number range is captured).

Finding the right sampling distribution means selecting the region of parameter space that is responsible for the extreme loads. This can be a tedious process if the loads follow from weaknesses in the control design. Unexpected control behaviour can trick the designer into concentrating on the wrong part of the parameter space, which removes the advantage of importance sampling and may even lead to more uncertainty than the crude Monte Carlo method. An alternative is to turn the search for the optimal sampling distribution into an optimisation problem and use a *genetic algorithm* to find the gust associated with the 50-year load. This removes most human input and speeds up the process.

#### 2.4. Finding the 50-year load with a genetic algorithm

The procedure with the genetic algorithm has the following steps (see Figure 4c):

- 1) Generate a set of random turbulent wind fields, each containing an embedded gust that is described by  $\mathbf{k} = [U, A, \dots]^T$ .
- 2) For each load case, find the extreme load by aero-elastic simulation.
- 3) Use Delaunay tessellation and integration to assign a probability to each load case.
- 4) Generate new combinations  $\mathbf{k} = [U, A, \dots]^T$  using a genetic algorithm, which uses for example the largest contribution to the blade failure probability as fitness.
- 5) Go to step 2.
- 6) Continue until the 50-year load (and the distribution) is established with sufficient accuracy.

Step 3) requires some more explanation. Because sampling is not according to some fixed scheme (say only on predefined grid points), load cases are spread randomly, and it is not obvious how to find the probability of a particular load case  $\mathbf{k}$ . Nevertheless the probability can be established as follows. Each combination  $\mathbf{k} = [U, A, \dots]^T$  is a point in  $K$ -dimensional sample space. Using these points, space is divided into  $K$ -simplices (e.g., triangles in 2D, tetrahedra in 3D, etc.) by Delaunay tessellation. The probability mass assigned to the  $i$ th load case (point  $\mathbf{k}_i$ ) is the integral of the combined probability density of all simplices of which point  $\mathbf{k}_i$  is a part:

$$f(\mathbf{k}_i) = \frac{1}{K+1} \sum_{s \in \mathbf{k}_i} \int_s f(\mathbf{k}) \, d\mathbf{k} . \quad (16)$$

Of course, in this way, each simplex is counted  $K+1$  times, so to get correct probabilities division by  $K+1$  is needed. Once the individual probabilities are found, load cases may be sorted to establish the cumulative distribution.

### 3. Results

#### 3.1. Importance sampling compared to crude Monte Carlo

The performance of importance sampling and the genetic algorithm is demonstrated by comparing the resulting distribution of extreme tip deflections to 96 years' worth of crude Monte Carlo from Barone *et al.* [3]. The exact same set up was used; the NREL 5 MW reference turbine [13] was simulated in FAST v7 with IEC class I B turbulence generated on a  $20 \times 20$  grid ( $y = z \cdot 7$  m) with a time step of 0.05 s (20 Hz). The first minute of every simulation was used as a spin-up time and was discarded from the results.



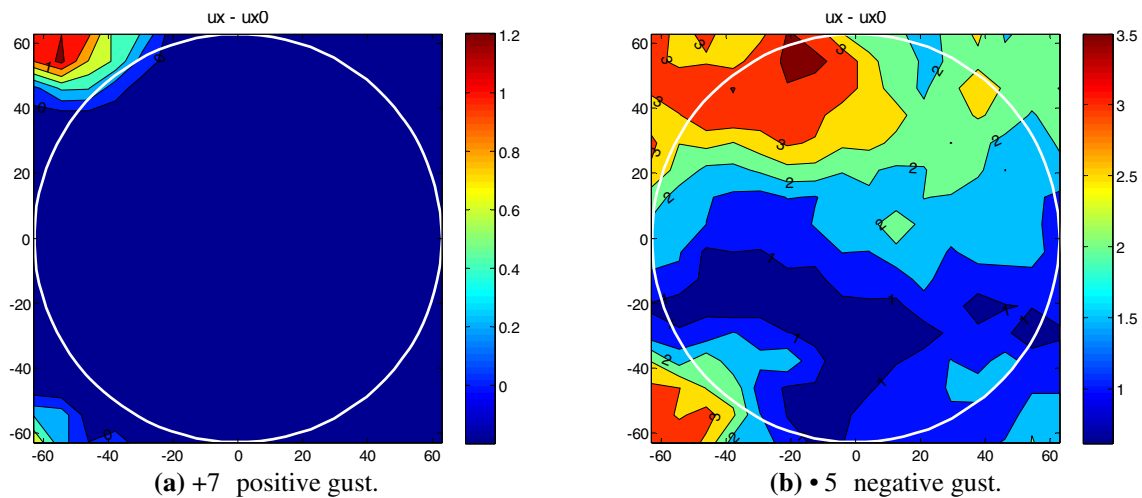

**Figure 5.** Difference between maximum deflection with and without a gust ( $U = 16$  m/s,  $I = 0.15$ ). The white circle represents the rotor surface.

In this example, the gusts are point gusts (with zero volume), such that the zeroth spectral moment is equal to the longitudinal variance ( $\sigma_0 = \sigma^2$ )<sup>1</sup>. During our investigations, it transpired that the NREL 5 MW turbine experiences extreme tip deflections at  $U \sim 18$  m/s for large *negative* gusts (see Figure 5). This was already noted by Barone et al. [3], who extracted two time series belonging to the maximum tip deflection and blade root flapwise bending moment. When we did alternative calculations with Flex5, with a controller designed by Bossanyi [14], we found the same result: positive gusts do not produce large tip deflections, while negative gusts do. At  $U = 16$  m/s ( $I = 0.15$ ), a positive gust with amplitude  $A = +7 = +16.8$  m/s was introduced in each of the 256 grid points of the turbulence field and the maximum downwind tip deflection (of 3 blades) was compared to the maximum deflection for the same wind field without a gust. The same was done with a negative  $A = -5$  gust. When comparing Figures 5a and b, it is seen that a positive gust makes no difference for the tip deflection, while negative gusts tend to increase it.

After some initial exploration of the parameter space, sampling distributions were set up where average speed  $U$  and gust amplitude  $A$  were chosen to be Gaussian, and the gust location  $\mathbf{x}_0$  was sampled uniformly in the domain  $B$ :

$$U \sim \mathcal{N}(19, 1.33^2), \quad (21)$$

$$A / \sigma \sim \mathcal{N}(-6.25, 0.2^2), \quad (22)$$

$$\mathbf{x}_0 \sim \mathcal{U}(B). \quad (23)$$

Figure 6 shows the results from  $N = 10^4$  load cases where each gust was embedded in a 2-min wind field (including a 1-min spin-up time). Figure 6b confirms that the method is able to match the result of the crude Monte Carlo method with RMSE of 0.27 m (among repeated MC analyses). To compare: to achieve the same accuracy with the crude Monte Carlo—with an extrapolation procedure as used in [12]—it would require roughly  $N = 10^5$  load cases with 11-min wind fields (again, including a 1-min spin-up time). This amounts to an efficiency gain of  $2 \times 10^4$  against  $1.1 \times 10^6$  minutes, or a factor 55.

### 3.2. Genetic algorithm compared to crude Monte Carlo

Next, a genetic algorithm was run where the genomes contained a wind speed  $U \in [3, 25]$  m/s and a gust amplitude  $A / \sigma \in [-10, 10]$ . Fitness was defined as the distance to the 50-year cumulative probability on a logarithmic axis; i.e.:

$$\varepsilon(\xi_i) = \left| \log_{10} \left( 1 - \hat{F}(\xi_i) \right) - \log_{10} \left( 3.8 \cdot 10^{-7} \right) \right|. \quad (24)$$

<sup>1</sup> The more detailed volumetric gusts require a finer turbulence grid and will be the subject of a future study.

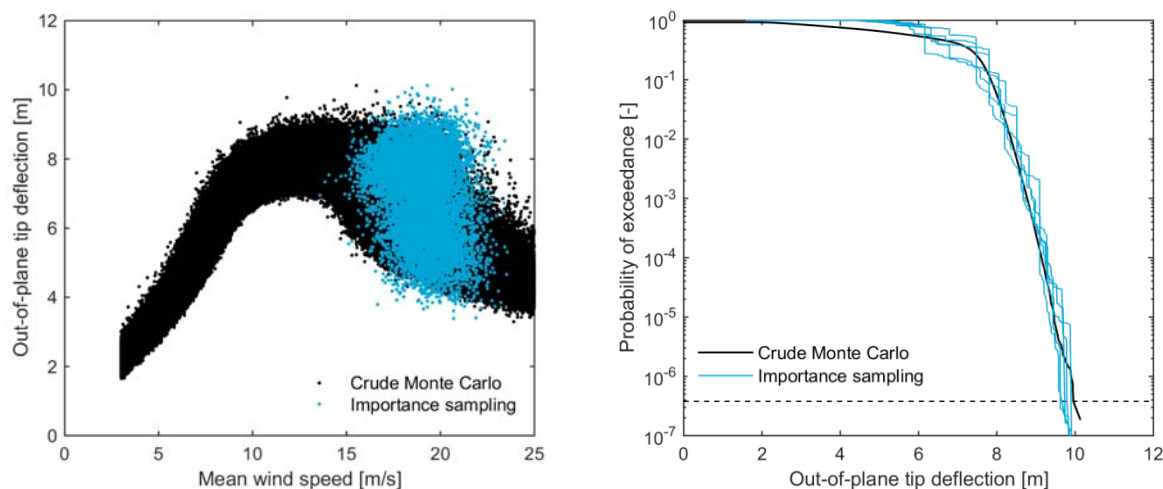

(a) Simulated load cases from an arbitrary sample. (b) Probability of exceedance from 5 different runs.

**Figure 6.** Calculation with importance sampling ( $N = 10^4$ ) compared to a crude Monte Carlo ( $N = 5 \times 10^6$ ) [3].

Figure 7 shows the results from 25 generations with a population size of 50, resulting in the distribution given by Figure 8. It is seen that the genetic algorithm is successful in predicting the right extreme load distribution with  $RMSE = 0.28$  m, compared to the “true” 50-year load obtained by brute force. One realisation cost  $(1+25) \times 50 = 1300$  simulations =  $2.6 \times 10^3$  minutes. This is about 8 times more efficient than the importance sampling method (not taking into account the time and effort required to find proper sampling distributions) and more than 400 times more efficient than the crude Monte Carlo method. Running a crude Monte Carlo simulation with the same computational effort ( $\bullet$  equivalent sample size 100) would result in a mean standard error of over 10 m (see Figure 9).

At the time of writing, we are testing which fitness function results in a quick and robust convergence to a 50-year level. With Equation (24), the genetic algorithm seems to favour strongly negative amplitudes that correspond to probabilities well beyond the 50-year level (which is somewhat strange). A different fitness requirement, perhaps in conjunction with a finer turbulence grid and more detailed gust events, might improve the quality of the results.

#### 4. Conclusions and further work

The results of comprehensive calculations on the NREL 5 MW reference turbine ( $5 \times 10^6$  simulations done by Barone *et al.* [3]), in particular extreme tip deflection values, can be reproduced using a new method that uses 3D constrained gusts, combined with importance sampling based on a genetic algorithm. The method requires on the order of  $10^3$  2-min simulations to find a 50-year load, yielding a result with the same quality as a crude Monte Carlo method with  $10^5$  11-min simulations – an efficiency gain of a factor 500 ( $2 \times 10^3$  against  $10^6$  minutes).

The genetic algorithm samples extreme gusts that are naturally embedded in random turbulence fields, without changing power spectra. The probability of such a gust occurring can be estimated with the Euler characteristic heuristic, or can be found manually by brute force (i.e., by Monte Carlo and fitting a GEV distribution). After several generations, the genetic algorithm will start to find gusts that trigger weaknesses in the turbine and/or controller design. With the current controller, the extreme deflections are found to be associated with negative gusts rather than positives ones. This was already found by Barone *et al.* [3] and when manually exploring the sample space [12]. The same kind of events are also favoured by the genetic algorithm.

Future work will involve more extensive testing and verification (for example, determining the blade root and tower base bending moments). Various other fitness functions will be considered to see whether convergence may be improved. In addition, a thorough analysis of the uncertainty surrounding the 50-year load will have to be carried out, to find out whether the new method can replace extrapolation schemes currently in use [1].

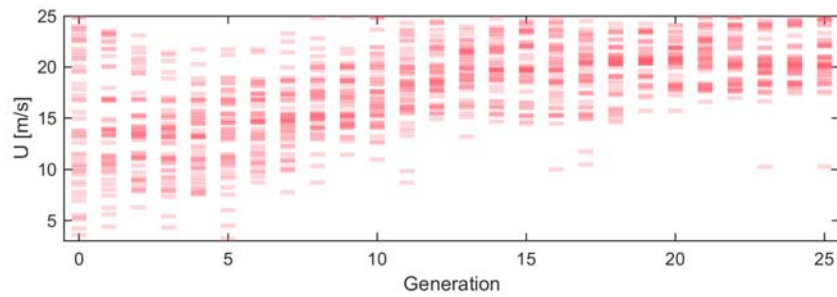

(a) Mean wind speed,  $U$ .

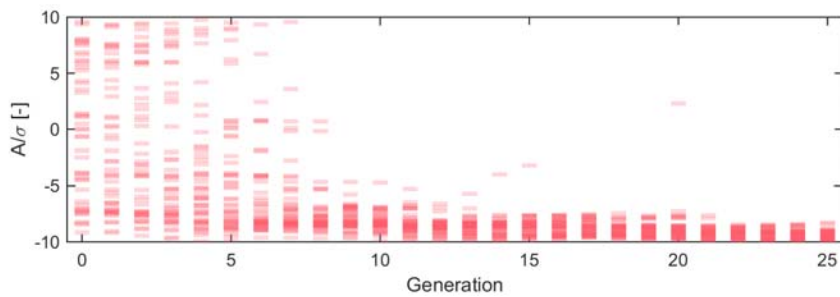

(b) Normalized gust amplitude,  $A/\sigma$ .

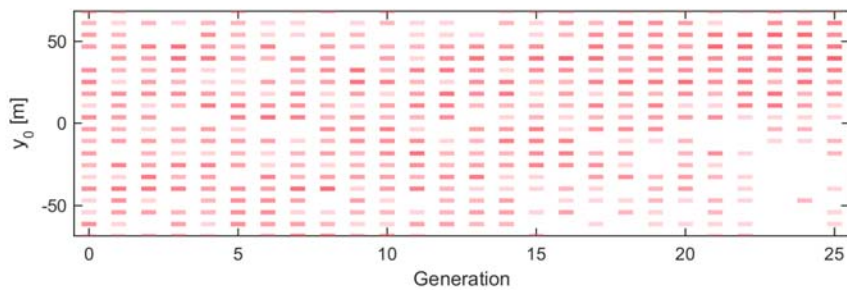

(c) Lateral gust position,  $y_0$ .

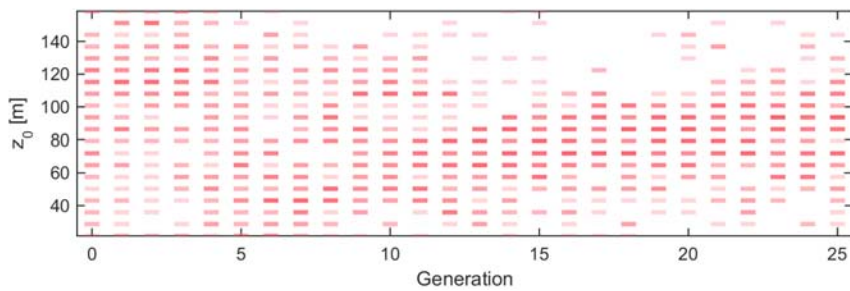

(d) Vertical gust position,  $z_0$ .

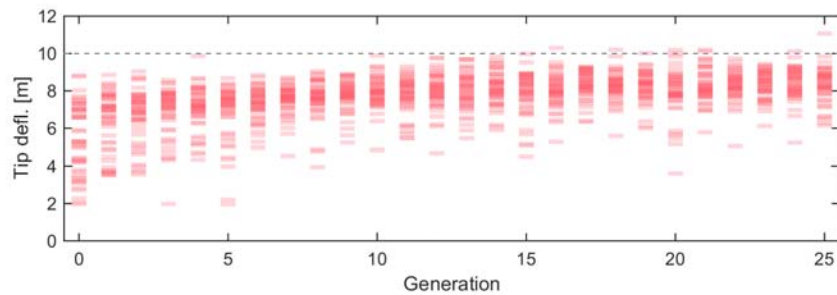

(e) Tip deflection (the 50-year level is approximately 10 m).

**Figure 7.** Evolution of the genomes.

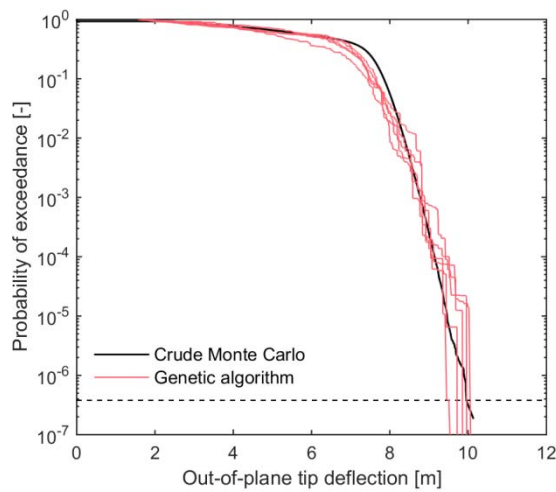

**Figure 8.** Probability of exceedance found with a genetic algorithm (5 different runs) after 1+25 generations with a population size of 50 ( $N = 1,300$ ), compared to crude Monte Carlo ( $N = 5 \times 10^6$ ) [3].

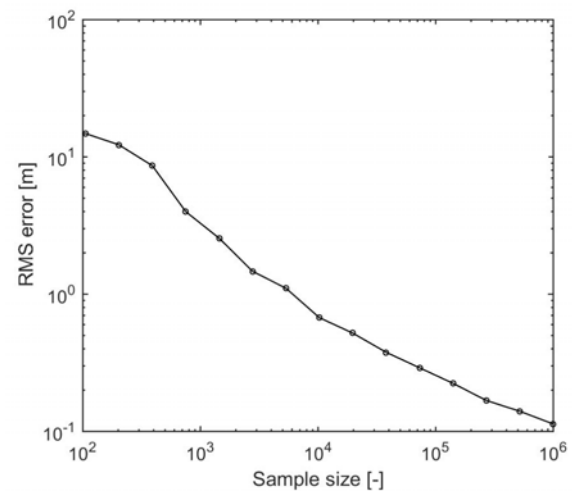

**Figure 9.** Root Mean Squared Error on tip deflection resulting from crude Monte Carlo method with 11-min simulations, obtained by resampling the data from [3].

## 5. References

- [1] IEC 2016 *Wind Turbines - part 1: Design Requirements, 4<sup>th</sup> edition* (Geneva: IEC)
- [2] Barone M *et al* 2012 *Proc. EWEA Annual Event (Copenhagen)*
- [3] Barone M *et al* 2012 *Proc. 50th AIAA Aerospace Sciences Meeting (Nashville, TN)*
- [4] Manuel L *et al* 2014 *Proc. AIAA SciTech/32<sup>nd</sup> ASME Wind Energy Symposium (National Harbor, MD)*
- [5] Toft H S *et al* 2011 *J. Sol Energy Eng* **133** 021001
- [6] Bierbooms W A A M *et al* 2001 *Modelling of extreme gusts for design calculations* (Delft: TU Delft)
- [7] Bierbooms W A A M 2009 *J Sol Energy Eng* **131** 031010
- [8] Bos R 2014 *J Phys Conf Ser* **524** 012107
- [9] Mann J 1994 *J. Fluid. Mech.* **273** 141–168
- [10] Adler R J *et al* 2007 *Random fields and geometry* (New York, NY: Springer)
- [11] Bos R *et al* *The spatial structure of severe wind gusts (in press)*
- [12] Bos R *et al* 2015 *Proc. EAWE PhD Seminar (Stuttgart)*
- [13] Jonkman J *et al* 2009 *Definition of a 5-MW reference wind turbine for offshore system development, NREL/TP-500-38060* (Golden, CO: NREL)
- [14] Bossanyi E 2006 *Integrated Wind Turbine Design (design of a controller) (UpWind 2002–2006)*