

# Tents and Flyovers: A Spatial and Structural Evaluation of Boundary Tensioned Membrane Systems beneath Flyovers

Arthur Hamelers

Faculty of Architecture & the Built Environment, Delft University of Technology

Julianalaan 134, 2628BL Delft

## *Abstract*

In a time of increasing awareness for the environment and rising energy prices, an efficiency in our material use is of paramount importance. This research is built on the notion that the design of light structures has a positive effect on the energy use of the built environment. The tent has been chosen to examine this approach of lightness in the domain of architecture. In an attempt to make the tent more efficient, the parasitic properties of the tent system are utilized by attaching it to an infrastructural object that can be found everywhere in the world: The Flyover. In this paper, a framework is developed to classify boundary tensioned membrane tents (a branch of the tensile structure systems), combine twelve of those types with the flyover, and evaluate the combinations by measuring them against spatial and structural attributes. The Outcome shows there are certain relations between the defined types and the evaluated attributes. Although these relations could be useful for preliminary designs, they are still strongly connected to the framework of this research, and thus need further research to be generalized.

**Keywords:** Parasitic Architecture, Tents, Tensile Structures, Boundary Tensioned Membranes, Flyovers, Material efficiency

## *Problem Statement*

### Energy and Mass

The world is in an energy crisis and the built environment plays a prominent role as contributor. 36% Of the final global energy use and 39% of energy and process-related carbon dioxide emissions are accounted for by the buildings and construction sector (2019 Global Status Report, 2019). These numbers represent considerable chunks of the total energy problem and, because of their significance, also offer great potential in solving the issue, since small contributions in this sector have a widespread impact on the environment.

On an abstract and purely theoretical level, the relationship between mass and energy can be approached by equations. Newton's second law, for instance, and Einstein's relativity theory are both examples of this. They imply that mass and energy are in some way related to each other. So less mass would mean less energy. This relation can also be seen in the nine r-strategies for a circular economy (Morseletto, 2020). *Reduce* is one of the most efficient strategies to adopt. It is also among the strategies that is closely related to design. If one was to translate this reduction in mass to the design of buildings, this could mean a general reduction of energy usage, not only in the initial amount of material needed, but also in the subsequent strategies of the circular economy.

## *Topic Introduction*

### Lightness in Architecture

The desire for lightness in architectural design has had a resurgence in the last century with two main characters as pioneers: Buckminster Fuller (1895 – 1983), father of the geodesic dome, and Frei Otto (1925 – 2015), the father of the tensile textile structure (Zanelli, 2016). The latter of the two said the following: “Our times demand lighter, more energy-saving, more mobile and more adaptable, in short more natural, buildings, without disregarding the demand for safety and security” (Otto, 2004). These attributes seem now more important than ever. In order to examine the topic of lightness in relation to architecture, the tent is chosen as a building typology.

### Defining the Tent

In architecture, the terms tent and tensile structure are often regarded as interchangeable. This is, however, a false assumption. Although most tents are part of the family of tensile structures, not all tensile structures are tents. A cable bridge, for example, is indeed a tensile structure, but not a tent. The main distinction is that tents, as defined in this research, use a membrane to fulfil a sheltering function as well as it being an essential part in its structural system (loaded in tension). Throughout the research, this will be how the term tent will be defined.

Tensile structures are divided into three categories (Lewis, 2003): 1. Boundary tensioned membranes, 2. Pneumatic structures, and 3. Pre-stressed cable nets and beams. Of these categories, only two are specifically about tents (1. & 2.) and, to create a more clear and concise scope for the research, only the first will be used to examine the main research question.

The boundary tensioned membranes, as described by Lewis, are stressed by stretching the surface to meet the boundaries of the membrane. These boundaries, as used by Lewis, contrary to one would expect, do not have to be located on the edge of the membrane. Tents with a central pole, for example, are also part of the boundary tensioned membranes family. Because the nature of the word boundary implies the end of

something, the word *node* will be used throughout this research. The node fulfils the same function. A point or a line (consisting of a series of points) to which the membrane is stretched. In this research, two kinds of nodes will be defined: Supports and anchors. A support pulls the membrane upward (away from the earth), an anchor pulls the membrane downward (towards the earth).

The surface’s load bearing capacity is provided by the double curvature of the membrane (Beccarelli, 2016). Mathematically, there are two ways of creating this curvature. The first is synclastic (the principal curvatures have the same sign), the other is anticlastic (the principal curvatures have opposite signs). Of the two, only the latter is possible with boundary tensioned membranes.

### The Tent’s Efficiency

There are three main reasons why the tent is efficient in its use of material and, subsequently, explains its lightness.:

- (1) The membrane has a double function. It functions both as barrier and structural component.
- (2) The membrane is loaded in pure tension and thus the material utilizes its full structural capacity.
- (3) The membrane is flexible, thus being able to shape itself in the most efficient form and being easily transported.

The first reason of the tent’s lightness is in the double function of the membrane. This flexible and malleable skin has the primary function of sheltering the inside from the outside, but also, in the tent as defined in this research, adds to the structural integrity of the system.

The second reason advocating for the tent’s efficiency is found in how the membrane is loaded. There is a hierarchy in the manner in which structures resist loads applied to them, with elements in pure tension being the most efficient (Chilton, 2010). Their full cross-section can be stressed at or close to the material’s ultimate strength, unlike elements loaded in pure compression, which generally suffer from buckling instability. So instead of losing capacity to unwanted bending moments or buckling instability, the tent (in tension) makes full use of its material.

The third reason for the efficiency in tents is found in the nature of a flexible membrane. A combination with the second reason is that tents are form-active structures, meaning they react to the forces acting upon them and take the most efficient shape. A foldable material also means that the transported form of the element can differ from the ultimately used form of the element. A large plane, for example, can be moved in a small box. This means there are less connections needed between elements and, consequently, a faster time to deploy the structure.

Alongside listing the advantages of the lightweight tent, some of the challenges should be addressed as well. One nuance in the story about lightness regards the material of the membrane: the most common materials used to make these membranes (PVC-coated polyester and PTFE coated glass fabric, for example) are not as energy efficient as some of the conventional building materials (Zanelli, 2020). Also the general shape complexity of tents (caused by the double curvature) introduces awkward cutting patterns (off-site) and connections which require extensive knowledge of form-active structures.

#### Moveability and Scale

The efficiency that results from the three reasons mentioned before have made the tent an excellent candidate for two main types of architectural spaces. The first one is the moveable space, a type that originated from the nomads, and is still used today in combination with temporary activities (Faegre, 1978) like camping or festivities. The second type of space is the large-span space. The lightness of the structure itself means there is a lower self-weight in the spanning material and thus larger spans are possible (Berger, 1999). As is demonstrated, for example, by the Denver International Airport (Fig. 1).



*Fig. 1 – Denver International Airport*

#### Hidden Mass

Conventional buildings can be seen as stacked systems. The most prominent force is gravity, pulling the material downward and creating the stresses in the material. To keep the building stable, all stresses should be answered for with adequate material. In tent systems, however, the gravitational loads are less (because of the limited mass) and additional tension forces are introduced to keep the system stable. The advantage of these additional tension forces (over compression forces in conventional buildings) is that they won't be able to make elements buckle, as explained before, thus making it possible for tension stresses to travel longer distances through the material and, consequently, granting the designer more freedom in where to place material.

The photograph below (Fig. 2) gives an insightful depiction on how stress in tension is capable of travelling relatively far distances in relatively little material towards anchor points. Note: These anchors still rely on mass and gravity (whether it being found in the earth or concrete blocks), so to consider these structures lightweight is not entirely fair. The mass is simply relocated to a more beneficial location.



*Fig. 2 – Bonga Stretch Tent*

Berger (1999) refers to the terminal building of the new Denver International Airport and states about the fabric structure: “It weighs one-tenth of any other roof system” as an example of how light these structures can become. Yet, it is only the roof itself which is considered by Berger and, as was discussed above, the mass (and energy) might well be hidden somewhere else in the system. Later he comes back to this point and explains that the additional reaction forces created by the tension in the membrane are the price to be paid for the advantages of tensile structures: “The skill and efficiency with which these forces are anchored have a large impact on the economy of the structural system”. Following this notion, focussing on the connection between tent and site might be a valuable next step in making the tent more efficient.

## **Research**

### Resolving reaction Forces of the Membrane

The membrane itself is the most efficient part of the tent. The masts, however, which push up the membrane (to create internal space) are subject to great compression (buckling) forces, because of the additional downward tension that has to be resolved. The anchors are subject to tension forces, which, depending on the soil beneath the tent, might be challenging to be resolved. So, the masts and the anchor points are less favourable locations in the structure of a tent. A way of circumnavigating these two weak locations in the tent system might be found when examining the parasitic attributes of the tent.

### The Flyover as Host Structure

In open tent systems, the site becomes an important part in maintaining the structural balance of the system. Take, for example, a simple camping tent. These structures both push against the ground (masts) and pull on the ground (anchors), already borrowing a lot of structural capacity from the site. Now, when leaning into this parasitic characteristic of dependency of the tent, might there be a way in which the surrounding of the tent can play an even bigger part in the structural system, and, by doing so, make the tent more efficient?

When considering host structures to support a tent, the flyover is an interesting candidate to examine, namely because it offers potential connection points for the membrane below the deck. This, in turn, could make the masts in compression, which are used in conventional tent systems, redundant. And, since most flyovers are built with large safety factors and are calculated to withstand big loads, there is – in most cases – enough excess material in the structure to bear additional loads.

Apart from the reasons above (the spatial configuration and structural excess of the flyover), the nature of the flyover also gives rise to an interesting environment on a larger, contextual scale. The function of a flyover is generally to make two fluxes of traffic cross each other as easily as possible. This is done by separating them at different altitudes. So, at the intersection of multiple fluxes, where, in most cases, one would expect interaction, there is instead segregation at the location of a flyover (Roushan, 2013). There is also a clear distinction in hierarchy, placing one flux literally above the other, and so explicitly indicating their relative importance. Because of this, the spaces beneath flyovers are often neglected and regarded as unsafe and unattractive places. Stephen Graham (2018) says the following about flyovers: “Edifices designed to literally lift up the mobile minority from the urban ground, to bring a striking aesthetic of mobile and modern life amidst cities where at ground level chaos and congestion reign”. Introducing lightweight structures might offer a means of activating these leftover spaces underneath the flyover.

So the tent does not only benefit from the flyover's existence, but the flyover could also benefit from the tent's. The research in this paper examines how these two entities will interact on a spatial and structural level. The main question that will guide the research is: How can the design and evaluation of boundary tensioned membrane tent systems be used to activate the spatial and structural potential under flyovers?

## Method

In order to answer the research question, the individual elements and actions of the phrase should be defined. The method will be a result of these definitions. The main question is roughly built up from three parts: (I) What types of boundary tensioned membrane tents can be classified? (II) What is the spatial and structural potential of flyovers? And (III) how are these two systems combined and evaluated?

Firstly, literary research is used to guide and position the paper. This information is then used to inform the research by design in the experimentation phase. During this phase, tents are classified into 12 different types. These types are later evaluated by overlaying diagrammatic representations of each type with five attributes. This evaluation is used to approach a general conclusion about which types (and which underlying spatial and structural principles) are prone to support corresponding attributes.

### (I) Simple and Efficient Tent Design

First, the tent will be distilled to its essence. This in order to examine what parts are superfluous and how to sensibly build up a pool of variations.

#### Minimum Amount of Nodes

The minimum amount of nodes to make a tensile surface structure is four (Berger, 1999). One of the four points has to be outside the plane defined by the other three to achieve an anticlastic double curvature. These four nodes can create two principal tent configurations: The orthogonal, with all four nodes at the edge of the membrane (Fig. 3, A). And the radial,

with one of the nodes in the centre of the membrane (Fig. 3, B). These two archetypes of the tent will be called the saddle and the tipi, respectively.

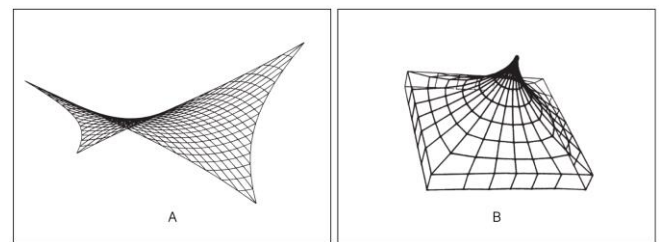

Fig. 3 – Two Archetypes: (A) Saddle & (B) Tipi

#### Degrees of Variation

*Structure Systems* (Engel, 1967) explores different types of the boundary tensioned membrane systems (chapter 1.2). These are, arguable, all variations on the saddle and the tipi, being either stretched in an undulating way around the edge of the membrane, or stretched between a supporting node in the centre and anchor nodes on the edge. The variations of the shape of the membrane of each type are based on the amount of the nodes – both anchor and support – and the repeatability of the system.

#### Strategy for the variations

In order to prepare the tent systems to be combined with the flyover, the tipi and saddle will be formed into three-dimensional diagrams (Fig. 4).

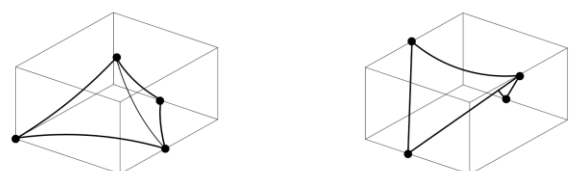

Fig. 4 – Diagrammatic representation of the two archetypes

The two tent systems above are making use of the minimal amount of nodes per system. This amount, both for anchors and supports, can be altered to make a greater pool of variations. This research uses this nodal transformation to make a variety of different types, in order to later get a

broader perspective of boundary tensioned membrane systems and what attributes are tied to certain geometries. The transformation will be done by either choosing the minimum amount of nodes (per support or anchor) or the maximum amount ( $\infty$ ). The tipi is a radial system, so the line will be depicted as a circle. Since the saddle is an orthogonal system, the maximum amount of nodes will be depicted by a line. The table in the appendix (A) shows the different variations of nodes per anchor/support per type. Below (Fig. 5) are the eight systems that are derived from the two original archetypes, with the variation of nodes.

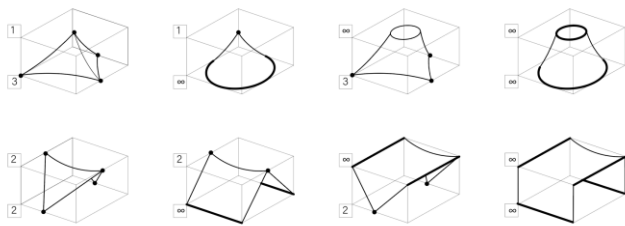

Fig. 5 – 8 Variations after Node Transformation

The second transformation is based on the repeatability of these eight types. Since the tipi (upper row) is radial, the axis of repetition is unnecessary to be defined, but for the saddle (lower row), there are two main directions the tent can expand in. By making this transformation of repetition, there are twelve systems in total (Fig. 6). These twelve will be defined as the main types of the boundary tensioned membrane family, and will later be used in the combination phase (III).

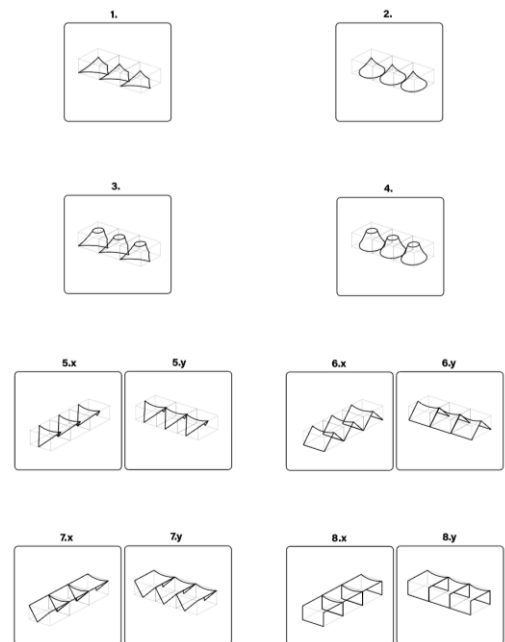

Figure 6 – 12 Variations after Expansion Transformation

## (II) Spatial and Structural Potential of Flyovers

### Space underneath flyover

A flyover is basically a bridge that carries one flux of traffic over another (Fig. 7). When the higher flux is ramping up to the appropriate height for crossing the lower flux, it loses its function and creates – in most cases – leftover spaces. These spaces underneath flyovers are defined by two basic elements. The first one is the deck which carries the eventual flux of traffic and the other is the pier which carries the deck.

The size, form and location of these elements are bound to their location and the fluxes that are carried over and under. For the deck, a minimal width for a two-way road or a two-way railway is around 8 m (depending on the country's regulations). The height is in most cases not a constant value, since the deck is ramping up from ground level and gradually rises to the appropriate clearance height. If, as an example, the lower flux is a normal traffic road, the deck has to rise to at least 4 m. The distance between the piers is a function of the carrying capacity of the deck. If the deck is able to withstand a big bending moment, the piers will be further apart.

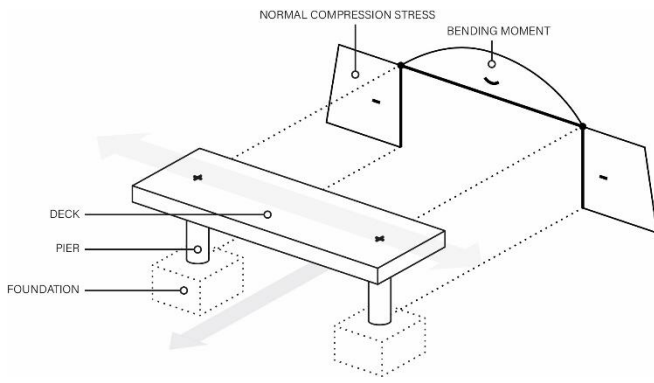

Fig. 7 – Space and Structure of Flyover

### Structure of flyover

Since flyovers are designed to withstand relatively big and dynamic loads (with a high safety factor), it is assumed there is a structural left-over capacity. Most of these flyovers, like many big infrastructural objects, are constructed from reinforced concrete, a material with a relative high dead-load. This, can be assumed, means there is a higher range within the calculated safety factors. Important to note (Fig. 7) is that the deck is built to mainly withstand a bending moment and the piers are mainly built to withstand compression forces.

As a general rule, since every element in a structure is calculated with safety factors and engineers work towards the foundation of an object when calculating these elements, it is assumed that the material closest to the foundation has the biggest left-over capacity. The closer the relation to the foundation, the better is the location for a structural node for an added tent. Note that the ground itself, although being in close proximity to the foundation, has little structural relation to it, and thus less capacity.

### (III) Combining the Tent and Flyover

The twelve types of tents (defined in I) will be combined with the general shape of the flyover (defined in II). In the appendix (B), there is an axonometric view, an elevation and a definition of the inside open space per system. This visual information will be used to evaluate each archetype.

In order to evaluate these combinations, several attributes will be used. The attributes listed below will inform a qualitative

analysis of the combinations and will be used to construct a general framework to approach a conclusion. Although this is a qualitative research, a point system will be used to evaluate the twelve types. This is done in order to compare them to each other.

### Openness

This is the most functional attribute. Openness is about view and accessibility through the structure. It also has influence on the behaviour of the acoustics, sunlight and temperature in the space. Openness, in other words, says something about the permeability of the structure. How easily can a flux, from one side of the flyover to the other, pass through the defined space? This attribute is closely related to the sheltering ability of the membrane. The openness is measured by how closed-off the membrane appears near the ground as depicted on the elevations (appendix B).

### Temporality

This is about the ease of movement of the system. As a tent, the system is prone to being relocated. This ability is closely related to the amount of nodes. The more nodes, the more difficult it is to relocate the system.

### Adaptiveness

As the function of these tents are subject to changing demands, it would be beneficial if the system could grow and shrink in order to answer these demands. Having a tent that is suited for a linear modular system makes sense underneath a linear object such as a flyover. A system will be regarded more suitable for adaptation if there is a more continuous open space running along the axis of repetition.

### Geometric Complexity

The membrane of the tent is made by joining together flat pieces of a membrane to create a 3D object in space. The complexity and dissimilarity of these individual pieces are big factors in describing the difficulty of constructing the membrane off-site. The simplest considered geometry is when all individual pieces are the same. When all pieces are different, the geometry is considered most complex.

## Structural Influence

As discussed before, the tent's structural balance is dependent on its surroundings. The nodes of the tent will exert forces on the immediate site, both the flyover and the ground below. The nodes of the tent that are structurally closest to the foundation of the flyover will be most beneficial for the structural system. Also: The more nodes, the more distributed the loads, the less concentrated the stress, the less structural impact.

## Results

By using the table in the appendix (C), each tent system could be summarized in a character sheet. In this character sheet (D), each tent system is evaluated according to the beforementioned attributes (openness, temporality, adaptiveness, geometric complexity and structural influence) on a scale from 0 to 3.

In order to interpret these results, the information of the character sheet (D) is examined per attribute. This is done in the attributes relations table (E) in the appendix. All systems with the highest value for a certain attribute are compiled in the "high value" column, the systems with the lowest value are compiled in the "low value" column. In the Column "possible relations", attributes which might be related to the attribute of the examined row, are noted, along with the corresponding relation. For example: In the second row (temporality row), the green (adaptiveness) high value differs two points from the low value. This could mean a relation of some sort between the two attributes. In the last column of the table, this relation is checked. So, if, for example, the second row implies that temporality has a relation with adaptiveness, we check in the third row (the adaptiveness row) if this relation still holds. From this table, as an extension of the research, three insights come to the surface:

1. Temporality relates positively to adaptiveness. Or, in other words, the less nodes used, the more continuous the internal space.
2. Adaptiveness relates negatively to structural influence. Or, in other words, the more continuous the inside space, the less

structural impact on the flyover (more nodes and closer to foundation)

3. Structural influence relates negatively to openness. Or, in other words, the more structural influence on the flyover (less nodes and further from foundation), the more difficult it is to pass through the tent.

## Discussion

There were three main challenges that gave shape to the research itself.

The first one being the manner of classification of the tents. The research shows there is, even when the term tent is delineated to only the group of boundary tensioned membranes, still a great variety of geometries that can be deployed underneath a flyover. The response to this first challenge was found in combining Engel (1967), Berger (1999), and basic mathematical simplifications. These choices had influence on the rest of the research, since these informed the basis for the eventual twelve tent types.

The second challenge was in how to evaluate the relative worth of each type. The decision was made to relate certain spatial and structural attributes to certain features of the tent. These were portrayed graphically, as I saw fit for a qualitative research.

The last main challenge was to find out if there is a pattern to these spatial and structural attributes per type: Underlying conclusions that would connect this group of investigated types. This research compiled the extreme types (both high scoring and low scoring) of each attribute in question in order to find some pattern. The three eventual patterns found in the results do not necessarily describe a truth about these types of tent-flyover combinations, but rather reveal information on the process of classification and evaluation itself. Its real value is hard to determine, since it is so closely tied to the research's framework.

In further research, these three challenges above could be re-examined and modified. The relation between these three succeeding steps in the research is interesting, but could even be dissected and looked at individually. Also the initial



assumption of the left-over carrying capacity of flyovers could be a subject for further research.

There is one main flaw in the last part of the research: The definition of the structural influence attribute was defined by two characteristics (amount of nodes & location of nodes). This made it difficult to position it against the other four attributes. In further research, it would be wise to split structural influence into two separate attributes: Location of forces & distribution of forces.

## ***Conclusion***

The goal of this research is to determine how the design and evaluation of different boundary tensioned membrane tent systems can be used to activate the spatial and structural potential under flyovers. Note that the research does not show that combining tents and flyovers will necessarily be a fruitful venture. The research rather gives a narrative on why the tent-flyover combination might be a reasonable one and demonstrates how these combinations could take shape, how to evaluate them and, eventually, what general conclusions could be drawn from this process.

Firstly, the boundary tensioned membrane tent systems are subdivided into twelve main types which could be used for combination with the flyover. Secondly, the spatial and structural potential of the flyover are defined generally. Thirdly, a method of combining the tent-flyover types is defined. This method entailed qualitatively measuring each type against a set of attributes (openness, temporality, adaptiveness, geometric complexity and structural influence) and, afterwards, comparing these measurements in order to approach general relations, defined within the framework. The relations found are:

1. Temporality relates positively to adaptiveness.
2. Adaptiveness relates negatively to structural influence.
3. Structural influence relates negatively to openness.

Although these results could be useful for preliminary designs of tent and flyover combinations, they are still strongly connected to the framework of this research, and thus need further research to be generalized.

I predict that, in this case, rather the methods than the results are more useful for usage in the design process. The classification of boundary tensioned membrane systems and the subsequent evaluation by using the five defined attributes could offer the designer a framed grasp of approaching a design brief. In subsequent research, these two methods could be tested in a design project and their usefulness evaluated and improved upon.

## *Literature*

- Azhar, J. (2020). *Re-imagining Urban Leftover Spaces*. Springer Nature. Victoria University of Wellington.
- Beccarelli, P. (2016). *Designing with Membranes*. Springer International Publishing. Politecnico Di Milano.
- Beukers, A. & van Hinte, E. (2020). *Designing Lightness*. nai publishers.
- Berger, H. (1999). *Form and Function of Tensile Structures for Permanent Buildings*. Elsevier Science Ltd. City College of New York.
- Chevalier, M., Geoffron, P. (2009). *The new Energy Crisis*. Macmillan Publishers Limited.
- Engel, H (1967). *Structure Systems*. Hatje Cantz Publishing.
- Faegre, T. (1979). *Tents: Architecture of the Nomads*. John Murray publishers Ltd.
- 2019 Global Status Report for Buildings and Construction. (2019).
- Hennike, J. [documentary]. (2016) *Spanning the Future*. Youtube.
- Morseletto, P. (2020). *Targets for a Circular Economy*. Elsevier Ltd. VU University Amsterdam.
- Otto, F. (2004) *Introduction: on the way to an architecture of the minimal*. European design guide for tensile surface structures. Tensinet Edition.
- Roushad, N. (2013) *In de Shadow: A Study for Utilization of Space under Flyovers in Dhaka*. BRAC University.
- Songel, J. (2022). *Tents: A Paradigm of Lightness and Sustainability in Vernacular Architecture and in Frei Otto's Work*. Emerald Publishing Limited.
- Qamaruz-Zaman, N. (2012). *Opportunity in Leftover Spaces: Activities under the flyovers of Kuala Lumpur*. Elsevier Ltd. Universiti Teknologi MARA.
- Zanelli, A., Spinelli, L., Monticelli, C., Pedrali, P. (2016). *Lightweight Landscape: Enhancing Design through Minimal Mass Structures*. Springer International Publishing.
- Zanelli, A., Monticelli, C., Viscuso, S. (2020). *Closing the Loops in Textile Architecture: Innovative Strategies and Limits of Introducing Biopolymers in Membrane Structures*. Springer International Publishing. Politecnico Di Milano.
- Fig. 1 – Denver International Airport. Hursley, T. (1995). [Architonic.com](http://Architonic.com).
- Fig. 2 – Bonga Stretch Tent. [Gazeboshop.uk.co](http://Gazeboshop.uk.co).
- Fig. 3 – Two Archetypes: (A) Saddle & (B) Tipi. Berger, H. (1999). *Form and Function of Tensile Structures for Permanent Buildings*.

# APPENDIX A – Node variations table

	TIPI				SADDLE			
SUPPORT	1	1	∞	∞	2	2	∞	2
ANCHOR	3	∞	3	∞	2	∞	2	∞

# APPENDIX B – Information for the combination types

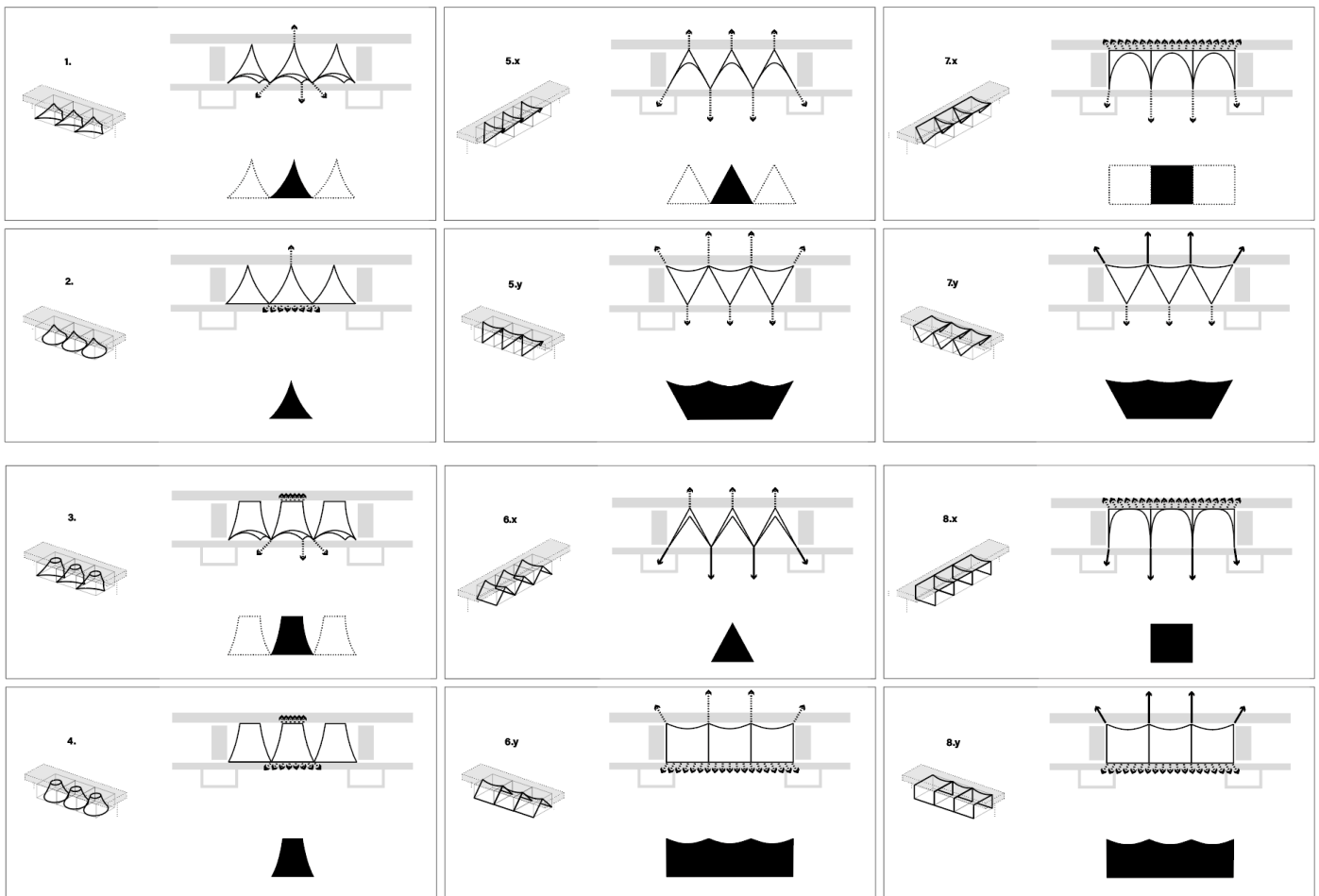
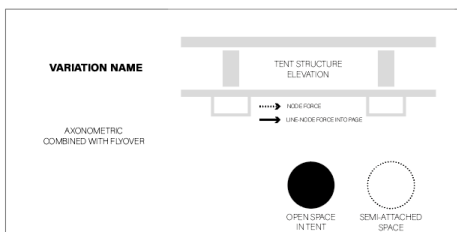

**APPENDIX C – Point system table**

	0	1	2	3
<b>OPENNESS</b>	<p>DIFFICULT TO PASS THROUGH</p>			<p>EASY TO PASS THROUGH</p>
<b>TEMPORALITY</b>	<p>MANY NODES AGAINST FLYOVER (LINES)</p>			<p>MINIMAL NODES (POINTS)</p>
<b>ADAPTIVENESS</b>	<p>SMALL CONTINUOUS SPACE</p>			<p>EXTENSIVE CONTINUOUS SPACE</p>
<b>GEOMETRIC COMPLEXITY</b>	<p>SIMILAR PIECES (POINT SYMMETRY)</p>			<p>DIFFERENT PIECES (NO SYMMETRY)</p>
<b>STRUCTURAL INFLUENCE</b>	<p>NODES DISTRIBUTED &amp; CLOSER TO FOUNDATION</p>			<p>ONLY NODES ATTACHED TO DECK</p>







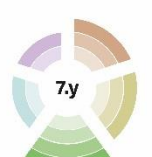
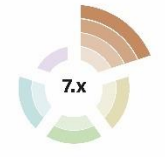
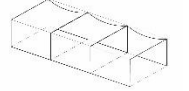
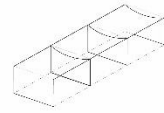
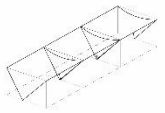
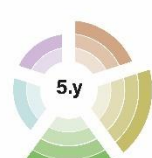
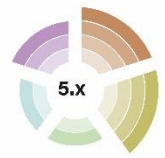
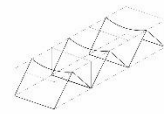
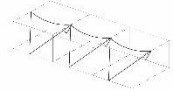
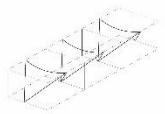
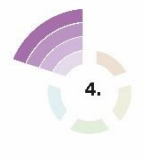
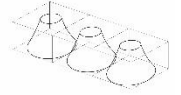
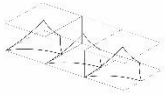









# APPENDIX D – Character sheet of the 12 systems



- OPENNESS
- TEMPORALITY
- ADAPTIVENESS
- GEOMETRIC COMPLEXITY
- STRUCTURAL INFLUENCE



# APPENDIX E – Attribute relations table

	HIGH VALUE	LOW VALUE	POSSIBLE RELATION	CHECK
OPENNESS	 <p>5.x. 6.x 7.x. 8.x.</p>	 <p>2. 4. 6.y. 8.y.</p>		
TEMPORALITY	 <p>1.5.x. 5.y.</p>	 <p>4. 8.x.</p>	 <p><b>less temporal</b> (less nodes) = <b>more adaptive</b> (more continuous internal space)</p>	
ADAPTIVENESS	 <p>5.y. 7.y.</p>	 <p>2. 4. 6.x</p>	 <p><b>more adaptive</b> (more continuous internal space) = <b>less structural influence</b> (nodes closer to foundation + more nodes)</p>	
GEOMETRIC COMPLEXITY	 <p>1.3.</p>	 <p>2. 4.</p>		
STRUCTURAL INFLUENCE	 <p>1. 2. 3. 4.</p>	 <p>6.y. 7.x. 8.x. 8.y.</p>	 <p><b>more structural influence</b> (nodes further from foundation + less nodes) = <b>less open</b> (more difficult to pass through structure)</p>  <p><b>more structural influence</b> (nodes further from foundation + less nodes) = <b>more complex geometry</b> (many different pieces)</p>	