

Exploring indoor movement patterns through eduroam connected wireless devices

Griffioen, Simon; Vermeer, Martijn; Dukai, Balázs; Spek, Stefan van der; Verbree, Edward

Publication date

2017

Document Version

Final published version

Published in

Proceedings of the 20th AGILE Conference on Geographic Information Science

Citation (APA)

Griffioen, S., Vermeer, M., Dukai, B., Spek, S. V. D., & Verbree, E. (2017). Exploring indoor movement patterns through eduroam connected wireless devices. In A. Bregt, T. Sarjakoski, R. V. Lammeren, & F. Rip (Eds.), *Proceedings of the 20th AGILE Conference on Geographic Information Science: Societal Geo-innovation* Wageningen University.

Important note

To cite this publication, please use the final published version (if applicable).
Please check the document version above.

Copyright

Other than for strictly personal use, it is not permitted to download, forward or distribute the text or part of it, without the consent of the author(s) and/or copyright holder(s), unless the work is under an open content license such as Creative Commons.

Takedown policy

Please contact us and provide details if you believe this document breaches copyrights.
We will remove access to the work immediately and investigate your claim.

Exploring indoor movement patterns through eduroam connected wireless devices

Simon Griffioen
Delft University of Technology
MSc Geomatics
Julianalaan 132-134
2628 BL Delft, the Netherlands
S.J.Griffioen@student.tudelft.nl

Martijn Vermeer
Delft University of Technology
MSc Geomatics
Julianalaan 132-134
2628 BL Delft, the Netherlands
M.Vermeer-3@student.tudelft.nl

Balázs Dukai
Delft University of Technology
MSc Geomatics
Julianalaan 132-134
2628 BL Delft, the Netherlands
B.Dukai@student.tudelft.nl

Stefan van der Spek
Delft University of Technology
Faculty of Architecture and the Built Environment
Urbanism
Julianalaan 132-134
2628 BL Delft, the Netherlands
S.C.vanderSpek@tudelft.nl

Edward Verbree
Delft University of Technology
Faculty of Architecture and the Built Environment
OTB – Research for the Built Environment
Julianalaan 132-134
2628 BL Delft, the Netherlands
E.Verbree@tudelft.nl

Abstract

Knowledge of people's locations and related mobility patterns are important for many decision-making processes. How to efficiently use the available space, is a common problem in many fields. Wireless Local Area Networks (WLAN) are widely used for locating mobile devices within this network. This study attempts to identify movement from Wi-Fi log data on the Delft University of Technology campus. The proposed method automatically explores people's movement by firstly, extract stay places, secondly discover movement and finally, identify movement patterns. This method is studied for two spatial levels: (1) at building level, movement between, from and to buildings can be detected, (2) at building-part level, movement between, from and to large indoor regions can be detected. For indoor analysis, the travelled path is estimated using a network graph of the underlying floorplan. This paper shows promising results for mining people's movement patterns between buildings and indoor building-parts.

1 Introduction

Location is a key element of many processes and activities, and the understanding of human movement behaviour is becoming increasingly important. Knowledge of people's locations and related mobility patterns are important for numerous activities, such as urban planning, transport planning and facility management. How to use the available space efficiently, is a common problem in many fields. In the educational sector, universities are struggling to meet the higher expectations of facilities for education and research by students and academic staff. Managing the campus of a university has become a complex and challenging task, in which many stakeholders are involved. Campus managers are in need for evidence-based information to support their decision-making (Heijer den, 2012). This includes better location data to detect activities, occupancy and usage of the infrastructure.

To understand the human motion behaviour many studies are conducted based on data collection of GPS receivers. The Global Navigation Satellite System (GNSS) is commonly used to track people in large scale environments. The movement of pedestrians in city centres has been studied

(Spek, 2008), where potential participants were asked to carry a GPS receiver. However, the distribution of GPS devices to participants limits the possibilities to collect location data at a large scale. Furthermore, due to the poor performance of received signals from satellites in indoor environments, GPS receivers are not suitable in these conditions. Technological developments in the acquisition of location data by smartphones and the use of Wi-Fi networks, enables new opportunities to track users.

Wireless Local Area Networks (WLAN) are widely used for locating mobile devices within this network. The use of the Wi-Fi network to estimate the location of people is an attractive approach, since Wi-Fi access points (AP) are often available in indoor environments. Furthermore, smartphones are becoming essential in daily life, making it convincing to track mobile devices. This provides a platform to track people by using WLAN as a sensor network, and study the mobility of users inside buildings or groups of buildings.

At Delft University of Technology (TU Delft) a large-scale Wi-Fi network is deployed across all facilities covering the indoor space of the campus. The network is known as an international roaming service for users in educational

environments and is called the eduroam network. It allows students and staff members from the university to use the infrastructure throughout the campus for free. This enables the possibility to collect Wi-Fi logs, including individual connections of mobile devices, at a large scale. A long-term continuous collection/logging of connections to different APs allows tracking of devices, revealing the movement of their users. This ubiquitous and individual georeferenced data derived from smartphones will present valuable knowledge about the movement on the campus.

1.1 Related work

Research has been conducted for studying human mobility patterns in a University's campus. The paper by Kotz and Essien (2005) is essential in understanding usage patterns in wireless local-area networks, as it covers the usage of the network: "how much traffic does the network handle?" as well as the Wi-Fi card activity. But back in 2005 people were not yet always-on-always-connected, thus persistently connected to the web anywhere and 24/7. Meneses and Moreira (2012) used the eduroam network to study connectivity between two places, by computing the number of movements between two places within a given observation time period. Previous work has also been conducted at TU Delft (Kalogianni et al. 2015), where several Wi-Fi monitors were placed to detect occupation and movement between different faculties.

Studies conducted using Wi-Fi location data, show that it is possible to discover daily life routines (Zhao et al, 2014) and activity patterns (Danalet et al., 2014) in terms of both individual and group behaviours. The authors study the sequence of visited places, or places where users stay for a significant amount of time, derived from Wi-Fi data. Radaelli et al. (2013) describes a similar method to detect movement patterns for any indoor localization technique, including Wi-Fi sensors. Tian et al. (2014) reconstructed the travelled path of people, using a mobility graph.

In this paper, we attempt to explore people's movement from the eduroam network of TU Delft. Other than previous studies, this research-driven project analysed data from more than 30.000 users, connected by their laptop and/or tablet and/or smartphone to the eduroam network. It tries to detect movement between buildings, and between large indoor regions. The project is carried out in request of the university's department of Facility Management and Real Estate (FMRE). With this project, we try to illustrate to what extent movement in and between buildings can be explored from anonymised Wi-Fi logs. Firstly, individual states are extracted from the Wi-Fi logs, where users stay for a longer time period. Secondly, movements are detected between a sequence of states (stays). Thirdly, movement patterns can be explored by counting the amount of movement from, to or between certain locations at different time intervals.

The aim of this paper is not to improve a Wi-Fi based positioning technique, but to use the location data to conduct a mobility analysis producing knowledge about the university's campus. Based on the three steps mentioned above, the aim of this project is to provide a method to detect movement from anonymised Wi-Fi logs. This includes the separation of mobile devices (i.e. smartphones) and static devices (e.g. laptops) from the Wi-Fi logs and detecting movement to and

from beyond the spatial extent of the eduroam network by introducing the concept of a 'world' state. Hereby, this paper attempts to contribute with a method to automatically mine people's movement at two spatial levels. First, movement at building level is analysed. Subsequently, indoor movement at building-part level is studied, by constructing a network graph of the underlying floorplan.

1.2 Case Description

The study area of the project is the campus of Delft University of Technology (TU Delft), used by more than 30.000 students and staff members. The eduroam network of the TU Delft campus consists of 1730 access points, distributed over more than 30 buildings, covering all indoor space. Even large outdoor areas around the buildings have access to the Wi-Fi network, because of the range of APs. At regular intervals of 5 minutes all connections in the network are logged; the information is finally stored in a database on a server. Every entry in the database represents a session, this is defined as a period during which a device is successively logged at the same AP. In general, the location of the APs could be deducted from the 'maploc' description, like: System Campus > 21-BTUD > first floor'. This will give an estimation of the location of the AP, the connected mobile devices, and thus the persons; but the exact position of the person nor the AP is known. The location of the Aps at the Faculty of Architecture and the Built Environment has been revealed more accurately from a (paper) map, but still the exact position of the connected mobile devices, and thus the persons is not revealed. This allows the tracking of devices in space and time by relating buildings and building-parts to an aggregation of APs. The data is collected for every single AP over a period of almost two months. In order to ensure privacy, MAC addresses and NetIDs (i.e. usernames) are hashed.

2 Methodology

An overview of the workflow to derive movement from the Wi-Fi log is shown in Figure 1. The two spatial levels for which movement will be derived are 'building' and 'building-part' level. The movement on building level concern the movement from, to and between the buildings on the campus. The movement on building-part level concern the movement from, to and between building-parts within the Faculty of Architecture and the Built Environment.

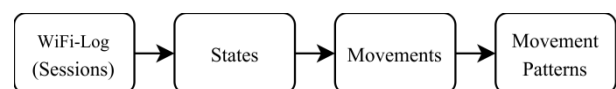

Figure 1: Workflow for retrieving movement patterns.

2.1 States and Movements

A movement is defined as going from one place to another and a state is defined as staying at a certain place for a significant amount of time. A movement can therefore be retrieved from two subsequent states. Therefore, states are mined first for both building and building-part level. To create states, subsequent sessions at the same location are grouped together. Figure 2 illustrates how sessions of the same device at location a, b and c are grouped to create states. Note that a,

b and c represent buildings on the building level and building parts on the building part level. For grouping, a time threshold of one hour is used, meaning that subsequent sessions between which the time gap is less than one hour are grouped together. The choice for the one-hour threshold is heuristic, gaps smaller than an hour are thought more likely to represent a person that was just smoking or having lunch outside for a short period. If a person is not recorded for more than an hour it is thought to be more likely that the person has left the campus. To be able to retrieve this movement away, from and back to the campus, 'world' states (i.e. beyond the spatial extent of the eduroam network) are added to the data during time periods a device has not been recorded anywhere for more than one hour (see Figure 2). Finally, 5 minute states (single scan by eduroam system) are filtered out, since they likely represent people that only pass by a building.

The extracted states contain implicit information on the movement of the device. If a device is first located at location A and subsequently at location B it must have moved from location A to B. However, in order to be able to retrieve movement patterns, the movements are stored explicitly (figure 3).

2.2 Movement Patterns

The final step is to extract movement patterns from the created movements. These patterns can be derived by counting the amount of movement from, to or between certain buildings and building-parts for different time intervals. The amount of movements is visualized both in time profiles and maps with specified time intervals. To visualize the indoor movement on a map, a network graph of the underlying building floor plan is created for the faculty (Figure 3). The building parts represent functional or spatial divisions, e.g. departments, community areas or building wings. The subdivision is optimized with respect to the layout of APs, such that devices within a building part are most likely be connected to an AP within this same building part. To determine the route taken from one building-part to another, the shortest path is computed using the Dijkstra algorithm. For building level, no graph is created as the movement in outdoor space is less constrained, especially considering the spacious character of the TU Delft campus.

2.3 Mobility ratio

The Wi-Fi log contains data of different device types (e.g. smartphones, laptops, tablets etc.). A distinction can be made between mobile devices (often smartphones) that are always

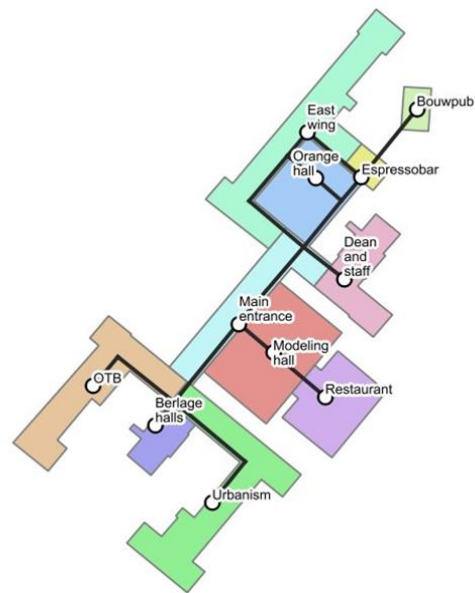

Figure 3: Building parts on the ground floor of the Faculty of Architecture and its underlying graph.

switched on and carried by the user, and static devices (often laptops) that are not. Since the record of static devices is incomplete (switched off) and false (left by the user) an attempt is made to filter these devices out. Mobile devices can be identified, based on the knowledge that they are likely to have relatively more very short sessions in the log-file, as they continuously connect to new APs when a person moves around. As a result, the mobility of a device can be defined by the ratio between the amount of short, 5 minutes, sessions in the Wi-Fi log and the total amount of sessions in the Wi-Fi log. Figure 4 shows a histogram of the mobility ratio of all devices. The two distinctive peaks are likely to correspond to mobile phones and laptops that make up the majority of the dataset. To track cell phones, static devices are filtered out.

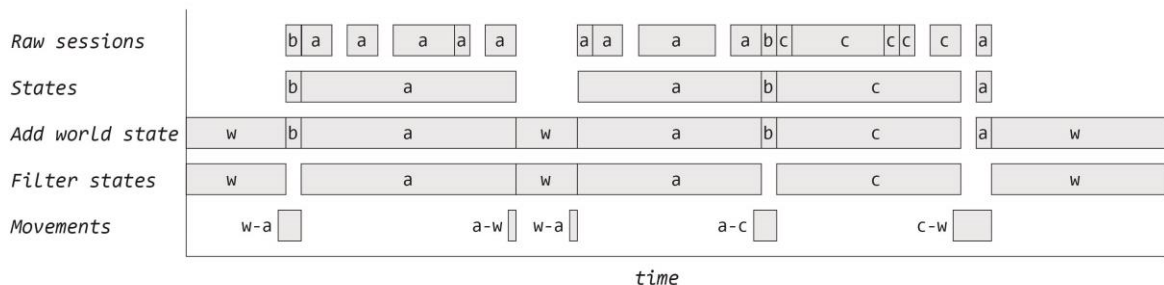

Figure 2: Processing steps; from raw data to movements.

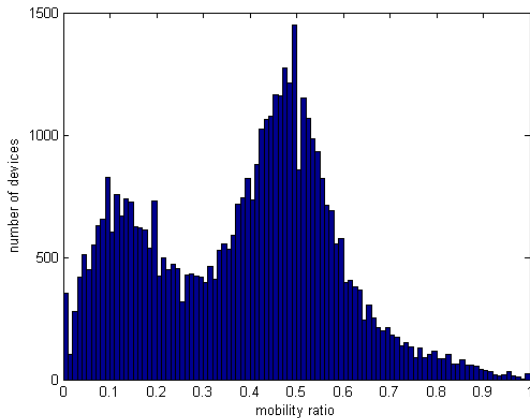

Figure 4: Histogram of mobility ratio of all devices in the Wi-Fi log.

3 Results

At building level, movement patterns between, from and to buildings can be detected. Figure 9 shows the time profile of all movements with and without the ‘world’ state. This graph shows that there is much movement around 8.45, 12.45, 13.45, 15.45 and 17.45, corresponding with lecture hours at TU Delft. With ‘world’ state (blue line), the morning and evening rush hours around 8.45 and 17.45 are detected, when students and staff arrive at the campus and leave the campus. Without introducing the ‘world’ state (red line), these two movement peaks are not detected.

Figure 5 illustrates the most occurring movements between buildings, on a map, where buildings are represented as nodes, and edges represent the number of movements. The number of movement, during the observation period, is illustrated with color and line width.

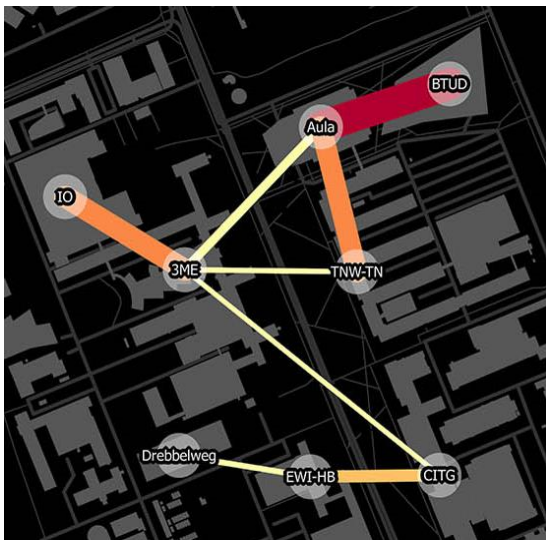

Figure 5: Most occurring movements on building level.

Instead of showing all movement on building or building-part level the movement data can also be queried based on origin and destination and/or specific time periods. This enables a more detailed analysis of specific buildings, building-parts, time periods or events. An example of this potential is given by looking at the BK-beats event, a festival organized in the faculty in the East wing on the ground floor. Figure 8 clearly shows a lot of movement during the night this event was organized. The corresponding movement map of the event (Figure 6) shows that all movement is concentrated in the east wing on the ground floor. Figure 7 shows how often each building-part occurred as origin or destination. Note that the ‘01_East wing’ (i.e. first floor, east wing) functions as origin or destination relatively often, even though this part of the building was closed. This is due to devices at the ground floor connecting to APs on the first floor. The time profile, map and histogram complement each other by giving insight in the timing, location and origin/destination of the movement respectively.

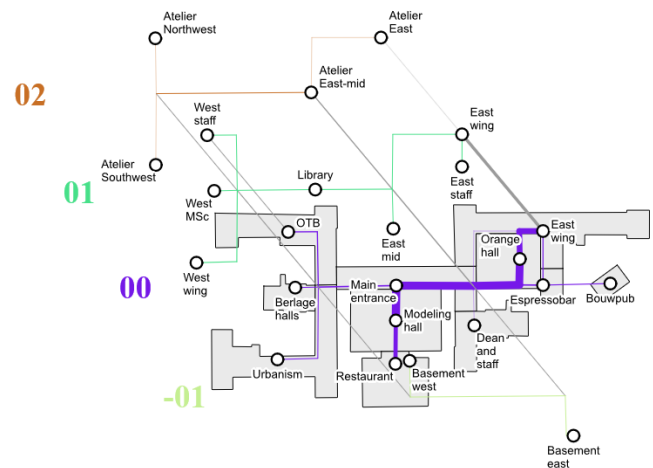

Figure 6: Map of all movement within the Faculty of Architecture and the Built Environment during BK-beats.

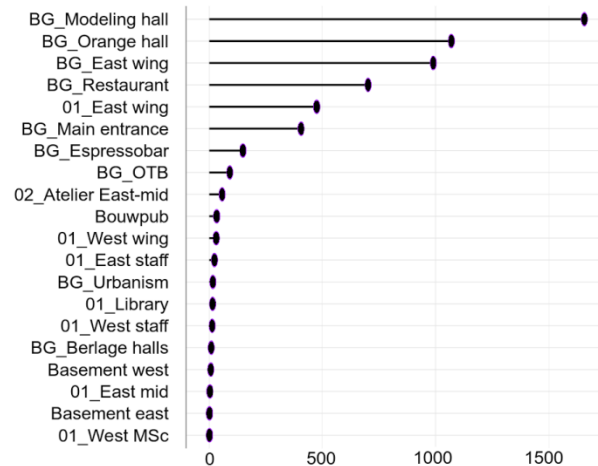

Figure 7: Occurrence of building part as origin or destination.

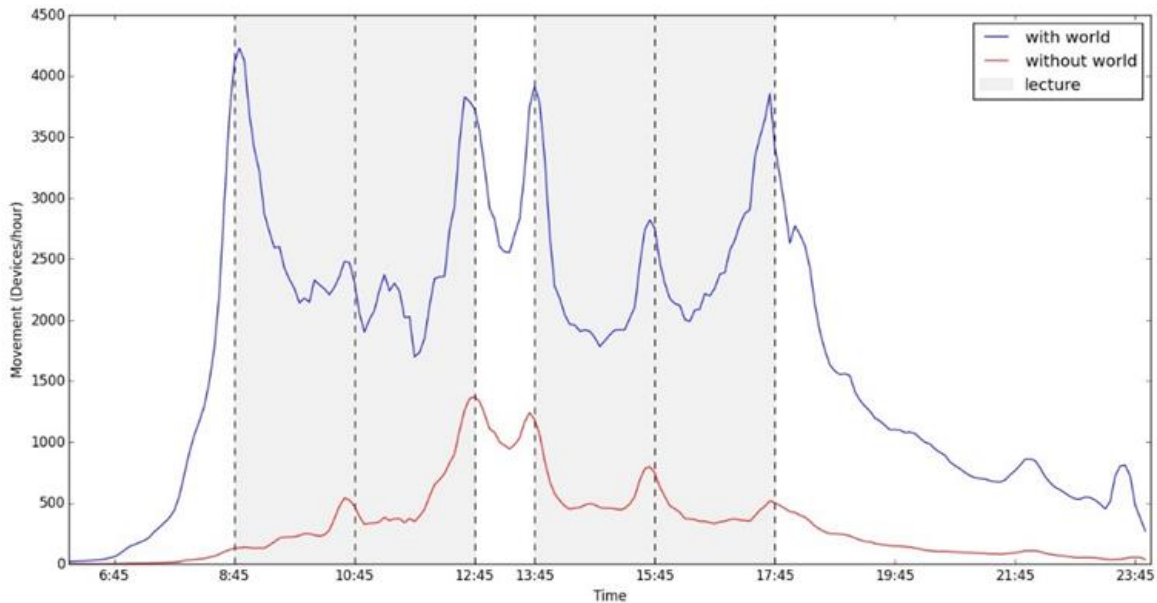

Figure 9: Time profile of movement without world (only between buildings) and with world (including movement from and to buildings from 'world').

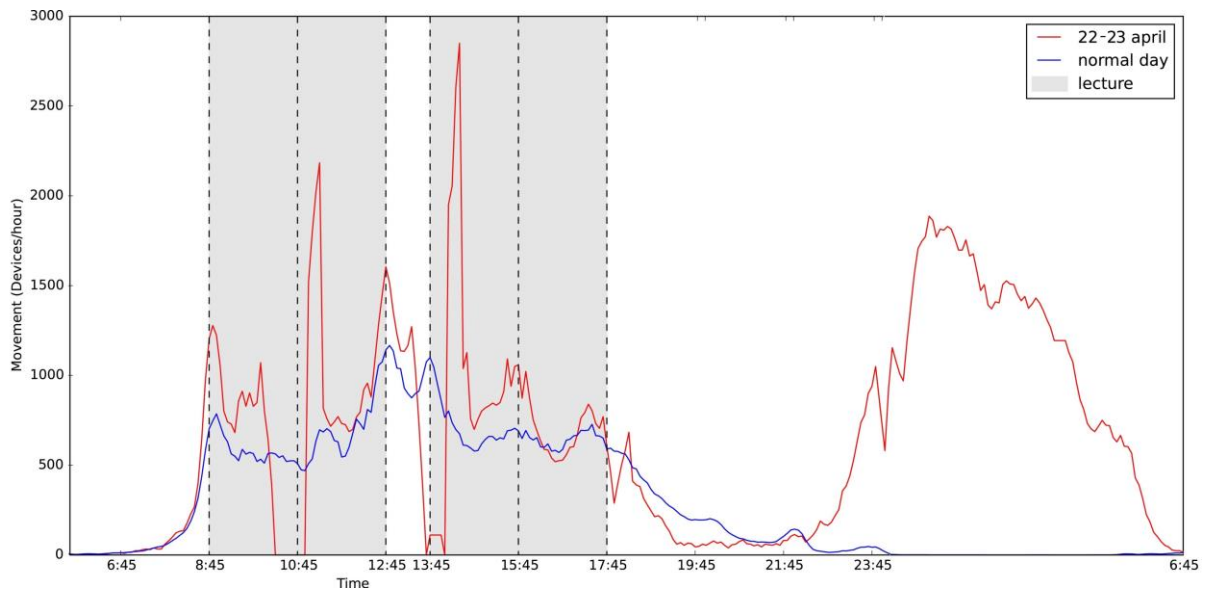

Figure 8: Time profile of all movement within the Faculty of Architecture and the Built Environment during BK-beats.

4 Discussion

This paper tried to illustrate to what extent movement patterns in and between buildings can be explored from anonymized Wi-Fi logs. Using the described methods, movement patterns can successfully be retrieved from, to and between buildings and building parts. Even through all obvious patterns linked to lecture hours, opening/closing times, lunch and other events are clearly captured in the results, there are several limitations to the accuracy of the described methods. First of all, devices are tracked via the eduroam network and not people

themselves. An attempt was made to filter out static devices, however this approach is limited and additional research is required to accurately determine the relation between patterns of devices and the people that use them. Secondly, the logging of all connections at 5-minute intervals means that the dataset is not continuous. Short (<5 minute) round trips, such as a coffee break or toilet visit, are therefore not always captured in the data. Especially indoors, this makes it impossible to determine which exact route is taken from one building part to another. As a result, a shortest path analysis is required to estimate the route taken. This could be solved by simply

logging Wi-Fi scan at a higher frequency than 5 minutes. Finally, the location of the APs is used and not the location of the device itself. This can result in false location estimations of devices. The problem is limited at the Faculty of Architecture and the Built Environment, since the floorplan has separated wings and only four floor levels. Buildings with more floor levels and non-distinctive floorplans (e.g. rectangular), location estimations can be less accurate. This also means that for the exploration of movement at room level, other techniques, e.g. including Received Signal Strength (RSS), need to be implemented.

5 Conclusion

On building level the layout and logging interval of the eduroam network has proved to be adequate to identify and analyse movement patterns. Considering a whole building as a single location, traffic peaks between buildings were successfully identified and validated against local knowledge. Enriching the data set with an "out of campus" (i.e. world) location has proven to yield more sensible and accurate patterns.

The five minute logging interval in combination with using the position of the Access Points as the position of the devices prohibits mining of room-level patterns. However, aggregation of rooms into larger spatial units (e.g. building parts), allows mapping of indoor traffic. Using the shortest path on a graph of the respective building parts allows detection of the flow of people through specific corridors, without directly measuring this flow. Validation against the expected movement patterns of an event at the Faculty of Architecture and the Built Environment showed the limitations of the system and presented method.

Aknowledgements

The authors would like to thank the anonymous reviewers for their valuable comments and suggestions to improve this paper.

References

- Danalet, A., Farooq, B. and Bierlaire, M. (2014). A Bayesian approach to detect pedestrian destination-sequences from WiFi signatures. *Transp Res Part C: Emerg Technol* 44, pp. 146-170.
- Heijer den, A. (2012). Managing the University Campus: Exploring models for the future and supporting today's decisions. In: *CELE Ex-change 2012/2*.
- Kalogianni, E, Sileryte, R., Lam, M., Zhou, K. van der Ham., M., van der Spek, S. and Verbree, E. (2015). Passive WiFi monitoring of the rhythm of the campus. *Proceedings of the 18th AGILE International Conference on Geographic Information Science*.
- Kotz, D. and Kobby, E. (2005). Analysis of a Campus-wide Wireless Network. In: *Wireless Networks* 11, pp. 115-133.

Meneses, F. and Moreira, A. (2012). Large scale movement analysis from WiFi based location data. In: *Indoor Positioning and Indoor Navigation (IPIN)*, 2012 International Conference on. IEEE, pp. 1–9.

Radaelli, L., Sabonis, D., Lu, H. and Jensen, C. (2013). Identifying Typical Movements among Indoor Objects–Concepts and Empirical Study. In: *Mobile Data Management (MDM)*, 2013 IEEE 14th International Conference on. Vol. 1. IEEE, pp. 197–206.

Spek van der, S. (2008). Mapping Pedestrian Movement: Using Tracking Technologies in Koblenz. In: *Lecture Notes in Geoinformation and Cartography*, pp. 95–118.

Zhao, S., Zhao, Z., Huang, R., Li, S. and Pan, G. (2014). Discovering People's Life Patterns from Anonymized WiFi Scanlists. In: *Ubiquitous Intelligence and Computing, International Conference on Scalable Computing and Communications and Its Associated Workshops (UTC-ATCScalCom)*. IEEE, pp. 276–283

Zhou, M., Tian, Z., Xu, K., Yu, X., Hong, X. and Wu, H. (2014). SCaNME: location tracking system in Wi-Fi environment using unlabeled mobility map. *Expert Syst. Appl.*, (41), pp. 3429-3443