



+

+

+

+

+

+

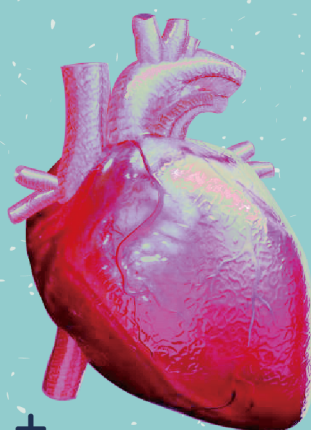

+

+

+

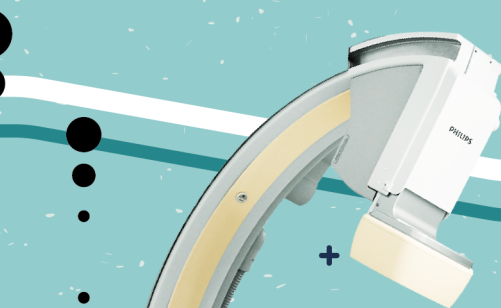

Design For Workflow Intelligence In Cardiology
Prompt User Liaison Service Experience system

Master Thesis by Hao Liu



+

+

+

Acknowledgement

It was an amazing journey.

I want to thank specifically to my supervisor team:

Ruud, thank you for always challenging me to be critical of myself as a designer. Moreover, you gave me the strength to break the myth of being too ambitious. Without your help I would not have completed everything in this limited amount of time while remaining a high quality.

Asli, you are the most considerate and thoughtful mentor I have ever encountered here in TU Delft. Talking to you is like talking to a good friend. Thank you for always supporting me in everything from personal life to this graduation project.

Koen, thank you for all the knowledge in Cardiology and healthcare in general. The open-mindedness of you allowed me to explore this topic freely. I am incredibly grateful to have you as a Philips mentor.

Marleen, having you as a co-mentor to this project is a blessing for me on the design aspect of this project.

Furthermore, I want to thank my colleagues at **Philips Research** and **Philips Design**. I am grateful to have all of you brilliant people sharing knowledge about healthcare and helping me along the project.

Also, I want to thank all the medical professionals from **Leiden University Medical Centre** who participated in my research. The project would not be a success without your insights and feedback.

To my **friends** who accompanied me throughout the journey, thank you all for the mental support and the critical feedback that moved me forward. And lastly, I sincerely thank my beloved **family**.

Preface - Motivation

Some years ago, in 2010, a valuable family member of mine suffered from Cholangiocarcinoma. It does not matter what Cholangiocarcinoma is. It is the change in the perspective of life that affects us. Several years later, I have become more and more convinced of how healthcare has played a critical part in our lives. As designers, we cannot treat people's health. However, as designers, we are capable of stepping our feet in the field of healthcare, and of making people's lives better and healthier.

In the context of healthcare, it is not only the sick people that designers are designing for. Also, for healthy people, for the people who work in hospital systems, health insurance systems, and many more surrounding the healthcare system. The world of healthcare can prosper and harmonize as we are thinking of each segment. This project, formerly known as 'Workflow Orchestration in Cardiology' together with Philips, we hope to bring you inspiration and satisfaction on how we explore opportunities on harmonizing the people who work inside hospital systems.

Executive Summary

Philips

Healthcare institutions are caught in a perfect storm of competing challenges to provide the best possible care for a growing number of patients, while reducing costs and increasing efficiency. While these dilemmas are universal, Philips knows that the problems you face are as unique as the patients you serve. Solving your daily problems calls for an innovative strategy to continuously improve your department and staff. By making your problems our focus, Philips connects expertise and actionable data to inform everyday decisions, from managing your assets to improving quality of care for patients in a secure and compliant manner.

The Challenge

Workflow orchestration in healthcare is a desirable field with massive opportunities. Healthcare providers are under pressure to deliver greater value and even faster than ever before. They have to deliver better care at lower cost while serving more patients. A number of integrated solutions are present in the field. However, the need for the medical staff to get the right information at the right time and the right place is prominent.

An intelligent and integrated solution

As part of the master thesis project, we tackle this problem by addressing the unmet needs from research, and translate them into requirements. The

requirements are the principles that lead to a strategic design solution – PULSE – Prompt User Liaison Service Experience system.

The PULSE system is designed for the Cardiology domain. Further, the target users are in the categories of doctors, physicians and nurses. It helps the Cardiology staff to plan the right actions and make the best decisions. Moreover, it supports the Cardiology staff to collaborate with other professionals more effectively. One way to achieve this, is the ideology of data visualisation. People are visually inclined in terms of interacting with data and information. PULSE provides a superior and intuitive way of interacting with medical information.

Furthermore, PULSE is designed to hover above existing systems in hospitals that integrates information a professional needs. It is believed that PULSE can help in accomplishing effective planning, and ultimately leads to more time in better patient care.

PULSE is not merely a digital product. It is a hybrid of product and service that brings workload efficiency and flexibility to the medical professionals. The vision we have for PULSE is connected well-being. It aligns to the mission of Philips: to improve the lives of billions of people in the near future.

Reading Guide

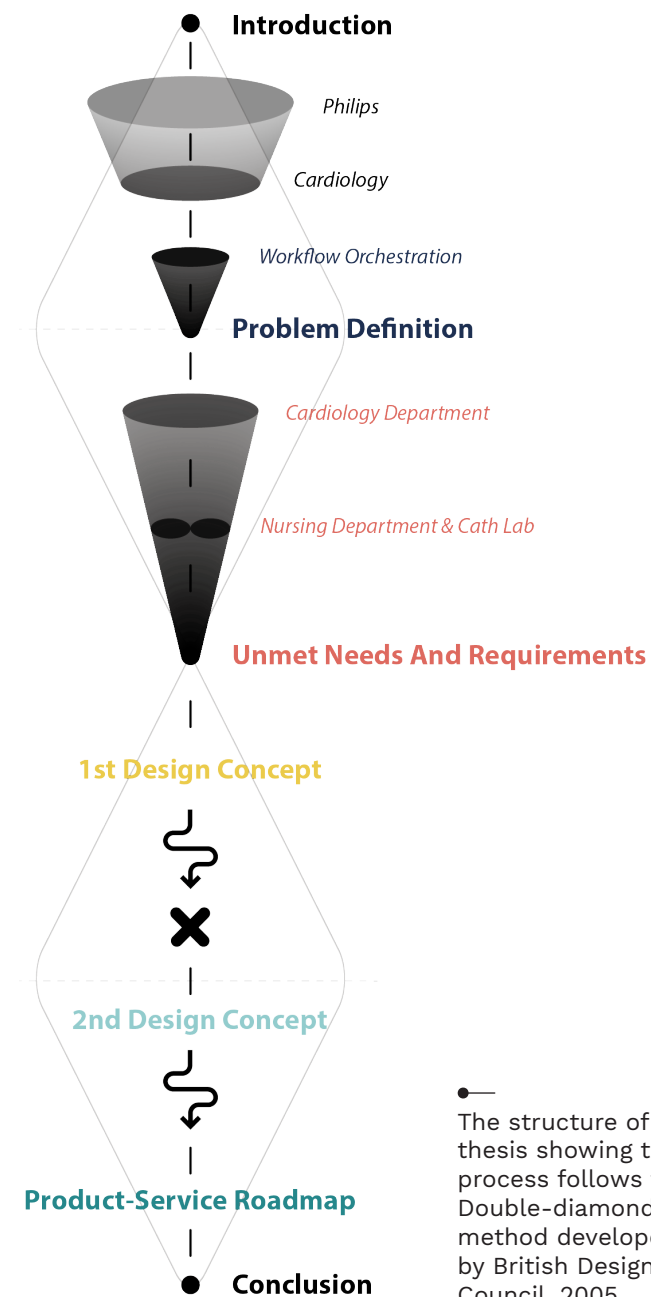

The structure of the thesis showing the process follows the Double-diamond method developed by British Design Council, 2005.

The structure of this thesis is based on 6 main phases. Following the design guideline of the double-diamond approach:

Introduction
Discover
Define
Develop
Deliver
Conclude.

The thesis starts with an introduction about healthcare in general, and how Philips plays a role in the field of designing healthcare solutions. Secondly, the Discover phase discusses what workflow orchestration is and why it is in high demand. Subsequently, elaborate on the problem definition. Thirdly, the Define phase illustrates the focused area within the Cardiology department, and elaborate on the unmet needs and requirements. Entering the Develop and Deliver phase, followed by two iterations of design concepts. The first being to find the right product-service positioning, and the second being to offer a desired product-service direction. Coupling with a roadmap for the product-service offering. The last phase, Conclude, express the limitation and future recommendation for further development. Finally, this phase ends with a personal reflection.

Content

Preface / Motivation
Executive Summary
Reading Guide

Chapter 1 Introduction

1.1	Designing For Healthcare	14
1.2	Philips - Global Leader In Healthcare Philips Research Strategic focus of Philips Cardiology	15

Chapter 2 Problem Context

2.1	Workflow Orchestration Challenges Aviation Industry Existing solution Tools used in hospitals for communication	20
2.2	Problem Definition	29

Chapter 3 Project Focus

3.1	Define Scope Within The Cardiology Department Cardiac Patient Journey Target Group Nursing Department & Cath Lab Vision in patient care	32
3.2	Unmet Needs From The Cardiology Staff	36
3.3	Conclusion	41

Chapter 4 Establish Product-Service Positioning

4.1	Initial Design Concept - Task Management System For The Cardiology Staff Ideation Evaluation	44
4.2	Conclusion	48

Chapter 5 Propose Product-Service Direction

5.1	Secondary Design Concept - Prompt User Liaison Service Experience System Ideation Evaluation	52
5.2	Reasons The Cardiology Staff Are Excited About PULSE Analyse the added value What the Cardiology staff say about PULSE	65
5.3	Conclusion	67

Chapter 6 Execution & Implementation

6.1	PULSE System Roadmap Phase 1 - Connected staff engagement Phase 2 - Connected organisation engagement Phase 3 - Connected well-being Validation	70
6.2	Conclusion	76

Chapter 7 Conclusion

7.1	Limitation Validity and reliability	80
7.2	Recommendation	82
7.3	Personal Reflection	84

List Of Abbreviation
Reference List

INTRODUCTION

1

In this chapter, we will talk about:
The importance of designing for healthcare.
The assignment provided by Philips.
The Cardiology domain in general.

Designing For Healthcare

The modern healthcare industry, one of the world's largest and fastest-growing industries, can form an enormous part of most developed countries' economy. The healthcare industry has been rapidly changing in terms of its technology and service. According to Peter Fitzgerald (MD, PhD), information technology collides with healthcare technology were seen as the most exciting thing that has happened in medicine. Overall, health information technology (HIT) in general and technologies such as electronic health records (EHR) in particular, have the potential to fundamentally transform almost every aspect of health services^[1].

On a societal level, patient-centric and user-centric mentality among organizations are the milestones in the healthcare industry. *"Online personal health records (PHR) has emerged as a patient-centric model of health information exchange. It enables patients to manage their medical records in a centralized way, which significantly facilitates the storage, access and sharing of personal health data."*^[2]

Design for healthcare is a new topic and has not yet been paid much attention in recent years. McCurdy (2016) argues that the need for design and user experience has not fully seeped into hospital culture. Moreover, it often has not been clearly articulated at the highest levels of these organizations^[3]. However, hospitals are looking for ways to provide patients with complete care and profound patient experience. Service design methodology is a decent way to run innovation in healthcare. *"It is a holistic, user-centric approach to create services that are useful, usable, desirable, efficient and effective. Any interaction between a patient and a service provider can be improved by service design methodology."*^[4]

The approach is applicable across healthcare organisations to improve service delivery. On the other hand, these organizations are also looking for ways to improve their staff experience. Many have clinical leads dedicated to increasing their staff working efficiencies and flexibilities, thereby mitigating problems of experiencing stress and burnouts.

—●
Health-CPS:
Health
Cyber-Physical
System

Philips – Global Leader In Healthcare

Philips Research

Philips Research is a global organization with research departments in Europe, North America, Africa, Asia and South America. It helps introduce meaningful innovations that improve people's lives and provide technology options for innovations in the area of health and well-being, targeted at both developed and emerging markets. Positioned at the front-end of the innovation process, Philips Research works on everything from spotting trends and ideation to proof of concept and – where needed – first-of-a-kind product development.

Philips Research in health solution services is strong and competitive in the market of:

- Radiology - Imaging and services
- Cardiology - Equipment and services
- Intensive Care Unit - Equipment and services

Strategic Focus Of Philips

"At Philips, we are striving to make the world healthier and more sustainable through innovation, with the goal of improving the lives of 3 billion people a year by 2030."

In today's increasingly connected world, the convergence of Philips' consumer technologies that facilitate healthy living, medical technologies that help clinicians to deliver better diagnosis and treatment, and cloud-based technologies that support data sharing and analysis, will be a key enabler of more effective, lower-cost integrated health solutions.

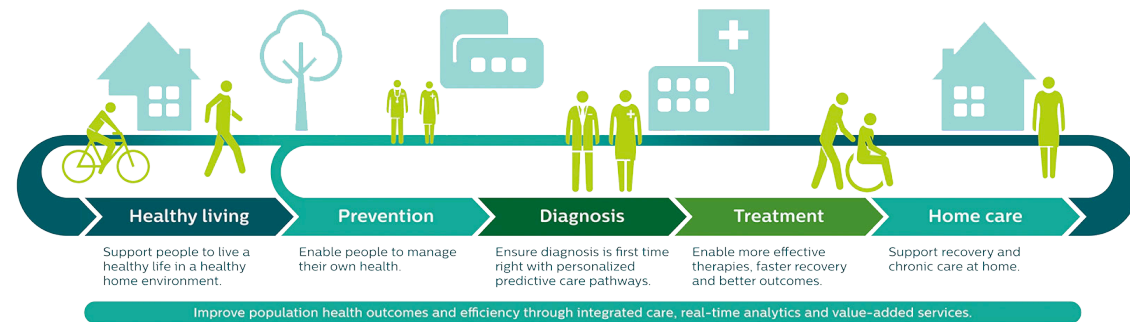

Figure 1.1
Philips Health
Continuum.

cc Philips

By addressing healthcare as a 'connected whole' in the health continuum (Figure 1.1), Philips unlock gains and efficiencies and drive innovations that help deliver on the **'quadruple aim'**: enhancing the patient experience, improving health outcomes, lowering the cost of care, and improving the work life of care providers.

Cardiology

The world of interventional cardiology, like any medical field, is at the cutting edge of on-going medical innovation.

In Cardiology, cardiovascular disease now heads the World Health Organisation list of biggest killers in the world and is rapidly increasing in prevalence. On the face of it, cardiovascular disease should be ideal for developing innovative models of care that will improve the well being of the population and the sustainability of their healthcare systems^[5]. On the other hand, cardiology staff, among other medical specialists, 43% have reported evidence of burnout. A survey showed that 13% of cardiologists experienced depression as well as burnout. Among those who reported depression, one-third stated that they were more easily exasperated by patients (33%) or less engaged with them (32%) as a result of their depression. Interactions with colleagues and medical staff are also affected. *"Doctors are reporting that they are spending more and more time dealing with computers and documents, and less time interacting with their patients and practising medicine."*^[6]

Today hospitals (Cath Labs) increasingly perform a critical balancing act between opposing demands. On the one hand, there's a growing and aging co-morbid patient population who need and deserve the most advanced cardiology care. On the other, a growing list of regulatory demands, legislative changes, staffing challenges, and technological advances to keep track of – as well as increasing cost pressure. With such constraints on time and resources, it can be a challenge to drive day-to-day operations, while at the same time plan the long-term strategy necessary to continue to deliver consistent, high quality care.

Not connected and with multiple data entry points – the potential for human error is greater. One important step is the development of **integrated solutions that streamline workflow and make procedures easier**. Most cath labs (the examination rooms in a hospital or clinic with diagnostic imaging equipment) contain numerous devices, each with different wires and user interfaces, backed up with hardware from different databases. Integrated solutions will help streamline this workflow, making it more efficient for a physician to perform a procedure and sign off on a clinical report.

Figure 1.2
Philips Research
Eindhoven.

© Norbert van Onna



2

PROJECT CONTEXT

In this chapter, we will talk about:
Workflow Orchestration, what is it?
Problem definition

Workflow Orchestration

We understand how streamlining workflow is crucial in the Cardiology domain, and the need for integrated solutions is desirable. Before going into solutions for workflow orchestration, we will first explain to the reader what the challenges are in orchestrating staff workflow in a hospital context.

Challenges

In hospitals, people and systems work together on tasks along a process. As referred to a Philips employee, a process comes from a higher organization (WHO) guideline. Also, it may deviate from the guideline, meaning that each hospital has its way of performing tasks with their workflow. Workflow, loosely defined, is the set of tasks - grouped chronologically into processes - and the set of people or resources needed for those tasks, that are necessary to accomplish a given goal^[7].

Organizations are continually seeking efficiency improvements for their business processes^[8]. Figure 2.1 shows that there is a mutual phenomenon across most hospital departments in a typical workflow: friction caused by suboptimal processes.

We address four important elements to give the reader an idea on what the frictions are:

- **Disempowered staff** - There are two reasons that the staff feel disempowered in their work. Firstly, the staff are busy in the sense that there is limited interaction with other healthcare professionals and the decision-making process. And secondly, the staff are restricted by guidelines or authority from other professionals. For instance, bedside nurses often disconnect from patient discharge planning. Thus, they are implicating the quality of care and nursing work.



- **Process deviation and variation** - Unexpected things are happening despite existing process guidelines. Emergency cases are always unexpected and with high urgency. Moreover, there are exceptional clinical cases that unpredictable things may occur, which affects both the clinician and the patient.

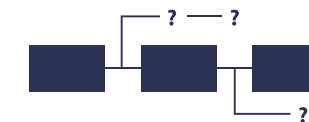

- **Organisation silos** - There is limited interaction between staff and limited integration between systems that people across departments have trouble aligning with each other.



- **Documentation burden** - Doctors and nurses spend a considerable amount of time doing paperwork and administrative work. It should be that the medical staff spend more time to provide genuine care for patients, rather than documentation tasks.



Get Inspired By The Aviation Industry

We were curious to see how the other industries deal with the optimisation of staff workflow. We were fascinated by the harmonious order of the airport crew as well as the airline crew. How do they ensure a seamless passenger journey with the staff involved in the process?

We interviewed Prof. Sicco Santema from TU Delft to discuss workflow orchestration in the aviation industry.

How do staff and IT systems communicate with each other? *"They received information from the headquarters where they do planning and advice instructions. There is information the staff 'need to know', which sent via direct message. Also, there is information that is nice to know, which are information coming via channels like websites, apps, and news"*, he said. Systems, on the other hand, are people-based design. There is no hierarchy between systems. It is, however, possible for the communication department to set rules for the hierarchy of systems.

Information overload and channel overload are the main obstacles the aviation staff are experiencing.

A surprising fact about the usage of apps: 30+ apps developed by the organisation, but the crew members use only 4 of them.

These factors result from confusion for the crew members. The same information sends through different channels, and the same information displays differently through different channels. The confusion can cause the crew members to choose to ignore or to neglect the pushed message, and therefore, they miss some vital information. A solution is needed to cope with the issue that the crew members need the right information at the right time.

It is surprising to see that the healthcare industry is experiencing somewhat the aviation industry is experiencing.

Figure 2.1
Example:
Flight planner.

© Weather & Aviation, Inc.



Figure 2.2
Example:
Checklists.

© RioPatuca Images



Figure 2.3
Example:
Digital Control
Tower.

© NATS & London
City Airport

Both industries acquire multiple services to serve different needs for their staff. Both use a lot of 'checklists' to make sure things go right to avoid mistakes. However, there is not yet an integrated system that works perfectly enough to give only the right information at the right time and place. It is good to keep in mind that in the healthcare industry, clinical staff do not have that many apps and channels as the aviation staff do. The clinical staff do, however, have all the healthcare information stored 'somewhere' in the hospital databases. The trick then is how to extract accessible information, and transform them into usable data to further use to orchestrate clinical staff workflows.

Existing Solutions For Workflow Orchestration In Healthcare

Several solutions for workflow orchestration are present in the healthcare industry. We explain to the reader with three prominent examples of integrated solutions for workflow orchestration.

—• AUTOMATION

Current automation often does not fit the clinician workflow. Sutherland and van den Heuvel (2006) stated that in a perioperative setting, hundreds of patients and staff might be flowing through dozens of operating rooms daily in a single facility. One-third of the patients are unscheduled and identified only on the day of surgery.

On the technical aspect, the orchestration of behaviour between information systems is ad-hoc and paper-based. Computer systems are dedicated to isolating operations or departments (organisation silos) with no computational means to communicate with one another. A deeper problem is that the majority of clinical decision support (CDS) systems are failures or underutilized because of an impedance mismatch between the analytical, linear process forced on clinicians by automation.

"New strategies are needed for intelligent automation in healthcare organizations to save time and resources, accelerate throughput, enhance patient safety, and improve outcomes."^[9]

Therefore, the need for workflow orchestration in hospitals is gaining traction in the healthcare setting. Healthcare professionals are asked to tackle the problem of doing more with less^[10].

—• DYNAMIC WORKFLOW

A well-thought workflow process can accommodate variations that inevitably arise in healthcare through interaction, not only with other workflow processes, but also with environmental factors, such as workload, staff schedules, and patient load^[11]. Change and time are the two main elements that make workflows dynamic. In other words, the most complex dealing of workflow instances is, process change and

time management^[12]. Dynamic workflows are introduced to orchestrate and automate critical process steps.

Dynamic workflows are specific tasks performed in various care settings, which are sequentially linked together and automated based on real-time data. Dynamic workflows run across the care continuum. It must be 'process-aware' in order to glue all existing healthcare IT technologies and other critical emerging technologies together. Into available and scalable workflows that serve patients and healthcare professionals.

Figure 2.4
Tracebook:
Checklist process.

cc TU/e, Philips
Research.

Tracebook (Figure 2.4) and the Stroke Communicator (Figure 2.5) are Philips' prominent examples in dynamic workflow orchestration. With the former proposition in reducing clinical failures, enabling empowered team decision making, and the later in reducing Door-to-Balloon time.

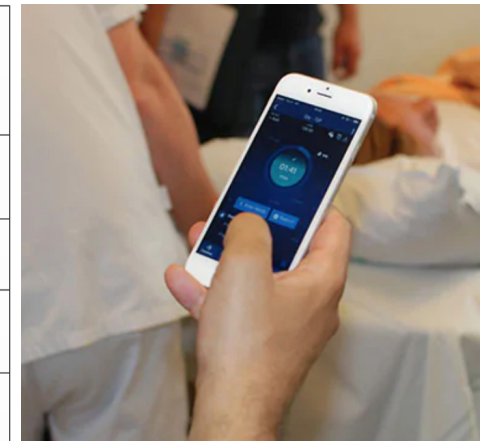
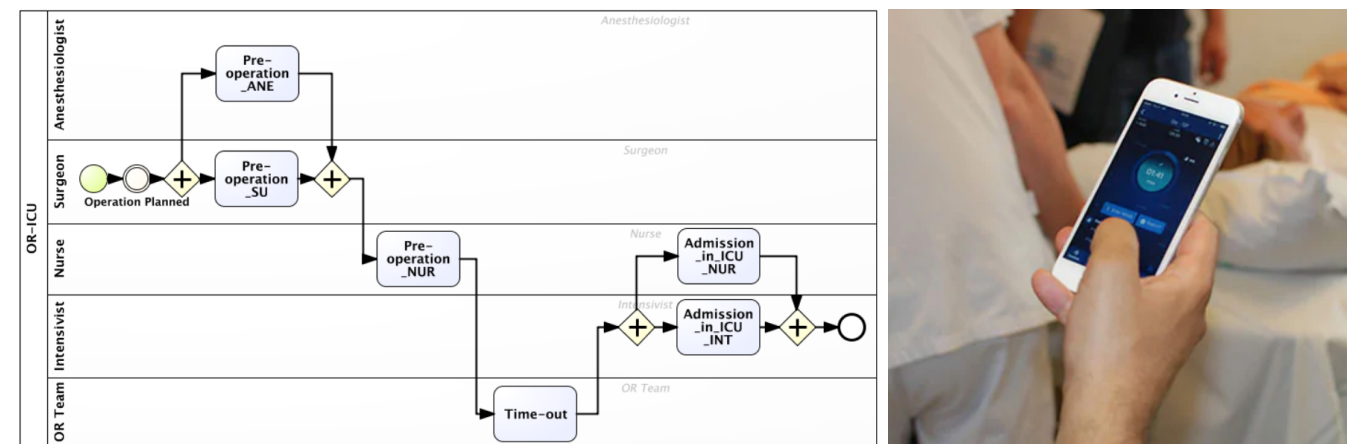

Figure 2.5
Stroke
Communicator.

cc Philips Research.

—• SYSTEM OF ENGAGEMENT

The term 'System of Engagement' only entered the lexicon in 2011 (Moore). According to Toelle (2019), System of Engagement provides the toolset for people within the organisation to collaborate, complete business processes, store data, or whatever else their jobs require. A System of Engagement could potentially increase productivity and to create additional value from organisation information assets^[13]. Moore (2011) proudly suggests that System of Engagement is the next stage of enterprise IT. He boldly declares that organisations who do not grab onto this new communication and collaboration system will end up as roadkill^[14].

System of Record, on the other hand, is known as the enterprise IT 1.0. According to Bersin (2012), they are the ERP-type systems that organisations rely on to run business (financials, manufacturing, CRM, HR). It is the legal, auditable system that tracks records, categorises them according to the file plan. They have to be 'correct' and 'integrated', so all data is consistent. Moreover, they were traditionally designed for people who have no choice but to use them^{[15][16]}.

EHR, for instance, is System of Record. The main difference between System of Record and System of Engagement is – EHR is only capable of capturing and storing the mass information that is needed to create a more efficient and effective healthcare system. However, it is not capable of driving the transformation on its own. It is the System of Engagement that makes its transformation actionable.

System of Engagement overlays and complements System of Record. It allows users to share and collaborate on mission-critical information in real-time.

In healthcare, CEO of LiveData, Jeff Robbins (2018) concluded that System of Engagement could mitigate the regulatory and safety burdens on System of Record. It allows for more rapid testing and targeted performance improvement initiatives^[17]. Furthermore, it transforms into an easy to understand format that synchronises with workflows and delivering it to patients and providers wherever they are^[18].

Tools Used In Hospitals For Communication

We know several solutions for workflow orchestration, and now we explain to the reader of the tools that are used for communication (Figure 2.6). In general, the **electronic medical record** (EMR) is the most radical element of a hospital IT system that connects almost every other equipment or systems in a hospital, across departments and across different hospitals.

Figure 2.6
Tools used in hospitals in the Netherlands



Mobile applications and computer softwares are frequently used in hospitals for information and data sharing among other professionals. Moreover, several applications support the staff internally in messaging and online communication. Therefore, applications and softwares are seen as a community-based platform for the medical staff.

Websites, on the other hand, are knowledge-based tools for communication. Staff visit websites for support in, for instance, guidelines, protocols, regulations for medicine.

Electronic devices are frequently used by clinicians. Computer hardwares include desktops and equipment in wards and Cath labs. As for portable devices like mobile phones, tablets and wearables, the amount of use is increasing more and more in hospitals. However, there is conflict in safety issues, security issues, and sterility issues (especially in the OR). Lastly, fax machines, yes, hospitals still use fax machines.

Other tools are **non-digital products**, for instance, whiteboards, paper checklists, post-it notes. They are essential because they are the ones that are the easiest to use and they are as direct as verbal communication.

Problem Definition

Healthcare is rapidly changing; hospitals and care providers are being held more and more accountable for their performance. Not only for the quality of care, but also for reduction of costs, and improving the patient and staff experience. To improve the care process, Cardiologists and Cardiology staff need the right information at the right time at the right place. To make the best decisions, plan the right actions, and collaborate more effectively.

However, current products and systems in the Cardiology department do not support them in getting their clinical tasks done most efficiently. They certainly do not have the flexibility to manage those clinical tasks of themselves and the others. Because of insufficient autonomy in the way they work and the lack of usable data to plan the next best actions. This dilemma could result in spending more time doing less quality work and eventually leads to burnout.

In response to this problem, our design research proposes to investigate several options for making the staff workflow more engaging for the user and more orchestrated on their care process. We plan to carry out a comprehensive participatory investigation into their pain points and needs then translate into requirements. We will also consider less expensive ways to fulfil the needs mentioned above.

Therefore, the aim of this project is to design a product-service offering that:

Gives the right information at the right time and place. Helps the Cardiology staff to make the best decisions and plan the right actions, and help them collaborate more effectively.

3

PROJECT FOCUS

In this chapter, we will talk about:

The area we focus on within the Cardiology department.

Vision of the Cardiology staff

The unmet needs and requirements

Define Scope Within The Cardiology Department

The Cardiology department is too big and complex of a domain for a master graduation project to cover. In this sub-chapter, we will define the scope by deciding on two important segments in the Cardiac patient journey for this project.

Cardiac Patient Journey

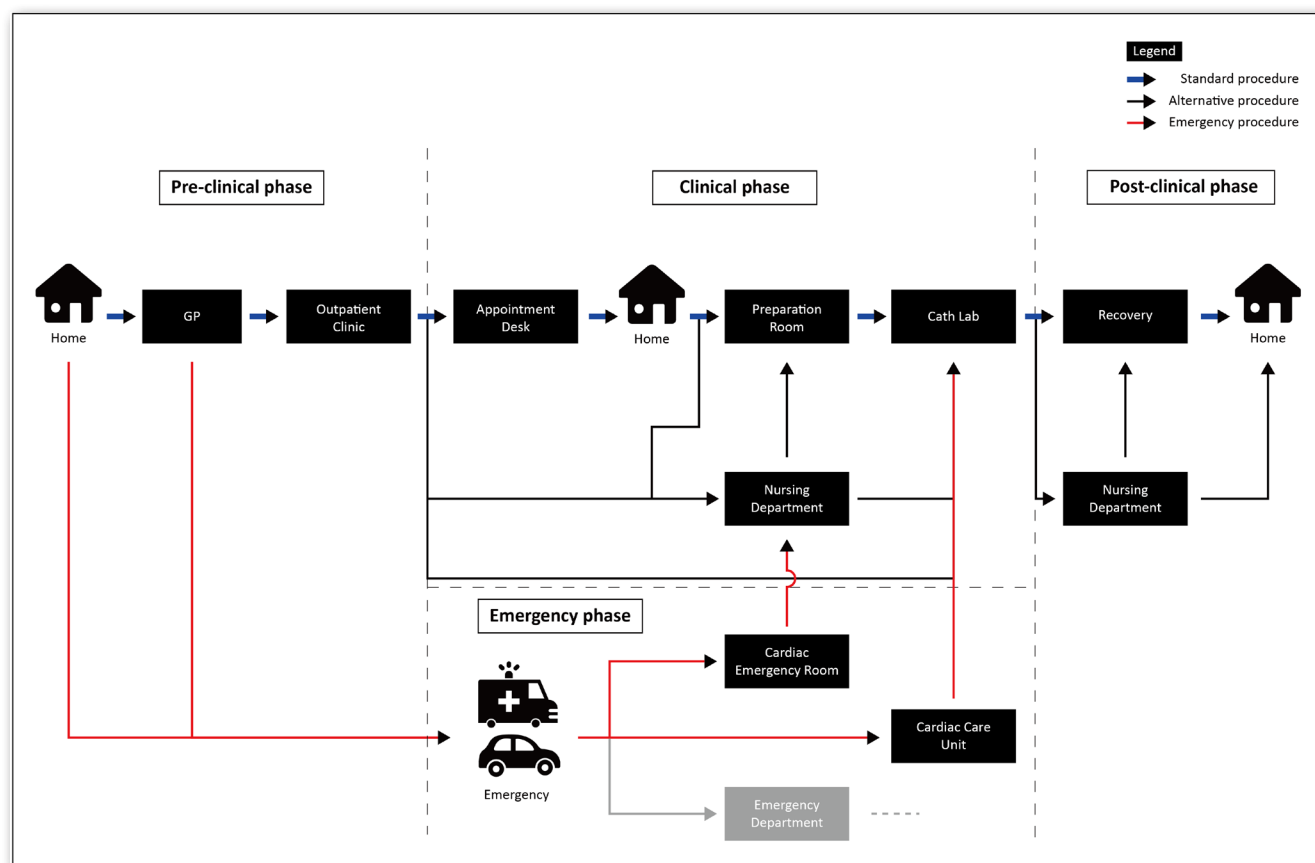

Figure 3.1 Cardiac patient journey.

First and foremost, we map out a cardiac patient journey to understand how a patient would go through a treatment process. Figure 3.1 shows how a cardiac patient experiences through their journey from leaving home and back to home. We validate this graph based on the input from a resident doctor from LUMC and a reference source from a Philips employee.

Target Group

Figure 3.2 Interviewee and observee.

We contacted with people across organisations in Philips, LUMC (academic hospital) and Elisabeth-TweeSteden Ziekenhuis (peripheral hospital). From which we selected eleven personnel (Figure 3.2) as interviewees and observees whom all have expertise and experience in the Cardiology domain.



We pay special attention to the categories of physicians, doctors and nurses because they are the ones who collaborate closely together towards the same goal: provide care and treatment for patients. Moreover, to discharge patients back home, safe and sound.

Nursing Department And The Cath lab

In the Cardiac patient journey, we spoke individually with people who play a role in the outpatient clinic, nursing department, CCU and the Cath lab. Moreover, we spoke individually with Philips employees who know the general workflow of the Cardiology staff and the implementation of clinical applications in a hospital. Furthermore, we performed on-site observations in the outpatient clinic, Cath lab, and the nursing department.

From the qualitative data and the observation data, we map out the journey of stakeholders (Appendix. H) from the outpatient clinic, nursing department and the Cath lab.

We have identified the 'nursing department' and the 'Cath lab' are in the most need for workflow orchestration solutions.

Evidence is that the nurse practitioner in the outpatient clinic has less interaction with other professionals than the other two. Also, the current system from announcing patients to diagnose patients works pretty well. Staff in the nursing department works in higher pressure that they have to be constantly alert of patients, and requires much teamwork. Moreover, the logistics of patients transferring from the nursing department to the Cath lab requires effective communication.

Therefore, the two have the most potential and the highest value for design opportunities.

Figure 3.3 & 3.4
LUMC hospital and
ETZ hospital



Figure 3.5 & 3.6
Nursing department
environment
& the Cath lab
environment.

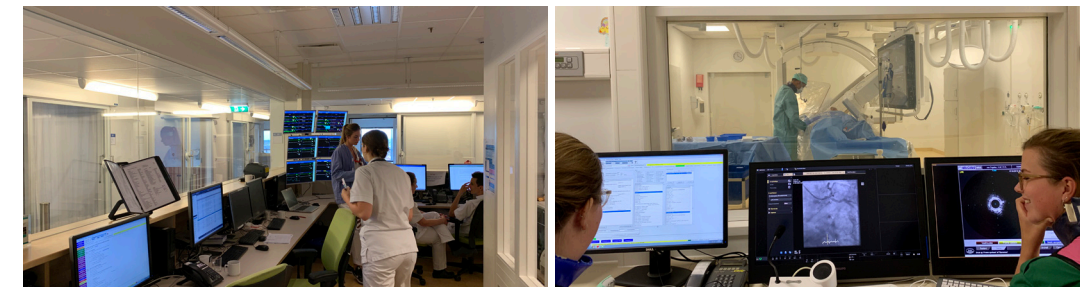

cc LUMC.

Vision in Patient Care

Before going further into the needs and requirements from the staff in the nursing department and the Cath lab, we want to bring up what the Cardiology staff we interviewed envisions their future of patient care:

- In the future, video consulting, so-called telemedicine, will play a vital role in patient-doctor interaction. Patients would only have to come to the hospital once for the test, go home, then have the online consultation to discuss the results.
- The next revolution in mobile strategy will change the way clinicians bring together the elements of communication, technology and security to patient care. They foresee a future where wearables, tablets, even glasses will be at-hand, whenever they need access to data.
- Network medicine and online coaching from hospital-patient-GP will allow seamless contact with everyone involved. The role of a hospital will 'not just being in the castle and throw people out of it'.

In Chapter 6, we will explain more in detail of a product-service offering and its roadmap with the vision involved.

Unmet Needs From The Cardiology staff

In order to articulate the unmet needs and requirements to the reader, we combined the problems and needs mentioned by the interviewees to create a scenario (Figure 3.5) with incidents that would potentially happen. As part of our service design approach, we created a service blueprint that includes stakeholder activities, their unmet needs and requirements and potential solutions (Appendix. J), which helped us to list the needs and requirements from the scenes.

Figure 3.5
Brainstorm current scenarios



We gathered seven high-level requirements from the 'unmet needs' that a system should potentially solve, and to eventually orchestrate staff workflows. The purpose of listing these high-level requirements is to measure the successfulness of our proposed design solution in the later stage of this project. Next, we will explain the unmet needs and requirements following the scenes.



- Night shift nurses brief morning shift nurses about patient status: New cases, DNR, outbursts.

- ⚠ Doctor's schedule rotates a lot. Nurses could have prepared for the next morning briefing section if they already knew who the doctor is for that day.

- ⚠ Staff who is not present because of punctuality issues or running other errands would be disconnected with the discussion and loses information from the conversation.



- Morning shift nurses explain the patient status and discuss with the doctor. The doctor makes decisions accordingly, gives orders to the nurses.

- ⚠ Knowing the medical details of patients earlier would benefit the doctor from being prepared for the briefing section and the patients.

- ⚠ Currently, the clinical tasks for the nurses are written down on their paper notes or similar kind. It could easily get lost or damaged.

- ⚠ Patient data scatters around the EMR system. Doctor and nurses want to have a 'visual aid' of a precise and straightforward overview of patient medical details.

1 Key Requirement 1: To be **context-aware** of the situation happened about patients, even if the personnel is not present. To have a **head start** at the beginning of the day.

To be context-aware means to know what is going on in the environment and adapt to behaviour. Moreover, a head start means the

advantage of getting all information in advance the personnel needs to act upon.

2-1 Key requirement 2: To establish **teamwork** and support in **decision-making**.

Doctor and nurses work as a clinical team when it comes to patient care and treatment. Teamwork is, therefore, essential in order to make the best decisions.

3 Key Requirement 3: To have **accessible and usable data** with **high mobility**.

Data is always available, stored in the databases of the hospital IT infrastructure. However, having data for the staff to easily have access to is a challenge. Moreover, the extracted data that is accessible should be meaningful in a way that it affects decisions or planning. High mobility means to carry the data wherever a staff is, whether it is on a phone app or wearable devices.



After the morning briefing, each staff works on their tasks. Nurses study the digital nursing report written by previous shift nurses, to update on patient history and patient status. The doctor checks on lab results and makes a list of problems to solve.

EMR systems have all the medical details of a patient. However, there is only some of the information the staff always looks at, which causes the staff to take extra effort to get the right information.

Patients often take lab tests from other departments in a hospital. However, the staff do not get notified when there is a new lab result ready in the system.

It is essential not to make the lives of the staff harder. A potential new support system should be intuitive and easy to use. Also, it should not change how the staff perform their work.

Nurses do regular rounds and visit patients, to make sure patients are well. Moreover, nurses would perform regular tasks, such as recording daily weighing, fluid intake, fluid output, medication.

A system could help the nurses do nursing work more thorough, by friendly reminding them to do specific tasks, such as prescribing medication periodically.



4 Key Requirement 4: To classify the **urgency of tasks** and **plan the right actions at the right time**.

Tasks range from emergency cases to regular routines. The time to solve emergency tasks is always 'now'. Regular routines are essential, but the time to do those tasks depends on the queue of other tasks. Therefore, a system might help in pushing notifications that specifies the actions the staff must take.

5 Key Requirement 5: To be **proactive** to interact with passive information and **reduce information overload**.

Passive information such as lab results, relevant emails, messages, newsletters, requires the staff to read them thoroughly in order to be updated. However, similar to the aviation staff mentioned in the earlier chapter, be aware of information overload that would possibly lead to stress and burnouts.

6 Key Requirement 6: To **have control** over their working habits, with a **short learning curve** to operate and manage a new system.

A newly introduced system has to provide the staff with the autonomy to manage their workload and tasks. Furthermore, a short learning curve concept means the user can learn in a short time, with intuitive functionalities and to the point.



10:00
Clinical Rounds

- Doctor together with nurses visit patients one by one. Doctor talks with patients, and knows the prescription a patient needs from the conversation. Subsequently give instructions and orders to the nurses.
- ⚠ For doctors, patient problems are currently written down on a piece of paper or by memorising. It would easily get lost or be forgotten.
- ⚠ For the nurses, sometimes they would not get verbal orders directly from the doctors during clinical rounds. Moreover, sometimes the doctor would not get back to them with new orders.

2-2 Key requirement 2: To establish **teamwork** and support in **decision-making**.

Doctors, nurses and patients are involved in clinical rounds. Sharing prescriptions and orders help boost connection amongst all parties. A platform for information sharing would be ideal.



15:00
Cath Lab Procedure

- The Cath lab nurse announces the scheduled patient and prepares for the procedure. The ward nurse (or the CCU nurse) brings the patient down to the Cath lab. Also, the physician studies the case before the procedure. The Cath lab nurse then hands over the patient after completing the procedure.
- *For emergency patients coming from the ambulances, they are sent to the Cath lab directly from the Cardiac emergency room or directly from the ambulance. Also, they will be treated first when there is confliction between a scheduled procedure.
- ⚠ In the Cath Lab environment, the physicians (cardiologists) want to have as many patients treated in a day as possible, in order to reach the maximum production rate of treatments. Therefore, real-time planning is crucial.

7 Key Requirement 7: To be **flexible** on the fixed schedule from both the personnel and its context, and to be adaptable to **plan the right actions**.

Cardiologists in the Cath lab need the flexibility to maximise the effective use for the cath lab rooms. Having a visual overview of patients details, staff agenda, room availabilities and the on-going progress of procedures is essential. A supporting system adapts to the changes in real-time planning. Moreover, it should give the right suggestion to support the user to make decisions.

Conclusion

This chapter explained to the reader how we choose to focus on the doctors, nurses, physicians from the nursing department and the Cath lab environment. We derived from the unmet needs and defined seven key requirements as the foundation for the concept design. In the next chapter, we will explore the product-service positioning with our first design concept.

ESTABLISH PRODUCT-SERVICE POSITIONING

4

In this chapter, we will talk about:

Our initial design concept.

From ideation, to prototype, to evaluation.

The reason it does not work, and how we start from a different direction.

Initial Design Concept – Task Management System for The Cardiology Staff

One way to address the needs and requirements mentioned by the stakeholders is through a smart task management system.

Ideation

The design idea is to build a smart task management system as an independent software. The system aims to orchestrate a user's workflow by allowing them to manage multiple tasks. Any notification sent from the system is labelled as 'tasks'. Also, tasks can be assigned by other users or suggested by the system. We expect the user to act on the tasks while they see them.

Further, we ideate on a dashboard that provides users with an overview of the essential information they need, including tasks, messages, news and updates, all in one screen.

During the night, the night shift nurses will be asked to report critical incidents, such as bleeding, resuscitation.

A digital checklist assists the nurses to report the medical details.

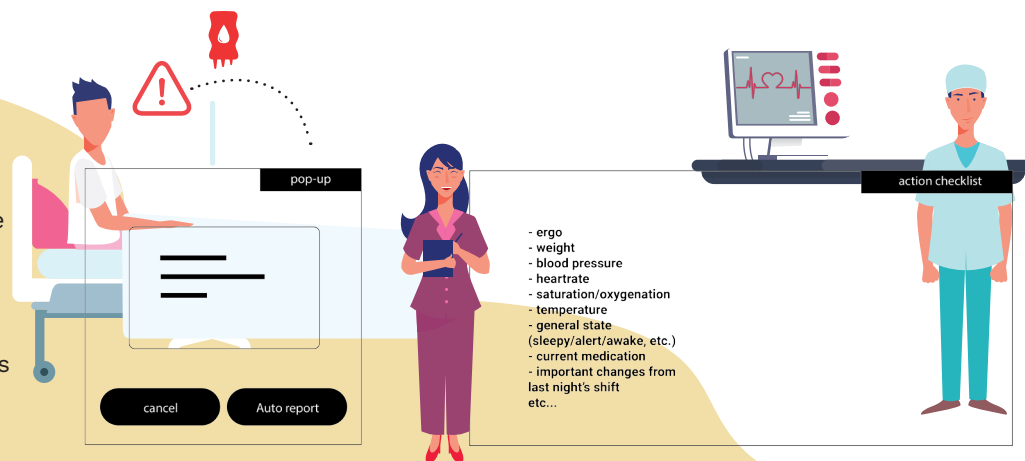

The morning shift doctor wakes up in the morning. His phone or tablet will show:
 1. No critical report from last night, or
 2. New critical cases that need attention.

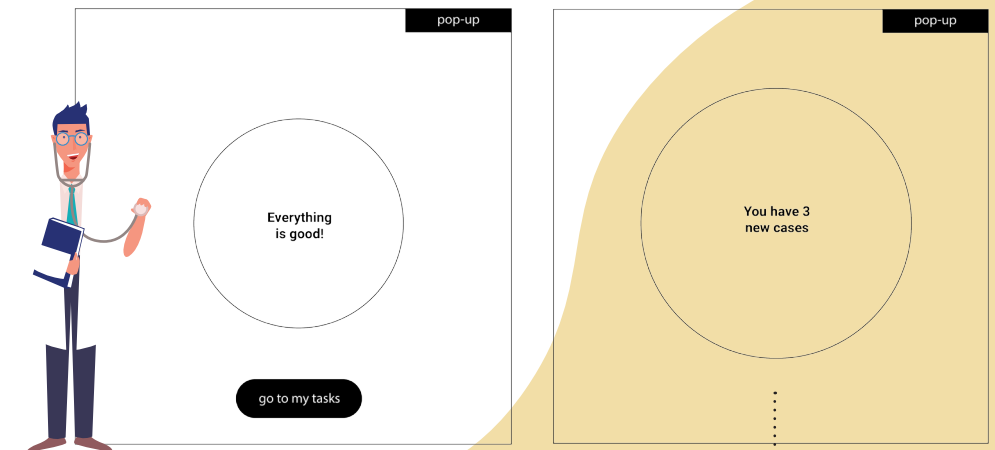

For new critical cases, the doctor will see a brief auto-generated by the system, about what happened from last night.



Time duration since the case is created.

If the doctor feels there is need to take another extra action, such as request a new lab test. Simply assign a task to a colleague.

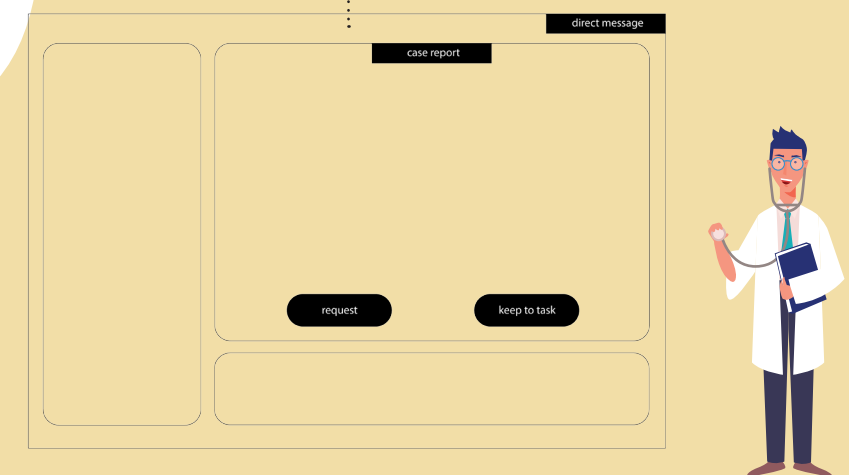

This dashboard contains six blocks of information in one view. The main functionality is in the 'task & agenda' section. Within this section, the user will have a real-time to-do list, consists of important tasks and regular tasks. Assign tasks to anyone, and resolve the remaining tasks; managing clinical work has never been this easy!

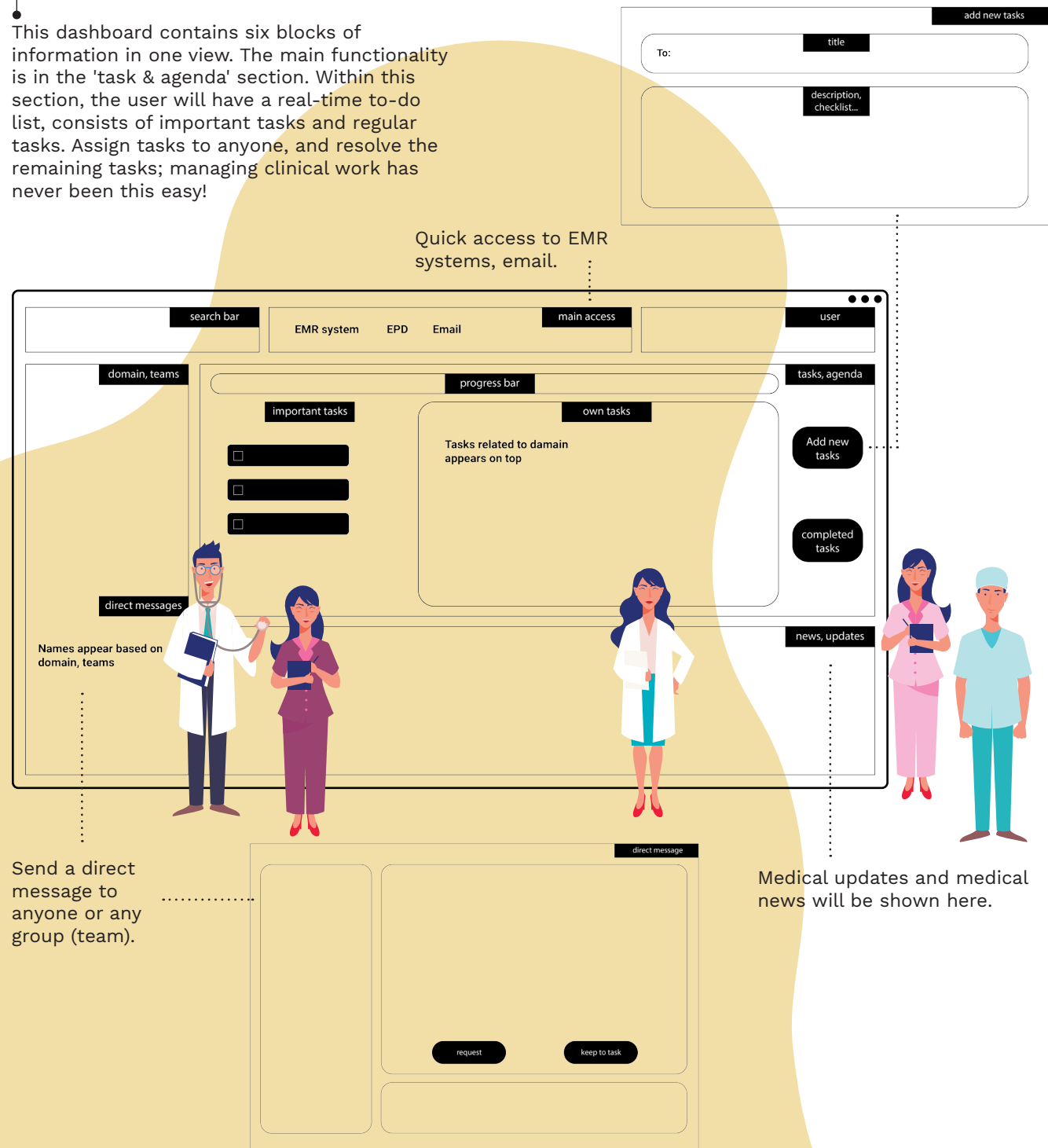

Evaluation

We conducted several individual interviews with the participants to get heuristic feedback on our initial design concept.

We analyse feedback with Figure 4.1 by addressing the 'action' factor (x-axis), which are the things they do, as two bipolar: a task-oriented action and a time-oriented action. Within these actions, we address the 'information' factor (y-axis), meaning how they handle information, as the other bipolar: to proactively manage information and to interact with prompted notifications.

We concluded that some participants, especially the nursing staff, find the dashboard useful because it gives a clear overview of what they should do, and when they should do it. They particularly like the idea of prompting notifications and reminders without affecting their work. However, Figure 4.1 tells us what the overall staff need is not a system to manage tasks. They, however, prefer a smart system that makes sure they do not miss out any vital information while working (Task-oriented – Notification). The top right corner indicates their need to flexibly manage their workflow by being aware of every other colleague's workload (Time-oriented – Management).

Figure 4.1 Initial design concept analysis

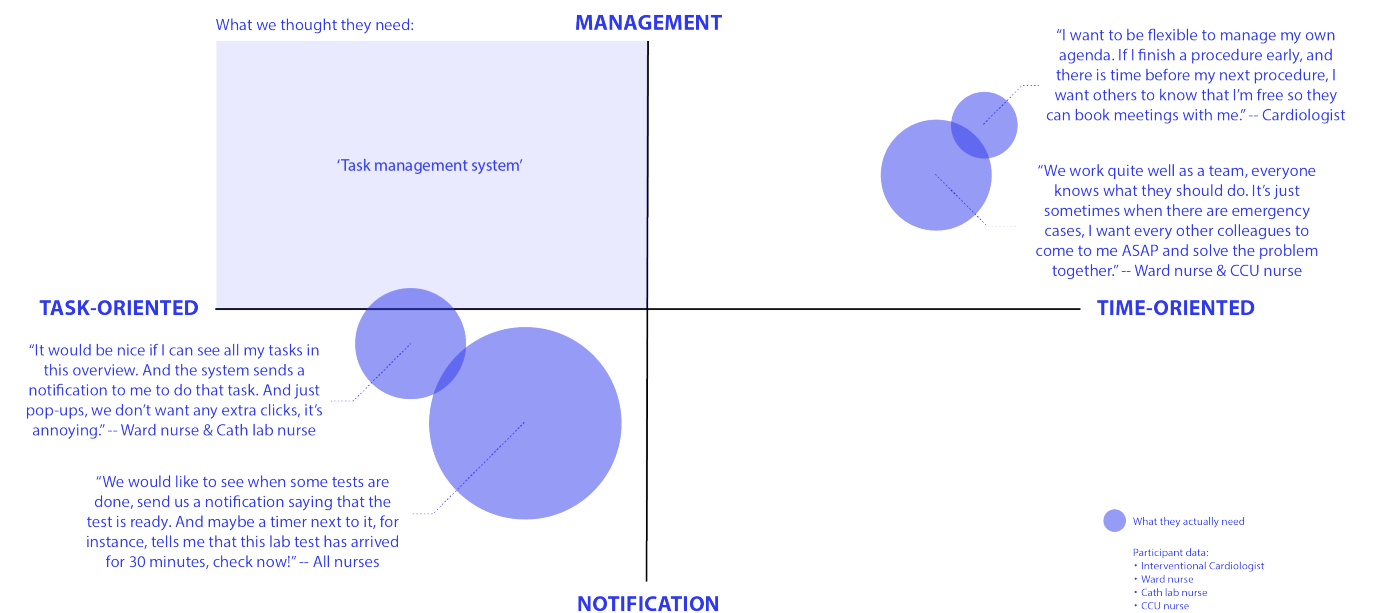

The staff do not see our proposed concept as a 'must-have' to orchestrate workflows. Therefore, we understand clearly that a concept like 'Slack or Trello for the medical professionals' is not desirable. It would be desirable to have a more straightforward, smarter, and more intuitive system. This insight is fundamental for our next concept iteration.

Conclusion

This chapter explains to the reader the first design concept as a smart task management system. The medical staff in Cardiology prefer a system that provides a clear overview of clinical information and flexibility in their workload. Therefore, a task managing system is not desirable. The first design concept was used to define the positioning in the Cardiology market. We have eliminated the option of designing a task management system for the Cardiology staff. We, however, kept the design elements of prompting notifications and reminders and apply to our next design concept. The feedback of this concept is used to propose the second design concept.

PROPOSE PRODUCT-SERVICE DIRECTION

5

In this chapter, we will talk about:

Our secondary design concept.

From ideation, to prototype, to evaluation.

Refining the key requirements.

The reasons the Cardiology staff find useful and like about.

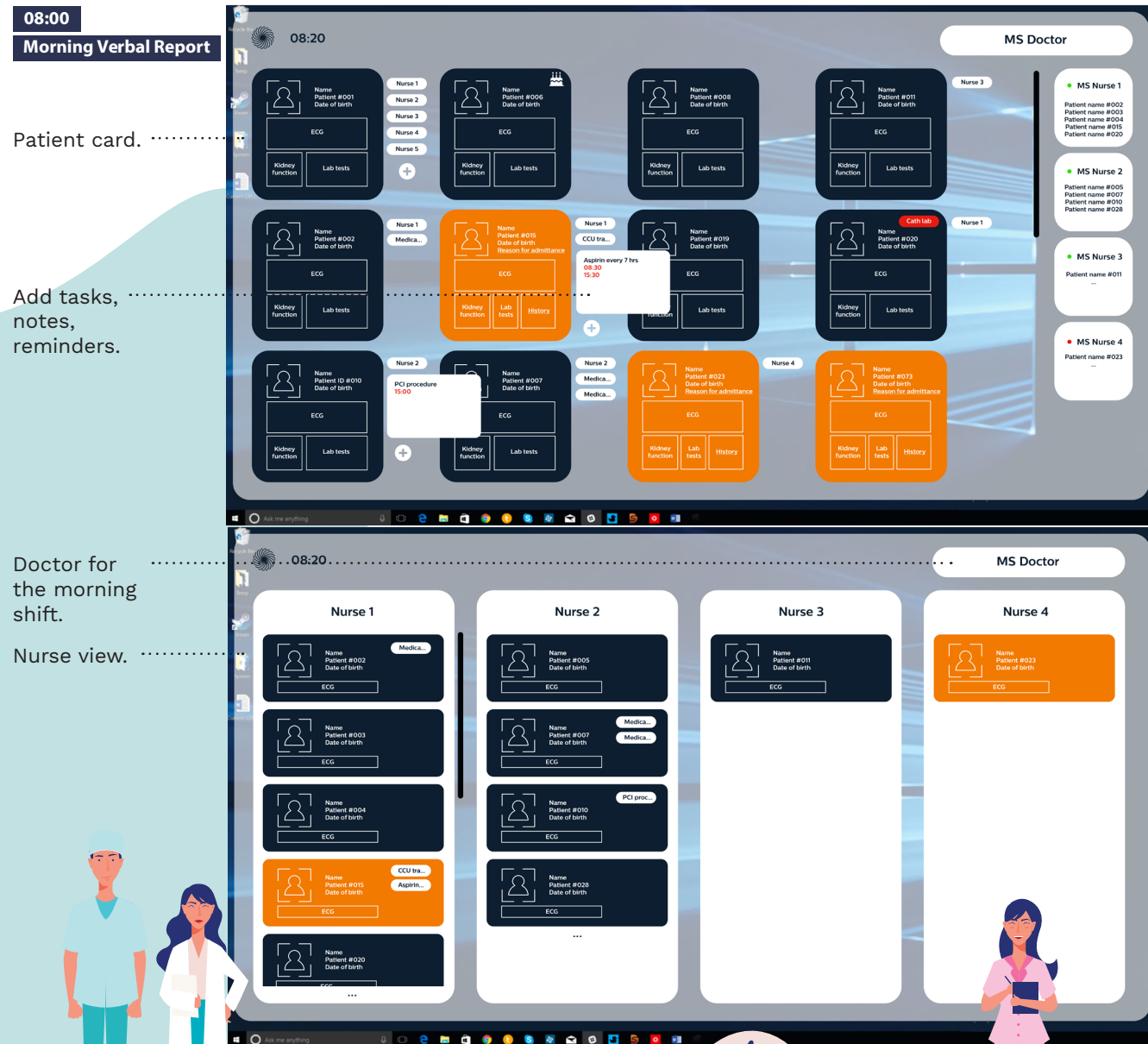

08:00
Morning Verbal Report

Patient card.
Add tasks, notes, reminders.

Doctor for the morning shift.

Nurse view.



* MS Doctor:
Name of the morning shift doctor.

* MS Nurse:
Names of the morning shift nurses.

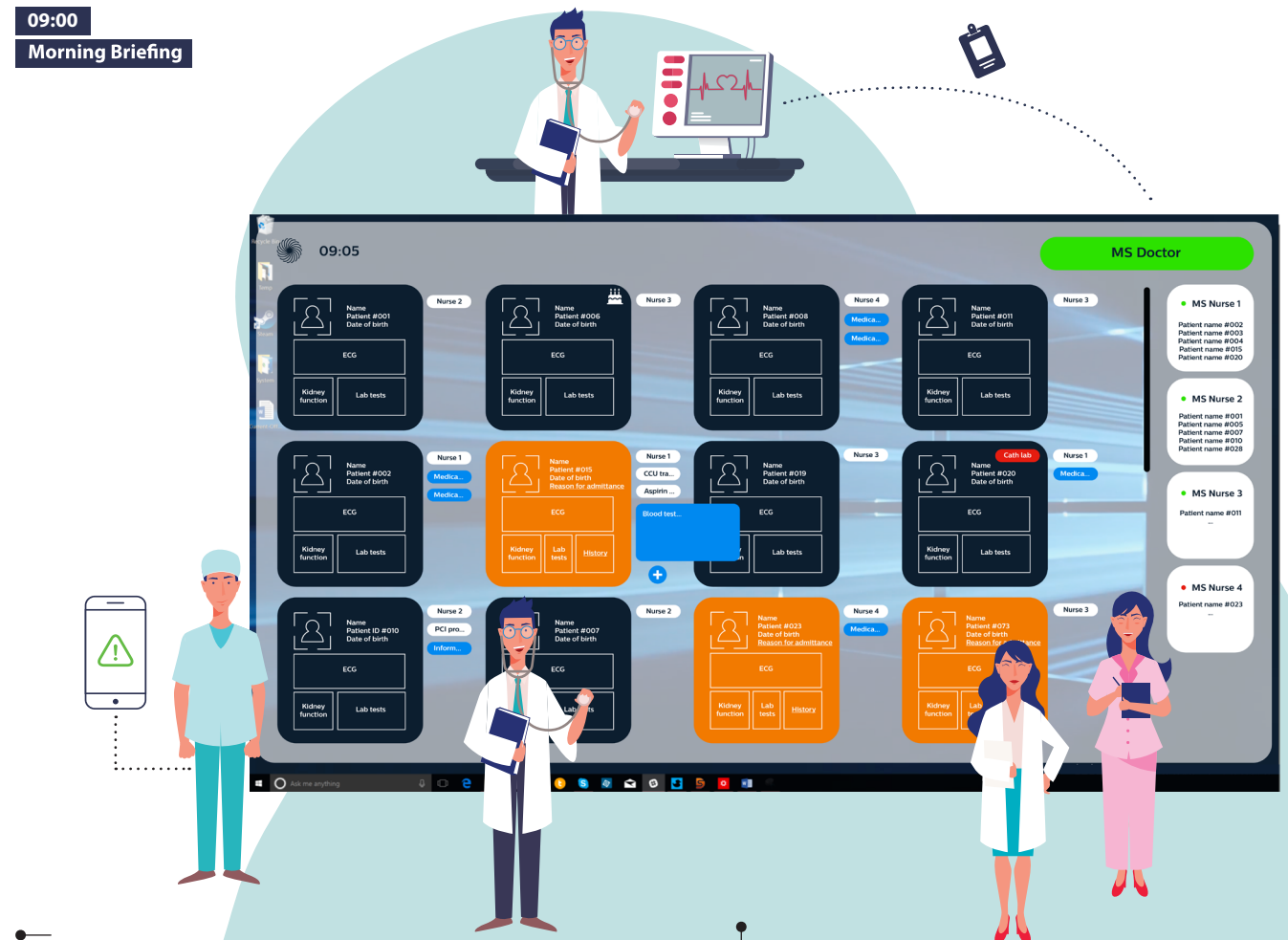

09:00
Morning Briefing

NURSING DEPARTMENT

The interactive real-time dashboard shows 'patient cards' with essential patient information, to quickly understand each patient. The dashboard is also available in another mode - nurse view.

Users can easily tap on patient cards, to assign clinical tasks, notes and reminders.

New admitted patients are labelled in a different colour. Moreover, the location of a patient is labelled on the patient card.

Information is available via computer software and phone applications, so the staff do not miss out information.

NURSING DEPARTMENT

By the time the doctor scans the badge, the smart assistant (PULSE) confirms the person as 'present'. The other staff responsible for the morning briefing will be informed accordingly.

The real-time dashboard then switches mode. Now that the input from the doctor is labelled in a different colour.

Vital medical information of patients is shown in a visual overview. No more single person blabbering around, we foresee staff engagement and teamwork!

CARDIOLOGY DEPARTMENT
PULSE activates when a user logs in any working desktop in the hospital. Subsequently shows the up-to-date activities to the user.

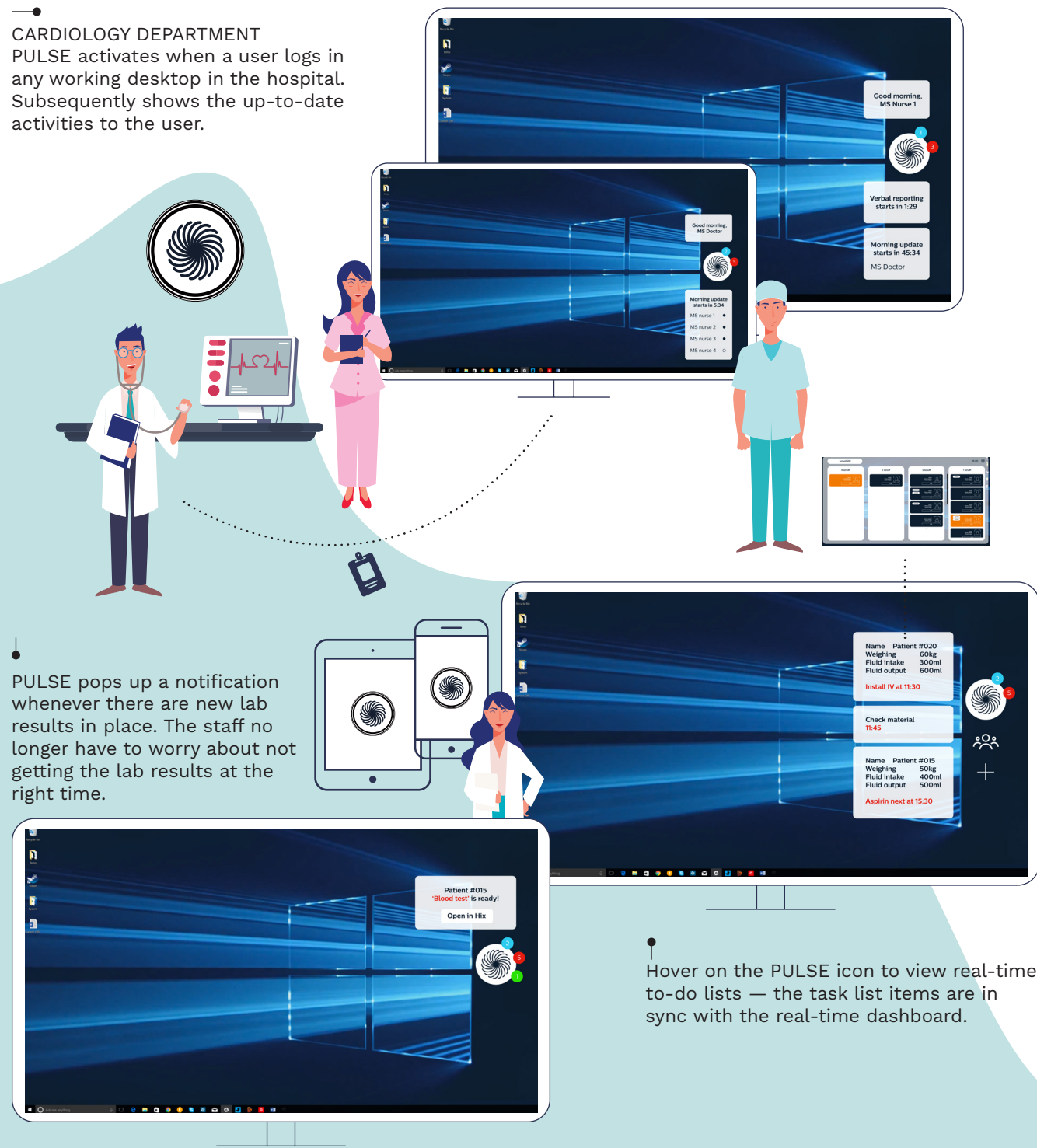

PULSE pops up a notification whenever there are new lab results in place. The staff no longer have to worry about not getting the lab results at the right time.

Hover on the PULSE icon to view real-time to-do lists — the task list items are in sync with the real-time dashboard.

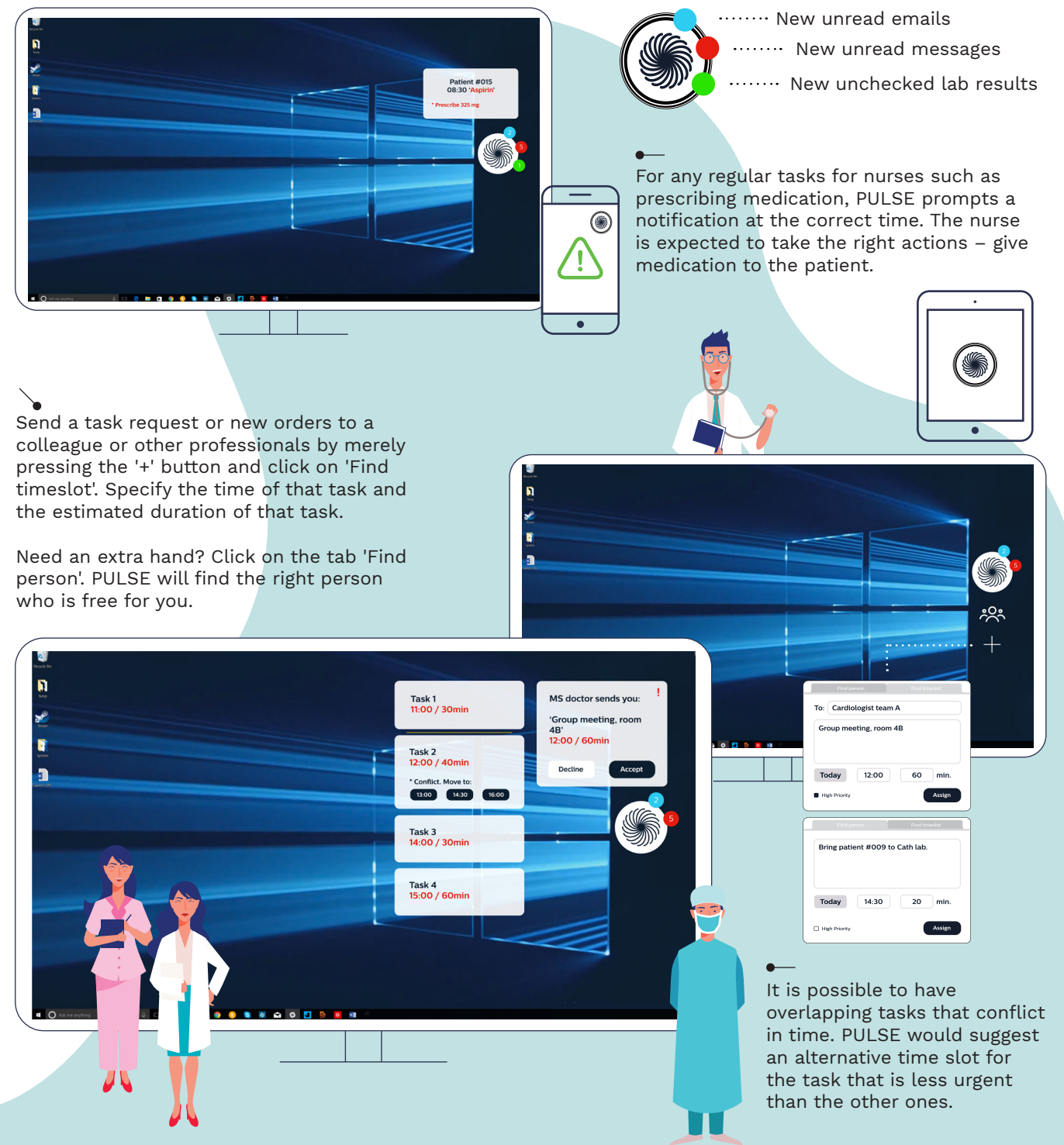

Send a task request or new orders to a colleague or other professionals by merely pressing the '+' button and click on 'Find timeslot'. Specify the time of that task and the estimated duration of that task.

Need an extra hand? Click on the tab 'Find person'. PULSE will find the right person who is free for you.

..... New unread emails
..... New unread messages
..... New unchecked lab results

For any regular tasks for nurses such as prescribing medication, PULSE prompts a notification at the correct time. The nurse is expected to take the right actions – give medication to the patient.

It is possible to have overlapping tasks that conflict in time. PULSE would suggest an alternative time slot for the task that is less urgent than the other ones.

Timetable of the staff.

Procedure details of a patient.

Lab view: Lab condition.

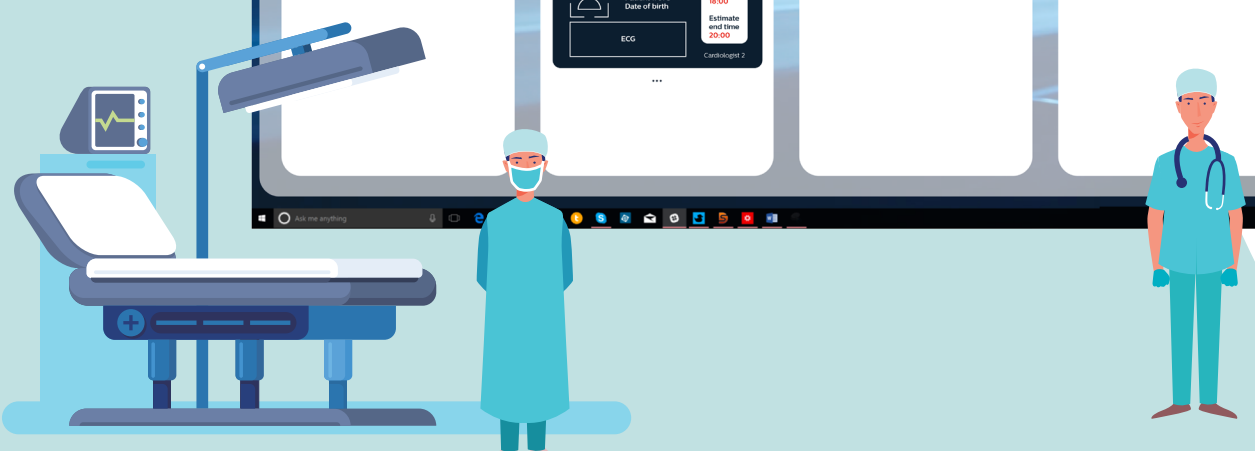
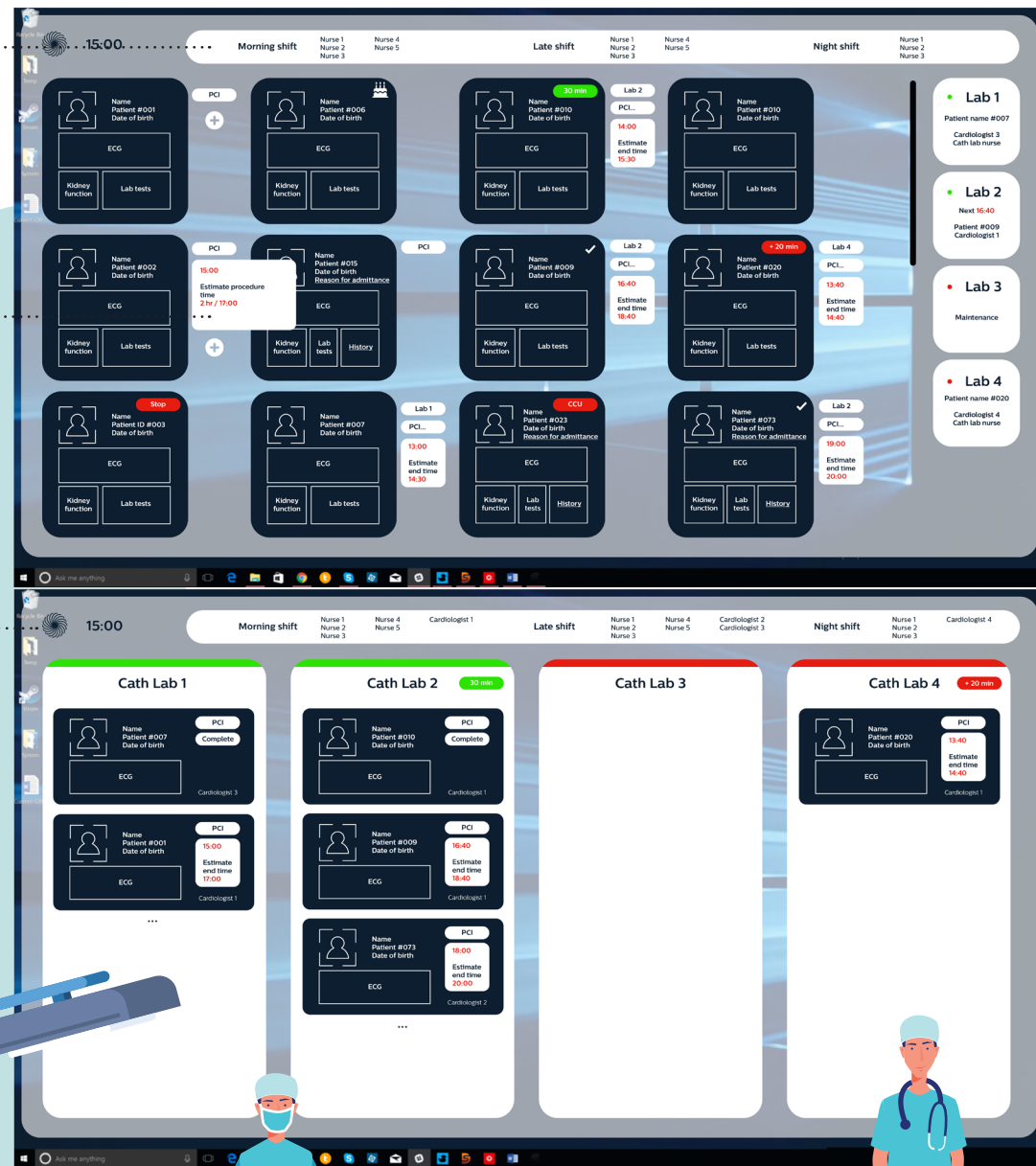

CATH LAB

Similar to the setting in the nursing department, PULSE in the Cath lab environment shows the planning of procedures of each patient. The staff will have a quick and clear overview of what the patients' status is. Moreover, the conditions of each cath lab rooms are available in another mode – lab view.

The real-time interactive dashboard is tailored for procedure planning. The staff would have to log in the type, the time, and the duration of the procedure.

In the lab view, the green label indicates the procedure has completed earlier than planned, while the red label shows a delay of procedures.

PULSE monitors each procedure and learns the estimated time a type of procedure would take. PULSE gives practical suggestions to the physician if there are sufficient time and space to treat another patient.

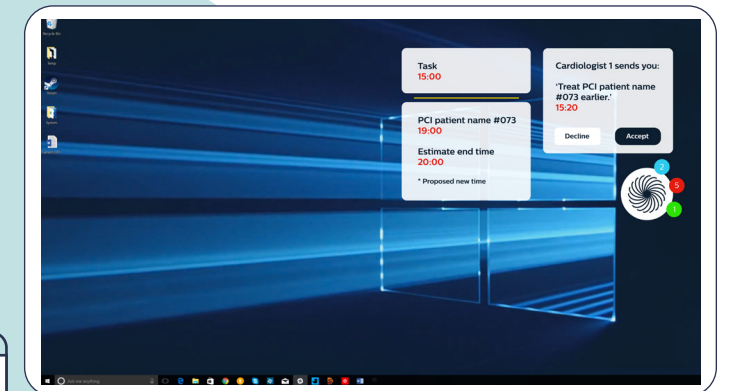
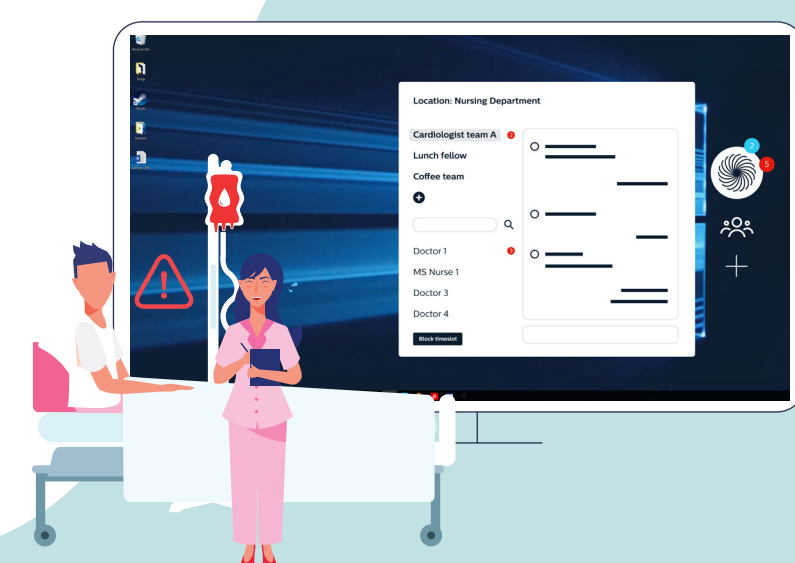

PULSE recognises free space and extra time; subsequently suggests fitting in another patient.

An operator (Cardiologist) could decide to put a patient in that free time slot. The other operator who is responsible for that specific patient would get a task request from the Cardiologist.

Click on the 👤 to start a conversation with anyone, anywhere.

Busy on a patient and do not want to be bothered? Press the 'block time slot' button to avoid notifications for 15 minutes.

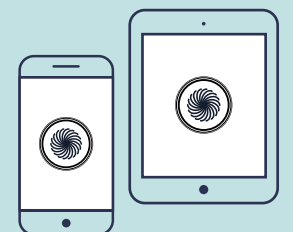

Evaluation



Figure 5.2
Co-creative
workshop with
stakeholders

Material:
Service blueprint
canvas,
Design mock-ups.

cc LUMC

In order to validate the scenario elements, the needs and requirements, and evaluate the proposed design solution, we organized a workshop (Figure 5.2) with four participants (Figure 5.3) involved. The use of user interface mockups rose an insightful and comprehensive discussion with the stakeholders. Reflecting on the design concept with mockups provides a more in-depth and critical atmosphere for the stakeholders to re-address their needs and requirements.



Figure 5.2
Four participants:
Resident Doctor x 1
Ward Nurse x 1
Cath Lab Nurse x 1
Interventional Cardiologist x 1

Facilitator:
Hao Liu

Observer:
Colleague from Philips

We refine the key requirements and analysed the functionality and usability of the design concept as follow:

- 1 In the context of cardiac care, patients' conditions are diverse in a way that there is never a static plan for their treatment. Anything could happen in between the journey while they walk in and out of a hospital.

We learned from an experienced resident doctor, 95% of the cases are:

- Procedures of patients run smoothly.
- Patients are getting planned treatments. 35-40% of patients are with unexpected or acute cases.
- Emergency cases happening in wards that are plannable. For instance, bleeding complications, infections.

The 5% cases are:

- Resuscitation cases (really rare).
"Things can still go right, because everyone can do their jobs perfectly." – Ward nurse
- Patients with complex co-morbidities.

Therefore, we sharpen our design concept that it would be to aim at 95% of the situations that would potentially happen in the Cardiology domain.

- 2 We refine key requirement 4 from chapter three, which was to classify the urgency of tasks and plan the right actions at the right time. We learned from the users that:
 - **The system should not give more work to a personnel. In emergency cases, the staff can handle the situation well without a system telling them what to do.**
"When emergencies happen in wards, someone presses a button, sounds the alarm. Then whoever can help will gather." – Ward nurse
"It will be great if a system supports us and shouldn't give us more work. Because if something goes wrong, we can handle it. We don't need a system to tell us what to do because that's our job." – Ward nurse & Cath lab nurse

- **The Cardiology staff would notice the problems based on their experiences and feelings. A system could not easily detect problems.**

"Bleeding emergencies do not easily get noticed because blood pressure gets higher if it's bleeding, but the medication is to keep the blood pressure low." – Ward nurse

"There's no rationality behind those variations, it's something you feel, see, hear, sense. Even though the patient's condition is completely normal, we can feel that something is not right." – Doctor

- **There is no time to check on any devices if there are emergency cases happening.**

"If we have to send out a message to someone with a backstory, that will take us more time than just hitting the button 'I NEED HELP RIGHT NOW', or just shout over the fence for help." – Ward nurse

Professionals are good at their job. Moreover, interacting with a system on a device will only add extra work to the staff in cases of emergencies. Therefore, planning actions for the staff to follow is hardly a useful solution to confirm if the staff are doing things correctly. A system, however, can help in planning 'checklists' for urgent tasks and sending reminders for regular tasks.

- 3** We refine key requirement 7 from chapter three, which was to be flexible on the fixed schedule from both the personnel and its context, and to be adaptable to plan the right actions. We learned from the users that:

- **Knowing other colleague's agenda affects greatly on the whole planning dynamics.**

"If I know that my colleagues are available to do the cases. And I know that they did not plan any meetings with other people, I know that I can plan something." – Interventional Cardiologist

"I want to see what the activities of my colleagues are at that time. So if they are fully available at the lab, or if they also have meetings with external parties." – Interventional Cardiologist

"Just have to hope that somebody else doesn't have a lot of appointments on that day. Otherwise, it will pose a problem. And it actually poses problems, we do get issues from that, because the nurses complain that we all have to leave at the same moment." – Interventional Cardiologist

- **Digital planning system is crucial to the Cardiologists/physician more than it is to the nurses.**

"The core activities of the other professionals, like the nurses and the secretaries, they don't have these other tasks as I do. Usually they're not so committed to the type of agenda interaction in the way I do" – Interventional Cardiologist

Therefore, it is not only to be flexible on their agenda. Being aware of every other personnel's agenda is essential to achieve effective planning.

Figure 5.4
Concept evaluation
with stakeholders

cc LUMC



4

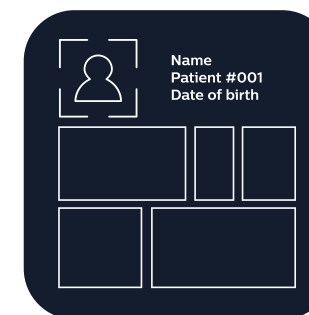

- **For the NURSING DEPARTMENT, the patient cards should contain information about:**

- Patient identifying details.
 - Name
 - Date of birth
 - Sex
 - Patient number
- Reason for admittance.
- DNR Yes ● No ●
- Most important medical histories.
- Cardiac-related information (pacemaker, implant).
- Real-time location of patients.

- **For the CATH LAB, the patient cards should contain information about:**

- Patient identifying details.
 - Name
 - Date of birth
 - Sex
 - Patient number
- Expected procedure time & The type of procedure.
- Specific conditions:
 - Reduced renal function
 - Technical (specific catheters)
 - Organisational (has to wait for ambulance; follow up dialysis therapy, contact with the dialysis department)

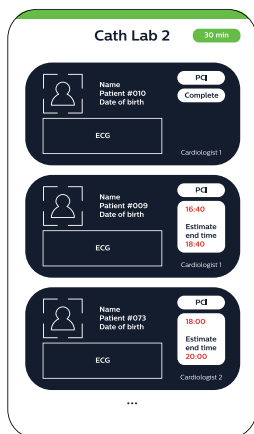

For the CATH LAB, the lab condition cards should contain information about:

- Characteristics of every lab room (maintenance).
- Acute case button – the on-call Cardiologists will identify as acute case based on the vitals sent from the ambulance.
- Identifying pictures of: Cardiologist, nurses, anesthesiologist, anesthesiology nurse, thoracic surgeon, sedation nurse, company.
- Other representative details (external professionals).

5

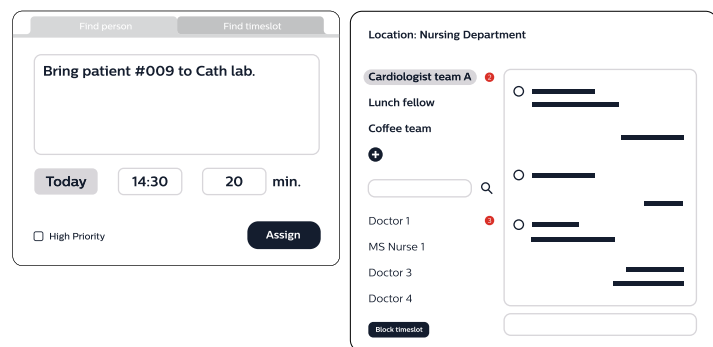

The usability for the task-assign functionality and the internal messaging functionality has to shift to a cross-department and a cross-position interaction. Not for the staff in the same working environment who see each other every minute.

- "I don't think any nurse would ever take the time to do this. Because I think it will take more time to send tasks than just ask someone, and we see each other so often." – Ward nurse
- "What would be useful for the connection between the ward and the cath lab is when the ward brings down a patient, you can also see it in the form of a color." – Cath lab nurse

6

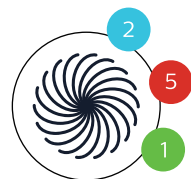

The time of 'not checking' the lab results is crucial for the staff because after a certain time, those results would not be viable anymore. We suggest to add a timer next to the unchecked lab results.

- "Notification for test results is great, because then you have automation. And it would be great to have a number of minutes that you didn't check it, because sometimes something's wrong, and not to point your finger at anybody, but you can really get people's attention, or something that I really need to check because a patient is dying." – Doctor

Reasons the Cardiology Staff Are Excited About PULSE

In this section, we will report on how the four participants evaluated the added value.

Analyse The Added Value

- 1 "How would you do your work differently with and without the PULSE system?" – HL
The staff **would not do their work differently** because a well-designed system should support them, not changing how they perform clinical work.
- 2 Using PULSE would **speed up their work** while **maintaining the same quality**:
 - Do not have to write everything down, and look everything up from other systems.
- 3 PULSE is **easy to use**:
 - Intuitive.
 - Modular and customised interface.
- 4 PULSE makes work and meetings **more efficient**.
"There would be **less administrative work**, and **more time to do things that actually matters to patients**." – All
- 5 PULSE triggers staff to **adjust more to the system**. To frequently check notifications, messages.
- 6 PULSE fosters **team building**. It is a better way to talk to colleagues about everyone who is involved.
- 7 Operating PULSE on a touch interface is more **practical** than typing or handwriting.

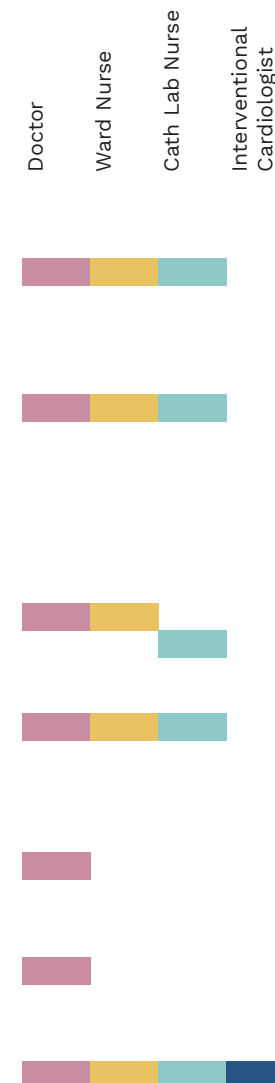

- 8** The digital planning system of PULSE **provides information and creates flexibility** to the user. *"PULSE integrates information a professional needs to get **effective planning**." – Interventional Cardiologist*

Interventional
Cardiologist

What The Cardiology Staff Say About PULSE

Below, the reader can find some of the comments of the PULSE concept we directly gathered from the participants during the workshop.

*"It would make so much, the **usability would be immense**. It will be very **intuitive**, but also **very connected**. And now you can see it right on the screen and say, this is what's going on." – Resident Cardiology*

*"So what's good about this design is that you see like a visual image of the patient because you see the patient head photo, you know, and you remind stuff because you **have a visual aid**. If somebody just blabbers around, nobody is gonna listen. And now everybody slumbers in the back, thinking of just being present." – Resident Cardiology*

*"This could be a real **game changer**, a **life changer**, definitely." – Cath lab nurse*

*"So I kind of liked the idea that this is basically a system that **hovers above all the other systems** and just **integrates the information that you need as a professional** to get an **effective planning** of your day." – Interventional Cardiologist*

*"So actually, it would be **extremely interesting to have this system**. So let's say in the prototype of the system, or the idea behind the system" – Interventional Cardiologist*

*"And I like the **flexibility** that it **uses actual data**, to **learn how cases are performed**." – Interventional Cardiologist*



From these positive comments can we understand that the desirability of the PULSE system is valid. The participants like about its usability, connectivity and intuitiveness. Moreover, they perceive the look of the overview of the system as a visual aid that fosters discussion and collaboration. Furthermore, they are impressed by the integration of information the system can bring, and reckon it to be able to achieve effective planning of their day. Lastly, they like about the system using real-time data and learn how cases are performed that creates flexibility to a user.

Conclusion

This chapter explained to the reader how we went from establishing the product-service positioning to a solution the Cardiology staff love. We proposed the PULSE system as a framework that revolutionises the way clinicians interact with medical data and clinical information in the Cardiology department.

We concluded several fundamental principles of a smart system for hospitals. Medical information has to be precise and desired. The interaction, as well as usability with a smart system, need to be intuitive and engaging. Furthermore, the installation of such a smart system should balance between work and personal life.

PULSE is undoubtedly a game-changer in hospital IT. The participants in general were very pleased with the suggestions. Most of them found it very interesting, and some of them thought it as a revolutionary to their work besides helping them with working efficiency.

In the next chapter, we will bring the reader a vision we have for PULSE. Also, we will portray several design innovation elements in a design roadmap.

EXECUTION AND IMPLEMENTATION

6

In this chapter, we will talk about:
A roadmap for the PULSE system.
Validate with Philips.

PULSE System Roadmap

Figure 6.1 shows the strategic roadmap for the PULSE system provided by Philips. The entire roadmap for PULSE is categorized into three phases: connected staff engagement, connected organisation engagement, and connected well-being. In each phase, we explain to the reader: the value proposition, business model, the product-service outline, value driver and the technologies that shape the value driver.

Phase 1 - Connected Staff Engagement

The first phase of the PULSE system – connected staff engagement. PULSE is an AI-supported interactive assistant that brings vital information to the medical staff at the right time and the right place. How does it look? PULSE system supports the user with a built-in application and computer software. Phones, tablets, touch screens and

Figure 6.1:
Product-service for
phase 1

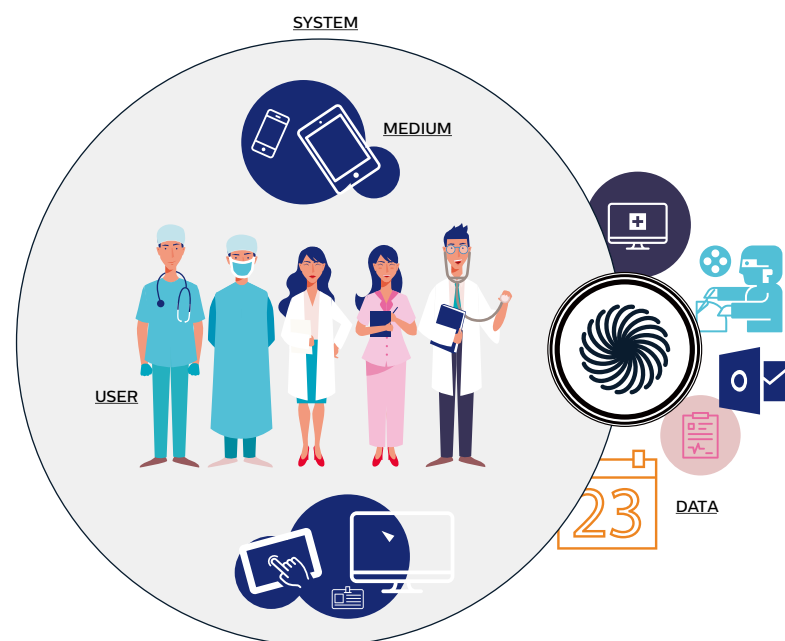

desktops, are the media used to demonstrate information to the users. PULSE extracts information and data from emails, agendas, cath lab conditions, EMR systems (patient identifying information and lab results from other departments), and personal notes.

We advise hospitals to select a secure environment to display such sensitive patient information, so that people do not readily see such sensitive information just on the corridor. Furthermore, make an investigation on the type of patient information that is allowed for display, for instance, the profile picture of a patient. Be aware of privacy regulations while implementing.

Technologies are brought up to support PULSE in achieving a great user experience to the users. Notification API (allow showing messages to the user), RTLS (real-time location systems tagging user locations), system overlay (similar to the Facebook messenger bubble on Android phones), sterile technologies, HL7 (standards for transfer of clinical and administrative data between software applications used by various healthcare providers), voice command, AI/ML (learning user behaviour in this case) shape the value driver - an excellent user experience to the medical staff.

—●
HL7:
Health Level 7
International.

Phase 2 - Connected Organisation Engagement

In connected organisation engagement, the second phase of the PULSE system, PULSE aligns the planning of clinical activities with other professionals and inter-connecting other professional organisation. The product service is about merging data (agenda, clinical tasks, external activities) from every staff, to achieve effective planning. PULSE acquires external data (from ambulance services, other hospitals and insurance services) as well to put all parties on the same page.

Sync technology is, therefore, particularly crucial in phase 2. Aligning information with numerous parties enables the value driver – superior brand awareness to the users as well as organisations in relation to healthcare.

Figure 6.1 Roadmap for PULSE.

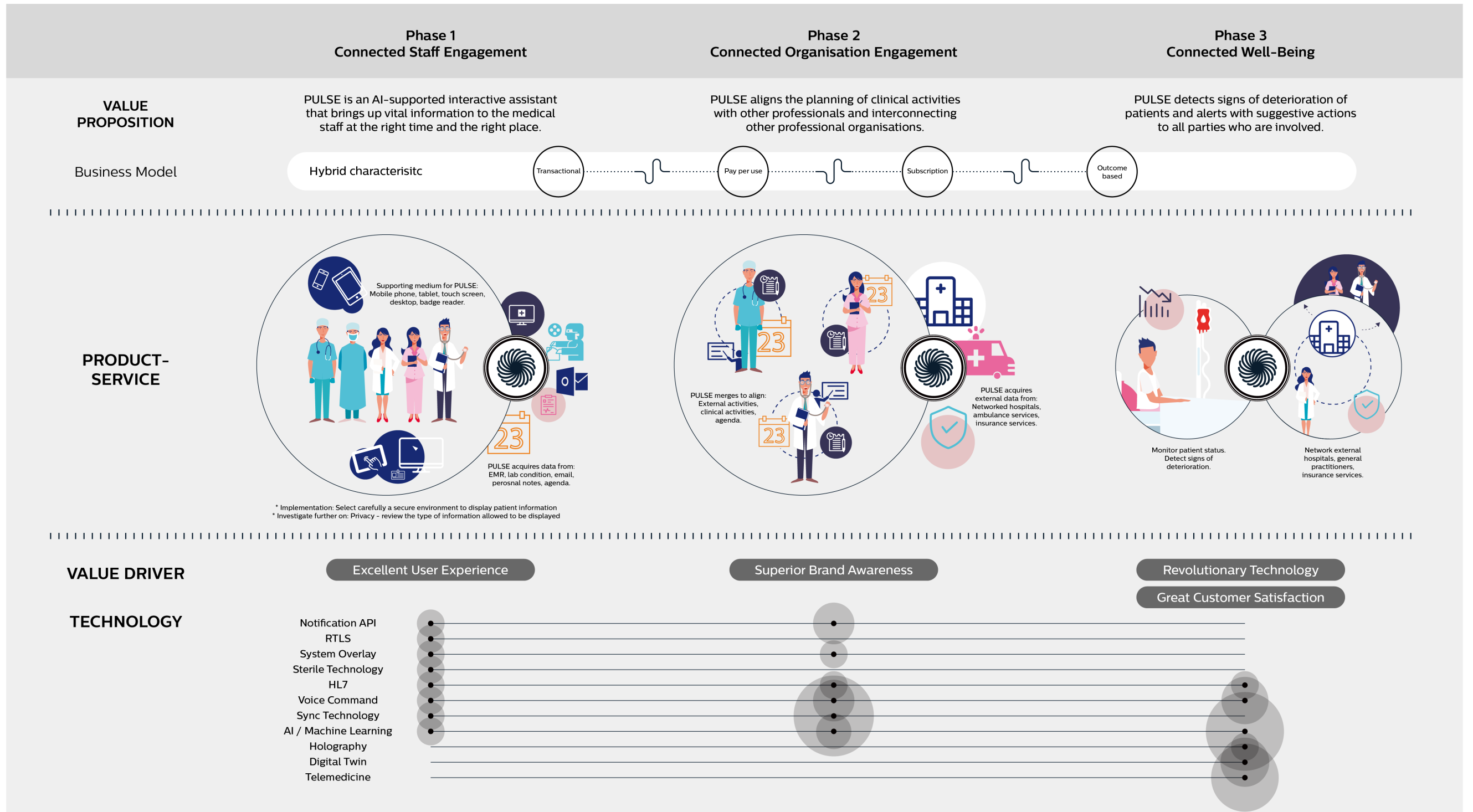

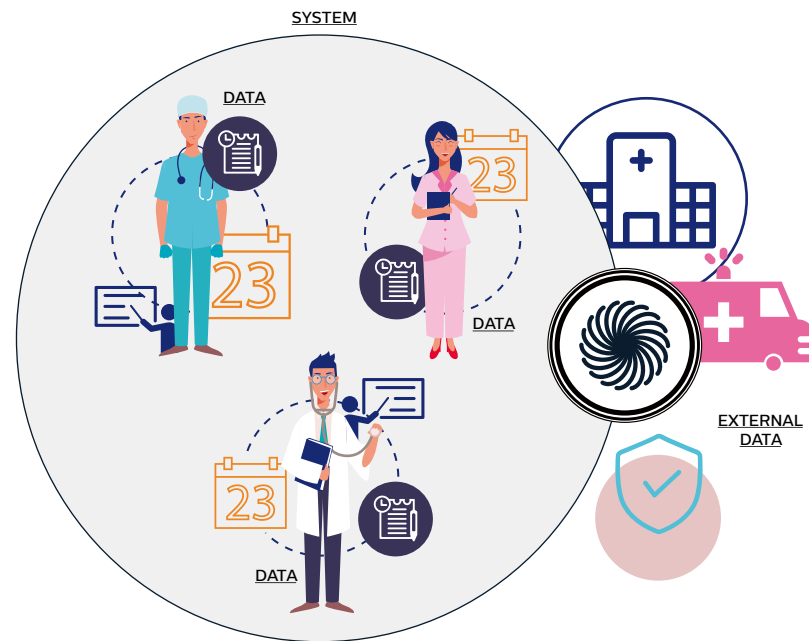

Figure 6.3:
Product-service for
phase 2

Phase 3 - Connected Well-Being

The third phase of the PULSE system is – connected well-being. PULSE would be able to detect signs of deterioration from patients and alerts with suggestive actions to all parties who are involved. Connected well-being is the ultimate vision we create for PULSE. 'Patient' is being put

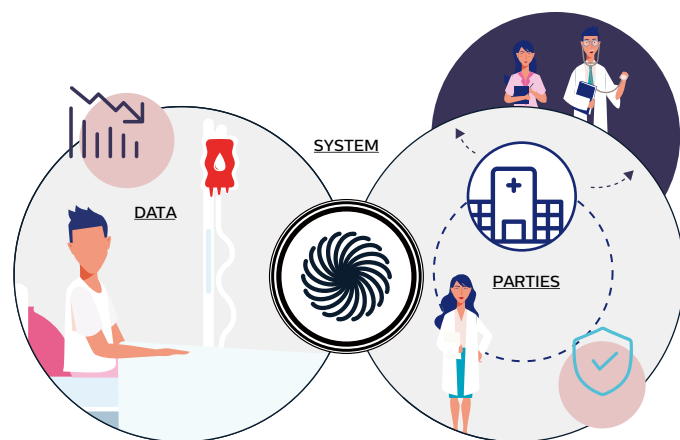

Figure 6.4:
Product-service for
phase 3

and emphasised along with the product-service rationale. With the revolutionised artificial intelligence and machine learning, we expect that in the near future, advanced algorithms are able to detect signs of deterioration or any kind from patients. PULSE integrates the technology of AI/ML, and the connection with other parties (hospitals, GP, insurance services), to bring excellent customer experience to patients.

Futuristic technologies - holograms, digital twin (digital replica of patients in this case), telemedicine (remote patient-clinician contact and care) are introduced to support in creating a great customer experience to patients.

Validation

We validated the roadmap internally within Philips, to see how the roadmap elements fit with the company's strategic view.

- Overall, the value proposition, value driver and technology in each phase of PULSE we proposed are found foreseeable and feasible from the company's point of view. Although the last phase is considered to be really in the far future, PULSE is found potentially to be part of the company's journey in improving lives through meaningful innovation.
- Secondly, the suggested business model of the PULSE system was found reasonable, since the products and services from Philips typically go for a hybrid business model in: transactional, pay per use, subscription and outcome-based. This decision requires the business develop segment in Philips to further research and assess the optimal business model for the PULSE system.
- In phase 3 – connected well-being, Philips mentioned that a service that considers the decentralisation of patient medical information requires regulations from governmental institutions. In the Netherlands, the role of the government is more a supportive facilitator than the owner. Philips mentioned that they needed a partnership to achieve the best outcome in phase 3.

- In phase 3, on the technological level, we suggested 'the digital twin technology' to be included. Philips commented that the terminology has different perspectives among Philips, meaning everyone has diverse interpretations of the term. The digital twin concept can be departmental or human. On the one hand, predict a scenario using AI with patients and the environment is departmental. For instance, putting an acute patient in the cath lab and simulate what would happen. On the other hand, the digital replica of the entire human body, a 'bio-physical modelling' of a human is another concept for digital twin. Under the light of this information, we suggested the term – human digital twin, to clarify the technology we suggested.

Conclusion

This chapter explained to the reader the vision we had for the PULSE system. A roadmap was built to illustrate the three phases: connected staff engagement, connected organisation engagement and connected well-being. Moreover, we elaborated on the value proposition, business model, product-service, value driver and technology for each phase. We validated PULSE and the roadmap internally with Philips to understand the feasibility of the system and how it fits Philips' vision.

The system was found fit with the strategic view of Philips. Moreover, it was found feasible for phase 1 and phase 2. For phase 3, Philips commented on the need for a partnership to achieve the best outcome.

In the last chapter, we will tell the reader about the limitations of the PULSE system that we proposed. Further, we will submit a recommendation section to the reader for further on the concept of the PULSE system.

CONCLUSION

7

In this chapter, we will talk about:
The limitations of the PULSE system.
Recommendations for further development.
Reflection for this project.

Limitation

Validity And Reliability

METHODOLOGY

- In the process of selecting target groups, the demography of the research subject is limited to **two hospitals** in the Netherlands. Within the two hospitals, 12.5 per cent of the research subject is from a peripheral hospital, while 78.5 per cent of the research subject is from an academic hospital. Although the representativeness of participants might be a concern due to low number (**only four participants involved in the whole design process**). We think they represent the population fairly, since the participants are recommended by Philips and an interventional Cardiologist from the LUMC hospital. Moreover, they are highly experienced in their field (some of the participants previously worked in a peripheral hospital).
- Due to time constraints and the availability of other healthcare professionals, we were only able to include four participants. However, we were able to include all four of them both in the design phase and the validation phase to improve internal reliability of our research.
- In the process of selecting the research area, we limited our scope to the **nursing department** and the **Cath lab** segment in the Cardiac patient journey. Some may argue that the research area does not include other segments, for instance, the outpatient clinic, Coronary care unit, or the emergency department. We propose further research in these areas in the recommendation section.
- We implement the **service design** approach to reach our goal in innovation as well as diagnosing problems with operational efficiency in the Cardiology domain. We **deviated from the typical service blueprint structure** because we want to compare the current staff journey and our envisioned future scenario with the support of the PULSE system. Therefore, we do not specify the

touchpoints, frontstage actions, backstage actions, supported processes of the current staff journey. Moreover, we ideated on **mock-up screens as the only touchpoint** due to time constraints. Service design mockups go beyond – human, environment, product, software. Thus, we propose further study the PULSE system with a comprehensive service design approach in the recommendation section.

- We conduct **user tests with the same target group** due to difficulties in recruiting other professionals and time constraints. We understand that opinions may vary with a different testing group, and the result would, therefore, look different. Thus, we would suggest iterating on the PULSE system with various testing groups in the recommendation section.

DESIGN

- The **design aesthetics** have not been researched because the aim of the project is not about designing user interfaces. Moreover, the **user experience** of PULSE is yet to be researched. The design mock-ups shown in this report are 'visual concepts' to explain the whole framework for the reader to understand easily. However, we would suggest investigating the aesthetics as well as user behaviour in the later stage of product development.

Recommendation

The PULSE system is a comprehensive solution for staff workflow orchestration in healthcare. To make PULSE a success across departments and hospitals, we propose to Philips as well as a healthcare innovation leader, to further on with four different stages:

- Extend Research Space
- Pilot
- Further Product Development
- Partnerships

Each stage has to be reviewed and analysed thoroughly before entering the next stage to make sure that every decision made is meaningful.

1 EXTEND RESEARCH SPACE

Our research subject is limited to the diversity of people working in the Cardiology domain. Overall, the staff are not only about doctors and nurses. To cover up different segments in the Cardiac patient journey (Figure 3.1), we suggest interviewing staff with different functions. For instance, secretaries, procurement, cleaning, management, to understand each of their needs and requirements.

Moreover, insights from the peripheral hospital's point of view are minimal. We suggest learning from the needs outside academic hospitals to get a comprehensive view of the hospital ecosystem. A service design approach would help in understanding the context of your environment and articulating the problems and needs.

Privacy issues are fundamentally crucial, especially with the rise of General Data Protection Regulation (GDPR) concerns in the European region. Choosing the right and legal information from the sensitive patient data may require consultation with experts.

Sterility issues also pose concerns in the installation of portable devices. Although we have confirmation from the research group that there are 'traditional ways' to prevent sterility problems. We still suggest investigating further on innovative ways to tackle sterility issues.

2 PILOT

Pilot tests with users are highly recommended because a lot of times the user would not know what they need until they use it! We suggest to build a minimum viable product (MVP) to validate the usability of PULSE in a quantitative scale. Conduct several pilots with selected groups is essential for the optimisation of the product as well as the debugging of the service. Re-iterate on the concept before launching to make PULSE readily available for every Cardiology department in every hospital.

3 FURTHER PRODUCT DEVELOPMENT

PULSE is designed for the Cardiology domain. However, the need for workflow orchestration is prevalent in other medical domains. We expect PULSE to work across different departments in a hospital, as the direction for further product development. We suggest to follow our research method while exploring opportunities in other domains. Take PULSE as a framework template and develop your own solution.

4 PARTNERSHIPS

Value the connection with other hospitals. Network and collaboration with other medical institutes would allow information-sharing and knowledge-sharing. The more data at hand, the more PULSE can learn from so that integration of information can be achieved to providing a seamless experience. Furthermore, partner up with external parties – ambulance services, GPs, health insurance companies, governmental health department to create a large decentralised health continuum.

Personal Reflection

I always ask myself, the things that I do, am I doing it for myself? Or am I doing it for the others? What I learned during the course of this master project, and also the answer to that question, is – happiness. Happiness is what I learned as the fuel of my motivation to do everything.

Happiness fosters the courage, confidence, ambition, persistence and perseverance inside me. My passion for design comes from the pleasant feeling of solving a complex challenge with design while a non-designer may do it in a completely different way.

I enjoyed this project, along with my supervisors and my company mentors. The complexity and scope of this project were massive, and I liked the way it was structured. It was the ambition to contribute to the healthcare industry that drove me to use my design skills to tackle problems in the field I have never touched upon. Trying new methods, and learning by doing was the mentality during the whole design process. I am delighted with the results. Also, I am honoured that a future collaboration between Philips and LUMC for this project is foreseeable, according to an interventional Cardiologist.

The interaction with all the stakeholders involved in this project was harmonious. I was surprised that the medical professionals were eager to try out new things and play with them. It changed my image to the medical professionals as being relatively 'serious'. Therefore, there is no doubt that designers can have good chemistry with medical professionals.

I was, however, hurdled by time constraints for this project. There is so much more in the field to be explored and further developed. Moreover, collaborating with hospitals is tricky in the sense that the medical professionals are really busy. Regular contact with the medical professionals within this limited amount of time is something to wait for, not to ask for. I forced myself to rethink the strategy of conducting research and make the best outcome from every valuable interaction with the stakeholders. I am glad that everyone involved in this project supported me along the way and made this project successful.

Last but not least, working at Philips made me realise that – designing for healthcare has definitely been rooted in hospital culture. Therefore, I oppose the statement mentioned in the introduction section of this report. I feel positive about seeing more innovations by designers in the healthcare industry in the future.

List Of Abbreviation

WHO	World Health Organisation
HIT	Health Information Technology
EHR	Electronic Health Record
PHR	Personal Health Record
Health-CPS	Healthcare Cyber-Physical System
UX	User Experience
CDS	Clinical Decision Support
HIS	Health Information System
OR	Operation Room
EMR	Electronic Medical Record
ERP	Enterprise Resource Planning
ICU	Intensive Care Unit
CCU	Coronary Care Unit
DNR	Do Not Resuscitate
ECG	Electrocardiography
ETA	Estimate Time of Arrival
AI	Artificial Intelligence
ML	Machine Learning
IGT	Image-Guided Therapy

Reference List

- [1] Agarwal, R., Gao, G., DesRoches, C., & Jha, A. K. (2010). The digital transformation of healthcare: Current status and the road ahead. *Information Systems Research*, 21(4), 796-809,1000-1001,1003.
- [2] Li, M., Yu, S., Ren, K., & Lou, W. (2010, September). Securing personal health records in cloud computing: Patient-centric and fine-grained data access control in multi-owner settings. In *International conference on security and privacy in communication systems* (pp. 89-106). Springer, Berlin, Heidelberg.
- [3] McCurdy, K., & McCurdy, K. (2016, February 01). How designers make hospitals awesome. Retrieved from <https://medium.com/hsxd-healthcare-systems-by-design/how-designers-make-hospitals-awesome-44514dbf0bcc>
- [4] Bowden, K. (2018, January 15). Service design for the patient of the future. Retrieved from <https://www.hospitalhealth.com.au/content/design-in-health/article/service-design-for-the-patient-of-the-future-105456264#axzz5xQc5WBcS>
- [5] Philips. (2019, January 24). Cardiology and beyond: It's time to rethink care that really meets the challenges of health. Retrieved from <https://www.philips.com/a-w/about/news/archive/future-health-index/articles/20161025-time-rethink-care-really-meets-challenges-health.html>
- [6] Cardiologist burnout, a growing problem. (n.d.). Retrieved from <https://www.escardio.org/Congresses-&-Events/ESC-Congress/Congress-resources/Congress-news/cardiologist-burnout-a-growing-problem>
- [7] Cain C, Haque S. Organizational Workflow and Its Impact on Work Quality. In: Hughes RG, editor. *Patient Safety and Quality: An Evidence-Based Handbook for Nurses*. Rockville (MD): Agency for Healthcare Research and Quality (US); 2008 Apr. Chapter 31
- [8] Adams, M., Ter Hofstede, A. H., Van Der Aalst, W. M., & Edmond, D. (2007, November). Dynamic, extensible and context-aware exception handling for workflows. In *OTM Confederated International Conferences" On the Move to Meaningful Internet Systems"* (pp. 95-112). Springer, Berlin, Heidelberg.
- [9] Sutherland, J., & van den Heuvel, W. J. A. M. (2006, January). Towards an intelligent hospital environment: adaptive workflow in the OR of the future. In *Proceedings of the 39th Annual Hawaii International Conference on System Sciences (HICSS'06)* (Vol. 5, pp. 100b-100b). IEEE.
- [10] Emanuele, J., & Koetter, L. (2007). Workflow opportunities and challenges in healthcare. *2007 BPM & Workflow Handbook*, 1, 157.
- [11] Cain C, Haque S. Organizational Workflow and Its Impact on Work Quality. In: Hughes RG, editor. *Patient Safety and Quality: An Evidence-Based Handbook for Nurses*. Rockville (MD): Agency for Healthcare Research and Quality (US); 2008 Apr. Chapter 31
- [12] Sadiq, S. W., Marjanovic, O., & Orlowska, M. E. (2000). Managing change and time in dynamic workflow processes. *International Journal of Cooperative Information Systems*, 9(01n02), 93-116.
- [13] Toelle, E. (2019, April 03). System of Record vs System of Engagement: Who wins? Retrieved from <https://www.recordpoint.com/system-record-system-engagement/>
- [14] Moore, G. (2011). *Systems of engagement and the future of enterprise IT-A sea change in enterprise IT*. AIIIM, Silver Spring, Maryland.
- [15] Toelle, E. (2019, April 03). System of Record vs System of Engagement: Who wins? Retrieved from <https://www.recordpoint.com/system->

record-system-engagement/

[16] Bersin, J. (2012, August 25). The Move from Systems of Record to Systems of Engagement. Retrieved from <https://www.forbes.com/sites/joshbersin/2012/08/16/the-move-from-systems-of-record-to-systems-of-engagement/#6a2b5a8947f5>

[17] Robbins, J., & LiveData, Inc. (2018, May 8). Improving Healthcare With Systems Of Engagement. Retrieved from <https://www.healthitoutcomes.com/doc/improving-healthcare-with-systems-of-engagement-0001>

[18] Robbins, J., & LiveData, Inc. (2018, June 21). Systems Of Engagement In Action. Retrieved from <https://www.healthitoutcomes.com/doc/systems-of-engagement-in-action-0001>

Author

Hao Liu
liuhao84813@gmail.com

Graduation Committee

Chair **Ir. R.J.H.G. van Heur**
Faculty of Industrial Design Engineering – Coordinator CardioLab Program

Mentor **Asli Boru**
Faculty of Industrial Design Engineering – PhD Candidate

Company Mentor **Koen Noordermeer**
Professional Health Services & Solutions – Business Development Manager at Philips

Second Company Mentor **Marleen van Leengoed**
I&S XD - UX Design – UX Designer at Philips

Cover Design

Hao Liu

August 2019

