

THIN GLASS INSTALLATION

integrated design for glass projects

Marialena Toliopoulou

thin glass installation

integrated design for glass projects

by

Marialena Toliopoulou

5614996

in partial fulfilment of the requirements for the degree of

Master of Science

in

Architecture, Urbanism & Building Science

Track of

Building Technology

Mentors: James O'Callaghan *Professor, Architectural Glass*
Paul de Ruiter *Lecturer, Design Informatics*

June 2023



ACKNOWLEDGEMENTS

This thesis marks the end of a remarkable educational and personal journey, that led to great discoveries, through trial and error, failure and hard work, but contributed to gaining valuable lessons and knowledge, within a very special environment. TU Delft and the track of Building Technology introduced me to a number of fields that I had little knowledge of and contributed significantly to the skills acquired in order to accomplish this journey. The last eight months of this masters were devoted to the two main fields that inevitably inspired me the most: “glass structures” and “computational design”.

This project would not have been realized without the help and contribution of both my mentors. I would like to express my gratitude and appreciation to James O' Callaghan for devoting his time and knowledge on the field of glass structural design. Every discussion was like opening up a new chapter of information on the subject, unveiling new perspectives, learning, coming up with more ideas. Furthermore, special thanks to my second mentor, Paul de Ruiter, for the endless talks on the corridors outside and inside the lama lab. Every meeting was a reminder of my focus, an inspirational talk on design principles and what one can achieve through computational design and precious insights. Moreover, I would like to express my gratitude to Marco Zaccaria and AGC, for sharing industry insights and feedback, test data and, of course, impeccable material samples, that without this project would not have been realized. Sophie Penner, for sharing her knowledge on the subject of thin glass and helping me start the project and Sam Gregson, for our discussions and for sharing his experience.

During this very special journey in and out TU Delft and its labs, there should be plenty of space of a “thank you” note, to all those people that made this possible in their own ways.

Firstly, I would like to express my gratitude to Dani, the person that “held my hand” throughout the good and the bad days, being the help that I needed the most and the laughs that I will never forget. Dimitra, was the virtual angel that provided much needed support and those little important reminders, proving that friends can “be there for you”. Also, the past months would not have been that special without my fellow Greeks, Menandros and Nathanael. Alex and Thomas, thanks for putting up with my crazy moments. And to all my friends scattered around the world, I am grateful that I could share a part of this experience with you.

Finally, I would like to thank the two most important people in my life, without which any part of this would not have been possible, my parents. They have relentlessly been supporting me to pursue my dreams, regardless of the distance that keeps us apart and have shaped me to the person I have become, teaching me patience, diligence, hard-work and moving forward despite the difficulties.

ABSTRACT

Keywords: thin glass, glass structures, computational method, workflow, design principles, connection design

Glass structures have been dominating in the architectural world for the past decades, unveiling the material's structural potential. Advancements in glass manufacturing and post-processing techniques have not only led to innovative applications but also resulted in the development of unique glass products. Aluminosilicate glass exhibits superior strength and flexibility compared to the commonly used soda lime glass, due to its distinct composition and manufacturing process. This enables the production of ultra-thin glass with thicknesses as low as 25 μm , giving rise to the category of "thin glass" encompassing any glass below 2 mm in thickness.

Thin glass has found applications in industries such as automotive and electronics due to its unique properties, including optical clarity, scratch resistance, durability, flexibility, and reduced weight. In architecture, the evolving design vocabulary embraces complex geometries and the integration of curved panels, offering clear structures that provide exceptional optical clarity and blend seamlessly with their surroundings. Thus, thin glass holds potential for creating complex, lightweight, and transparent architectural structures.

This research addresses the limitations of thin glass in construction and explores optimal bending techniques to maximize its capabilities. The methodology comprises a literature review of the glass industry, design principles, and an in-depth study of thin glass properties. This study culminates in the establishment of design guidelines and a computational approach to assist the design process while using cold bent thin glass. After investigating the available and most used design and structural simulation software, the ones found more accurate are integrated in the process.

The findings highlight the successful development of a computational method that provides tools, design principles, and guidelines for working with single curved cold bent thin glass panels. Additionally, the research examines suitable connection types for thin glass projects and concludes with a proposal for a hinge clamp connection. A case study showcases the proposed workflow, leading to the creation of a prototype utilizing a 3d-printed based approach of the suggested connection design.

The conclusions emphasize the significance of the integrated computational design workflow and its implications for architectural design using thin glass.

CONTENTS

Acknowledgements	ii
Abstract.....	iii
0. Introduction	3
0.0 Context	4
0.1 Problem Statement	11
0.2 Relevance & Objectives	12
0.3 Research question & sub-questions	12
0.4 Methodology overview & timeline	13
1. Literature study	15
1.0 Why thin glass?	16
1.1 Understanding thin glass.....	17
1.1.0 Production and post-processing.....	17
1.1.1 Structural behaviour	20
1.1.2 Types of thin glass	22
1.2 Glass connection design	23
1.3 Thin glass in the built environment.....	27
1.3.0 Research in the field.....	27
1.3.1 Case studies	30
1.3.2 Conclusions and lessons learned.....	32
2. Research through design	33
2.0 Designing with thin curved glass panels.....	34
2.0.0 Setting up the workflow	34
2.0.1 Limitations in bending	37
2.0.2 Characteristic & design strength	38
2.0.3 Load case scenarios	44
2.0.4 Structural verification process	46
2.0.5 Summary – Workflow definition	51

2.1 Guiding principles.....	52
2.2 Proposed method	55
2.2.0 Strategy and goals	55
2.2.1 Design evaluation.....	57
2.3 Case study.....	61
2.3.0 Simple linear partition wall	61
2.3.1 Interior installation on an interpolated curve	63
2.4 Design of connection	64
2.5 Prototype.....	66
3. Conclusion	71
3.0 Research conclusions	72
3.0.0 Research question	72
3.0.1 Technical and design conclusions	72
3.1 Recommendations for further research	73
3.2 Reflection	74
3.2.0 Graduation process.....	74
3.2.1 Societal impact.....	75
4. Bibliography	77
5. Appendix	81
5.0 ANSYS Calibration	82
5.1 ANSYS simulations on multiple combinations.....	84
5.2 Clamp bender test results	86
Ground Edge (Test 1)	86
Weibull distribution.....	88
Ground Edge (Test 2)	89
Weibull distribution.....	90
Laser Cut (Test 1)	91
Weibull distribution.....	92
Laser Cut (Test 2)	93
Weibull distribution.....	94

0. INTRODUCTION

0.0 Context

During the past decades glass structures have been dominating the architectural world and impressing the public. From the most common greenhouses, it has been gradually trusted as a structural material in numerous other constructions combining its transparent nature while unveiling structural potential (Oikonomopoulou et al., 2019). Contrary to the common belief that it is extremely fragile, glass has a high value of compressive strength, even higher than concrete (Oikonomopoulou et al., 2019).

Apart from the use of glass in objects such as weapons or even for decorative reasons in jewellery and ceramics, glass in architecture can be traced several millennia ago. The earliest known use of the material for architectural purposes was in ancient Egypt and Mesopotamia, back to about 7000 BC (Nascimento, 2014). Throughout the centuries and while technology and production methods evolved, the use of glass became more popular and commonly used in construction, leading to very ambitious and innovative ways of utilizing it.

By the 20th century, the technological improvements and innovative advancements of building materials were a turning point in the construction industry - e.g., how reinforced concrete and structural steel have allowed the construction of large-scale buildings, like skyscrapers, possible and safe. With that said, there have also been great advancements in the manufacturing and development of glass, which has allowed it to gain a lot of attention in the world of architecture and construction (Wurm, 2007).

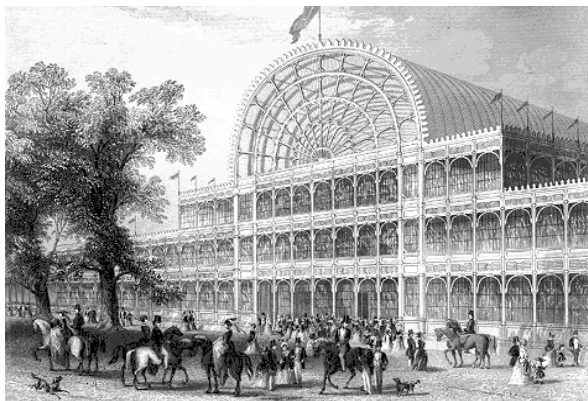

Figure 0-1: The Crystal Palace comprised of iron rods intricately connected to sustain walls of clear glass. Its highest part was 33 metres and was located in Hyde Park, London (Merin, 2013)

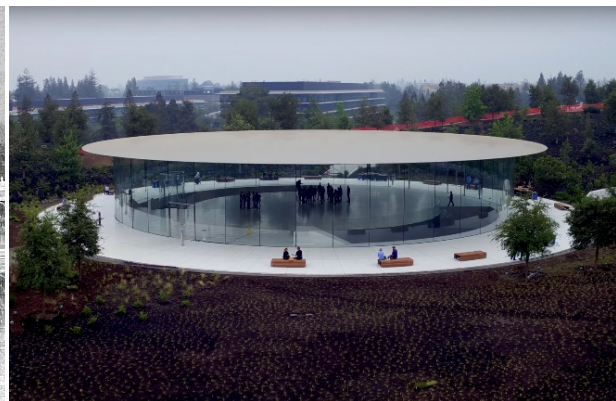

Figure 0-2: The 80-ton roof of the "Steve Jobs' theatre" is supported by 44 glass panels of 7m high, without any additional framing, forming a 41m diameter area. Being "the largest structure in the world solely supported by glass", it was engineered by EOC in 2017 (Team, 2017)

The construction of the "Crystal Palace" in London in 1851, by Joseph Paxton, brings glass from the greenhouses to the architectural field and since dozens of other constructions followed along (O' Regan, 2014).

While advancements in technology and production continue, glass has been the main structural element in multiple iconic buildings, for example the Steve Jobs Theatre. According to Eckersley O' Callaghan Engineers (2018), the theatre is located in a 71-hectare campus where its 41 meters in diameter and 80.7 tons in weight carbon roof is entirely supported by 44 identical radial panels of almost 7 meters high. Currently being the largest structure in the world made completely by glass, it is a manifestation of glass' structural abilities when accompanied by creative, innovative, and informed design thinking.

Glass production and post-processing

All the progress made throughout the centuries led to the popularity of structural glass and the different production and treatment methods. The most used process for structural glass nowadays is float glass (Hynd, 1984), which can be post processed further. The typical mixture includes silica sand, soda, lime, magnesia and other minor ingredients, such as cullets (recycled broken glass), usually from panels that did not meet the criteria after production and are fed back into the loop. The described composition is also the reason that the certain type of glass is often referred to as soda-lime glass. The table below shows a typical composition for a soda-lime-silica glass, based on information provided by literature and the website of Corning's Museum of Glass.

Table 0.1: Typical composition of soda-lime-silica glass(Corning, 2011; O' Regan, 2014)

	Material	Formula	Composition
Soda – Lime – Silica Glass	Silica sand	SiO ₂	60-75 %
	Lime	Na ₂ O	5-12 %
	Soda	CaO	12-18 %
	Magnesia	MgO	0-6 %
	Alumina	Al ₂ O ₃	0-3 %

The production process differs depending on the chemical composition of the glass, but this is the most used type for structural applications. Hence, the process used is the float process and therefore this type is also known as float glass, as it was mentioned before. Following the production method is being analysed.

Float glass process

When the ingredients are mixed and blended, they get melted in a furnace at about 1500°C and the melted glass is fed into a tin bath of controlled temperature where it floats forming an even and smooth surface of uniform thickness, with range between 6 to 7 mm (Haldimann et al., 2008). At the end of this process the flat sheet is slowly cooled, the surface hardens and is carried out on conveyor rollers without suffering damage. The speed of the rollers also determines the final thickness of the glass sheet. The end product is referred to as *float glass* or *annealed glass*.

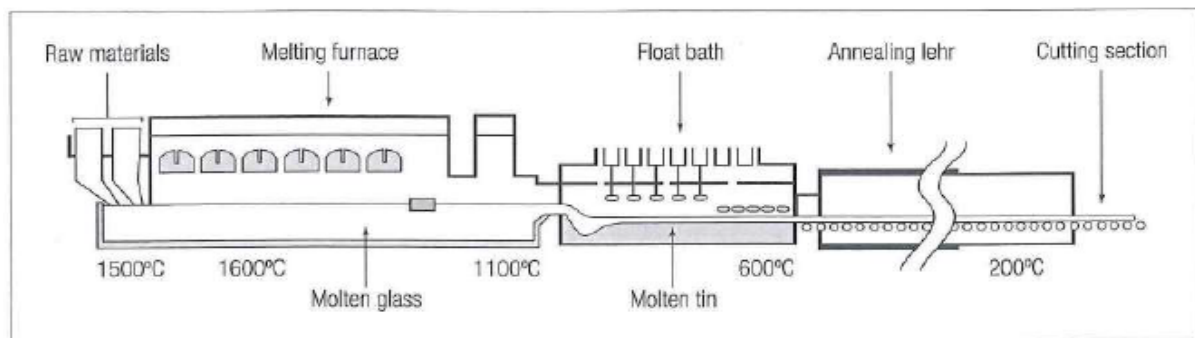

Figure 0-3: The float glass process (O' Regan, 2014).

Nevertheless, there are still manufacturing limitations regarding float glass. The standard size, often referred to as jumbo plate, is 6 m * 3.21 m. Plates larger than 6 meters (up to 20m) are possible, whereas the width of 3.21 meters is still restricted due to the width of the furnace (O' Regan, 2014). However, oversized panels result in higher manufacturing costs.

While this is the main manufacturing method, there are several post-processing products, depending on the need and demands of each project. The panels can be cut to size and shape, polished and coated and even drilled. The treatments after production affect the material's behaviour after possible failure as well as its structural properties. Some of the most significant processes are shortly discussed below.

Tempering

As mentioned above, annealed glass is already considered a product without undergoing any further treatment. It is widely used with the disadvantage of a large fracture pattern – as shown on figure 0.4 below – that makes it less safe for certain uses.

However, there are three basic toughening processes for high strength glass. Namely by ascending strength order, *heat strengthened* – or semi-tempered – glass, *fully tempered* – or toughened glass – and *chemically tempered* glass. Apart from the different strength capacities of the post-tempered products, the cracking pattern differs a lot – and is important

depending on the use – as well as the thickness limitations due to the process' specifications. To avoid damaging the panels any cutting, grinding, or drilling should be performed prior to tempering. These processes result in pre-stressing through the thickness of glass. This introduces tensile stress on the core of the glass and compressive stress on the outer surface (Datsiou, 2017). The following diagrams depict the residual stress profiles as well as the fracture patterns for the below described strengthening products.

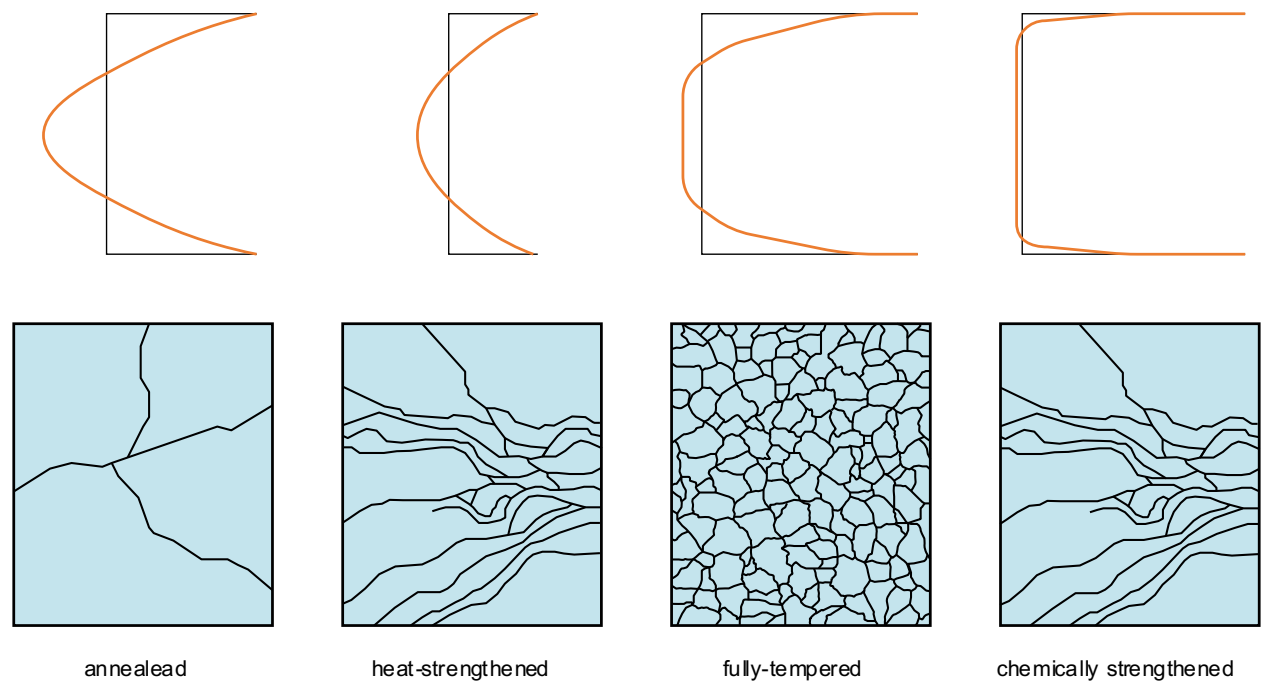

Figure 0-4: Impact of the different tempering processes on glass pre-compression and fracture patterns.

Heat strengthening

Heat strengthen glass is produced by rapidly cooling the glass, after that has been heated above its transition temperature. That results in the external faces being solidified quicker than the core and therefore leading to the shrinkage of the outer layer (Datsiou, 2017). The damage sensitivity is similar to annealed glass, although it resists longer under tension.

Fully tempered

Fully tempered glass has the highest (tensile) strength due to the high level of residual stress. Although the tempering process is identical to that of heat strengthened glass, the cooling rate is higher, which gives a smaller depth of layer to the panel. Fully tempered glass shatters into small fragments, the edges of which are rounded, and therefore it is also known as safety glass. However, that does not allow for any post-breakage carrying capacity.

Chemically tempered

Since it is a considerably expensive process, compared to the aforementioned it is not normally favoured (Haldimann et al., 2008). However, it offers an external layer under pressure and a similar breaking pattern to that of a heat strengthened glass. It is mostly used for complex geometry and where thermal treatment is not suitable.

Lamination



Figure 0-5: Layers of lamination (left) and diagram of final product (right).

Lamination includes two or more panels which are bonded with a viscoelastic interlayer. According to O' Regan (2014) these could be: polyvinyl butyral (PVB), thermoplastic polyurethane (TPU), ethyl vinyl acetate (EVA), polyester (PET), ionoplast or any resin such as acrylic. Depending on the interlayer, the panels and the layers are put together and then heated or cured chemically or via ultraviolet (UV) light.

Lamination is possible with any type of post-processed or annealed glass. Usually, laminated panels are preferred for safety and security reasons, since in case of failure the interlayer has the capacity to keep the layers together and thus, the likelihood of injuries is minimized.



Figure 0-6: Section through laminated glass indicating bending stress within plies for short-term and long-term conditions.

Bending

The process of producing a curved glass panel involves accounting for its deviation from a flat surface. In order to approximate this behaviour in two dimensions, it is necessary to apply the geometric rules of an arc. When working with a two-dimensional plan, the curvature of the arc can be expressed using the following formula, where "M" and "M1" represent two points on the

arc and "ds" represents the length of arc between them (Datsiou, 2017). These formulas provide a definition of the curvature and other arc rules:

$$R = \frac{ds}{d\phi} \text{ and } \kappa = \frac{1}{R}$$

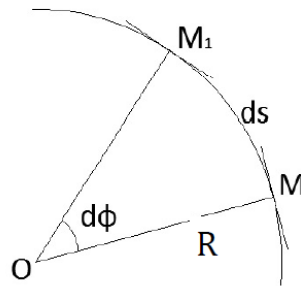

Figure 0-7: Radius of curvature for a 2D arc (Datsiou, 2017)

Curvature can be achieved with different methods, some of which are described below. The clarity of a bent glass panel, its capacity for further processing after bending, and the final product's dimensions are all significantly impacted by the method used to bend the glass.

Cold bending

Cold bending is a more recent and alternative technique for producing curved glass plates. This process involves elastically inducing curvature through out-of-plane loads at ambient conditions. With a relatively small amount of equipment, this method is energy-efficient and can be executed on site. In addition, the required glass plates of various curvatures can be cold bent into shape without the need for costly moulds, thereby minimizing expenses and making cold bending a highly attractive method for creating curved glass surfaces. Not only does this method offer energy and cost savings, but it is also believed that it does not compromise the optical quality of the glass from its original flat state because it does not require viscous flow, unlike thermal bending. Cold bent glass can be used to produce single or double curved forms, with single curvature or developable glass surfaces being easier to form.

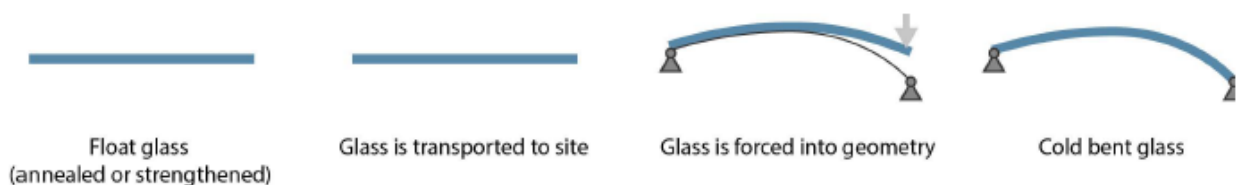

Figure 0-8: Cold bending process (van der Velden, 2019)

Cold lamination bending (warm bending)

Cold lamination bending is a variation of the cold bending process that is used to restrain curved glass plates during the cold bending of laminated glass. This process involves several steps: first, the unbonded unit of glass plates and interlayer(s) are bent into the desired shape and mechanically restrained. Next, the un-bonded bent unit is laminated in an autoclave, and finally, the mechanical supports are removed. In this case, the interlayer preserves the shape of the glass to a certain extent, although some initial spring-back can be expected when the restraints are removed after the lamination process.

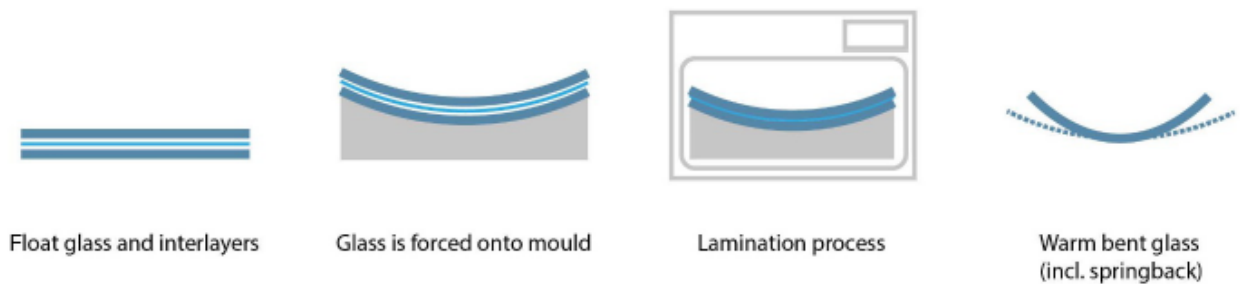

Figure 0-9: Cold lamination bending (warm bending) process (van der Velden, 2019).

Hot bending – slumped (static mould bending)

Static mould bending starts by heating the glass plate above the transition temperature ($T > 550^{\circ}\text{C}$) until it becomes viscous. The desired curvature is then achieved by allowing the heated flat plate to sag under its self-weight onto a concave or convex mould, typically made with steel tubes covered by refractory fibres. The temperature required for heating depends on the desired radius of curvature, with higher temperatures needed for smaller bending radii. While this method of glass bending is well-established, it is not energy or cost-effective since different moulds are required for plates of varying curvatures. Additionally, the optical quality of the curved glass plate is highly sensitive to imperfections in the mould, and the transportation of curved plates can be challenging and impractical.

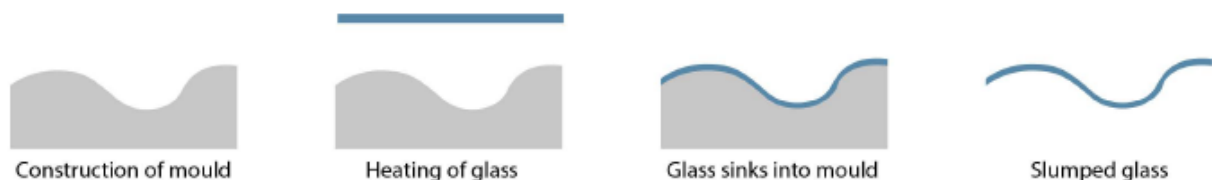

Figure 0-10: Hot slumped bending process (van der Velden, 2019).

Hot bending – tempered

Roller bending is an alternative method of hot bending that can be performed in either a horizontal or vertical setup. In the horizontal version, the glass is heated and transported horizontally to the bending apparatus, which consists of a roller bed with cylindrical roller cores covered by flexible mantels that rotate around them. The rollers start out flat but lift and move out of the plane to press the glass into the desired curved shape. After bending, the glass is quenched with jets of cold air to create the appropriate residual stress profile for toughened glass. During this process, the rollers move back and forth to avoid any defects known as "black spots." This technique is primarily used to create circular cylindrical bending shapes. This method is often employed during the toughening process of glass in a horizontal bending toughener.

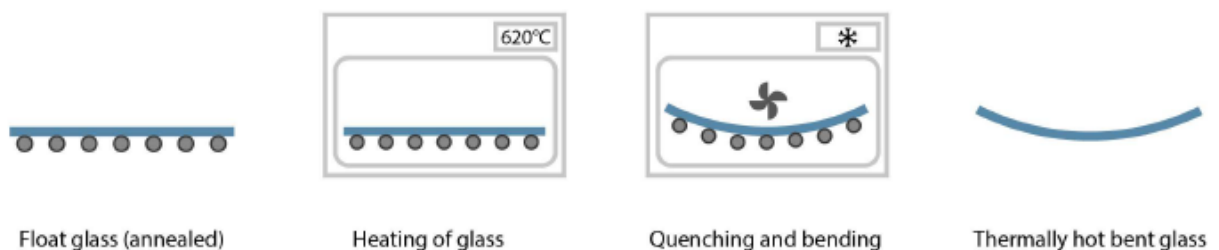

Figure 0-11: Hot bending by tempering (van der Velden, 2019).

0.1 Problem Statement

The construction industry has long relied on float glass, but limitations on its architectural use persist due to factors such as weight, difficulty in curving or tensioning, and the carbon-intensive post-processing and installation required. Although glass is highly recyclable, the existing closed-loop system only caters to post-consumer containers, leaving significant portions of disposed cullet contaminated and unsuitable for recycling. As such, repurposing and reusing glass construction waste has become an area of extensive research, including at TU Delft as according to Bristogianni (2022). However, integrating such research into the industry has yet to be fully realized.

Thin glass, which offers durability, optical clarity, and flexibility, represents a promising alternative that could provide more complex, lightweight, and clear structures. Yet while research has explored its potential use in the construction industry, such investigations have largely focused on framed compositions, composite panels, or complex techniques such as double curving to exploit all the material's capabilities at once.

Taking into consideration the aforementioned as well as the properties of the product, architectural applications would benefit from the potentials of the material itself. This will provide more complex, lightweight, and clear structures.

Hence, the current research is focused on studying thin glass on a small architectural scale and embracing the simple features that it can add on a design. This forms a promising opportunity for the existing products to be employed into construction and be brought to the fore. Should the process be done implementing an efficient computational method, it would result in an efficient and informed design process while also accounting for the material's behaviour throughout the process.

0.2 Relevance & Objectives

"Building Technology" provides the ability to identify an industry-related problem, being able to break it down into quantifiable parameters and provide tangible solutions. The issue that this research is going to dive into has been identified throughout the previous sections and has been separated into the different parameters. Therefore, the focus of this research is to pave the way towards a more tangible design solution, with an already existing product – thin glass.

The main goal of the current thesis is to explore the limitations of thin glass in design and construction, by understanding the material's limits when it is curved, as well as provide design guidelines that will bring the research one step closer to utilizing the product in practice. These will be investigated through the process of establishing a workflow for the design of a thin glass structure. That entails the definition of a computational method that will be able to assist the process and finally provide an informed and verified design solution.

The stated objectives will culminate with a case study to showcase the proposed workflow. This will evolve into a prototype, with a suggested connection design.

0.3 Research question & sub-questions

According to the stated and in view to accomplish the aforementioned objectives of this thesis, the main research question is formulated as follows:

"How can a design of a thin glass installation be informed by the use of computational methods?"

From this, there can be three distinguished parts. Specifically, *thin glass*, *small scale architectural design* and *computational design*. Since the design is intended to be informed by the computational workflow, the focus will be on the two remaining parts. Consequently, and to complement the various subjects, the following sub-questions arise:

Thin glass:

- *What are the limitations of thin glass in construction?*
- *What is the optimal way to bend thin glass and achieve its maximum capabilities?*

Additionally, carefully designed connections are an essential part of glass design. Thus, an additional sub-question is needed:

- *What types of connections are used in (structural) glass design?*
- *Which of the existing connections could be utilized for thin glass?*

Computational design:

- *What kind of tools can be utilized to optimize the design of thin glass structures?*
- *What data should be used and how, so as to provide limitations within the design process?*

0.4 Methodology overview & timeline

The methodology aimed to be followed for this research is a combination of two methods, separated in three different parts. To understand the overall glass industry considering that thin glass design should follow the same principles, knowledge through literature research is gained. The focus is on the capabilities of glass as a design and structural element. The second and main part entails the complete literature study on thin glass, to understand the product and its potential. Guidelines to achieve design configurations and connection principles will be created. Based on the gained knowledge, educated assumptions will be made to proceed with the third part of the research method. That is research by design, where after the conducted study a design approach will be set, limited and a workflow for its verification established.

This method should provide a step-by-step approach to design with respect to the material's properties and limitations. This final phase will culminate with building a prototype as a proof of concept and process evaluation.

The aforementioned are illustrated on the following flowchart:

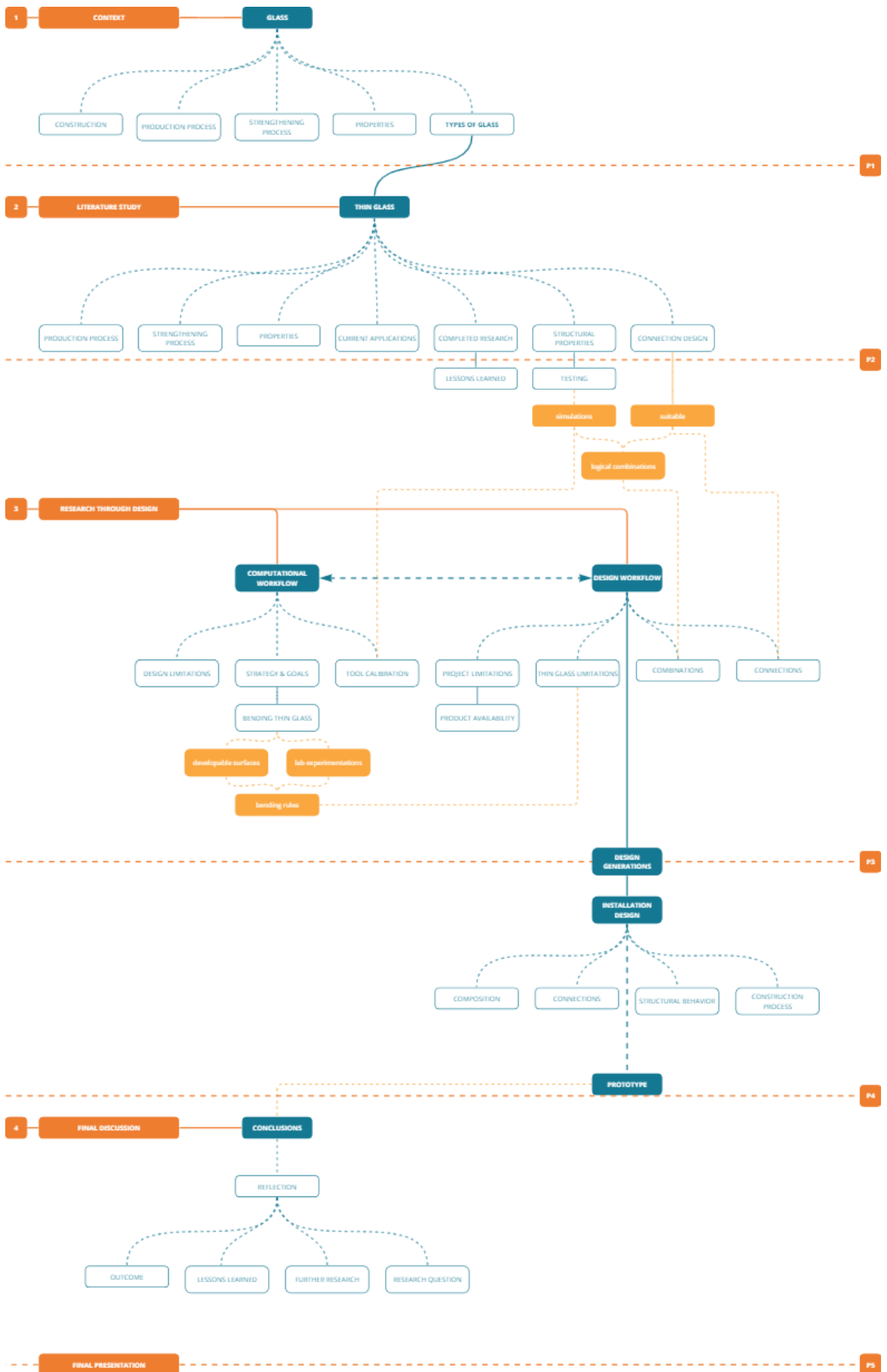

1. LITERATURE STUDY

1.0 Why thin glass?

According to Topcu and Marinov (2020), glass sheets with a thickness less than 2 mm, belong to the thin glass category. Nowadays, production can reach a 25 μm thickness (Schneider et al., 2017), introducing another sub-category called ultra-thin glass – specifically for sheets of less than 1 mm of thickness.

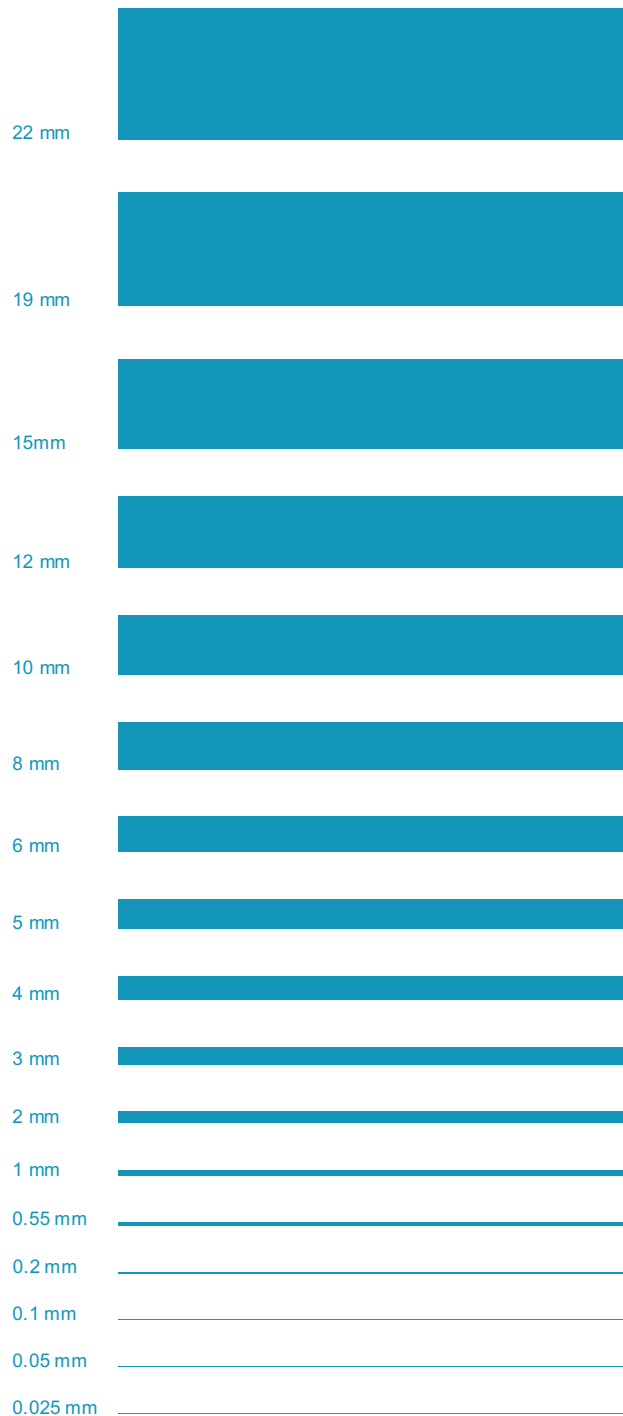

Figure 1-1: Scaled comparison of the different thicknesses of glass.

The discovery was completely accidental, when in 1952, a chemistry of Corning Glass Works used higher temperatures, and this resulted in a glass sample that formed unique properties (Rohrig, 2015). After that incident, Corning continued the research until 1962 when they ended up with strong but flexible and scratch resistant thin sheets of glass with unique optical properties. Due to these unique characteristics, thin glass products gained popularity amongst the automotive and electronics industry (Louter et al., 2018), where all the above play an important role.

Since the 20th century the use of glass in the world of architecture has been increasing and there is a continuous desire to raise the percentage of transparency in buildings (Topcu & Marinov, 2020), while the design and construction have also become more challenging. Answering to those challenges, thin glass products can provide a sufficient solution, not only by providing new possibilities, but also a more lightweight result (Pfarr & Louter, 2023). As it will be analysed in the upcoming sections, the production methods for glass sheets of thickness lower than 2 mm, need less amount of raw material and therefore result in a considerably higher number of panels when compared to regular float glass.

According to Pfarr and Louter (2023), it would be a beneficial addition to the construction industry – both creatively and financially – positively affecting the already involved industries.

1.1 Understanding thin glass

Typical flat glass is generally known, since it is a material widely used for the past centuries (Wurm, 2007). However, thin glass is still to be exploited in the architectural world where it would open up new horizons for expressions (Topcu & Marinov, 2020), due to its unique properties that will be further discussed within this section. Apart from thickness limitations, significant differences between thin and “regular” glass appear to their mechanical properties (Peters et al., 2019). To realize the material's behaviour, the production method as well as the post-processing procedures, the mechanical properties and the products available in the market follow.

1.1.0 Production and post-processing

According to Zaccaria and Gillon (2019), thin glass is an aluminosilicate glass, which composition changes depending on the different products that are available in the market. In general, aluminosilicate glasses tolerate higher temperatures – up to 800 °C –which also result in higher durability.

Aluminosilicate glass (ASG)

Increased durability in glass panels can be achieved by adding alumina to the soda lime mixture, in a much higher amount compared to soda lime (Corning, 2011). A percentage of 10-25 of Al_2O_3 , not only increases the panel's strength but also its thermal resistance – which is not a focus for this thesis but is therefore important for the composition of the material. There are two categories of aluminosilicate glass, the Alkaline Earth Aluminosilicate glass and the Alkali Aluminosilicate glass and are composed as shown on the table 1.1 below.

Alkali elements are soft metals whereas Alkaline Earth metals are hard and are both classified as glass “modifiers” (Huang & Behrman, 1991). The chemical composition of the aluminosilicate glasses is not the focus of this research; however, it is important to understand what makes the difference to the material's properties.

Table 1.1: Typical compositions of Alkaline Earth ASG and Alkali ASG, without specification on the used metals.

Type	Material	Formula	Composition
	Silica sand	SiO ₂	60-75 %
	Lime	Na ₂ O	5-12 %
	Soda	CaO	12-18 %
	Magnesia	MgO	0-6 %
Alkaline Earth ASG	Alumina	Al ₂ O ₃	15-25 %
	Alkaline earth		~15 %
Alkali ASG	Alumina	Al ₂ O ₃	10-25 %
	Alkali		> 10 %

Production process

Due to its thickness range (0.5 mm – 2.1 mm) the most suitable and most used manufacturing processes are the down-draw or overflow methods, which allow for thicknesses up to 25 µm. Both are vertical processes, whilst the float process that was discussed earlier is a horizontal one. The main advantage of such methods, according to Lambert and O'Callaghan (2013), is that there is no other surface – e.g., tin – touching the molten glass as it solidifies, except pure air in the controlled environment of a lab. This results in fewer to no impurities at the surface and therefore makes the production line more efficient.

Down-draw process

In the down-draw process, the molten mixture is held in a tank and then slowly let to flow through rollers where its thickness is controlled and is then left to cool down. The same process can be followed the other way round, drawn upwards. With this method thicknesses range from 25 µm to 10 mm.

Overflow process

As shown on the diagram above, during the overflow process, the glass mix is melted in temperatures over 1000 °C and evenly poured over a so-called "isopipe". This could also be described as a V-shaped trough. Following, the molten mix continually drawn, and a smooth

glass surface is formed. When the glass has cooled enough is cut to size and transformed to be further processed.

DOWN-DRAW PROCESS

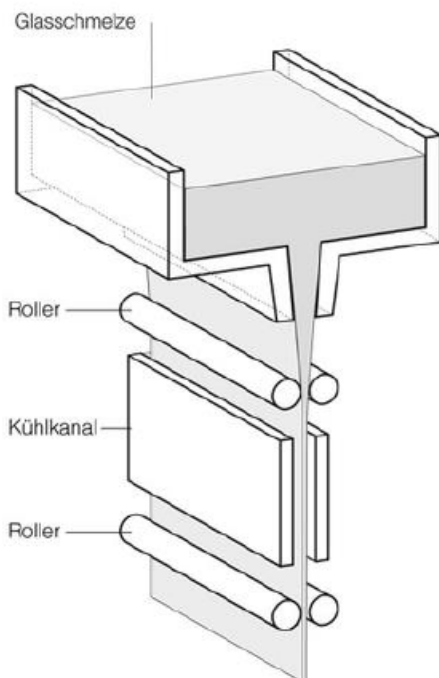

OVERFLOW-FUSION PROCESS

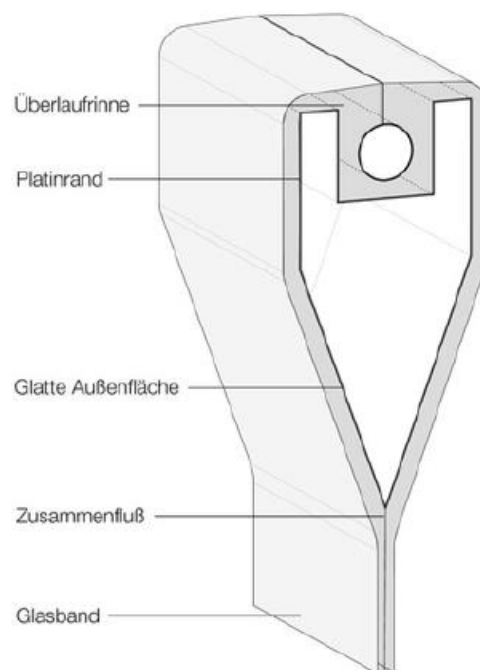

Figure 1-2: Down-draw and overflow process diagram (Albus & Robanus, 2014)

On the downside, both methods appear to be too expensive for the industry since the raw materials of an aluminosilicate glass need much higher temperature to melt compared to soda lime silica glass (Zaccaria & Gillon, 2019).

An exception to this rule is the *Falcon™ glass, by AGC*, which has a chemical composition between the common soda lime and an aluminosilicate glass. This makes the product suitable for the float line process that was described in the previous chapter and reduces its cost subsequently.

Strengthening thin glass (chemical tempering)

There are several ways of tempering and pre-stressing the glass, as it was described in the [Introduction chapter](#). However, due to the thickness of thin glass panels, thermal tempering is avoided since there are high chances of impurities when touching another. Therefore, the chemical tempering or ion exchange method is chosen.

As described by Neugebauer (2016), the glass is placed into a bath of molten potassium nitrate (KNO_3) and left for a given amount of time and in standard temperatures (depending on the product's composition). During this process, sodium ions (Na^+) diffuse from the glass into the liquid and are replaced by the larger potassium ions (K^+). This creates pre-compression at the glass panel and the process is favoured for aluminosilicate glass due to its chemical composition and thickness (Zaccaria & Gillon, 2019).

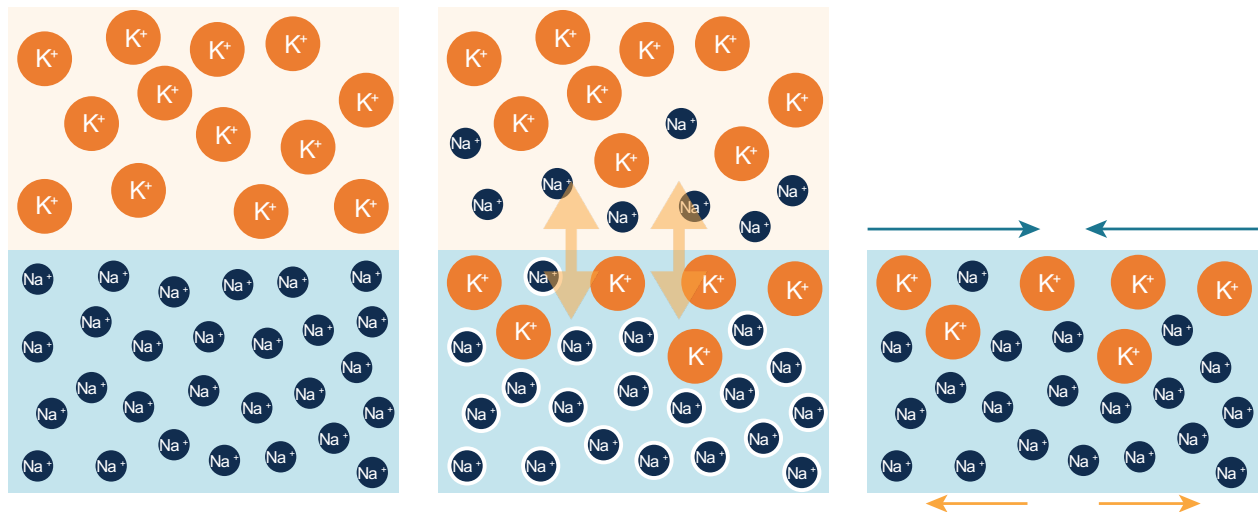

Figure 1-3: Chemical treatment diagram. The sodium ions are replaced by the larger potassium ions (own illustration).

1.1.1 Structural behaviour

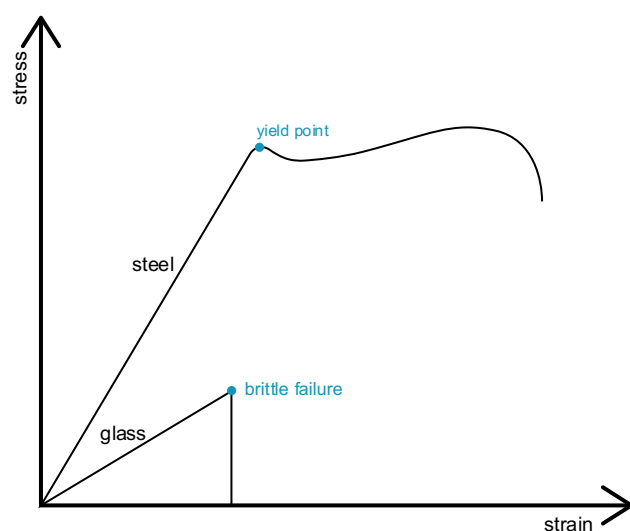

Figure 1-4: Stress / Strain curves for steel and float glass (own illustration).

Glass has a brittle nature, even though it can withstand a lot under compression. Contrary to other structural materials, it does not yield and its failure is difficult to predict (O' Regan, 2014). The main difference between glass and other brittle construction materials, like concrete and masonry that are also brittle in tension, is that they can utilize reinforcement (Green, 2016). This gives the advantage of acceptable cracks in the material while utilizing the reinforcement's properties. On the contrary, glass structural components

“depend on the distribution of flaws on the surface, such that there can be wide variability of performance and cracks do not necessarily initiate from the point of greater stress” (Green, 2016).

As O' Regan (2014) states: "glass panes can deflect by more than their own thickness" and same applies to thin glass panes as well. The combination of strength and small thickness assigns a unique flexibility to these panels (Santos et al., 2018), that is structurally challenging. Thus, thin glass requires different handling to determine the strength and for the time being it does not apply to the European code EN16612 (Glass in building – Determination of the load resistance of glass panes by calculation and testing). However, one common standard is the amount of allowable deflection, due to human comfort. Flexibility does not mean that a structure is unsafe.

The described characteristics offer different possibilities in terms of structural behaviour, that nevertheless should be tested prior to application. Neugebauer (2016) studied different methods of testing the bending tensile stress of thin glass, using existing equipment and according to the principles provided by European codes.

Table 1.2: Tensile bending stresses of float glass based on the European code (EN16612) limitations and testing performed by Veer, Louter and Bos (2009).

	Characteristic strength EN16612	Characteristic strength (Veer et al, 2009)	
Annealed	45	20	MPa
Heat strengthened	70	40	MPa
Fully tempered	120	80	MPa
Chemically tempered	150	-	MPa

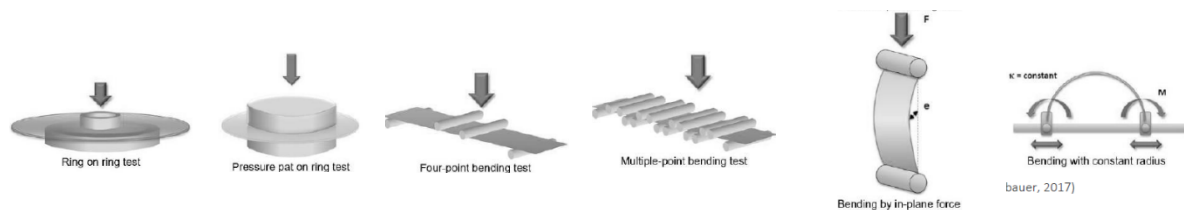

Figure 1-5: Different test set-ups for thin glass (Neugebauer, 2016).

Moreover, AGC Europe, in cooperation with two other institutions – TU Dresden and TU Darmstadt – developed an innovative testing process, in accordance with the European standards (Zaccaria et al., 2022). This process is extensively described in a following chapter of this report, in [section "2.0.2"](#), since it is the one used to acquire data regarding the material's strength for the current project.

Thin glass bending strength

As mentioned before, bending strength is also influenced by the specific product's properties and the post-processing (e.g., chemically tempered). Since thin glass is chemically tempered, the differences rely on the different products. As shown on the table below, there is a comparison of the (ultimate and design) strength of some products that exist in the market with that of the ones on the table presented above.

Table 1.3: Strength comparison according to product's specifications sheets.

	Ultimate bending strength	Design strength	Unit
Xensation glass	800	±260	MPa
Gorilla glass	-	200	MPa
Dragontail glass	600	±200	MPa
Leoflex glass	-	260	MPa
Falcon glass	-	200	MPa

1.1.2 Types of thin glass

After Corning various glass companies have been investing in the production of thin and ultra-thin glass and therefore, this resulted in a lot of product availability in the market. Some of these were investigated for the purpose of this research and the following table serves as a comparison of their properties and those of the regular float glass.

Table 1.4: Thin glass products properties comparison.

Properties	Density at 18 °C	Modulus of Elasticity	Poisson's Ration	Average CTE	Specific Heat Capacity	Thermal Conductivity	Hardness
Symbol	ρ	E	μ	α	c	λ	-
Units (SI)	Kg/m ³	GPa	-	K ⁻¹	J/(kg*K)	W/(m*K)	Units on Moh's scale
Soda-lime-silica	2500	70	0.2	9 *10 ⁻⁶	0.72 *10 ⁻³	1	6
Willow Glass	2300-2500	70-80	0.2-0.25	3-5 *10 ⁻⁶			
Gorilla Glass	2430	76.7	0.21	7.9 *10 ⁻⁶			
Gorilla Glass for automotive	2440	71.7	0.21	8.3 *10 ⁻⁶			
Dragontrail glass							
Leoflex glass							
Falcon glass							
Xensation glass							

1.2 Glass connection design

Connection design is a key aspect in glass systems, as they concentrate a lot of stress and they need to address high deformations under specific loading or boundary conditions (Bedon & Santarsiero, 2018). Thus, connection design requires a multidisciplinary process from design to reach the construction phase.

The design process with thin glass should not utilize the same standards as regular float glass. The mechanical behaviour of the material is slightly different, and the material appears to have higher bending strength and flexibility, which changes the perspective and utilization of it in an architectural design scenario. During a personal interview with Sam Gregson, ex project manager of EOC engineers, admitted that the connection design was one of the most challenging parts when discussing the Thin Glass Pavilion shown in the figure below. This is further discussed in [section "1.3.1"](#).

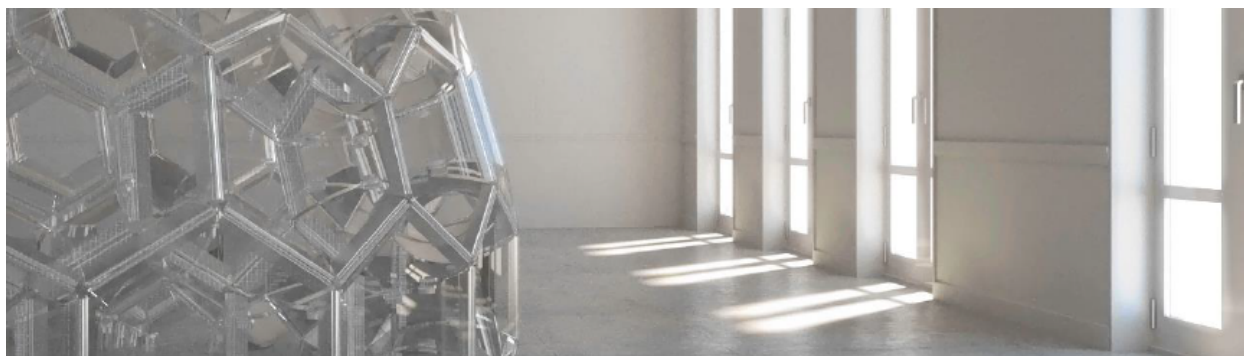

Figure 1-6: Thin glass pavilion design by EOC (2019)

However, to be able to design with this relatively complex type of glass, an investigation through the different connection types was conducted and the different types are explained in the following paragraphs.

Continuous linear supports

The glass panel is supported usually on an aluminium, steel, plastic or timber frame. The out-of-plane load is transmitted via structural sealant or gaskets and the in-plane load via setting blocks (O' Regan, 2014). The design should account for any movement at the edges of the panel and the fact that the stress distribution is not always constant along the line support.

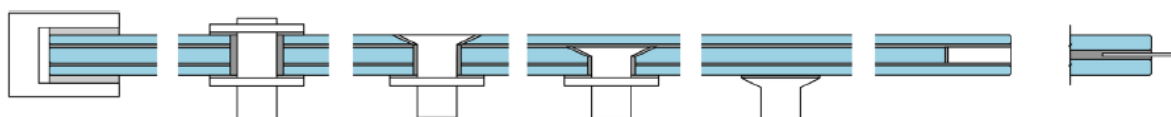

Figure 1-7: Series of different connection typologies. From left to right: clamped, bolted, bolted with countersunk bolt, hybrid with countersunk bolt, adhesive, embedded with thick insert and embedded with thin insert. (Bedon & Santarsiero, 2018).

Clamp connections

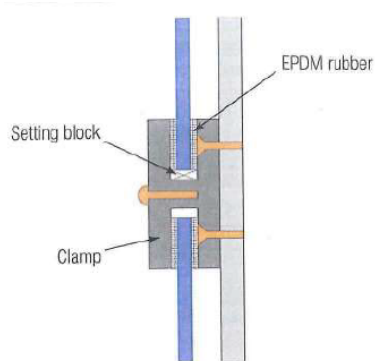

Figure 1-8: Section through a clamp fixing (O' Regan, 2014).

Clamp connections are designed to carry both out-of-plan and in-plane loads. These connections are realized with a metal clamp that is mechanically adjusted to the glass element (Bedon & Santarsiero, 2018; O' Regan, 2014). A soft plastic layer of neoprene, or ethylene propylene diene terpolymer (EPDM) is added between the metal part and the glass panel to reduce stress. Typically used in elements with minor structural role, such as balustrades or facades.

Friction grip connections

Inspired by structural steel design, such connections take advantage of preload of bolts and work best with in-plane loads. In contrast with clamp connections, here aluminium or fibre interlayers are introduced between the glass pane and the metal part, so as to provide appropriate resistance (Bedon & Santarsiero, 2018). According to O' Regan (2014), drilling on the panel to position the bolt is oversized to prevent any contact with the glass. Such connections are used in the design practice of structural fins and facades.

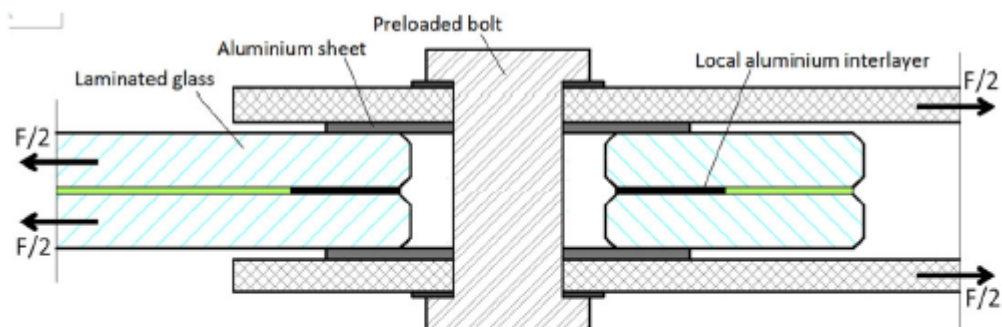
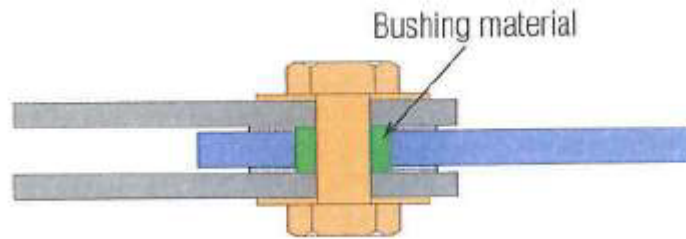

Figure 1-9: Cross-section detail of a friction-grip connection (Bedon & Santarsiero, 2018).

Bolted connections

Bolted connections are widely used. It is typical to fix multiple structural glass elements or façade panels. However, the stress around a bolted connection varies considerably and thus, a toughened glass is preferred. A bush material is introduced around the bolt to overcome the effect of localized stresses.

Figure 1-10: Through-bolted connection (O' Regan, 2014).



Adhesive connections

Adhesive connections are widely used to bond glass components to metal parts or other glass components using adhesive polymeric materials. These materials possess a broad range of mechanical and physical properties, which allows for various technical solutions with different performances.

Embedded connections

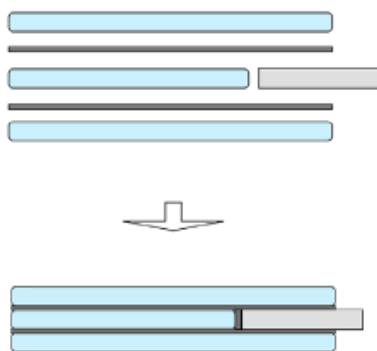

Known also as laminated connections, are fabricated with a similar process to that of laminated glass. The main advantage of such connections is that the loads are transferred evenly along the glass panes since the adhesive layer is homogeneously spread between the different layers.

Figure 1-11: Fabrication scheme for embedded laminated connections (Bedon & Santarsiero, 2018).

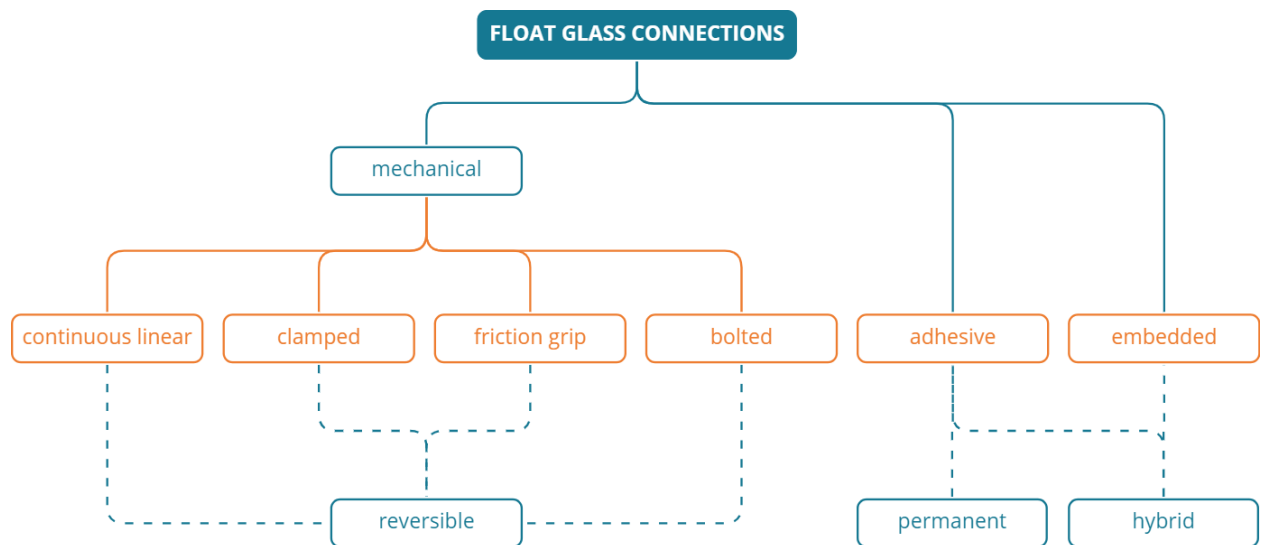

Figure 1-12: Categorization of float glass connections (own illustration).

As mentioned, each connection can serve various design and structural purposes. The above diagram presents a summary of the available categories and divides them into three distinct groups based on their ability to be converted into reversible connections (Kouvela, 2022).

Following this categorization, connections suitable for thin glass should be distinguished. The literature research on the topic does not provide sufficient information on actual applications and therefore the assumptions made are based on prior academic research and knowledge on general glass behaviour.

Due to the glass' thickness, bolted connections should be avoided since the stress concentration that such connections required is not favoured for the material's structural behaviour. Therefore, the connections – as they were grouped earlier – evolve as follows on the diagram below, with the ones highlighted being mostly favoured. However, the connection design is directly influenced by the design itself. For example, adhesives would not be chosen in a cold bent design, since the structural capacity of the adhesive would most possibly not be enough to withstand the cold bent panel's spring back. Pennetier's sculpture is discussed in [section 1.3.1. "Case studies"](#) and the above-mentioned fact is also proven through her study.

Detailed research on the topic is not within the scope of this research. However, suitable connection design methods for this thesis will be further discussed in the following chapter.

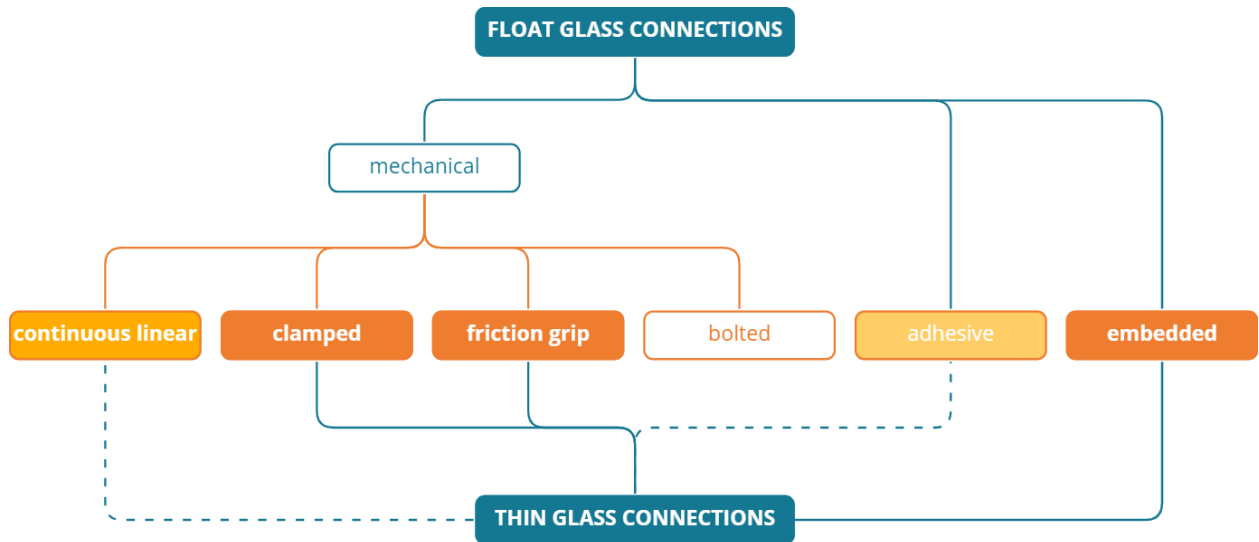

Figure 1-13: Discretization of connections for designs with thin glass (own illustration).

1.3 Thin glass in the built environment

Types of thin glass have already been implemented in architecture, although mostly in interior design (Pennetier & Stoddard, 2019). There are numerous potentials of (ultra) thin glass in façade design, for example by making Insulated glass units lighter or for more complex designed second skins (Louter et al., 2018). Following there is a list of the most researched topics and the lessons learned that could be used to facilitate the current project.

1.3.0 Research in the field

The topics selected for the upcoming discussion are primarily related to academic or professional research rather than practical applications of the material. Consequently, each study has a distinct focus that can contribute valuable insights to the current research goals.

Composite panels

Since flat thin glass panes are not stiff enough to be used structurally on their own with the acquired knowledge, composite panels have been researched. In combination with plastic, recycled PET, or other materials used as interlayers the panel can gain strength and stiffness to withstand the needed loads (Saleh et al., 2020). A series of studies conducted at TU Delft (Akilo, 2018; Burgman, 2019) have investigated different scenarios on how to better utilize a core structure not only to provide stiffness to a lightweight panel, but also contribute to the architectural expression and other related characteristics of the panel. The production

technique used for the core is 3D printing, as it provides flexibility in fabrication of complex geometries and the ability to produce in one-piece (Saleh et al., 2020).

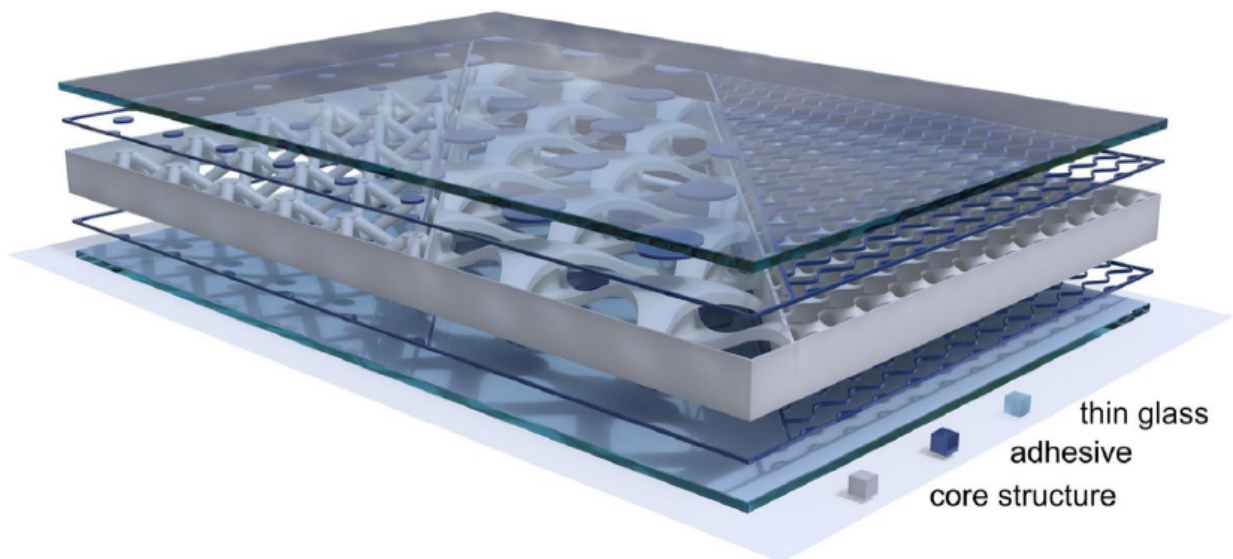

Figure 1-14: Rendering of the composite panel with thin glass as cover layer, an adhesive bonding, and an additively manufactured core structure (Pfarr & Louter, 2023).

Curved panels

Curving the glass does not only have an architectural interest but it also has structural potentials since bending increases the moment of inertia and therefore the stiffness (Weber, 2018). Nonetheless, as thin glass is a rather flexible material it allows for smaller radii, but attention is needed to the design due to the material's properties (Neugebauer & Wallner-Novak, 2018).

Cold bending

Cold bending – as described in ["0.0 Context – Bending/ Cold bending"](#) – is the most affordable way of creating curved glass panels, since no prior process is required and the panels are fixed on site at room temperature (Belis et al., 2007). Even though the panel is then subjected to bending stresses throughout its lifetime, it still takes advantage of the additional geometric stiffness due to bending (Gregson et al., 2019).

Accordingly and based on the small thickness of it, thin glass is particularly adept for cold bending (Schneider et al., 2017). Considering the fact that it is substantially lighter compared to a regular float glass panel of the same size, it also makes it easier to be transported and

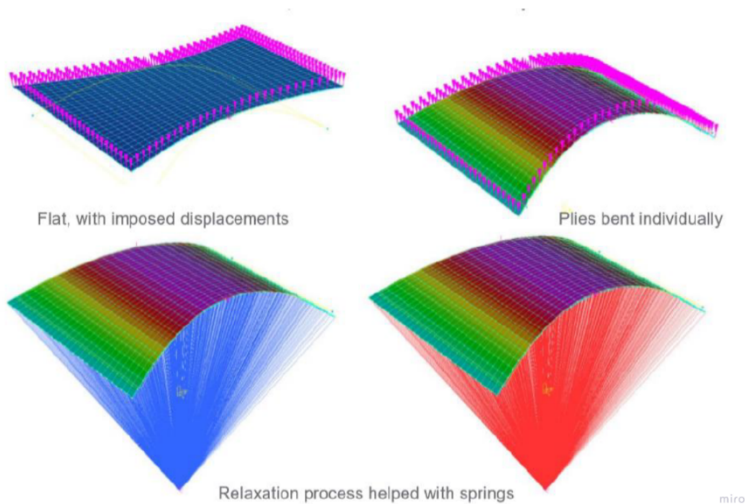

Figure 1-15: Digital structural diagrams of cold bent panels for the thin glass pavilion (image courtesy of EOC Engineers).

assembled (Gregson, 2018). Apart from studies conducted within TU Delft, that provide a great insight on the behaviour of cold bending thin glass panels (van Driel, 2021), there are also numerous research outside of this particular institution that focus on the same process. For example, Neugebauer and Wallner-Novak (2018); Neugebauer et al. (2018) focused on studying

movable façade elements made from thin glass. Such studies show the potential that the material and its unique characteristics has to offer to the construction industry.

Tensioned structures

Studies initiated by Lambert and O'Callaghan (2013), attributed to thin glass characteristics like those of fabrics, with the difference that it is a more homogenous material and therefore orientation under tension is not an issue. Therefore, research treating thin glass as a membrane exists. A cable net structure was exhibited during the Glasstec 2018 in Dusseldorf by (Peters et al., 2019). This required continuous linear clamped connections to secure the panel in all its dimensions and provide additional insulation as weatherproofing. Since the structure resulted in double curved panels, such connections were required to involve the glass in load transferring.

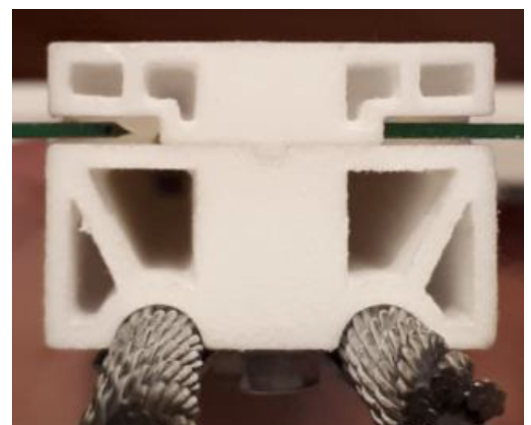
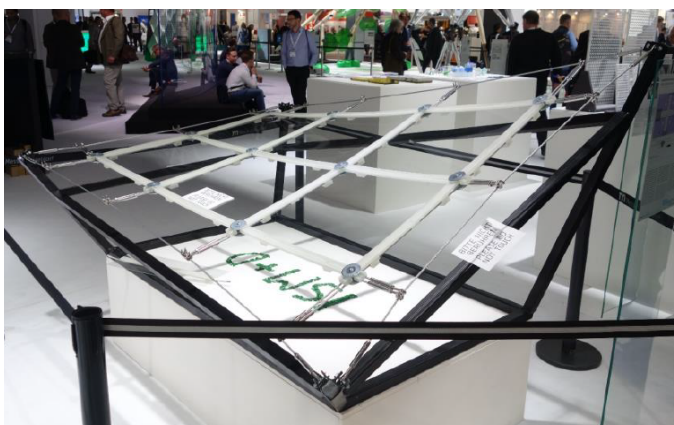

Figure 1-16: Thin glass cable net structure at Glasstec 2018 (left) and Cross-section of the clamping bar of the same structure (right)(Peters et al., 2019).

1.3.1 Case studies

Ultra-thin glass sculpture, Sophie Pennetier



Figure 1-17: Photographs of the ultra-thin glass structure in different design stages and a simulation using Strand7 (Pennetier & Stoddard, 2019).

Structural engineer, Sophie Pennetier, investigated the abilities of ultra-thin glass and presented her work in 2017. In an attempt to exploit the properties of the product, a corrugated shaped sculpture was design by bending strips of glass elastically (Pennetier & Stoddard, 2019).

The final sculpture fits within a rectangle of 750 mm by 750 mm, in plan, and 700 mm, in height, and the product used for it was 200 μm Willow glass (by Corning Inc.) – with the properties as mentioned in [table 1.4 of section "1.1.2"](#). The thickness and properties of the product make it possible to process it after strengthening. The corrugated spiral shape provides enhanced stiffness while the glass conoid strips support each other (GPD, 2020). The glass-to-glass connection was done with an adhesive structural VHB (Very High Bond) tape (Stoddard, 2019) which provided immediate bonding. However, it appeared to deteriorate due to heat and could not hold on to the product, meaning that such a tape would not be appropriate for long term loading (GPD, 2020).

Rhino 3D and Grasshopper were utilized to model the design, while Strand7 Finite Element Analysis software was used for structural simulations. A flat geometry of unrolled strips was imported to Strand7 and was increasingly deformed to observe the stresses on surface. The communication between software was a rather manual process that required a lot of back-and-forth adjustments and feedback to achieve a material stress below the allowable levels.

Prototype for thin flexible glass pavilion, EOC Engineers

Eckersley O'Callaghan Engineers investigated the potential of thin, flexible glass with the design of a domed pavilion that was presented at the International Association of Shell and Spatial Structures (IASS) 2019 conference in Barcelona, Spain.

Following the same principle of bending glass in order to provide additional geometrical stiffness and therefore contributes to a lighter structure both in weight and appearance (Gregson et al., 2019). The pavilion's form evolved from optimizing a regular icosahedron to produce a dome (EOC, 2019). The final geometry derives from a thickened version of the dual of a geodesic dome. Like other structures based on geodesic domes, it benefits from having repetitive elements that simplify the fabrication and assembly process on site. The process of thickening the geodesic wireframe results in a stiff, curved glass beam structure.

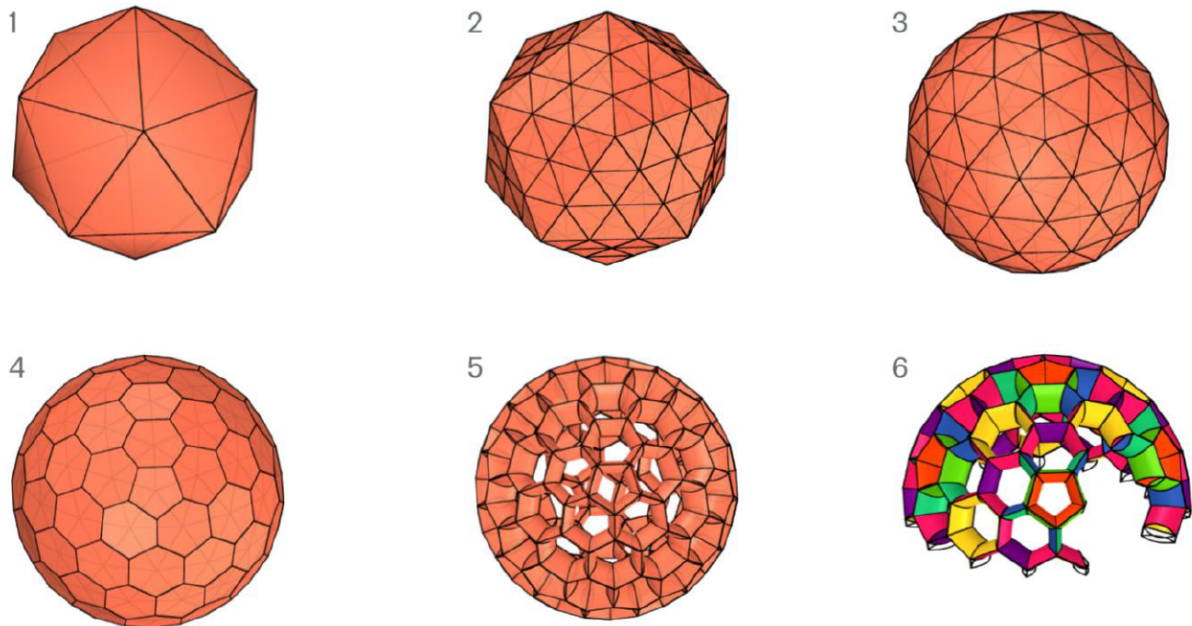

Figure 1-18: Geometrical studies of a geodesic dome (Image courtesy of EOC Engineers).

Sam Gregson, during the presentation of the pavilion at the IASS conference, mentioned the challenges of designing with thin glass and that a very critical point during the process is the connection design. For this project, the focus was on keeping the structure as transparent as possible and therefore, the designers chose to utilize transparent or translucent materials for the connections. The final pin connection, which is displayed on the figures below, was 3D printed and allows for a 20° rotation and the adhesive used was cured with UV light.



Figure 1-19: Connections designed for the "Thin flexible glass pavilion" by Eckersley O' Callaghan (Images courtesy of EOC Engineers).

Two sheets of 0.5mm thickness of “Falcon Glass” by AGC were laminated to produce a 1mm thick sheet and curved glass panel. The chemically strengthened glass was bent with the process of lamination bending.

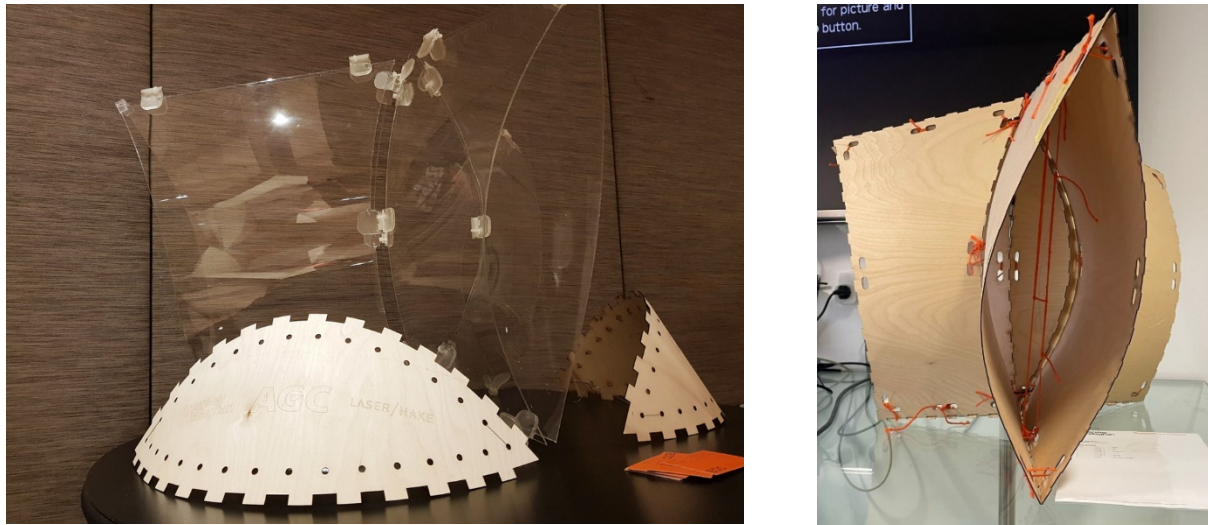

Figure 1-20: Laminated bent Falcon glass with the 3d printed connections holding the 4 panels together (EOC, 2019) (left) and the prototype made of plywood for the same concept design (own image) (right).

1.3.2 Conclusions and lessons learned.

Such studies show the potential that the material and its unique characteristics has to offer to the construction industry. The examples presented show that the material can be utilized in several different ways and that its unique properties and mainly its flexibility could be more of an advantage than a drawback.

Case studies prove that such glass sheets can utilize geometry to strengthen their structural behaviour and therefore provide clear and lightweight structures. One of the biggest challenges is the design of connections, not only for the glass thickness but also due to the flexibility that it presents. When the panel is under constant stress due to bending, it has the tendency to spring back and therefore the connections need to withstand this. Furthermore, this confirms that the glass-to-glass adhesives would not be ideal in long term scenarios when cold bending is used to provide curvature. This is also confirmed through the “Ultra-thin glass structure” where the used VHB tape deteriorated and started to fail.

2. RESEARCH THROUGH DESIGN

2.0 Designing with thin curved glass panels

As described in section ["0.2"](#), this research focuses on finding an optimum way to exploit the material's properties and utilize it in design. Based on the literature research that was presented on the [previous chapter](#), the investigation is comprised on *cold bending thin glass panels* as this provides additional geometrical stiffness, allows for greater curvatures, and can be done directly on site, minimizing the complexity of transport and assembly.

Therefore, in order to build a computational method that will assist the design process when utilizing cold bent thin glass, parameters and limitations need to be set. The section that follows describes the steps followed to set up such a method and the considerations implemented according to the literature research and case studies.

2.0.0 Setting up the workflow

Designing with the purpose of best utilizing a material's characteristics, means that there should be an overall understanding of its mechanical and structural properties, as well as what are the available products to be used – since those properties would differ per product.

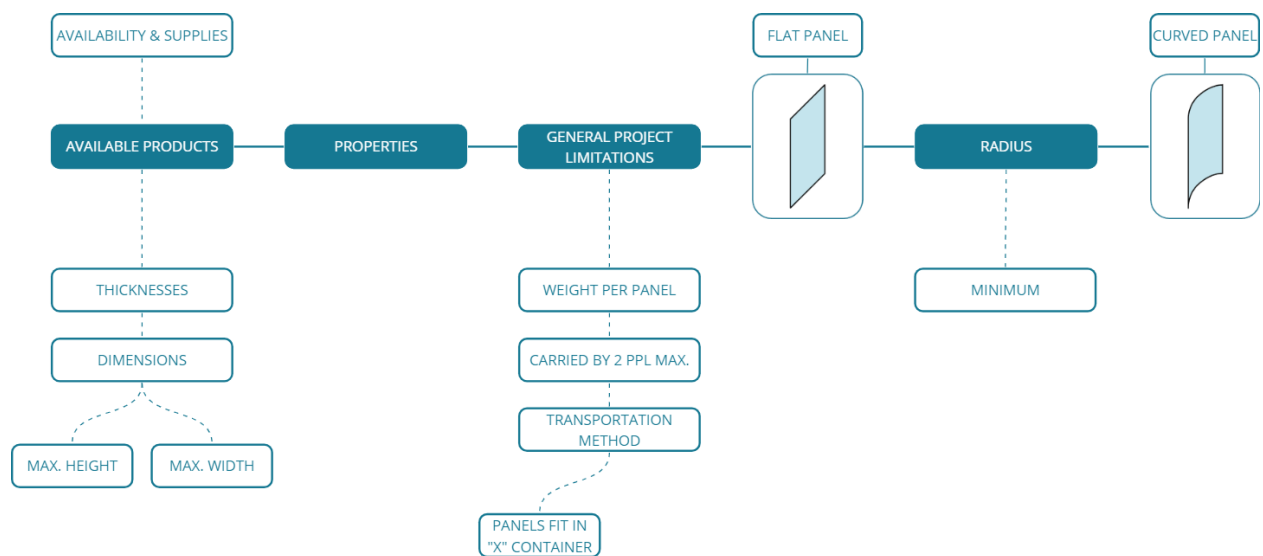

Figure 2-1: First steps of setting up a design workflow to end up with curved panels (own illustration).

For this thesis, the product that is being used is AGC's *Falcon Glass*. As discussed in [chapter 1.1.0](#), Falcon Glass is still an aluminosilicate glass, but with a slightly different composition that makes it possible to be produced through the float glass process. Therefore, this makes it more affordable while still preserving the unique properties of a strong and flexible thin glass product (Zaccaria & Gillon, 2019). Through [AGC's website](#), there is access to the [product's](#)

[specifications document](#), where the available dimensions as well as the performance properties could be found. Those are as presented on the tables below. However, regardless of the product, the properties presented are the ones needed to identify a panel's behaviour in a design concept and therefore the ones needed in such a workflow.

Table 2.1: Falcon Glass performance properties (source: AGC).

Chemical strengthening properties	Compressive stress (@20µm DoL)	> 800 MPa
	Depth of Layer (in 8h)	> 40 µm
	Reinforcement (for 15µm defect)	> 500 MPa
	Warpage (in 0.7mm – 420°C/4h)	< 0.05%
Mechanical properties	Density	~ 2.48 g/cm ³
	Young's modulus	~ 70 GPa
	Poisson's ratio	~ 0.21
	Shear Modulus	~ 30 GPa
	Knoop hardness HK _{0.1,20}	450 (before chemical strengthening) – 546 (after c.s.)
Thermal properties	Softening point	~ 665 °C
	Tg	~ 575 °C
	Coefficient of thermal expansion	~ 9*10 ⁻⁶ (25-300 °C)
	Thermal conductivity	~ 1.19 W/(m*K)

Table 2.2: Falcon Glass available panel sizes per thickness. Other thicknesses and dimensions are available upon request (source: AGC).

Thickness	Size
0.5 mm	Up to 1.245 * 3.21 m
0.7 mm	Up to 1.35 * 3.21 m
1.1 mm	Up to 1.35 * 3.21 m
2.1 mm	Up to 1.60 * 3.21 m
3 mm	Up to 1.60 * 3.21 m
4 mm	Up to 1.60 * 3.21 m

As is shown in figure 2.1, there are also some general project limitations that could be applied. Those can vary depending on the project. The parameter used in this project is the weight of the panel which is influenced mainly by its dimensions and consequently affects both the transportation and installation of it. In order to make the construction and assembly process easier there is a limit of a maximum of two people that should be able to carry one glass panel. According to the guidelines published by the "Health and Safety Executive" in the UK, the maximum weight that one man could lift at work is 25 kilograms, whereas the maximum for a woman is 16 kilograms.

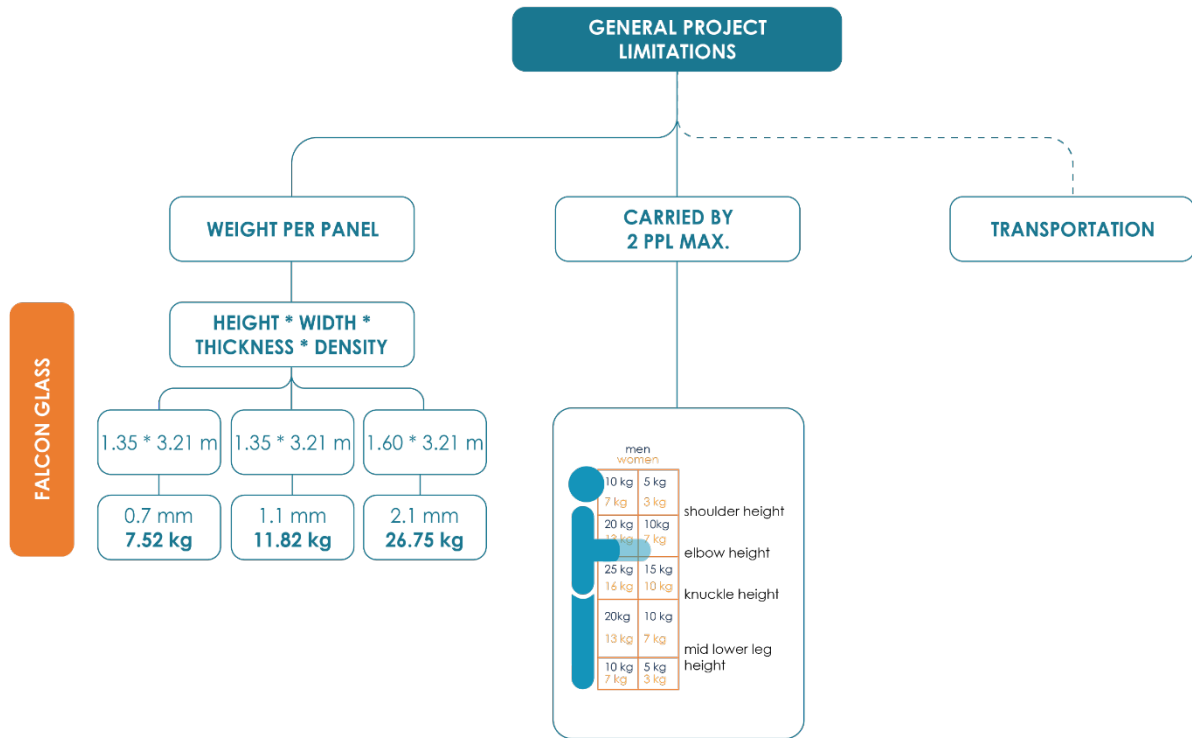

Figure 2-2: Example of the general project limitations set for the current project and the parameters referring to it (own illustration).

Considering the density of Falcon glass – which is used for the current project – if the thickness does not exceed that of 2.1 mm, being the limit of thin glass thicknesses, the weight of a panel with the maximum available dimensions would be 26.75 kilograms. Therefore, it is acceptable for two people to carry it on site.

Despite the fact that the proposed limitations are fulfilled without difficulty, it is proposed that such limitations are set as boundaries within a design workflow.

After these steps, the first design parameters are set and therefore a flat panel of thin glass is defined.

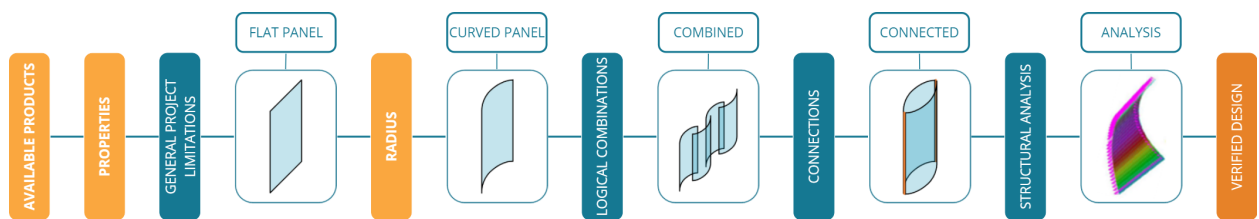

Figure 2-3: Steps that define the overall proposed workflow when designing with curved thin glass panels (own illustration).

To complete the design workflow, the bending radius follows, as well as the design combinations leading to a structural analysis that will end up with an informed and verified design outcome. The proposed workflow evolved as shown in figure 2.3.

The subsequent sections are going to analyse the necessary steps and parameters that should be taken into consideration when designing with bent (thin) glass and that would therefore define the overall design workflow.

2.0.1 Limitations in bending

Through the multiple ways that exist to achieve curvature in glass panels, cold bending has been recently explored more in the architectural world, as a more cost-effective alternative that offers less optical distortion (Gavriil et al., 2020). Single curvatures are easily achieved through cold bending, but also, according to Datsiou (2017), doubly curved surfaces could be created by introducing a controlled amount of strain and associated stress at ambient temperatures.

Principles

In general, curved 3D surfaces classify as single or double curved according to their Gaussian curvature. The theory of *developable surfaces* characterizes all single curved surfaces, which are created through uniaxial bending of a planar surface and have zero Gaussian curvature (Datsiou, 2017). Developable surfaces are surfaces that can be flattened into a two-dimensional plane without stretching, tearing, or warping (Zhang & Zheng, 2022). They are useful in many fields, including manufacturing, engineering, architecture, and art. There are three types of developable surfaces: ruled surfaces, developable surfaces of revolution, and developable helicoids. Ruled surfaces are developable surfaces that can be created by moving a straight line along a curve in space. Examples include cylinders, cones, and hyperbolic paraboloids. Developable surfaces of revolution are developable surfaces that are created by rotating a curve around an axis. Examples include spheres, tori, and cones. Developable helicoids are developable surfaces that are created by twisting a flat surface.

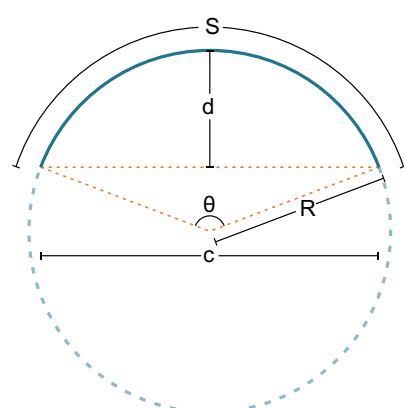

Figure 2-4: The geometrically calculated parameters of a 2D arc (own illustration).

Examples include spirals, ramps, and screw threads. According to Gavriil et al. (2020) and Rabinovich et al. (2018), there are ways to achieve double curvature when designing with developable surfaces.

Since the current research is focusing more on the method than the design outcome, the applied curvature will be limited to single cold bent panels. By simplifying a surface on 2D, a single bent panel follows the geometric rules of an arc that are as follows:

$$S = \vartheta \cdot R \text{ (}\vartheta \text{ in rad)} \text{ or } S = \frac{\vartheta}{360} \cdot 2\pi R \text{ (}\vartheta \text{ in degrees)}$$

$$c = 2 \cdot R \cdot \sin \frac{\vartheta}{2}$$

$$d = R \left(1 - \cos \frac{\vartheta}{2} \right)$$

where S is the length of the arc and therefore the actual length of the glass panel, d is the depth of the arc, R the arc radius, ϑ the angle and c the chord of the arc.

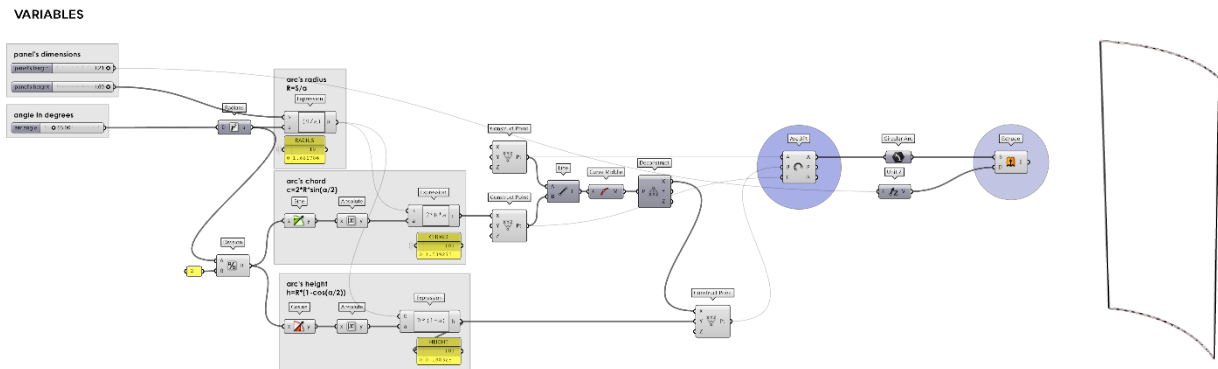

Figure 2-5: Example of modelling a curved panel as a 3D surface in grasshopper, based on the geometrical rules of an arc. Screenshot of own grasshopper definition (left) and resulting panel on Rhino perspective viewport (right).

Apart from the simplicity in modelling and conducting structural simulations, that will be explained in the following chapters, the testing process for determining the bending strength of thin glass – as this is described in the following [section “2.0.2”](#) – follows the geometric rules of an arc. This means that using a single curved, cylindrical shape allows for verifying the structural calculations based on the test results and limiting the curvature according to the actual strength obtained through testing.

2.0.2 Characteristic & design strength

The European codes provide a common approach to the design of structures in Europe and aim to ensure that construction projects meet the required safety, health, and environmental standards (Commision, 2021). Therefore, EN 1288 (Glass in building – Determination of the bending strength of glass), part of Eurocode 1 (Actions on structures), specifies the test methods and procedures for determining the performance characteristics of glass in buildings. The standard covers various types of glass, including annealed glass, heat-strengthened glass, tempered glass, laminated glass, and insulating glass units (IGUs). The standard also includes procedures for evaluating the resistance of glass to impact, bending, and thermal stress, which are important considerations in the design and construction of buildings.

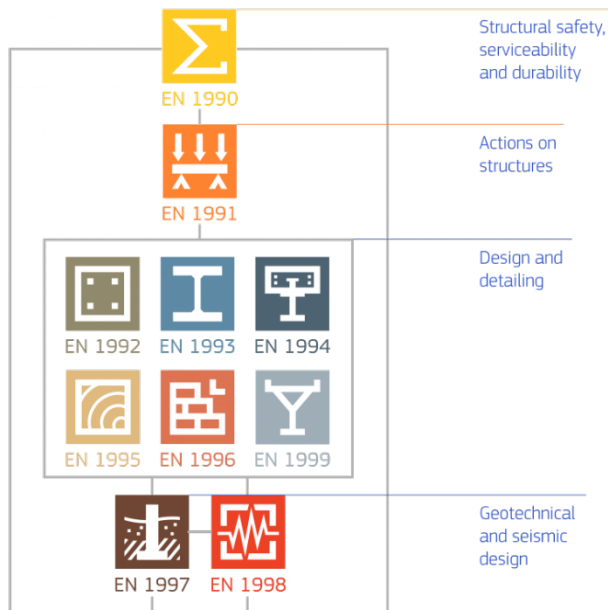

Figure 2-6: The Eurocodes at a glance (Commission, 2021).

According to those standards, the characteristic strength of a material – in this case thin glass – is determined. Hence, after performing the equivalent material testing the characteristic value is calculated as of the *5% probability of failure*.

To move forward with calculating the design strength, EN16612 (Glass in building – Determination of the load resistance of glass panes by calculation and testing), part of Eurocode 8 (Geotechnical and seismic design), is advised. Therefore, the design value of bending strength ($f_{g;d}$) for prestressed glass material of any

composition is calculated by the following formula:

$$f_{g;d} = \frac{k_{mod} * k_{sp} * f_{g;k}}{\gamma_{M;A}} + \frac{k_v(f_{b;k} - f_{g;k})}{\gamma_{M;v}}$$

where k_{mod} is a factor for the load duration, k_{sp} is a factor for the glass surface profile, k_v is a factor for strengthening of prestressed glass, $\gamma_{M;A}$ is a material partial factor for annealed glass, $\gamma_{M;v}$ is a material partial factor for surface prestress, $f_{g;k}$ is the characteristic value of the bending strength of annealed glass and $f_{b;k}$ is the characteristic value of the bending strength for the surface of the glass panes. The European standards define those factors and are mostly dependent on the production process and post-processing, except for the load duration factor that is time dependent. The valid factors for the current thesis are displayed on figure 2.10 in the current section.

For the current project, test data that was received from *AGC Glass Europe* has been used to calculate the bending strength of *Falcon glass*. However, since thin glass presents extreme flexibility, and as mentioned in section [“1.1.1”](#) the established methods do not correspond to the characteristics of that specific type of glass, since large deformations will occur and the specimens will most probably not reach failure (Maniatis et al., 2016).

The clamp bender

To obtain the required data a testing method needs to be selected. Thus, AGC together with TU Dresden and TU Darmstadt have worked on establishing such a method that follows the

procedures for material testing according to EN 1288-3 and that was named “*clamp bender*”.

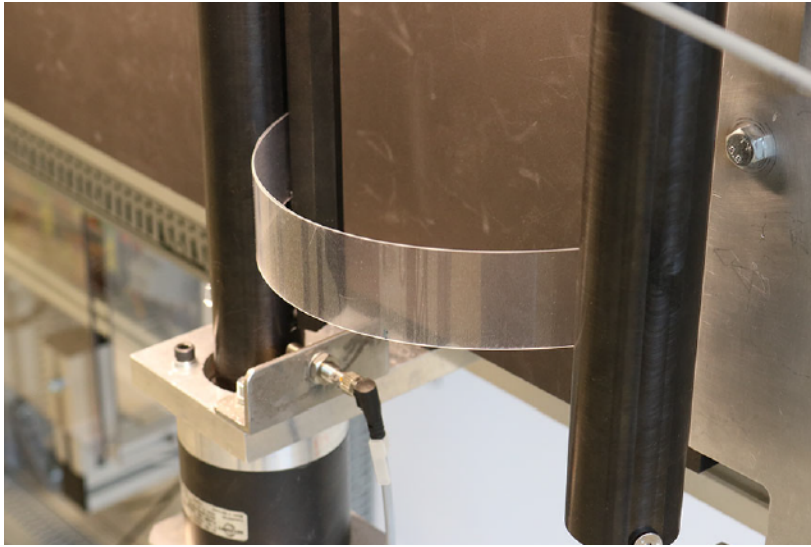

Figure 2-7: The clamp bender set up as developed by AGC (Zaccaria et al., 2022).

The three institutions developed three similar set-ups that increase the applied stresses monotonically from zero to fracture, control the speed of the increase, control movements with a given degree of accuracy and impose boundary conditions that match the theory (Zaccaria et al., 2022). On the clamp bender a thin glass specimen is

imposed to an increasing curvature, until fracture, from a flat position, where there is no curvature. The thin glass specimen is held in place at two opposite edges using clamps, and then coordinated translation and rotation are used to achieve the desired curvature.

Figure 2.7 shows a picture of AGC's set up, where the motor on the right performs only rotation whereas the left motor translates and rotates. The rotation is synchronized and the distance between the motor's axis is verified by the following equation:

$$d = L_e \frac{\sin a}{a} + 2 \cdot \cos ax_1 + 2 \cdot \sin a \cdot \left(y_1 + \frac{h_g}{2} \right)$$

where L_e is the effective length of the specimens, a the angle of rotation, x_1 and y_1 the offset position of the glass within the clamps and h_g the specimen's thickness.

The speed of the motors is 2 MPa/sec and the stress, σ , is calculated according to Navier-Stokes's formula:

$$\sigma = \frac{Mh_g}{2I}$$

where M is the bending moment and I the second moment of area. Consequently, the bending moment is equal to:

$$M = \frac{EI}{R} = \frac{2 \cdot E Ia}{L_e}$$

where E is the Young's modulus.

Handling test data

To describe the strength data obtained from thin glass specimens that have similar macroscopic properties, it is common to use a two-parameter Weibull distribution (Datsiou & Overend, 2018). This statistical model can provide insights into the variability and probability of failure of the glass under loading conditions, which can be useful for design and reliability analysis. Within the statistics community, the accepted number of specimens that would provide sufficient data for good estimates is 30 (Lau, 2017) and therefore a number of specimens of 30 and above should be considered. Different tests of similar set ups with more than 30 valid specimens were performed by the Research and Development department of AGC and the results were received for the purpose of the current thesis. The clamp bender was utilized with the settings as described above.

The received data refers to two sets of 32 laser cut Falcon glass specimens, of a span of 120 mm and 0.50 mm of thickness and another two sets of 32 ground edge Falcon glass specimens, of a span of 120 mm and 0.50 mm of thickness. The Weibull distribution of those tests was estimated and therefore a characteristic strength value is calculated, by considering the European regulations as described earlier.

The following plots on figures 2.8 and 2.9 show the Weibull distribution performed on the tests regarding the laser cut specimens. There is quite a difference on the overall of the results, but when considering the low bound of 5% probability of failure the difference is almost 1%, which is considered negligible. However, the second test presents less favorable results and therefore the characteristic value will be taken according to that set up and is equal to: $f_{b;k} = 281,70 \text{ MPa}$.

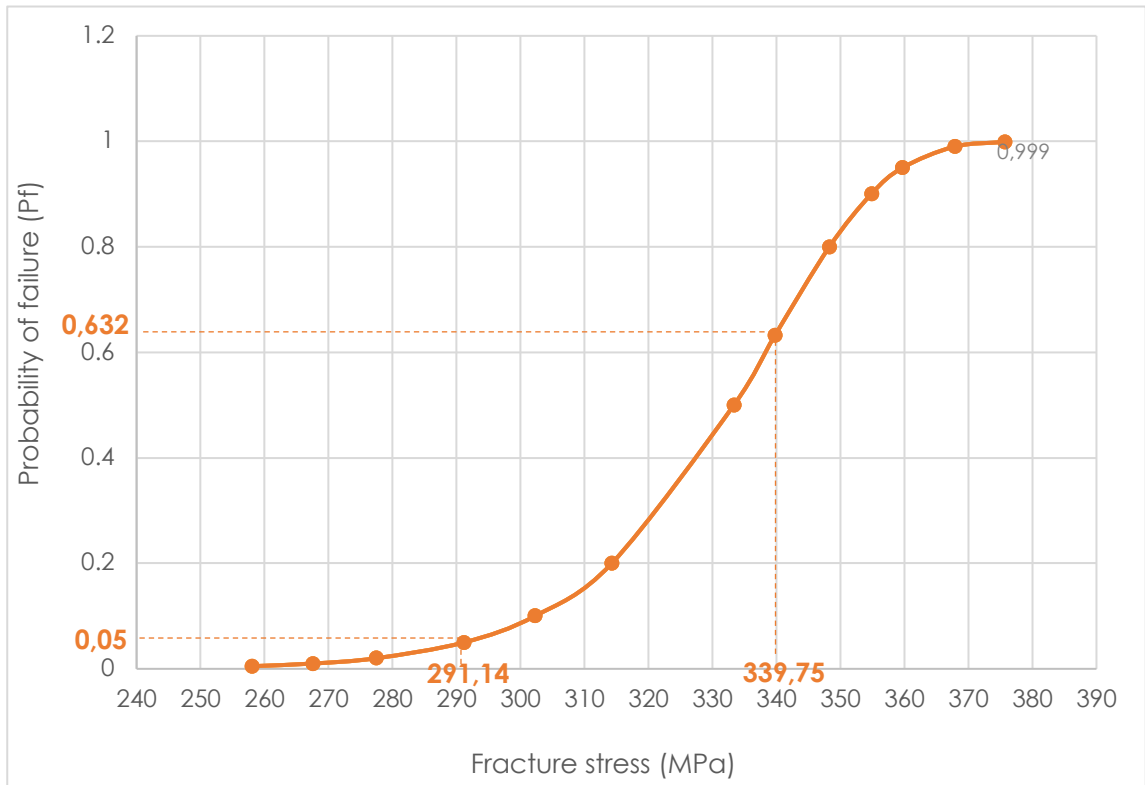

Figure 2-8: Empirical distribution function (EDF) of laser cut falcon glass second test set up, with the probabilities of 63,2% and 5% shown (own calculations).

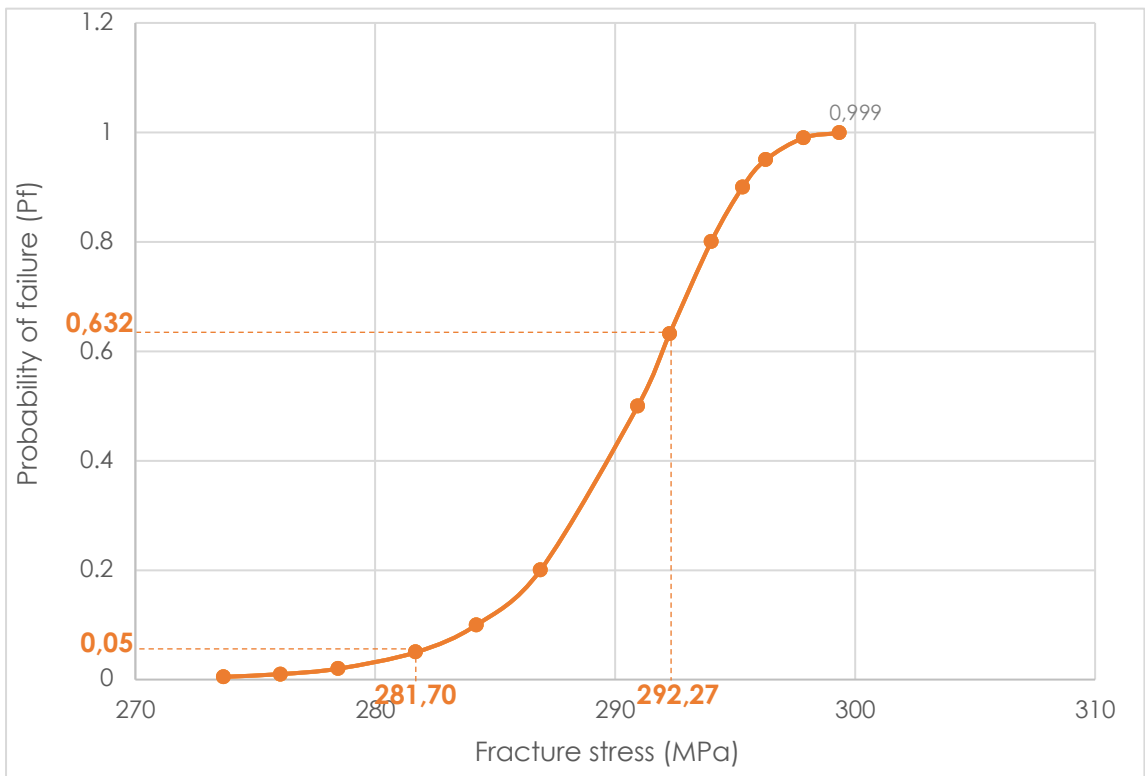

Figure 2-9: Empirical distribution function (EDF) of laser cut falcon glass second test set up, with the probabilities of 63,2% and 5% shown (own calculations).

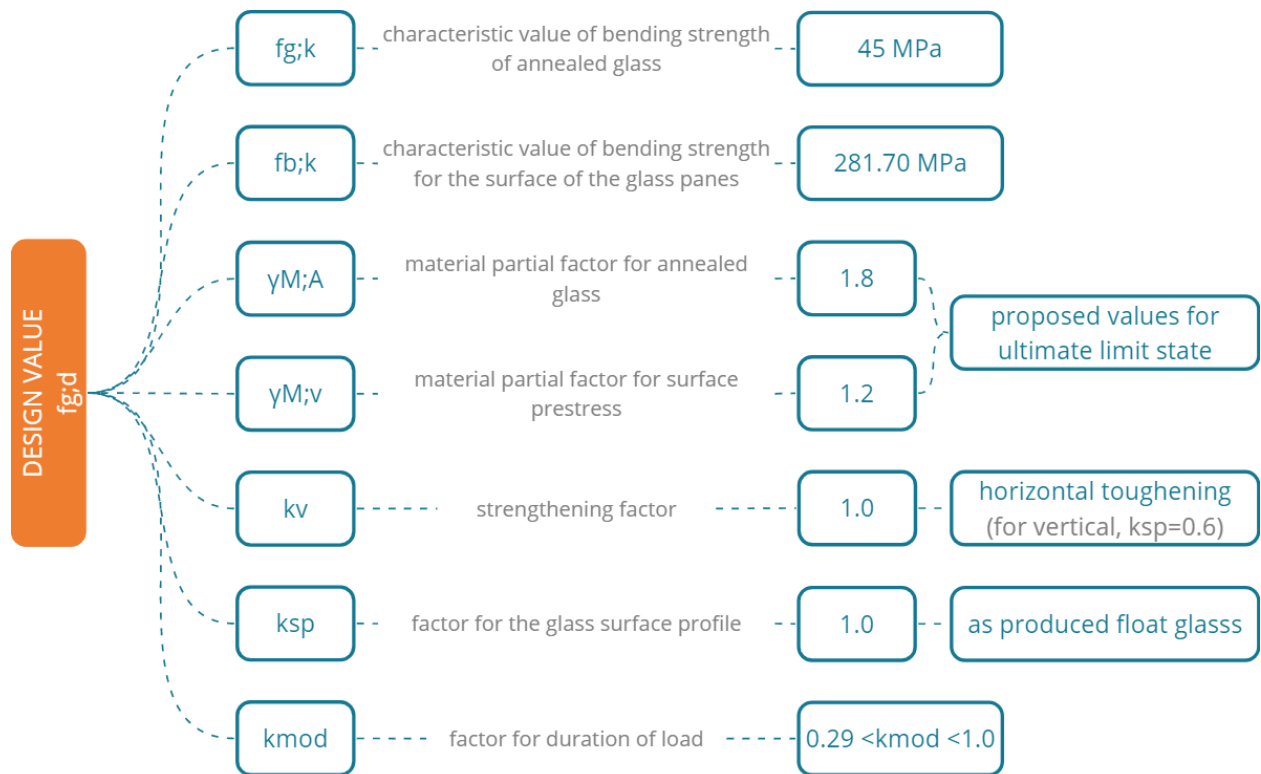

Figure 2-10: The values to determine the design value of bending strength for Falcon glass. The values for all the factors are according to EN 16612. The characteristic value is determined after the testing that was previously described and the characteristic bending strength of annealed glass. (Own illustration).

Depending on the specimen sizing and the final dimensions of the material that is being tested, there might be a need for scaling up the results in order to match the characteristic stress for the real application. The formula used for this calculation is either dependent on the volume or the area of the tested material – a glass pane in this case – and is as follows:

$$\frac{f_{b;k_1}}{f_{b;k_2}} = \left(\frac{V_{E_1}}{V_{E_2}} \right)^{1/m}$$

where m is the Weibull modulus, that is calculated through the Weibull distribution that is performed in order to define the characteristic strength. However, in the current scenario such scaling is not needed, as the dimensions of the final panels are not excessively large compared to the tested specimens.

According to the aforementioned, the design strength of Falcon glass, without considering the load duration factor, is:

$$f_{g;d} = \frac{k_{mod} * 1.0 * 45}{1.8} + \frac{1.0 * (281.70 - 45)}{1.2}$$

The factor for the load duration is time dependent and is therefore affected by the actions on the structure. The Eurocode provides guidance for the assignment of this value and is as shown on table 2.5 on the following section.

2.0.3 Load case scenarios

Structures need to withstand under specific load scenarios, for them to be safe. As per the EN 16612 European standard, there are some assumptions made for the loads to be determined, related to the action itself or a combination of actions.

The two key criteria to be considered in the design of structures are the ultimate limit state (ULS) and the serviceability limit state (SLS). Both must be considered to ensure safety, reliability and functionality. According to EN 1990:2002, in the service limit state, the assumptions are made according to the characteristic or frequent combination, both when referring to actions and combinations of actions, whereas in the ultimate limit state, the fundamental combination applies. Therefore, the design loads are calculated with the following formulas:

- For ultimate limit state:

$$F_d = \gamma_G G + \gamma_Q \cdot Q_{k,1} + \gamma_Q \sum_i \psi_{0,i} Q_{k,i} \quad (1)$$

- For irreversible characteristic serviceability limit state, which corresponds to the frequent combination:

$$F_d = G + "Q_{k,1}" + " \sum_i \psi_{0,i} Q_{k,i} \quad (2)$$

- For reversible serviceability limit state, which corresponds to the frequent combination:

$$F_d = G + " \psi_1 \cdot Q_{k,1} " + " \sum_i \psi_{2,i} Q_{k,i} \quad (3)$$

where γ_G is the partial factor for permanent actions, also accounting for model uncertainties and dimensional variations, γ_Q is the partial factor for variable actions, also accounting for model uncertainties and dimensional variations, G is the permanent action, $Q_{k,1}$ is the single or dominant action, $Q_{k,i}$ are the non-dominant actions, $\psi_{0,i}$ are factors for combination value of accompanying variable actions, ψ_1 is the combination factor for a frequent value of a variable action and $\psi_{2,i}$ are the combination factor for a quasi-permanent value of a variable action.

The partial factors depend on a number of parameters, like the location, size and the intended use of the structure. Therefore, the load cases differ per project and Eurocode 1 (EN 1991-1-1, 2002 & EN 1990:2002) should be consulted to develop the proper scenarios.

For example, for a structure that falls under category C (congregation areas), the Dutch Annex corresponding to Eurocode indicates the suggested values for the partial factors described above, as well as the values for the imposed loads on structures.

Table 2.3: Values of partial factors ψ for variable actions in buildings that belong to category C, according to the Dutch Annex, corresponding to the European standards.

action	ψ_0	ψ_1	ψ_2
Imposed loads in buildings:			
cat. C: congregation areas	0.6 / 0.4 ¹	0.7	0.6
Snow loads	0	0.2	0
Wind loads	0	0.2	0
Temperature (non-fire) in buildings	0	0.5	0

Table 2.4: Partial limit factors for actions for several limit states and design situations, according to the Dutch Annex, corresponding to the European standards.

limit state	design situation or combinations of actions	γ_G		γ_Q	γ_A	
		unfavourable	favourable			
ULS EQU (set A)	persistent or transient design situation (fundamental combinations)	1.1	0.9	1.5	-	
ULS STR/GEO (set B)	persistent or transient design situation (fundamental combinations)	RC1 ²	1.5	0.9	1.65	-
			1.3	0.9	1.65	-
		RC2	1.35	0.9	1.5	-
			1.2	0.9	1.5	-
		RC3	1.2	0.9	1.35	-
			1.1	0.9	1.35	-
ULS STR/GEO (set C)	persistent or transient design situation (fundamental combinations)	1.0	1.0	1.3	-	
ULS	accidental design situation	1.0	1.0	1.0	1.0	
ULS	seismic design situation	1.0	1.0	1.0	1.0	
SLS	characteristic, frequent, quasi-permanent combinations	1.0	1.0	1.0	-	

Imposed loads also differ depending on the same parameters – as those for the partial factors – and the suggested values for imposed loads and their safety factors are as presented in the table 2.5:

¹ According to the annex, "the value 0.6 should be applied for parts of the building which can be loaded heavily by a crowd during exceptional events (escape routes, stairs).

² RC is an abbreviation for "Reliability Class". The Eurocode defines four different levels of reliability for a structure and design situation. The selection of the appropriate Reliability Class depends on factors such as the consequences of failure, the intended use of the structure, and the level of uncertainty and variability in the design parameters.

Table 2.5: Permanent and variable loads according to Eurocode 1 and the Dutch Annex.

		Action	Value	Units	Load duration	k_{mod}
Variable (short-term)		Live load	1.0 – 2.0	kN/m ²	30 min	0.69
		Wind gusts	0.58 – 0.68 ³		5 sec (or less)	1.0
		Wind	0.51 ⁴		10 min equivalent	0.74
		Seismic				
Permanent		Self weight		kN/m ²	Permanent (50 years)	0.29
		Dead loads	0.0 – 1.0	kN/m ²		
		Dead load (point)		kN		
NLD Partial factor	γ_G	permanent actions	1.35			
	γ_Q	variable actions	1.5			

When designing a vertical structure as is a façade panel or a balustrade, the load cases include the effects of selfweight, as well as possible windloads, but also a live load which is applied 1200mm from floor level. The load cases following ultimate limit state design (ULS) can be developed as follows:

- Load case 1: $F_{d1} = \gamma_G * F_{weight}$
- Load case 2: $F_{d2} = \gamma_G * F_{weight} + \gamma_Q * F_{wind}$
- Load case 3: $F_{d3} = \gamma_G * F_{weight} + \gamma_Q * (F_{wind} + F_{live})$

As discussed in section ["2.0.2"](#), the load cases would also affect the value of the bending strength, as it is affected by the load duration factor. Consequently, the design value of the bending strength per load case scenario, would use the values for k_{mod} as shown on table 2.5.

2.0.4 Structural verification process

The Finite Element Method (FEM), often referred to as Finite Element Analysis (FEA), is used within the structural design phase in order to simulate the behaviour of complex structures under different loading conditions without the need for physical testing. FEM enables the

³ The wind velocity in the Netherlands is categorized in 3 different areas, that also include the sub-categories of coastal, non-urbanized and urbanized. The values refer to the wind area II, that Delft belongs to, for an urbanized neighbourhood and for a structure of a maximum height of 10 meters.

⁴ According to the Dutch Annex for Eurocode 1, the basic wind speed in wind area II would be 26 m/s.

prediction of stresses, deformations, and other values in structures that cannot be easily calculated using traditional analytical methods and is used to obtain approximate solutions to engineering problems. As the name indicates, the structure is divided into multiple elements, that altogether form a mesh, where results are calculated.

The Finite Element Analysis consists of three main phases, as shown in figure 2.11 below. These are similar to those of an analytical calculation where geometry, material, and properties are defined, followed by calculation and comparison of results. To perform a structural analysis using FEA, one can define the geometry and properties, material properties, boundary conditions, loads, and then set up and calculate the analysis before verifying the validity of the results and interpreting them further.

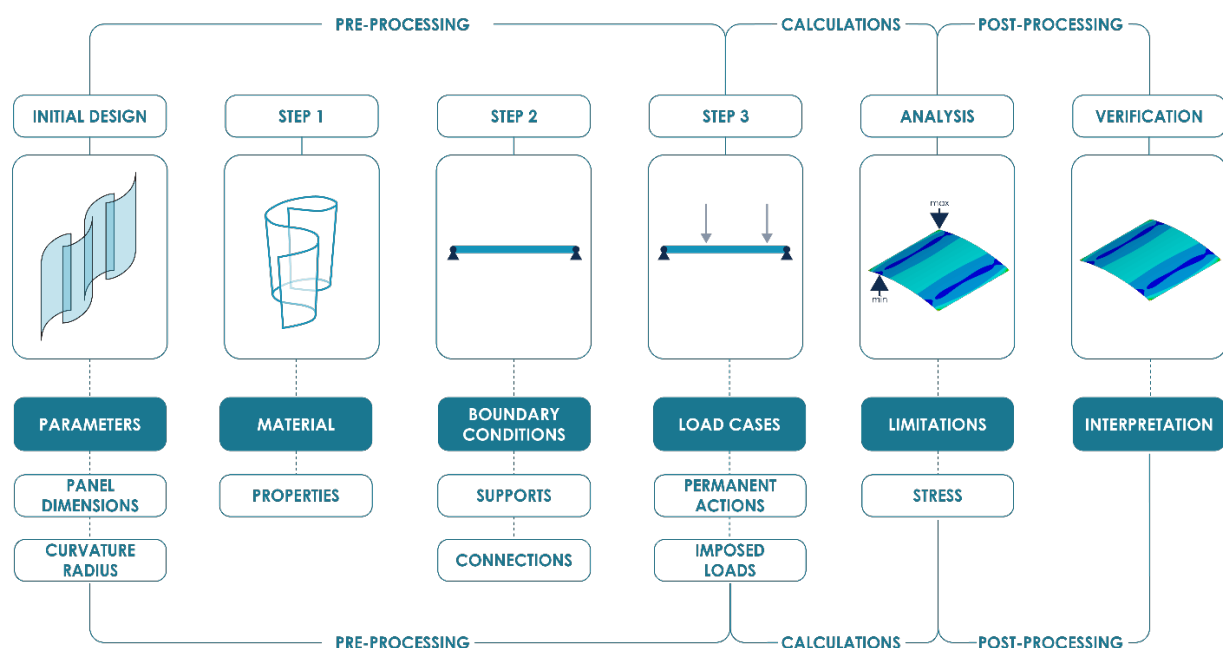

Figure 2-11: Steps that define the Finite Element Method within a software. The analysis consists of three phases: 1) the generation of the data of the model (pre-processing), 2) solving a set of formulas (calculation) and 3) analysis of the results of the calculations (post-processing) (own illustration).

For the current thesis, a software should be selected to establish a valid computational method that incorporates structural simulation. The mechanical properties of thin glass – or Falcon glass in specific – indicate that a non-linear approach should be considered (Galuppi & Riva, 2022) and therefore *ANSYS Workbench* and *DIANA FEA*, are explored, since the license is provided by TU Delft and are both able to perform non-linear analysis with large deformations. To establish that the received results are accurate, a simple model is simulated to see if the calculations are according to literature and therefore could be expanded to the ones needed for the current method.

Software calibration

ANSYS Workbench (2022 R2)

Galuppi and Riva (2022) explored the response of thin glass when twisted and provide the results and process analytically. Therefore, a simple rectangular plate of length $L = 1000\text{mm}$ and width $b = 500\text{mm}$ is modelled. Galuppi and Riva (2022) provide the results for two different thicknesses of $h_1 = 1.1\text{mm}$ and $h_2 = 2.1\text{mm}$ and hence these are simulated in the current model as well. The material used within the software is an aluminosilicate glass with the mechanical properties of the product Falcon glass. The advantage of selecting the material from the software's database is that certain settings are already made and hence mistakes are delimited. Therefore, the simulation is accounting for a non-linear analysis with large deformations, on a material with flexible, membrane-like behavior.

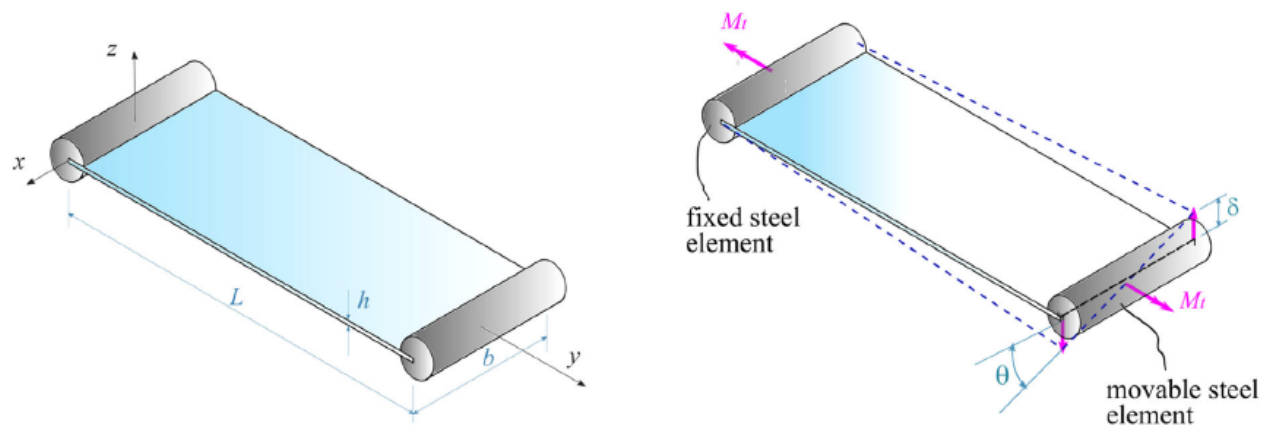

Figure 2-12: Geometry as considered (a) and the loading conditions (b) as per Galuppi and Riva (2022)

The described geometry is modelled within the ANSYS Discovery as a 2D surface. Following in the Mechanical window the thickness is assigned and a mesh of $10\text{mm} * 10\text{mm}$ is generated. In order to simulate the fixed steel element, a fixed support is placed on the one short edge, while in order to simulate the rotation of the movable steel element on the opposite side, two different approaches were followed: 1. displacement is applied on the two vertexes of the side and 2. rotation – as remote displacement – is applied in the middle point of the same edge. For the second approach, the geometry needs to be split into two parts, so that the software can detect the middle point.

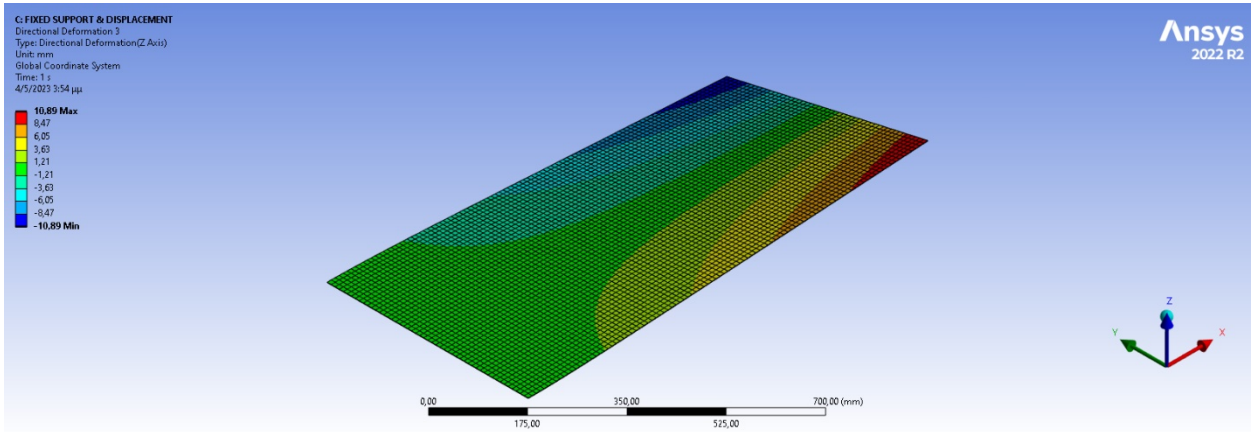

Figure 2-13: Deformation on z-axis for 1.1 mm thickness, with the one edge simply supported and controlled deformation applied on both edges of the second short edge. The amount of deformation was calculated by Galuppi and Riva (2022) based on the arising instability of the material.

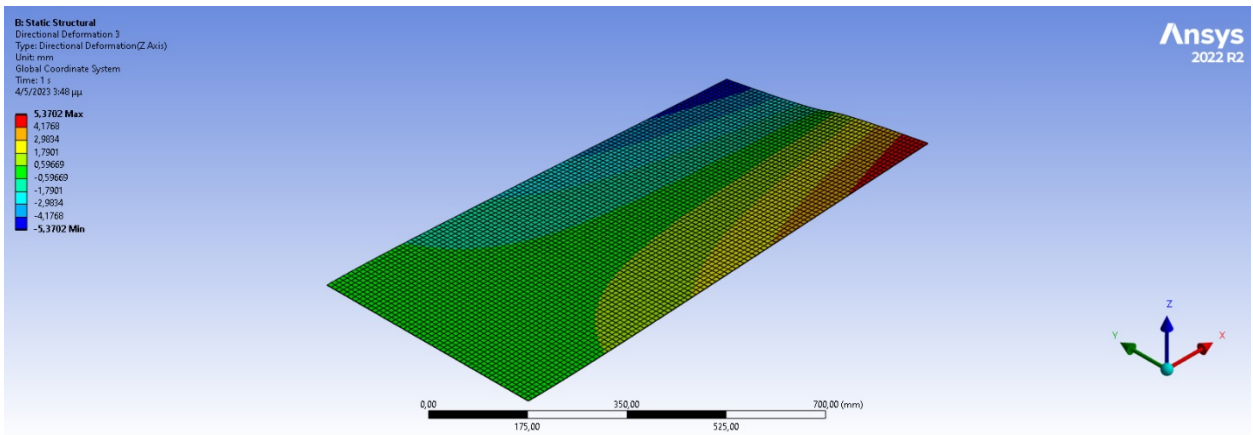

Figure 2-14: Deformation on z-axis for 1.1 mm thickness, with the one edge simply supported and rotation applied on the mid-point of the opposite edge (own).

The deformation distribution is as expected and similar to those in literature. When the second method is used, there is a difference of almost 4 mm for the maximum displacement on the z-axis, however this can be considered negligible as the set-up is not identical and the software used is different. Also, as shown in figure 2.14, there is a local deformation on the z-axis on the mid-point since the rotation is applied locally and not along the edge as would normally happen during the experiment. The distribution remains equivalent, nevertheless. Hence, since the behaviour is as expected, the software and the method used can be expanded to serve the purpose of the current project.

DIANA FEA

The same model was developed in DIANA FEA (version 10.5.967). The process differs substantially from the previously used program. A two-dimensional plate 1000 mm by 500 mm (flat shell elements) with a thickness of 1.1. mm is modelled. The material's Young's modulus

and Poisson's ratio are defined as per the manufacturer. Pin support conditions are applied at the vertices of the one short edge and roller supports at the remaining two. Lastly, two vertical displacement point loads of opposite directions are applied at the vertices of the roller supports.

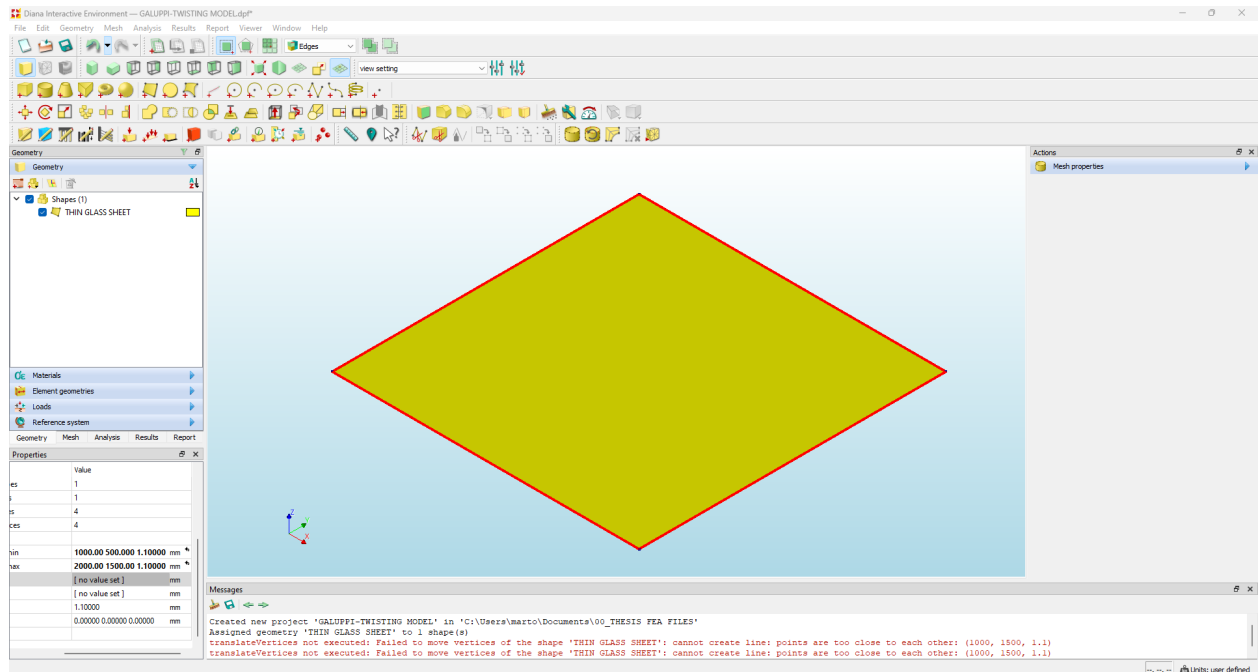

Figure 2-15: DIANA FEA interface on setting up the simulation.

Software comparison

Both FEA software provide sufficient information to evaluate a design and structure. However, there are minor differences during the set-up process. While the interface of both software is similarly sophisticated, ANSYS is more straightforward and comes with an elaborate material library that automatically define the required analysis settings. The boundary conditions are easily assigned and there is a clear distinction between the different options. This is a more manual procedure when using DIANA, while there is not an available material or settings for glass simulations. Thus, the first can eliminate mistakes when it comes to program settings. Therefore, ANSYS Workbench is chosen to perform the additional simulations for the current project.

2.0.5 Summary – Workflow definition

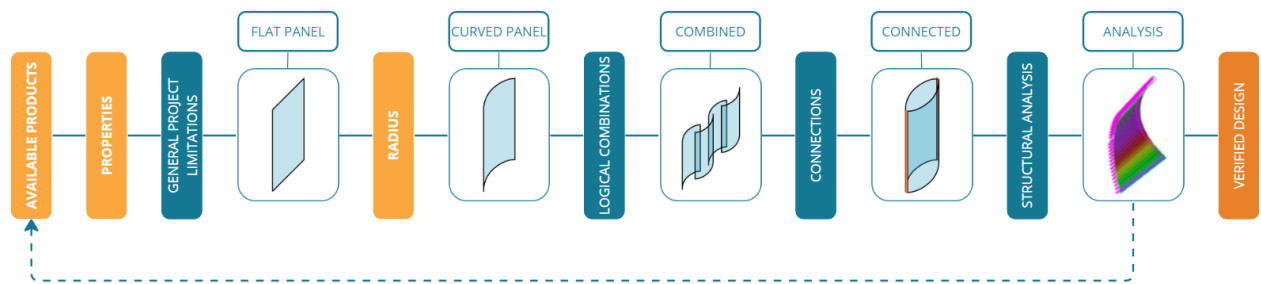

Figure 2-16: The ideal workflow would run in a loop of an optimization process, depending on the needs of each project, giving an efficient, informed and verified design outcome (own illustration).

The previous sections analysed the different steps and the information needed as well as the necessary parameters that need to be considered and define a project, where cold bent thin glass is utilized.

As shown in figure 2.16 above, the design process starts by defining a flat panel. This entails the material properties and maximum dimensions, which vary per product, as well as any project limitations that might be set. The latter could, for example, entail the weight of the panel or even the transportation method. Any additional parameter that could possibly influence the dimensioning of the flat panel should be included in this first step.

Following, since the workflow discusses designs with curved panels, the process of defining the minimum possible radius that could be achieved should be included. This entails the modelling parameters and associates them with the maximum bending strength of the panel. This value is established through material testing.

Hence, the decisions are design related, including the possible design combinations of bent panels, depending on the use, goals, and design strategy. Following, connectivity should be accounted for.

The last step that guides towards an informed and verified design process is the structural analysis. During this step, the design is simulated on the different load case scenarios and the design value of the bending strength sets a limit on the aforementioned parameters, especially the radius and overall dimensions.

Ideally, this workflow runs in an optimization loop. Meaning that each design with certain goals as final outcome, should be set up with the equivalent parameters and limitations and let the established method come up with an end result that would satisfy the majority of those.

2.1 Guiding principles

Since cold bent curvature is the first parameter for the proposed workflow, a set of design strategies could be set as guidance. Following the modelling method that was discussed in [section "2.0.1"](#), there are certain combinations of panels that could be achieved within a design concept. Those combinations follow basic connection principles, and both were investigated, with a view to creating guidelines for design.



Figure 2-17: Tension is needed from the sides so the panel could be held bent in place (own illustration).

One common principle that should be accounted for is the way that the panels stay bent and in place. Therefore, constant tension needs to be applied from the sides with any appropriate means, as this is shown in the diagram in figure 2.16. Scaled models that used tie-wraps to apply the described tension helped to practically understand this principle and the geometrical stiffness gained when the panel stays bent. Regarding this, a combination catalogue is established. The rules followed for these along with the produced combinations are as shown in figure 2.18 that follows.

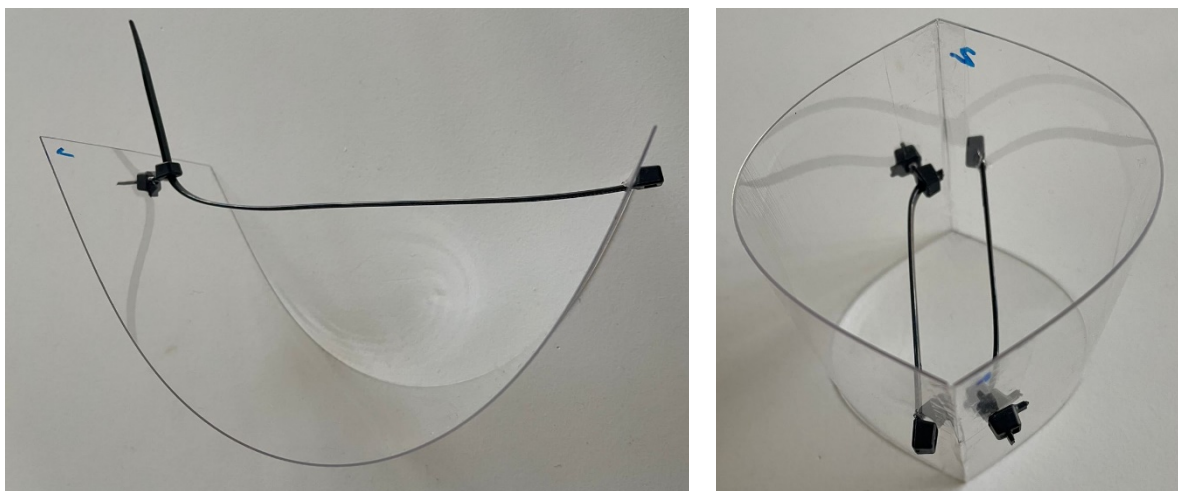

Figure 2-18: Scaled model made from Perspex and tie-wraps to apply tension, so the panel stays bent (own images).

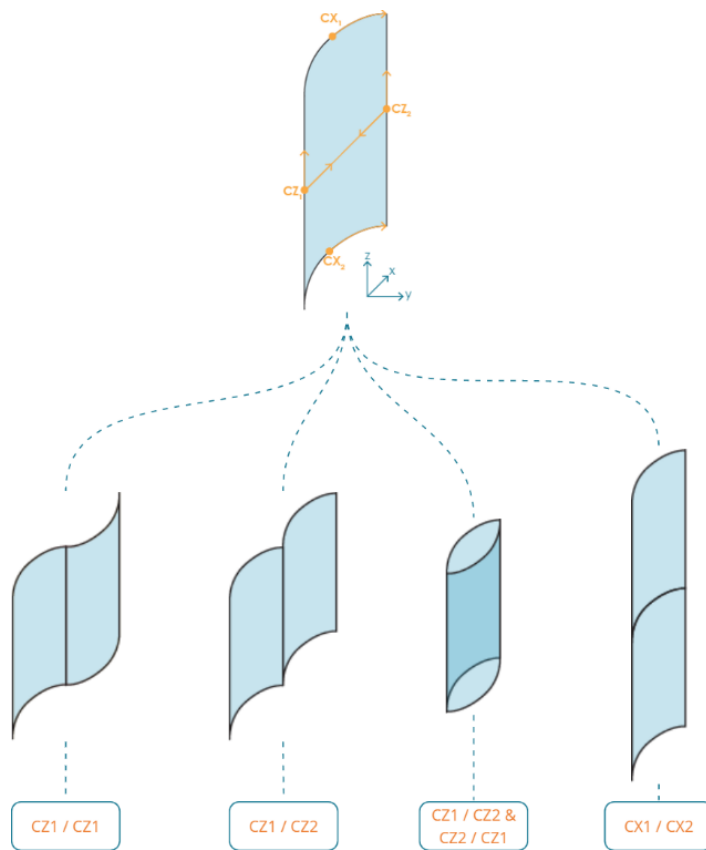

Figure 2-19: The connection rules are based on the centre of the side that the connection is being placed and the direction that the panel needs to keep. Therefore, there are 4 combinations generated and are as shown (own illustration).

Based on these connection rules, a computational model is developed through Grasshopper in Rhino3D, utilizing WASP⁵ - a plug-in that offers tools to design with discrete elements. This tool validated the thought process behind the connection principle and is also a way to produce design iterations when that is based on an aggregation of discrete elements and their connection principles.

Wasp definition

Depending on the way one bent panel is modelled in Grasshopper, as shown in figure 2.5, the connection principles are set as shown in figure 2.18, by defining the centre point of it and the upward direction of it. For

example, points CZ₁ and CZ₂ define the centre point of the panel's edge and the z axis defines the direction of this connection. Therefore the "digital" connection between those points is going to happen by attaching those two points together and keeping the panel's orientation on the z axis, as shown on the combination diagram in figure 2.14.

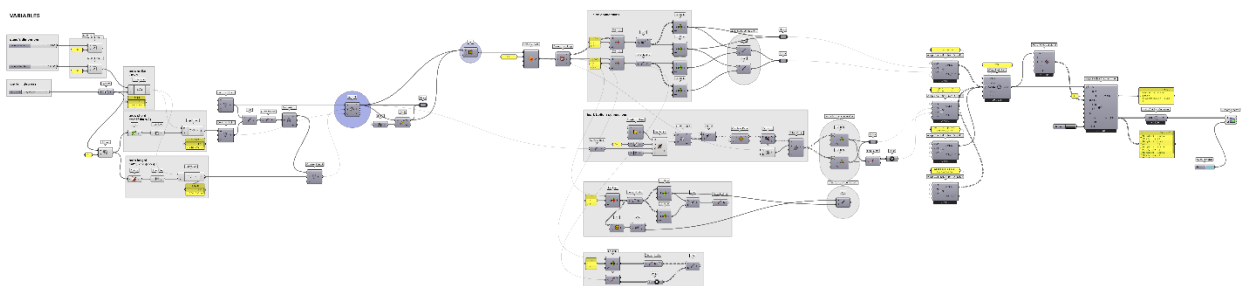

Figure 2-20: Screenshot of simple own grasshopper definition utilizing the WASP components (on the right) to create the connections between the panels and create an aggregation with 5 panels.

⁵ More information about WASP can be found here: <https://www.food4rhino.com/en/app/wasp>.

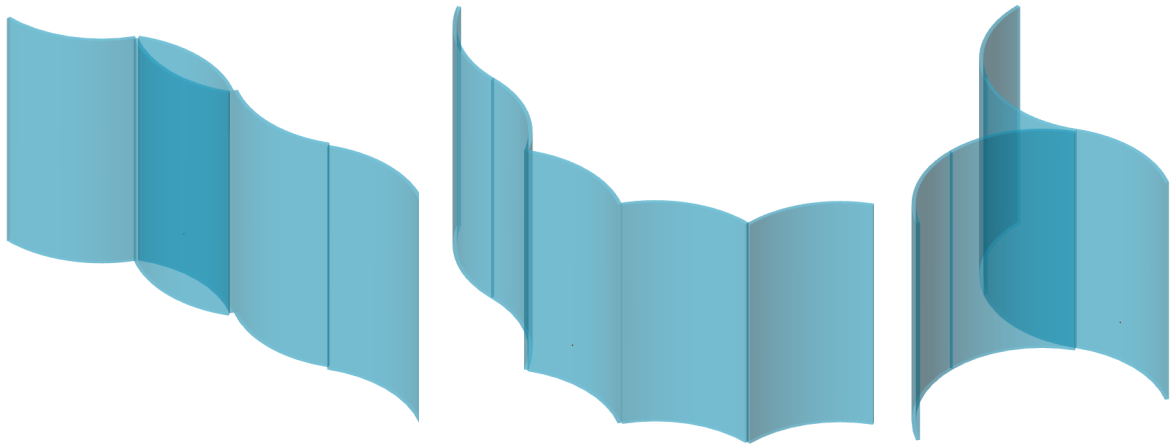

Figure 2-21: Examples of different WASP aggregations with five (5) identical panels (own illustration).

The definition shown above does not give the flexibility of iterating the panel's dimensions or curvature and therefore the design consists of equally shaped panels. However, WASP and Grasshopper offer the possibility of establishing such a parametrization and separate connection and aggregation rules, to end up with a more complex and intricate design.

2.2 Proposed method

Since the workflow is established, Grasshopper in Rhino3D is employed to generate a design with curved panels, using the parameters outlined in the previous sections. The parametrization is fully dependent on the desired outcome; therefore, this does not indicate a rigid set of rules to be followed, but rather serves as a framework and showcase of the method.

2.2.0 Strategy and goals

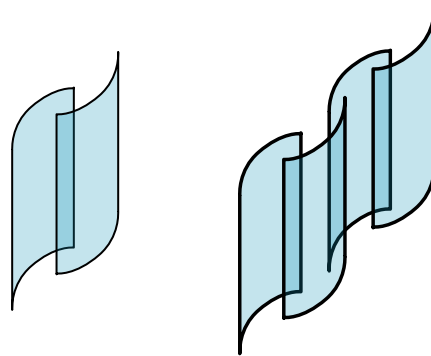

Figure 2-22: The tested design aims to utilize a parametrized grasshopper model, as per the panels' dimensions as well as giving different curvatures per panel and experiment with the connections between the panels and with a rationalized aggregation method (own illustration).

With a view to reaching the objectives of the current research, the proposed method presents the ability of the grasshopper definition to produce design iterations by having control over certain parameters as those were explained in previous sections and are further explained along this chapter.

In order to keep a rational design process, the design depends on a curve that is developed by the designer/user as a “guiding” rail were the aggregation of the panels will happen.

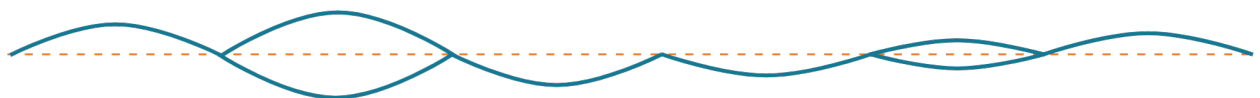

Figure 2-23: The first intention of the grasshopper definition is that the curved panels are distributed along a rail that defines their geometrical properties and all could have different dimensions (own illustration).

The following diagram shows the approach and the flow of information that the developed tool follows and therefore the one that the presented case study utilizes. Beginning with the product specifications, it is possible to set the first project limitations. In this case the weight of the panels is calculated, throughout the possible combinations and when the set limit is

exceeded, certain dimensions are excluded from the list. Following, the 2d arc is defined and the “guiding” curve is set by the designer/user, where the possible design combinations are generated and the 3d geometry is finally set. The arcs and the bent panels are defined as explained in [section “2.0.1”](#). To import the geometry into the structural analysis software, the connection points are also defined. A non-linear, large deformation analysis is performed with a stress limit. Finally, the panels are put into an efficient panelization algorithm.

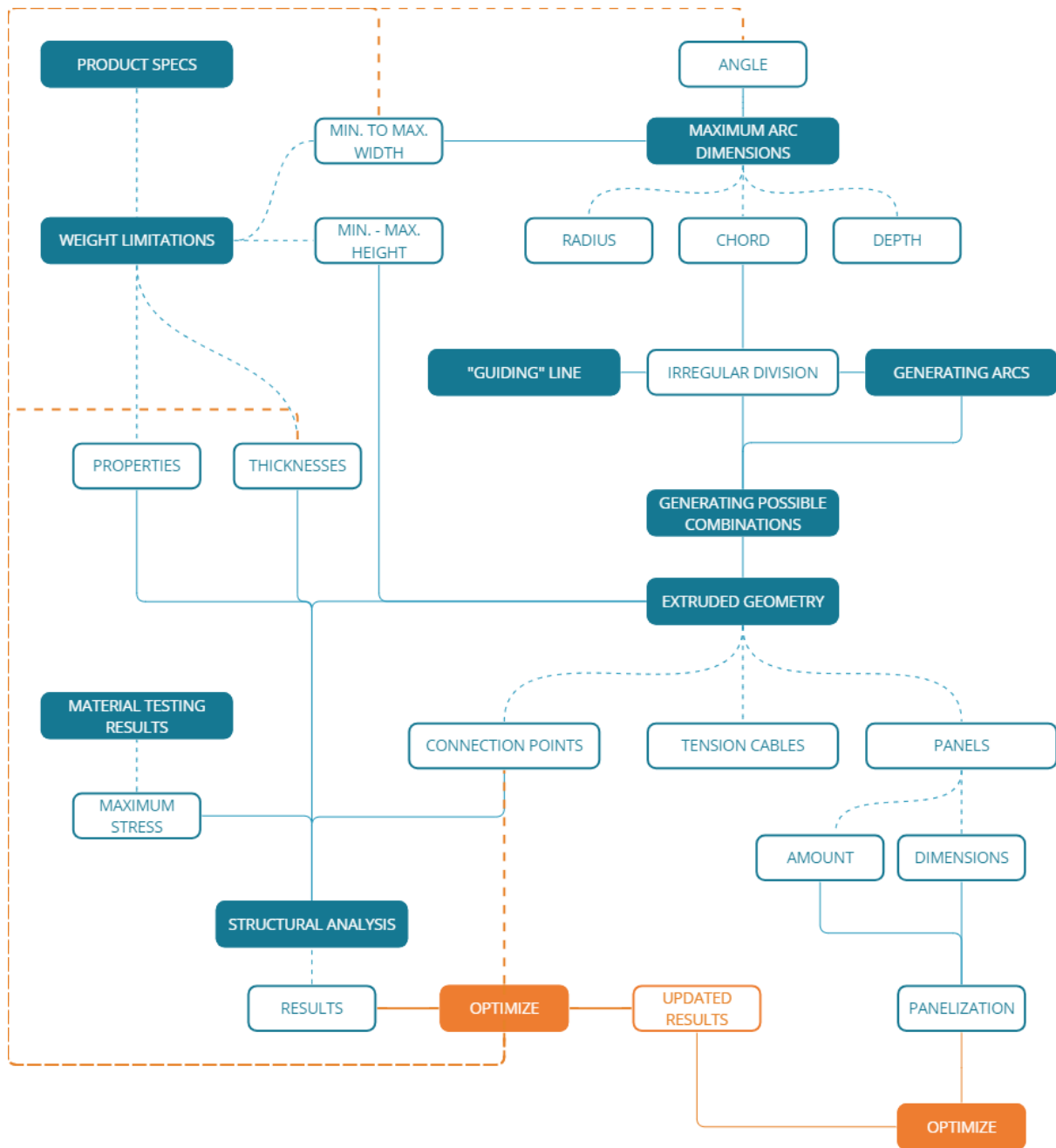

Figure 2-24: Diagram that shows the process and flow of information within the grasshopper definition that is set for the proposed computational method.

Within this method, two optimization processes are proposed. Firstly, optimizing the results of the structural analysis with regards to the product's dimensions and connection points as well as the arc definition and secondly, optimizing the panelization process, utilizing the updated results of the first optimization and with regards to minimizing the produced waste.

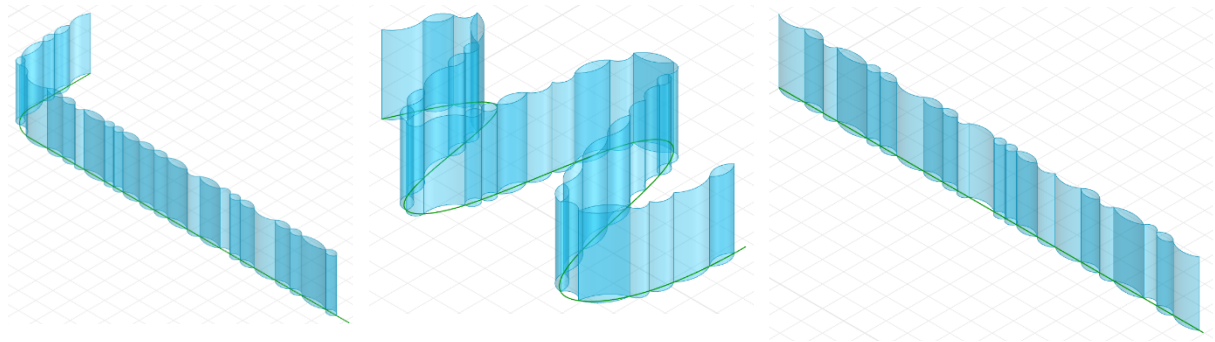

Figure 2-25: Screenshots from variations of "guiding" lines used as input on the proposed method, as this is described with the previous diagram in the current report (own).

2.2.1 Design evaluation

Structural simulation

For the evaluation of the design, it would be useful to place it in a real location and therefore the faculty of Architecture of TU Delft is chosen. This now defines the structural simulation since the load case scenarios can be determined. According to section "2.0.3" some load cases evolve as presented on the following table:

Table 2.6: Load cases for the structural evaluation of the design. For the values of each load, table 2.5 of section 2.0.3 should be consulted.

	Exterior structure	Interior structure
ULS FQP	$1.35 * F_{weight} + 1.5 * F_{wind}$	$\gamma_G * F_{weight} + \gamma_Q * F_{live}$
	$1.35 * F_{weight} + 1.5 * (F_{wind} + F_{live})$	
ULS IF	$1.35 * F_{weight} + 1.5 * (F_{wind} + F_{live})$	$1.35 * F_{weight} + 1.5 * F_{live}$
SLS FQP	$1.0 * F_{weight} + 1.0 * F_{live} + 0.5 * F_{wind} + 0.5 * F_t^6$	$1.0 * F_{weight} + 1.0 * F_{live}$
SLS IF	$1.0 * F_{weight} + 1.0 * F_{live} + 0.5 * F_{gusts} + 0.5 * F_t$	$1.0 * F_{weight} + 1.0 * F_{live}$

Moreover, what is left to be determined as well is the design value of the bending strength of the material. In order to simplify the process, the worst scenario would be taken into account for the partial factor of load duration (k_{mod}), that is determined by the permanent loads and is

⁶ F_t defines the load due to temperature change. According to Eurocode 1, this can be calculated as: $F_t = A * E * \Delta T$, where A is the cross-sectional area of the element, E the Young's modulus and ΔT the temperature difference, which is normally 28 degrees.

equal to 0.29. Therefore, the design value develops as follows and defines the maximum bending stress that the curved panels can accommodate.

$$f_{g;d} = \frac{0.29 * 1.0 * 45}{1.8} + \frac{1.0 * (281.70 - 45)}{1.2} \leftrightarrow$$

$$f_{g;d} = 204.50 \text{ MPa}$$

The structure is then imported in the FEA software, where the loads are set. Within ANSYS Workbench interface the different loads are defined. For any uniformly distributed load, a “Force” is applied on a face of the geometry. “Force” can also be used when applying a line or point load. “Pressure”, is chosen for any surface load. The supports used in this case are all linear fixed supports, for the purpose of simplification.

Therefore, the load cases are defined by applying such settings within the ANSYS Mechanical window. Since the load cases require certain safety factors it is preferable to import the load as already multiplied by these factors, since there is no option of selecting combinations and applying the factors afterwards – that could be the case in other software, such as Dlubal⁷.

To showcase the described workflow, one curved panel of 500 mm height and 500 mm width, thickness of 1.1 mm and a radius of 955 mm was modelled, and the analysis was performed with a wind and live load.

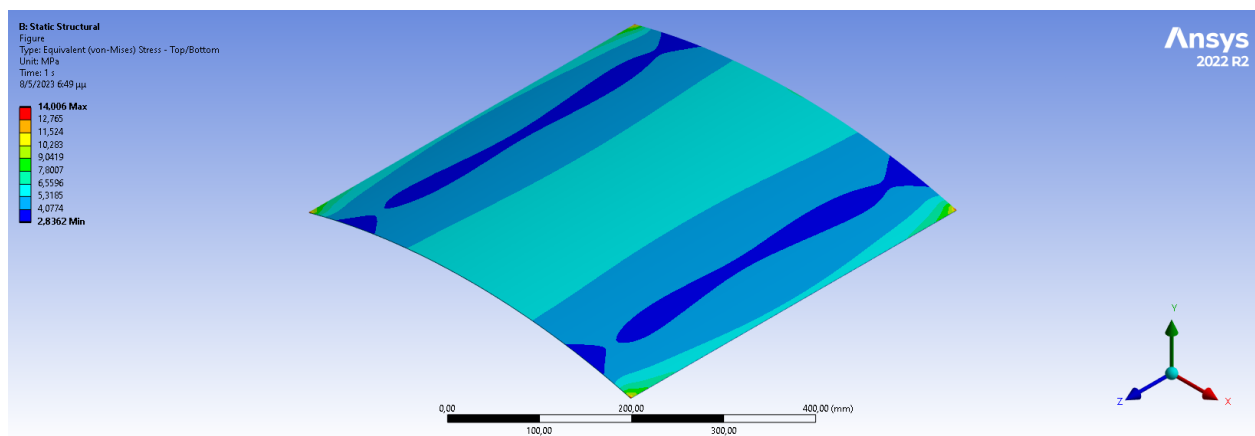

Figure 2-26: Equivalent stresses on a 500*500 mm panel of 1.1 mm thickness and a radius of 955 mm.

As a result, the distribution of stresses seems to be correct, however the stress values are quite low compared to the expected ones. That is because the used settings do not account for the material's prestress values, however this requires just an addition of the prestress value – in this case 150 MPa, according again to the European standards⁸ – to the final results.

⁷Dlubal is a structural analysis and design software. More information about Dlubal can be found here: <https://www.dlubal.com/en>

⁸ The European standards account only for regular float glass. In the case of thin glass, the prestress value is usually higher. However, this is a value regularly known by the manufacturer and was not accounted for in this research.

In the case that the stress values are exceeded, the design definition should be revisited. Assumptions as to which values should be modified could be made according to literature and prior knowledge, however, a more automated workflow of direct feedback is suggested.

API Grasshopper to ANSYS

For an optimized solution, an API⁹ that allows ANSYS and Grasshopper to communicate can be built. Hence, it would be possible to apply controlled changes to the geometry definition, as described in [section "2.2.0"](#), set a maximum value that cannot be exceeded – in this case the bending stress per panel – and run as many calculations as needed in order to end up with the most efficient design result. For the optimization process, there are several available plugins that can be used within Grasshopper, but in the case of a multi-objective optimization, "Wallacei"¹⁰ is preferred, since it is an open-source tool that offers a wide range of information per optimized solution and an elaborate analysis of the process.

An open-source Python script is available, under the license of MIT. This provides a direct link between ANSYS and Grasshopper.

For this to be incorporated in the current workflow there need to be some changes made, so as it can receive meshes or surfaces as inputs. Therefore, the outcome of the desired design is directly used as an input in ghANSYS and the FE Analysis is ran.

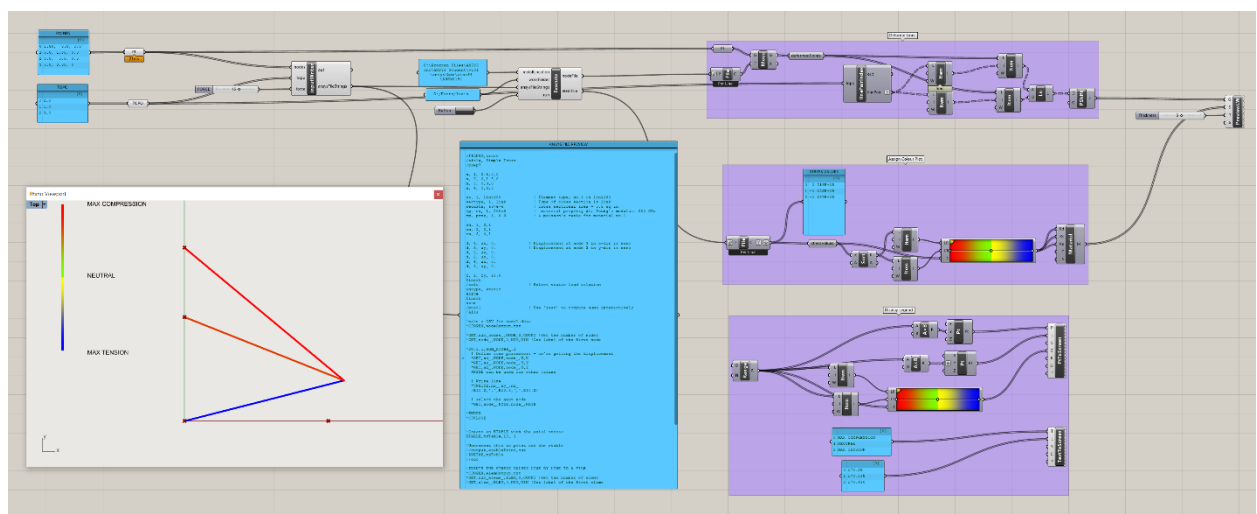

Figure 2-27: Workflow as provided by the initial developer (source: <https://github.com/louislbnc/ghAnsys#link-example>)

⁹ API stands for application programming interface and provides a way for different software to interact with each other in a standardized and structured manner, allowing for seamless communication and exchange of data.

¹⁰ More information about Wallacei can be found here: <https://www.wallacei.com/>

Karamba3D Non-Linear analysis

Karamba3D offers a “Work In Progress” component that performs non-linear analysis, which is the one recommended when using thin glass, as it was mentioned in [section “2.0.4”](#). Since building an API requires more extensive coding knowledge and understanding of a software's documentation and in that case ANSYS Workbench is a computationally expensive software, Karamba3D is utilized to demonstrate the workflow in complete, within the grasshopper environment. Therefore, as illustrated in figure 2.24, the part of the structural analysis is happening by utilizing Karamba3D.

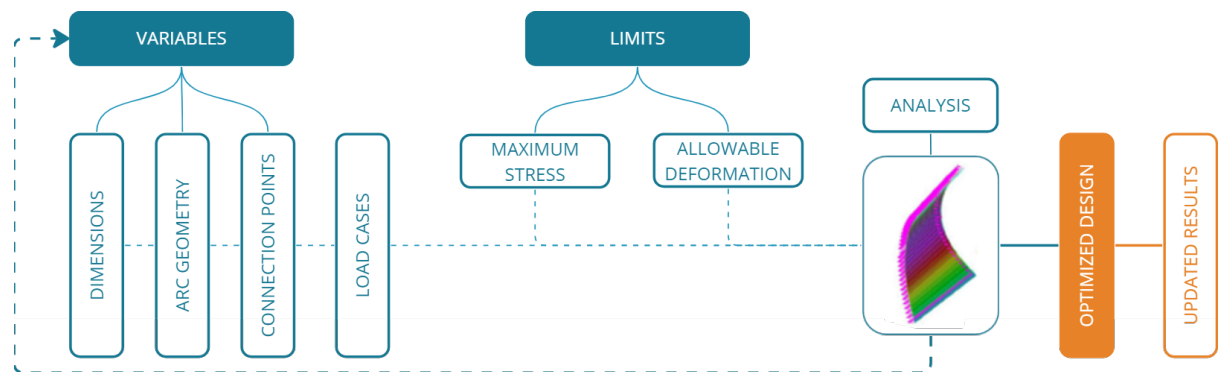

Figure 2-28: Diagram of optimization process within the computational method (own).

Optimized solution

For an optimization to run, there needs to be one or more variables and one or more desired outcomes. For example, in the case described in figure 2.28 above, the variables are set from the beginning of the design definition – as in the proposed method – and the desire is that the maximum design strength is achieved, without exceeding the material's stress capacity, as well as the allowable deformation for a glass structure.

To set up such an optimization in Wallacei, the described variables that are developed as sliders, are imported into the main component as “genes”, the stress and deformation calculation as the “fitness objectives”. Through this machine, the data is stored and able to be accessed after the simulation is completed and the designer/user can have the option of choosing the results they regard as more appropriate to their needs.

To validate that the developed definition would work in an optimization process, it is recommended that it is tested in a less expensive operation computationally. Therefore, the proposed panelization algorithm is put to test, as a single-objective optimization process within the proposed method. The process ran smoothly and there is the conclusion that the set definition is properly built to extract optimized results.

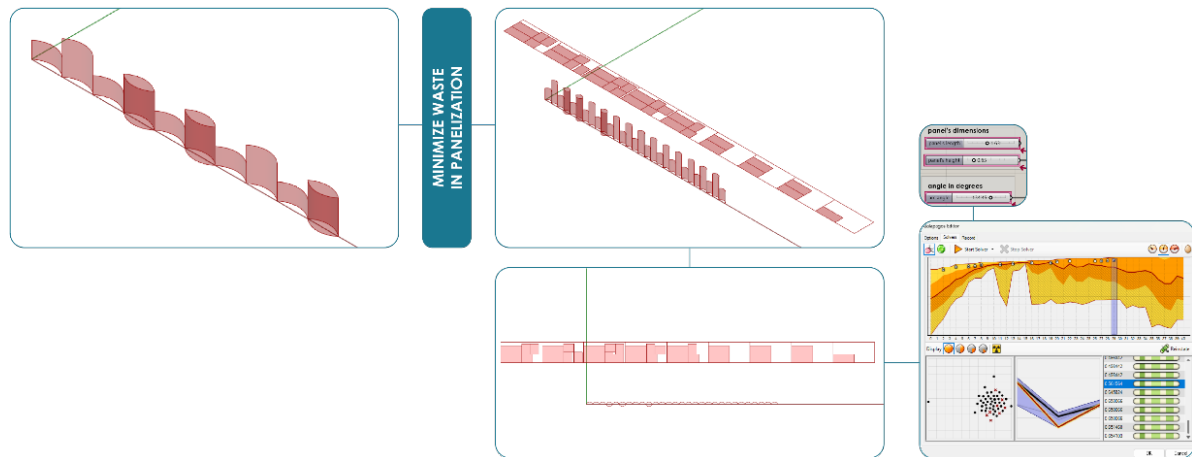

Figure 2-29: Simple test optimization to minimize waste during panelization, using the built-in optimization tool "galapagos" (own).

2.3 Case study

The design of a case study is developed to further explain, validate the method, and prove its efficiency.

2.3.0 Simple linear partition wall

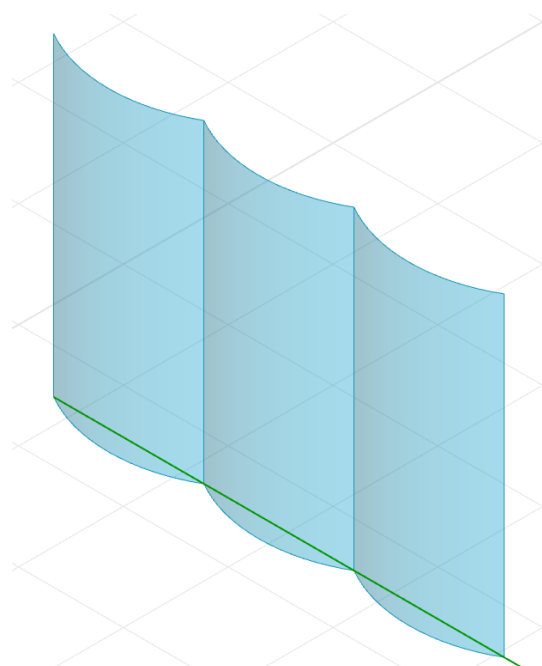

Figure 2-30: Division of a 5m partition wall (own).

Starting out simple, in order to design an interior partition wall with a length of 5m, for example, the designer imports the 5m line as a the "guiding" line. Prior to that, the dimensions, available thicknesses and material properties are also imported in the tool and the maximum arc dimensions are calculated. Here the user can choose the desired arc angle. Following and by using the arc's chord as a maximum dividing dimension, the line is divided into equal or unequal parts, according to the user's desire. Further on and with respect to the needed height, the total geometry is built. Figure 2.30 on the left, shows the result of the actions in the tool that were so far described.

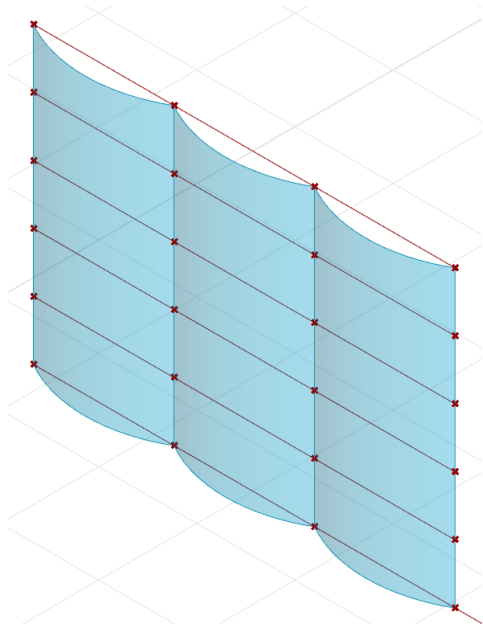

Figure 2-31: The same design when the connections and tension cable are assigned (own).

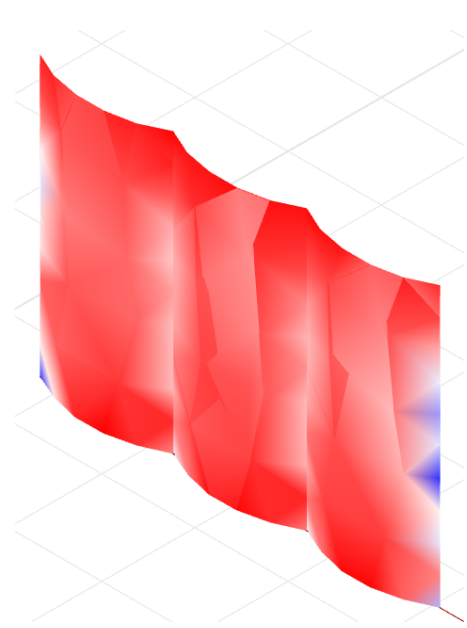

Figure 2-32: Simulation of stresses on the panels with a live load and their self weight applied (own).

Moving on to have the needed information for the structural analysis, the connection points are generated. Top and bottom connection points are separated, since they might need different connection requirements – e.g. the panels reach the top of the ceiling and therefore are fixed on the top. For the middle connections that would also require the tension cable, the side of the panel is divided in maximum 6 parts – considering that the maximum height of a Falcon glass panel is 3.21m, this would result in connections approximately every 0.54m. Those are then connected with a line that serves as the tension cable. To end with the needed information, the loads are developed and assigned on the surfaces. In this case a uniformly distributed live load is assigned, along with the self-weight.

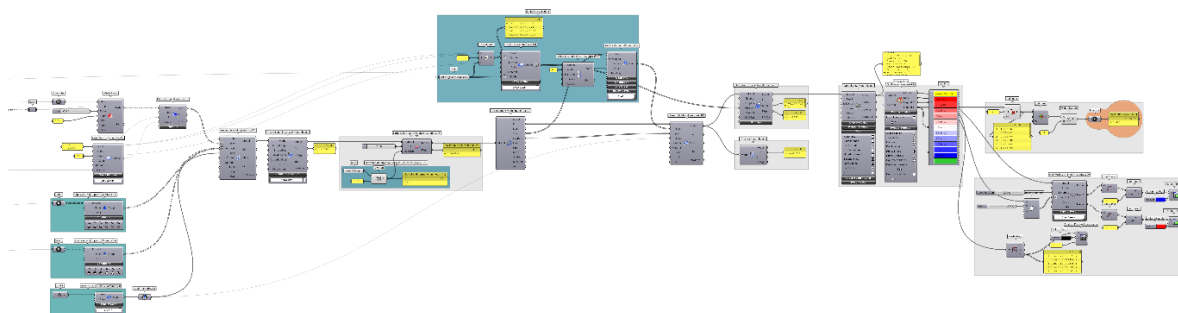

Figure 2-33: Screenshot of the structural calculation part of the definition. Here Karamba3D is utilized to perform a non-linear analysis with large deformation limitations (own).

Finally, all is defined, and the structural analysis is completed. The last step is to perform an optimization if this is needed and perform the calculation process, as this is defined within the tool.

2.3.1 Interior installation on an interpolated curve

Since the prior simple example proves the aspect that the tool is able to provide a validated design outcome, the following presents an example of a more complicated geometry, that could be an interior installation in a scenario of a museum exhibition. In this example, the “guiding” line is irregularly divided and there’s a number of different combinations generated per the user’s needs.

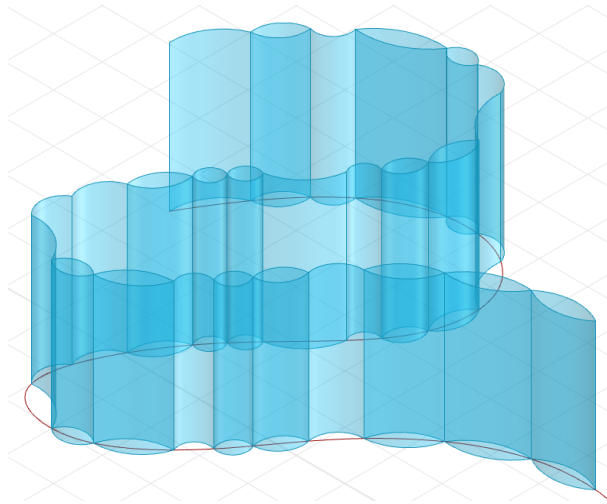

Figure 2-34: Screenshot of the geometry as firstly generated in grasshopper (own).

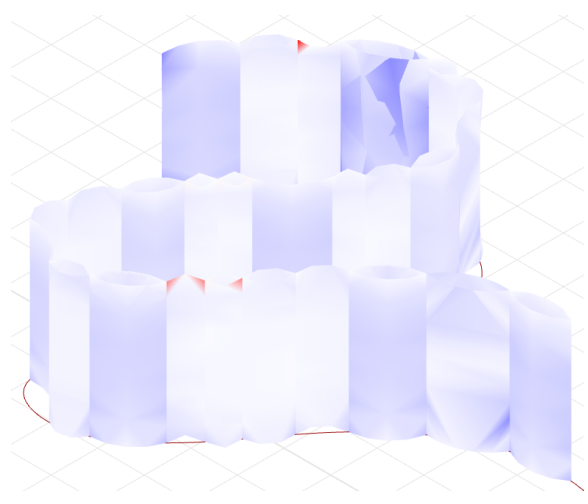

Figure 2-35: Visual result of the stress simulation (own).

Based on both cases, the tool can be considered successful in terms of design generation and validation, as it can give certain design flexibility, based on a rational process and the user would end up with a verified outcome.



Figure 2-36: Interior view in a case study where the tool was utilized to create partitions in a showroom (own).







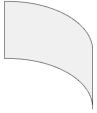
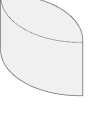

2.4 Design of connection

Connection design is in fact a crucial parameter in the design of glass structures, whether these are structural parts or not. In [section "1.2"](#) a summarized inventory of existing connections was presented and categorized. Following the ones that could potentially be utilized for thin glass were distinguished and are shown in figure 1.2 in the same section.

According to the presented case studies, purely adhesive connections should not be considered (Pennetier & Stoddard, 2019), as the panel's spring back presents higher strength than the ones that high strength adhesives can accommodate. Therefore, adhesives should only be considered in combination with another connection type, for example as in the connection designed by EOC – which is the second case study presented in the current report.

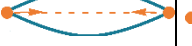
Furthermore, continuous linear connections are an option, as used by Stoddard (2019) in a pavilion design and other projects utilizing single and double curved thin glass or as in IGUs (Ottens, 2018; van Driel, 2021). However, the existence of an element along one of the panel's edges is rather a design decision, but that does not make the connection unsuitable for thin glass, in general.

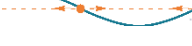
Table 2.7: Preliminary matrix to be used as support for decision making when designing connections (own illustration).

					
					
continuous	●	●	●	●	●
clamped	●	●	●		●
friction grip	●	●	●		
hybrid	●	●	●	●	●

Specifically with regards to cold bent panels – when being the only element of a design – the connection should provide the tension that keeps the panel bent, as described in [section "2.1"](#). For that instance, a matrix is proposed, linking design combinations with connection principles. However, since thin glass connections is not the focus of the current research, the table serves as a preliminary support for design decisions. Still, designs need to be developed and further tested, for the table to be used as a trustworthy guideline.

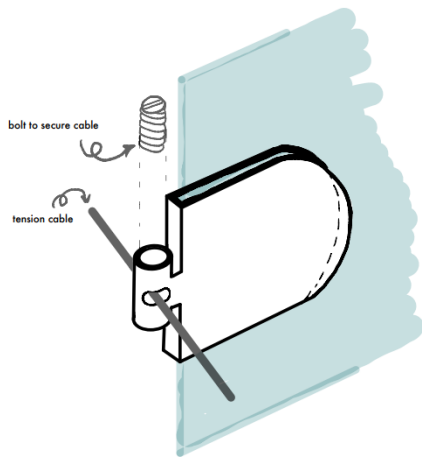

Figure 2-37: Connection design that follows the desired principles to accommodate design needs (own).

For the presented design, a connection that accommodates the needed principles is designed. To minimize complexity, one single unit is designed and can be adjusted to connect from one (1) to two (2) cold bent panels simultaneously. This is needed so the panel combinations could be achieved within any design.

The needed tension is applied through a tension cable that is also adjusted in the connection. Figure 2.30 below, shows how the connection is adjusted on the curved panel and the cable that applies the required tension,

The connection follows the principle of a door hinge, inspired by the design of the connection for the EOC pavilion as described in [section "1.3.1"](#). The flaps are adjusted on the panel with an adhesive. The slot that the tension cable goes through, allows for slight horizontal movements, so that it can withstand the additional loads but also make the connection suitable for the different possible radii.

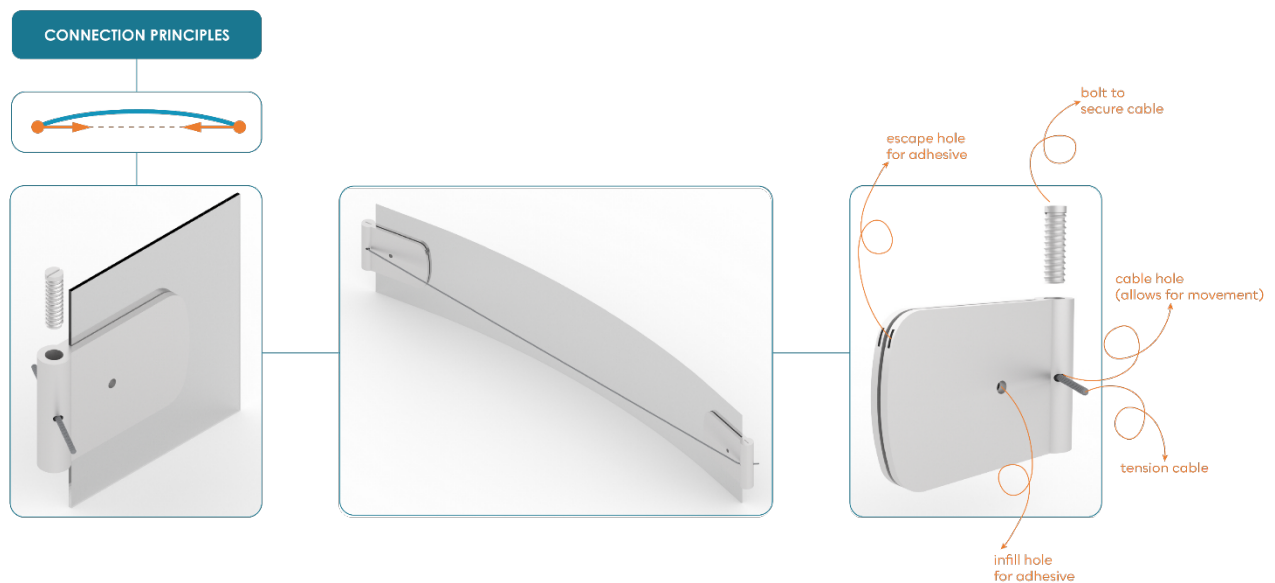

Figure 2-38: Connection design that follows the desired principles to accommodate design needs (own).

As mentioned, in order to accommodate the different design needs, the connection should be able to accommodate various design needs. Therefore, the hinge principle offers a rather easy way to accommodate two tension cables and therefore two possible radii in a design. The difference is that the option for unequal needed tension would require two bolts for the cable's pretension, as illustrated in figure 2.31 below.

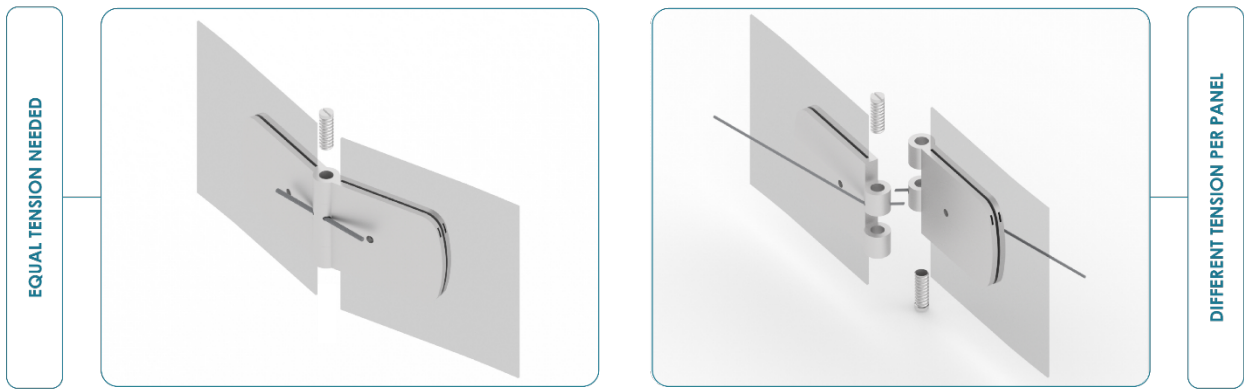

Figure 2-39: To accommodate for different radius per panel, the hinge is adjusted so that two cables and therefore two bolts can be inserted (own).

2.5 Prototype

With a view to proving the concept that cold bending thin glass is a possible scenario and that the design of the connection is suitable for such a study, a prototype is built. For that, the established workflow is put forward as well as the developed design combinations.

To make that possible, *AGC Europe* provided several *Falcon glass* panels of two different thicknesses, 1.1 mm, and 0.7 mm. The dimensions of the samples are 500 mm by 500 mm and they are already chemically tempered.

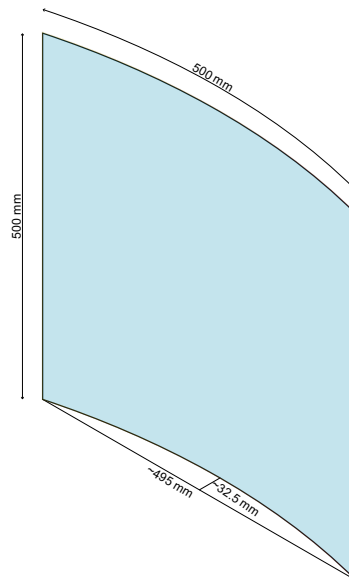

Figure 2-40: Illustration of the panel and curvature used for the following simulations and prototypes (own).

Safety

To ensure safety in assembly, a conservative radius was chosen to begin with, and two different scenarios of connection points and loads were calculated in the FEA model, to ensure that the panel is not going to break during or after assembly.

The panel that was simulated in ANSYS is a representation of the provided Falcon glass, curved in a radius of 954,9 mm. Following, 3 connection points were inserted on the two opposing sides, and the own weight was accounted for. The results are presented on the figure 2.32 below. Even when the initial stresses of the material are added, the stress values do not exceed the maximum ones.

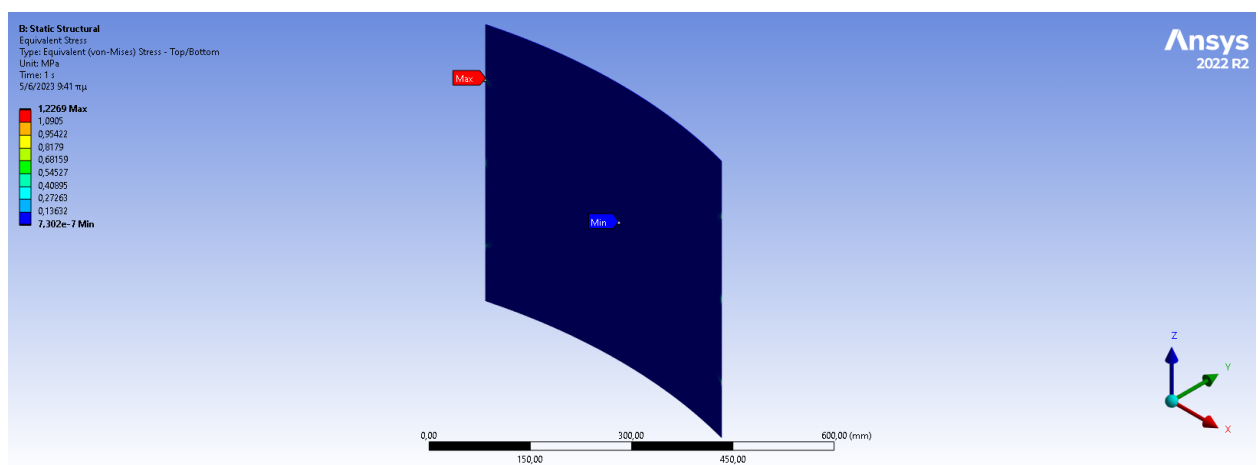

Figure 2-41: Rough simulation of the prototype in ANSYS Workbench, with 3 connection points (own).

Figure 2.41 shows the same simulation, but with only 2 connection points on the two opposing sides. Therefore, it is still possible to construct the prototype by using only 2 connection points.

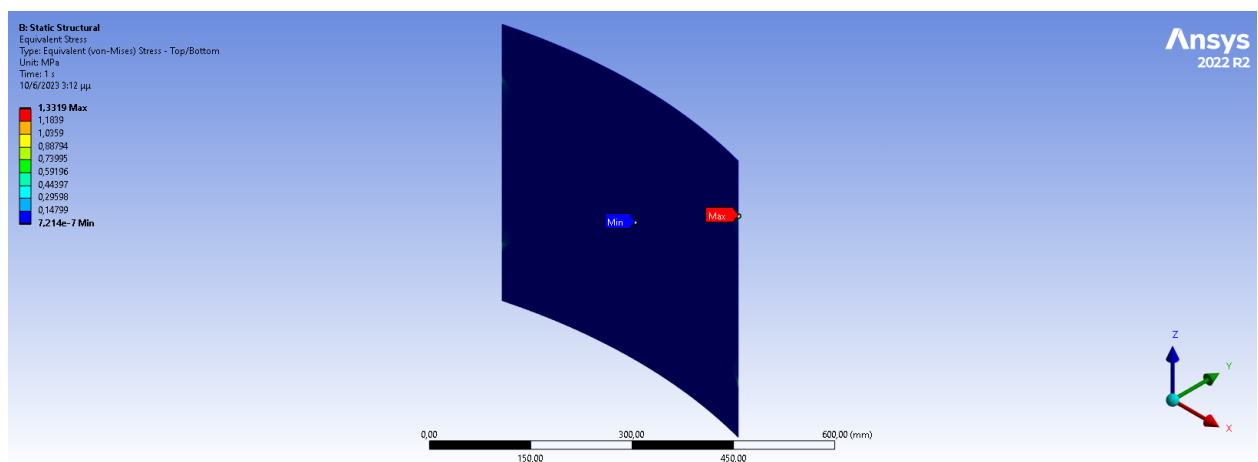

Figure 2-42: Simulation with the same settings, using only the "corner" connection points (own).

3d printed connections

For the current prototype the proposed connection was 3d printed. One first attempt is done with the use of a transparent PETG¹¹ filament. For time saving and to ensure quality in printing, the connections were slightly simplified, the slot for the tension cable was drilled by hand and the bolt hole adjusted accordingly.



Figure 2-43: Capture of the .stl file, ready to be 3d-printed (left) and the actual 3d-printed connections, made from PETG (mid and right). (own).

A second approach was done by using clear liquid resin. This type of 3d printing can create numerous objects in a short amount of time, when compared to the previous method and the detail can reach 0.001 mm of accuracy. However, due to the material's brittle behaviour and lack of knowledge on the printing process, the previous connections were chosen to be used on the actual glass sample. Therefore, further research is needed regarding this type of printing and the material. The figure 2.35 below shows some of the finest results of this process.



Figure 2-44: 3d printed connections using uv treated clear resin. The detail in such a method is higher (own).

Assembly

To start with, the correct position of the connections is marked on the panel and afterwards those are placed, while the panel is still flat and in a relaxed position. A wooden mould that

¹¹ Polyethylene terephthalate (or poly(ethylene terephthalate), PET, PETE, or the obsolete PETP or PET-P)

resembles the desired curvature is built and the panel is forced onto it and clamped in place. Following, the cable is put through the slot on the connection and then bolted in place. The panel is released from the mould.

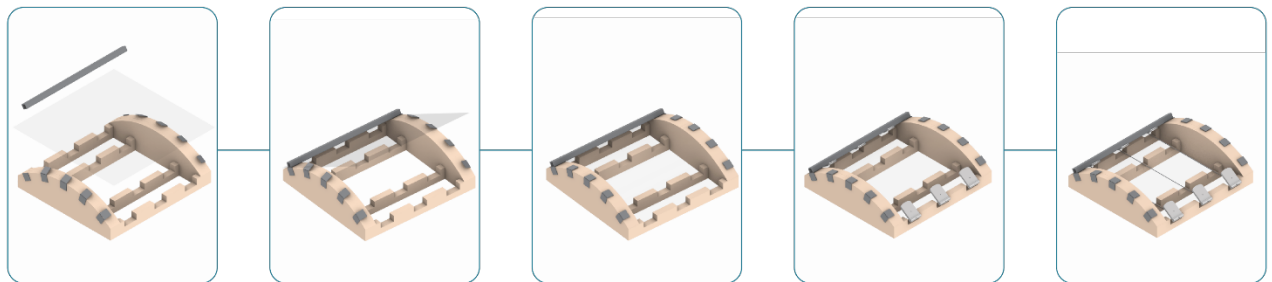

Figure 2-45: Diagram of assembly order with the use of a wooden mould (own).

The constructed mould was manually cut by the author and therefore, there are a couple of imperfections. However, this does not make it unsuitable for the current study.

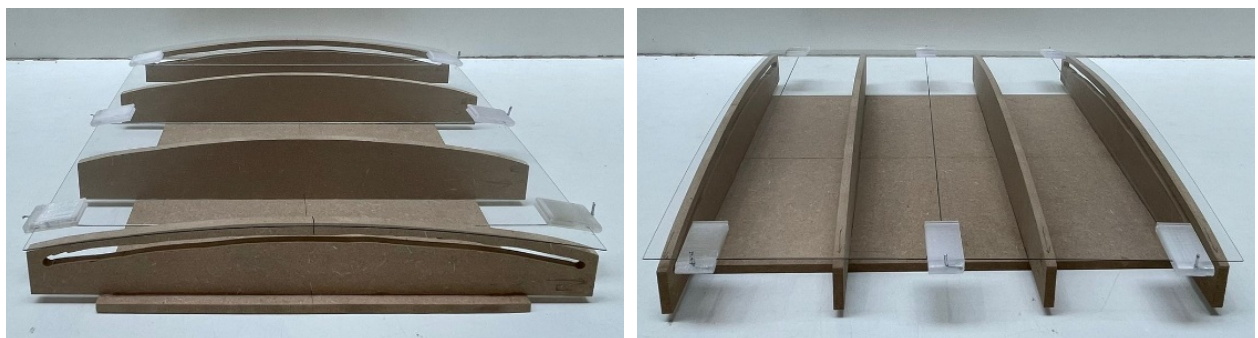

Figure 2-46: Photographs of the final mould design (own).

Equipment catalogue

To complete the assembly and being able to curve the panel onto the mould, there were some equipment needed. These are shown in the figure 2.37, below.

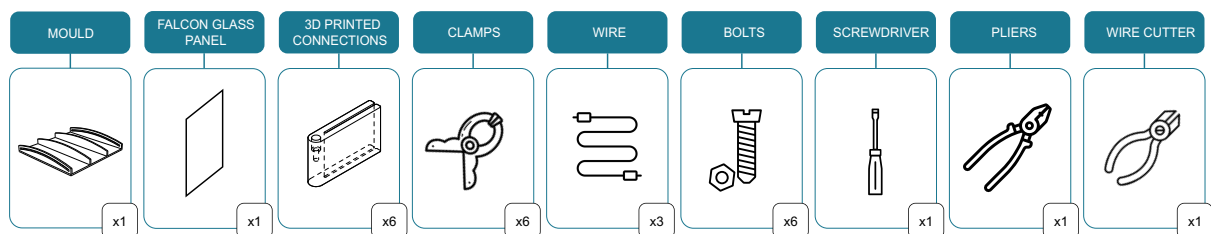

Figure 2-47: Equipment catalogue, to curve a single thin glass panel. In this case, each connection uses a single bolt, and a tension cable (wire) is shared between two opposing connections (own).

Test prototype

To test the assembly sequence and method, a test prototype was first built. For that, a protective foil was put on the outer surface of the glass pane, in order to hold it together in case of failure. The figures below show the outcome.

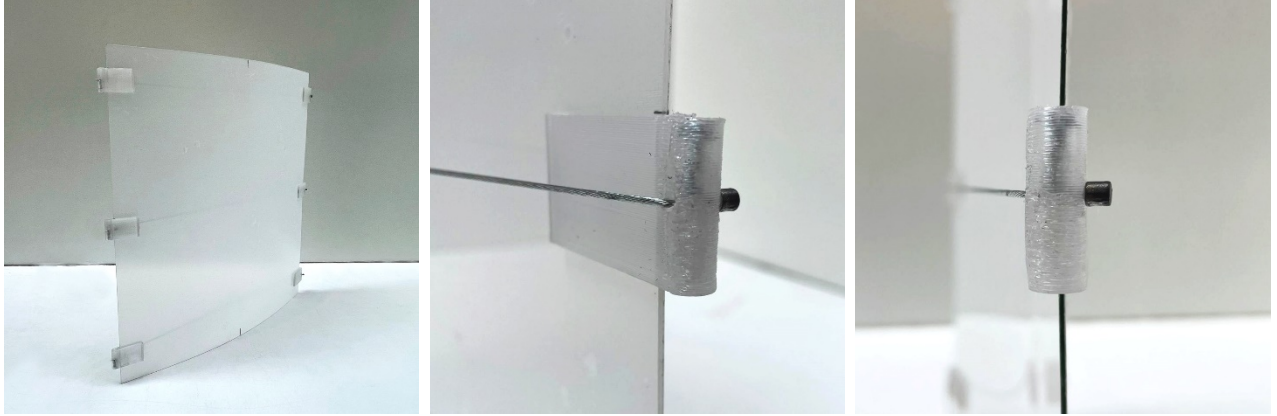

Figure 2-48: Photographs of the first test prototype. Whole panel (left) and the attached 3d-printed connections (middle and right) (own).

Final prototypes

Following the same principles, since there was no failure, a second prototype was done, without the use of the protective layer, as well as without any adhesive on the 3d printed connection.

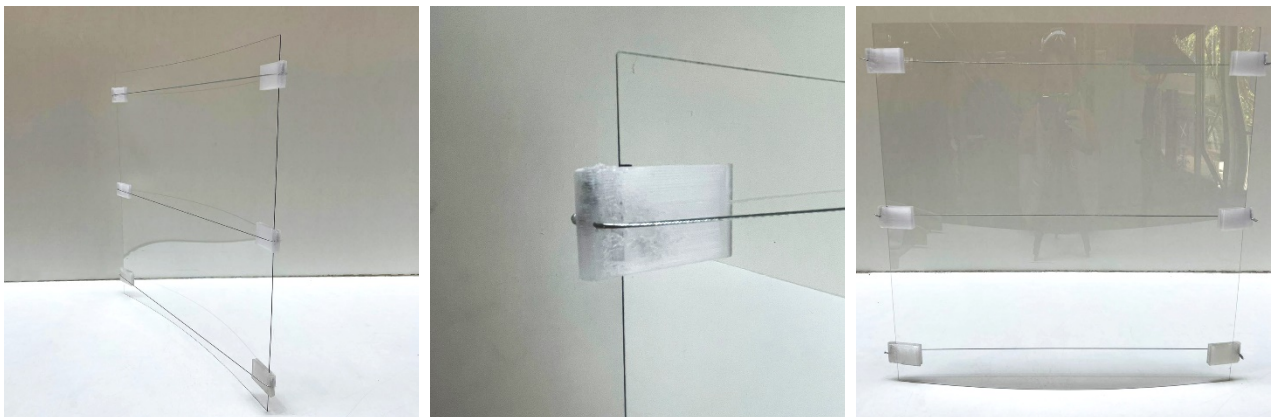

Figure 2-49: Prototype without the attached foil (own).

3. CONCLUSION

3.0 Research conclusions

The present thesis explored the feasibility of utilizing thin glass in architectural projects within an integrated design workflow involving computational methods. Considering the range of the required research and background knowledge, as well as the time limitation there were certain simplifications made and decisions taken towards a simplified approach.

Ultimately, the goal of providing an informed and reliable approach to using cold bent thin glass in architectural applications is achieved. Within the proposed computational method, this is attained by suggested computational tools, design methods and guidelines. In addressing the design with thin glass, the research and, ultimately, the method is representative of the potential of the cold bent material to a large extent.

3.0.0 Research question

How can a design of a thin glass installation be informed by the use of computational methods?

In accordance with this main research question, the answer lays on the development of the presented workflow. The final case study exhibits the method that is being followed to ultimately end with an installation using thin glass.

For this, several other parameters needed to be determined and incorporated into the design process. Starting from understanding the material and finally verifying the design structurally. The workflow includes the use of two main software. The first, in order to create a parametric design model and the second to validate the structural integrity of the design while performing a finite element analysis.

This workflow is suitable for the use of any design utilizing bent (glass) panels. Overall, the desired outcome has been fulfilled with minor challenges yet to be addressed.

3.0.1 Technical and design conclusions

The acquired knowledge throughout this thesis project, with regards to the technical side of it, revealed the potential of thin glass in architecture. However, the limited amount of literature studies to the pure material's capabilities is a vulnerability to such research. The following section, however, lists some further points to be considered in future projects.

From a design perspective, thin glass could offer a new and more complex architectural vocabulary. Glass design has been pushing for innovation and limits have been exceeded numerous times, therefore, the future of glass design is still to be discovered.

Computationally, the proposed workflow could be utilized in several projects if adjusted accordingly, however it requires a closer cooperation between the design team if it is to be incorporated in practice.

3.1 Recommendations for further research

Based on the conducted research, the findings, and the conclusions presented in the current thesis, there are aspects yet to be determined.

Material testing

Since thin glass has not been explored enough architecturally, the existing database for the characteristic values of the material's strength is quite limited. Thus, creating such a library would be useful. Material testing requires a variety of knowledge and processes and therefore it would be beneficial to dive into that aspect in further detail so as it can be better defined architecturally and structurally.

Bending

While cold bending offers a cost-efficient solution as well as simpler calculations, other bending processes could also be considered. For example, lamination bending could provide more stable but also complex design outcomes, as well as a simpler and less invasive connection design. Moreover, doubly curved surfaces could also be investigated.

Connection design

As mentioned in previous sections of the current report, connections are an important aspect when designing with glass. Using such a delicate and transparent material, connections are more than a structural part of the structure. There are also a design decision. Hence, investigating the suitability of different connection principles and designs is an additional point to be researched.

Considering that there are already some combinations of cold bent panels linked with possibly suitable connections, developed for the current project, the development of detailed connections is a possibility. Furthermore, these options can be developed for any type of bent thin glass panels and create a catalogue of suitable connections, linked to possible design outcomes.

Workflow automation & generative design iterations

The communication between software while being able to apply the correct settings for a computationally expensive process is a rather diligent coding work, that would be of great interest if it was to be further investigated. In view of achieving optimization within several design parameters, while maintaining the design's structural integrity is an important part of informed design, Computational design can assist in numerous ways and help to achieve more efficient, verified and therefore sustainable design options. Hence, further research on points along the workflow that can be incorporated into a more automated process would be a valuable addition.

If design iterations were to be included in such a process, it could be of additional importance. However, this also entails more specific parameters from the beginning of the workflow.

3.2 Reflection

3.2.0 Graduation process

How is the graduation topic positioned in the studio?

The discussed thesis engages two chairs within the “Building Technology” track, of Architectural Glass and Design Informatics. It is conducted under the guidance of James O’Callaghan and Paul de Ruiter of the two respective departments. Within the chair of Structural Design and Mechanics, the thesis project is investigating the possibilities of Thin Glass in the built environment, under the spectrum of a design workflow where the material data could be utilized to achieve informed design outcomes.

Moreover, the current project extends the knowledge on cold bent thin glass design and identifies tangible guidelines to existing issues in design. This evolves, under the spectrum of a digital and optimized workflow, as a result of a meticulous material understanding and analysis.

What is the relationship between the methodical line of approach of the graduation studio and your chosen method?

The methodical approach of the studio starts from technical-scientific study and ends with design research or execution of design. The approach for the current thesis was based on this guideline, choosing to first complete a technical-scientific study to identify the possible issues and gain adequate background knowledge and continues by researching through design, which provides more general, yet practical aspects. The findings from the first part are a vital part for the second part since they contain the overall analysis of the material as well as additional information regarding glass design and principles. An integral part of the thesis is

the final case study and prototype that proves the efficiency of the method, but also provide an insight into the aspects that require better calibration and further research.

How did the research approach work out (and why and why not)? And did it lead to the results you aimed for? (SWOT method)

The research approach required studies within several areas, vital for the desired outcome. Since the main goal of this research is to explore design possibilities with cold bent thin glass panels within a computational method, a detailed analysis was needed. Therefore, throughout the course of this project, 5 different areas have been investigated. Namely, glass design, material testing, computational design, glass connection design and structural simulations. Each area entails various difficulties but all fall under the umbrella of glass design with computational tools, making each one an important aspect of this thesis project. Each area provided with useful information, but also opened numerous additional aspects for further research or others that were indeed simplified due to time limitation.

The desired results are fairly achieved, leading to better understanding of the material, and paving the road for more architectural applications of thin glass.

How are research and design related?

The produced case study, as a design outcome, is a result of the conducted research. The proposed computational method as a design workflow highly depends on material studies and analysis as well as on the discretization of the process into tangible parameters.

3.2.1 Societal impact

To what extent are the results applicable in practice?

Firstly, from the perspective of materiality, the discussed thesis provides sufficient information as per the properties of the product and its capabilities. Also, guidelines are provided for the specific case of cold bending thin glass panels, as it is considered the most optimal design solution from a structural viewpoint. Thus, vital design issues have been faced.

Secondly, the proposed computational method provides an insight into suitable tools to complement the design process.

In conclusion, there are still several points to be further elaborated, but with the author's expertise the results are one step prior to being implemented in practice, considering that additional research could be pursued, and the proposed tools are adjusted to project preference.

Does the project contribute to sustainable development? What is the impact of your project on sustainability (people, planet, profit/prosperity)?

While thin glass is already being produced for the use in other industries, however its architectural application is limited. The composition of it, as well as its thickness requires less raw material compared to the same amount of regular float glass. Gradual integration of the material in the built environment would substantially reduce the raw material for regular glass, resulting in reduced carbon footprint. Additionally, the specific product used for the current project (Falcon glass by AGC) is produced with the float process, while other aluminosilicate glasses are produced with methods requiring high energy consumption.

Furthermore, considering that the proposed computational method works in an optimization loop, leaving several design goals open to the user, sustainable aspects, related to each project could be used as parameters.

Finally, exploiting methods and materials that are already in practice in different fields open new horizons both for the architectural industry and the people involved.

How does the project affect architecture / the built environment?

With the use of thin glass in the built environment, there are several design opportunities to be explored. Considering the integration of the proposed method in practice, architectural design could gain more complexity as well as clarity and resistance. Thin glass is a lightweight and flexible material, yet incredibly strong. Design wise this could potentially provide with intriguing design outcomes. Structurally, the material's weight would result in lighter structures overall. In view of the glass extensive use in a lot of elements in the built environment, the two aforementioned points are great advantages. Finally, the computational method provides with informed and verified design outcomes, making the process more efficient and open to optimization.

4. BIBLIOGRAPHY

- Akilo, M. (2018). *Design and analysis of a composite panel with ultra-thin glass faces and a 3D-printed polymeric core* [University of Bologna].
- Bedon, C., & Santarsiero, M. (2018). Transparency in Structural Glass Systems Via Mechanical, Adhesive and Laminated Connections - Existing Research and Developments. *Advanced Engineering Materials*. <https://doi.org/10.1002/adem.201700815>
- Belis, J., Inghelbrecht, B., Van Impe, R., & Callewaert, D. (2007). Cold bending of laminated glass panels. *Heron*, 52(1-2), 123-146.
- Bristogianni, T. (2022). Anatomy of cast glass: The effect of casting parameters on the meso-level structure and macro-level structural performance of cast glass components.
- Burgman, S. (2019). *Thin glass composite panel with 3D printed core: Thermal and structural properties* [TU Delft]. Delft, NL. <http://resolver.tudelft.nl/uuid:02c1b519-b5e0-4084-8b6f-18543133d96f>
- Commission, E. (2021). *EN Eurocodes*. European Union. Retrieved 19 April from <https://eurocodes.jrc.ec.europa.eu/en-eurocodes/about-en-eurocodes#why-the-eurocodes>
- Corning, M. o. g. (2011). TYPES OF GLASS. . <https://www.cmog.org/article/types-glass>
- Datsiou, K. C. (2017). *Design and performance of cold bent glass* [University of Cambridge].
- Datsiou, K. C., & Overend, M. (2018). Weibull parameter estimation and goodness-of-fit for glass strength data. *Structural Safety*, 73, 29-41.
- EOC, E. (2018). *Steve Jobs Theater*. Eckersley O' Callaghan Engineers. Retrieved 08 January 2023 from <https://www.eocengineers.com/projects/steve-jobs-theater-293/>
- EOC, E. (2019). Prototype for thin flexible glass pavilion showcased. <https://www.eocengineers.com/prototype-for-thin-flexible-glass-pavilion-showcased/>
- Galuppi, L., & Riva, E. (2022). Experimental and numerical characterization of twisting response of thin glass. *Glass Structures & Engineering*, 7(1), 45-69.
- Gavriil, K., Guseinov, R., Pérez, J., Pellis, D., Henderson, P., Rist, F., Pottmann, H., & Bickel, B. (2020). Computational design of cold bent glass façades. *ACM Transactions on Graphics (TOG)*, 39(6), 1-16.
- GPD. (2020, 2019). *Sophie Pannetier | Ultra-Thin Glass Projects*.
- Green, R. (2016). The Challenges of Writing a Structural Standard for Glass. *Challenging Glass Conference Proceedings*,
- Gregson, S. (2018, November 2018). *Thin Glass applications for Yachts* International HISWA Symposium on Yacht Design and Yacht Construction, Amsterdam, NL.
- Gregson, S., Santelli, L., & Jouy, A. (2019, 7-10 October 2019). Design of the Thin Glass Pavilion. IASS Annual Symposium 2019 - Structural Membranes 2019, Barcelona, Spain.
- Haldimann, M., Luible, A., & Overend, M. (2008). *Structural use of glass* (Vol. 10). labse.
- Huang, C., & Behrman, E. (1991). Structure and properties of calcium aluminosilicate glasses. *Journal of non-crystalline solids*, 128(3), 310-321.

- Hynd, W. (1984). Flat glass manufacturing processes. *Glass Science and Technology*, 2, 83.
- Kouvela, S. (2022). *Re-LOOP TRANSPARENCY: Exploring the potential of combining transparency and circularity in an insulated glass unit* [Master Thesis, TU Delft]. Delft. <http://resolver.tudelft.nl/uuid:374dc027-fdbb-447d-9167-be6e71da16ee>
- Lambert, H., & O'Callaghan, J. (2013). Ultra-thin high strength glass research and potential applications. *Glass Performance Days*, 95-99.
- Lau, A. T. C. (2017). Why 30? A Consideration for Standard Deviation. *ASTM Standardization News*, 2.
- Louter, C., Akilo, M., Miri, B., Neeskens, T., Ribeiro Silveira, R., Topcu, Ö., van der Weijde, I., Zha, C., Bilow, M., & Turrin, M. (2018). Adaptive and composite thin glass concepts for architectural applications. *Heron*, 63(1/2), 199-218. <https://heronjournal.nl/63-12/9.pdf>
- Maniatis, I., Nehring, G., & Siebert, G. (2016). Studies on determining the bending strength of thin glass. *Proceedings of the Institution of Civil Engineers-Structures and Buildings*, 169(6), 393-402.
- Merin, G. (2013). AD Classics: The Crystal Palace / Joseph Paxton. *AD Classics*. <https://www.archdaily.com/397949/ad-classic-the-crystal-palace-joseph-paxton>
- Nascimento, M. L. F. (2014). Brief history of the flat glass patent—Sixty years of the float process. *World Patent Information*, 38, 50-56.
- Neugebauer, J. (2016). Determination of bending tensile strength of thin glass. *Challenging Glass Conference Proceedings*,
- Neugebauer, J., & Wallner-Novak, M. (2018). LET THIN GLASS IN THE FAÇADE MOVE: Thin glass-new possibilities for glass in the facade. *Facade Tectonics*, 11. https://www.researchgate.net/publication/325645285_LET_THIN_GLASS_IN_THE_FACADE_MOVE_Thin_glass-new_possibilities_for_glass_in_the_facade
- Neugebauer, J., Wallner-Novak, M., Lehner, T., Wrulich, C., & Baumgartner, M. (2018). Movable thin glass elements in façades. *Challenging Glass Conference Proceedings*, Delft, NL.
- O' Regan, C. (2014). *Structural use of glass in buildings* (Vol. Second). The Institution of Structural Engineers.
- Oikonomopoulou, F., Bristogianni, T., Louter, C., Veer, F., & Nijse, R. (2019). Education on Structural Glass Design: Redefining glass through the design of innovative, full-glass structures. In *Structures and Architecture: Bridging the Gap and Crossing Borders* (pp. 593-600). CRC Press.
- Ottens, R. (2018). *HIGH STRENGTH THIN GLASS AS STIFF STRUCTURAL FABRIC* TU Delft]. Delft.
- Pennetier, S., & Stoddard, J. (2019). Prototyping with Ultra-Thin Glass. *Proceedings of IASS Annual Symposia*,
- Peters, T., Jaschke, S., & Schneider, J. (2019). Thin glass in membrane-like structures-applications, modelling and testing. *Proceedings of IASS Annual Symposia*,
- Pfarr, D., & Louter, C. (2023). Prototyping of digitally manufactured thin glass composite façade panels. *Architecture, Structures and Construction*. <https://doi.org/10.1007/s44150-022-00080-7>
- Rabinovich, M., Hoffmann, T., & Sorkine-Hornung, O. (2018). Discrete geodesic nets for modeling developable surfaces. *ACM Transactions on Graphics (TOG)*, 37(2), 1-17.

Rohrig, B. (2015). Smartphones. *ChemMatters*, 12.

Saleh, C. M. N., Louter, C., & Turrin, M. (2020, 04 May 2020). *Ultra Thin Composite Panel – An Exploratory Study on the Durability and Stiffness of a Composite Panel of Thin Glass and 3D printed Recycled PET* Challenging Glass 7 - Conference on Architectural and Ghent, Belgium. <https://proceedings.challengingglass.com/index.php/cgc/article/view/337>

Santos, F. O., Louter, C., & Correia, J. R. (2018). Exploring thin glass strength test methodologies. Challenging Glass Conference Proceedings,

Schneider, J., Neugebauer, J., Schuster, M., & Peters, T. (2017). Cold-bent thin glass laminates for architectural applications: Computational design and material modeling. Proceedings of IASS Annual Symposia,

Stoddard, J. (2019). *Concepts for Working with Ultra-Thin Glass in Elastic Bending: Typological Development and Emergent Technology* University of Southern California]. Southern California.

Team, A. E. (2017). Apple's Steve Jobs Theater Set to Take Center Stage Ahead of New Product Launch. *ArchDaily*. <https://www.archdaily.com/879278/apples-steve-jobs-theater-set-to-take-center-stage-ahead-of-new-product-launch>

Topcu, Ö., & Marinov, V. (2020). Thin Glass in Architecture-Possible Applications and Challenges. Challenging Glass Conference Proceedings,

van Driel, T. (2021). *Investigations on the Cold Bending Behaviour of a Cold-Bent Double Glazing Unit with a Rigid Edge-Spacer Frame* TU Delft]. Delft, NL.

Weber, F. (2018). The shape of spaces - Projects with Curved Glass. *Glass on Web*. Retrieved 10 February 2023, from <https://www.glassonweb.com/article/shape-spaces-projects-with-curved-glass>

Wurm, J. (2007). *Glass structures: design and construction of self-supporting skins*. Walter de Gruyter.

Zaccaria, M., & Gillon, X. (2019). Scaling Thin Glass Use to the Architectural World. *Świat Szkła*, 24.

Zaccaria, M., Peters, T., Ebert, J., Lucca, N., Schneider, J., & Louter, C. (2022). The clamp bender: a new testing equipment for thin glass. *Glass Structures & Engineering*, 7(2), 173-186.

Zhang, Y., & Zheng, J. (2022). An Overview of Developable Surfaces in Geometric Modeling. *Recent Patents on Engineering*, 16(5), 87-103.

5. APPENDIX

5.0 ANSYS Calibration

The Galuppi and Riva (2022) model of twisting twin glass was used in order to calibrate the used software and prove the suitability in the analysis of thin glass structures. Following are some results of the twisting model, with two different thicknesses and two different approaches.

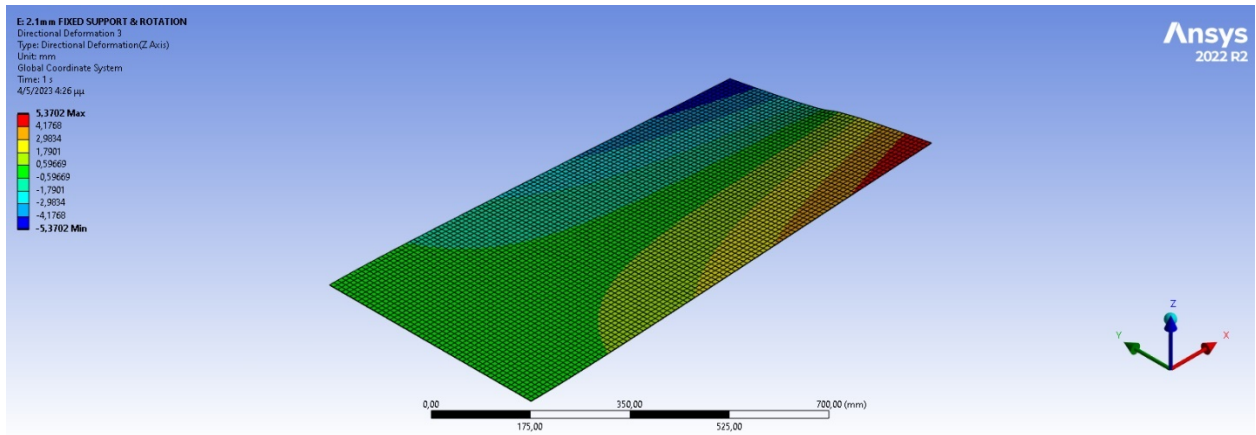

Figure 5-1: 2.1mm plate with mixed support on the one short edge and applied rotation on the mid-point of the second short edge.

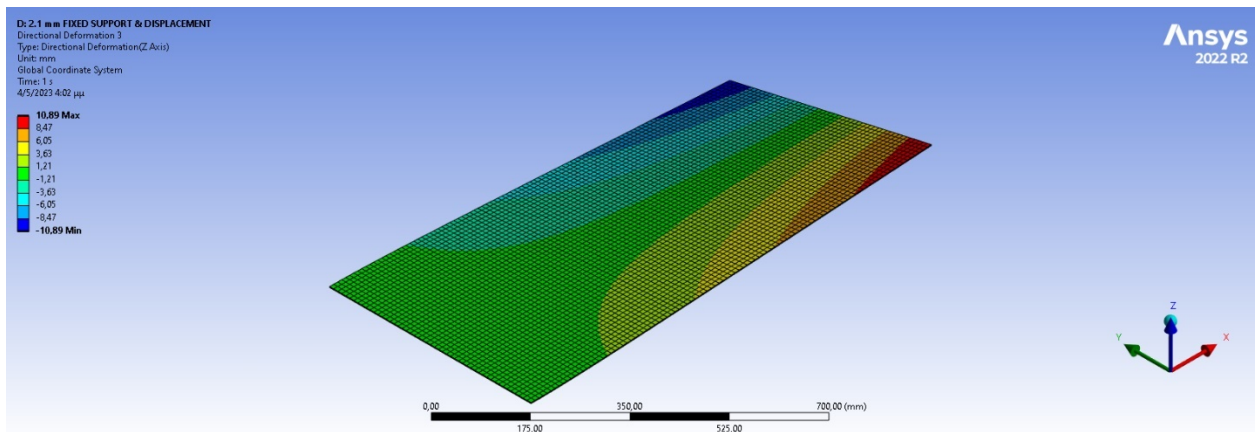

Figure 5-2: 2.1 mm plate with fixed support on the one short edge and applied controlled displacement on the edges of the opposite short edge.

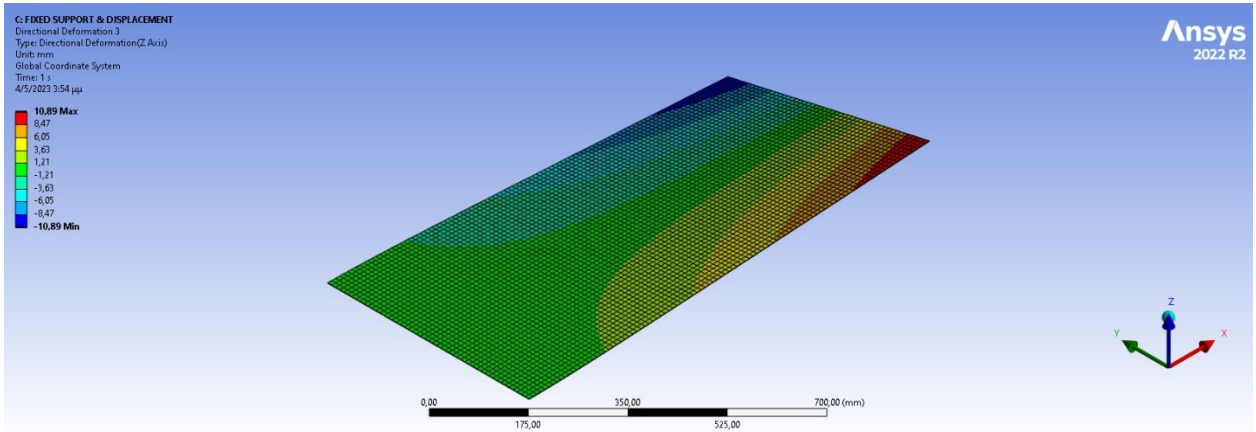

Figure 5-3: 1.1 mm plate with mixed support on the one short edge and applied rotation on the mid-point of the second short edge.

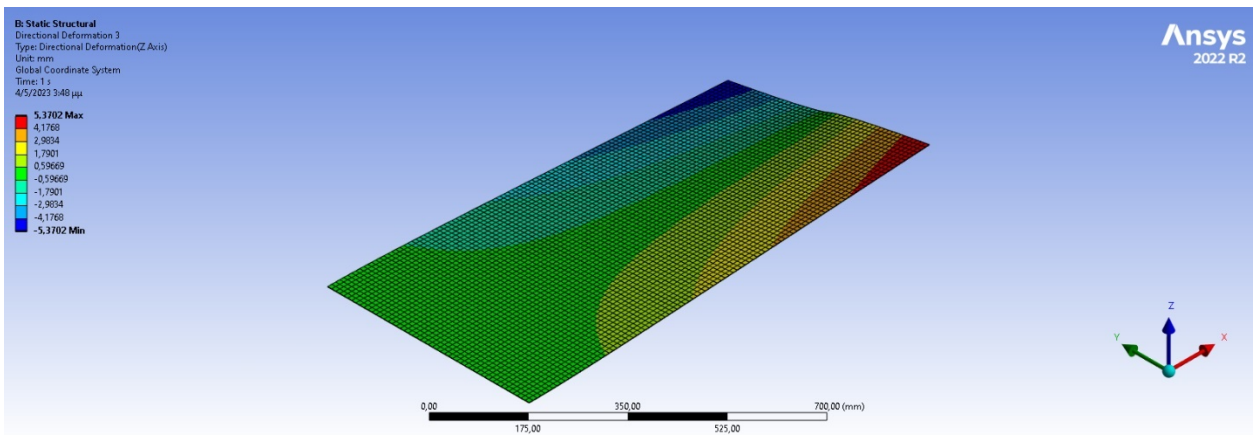

Figure 5-4: 1.1 mm plate with fixed support on the one short edge and applied controlled displacement on the edges of the opposite short edge.

5.1 ANSYS simulations on multiple combinations

Curved panel combinations were tested under the same load case scenario, on their self-weight and a combination of wind and live load, as those were presented in [section "2.03"](#).

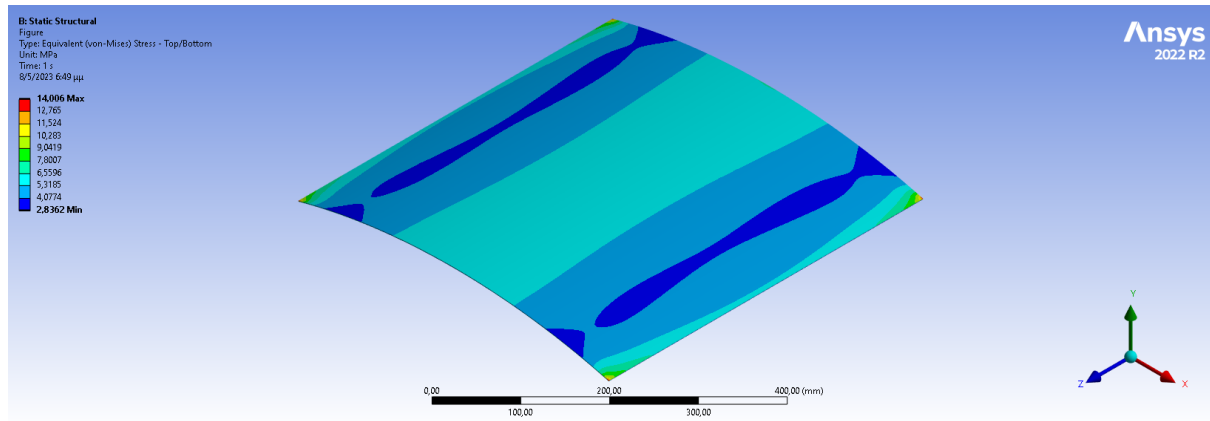

Figure 5-5: Single curved panel, 500 mm by 500 mm (own).

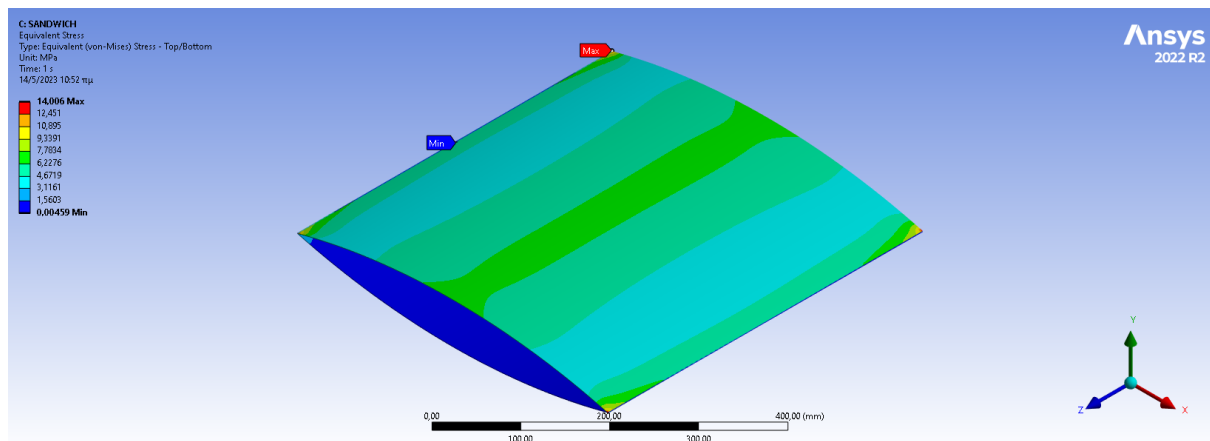

Figure 5-6: Two curved panels, 500 mm by 500 mm, attached on both sides (own).

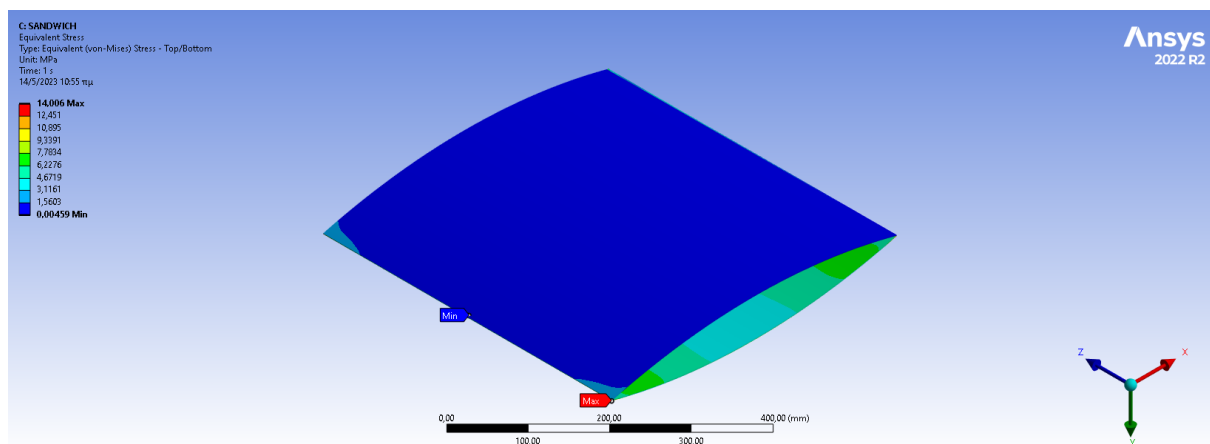

Figure 5-7: Flipped panel combination of figure 5.6 (own).

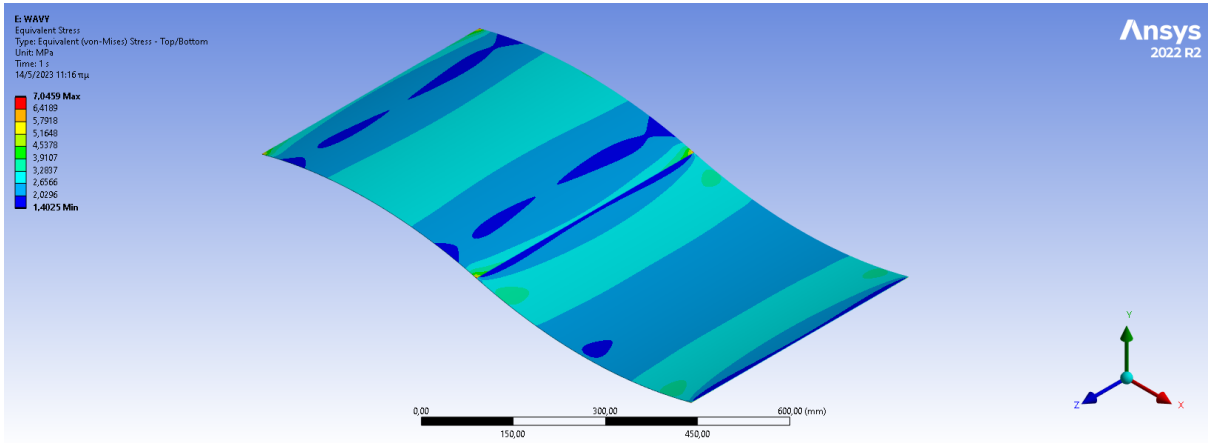

Figure 5-8: Two curved panels, 500 mm by 500 mm, attached on one side, forming a wave (own).

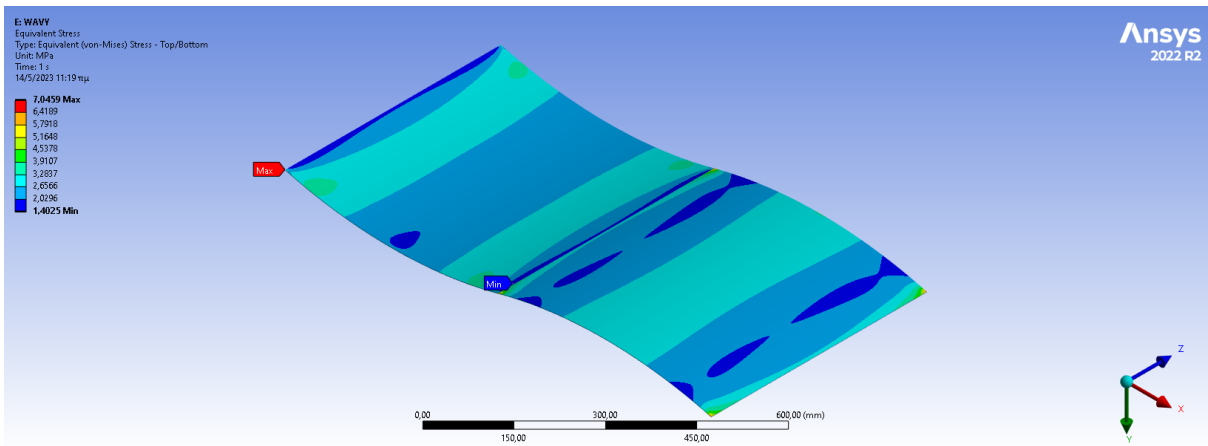

Figure 5-9: Flipped panel combination of figure 5.8 (own).

5.2 Clamp bender test results

Executor	AGC Glass Europe	
Thin glass product	Falcon Glass	
Method	Clamp bender	
Span ¹²	120	mm
Young's Modulus (E)	70000	N/mm ²

As mentioned in section "2.0.1", the stress is calculated according to the following formula:

$\sigma = \frac{Mhg}{2I}$ and by using the bending moment formula $M = \frac{EI}{R} = \frac{2 \cdot E I a}{L e}$ stress is ultimately calculated

in the excel file as: $\sigma = \frac{E h g}{2R}$.

Ground Edge (Test 1)

Table 5.1: First test results of ground edge cut falcon glass, as received by Marco Zaccaria of AGC Glass Europe.

n (number of specimen)	SPECIMEN	THICKNESS (h _g)	RADIUS (R)	STRESS (σ)	NOTES ON SPECIMENTS
		mm	mm	MPa	
1	GE0805A_01	0,521	51,24	355,7036	
2	GE0805A_02	0,519	48,81	372,1573	
3	GE0805A_03	0,507	48,08	368,8904	
4	GE0805A_04	0,505	47,81	369,6925	
5	GE0805A_05	0,516	48,75	370,2821	
6	GE0805A_06	0,512	48,68	368,1183	
7	GE0805A_07	0,516	48,41	372,7019	
8	GE0805A_08	0,508	51,17	347,6402	
9	GE0805A_09	0,515	49,09	367,1827	
10	GE0805A_10	0,517	48,81	370,5439	
11	GE0805A_11	0,511	53,11	336,9187	
12	GE0805A_12	0,521	51,02	357,2374	
13	GE0805A_13	0,520	52,63	345,9766	
14	GE0805A_14	0,521	49,86	365,8995	
15	GE0805A_15	0,513	48,68	369,0171	
16	GE0805A_16	0,506	48,95	361,4402	
17	GE0805A_17	0,521	49,44	368,8309	

¹² According to Zaccaria et al. (2022) the width of the specimens attached on the clamp bender is equal to 30 mm. The usual span is 200 mm, but the received results were performed with a 120 mm.

18	GE0805A_18	0,515	49,09	366,8262	
19	GE0805A_19	0,519	49,72	365,5219	
20	GE0805A_20	0,513	48,81	368,0342	
21	GE0805A_21	0,520	51,24	355,1913	
22	GE0805A_22	0,505	49,79	355,1667	
23	GE0805A_23	0,520	48,88	372,5194	
24	GE0805A_24	0,520	50,65	359,5015	
25	GE0805A_25	0,519	53,85	337,0009	
26	GE0805A_26	0,517			damaged
27	GE0805A_27	0,512	50,43	355,5175	
28	GE0805A_28	0,505	48,01	368,1525	
29	GE0805A_29	0,504	51,78	340,6721	
30	GE0805A_30	0,502	45,75	384,235	
31	GE0805A_31	0,521	49,23	370,2265	
32	GE0805A_32	0,522			

Weibull distribution

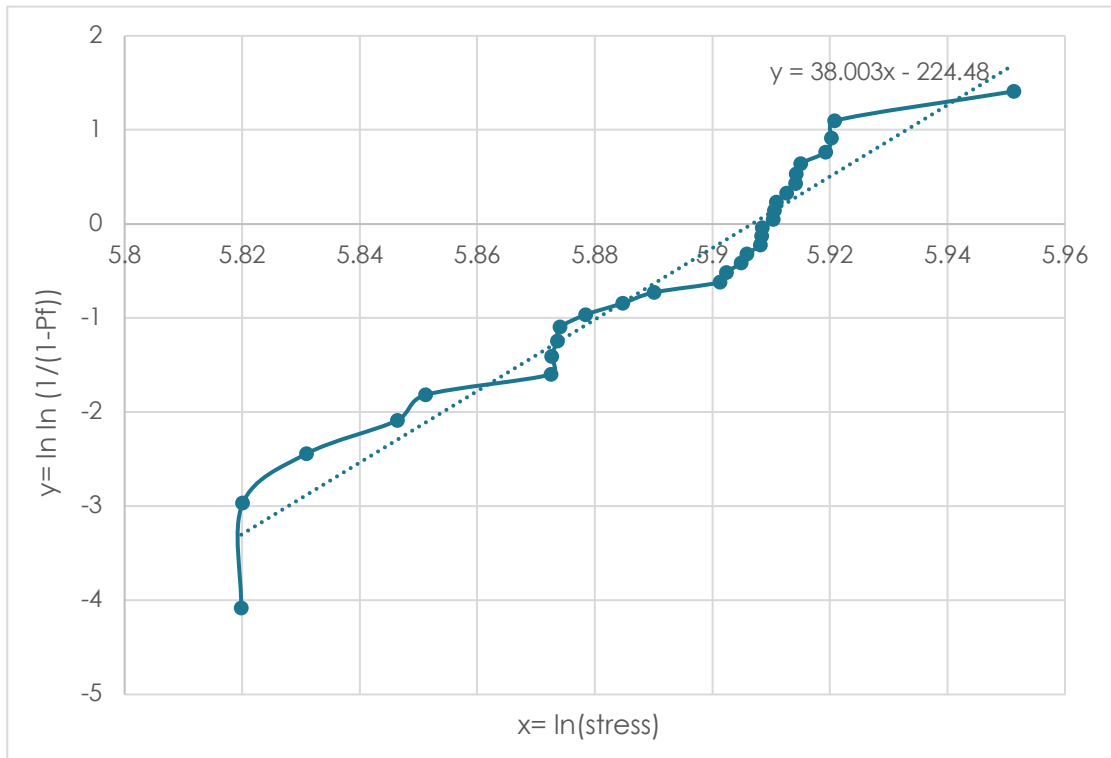

Figure 5-11: Cumulative distribution function (CDF) of ground edge cut falcon glass first test set up (own calculations).

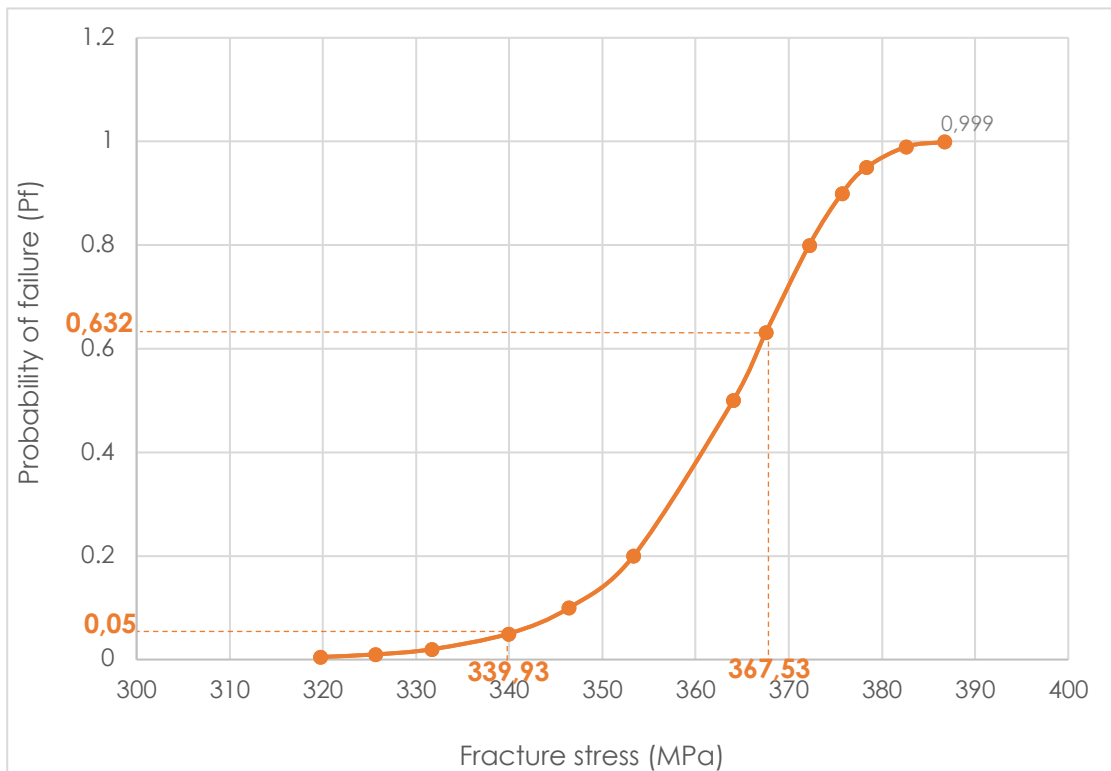

Figure 5-10: Empirical distribution function (EDF) of ground edge cut falcon glass first test set up, with the probabilities of 63,2% and 5% shown (own calculations).

Ground Edge (Test 2)

Table 5.2: Second test results of ground edge cut falcon glass, as received by Marco Zaccaria of AGC Glass Europe.

n (number of specimen)	SPECIMEN	THICKNESS (h _g)	RADIUS (R)	STRESS (σ)	NOTES ON SPECIMENTS
		mm	mm	MPa	
1	GE2405A_01	0,512	53,35	335,731	
2	GE2405A_02	0,516	56,18	321,6225	
3	GE2405A_03	0,505	52,95	333,8055	
4	GE2405A_04	0,519	55,12	329,395	
5	GE2405A_05	0,512	54,01	331,6284	
6	GE2405A_06	0,520	56	324,6875	
7	GE2405A_07	0,516	52,87	341,7581	
8	GE2405A_08	0,514	56,63	317,8307	
9	GE2405A_09	0,521	54,52	334,6249	
10	GE2405A_10	0,512	57,1	313,9886	
11	GE2405A_11	0,517	54,01	334,8685	
12	GE2405A_12	0,513	55,47	323,373	
13	GE2405A_13	0,520	56	324,6875	
14	GE2405A_14	0,515	55,82	322,5994	
15	GE2405A_15	0,518	57,66	314,1259	
16	GE2405A_16	0,519	56,91	319,1882	
17	GE2405A_17	0,522	56,91	321,187	
18	GE2405A_18	0,521	55,73	326,8886	
19	GE2405A_19	0,521	55,56	327,8888	
20	GE2405A_20	0,518	55,73	325,4755	
21	GE2405A_21	0,508	54,77	324,79	
22	GE2405A_22	0,513	54,95	326,5924	
23	GE2405A_23	0,515	52,4	343,8216	
24	GE2405A_24	0,512	56,09	319,6425	
25	GE2405A_25	0,519	55,47	327,1588	
26	GE2405A_26	0,512	55,47	323,0575	
27	GE2405A_27	0,516	55,29	326,6413	
28	GE2405A_28	0,509	57,19	311,5055	
29	GE2405A_29	0,510	79,01	226,0315	Surface failure
30	GE2405A_30	0,517	53,44	338,7678	
31	GE2405A_31	0,512	55,03	325,3226	
32	GE2405A_32	0,521			

Weibull distribution

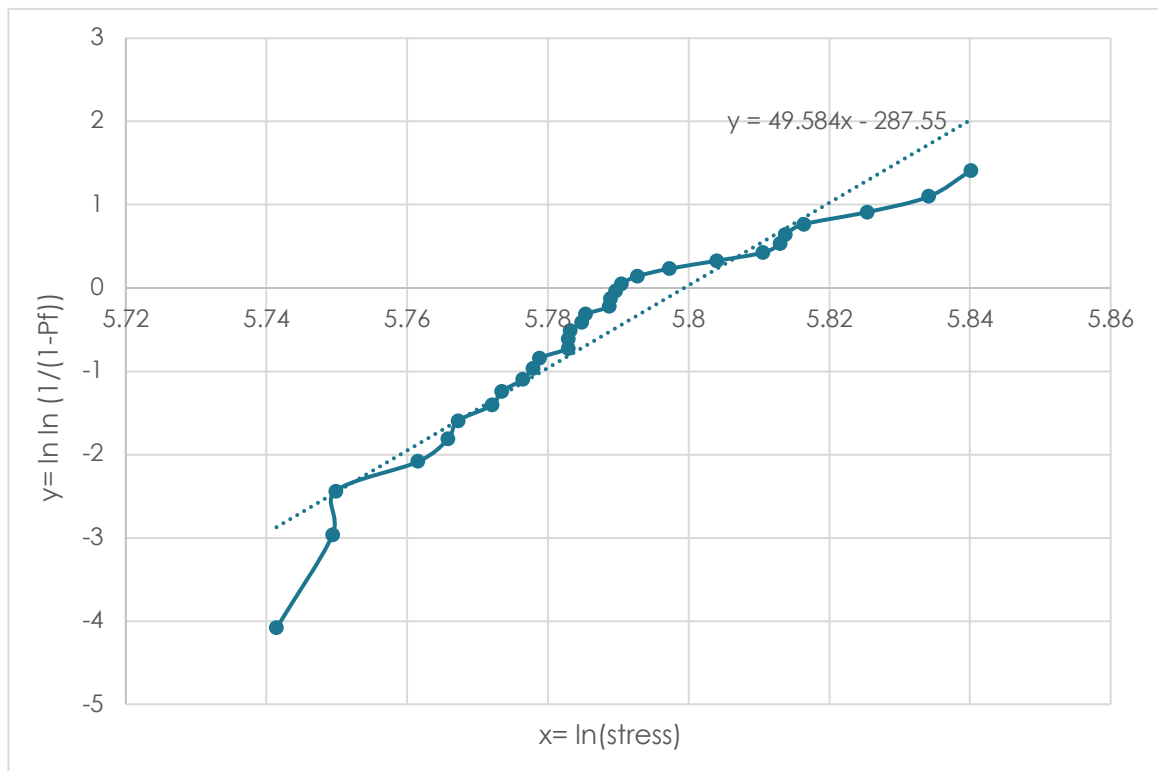

Figure 5-12: Cumulative distribution function (CDF) of ground edge cut falcon glass second test set up (own calculations).

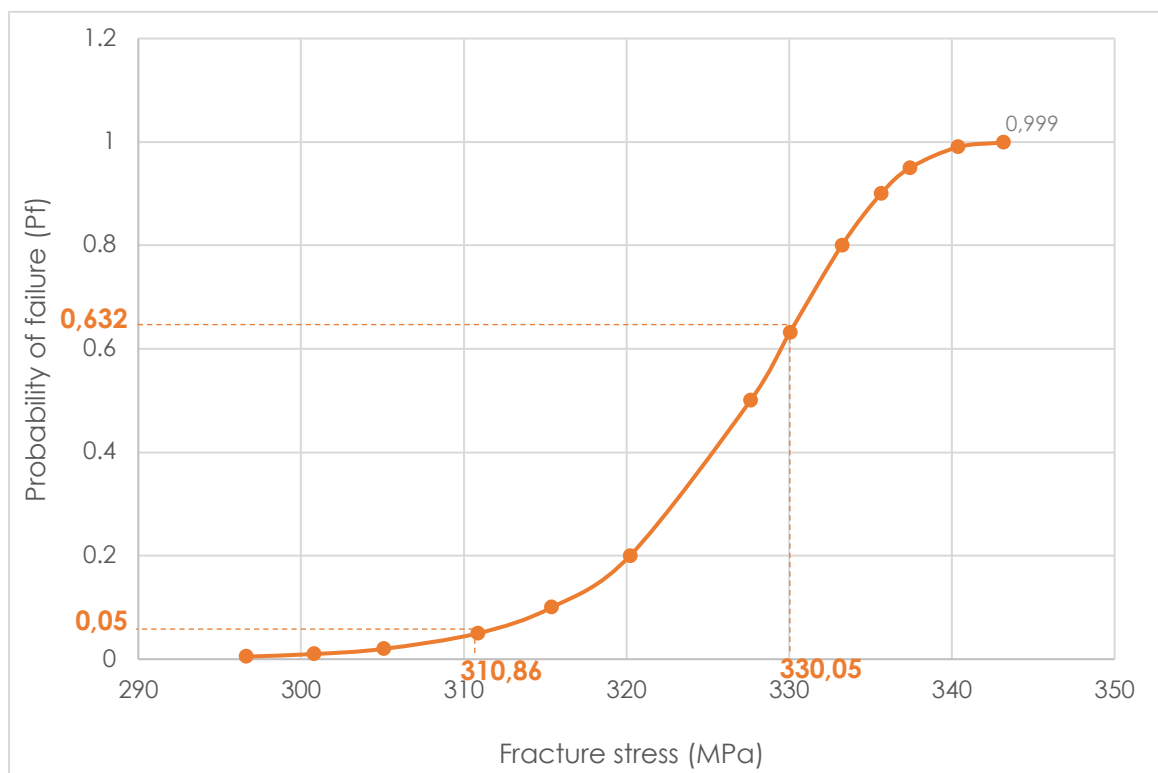

Figure 5-13: Empirical distribution function (EDF) of ground edge cut falcon glass second test set up, with the probabilities of 63,2% and 5% shown (own calculations).

Laser Cut (Test 1)

Table 5.3: First test results of laser cut falcon glass, as received by Marco Zaccaria of AGC Glass Europe.

n (number of specimen)	SPECIMEN	THICKNESS (h_g)	RADIUS (R)	STRESS (σ)	NOTES ON SPECIMENTS
		mm	mm	MPa	
1	L10805A_03	0,510	65,79	271,3178	
2	L10805A_05	0,528	66,54	277,4647	
3	L10805A_02	0,505	54,52	324,193	
4	L10805A_04	0,523	55,91	327,2447	
5	L10805A_31	0,522	55,47	329,0517	
6	L10805A_29	0,514	54,52	330,1311	
7	L10805A_06	0,525	55,64	330,4053	
8	L10805A_27	0,514	54,35	330,8418	
9	L10805A_19	0,519	54,53	332,7985	
10	L10805A_25	0,515	54,1	333,1793	
11	L10805A_01	0,518	54,43	333,2491	
12	L10805A_24	0,510	53,52	333,3567	
13	L10805A_22	0,518	54,35	333,7397	
14	L10805A_26	0,516	53,93	334,7163	
15	L10805A_09	0,520	54,35	334,8666	
16	L10805A_21	0,515	53,76	334,9609	
17	L10805A_13	0,514	53,68	334,9711	
18	L10805A_23	0,513	53,52	335,1551	
19	L10805A_28	0,518	54,1	335,2819	
20	L10805A_07	0,513	53,52	335,3186	
21	L10805A_17	0,522	54,43	335,4997	
22	L10805A_30	0,520	54,18	336,0788	
23	L10805A_12	0,520	54,18	336,0788	
24	L10805A_16	0,512	53,27	336,5637	
25	L10805A_20	0,520	54,01	337,1366	
26	L10805A_11	0,521	53,85	338,3008	
27	L10805A_08	0,520	53,76	338,5417	
28	L10805A_18	0,517	53,44	338,604	
29	L10805A_10	0,515	53,19	338,715	
30	L10805A_15	0,514	52,95	339,9197	
31	L10805A_14	0,519	53,27	341,1629	
32	L10805A_32	0,530	54,18	342,2158	

Weibull distribution

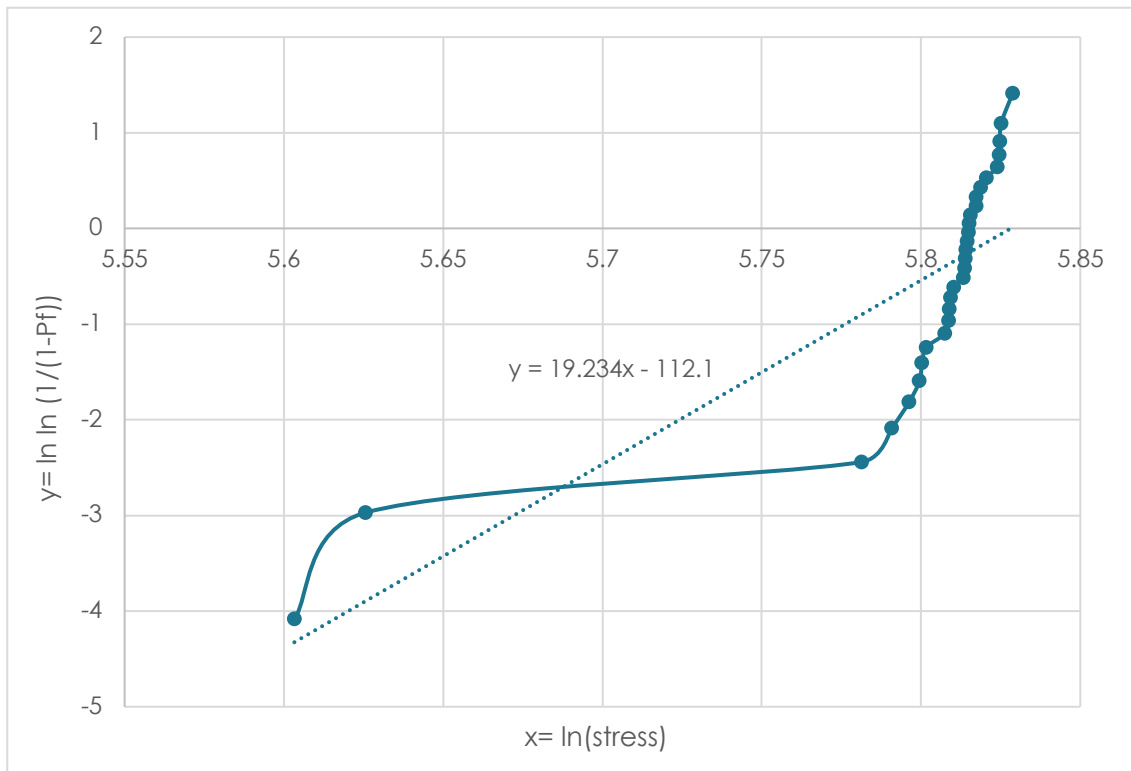

Figure 5-15: Cumulative distribution function (CDF) of laser cut falcon glass first test set up (own calculations).

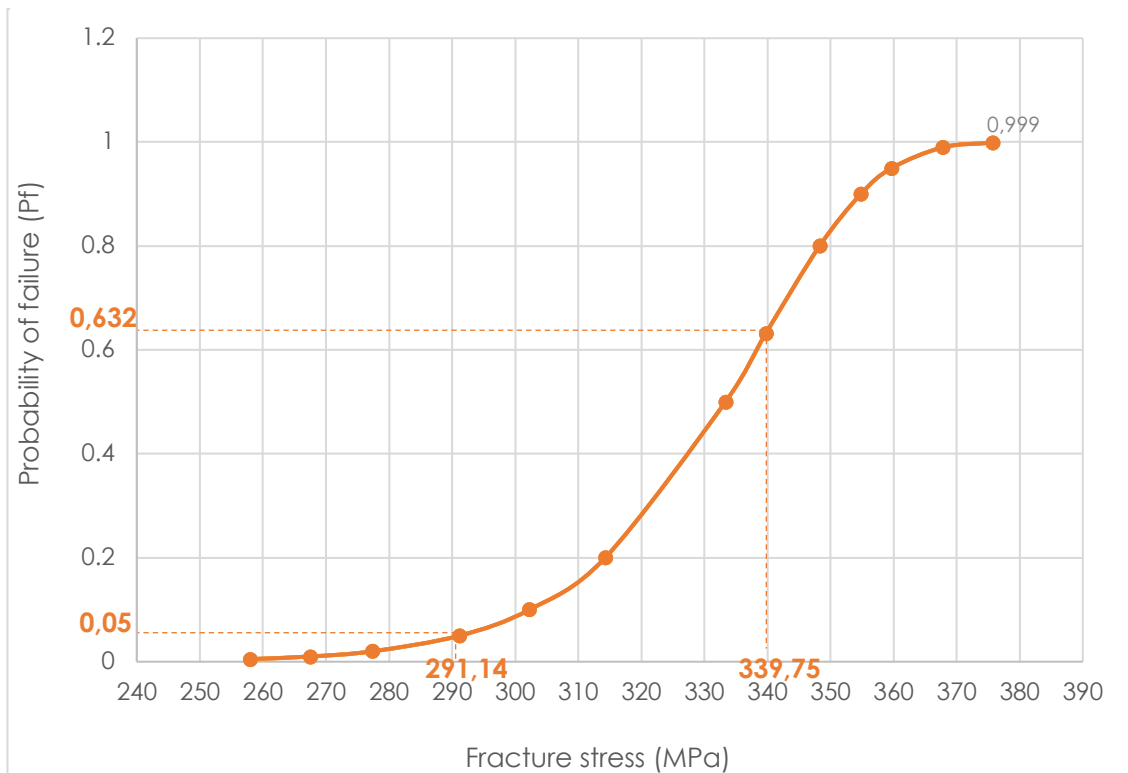

Figure 5-14: Empirical distribution function (EDF) of ground edge cut falcon glass second test set up, with the probabilities of 63,2% and 5% shown (own calculations).

Laser Cut (Test 2)

Table 5.4: Second test results of laser cut falcon glass, as received by Marco Zaccaria of AGC Glass Europe.

n (number of specimen)	SPECIMEN	THICKNESS (h _g)	RADIUS (R)	STRESS (σ)	NOTES ON SPECIMENTS
		mm	mm	MPa	
1	L12405A_01	0,520	74,31	245,0377	Surface failure
2	L12405A_02	0,518	62,72	288,7835	
3	L12405A_03	0,516	61,08	295,3913	
4	L12405A_04	0,519	62,06	292,5596	
5	L12405A_05	0,517	60,98	296,7366	
6	L12405A_06	0,521	62,61	290,9679	
7	L12405A_07	0,514	62,5	287,98	
8	L12405A_08	0,519	63,18	287,2349	
9	L12405A_09	0,516	63,75	283,2941	
10	L12405A_10	0,515	61,95	290,9605	
11	L12405A_11	0,521	63,06	289,169	
12	L12405A_12	0,517	62,06	291,7137	
13	L12405A_13	0,512	60,98	293,8668	
14	L12405A_14	0,515	61,95	290,8192	
15	L12405A_15	0,514	60,98	295,1582	
16	L12405A_16	0,513	60,66	295,9941	
17	L12405A_17	0,512	61,51	291,3347	
18	L12405A_18	0,521	61,84	294,5909	
19	L12405A_19	0,520	63,29	287,5652	
20	L12405A_20	0,523	61,84	296,1473	
21	L12405A_21	0,513	61,51	291,7615	
22	L12405A_22	0,515	61,51	293,184	
23	L12405A_23	0,524	63,29	289,9155	
24	L12405A_24	0,523	62,72	291,8527	
25	L12405A_25	0,526	63,06	291,6667	
26	L12405A_26	0,527	64,7	285,2202	
27	L12405A_27	0,526	62,17	295,842	
28	L12405A_28	0,516	63,75	283,2941	
29	L12405A_29	0,521	63,87	285,2278	
30	L12405A_30	0,522	62,28	293,2121	
31	L12405A_31	0,521	64,1	284,6139	
32	L12405A_32	0,524			

Weibull distribution

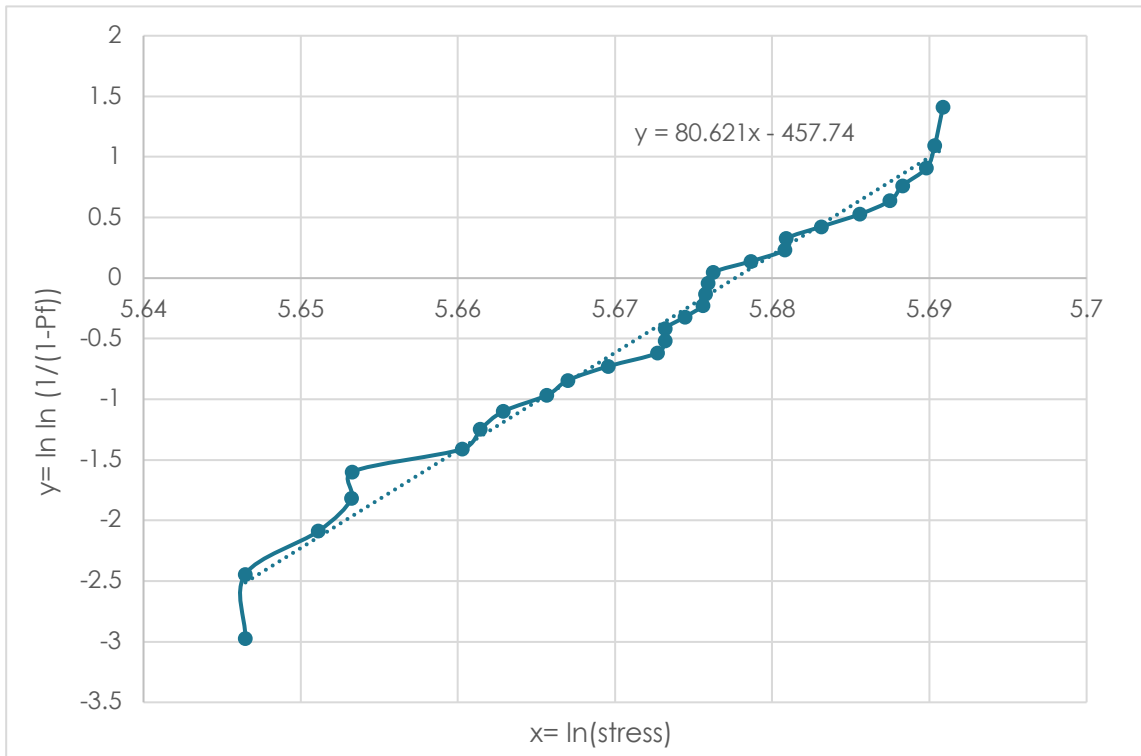

Figure 5-16: Cumulative distribution function (CDF) of laser cut falcon glass second test set up (own calculations).

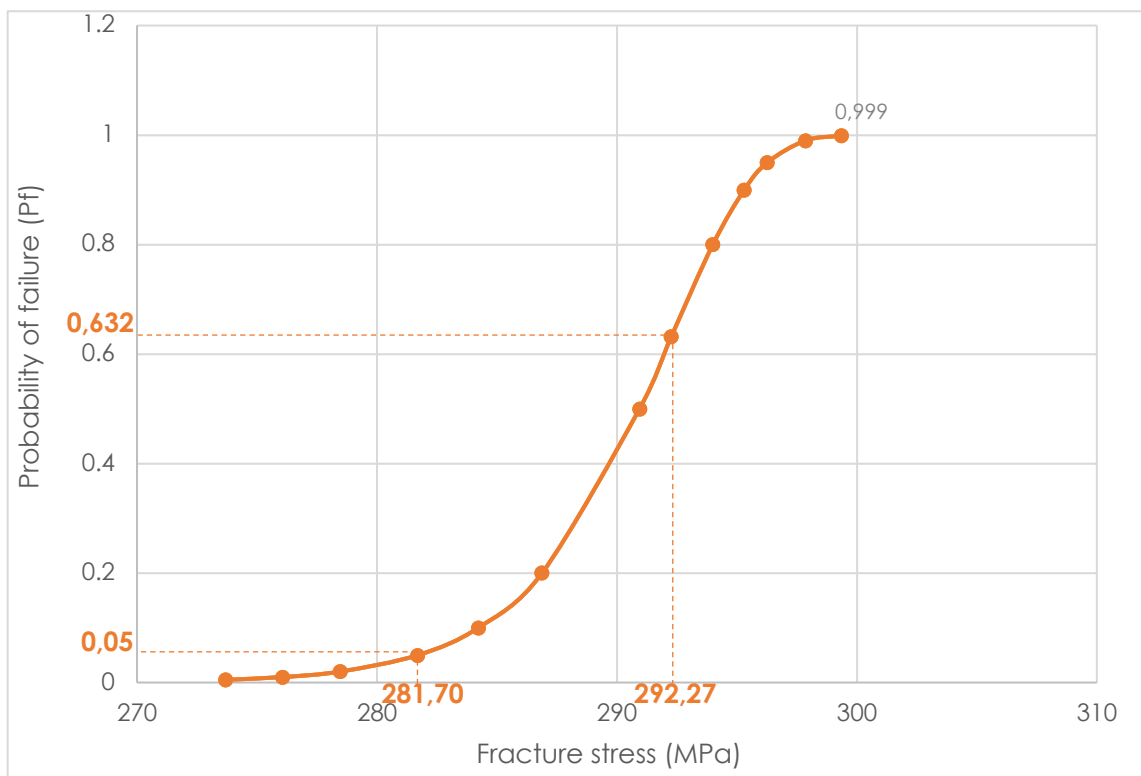

Figure 5-17: Empirical distribution function (EDF) of ground edge cut falcon glass second test set up, with the probabilities of 63,2% and 5% shown (own calculations).

