

Drinking Water Microbial Communities

El Chakhtoura, Joline

DOI

[10.4233/uuid:9bcd7269-e56f-4234-8ad4-1a43b9240b14](https://doi.org/10.4233/uuid:9bcd7269-e56f-4234-8ad4-1a43b9240b14)

Publication date

2018

Document Version

Final published version

Citation (APA)

El Chakhtoura, J. (2018). *Drinking Water Microbial Communities*. [Dissertation (TU Delft), Delft University of Technology]. <https://doi.org/10.4233/uuid:9bcd7269-e56f-4234-8ad4-1a43b9240b14>

Important note

To cite this publication, please use the final published version (if applicable).
Please check the document version above.

Copyright

Other than for strictly personal use, it is not permitted to download, forward or distribute the text or part of it, without the consent of the author(s) and/or copyright holder(s), unless the work is under an open content license such as Creative Commons.

Takedown policy

Please contact us and provide details if you believe this document breaches copyrights.
We will remove access to the work immediately and investigate your claim.

DRINKING WATER MICROBIAL COMMUNITIES

JOLINE EL-CHAKHTOURA

Copyright © Joline El-Chakhtoura, 2018

ISBN: 978-94-6186-988-3

Printed by Ipskamp Drukkers, Enschede, the Netherlands using Biotop paper from FSC-certified material, recycled material or controlled wood

Front cover image by:

Back cover image by:

Drinking Water Microbial Communities

Dissertation

for the purpose of obtaining the degree of Doctor
at Delft University of Technology
by the authority of the Rector Magnificus Prof.dr.ir. T.H.J.J. van der Hagen,
chair of the Board for Doctorates

to be defended publicly on
Thursday 8 November 2018 at 10:00 o'clock

by

Joline EL-CHAKHTOURA

Master of Science in Environmental Technology,
American University of Beirut, Lebanon
born in Brummana, Lebanon

This dissertation has been approved by the promotors.

Composition of the doctoral committee:

Rector Magnificus	chairperson
Prof.dr. J.S. Vrouwenvelder	Delft University of Technology, promotor
Prof.dr.dr.h.c.ir. M.C.M. van Loosdrecht	Delft University of Technology, promotor
Prof.dr. P.E. Saikaly	KAUST, promotor

Independent members:

Prof.dr.ir. W.G.J. van der Meer	University of Twente
Prof.dr. G.J. Medema	Delft University of Technology
Prof.dr.ir. L.C. Rietveld	Delft University of Technology
Dr. A.J. Pinto	Northeastern University, U.S.A.

The research presented in this doctoral dissertation was financially supported by and conducted in collaboration with King Abdullah University of Science and Technology (KAUST, Saudi Arabia) and Evides Waterbedrijf (the Netherlands).

for mom and dad

Contents

Summary	9
Samenvatting	11

INTRODUCTION

Chapter 1	Background and research questions	13
------------------	-----------------------------------	----

METHODOLOGY

Chapter 2	Flow cytometry and 16S rRNA gene pyrosequencing for drinking water bacterial analysis	43
------------------	---	----

NETHERLANDS STUDIES: fresh water - conventional treatment

Chapter 3	Bacterial temporal dynamics: before and after distribution	81
Chapter 4	Bacterial spatial dynamics: during distribution and network flushing	111

SAUDI ARABIA STUDIES: seawater - membrane desalination

Chapter 5	Bacterial community structure and variation	151
Chapter 6	Eukaryotic community structure and variation	193

WASTEWATER REUSE STUDY

Chapter 7	Impact of residual monochloramine on biological stability and membrane biofouling control	239
------------------	---	-----

OUTLOOK

Chapter 8	Conclusions and research prospects	281
------------------	------------------------------------	-----

Abbreviations	295
---------------	-----

About the author	297
------------------	-----

Acknowledgments	300
-----------------	-----

Summary

Water crises are predicted to be amongst the risks of highest concern for the next ten years, due to availability, accessibility, quality and management issues. Knowledge of the microbial communities indigenous to drinking water is essential for treatment and distribution process control, risk assessment and infrastructure design. Drinking water distribution systems (DWDSs) ideally should deliver to the consumer water of the same microbial quality as that leaving a treatment plant (“biologically stable” according to WHO). At the start of this Ph.D. program water microbiology comprised conventional culture-dependent methods, and no studies were available on microbial communities from source to tap.

A method combining 16S rRNA gene pyrosequencing with flow cytometry was developed to accurately detect, characterize, and enumerate the microorganisms found in a water sample. Studies were conducted in seven full-scale Dutch DWDSs which transport low-AOC water without disinfectant residuals, produced from fresh water applying conventional treatment. Full-scale studies were also conducted at the desalination plant and DWDS of KAUST, Saudi Arabia where drinking water is produced from seawater applying RO membrane treatment and then transported with chlorine residual. Furthermore, biological stability was evaluated in a wastewater reuse application in the Netherlands.

When low-AOC water was distributed without disinfectant residuals, greater bacterial richness was detected in the networks, however, temporal and spatial variations in the bacterial community were insignificant and a substantial fraction of the microbiome was still shared between the treated and transported

water. This shared fraction was lower in the system transporting water with chlorine residual, where the eukaryotic community changed with residence time. The core microbiome was characterized and dominant members varied between the two systems. Biofilm and deposit-associated communities were found to drive tap water microbiology regardless of water source and treatment scheme. Network flushing was found to be a simple method to assess water microbiology. Biological stability was not associated with safety. The biological stability concept needs to be revised and quantified. Further research is needed to understand microbial functions and processes, how water communities affect the human microbiome, and what the “drinking” water microbiome is like in undeveloped countries.

Samenvatting

Watercrises zullen in de komende 10 jaar naar verwachting deel uitmaken van de meest zorgwekkende risico's, door problemen met beschikbaarheid, toegankelijkheid, kwaliteit en management. Kennis over de microbiologische gemeenschappen die in drinkwater voorkomen is essentieel voor sturing van zuiverings- en distributieprocessen, risicobeheersing en ontwerp van infrastructuur. Distributie netwerken leveren in het ideale geval drinkwater van dezelfde microbiologische kwaliteit als het drinkwater dat het zuiveringsstation verlaat ("biologisch stabiel" volgens de WHO). Voorafgaand aan dit promotietraject bestond microbiologische analyse van water vooral uit kweekmethoden en werd er geen onderzoek gedaan naar microbiologische gemeenschappen van bron tot tap.

Er werd een methode ontwikkeld, om op basis van 16S rRNA gene pyrosequencing met flow cytometry, nauwkeurig micro-organismen in een watermonster te detecteren, kwantificeren en karakteriseren. Er werd onderzoek gedaan bij zeven Nederlandse waterzuiveringsstations die met conventionele processen water met een laag AOC-gehalte en zonder residueel desinfectant produceren. Daarnaast werd er ook onderzoek gedaan in de zeewaterontzoutingsinstallatie van KAUST (Saudi Arabië), waar drinkwater wordt geproduceerd door middel van membraanfiltratie en wordt gedistribueerd met residueel chloor. Tenslotte werd de biologische stabiliteit geëvalueerd in een afvalwater hergebruik toepassing in Nederland.

Wanneer water met een laag AOC gehalte, zonder desinfectant wordt gedistribueerd, zijn er geen significante tijd- en plaats-afhankelijk variaties in de

microbiologische samenstelling. De structuur van de microbiologische gemeenschap verandert na distributie, dankzij zeldzame phylotypes, die relatief vaker voorkomen in het netwerk. Een significant deel van de microbiom kwam overeen tussen het gezuiverde en getransporteerde water. Deze overeenkomst was kleiner wanneer een rest-concentratie chloor aanwezig was, waar het eukaryotisch deel veranderde met de verblijftijd. De kern microbiom werd gekarakteriseerd en verschilde tussen de twee systemen. Gemeenschappen uit de biofilm en sediment leverden de belangrijkste bijdrage aan de microbiologie uit de kraan, ongeacht de waterbron en zuiveringsproces. Netwerkspoeling bleek een effectieve methode om de water microbiologie in kaart te brengen. Biologische stabiliteit werd niet geassocieerd met veiligheid. Het biologische stabiliteit concept zou moeten worden herzien en gekwantificeerd. Nader onderzoek is nodig voor beter begrip van de microbiologische functies, hoe microbiologische watergemeenschappen het menselijke microbiom beïnvloeden en wat het "drinkwater" microbiom is in ontwikkelingslanden.

Chapter 1

Background and research questions

1.1 Water Crisis

Our planet holds 1,385 million trillion liters of water, yet 4 billion people experience severe water scarcity during at least part of the year and 1.8 billion people do not have access to safe drinking water (National Geographic, 2010; Mekonnen and Hoekstra, 2016; UNICEF/WHO, 2015). While large-scale migration and geopolitical issues topped the list of (projected) global risks of highest concern for 2016–2017, water crises and other socio-environmental issues are predicted to be the risks of highest concern for the next 10 years (Fig. 1.1) (World Economic Forum, 2016). Such risks are not autonomous but are highly correlated with other global risks (Fig. 1.2), whereby “water crises can trigger or exacerbate geopolitical and societal risks” and could in regions such as the Middle East and the Sahel put at risk 6% of GDP by 2050 (World Economic Forum, 2017; World Bank, 2016). Human population is expected to reach 9.4–10.2 billion in 2050 (UN DESA, 2017). Global water demand is estimated to rise by 55% due to increasing demands from manufacturing (400%), electricity generation (140%), domestic use (130%), and irrigation (5.5%) (especially for water-intensive food such as meat) (OECD, 2012; FAO, 2011). Furthermore, effects of climate change can include a regional decline in water availability and a deterioration in water quality (IPCC, 2014). Water security has four dimensions: physical availability, quality or safety, accessibility to services (financial and/or technical capacity), and management or governance (institutional capacity). Combining these indices reveals that very few countries have high water security (Fig. 1.3) (Gain et al., 2016). The right to water is an internationally recognized human right, integral to the right to life and dignity. The United Nations has embedded this right in its Sustainable Development Goals (Fig. 1.4), wherein Goal 6 comprises improving water quality, implementing integrated water

resources management, and achieving equitable and affordable access to drinking water for all by 2030 (UN, 2015).

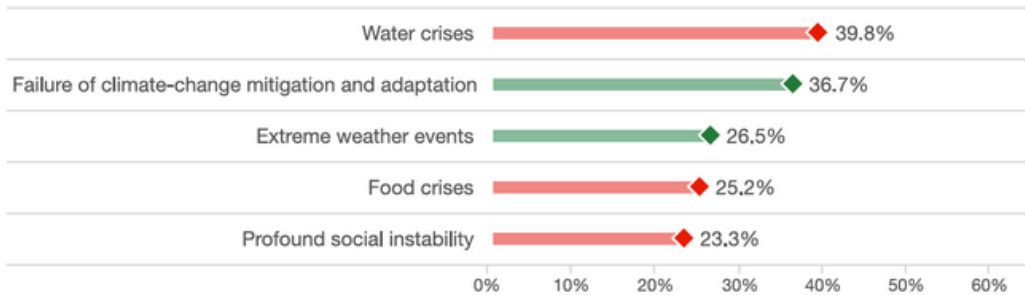

Figure 1.1. Global risks of highest concern for the next 10 years. Top 5 projected risks and percentage of (750) experts citing the respective risk to be of high concern. (red: societal risk / green: environmental risk) *Adapted from: Global Risks Perception Survey 2016, World Economic Forum*

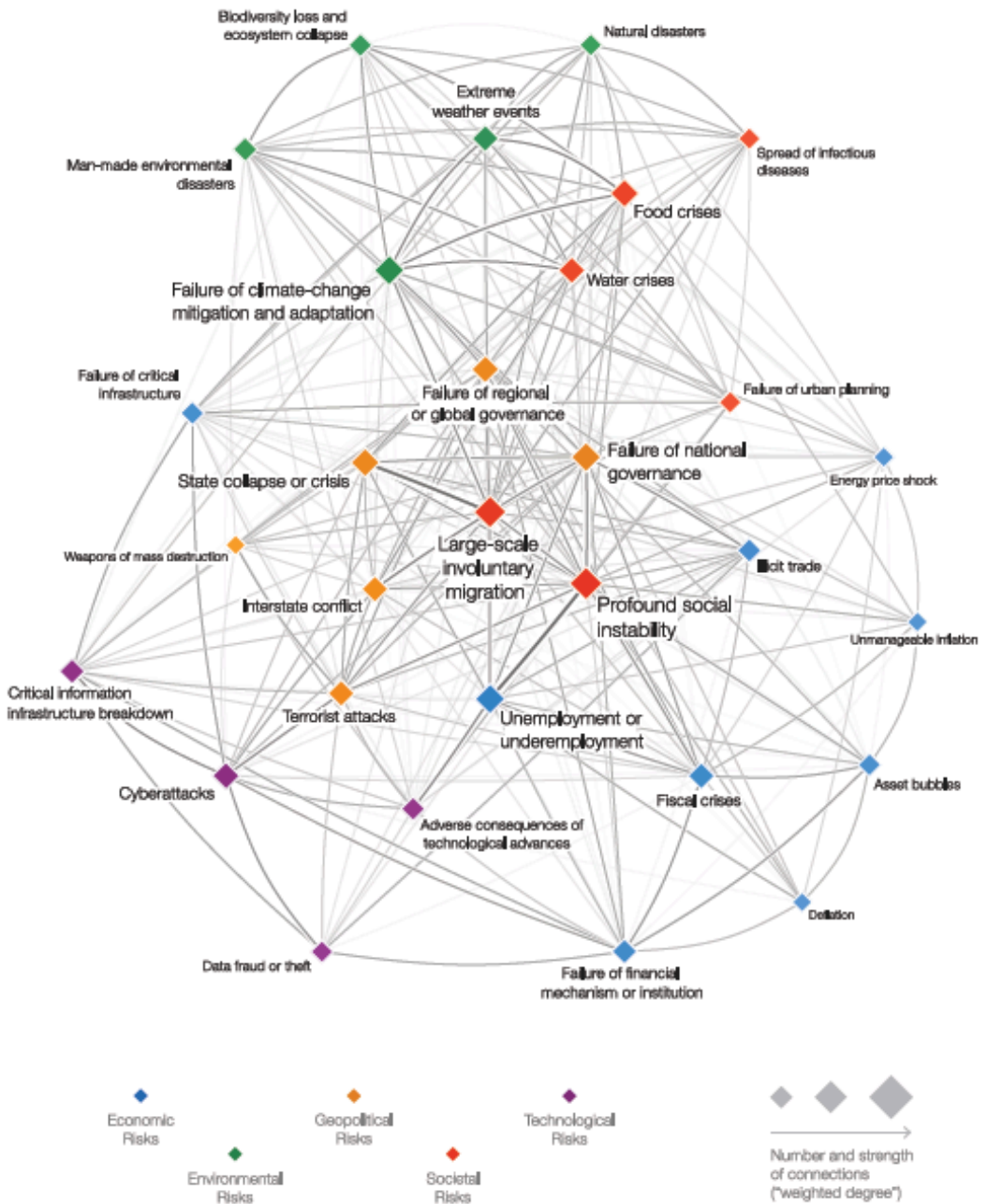

Figure 1.2. **Global risks interconnections map.** Adapted from: *Global Risks Perception Survey 2016, World Economic Forum*

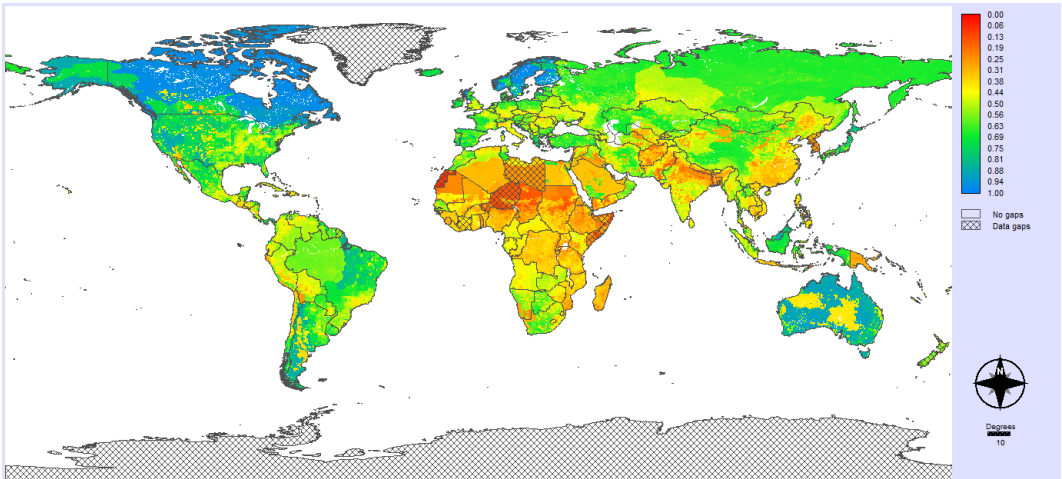

Figure 1.3. Global water security index (GWSI), calculated using the aggregation of water availability, accessibility, quality/safety, and management indices. The value '0–1' (indicated as color 'red to blue') represents 'low to high' security. The shaded areas represent regions with data gaps. Adapted from: Gain et al., 2016 (Fig.5)



Figure 1.4. United Nations 2030 Sustainable Development Goals. Adapted from: UN.org, 2015

1.2 Water Treatment

Around 97% of Earth's water is salty and less than 3% is fresh; about two-thirds of the latter is frozen- sealed in ice caps, glaciers and snow. Most people therefore obtain water from the remaining sources (<1%), mainly groundwater (aquifers) and surface water (rivers and lakes). In order to be used, the water needs to be abstracted, treated and distributed. A simplified diagram of this process is shown in Fig. 1.5. Treatment system varies with raw water source, its chemical and microbial contamination levels, country, and water quality standards. In the Netherlands ~17 million people are supplied with a total of ~1.3 billion m³ of drinking water annually produced in 250 water treatment plants (WTPs) (van Lieverloo et al., 2012). Groundwater (aerobic and anaerobic) is the primary source, followed by surface water from the rivers Meuse and Rhine. While groundwater usually undergoes de-ironing treatment only, surface water is normally pretreated, transported to the dunes, infiltrated, and then treated in a multiple barrier system. Direct surface water treatment usually involves coagulation-sedimentation, rapid sand filtration, advanced oxidation by ozone or UV, and granular activated carbon or slow sand filtration. Membrane filtration is also applied in the Netherlands. In the Arabian Gulf region on the other hand where fresh water is scarce and fossil fuel is cheap, desalination of ocean water and brackish groundwater using thermal processes took off in the 1970's. Today the desalination market has expanded worldwide (particularly in coastal areas), adopting less energy-intensive and less costly membrane-based technologies, and about 50% of total desalination investments are for seawater reverse osmosis (RO) projects (Ghaffour et al., 2013). The KAUST water treatment plant in Saudi Arabia (Thuwal, Jeddah) serving the university campus residents has a drinking water production capacity of 40,000 m³ / day. It abstracts water from the Red Sea

and entails three stages: pre-treatment, RO membrane system, and post-treatment (shown in Fig. 1.7 and described in detail in Chapter 5).

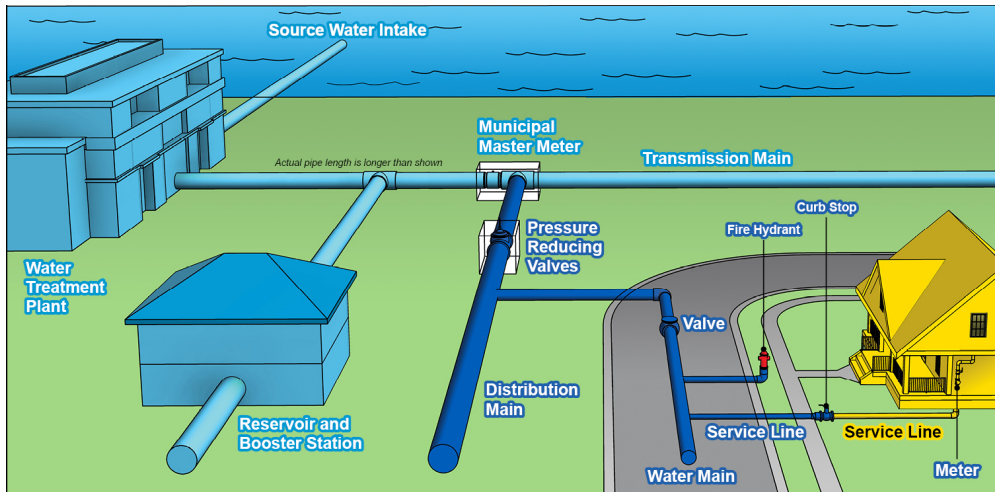

Figure 1.5. Water route from source to consumer. Adapted from: GLWA, 2017



Figure 1.6. Water treatment plant in the Netherlands.

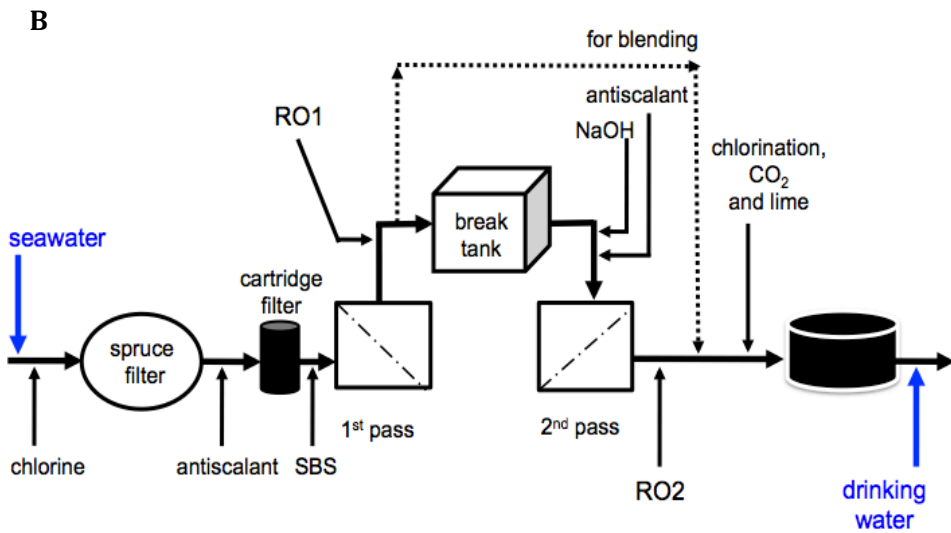

Figure 1.7. KAUST desalination plant (A) segment and (B) scheme of treatment stages. SBS: sodium bisulphite / RO1: seawater reverse osmosis permeate / RO2: brackish water reverse osmosis permeate

1.3 Water Distribution and Biological Stability

Around 43% of our world's population does not have water piped to their homes (WHO/UNICEF, 2014). The rest benefit from sanitary water delivery systems that were one of the greatest developments of the last century, terminating disease outbreaks such as cholera and typhoid. Drinking water distribution systems (DWDSs) serve as a vital network for transporting clean and safe water to the public. These systems are complex, often comprising multiple water sources that supply differently treated water. They are governed by variable environmental and operational conditions, such as temperature, oxygen, flow velocity, residence time, shearing force, hydraulic pressure, piping material / size / age etc. (Ingerson-Mahar and Reid, 2012; Torvinen et al., 2007). DWDS materials provide a large surface area for microorganisms to adhere to and grow (Langmark et al., 2005), whereby the microbial communities prevalent are influenced by the natural and hydraulic conditions to which they are exposed. Water distribution networks are actually home to hundreds or thousands of species of bacteria, archaea, viruses, fungi and invertebrates (Ingerson-Mahar and Reid, 2012; van der Wielen et al., 2009). However, most of these organisms are benign; e.g. it is estimated that completely safe drinking water contains 10^6 – 10^8 bacterial cells per liter (and this is also the case for bottled water) (Hammes et al., 2008; Lautenschlager et al., 2010). Sterile drinking water has never been the goal as microbes are ubiquitous in practically any environment (natural or human-built); moreover, “good” microbes actually may suppress pathogens (Ingerson-Mahar and Reid, 2012). Excessive microbial growth in DWDSs becomes problematic however when it causes pipe corrosion (Beech and Sunner, 2004; Lee et al., 1980), nitrification (Lipponena et al., 2002; Regan et al., 2003), aesthetic (water taste, odor, discoloration) (Hoehn, 1988; van der Kooij, 2000)

and/or health (pathogen proliferation) (Emtiazi et al., 2004; Thomas et al., 2004) concerns. Despite immense engineering improvements waterborne illnesses continue to occur today even in developed countries that employ advanced water treatment technologies. For instance in the U.S. 4–32 million cases are reported annually (Colford et al., 2006; Messner et al., 2006), and the primary cause of drinking water-associated disease outbreaks is *Legionella pneumophila* from building plumbing systems that can be inhaled during showers causing Legionnaires' disease (Beer et al., 2015). Hazardous events involving the source water (e.g. severe rain or drought), during treatment (e.g. equipment failure, operational or human error), and during distribution (e.g. faulty cross-connections, leaks or breaks, pressure loss) can lead to chemical contamination or excessive microbial growth (Smeets et al., 2009). Frequently, the exact cause of microbial growth in DWDSs is unknown and control measures are difficult to set due to the “infinite number of interactions between microorganisms, mostly with unknown physiological properties, and undefined environmental conditions, e.g. in microniches” (van der Kooij and van der Wielen, 2013). Bacteria in DWDSs grow in different microenvironments: the bulk water, biofilm attached to the inner pipe surface, loose deposits accumulated at the bottom of the pipe, and suspended solids transported through the mains (Liu et al., 2013). These four phases are dynamic and interchangeable under certain conditions (Fig. 1.9).



Figure 1.8. **Biofilm and deposits in a water pipe.** Adapted from: WaterCareer, 2015

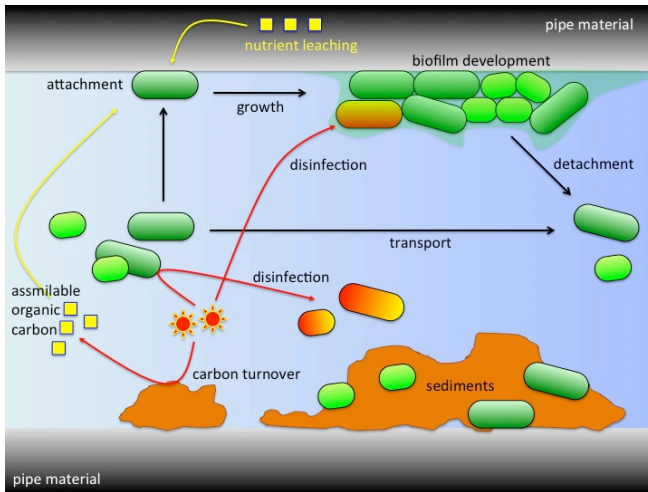

Figure 1.9. Microbial ecology of a water distribution pipe. By: Frederik Hammes

The World Health Organization drinking water guidelines state that “Water entering the distribution system must be microbiologically safe and ideally should also be biologically stable” (WHO, 2006). Biological stability generally denotes insignificant microbial growth during distribution (Rittmann and Snoeyink, 1984), or the delivery of water to the consumer of the same microbial quality as the water leaving the treatment plant. To deliver biologically stable water to end users, water utilities normally apply a final oxidative disinfection step (primarily chlorination) and maintain a sufficient disinfectant residual in the network to suppress microbial growth (LeChevallier et al., 1993). Different concentrations (0.05–5 mg/L) and types of disinfectants (e.g. chlorine, chlorine dioxide, monochloramine) can be dosed. This is the strategy adopted in countries such as the U.S., Canada, Australia, France and Saudi Arabia. In KAUST’s 60 km polyvinyl chloride (PVC) distribution network a chlorine residual is maintained at a concentration of 0.5–1 mg/L. Chlorine however has many drawbacks. It can instigate customer complaints concerning taste and odor and has been linked with harmful by-products such as trihalomethanes (Rook,

1976), and some disinfection by-products have been associated with cancer (Hrudey and Charrois, 2012; King and Marrett, 1996; Panyakapo et al., 2008) and congenital health issues (Nieuwenhuijsen et al., 2009). Chlorine can mask the presence of indicator organisms key for evaluating contamination, and it can inhibit certain microorganisms while selecting for opportunistic pathogens that are relatively chlorine-resistant such as *Mycobacterium avium* (Ingerson-Mahar and Reid, 2012). Moreover, disinfectant residuals can react with particles, organics and pipe material releasing assimilable organic carbon (AOC) that can be consumed by microorganisms, causing growth (Polanska et al., 2005; Ramseier et al., 2011). Consequently, some European countries such as the Netherlands, Germany, Switzerland, Sweden and Austria do not use chlorine and apply instead the “starvation and not suppression” approach (Smeets et al., 2009). That is, high-quality water is distributed after limiting organic carbon and other growth-supporting nutrients during treatment (van der Kooij, 2000) and this is often carried out by innocuous microbial communities colonizing biological filters. In the Netherlands microbial safety standards are high set to 10^{-4} risk of infection per person per year, and stringent protocols are followed for the construction, maintenance and repair of DWDSs. The country’s 100,000 km mains are made of diverse materials (40% PVC, 36% asbestos cement, 14% cast iron, 2.5% polyethylene...) (Smeets et al., 2009) and leakage rates are amongst the lowest in the world ($1.6 \text{ m}^3/\text{km}/\text{day}$) (OFWAT, 2008).

1.4 Microbiological Techniques

Qualitative and quantitative knowledge of the microbial communities indigenous to drinking water is essential for treatment / distribution process

control, risk assessment and infrastructure design. Drinking water microbiology is a conventional field though and most water utilities and analytical laboratories still apply the culture-dependent methods and guidelines proposed by Robert Koch 130 years ago. These involve (i) the detection of index organisms such as *Escherichia coli*, indicating fecal contamination and (ii) the counting of colony-forming microbes growing on a nutrient agar plate (heterotrophic plate counts or HPCs), describing the general microbial quality of a water sample (Koch, 1893; Frankland, 1896). Other guidelines are also available for evaluating biological stability, linked to conventional parameters such as AOC, biodegradable dissolved organic carbon (BDOC), and biofilm formation rate (BFR) (van der Kooij et al., 1982; Servais et al., 1989; van der Kooij, 1995). All these methods are mostly indicative however, time-consuming and labor-intensive. They only describe a limited, specific fraction (~0.25%) of the microorganisms found in water samples (Maki et al., 1986; Amann et al., 1995; Siebel et al., 2008, Egli and Kotzsch, 2014), and are therefore inaccurate. Culture-dependent methods do not effectively measure or characterize microbial populations or activity (Douterelo et al., 2014; Riesenfeld et al., 2004; van der Wielen and van der Kooij, 2010).

Numerous culture-independent methods have been developed and used to detect and quantify water microorganisms, each with its own pros and cons (Douterelo et al., 2014). These techniques include epifluorescence microscopy, fluorescent in situ hybridization (FISH), quantitative and multiplex polymerase chain reaction (PCR), phospholipid fatty acids (PLFAs) technique, and flow cytometry (FCM). The latter is a rapid, sensitive and accurate enumeration technique initially employed in the medical field and its working principle is briefly explained in Fig. 1.10. On the other hand, various molecular techniques based on the extraction of nucleic acids have enabled a comprehensive characterization of microbial communities and a deeper understanding of water

microbial ecology. The extraction is followed by PCR amplification of marker genes, usually ribosomal RNA- 16S rRNA for prokaryotes and 18S rRNA for eukaryotes. The entire genome can also be studied (metagenomic approach). Once primers are selected the resulting PCR products or amplicons can be separated and analyzed using different techniques: (i) genetic fingerprinting tools such as denaturing gradient gel electrophoresis (DGGE), temperature gradient gel electrophoresis (TGGE), terminal restriction fragment length polymorphism (T-RFLP), and amplified ribosomal DNA restriction analysis (ARDRA); (ii) sequencing-based tools such as cloning and Sanger sequencing, shot-gun sequencing, and high-throughput sequencing (HTS). The main drawback of fingerprinting techniques is they can only assess changes in the dominant microorganisms (Forney et al., 2004). High-throughput sequencing platforms (Roche 454, Illumina/Solexa, Ion Torrent, Single Molecule etc.) have a better sequencing depth than first-generation sequencers and can characterize dominant as well as less abundant microbes (Metzker, 2010). They are faster and less expensive than traditional sequencing and allow a large number of samples (1500+) to be combined in a single run (Hamady et al., 2008). 454 pyrosequencing is a four-enzyme DNA sequencing technology that monitors in real-time the DNA synthesis detected by bioluminescence (Melamide, 1985; Ronaghi et al., 1998) (Fig. 1.11 and 1.12). It provides data on microbial community composition (identity), structure (proportion) and diversity, often down to the species level. During the last decade HTS such as pyrosequencing has revolutionized the microbial ecology field, delineating the microbiome of oceans, soils, animal and human bodies, and the detection of pathogens in clinical and environmental samples (Aw and Rose, 2012).

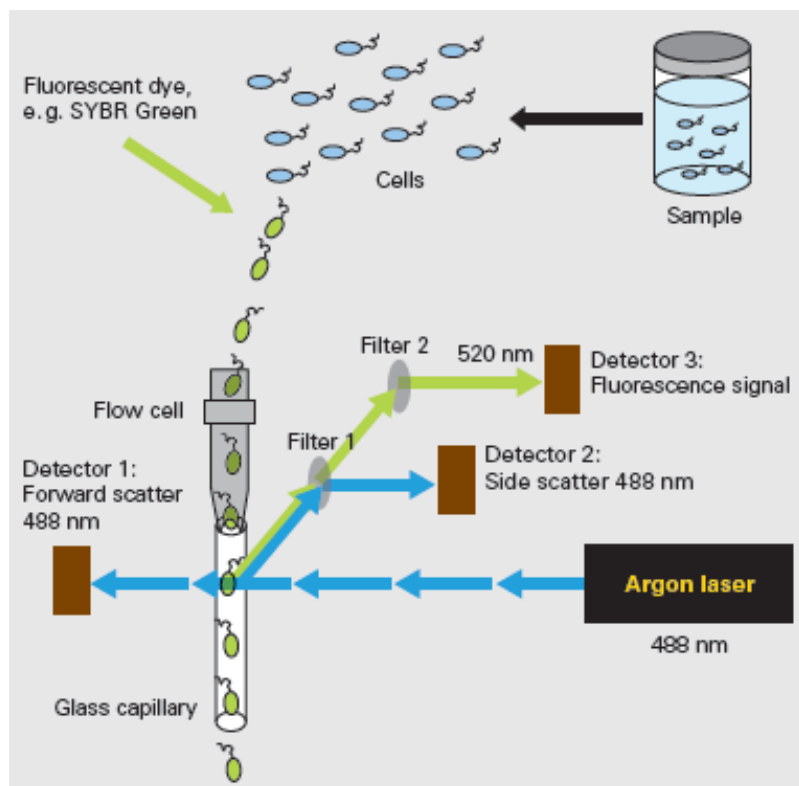

Figure 1.10. Flow cytometry principle. A beam of light from a laser is passed through a stream of microorganisms in water flowing in a single line through a glass capillary. When the beam strikes a cell, part of the radiation is scattered and – redirected by lens, mirror and filter systems – picked up by a light detector. 1000–100,000 particles per second can be counted. The cells can also be stained with fluorescent dyes which bind to nucleic acids, proteins or cell surface structures, allowing a distinction between intact and damaged cells. Determining total cell count and the “fingerprint” of a water sample takes a few minutes. *Adapted from: Eawag News 65e/Dec. 2008 (p.21)*

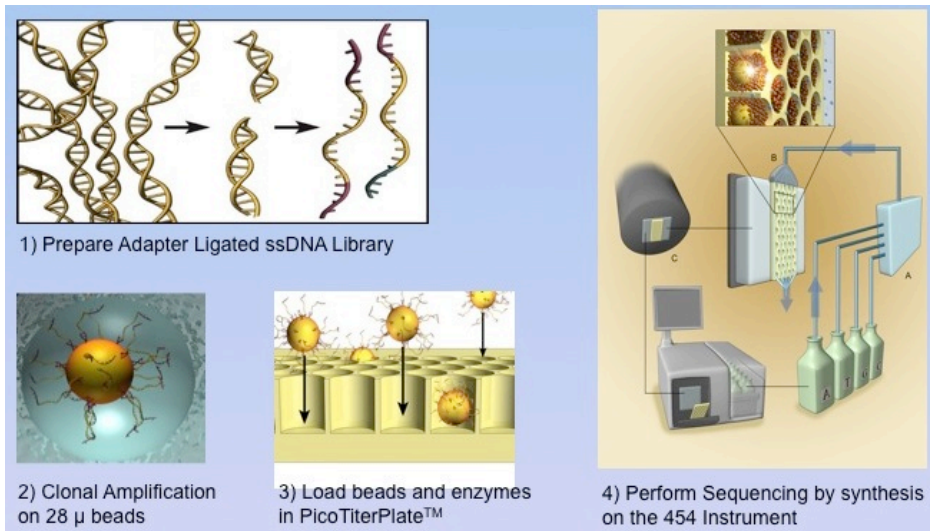

Figure 1.11. Pyrosequencing procedure. Adapted from: PennState website

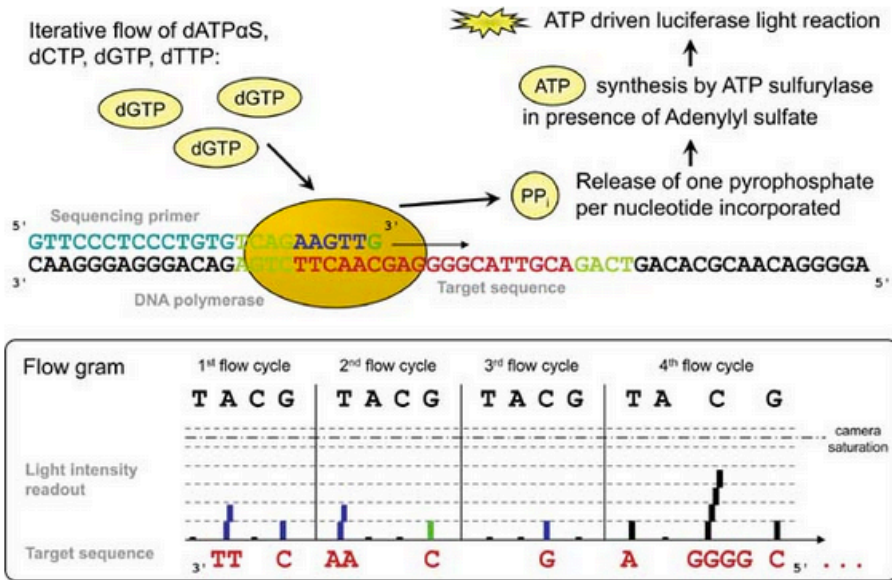

Figure 1.12. Pyrosequencing process. "One of four nucleotides is washed sequentially over copies of the sequence to be determined, causing polymerases to incorporate complementary nucleotides. The incorporation stops if the longest possible stretch of the available nucleotide has been synthesized. In the process of incorporation, one pyrophosphate per nucleotide is released and converted to ATP by an ATP sulfurylase. The ATP drives the light reaction of luciferases present and a light signal proportional (within limits) to the number of nucleotide incorporations can be measured." *Adapted from: Kircher and Kelso, 2010 (Fig.2)*

1.5 Research Questions

Research on the drinking water microbiome using high-throughput sequencing methods is relatively nascent. At the start of this PhD program, two papers only had been published on water microbial communities applying 454 pyrosequencing (which was commercialized in 2005). These studies characterized the bacterial communities found in biofilms of two water meters (Hong et al., 2010) and membrane filtration systems (Kwon et al., 2011), although the latter was from a pilot-scale WTP. Moreover, studies utilizing flow cytometry involved total and intact cell counting while fluorescence fingerprints had not been used for characterizing drinking water microbial communities (Hoefel et al., 2005; Berney et al., 2008; Hammes et al., 2008). Studies that had been conducted using other culture-independent methods e.g. genetic fingerprinting focused on the biofilm compartment, its development, the influence of disinfection mode, and the isolation of pathogenic strains (Falkinham et al., 2001; Martiny et al., 2003; Emtiazi et al., 2004; Servais et al., 2004; Codony et al., 2005; Gagnon et al., 2005; Lee et al., 2005). It was mainly recognized that *Proteobacteria* and other Gram-negative bacteria are the dominant members of DWDSs (Williams et al., 2004; Tokajian et al., 2005; Keinanen-Toivola et al., 2006; Hong et al., 2010; Revetta et al., 2010). The research however was still very limited and most studies were conducted in model or pilot-scale systems. HTS studies on full-scale DWDSs were needed in order to gain insight into microbial processes in networks and to answer some of the critical questions raised by water utilities and public health agencies.

This dissertation tackles the following research questions:

- Is there a method that can be applied to accurately detect, characterize, and enumerate the microorganisms found in a water sample?
- Do drinking water microbial communities change with time?
- Do drinking water microbial communities change during distribution, at different locations in the network (different residence time)?
- Do drinking water microbial communities change during network flushing (cleaning procedure)?
- Is there a baseline drinking water microbial community? Which microorganisms are stable and which ones are transient?
- Are the bacterial communities found in drinking water produced from fresh water applying conventional treatment different from those in drinking water produced from seawater applying membrane filtration treatment?
- How do eukaryotic communities vary from source to tap?
- How does reverse osmosis membrane treatment influence microbial communities?
- What is the impact of disinfectant residual on microbial growth or biological stability?
- Is biological stability during distribution critical and can it be attained?
- What are the most important factors that determine the final tap water microbial quality?

1.6 Dissertation Outline

The dissertation structure is shown in Fig. 1.13. (Except for the Introduction and Outlook chapters), the dissertation is arranged as a succession of science articles published in scientific, peer-reviewed journals.

In Chapter 2 the methodology applied in most of the PhD research is introduced and developed combining two culture-independent techniques: 16S rRNA gene pyrosequencing and flow cytometry. The method is tested on 52 samples collected from a full-scale DWDS in the Netherlands and compared with culture-dependent tools. This research was conducted in collaboration with Emmanuelle Prest, a former PhD candidate at TU Delft.

Chapters 3 and 4 involve full-scale studies that were conducted in Dutch DWDSs which transport water without disinfectant residuals, produced from fresh water applying conventional treatment strategies. In Chapter 3 bacterial dynamics are examined by analyzing 156 samples collected over short time-scales (minutes/hours/days) and across two locations (WTP outlet and corresponding network location). The persistent and transient bacterial phylotypes are studied. (This research was conducted in collaboration with Emmanuelle Prest.) In Chapter 4 the presence of a core drinking water microbiome is investigated by analyzing 56 samples collected from 7 distinct DWDSs. The effects of network flushing and distribution distance on the water microbiology are also studied.

Chapters 5 and 6 concern full-scale studies that were conducted at the KAUST desalination plant and DWDS which transports water with chlorine residual, produced from seawater applying relatively novel membrane treatment. In Chapter 5 the bacterial communities at all treatment stages of the RO-based plant are characterized and compared. The efficacy of chlorine is also evaluated. In Chapter 6 the eukaryotic communities from source to tap are characterized and compared using 18S rRNA gene pyrosequencing. The research pertaining to these chapters was conducted in collaboration with Abdelaziz Belila, a former postdoctoral researcher at KAUST.

In Chapter 7 biological stability is evaluated applying various techniques (including pyrosequencing and flow cytometry) in a wastewater reuse application in the Netherlands. A full-scale wastewater membrane bioreactor (MBR) effluent is disinfected with monochloramine and monitored during transport over a 13 km pipe to a full-scale RO plant. The effectiveness of monochloramine in biofouling control is also assessed in lab-scale membrane fouling simulator experiments and pilot-scale membrane module experiments. This study involved a large number of researchers and I was responsible for the pyrosequencing lab work and data analysis.

In Chapter 8 the main conclusions of the dissertation are summarized and research opportunities are proposed.



Figure 1.13. **Dissertation structure.** Note: The chapter headings do not fully reflect the themes covered in each chapter.

Bibliography

Amann, R.I., Ludwig, W., Schleifer, K.H., 1995. Phylogenetic identification and in situ detection of individual microbial cells without cultivation. *Microbiol. Rev.* 59 (1), 143-169.

Aw, T.G., Rose, J.B., 2012. Detection of pathogens in water: From phylochips to qPCR to pyrosequencing. *Curr. Opin. Biotech.* 23 (3), 422-430.

Beech, I.B., Sunner, J., 2004. Biocorrosion: Towards understanding interactions between biofilms and metals. *Curr. Opin. Biotechnol.* 15 (3), 181-186.

Beer, K.D., Gargano, J.W., Roberts, V.A., Hill, V.R., Garrison, L.E., Kutty, P.K., et al., 2015. Surveillance for waterborne disease outbreaks associated with drinking water- United States, 2011-2012. *CDC Morb. Mortal. Wkly. Rep.* 64, 842-848.

Berney, M., Vital, M., Hülshoff, I., Weilenmann, H.U., Egli, T., Hammes, F., 2008. Rapid, cultivation-independent assessment of microbial viability in drinking water. *Water Res.* 42 (14), 4010-4018.

Codony, F., Morato, J., Mas, J., 2005. Role of discontinuous chlorination on microbial production by drinking water biofilms. *Water Res.* 39 (9), 1896-1906.

Colford, J.M., Roy, S., Beach, M.J., Hightower, A., Shaw, S.E., Wade, T.J., 2006. A review of household drinking water intervention trials and an approach to the estimation of endemic waterborne gastroenteritis in the United States. *J. Water Health* 4 (Suppl. 2), 71-88.

Douterelo, I., Boxall, J.B., Deines, P., Sekar, R., Fish, K.E., Biggs, C.A., 2014. Methodological approaches for studying the microbial ecology of drinking water distribution systems. *Water Res.* 65, 134-156.

Egli, T., Kotzsch, S., 2014. Rapid and robust: a new future of cytometry-based microbial analysis. *Water21*, April 2014, page 42.

Emtiazi, F., Schwartz, T., Marten, S.M., Krolla-Sidenstein, P., Obst, U., 2004. Investigation of natural biofilms formed during the production of drinking water from surface water embankment filtration. *Water Res.* 38 (5), 1197-1206.

Falkinham, J.O., Norton, C.D., LeChevallier, M.W., 2001. Factors influencing numbers of *Mycobacterium avium*, *Mycobacterium intracellulare*, and other *Mycobacteria* in drinking water distribution systems. *Appl. Environ. Microbiol.* 67 (3), 1225–1231.

FAO, 2011. *The State of the World's Land and Water Resources for Food and Agriculture: Managing Systems of Risk*. Food and Agriculture Organization of the United Nations, London / Rome.

Forney, L.J., Zhou, X., Brown, C.J., 2004. Molecular microbial ecology: land of the one-eyed king. *Curr. Opin. Microbiol.* 7 (3), 210–220.

Frankland, P.F., 1896. Koch's gelatine process for the examination of drinking water. *Nature* (54) 52.

Gagnon, G.A., Rand, J.L., O'Leary, K.C., Rygel, A.C., Chauret, C., Andrews, R.C., 2005. Disinfectant efficacy of chlorite and chlorine dioxide in drinking water biofilms. *Water Res.* 39 (9), 1809–1817.

Gain, A.K., Giupponi, C., Wada, Y., 2016. Measuring global water security towards sustainable development goals. *Environ. Res. Lett.* 11 (12), 124015.

Ghaffour, N., Missimer, T.M., Amy, G.L., 2013. Technical review and evaluation of the economics of water desalination: Current and future challenges for better water supply sustainability. *Desal.* 309, 197–207.

GLWA, 2017. Great Lakes Water Authority, Orion Township. <http://oriontownship.org/Departments/PublicServices.aspx>

Hamady, M., Walker, J.J., Harris, J.K., Gold, N.J., Knight, R., 2008. Error-correcting barcoded primers for pyrosequencing hundreds of samples in multiplex. *Nat. Methods* 5 (3), 235–237.

Hammes, F., Berney, M., Wang, Y., Vital, M., Koster, O., Egli, T., 2008. Flow-cytometric total bacterial cell counts as a descriptive microbiological parameter for drinking water treatment processes. *Water Res.* 42 (1–2), 269–277.

Hoefel, D., Monis, P.T., Grooby, W.L., Andrews, S., Saint, C.P., 2005. Profiling bacterial survival through a water treatment process and subsequent distribution system. *J. Appl. Microbiol.* 99 (1), 175–186.

Hoehn, R.C., 1988. Biological causes of tastes and odors in drinking water supplies. *Water Qual. Bull.* 13, 46–52.

Hong, P.Y., Hwang, C., Ling, F., Andersen, G.L., LeChevallier, M.W., Liu, W.T., 2010. Pyrosequencing analysis of bacterial biofilm communities in water meters of a drinking water distribution system. *Appl. Environ. Microbiol.* 76 (16), 5631–5635.

Hrudey, S.E., Charrois, J.W.A., 2012. *Disinfection by-products and human health.* IWA Publishing, London, UK.

Ingerson-Mahar, M., Reid, A., 2012. *MIP: The Microbiology of the Water Distribution System.* American Academy of Microbiology, Boulder, CO.

IPCC, 2014. *Climate Change 2014: Impacts, Adaptation and Vulnerability- Part A: Global and Sectoral Aspects.* Intergovernmental Panel on Climate Change, Cambridge / New York.

Keinänen-Toivola, M.M., Revetta, R.P., Santo Domingo, J.W., 2006. Identification of active bacterial communities in a model drinking water biofilm system using 16S rRNA-based clone libraries. *FEMS Microbiol. Lett.* 257 (2), 182–188.

King, W.D., Marrett, L.D., 1996. Case-control study of bladder cancer and chlorination by-products in treated water (Ontario, Canada). *Cancer Causes Control*, 7 (6), 596–604.

Kircher, M., Kelso, J., 2010. High-throughput DNA sequencing- concepts and limitations. *Bioessays*, 32 (6), 524–536.

Koch, R., 1893. Wasserfiltration und Cholera. *Zeitschrift für Hygiene und Infektionskrankheiten* (14), 393–426.

Kwon, S., Moon, E., Kim, T.S., Hong, S., Park, H.D., 2011. Pyrosequencing demonstrated complex microbial communities in a membrane filtration system for a drinking water treatment plant. *Microbes Environ.* 26 (2), 149–155.

Långmark, J., Storey, M.V., Ashbolt, N.J., Stenström, T.A., 2005. Biofilms in an urban water distribution system: measurement of biofilm biomass, pathogens and pathogen persistence within the Greater Stockholm area, Sweden. *Water Sci. Technol.* 52 (8), 181–189.

Lautenschlager, K., Boon, N., Wang, Y., Egli, T., Hammes, F., 2010. Overnight stagnation of drinking water in household taps induces microbial growth and changes in community composition. *Water Res.* 44 (17), 4868–4877.

LeChevallier, M.W., Shaw, N.E., Kaplan, L.A., Bott, T.L., 1993. Development of a rapid assimilable organic carbon method for water. *Appl. Environ. Microbiol.* 59 (5), 1526–1531.

Lee, S.H., O’Conner, J.T., Park, S.J., 1980. Biologically mediated corrosion and its effects on water quality in distribution systems. *J. Am. Water Works Assoc.* 72 (11), 636–645.

Lee, D.-G., Lee, J.-H., Kim, S.-J., 2005. Diversity and dynamics of bacterial species in a biofilm at the end of the Seoul water distribution system. *World J. Microbiol. Biotechnol.* 21 (2), 155–162.

Lipponen, M.T., Suutari, M.H., Martikainen, P.J., 2002. Occurrence of nitrifying bacteria and nitrification in Finnish drinking water distribution systems. *Water Res.* 36 (17), 4319–4329.

Liu, G., Verberk, J.Q., van Dijk, J.C., 2013. Bacteriology of drinking water distribution systems: an integral and multidimensional review. *Appl. Microbiol. Biotechnol.* 97 (21), 9265–9276.

Maki, J.S., LaCroix, S.J., Hopkins, B.S., Staley, J.T., 1986. Recovery and diversity of heterotrophic bacteria from chlorinated drinking waters. *Appl. Environ. Microbiol.* 51 (5), 1047–1055.

Martiny, A.C., Jorgensen, T.M., Albrechtsen, H.-J., Arvin, E., Molin, S., 2003. Long-term succession of structure and diversity of a biofilm formed in a model drinking water distribution system. *Appl. Environ. Microbiol.* 69 (11), 6899–6907.

Mekonnen, M.M., Hoekstra, A.Y., 2016. Four billion people facing severe water scarcity. *Sci. Adv.* 2 (2), e1500323.

Melamede, R.J., 1985. Automatable process for sequencing nucleotide. U. S. Patent 4863849.

Messner, M., Shaw, S., Regli, S., Rotert, K., Blank, V., Soller, J., 2006. An approach for developing a national estimate of waterborne disease due to drinking water and a national estimate model application. *J. Water Health* 4(Suppl. 2), 201–240.

Metzker, M.L., 2010. Sequencing technologies- the next generation. *Nat. Rev. Genet.* 11 (1), 31-46.

National Geographic, April 2010. Water: Our Thirsty World. Special Issue. 217 (4).

Nieuwenhuisen, M.J., Grellier, J., Smith, R., Iszatt, N., Bennett, J., Best, N., Toledano, M., 2009. The epidemiology and possible mechanisms of disinfection by-products in drinking water. *Philosophical transactions of the Royal Society A: mathematical, physical and engineering sciences*, 367 (1904), 4043-4076.

OECD, 2012. OECD Environmental Outlook to 2050: The Consequences of Inaction. Organization for Economic Cooperation and Development, Paris, France.

OFWAT, 2008. International comparison of water and sewerage service report. Water Services Regulation Authority, Birmingham, UK.

Panyakapo, M., Soontornchai, S., Paopuree, P., 2008. Cancer risk assessment from exposure to trihalomethanes in tap water and swimming pool water. *J. Environ. Sci. (China)*, 20 (3), 372-378.

PennState, 2017. Mammoth Genome Project. Pennsylvania State University. <http://mammoth.psu.edu/howToSeqMammoth.html>

Polanska, M., Huysman, K., van Keer, C., 2005. Investigation of assimilable organic carbon (AOC) in flemish drinking water. *Water Res.* 39 (11), 2259-2266.

Ramseier, M.K., Peter, A., Traber, J., von Gunten, U., 2011. Formation of assimilable organic carbon during oxidation of natural waters with ozone, chlorine dioxide, chlorine, permanganate, and ferrate. *Water Res.* 45 (5), 2002-2010.

Regan, J.M., Harrington, G.W., Baribeau, H., De Leon, R., Noguera, D. R., 2003. Diversity of nitrifying bacteria in full-scale chloraminated distribution systems. *Water Res.* 37 (1), 197-205.

Revetta, R.P., Pemberton, A., Lamendella, R., Iker, B., Santo Domingo, J.W., 2010. Identification of bacterial populations in drinking water using 16S rRNA-based sequence analyses. *Water Res.* 44 (5), 1353-1360.

- Riesenfeld, C.S., Schloss, P.D., Handelsman, J., 2004. Metagenomics: genomic analysis of microbial communities. *Annu. Rev. Genet.* 38, 525–552.
- Rittmann, B.E., Snoeyink, V.L., 1984. Achieving biologically stable drinking water. *J. Am. Water Works Assoc.* 76 (10), 106–114.
- Ronaghi, M., Uhlen, M., Nyren, P., 1998. A sequencing method based on real-time pyrophosphate. *Science* 281, 363–365.
- Rook, J.J., 1976. Haloforms in drinking-water. *J. Am. Water Works Assoc.* 68 (3), 168–172.
- Servais, P., Anzil, A., Ventresque, C., 1989. Simple method for determination of biodegradable dissolved organic carbon in water. *Appl. Environ. Microbiol.* 55 (10), 2732–2734.
- Servais, P., Anzil, A., Gatel, D., Cavard, J., 2004. Biofilms in the Parisian suburbs drinking water distribution system. *J. Water SRT-Aqua*, 53 (5), 313–324.
- Siebel, E., Wang, Y., Egli, T., Hammes, F., 2008. Correlations between total cell concentration, total adenosine tri-phosphate concentration and heterotrophic plate counts during microbial monitoring of drinking water. *Drink. Water Eng. Sci.* 1, 71–86.
- Smeets, P.W.M.H., Medema, G.J., van Dijk, J.C., 2009. The Dutch secret: how to provide safe drinking water without chlorine in the Netherlands. *Drink. Water Eng. Sci.* 2, 1–14.
- Thomas, V., Bouchez, T., Nicolas, V., Robert, S., Loret, J.F., Levi, Y., 2004. Amoebae in domestic water systems: resistance to disinfection treatments and implication in *Legionella* persistence. *J. Appl. Microbiol.* 97 (5), 950–963.
- Tokajian, S.T.H., Fuad, A., Hancock, I.C., Zalloua, P.A., 2005. Phylogenetic assessment of heterotrophic bacteria from a water distribution system using 16S rDNA sequencing. *Can. J. Microbiol.* 51, 325–335.
- Torvinen, E., Lehtola, M.J., Martikainen, P.J., Miettinen, I.T., 2007. Survival of *Mycobacterium avium* in drinking water biofilms as affected by water flow velocity, availability of phosphorus, and temperature. *Appl. Environ. Microbiol.* 73 (19), 6201–6207.

UN, 2015. Sustainable Development Goals. United Nations. <https://www.un.org/sustainabledevelopment/water-and-sanitation/>

UN DESA, 2017. World Population Prospects: The 2017 Revision. United Nations Department of Economic and Social Affairs, New York.

UNICEF/WHO, 2015. Progress on Sanitation and Drinking Water: 2015 Update and MDG Assessment. United Nations Children's Fund / World Health Organization, New York / Geneva.

van der Kooij, D., Visser, A., Hijnen, W.A.M., 1982. Determining the concentration of easily assimilable organic carbon in drinking water. *J. Am. Water Works Assoc.* 74 (10), 540-545.

van der Kooij, D., Vrouwenvelder, J.S., Veenendaal, H.R., 1995. Kinetic aspects of biofilm formation on surfaces exposed to drinking water. *Water Sci. Technol.* 32 (8), 61-65.

van der Kooij, D., 2000. Biological stability: a multidimensional quality aspect of treated water. *Water Air Soil Pollut.* 123 (1-4), 25-34.

van der Kooij, D., van der Wielen, P.W., 2013. Microbial growth in drinking water supplies: a continuing challenge. *Water* 21, Dec. 2013, page 18.

van der Wielen, P.W.J.J., Voost, S., van der Kooij, D., 2009. Ammonia-oxidizing bacteria and archaea in groundwater treatment and drinking water distribution systems. *Appl. Environ. Microbiol.* 75 (14), 4687- 4695.

van der Wielen, P.W., van der Kooij, D., 2010. Effect of water composition, distance and season on the adenosine triphosphate concentration in unchlorinated drinking water in the Netherlands. *Water Res.* 44 (17), 4860-4867.

van Lieverloo, J.H., Hoogenboezem, W., Veenendaal, G., van der Kooij, D., 2012. Variability of invertebrate abundance in drinking water distribution systems in the Netherlands in relation to biostability and sediment volumes. *Water Res.* 46 (16), 4918-4932.

WaterCareer, 2015. Corrosion wears hard on industry. Australia. <http://www.watercareer.com.au/archived-news/corrosion-wears-hard-on-industry>

WHO, 2006. Guidelines for Drinking-water Quality: Incorporating first addendum to third edition. Vol 1: Recommendations. World Health Organization, Geneva, Switzerland.

WHO/UNICEF, 2014. Progress on Drinking Water and Sanitation: 2014 Update. World Health Organization / United Nations Children's Fund, Geneva / New York.

Williams, M.M., Domingo, J.W., Meckes, M.C., Kelty, C.A., Rochon, H.S., 2004. Phylogenetic diversity of drinking water bacteria in a distribution system simulator. *J. Appl. Microbiol.* 96 (5), 954–964.

World Bank, 2016. High and Dry: Climate Change, Water, and the Economy. Washington, D.C.

World Economic Forum, 2016. The Global Risks Report 2016. Geneva, Switzerland.

World Economic Forum, 2017. The Global Risks Report 2017. Geneva, Switzerland.

Chapter 2

Methodology

Flow cytometry and 16S rRNA gene pyrosequencing for drinking water bacterial analysis

This chapter has been published as: Prest, E.I., El-Chakhtoura, J., Hammes, F., Saikaly, P.E., van Loosdrecht, M.C.M., Vrouwenvelder, J.S., 2014. Combining flow cytometry and 16S rRNA gene pyrosequencing: a promising approach for drinking water monitoring and characterization. *Water Research* 63, 179-189.

Abstract

The combination of flow cytometry (FCM) and 16S rRNA gene pyrosequencing data was investigated for the purpose of monitoring and characterizing microbial changes in drinking water distribution systems. High frequency sampling (5 min intervals for 1 h) was performed at the outlet of a treatment plant and at one location in the full-scale distribution network. In total, 52 bulk water samples were analysed with FCM, pyrosequencing and conventional methods (adenosine triphosphate, ATP; heterotrophic plate count, HPC). FCM and pyrosequencing results individually showed that changes in the microbial community occurred in the water distribution system, which was not detected with conventional monitoring. FCM data showed an increase in the total bacterial cell concentrations (from $345 \pm 15 \times 10^3$ to $425 \pm 35 \times 10^3$ cells mL⁻¹) and in the percentage of intact bacterial cells (from 39 ± 3.5 % to 53 ± 4.4 %) during water distribution. This shift was also observed in the FCM fluorescence fingerprints, which are characteristic of each water sample. A similar shift was detected in the microbial community composition as characterized with pyrosequencing, showing that FCM and genetic fingerprints are congruent. FCM and pyrosequencing data were subsequently combined for the calculation of cell concentration changes for each bacterial phylum. The results revealed an increase in cell concentrations of specific bacterial phyla (e.g. *Proteobacteria*), along with a decrease in other phyla (e.g. *Actinobacteria*), which could not be concluded from the two methods individually. The combination of FCM and pyrosequencing methods is a promising approach for future drinking water quality monitoring and for advanced studies on drinking water distribution pipeline ecology.

2.1 Introduction

Drinking water should be biologically stable in order to limit unwanted bacterial growth within distribution systems. Bacterial growth can cause operational problems such as pipeline bio-corrosion or fouling, resulting in maintenance issues and customer complaints, and in the worst case hygiene-related problems. It is therefore important to rapidly identify distribution system areas with bacterial growth issues in order to undertake early maintenance actions. However, the occurrence of such situations may also require long-term improvement of the distribution conditions and maintenance strategies, which can only be achieved with an in-depth understanding of microbial dynamics in distribution pipelines. There is therefore a need for rapid, sensitive and accurate tools for microbial monitoring but also a need for quantitative and qualitative tools for detailed characterization of microbial communities in water samples.

The value of flow cytometry (FCM) for assessment and monitoring of total and intact bacterial cell concentrations during drinking water treatment and distribution has been highlighted before (Hoefel et al., 2003; Hammes et al., 2008, 2010a; Ho et al., 2012; Lautenschlager et al., 2013; Liu et al., 2013c). The method is easy and rapid, with results obtained in 15 min from sampling. Moreover, FCM is quantitative, highly reproducible (less than 5% error) and sensitive (detection of change down to 3% from initial value) (Prest et al., 2013). In addition, correctly performed FCM measurements also generate so-called fluorescence fingerprints (De Roy et al., 2012; Koch et al., 2013c), which are unique to each sample and apparently dependent on the bacterial community composition and DNA content (De Roy et al., 2012; Vila-Costa et al., 2012; Koch et al., 2013a, 2013c; Müller, 2010). FCM fingerprints thus provide information on the bacterial

community characteristics that is not obtained with FCM cell counting alone. The combination of FCM cell counting and fluorescence fingerprinting can have value for both monitoring purposes and for advanced studies in distribution pipelines, by providing rapid and quantitative information on the bacterial community characteristics, also revealing changes that are not reflected in the total cell concentration (e.g. a bacterial community turnover due to continuous attachment and detachment from pipe wall biofilms; Liu et al., 2013a). A recent laboratory-scale study has shown that the fingerprints can be quantified and used in combination with the total cell concentration for accurate detection of events affecting the bacterial community in water (Prest et al., 2013). However this approach has not yet been tested on real, full-scale drinking water distribution systems, where changes may well be less pronounced than those created under controlled laboratory conditions. Sequencing methods have also gained considerable interest for microbial community characterization during drinking water treatment and distribution (Henne et al., 2008; Pinto et al., 2012; Liu et al., 2013d). Pyrosequencing is a high-throughput sequencing technology that provides insight on the microbial community composition (identity) and structure (proportion). It does not require labelled primers/nucleotides or gel electrophoresis and allows a large number of samples to be pooled (Ronaghi, 2001; Fakruddin and Chowdhury, 2012). This technique has recently been applied for the identification of species present in water during treatment (Wakelin et al., 2011; Pinto et al., 2012) and distribution (Henne et al., 2008; Hong et al., 2010; Hwang et al., 2012; Lin et al., 2013; Liu et al., 2013c; Lautenschlager et al., 2013). The studies using pyrosequencing have proved the value of identifying bacterial groups, for the evaluation of e.g. disinfection (Hwang et al., 2012) or residence time (Lautenschlager et al., 2013) effects on bacterial community composition. Pyrosequencing can therefore provide meaningful qualitative information on drinking water distribution pipeline ecology.

Combining highly quantitative FCM data with detailed qualitative pyrosequencing data could provide adequate tools for both monitoring and detailed investigations of full-scale drinking water treatment and distribution systems. To date, only few recent studies have applied both FCM and pyrosequencing. The studies were either applied to different fields than drinking water (e.g. seawater bacterial community identification, Vila-Costa et al., 2012) or were lab-scale batch experiments under controlled conditions (Bombach et al., 2010). Two recent studies applied both methods on full-scale drinking water systems, one focusing on the characterization of particle associated bacteria (Liu et al., 2013d), the other exploring the variations in bacterial community characteristics in a distribution network (Lautenschlager et al., 2013). The latter study showed that relatively small changes in bacterial cell concentration and community composition can occur during water distribution and can be detected using FCM and pyrosequencing individually.

The objective of this study was to evaluate the combination of FCM bacterial cell counting, newly developed FCM fingerprinting and 454-pyrosequencing data for the detection and characterization of microbial changes occurring in full-scale drinking water distribution systems. For this purpose, we moved a step forward from previous studies by (i) evaluating the complementary nature of data derived from these methods, particularly comparing FCM fingerprints with pyrosequencing-derived genetic fingerprints and (ii) combining data sets obtained independently by the two methods, for the generation of new quantitative information on the bacterial community composition. To provide statistical credibility to the approach and solid comparison of the methods, a large amount of samples were taken at high frequency (52 samples on the same day) from only two locations in a full-scale distribution system.

2.2 Materials and Methods

2.2.1 *Sampling scheme*

The study was performed on the large-scale drinking water treatment plant of Kralingen (Rotterdam area, the Netherlands) and its corresponding distribution network. The annual drinking water production at Kralingen is 40×10^6 m³/year. Surface water is treated at Kralingen by coagulation, flocculation and sedimentation followed by ozonation, dual medium filtration, and granular active carbon filtration. Chlorine dioxide (0.1 mg L⁻¹) is added at the end of the treatment and the water is collected in a reservoir before distribution. The chlorine dioxide concentration in the reservoir effluent water is below detection limit. The water is thereafter distributed in a well-maintained drinking water distribution network operating without residual disinfectant, which can be considered as representative for other locations in many industrialised countries. Samples were taken at the treatment outlet of the drinking water treatment plant and at one location in the network. Sampling was specifically limited to only two locations to enable the collection of a large amount of similar samples at high frequency, thus providing a solid basis for comparison between the datasets. The network location was selected based on preliminary studies indicating that microbial characteristics of the water differed from the treatment outlet water, thus allowing an evaluation of the capacity of the analytical methods to detect events affecting the microbial community in drinking water. Samples were collected from the two locations every 5 min during 1 h. This procedure was performed in the morning from 08:00 to 09:00 and repeated in the afternoon of the same day from 13:00 to 14:00 (Fig. 2.1), to evaluate variations in water quality on short time-scales (morning vs. afternoon). The residence time of the water in

the system at the network location was approximately two days. However, the residence time was not taken in account in the sampling scheme, as the available tools to estimate residence time provide only rough estimations, and sampling of the “same water” at both locations could therefore not be accurately achieved. The sampling taps at both locations were opened at least 1 h before sampling and were running continuously during the entire sampling period. At each sampling time, water was collected in separate bottles for each parameter to be measured, i.e. adenosine tri-phosphate (ATP), heterotrophic plate count (HPC), total and intact bacterial cell concentrations and fluorescence fingerprints (flow cytometry), TOC, pH, conductivity, temperature and 454-pyrosequencing. Bottle materials and measurement procedures are described below for each parameter. Water temperature was $20.9 \pm 0.1^\circ\text{C}$ at the treatment outlet and $22.7 \pm 0.1^\circ\text{C}$ at the network location. The water samples were transported on ice, stored at 4°C until analysis and processed within 24h.

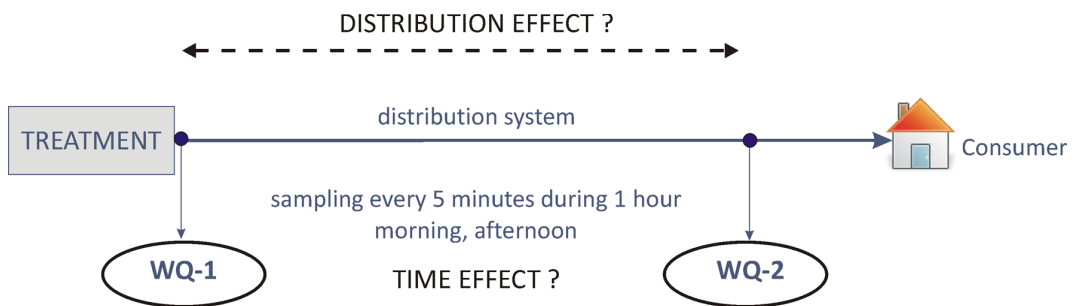

Figure 2.1. Experimental scheme for evaluation of flow cytometry and 454 pyrosequencing for the detection and characterization of microbial changes in full-scale drinking water distribution systems. Drinking water samples were taken at the plant outlet and from one location in the distribution network, every 5 min during 1 h. The sampling was performed once in the morning and repeated once in the afternoon on the same day. Such sampling enables detection and characterization of (i) short-term temporal changes at each sampling location (time effect) and (ii) spatial changes by comparing water samples taken at both locations (distribution effect). WQ: water quality

2.2.2 *Conventional parameters*

For HPC and ATP measurements, water was collected in high-density polyethylene (HD-PE) plastic bottles containing 2 mL L⁻¹ of a mixed solution of sodium thiosulfate (20 g L⁻¹) and of nitrilotriacetic acid (25 g L⁻¹), as routinely applied by accredited laboratories for drinking water analysis in the Netherlands. HPC was measured by Aqualab Zuid (Werkendam, NL), according to the Dutch standard procedure (NEN-EN-ISO 6222, 1999). In short, 2 mL of the sample were transferred to a sterile Petri-dish and mixed with about 20 mL yeast extract agar. The agar was kept at 44°C before plating. The samples were incubated at 22°C for 3 days. ATP was measured by Het Waterlaboratorium (Haarlem, NL), as described previously by Magic-Knevez and van der Kooij (2004). The ATP measurement is based on the emission of light resulting from the reaction between the ATP molecule and a luciferin/luciferase reagent (LuminATE, Celsis). For total ATP determination, ATP was first released from suspended cells with nucleotide-releasing buffer (LuminEX, Celsis), while this step was not performed for assessment of free ATP. The intensity of the emitted light was measured using a luminometer (Celsis Advance™) that was calibrated with solutions of free ATP (Celsis) in autoclaved tap water following the procedure given by the manufacturer. The detection limit of the method was 1 ng ATP L⁻¹. Bacterial ATP concentrations were calculated by subtracting free ATP from total ATP concentrations. Drinking water samples were collected in polyethylene terephthalate (PET) bottles without headspace for pH and conductivity analysis and in glass bottles containing sulphuric acid (8 mol L⁻¹, 0.2 mL in 100 mL bottle) for TOC analysis. The three parameters were measured by Aqualab Zuid (Werkendam, NL). The water temperature was measured directly on site.

2.2.3 *Flow cytometry*

Drinking water was collected in HD-PE bottles containing 2 mL L⁻¹ of a mixed solution of sodium thiosulfate solution (20 g L⁻¹) and of nitrilotriacetic acid (25 g L⁻¹) for FCM measurements. Water samples were stained according to the standardized protocol proposed in the Swiss guideline for drinking water analysis (SLMB, 2012) for the determination of total bacterial cell concentrations. In short, samples (500 µL) were pre-heated to 35 °C (5 minutes) and then stained with 10 µL mL⁻¹ SYBR® Green I (1:100 dilution in DMSO; Molecular Probes), and incubated in the dark for 10 minutes at 35 °C before measurement. For the assessment of intact bacterial cell concentrations, a working solution containing SYBR® Green I (1:100 dilution in DMSO; Molecular Probes) and propidium iodide (0.3 mM) was prepared. The same protocol as described above was used for the staining. Flow cytometric measurements were performed, as described in Prest et al., 2013, using a BD Accuri C6® flow cytometer (BD Accuri cytometers, Belgium) equipped with a 50 mW laser emitting at a fixed wavelength of 488 nm. The FCM is equipped with volumetric counting hardware, calibrated to measure the number of particles in 50 µL of a 500 µL sample. Measurements were performed at pre-set flow rate of 35 µL min⁻¹. A threshold value of 500 a.u. was applied on the green fluorescence channel (FL1).

Data analysis was performed using the BD Accuri CFlow® software, following the procedure described in Prest et al., 2013. Briefly, bacterial signal was selected using electronic gating on density plots of green fluorescence (FL1; 533 nm), and red fluorescence (FL3; >670 nm). The selected data was subsequently visualized on a green fluorescence histogram, which was used as the main FCM “fingerprint” for the bacterial community. Analysis of the fingerprints was based on the separation, using fixed electronic gates, of the typical two-clusters formed by the low (LNA) and high (HNA) nucleic acid content bacteria, as described in Prest et al., 2013. Quantification and

straightforward comparison of fingerprints from different water samples was made using the percentage of HNA cells (compared to total cells) and the relative nucleic acid content (calculated from the green fluorescence distribution). The fingerprinting approach is discussed in supplementary information (calculation of the relative nucleic acid content and comparison with similar fingerprinting strategies, Fig. S2.1.1).

2.2.4 *Bacterial community analysis with 16S rRNA gene pyrosequencing*

Water samples (2 L) were collected in HD-PE bottles containing 2 mL L⁻¹ of a mixed solution of sodium thiosulfate solution (20 g L⁻¹) and nitrilotriacetic acid (25 g L⁻¹). Each sample was filtered through a 0.2 µm-pore-size Isopore membrane filter (Merck Millipore, Billerica, MA) within 5 hours of sampling. The filters were stored at -20 °C until processing. Genomic DNA was extracted from the collected biomass using the FastDNA SPIN Kit (MP Biomedicals, Santa Ana, CA) according to the manufacturer's instructions. Bacterial 16S rRNA genes were amplified with the bacteria-specific forward primer 515F (5'-LinkerA-Barcode-GTGYCAGCMGCCGCGTA-3') and reverse primer 909R (5'-LinkerB-CCCCGYCAATTCMTTTRAGT-3'). A single-step 28-cycle PCR using the HotStarTaq Plus Master Mix Kit (QIAGEN, Valencia, CA) was performed for each DNA sample (triplicate reactions). The PCR conditions are described in supplementary information. Pyrosequencing was carried out on the Roche 454 FLX Titanium genome sequencer (detailed processing procedure is described in supplementary information). Multidimensional scaling (MDS) was performed with the Bray-Curtis coefficient using the R statistical package to ordinate the pyrosequencing operational taxonomic unit (OTU) data. An analysis of similarity (ANOSIM; Ramette, 2007) tool was used to examine statistical differences

between samples using the Bray-Curtis measure of similarity (vegan package within the R statistical software).

2.3 Results

High frequency sampling of drinking water was performed at the treatment plant outlet and at one location in the distribution network to provide strong statistical basis for (i) the evaluation of variations in bacterial cell concentration and community composition on short time-scales (morning vs. afternoon) at each location and (ii) the comparison of the microbial community characteristics (cell concentration, viability, community composition) at the two locations based on a large data set. Table 2.1 gives an overview of the methods and data processing approaches used for the analysis of the results presented in the paper. Results of each test can be found in the figures and sections noted.

Table 2.1. Overview of study focus, methods and data analysis procedures applied for the detection and characterization of variations in bacterial community with time and during distribution in a full-scale network. FCM: flow cytometry; TCC: total cell concentration; ATP: Adenosine-triphosphate; HPC: heterotrophic plate count; MDS: multidimensional scaling

Focus	Methods	Data analysis approach	Figure	Results
Rapid detection of change with bacterial cell concentrations and conventional tools	FCM: total and intact cell concentrations	Direct cell concentration data	2.2	2.3.1
	ATP, HPC	Direct measurement	2.3	
Correlation between flow cytometric and genetic fingerprints	FCM: fingerprints	Processed FCM fingerprints	2.4A	2.3.2
	454 pyrosequencing	Unprocessed FCM fingerprints	2.4C	
		MDS graphs	2.4B	
		Phyla relative abundance	2.4D	
Combination of FCM and pyrosequencing data for quantitative characterization of change	FCM: TCC 454 pyrosequencing	Combined data of TCC and relative phyla abundance	2.5	2.3.3

2.3.1 Rapid detection of change in bacterial cell concentrations

FCM total bacterial cell concentrations and percentage of intact bacterial cells data revealed changes in the drinking water samples both in time (morning vs. afternoon) and between the two locations (Fig. 2.2). These changes were not detected with conventional analysis (heterotrophic plate counting, HPC; and adenosine tri-phosphate, ATP; Fig. 2.3, and Fig. S2.3.1 and S2.3.2 in supplementary information). Short-term temporal changes in cell concentrations were limited in general. Reproducible total cell concentrations were measured over one hour at the treatment plant outlet during each of the two sampling periods, with less than 5 % variation, which is in the range of FCM measurement error (Prest et al., 2013). However, a small but significant difference ($t=3.88$, $p=0.0007$, based on an independent-sample t-test) in total cell concentrations was

measured between the treatment plant outlet water sampled in the morning ($355 \pm 17 \times 10^3$ cells mL⁻¹, n=13) and in the afternoon ($336 \pm 9 \times 10^3$ cells mL⁻¹, n=13) of the same day. At the network location, also less than 5% variation in total cell concentration was detected over one hour in the morning ($406 \pm 13 \times 10^3$ cells mL⁻¹, n=13), but a clear peak in total cell concentration was observed in the network in the afternoon (between 13:30 to 13:55, from 410×10^3 to 520×10^3 cells mL⁻¹). The peak might be due to increased water consumption during lunch time in the building where the samples were taken, possibly resulting in bacterial cell re-suspension from e.g. sediments in the piping network into the bulk water (Tsai, 2005; Lehtola et al., 2006; Nescerescka et al., 2014). Reproducible percentages of intact cells were also measured during 1 h at both locations during the two sampling periods (less than 5 % variation), except for a few data points at the treatment plant outlet and in the network. Differences in cell concentrations between the two locations were more pronounced than these temporal variations: total bacterial cell concentrations clearly increased between the treatment plant and the network location (n=26 on each location, increase from $345 \pm 15 \times 10^3$ to $425 \pm 35 \times 10^3$ cells mL⁻¹), as well as the percentage of intact bacterial cells (increase from 39 ± 3.5 % to 53 ± 4.4 %). The direct inference from this data is that significant microbial growth, or contamination from an external source, occurred during water distribution.

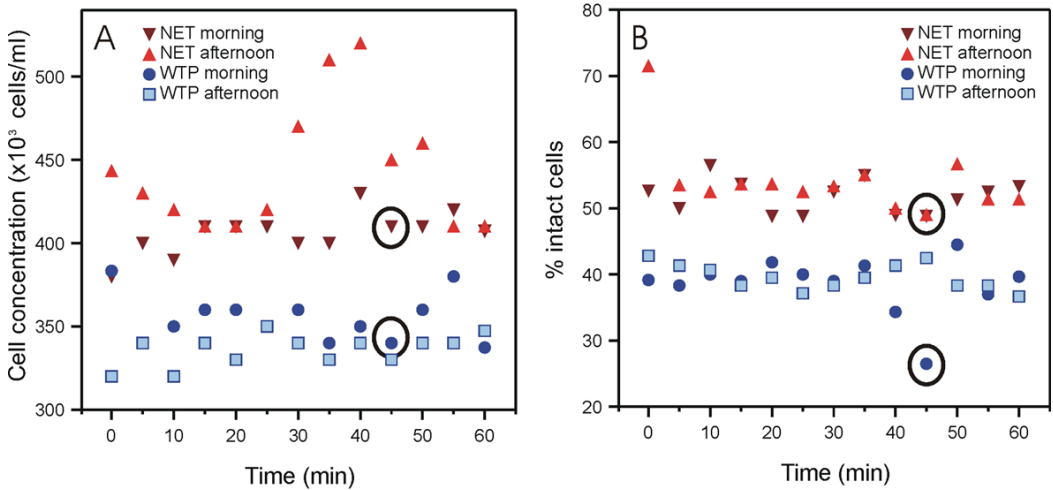

Figure 2.2. Variations over 1 h, in the morning (08:00-09:00) and in the afternoon (13:00-14:00), of drinking water (A) total bacterial cell concentration and (B) percentage of intact bacterial cells at the treatment outlet (WTP) and at the network location (NET). Drinking water samples were taken every 5 min during each sampling period. The circles indicate the two samples that were analysed in detail in figures 2.4C, 2.4D and 2.5. The standard error for the flow cytometric measurements is less than 5%.

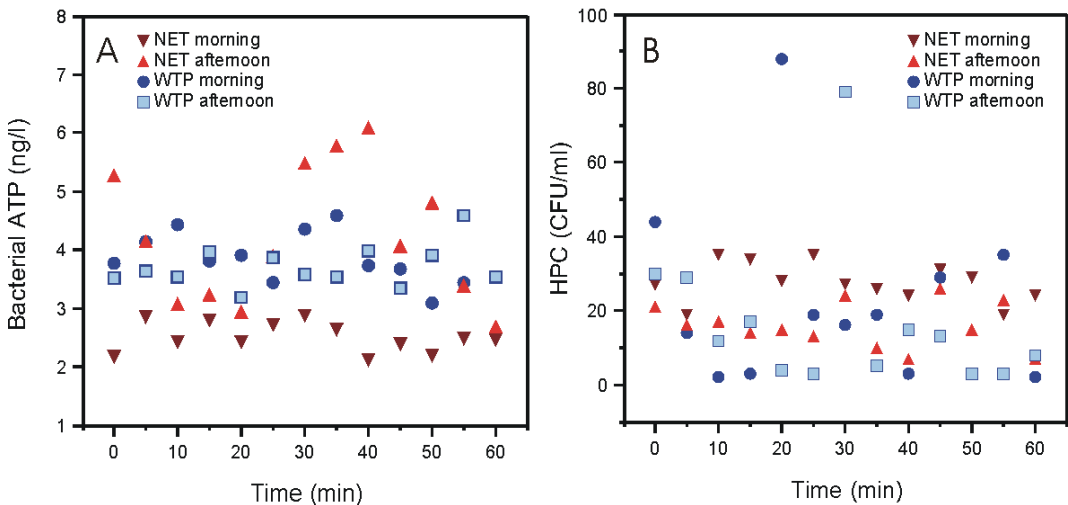

Figure 2.3. Variations over 1 h, in the morning (08:00-09:00) and in the afternoon (13:00-14:00), of (A) bacterial Adenosine triphosphate (ATP) and (B) heterotrophic plate counts (HPC) of drinking water at the plant outlet (WTP) and at the distribution network location (NET). Drinking water samples were taken every 5 min during each sampling period.

2.3.2 Comparison of flow cytometric and genetic fingerprints

The change in bacterial cell concentrations detected between the treatment outlet and the network location was clearly related to a change in FCM fingerprints and this was reflected in a change in bacterial community composition as well. All fingerprint data points were reproducible for each location, at each sampling period, with less than 5 % error on the percentage of HNA cells and the relative nucleic acid content, which is within the range of the flow cytometric measurement error (Fig. 2.4A; time sequence is provided in Fig. S2.4.1 in supplementary information). Fig. 2.4A shows that samples from the two locations displayed distinct FCM fingerprints, as the treatment plant and network data clustered separately. The network samples (n=26) had higher high nucleic acid (HNA) values, with average %HNA values of 43.5 ± 2.1 % compared to 35.8 ± 1.7 % for the treatment plant (n=26). Differences between the morning and afternoon samples were reflected as well in the FCM fingerprints, although less pronounced than the changes between the two locations. The FCM fingerprints of the treatment outlet samples in the morning and afternoon (n=13 for each time period) were located in different areas of the graph, although slightly overlapping (34.6 ± 1.4 %HNA in the morning and 36.8 ± 1.3 %HNA in the afternoon). More overlap in FCM fingerprints between the morning and afternoon samples of the network was observed (42.5 ± 2.6 %HNA in the morning and 44.5 ± 5.2 %HNA in the afternoon). For both locations, the differences between morning and afternoon could be considered as significant based on independent-samples t-tests ($t=-4.04$, $p=0.0005$ for the treatment plant outlet and $t=-2.90$, $p=0.008$ for the network).

The FCM fingerprinting data were subsequently compared to the results of the 454 pyrosequencing (Fig. 2.4B), and a similar trend was observed. The

multidimensional scaling (MDS) graph indicates the degree of similarity in bacterial community composition between samples. A difference in community structure was clearly observed between the two water sampling locations, as well as between the morning and the afternoon treatment outlet samples, while the network samples displayed more overlap between morning and afternoon. The differences in bacterial community composition were found to be statistically significant in all cases (Table 2.2), based on analysis of similarity (ANOSIM).

To illustrate the relation between the FCM and the genetic fingerprints, a detailed comparison was made between two samples taken at the same time (8:45) at each location on the basis of unprocessed FCM fingerprints (Fig. 2.4C) and phyla-level community analysis (Fig. 2.4D). The samples had clearly different cell concentrations, FCM fingerprints and community compositions, as indicated in Fig. 2.2, 2.4A and 2.4B. Comparison of the unprocessed fingerprints showed that the network samples contained more cells with high fluorescence intensity, i.e. high nucleic acid content (HNA) cells, which was reflected by a higher %HNA value in Fig. 2.4A. Such increase in HNA cells can be due to the growth of specific bacterial species (Müller et al., 2010; Vila-Costa et al., 2012). The relative abundance analysis of the pyrosequencing data allowed for characterizing the change between the two samples and revealed that the main bacterial phylum present in both water samples was *Proteobacteria*. The percentage of *Proteobacteria* increased during distribution from 47.7 to 57.4 % of the total bacterial population. Deeper analysis of this phylum at the class level showed that this increase was mainly due to an increase in the percentage of *Betaproteobacteria* (from 12.5 to 32.8 % of the total population, data not shown).

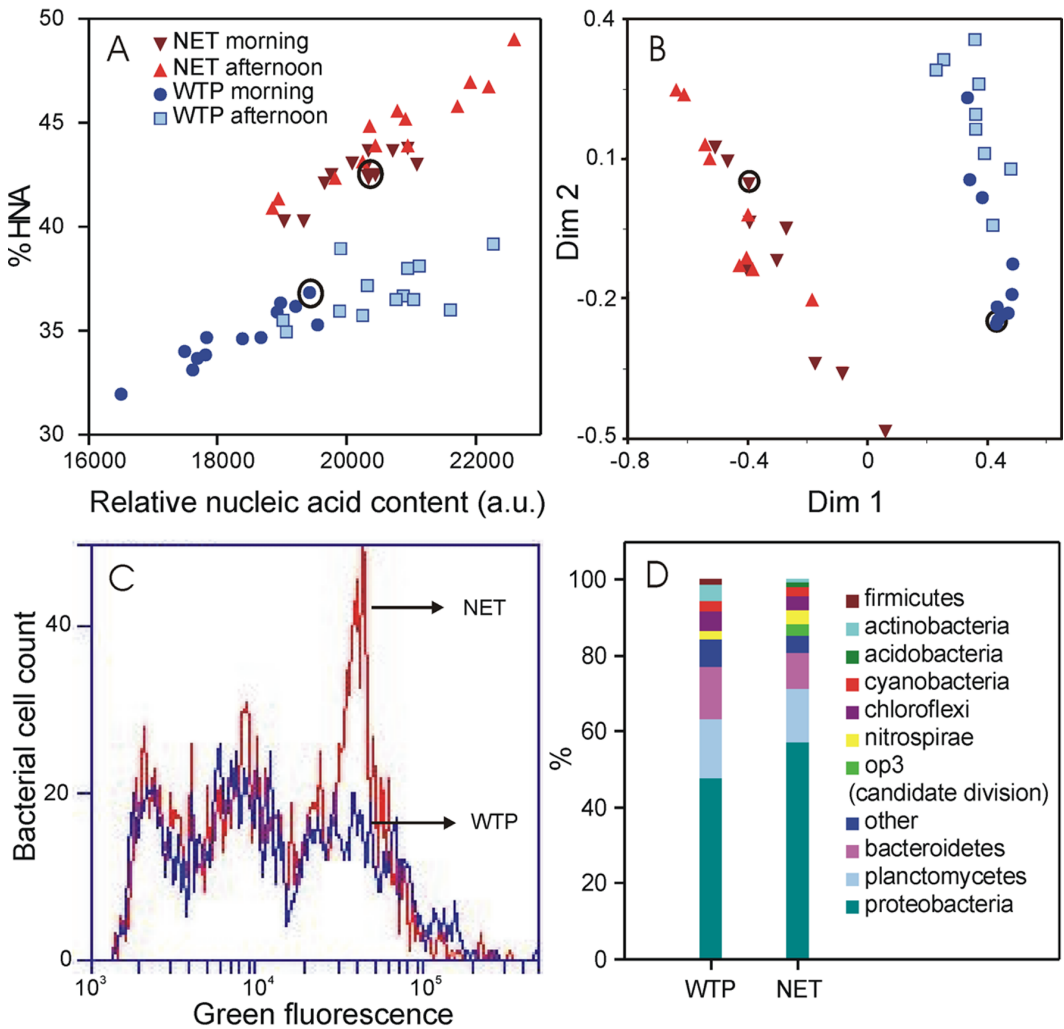

Figure 2.4. Comparison of processed (A) flow cytometric fingerprints and (B) genetic fingerprints (molecular data, multidimensional scaling) of bacteria in the drinking water samples taken at the plant outlet (WTP) and at the distribution network location (NET) in the morning (08:00-09:00) and in the afternoon (13:00-14:00). Drinking water samples were taken every 5 min during each sampling period. The circles in Figures 2.4A and 2.4B indicate two samples taken at 8:45 at both locations that were studied in detail in Figures 2.4C, 2.4D and 2.5. (C) Overlay of the flow cytometric green fluorescence distribution histograms (unprocessed fingerprints) of the two samples. (D) Comparison of relative abundance of phyla present in the two samples. %HNA: percentage of high nucleic acid cells compared to the total population

Table 2.2. Results of analysis of similarity (ANOSIM) for determination of statistical significance of differences between community composition of water samples, as analysed with pyrosequencing. Data sets were obtained from water samples taken at the treatment plant outlet (WTP) and in the distribution network (NET) at different times of the day (morning and afternoon). A p-value lower than 0.01 indicates a statistically significant difference. The R value indicates whether the separation between the two data sets is strong ($R > 0.75$: well separated; $R > 0.5$: separated but overlapping; $R < 0.25$: barely separable).

Data set 1	Data set 2	P value	R value
WTP (all samples)	NET (all samples)	0.0001	0.9756
NET morning	NET afternoon	0.0008	0.3296
WTP morning	WTP afternoon	0.0091	0.3268

2.3.3 Combination of FCM and pyrosequencing data for quantitative characterization of change

The combination of FCM bacterial cell concentrations and relative abundance of bacterial phyla obtained with pyrosequencing enabled a quantitative evaluation of the contribution of each bacterial phylum to the observed change between the samples compared in Fig. 2.4C and 2.4D. The obtained absolute cell concentration information is particularly useful since the total bacterial cell number was different in the two samples, thus making direct comparison of the samples difficult when only based on the relative abundance obtained from 454 pyrosequencing data. Fig. 2.5 gives the absolute change in bacterial cell concentration of the different phyla detected, calculated from the total cell concentration of each sample as determined with FCM, and the relative abundance of different phyla obtained using 454 pyrosequencing. The figure shows that *Proteobacteria* have increased in number during distribution, and that the change is significant compared to all other detected phyla (increase of 73×10^3 cells mL⁻¹, while the maximum change in other phyla was 12×10^3 cells mL⁻¹).

Although most bacterial phyla have increased in cell concentration, other phyla, such as the *Actinobacteria* decreased in cell concentration (decrease of 11×10^3 cells mL^{-1}), which could not be observed based on the relative abundance data alone.

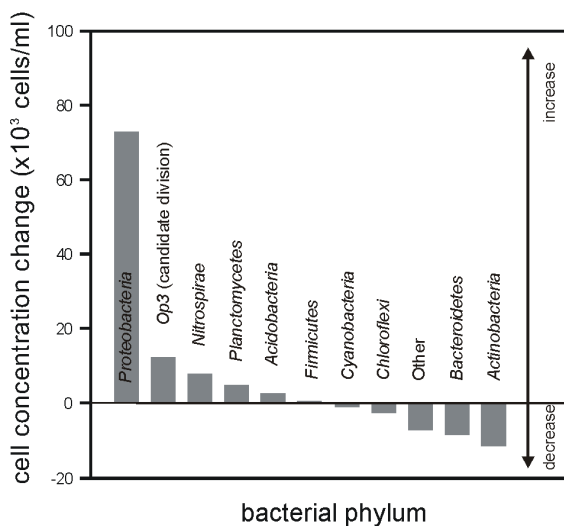

Figure 2.5. Absolute total bacterial cell concentration change per phylum between the treatment plant outlet and the distribution network location for the samples taken at 8:45. The total cell concentration increase between the two locations was 70×10^3 cells/ml.

2.4 Discussion

High frequency sampling was performed in a full-scale drinking water distribution system in order to investigate variations in the microbial characteristics of the water on short time-scales (morning vs. afternoon of the same day) at two locations and compare them with each other. Flow cytometry (FCM) and 16S rRNA gene pyrosequencing independently showed the microbial concentration and community structure varied slightly in time on the same location and was clearly differing from one location to the other (Fig. 2.2 and 2.4),

while no detectable difference was observed with conventional methods (ATP, HPC; Fig. 2.3, Fig. S2.3.1 and S2.3.2 supplementary information). The large number of analysed samples (52) from a limited number of locations provided a strong basis to consider the changes as statistically significant. The detection with FCM was rapid and quantitative, based on bacterial cell concentration, percentage of intact bacterial cells and FCM fingerprints (Fig. 2.2A, 2.2B and 2.4A). Analysis with pyrosequencing enabled extensive characterization of the detected change in bacterial community composition (Fig. 2.4D). Importantly, comparison of the two methods showed that the bacterial community structure and FCM fingerprints are congruent (Fig. 2.4A and 2.4B). The combination of the data from the two methods provided quantitative description of change in bacterial composition, which could not be obtained by either method separately (Fig. 2.5).

2.4.1 Rapid and informative detection of microbial changes with flow cytometry

FCM is an appropriate method for rapid detection of changes in microbial community characteristics. Results can be obtained within 15 minutes from sampling and were shown to be reproducible (less than 5% error) and sensitive (detection of change in a sample down to 3% of the initial value) on both cell counting and fingerprints (Hammes et al., 2008; Prest et al., 2013). Moreover, FCM measurements using only two fluorescent dyes (SYBR® Green I and propidium iodide) provide a detailed set of information on the detected change: an increase or a decrease in total bacterial cell concentration is a straightforward indication that events have occurred that affect the microbial community (which can have multiple origins; Hammes et al., 2008, 2010a), while the percentage of intact cells provides information on cell viability (Boulos et al., 1999; Falcioni et al., 2008). The latter is especially valuable in chlorinated systems where cell

damages are indicative of disinfection efficacy (Ramseier et al., 2011a; Nescerecka et al., 2014).

Additionally, it has been clearly shown in the present study that a change in FCM fingerprints is indicative for a shift in the microbial community composition. A link between community composition and the FCM fingerprints was suggested previously in studies where a shift in community composition was induced in a sample. For example, variations in FCM fingerprints were clearly detected during batch growth of autochthonous bacteria, after mixing of drinking or wastewater samples (Prest et al., 2013; Koch et al., 2013a) or after a change in environmental conditions in bottled water or biogas reactors (e.g. change in temperature, pH or nutrient concentration and type; De Roy et al., 2012; Koch et al., 2013a). However, in our study, the shift in community composition was not only assumed, it was detected and analysed with pyrosequencing. Moreover, this was observed from samples from a full-scale drinking water network in which relatively small changes occur, opposed to laboratory-induced changes under controlled conditions. In this way we showed that the shift in FCM fingerprints between the treatment plant and the network samples (Fig. 2.4A) was concomitant with a shift in community composition, as determined from the multivariate data analysis of the 454 pyrosequencing results (Fig. 2.4B). The direct link between the FCM fingerprints and genetic fingerprints is a major finding for drinking water analysis: it can be concluded in a few minutes from FCM data that a community shift has occurred in a drinking water sample. To our knowledge this is the first study demonstrating the link between FCM fingerprints and pyrosequencing-based genetic fingerprints in real drinking water samples.

2.4.2 Detailed description of community shift using pyrosequencing combined with flow cytometry

454 pyrosequencing is valuable for an in-depth characterization of microbial communities in water, by providing the information on the relative abundance of organisms in water samples. In the present study, the results showed that the dominant phylum was *Proteobacteria*, which was also the case in multiple drinking water systems (Hoefel et al., 2005; Hong et al., 2010; Hwang et al., 2012; Pinto et al., 2012; Lautenschlager et al., 2013; Liu et al., 2013c), although studies have demonstrated that the predominant class (*Alpha*, *Beta*, *Gammaproteobacteria*) differed from one network to another (Mathieu et al., 2009; Hwang et al., 2012; Liu et al., 2013d). Our study showed that even within the same system, water distribution can result in community structure changes. *Proteobacteria* remained prevalent, but the relative abundance was modified and new phyla could be detected. Also within the *Proteobacteria* phylum, the class composition changed with an increased proportion of *Betaproteobacteria*, as already observed elsewhere (Pinto et al., 2012).

However, pyrosequencing of amplified 16S rRNA gene fragments only provides information on the relative abundance of bacterial groups in terms of absolute cell concentrations (Lin et al., 2014). Thus, combining the relative abundance of each phylum determined by pyrosequencing with the total cell concentration in the water sample measured with FCM was valuable for quantitative description of changes that occurred at the phyla level. Although FCM and pyrosequencing have been used in parallel in other drinking water studies (Liu et al., 2013d; Lautenschlager et al., 2013), the data of the two methods have to our knowledge never been combined before. We showed in this way that quantitative information can be obtained that is not available from the relative abundance data only: the cell concentration increased for some bacterial phyla

(e.g. *Proteobacteria*) while it decreased for others (e.g. *Actinobacteria*, Fig. 2.5). The cause of this community change is not clear yet, as processes in networks are complex and cannot only be explained by bacterial growth. Such community shifts can have multiple origins, such as attachment of certain species to pipe wall biofilms and detachment of others (Flemming et al., 2002a) or re-suspension of bacteria from sediments (Lehtola et al., 2004). Competition between bacterial species can also result in the growth of specific bacterial populations taking advantage over others (Egli, 2010). Moreover, other organisms such as viruses or protozoa can target specific bacterial species or groups, leading to their decline or even disappearance. Considerably more knowledge on the drinking water distribution pipeline ecology and dynamics is needed and the combination of pyrosequencing data with flow cytometric cell counting will help gaining understanding on microbial dynamics in such systems.

2.4.3 *Combining flow cytometry and pyrosequencing data: a promising approach*

The approach of combining flow cytometry and pyrosequencing of amplified 16S rRNA gene fragments has clear potential for applications in drinking water quality monitoring in full-scale treatment and distribution systems as well as for advanced studies on distribution pipeline ecology.

Major advances in the understanding of distribution pipeline ecology can be achieved using the combined tools. Because of the ease and rapidity of the FCM method, a large number of samples can be analysed for pre-selection of samples of interest. For example, van Nevel et al. (2013b) described the methodology for measuring at a rate of approximately 1 sample per minute from 96-well plates. The multiple parameters (total cell concentration, percentage of intact cells and fluorescence fingerprints) provide a first set of information on the

bacterial community characteristics in the water sample, and can reveal for example areas in the network with excessive bacterial growth or external contamination (Hammes et al., 2010a; Liu et al., 2013c; Nescerecka et al., 2014). From such a high-throughput screening, a sub-set of selected samples can be further characterised in detail with pyrosequencing. This approach has clear value to investigate fundamental pipeline ecology related phenomena, such as competition processes between different bacterial groups (Egli, 2010), interactions between bulk, sediment and biofilm compartments (Liu et al., 2013a) or associations of specific bacterial groups with others (Wang et al., 2014). Problematic scenarios (e.g. bio-corrosion or excessive growth) might be linked with specific bacterial groups or species that can be identified in this way and could serve as indicator organisms for future monitoring. Although the information obtained nowadays with pyrosequencing is often limited to a list of group names, a constantly increasing database on drinking water bacteria types and their specificities is evolving. In our opinion, the possibility to identify bacterial groups with specific functions (e.g. nitrifiers or methanogens, Gomez-Alvarez, 2013; Wang et al., 2014) or characteristics (e.g. anoxic or anaerobic bacteria, Liu et al., 2013d) will therefore increase manifold in the near future. Such information, when examined quantitatively in combination with FCM cell counts, will lead to the characterization of microbial dynamics in systems with specific features (e.g. systems treating deep ground water vs. surface water, systems distributing water with or without residual disinfectant, systems with specific pipe materials, Hwang et al., 2012; Wang et al., 2014) and improvement of maintenance strategies can be considered.

We can also envision that flow cytometry and pyrosequencing have the potential to become standard tools in the future for drinking water quality monitoring. Flow cytometry has already been proposed as an ideal monitoring

tool because of the detection sensitivity of the method, as well as the rapidity and ease of measurement (Hammes et al., 2008; SLMB, 2012). These features might even improve in the future with smaller, automated or even online systems (Hammes et al., 2012; Van Nevel et al., 2013). Pyrosequencing might also be considered in the future for monitoring purposes, as technical advances in the method are expected to lead to smaller sequencers with lower prices, increased rapidity and ease (Cardenas and Tiedje, 2008; Fakruddin and Chowdhury, 2012). Long term systematic monitoring using both methods will lead to the construction of a database on the water microbial characteristics, including cell concentrations and community composition. The naturally present bacterial groups or species in the system can be identified, and the genetic fingerprint of the water can be built in a quantitative way when the pyrosequencing data is combined with the flow cytometric cell concentrations. Moreover, the long term monitoring will reveal variations in the water microbial community characteristics in time and in space, that are inherent to the distribution system (this study; Nescerecka et al., 2014). With such a database, flow cytometry can be used for the rapid detection of events related to uncontrolled bacterial growth or bacterial intrusion (e.g. bio-corrosion or pipe breakage) that require taking action. The events can be further characterized with pyrosequencing by comparing the bacterial community in the problematic samples with the database.

The combination of flow cytometry and pyrosequencing could also be considered in future for the detection and quantification of specific bacterial groups or species of interest. Because pyrosequencing can screen in one measurement for the total bacterial community structure and composition in water samples, the technique could replace existing culture-based methods that are time consuming and can only target specific bacterial groups or species (e.g. heterotrophic bacteria, *Legionella*, *Aeromonas*...), resulting in less effort (Ye and

Zhang, 2011). Several improvements of the sequencing method are still needed for such applications. Presently, 16S rRNA gene pyrosequencing does not allow the detection of specific species with certainty, due to the short sequence read lengths (Aw and Rose, 2012; Wang et al., 2014). However, further developments are expected in the coming years with foreseeable improvements with respect to read length allowing the identification of OTUs, possibly down to species level. Also, new sequencers are emerging with higher reads and throughput, and lower cost than 454 pyrosequencing (e.g. Ion Proton or Illumina; Fakruddin and Chowdhury, 2012; Morey et al., 2013).

2.5 Conclusions

Studies on microbial community characteristics in a full-scale drinking water distribution system with high frequency sampling at two locations (treatment plant effluent and a location in the network) showed that:

- flow cytometry and pyrosequencing enable the detection of events affecting the water microbial community that are not detected with classical methods such as ATP or HPC
- flow cytometric fingerprints can be used as an indicator for shifts in bacterial community composition
- the combination of data obtained with the two methods provides quantitative information on microbial community composition that cannot be obtained from the methods individually

The combination of flow cytometry and pyrosequencing is a promising approach for monitoring full-scale drinking water distribution systems and for gaining knowledge on drinking water distribution pipeline microbial dynamics.

Supplementary Material

S2.1. Flow cytometric fingerprinting

a. Calculation of relative nucleic acid content

During flow cytometric measurements, fluorescence intensity is recorded for each bacterial cell present in a water sample. Bacterial cells are usually labeled with fluorescent dyes prior to the measurement. When the dye binds specifically to nucleic acids (e.g. SyBr Green I), the recorded fluorescence intensity is dependent on the amount of nucleic acids contained in the bacterial cell. Therefore, the distribution of the green fluorescence measured for all bacteria in a water sample is indicative for the distribution of the nucleic acid content of the bacteria in the sample.

It is possible to calculate an estimation of the geometric average of the green fluorescence using the formula below (Eq. S2.1.1). The obtained value is an estimation of the average nucleic acid content of the bacteria in the water sample, and referred to as relative nucleic acid content. The calculation (Eq. S2.1.1) is based on the classical separation between low and high nucleic acid cells (LNA and HNA) usually observed in aquatic samples and takes into account the distribution of the bacterial cells into the two clusters. The separation between the LNA and HNA clusters is determined using fixed gating as described in Prest et al., 2013.

Eq. (S2.1.1)

Relative nucleic acid content = (Median LNA x %LNA) + (Median HNA x %HNA)

where Median LNA and Median HNA are the median fluorescence values of the LNA and HNA groups and %LNA and %HNA are the percentages of the LNA and HNA groups concentration compared to the total bacterial cell concentration (LNA+HNA).

b. Fingerprinting approach

For easy interpretation and comparison of fingerprints of different samples, the percentage of HNA cells compared to total cells (%HNA) and the relative nucleic acid content were plotted (Fig. 2.4A). Using this approach, the treatment outlet and distribution network samples were separated in two clearly distinct clusters. Morning and afternoon samples were also separated, although with some overlap, for samples of each location.

In Prest et al., 2013, another fingerprinting approach was proposed, where the percentage of HNA cells was plotted against the total cell concentration measured in the water sample. Figure S2.1.1 shows that, using this plot, the same discrimination was observed between treatment outlet and distribution network samples, as well as morning and afternoon samples. This shows that the results presented in the present paper are independent from the fingerprinting strategy chosen for discrimination of water samples.

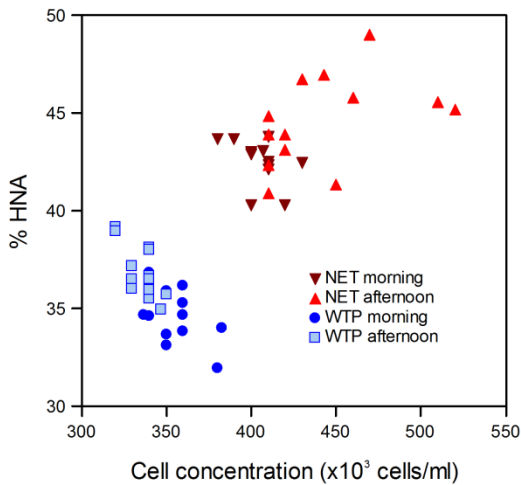

Figure S2.1.1. Alternative fingerprint graph, plotting the total bacterial cell concentration against the percentage of HNA cells (%HNA). Comparison of samples taken in the morning and in the afternoon of the same day, at the plant outlet (WTP) and at the network location (NET).

S2.2. Bacterial community analysis with 16S rRNA gene pyrosequencing

Polymerase chain reaction (PCR) was performed for each DNA sample (triplicate reactions) under the following conditions: 94°C for 3 min, followed by 28 cycles of 94°C for 30 s, 53°C for 40 s and 72°C for 1 min, after which a final elongation step at 72°C for 5 min was performed. Following PCR, all amplicon products from different samples were mixed in equal concentrations and then purified using Agencourt Ampure beads (Agencourt Bioscience Corp., Beverly, MA). 454 pyrosequencing was carried out at MR DNA Lab (Shallowater, TX, USA) on the Roche 454 FLX Titanium genome sequencer according to the manufacturer's instructions. Sequence data was processed at MR DNA Lab (Shallowater, TX,

USA). In summary, sequences were depleted of barcodes and primers, then sequences <150bp were removed, as well as sequences with ambiguous base calls and with homopolymer runs exceeding 6bp. Sequences were denoised, operational taxonomic units (OTUs) generated and chimeras removed. OTUs were defined by clustering at 3% divergence (97% similarity). Final OTUs were taxonomically classified using BLASTn against a curated database derived from NCBI and GreenGenes. Multidimensional scaling (MDS) was performed with the Bray-Curtis coefficient using the R statistical package to ordinate the pyrosequencing OTU data.

S2.3. Overview of routine parameters results

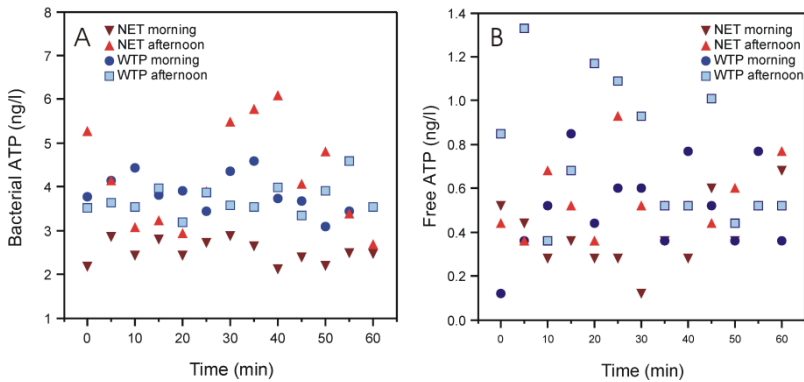

Figure S2.3.1. Variations over one hour, in the morning and in the afternoon, of (A) bacterial and (B) free adenosine tri-phosphate (ATP) of drinking water at the plant outlet (WTP) and at the distribution network location (NET). Drinking water samples were taken every five minutes during each sampling period.

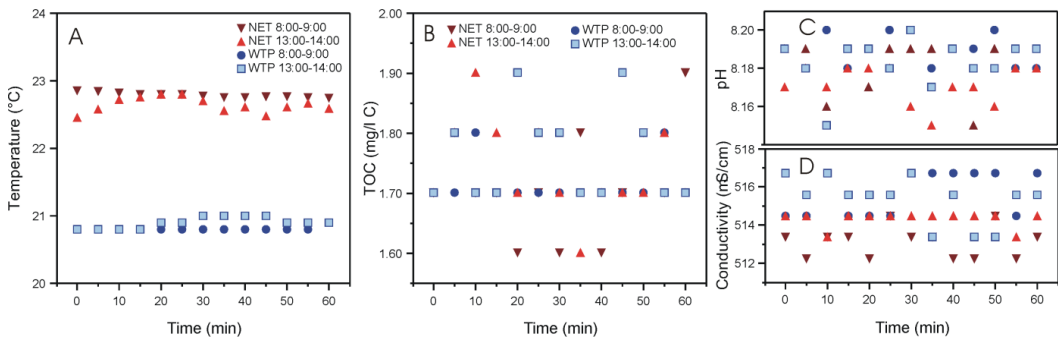

Figure S2.3.2. Overview of routine parameters variations over one hour, in the morning and in the afternoon of the same day, at the plant outlet (WTP) and at the network location (NET), (A) water temperature, (B) TOC, (C) pH, and (D) conductivity. Drinking water samples were taken every five minutes during each sampling period.

TOC was measured according to the Dutch standard procedure (NEN-EN-1484) with a TOC analyser (TOC-V CPN, Leverancier Shimadzu). The detection limit was 1 mg L⁻¹.

S2.4. Comparison of fluorescence fingerprints and community composition with time sequence

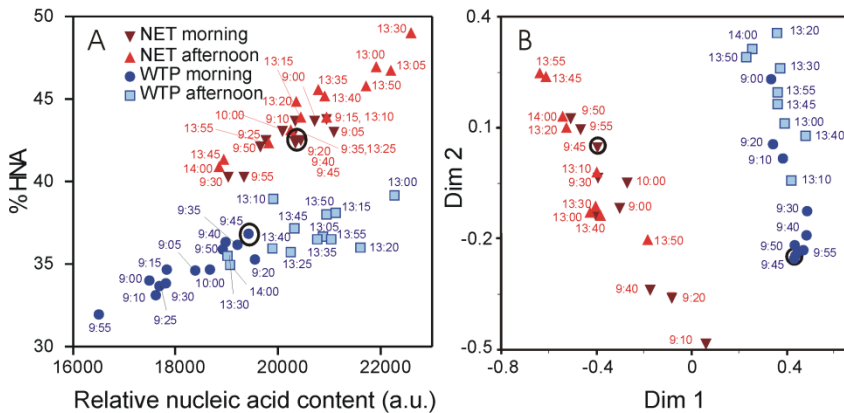

Figure S2.4.1. Comparison of processed (A) flow cytometric fingerprints and (B) genetic fingerprints (molecular data, multidimensional scaling) of bacteria in the drinking water samples taken at the plant outlet (WTP) and at the distribution network location (NET) in the morning (08:00-09:00) and in the afternoon (13:00-14:00). Drinking water samples were taken every five minutes during each sampling period. The circles indicate two samples, taken at 8:45 at both locations, that were studied in detail in Figures 2.4C, 2.4D and 2.5. The numbers indicate the sampling time for each data point.

Bibliography

Aw, T.G., Rose, J.B., 2012. Detection of pathogens in water: from phylochips to qPCR to pyrosequencing. *Curr. Opin. Biotechnol.* 23 (3), 422–430.

Bombach, P., Hübschmann, T., Fetzer, I., Kleinstüber, S., Geyer, R., Harms, H., Müller, S., 2010. Resolution of natural microbial community dynamics by community fingerprinting, flow cytometry, and trend interpretation analysis. *Adv. Biochem. Eng. Biotechnol.* 124, 151–181.

Boulos, L., Prevost, M., Barbeau, B., Coallier, J., Desjardin, R., 1999. LIVE/DEAD BacLight: application of a new rapid staining method for direct enumeration of viable and total bacteria in drinking water. *J. Microbiol. Methods* 37, 77–86.

Cardenas, E., Tiedje, J.M., 2008. New tools for discovering and characterizing microbial diversity. *Curr. Opin. Biotechnol.* 19 (6), 544–549.

De Roy, K., Clement, L., Thas, O., Wang, Y., Boon, N., 2012. Flow cytometry for fast microbial community fingerprinting. *Water Res.* 46 (3), 907–919.

Egli, T., 2010. How to live at very low substrate concentration. *Water Res.* 44 (17), 4826–4837.

Fakruddin, Md., Chowdhury, A., 2012. Pyrosequencing- an alternative to traditional Sanger sequencing. *Am. J. Biochem. Biotechnol.* 8 (1), 14–20.

Falcioni, T., Papa, S., Gasol, J.M., 2008. Evaluating the flow-cytometric nucleic acid double-staining protocol in realistic situations of planktonic bacterial death. *Appl. Environ. Microbiol.* 74 (6), 1767–1779.

Flemming, H.-C., Percival, S.L., Walker, J.T., 2002. Contamination potential of biofilms in water distribution systems. *Water Sci. Technol.* 2 (1), 271–280.

Gomez-Alvarez, V., Schrantz, K.A., Pressman, J.G., Speitel, G.E. and Wahman, D.G., 2013. Pyrosequencing analysis of bench-scale nitrifying biofilters removing trihalomethanes. *Environ. Eng. Sci.* 30 (9), 582–588.

Hammes, F., Broger, T., Weilenmann, H.U., Vital, M., Helbing, J., Bosshart, U., Huber, P., Odermatt, R.P., Sonnleitner, B., 2012. Development and laboratory-scale testing of a fully automated online flow cytometer for drinking water analysis. *Cytom. A* 81 (6), 508–516.

Hammes, F., Berger, C., Köster, O., Egli, T., 2010. Assessing biological stability of drinking water without disinfectant residuals in a full-scale water supply system. *J. Water Supply: Res. Technol. – AQUA* 59 (1), 31.

Hammes, F., Berney, M., Wang, Y., Vital, M., Köster, O., Egli, T., 2008. Flow-cytometric total bacterial cell counts as a descriptive microbiological parameter for drinking water treatment processes. *Water Res.* 42 (1-2), 269–277.

Henne, K., Kahlisch, L., Draheim, J., Brettar, I., Höfle, M.G., 2008. Polyvalent fingerprint based molecular surveillance methods for drinking water supply systems. *Water Sci. Technol.: Water Supply* 8 (5), 527.

Ho, L., Braun, K., Fabris, R., Hoefel, D., Morran, J., Monis, P., Drikas, M., 2012. Comparison of drinking water treatment process streams for optimal bacteriological water quality. *Water Res.* 46 (12), 3934–3942.

Hoefel, D., Monis, P.T., Grooby, W.L., Andrews, S., Saint, C.P., 2005. Profiling bacterial survival through a water treatment process and subsequent distribution system. *J. Appl. Microbiol.* 99 (1), 175–186.

Hoefel, D., 2003. Enumeration of water-borne bacteria using viability assays and flow cytometry: a comparison to culture-based techniques. *J. Microbiol. Methods* 55 (3), 585–597.

Hong, P.Y., Hwang, C., Ling, F., Andersen, G.L., LeChevallier, M.W., Liu, W.T., 2010. Pyrosequencing analysis of bacterial biofilm communities in water meters of a drinking water distribution system. *Appl. Environ. Microbiol.* 76 (16), 5631–5635.

Hwang, C., Ling, F., Andersen, G.L., LeChevallier, M.W., Liu, W.T., 2012. Microbial community dynamics of an urban drinking water distribution system subjected to phases of chloramination and chlorination treatments. *Appl. Environ. Microbiol.* 78 (22), 7856–7865.

Koch, C., Gunther, S., Desta, A.F., Hubschmann, T., Müller, S., 2013a. Cytometric fingerprinting for analyzing microbial intracommunity structure variation and identifying subcommunity function. *Nat. Protoc.* 8 (1), 190–202.

Koch, C., Fetzer, I., Harms, H., Müller, S., 2013b. CHIC- an automated approach for the detection of dynamic variations in complex microbial communities. *Cytom. A* 83 (6), 561–567.

Lautenschlager, K., Hwang, C., Liu, W.T., Boon, N., Koster, O., Vrouwenvelder, H., Egli, T., Hammes, F., 2013. A microbiology-based multi-parametric approach

towards assessing biological stability in drinking water distribution networks. *Water Res.* 47 (9), 3015–3025.

Lehtola, M.J., Laxander, M., Miettinen, I.T., Hirvonen, A., Vartiainen, T., Martikainen, P.J., 2006. The effects of changing water flow velocity on the formation of biofilms and water quality in pilot distribution system consisting of copper or polyethylene pipes. *Water Res.* 40 (11), 2151–2160.

Lehtola, M.J., Nissinen, T.K., Miettinen, I.T., Martikainen, P.J., Vartiainen, T., 2004. Removal of soft deposits from the distribution system improves the drinking water quality. *Water Res.* 38 (3), 601–610.

Lin, W., Yu, Z., Zhang, H., Thompson, I.P., 2014. Diversity and dynamics of microbial communities at each step of treatment plant for potable water generation. *Water Res.* 52, 218–230.

Lin, W., Yu, Z., Chen, X., Liu, R., Zhang, H., 2013. Molecular characterization of natural biofilms from household taps with different materials: PVC, stainless steel, and cast iron in drinking water distribution system. *Appl. Microbiol. Biotechnol.* 97 (18), 8393–8401.

Liu, G., Van der Mark, E.J., Verberk, J.Q., Van Dijk, J.C., 2013a. Flow cytometry total cell counts: a field study assessing microbiological water quality and growth in unchlorinated drinking water distribution systems. *Biomed. Res. Int.* 2013, 595872.

Liu, G., Verberk, J.Q., Van Dijk, J.C., 2013b. Bacteriology of drinking water distribution systems: an integral and multidimensional review. *Appl. Microbiol. Biotechnol.* 97 (21), 9265–9276.

Liu, G., Ling, F.Q., Magic-Knezev, A., Liu, W.T., Verberk, J.Q., Van Dijk, J.C., 2013c. Quantification and identification of particle-associated bacteria in unchlorinated drinking water from three treatment plants by cultivation-independent methods. *Water Res.* 47 (10), 3523–3533.

Magic-Knezev, A., van der Kooij, D., 2004. Optimisation and significance of ATP analysis for measuring active biomass in granular activated carbon filters used in water treatment. *Water Res.* 38, 3971–3979.

Mathieu, L., Bouteleux, C., Fass, S., Angel, E., Block, J.C., 2009. Reversible shift in the alpha-, beta- and gamma-proteobacteria populations of drinking water biofilms during discontinuous chlorination. *Water Res.* 43 (14), 3375–3386.

Morey, M., Fernandez-Marmiesse, A., Castineiras, D., Fraga, J.M., Couce, M.L., Cocho, J.A., 2013. A glimpse into past, present, and future DNA sequencing. *Mol. Genet. Metab.* 110 (1-2), 3–24.

Müller, S., Harms, H., Bley, T., 2010. Origin and analysis of microbial population heterogeneity in bioprocesses. *Curr. Opin. Biotechnol.* 21 (1), 100–113.

Nescerecka, A., Rubulis, J., Vital, M., Juhna, T., Hammes, F., 2014. Biological Instability in a Chlorinated Drinking Water Distribution Network. *PLOS one* 9 (5), e96354.

Pinto, A.J., Xi, C., Raskin, L., 2012. Bacterial community structure in the drinking water microbiome is governed by filtration processes. *Environ. Sci. Technol.* 46 (16), 8851–8859.

Prest, E.I., Hammes, F., Kotzsch, S., van Loosdrecht, M.C.M., Vrouwenvelder, J.S., 2013. Monitoring microbiological changes in drinking water systems using a fast and reproducible flow cytometric method. *Water Res.* 47 (19), 7131–7142.

Ramseier, M.K., von Gunten, U., Freihofer, P., Hammes, F., 2011. Kinetics of membrane damage to high (HNA) and low (LNA) nucleic acid bacterial clusters in drinking water by ozone, chlorine, chlorine dioxide, monochloramine, ferrate(VI), and permanganate. *Water Res.* 45 (3), 1490–1500.

Ramette, A., 2007. Multivariate analyses in microbial ecology. *FEMS Microbiol. Ecol.* 62 (2), 142–160.

Ronaghi, M., 2001. Pyrosequencing sheds light on DNA sequencing. *Genome Res.* 11, 3–11.

SLMB, 2012. Determining the total cell count and ratios of high and low nucleic acid content cells in freshwater using flow cytometry. Analysis method 333.1, *The Swiss Food Book (Schweizerische Lebensmittelbuch)*. Federal Office of Public Health, Switzerland.

Tsai, Y.P., 2005. Impact of flow velocity on the dynamic behaviour of biofilm bacteria. *Biofouling* 21 (5-6), 267–277.

Van Nevel, S., Koetzsch, S., Weilenmann, H.U., Boon, N., Hammes, F., 2013. Routine bacterial analysis with automated flow cytometry. *J. Microbiol. Methods* 94 (2), 73–76.

Vila-Costa, M., Gasol, J.M., Sharma, S., Moran, M.A., 2012. Community analysis of high- and low-nucleic acid-containing bacteria in NW Mediterranean coastal waters using 16S rDNA pyrosequencing. *Environ. Microbiol.* 14 (6), 1390–1402.

Wakelin, S., Page, D., Dillon, P., Pavelic, P., Abell, G.C.J., Gregg, A.L., Brodie, E., DeSantis, T.Z., Goldfarb, K.C., Anderson, G., 2011. Microbial community structure of a slow sand filter schmutzdecke: a phylogenetic snapshot based on rRNA sequence analysis. *Water Sci. Technol: Water Supply* 11 (4), 426.

Wang, H., Masters, S., Edwards, M.A., Falkinham 3rd, J.O., Pruden, A., 2014. Effect of disinfectant, water age, and pipe materials on bacterial and eukaryotic community structure in drinking water biofilm. *Environ. Sci. Technol.* 48 (3), 1426–1435.

Ye, L., Zhang, T., 2011. Pathogenic bacteria in sewage treatment plants as revealed by 454 pyrosequencing. *Environ. Sci. Technol.* 45 (17), 7173–7179.

Chapter 3

The Netherlands: fresh water - conventional treatment

**Bacterial temporal dynamics:
before and after distribution**

This chapter has been published as: El-Chakhtoura, J., Prest, E.I., Saikaly, P.E., van Loosdrecht, M.C.M., Hammes, F., Vrouwenvelder, J.S., 2015. Dynamics of bacterial communities before and after distribution in a full-scale drinking water network. *Water Research* 74, 180–190.

Abstract

Understanding the biological stability of drinking water distribution systems is imperative in the framework of process control and risk management. The objective of this research was to examine the dynamics of the bacterial community during drinking water distribution at high temporal resolution. Water samples (156 in total) were collected over short time-scales (minutes/ hours/ days) from the outlet of a treatment plant and a location in its corresponding distribution network. The drinking water is treated by biofiltration and disinfectant residuals are absent during distribution. The community was analyzed by 16S rRNA gene pyrosequencing and flow cytometry as well as conventional, culture-based methods. Despite a random dramatic event (detected with pyrosequencing and flow cytometry but not with plate counts), the bacterial community profile at the two locations did not vary significantly over time. A diverse core microbiome was shared between the two locations (58–65% of the taxa and 86–91% of the sequences) and found to be dependent on the treatment strategy. The bacterial community structure changed during distribution, with greater richness detected in the network and phyla such as *Acidobacteria* and *Gemmatimonadetes* becoming abundant. The rare taxa displayed the highest dynamicity, causing the major change during water distribution. This change did not have hygienic implications and is contingent on the sensitivity of the applied methods. The concept of biological stability therefore needs to be revised. Biostability is generally desired in drinking water guidelines but may be difficult to achieve in large-scale complex distribution systems that are inherently dynamic.

3.1. Introduction

Drinking water distribution systems (DWDSs) serve as a vital network for transporting clean, safe, palatable and ideally biologically stable water. These systems are complex, governed by variable natural and operational conditions that influence the indigenous microbial communities which thrive in the water, biofilm and sediments. Monitoring water quality during distribution and establishing appropriate remedial actions are therefore imperative in the framework of process control and risk management (Smeets et al., 2010). Biological stability is generally defined as the inability of water (and/or pipe material) to promote microbial growth, and many guidelines have been proposed for its evaluation, linked to conventional parameters such as assimilable organic carbon (AOC), biofilm formation rate and heterotrophic plate counts (Liu et al., 2013; van der Kooij, 2000). Since these methods are mostly indicative and often inaccurate, recent studies have recommended more advanced, sensitive tools such as pyrosequencing and flow cytometry that can provide in-depth qualitative and quantitative data on microbial cell concentrations and community structure variations (Lautenschlager et al., 2013; Liu et al., 2013; Prest et al., 2014).

To deliver biologically stable water to end users water utilities normally apply a final oxidative disinfection step (primarily chlorination) and maintain a sufficient disinfectant residual in the network to suppress microbial growth (LeChavellier et al., 1993). Chlorine however has instigated customer complaints concerning taste and odor and has been linked with harmful by-products such as trihalomethanes (Rook, 1976). Chlorination can inhibit certain microorganisms while selecting for opportunistic pathogens that are relatively chlorine-resistant such as *Mycobacterium avium* (Ingerson-Mahar and Reid, 2012). Moreover, disinfectant residuals can react with particles, organics and pipe

material releasing AOC that can be consumed by microorganisms, contributing to biological instability (Polanska et al., 2005; Ramseier et al., 2011). As an alternative, high-quality, biologically stable water can be produced by limiting organic carbon and other growth-supporting nutrients during treatment (van der Kooij, 2000) and this is often carried out by benign microbial communities colonizing biological filters.

Previous studies have examined spatial and temporal variations in the microbial water quality, in both chlorinated and non-chlorinated DWDSs. Distribution effects were mainly determined based on sampling a few locations in the network (Lautenschlager et al., 2013; Liu et al., 2014; McCoy and VanBriesen, 2014) while temporal studies focused primarily on monthly or seasonal variations (Hu et al., 1999; Pinto et al., 2014; Revetta et al., 2010). Most studies reported long-term effects to be more significant than spatial variations, although distribution network samples were rarely compared to the original treatment plant samples. Studies investigating in-depth short-term dynamics are scarce but important for establishing the specific trend characteristic of a particular DWDS, allowing deviations from that trend to be easily recognized and investigated.

In this study, a full-scale, well-maintained drinking water distribution system was sampled intensively over short time-scales (minutes/ hours/ days) and across two locations (156 samples in total), and analyzed using advanced techniques like 16S rRNA gene pyrosequencing and flow cytometry as well as conventional, culture-based methods like plate counts. The objective of the research was to (i) examine bacterial dynamics at high temporal resolution and (ii) determine the impact of distribution on the water microbiology, in an effort to evaluate the biological stability of systems that apply biofiltration treatment and distribute water without disinfectant residuals.

3.2. Materials and Methods

3.2.1 Sampling scheme

The research was conducted on a drinking water treatment plant in the Netherlands and its corresponding distribution network. The plant treats surface water from the Meuse River by coagulation, flocculation and sedimentation followed by ozonation, rapid dual-medium filtration and granular activated carbon filtration. The filtrate is dosed with chlorine dioxide to a concentration of $0.1 \text{ mg ClO}_2 \text{ L}^{-1}$ before being pumped into a storage reservoir located at the plant. The effluent of this reservoir that is distributed contains no detectable disinfectant residual. The drinking water production rate of the plant is $4 \times 10^7 \text{ m}^3 \text{ year}^{-1}$ (Chapter 2) and it is the sole source of water for this distribution network (no mixing). The pipes in this network are made of cemented steel and (at some locations) PVC. Bulk water samples were collected simultaneously from the outlet of the water treatment plant (WTP) and from one location in the distribution network, both from a continuously running tap to avoid unwanted stagnation influences. The hydraulic residence time was estimated by the local water utility to be 2 days. The research comprised three parts; hour, day and week studies and an overview of these studies is shown in Table 3.1. In the (i) hour study, samples were taken from the two locations every five minutes for one hour, done in the morning (8 to 9 am) and afternoon (1 to 2 pm) of the same day, and resulting in 52 samples. In the (ii) day study, samples were taken every hour for an entire day (48 samples). In the (iii) week study, samples were taken four times a day (at 8 am, 11 am, 2 pm and 4 pm) for one week, resulting in 56 samples. The sampling was conducted in August 2012 when the water temperature was $20.9 \pm 0.1 \text{ }^\circ\text{C}$ at the plant outlet and $22.7 \pm 0.1 \text{ }^\circ\text{C}$ at the network location. Depending on the subsequent analysis, samples were collected in

specific, separate bottles as described in Chapter 2. All samples were transported on ice to the laboratory, stored at 4 °C and processed within 24 h.

Table 3.1. Overview of three studies examining short-term bacterial dynamics of drinking water at treatment plant outlet and distribution network location.

Study set	Sampling frequency	No. of samples	Pyrosequencing samples
HOURLY	5 min	52	36
DAY	1 h	48	20
WEEK	4 x / day	56	56

3.2.2 Chemical and microbial analysis

Every drinking water sample was analyzed for temperature, conductivity, pH, total organic carbon (TOC), heterotrophic plate counts (HPC), adenosine triphosphate (ATP) and flow cytometric (FCM) bacterial cell counts. Temperature was measured directly on site. Conductivity, pH, TOC and HPC were analyzed by Aqualab Zuid (Werkendam, NL). TOC was measured according to a Dutch standard procedure (NEN-EN 1484). The HPC method was performed with yeast extract agar and the plates were incubated at 22 °C for 3 days (Dutch procedure NEN-EN-ISO 6222). ATP analysis was carried out by Het Waterlaboratorium (Haarlem, NL) as described previously by Magic-Knezev and van der Kooij (2004). A pre-calibrated luminometer (Celsis Advance TM230) was used to measure the intensity of the emitted light. The detection limit of the method was 1 ng ATP L⁻¹. Unlike free ATP measurements, a nucleotide-releasing buffer step was added for total ATP analysis. Bacterial ATP concentrations were calculated by subtracting free ATP from total ATP concentrations. Measurement of total bacterial cell concentrations with flow cytometry was done according to the standardized protocol proposed by Prest and colleagues (2013). Briefly, samples

were pre-heated to 35 °C for 5 min, stained with 10 µL mL⁻¹ SYBR Green I (Molecular Probes, Eugene, OR, USA) and then incubated in the dark at 35 °C for 10 min. An Accuri C6 flow cytometer equipped with a 50 mW laser was used for the analysis.

3.2.3 Bacterial community analysis: pyrosequencing

A selection of 112 drinking water samples was processed for bacterial community analysis with 16S rRNA gene pyrosequencing. For the hour study, 36 out of 52 samples were processed (sample time 0, 10, 20, 30, 40, 45, 50, 55 and 60 min on both locations; randomly selected). For the day study, 20 out of 48 samples were processed (sample time 8, 10, 11, 14, 19, 21, 23, 1, 4 and 8 o'clock on both locations; selected based on FCM results). For the week study, all 56 samples were processed and the four individual samples taken per day were pooled for further analyses. Each 2 L sample was filtered through a 0.2 µm-pore-size Isopore membrane filter within 5 h of sampling, using sterile (autoclaved) filtration units (Millipore, Billerica, MA, USA). The filters were stored at -20 °C until processing.

Genomic DNA was extracted from the collected biomass using the FastDNA SPIN Kit (MP Biomedicals, Santa Ana, CA, USA) according to the manufacturer's instructions. Bacterial 16S rRNA genes were amplified with the bacteria-specific forward primer 515F (5'-LinkerA-Barcode-GTGYCAGCMGCCGCGTA-3') and reverse primer 909R (5'-LinkerB-CCCCGYCAATTCMTTTRAGT-3'). A single-step 28-cycle PCR using the HotStarTaq Plus Master Mix Kit (Qiagen, Valencia, CA, USA) was performed for each DNA sample (triplicate reactions) under the following conditions: initial denaturation at 94 °C for 3 min, followed by 28 cycles of 94 °C for 30 s; 53 °C for 40 s and 72 °C for 1 min; after which a final elongation step at 72 °C for 5 min was performed. Following PCR, all amplicon products from different samples were

mixed in equal concentrations and then purified using Agencourt AMPure beads (Agencourt Bioscience Corp., Beverly, MA, USA).

Pyrosequencing was carried out at MR DNA Lab (Shallowater, TX, USA) on the Roche 454 FLX Titanium genome sequencer according to the manufacturer's instructions. Sequence data was processed at MR DNA Lab. In summary, sequences were depleted of barcodes and primers, then sequences < 150 bp were removed, as well as sequences with ambiguous base calls and with homopolymer runs exceeding 6 bp. Sequences were denoised, operational taxonomic units (OTUs) generated and chimeras removed. OTUs were defined by clustering at 3% divergence (97% similarity). Final OTUs were taxonomically classified using BLASTn against a curated database derived from NCBI and Greengenes.

3.2.4 Statistical analysis

Statistical methods were applied to assess the similarity in bacterial community structure among samples. Weighted multidimensional scaling (MDS) was performed with the Bray-Curtis matrix using the R statistical package to ordinate the OTU data (samples with similar community structure cluster together, taking into account the relative abundance of each OTU). Temporal variation of total (3% divergence clustering), general (top 10 most abundant) and rare (< 0.01% average abundance) taxa was also analyzed by nonmetric MDS ordination (NCSS 8 statistical software). Analysis of similarity (ANOSIM) was used to examine the statistical significance of differences among samples using the Bray-Curtis measure of similarity (vegan package within R), where the *R* statistic value ranges between 0 (complete similarity) and 1 (complete separation).

3.3. Results

3.3.1 Overall variation

A large number of samples was collected at high frequency from the water treatment plant outlet and one distribution network location in three sets: hour, day and week. To depict overall variation, all samples from the three studies were combined in one MDS plot shown in Fig. 3.1. Treatment plant and distribution network samples clustered separately indicating different bacterial community structures for the two locations and this difference between the locations was confirmed with ANOSIM ($p = 0.0001$; $R = 0.8617$). Over time at the individual locations, a similar bacterial community structure was found. For a better understanding of short-term dynamics, results from the day and week studies will be presented below. Results from the hour study have been shown in Chapter 2 and will not be presented in detail herein.

3.3.2 Day study

A closer look at the day study samples is shown in Fig. 3.2. Two separate clusters were observed for the treatment plant and distribution network samples, indicating different bacterial community structures at the two locations. The network samples clustered more closely (Fig. 3.2), although two outliers were found at 10 am and 11 am, while the plant samples contained one outlier at 2 pm. Statistically significant differences between the two locations were found with ANOSIM ($p = 0.0001$; $R = 0.9231$).

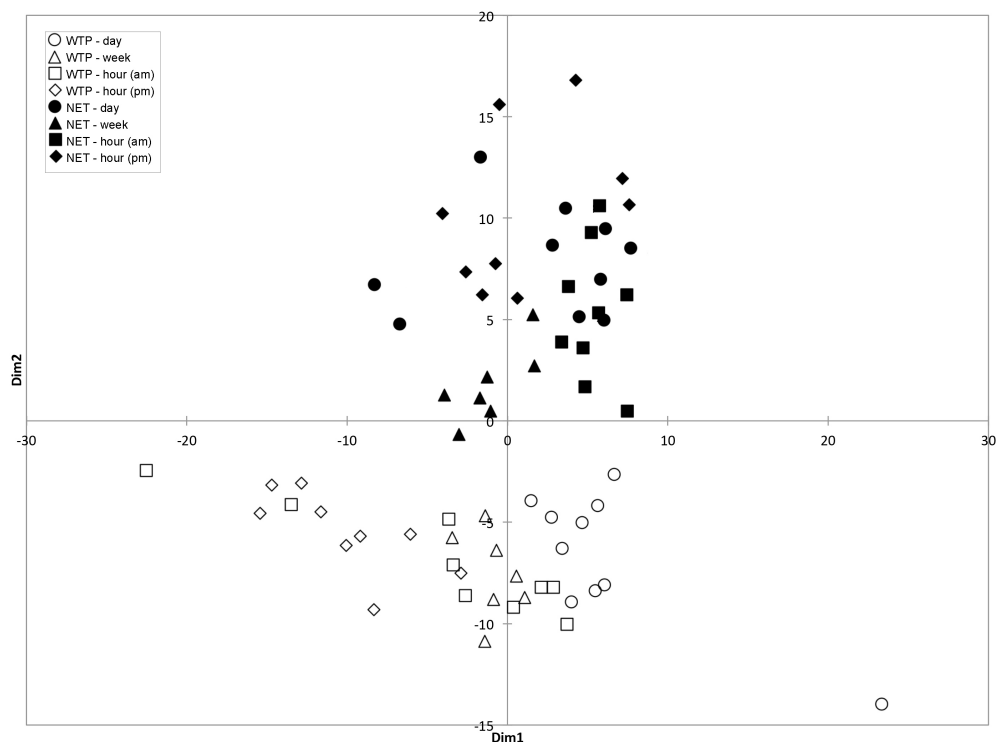

Figure 3.1. Weighted multidimensional scaling (MDS) plot for water treatment plant outlet (WTP) and distribution network location (NET) drinking water samples collected from the hour (morning; am - afternoon; pm), day and week studies. Each symbol represents an individual sample. The bigger the distance between samples, the bigger the difference in microbial community structure.

Total cell concentrations showed small (7.5%) variation at the WTP with an average of 3.8×10^5 cells mL^{-1} (Fig. 3.3A). In the network samples a dramatic increase in the total bacterial cell concentration was detected between 9 and 11 am (from 420×10^3 to $1,440 \times 10^3$ cells mL^{-1}), correlating with the community outliers detected with pyrosequencing. After 11 am the cell concentration decreased gradually down to the WTP values, with little (5.9%) variation after 5 pm. While free ATP values were below the detection limit in most samples (< 1 ng L^{-1}), bacterial ATP variations revealed a trend similar to FCM results (Fig.

3.3B). A 20% variation was observed at the WTP (average of 3 ng L⁻¹). In the network, a significant increase in ATP was detected between 9 and 11 am (from 2.5 to 11.5 ng L⁻¹), followed by a decrease reaching WTP values after 3 pm (13% variation thereafter). With respect to plate counts, higher values were continuously detected at the network location (average of 26 CFU mL⁻¹ versus 6 CFU mL⁻¹ at the treatment plant), but this method did not detect the peak in bacterial numbers during the morning (Fig. 3.3C). All other methods (pyrosequencing, FCM and ATP) independently showed and thus confirmed an unusual dramatic event.

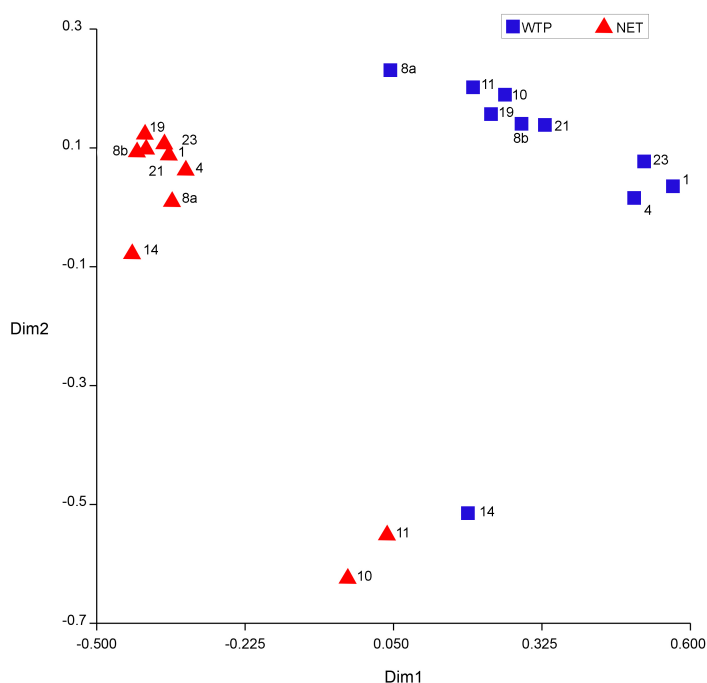

Figure 3.2. Weighted multidimensional scaling (MDS) plot for water treatment plant outlet (WTP) and distribution network location (NET) samples collected during the day study. Each symbol represents a specific sampling time, from 8 am (8a) until 8 am the next day (8b).

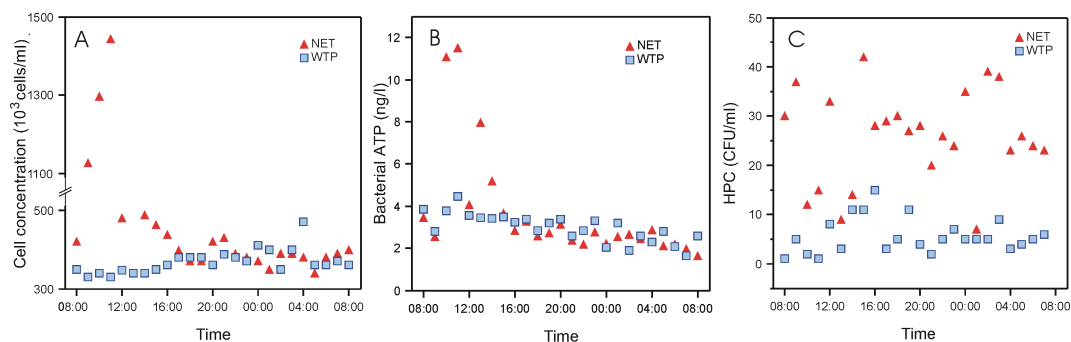

Figure 3.3. Evolution over one day of (A) flow cytometric bacterial cell concentrations, (B) bacterial ATP concentrations and (C) heterotrophic plate counts of samples collected from the water treatment plant outlet (WTP) and distribution network location (NET).

Pyrosequencing revealed that the drinking water at the plant outlet and in the distribution network harbored a diverse bacterial community (Fig. 3.4). At phylum level classification, bacteria with a relative abundance below 1% across all samples were grouped together under the “other” category. After this percentage cutoff, 9 phyla (including one candidate phylum) were identified at the plant and exhibited relative stability over 24 h (Fig. 3.4A). *Proteobacteria* dominated the community with a relative abundance of 58.3 ± 6.7 %. The remaining phyla were *Planctomycetes* (12.2 ± 2.6 %), *Bacteroidetes* (8.3 ± 2.1 %), *Actinobacteria* (5.3 ± 1.6 %), *Chloroflexi* (3.8 ± 0.9 %), *Cyanobacteria* (2.5 ± 1.2 %), *Nitrospirae* (2.3 ± 0.6 %), *Firmicutes* (2.0 ± 1.0 %) and GN02 (1.1 ± 0.4 %). *Proteobacteria* subclasses were detected in the following order of decreasing abundance (Fig. 3.4B): *Betaproteobacteria* (19.6 ± 4.7 %), *Deltaproteobacteria* (15.8 ± 3.9 %), *Alphaproteobacteria* (11.8 ± 2.9 %) and *Gammaproteobacteria* (11.0 ± 7.5 %). The outlier observed with MDS analysis at 2 pm (Fig. 3.2) was characterized by the highest abundance of *Gammaproteobacteria* (32.2%).

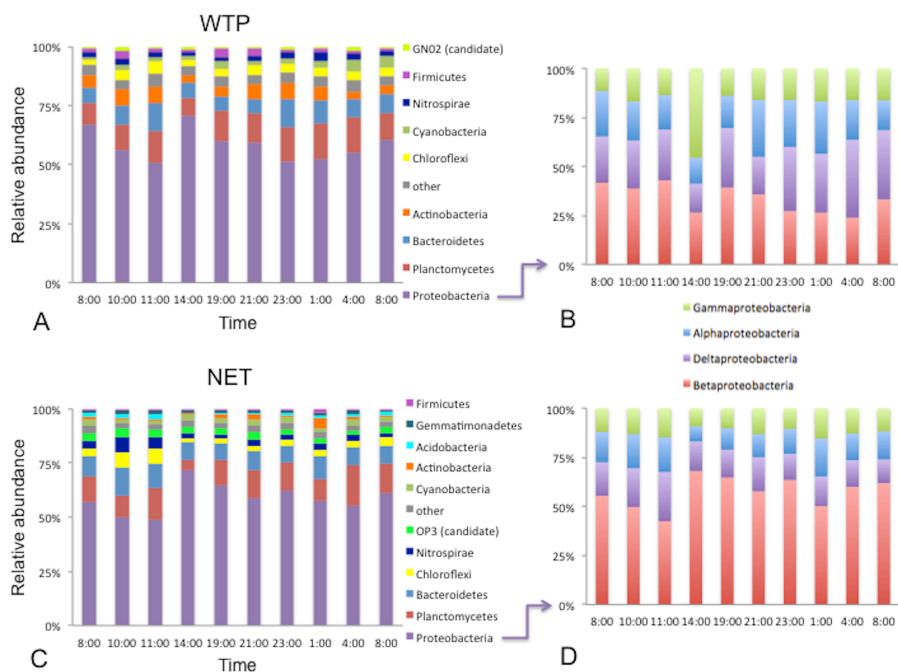

Figure 3.4. Relative abundance of bacterial phyla (A and C) and Proteobacteria classes (B and D) in samples collected from the water treatment plant outlet (WTP) and distribution network location (NET) over one day.

With respect to the network, a bacterial community composition similar to the WTP effluent was found but with varying proportions (Fig. 3.4C,D). Additionally, 3 new phyla appeared as abundant members (OP3, *Acidobacteria* and *Gemmatimonadetes*) compared to the treatment plant samples, while the GN02 candidate phylum became a rare group (< 1% abundance). The relative abundance of each phylum was (Fig. 3.4C): *Proteobacteria*; 58.6 ± 6.7 %, *Planctomycetes*; 12.2 ± 3.5 %, *Bacteroidetes*; 9.2 ± 1.8 %, *Chloroflexi*; 3.6 ± 1.9 %, *Nitrospirae*; 3.3 ± 1.6 %, OP3; 3.1 ± 0.6 %, *Cyanobacteria*; 2.4 ± 0.6 %, *Actinobacteria*; 1.5 ± 1.1 %, *Acidobacteria*; 1.2 ± 0.5 %, *Gemmatimonadetes*; 1.1 ± 0.3 % and *Firmicutes*; 1.1 ± 0.4 %. At the class level (Fig. 3.4D), an increase in the relative

abundance of *Betaproteobacteria* was observed (34.0 ± 8.2 %) coupled with a decrease in the other groups (*Deltaproteobacteria*; 9.4 ± 1.5 %, *Alphaproteobacteria*; 8.1 ± 1.5 % and *Gammaproteobacteria*; 7.1 ± 0.7 %). The outliers observed with other analyses at 10 and 11 am in the distribution network (Figs. 3.2 and 3.3) had a different bacterial community structure (lower relative abundance of *Betaproteobacteria* and higher relative abundance of *Chloroflexi* and *Nitrospirae*) as compared to the other network samples that exhibited a relatively stable community over 24 h.

Physico-chemical parameters are shown in Fig. 3.5. Water temperature increased during distribution (from 21.3 to 24.2 °C on average), but was constant over 24 h, with < 2% variation at both locations (Fig. 3.5A). TOC concentrations were slightly (0.1 mg C L^{-1} difference) but consistently lower in the network, and also stable during the day with 2–3% variation at both locations (Fig. 3.5B). Stable pH and conductivity values were measured at both locations over time (< 1% variation), with slightly lower conductivity values ($4 \text{ }\mu\text{S cm}^{-1}$ difference on average) detected in the network (Fig. 3.5C,D).

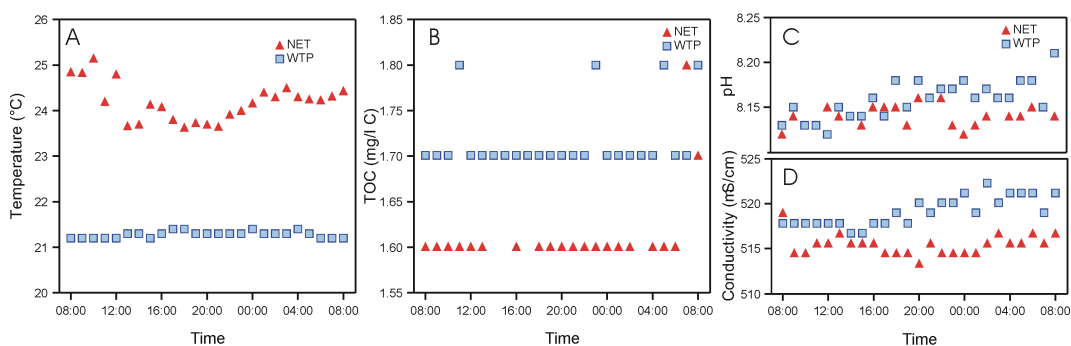

Figure 3.5. Evolution over one day of (A) temperature, (B) total organic carbon concentrations, (C) pH and (D) conductivity of drinking water samples collected from the water treatment plant outlet (WTP) and distribution network location (NET).

3.3.3 Week study

Weighted MDS analysis of the week study samples showed an ordination similar to the day study, with two distinct clusters representing the treatment plant and distribution network bacterial communities (Fig. S3.1). The WTP community appeared less stable than the network community (larger distance between samples). ANOSIM confirmed a statistically significant and strong difference between the WTP and network community structure ($p = 0.0002$; $R = 1$), while temporal variations within the two locations individually were significant but small ($p = 0.0001$; $R = 0.3423$ for the WTP and $p = 0.0007$; $R = 0.2715$ for the network). Total cell concentrations were rather stable at the two locations with ~7% variation at the WTP and ~10% variation in the network (Fig. S3.2A). Higher cell concentrations were continuously detected in the network (400×10^3 cells mL⁻¹ on average versus 330×10^3 cells mL⁻¹ for the WTP effluent) and lower cell concentrations were measured at both locations during the weekend with a surge observed on Monday (from 310×10^3 to 360×10^3 cells mL⁻¹ at the WTP and from 380×10^3 to 450×10^3 cells mL⁻¹ in the network). Bacterial ATP variations over time were not significant and slightly lower values were found in the network (Fig. S3.2B), close to the detection limit however. Plate counts varied over time and were higher in the network (Fig. S3.2C). This culture-based method showed high (up to 100%) variation during the same day (four measurements).

Pyrosequencing showed a bacterial community composition very similar to the day study, with the same groups of bacteria identified (Fig. 3.6). Temporal stability was observed at the plant over the week (Fig. 3.6A) with the following phyla: *Proteobacteria* (55.4 ± 2.7 %), *Planctomycetes* (15.6 ± 1.6 %), *Bacteroidetes* (8.4 ± 1.0 %), *Cyanobacteria* (4.2 ± 1.1 %), *Chloroflexi* (3.9 ± 0.5 %), *Actinobacteria* (3.6 ± 0.5 %), *Nitrospirae* (2.7 ± 0.4 %) and *Firmicutes* (1.3 ± 0.2 %). *Proteobacteria* subclasses were detected in the following order of decreasing

abundance (Fig. 3.6B): *Betaproteobacteria* (19.9 ± 3.4 %), *Deltaproteobacteria* (14.3 ± 1.4 %), *Alphaproteobacteria* (11.8 ± 1.1 %) and *Gammaproteobacteria* (9.3 ± 2.0 %).

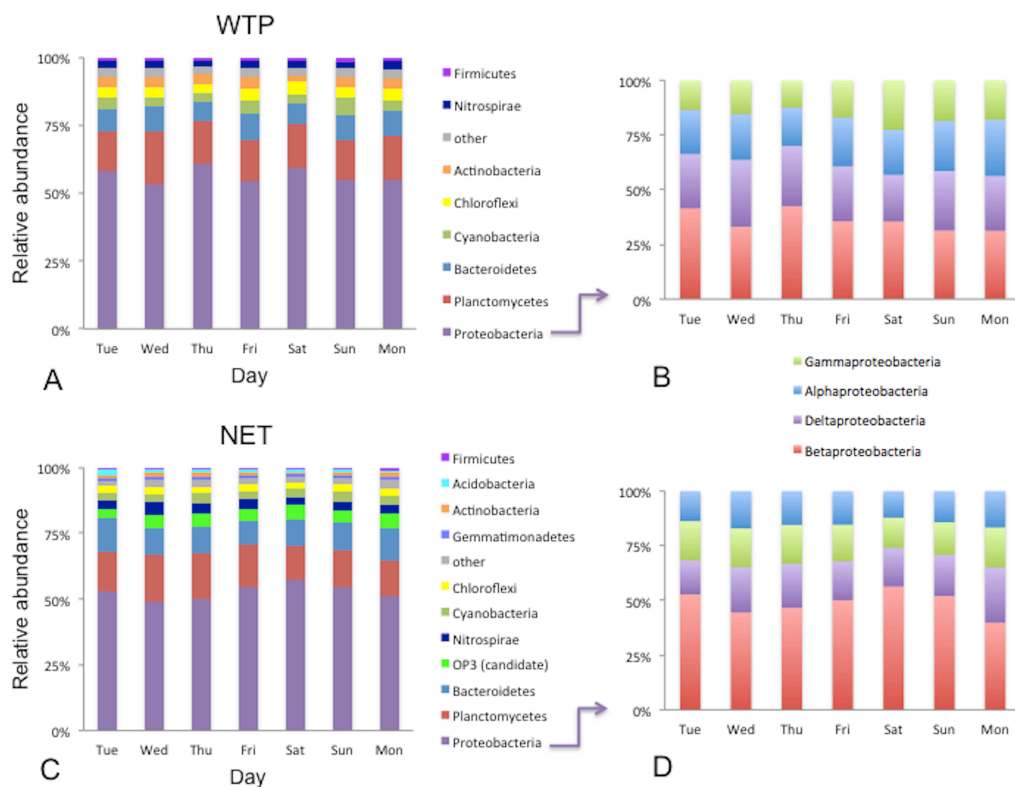

Figure 3.6. Relative abundance of bacterial phyla (A and C) and Proteobacteria classes (B and D) in samples collected from the water treatment plant outlet (WTP) and distribution network location (NET) over one week.

With respect to the network, a similar community was found in different proportions (Fig. 3.6C,D) with OP3, *Acidobacteria* and *Gemmatimonadetes* also becoming abundant groups. The relative abundance of each phylum was (Fig. 3.6C): *Proteobacteria*; 52.5 ± 3.0 %, *Planctomycetes*; 15.1 ± 2.0 %, *Bacteroidetes*; 10.7 ± 1.3 %, OP3; 4.9 ± 0.7 %, *Nitrospirae*; 3.7 ± 0.6 %, *Cyanobacteria*; 3.2 ± 0.5 %,

Chloroflexi; 2.7 ± 0.3 %, *Gemmatimonadetes*; 1.3 ± 0.2 %, *Actinobacteria*; 1.2 ± 0.3 %, *Acidobacteria*; 1.1 ± 0.4 % and *Firmicutes*; 0.9 ± 0.1 %. At the class level, a stable bacterial community was also observed over time (Fig. 3.6D). Compared to the WTP, *Betaproteobacteria* increased in relative abundance (25.8 ± 4.2 %) while the other classes decreased (although the Gamma group became more abundant than the Alpha group): *Deltaproteobacteria*; 10.2 ± 1.4 %, *Gammaproteobacteria*; 8.7 ± 0.5 % and *Alphaproteobacteria*; 7.8 ± 0.6 %.

Temporal dynamics of the total, general (or dominant), and rare bacterial taxa (defined in section 3.2.4) are shown in Fig. 3.7. Total and general taxa displayed similar dynamics (for both the treatment plant and distribution network). In the network, taxa representing Friday, Saturday and Sunday were adjacent on the plot. Considering the wide distribution of the rare taxa in the ordination and their distant position with respect to the other taxa (especially for the network), these taxa were the most dynamic. Regarding physico-chemical parameters, water temperature was higher in the network (1.6 °C difference on average) and decreased over the week at both locations (Fig. S3.3A). TOC concentrations were very similar at both locations and stable during the week with 3–4% variation (Fig. S3.3B). Similar pH and conductivity values were measured at both locations with < 1% variation over the week (Fig. S3.3C,D).

3.3.4 Core microbiome

OTUs and sequences characteristic of the plant outlet and/or network samples are shown in Fig. 3.8, generated based on a normalization zone of $\sim 6,700$ sequences per sample. In the three studies the network harbored a larger number of unique OTUs and sequences, thus showing greater bacterial richness. On the other hand, 57.8–64.9 % of the OTUs comprising 86.3–91.3 % of the reads were

found at both sites. This large fraction of common taxa constitutes the core microbiome for this drinking water distribution system.

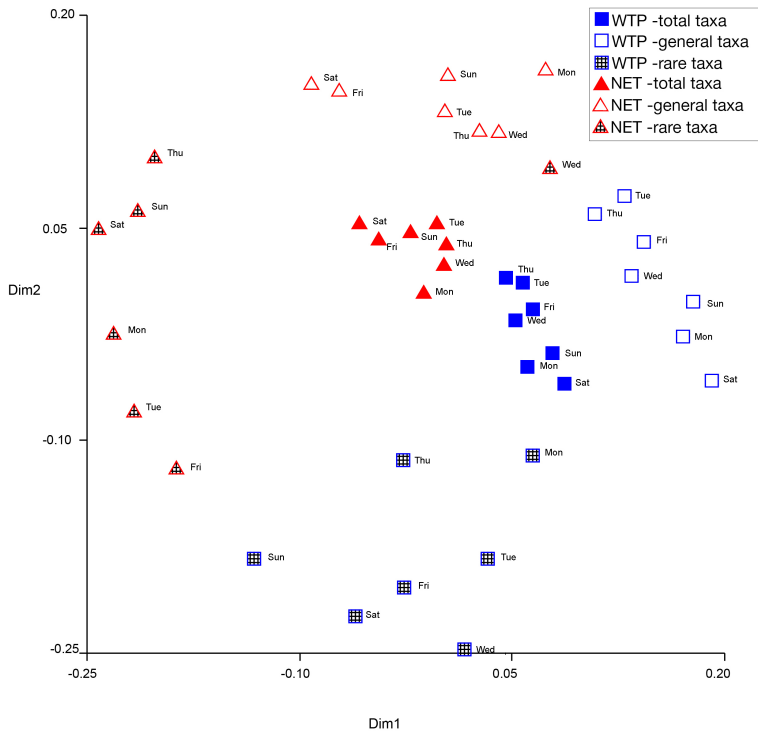

Figure 3.7. Ordination of nonmetric multidimensional scaling (MDS) based on operational taxonomic units (OTUs) (3% divergence) for total, general and rare taxa obtained from the water treatment plant outlet (WTP) and distribution network location (NET) samples collected over one week.

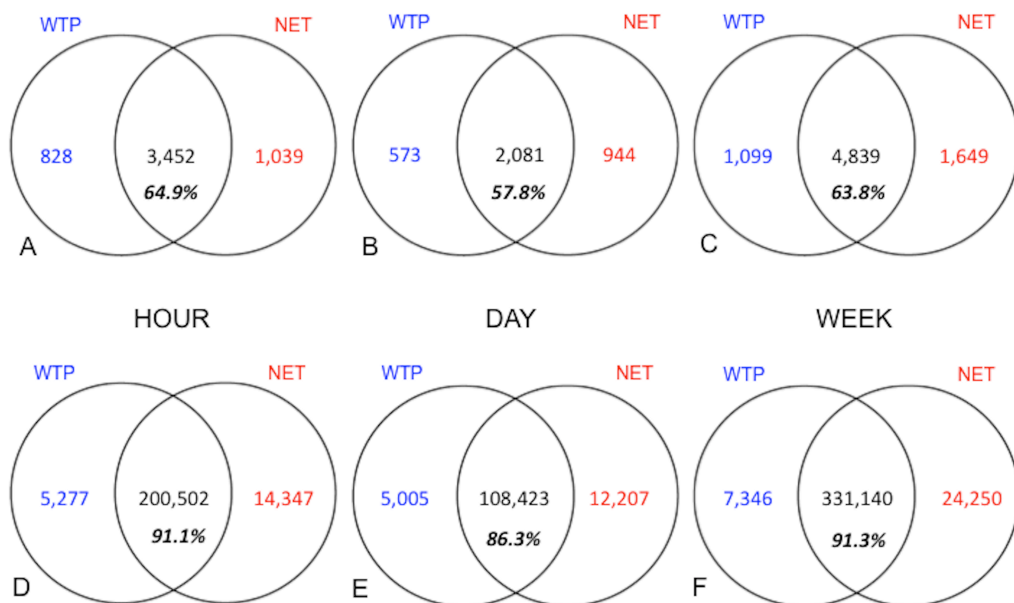

Figure 3.8. Venn diagrams showing number of operational taxonomic units (OTUs) (A, B and C) and sequences (D, E and F) in the water treatment plant outlet (WTP), distribution network location (NET) and both (shared fraction) for the hour (A and D), day (B and E) and week (C and F) studies. The shared fraction is also expressed as a percentage (%).

3.4. Discussion

3.4.1 Temporal variations: insignificant at plant and network locations

The microbial community at the two individual sampling locations was stable over time. With respect to the plant effluent, FCM total bacterial cell count variations were less than 10% and bacterial activity (ATP measurements) did not fluctuate significantly either (Figs. 3.3 and S3.2). With the exception of one outlier (Figs. 3.2 and 3.4), pyrosequencing revealed a similar bacterial community composition at all sampling times with a small change in the proportion of each phylotype (< 7%). One reason for this relative stability could be high flow rates near the plant that hinder water stagnation, sedimentation and other disrupting

processes (Nescerecka et al., 2014). A second justification involves appropriate treatment applying biofiltration which is likely to have exerted a stabilizing force on the bacterial communities in the produced water. This was also shown in a study by Pinto and colleagues (2012) where postfiltration samples were largely decoupled from the temporal effects observed in prefiltration samples. At the network location, flow cytometric temporal variations were also less than 10%, excluding the dramatic event that was observed during the 24 h sampling when a notable increase in bacterial cell concentration was measured at 10 and 11 am (also detected with ATP and pyrosequencing analyses but not with HPC) (Figs. 3.2-3.4 and S3.2). The tap in this study was located in a university laboratory and thus the event cannot be justified by local water consumption patterns as most people arrive at 8-9 am. An event early in the morning or around lunchtime when water usage changes would have been more plausible (Besmer et al., 2014). The reason behind an increased abundance of nitrifiers and *Chloroflexi* in these two particular samples is unknown. These two groups of bacteria have been associated with loose deposits (Liu et al., 2014). An inexplicable hydraulic event may have occurred causing a disturbance in suspended solids and loose deposits, leading to increased cell concentrations and the appearance of these bacteria in the bulk water phase. It should be pointed out that the hour measurements were repeated in the morning of 7 additional days and analyzed with flow cytometry (data not shown). The morning peak was not detected again and variations were less than 8% on all days, showing that the detected peak was incidental. Another discrepancy detected was the weekday/weekend pattern (Figs. 3.7, S3.1 and S3.2A). Samples collected during the weekend clustered together in MDS plots and had lower cell counts. This could be linked with water consumption routines, highlighting the influence of hydraulic conditions on bacterial communities in tap water. Nevertheless, disregarding the morning event observed in the network, temporal variations in the water microbiology

were generally not substantial at both sites. It should be highlighted that this water was distributed in the network without disinfectant residuals.

3.4.2 Distribution effect: change linked with rare taxa

A change in bulk water microbiology was found during distribution. Significantly higher FCM total cell concentrations were measured at the network location (403×10^3 cells mL⁻¹ on average) compared to the plant outlet (347×10^3 cells mL⁻¹ on average) for the three studies combined (hour, day and week). This increase in cell number would be associated with a conversion of 5.6 $\mu\text{g AOC L}^{-1}$ (Hammes et al., 2006). A significant change in the community structure was also found with pyrosequencing and statistical analyses. Some taxa present at the plant disappeared in the network (Fig. 3.8). This could be due to cell lysis by indigenous, resistant viruses and/or protozoa (if present) (Berry et al., 2006) or simply due to the stressful, oligotrophic environment of DWDSs where some species have a competitive advantage over others. Chlorine dioxide disinfection at the plant may also have caused the slow disintegration of these microorganisms in the network despite the absence of disinfectant residuals in the produced drinking water. More importantly, planktonic bacteria represent a small fraction of the microbial load established in a DWDS, whereby bacterial activity can be heavily associated with pipe biofilms and loose deposits (Liu et al., 2014). These habitats are inherently dynamic and during water distribution some species may have become trapped in biofilms or sediments resulting in their “disappearance” from the water phase.

Compared to the plant effluent, the network was characterized by greater bacterial richness (Fig. 3.8) and promoted the growth of some phylotypes that were not abundant at the plant (Figs. 3.4 and 3.6). These rare taxa constituted a diverse, small fraction of the community (3–4%) and exhibited the highest dynamicity (Fig. 3.7). Likely these microorganisms are highly oligotrophic,

however their role in DWDSs is not described in the literature yet and the specific environmental or hydraulic conditions that favored their growth are unknown. While pH and conductivity did not vary during distribution a small rise in temperature was detected (Figs. 3.5 and S3.3). Temperature changes can greatly affect microbial processes and metabolism. For instance higher bacterial abundance and richness in drinking water during the summer season has been previously reported (McCoy and VanBriesen, 2014; Pinto et al., 2014). The increased water temperature, combined with the absence of disinfectant residuals, could have induced the growth of rare taxa. Furthermore, the continuously running tap may have affected water hydraulics causing the detachment of some cells from biofilms and/or the resuspension of sediment-associated bacteria, hence their manifestation in the water phase. Pipe material also may have affected the microbial community of this system. The main piping originating from the treatment plant is cemented steel while in the university town PVC is used. It is possible that this conversion in pipe material had affected the bacterial community composition and corresponding ecosystem balance, with e.g. the different materials releasing chemicals that would act as substrates for some bacteria and as inhibitors for others (Ingerson-Mahar and Reid, 2012).

3.4.3 Core microbiome: diverse and persistent

Despite the change detected during distribution a substantial shared microbiome was found between the produced and distributed water (Fig. 3.8). The bacterial phyla detected were characteristic of DWDSs, particularly those that apply a similar treatment strategy. *Proteobacteria* found in most freshwater environments dominated and the remaining phylotypes have been found in drinking water treated by biofiltration and distributed without disinfectant residuals, i.e. applying the “starvation versus suppression” approach common in European countries (Hammes et al., 2010; Smeets et al., 2009). A similar bacterial

community composition has been reported in drinking water systems that employ this strategy despite using groundwater as a source (Liu et al., 2014; Martiny et al., 2005), thus supporting the finding that the biofilter both seeds and shapes the water microbiome (Lautenschlager et al., 2014; Pinto et al., 2012). The core microbiome in this study was diverse and persistent with time and location, and variations happened mainly with the rare phylotypes. *Betaproteobacteria* have been found more frequently in non-chlorinated DWDSs (Emtiazi et al., 2004; Lautenschlager et al., 2013) and this could explain their increased abundance during distribution. *Nitrospirae* have been found in the absence of chlorinated nitrogen compounds, originating from sand filter biofilms and surviving starvation periods (Martiny et al., 2005). The precise conditions that promoted the growth of other less abundant groups such as *Acidobacteria* and *Gemmatimonadetes* are unknown, although these two phyla were linked with similar warm temperatures (20–25 °C) in a study by Pinto and colleagues (2014).

3.4.4 Biological stability: accepting change

“Biologically stable water does not promote the growth of microorganisms during its distribution” (Rittmann and Snoeyink, 1984). There are no guidelines that delineate the concept of biological stability in terms of microbial community composition (identity), structure (relative abundance) or cell number. A substantial baseline microbiome was established for this DWDS and temporal variations were insignificant. A change however in the bacterial community structure was observed during distribution, driven mainly by the rare taxa. Further research is needed to understand the function of these rare phylotypes and their impact on the overall ecology. Given the stringent regulations enforced in the Netherlands and the high quality of the supplied drinking water, this change or “biological instability” detected during distribution did not have hygienic implications– it is therefore the norm and contingent on the sensitivity

of the applied analytical methods (pyrosequencing and FCM). When a core microbiome is established for a DWDS, deviations can be accepted as long as the water quality is not compromised from a public health perspective. Biostability is generally desired in drinking water guidelines but it is not an absolute measure of safety and may be difficult to achieve in large-scale complex distribution systems that are inherently dynamic. The concept of biological stability needs to be revised and quantified, allowing a certain degree of change in microbiology.

3.5. Conclusions

This is the first study that applies a combination of methods to examine drinking water bacterial dynamics at high temporal resolution in a full-scale drinking water distribution system. The main findings were:

- The bacterial community profile at the treatment plant and distribution network locations did not vary significantly over time (hour/ day/ week).
- A substantial core microbiome was shared between the produced and distributed water, shaped by the treatment strategy i.e. biofiltration and absence of disinfectant residuals.
- The bacterial community structure changed during distribution, with greater bacterial richness detected in the network.
- The rare taxa exhibited the highest dynamicity causing the major change detected during water distribution.
- Conventional microbial analysis techniques were not adequate to measure changes in the bacterial community.
- With the advance of more sensitive microbial analysis techniques, the concept of biological stability needs to be revised.

Supplementary Material

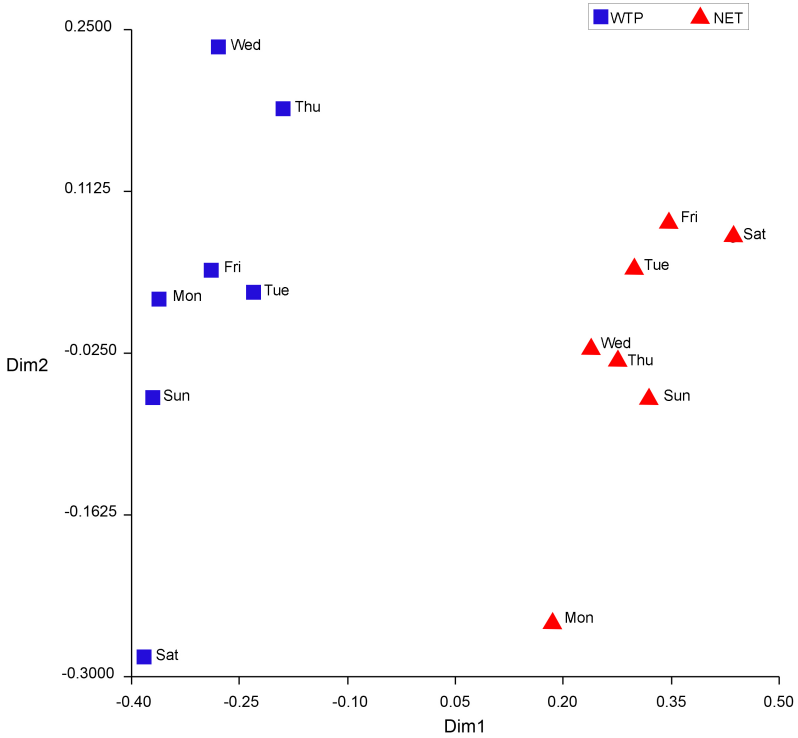

Figure S3.1. Weighted multidimensional scaling (MDS) plot for water treatment plant outlet (WTP) and distribution network location (NET) samples collected from the one week study.

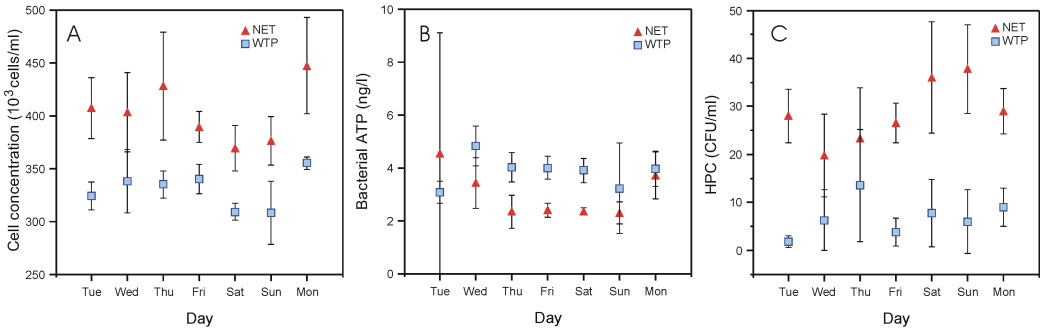

Figure S3.2. Evolution over one week of (A) flow cytometric cell concentrations, (B) bacterial ATP concentrations and (C) heterotrophic plate counts of samples collected from the water treatment plant outlet (WTP) and distribution network location (NET).

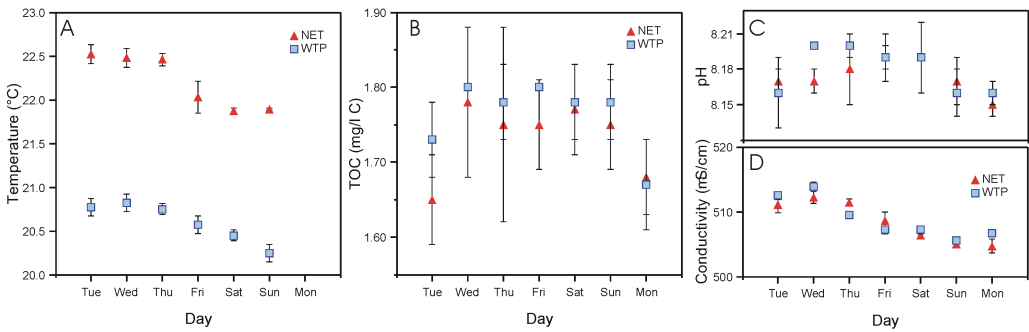

Figure S3.3. Evolution over one week of (A) temperature, (B) total organic carbon concentrations, (C) pH and (D) conductivity of samples collected from the water treatment plant outlet (WTP) and distribution network location (NET).

Bibliography

Berry, D., Xi, C., Raskin, L., 2006. Microbial ecology of drinking water distribution systems. *Curr. Opin. Biotechnol.* 17 (3), 297–302.

Besmer, M.D., Weissbrodt, D.G., Kratochvil, B.E., Sigrist, J.A., Weyland, M.S., Hammes, F., 2014. The feasibility of automated online flow cytometry for in-situ monitoring of microbial dynamics in aquatic ecosystems. *Front. Microbiol.* 5, 265.

Emtiazi, F., Schwartz, T., Marten, S.M., Krolla-Sidenstein, P., Obst, U., 2004. Investigation of natural biofilms formed during the production of drinking water from surface water embankment filtration. *Water Res.* 38 (5), 1197–1206.

Hammes, F., Salhi, E., Koster, O., Kaiser, H.P., Egli, T., von Gunten, U., 2006. Mechanistic and kinetic evaluation of organic disinfection by-product and assimilable organic carbon (AOC) formation during the ozonation of drinking water. *Water Res.* 40 (12), 2275–2286.

Hammes, F., Berger, C., Koster, O., Egli, T., 2010. Assessing biological stability of drinking water without disinfectant residuals in a full-scale water supply system. *J. Water Supply: Res. Technol. – AQUA* 59 (1), 31–40.

Hu, J.Y., Wang, Z.S., Ng, W.J., Ong, S.L., 1999. The effect of water treatment processes on the biological stability of potable water. *Water Res.* 33 (11), 2587–2592.

Ingerson-Mahar, M., Reid, A., 2012. MIP: The microbiology of the water distribution system. American Academy of Microbiology, Boulder, CO.

Lautenschlager, K., Hwang, C., Liu, W.T., Boon, N., Koster, O., Vrouwenvelder, H., Egli, T., Hammes, F., 2013. A microbiology-based multi-parametric approach towards assessing biological stability in drinking water distribution networks. *Water Res.* 47 (9), 3015–3025.

Lautenschlager, K., Hwang, C., Ling, F., Liu, W.T., Boon, N., Koster, O., Egli, T., Hammes, F., 2014. Abundance and composition of indigenous bacterial communities in a multi-step biofiltration-based drinking water treatment plant. *Water Res.* 62, 40–52.

LeChevallier, M.W., Shaw, N.E., Kaplan, L.A., Bott, T.L., 1993. Development of a rapid assimilable organic carbon method for water. *Appl. Environ. Microbiol.* 59 (5), 1526–1531.

Liu, G., Verberk, J.Q., van Dijk, J.C., 2013. Bacteriology of drinking water distribution systems: an integral and multidimensional review. *Appl. Microbiol. Biotechnol.* 97 (21), 9265–9276.

Liu, G., Bakker, G.L., Li, S., Vreeburg, J.H., Verberk, J.Q., Medema, G.J., Liu, W.T., van Dijk, J.C., 2014. Pyrosequencing reveals bacterial communities in unchlorinated drinking water distribution system: an integral study of bulk water, suspended solids, loose deposits, and pipe wall biofilm. *Environ. Sci. Technol.* 48 (10), 5467–5476.

Magic-Knezev, A, van der Kooij, D., 2004. Optimisation and significance of ATP analysis for measuring active biomass in granular activated carbon filters used in water treatment. *Water Res.* 38 (18), 3971–3979.

Martiny, A.C., Albrechtsen, H.J., Arvin, E., Molin, S., 2005. Identification of bacteria in biofilm and bulk water samples from a nonchlorinated model drinking water distribution system: detection of a large nitrite-oxidizing population associated with *Nitrospira* spp. *Appl. Environ. Microbiol.* 71 (12), 8611–8617.

McCoy, S.T., VanBriesen, J.M., 2013. Comparing spatial and temporal diversity of bacteria in a chlorinated drinking water distribution system. *Environ. Eng. Sci.* 31 (1), 32–41.

Nescerecka, A., Rubulis, J., Vital, M., Juhna, T., Hammes, F., 2014. Biological instability in a chlorinated drinking water distribution network. *PLoS ONE* 9 (5): e96354.

Pinto, A.J., Xi, C., Raskin, L., 2012. Bacterial community structure in the drinking water microbiome is governed by filtration processes. *Environ. Sci. Technol.* 46 (16), 8851–8859.

Pinto, A.J., Schroeder, J., Lunn, M., Sloan, W., Raskin, L., 2014. Spatial-temporal survey and occupancy-abundance modeling to predict bacterial community dynamics in the drinking water microbiome. *mBio* 5 (3): e01135-14.

Polanska, M., Huysman, K., van Keer, C., 2005. Investigation of assimilable organic carbon (AOC) in Flemish drinking water. *Water Res.* 39 (11), 2259–2266.

Prest, E.I., Hammes, F., Kotzsch, S., van Loosdrecht, M.C.M., Vrouwenvelder, J.S., 2013. Monitoring microbiological changes in drinking water systems using a fast and reproducible flow cytometric method. *Water Res.* 47 (19), 7131–7142.

Prest, E.I., El-Chakhtoura, J., Hammes, F., Saikaly, P.E., van Loosdrecht, M.C.M., Vrouwenvelder, J.S., 2014. Combining flow cytometry and 16S rRNA gene pyrosequencing: a promising approach for drinking water monitoring and characterization. *Water Res.* 63, 179–189.

Ramseier, M.K., Peter, A., Traber, J., von Gunten, U., 2011. Formation of assimilable organic carbon during oxidation of natural waters with ozone, chlorine dioxide, chlorine, permanganate, and ferrate. *Water Res.* 45 (5), 2002–2010.

Revetta, R.P., Pemberton, A., Lamendella, R., Iker, B., Santo Domingo, J.W., 2010. Identification of bacterial populations in drinking water using 16S rRNA-based sequence analyses. *Water Res.* 44 (5), 1353–1360.

Rittmann, B.E., Snoeyink, V.L., 1984. Achieving biologically stable drinking water. *J. Am. Water Works Assoc.* 76 (10), 106–114.

Rook, J.J., 1976. Haloforms in drinking-water. *J. Am. Water Works Assoc.* 68 (3), 168–172.

Smeets, P.W.M.H., Medema, G.J., van Dijk, J.C., 2009. The Dutch secret: how to provide safe drinking water without chlorine in the Netherlands. *Drink. Water Eng. Sci.* 2, 1–14.

Smeets, P.W.M.H., Rietveld, L.C., van Dijk, J.C., Medema, G.J., 2010. Practical applications of quantitative microbial risk assessment (QMRA) for water safety plans. *Water Sci. Technol.* 61 (6), 1561–1568.

van der Kooij, D., 2000. Biological stability: a multidimensional quality aspect of treated water. *Water Air Soil Pollut.* 123 (1–4), 25–34.

Chapter 4

The Netherlands: fresh water - conventional treatment

**Bacterial spatial dynamics:
during distribution and network flushing**

This chapter has been published as: El-Chakhtoura, J., Saikaly, P.E., van Loosdrecht, M.C.M., Vrouwenvelder, J.S., 2018. Impact of distribution and network flushing on the drinking water microbiome. *Frontiers in Microbiology* 9, 2205.

Abstract

We sampled the tap water of seven unique, full-scale drinking water distribution systems at different locations as well as the corresponding treatment plant effluents to evaluate the impact of distribution and the potential presence of a core drinking water microbiome. The water was also sampled during network flushing to examine its effect on the microbial ecology. While a core microbiome dominated by *Gammaproteobacteria* was found using 16S rRNA gene pyrosequencing, an increase in biomass was detected in the networks, especially during flushing. Water age did not significantly impact the microbiology. Irrespective of differences in treatment plants, tap water bacterial communities in the distinct networks converged and highly resembled the flushed water communities. Piping biofilm and sediment communities therefore largely determine the final tap water microbial quality, attenuating the impact of water source and treatment strategy and highlighting the fundamental role of local physicochemical conditions and microbial processes within infrastructure micro-niches.

4.1. Introduction

Drinking water is nowhere near a sterile environment; after leaving a treatment plant it travels long distances in large distribution networks that are home to hundreds or thousands of species of bacteria, archaea, viruses, fungi and invertebrates (Ingerson-Mahar and Reid, 2012; van der Wielen et al., 2009). However, most of these organisms are benign; e.g. it is estimated that completely safe water contains 10^6 – 10^8 bacterial cells per liter (Hammes et al., 2008; Lautenschlager et al., 2010). Excessive microbial growth in drinking water distribution systems (DWDSs) can become problematic though when it causes pipe corrosion (Beech and Sunner, 2004; Lee et al., 1980), nitrification (Lipponena et al., 2002; Regan et al., 2003), aesthetic (water taste, odor, discoloration) (Hoehn, 1988; van der Kooij, 2000) and/or health (pathogen proliferation) (Emtiazi et al., 2004; Thomas et al., 2004) concerns. Waterborne illnesses continue to occur today even in developed countries that employ advanced water treatment technologies, where e.g. in the U.S. 4–32 million cases are reported annually (Colford et al., 2006; Messner et al., 2006), and the primary cause of drinking water-associated disease outbreaks is *Legionella pneumophila* in building plumbing systems (Beer et al., 2015). Characterizing the microbial communities indigenous to DWDSs and understanding network micro-scale processes is essential for assessing contamination risks and optimizing engineering designs.

A drinking water distribution system is a dynamic ecological niche for microbes that may be influenced by selection, drift, dispersal and speciation processes whereby the resultant microbial tap water quality reflects historical population dynamics within the community as it was transported through a complex network interacting with its surroundings (El-Chakhtoura et al., 2015; Schroeder et al., 2015; Vellend, 2010). Research on the drinking water microbiome

with high-throughput sequencing methods is relatively nascent compared to e.g. the human gut, ocean, or soil microbiomes (Bautista-de los Santos et al., 2016). While most studies have reported *Alpha-* and *Beta-Proteobacteria* as the dominant bacterial groups thriving under different network physico-chemical and operational conditions, bacterial community structure and diversity has varied between DWDS studies (Holinger et al., 2014; Lautenschlager et al., 2013; Liu et al., 2014; Pinto et al., 2014) and occasionally different findings have been reported in different DWDSs pertaining to the impact of treatment strategy, temporal, spatial, hydraulic and abiotic factors on drinking water microbiota. Investigating multiple DWDSs simultaneously applying a consistent methodology provides an opportunity to explore the core drinking water microbiome (or lack thereof) while avoiding biases that may arise from various sampling, DNA extraction, PCR amplification and sequencing protocols used in different studies. In this study we sampled the water of seven unique, full-scale DWDSs at different locations as well as the corresponding water treatment plant (WTP) effluents in order to evaluate the impact of distribution and the potential presence of a baseline drinking water microbiome. We also sampled the water during flushing of the networks (routinely performed for cleaning purposes) to examine its effect on the water microbiology.

4.2. Materials and Methods

4.2.1 Sampling scheme

The research was conducted on seven full-scale drinking water treatment plants in The Netherlands and their corresponding distribution networks. Each plant (labeled a to g) is unique, treating surface or/and groundwater applying various

treatment strategies, listed in Table S4.1. All the plants distribute drinking water that does not contain disinfectant residual. The pipes at the outlet of each WTP are made of steel and were built in different years, from 1967 to 1992 (Table S4.2). As for distribution network pipes, either polyvinyl chloride (PVC) or asbestos cement (AC) is used at the locations where water samples were collected, and construction / renovation dates range from 1950 to 2009 (Table S4.2), with inner diameters of over 50 mm. Throughout the distribution networks though the pipes have different characteristics and sundry materials including cast iron and polyethylene are used. Bulk water samples were collected from (i) the treatment plant outlet (WTP) and from the distribution network (ii) before (TAP) and (iii) during (FLUSH) flushing. The network water samples (TAP and FLUSH) were taken from different locations, representing short, middle and long distance from the treatment plant. The sampling took place in September / October 2011. A total of 56 water samples were collected and analyzed. For the WTP, two samples were collected from each outlet, a week apart, and the two samples were pooled as one in subsequent microbial analysis. As for the distribution networks (TAP and FLUSH), three samples were collected from each network at different locations (short, middle and long distance) with the average hydraulic residence time estimated by the local water utilities to be 12 h, 23 h and 41 h, respectively. These three samples were collected on the same day, on different days for the different plants (Sept. 14 for plant a, Oct. 10 for plant b, Oct. 10 for plant c, Sept. 7 for plant d, Oct. 6 for plant e, Oct. 12 for plant f and Sept. 21 for plant g). TAP samples were collected from household taps. Unidirectional network flushing was conducted by applying high flow velocities (extra flow of 1.0 m s^{-1}) as described by van Lieverloo et al. (2004) and samples were collected from fire hydrant faucets (on mains adjoining the sampled houses) during the flushing process (Fig. S4.1). Depending on the required subsequent analysis, samples were collected in specific, separate bottles as described in Chapter 2. All samples

were transported on ice to the laboratory, stored at 4 °C and processed within 24 h. For 16S rRNA gene pyrosequencing, each 3 L sample was filtered through a 0.2 µm-pore-size Isopore membrane filter using sterile (autoclaved) filtration units (Millipore, Billerica, MA, USA) and the filters were stored at -20 °C until processing.

4.2.2 Physico-chemical and microbial analysis

Each water sample was analyzed for temperature, turbidity, total organic carbon (TOC), adenosine triphosphate (ATP) and heterotrophic plate counts (HPCs). Temperature and turbidity were measured directly on site. TOC was measured according to a Dutch standard procedure (NEN-EN 1484). ATP analysis was carried out as described previously by Magic-Knezev and van der Kooij (2004). A pre-calibrated luminometer (Celsis Advance TM230) was used to measure the intensity of the emitted light. The detection limit of the method was 1 ng ATP L⁻¹. Unlike free ATP measurements, a nucleotide-releasing buffer step was added for total ATP analysis. Bacterial ATP concentrations were calculated by subtracting free ATP from total ATP concentrations. Free ATP values were below the detection limit in most samples. The HPC method was performed with yeast extract agar and the plates were incubated at 22 °C for 3 days (Dutch procedure NEN-EN-ISO 6222).

4.2.3 16S rRNA gene pyrosequencing and data processing

Genomic DNA was extracted from the collected (filtered) biomass using the FastDNA SPIN Kit (MP Biomedicals, Santa Ana, CA, USA) according to the manufacturer's instructions. Bacterial 16S rRNA genes were amplified with the bacteria-specific forward primer 515F (5'-LinkerA-Barcode-GTGYCAGCMGCCGCGGTA-3') and reverse primer 909R (5'-LinkerB-

CCCCGYCAATTCMTTTRAGT-3'). A single-step 28-cycle polymerase chain reaction (PCR) using the HotStarTaq Plus Master Mix Kit (Qiagen, Valencia, CA, USA) was performed for each DNA sample (triplicate reactions) under the following conditions: initial denaturation at 94 °C for 3 min, followed by 28 cycles of 94 °C for 30 s; 53 °C for 40 s and 72 °C for 1 min; after which a final elongation step at 72 °C for 5 min was performed. Following PCR, all amplicon products from different samples were mixed in equal concentrations and then purified using Agencourt AMPure beads (Agencourt Bioscience Corp., Beverly, MA, USA). Pyrosequencing was carried out at MR DNA Lab (Shallowater, TX, USA) on the Roche 454 FLX Titanium genome sequencer according to the manufacturer's instructions. Sequence data was processed at MR DNA Lab. In summary, sequences were depleted of barcodes and primers, then sequences <150 bp were removed, as well as sequences with ambiguous base calls and with homopolymer runs exceeding 6 bp. Sequences were denoised, operational taxonomic units (OTUs) generated and chimeras removed. OTUs were defined by clustering at 3% sequence divergence (97% similarity). Final OTUs were taxonomically classified using BLASTn against a curated database derived from NCBI and Greengenes.

4.2.4 Bioinformatic and statistical analysis

To study alpha-diversity Shannon-Weaver index and Chao1 richness estimator were computed for each sample using the R vegan package. Heatmaps showing relative taxonomic abundance were generated in the R Complex Heatmap package. Bar plots showing phylotype relative abundance were created using the R ggplot2 package. Venn diagrams showing unique and shared fraction of OTUs were created using the R VennDiagram package. Multidimensional scaling (MDS) was performed with the Bray-Curtis matrix using the R statistical package to ordinate the OTU data (samples with similar community structure cluster

together, taking into account the relative abundance of each OTU). Analysis of similarity (ANOSIM) was used to examine statistical significance between samples using the same Bray-Curtis distance matrix (vegan package within R). ANOSIM tests the null hypothesis that the average rank similarity between objects within a group is the same as the average rank similarity between objects between groups. It produces a test statistic (R) which can range from -1 to $+1$. Objects that are more dissimilar between groups than within groups will be indicated by an R statistic greater than 0 . An R value of 0 indicates the null hypothesis is true. A level of significance (p value) is also produced (Rees et al., 2004).

4.3. Results and Discussion

4.3.1 Change in drinking water quality during distribution and flushing

The water physico-chemical and microbial parameters were measured at the production site and in the distribution networks at the taps before and during flushing (Fig. 4.1). Some characteristics were affected by distribution and flushing. Most notable was the increase in bacterial richness and diversity, as indicated by HPCs, OTUs, and Shannon / Chao1 values, possibly indicating bacterial growth. Shannon diversity median values increased from 4.30 in the treatment plant effluent to 4.69 in the tap water and to 4.89 in the flushed water (Fig. 4.1B). Chao1 richness median values increased from 299.56 in the WTP to 398.69 in the tap water and to 589.83 in the flushed water (Fig. 4.1C). The largest range of variation was found in the community diversity (Shannon index) of the treatment plant effluents, likely due to the various water sources and treatment schemes used (Table S4.1), which host or disseminate diverse bacterial

communities in each unique system: surface or groundwater indigenous microbiota, species selected for with e.g. the addition of different chemicals during the treatment process, innocuous bacteria that disperse from biological filter media etc. As for potential bacterial growth in the DWDSs, the exact cause is unknown. For mesophilic bacteria the slightly warmer environment of the networks may have accelerated chemical and enzymatic reactions, triggering metabolic activity and growth (McCoy and VanBriesen, 2014). This is supported by the relative increase in ATP values. The alteration in pipe material from steel at all the WTP outlets to PVC or AC in the networks (and other various materials near the sample locations where the water had flowed) (Table S4.2) may have been another factor. Different materials release different chemicals that act as substrates for some bacteria and as inhibitors for others. It has been reported that plastic substrates prompt biofilm growth due to the leaching of biodegradable compounds (Keevil, 2003). Asbestos cement has also been linked with the growth of slime forming and heterotrophic aerobic bacteria (Wang and Cullimore, 2010). Aging of network pipes has also been correlated with changes in bacterial communities. It takes years for pipe-wall biofilms to mature, and old corroding pipes release particles that can serve as a nutrient source for microbes (Ingerson-Mahar and Reid, 2012; Martiny et al., 2005; Pinto et al., 2014). Moreover, little is known about how water microbiota respond to the insertion of new (disinfected but unsterile) pipes during renovation periods.

A

	WTP	TAP	FLUSH
Temperature (°C)	14.6 (± 2.8)	16.4 (± 2.6)	16.0 (± 2.7)
Turbidity (NTU)	< 0.05	0.10 (± 0.05)	5.7 (± 8.4)
TOC (mg/L)	1.8 (± 0.1)	2.2 (± 0.6)	3.2 (± 2.0)
ATP (ng/L)	6.6 (± 1.2)	7.0 (± 4.3)	114 (± 112)
HPCs 22°C (CFU/mL)	6 (± 6)	27 (± 38)	169 (± 205)
Raw reads	138095	185678	241478
OTUs	828	1183	1213

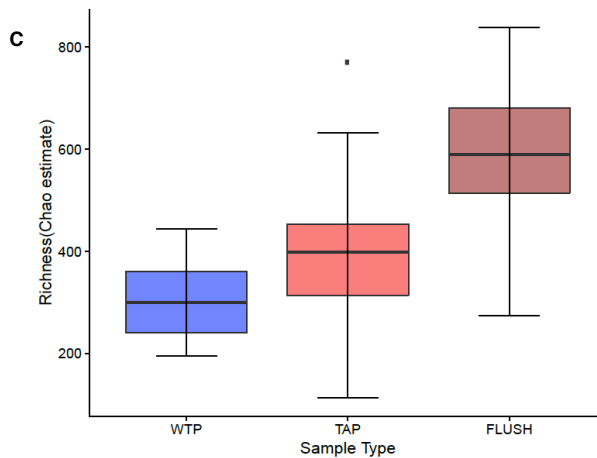
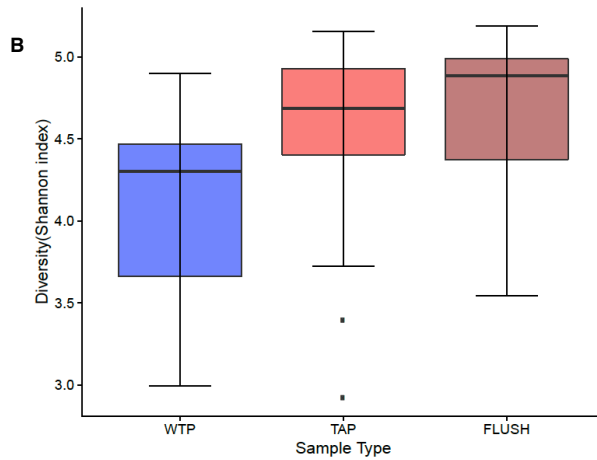

Figure 4.1. Water characteristics for treatment plant effluents (WTP), distribution network tap (TAP) and flushed (FLUSH) water. (A) Values represent the average (and standard deviation) of measurements taken from the 7 plants and corresponding networks (14 WTP samples, 21 TAP samples, 21 FLUSH samples). TOC= total organic carbon; ATP= Adenosine triphosphate; HPC= heterotrophic plate count; OTU= operational taxonomic unit. (B) Shannon diversity and (C) Chao1 richness box plots: Displayed are IQRs or interquartile ranges (1st and 3rd quartiles; boxes), medians (horizontal lines in the boxes), minimum and maximum values within 1.5 IQR (whiskers below and above the boxes), and outliers (dark points beyond the whiskers).

Bacteria in DWDSs grow in different microenvironments: the bulk water, biofilm attached to the inner pipe surface, loose deposits accumulated at the bottom of the pipe, and suspended solids transported through the mains (Liu et al., 2013). The contribution of the last two phases to total biomass diversity and activity is often overlooked and was found to be highest compared to the other phases (Liu et al., 2014), with e.g. more than 90 bacterial cells per particle found in Liu et al. (2016). These four phases are dynamic and interchangeable under certain conditions. It is possible that during water distribution the increase in microbial parameter values was not due to bacterial growth but rather due to biofilm sloughing or deposit resuspension due to changing consumption or hydraulic events, causing the flow of some taxa into the bulk water phase. Similarly, during network flushing, high flow rates re-suspended deposits and exerted shear forces on the biofilm, causing attached and trapped bacteria (as well as any other non-sessile microorganisms) to (partially) dislodge and mobilize into the transported water. This phenomenon is supported by the significant increase in ATP, turbidity and alpha diversity of the flushed water (Fig. 4.1). What is uncertain is whether biofilms regenerate after this cleaning routine, and whether denser, more resistant communities evolve as an adaptation to turbulent flow conditions (Abe et al., 2012; Rochex et al., 2008).

4.3.2 Bacterial community composition and structure

Pyrosequencing revealed that the drinking water treatment plant effluents harbored a diverse bacterial community varying in structure at the different plants (Figs. 4.2A and S4.2). The 12 detected phyla (including 2 candidate phyla) and their average relative abundance were: *Proteobacteria* (46.9 ± 5.6 %), *Bacteroidetes* (15.2 ± 5.6 %), *Actinobacteria* (6.7 ± 2.7 %), *Planctomycetes* (5.8 ± 1.7 %), *Firmicutes* (3.9 ± 4.5 %), *Chloroflexi* (3.9 ± 1.0 %), *Acidobacteria* (3.5 ± 5.7 %), OP3 (3.4 ± 1.5 %), *Nitrospirae* (1.2 ± 0.5 %), *Verrucomicrobia* (1.2 ± 0.9 %), *Cyanobacteria* (0.7 ± 0.7 %), and Spam (0.6 ± 0.6 %). *Proteobacteria* classes were detected in the following order of decreasing abundance: *Gammaproteobacteria* (13.4 ± 1.6 %), *Deltaproteobacteria* (12.9 ± 6.3 %), *Alphaproteobacteria* (10.4 ± 4.3 %), and *Betaproteobacteria* (10.1 ± 2.2 %). In the distribution networks the bacterial community composition and structure changed (Figs. 4.2 and S4.2). Most prominent was the change in the dominant phylum subclass structure to: *Gammaproteobacteria* (18.1 ± 7.0 %), *Betaproteobacteria* (14.2 ± 3.7 %), *Alphaproteobacteria* (13.9 ± 6.6 %), and *Deltaproteobacteria* (7.3 ± 2.7 %), and the detection of 5 new phyla: *Elusimicrobia*, *Gemmatimonadetes*, *Chlorobi*, WS3 and NC10 candidate phyla. During network flushing 2 new candidate phyla were detected (TM6 and OP11) and the remaining community structure was similar to the bulk water TAP samples, particularly with respect to the *Proteobacteria* class structure and the dominant genera (Figs. 4.2 and S4.2).

A

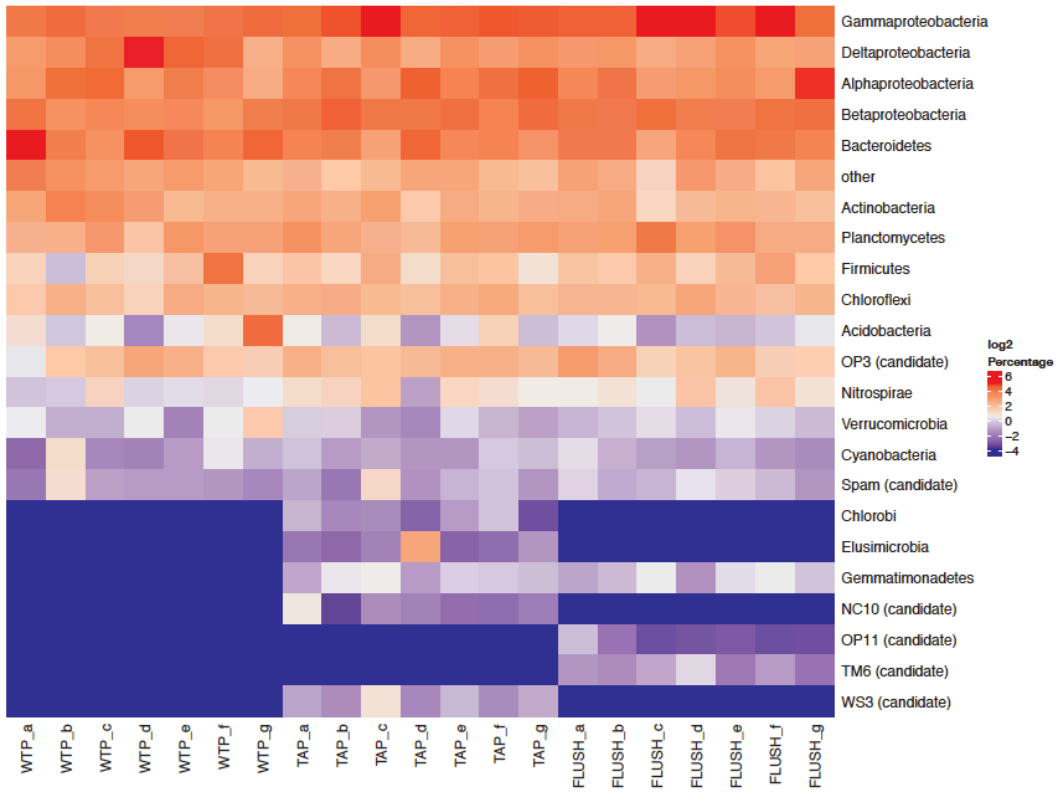

B

Dominant Families			Dominant Genera		
WTP	TAP	FLUSH	WTP	TAP	FLUSH
Syntrophaceae	Planctomycetaceae	Legionellaceae	Fluviicola	Pseudomonas	Legionella
Cryomorphaceae	Pseudomonadaceae	Planctomycetaceae	OP3 (candidate)	OP3 (candidate)	OP3 (candidate)
Planctomycetaceae	OP3 (candidate)	OP3 (candidate)	Planctomycetaceae	Planctomycetaceae	Pseudomonas
OP3 (candidate)	Comamonadaceae	Pseudomonadaceae	Acidobacteriaceae	Legionella	Escherichia_shigella
Acidobacteriaceae	Rhodospirillaceae	Enterobacteriaceae	Crenothrix	Sinobacteraceae	Sinobacteraceae
Chitinophagaceae	Caldilineaceae	Sinobacteraceae	Pseudomonas	Caldilineaceae	Planctomycetaceae
Sporichthyaceae	Legionellaceae	Cryomorphaceae	Nitrosomonadaceae	Azospira	Caldilineaceae

Figure 4.2. Bacterial groups in samples collected from 7 water treatment plant outlets (WTP) and corresponding distribution network taps before (TAP) and during flushing (FLUSH). (A) Heatmap of bacterial phyla and *Proteobacteria* classes. Letters a to g represent the different water

treatment plants as per Supplementary Table S4.1. Bacteria with a relative abundance below 1% across all samples were grouped together under the “other” category. **(B)** Top 7 dominant bacterial families and genera detected in all WTPs, all TAP or all FLUSH samples, listed in decreasing order of contribution to total reads.

Gammaproteobacteria have not been reported previously as the dominant *Proteobacteria* class in drinking water. This group has been found in abundance in piping biofilms and in loose deposits (Douterelo et al., 2013; Liu et al., 2014), indicating they may have migrated into the water from these two environments. *Betaproteobacteria* also tend to thrive in biofilms (Araya et al., 2003; Manz et al., 1999), suggesting their increased abundance during distribution may have been due to pipe biofilm sloughing. *Betaproteobacteria* have also been found more frequently in DWDSs lacking disinfectant residuals (Emtiazi et al., 2004; Lautenschlager et al., 2013) while other studies have found them to be significantly correlated with *Gammaproteobacteria* abundance and not with disinfectant residuals (McCoy and VanBriesen, 2014). The other detected phyla have been reported in other DWDSs (in the presence and absence of disinfectant residuals), in varying proportions. The relatively high diversity could denote a metabolically versatile community capable of adapting to changes in environmental or hydraulic conditions during water distribution. The exact cause behind the appearance of new phyla in the DWDSs is unknown, but likely due to interchange between the different network microenvironments described earlier. *Elusimicrobia* are anaerobes regularly encountered in termite hindguts (Herlemann et al., 2009). *Gemmatimonadetes* are abundant members of soil and sediment communities (DeBruyn et al., 2011), and *Chlorobi* comprise green sulfur bacteria closely related to *Bacteroidetes* (Hiras et al., 2016). WS3 is an anaerobic fermentative candidate phylum found in various terrestrial, aquatic and marine ecosystems (Youssef et al., 2015) while NC10 constitute denitrifying methanotrophs (Zhanfei et al., 2016). OP11 is a ubiquitous, yet poorly understood

division (Youssef et al., 2011) and TM6 is dependent on eukaryotic hosts for its metabolic needs (Yeoh et al., 2016). Genera that were not detected in the WTP effluent but appeared during distribution are discussed further in the last section.

At family and genus level classification the 7 most dominant groups are listed in Fig. 4.2B. Most groups which were found to be dominant members of the distribution networks were originally present in the WTP effluents. *Pseudomonas* is a common DWDS member and increased from 2.18% at the WTPs to 4.27% in TAP samples and 3.79% in FLUSH samples. (The pathogenic species *Pseudomonas aeruginosa* was not detected.) *Legionella* increased from 0.69% at the WTPs to 2.62% in TAP samples and 6.66% in FLUSH samples. Although this group is common in building plumbing systems (particularly the biofilm component), its increase is noteworthy as some *Legionella* species are opportunistic pathogens. Pyrosequencing data is not suitable however for species-level classification as the sequences are too short for reliable identification and can only give us a certain percentage of homology to a species. Further testing is needed via e.g. metagenomic approaches or designing primers that target specific species with qPCR to identify the bacteria at species level. Another dominant bacterial group detected in all the samples was the candidate division OP3. This group has been found in anoxic environments (Glockner et al., 2010) and has also been detected as a dominant member of particle-associated bacteria in unchlorinated DWDSs (Liu et al., 2016).

4.3.3 Core microbiome across distributed and flushed water

Despite the changes detected during distribution and flushing, a substantial fraction of the total OTUs (690/1440 or 47.9%) was shared between all the WTP, TAP and FLUSH samples (Fig. 4.3A). This large fraction of common taxa constitutes the core microbiome for these drinking water systems, resilient to the stressful and oligotrophic conditions of the distribution network environment.

The 14 WTP samples shared 82 bacterial genera and 83 families in common; the 21 DWDS TAP samples shared 171 genera and 126 families in common; and the 21 DWDS FLUSH samples shared 279 genera and 165 families. Comparing the 7 distribution networks to the 7 treatment plants, 745 OTUs (58.6% of the total) were found at both sites (Fig. 4.3B) while comparing the bacterial communities of the tap and flushed water (from all 7 DWDSs), 1013 or 72.9% of the total OTUs (representing 198345 reads or 99.2% of the total normalized reads) were found in both types of water (Fig. 4.3C). (Potential reasons behind the “disappearance” of 83 OTUs in the network include cell lysis by viruses and/or protozoa, the oligotrophic environment where some species have a competitive advantage over others, and migration from the water phase to the deposits or biofilm phase. For more details see Chapter 3.) Moreover, combining all the samples in one MDS plot showed that the water treatment plant samples had a different bacterial community structure (for reasons discussed previously in the section “Change in drinking water quality during distribution and flushing”), with the samples collected from the plants with the same water source and treatment scheme (plants e, f and g) grouped relatively adjacently (Fig. S4.3). The tap water samples from the various networks had a relatively similar community structure, and the flushed water samples clustered very closely (Figs. 4.3D and S4.3), likely due to the more variable conditions found within households where tap water samples were collected. Additionally, the tap and flushed water samples clustered closely, separate from the WTP samples. These observations were confirmed statistically. Treatment plant and distribution network samples were statistically significantly different ($p < 0.01$; $R = 0.419$), with dissimilarity ranks highest within the WTP samples (Figs. 4.3E and S4.4), while TAP and FLUSH samples were highly similar ($p = 0.025$; $R = 0.06$) and flushed water samples had the lowest dissimilarity rank (Figs. 4.3F and S4.4).

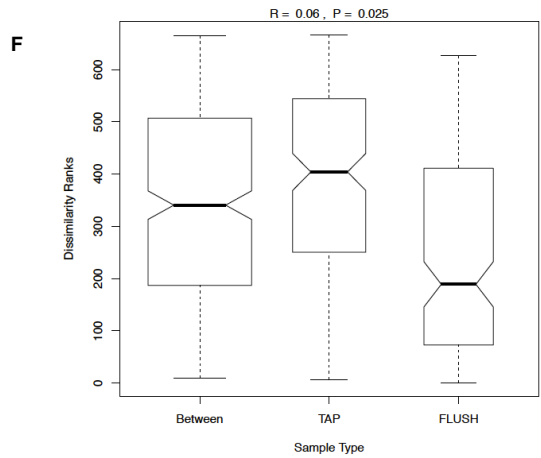
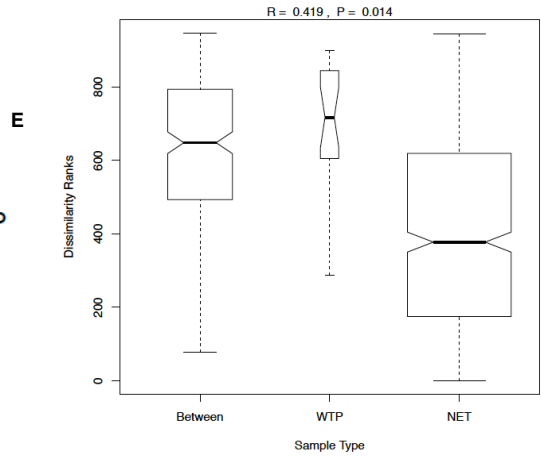
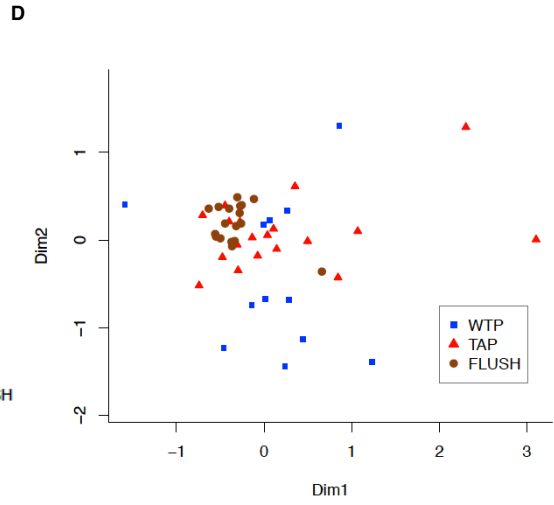
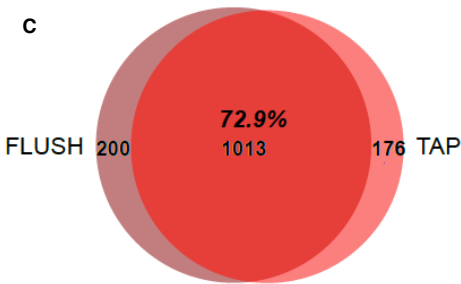
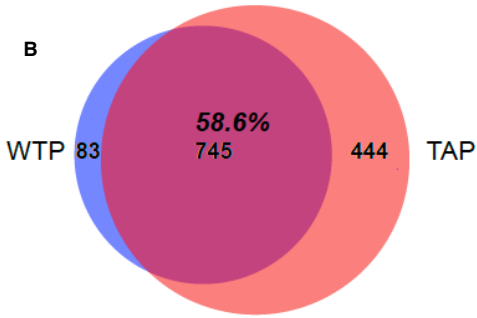
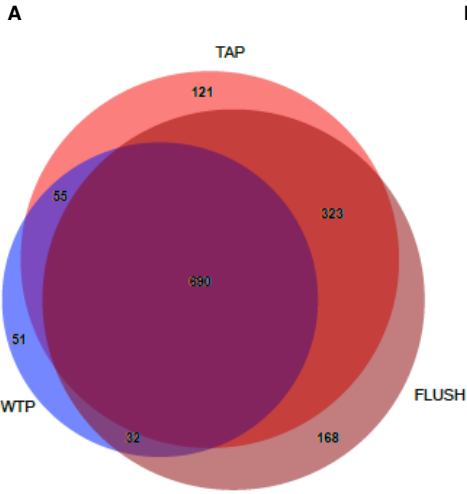

Figure 4.3. Core microbiome and statistical analysis of samples collected from water treatment plant outlets (WTP) and distribution network taps before (TAP) and during flushing (FLUSH). (A, B and C) Venn diagrams showing number of OTUs at each location and the shared fraction. (D) Multidimensional scaling (MDS) plot: Each symbol represents an individual sample; the bigger the distance between samples, the bigger the difference in microbial community structure. (E and F) Analysis of similarity (ANOSIM) box plots showing within and between rank dissimilarities, with R and p values.

This finding indicating the tap water microbiology highly resembles that of the flushed water- and to a lesser extent that of the treatment plant effluent- has not been reported before. Several studies have shown that the WTP and tap water communities are highly similar, with the treatment plant (e.g. communities colonizing biofilters) seeding and shaping the final tap water microbial community (Lautenschlager et al., 2013; Martiny et al., 2005; Pinto et al., 2012; Pinto et al., 2014). In a study that compared biofilm samples before and during network flushing (Douterelo et al., 2014), significant differences between the samples and also between different flushing sites were found. This study explored a single DWDS though containing residual disinfectant and the last recorded interventions within the network were 42 months previously, which could have allowed for more mature biofilms to grow (in our study network flushing is conducted at least once a year). Bulk water and biofilm phylotypes in DWDSs have been described generally as distinct communities (Douterelo et al., 2014; Henne et al., 2012; Liu et al., 2014; Martiny et al., 2005). The high similarity of the distributed and flushed water communities compared to the treated water in our study, as well as the elevated microbial load detected in the flushed water, reveal that the highly dynamic communities thriving within the biofilms and deposits had driven the microbial processes in the network and governed the change in the tap water microbiology during distribution. The biofilm and particle-associated communities therefore seem to act as a source from which

migrants enter the bulk water community, shaping the resultant tap water quality. Furthermore, the convergence of the TAP and FLUSH bacterial communities from different networks is remarkable as it attenuates the impact of water source and treatment strategy and highlights the fundamental role of local physicochemical conditions and infrastructure quality. These findings most likely would not have applied in systems that do not deliver high-quality water in the first place, but seem to pertain to well-maintained DWDSs that are regularly cleaned (flushed) and subjected to similar operational (and environmental) conditions. Flushing could be a relatively rapid and simple method to evaluate tap water microbiology and levels of contamination risk.

4.3.4 Similar bacterial community at different network locations

The findings above inherently indicate that distance from the WTP (or water age) did not affect the drinking water microbiology. A large fraction of the total OTUs (544/1183 or 46%) (Fig. 4.4A) and normalized sequence reads (285885/300000 or 95.3%) from all 7 distribution networks were shared between the different tap water locations (short, middle and long distance to the plants). This was also the case for the flushed water, with 629/1213 or 51.9% of the total OTUs (Fig. S4.5) comprising 293845/300000 or 98% of the total reads shared between the different network locations. Combining all the distribution network tap and flushed water samples in one MDS plot revealed a similar bacterial community structure (with the exception of 2 outlier samples) (Fig. S4.6), and disregarding these 2 samples resulted in a similar clustering (Fig. 4.4B) (with the FLUSH samples clustered more closely than the TAP samples). Examining the tap and flushed water samples separately in 2 MDS plots showed again no trend with distance, i.e. the samples were not grouped by network location (or residence time) (Fig. S4.7). ANOSIM confirmed that samples taken from different distance locations relative to the WTP were statistically not significantly different and in fact highly similar

(Fig. S4.8). Drinking water samples collected from the locations nearest to the WTPs however had the highest number of OTUs and diversity/richness values (Fig. 4.4A,C,D).

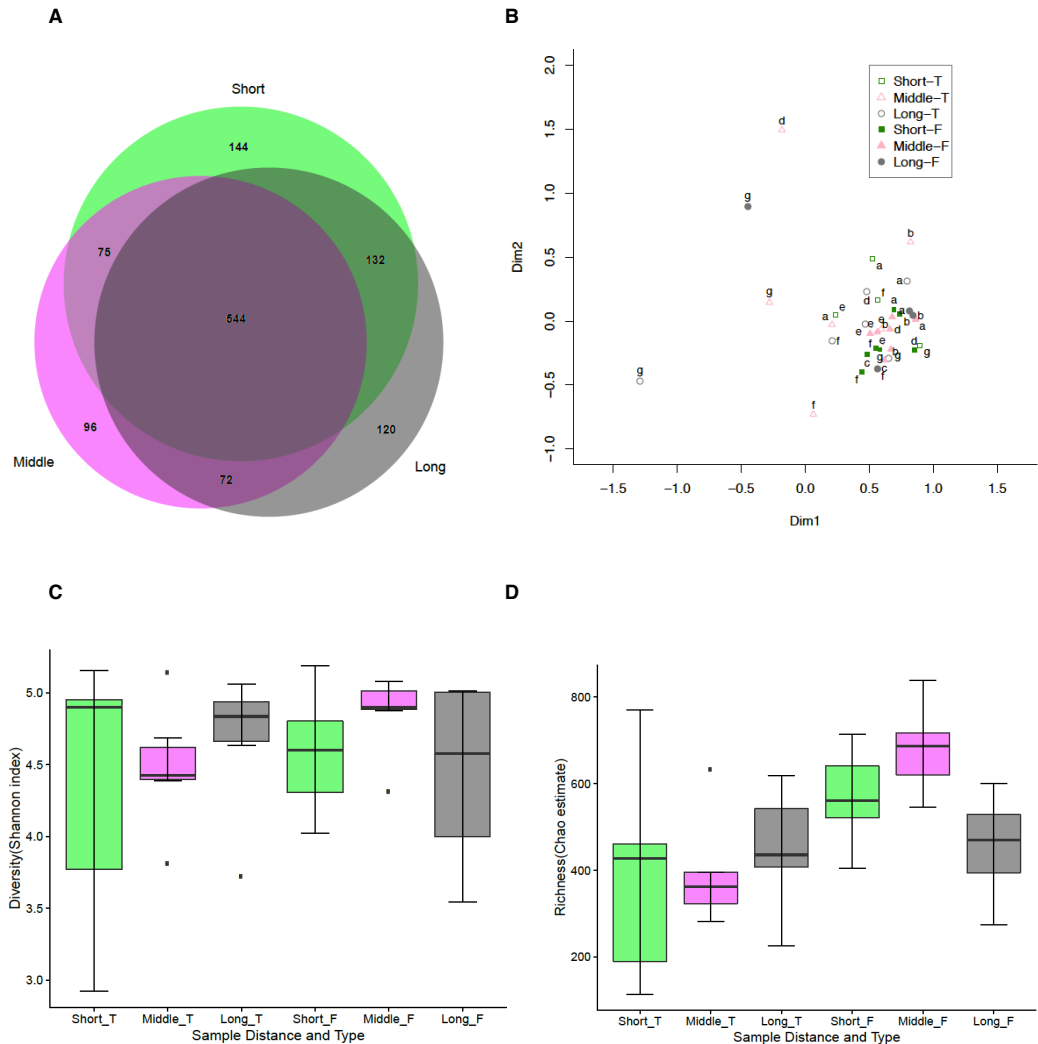

Figure 4.4. Tap and flushed water bacterial community variation with distance to treatment plant. (A) Venn diagram showing number of tap water OTUs at different distances and the shared fraction. (B) Multidimensional scaling (MDS) plot after eliminating 2 outliers from Supplementary Fig. S4.6. Empty symbols represent TAP samples and filled symbols represent

FLUSH samples. Letters represent the different water treatment plants as per Supplementary Table S4.1. (C) Shannon diversity and (D) Chao1 richness box plots for tap (T) and flushed (F) water: Displayed are IQRs or interquartile ranges (1st and 3rd quartiles; boxes), medians (horizontal lines in the boxes), minimum and maximum values within 1.5 IQR (whiskers below and above the boxes), and outliers (dark points beyond the whiskers).

There have been mixed findings regarding the impact of water age or residence time on drinking water microbiology. In one chlorinated DWDS total bacterial cell concentrations varied with distance to the WTP (Nescerecka et al., 2014) while in other DWDSs containing residual disinfectant the bacterial community structure was found to be more variable in samples of low water age and ANOSIM showed water age had a significant effect on biofilm communities (Wang et al., 2014). In a study that examined DWDSs delivering water without residual disinfectant bacterial parameters were found to be stable with distance except one plant that showed high bacterial activity at proximal locations (van der Wielen and van der Kooij, 2010). In a chlorine-treated system that distributed water without residual disinfectant the water bacterial community was stable spatially (Henne et al., 2012), and in another disinfectant-free Dutch DWDS the water and biofilm communities were not affected by distance (Liu et al., 2014). Spatial effects have generally been reported to be less prominent than seasonal trends (McCoy and VanBriesen, 2014; Pinto et al., 2014), but it seems water chemistry shaped by the availability of residual disinfectant is a significant factor influencing the biological stability of DWDSs. The depletion of disinfectant residuals over time or distance is likely related to the change in water microbiology during distribution, while our study that analyzed 7 DWDSs substantiates that (well-treated) water transported without a residual disinfectant seems to be more biologically stable. As for relatively higher bacterial richness or activity at proximal locations in such systems that rely on nutrient limitation during treatment, a reason could be the availability of residual biodegradable

organic matter in the areas close to the water treatment plant, and/or due to bacterial removal by viruses and/or invertebrates in the areas further away from the plant. The high similarity of the flushed water bacterial communities at different network locations is expected as TAP and FLUSH microbiomes were highly similar. We would like to note that sediments and invertebrates were also sampled and analyzed and were found to be stable with distance in terms of volume, mass and composition (data not shown).

4.3.5 *Bacteria emerging during drinking water distribution*

Bacterial families or genera that were not detected in the water leaving the treatment plants but appeared in distribution network i) tap water, ii) flushed water, or iii) tap and flushed water are displayed in Fig. 4.5, with the 10 most abundant groups listed for each of the three categories (percentage of total sequence counts did not exceed 0.2% however, which is reflected in the heatmap color coding). In total, while absent in WTP effluent samples, 15 families comprising 46 genera were found exclusively in tap water, 15 families or 71 genera were found solely in flushed water, and 76 families or 271 genera were found in both tap and flushed water samples. The most abundant genus detected only in the tap water (of plant g) was *Thiohalomonas*, a halophilic and facultatively anaerobic sulfur-oxidizing group belonging to *Gammaproteobacteria* and capable of complete denitrification (Sorokin et al., 2007). It is possible that sulfur compounds in the groundwater source of plant g were carried over to the distribution network allowing growth of these bacteria but it is unclear how the non-saline DWDS environment allowed them to thrive. As OTU sequence similarity to a *Thiohalomonas* strain was ~ 92% as obtained by BLAST, the detected genus may instead have been a closely related sulfur-oxidizing group. The most abundant genus detected only in FLUSH samples (of plants a, b and d) was *Sphingobacterium*, an aerobic chemoorganotrophic subgroup of *Bacteroidetes*

having high concentrations of sphingophospholipids as cellular components. These bacteria exhibit sliding mobility (Yabuuchi et al., 1983), and this could have caused their migration from pipe biofilms into the flushed water at high flow rates. They have been found in cold-water plumbing systems in association with corroded pipes (Arens et al., 1995).

Bacteria that emerged during water distribution (not found at the treatment plant outlets) were more prone to be found in both the tap and flushed water samples (Fig. 4.5). The most abundant genus (in terms of sequence counts) in this category was detected in all the DWDS samples (except the tap water from network a). It was *Thioalkalispira*, an alkaliphilic, chemolithoautotrophic, sulfur-oxidizing group belonging to *Gammaproteobacteria* and able to grow only under microaerophilic conditions (Sorokin et al., 2002). It is possible that cement lining in the water mains (mainly from AC pipes) provided an alkaline environment for these bacteria (Al-Mutaz et al., 1999; Deb et al., 2010) that potentially thrived within the biofilm on the cement surface, occasionally migrating into the bulk water. However, since OTU sequence similarity to a *Thioalkalispira* strain did not exceed ~ 94%, further research is needed at species level to precisely identify these microorganisms. The second most abundant genus (detected in all the DWDS samples except the tap water from 2 networks) was *Lewinella*, of the *Bacteroidetes* phylum. They are aerobic, halotolerant chemo-organotrophs that exhibit gliding mobility and have been isolated from marine water and sediments as well as river epilithons (O'Sullivan et al., 2002; Sly et al., 1998), indicating they can thrive in different phases like bulk water, biofilm matrices and loose deposits. *Syntrophobacter* was also detected in most of the DWDS samples. These anaerobic *Deltaproteobacteria* grow syntrophically on propionate in the presence of hydrogen- and formate-utilizing bacteria or methanogens, and optimal growth is in fresh water at neutral pH (Harmsen et al., 1998). *Phenylobacterium* was another detected genus, a member of the *Alphaproteobacteria*

class, comprising strict aerobes or facultative anaerobes that generally have a unique preference for phenyl moieties from heterocyclic compounds. They have been isolated from various environments including groundwater aquifers and drinking water reservoir sediments (Cheng et al., 2014; Ginige et al., 2013). *Arcicella* was another genus detected in the DWDS samples but not at the WTPs. They are aerobic, ring-forming bacteria (phylum *Bacteroidetes*) that grow in fresh water on a wide range of carbohydrates, and they have been isolated from tap water before (Kampfer et al., 2009). Drinking water distribution systems seem to sustain a unique, diverse ecosystem regardless of location or water origin.

A

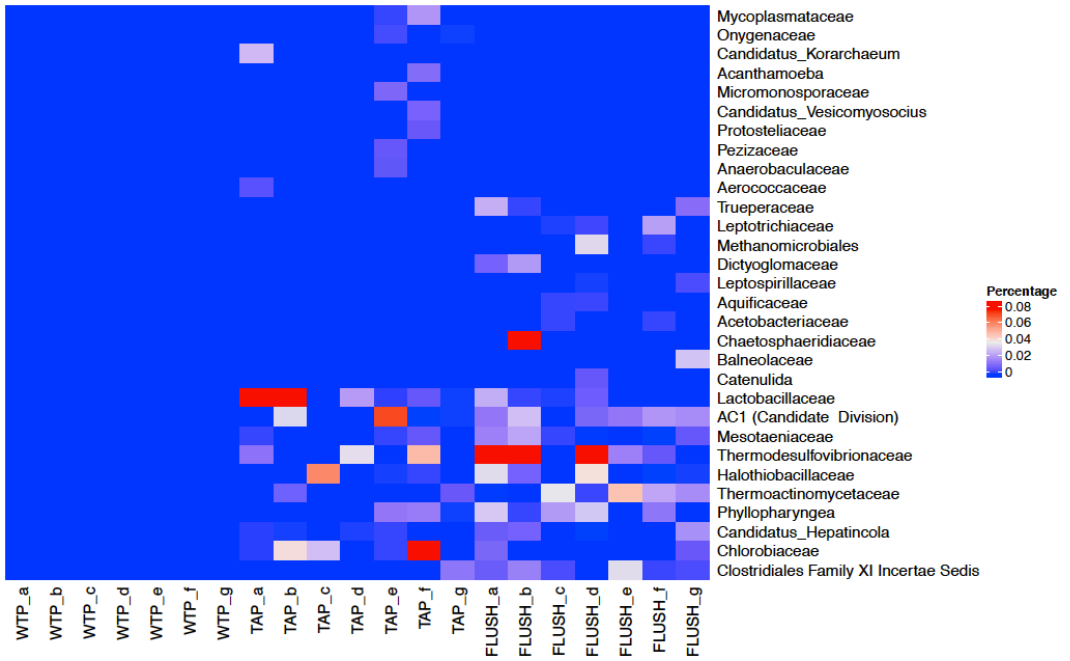

B

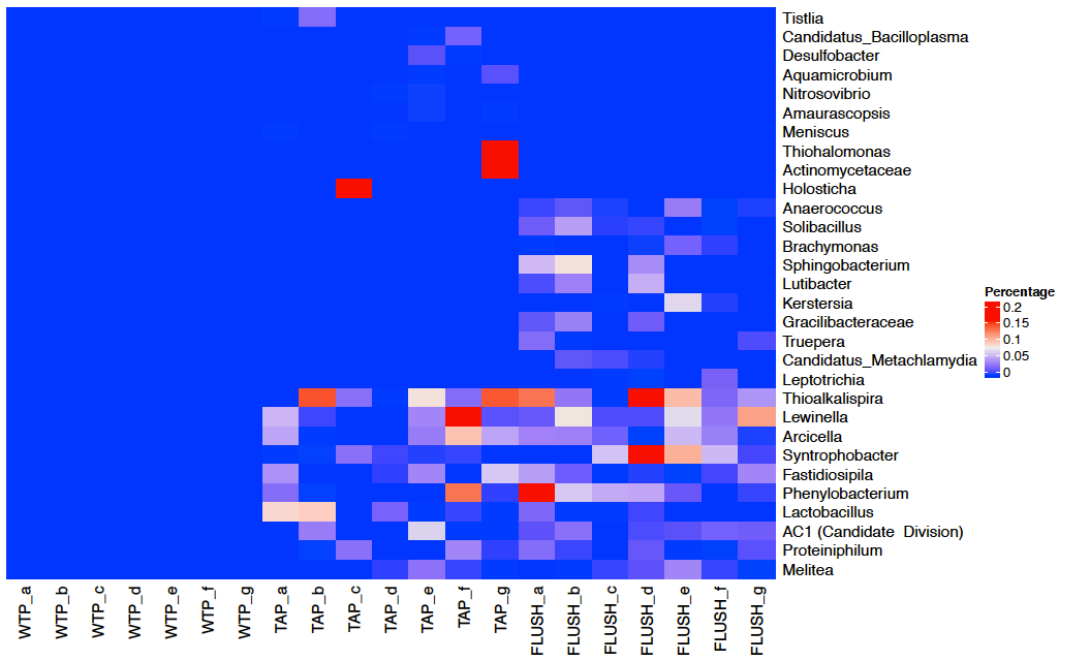

Figure 4.5. Bacterial groups absent in water treatment plant effluents (WTP) yet present in distribution network tap water (TAP) and/or flushed water (FLUSH). Heatmaps are shown at (A) family and (B) genus classification level. Letters represent the different water treatment plants as per Supplementary Table S4.1.

4.4. Prospects

The main findings of this study are: i) A substantial, diverse core microbiome subsists in such DWDSs, dominated by *Gammaproteobacteria*; ii) There is an increase in biomass in the distribution networks, especially during flushing, primarily due to pipe biofilm sloughing and loose deposit resuspension; iii) Residence time does not significantly impact the microbiology in (well-maintained) DWDSs transporting (well-treated) water without a residual disinfectant; iv) Piping biofilm and sediment communities largely determine the final tap water microbial quality, attenuating the impact of water source and treatment scheme; v) Flushing is a relatively rapid, simple method to assess drinking water microbiology.

The finding that tap and flushed water microbiota are highly alike and even converge in multiple, distinct drinking water distribution networks has several implications. The water that is dispensed from our taps is not the same water that is produced by the treatment plant but rather a dynamic ecosystem driven by micro-niches within piping biofilms and loose deposits. The drinking water quality seems to reflect the ‘network quality’, shaped by the physical integrity of the system as well as local operational and natural conditions that select for specific microbes. This challenges efforts to predict, using mathematical models, downstream microbiology based on the composition of the community that leaves the treatment plant (Schroeder et al., 2015). Designing self-flushing

networks with the optimal hydraulic regime and physical components to limit sedimentation and biofilm formation (and rejuvenation) is a challenging task but could help us 'manipulate' the microbial ecology. A change in the water microbiology during distribution may not require control measures however when the hygienic (and aesthetic) quality of the water is not compromised, as the ultimate purpose of this built environment is to deliver safe water. Our understanding of drinking water microbial ecology is still limited and primarily based on DNA studies that do not tackle microbial function and processes. Moreover, due to the vital role of temperature, climate change is also bound to influence the microbial communities indigenous to DWDSs in ways we cannot prognosticate yet. This study shifts our focus from water treatment efficacy to distribution network (physical and hydraulic) quality and these findings need to be tested in DWDSs that apply a residual disinfectant.

Supplementary Material

Table S4.1. Seven selected water treatment plants (WTPs) with corresponding water source and treatment scheme. coag= coagulation; floc= flocculation; fil= rapid dual layer filtration; GAC= granular activated carbon filtration; sed= sedimentation; O₃= ozonation; ms= microstrain; infil= infiltration; aer= aeration; soft= softening. The water is distributed without disinfectant residuals.

WTP	Source	Treatment
(a)	surface water	ms-coag-floc-sed-fil-UV-GAC-CIO ₂
(b)	surface water	coag-floc-sed-O ₃ -fil-GAC-CIO ₂
(c)	infiltrated surface water	ms-coag-fil-infil-aer-fil-GAC-UV
(d)	surface & groundwater	coag-floc-fil-fil-UV-GAC-CIO ₂
(e)	deep groundwater	aer-fil-soft-fil
(f)	deep groundwater	aer-fil-aer-fil
(g)	deep groundwater	aer-fil-aer-fil

Table S4.2. Piping material and construction / renovation year for water treatment plants (WTPs) and corresponding distribution networks. Short, middle and long represent the distance between the WTP and the sampled network location. PVC= polyvinyl chloride; AC= asbestos cement. Throughout the distribution networks though the pipes have different characteristics and sundry materials including cast iron and polyethylene are used.

WTP	Short	Middle	Long
(a) steel 1967	PVC 1967	PVC 1968	PVC 1986
(b) steel 1976	PVC 1999	PVC 2000	PVC 1982
(c) steel 1977	PVC 1991	AC 1965	AC 1954
(d) steel 1967	PVC 1991	PVC 1987	PVC 1965
(e) steel 1992	PVC 2002	AC 1951	PVC 1979
(f) steel 1967	PVC 1988	PVC 1970	PVC 2009
(g) steel 1991	AC 1950	AC 1977	AC 1950



Figure S4.1. Mains flushing. A fire hydrant is opened and using a high flow rate, water together with sloughed biofilm, loose deposits, and suspended solids are collected.

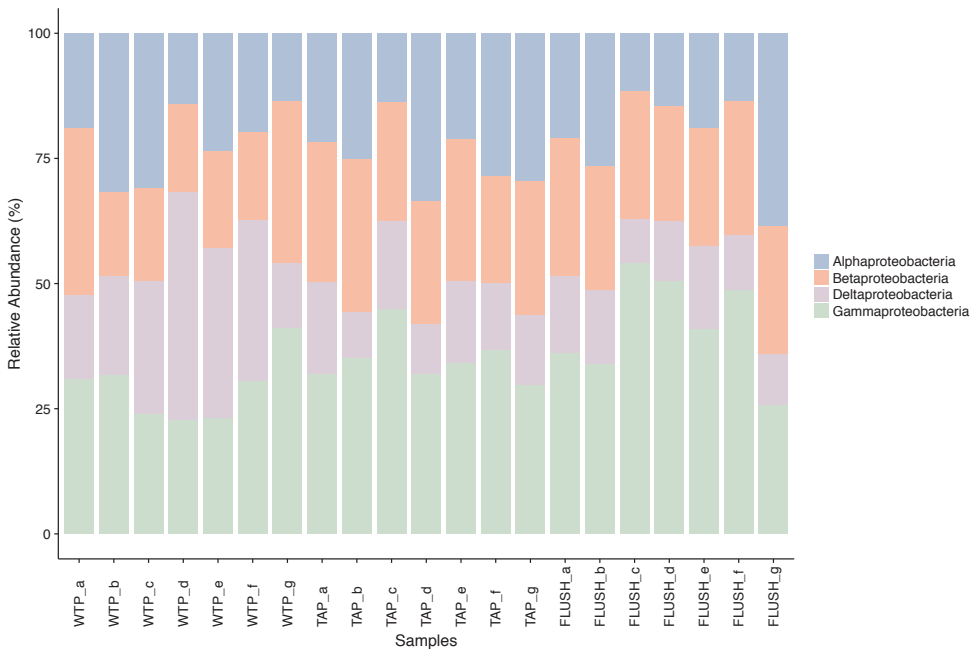

Figure S4.2. Relative abundance bar plots of *Proteobacteria* classes of samples collected from 7 water treatment plant outlets (WTP) and corresponding distribution network taps before (TAP) and during flushing (FLUSH). Letters a to g represent the different water treatment plants as per Table S4.1.

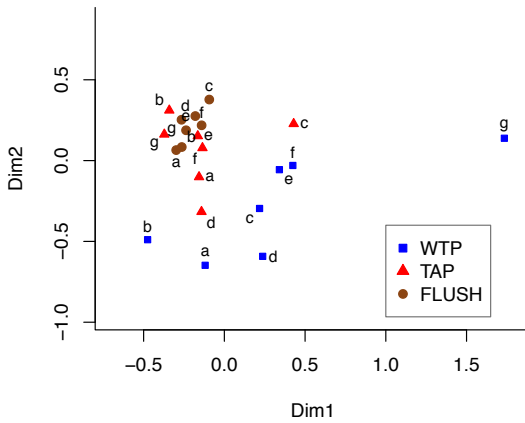

Figure S4.3. Multidimensional scaling (MDS) plot of water treatment plant outlet samples (WTP) and distribution network tap samples before (TAP) and during flushing (FLUSH). Each symbol represents the pooling of 2 replicate samples for the WTPs and the pooling of 3 different distance samples for the TAP and FLUSH. The bigger the distance between samples, the bigger the difference in microbial community structure.

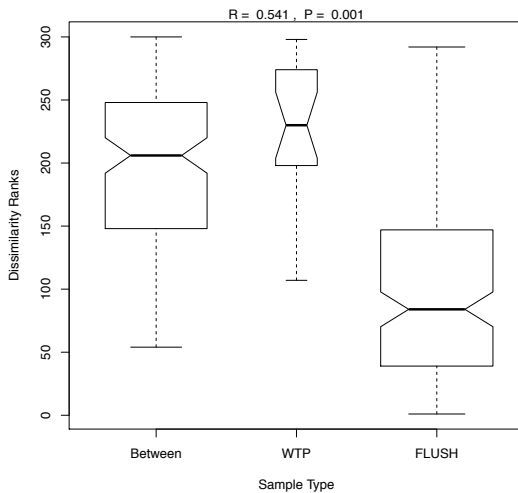

Figure S4.4. Analysis of similarity (ANOSIM) box plot showing within and between rank dissimilarities for water treatment plant outlet samples (WTP) and distribution network flushed water samples (FLUSH), with R and p values.

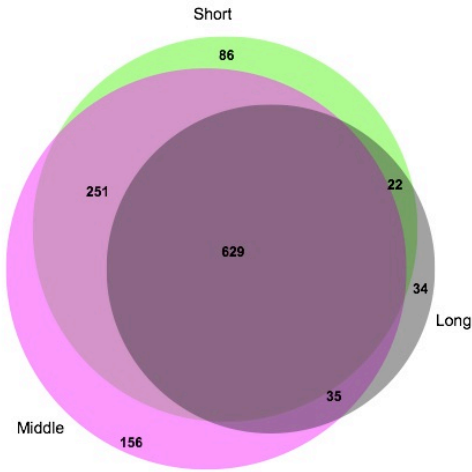

Figure S4.5. Venn diagram showing number of flushed water OTUs at different network locations and the shared fraction.

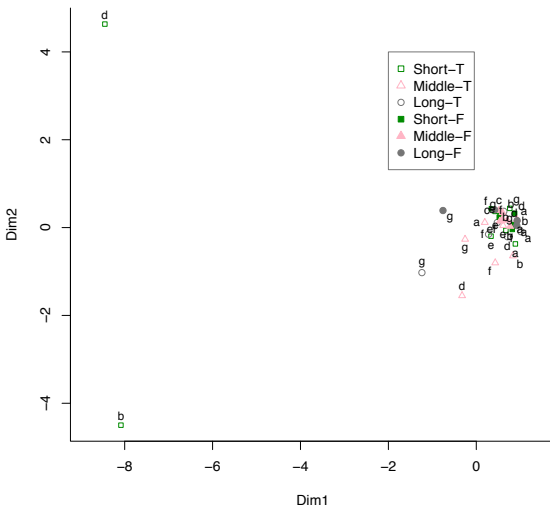

Figure S4.6. Multidimensional scaling (MDS) plot of all distribution network samples. Empty symbols represent TAP samples and filled symbols represent FLUSH samples. Letters represent the different water treatment plants as per Table S4

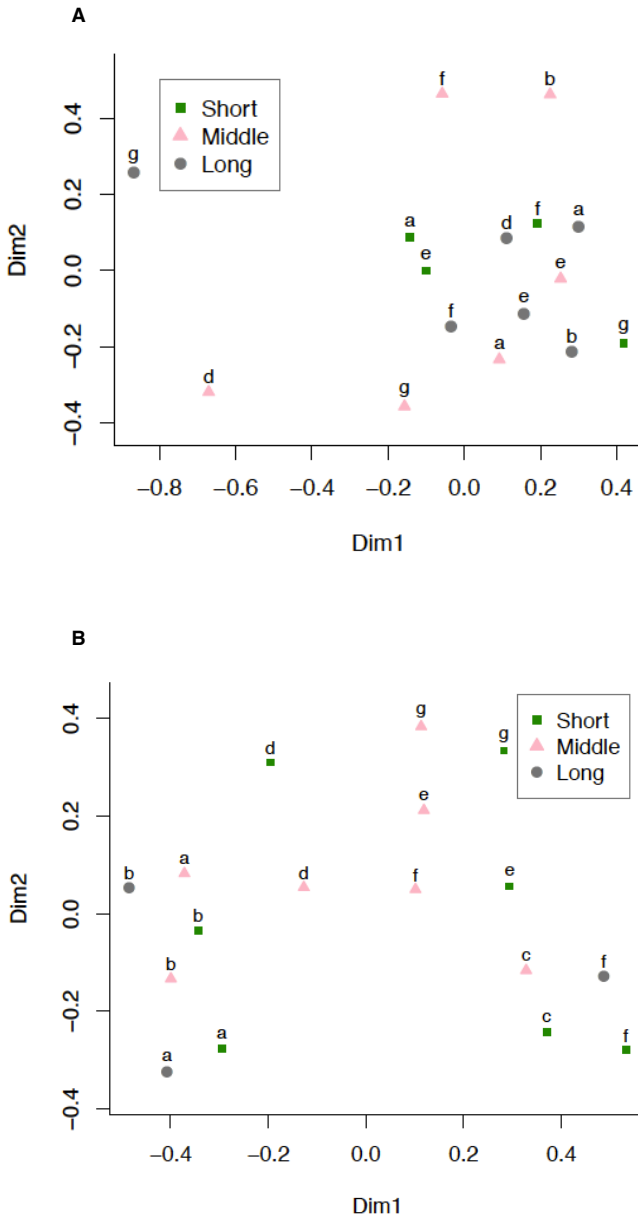

Figure S4.7. Multidimensional scaling (MDS) plot break down of Fig. S4.6 separating TAP (A) from FLUSH (B) samples. Short, middle and long represent the distance between the WTP and the sampled network location. Letters represent the different water treatment plants as per Table S4.1.

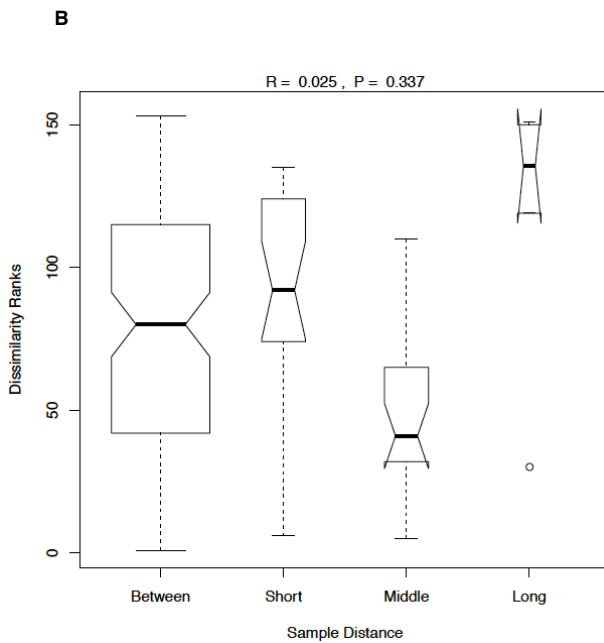
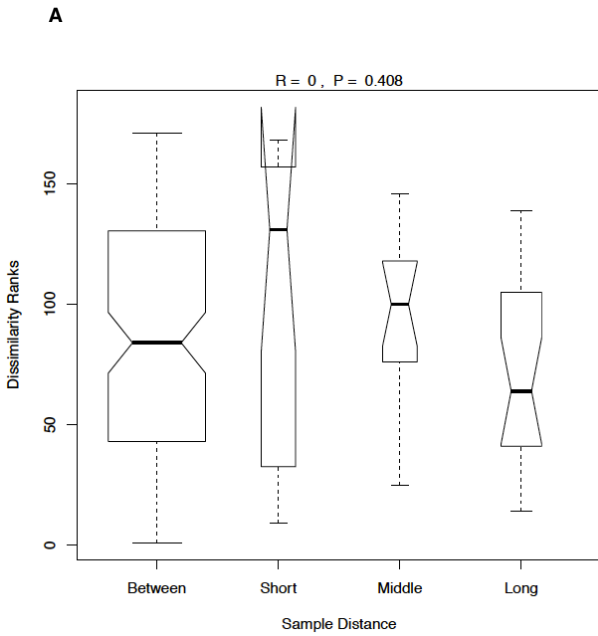

Figure S4.8. Analysis of similarity (ANOSIM) box plots showing within and between rank dissimilarities for distribution network (A) tap and (B) flushed water samples, with corresponding R and p values. Short, middle and long represent the distance between the WTP and the sampled network location.

Bibliography

Abe, Y., Skali-Lami, S., Block, J. C., Francius, G., 2012. Cohesiveness and hydrodynamic properties of young drinking water biofilms. *Water Res.* 46, 1155–1166.

Al-Mutaz, I., Al Ghunami, M. A., Al Busaili, S. A., 1999. pH Increase In Water Distribution Pipes. paper presented at IDA World Congress on Desalination and Water Re-Use, San Diego, CA.

Araya, R., Tani, K., Takagi, T., Yamaguchi, N., Nasu, M., 2003. Bacterial activity and community composition in stream water and biofilm from an urban river determined by fluorescent in situ hybridization and DGGE analysis. *FEMS Microbiol. Ecol.* 43, 111–119.

Arens, P., Tuschewitzki, G. J., Wollmann, M., Follner, H., Jacob, H., 1995. Indicators for microbiologically induced corrosion of copper pipes in a cold-water plumbing system. *Zentralbl Hyg Umweltmed.* 196, 444–454.

Bautista-de los Santos, Q. M., Schroeder, J. L., Sevillano-Rivera, M. C., Sungthong, R., Ijaz, U. Z., Sloan, W. T., Pinto, A. J., 2016. Emerging investigators series: microbial communities in full-scale drinking water distribution systems – a meta-analysis. *Environ. Sci.: Water Res. Technol.* 2, 631–644.

Beech, I. B., Sunner, J., 2004. Biocorrosion: Towards understanding interactions between biofilms and metals. *Curr. Opin. Biotechnol.* 15, 181–186.

Beer, K. D. et al., 2015. Surveillance for waterborne disease outbreaks associated with drinking water – United States, 2011–2012. *CDC Morb. Mortal. Wkly Rep.*, 64, 842–848.

Cheng, W., Zhang, J., Wang, Z., Wang, M., Xie, S., 2014. Bacterial communities in sediments of a drinking water reservoir. *Ann. Microbiol.* 64, 875–878.

Colford, J. M. Roy, S., Beach, M. J., Hightower, A., Shaw, S. E., Wade, T. J., 2006. A review of household drinking water intervention trials and an approach to the estimation of endemic waterborne gastroenteritis in the United States. *J. Water Health.* 4 (Suppl 2), 71–88.

Deb, A. K., McCammon, S. B., Snyder, J., Dietrich, A., 2010. Impacts of lining material on water quality. Project no. 4036.

DeBruyn, J. M., Nixon, L. T., Fawaz, M. N., Johnson, A. M., Radosevich, M., 2011. Global biogeography and quantitative seasonal dynamics of Gemmatimonadetes in soil. *Appl. Environ. Microbiol.* 77, 6295–6300.

Douterelo, I., Sharpe, R. L., Boxall, J. B., 2013. Influence of hydraulic regimes on bacterial community structure and composition in an experimental drinking water distribution system. *Water Res.* 47, 503–516.

Douterelo, I., Husband, S., Boxall, J. B., 2014. The bacteriological composition of biomass recovered by flushing an operational drinking water distribution system. *Water Res.* 54, 100–114.

El-Chakhtoura, J., Prest, E. I., Saikaly, P. E., van Loosdrecht, M. C. M., Hammes, F., Vrouwenvelder, J. S., 2015. Dynamics of bacterial communities before and after distribution in a full-scale drinking water network. *Water Res.* 74, 180–190.

Emtiazi, F., Schwartz, T., Marten, S. M., Krolla-Sidenstein, P., Obst, U., 2004. Investigation of natural biofilms formed during the production of drinking water from surface water embankment filtration. *Water Res.* 38, 1197–1206.

Ginige, M. P., Kaksonen, A. H., Morris, C., Shackelton, M., Patterson, B. M., 2013. Bacterial community and groundwater quality changes in an anaerobic aquifer during groundwater recharge with aerobic recycled water. *FEMS Microbiol. Ecol.* 85, 553–567.

Glöckner, J. et al., 2010. Phylogenetic diversity and metagenomics of candidate division OP3. *Environ. Microbiol.* 12, 1218–1229.

Hammes, F., Berney, M., Wang, Y., Vital, M., Koster, O., Egli, T., 2008. Flow-cytometric total bacterial cell counts as a descriptive microbiological parameter for drinking water treatment processes. *Water Res.* 42, 269–277.

Harmsen, H. J., Van Kuijk, B. L., Plugge, C. M., Akkermans, A. D., De Vos, W. M., Stams, A. J., 1998. *Syntrophobacter fumaroxidans* sp. nov., a syntrophic propionate-degrading sulfate-reducing bacterium. *Int. J. Syst. Bacteriol.* 48, 1383–1387.

Henne, K., Kahlisch, L., Brettar, I., Hofle, M. G., 2012. Analysis of structure and composition of bacterial core communities in mature drinking water biofilms and bulk water of a citywide network in Germany. *Appl. Environ. Microbiol.* 78, 3530–3538.

Herlemann, D. P. et al., 2009. Genomic analysis of "Elusimicrobium minutum," the first cultivated representative of the phylum "Elusimicrobia" (formerly termite group 1). *Appl. Environ. Microbiol.* 75, 2841–2849.

Hiras, J., Wu, Y. W., Eichorst, S. A., Simmons, B. A., Singer, S. W., 2016. Refining the phylum Chlorobi by resolving the phylogeny and metabolic potential of the representative of a deeply branching, uncultivated lineage. *ISME J.* 10, 833–845.

Hoehn, R. C., 1988. Biological causes of tastes and odors in drinking water supplies. *Water Qual. Bull.* 13, 46–52.

Holinger, E. P., Ross, K. A., Robertson, C. E., Stevens, M. J., Harris, J. K., Pace, N. R., 2014. Molecular analysis of point-of-use municipal drinking water microbiology. *Water Res.* 49, 225–235.

Ingerson-Mahar, M., Reid, A., 2012. MIP: The microbiology of the water distribution system. *American Academy of Microbiology.*

Kämpfer, P., Lodders, N., Busse, H. J., 2009. *Arcicella rosea* sp. nov., isolated from tap water. *Int. J. Syst. Evol. Microbiol.* 59, 341–344.

Keevil, C. W., 2003. Pathogens in Environmental Biofilms. *Encyclopedia of Environmental Microbiology.* (John Wiley & Sons, Inc.).

Lautenschlager, K., Boon, N., Wang, Y., Egli, T., Hammes, F., 2010. Overnight stagnation of drinking water in household taps induces microbial growth and changes in community composition. *Water Res.* 44, 4868–4877.

Lautenschlager, K., Hwang, C., Liu, W. T., Boon, N., Koster, O., Vrouwenvelder, H., Egli, T., Hammes, F., 2013. A microbiology-based multi-parametric approach towards assessing biological stability in drinking water distribution networks. *Water Res.* 47, 3015–3025.

Lee, S. H., O'Conner, J. T., Park, S. J., 1980. Biologically mediated corrosion and its effects on water quality in distribution systems. *J. Am. Water Works Assoc.* 72, 636–645.

Lipponen, M. T., Suutari, M. H., Martikainen, P. J., 2002. Occurrence of nitrifying bacteria and nitrification in Finnish drinking water distribution systems. *Water Res.* 36, 4319–4329.

Liu, G., Verberk, J. Q., van Dijk, J. C., 2013. Bacteriology of drinking water distribution systems: an integral and multidimensional review. *Appl. Microbiol. Biotechnol.* 97, 9265–9276.

Liu, G., Bakker, G. L., Li, S., Vreeburg, J. H., Verberk, J. Q., Medema, G. J., Liu, W. T., van Dijk, J. C., 2014. Pyrosequencing reveals bacterial communities in unchlorinated drinking water distribution system: an integral study of bulk water, suspended solids, loose deposits, and pipe wall biofilm. *Environ. Sci. Technol.* 48, 5467–5476.

Liu, G. et al., 2016. Comparison of particle-associated bacteria from a drinking water treatment plant and distribution reservoirs with different water sources. *Sci. Rep.* 6, (20367).

Magic-Knezev, A., van der Kooij, D., 2004. Optimisation and significance of ATP analysis for measuring active biomass in granular activated carbon filters used in water treatment. *Water Res.* 38, 3971–3979.

Manz, W., Wendt-Potthoff, K., Neu, T. R., Szewzyk, U., Lawrence, J. R., 1999. Phylogenetic composition, spatial structure, and dynamics of lotic bacterial biofilms investigated by fluorescent in situ hybridization and confocal laser scanning microscopy. *Microb. Ecol.* 37, 225–237.

Martiny, A. C., Albrechtsen, H. J., Arvin, E., Molin, S., 2005. Identification of bacteria in biofilm and bulk water samples from a nonchlorinated model drinking water distribution system: detection of a large nitrite-oxidizing population associated with *Nitrospira* spp. *Appl. Environ. Microbiol.* 71, 8611–8617.

McCoy, S. T., VanBriesen, J. M., 2014. Comparing spatial and temporal diversity of bacteria in a chlorinated drinking water distribution system. *Environ. Eng. Sci.* 31, 32–41.

Messner, M., Shaw, S., Regli, S., Rotert, K., Blank, V., Soller, J., 2006. An approach for developing a national estimate of waterborne disease due to drinking water and a national estimate model application. *J. Water Health.* 4 (Suppl 2), 201–240.

Nescerecka, A., Rubulis, J., Vital, M., Juhna, T., Hammes, F., 2014. Biological instability in a chlorinated drinking water distribution network. *PLoS ONE.* 9.

O'Sullivan, L. A., Weightman, A. J., Fry, J. C., 2002. New degenerate Cytophaga-Flexibacter-Bacteroides-specific 16S ribosomal DNA-targeted oligonucleotide probes reveal high bacterial diversity in river taff epilithon. *Appl. Environ. Microbiol.* 68, 201-210.

Pinto, A. J., Xi, C., Raskin, L., 2012. Bacterial community structure in the drinking water microbiome is governed by filtration processes. *Environ. Sci. Technol.* 46, 8851-8859.

Pinto, A. J., Schroeder, J., Lunn, M., Sloan, W., Raskin, L., 2014. Spatial-temporal survey and occupancy-abundance modeling to predict bacterial community dynamics in the drinking water microbiome. *mBio* 5, (3):e01135-14.

Rees, G. N., Baldwin, D. S., Watson, G. O., Perryman, S., Nielsen, D. L., 2004. Ordination and significance testing of microbial community composition derived from terminal restriction fragment length polymorphisms: application of multivariate statistics. *Antonie Van Leeuwenhoek.* 86, 339-347.

Regan, J. M., Harrington, G. W., Baribeau, H., De Leon, R., Noguera, D. R., 2003. Diversity of nitrifying bacteria in full-scale chloraminated distribution systems. *Water Res.* 37, 197-205.

Rochex, A., Godon, J. J., Bernet, N., Escudie, R., 2008. Role of shear stress on composition, diversity and dynamics of biofilm bacterial communities. *Water Res.* 42, 4915-4922.

Schroeder, J. L., Lunn, M., Pinto, A. J., Raskin, L., Sloan, W. T., 2015. Probabilistic models to describe the dynamics of migrating microbial communities. *PLoS ONE* 10.

Sly, L. I., Taghavi, M., Fegan, M., 1998. Phylogenetic heterogeneity within the genus *Herpetosiphon*: transfer of the marine species *Herpetosiphon cohaerens*, *Herpetosiphon nigricans* and *Herpetosiphon persicus* to the genus *Lewinella* gen. nov. in the Flexibacter-Bacteroides-Cytophaga phylum. *Int. J. Syst. Bacteriol.* 3, 731-737.

Sorokin, D. Y., Tourova, T. P., Kolganova, T. V., Sjollem, K. A., Kuenen, J. G., 2002. *Thioalkalispira microaerophila* gen. nov., sp. nov., a novel lithoautotrophic, sulfur-oxidizing bacterium from a soda lake. *Int. J. Syst. Evol. Microbiol.* 52, 2175-2182.

- Sorokin, D. Y., Tourova, T. P., Braker, G., Muyzer, G., 2007. *Thiohalomonas denitrificans* gen. nov., sp. nov. and *Thiohalomonas nitratreducens* sp. nov., novel obligately chemolithoautotrophic, moderately halophilic, thiodenitrifying Gammaproteobacteria from hypersaline habitats. *Int. J. Syst. Evol. Microbiol.* 57, 1582–1589.
- Thomas, V., Bouchez, T., Nicolas, V., Robert, S., Loret, J. F., Levi, Y., 2004. Amoebae in domestic water systems: resistance to disinfection treatments and implication in *Legionella* persistence. *J. Appl. Microbiol.* 97, 950–963.
- van der Kooij, D., 2000. Biological stability: a multidimensional quality aspect of treated water. *Water Air Soil Pollut.* 123, 25–34.
- van der Wielen, P. W. J. J., Voost, S., van der Kooij, D., 2009. Ammonia-oxidizing bacteria and archaea in groundwater treatment and drinking water distribution systems. *Appl. Environ. Microbiol.* 75, 4687–4695.
- van der Wielen, P. W., van der Kooij, D., 2010. Effect of water composition, distance and season on the adenosine triphosphate concentration in unchlorinated drinking water in the Netherlands. *Water Res.* 44, 4860–4867.
- van Lieverloo, J. H., Bosboom, D. W., Bakker, G. L., Brouwer, A. J., Voogt, R., De Roos, J. E., 2004. Sampling and quantifying invertebrates from drinking water distribution mains. *Water Res.* 38, 1101–1112.
- Vellend, M., 2010. Conceptual synthesis in community ecology. *Q. Rev. Biol.* 85, 183–206.
- Wang, D., Cullimore, D. R., 2010. Bacteriological challenges to asbestos cement water distribution pipelines. *J. Environ. Sci. (China)* 22, 1203–1208.
- Wang, H., Masters, S., Edwards, M. A., Falkinham, J. O., Pruden, A., 2014. Effect of disinfectant, water age, and pipe materials on bacterial and eukaryotic community structure in drinking water biofilm. *Environ. Sci. Technol.* 48, 1426–1435.
- Yabuuchi, E., Kaneko, T. A., Yano, I., Moss, C. W., Miyoshi, N., 1983. *Sphingobacterium* gen. nov., *Sphingobacterium spiritivorum* comb. nov., *Sphingobacterium multivorum* comb. nov., *Sphingobacterium mizutae* sp. nov., and *Flavobacterium indologenes* sp. nov.: Glucose-nonfermenting gram-negative rods in CDC Groups IIK-2 and IIB. *Int. J. Syst. Evol. Microbiol.* 33, 580–598.

Yeoh, Y. K., Sekiguchi, Y., Parks, D. H., Hugenholtz, P., 2016. Comparative genomics of candidate phylum TM6 suggests that parasitism is widespread and ancestral in this lineage. *Mol. Biol. Evol.* 33, 915–927.

Youssef, N. H., Blainey, P. C., Quake, S. R., Elshahed, M. S., 2011. Partial genome assembly for a candidate division OP11 single cell from an anoxic spring (Zodletone Spring, Oklahoma). *Appl. Environ. Microbiol.* 77, 7804–7814.

Youssef, N. H., Farag, I. F., Rinke, C., Hallam, S. J., Woyke, T., Elshahed, M. S., 2015. In silico analysis of the metabolic potential and niche specialization of candidate phylum "Latescibacteria" (WS3). *PLoS ONE.* 10.

Zhanfei, H. et al., 2016. A novel denitrifying methanotroph of the NC10 phylum and its microcolony. *Sci. Rep.* 6, 32241.

Chapter 5

Saudi Arabia: seawater - membrane desalination

Bacterial community structure and variation

This chapter has been published as: Belila, A., El-Chakhtoura, J., Otaibi, N., Muyzer, G., Gonzalez-Gil, G., Saikaly, P.E., van Loosdrecht, M.C.M., Vrouwenvelder, J.S., 2016. Bacterial community structure and variation in a full-scale seawater desalination plant for drinking water production. *Water Research* 94, 62–72.

Abstract

Microbial processes inevitably play a role in membrane-based desalination plants, mainly recognized as membrane biofouling. We assessed the bacterial community structure and diversity during different treatment steps in a full-scale seawater desalination plant producing 40,000 m³/d of drinking water. Water samples were taken over the full treatment train consisting of chlorination, spruce media and cartridge filters, de-chlorination, first and second pass reverse osmosis (RO) membranes and final chlorine dosage for drinking water distribution. The water samples were analyzed for water quality parameters (total bacterial cell number, total organic carbon, conductivity, pH, etc.) and microbial community composition by 16S rRNA gene pyrosequencing. The planktonic microbial community was dominated by *Proteobacteria* (48.6%) followed by *Bacteroidetes* (15%), *Firmicutes* (9.3%) and *Cyanobacteria* (4.9%). During the pretreatment step, the spruce media filter did not impact the bacterial community composition dominated by *Proteobacteria*. In contrast, the RO and final chlorination treatment steps reduced the relative abundance of *Proteobacteria* in the produced water where *Firmicutes* constituted the most dominant bacterial group. Shannon and Chao1 diversity indices showed that bacterial species richness and diversity decreased during the seawater desalination process. The two-stage RO filtration strongly reduced the water conductivity (>99%), TOC concentration (98.5%) and total bacterial cell number (>99%), albeit some bacterial DNA was found in the water after RO filtration. About 0.25% of the total bacterial operational taxonomic units (OTUs) were present in all stages of the desalination plant: the seawater, the RO permeates and the chlorinated drinking water, suggesting that these bacterial strains can survive in different environments such as high/low salt concentration and with/without residual disinfectant. These bacterial strains were not caused by contamination during

water sample filtration or from DNA extraction protocols. Control measurements for sample contamination are important for clean water studies.

5.1. Introduction

In coastal areas around the world seawater desalination is becoming increasingly important as a source of drinking water. The total desalination capacity worldwide using reverse osmosis (RO) membrane technology is the largest compared to other desalination processes such as multistage flash distillation, multiple-effect distillation, vapor compression, and electrodialysis. The global RO capacity is continuously rising with time (Ghaffour et al., 2013). In addition, the strong reduction with time in the costs of membrane-based desalination has enabled many countries to implement desalination for potable water supply.

The variation of the microbial quality of the drinking water during production and distribution processes has long been a critical issue since many problems in those systems – including desalination systems – are microbial in nature, including biofilm growth, pathogen persistence and biofouling (Berry et al., 2006). Determining the microbial ecology of drinking water production systems is imperative, as recent investigations have found that the resistance of pathogens to chlorination is affected by the bacterial community diversity and interspecies relationships (Kormas et al., 2010.). Several studies have investigated the microbial ecology and dynamics of drinking water supply systems (El-Chakhtoura et al., 2015), but the majority (even in full-scale desalination plants) focused on the exploration of the biofilm microbial communities on RO membranes and cartridge filters (CF) and their role in biofouling (Zhang et al., 2011; Chiellini et al., 2012) with the aim to improve treatment efficiency and plant performance (Bereschenko et al., 2008). Few studies have characterized planktonic communities in full-scale water supply systems supplemented with different source waters, e.g. surface and groundwater (Eichler et al., 2006; Pinto et

al., 2012) and discussed how the treatment train shapes the planktonic microbiome and influences the final bacterial communities.

In this study, we applied 16S rRNA gene pyrosequencing to: (i) identify and characterize the planktonic bacterial communities associated with different compartments of a full-scale desalination plant for drinking water production and (ii) compare these communities across different locations throughout the water treatment process. To the authors' knowledge, this is the first study that investigates the microbial ecology of a seawater desalination plant for drinking water production.

5.2. Materials and Methods

5.2.1 KAUST desalination plant

The desalination plant is located at King Abdullah University of Science and Technology (KAUST) in the West of the Kingdom of Saudi Arabia. The facility was designed to provide all potable water needs for the campus as well as the residential areas. The plant has a drinking water production capacity of 40,000 m³ per day. The source is the Red Sea. The desalination plant consists of three parts: pre-treatment, reverse osmosis (RO) system and post-treatment.

Pre-treatment involves the sequence of (i) open seawater intake, (ii) fine screen filtration, (iii) water chlorination at the intake point, and filtration through (iv) spruce multi-media filters (SMF) to remove particulate and colloidal matter. The water is chlorinated once a week for a period of 1 h to prevent microbial growth on the inside of the water intake pipe and the SMF. Thereafter, a portion of the water flow is directed to fill the SMF backwash water tank (an SMF is

backwashed every 12 h for a period of ≈ 30 minutes) while the remaining water flow is directed towards the RO treatment trains (Fig. 5.1).

The RO system involves the sequence of (i) anti-scalant dosage (1.5 mg/L, to avoid the RO system from inorganic deposition, also named scaling), (ii) cartridge filtration (10 μm pore size, to protect the RO from particulate fouling) and (iii) sodium bisulphite (SBS) dosage (to neutralize chlorine residual that may compromise the RO membrane integrity) and then (iv) the RO installation consisting of a seawater (SWRO) and brackish water RO (BWRO) pass.

The first pass SWRO produces the design fresh water quality goals except for Boron, while the second pass BWRO treatment is needed to lower the Boron concentration. The SWRO produced water passes a break tank (8000 m^3) and is subsequently fed with caustic soda to increase the pH in order to increase Boron rejection in the second pass treatment (BWRO). Addition of caustic soda will shift the equilibrium from $\text{B}(\text{OH})_3$ to $\text{B}(\text{OH})_4^-$. Because of the larger sized $\text{B}(\text{OH})_4^-$ ions, higher Boron rejection is achieved by the BWRO membranes. The SWRO pass has four trains, each with 140 pressure vessels of 7 membrane modules, making a total of 3920 membrane modules. 8 inch diameter Toray TMC820C-400 membrane modules with 34 mil thick feed spacer, a membrane surface area of 37 m^2 and salt rejection properties of 99.75% were used. The water recovery of the SWRO pass is 40%. The inlet pressure is about 60.6 bar and the reject pressure about 59.4 bar. Conductivity of the SWRO feed is about 56.47 mS/cm and that of the SWRO permeate is about 700 $\mu\text{S}/\text{cm}$ (note the unit). The membrane differential pressure is about 1.2 bar across one pressure vessel.

The second pass BWRO has 4 trains, each with 34 pressure vessels of 7 membrane modules, making a total of 952 membrane modules. 8 inch diameter Toray TM720-440 membrane modules with 28 mil feed spacer thickness, a membrane surface area of 40 m^2 and salt rejection properties of 99.7% were used. The water recovery of the BWRO pass is 90%. The inlet pressure is about 10.5 bar

and the reject pressure about 7.5 bar. Conductivity of the BWRO permeate is about 30 $\mu\text{S}/\text{cm}$. The membrane differential pressure is about 3 bar across one pressure vessel. Both the SWRO and BWRO membrane types are cross-linked fully aromatic polyamide composite in a spiral wound configuration.

Post-treatment: About 60% of the BWRO permeate is mixed with 40% of the SWRO permeate to meet the World Health Organization health-based guideline for Boron. Finally, the produced water (mix of BWRO and SWRO permeates) is chlorinated to maintain 0.5-1.0 mg/L of residual chlorine. Post-chlorination is applied to avoid microbial growth during distribution. In addition, the following chemicals are dosed (i) hydrated lime (43 mg/L) for water conditioning to prevent pipe corrosion and (ii) CO_2 (20 mg/L) to adjust the pH to near a neutral value with positive Langelier saturation index (LSI). Subsequently, the produced drinking water is pumped into storage reservoirs (two vessels, each 10,500 m^3) feeding the drinking water distribution network. Water quality analysis data is shown in Table 5.1 (selected) and Table S5.1 (raw seawater, SWRO and BWRO permeate and product) in the supplementary material. The overall water recovery of the plant is 38%. The water production (O&M) costs are USD 0.40 / m^3 (IDA, 2015).

Hydraulic retention time (hydraulic residence time) of water in the break tank and the drinking water reservoirs: The break tank (8000 m^3) provides (i) make up water for the chillers (250 m^3/h), (ii) blending water for the BWRO permeate (680 m^3/h), and (iii) BWRO feed water (1100 m^3/h), indicating a 4 h retention time in the break tank. Daily, about 40,000 m^3 (1667 m^3/h) drinking water passes the storage tanks (21,000 m^3), indicating a 12.6 h retention time in the drinking water storage tanks.

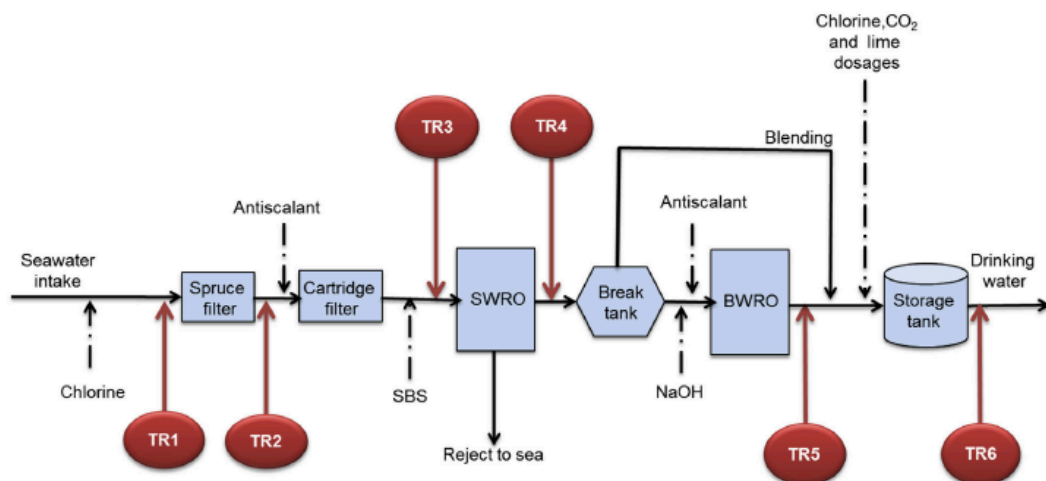

Figure 5.1. Schematic diagram of the drinking water treatment plant. Sampling sites are indicated with circles as follows– TR1: inlet seawater, TR2: after spruce media filter, TR3: seawater reverse osmosis (SWRO) feed, TR4: seawater reverse osmosis permeate, TR5: brackish water reverse osmosis (BWRO) permeate, TR6: produced drinking water. TR6 is a blend of TR4 and TR5. Dosed are chlorine, antiscalant, SBS (sodium bisulphite), NaOH, CO₂ and lime.

Table 5.1. Water quality parameters and total bacterial cell count during desalination.

Abbreviations of sample IDs are the same as those shown in Figure 5.1. TOC: total organic carbon, TCC: total cell count, *flow cytometry detection limit. The values between parentheses represent the standard deviation of three measurements of the same water sample.

Sample ID	Conductivity (mS/cm)	TOC (mg/L)	Residual chlorine (mg/L)	Temperature (°C)	pH	TCC (cells/mL)
TR1	65.0 (±0.3)	1.68 (±0.06)	< 0.02	25.6 (±0.3)	8.9 (±0.2)	5.47 × 10 ⁴ (±172)
TR2	61.3 (±0.2)	1.10 (±0.04)	< 0.02	24.1 (±0.1)	8.9 (±0.2)	3.16 × 10 ⁴ (±93)
TR3	59.7 (±0.1)	0.76 (±0.06)	< 0.02	24.4 (±0.1)	8.1 (±0.1)	2.74 × 10 ⁴ (±153)
TR4	0.87 (±0.02)	N/A	< 0.02	24.7 (±0.2)	7.7 (±0.1)	≤ 200*
TR5	0.12 (±0.02)	0.04 (±0.02)	< 0.02	23.7 (±0.4)	10.1 (±0.3)	≤ 200*
TR6	0.22 (±0)	0.02 (±0.00)	0.5	23.5 (±0.2)	7.5 (±0)	≤ 200*

5.2.2 Water sampling and sample IDs

Six water samples were collected on the same day (6 August 2012) from the desalination plant using 4 L sterile PVC bottles at the following locations: inlet seawater (TR1), spruce media filter permeate (TR2), seawater reverse osmosis feed (TR3), seawater reverse osmosis permeate (TR4), brackish water reverse osmosis permeate (TR5) and final chlorinated drinking water (TR6) (Fig. 5.1). The labels TR1 to TR6 are used to indicate the water sampling locations. The water samples were kept on ice until analysis. Within 24 hours after sampling, the water samples were analyzed for water quality parameters and filtered for microbial community analysis.

5.2.3 Water quality analysis

The water quality was analyzed through the measurement of pH (Cyberscan pH6000, Eutech, USA), conductivity (CON 510, Oakton, USA), Total Organic Carbon (TOC; TOC-VCPH Analyzer, Shimadzu, Japan) and residual chlorine concentration which was measured by the DPD method using a pocket colorimeter TM II (HACH). Flow cytometry analysis of the total bacterial cell concentrations was done by SYBR Green I cell staining followed by cell count in a defined sample volume using an Accuri C6 Flow Cytometer (BD Biosciences) as previously described (Berney et al., 2008; Hammes et al., 2008; Prest et al., 2013, Chapter 2).

5.2.4 DNA extraction, quantification and control measurements

Water samples of 3 L from each of the locations TR1-TR6 were filtered through polycarbonate membranes (pore size 0.2 μm , membrane diameter 45 mm, Millipore) which were rolled and placed into Cryo-vials (Nalgene, Nunc, Rochester, NY, USA), and frozen at $-80\text{ }^{\circ}\text{C}$ until DNA extraction. DNA was

extracted from the membranes using a FastDNA spin kit for soil (FastDNA, MP Biomedical, Illkirch, France). The extracted DNA was concentrated in 50 μ L DNAase-free water (extracted from 3 L water). The DNA concentration was quantified using Nanodrop 2000c (www.nanodrop.com, Wilmington, DE 19810, USA) and expressed as ng/ μ l in a total elution volume of 50 μ L.

Low extracted DNA concentrations were expected in the water samples after reverse osmosis filtration (TR4-TR6). Therefore, controls were applied to quantify possible contamination of the samples with DNA from the materials used and the environment (e.g. sample handling, extraction kit, water filtration unit, membrane and air contact). As controls, (i) virgin membranes without water and (ii) virgin membranes filtering 0.5 L of DNA-free water were applied. For the control samples, the same DNA extraction and quantification method was applied as for the water samples taken at the locations TR1-TR6.

5.2.5. PCR and 16S RNA gene pyrosequencing

The V4-V5 hypervariable region of the bacterial 16S rRNA genes was amplified using the PCR primers 515F and 907R (Zhou et al., 2011). Both primers covered >98% of the 16S gene sequences in the Ribosomal Database Project (Cole *et al.*, 2009). A single-step 30 cycles PCR using HotStarTaq Plus Master Mix Kit (Qiagen, Valencia, CA) was used with the following conditions: 94°C for 3 minutes, followed by 30 cycles of 94°C for 30 seconds; 53°C for 40 seconds and 72°C for 1 minute; after which a final elongation step at 72°C for 5 minutes was performed. Following the PCR, all amplified products from the different samples were mixed in equal concentrations and purified using Agencourt Ampure beads (Agencourt Bioscience Corporation, MA, USA). Samples were sequenced utilizing Roche 454 FLX titanium instruments (Roche, Indianapolis, IN) and reagents and following the manufacturer's guidelines.

5.2.6. Data processing

The sequences were processed using a proprietary analysis pipeline (www.mrdnalab.com, MR DNA, Shallowater, TX, USA). Sequences were depleted of barcodes and primers. Subsequently, sequences shorter than 200 bp, sequences with ambiguous base calls, and sequences with homopolymer runs exceeding 6 bp were removed. Sequences were then denoised and checked for chimera sequences. Operational taxonomic units (OTUs) were defined after removal of singleton sequences, clustering at 3% divergence (97% similarity) (Eren et al., 2011; Swanson et al., 2011). OTUs were then taxonomically classified using BLASTn against a curated GreenGenes database (DeSantis et al., 2006).

5.2.7. Alpha and beta diversity measures

Rarified OTU tables were used to generate alpha and beta diversity metrics. Shannon diversity index (H) and species richness estimator of Chao1 were generated for each sample using QIIME as a measure of alpha diversity. Spatial variation of bacterial community was analyzed with principal coordinate analysis (PCoA) in QIIME using unweighted UniFrac distance matrix (Lozupone et al., 2010) as a measure of beta diversity.

Shared and sample-specific OTUs were calculated using Venny online software (Oliveros, 2007) (<http://bioinfo.gp.cnb.csic.es/tools/venny/index.html>).

5.3. Results

5.3.1 Water parameters

The mean water temperature in the seawater desalination process was 24.4 ± 0.72 °C and ranged between 25.6°C and 23.5°C (Table 5.1). The TOC concentration

ranged between 1.68 mg/L in the inlet water (TR1) and 20 µg/L in the final chlorinated water (TR6): 98.5 % of the total organic carbon was removed during seawater desalination. The increase in pH to 10.1 in TR4 is due to the addition of NaOH and anti-scalant necessary to enhance the removal of Boron. The water conductivity was reduced by 98.5% in the first RO pass while the second RO pass reduced conductivity by 86.2% resulting in an overall conductivity reduction of 99.8%. No residual chlorine was detected during the desalination process. After chlorination, we detected 0.50 mg/L free residual chlorine in the produced drinking water. All measured parameters of the final product water were in accordance with World Health Organization physicochemical quality standards for drinking water (WHO, 2004).

Based on flow cytometry results, 40% of the total bacteria in the inlet water ($5.47 \times 10^4 \pm 860$ cells/mL) were retained by the spruce media filter during the pretreatment step while 13% of the rest of the bacterial cells were removed by the cartridge filter. The total number of bacteria in the water decreased by $\geq 99.3\%$ after the first reverse osmosis filtration step and remained below the detection limit (≤ 200 cells/mL) of the flow cytometer in TR4, TR5 and TR6 (Table 5.1).

5.3.2 Bacterial diversity

A total of 252,648 sequence reads were obtained from all sampling sites with an average length of 379 bp. Of the total reads, 49,213 reads (19.4%) were removed after trimming and chimera check. For the downstream analyses, only OTUs with 97% similarity cut-off were used. The species richness estimator Chao1 was up to 2176 in the spruce media filter permeate water (TR2) (Table 5.2). The Chao1 index decreased during the pre-treatment step from 2083 (TR1) to 1641 (TR3) and then dropped to 445 after the first RO pass (SWRO pass). After the second RO

pass (BWRO pass), the Chao 1 richness increased to 574 and 614 in TR5 and TR6, respectively. The Shannon diversity index showed the same trend during the pre-treatment step and decreased progressively from 8.59 (TR1) to 7.98 and 7.75 in TR2 and TR3, respectively. The bacterial species diversity increased slightly after the first RO pass to 7.97, then dropped to 7.24 after the second RO pass and to 6.08 after chlorination of the drinking water (Table 5.2).

Rarefaction curves did not reach a plateau for samples TR1, TR2 and TR3 as OTUs continued to emerge for some samples even after 8,000 reads, suggesting that there was additional diversity in those samples that was probably not captured by pyrosequencing. In contrast, rarefaction curves for samples TR4, TR5 and TR6 reached a plateau after 6,000 reads, reflecting a more limited bacterial diversity (Figure S5.1 in supplementary material).

Table 5.2. Alpha diversity indices of bacterial phlotypes. Abbreviations of sample IDs are the same as those shown in Figure 5.1. The indices were calculated based on the abundance of each operational taxonomic unit (OTU) (97% cutoff). bp: base pair, *sequence reads that passed all quality controls (see materials and methods)

Sample ID	Number of sequences*	Average length (bp)	Observed OTUs	Chao1	Shannon index
TR1	12,945	380	1925	2082	8.59
TR2	50,098	375	3211	2176	7.98
TR3	68,462	375	3781	1641	7.75
TR4	12,065	381	876	445	7.97
TR5	13,364	381	1074	574	7.24
TR6	24,318	382	1761	614	6.08

5.3.3 Microbial community structure

PCoA based on unweighted UniFrac showed three separate clusters consisting of pre-treatment water samples (TR1, TR2 and TR3), RO permeate samples (TR4 and TR5) and the final chlorinated drinking water (TR6) (Fig. 5.2). PCoA revealed a clear separation in the microbial community structure between pre- (TR1, TR2 and TR3) and post-RO treatment (TR4 and TR5) samples along principal component 1 (PC1) while the effect of chlorination is seen along principal component 2 (PC2) where there is a separation between TR4/TR5 and TR6 (Fig. 5.2).

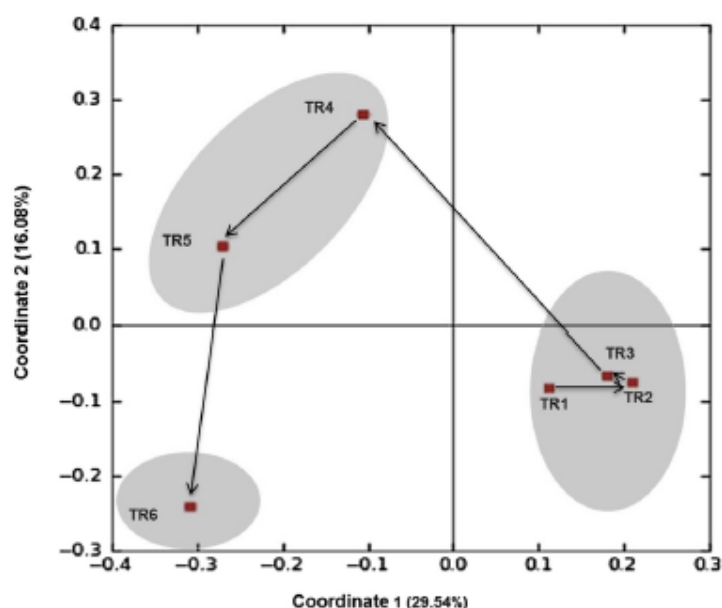

Figure 5.2. Principal coordinate analysis (PCoA) based on unweighted UniFrac distance matrix showing the phylogenetic relatedness between bacterial communities retrieved from different sampling sites. Abbreviations of samples are the same as those shown in Figure 5.1.

5.3.4 Taxonomic diversity

Diverse bacterial phyla were detected at all sampling sites (Fig. 5.3). The bacterial community was dominated by *Proteobacteria* (48.6%) followed by *Bacteroidetes*

(15.0%), *Firmicutes* (9.3%), *Cyanobacteria* (4.9%), *Planctomycetes* (3.0%) and *Actinobacteria* (1.9%).

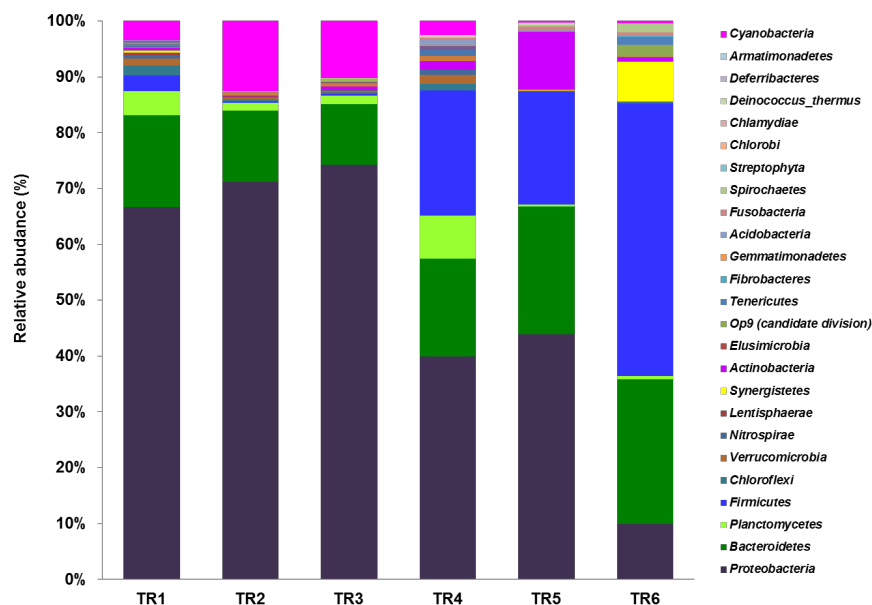

Figure 5.3. Taxonomic composition of the bacterial communities revealed by 16S rRNA gene pyrosequencing (phylum level). Abbreviations of samples are the same as those shown in Figure 5.1.

Six Proteobacterial classes were identified within all processed samples with *Alphaproteobacteria* (29.5%) being the most dominant followed by *Gammaproteobacteria* (14.7%), *Deltaproteobacteria* (2.7%), and *Betaproteobacteria* (2.3%). When moving from the seawater intake side of the desalination plant to the produced drinking water, the relative abundance of *Alphaproteobacteria* increased in the first three sampling locations (TR1, TR2 and TR3) and reached 74.1% then decreased to 31.4% after the first RO pass and finally dropped to 25.0% in the produced drinking water. While present in all sampling sites, the relative abundance of *Betaproteobacteria* reached the highest value in the produced drinking water at 45.3%. The relative abundance of *Deltaproteobacteria*

varied between 0.94% (TR5) and 9.2% (TR4). For a more detailed characterization of the *Proteobacteria* community composition we analyzed the taxonomic structure down to the order level as shown in Fig. 5.4. The *Alphaproteobacteria* were dominated by *Sphingomonadales* (1.5% - 41%), *Rhodobacterales* (SAR86 clade) (23.5% - 57%), *Rhizobiales* (0.8% - 48%), and *Rickettsiales* (SAR11 clade) (5.0% - 70%) (Fig. 5.4a). The *Betaproteobacteria* exhibited the highest community structure stability during the desalination process and was dominated by the order of *Burkholderiales* (Fig. 5.4b). The *Gammaproteobacteria* were the most diverse *Proteobacterial* group and were dominated by the order *Alteromonas* (3.5%-27%), *Pseudomonadales* (24.5% - 65%), *Oceanospirillales* (7.5% - 39%) and the phototrophic anoxygenic purple bacteria of the order *Chromatiales* (1.4% - 16.5%) (Fig. 5.4c). The *Deltaproteobacteria* were dominated by *Desulfobacterales* (9.0% - 29%), *Myxococcales* (11.0 - 47%) and *Desulfuromonadales* (8.8% - 52%) (Fig. 5.4d).

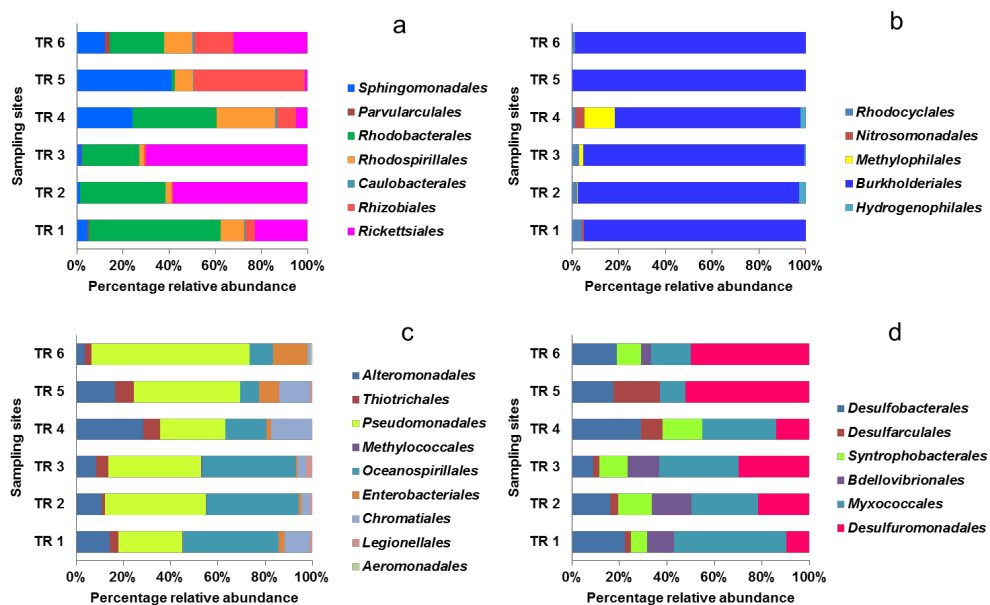

Figure 5.4. Taxonomic distribution of the Alpha-proteobacterial (a), Beta-proteobacterial (b), Gamma-proteobacterial (c), and Delta-proteobacterial (d) orders during water production process. Abbreviations of samples are the same as those shown in Figure 5.1.

The most dominant non-Proteobacterial classes for all sampling locations combined in descending order of their relative abundance were *Synechococcophycideae* (15.3%), *Flavobacteria* (15.3%), *Clostridia* (11.1%), *Bacteroidia* (7.8%), *Sphingobacteria* (6.2%), *Cytophagia* (6.2%), *Planctomycetacia* (5.0%), *Bacilli* (2.8%), *Unclassified Actinobacteria* (1.8%) and *Opitutae* (1.7%). The *Synechococcophycideae*, a class in the phylum *Cyanobacteria* was one of the most abundant non-Proteobacterial classes especially during the spruce and cartridge filtration where the relative abundance reached 46.4% in the spruce media filter permeate (TR2) and then declined to less than 1% in the water after RO (TR5 and in TR6). The *Flavobacteria* were one of the most abundant non-Proteobacterial class detected at all sampling sites before the RO treatment. Their relative abundance was 30%, 25% and 19% at TR1, TR2 and TR3, respectively (Fig. 5.5). Despite their presence within all water samples, the relative abundance of *Bacilli* increased remarkably from 0.4% in TR3 to 9.6% and 6.0% in the RO permeates (TR4 and TR5, respectively). In TR6 the *Bacilli* class represented 5.9% of the total non-Proteobacterial community. The *Planctomycetacia* were present only within the three first sampling sites (TR1, TR2 and TR3), while the *Sphingobacteria* were detected at all sampling locations (Fig. 5.5). The relative abundance of the *Bacteroidia* increased downstream the RO treatment process from 17.6% in TR4 to 26.8% in TR5 then decreased to 20.0% in TR6.

5.3.5 Core and unique OTUs

The presence of core OTUs at all stages of the desalination plant was determined and analyzed. Commonly occurring bacteria that appear in all assemblages associated with a particular habitat are critical for the function of the community.

Thus, identifying a core community may help in predicting community responses to a perturbation (e.g. filtration, chlorination) (Shade and Handelsman, 2012).

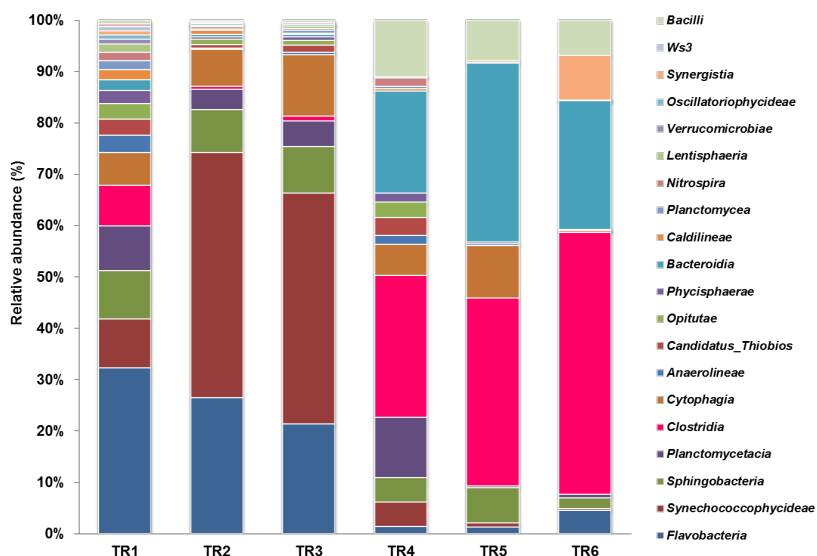

Figure 5.5. Variation of the non-Proteobacterial community composition during the desalination process. Abbreviations of samples are the same as those shown in Figure 5.1.

Venn diagrams were used to assess the core OTUs during seawater processing (Oliveros, 2007). For this, OTUs (97% cutoff) were classified in three groups: Core OTUs, detected in all sampling locations; Variable OTUs, not detected in all locations, but found in more than one location, and Unique OTUs, defined as OTUs detected in one sampling location. For the 11728 OTUs detected at all sampling locations 54.3%, 45.5% and 0.25% were classified as Unique, Variable and Core OTUs, respectively. Only 3 bacterial species were detected in all six sampling locations over the full treatment train and were identified as *Rhodobacteraceae* spp., *Candidatus Pelagibacter ubique*, and the cyanobacterial species *Prochlorococcus* spp. The Venn diagram showed that 811 OTUs were

shared between the bacterial communities collected from the three sampling locations prior to RO filtration (TR1, TR2 and TR3) (Fig. 5.6a), 361 OTUs were shared between bacterial communities from TR5 (BWRO permeate) and TR6 (the final chlorinated drinking water) (Fig. 5.6c) while 66 OTUs were shared between TR3, TR4 and TR5 (Fig. 5.6b). About 0.25% of the total bacterial OTUs was present in all stages of the desalination plant: the seawater, the RO permeates and the chlorinated drinking water, suggesting that some bacterial strains can survive in strongly different environments such as high/low salt concentrations and without/with residual disinfectant. Most likely these bacteria did not pass the RO membranes (no leakage), suggesting that the bacteria were present at the start-up of the installation (e.g. by placement of the RO membrane elements in the pressure vessels) and/or were introduced later as contamination from the environment (e.g. by maintenance and inspection of the RO installation including the reservoirs).

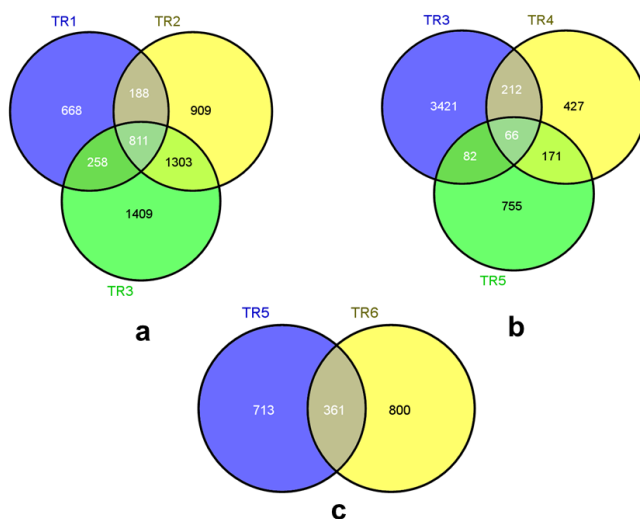

Figure 5.6. Venn diagrams displaying overlap between the bacterial communities across different sampling sites based on bacterial OTUs (3% distance cutoff); (a) during the pre-treatment step, (b) during reverse osmosis treatment steps and (c) after chlorination. Abbreviations of samples are the same as those shown in Figure 5.1.

5.3.6 Sample contamination

Low DNA concentrations and low OTU numbers were expected in the water after reverse osmosis filtration. The DNA concentration is presented in ng/ μ L DNA in a final volume of 50 μ L, extracted from 3 L of water. The DNA concentration decreased by 30% after the spruce media filter (from 200 ng/ μ L to 153 ng/ μ L) and by 78% (from 133 ng/ μ L to 30 ng/ μ L) after the first RO step. Remarkably, the DNA concentration remained stable in both RO permeates (30.0 ng/ μ L in TR4 and 26.6 ng/ μ L in TR5) and in the final produced drinking water (27.1 ng/ μ L in TR6) despite the decrease in the total bacterial cell number accounted by flow cytometry (Table 5.1). Therefore, to quantify possible DNA contamination by water sample processing, a series of control measurements were done with the same materials for bacteria collection (filter and filter unit) without and with filtration of DNA-free water.

In all control samples, (i) DNA concentrations (ranging from 9 to 10 ng/ μ L) were much lower than in the water samples, and (ii) an average OTU number of 72 ± 5 was detected. Although the fraction of shared OTUs between the 8 control samples was 46% (30 out of 72), these shared OTUs corresponded to a high percentage (~80%) of the total sequence reads, implying the detected bacteria were similar in the different control samples.

The OTU numbers in the control samples were much lower than in the water samples (Table 5.2). The contamination of the water sample OTUs with OTUs from the sample processing is in the range of 0.9% to 6.0% of the total OTUs found, indicating that nearly all of the OTUs (94%-99%) and the DNA originate from the water samples itself. The bacterial species identified in all control samples differed from the bacterial species found in all water samples over the treatment train, indicating that the three common bacterial strains (0.25% of OTUs) in the treatment plant were not caused by contamination from water sample filtration and DNA extraction protocols (Table S5.2). These results

suggest that the origin of the three bacterial species is the water. Bacterial growth or intrusion after reverse osmosis may occur as suggested by the detection of some OTUs affiliated with non-marine microbes and detected only in the final stage (TR6) of the treatment train (Table S5.3).

5.4. Discussion

5.4.1 *Microbial community diversity and structure*

16S rRNA genes pyrosequencing of water samples at different stages of the desalination plant revealed taxonomically diverse bacterial communities. The diversity of planktonic bacteria declined after the spruce media filter, after each RO unit, and after chlorination (Table 5.2), indicating that water treatment caused an alteration in the diversity of the planktonic bacterial community (Kormas et al., 2010; Pinto et al., 2012). This is supported by the fact that the water chemical and physical qualities changed after each treatment step along the desalination process (Table 5.1). Principal coordinate analysis revealed spatial variation in the bacterial community structure (Fig. 5.3) suggesting the role of different treatment processes and salinity changes in shaping the microbial communities during drinking water production.

5.4.2. *Interpretation of bacterial community composition*

The pyrosequencing analyses revealed that the desalination plant hosted a high bacterial diversity and that distinct communities were detected at each step of the desalination process despite the effectiveness of the RO process in removing bacterial cells from the water. This bacterial community was predominated by *Proteobacteria*, *Bacteroidetes*, *Firmicutes* and *Cyanobacteria*. Similar bacterial

community assemblages have been previously described in marine ecosystems (Manes et al., 2011; Elifantz et al., 2013). Moreover, *Alphaproteobacteria*, *Gammaproteobacteria* and *Bacteroidetes* have been shown to be the most dominant bacterial assemblage in coastal marine ecosystems (Dang et al., 2008). *Cyanobacteria* strains have been isolated from drinking water reservoirs and tap water samples (Codony et al., 2003; Izaguirre et al., 2007; Revetta et al., 2011), suggesting that there might be some cyanobacterial groups that not only can withstand disinfection treatment but might have physiological capabilities that enhance their survival in the absence of light.

5.4.2.1. Proteobacterial community in desalination plant

Members of the *Alphaproteobacteria* were dominant in the water prior to RO filtration (TR1, TR2 and TR3) and in the produced drinking water (TR6) while *Gammaproteobacteria* were dominant in the seawater reverse osmosis permeate (TR4). After chlorination (TR6) the bacterial community was dominated by the *Betaproteobacteria* (45.3%) which contrasts with previous findings showing *Alphaproteobacteria* to be the dominant group in treated water samples due to their capacity to survive in low nutrient and chlorinated environments, while *Betaproteobacteria* were observed more frequently in water with low disinfectant residuals (Chao et al., 2013; El-Chakhtoura et al., 2015). However, a previous study showed that 0.4 mg L⁻¹ of residual chlorine was a sensitive oxidant level to the *Alphaproteobacteria* population and could favor *Beta*- and *Gammaproteobacteria* which normally are favored by higher free residual chlorine concentrations (Mathieu et al., 2009). The treatment train was distinctly effective in removing *Proteobacteria* (Fig. 5.3, from ca 70% before RO to ca 10% in the final water (TR6) with cell numbers below flow cytometry detection limits (Table 5.1) and in tandem the *Gammaproteobacteria* class was considerably reduced throughout all treatment steps (3.9% in TR6).

Within the *Alphaproteobacteria*, the increase in *Rhizobiales* relative abundance within the SWRO and BWRO permeate water (TR4 and TR5) may indicate bacterial growth and/or the detachment of bacteria from biofilm present (i) at the permeate side of the RO membranes, (ii) in the pipes and (iii) in the reservoir. In fact, *Rhizobiales* represents one of the largest bacterial fractions in bench-scale RO membranes and full-scale biofilms from water purification systems and are known to produce extracellular polymeric substances (EPS) providing a protective environment for microbial cells to grow and persist in biofilms (Pang and Liu, 2007). *Rhodobacterales* with the SAR11 clade (Rickettsiales) were the most dominant alphaproteobacterial group at all sampling sites (except in TR6). The former group is a rapid primary surface-colonizer in coastal waters (Zhang et al., 2006; Dang et al., 2008) participating in bio-corrosion and biofouling phenomenon (Beech et al., 2005). Their ubiquitous presence in all sampling sites may be linked to the presence of biofilm in all compartments of the desalination plant. In contrast, the SAR11 clade members are considered to be planktonic (Giovannoni and Stingl, 2005). All *Betaproteobacteria* were identified as members belonging to the order *Burkholderiales* and in particular to the *Burkholderiaceae* and *Comamonadaceae* families. This bacterial group was described previously as a major component of the RO membrane biofilm (Xia et al., 2010; Al Ashhab et al., 2014). Within the *Deltaproteobacteria*, phylotypes belonging to the *Desulfarculales*, *Desulfobacterales*, and *Desulfomonadales* orders were detected. These bacterial groups may act as sulfate reducers or metal oxidizers that could affect water distribution pipe integrity (Seth and Edyvean, 2006).

5.4.2.2. Effect of filtration process on bacterial community structure

Distinct bacterial communities were detected in the water at each step of the water treatment plant. It is likely that particular operations employed during the

drinking water production process affected the bacterial composition in distinctive ways (Pinto et al., 2012). Based on the Alpha diversity index (Table 5.2), the bacterial diversity remained unchanged after the seawater reverse osmosis (SWRO) pass, but decreased after the following brackish water reverse osmosis (BWRO) pass and after the disinfection step of the water before distribution. Thus, the impact of the BWRO and chlorination was more pronounced on the bacterial diversity than the impact of the SMF process and the SWRO. On the other hand, while the SMF and chlorination showed no effect on the species richness (Chao1 index), it was clear that both the SWRO and BWRO reduced the bacterial species richness of the planktonic bacterial community. Both types of treatments (RO and chlorination) had distinct effects on the bacterial species richness during the drinking water production process.

5.4.2.2.1. Effect of spruce media filter: The SMF is an improved system for lowering suspended solids and microorganisms from seawater. It is a multi-media deep bed filter consisting of 4 layers of natural, long lasting, inert media with an increasing density, decreasing particle size and specific shape factor able to achieve submicron particle filtration ranging between 0.2 and 50 μm . The main objectives of the pretreatment filtration step are the mechanical retention of the suspended solids and adsorption of negatively charged microorganisms. After the SMF treatment step, 34%, 33% and 45% of the total organic carbon, water turbidity and total cell concentration were removed by the SMF, respectively. Crossing the SMF, *Proteobacteria* remained the dominant phylum slightly increasing in the water (67% (TR1) to 73% (TR2)). The *Alphaproteobacteria* dominated the Proteobacterial community with a relative abundance of 68.9%. Also, the relative abundance of *Planctomycetes* and *Bacteroidetes* decreased in the water. In contrast, *Cyanobacteria* abundance increased after the SMF filtration step (from 3.0% to 14.3%). At the class level, the relative abundance of

Synechococcophycideae, *Cytophagia* and *Flavobacteria* increased after the SMF step, while *Clostridia* and *Planctomycetacia* abundance decreased.

5.4.2.2.2. *Community structure after first RO pass*: At this SWRO step, 29% of the TOC was removed. $\geq 99\%$ of the total bacterial cell concentration was removed after the 1st RO pass. The most relevant changes within the bacterial community composition observed were the decrease by 50% of the relative abundance of the *Proteobacteria*, and the increase in the relative abundance of *Firmicutes*, *Bacteroidetes* and *Planctomycetes*, possibly by growth and/or detachment. Indeed, the *Bacteroidetes* group likely plays a role in the degradation of polymeric organic matter and is found in marine pelagic zones and often associated with surfaces (Frette et al. 2004). *Bacteroidetes* are known to constitute one of the components of the fouling layers on SWRO-membranes (Rapenne et al., 2009) since they are well adapted to grow on surfaces and could play a role in degrading biopolymers. In contrast, in our study, they constituted the second major group in the bulk water. *Cyanobacteria* have been identified among potentially active bacteria in chlorinated drinking water suggesting that they survive treatment disinfection and harsh conditions in distribution systems and have been shown to break through filtration treatment (Dugan and Williams, 2006). Crossing the first reverse osmosis pass, *Gammaproteobacteria* dominated the *Proteobacteria* community. In addition, the abundance of the *Beta*- and *Deltaproteobacteria* increased in the produced water. An increase in the abundance of *Bacteroidia* (from 0.5% to 17.3%), *Clostridia* (from 0.8% to 24%), *Bacilli* (from 0.4% to 9.5%), and *Planctomycetacia* (from 4.5% to 10%) was observed in TR4.

5.4.2.2.3. *Comparison of RO permeates*: Compared with TR4, minor changes in the bacterial community composition were observed in TR5 such as the relative increase in the abundance of *Proteobacteria* and *Bacteroidetes* and the decrease of

Planctomycetes as shown in Fig. 5.3. *Actinobacteria* reached their highest abundance during the water production process constituting 10.4% of the total bacterial community in the BWRO permeate. At the class level, the relative abundance of *Clostridia* and *Bacteroidia* increased in TR5 unlike the *Bacilli* and *Planctomycetacia*. After the second RO pass, the *Proteobacteria* community was dominated by the *Alphaproteobacteria*.

5.4.2.3 Effect of chlorination of produced drinking water

The bacterial community was dominated by *Firmicutes* (49%) followed by *Bacteroidetes* (26%), *Proteobacteria* (10%) and *Synergistetes* (3%). Based on their respective relative abundance, chlorination did not affect *Bacteroidetes*, but reduced the relative abundance of *Actinobacteria* and *Proteobacteria*. At the class level, the relative abundance of *Clostridia* increased from 28% to 44%, while the abundance of *Cytophagia* and *Bacteroidia* decreased from 7.8% to 0.6% and from 26% to 21%, respectively. The Proteobacterial community was dominated by members of the *Betaproteobacteria* (45.2%) followed by the *Alphaproteobacteria* (25.2%), *Gammaproteobacteria* (21.5%), *Deltaproteobacteria* (7.2%) and *Zetaproteobacteria* (0.7%).

5.4.3. RO filtration removed bacterial cells

The conductivity data of the water before and after the SWRO filtration indicated that salt ions were removed strongly (99%). Bacteria are much bigger than salt ions, suggesting that bacteria, also the very small-sized ones in seawater, were rejected by the SWRO. The separation properties of RO membranes are not based on pores (like the membrane types microfiltration, ultrafiltration and nanofiltration) but on diffusion of water through the membranes, an indication that there are no pores in the RO membrane that allow bacteria to pass. The

bacterial cell numbers in the water after RO filtration were most likely lower than the lower limit of detection (Table 5.1).

RO filtration therefore showed extensive removal of bacteria from the RO feed water. However, the reduction in water DNA concentration (77%) was much less than the reduction in bacterial cell numbers (>99%), possibly due to: i) contamination during water sample collection and processing, ii) presence of free DNA in the RO produced water, iii) intrusion of bacteria that occurred during the plant start-up (e.g. during placement of the RO membrane modules in the installation) and/or maintenance and inspection work in the RO installation and/or reservoirs, iv) the RO filtration did not eliminate microbial processes in the produced water, and/or (v) a combination thereof. Despite the oligotrophic environment bacterial growth can occur in the RO permeates and the produced drinking water (Park and Hu, 2010).

5.4.4. Bacterial strains observed at all stages of treatment: not caused by sample contamination

Control measurements to quantify possible contamination of the water samples with DNA from the materials used and the environment (e.g. sample handling, extraction kit, water filtration unit, membrane and air contact) resulted in the detection of unique OTUs affiliated to 16 bacterial species (Table S5.2 in supplementary material). The bacterial species in the control samples differed from the core bacterial species present in all the different compartments of the desalination plant, indicating that the treatment plant core OTUs were not caused by sample contamination.

5.4.5. Controls of potential contamination important for clean water studies

Contamination of DNA was found during control studies (Table S5.2). The DNA contamination can originate from e.g. sample handling, the DNA extraction kit,

the water filtration unit, membrane and air contact and combinations thereof. The specific sources of the contamination were not determined.

Contamination could be especially important for environments with “low DNA levels” such as air and clean water. Examples of “low DNA level” environments are the permeates of membrane-based separation processes such as ultrafiltration, nanofiltration and reverse osmosis, as well as industrial and drinking water. Presently, contamination controls are not applied in studies characterizing and evaluating the microbial ecology during drinking water production and distribution.

5.4.6. Chlorination pre-treatment did not eliminate microbial processes

One of the most serious problems in RO applications is biofouling – excessive growth of biomass – affecting the performance of these membrane systems, influencing the (i) amount and quality of the produced water and/or (ii) reliability of water production and (iii) costs (Ridgway and Flemming, 1996; Shannon et al., 2008, Vrouwenvelder et al., 2001, 2008, 2011, van Loosdrecht et al., 2012). In the Middle East, about 70% of seawater RO membrane installations suffer from biofouling problems (Gamal Khedr, 2000).

A strategy pursued to prevent and control membrane biofouling is metabolic inactivation of the feed water bacteria by applying chemicals such as chlorine. RO membranes are sensitive to free chlorine. Free chlorine damages the thin-film composite membrane structure causing a decrease in membrane rejection. Therefore, residual chlorine in the seawater has to be removed prior to the RO membranes, which can be achieved by sodium bisulphite dosage.

This study shows that the taxonomic composition of the bacterial communities differed between the inlet water (residual chlorine) and after the cartridge filter (after de-chlorination). Of special interest is the increase in the relative abundance of *Cyanobacteria* after the spruce filter, which can be

associated with increased numbers of these microorganisms if the total cell counts before and after the spruce filter are considered.

Chlorination prior to the desalination plant is not an effective strategy to inhibit microbial processes and to control membrane biofouling. The change in microbial structure over TR1, TR2 and TR3 illustrated by e.g. the increase in the Beta-Proteobacterial class (Fig. 5.3) and the variation in relative abundance of the non-Proteobacterial community (Fig. 5.5) suggest that there is bacterial growth in the seawater during the SWRO pre-treatment. However, further studies are needed to better characterize this bacterial growth. Dissecting the extent and mechanisms of microbial growth in the different stages of a treatment train requires further investigations.

5.4.7. Presence of bacteria related to biofouling in desalination plant

Estimation of the degree of biofouling is an important task in RO plant operation and management. Diverse bacterial communities and marine environments can severely affect the SWRO membrane systems (Chun et al., 2012). Therefore, there is a high demand for detailed understanding of the microbial community comprising the biofilm on RO membranes. The 16S rRNA gene pyrosequencing method was successfully used to establish the fouling profile of SWRO membranes (Kim et al., 2013). Although biofilm formation has been extensively investigated, there are no studies in the literature on variation of the planktonic bacterial communities during desalination for drinking water production. Numerous bacterial genera have been found to participate in biofilm development on RO membranes for fresh or brackish water, among them *Pseudomonas*, *Corynebacterium*, *Flavobacterium*, *Aeromonas* spp. and fungi (Baker and Dudley, 1998). Microbial community analyses of RO membranes employing seawater as the water source and the use of a genetic approach as the identification method are seldom reported.

In this study, 6 bacterial genera known as organisms potentially responsible for biofouling were detected in the water during the desalination process (i.e., *Lactobacillus*, *Corynebacterium*, *Sphingomonas*, *Mycobacterium*, *Flavobacterium*, and *Pseudomonas*). All these bacterial genera were detected specifically in the RO permeates (TR4 and TR5). Distinctively, members of the genera *Pseudomonas* and *Sphingomonas* are known to produce the exopolysaccharides alginate and gellan, respectively (Freitas et al., 2011), and this physiological trait can favor their attachment to surfaces. Both *Flavobacterium* and *Pseudomonas* genera were exclusively detected in TR4 while *Mycobacterium* was only detected in TR5. 1,408 OTUs related to *Sphingomonas* genus were identified in TR4. Members of this genus have been previously reported as initial colonizers in larger fouling layers in a freshwater RO treatment facility and considered responsible for biofouling of RO membranes (Bereschenko et al., 2008). *Lactobacillus*, which was reported as a biofouling cause (Matin et al., 2011), was detected in both SWRO and BWRO permeates in which 299 and 116 related OTUs were identified, respectively. The *Alpha*- and *Gammaproteobacteria* were the most dominant groups of the microbial community detected in the bulk water during the water desalination process, but these bacteria were found to be also dominant members in the biofilm of SWRO membranes (Zhang et al, 2011). *Alphaproteobacteria* were reported to dominate over other bacterial communities in the fouling layer of full-scale SWRO membranes, fed by Red Sea water (Khan et al., 2013).

5.5. Conclusions

Exploration of the water bacterial community structure and variation at different treatment stages of a full-scale seawater desalination plant for 40,000 m³/day drinking water production revealed that:

- Chlorination at the seawater intake point was not effective in inhibiting microbial processes in the water treatment train. The taxonomic composition of the bacterial communities differed between the inlet water (residual chlorine) and water after the cartridge filters (after de-chlorination), indicating that the chlorination process was not effective in (i) inactivating all bacteria and (ii) preventing microbial growth in the treatment train, including the RO membrane system.
- Spatial changes in the bacterial community structure reflect the changes in water quality after the different treatment steps.
- As expected,
 - o the two-stage reverse osmosis filtration strongly reduced the water conductivity (>99%), TOC (98.5%) and the total bacterial cell number (>99%).
 - o reverse osmosis and chlorination were the most important processes shaping the bacterial community structure and diversity.
- As not expected,
 - o 0.25% of the total bacterial OTUs was present at all stages of the desalination plant: the seawater, the reverse osmosis permeate and the chlorinated drinking water, suggesting that these bacterial strains can survive in extreme environments such as high/low salt concentration and with/without residual disinfectant.

- control studies evaluating sample filtration and DNA extraction protocols without water showed that DNA contamination occurred, highlighting the importance of controls for studying the ecology of clean water. The bacterial strains found at all stages of treatment (0.25% of total OTUs) did not originate from sample contamination.

Additional investigations are needed to determine the origin of the DNA detected after reverse osmosis and chlorination treatment steps. Biofilm analysis is needed to confirm the presence, locations and the role of biofilms during desalination treatment.

Supplementary Material

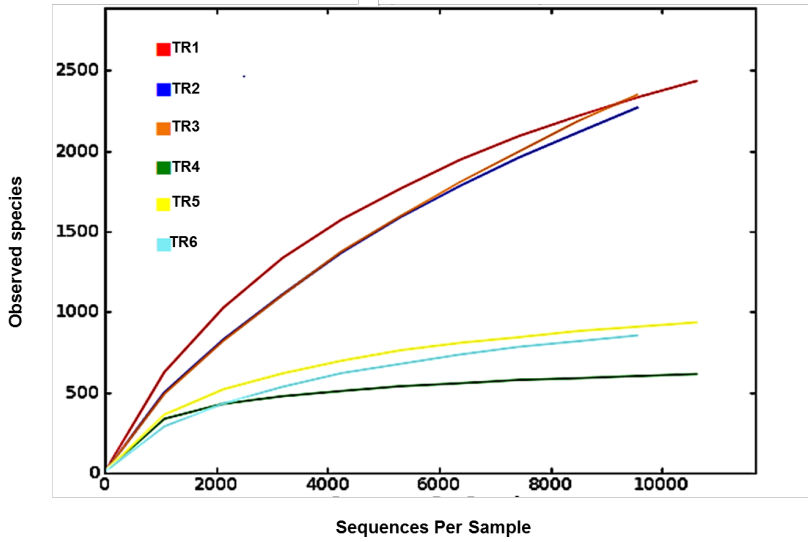

Figure S5.1. Rarefaction curves of bacterial operational taxonomic units (OTUs) during the desalination process. TR1: inlet seawater, TR2: after spruce media filter, TR3: seawater reverse osmosis (SWRO) feed, TR4: seawater reverse osmosis permeate, TR5: brackish water reverse osmosis (BWRO) permeate, TR6: produced drinking water.

Table S5.1. Water quality analysis. SWRO: seawater reverse osmosis feed, BWRO: brackish water reverse osmosis permeate, TDS: total dissolved solids, #: no value available, below detection limit

Parameter	Unit	Raw seawater	SWRO permeate	BWRO permeate	Product
T	°C	32.3	31.5	32.6	33.0
pH		8.05	7.08	10.39	7.6
Turbidity	NTU	0.13	0.09	0.05	0.09
Conductivity	µS/cm	62248	870	124	216
TDS	ppm	40981	600	78	139
Calcium	ppm	480	0.8	0.08	4.8
Calcium hardness	ppm	1200	2	0.2	12
Sodium	ppm	12628	165	30	39
Magnesium	ppm	1530	2.4	0.1	0.48
Magnesium hardness	ppm	1530	10	0.4	2
Total hardness	ppm	7500	12	0.6	14
Potassium	ppm	425	7.5	0.9	1.5
Iron, total	ppm	0.02	0.02	0.02	0.02
Chloride	ppm	23128	264	27	48
Sulphate	ppm	2650	3.0	N.A. #	N.A. #
Silica	ppm	0.13	0.09	0.11	0.10
Bicarbonate	ppm	134	6.1	N.A. #	43

Table S5.2. Water Differences in core microbiome composition between the test control samples and the desalination plant water samples. OTU: operational taxonomic unit

Test control samples		Desalination plant	
Common OTUs	Species affiliation	Common OTUs	Species affiliation
OTU_402, OTU_801, OTU_832, OTU_776	<i>Acinetobacter calcoaceticus</i>	OTU_6719	<i>Rhodobacteraceae</i> spp.
OTU_4, OTU_378	<i>Acinetobacter johnsonii</i>	OTU_9467	<i>Candidatus pelagibacter ubique</i>
OTU_16	<i>Brevundimonas diminuta</i>	OTU_7711	<i>Prochlorococcus</i> spp.
OTU_2, OTU_807, OTU_938	<i>Caulobacter leidyia</i>		
OTU_30	<i>Cystobacterineae</i> spp.		
OTU_3, OTU_445	<i>Herbaspirillum rubrisubalbicans</i>		
OTU_37	<i>Nitrosomonas ureae</i>		
OTU_11, OTU_717	<i>Nitrospira</i> spp.		
OTU_17	<i>Novospirillum itersonii</i>		
OTU_957, OTU_381, OTU_977, OTU_814, OTU_951, OTU_690, OTU_676	<i>Pseudomonas putida</i>		
OTU_435	<i>Pseudomonas savastanoi</i>		
OTU_902	<i>Pseudomonas veronii</i>		
OTU_824	<i>Sphingomonas azotifigens</i>		
OTU_13	<i>Thauera phenylacetica</i>		
OTU_50	<i>Thauera</i> spp.		
OTU_705	<i>Variovorax</i> spp.		

Table S5.3. Some bacterial species for which associated OTUs could be detected in TR6.

Bacterial species	Example habitat	Reference
<i>Brachymonas</i> spp.	Oil reservoir	Silva et al., 2013
<i>Listeria welshimeri</i> serovar 6b	Decaying plants	Welshimer, 1968
<i>Caulobacter vibrioides</i>	Freshwater isopods gut	Mayer et al., 2015
<i>Paludibacter</i> spp.	River sediments	Sánchez-Andrea et al., 2013
<i>Anaerobaculum mobile</i>	Wastewater lagoon	Menes and Muxí , 2002
<i>Proteiniphilum</i> spp.	Anaerobic digester	Nelson et al., 2011
<i>Roseburia</i> spp.	Human gut	Aminov et al., 2006
<i>Pseudobutyrvibrio</i> spp.	Animal rumen	Edwards et al., 2004
<i>Kosmotoga</i> spp.	Oil reservoir	Lewin et al., 2014
<i>Petrotoga mobilis</i>	Sea oil production well	Lien et al., 1998
<i>Anaerostipes</i> spp.	Human faeces	Hold et al., 2003
<i>Undibacterium</i> spp.	Drinking water	Kwon et al., 2011
<i>Peptococcaceae</i> spp.	Intestinal and respiratory tracts of humans and other animals	Mitsuoka, 1992

Bibliography

Al Ashhab, A., Herzberg, M., Gillor, O., 2014. Biofouling of reverse-osmosis membranes during tertiary wastewater desalination: microbial community composition. *Water Res.* 50, 341–349.

Baker, J.S., Dudley, L.Y., 1998. Biofouling in membrane systems - a review. *Desalination* 118, 81–89.

Beech, I.B., Sunner, J.A., Hiraoka, K., 2005. Microbe-surface interactions in biofouling and biocorrosion processes. *Int. Microbiol.* 8, 157–168.

Bereschenko, L.A., Heilig, G.H.J., Nederlof, M.M., van Loosdrecht, M.C.M., Stams, A.J.M., Euverink, G.J.W., 2008. Molecular characterization of the bacterial communities in the different compartments of a full-scale reverse-osmosis water purification plant. *Appl. Environ. Microbiol.* 74 (1), 5297–5304.

Berney, M., Vital, M., Hulshoff, I., Weilenmann, H.-U., Egli, T., Hammes, F., 2008. Rapid, cultivation-independent assessment of microbial viability in drinking water. *Water Res.* 42, 4010–4018.

Berry, D., Xi, C., Raskin, L., 2006. Microbial ecology of drinking water distribution systems. *Curr. Opin. Biotechnol.* 17, 297–302.

Chao, Y., Ma, L., Yang, Y., Ju, F., Zhang, X.X., Wu, W.M., Zhang, T., 2013. Metagenomic analysis reveals significant changes of microbial compositions and protective functions during drinking water treatment. *Sci. Rep.* 3.

Chiellini, C., Lannelli, R., Modeo, L., Bianchi, V., Petroni, G., 2012. Biofouling of reverse osmosis membranes used in river water purification for drinking purposes: analysis of microbial populations. *Biofouling. J. Bioadhesion Biofilm Res.* 28 (9), 969–984.

Chun, Y., Ha, P.T., Powell, L., Lee, J., Kim, D., Choi, D., et al., 2012. Exploring microbial communities and differences of cartridge filters (CFs) and reverse osmosis (RO) membranes for seawater desalination processes. *Desalination* 298, 85–92.

Codony, F., Miranda, A.M., Mas, J., 2003. Persistence and proliferation of some unicellular algae in drinking water systems as a result of their heterotrophic metabolism. *Water SA* 29, 113–116.

Cole, J.R., Wang, Q., Cardenas, E., Fish, J., Chai, B., Farris, R.J., et al., 2009. The Ribosomal Database Project: improved alignments and new tools for rRNA analysis. *Nucleic acids Res.* 37, 141–145.

Dang, H., Li, T., Chen, M., Huang, G., 2008. Cross-ocean distribution of Rhodobacterales bacteria as primary surface colonizers in temperate coastal marine waters. *Appl. Environ. Microbiol.* 74, 52–60.

DeSantis, T.Z., Hugenholtz, P., Larsen, N., Rojas, M., Brodie, E.L., Keller, K., Huber, T., Dalevi, D., Hu, P., Andersen, G.L., 2006. Greengenes, a chimera checked 16S rRNA gene database and workbench compatible with ARB. *Appl. Environ. Microbiol.* 72, 5069–5072.

Dugan, N.R., Williams, D.J., 2006. Cyanobacteria passage through drinking water filters during perturbation episodes as a function of cell morphology, coagulant and initial filter loading rate. *Harmful Algae* 5, 26–35.

Eichler, S., Christen, R., Holtje, C., Westphal, P., Botel, J., Brettar, I., Mehling, A., Holfe, M.G., 2006. Composition and dynamics of bacterial communities of a drinking water supply system as assessed by RNA- and DNA-based 16S rRNA gene fingerprinting. *Appl. Environ. Microbiol.* 72 (3), 1858–1872.

El-Chakhtoura, J., Prest, E., Saikaly, P., van Loosdrecht, M.C.M., Hammes, F., Vrouwenvelder, J.S., 2015. Dynamics of bacterial communities before and after distribution in a full-scale drinking water network. *Water Res.* 74, 180–190.

Elifantz, H., Horm, G., Ayon, M., Cohen, Y., Minz, D., 2013. Rhodobacteraceae are the key members of the microbial community of the initial biofilm formed in Eastern Mediterranean coastal seawater. *FEMS Microbiol. Ecol.* 85, 348–357.

Eren, A.M., Zozaya, M., Taylor, C.M., et al., 2011. Exploring the diversity of *Gardnerellavaginalis* in the genitourinary tract microbiota of monogamous couples through subtle nucleotide variation. *PLoS One* 6 (10), e26732.

Freitas, F., Alves, V.D., Reis, M.A.M., 2011. Advances in bacterial exopolysaccharides: from production to biotechnological applications. *Trends Biotechnol.* 29, 388–398.

Frette, L., Jørgensen, N.O.G., Irming, H., Kroer, N., 2004. *Tenacibaculum skagerrakense* sp. nov., a marine bacterium isolated from the pelagic zone in Skagerrak, Denmark. *Int. J. Syst. Evol. Microbiol.* 54, 519–524.

Gamal Khedr, M., 2000. Membrane fouling problems in reverse osmosis desalination applications. *Desalination Water Reuse* 10, 8–17.

Ghaffour, N., Missimer, T.M., Amy, G.A., 2013. Technical review and evaluation of the economics of water desalination: current and future challenges for better water supply sustainability. *Desalination* 309, 197–207.

Giovannoni, S.J., Stingl, U., 2005. Molecular diversity and ecology of microbial plankton. *Nature* 437, 343–348.

Hammes, F., Berney, M., Wang, Y., Vital, M., K€oster, O., Egli, T., 2008. Flow-cytometric total bacterial cell counts as a descriptive microbiological parameter for drinking water treatment processes. *Water Res.* 42 (1–2), 269–277.

IDA desalination yearbook 2014–2015, 2015.

<http://idadesal.org/publications/idadesalination--yearbook/>.

<http://www.edmgr.com/ida>.

Izaguirre, G.G., Jungblut, A.-D., Neilan, B.A., 2007. Benthic cyanobacteria (*Oscillatoriaceae*) that produce microcystin-LR, isolated from four reservoirs in southern California. *Water Res.* 41, 492–498.

Khan, M.T., Manes, C.-L.O. d., Aubry, C., Croue, J.-P., 2013. Source water quality shaping different fouling scenarios in a full-scale desalination plant at the Red Sea. *Water Res.* 47 (2), 558–568.

Kim, I.S., Lee, J., Kim, S.-J., Yu, H.-W., Jang, A., 2013. Comparative pyrosequencing analysis of bacterial community change in biofilm formed on seawater reverse osmosis membrane. *Environ. Technol.* 35 (2), 125–136.

Kormas, K.A., Neofitou, C., Pachiadaki, M., Koufostathi, E., 2010. Changes of the bacterial assemblages throughout an urban drinking water distribution system. *Environ. Monit. Assess.* 165 (1), 27–38.

Lozupone, C., Lladser, M.E., Knights, D., Stombaugh, J., Knight, R., 2010. UniFrac: an effective distance metric for microbial community comparison. *ISME J.* 5, 169–172.

Manes, C.L.d.O., Barbe, C., West, N.J., Rapenne, S., Lebaron, P., 2011. Impact of seawater-quality and water treatment procedures on the active bacterial assemblages at two desalination sites. *Environ. Sci. Technol.* 45 (14), 5943-5951.

Mathieu, L., Bouteleux, C., Fass, S., Angel, E., Block, J.C., 2009. Reversible shift in the alpha-, beta-, and gammaproteobacteria populations of drinking water biofilms during discontinuous chlorination. *Water Res.* 43, 3375-3386.

Matin, A., Khan, Z., Zaidi, S.M.J., Boyce, M.C., 2011. Biofouling in reverse osmosis membranes for seawater desalination: phenomena and prevention. *Desalination* 281, 1-16.

Oliveros, J.C., 2007. VENNY: an Interactive Tool for Comparing Lists with Venn Diagrams. <http://bioinfogp.cnb.csic.es/tools/venny/index.html>.

Pang, C.M., Liu, W.T., 2007. Community structure analysis of reverse osmosis membrane biofilms and the significance of Rhizobiales bacteria in biofouling. *Environ. Sci. Technol.* 41, 4728-4734.

Park, S.-K., Hu, J.Y., 2010. Assessment of the extent of bacterial growth in reverse osmosis system for improving drinking water quality. *J. Environ. Sci. Health Part A* 45, 968-977.

Pinto, A.J., Xi, C.W., Raskin, L., 2012. Bacterial community structure in the drinking water microbiome is governed by filtration processes. *Environ. Sci. Technol.* 46 (16), 8851-8859.

Prest, E.I., El-Chakhtoura, J., Hammes, F., Saikaly, P.E., van Loosdrecht, M.C.M., Vrouwenvelder, J.S., 2014. Combining flow cytometry and 16S rRNA gene pyrosequencing: A promising approach for drinking water monitoring and characterization *Water Res.* 63, 179-189.

Prest, E.I., Hammes, F., K€otzsch, S., Van Loosdrecht, M.C.M., Vrouwenvelder, J.S., 2013. Monitoring microbiological changes in drinking water systems using a fast and reproducible flow cytometric method. *Water Res.* 47 (19), 7131-7142.

Rapenne, S., Barbe, C., Mondamert, L., Manes, C., Schaule, G., Lebaron, P., Croue, J.-P., 2009. Seawater characterization and membrane autopsy tools for better operation of SWRO plants. In: *Annals of IDA World Congress on Desalination and Water Reuse*, pp. DB09-189.

Revetta, R.P., Matlib, R.S., Santo Domingo, J.W., 2011. 16S rRNA gene sequence analysis of drinking water using RNA and DNA extracts as targets for clone library development. *Curr. Microbiol.* 63, 50–59.

Ridgway, H.F., Flemming, H.F., 1996. Membrane biofouling. In: Mallevalle, J., Odendaal, P.E., Wiesner, M.R. (Eds.), *Water Treatment Membrane Processes*. McGraw-Hill, New York, pp. 6.1–6.62.

Seth, A.D., Edyvean, R.G.J., 2006. The function of sulfate-reducing bacteria in corrosion of potable water mains. *Int. Biodeterior. Biodegrad.* 58, 108–111.

Shade, A., Handelsman, J., 2012. Beyond the Venn diagram: the hunt for a core microbiome. *Environ. Microbiol.* 14, 4–12.

Shannon, M.A., Bohn, P.W., Elimelech, M., Georgiadis, J.G., Marinas, B.J., Mayes, A.M., 2008. Science and technology for water purification in the coming decades. *Nature* 452, 301–310.

Swanson, K.S., Dowd, S.E., et al., 2011. Phylogenetic and gene-centric metagenomics of the canine intestinal microbiome reveals similarities with humans and mice. *ISME J.* 5 (4), 639–649.

Van Loosdrecht, M.C.M., Bereschenko, L.A., Radu, A.I., Kruithof, J.C., Picioreanu, C., Johns, M.L., Vrouwenvelder, J.S., 2012. New approaches to characterizing and understanding biofouling of spiral wound membrane systems. *Water Sci. Technol.* 66 (1), 88–94.

Vrouwenvelder, J.S., Manolarakis, S.A., van der Hoek, J.P., van Paassen, J.A.M., van der Meer, W.G.J., van Agtmaal, J.M.C., Prummel, H.D.M., Kruithof, J.C., van Loosdrecht, M.C.M., 2008. Quantitative biofouling diagnosis in full scale nanofiltration and reverse osmosis installations. *Water Res.* 42 (19), 4856–4868.

Vrouwenvelder, J.S., Van Der Kooij, D., 2001. Diagnosis, prediction and prevention of biofouling of NF and RO membranes. *Desalination* 139 (1e3), 65–71.

Vrouwenvelder, J.S., Van Loosdrecht, M.C.M., Kruithof, J.C., 2011. A novel scenario for biofouling control of spiral wound membrane systems. *Water Res.* 45, 3890–3898.

World Health Organization, 2004. *Guidelines for Drinking Water Quality*, second ed. World Health Organization.

Xia, S.Q., Li, J.X., He, S.Y., Xie, K., Wang, X.J., Zhang, Y.H., Duan, L.A., Zhang, Z.Q., 2010. The effect of organic loading on bacterial community composition of membrane biofilms in a submerged polyvinyl chloride membrane bioreactor. *Bioresour. Technol.* 101, 6601–6609.

Zhang, H., Parameswaran, P., Badalamenti, J., Rittmann, B.E., Krajmalnik-Brown, R., 2011a. Integrating high-throughput pyrosequencing and quantitative real time PCR to analyze complex microbial communities. In: Kwon, Y.M., Ricke, S.C. (Eds.), *High-throughput Next Generation Sequencing: Methods and Application*. Humana Press Inc, Totowa, pp. 107–128.

Zhang, K., Choi, H., Dionysiou, D.D., Sorial, G.A., Oerther, D.B., 2006. Identifying pioneer bacterial species responsible for biofouling membrane bioreactors. *Environ. Microbiol.* 8, 433–440.

Zhang, M., Jiang, S., Tanuwidjaja, D., Voutchkov, N., Hoek, E.M.V., Cai, B., 2011b. Composition and variability of biofouling organisms in seawater reverse osmosis desalination plants. *Appl. Environ. Microbiol.* 77 (13), 4390–4398.

Zhou, J., Wu, L., Deng, Y., Zhi, X., Jiang, Y.-H., Tu, Q., Xie, J., Van Nostrand, J.D., He, Z., Yang, Y., 2011. Reproducibility and quantitation of amplicon sequencing based detection. *ISME J.* 5, 1303–1313.

Chapter 6

Saudi Arabia: seawater - membrane desalination

Eukaryotic community structure and variation

This chapter has been published as: Belila, A., El-Chakhtoura, J., Saikaly, P.E., van Loosdrecht, M.C.M., Vrouwenvelder, J.S., 2017. Eukaryotic community diversity and spatial variation during drinking water production (by seawater desalination) and distribution in a full-scale network. *Environmental Science: Water Research and Technology* 3, 92-105.

Abstract

Eukaryotic microorganisms are naturally present in many water resources and can enter, grow and colonize water treatment and transport systems, including reservoirs, pipes and premise plumbing. In this study, we explored the eukaryotic microbial community structure in water during the (i) production of drinking water in a seawater desalination plant and (ii) transport of the drinking water in the distribution network. The desalination plant treatment involved pre-treatment (e.g. spruce filters), reverse osmosis (RO) membrane filtration and post-treatment steps (e.g. remineralization). 454 pyrosequencing analysis of the 18S rRNA gene revealed a highly diverse (35 phyla) and spatially variable eukaryotic community during water treatment and distribution. The desalination plant feed water contained a typical marine picoeukaryotic community dominated by Stramenopiles, Alveolates and Porifera. In the desalination plant Ascomycota was the most dominant phylum (15.5% relative abundance), followed by Alveolata (11.9%), unclassified fungi clade (10.9%) and Porifera (10.7%). In the drinking water distribution network, an uncultured fungi phylum was the major group (44.0%), followed by Chordata (17.0%), Ascomycota (11.0%) and Arthropoda (8.0%). Fungi constituted 40% of the total eukaryotic community in the treatment plant and the distribution network and their taxonomic composition was dominated by an uncultured fungi clade (55%). Comparing the plant effluent to the network samples, 84 OTUs (2.1%) formed the core eukaryotic community while 35 (8.4%) and 299 (71.5%) constituted unique OTUs in the produced water at the plant and combined tap water samples from the network, respectively. RO membrane filtration treatment significantly changed the water eukaryotic community composition and structure, highlighting the fact that (i) RO produced water is not sterile and (ii) the microbial community in the final tap water is influenced by the downstream distribution system. The study

results raise questions concerning the source of the major eukaryotic community in the network and the emergence of fungi as a dominant group in the drinking water distribution system suggests that these microorganisms need special attention.

6.1. Introduction

From source to tap, different stages of drinking water production and transport systems offer unique habitats where complex microbial communities may thrive with their structure changing at each stage. These communities change dynamically with upstream microbial communities in e.g. feed water potentially seeding the downstream system, and thus influencing the final drinking water microbial quality. Eukaryotic microorganisms are present in drinking water production and distribution systems, where several studies worldwide have reported the presence of protozoa (Loret and Greub, 2010; Valster et al., 2009), algae (Heng et al., 2008; Hoeger et al., 2008), invertebrates (van Lieverloo et al., 2004; Wolmarans et al., 2005) and fungi (Hurtado-McCormick et al., 2016; Hageskal et al., 2009; Nagy and Olson, 1982; Pereira et al., 2010; Siqueira et al., 2011). The presence of some microbial eukaryotes (i.e. free living protozoa) in drinking water distribution systems (DWDSs) constitutes a public health concern either due to their potential pathogenicity such as *Acanthamoeba*, *Candida* and *Aspergillus* (Poitelon et al., 2009; Marciano-Cabral et al., 2010; Liu et al., 2014) or by harboring a variety of pathogenic bacteria (Lupi et al., 1995), including *Legionella* (Kuiper et al., 2004). Microbial eukaryotes may shelter potentially pathogenic microbes and provide disinfection protection, e.g. nematodes which were shown to be responsible for recurring high levels of total coliforms (i.e. *Shigella* spp.) in chlorinated drinking water storage reservoir pump stations (Lupi et al., 1995). Also, amphipods, insect larvae and copepods isolated from a distribution system were found to contain putative opportunistic pathogens from various *Aeromonas*, *Pseudomonas*, and *Staphylococcus* spp. (Buse et al., 2013). Moreover, eukaryotes visibly occurring in drinking water will be perceived by consumers as indicative of low water quality and hygiene.

Based on their main food source (bacteria, fungi and algae), eukaryotes potentially play an important role in shaping the *in situ* microbial composition of DWDSs. However, little is known about microbial eukaryotic diversity in these engineered systems. Compared to 16S rRNA gene-based prokaryotic community analysis, limited data is available on the eukaryotic ecology of drinking water treatment plants (WTPs) and DWDSs. A few studies have assessed eukaryotic community diversity in the bulk water (Poitelon et al., 2009; Lin et al., 2014; Wang et al., 2014) in comparison with biofilms (Buse et al., 2014; Liu et al., 2012; Valster et al., 2010; Otterholt and Charnock, 2011). 18S rRNA gene pyrosequencing has provided insight on the eukaryotic community structure of drinking water produced from surface water (Poitelon et al., 2009; Caporaso et al., 2011) and groundwater (Poitelon et al., 2009).

Reverse osmosis (RO) membrane-based seawater desalination has gained wide acceptance around the world as a solution for the alarming fresh water crisis in many regions. Compared with other WTPs, there is still scant information about the microbial ecology of desalination plants (Belila et al., 2016). The objectives of this study were to investigate the taxonomic and phylogenetic diversity of the eukaryotic community in water during the (i) production of drinking water in a seawater desalination plant and (ii) transport of the drinking water in the distribution network, including storage reservoirs, pipes and premise plumbing. The spatial variation of the eukaryotic community was characterized from the seawater (source) to several points of use in the drinking water distribution network.

6.2. Materials and Methods

6.2.1 Desalination plant

The desalination plant is located at King Abdullah University of Science and Technology (KAUST) in the West of the Kingdom of Saudi Arabia. The facility was designed to provide all potable water needs for the campus as well as the residential areas. The plant has a drinking water production capacity of 40,000 m³ per day. The source is the Red Sea. The desalination plant consists of three parts: pre-treatment, reverse osmosis (RO) system and post-treatment. Pre-treatment involves the sequence of (i) open seawater intake, (ii) fine screen filtration, (iii) water chlorination at the intake point, and (iv) filtration through spruce multi-media filters (SMF) to remove particulate and colloidal matter (Fig. 6.1). The RO system involves the sequence of (i) anti-scalant dosage (1.5 mg/L), (ii) cartridge filtration (10 µm pore size), (iii) sodium bisulphite (SBS) dosage and then the (iv) RO installation consisting of a seawater (SWRO) and brackish water RO (BWRO) pass. As for post-treatment, about 60% of the BWRO permeate is mixed with 40% of the SWRO permeate to meet the World Health Organization health-based guideline for Boron. Finally, the produced water is chlorinated to maintain 0.5 - 1.0 mg/L of residual chlorine. In addition, the following chemicals are dosed: (i) hydrated lime (43 mg/L) for water conditioning to prevent pipe corrosion and (ii) CO₂ (20 mg/L) to adjust the pH to near a neutral value with positive Langelier saturation index (LSI). Subsequently, the produced drinking water is pumped into storage reservoirs (two vessels, each 10,500 m³) feeding the drinking water distribution network. The hydraulic retention times in the break tank and the drinking water reservoirs were 4 h and 12.6 h, respectively.

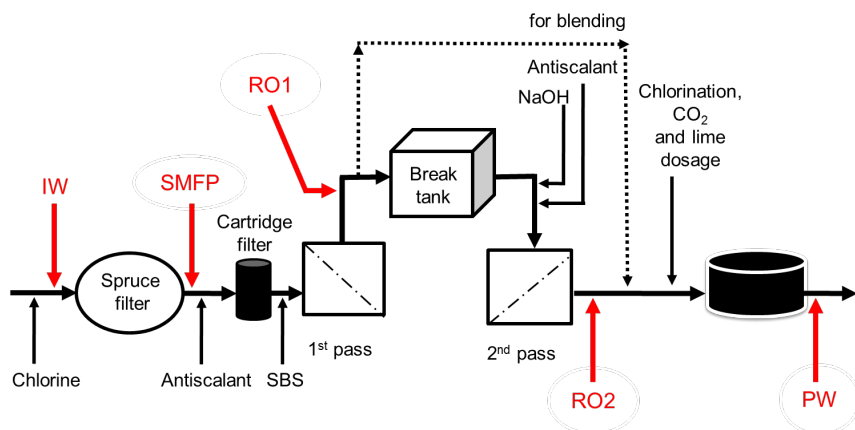

Figure 6.1. Schematic diagram of sampling points from KAUST desalination plant. IW: inlet water; SMFP: spruce media filter permeate; RO1: seawater reverse osmosis permeate; RO2: brackish water reverse osmosis permeate; PW: produced water. Dosed are chlorine, antiscalant, SBS (sodium bisulphite), NaOH, CO₂ and lime.

6.2.2 Distribution network

The full-scale desalination plant and the distribution network were taken into operation at the same time in 2009. The network piping material is only polyvinyl chloride (PVC). The total distribution network pipe length covered about 60 km and involved a confined area, meaning there was no mixing with drinking water from other sources. The piping network is periodically flushed with drinking water as part of routine maintenance.

6.2.3. Water sampling and sample IDs

Ten water samples were collected on the same day (6 August 2012): five from the desalination plant and five from selected network taps, using 4 L sterile polyvinyl chloride (PVC) plastic bottles. The locations of sampling from the desalination plant were: the chlorinated raw seawater entering the spruce multimedia filters (IW), spruce media filter permeate (SMFP), seawater reverse osmosis permeate (RO1), brackish water reverse osmosis permeate (RO2) and the

final chlorinated water (PW) (Figure 1). The tap water sampling locations were situated at 1.5 (TP1), 2.5 (TP2), 3 (TP3), 4 (TP4) and 7.5 (TP5) km from the desalination plant (Figure S1), respectively. All tap water samples were collected after flushing the tap for 5 minutes, then the water samples were transported directly to the Water Desalination and Reuse Center laboratory at KAUST to analyze water quality parameters and then they were filtered through 0.2 μm pore-sized filters (Millipore) for subsequent molecular biology analyses.

6.2.4. Water quality analysis

The water quality was analyzed through the measurement of pH (Cyberscan pH6000, Eutech, USA), conductivity (CON 510, Oakton, USA), turbidity (2100Q, HACH, USA), total organic carbon (TOC) (TOC-VCPH Analyzer, Shimadzu, Japan) and residual chlorine concentration which was measured by the N,N-Diethyl P-Phenylenediamine (DPD) method using a pocket colorimeter TM II (HACH). All these analyses were done following standard methods for the examination of water and wastewater (APHA/ AWWA/ WEF, 1998).

6.2.5. DNA extraction

Water samples of 3 L from each location were filtered through polycarbonate membranes (pore size 0.2 μm , membrane diameter 45 mm, Millipore) which were rolled and placed into Cryo-vials (Nalgene, Nunc, Rochester, NY, USA) and frozen at -80°C until DNA extraction. DNA was extracted from the membranes using a FastDNA spin kit for soil (FastDNA, MP Biomedical, Illkirch, France). The extracted DNA was concentrated in 50 μL DNAase-free water (extracted from 3 L water).

6.2.6. PCR amplification and 18S rDNA gene pyrosequencing

The 18S rRNA gene fragments were amplified using primers Euk-A7F and Euk-570R (Logares et al., 2012) following these PCR conditions: 94°C for 3 minutes, followed by 30 cycles of 94°C for 30 seconds; 53°C for 40 seconds and 72°C for 1 minute and a final elongation step at 72°C for 5 minutes. After that, all amplicon products were mixed in equal concentrations and purified using Agencourt Ampure Beads (Agencourt Bioscience Corporation, MA, USA).

Pyrosequencing was carried out at MR DNA Lab (Shallowater, TX, USA) on the Roche 454 FLX Titanium genome sequencer according to the manufacturer's instructions. Sequence data was processed at MR DNA Lab. In summary, sequences were depleted of barcodes and primers, then sequences < 150 bp were removed, as well as sequences with ambiguous base calls and with homopolymer runs exceeding 6 bp. Sequences were denoised, operational taxonomic units (OTUs) generated and chimeras removed. OTUs were defined by clustering at 3% divergence (97% similarity). Final OTUs were taxonomically classified using BLASTn against a curated database derived from NCBI and RDP II.

6.2.7. Alpha and beta diversity measures

Rarified OTU tables were used to generate alpha and beta diversity metrics. Shannon diversity (H) and species richness estimator of Chao1 indices were generated for each sample using QIIME as a measure of alpha diversity. Spatial variation of eukaryotic community was analyzed with principal coordinate analysis (PCoA) in QIIME using unweighted UniFrac distance matrix as a measure of beta diversity. The Emperor visualization tool (Vázquez-Baeza, 2013) was used to visualize the PCoA graph. Shared and sample-specific OTUs were calculated using Venny online software (Oliveros, 2007).

6.3. Results

6.3.1 Water parameters

During the seawater desalination process, 98.8% of the total organic carbon (TOC) was removed while the conductivity decreased by 99.6%. Crossing the spruce media filter, water pH remained stable (8.9), then increased to 10.1 after the second reverse osmosis stage due to the addition of NaOH and antiscalant necessary to enhance the removal of Boron. After treatment the pH of the produced water was corrected to 7.5 (± 0.1) before distribution. No residual chlorine was detected during the desalination process but after chlorination, the free chlorine concentration detected was 0.60 mg/L in the produced drinking water. The water temperature during treatment was 25.6°C. Minor variations were observed in the tap water parameters measured at various spots in the network (Table 6.1). The tap water pH ranged between 6.8 and 7.3, residual chlorine between 0.22 and 0.53 mg/L; and turbidity ranged between 0.18 and 0.36 nephelometric turbidity units (NTU). All tap water measured parameters were in accordance with World Health Organization physicochemical quality standards for drinking water (WHO, 2011).

6.3.2 Alpha and beta diversity measures

Crossing the desalination plant, the Shannon diversity index decreased gradually from 6.54 (IW) to 2.39 (PW) (Table 6.2). The first reverse osmosis pass had the largest impact on the reduction of the Shannon diversity index (reduction from 5.40 to 2.49). After chemical treatment and the disinfection step by chlorination, the Shannon diversity index stabilized to around 2.39.

In the network, all measured tap water Shannon indices were lower than the produced water (PW) (Table 6.2). All tap water Shannon diversity indices were lower than 2 except for TP4 (2.13), which could be explained by the increase

in the abundance of Blastocladiomycota and Amoebozoa in this tap water location (Figs. 6.2 and 6.3).

Table 6.1. Physico-chemical characteristics of the water at various locations in the desalination plant and drinking water distribution network. IW: inlet water; SMFP: spruce media filter permeate; RO1: seawater reverse osmosis permeate; RO2: brackish water reverse osmosis permeate; PW: produced water, TP1–TP5: tap water samples. The values between parentheses represent the standard deviation of three measurements of the same water sample. #distance between the produced water feeding the network and tap water sampling locations

	TOC (mg/L)	Temperature (°C)	pH	Conductivity (mS/cm)	Free chlorine (mg/L)	Turbidity (NTU)	Distribution distance (km) [#]
Desalination plant: Samples during treatment							
IW	1.68(±0.06)	25.6	8.9(±0.2)	65.0(±0.3)	< 0.02	2.10(±0.02)	-
SMFP	1.10 (±0.04)	25.6	8.9(±0.2)	61.3(±0.2)	< 0.02	1.41(±0.03)	-
RO1	0.54(±0.05)	25.6	7.7(±0.1)	0.87(±0.02)	< 0.02	0.48(±0.01)	-
RO2	0.04(±0.02)	25.6	10.1(±0.3)	0.30(±0.02)	< 0.02	0.20(±0.00)	-
PW	0.02 (±0.02)	25.6	7.5 (±0.1)	0.24 (±0.01)	0.6 (±0.01)	0.25(±0.00)	-
Distribution network: Tap water samples							
TP1	0.03	23.2	7.2	243	0.45	0.18	1.5
TP2	0.02	25.1	6.8	283	0.42	0.18	2.5
TP3	0.02	23.4	7.1	193	0.36	0.36	3.0
TP4	0.02	24.4	7.0	252	0.53	0.20	4.0
TP5	0.03	25.2	7.3	221	0.22	0.24	7.5
mean (SD)	0.02 (±0.01)	24.2 (±0.9)	7.1 (±0.2)	238 (±34)	0.39 (±0.12)	0.23 (±0.08)	-

Table 6.2. Alpha diversity indices of the eukaryotic communities during seawater desalination and drinking water distribution. Abbreviations of samples are the same as those listed in Table 6.1. OTUs were defined by clustering at 3% divergence.

		Number of raw reads	Average length (bp)	Observed OTUs	Richness estimate (Chao 1)	Shannon diversity index (H)
Desalination plant	IW	35,307	461	478	510	6.54
	SMFP	19,205	456	440	414	5.40
	RO1	20,199	460	30	28	2.49
	RO2	26,670	480	178	82	3.34
	PW	31,413	472	119	50	2.39
Distribution network	TP1	12,410	483	22	22	1.71
	TP2	9,711	478	126	36	1.22
	TP3	10,643	466	161	42	1.91
	TP4	28,837	474	108	56	2.13
	TP5	35,370	476	102	40	1.34

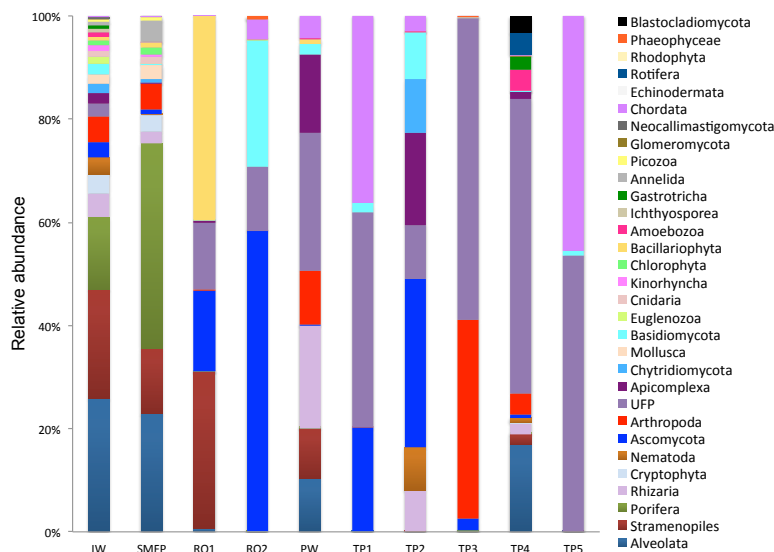

Figure 6.2. Relative abundance of the eukaryotic community (phyla level). UFP: unclassified Fungi phylum. IW: inlet water; SMFP: spruce media filter permeate; RO1: seawater reverse osmosis permeate; RO2: brackish water reverse osmosis permeate; PW: produced water, TP1–TP5: tap water samples, UFP: unclassified Fungi phylum

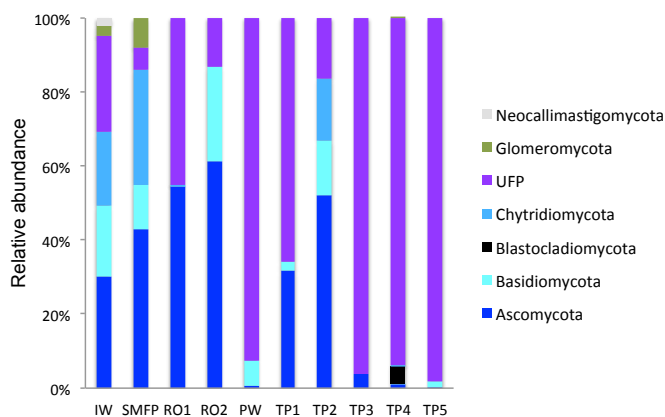

Figure 6.3. Variation in the fungal community composition (phyla level) during desalination and after water distribution. Abbreviations of samples are the same as those listed in Figure 6.2.

To estimate the variation of OTU richness during the water desalination process, nonparametric Chao 1 index was calculated for all samples. The highest

OTU richness values (calculated at a cluster distance of 0.03) were detected in the inlet water (510) and spruce media filter permeate (414) (Table 6.2). Chao 1 index decreased by 93% after RO1 pass to reach 28 and then increased to 82 after RO2 pass and stabilized at 50 in PW. The Chao1 values calculated in the network for the tap water samples (i.e. TP1 to TP5) were lower than the produced water value except in TP4 where the Chao1 index was 56. The rarefaction curves did not reach a plateau for samples IW and SMFP as operational taxonomic units continued to emerge even after 5,000 reads suggesting that there was additional diversity in those samples that was probably not captured by the pyrosequencing.

Based on unweighted UniFrac distance matrix, the PCoA plots showed divergent positions of the different water samples during the desalination process. A clear separation was found between (i) the pre-treatment water samples (IW and SMFP) and (ii) the post-treatment water samples (RO1, RO2 and PW). During pretreatment, a clear variation in the community structure was observed (Fig. 6.4). The most important changes in eukaryotic community structure were observed following the reverse osmosis trains 1 and 2 (RO1 and RO2, Fig. 6.4). The influence of water distribution on the eukaryotic community structure was relatively less significant than observed during the desalination process, indicating a relatively stable eukaryotic community in the distribution network. In fact, all tap water samples showed close or converging positions (Fig. 6.4).

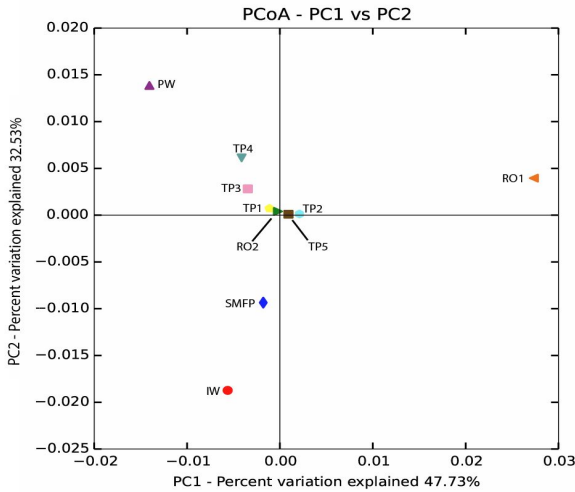

Figure 6.4. PCoA based on unweighted UniFrac distance matrix showing the phylogenetic link between eukaryotic communities in the desalination plant and after water distribution. Abbreviations of samples are the same as those listed in Figure 6.2.

Aiming to evaluate the eukaryotic community response to the different treatment steps (e.g. filtration, chlorination, water distribution), the presence of core OTUs in the desalination plant and in the network distribution system was assessed applying Venn diagram analysis. “Core OTUs” implies the total of shared OTUs between the five sampling locations within the desalination plant and also the shared OTUs between the five sampling locations in the distribution network. Results showed the absence of a core community in the desalination plant. On the other hand, Venn diagram analysis revealed the presence of two distinct core OTUs (shared OTUs): in the desalination plant: the first during pre-treatment (IW+ SMFP) and the second during the reverse osmosis treatment and post-treatment steps (Fig. S6.2). During the pretreatment step, the core community was composed of 317 shared OTUs between the inlet water and spruce media filter permeate (Fig. S6.2A) sampling sites, representing 52.7% of the total OTUs detected. Out of these 317 OTUs, 161 were identified as unique

OTUs in the IW (26.8%) and 123 OTUs as unique OTUs in the SMFP (20.5%). Taxonomic assignment showed that 70 OTUs (22.0%) from the core community belonged to *Grantessa sp.*, 22 OTUs to uncultured *Stramenopiles* and 19 OTUs to uncultured *Dinoflagellate*. During the reverse osmosis treatment and post-treatment steps (Fig. S6.2B), the core community was composed of one unique OTU (0.4%) that was assigned to an uncultured fungus while 15 OTUs were shared between the RO1 and RO2 permeate. Remarkably, all 15 (5.5%) OTUs belonged to the kingdom of fungi: 14 were assigned to the fungal species *Herpotrichiellaceae sp.* and 1 OTU to *Exophiala aquamarina*. 13 unique OTUs were detected in RO1 (4.8%), 124 unique OTUs in RO2 (45.8%) and 78 unique OTUs were identified in the produced water (28.8%). The presence of similar organisms in the water before and after RO was not expected because of the strongly different environments: seawater and fresh water.

To better understand the effect of water distribution on the eukaryotic community structure we combined the OTUs of all the tap water samples and compared them to the core community of the produced water. The Venn diagram (Fig. S6.3) showed that 84 OTUs (2.1%) formed the core community while 35 (8.4%) and 299 (71.5%) constituted unique OTUs in the PW and all combined tap water samples, respectively. Taxonomic analysis of the core community revealed that 75 OTUs (89.0%) forming the core community belonged to the kingdom of fungi. 64 of the 75 OTUs were assigned to an uncultured fungus with percentage of homology varying between 97.0% and 99.4%. 7 OTUs were assigned to *Cochliobolus sp.*, 2 OTUs to an uncultured marine fungus and 2 OTUs to uncultured *Climacodon*. The rest of the OTUs forming the core community (9) were assigned to the kingdom Metazoa. 8 OTUs were assigned to the phylum Chordata and 1 OTU to the phylum Porifera.

51 shared OTUs were identified in both the inlet water and the tap water samples (TP1-TP5), implying that 13.1% of the OTUs detected in the network

were supplied by the feed water. 94.1% of the shared OTUs between IW and TP1-TP5 were assigned to *Grantessa* sp. Additional analysis showed that 96 OTUs were shared between the tap water samples (TP1-TP5) and the reverse osmosis permeates (RO1 and RO2) which represented 25.0% of the OTUs detected in the drinking water distribution system. 88 of these shared OTUs were assigned to the Fungi phylum and 39 of the fungal OTUs were assigned to an uncultured fungus. The rest of the fungal OTUs belonged to Ascomycota and Basidiomycota phyla. This result points on the role of reverse osmosis treatment in the growth of fungi in the drinking water distribution system. On the other hand, 64 OTUs were shared between IW, SMPF and the tap water samples (TP1-TP5) representing 16.6% of the total OTUs detected in the drinking water distribution system. 48 of the shared OTUs were assigned to *Grantessa* sp. and only one OTU was assigned to the phylum Fungi. A varying number of shared OTUs was found when comparing the tap water samples to each other (Table S6.1). The highest number of shared OTUs was observed between TP2 and TP3 (61 OTUs).

6.3.3. Taxonomic diversity of desalination plant eukaryotes

18S rRNA gene reads were assigned to 8 supergroups namely: Picozoa, SAR supergroup (Stramenopiles, Alveolates and Rhizaria), Metazoa, Chromalveolata, Fungi, Euglenozoa, Archaeplastida, Amoebozoa, and Opisthokonta, based on the revised classification of Eukaryotes (Adl et al., 2012) (Fig. 6.5). After trimming and chimera removal, a 97% similarity cut-off was used to delineate OTUs in downstream analyses. Following subsampling, a total of 1773 eukaryotic OTUs were acquired. 28 eukaryotic phyla were identified in the desalination plant dominated by Ascomycota (15.6%), followed by Alveolata (11.9%), uncultured fungi phylum (10.9%), Porifera (10.7%), Stramenopiles (10.5%), and Bacillariophyta (8.4%) whereas Annelida, Mollusca, Nematoda, Chytridiomycota were found to be minor groups (<1%) (Fig. 6.2). In the network, 20 eukaryotic

phyla were identified in the tap water samples dominated by the uncultured fungi phylum (44.1%), followed by Chordata (17.1%), Ascomycota (11.1%) and Arthropoda (8.6%) while Rotifera, Amoebozoa, Blastocladiomycota and Nematoda were minor groups in the tap water samples (<1%) (Fig. 6.2). Throughout the full drinking water system, the unclassified fungi phylum and Ascomycota dominated the total eukaryotic community with a relative abundance of 27.5% and 13.3%, respectively.

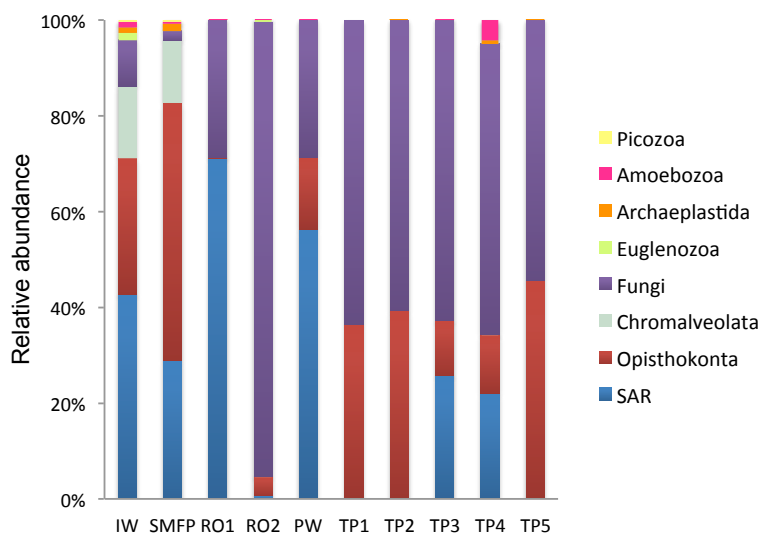

Figure 6.5. Relative abundance of the eukaryotic community (kingdom level) in KAUST water samples. Abbreviations of samples are the same as those listed in Figure 6.2. SAR: Stramenopiles, Alveolates and Rhizaria

6.3.3.1. *Effect of spruce multi-media filters:* Crossing the SMF, 35% of the TOC and 33% of the water turbidity were removed in the filters.

In the inlet water feeding the multi-media filters, the eukaryotic community was dominated by the SAR and metazoan supergroups; only 9.7% of the sequences were assigned to fungi. The fungal community was represented by

the Ascomycota, Basidiomycota, Chytridiomycota, Glomeromycota and Neocallimastigomycota phyla. After crossing the SMF, the eukaryotic community remained dominated by SAR and Metazoa while the relative abundance of fungi decreased to 2.1%. The same taxonomic composition of the fungal community was retrieved in the SMFP with the exception of Neocallimastigomycota which were absent within this permeate. Additionally an increase in the relative abundance of Ascomycota, Chytridiomycota and Glomeromycota was noted in the SMFP.

As for the rest of the eukaryotic community, Alveolata, Porifera, and Pinguiphyceae remained the major eukaryotic phyla in the filtered water (SMFP). The relative abundance of Porifera, represented by the class of Calcarea (*Grantessa* sp), increased to 39.7% while the relative abundance of Stramenopiles, represented by the class of Dinophyceae, decreased to 12.7%. During this first filtration step, Chao 1 and Shannon diversity indices dropped by 19% and 17%, respectively. .

6.3.3.2. *Effect of reverse osmosis:* After crossing the first pass RO membranes, 98.6% of the water conductivity, 51% of the TOC concentration and 66% of the water turbidity were reduced. Concomitantly, important changes in the eukaryotic microbial community structure were observed. Both diversity indices decreased: The Chao 1 and Shannon decreased by 93.3% and 54.7%, respectively. Only representatives of the SAR supergroup and fungi were detected in RO1 (Fig. 6.5). At phylum level, Bacillariophyta, represented by species *Cylindrotheca* sp. and *Psammodictyon* sp., dominated the eukaryotic community in this compartment of the desalination plant followed by Stramenopiles and fungi. Bacillariophyta are unicellular organisms that are important components of phytoplankton as primary sources of food for zooplankton in both marine and freshwater habitats (known also as Diatoms), able to survive in the absence of light by respiring

nitrate through the dissimilatory NO_3^- reduction (Kamp et al., 2011). The Stramenopiles community was represented by two main classes: Pinguiphyceae and Chrysophyceae (golden algae). This latter eukaryotic group (i.e. Chrysophyceae), while photosynthetic, is reported to be able to switch its metabolism to phagotrophy.

After RO1 treatment in the desalination plant, the relative abundance of fungi increased to 28.5% (Fig. 6.5) and the fungal community was represented by the class of Eurotiomycetes (15.6%) (Fig. S6.4) belonging to the phylum of Ascomycota and by an uncultured fungi clade (12.9%). Two dominant fungal species were identified; the *Herpotrichiellaceae* sp. Im294 and *Exophiala aquamarina*.

After RO2 treatment, the TOC concentration dropped to 4.1 $\mu\text{g/L}$, water conductivity to 302 $\mu\text{S/cm}$ and water turbidity to 0.2 NTU but alkaline conditions prevailed in this compartment ($\text{pH}=10.1$) to enhance Boron removal. Fungi largely dominated in RO2 where they constituted 94.9% of the total eukaryotic community (Fig. 6.5). The taxonomic diversity of the fungi increased after RO2 with the detection of Basidiomycota fungi in addition to the fungal groups identified after RO1 treatment. After RO2 treatment, the Ascomycota were represented by the genera *Aureobasidium*, *Dothidea*, *Cladosporium*, *Acephala*, *Penicillium* and *Exophiala* while the Basidiomycota were represented by genera *Bensingtonia*, *Cryptococcus*, *Trichosporon* and *Rhodotorula*. The rest of the eukaryotic community (i.e. non-fungal community) was assigned to the metazoan phylum Chordata.

6.3.3.3. *Effect of chemical dosages and chlorination:* During post-treatment (lime and CO_2 dosages and chlorination), the relative abundance of fungi decreased in the produced drinking water (PW). Metazoan (Chordata and Arthropoda) and SAR assigned groups were detected in the produced drinking water. Before being distributed in the network, the eukaryotic microbial community was dominated

by an unclassified fungi clade (26.6%), Rhizaria (19.9%) and Apicomplexa (15.1%). After chlorination, the fungal community was dominated by uncultured fungi with a clear decrease in the relative abundance of both Ascomycota (<1%) and Basidiomycota (2%) (Fig. 6.2).

6.3.4. Taxonomic diversity of desalination plant fungi

To better understand the taxonomic diversity of the fungal community within the desalination plant, the fungal 18S rRNA gene sequences were analyzed separately from the rest of the eukaryotic community at the phylum (Fig. 6.3) and class levels (Fig. S6.4). The fungal community (9.7%) identified in the inlet water of the desalination plant was of marine origin and was reported to play a diverse ecological role in marine ecosystems and has frequently been associated with parasitism of marine animals, plants and algae (Jephcott et al., 2016). Several Ascomycota and Chytridiomycota constitute parasitic agents of marine algae (Srivastava, 1967). Five fungal phyla were identified in the desalination plant: Ascomycota, Basidiomycota, Glomeromycota, Neocallimastigomycota and Chytridiomycota in addition to the unclassified fungi clade (Fig. 6.3). In the desalination plant, Ascomycota and the unclassified fungi clade had relatively equal abundance but in all tap water samples most of the sequences (69.4%) were assigned to the unclassified fungi clade (Fig. 6.3). Based on their relative abundance, Eurotiomycetes and Agaricomycetes were the most abundant classes of the Ascomycota and Basidiomycota groups in the desalination plant, respectively (Fig. S6.4).

6.3.5. Taxonomic diversity of network fungi

In the tap water samples, the fungal community was represented by five phyla: Ascomycota, Basidiomycota, Chytridiomycota, Blastocladiomycota and the unclassified fungi clade. The relative abundance and taxonomic composition of

the fungal community varied within each tap water sample, as shown in Figs. 6.3 and S6.4: Chytridiomycota were detected only in TP3, Basidiomycota were detected in TP1 and TP2, and Ascomycota in TP1, TP2 and TP3.

At class level, Dothideomycetes and Tremellomycetes were the most abundant representatives of the Ascomycota and Basidiomycota groups, respectively. The Ascomycota in TP2 were represented by the class of Dothideomycetes and in TP3 by Dothideomycetes and Leotiomycetes. OTUs displaying high percentage of homology ($\geq 97\%$) with known 18S rDNA sequences of the fungal species *Cladosporium cladosporioides* (Ascomycota, Dothideomycetes), shown to be linked with human infections⁷ (Table S6.2) were identified within both tap water samples. Basidiomycota were represented by the class of Agaricomycetes in TP1 and TP5 and by Tremellomycetes in TP1. Chytridiomycota were represented by the class of Chytridiomycetes. At genus level, Ascomycota were represented by the dominant genus *Cochliobolus*, Basidiomycota were represented by genera *Cryptococcus* and *Trichosporon*, Chytridiomycota by genus *Chytridium* and Blastocladiomycota by the genus *Catenaria*.

6.3.6. Taxonomic diversity of non-fungal eukaryotes in tap water samples

Sequences retrieved from the tap water samples were assigned to Metazoa, fungi, SAR and Amoebozoa groups. Remarkably, the fungi represented 60% of the total community and diverse metazoan groups were identified in tap water samples such as Arthropoda, Nematoda, Craniata, Calcarea, and Gastrotrichia. All eukaryotic groups detected in the different tap water samples were also identified in the produced water leaving the desalination plant (Fig. 6.2) suggesting that the eukaryotic community identified in the tap water samples originated from the plant water. Nevertheless, different eukaryotic communities were identified within each of the tap water samples. In TP1 and TP5, the

Craniata class of the Chordata phylum was the unique eukaryotic group detected with *Blarina* sp identified as the dominant species in both tap water samples. In addition, OTUs belonging to Nematoda and Arthropoda phyla (Table S6.2), which are known to cause aesthetic problems in drinking water (Christensen, 2011) (such as insects), were detected in both tap water samples TP1 and TP5. In TP2, Arthropoda was represented by the class Maxillopoda, a diverse class of crustaceans where the most dominant taxonomic group was species *Paramphiascella fulvofasciata*. The taxonomic diversity of the eukaryotic community increased in TP3 and TP4. In TP3, the eukaryotic community was dominated by *Coccidia* (48%), an obligate intracellular parasite belonging to the phylum Apicomplexa and infecting the intestinal tracts of animals (Chapman, 2014). In TP4, the eukaryotic community was the most diverse compared to the rest of the tap water samples, with representatives of the SAR supergroup; Arthropoda, Rotifera, Gastrotrichia and Amoebozoa present (Fig. 6.2). Unexpectedly, different eukaryotic communities were identified within each of the five tap water samples in the network despite being supplied by the same drinking water leaving the desalination plant.

6.4. Discussion

454 pyrosequencing revealed highly diverse and variable eukaryotic communities in the water during (i) production of drinking water in a seawater desalination plant and during (ii) transport of the drinking water in the distribution network, including storage reservoirs, pipes and premise plumbing.

6.4.1. Variation of diversity indices and community structure during treatment

During the desalination process, each of the explored treatment compartments was characterized by a unique eukaryotic community composition and structure that changed during treatment. These changes illustrate the effect of each treatment step in shaping the eukaryotic community and in influencing the produced chlorinated drinking water composition. Chlorination was not capable of preventing eukaryotes.

The unexpected increase in the eukaryotic community diversity after the second reverse osmosis pass could not be attributed to reduced RO2 membrane performance (e.g. conductivity and TOC of the RO2 permeate were very low, Table 6.1) but most probably to contamination and/or microbial regrowth (e.g. by maintenance). In fact, a small fraction of the living microorganisms can and does pass through reverse osmosis membranes due to minor imperfections, or they bypass the membrane entirely through tiny leaks in surrounding seals (such as fungi as shown previously by Valster et al., 2011). Moreover, the presence of diverse alkalophilic and alkalotolerant fungi (Grum-Grzhimaylo et al., 2013) that thrive in high pH environments (i.e. *Acremonium* and *Sodiomyces* genera from Ascomycota phylum) supports the fungal diversity detected in RO2 (with pH=10.1).

6.4.2. Interpretation of the taxonomic composition of the eukaryotic community

The microbial eukaryotic community identified in the spruce media filter inlet water (IW) of the desalination plant was a typical diverse oligotrophic community of small eukaryotes with representatives from most major marine picoeukaryotic phyla such as SAR supergroup. A similar community was described in an oligotrophic Red Sea coastal site (Acosta et al., 2013; Massana, 2011). Within this community, the Alveolates and the Stramenopiles constitute an important component of marine ecosystems and include phototrophic,

heterotrophic and mixotrophic organisms which can represent the main primary producers in surface waters. Metazoa also constituted a significant proportion of the eukaryotic community in the explored WTP. They are naturally present in many drinking water sources and have been detected in chlorinated and unchlorinated drinking water samples (Valster et al., 2009; Poitelon et al., 2009; Valster et al., 2011). These eukaryotes can survive within distribution systems by deriving their food from organic matter in the water and biofilms. Metazoa are also commonly present in deposits on pipe and tank surfaces. The presence of Metazoa in drinking water has largely been regarded as an “aesthetic” problem, however they may have a beneficial effect by limiting the growth potential of bacteria and by reducing the total microbial biomass (Sanders and Wickham, 1993). Fungi constituted an important eukaryotic group in the desalination plant (32.8%) and in the network (60.4%). Fungi have been reported as common microbial constituents of drinking water distribution systems (Hageskal et al., 2008) and their occurrence is described in drinking water sources (Pereira et al., 2009), bottled mineral water (Yamaguchi et al., 2007) and tap water (Hageskal et al., 2006; Hageskal et al., 2007). Fungal presence in water may contribute to the degradation of complex natural and anthropogenic substances due to their broad enzymatic capabilities (Junghanns et al., 2005). However, fungi may be linked to taste and odor problems, skin irritations and allergic reactions, as well as the increased occurrence of opportunistic systematic mycosis in immune-compromised patients (Hageskal et al., 2006).

Fungi have been poorly recovered from marine surface waters (Richards et al., 2012) as reported in this study, only 9% of the total eukaryotic community in the feed water of the spruce filter media (IW) belonged to fungi. Similar results have been found in marine environments (Richards et al., 2012; Richards and Bass, 2005). Furthermore, a similar fungal community has been described in the bulk water of a drinking water production plant (Lin et al., 2014). Both molecular

analyses (Kis-Papo et al., 2011; Burgaud et al., 2009) and culture-based inventories (Le Calves et al., 2009) have shown that fungi are non-diverse and poorly recovered from surface marine waters. Richards et al. (2012) have reported ecological, morphological, and trophical limitations for studying fungi in marine environments. The dominance of Ascomycota and Basidiomycota in the inlet water of the desalination plant (feed of spruce filter) is in agreement with previous results suggesting that both fungal phyla are the most recovered marine fungal lineage (Richards et al., 2012; Cathrine and Raghukumar, 2009; Massana and Pedrós-Alió, 2008; Stoeck et al., 2010).

6.4.3. Influence of different treatment steps on eukaryotic community structure

The role of the spruce media filter as the main pre-treatment process has been described previously (Rachman et al., 2013). It is an improved mechanism of the regular media filter to remove solid matter by mechanical retention and surface adsorption. The SMF allows excellent removal by extracting and retaining over 99.954% of particle counts. In this study the SMF influenced the community structure by reducing all the diversity indices.

The increase in the relative abundance of fungi from 2% (in SMF permeate) to 95% in RO2 reflected the importance and influence of reverse osmosis as a key step in shaping the ecology of fungi in the desalination plant. Fungi and bacteria are considered the prime fouling microorganisms (Baker and Dudley, 1998). Numerous fungi have been found to participate in early biofilm development on RO membranes such as *Penicillium*, *Trichoderma*, *Mucor* and *Aspergillus* sp. (Pereira et al., 2013). Moreover, the dispersion and colonization mechanisms could have facilitated the increase in the relative abundance of fungi in RO2. Fungi have been shown to be able to grow on and degrade reverse osmosis membrane materials such as acetate cellulose (Murphy et al., 2001; Ho et al., 1983). The high water pH (10.1) of RO2 could have favored the growth of

Ascomycota which have alkaliphilic traits (Grum-Grzhimaylo et al., 2016). Kladwang et al. (2003) have also demonstrated the existence of fungi able to tolerate high pH (alkaline-tolerant fungi) such as marine Ascomycota and Basidiomycota.

The community structure in the desalination plant produced drinking water (PW) was not only influenced by the structure of the eukaryotic communities in RO2 and the blending water (RO1+RO2) but also by the chemical treatment (lime dosage) and the disinfection step. Some eukaryotic groups of the PW were present in RO1 and others in RO2 but new eukaryotic groups were also detected in the PW such as Arthropoda, Rhizaria and Apicomplexa.

Concerning the fungal community, the chlorination step affected the taxonomic composition of the fungal community and their relative abundance which decreased to 28.7%. The relative abundance of Ascomycota decreased significantly from 61.3% to <1% and that of Basidiomycota from 25.6% to 6.9%. In contrast, an increase in the relative abundance of the unclassified fungi clade was observed after the relative decline in the free chlorine concentration in the network during the water distribution process (Fig. 6.3).

Previous studies have shown that chlorination, (Poitelon et al., 2009; Valster et al., 2011) the nature of the disinfectant (chlorine or chloramines), its residual concentration, and water age (contact time) are important factors in shaping the eukaryotic community structure in drinking water network biofilms (Buse et al., 2014). Kinsey et al. (2003) showed that the disinfection efficiency of chlorination against fungi is variable between species: some groups show high resistance to disinfection and others are protected from inactivation by the water matrix components. The chlorine efficiency depends on water temperature and exposure time (Paterson and Lima, 2005). Based on the high resistance of fungi to chlorine (Kelley et al., 1997), it has been suggested that an initial free chlorine concentration of approximately 1 mg L⁻¹ is sufficient for spore inactivation,

providing sufficient residual chlorine in the system to assist in the prevention of microbial growth and biofilm development (Kinsey et al., 2003).

6.4.4. Eukaryotic communities in the network tap water samples

In the drinking water samples taken at 5 tap locations in the same drinking water distribution network (Fig. S6.1, TP1-TP5), different eukaryotic communities were identified within each of the tap water samples. These differences may reflect the existence of a variety of microhabitats defined by complex environmental conditions existing in the distribution network (reservoir, pipes and premise plumbing) that affect the eukaryotic community composition and structure.

Both the number of shared eukaryotic groups and their relative abundance varied between the PW (drinking water feeding the network) and each of the tap water samples in the network (except *Gastrotrich* detected only in TP4). In addition, the taxonomic diversity of the fungal community in the network was higher than observed in the PW (Fig. S6.4). Results showed that the core community shared between the PW and the all combined tap water samples was composed of 84 OTUs (28.1%). The core community between the PW and each of the tap water samples varied between 0 (TP1) and 68 OTUs (42.8%) (TP4) (Table S6.1). No relationship was observed between the number of shared OTUs and the distance separating the tap water from the desalination plant, thus the changes did not depend on the distance separating the desalination plant effluent from the tap water sampling locations. In addition, 71.5% of the total OTUs detected in the network were unique and differed from the core community in the PW. This finding indicates that the PW was not the main source of the eukaryotic community identified in the network. This 'unique' community in the network could come from biofilms or sediments within the network and/or could have been introduced in the distribution system during installation of the network and premise plumbing pipes or even due to contamination from the

environment (e.g. by network maintenance operations). On the other hand, these core community members may also exist in the PW samples at concentrations below the detection limit. Another reason could be the water age whereby the water sampled in the network does not correspond to the same water collected at the desalination plant effluent on the same day. It could be that the previous water from the treatment plant had these OTUs. The network is relatively small with relative high water consumption suggesting that residence time of the water in the network is relatively short.

Previous studies showed that fungi, Metazoa, SAR and Amoebozoa are the most prevalent eukaryotes in DWDSs. Metazoa were reported as the dominant bulk water eukaryotic group in Chinese (Liu et al., 2012), Norwegian (Otterholt and Charnock, 2011) and French (Paris) drinking water samples (Poitelon et al., 2009). In this study, Metazoa and fungi constituted major groups in the produced chlorinated drinking water samples produced by seawater desalination by RO. Similar results have also been found in chlorinated drinking water systems produced by a seawater desalination plant in a Caribbean DWDS. Amoebozoa constituted a minor group in the produced chlorinated drinking water in our study, similar to the results obtained by Otterholt and Charnock (2011) in Norwegian chlorinated drinking water however Amoebozoa constituted the second major group in finished chlorinated drinking water samples from three Parisian surface water treatment plants (Poitelon et al., 2009). This eukaryotic group has been reported - with fungi - as a major constituent of eukaryotic biofilms in DWDS (Liu et al., 2012; Valster et al., 2010) where it preys on bacteria (Delafont et al., 2013).

The persistence of the emergent uncultured fungi clade observed in the drinking water distribution system was not expected in a chlorinated and nutrient-limiting environment. This unclassified clade formed a major eukaryotic group which likely represents a new marine fungal clade. Le Calvez et al. (2009)

reported that marine environments host numerous uncultured deep branching fungal forms and a significant number of highly novel groups. Most molecular techniques do not discriminate between live, dead, and viable non-culturable (VBNC) states of microorganisms, limiting a proper interpretation of the genetic/phylogenetic diversity with respect to the ecology and function of these uncultured sequences. Thus, attempting to culture these unknown fungi may provide key insight on their ecological and physiological significance in such engineered ecosystems.

Pinto and colleagues (2012) found that the bacterial community structure of the drinking water microbiome in the network was governed by the filtration process. Their study involved conventional water treatment (involving dual media rapid filters) for a mix of fresh ground and surface water. Their study differed strongly in water source and water treatment and they investigated bacterial communities. Our study did not show that the seawater filtration by RO membranes governed the fungal community composition and structure in the network. Assessing the factors determining the growth of both bacteria and eukaryotes in the distribution networks would require additional research to unravel the influence of water source, treatment type and operation, and distribution network characteristics.

6.4.5. Accuracy of the applied sequencing method

While the pyrosequencing method allowed sensitive and deep analysis of the eukaryotic community, there are some limitations that should be taken into account when interpreting these results. First, the DNA-based molecular approach does not differentiate between viable and non-viable eukaryotic microbial organisms or fragmented cells nor the active or inactive physiological state of the cell. Secondly, the water filtration process used to concentrate the eukaryotes present in the water samples was shown to affect the community

composition (Sorensen et al., 2013). In addition, the eukaryotic cell membrane structure and composition particularly for fungi could induce biases in DNA extraction and/or in the PCR reaction (Berney et al., 2004). Several methods have been used to extract eukaryotic DNA such as CTAB (cetyl-trimethyl-ammonium bromide) based method (Lanzen et al., 2013) or phenol extraction (Heidelberg et al., 2013), but commercial kits (i.e. MoBio, FastDNA) have proven their efficiency in studying eukaryotic communities (Bachy et al., 2013; Schmidt et al., 2013). Despite 18S rRNA gene sequencing being an efficient and powerful tool for profiling the biodiversity of eukaryotic communities in natural aquatic (marine and fresh) (Zhan et al., 2014; Bik et al., 2012) and engineered ecosystems (Wang et al., 2014; Buse et al., 2014; Liu et al., 2012), its use as a unique molecular marker for the phylogenetic assignment of fungi is still controversial. In fact ITS sequences have been shown to be more taxonomically informative than 18S rRNA sequences in DNA-based studies (Anderson and Parkin, 2007). Although this high-throughput sequencing method has provided sufficient information for in-depth phylogenetic analyses of certain eukaryote groups, further investigation is needed concerning the use of 18S for phylogenetic assignment of fungi (Monchy et al., 2011). The 18S rRNA gene has fewer hyper-variable domains in fungi and some regions of fungal 18S rRNA genes share high similarity with other eukaryotes (Schoch et al., 2012). Moreover, several biases related to the specificity of 18S primers designed for fungi have been reported (Borneman and Hartin, 2000). With the emergence of fungi as a major microbial group in the assessed DWDS, the need for a second marker such as internal transcribed spacer (ITS)– proposed as the official primary barcoding marker for fungi (Bellemain et al., 2010; Lindahl et al., 2013) in combination with a small subunit (SSU) marker – is necessary to achieve a better understanding of the taxonomic and phylogenetic composition of the fungal community in drinking water distribution systems (Vetrovsky et al., 2016) and their implications on the drinking water quality. This

can help determine the biological significance of the eukaryotic organisms detected within the drinking water system.

6.4.6. Nature, growth and origin of fungi

In this study no discrimination could be made as to which fraction of the fungi was vegetative or spores. No odor-related problems have been reported, possibly suggesting the dominant presence of fungal spores. Fungi can grow on biodegradable organics originating from the membrane (Klun et al., 2003) and other membrane module materials, e.g. the module seals. Microbial growth also could occur on the permeate side of the membrane (Park and Hu, 2010). A membrane system is by definition not sterile because during membrane module manufacturing and loading of the membrane elements into the membrane filtration installation microbial contamination can occur. Moreover, bacteria, fungi and other microorganisms can grow back into the membrane system. Most materials can leach out biodegradable compounds (e.g. plasticizers) and fungi can degrade polymers. It is possible that fungi in the network water originated from pipe sediments and biofilm. In summary, a variety of reasons may explain the presence of fungi in membrane systems and the produced water.

The microbial community shifts during the treatment process can be (i) generated by the selective pressure of treatment processes and also (ii) caused by different contaminations at the individual treatment steps and (iii) caused by the combination thereof, with microbial population compositions independently developing, which might be a purely stochastic process. In the distribution network similar selective pressures and contaminations may play a role as well. In this study, no conclusive explanations for the occurrence of the respective fungal population shifts in the treatment plant and the distribution network can be given. Possibly, a similar study at another time period or at another location may yield different eukaryotic communities; temporal and spatial conditions

affect microbial community dynamics (Prest et al., 2016; El-Chakhtoura et al., 2015).

The presence of fungi is grossly underestimated in the drinking water world and this study revealed their presence very clearly. There is a need for follow-up studies to provide quantitative data on the presence of bacteria and fungi during drinking water production and distribution.

6.5 Conclusions

This study explored the taxonomic and phylogenetic diversity of the microbial eukaryotic community in water during the production of drinking water in a seawater desalination plant and during transport of the drinking water in the distribution network, including reservoirs, pipes and premise plumbing. Results revealed a highly diverse community containing fungi which constituted a dominant group in the water during the reverse osmosis treatment steps and in all tap water samples in the network. Moreover, 71.5% of the eukaryotic community in the network was not found in the produced drinking water supplying the network, implying a shift in the eukaryotic community composition during distribution in the network.

Reverse osmosis membrane treatment significantly changed the water eukaryotic community composition and structure, highlighting the fact that (i) reverse osmosis produced water is not sterile and (ii) the microbial community in the tap water is influenced by the downstream distribution system. The emergence of fungi as a major group in the drinking water distribution system suggests that these microorganisms need special attention.

Supplementary Material



Figure S6.1. KAUST campus map showing the drinking water sampling locations for (i) the produced water (PW) feeding the distribution network and (ii) five household tap water sampling locations (TP1-TP5) in the distribution network.

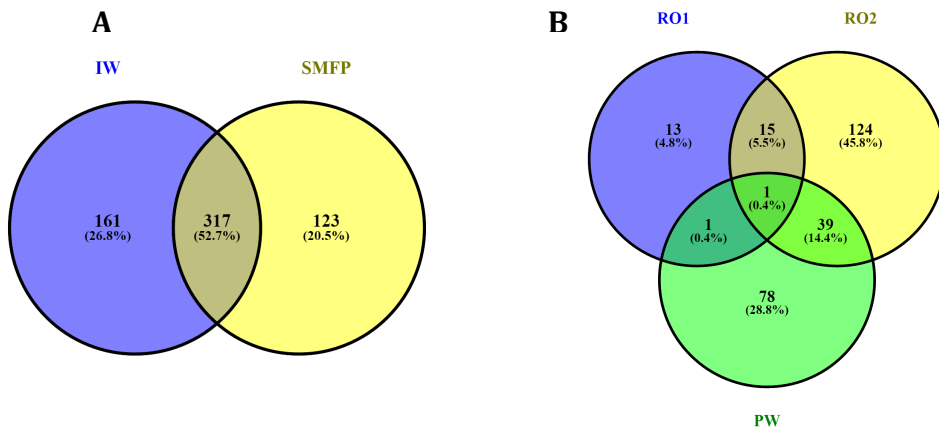

Figure S6.2. Venn diagrams displaying the overlap between the eukaryotic communities across different sampling locations based on OTUs (3% distance cutoff) (A) during the pretreatment step and (B) during the reverse osmosis and post-treatment steps. IW: inlet water; SMFP: spruce media filter permeate; RO1: seawater reverse osmosis permeate; RO2: brackish water reverse osmosis permeate; PW: produced water

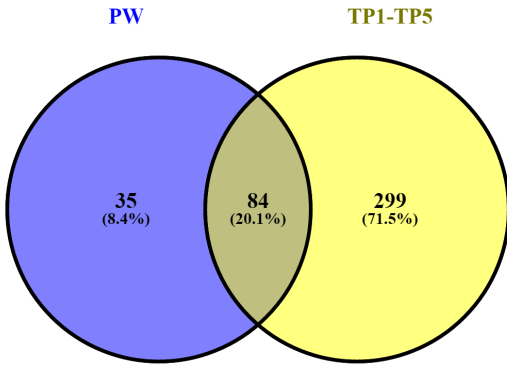

Figure S6.3. Venn diagram displaying the overlap between the eukaryotic communities of the produced water (PW) and the combined tap water samples (TP1-TP5) based on OTUs (3% cutoff).

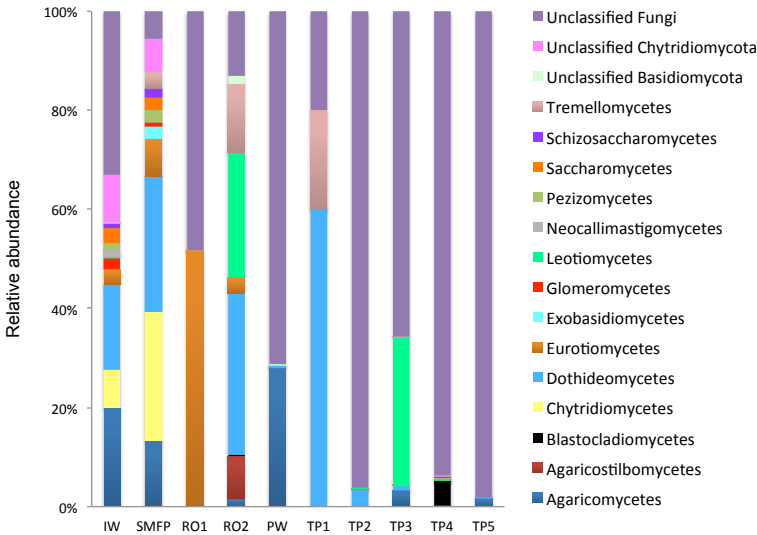

Figure S6.4. Variation of the fungal community composition (class level) during water desalination and after distribution. Abbreviations of samples are the same as those listed in Figure S6.2.

Table S6.1. Number of shared OTUs between tap water samples. TP1-TP5: tap water samples, Values in parentheses represent the percentage of the shared OTUs compared to the total number of OTUs in both locations.

	TP1	TP2	TP3	TP4	TP5
TP1	-	11 (8%)	0	4 (3.2%)	0
TP2	-	-	61 (27%)	2 (0.9%)	1 (0.4%)
TP3	-	-	-	51 (23.4%)	8 (3.1%)
TP4	-	-	-	-	7 (3.4%)
TP5	-	-	-	-	-

Table S6.2. Classification of OTUs recovered from tap water samples.

Tap location ID	Species	Percentage homology (%)	OTU percentage (%)
TP1			
Nematoda	<i>Plectus minimus</i>	97.3-98.0	22.82
Fungi	<i>Cochliobolus sp. 007(l)1</i>	97.1-99.0	22.15
Chordata	<i>Budorcasta xicolor</i>	97.3	10.07
Fungi	<i>Pleospora herbarum</i>	97.1-98.3	9.40
Fungi	<i>Cryptococcus ater</i>	97.2-98.4	8.72
Fungi	<i>Uncultured fungus</i>	97.1-99.4	8.05
Fungi	<i>Uncultured ascomycota</i>	98.2-98.4	6.71
Nematoda	<i>Diplolaimelloides myeli</i>	98.3	6.71
Chordata	<i>Blarina sp.</i>	98.4-98.9	5.37
TP2			
Fungi	<i>Cladosporium cladosporioides</i>	98.3-97.1	34.21
Arthropoda	<i>Blattella germanica</i>	97.3-99.2	23.68
Fungi	<i>Uncultured cladosporium</i>	97.5-98.0	15.79
Fungi	<i>Uncultured fungus</i>	97.6-98.5	9.21
Fungi	<i>Aureobasidium pullulan</i>	97.1-97.7	6.58
Fungi	<i>Cladosporium sp. zhi2</i>	97.1-97.2	5.26
Fungi	<i>Dothidea ribesia</i>	97.5-97.6	2.63

Fungi	<i>Herpotrichiellaceae sp. Im294</i>	98.0	1.32
Fungi	<i>Hymenoscyphus scutula</i>	97.5	1.32

TP3

Fungi	<i>Pleospora herbarum</i>	97.1-99.1	23.78
Fungi	<i>Dothidea insculpta</i>	97.3-98.8	20.28
Fungi	<i>Cochliobolus sp. 007(l)1_1</i>	97.1-98.3	13.99
Fungi	<i>Aureobasidium pullulans</i>	97.1-98.7	13.29
Fungi	<i>Cladosporium cladosporioides</i>	98.3	8.39
Fungi	<i>Uncultured ascomycota</i>	98.2-98.4	6.99
Nematoda	<i>Plectus minimus</i>	97.0	6.99
Fungi	<i>Uncultured fungus</i>	97.3-98.5	3.50
Phaeophyceae	<i>Undaria pinnatifida</i>	98.2	2.80

TP4

Fungi	<i>Uncultured fungus</i>	97.2-99.0	36.84
Fungi	<i>Acephala sp. 1</i>	97.4-98.7	16.84
Fungi	<i>Cladosporium sp. zhi2</i>	97.1-97.3	9.47
Chordata	<i>Blarina sp.</i>	97.3-98.4	8.42
Fungi	<i>Cladosporium cladosporioides</i>	98.1	7.37
Fungi	<i>Uncultured fungus</i>	97.6-98.5	6.32
Arthropoda	<i>Gymnoglyphus osu</i>	97.5	5.26
Chordata	<i>Bubalus bubalis</i>	97.1-97.5	5.26
Fungi	<i>Cryptococcus ater</i>	97.1-97.3	4.21

TP5

Porifera	<i>Grantessa sp.</i>	97.1-98.4	28.57
Chordata	<i>Bubalus bubalis</i>	97.1-97.3	21.43
Arthropoda	<i>Blattella germanica</i>	97.3-99.2	12.86
Chordata	<i>Budorcasta xicolor</i>	97.4	10.71
Chordata	<i>Blarina sp</i>	97.4-99.1	7.86
Fungi	<i>Uncultured fungus</i>	97.9	7.14
Fungi	<i>Cochliobolus sp. 007(l)1_1</i>	97.7	6.43
Fungi	<i>Uncultured fungus</i>	97.6-98.5	5.00

Bibliography

A.P.H.A, 1998. Port City Press, Baltimore, Maryland.

Acosta, F., Ngugi, D.K., Stingl, U., 2013. Diversity of picoeukaryotes at an oligotrophic site off the northeastern red sea coast. *Aquatic Biosystems* 9(1).

Adl, S.M., Simpson, A.G.B., Lane, C.E., Lukeš, J., Bass, D., Bowser, S.S. et al., 2012. The revised classification of eukaryotes. *Journal of Eukaryotic Microbiology* 59(5), 429-493.

Anderson, I.C., Parkin, P.I., 2007. Detection of active soil fungi by rt-pcr amplification of precursor rRNA molecules. *Journal of Microbiological Methods* 68(2), 248-253.

Bachy, C., Dolan, J.R., López-García, P., Deschamps, P., Moreira, D., 2013. Accuracy of protist diversity assessments: Morphology compared with cloning and direct pyrosequencing of 18S rRNA genes and its regions using the conspicuous tintinnid ciliates as a case study. *ISME Journal* 7(2), 244-255.

Baker, J.S., Dudley, L.Y., 1998. Biofouling in membrane systems - a review. *Desalination* 118(1-3), 81-90.

Belila, A., El-Chakhtoura, J., Otaibi, N., Muyzer, G., Gonzalez-Gil, G., Saikaly, P.E., van Loosdrecht, M.C.M., Vrouwenvelder, J.S., 2016. Bacterial community structure and variation in a full-scale seawater desalination plant for drinking water production. *Water Research* 94, 62-72.

Bellemain, E., Carlsen, T., Brochmann, C., Coissac, E., Taberlet, P., Kuserud, H., 2010. ITS as an environmental DNA barcode for fungi: An in silico approach reveals potential PCR biases. *BMC Microbiology* 10.

Berney, C., Fahrni, J., Pawlowski, J., 2004. How many novel eukaryotic 'kingdoms'? Pitfalls and limitations of environmental DNA surveys. *BMC Biology* 2.

Bik, H.M., Porazinska, D.L., Creer, S., Caporaso, J.G., Knight, R., Thomas, W.K., 2012. Sequencing our way towards understanding global eukaryotic biodiversity. *Trends in Ecology and Evolution* 27(4), 233-243.

Borneman, J., Hartin, R.J., 2000. Pcr primers that amplify fungal rRNA genes from environmental samples. *Applied and Environmental Microbiology* 66(10), 4356-4360.

Burgaud, G., Le Calvez, T., Arzur, D., Vandenkoornhuyse, P., Barbier, G., 2009. Diversity of culturable marine filamentous fungi from deep-sea hydrothermal vents. *Environmental Microbiology* 11(6), 1588-1600.

Buse, H.Y., Lu, J., Lu, X., Mou, X., Ashbolt, N.J., 2014. Microbial diversities (16s and 18s rRNA gene pyrosequencing) and environmental pathogens within drinking water biofilms grown on the common premise plumbing materials unplasticized polyvinylchloride and copper. *FEMS Microbiology Ecology* 88(2), 280-295.

Buse, H.Y., Lu, J., Struewing, I.T., Ashbolt, N.J., 2013. Eukaryotic diversity in premise drinking water using 18s rDNA sequencing: Implications for health risks. *Environmental Science and Pollution Research* 20(9), 6351-6366.

Caporaso, J.G., Lauber, C.L., Walters, W.A., Berg-Lyons, D., Lozupone, C.A., Turnbaugh, P.J., Fierer, N., Knight, R., 2011. Global patterns of 16s rRNA diversity at a depth of millions of sequences per sample. *Proceedings of the National Academy of Sciences of the United States of America* 108(SUPPL. 1), 4516-4522.

Cathrine, S.J., Raghukumar, C., 2009. Anaerobic denitrification in fungi from the coastal marine sediments off Goa, India. *Mycological Research* 113(1), 100-109.

Chapman, H.D., 2014. Milestones in avian coccidiosis research: A review. *Poultry Science* 93(3), 501-511.

Christensen, S.C.B., 2011. Phd thesis. Technical University of Denmark.

Delafont, V., Brouke, A., Bouchon, D., Moulin, L., Héchard, Y., 2013. Microbiome of free-living amoebae isolated from drinking water. *Water Research* 47(19), 6958-6965.

Edgcomb, V.P., Beaudoin, D., Gast, R., Biddle, J.F., Teske, A., 2011. Marine subsurface eukaryotes: The fungal majority. *Environmental Microbiology* 13(1), 172-183.

El-Chakhtoura, J., Prest, E., Saikaly, P., van Loosdrecht, M., Hammes, F., Vrouwenvelder, H., 2015. Dynamics of bacterial communities before and after distribution in a full-scale drinking water network. *Water Research* 74, 180-190.

Grum-Grzhimaylo, A.A., Debets, A.J.M., van Diepeningen, A.D., Georgieva, M.L., Bilanenko, E.N., 2013. *Sodiomyces alkalinus*, a new holomorphic alkaliphilic ascomycete within the plectosphaerellaceae. *Persoonia: Molecular Phylogeny and Evolution of Fungi* 31, 147-158.

Grum-Grzhimaylo, A.A., Georgieva, M.L., Bondarenko, S.A., Debets, A.J.M., Bilanenko, E.N., 2016. On the diversity of fungi from soda soils. *Fungal Diversity* 76(1), 27-74.

Hageskal, G., Gaustad, P., Heier, B.T., Skaar, I., 2007. Occurrence of moulds in drinking water. *Journal of Applied Microbiology* 102(3), 774-780.

Hageskal, G., Knutsen, A.K., Gaustad, P., De Hoog, G.S., Skaar, I., 2006. Diversity and significance of mold species in norwegian drinking water. *Applied and Environmental Microbiology* 72(12), 7586-7593.

Hageskal, G., Lima, N., Skaar, I., 2009. The study of fungi in drinking water. *Mycological Research* 113, 165-172.

Hageskal, G., Vrålstad, T., Knutsen, A.K., Skaar, I., 2008. Exploring the species diversity of trichoderma in norwegian drinking water systems by DNA barcoding. *Molecular Ecology Resources* 8(6), 1178-1188.

Heidelberg, K.B., Nelson, W.C., Holm, J.B., Eisenkolb, N., Andrade, K., Emerson, J.B., 2013. Characterization of eukaryotic microbial diversity in hypersaline lake tyrell, australia. *Frontiers in Microbiology* 4(MAY).

Heng, L., Yanling, Y.L., Weijia, G.J., Xing, L., Li, G.B., 2008. Effect of pretreatment by permanganate/chlorine on algae fouling control for ultrafiltration (uf) membrane system. *Desalination* 222(1-3), 74-80.

Ho, L.C.W., Martin, D.D., Lindemann, W.C., 1983. Inability of microorganisms to degrade cellulose acetate reverse-osmosis membranes. *Applied and Environmental Microbiology* 45(2), 418-427.

Hoeger, S.J., Hitzfeld, B.C., Dietrich, D.R., 2005. Occurrence and elimination of cyanobacterial toxins in drinking water treatment plants. *Toxicology and Applied Pharmacology* 203(3), 231-242.

Hurtado-McCormick, S., Sanchez, L., Martinez, J., Calderon, C., Calvo, D., Narvaez, D., Lemus, M., Groot, H., Susa, M.R., 2016. Fungi in biofilms of a drinking water network: Occurrence, diversity and mycotoxins approach. *Water Science and Technology-Water Supply* 16(4), 905-914.

J. Kelley, R.P., G. Kinsey, R. Pitchers, and H. Rossmore, 1997. Identification, significance and control of fungi in water distribution systems. *Water Technology Conference Proceedings*.

Jephcott, T.G., Alves-de-Souza, C., Gleason, F.H., van Ogtrop, F.F., Sime-Ngando, T., Karpov, S.A., Guillou, L., 2016. Ecological impacts of parasitic chytrids, syndiniales and perkinsids on populations of marine photosynthetic dinoflagellates. *Fungal Ecology* 19, 47-58.

Junghanns, C., Moeder, M., Krauss, G., Martin, C., Schlosser, D., 2005. Degradation of the xenoestrogen nonylphenol by aquatic fungi and their laccases. *Microbiology* 151(1), 45-57.

Kamp, A., De Beer, D., Nitsch, J.L., Lavik, G., Stief, P., 2011. Diatoms respire nitrate to survive dark and anoxic conditions. *Proceedings of the National Academy of Sciences of the United States of America* 108(14), 5649-5654.

Kinsey, G., Paterson, R., Kelley, J. (2003) *Handbook of water and wastewater microbiology*, pp. 77-98.

Kis-Papo, T., Grishkan, I., Oren, A., Wasser, S.P., Nevo, E., 2001. Spatiotemporal diversity of filamentous fungi in the hypersaline dead sea. *Mycological Research* 105(6), 749-756.

Kladwang, W., Bhumirattana, A., Hywel-Jones, N., 2003. Alkaline-tolerant fungi from thailand. *Fungal Diversity* 13, 69-84.

Klun, U., Friedrich, J., Kržan, A., 2003. Polyamide-6 fibre degradation by a lignolytic fungus. *Polymer Degradation and Stability* 79(1), 99-104.

Kuiper, M.W., Wullings, B.A., Akkermans, A.D.L., Beumer, R.R., van der Kooij, D., 2004. Intracellular proliferation of legionella pneumophila in hartmannella

vermiformis in aquatic biofilms grown on plasticized polyvinyl chloride. *Applied and Environmental Microbiology* 70(11), 6826-6833.

Lanzén, A., Simachew, A., Gessesse, A., Chmolowska, D., Jonassen, I., Øvreås, L., 2013. Surprising prokaryotic and eukaryotic diversity, community structure and biogeography of ethiopian soda lakes. *PLoS ONE* 8(8).

Le Calvez, T., Burgaud, G., Mahé, S., Barbier, G., Vandenkoornhuysse, P., 2009. Fungal diversity in deep-sea hydrothermal ecosystems. *Applied and Environmental Microbiology* 75(20), 6415-6421.

Lin, W., Yu, Z., Zhang, H., Thompson, I.P., 2014. Diversity and dynamics of microbial communities at each step of treatment plant for potable water generation. *Water Research* 52, 218-230.

Lindahl, B.D., Nilsson, R.H., Tedersoo, L., Abarenkov, K., Carlsen, T., Kjølner, R., Kõljalg, U., Pennanen, T., Rosendahl, S., Stenlid, J., Kauserud, H., 2013. Fungal community analysis by high-throughput sequencing of amplified markers - a user's guide. *New Phytologist* 199(1), 288-299.

Liu, R., Yu, Z., Guo, H., Liu, M., Zhang, H., Yang, M., 2012. Pyrosequencing analysis of eukaryotic and bacterial communities in faucet biofilms. *Science of the Total Environment* 435-436, 124-131.

Liu, R.Y., Zhu, J.G., Yu, Z.S., Joshi, D., Zhang, H.X., Lin, W.F., Yang, M., 2014. Molecular analysis of long-term biofilm formation on pvc and cast iron surfaces in drinking water distribution system. *Journal of Environmental Sciences* 26(4), 865-874.

Logares, R., Audic, S., Santini, S., Pernice, M.C., De Vargas, C., Massana, R., 2012. Diversity patterns and activity of uncultured marine heterotrophic flagellates unveiled with pyrosequencing. *ISME Journal* 6(10), 1823-1833.

Loret, J.F., Greub, G., 2010. Free-living amoebae: Biological by-passes in water treatment. *International Journal of Hygiene and Environmental Health* 213(3), 167-175.

Lupi, E., Ricci, V., Burrini, D., 1995. Recovery of bacteria in nematodes isolated from a drinking-water supply. *Journal of Water Supply Research and Technology-Aqua* 44(5), 212-218.

Marciano-Cabral, F., Jamerson, M., Kaneshiro, E.S., 2010. Free-living amoebae, legionella and mycobacterium in tap water supplied by a municipal drinking water utility in the USA. *Journal of Water and Health* 8(1), 71-82.

Massana, R. (2011) Eukaryotic picoplankton in surface oceans, pp. 91-110.

Massana, R., Pedrós-Alió, C., 2008. Unveiling new microbial eukaryotes in the surface ocean. *Current Opinion in Microbiology* 11(3), 213-218.

Monchy, S., Sancier, G., Jobard, M., Rasconi, S., Gerphagnon, M., Chabé, M., Cian, A., Meloni, D., Niquil, N., Christaki, U., Viscogliosi, E., Sime-Ngando, T., 2011. Exploring and quantifying fungal diversity in freshwater lake ecosystems using rDNA cloning/sequencing and ssu tag pyrosequencing. *Environmental Microbiology* 13(6), 1433-1453.

Murphy, A.P., Moody, C.D., Riley, R.L., Lin, S.W., Murugaverl, B., Rusin, P., 2001. Microbiological damage of cellulose acetate membranes. *Journal of Membrane Science* 193(1), 111-121.

Nagy, L.A., Olson, B.H., 1982. The occurrence of filamentous fungi in drinking-water distribution-systems. *Canadian Journal of Microbiology* 28(6), 667-671.

Oliveira, H.M.B., Santos, C., Paterson, R.R.M., Gusmao, N.B., Lima, N., 2016. Fungi from a groundwater-fed drinking water supply system in Brazil. *International Journal of Environmental Research and Public Health* 13(3).

Oliveros, J.C., 2007. <http://bioinfo.cnb.csic.es/tools/venny/index.html>.

Otterholt, E., Charnock, C., 2011. Identification and phylogeny of the small eukaryote population of raw and drinking waters. *Water Research* 45(8), 2527-2538.

Park, S.K., Hu, J.Y., 2010. Assessment of the extent of bacterial growth in reverse osmosis system for improving drinking water quality. *Journal of Environmental Science and Health - Part A Toxic/Hazardous Substances and Environmental Engineering* 45(8), 968-977.

Paterson, R.R.M., Lima, N. (2005) *Water encyclopedia*, John Wiley & Sons, Inc.

Pereira, V.J., Basílio, M.C., Fernandes, D., Domingues, M., Paiva, J.M., Benoliel, M.J., Crespo, M.T., San Romão, M.V., 2009. Occurrence of filamentous fungi and

yeasts in three different drinking water sources. *Water Research* 43(15), 3813-3819.

Pereira, V.J., Fernandes, D., Carvalho, G., Benoliel, M.J., Romao, M.V.S., Crespo, M.T.B., 2010. Assessment of the presence and dynamics of fungi in drinking water sources using cultural and molecular methods. *Water Research* 44(17), 4850-4859.

Pereira, V.J., Marques, R., Marques, M., Benoliel, M.J., Barreto Crespo, M.T., 2013. Free chlorine inactivation of fungi in drinking water sources. *Water Research* 47(2), 517-523.

Pinto, A.J., Xi, C., Raskin, L., 2012. Bacterial community structure in the drinking water microbiome is governed by filtration processes. *Environmental Science and Technology* 46(16), 8851-8859.

Poitelon, J.B., Joyeux, M., Welte, B., Duguet, J.P., Peplies, J., DuBow, M.S., 2009. Identification and phylogeny of eukaryotic 18s rDNA phylogenotypes detected in chlorinated finished drinking water samples from three Parisian surface water treatment plants. *Letters in Applied Microbiology* 49(5), 589-595.

Prest, E.I., Weissbrodt, D.G., Hammes, F., van Loosdrecht, M.C.M., Vrouwenvelder, J.S., 2016. Long-term bacterial dynamics in a full-scale drinking water distribution system. *PLoS ONE* 11(10), e0164445.

Rachman, R.M., Ghaffour, N., Wali, F., Amy, G.L., 2013. Assessment of silt density index (SDI) as fouling propensity parameter in reverse osmosis (RO) desalination systems. *Desalination and Water Treatment* 51(4-6), 1091-1103.

Richards, T.A., Bass, D., 2005. Molecular screening of free-living microbial eukaryotes: Diversity and distribution using a meta-analysis. *Current Opinion in Microbiology* 8(3), 240-252.

Richards, T.A., Jones, M.D.M., Leonard, G., Bass, D., 2012. Marine fungi: Their ecology and molecular diversity. *Annual Review of Marine Science* 4, 495-522.

Sanders, R.W., Wickham, S.A., 1993. Planktonic protozoa and metazoa: Predation, food quality and population control. *Marine Microbial Food Webs* 7(2), 197-223.

Schmidt, P.A., Bálint, M., Greshake, B., Bandow, C., Römbke, J., Schmitt, I., 2013. Illumina metabarcoding of a soil fungal community. *Soil Biology and Biochemistry* 65, 128-132.

Schoch, C.L., Seifert, K.A., Huhndorf, S., Robert, V., Spouge, J.L., Levesque, C.A. et al., 2012. Nuclear ribosomal internal transcribed spacer (ITS) region as a universal DNA barcode marker for fungi. *Proceedings of the National Academy of Sciences of the United States of America* 109(16), 6241-6246.

Sørensen, N., Daugbjerg, N., Richardson, K., 2013. Choice of pore size can introduce artefacts when filtering picoeukaryotes for molecular biodiversity studies. *Microbial Ecology* 65(4), 964-968.

Srivastava, G.C., 1967. Ecological studies on some aquatic fungi of gorakhpur, india. *Hydrobiologia* 30(3-4), 385-404.

Stoeck, T., Bass, D., Nebel, M., Christen, R., Jones, M.D.M., Breiner, H.W., Richards, T.A., 2010. Multiple marker parallel tag environmental DNA sequencing reveals a highly complex eukaryotic community in marine anoxic water. *Molecular Ecology* 19(SUPPL. 1), 21-31.

Valster, R.M., Wullings, B.A., Bakker, G., Smidt, H., van der Kooij, D., 2009. Free-living protozoa in two unchlorinated drinking water supplies, identified by phylogenetic analysis of 18s rRNA gene sequences. *Applied and Environmental Microbiology* 75(14), 4736-4746.

Valster, R.M., Wullings, B.A., van den Berg, R., van der Kooij, D., 2011. Relationships between free-living protozoa, cultivable legionella spp., and water quality characteristics in three drinking water supplies in the caribbean. *Applied and Environmental Microbiology* 77(20), 7321-7328.

Valster, R.M., Wullings, B.A., Van Der Kooij, D., 2010. Detection of protozoan hosts for legionella pneumophila in engineered water systems by using a biofilm batch test. *Applied and Environmental Microbiology* 76(21), 7144-7153.

van Lieverloo, J.H.M., Bosboom, D.W., Bakker, G.L., Brouwer, A.J., Voogt, R., De Roos, J.E.M., 2004. Sampling and quantifying invertebrates from drinking water distribution mains. *Water Research* 38(5), 1101-1112.

Vázquez-Baeza, Y., Pirrung, M., Gonzalez, A., Knight, R., 2013. Emperor: A tool for visualizing high-throughput microbial community data. *GigaScience* 2(1).

Větrovský, T., Kolařík, M., Žifčáková, L., Zelenka, T., Baldrian, P., 2016. The *rpb2* gene represents a viable alternative molecular marker for the analysis of environmental fungal communities. *Molecular Ecology Resources* 16(2), 388-401.

W.H.O, 2011. World Health Organization.

Wang, H., Masters, S., Edwards, M.A., Falkinham, J.O., Pruden, A., 2014. Effect of disinfectant, water age, and pipe materials on bacterial and eukaryotic community structure in drinking water biofilm. *Environmental Science and Technology* 48(3), 1426-1435.

Wolmarans, E., du Preez, H.H., de Wet, C.M.E., Venter, S.N., 2005. Significance of bacteria associated with invertebrates in drinking water distribution networks. *Water Science and Technology* 52(8), 171-175.

Yamaguchi, M.U., Rampazzo, R.D.C.P., Yamada-Ogatta, S.F., Nakamura, C.V., Ueda-Nakamura, T., Dias Filho, B.P., 2007. Yeasts and filamentous fungi in bottled mineral water and tap water from municipal supplies. *Brazilian Archives of Biology and Technology* 50(1), 1-9.

Zhan, A., Bailey, S.A., Heath, D.D., Macisaac, H.J., 2014. Performance comparison of genetic markers for high-throughput sequencing-based biodiversity assessment in complex communities. *Molecular Ecology Resources* 14(5), 1049-1059.

Chapter 7

Wastewater reuse application

Impact of residual monochloramine on biological stability and membrane biofouling control

This chapter has been published as: Farhat, N.M., Loubineaud, E., Prest, E.I.E.C., El-Chakhtoura, J., Salles, C., Bucs, Sz.S., Trampé, J., van den Broek, W.B.P., van Agtmaal, J.M.C., van Loosdrecht, M.C.M., Kruithof, J.C., Vrouwenvelder, J.S., 2018. Application of monochloramine for wastewater reuse: Effect on biostability during transport and biofouling in RO membranes. *Journal of Membrane Science* 551, 243–253.

Abstract

The rising demand for clean and safe water has increased the interest in advanced wastewater treatment and reuse. Reverse osmosis (RO) can reliably provide high-quality water from treated wastewater. Biofouling inevitably occurs, undoubtedly with wastewater effluents, resulting in RO performance decline and operational problems. Chlorination of feed water has been commonly applied to limit biological growth. However, chlorine use may lead to a loss of membrane integrity of RO systems. In this study the potential of monochloramine as an alternative for chlorine was studied by (i) evaluating the biological stability of a full-scale wastewater membrane bioreactor (MBR) effluent during transport over 13 km to a full-scale RO plant and (ii) assessing the biofouling control potential in a membrane fouling simulator (MFS) and pilot-scale RO installation. Microbial water analysis was performed on samples taken at several locations in the full-scale water reuse system (MBR effluent, during transport, and at the RO inlet and outlet) using a suite of tools including heterotrophic plate counts, adenosine triphosphate, flow cytometry, and 16S rRNA gene pyrosequencing. Growth potential tests were used to evaluate the effect of monochloramine presence and absence on bacterial growth. Results showed limited changes in the microbial water quality in the presence of monochloramine. MFS studies showed that membrane biofouling could be effectively repressed by monochloramine over prolonged time periods. The normalized salt passage in a pilot RO system with monochloramine dosage was constant over a one-year period (data of last 130 days presented), demonstrating that no membrane damage occurred. From this study, it can be concluded that monochloramine dosage in wastewater applications is effective in controlling

biofouling in RO systems and maintaining a monochloramine residual during water transport provides biologically stable water.

7.1. Introduction

The Environmental Protection Agency 2012 guidelines for water reuse reported that “Treated wastewater is increasingly being seen as a resource rather than simply waste”. Reclaimed water can fulfill most water demands, as long as it is satisfactorily treated to ensure water quality suitable for the intended use (Shannon et al., 2008). Reverse osmosis (RO) and nanofiltration (NF) membranes produce high-quality water from sources such as brackish or seawater and secondary treated wastewater effluent (Alturki et al., 2010). The pre-treated feed water or secondary wastewater effluents still contain dissolved organic compounds, microorganisms and colloidal particles, contributing to membrane fouling (Agenson and Urase, 2007). Therefore, membrane fouling is a major constraint for the operation and cost effectiveness of membrane systems (Jiang et al., 2017). Fouling severely limits membrane performance, leading to a reduction in permeate quality and quantity, and eventually causing membrane damage. Several types of fouling can occur simultaneously and affect each other (Flemming, 2003). In practice, extensive pre-treatment can eliminate scaling and particulate fouling but to a lesser extent organic and biological fouling (Baker and Dudley, 1998; Vrouwenvelder et al., 2008).

Biofouling or biological fouling is the excessive growth of a biofilm that results in unacceptable performance decline (Baker and Dudley, 1998). In practice, a 10-15 percent increase in feed channel pressure drop or reduction in permeate flux is considered operationally unacceptable (Al-Ahmad et al., 2000; Vrouwenvelder et al., 2008). Reducing biological growth and biofouling in transport pipes and membrane systems is normally achieved by limiting the essential nutrients for bacterial growth, mainly (but not exclusively) organic carbon (Van der Kooij, 2000), and/or dosing disinfectants. Free chlorine is the

most commonly used disinfectant to prevent biological growth in water because of its ability to rapidly inactivate most pathogenic microorganisms (Liu et al., 2016; Shannon et al., 2008); however residual chlorine has to be removed from the water before entering RO systems with chlorine-intolerant polyamide membranes. Moreover, the reaction of chlorine with organics present in the water results in the formation of halogenated organic by-products such as trihalomethanes (THMs), which are classified as suspect carcinogens for humans (Hrudey, 2009; Richardson et al., 2007). Several studies have reported that RO membranes reduce up to 80% of the THM concentration present in the feed water (Mazloomi et al., 2009; Rajamohan et al., 2014); however, using an alternative disinfectant with a lower halogenated organic by-product formation is desirable. Monochloramine dosage was introduced in an attempt to abide by the new THM regulations, due to its weaker tendency to produce halogenated organic reaction products (Bougeard et al., 2010). Monochloramine, the most stable form of chloramine, although a more slowly acting and weaker disinfectant than free chlorine, can be more effective in penetrating and inactivating biofilms (Griebe et al., 1994; Le Chevallier et al., 1988). In aqueous solution, naturally present ammonia (NH_3) or ammonium ions react with chlorine or hypochlorite to form inorganic chloramines (Weil and Morris, 1949) through the reaction:

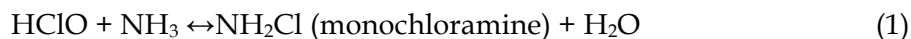

The stability and the type of chloramine formed depends on the ratio ammonia/chlorine. Monochloramine formation is a function of the pH and occurs most rapidly at a pH value of approximately 8.3.

For wastewater reuse applications and further treatment of secondary wastewater effluents, preventing bacterial regrowth during transport to tertiary treatment facilities is essential for an optimal RO treatment performance. During

transport, several biological processes can occur including biofilm formation on the pipe walls and biofilm detachment (Liu et al., 2013; Liu et al., 2016), microbial growth in the bulk water (Douterelo et al., 2014), bio-corrosion of pipe material (Bremer et al., 2001; Pizarro and Vargas, 2016), and proliferation of pathogenic bacteria (van der Wielen et al., 2013), deteriorating the water quality. Ideally, the goal is to transport biologically stable water where microbial growth is restricted (Rittman and Snoeyink, 1984); however, due to the development of more sensitive and accurate microbial analysis techniques changes in microbial presence can be detected without necessarily having a negative impact on the water quality, rebuking the earlier definition of biological stability (El-Chakhtoura et al., 2015; Lautenschlager et al., 2013).

In this study, monochloramine was used to disinfect a membrane bioreactor (MBR) permeate and provide biologically stable effluent water during transport to an RO treatment facility. The treated effluent was transferred via a 13 km long pipe to the RO facility, where monochloramine residual was removed before the water entered the RO membranes. The RO treatment plant suffered from performance decline due to fouling development in the membrane modules. The aim of this study was to investigate the effect of monochloramine dosage on the biological stability of the water during transport. The effectiveness of monochloramine dosage in biofouling control and possible consequences for membrane damage were assessed in lab-scale membrane fouling simulator (MFS) experiments and pilot-scale membrane module experiments. The effect of monochloramine removal and RO filtration on microbial water quality was also examined. A suite of microbial analysis techniques including flow cytometry and pyrosequencing was applied.

7.2. Materials and Methods

7.2.1 Analysis of water samples from practice

7.2.1.1 Site description

The RO water treatment facility (DECO) produces demineralized water, cooling tower supply water, and ultrapure water for industrial usage in Terneuzen, the Netherlands (51°20'08" N, 3°49'40" E). Since 2010, a membrane bioreactor (MBR) constructed and operated by Evides Industriewater on the site of the municipal wastewater treatment plant (WWTP) (51°17'49" N, 3°50'14" E) has been used to produce feed water for the DECO water treatment facility. Table 7.1 summarizes the average MBR effluent quality. The effluent from the MBR is disinfected using monochloramine and transported over a 13 km long pipe to the DECO facility (residence time of 4 h). Monochloramine was formed by dosing ammonium chloride (NH₄Cl - a 20% solution) and sodium hypochloride (NaClO - a 12.5% solution) according to the following stoichiometric equation (Molar ratio=1).

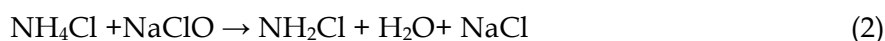

At the DECO facility, the water is consecutively treated by sulphuric acid dosage (H₂SO₄), 50 µm screens, an antiscalant, and sodium bisulfite dosage for monochloramine removal (residual monochloramine ≈ 1 ppm). The water is then fed into the reverse osmosis (RO) system. DOW FILMTEC BW30-400/34i membranes were used. The plant is operated at a minimum capacity of 210 m³.h⁻¹. The recovery of the RO system is 75%. The DECO RO installation has performance decline problems, and membrane cleanings have to be carried out frequently. Cleaning the modules in place (CIP) is done by dosing NaOH up to a pH of 12.

Table 7.1. Average MBR effluent quality. COD: chemical oxygen demand, BOD: biological oxygen demand, TSS: total suspended solids, TKN: Total Kjeldahl Nitrogen

Parameter	Unit	Value
Specific conductivity at 25 °C	μS/cm	1600 ± 450
pH after acid dosage	-	7.4 ± 0.2
Temperature	°C	15 ± 4
O ₂	mg/L	9.7 ± 0.2
Total COD	mg/L	34 ± 8
Total BOD	mg/L	<3
Ca ⁺²	mg/L	71 ± 19
Mg ⁺²	mg/L	22 ± 8
Bicarbonate (HCO ₃ ⁻)	mg/L	280 ± 80
TSS	mg/L	0.3 ± 0.1
TKN	mg/L	1.9 ± 0.6
NH ₄ ⁺	mg/L	0.9 ± 0.1
Ortho-P	mg/L	0.8 ± 0.9
SO ₄ ⁻²	mg/L	88 ± 22

7.2.1.2 Sampling scheme

The schematic diagram of the treatment train between the MBR and the RO water treatment facility with an overview description of the sampling locations is schematized in Fig. 7.1. Triplicate samples were taken at each location. Microbial analysis and bacterial community analysis were performed on the samples.

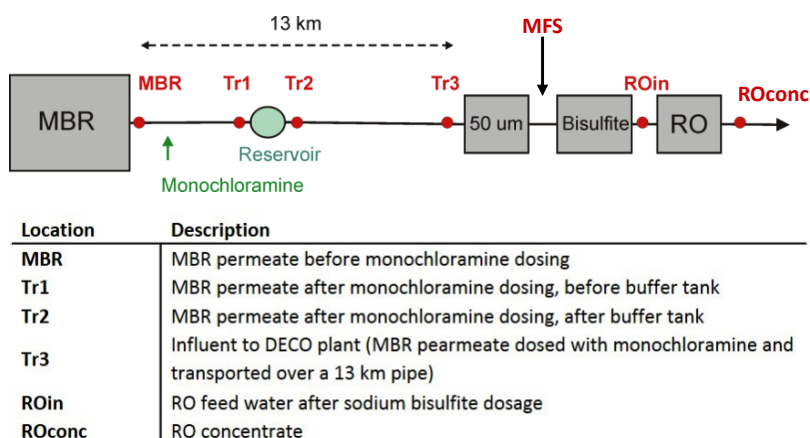

Figure 7.1. Schematic diagram of the treatment train and overview of locations where samples were collected for microbial analysis.

7.2.1.3 Microbial analysis

7.2.1.3.1 Heterotrophic plate counts (HPCs) and adenosine triphosphate (ATP) measurements: For HPC and ATP measurements, water was collected in high-density polyethylene (HDPE) plastic bottles containing 2 mL·L⁻¹ of a mixed solution of sodium thiosulfate (20 g·L⁻¹) and nitrilotriacetic acid (25 g·L⁻¹). HPC was measured by Aqualab Zuid (Werkendam, NL), according to the Dutch standard procedure (NEN-EN-ISO 6222, 1999) (Prest et al., 2014). ATP was measured by Het Waterlaboratorium (Haarlem, NL) using a luminometer (Celsis Advance). ATP was first released from suspended bacterial cells with nucleotide-releasing buffer (LuminEX, Celsis) for total ATP measurement, while this step was not performed for assessment of free ATP. Bacterial ATP concentrations were calculated by subtracting free ATP from total ATP concentrations. The detection limit of the method was 1 ng ATP·L⁻¹.

7.2.1.3.2 Flow cytometry: Measurements of the total and intact bacterial cell concentrations in the water samples taken at the six locations shown in Fig. 7.1 were done using flow cytometry according to the protocol reported by Prest et al., 2013. For the determination of the total bacterial cell concentration, 500 µL samples were preheated to 35°C for 10 min, stained with 10 µL·mL⁻¹ SYBR Green I (Molecular Probes, Eugene, OR, USA), then incubated in the dark at 35 °C for 10 min. For the determination of the intact bacterial cell concentration, propidium iodide in combination with SYBR Green I was used according to the same protocol used for total bacterial cell concentration. Measurements were performed using a BD Accuri C6 flow cytometer (BD Accuri Cytometers, Belgium) equipped with a 50 mW laser having a fixed emission wavelength of 488 nm. Fluorescence intensity was collected at FL1 = 533 ± 30 nm, FL3 > 670 nm, sideward and forward scattered light intensities were obtained as well. All data

were processed with the BD Accuri CFlow® software, and electronic gating was used to select SYBR green labelled signals for quantifying total bacterial cell count following the procedure described by Hammes and Egli (2005). The same electronic gating was used to quantify intact bacterial cells when the mixture of propidium iodide and SYBR Green I staining was used. Additional gates on the green fluorescence histogram were applied to differentiate low (LNA) and high (HNA) nucleic acid containing bacterial communities (Vila-Costa et al., 2012; Wang et al., 2009). The percentages of LNA and HNA are used as basic flow cytometric fingerprinting strategy (Prest et al., 2013).

7.2.1.3.3 Growth potential of water: Water samples were collected in triplicates in assimilable organic carbon (AOC)-free glass vials for growth potential assessment. No sample treatment and no chemical or bacterial dosage was performed. After that, the vials were incubated at 30°C for 11 days (Hammes and Egli, 2005). Flow cytometry measurements were performed at the start and after 1, 2, 3, 4, 7, 9 and 11 days of incubation for a comparison of bacterial growth potential at the different water sampling locations.

7.2.1.3.4 16S rRNA gene pyrosequencing: Water samples (2 L) were collected in HDPE bottles containing 2 mL·L⁻¹ of a mixed solution of sodium thiosulfate (20 g·L⁻¹) and nitrilotriacetic acid (25 g·L⁻¹). Each sample was filtered through a 0.2 µm-pore-size Isopore membrane filter (Merck Millipore, Billerica, MA) on the same day of sampling. The filters were stored at minus 20°C until processing. Genomic DNA was extracted from the collected biomass using the Fast DNA SPIN Kit (MP Biomedicals, Santa Ana, CA) according to the manufacturer's instructions. Bacterial 16S rRNA genes were amplified with the bacteria-specific forward primer 515F (5'-LinkerA-Barcode-GTGYCAGCMGCCGCGGTA-3') and reverse primer 909R (5'-LinkerB-CCCCGYCAATTCMTTTRAGT-3'). A single-

step 28-cycle PCR using the HotStarTaq Plus Master Mix Kit (QIAGEN, Valencia, CA) was performed for each DNA sample (triplicate reactions) under the conditions described in El-Chakhtoura et al. (2015). Pyrosequencing was carried out on the Roche 454 FLX Titanium genome sequencer, and sequence data was processed as described in El-Chakhtoura et al. (2015). OTUs were defined by clustering at 3% divergence. Final OTUs were taxonomically classified using BLASTn against a curated database derived from NCBI and Greengenes. Multidimensional scaling (MDS) was performed with the Bray-Curtis matrix using the R statistical package to ordinate the sequencing operational taxonomic unit (OTU) data (samples with similar community structure cluster together, taking into account the relative abundance of each OTU).

7.2.2 Lab-scale monochloramine studies

7.2.2.1 Experimental set-up

Four membrane fouling simulator (MFS) setups (Vrouwenvelder et al., 2007a) were installed at the DECO water treatment facility after the 50 μm screens to assess the RO feed water biofouling potential. The feed water entering the DECO water treatment facility contained 1 ppm of monochloramine. The MFS setup consisted of a diaphragm pump, temperature and differential pressure transmitter (Delta bars, Endress+Hauser, PMD75), pressure-reducing valve, chemical dosing diaphragm metering pump, and the MFS flow cell. The MFS contained a 20 cm \times 4 cm coupon of a membrane and a feed spacer. The spacer and membrane sheets were taken from virgin spiral wound membrane elements (DOW FILMTEC LE-440i). The feed spacer consisted of a sheet of 28 mil (711 μm) thick, diamond-shaped polypropylene spacer.

7.2.2.2 Operating conditions

Different operating conditions were applied for each MFS setup (Fig. 7.2). Two MFS setups were placed directly after the 50 μm screeners (MFS 1 and 2). The other two MFS setups were placed after a 1 μm cartridge filter that was installed after the 50 μm screeners (MFS 3 and 4). Excess sodium bisulfite (SBS – 8.2 mg·L⁻¹) was dosed using a diaphragm metering pump (STEPDOS 03S, Knf NEUBERGER) to two MFS setups (MFS 2 and 4) at a rate of 0.4 ml·min⁻¹ to remove residual monochloramine. The MFS setups were operated without permeate production at a pressure of one bar for a period of 50 days. Earlier studies done with membrane elements in the same parallel position in an NF installation, with and without permeate production, showed the same feed channel pressure drop increase and biofilm formation (Vrouwenvelder et al., 2007a; Vrouwenvelder et al., 2007b; Vrouwenvelder et al., 2009a; Vrouwenvelder et al., 2008). Mass transfer calculations supported the observations that the permeate flux is not playing a significant role in the nutrient supply to the fouling layer. Hydrodynamic conditions in the MFS were similar to spiral wound membrane modules as applied in practice for water treatment (Vrouwenvelder et al., 2007a). A flow rate of 16 L·h⁻¹ equivalent to a linear flow velocity of 0.16 m·s⁻¹, representative for practice, was used (Bucs et al., 2015). Pressure drop (ΔP) development in time was recorded for all the MFS systems and the increase in ΔP was used as an indication of fouling development (Vrouwenvelder et al., 2009b).

7.2.3 Pilot-scale monochloramine studies

Two pilot-scale membrane filtration units (P1 – P2) were operated in parallel to the full-scale DECO water treatment facility to assess the effect of monochloramine dosage on membrane performance. DOW FILMTEC LE-440i elements, containing a 28 mil (711 μm) thick feed spacer with a membrane surface area of 41 m²/module, were used for the two pilots (P1 – P2). The DECO full-

scale installation is equipped with DOW FILMTEC BW30-400/34i elements; containing a 34 mil (863 μ m) thick feed spacer with a total membrane surface area of 37 m²/module.

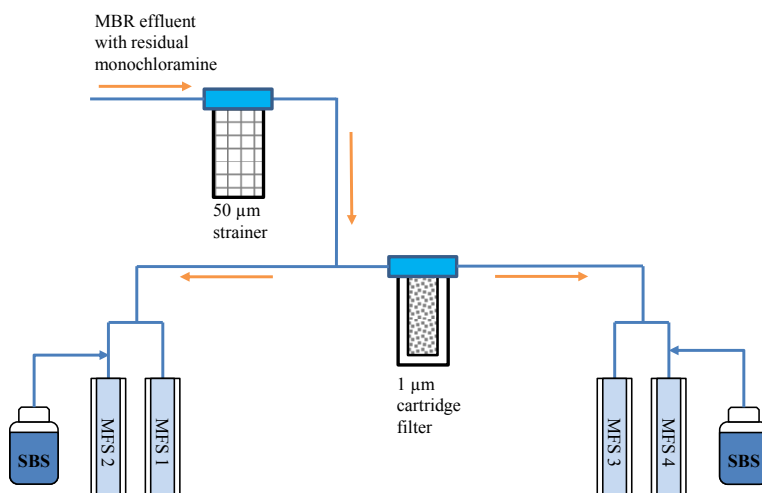

MFS	Code	Experiment description	Particles > 1 μ m	Monochloramine residual
1	-CF +M	Feed water passing 50 μ m strainer	+	+
2	-CF -M	Feed water passing 50 μ m strainer, dosed with sodium bisulphite (SBS) to remove residual monochloramine	+	-
3	+CF +M	Feed water passing 50 μ m strainer, filtered using 1 μ m cartridge filter to remove particles	-	+
4	+CF -M	Feed water passing 50 μ m strainer, filtered using 1 μ m cartridge filter to remove particles, and dosed with SBS to remove residual monochloramine	-	-

(+) present (-) absent CF: cartridge filter; M: monochloramine

Figure 7.2. Schematic diagram and operating conditions for the four membrane fouling simulator (MFS) setups run in parallel. The MFS arrow in Figure 7.1 shows the location in the treatment train where the MFS setups were placed. SBS: sodium bisulphite

The pilot research was carried out with DOW FILMTEC LE-440i membranes as in that stage the original DOW FILMTEC BW30-400/34i membranes were not available. DOW FILMTEC LE-440i membranes have a slightly higher permeate flow, with a similar permeate quality as DOW FILMTEC BW30-400/34i membranes. The feed water was passed through a 10 μ m pore size cartridge filter

before flowing into P1. The 10 μm pore size cartridge filter was not used after the feed water to P2. Both pilot units received monochloramine dosage while the full-scale facility had monochloramine (1 ppm) removed by dosing sodium bisulfite. The pilot modules were operated with the same average permeate flux (14.7 L·m⁻²·h⁻¹) and recovery (10% per module) as the full-scale plant. Normalized salt passage was recorded for the two pilot units as well as the full-scale plant for a period of 12 months. The normalized salt passage is used to describe the efficiency of salt rejection by the membrane and is normalized for temperature and permeate flow rate according to the method described by Huiting et al., 2001. The salt passage data presented in the manuscript is for a period of 130 consecutive days in between two cleanings performed for the full-scale installation.

7.3. Results

7.3.1 Monochloramine dosage and biological stability

Microbial analysis was performed on water samples that were taken from six different locations starting from the MBR outlet, along the transport pipe to the DECO water treatment facility, as well as the RO treatment train at the DECO plant (Fig. 7.1). The samples can be differentiated into two groups (i) the samples during transport: the MBR effluent and samples containing monochloramine (MBR, Tr1, Tr2, and Tr3), and (ii) the samples at the RO plant: after removal of the monochloramine residual with sodium bisulfite and the RO concentrate (ROin and ROconc).

ATP measurements showed relatively high ATP concentrations in all water samples (≈ 100 pg ATP·mL⁻¹). Limited changes in ATP (5% – 15%

increase) were seen in the water samples during transport (MBR, Tr1, Tr2, and Tr3, Fig. 7.3A). No increase in HPC was seen in sample Tr2 compared to the MBR sample (Fig. 7.3B); however, the HPC in sample Tr3 was approximately 800% higher than the MBR sample, inconsistent with the ATP measurements. Compared to sample ROin, sample ROconc showed a relatively high HPC (700% increase) (Fig. 7.3B). Furthermore, compared to ROin, an increase in bacterial ATP ($\approx 430\%$) was observed in the ROconc samples (Fig. 7.3A); the increase was higher than the expected concentration yield (factor of 4 increase) due to 75% recovery of the RO modules. Both ATP and HPC results suggest bacterial growth in the membrane modules.

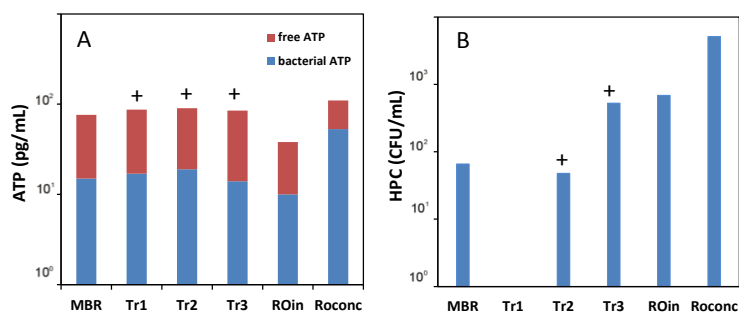

Figure 7.3. (A) ATP concentrations (pg ATP/mL) and (B) Heterotrophic Plate Counts (CFU/mL) of water samples taken at the locations shown in Figure 7.1. Samples containing monochloramine are marked with + sign.

Total, intact, and damaged bacterial cell concentrations were determined for samples taken at the six locations using flow cytometry (Fig. 7.4). An average bacterial cell concentration of $\approx 11.7 \times 10^3$ cells·mL⁻¹ was found at the MBR outlet, before monochloramine dosage. The total cell concentration increased to an average of $\approx 19 \times 10^3$ cells·mL⁻¹ during water transport (Tr1, Tr2, and Tr3, Fig. 7.4A); however, a decrease in the intact cell fraction was seen (from 83% to 59%) indicating cell damage due to the disinfection by monochloramine (Fig. 7.4B).

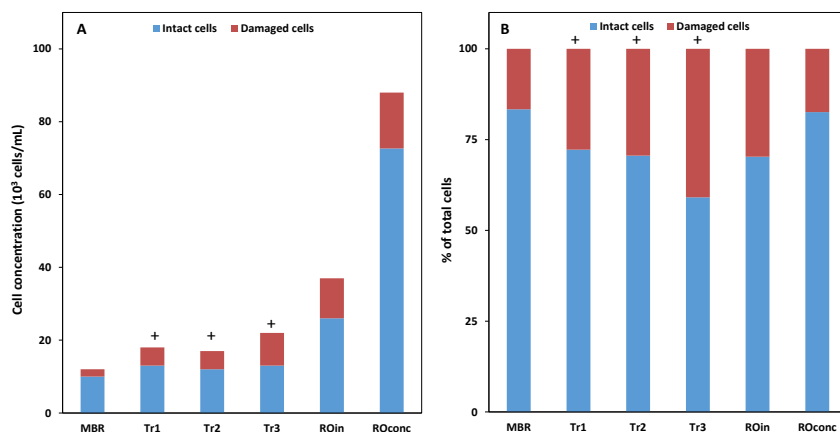

Figure 7.4. Comparison between (A) cell numbers (total, intact and damaged) and (B) percentages of intact and damaged cells, of samples taken at the locations shown in Figure 7.1. Samples containing monochloramine residual are marked with + sign.

After dosing of sodium bisulfite to quench residual monochloramine, an increase in total cell concentration in ROin (37×10^3 cells·mL⁻¹) and ROconc (88×10^3 cells·mL⁻¹) samples (Fig. 7.4A) was observed. An increase in the intact cell fraction (Fig. 7.4B) and HNA concentration was observed compared to the transport samples (Fig. 7.5A). Both addition of sodium bisulfite and RO filtration induced large changes in total cell numbers (ROin and ROconc) and cell composition (Figs. 7.4 and 7.5). The flow cytometric fingerprint plot (Fig. 7.5B) clearly showed the samples after the MBR and during transport (monochloramine residual) clustered together signifying their similarity; the samples after sodium bisulfite dosage (ROin) and RO filtration (ROconc) appeared as outliers clearly demonstrating the bacterial changes that occurred in these samples. The limited increase in HPC except for sample Tr3, ATP, cell concentration and the similarity in flow cytometric fingerprints for the MBR sample and the samples during transport all indicate biologically stable water after monochloramine dosage, while the highest biological growth was observed after monochloramine removal.

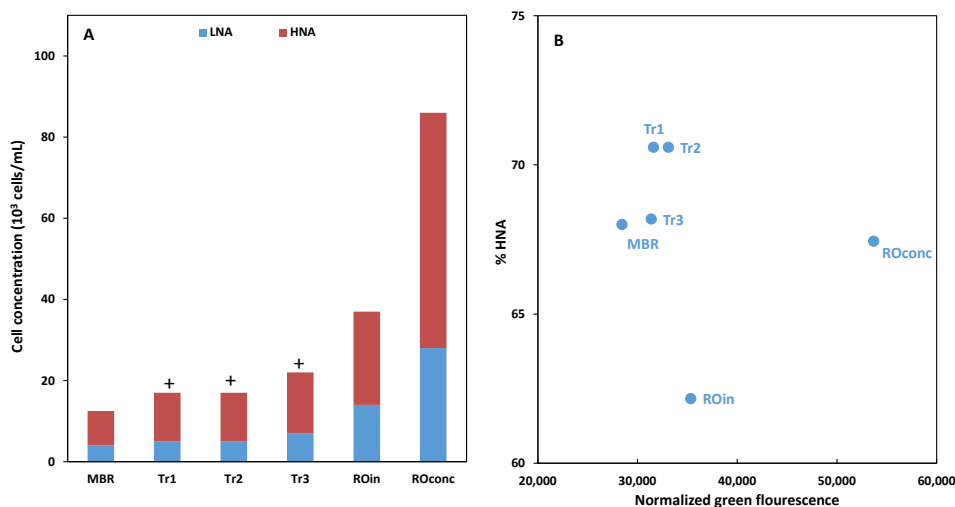

Figure 7.5. Comparison between (A) proportions of LNA and HNA cells and (B) flow cytometric fingerprints of samples taken at the locations shown in Figure 7.1. HNA: high nucleic acid containing cells, LNA: low nucleic acid containing cells. Samples containing monochloramine residual are marked with + sign. In (B) the closer the samples are located to each other, the higher the similarity in bacterial composition.

7.3.1.1 Growth potential tests

In parallel to HPC, ATP, and bacterial cell concentration analysis, growth potential tests were performed on the water samples taken at the six different locations to evaluate the impact of monochloramine dosage and the impact of monochloramine removal on the water bacterial growth potential (Fig. 7.6). Faster growth occurred in the sample before monochloramine dosage (MBR) compared to samples after monochloramine dosage (Tr1, Tr2, and Tr3) showing the delaying effect of monochloramine on microbial growth (Fig. 7.6A). The total cell concentration for samples Tr1, Tr2, and Tr3 only started to increase after day four, reaching the same plateau value as the MBR effluent sample. The dosage of sodium bisulfite before samples ROIn and ROconc apparently reduced the bacterial growth lag phase compared to the samples when monochloramine was present. Compared to Tr1, Tr2, and Tr3, a faster growth occurred in ROIn and

ROconc (Fig. 7.6B). A higher growth potential for ROconc compared to ROin was measured (Fig. 7.6B). After six days, approximately the same plateau value in total cell numbers was reached for all six samples indicating equal nutrient concentrations in the six samples. As expected, the RO permeate had the lowest cell concentration and the lowest growth potential.

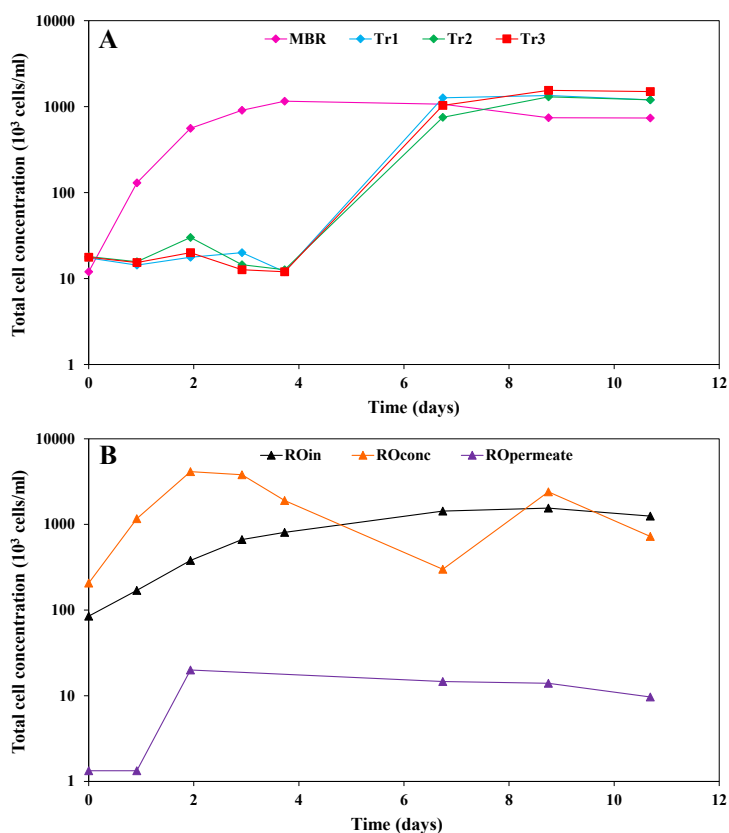

Figure 7.6. (A) and (B) Development with time of the total bacterial cell concentration during growth potential tests performed on the water samples taken at the locations shown in Figure 7.1.

7.3.1.2 Bacterial community structure

Bacterial community analysis using 16S rRNA gene pyrosequencing showed a diverse bacterial community in the water samples. At phylum level

classification, bacteria with a relative abundance below 1% across all samples were grouped together under the “other” category. After this percentage cutoff, 12 phyla (including three candidate phyla) were identified in all water samples. The bacterial community in the MBR effluent sample and the samples along the transport pipe which contained monochloramine residual were relatively comparable (samples MBR, Tr1, Tr2, and Tr3), as seen in the bacterial community structure in Fig. 7.7 and the multidimensional scaling (MDS) plot in Fig. 7.8. Fig. 7.8 clearly shows that these samples which contain monochloramine are clustered together with the MBR effluent sample indicating a similar bacterial community structure in agreement with the flow cytometric fingerprint results (Fig. 7.5B). *Proteobacteria* was the dominant phylum in all the samples (with and without monochloramine residual) with a relative abundance of $49.6 \pm 5.1\%$. The other detected phyla in addition to *Proteobacteria* in the MBR effluent and samples containing monochloramine were *Bacteroidetes* ($14.9 \pm 4.8\%$), *Planctomycetes* ($7.2 \pm 2.3\%$), *Chloroflexi* ($5.1 \pm 1.9\%$), *Actinobacteria* ($4.9 \pm 1.0\%$), *Firmicutes* ($3.9 \pm 0.9\%$), *OP3* ($3.8 \pm 0.5\%$), and *WS3* ($1.1 \pm 0.6\%$). *Acidobacteria*, *Verrucomicrobia*, *Spam*, and *Spirochaetes* were found at a low relative abundance, average less than 1% in the samples containing monochloramine residual. The addition of sodium bisulfite to remove residual monochloramine before the RO installation resulted in changes in the bacterial community composition and structure (Fig. 7.7A,B). At a phylum level, *Spirochaetes* (10.8%) and *Verrucomicrobia* (3.0%) increased in relative abundance. Passing across the RO feed spacer channel induced another shift in the relative abundance where *Acidobacteria* fraction substantially increased from 1.4% to 31.5%. Samples ROin and ROconc appeared as outliers in the MDS plot (Fig. 7.8) when compared with the samples that contained monochloramine and the MBR effluent sample, and this further validates the difference of the bacterial community structure of ROin and ROconc. At a class level, very minor changes in the classes of the dominant

phylum *Proteobacteria* were observed. Fig. 7.7B compares a sample containing monochloramine (Tr3) to samples without monochloramine before RO filtration (ROin) and in the RO reject stream (ROconc) at a genus level and shows that the relative abundance of genera evidently changed between these samples. Removal of monochloramine resulted in an increase in extremophilic genera like *Planctomycetaceae*, *Spirochaeta*, *Phyllobacteriaceae*, *Caldilinea*, and nitrifiers like *Nitrosopumilus*. Passing across the RO feed spacer channel caused another shift in the relative abundance of bacterial genera showing high microbial diversity and activity in the RO system. Compared to RO feed, genera like *Candidatus_Chloracidobacterium*, *Rhodovulum*, *Sinobacteraceae*, *Massilia*, and *Rhodobacter* became more abundant in the RO concentrate. Based on the above reported HPC, ATP, flow cytometry, and pyrosequencing results, the use of monochloramine as a residual disinfectant resulted in a stable microbial water quality during water transport, as long as monochloramine is present.

7.3.2 Monochloramine effectiveness for biofouling control: MFS research

Monochloramine efficiency for biofouling control was tested by running four MFS setups in parallel at the DECO water treatment facility using the same feed water source as the full-scale installation. The effect of using a 1 μm cartridge filter to remove particles on fouling development was evaluated. Fig. 7.2 summarized the different operating conditions for each MFS setup. No increase in ΔP and a minor increase in ΔP were observed for MFS3 (+CF +M) and MFS1 (-CF +M) respectively (Fig. 7.9). Both MFS1 and MFS3 had a monochloramine residual; however, a 1 μm cartridge filter was used before MFS3, resulting in no increase in ΔP at all. MFS2 (-CF -M) and MFS4 (+CF -M) displayed a major increase in ΔP . MFS2 had the highest increase in ΔP during the 50 day experiments (Fig. 7.9); the ΔP increase was exponential indicative of biomass

formation. This highest ΔP development in MFS2 was caused by the absence of both the 1 μm cartridge filter and monochloramine residual.

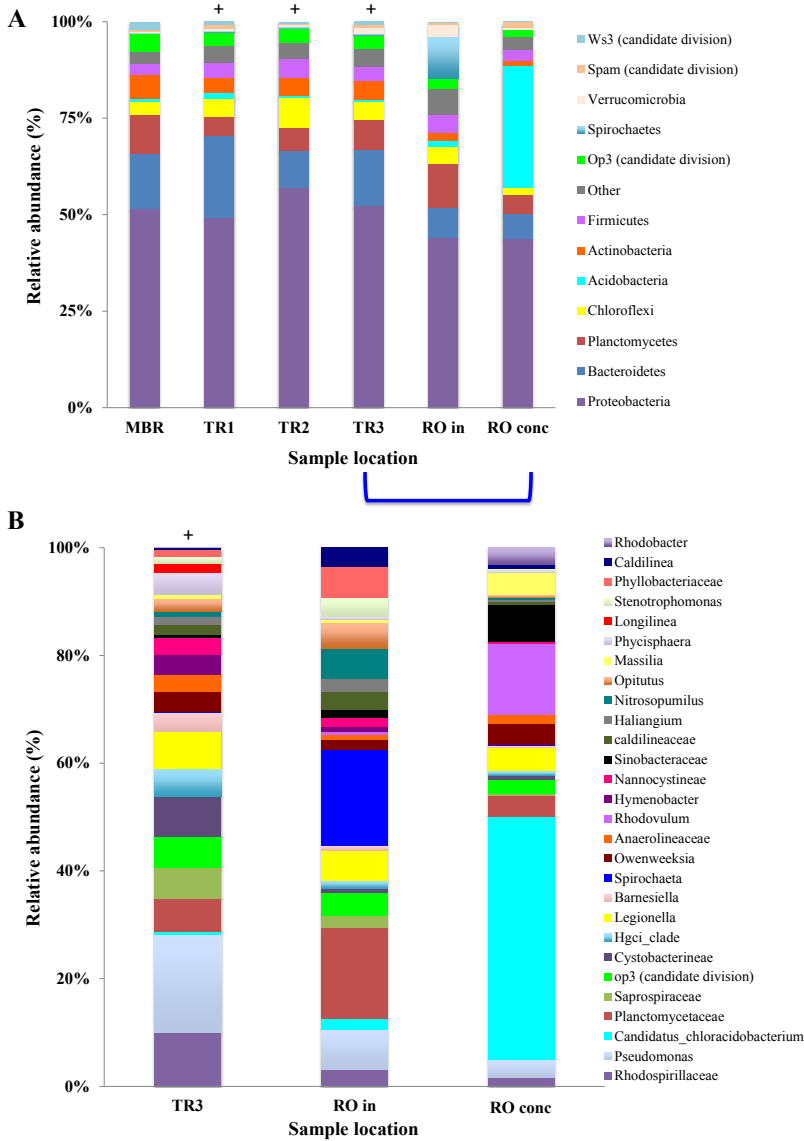

Figure 7.7. Relative abundance of bacterial phyla (A) and genera (B) in samples collected at the locations shown in Figure 7.1. Samples containing monochloramine residual are marked with + sign.

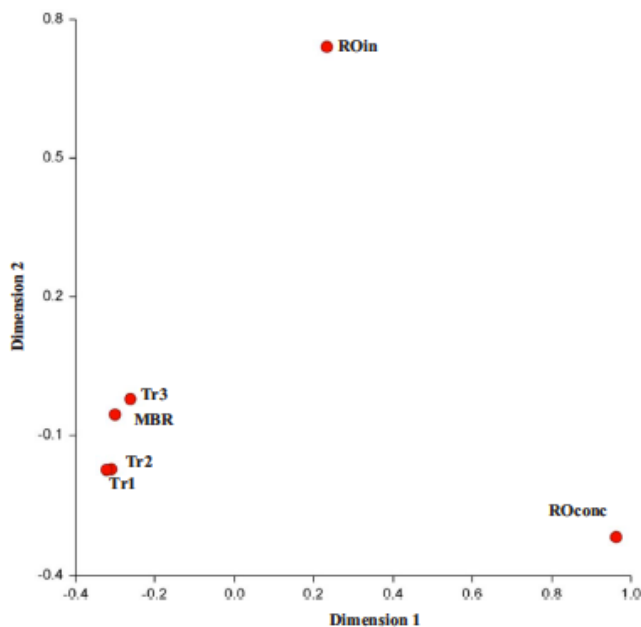

Figure 7.8. Pyrosequencing multidimensional scaling (MDS) plot for the samples taken at the locations shown in Figure 7.1. The closer the samples are located to each other, the higher the similarity in bacterial community structure.

A closer look at the 50 μm strainer and the 1 μm cartridge filters showed the deposition of black particles on the cartridge filters. Analysis of the filter deposits revealed, in addition to a majority of organics, the presence of manganese, therefore, explaining the black color (Supplementary material Figs. S7.2–5 and Tables S7.1 and S7.2). The MFS studies revealed that maintaining a monochloramine residual enabled control of biofilm development. The addition of a 1 μm cartridge filter to the pretreatment train further reduced ΔP development in the MFS suggesting that besides biofouling, particulate fouling was playing a role in performance decline at the DECO water treatment facility.

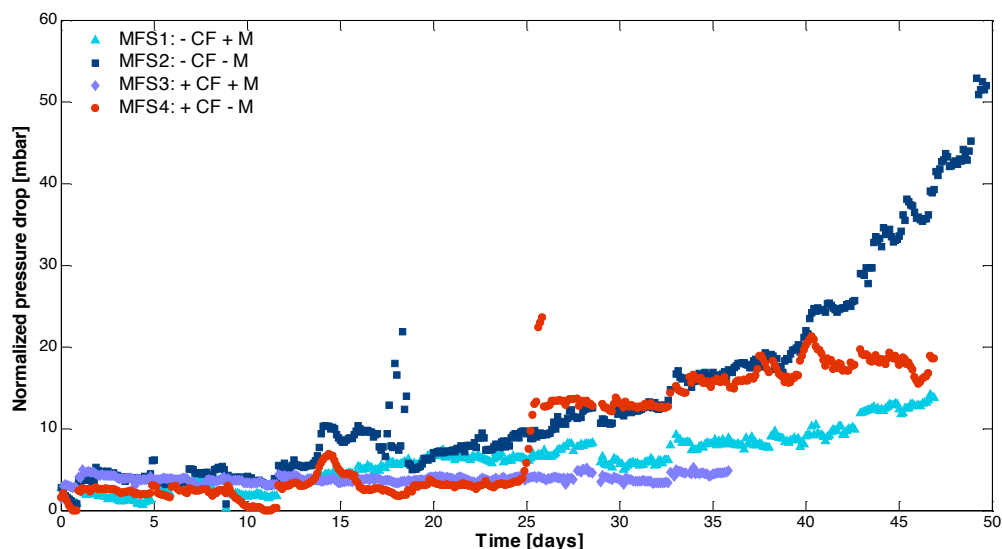

Figure 7.9. Pressure drop (mbar) development with time for the 4 MFS units run in parallel under the operating conditions described in Figure 7.2. CF: 1 μm cartridge filter, M: monochloramine; (+) present (-) absent

7.3.3 Monochloramine suitability for biofouling control: pilot research

Two pilot spiral wound elements (P1 and P2) were operated in parallel to the full-scale installation and monochloramine was continuously dosed to these pilot elements for a period of one year to assess the effect of monochloramine on membrane performance (data shown for the last 130 days). The primary concern was whether monochloramine would result in an increase in salt passage caused by membrane damage. Normalized salt passage development in time was monitored for the full-scale installation and the two pilots (Fig. 7.10). Normalized salt passage remained constant throughout the 130 day period, so it can be concluded that no membrane damage was caused by monochloramine dosage.

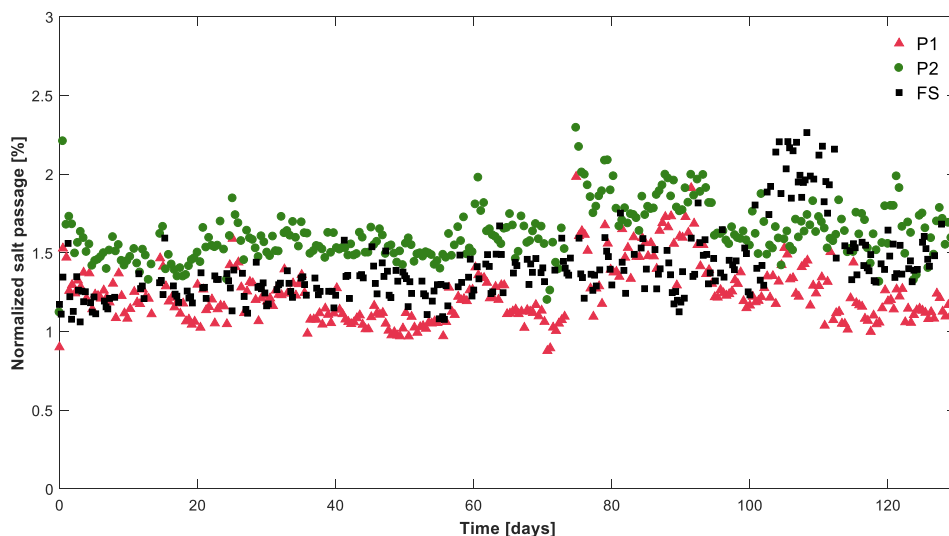

Figure 7.10. Normalized salt passage (%) development with time over the two pilot units P1 and P2 and the full-scale installation (FS) for a period of 130 days. P1: with a 10 μm cartridge filter before the RO module, P2: without a 10 μm cartridge filter before the RO module

7.4. Discussion

7.4.1 Monochloramine promotes biological stability and biofouling control

Disinfection is a commonly applied practice to achieve biological stability during transport of both drinking water and treated wastewater. Water utilities have been urged to switch to monochloramine disinfection as an alternative to chlorination to limit the production of the two regulated groups of disinfection by-products (DBPs): trihalomethanes (THMs) and haloacetic acids (HAAs) (Le Roux et al., 2016). Monochloramine has been applied as a disinfectant for drinking water distribution (Gomez-Alvarez et al., 2012; Kelly et al., 2014; Marchesi et al., 2012; Pinto et al., 2014; Zhang et al., 2002). In this study,

monochloramine was dosed to an MBR effluent before transport to an RO treatment facility.

Various microbial analysis techniques including flow cytometry and pyrosequencing were applied. Flow cytometry measurements enabled detection of variations in the total bacterial cell concentration as well as changes in the intact and damaged bacterial cell concentration (Fig. 7.4), providing information on cell integrity (Falcioni et al., 2008; Prest et al., 2014). Information on intact and damaged bacterial cell concentration was particularly useful to evaluate the efficiency of monochloramine disinfection (Ramseier et al., 2011). Results showed that monochloramine was efficient in controlling microbial growth during water transport based on measurements of ATP concentration (Fig. 7.3), total cell concentration (Fig. 7.4) and bacterial community structure (Figs. 7.6 and 7.7). Monochloramine affected the bacterial cell integrity (increase in damaged cell concentration) and delayed microbial growth under controlled conditions (growth tests). In this study, monochloramine use did not result in a major change in the bacterial community structure of the MBR effluent during transport. The phyla with the highest relative abundance were *Proteobacteria* and *Bacteroidetes* similar to MBR effluent bacterial community structure reported in other studies (Hu et al., 2012; McLellan et al., 2010). In this study, the bacterial community structure after monochloramine dosage was similar to the MBR effluent sample. Removal of monochloramine immediately resulted in bacterial growth, changes in bacterial community structure (Figs. 7.7 and 7.8) and to a similar growth potential as observed in the MBR effluent before monochloramine addition (Fig. 7.6). In this study, maintaining adequate monochloramine concentration in the transport pipe to avoid bacterial growth was relatively easy, due to the short residence time from the MBR to the RO plant (approximately 4-8 hours).

Few studies are reported in the literature addressing monochloramine application in RO membrane systems (Bartels et al., 2005; Linge et al., 2013; Norberg et al., 2007). Most of these studies mainly focused on the type of DBPs forming when monochloramine was used and membrane rejection ability of the formed DBPs. This study focused on monochloramine application for biofouling control and possible membrane damage due to monochloramine use and demonstrated that monochloramine could control biofouling development in RO membranes without causing membrane damage.

7.4.2 Balancing pros and cons of using chlorine versus monochloramine to achieve biological stability and biofouling control

Chlorine, the most commonly used oxidizing agent for water disinfection, has shown to react with the RO polyamide membrane active layer, resulting in membrane degradation and performance decline (Kang et al., 2007; Kwon and Leckie, 2006). Chlorine reacts rapidly with organics which are typically in higher concentrations in MBR effluents and results in higher assimilable organic carbon (AOC) formation (Liu et al., 2015) leading to increased biofouling potential in the RO modules. Monochloramine, a less aggressive oxidizing agent than free chlorine, has been recommended to minimize biofilm formation in RO polyamide membranes (Bartels et al., 2005; Linge et al., 2013; Norberg et al., 2007). In this study, monochloramine was effective in achieving biological stability during water transport. Results of the MFS experiments revealed that monochloramine had great potential in controlling biofilm formation. Normalized salt passage during the pilot membrane module experiments remained constant throughout the 130 day period, indicating no membrane damage. In contrast, some studies in the literature reported that monochloramine resulted in an increase of permeate flux and salt passage as a result of membrane damage (da Silva et al., 2006; Gabelich et al., 2005; Norberg et al., 2007; Valentino

et al., 2015). Different feed water types, longer monochloramine contact time, monochloramine application techniques, and the presence of some metals such as ferrous and aluminium can be factors affecting membrane performance, resulting in membrane damage during monochloramine application in these studies. Concerning membrane performance loss, special attention should be given to the formation of free chlorine and of secondary oxidizing agents from the reactions of monochloramine with organics and inorganics present in the water. For example, if monochloramine is applied in seawater, two species of particular concern are bromide and iodide, as monochloramine can react with these ions to form bromine and iodine species that have been found to be reactive towards polyamide (Kwon et al., 2011; Shemer and Semiat, 2011).

In addition to membrane damaging potential, the use of disinfectants is also of concern due to the undesirable formation of DBPs. DBPs are considered a potential human health risk (Richardson et al., 2007; Sedlak and von Gunten, 2011) and DBP concentrations been regulated to reduce the associated health risks. Chlorination produces the highest amount of THMs and HAAs (Sedlak and von Gunten, 2011). Many other halogenated DBPs are also formed during chlorination, however, in lower concentrations. Although monochloramine has been introduced as a better option than chlorine due to its lower THMs and HAAs formation potential, studies on the use of monochloramine disinfection showed an increase in a different set of toxic DBPs, namely the nitrogenous disinfection by-products (N-DBPs) such as N-nitrosodimethylamine (NDMA) (Chu et al., 2010; Doederer et al., 2014b; Farré et al., 2011; Hua et al., 2015). N-DBPs, although formed at considerably lower concentrations than regulated DBPs, may pose a greater health risk (Muellner et al., 2007; Plewa et al., 2004). Disinfection of water rich in nitrogen-containing compounds, specifically in the case of treated wastewater effluents, has been associated with the formation of N-DBPs (Bond et al., 2011; Mitch and Sedlak, 2002). Monochloramine can also be a

source of nitrogen when used as a disinfectant, therefore, increasing N-DBP formation potential. In addition to nitrogen as a precursor, Le Roux et al. (2016) demonstrated that aromatic dissolved organic compounds can play a role as precursors for N-DBP formation and Chu et al. (2010) revealed that protein-like organic matter in certain hydrophilic fractions (acids and bases) played a role in the formation of haloacetamides, an emerging class of N-DBPs. A limited number of studies has investigated N-DBP rejection by RO membranes. Rejection of N-nitrosodimethylamine (NDMA) by RO membranes has been reported to be between 10% and 50% (Fujioka et al., 2013; Steinle-Darling et al., 2007; Van Houtte and Verbauwhede, 2013) while rejections of above 50% have been found for haloacetonitriles (HANs) (Agus and Sedlak, 2010; Linge et al., 2013). Doederer et al. (2014a) emphasized the influence of feed water quality, membrane properties, and operational conditions on the rejection of DBPs in general and N-DBPs in particular.

In this study, wastewater was treated to produce demineralized water for industrial applications and not as potable reuse; nevertheless, DBPs would still be concentrated in the brine and later discharged to the environment posing human health risks emphasizing the importance of reducing DBP formation. In conclusion, the application of monochloramine as a disinfectant especially for wastewater effluents should be implemented with emphasis on pretreatment and better removal of N-DBP precursors.

7.4.3 Considerations for monochloramine use (practical implications)

Feed water quality will have a major effect on DBP formation during monochloramination and on monochloramine decay. Providing sufficient pretreatment for removing DBP precursors helps in restricting DBP formation and consequently DBP concentrations in the permeate; although this might sometimes be technologically or economically impractical especially in

wastewater treatment. A better understanding of N-DBP precursors and mechanisms of formation is another step forward toward a better DBP control (Le Roux et al., 2016).

During monochloramine use, chlorine residuals should always be monitored in membrane systems. Special attention should be given to monochloramine application techniques (Ward et al., 1984). When dosing preformed monochloramine, prevention of monochloramine decay is essential as free chlorine may be released through dissociation of monochloramine, which may be the cause of polyamide membrane damage and membrane performance loss (Owens et al., 2011). Another application technique, specifically used for wastewater where the effluent already contains ammonia, is the separate addition of free chlorine to achieve a certain Cl:N ratio and therefore form monochloramine at a controlled pH. In this case, monitoring that all chlorine is converted into monochloramine is crucial (Shang et al., 2005).

7.5 Conclusions

The main study findings can be summarized as:

- Monochloramine was effective in controlling microbial growth during transport and in biofouling control in RO systems of treated wastewater.
- After removal of monochloramine microbial growth in the RO membrane modules occurred.
- Monochloramine did not affect the bacterial growth potential of the water.
- No increase in salt passage was observed during the operation of two pilot-scale units with monochloramine dosage indicating that in this

study no membrane damage occurred and therefore monochloramine use is suitable for biofouling control during RO filtration of the MBR effluent.

Supplementary Material

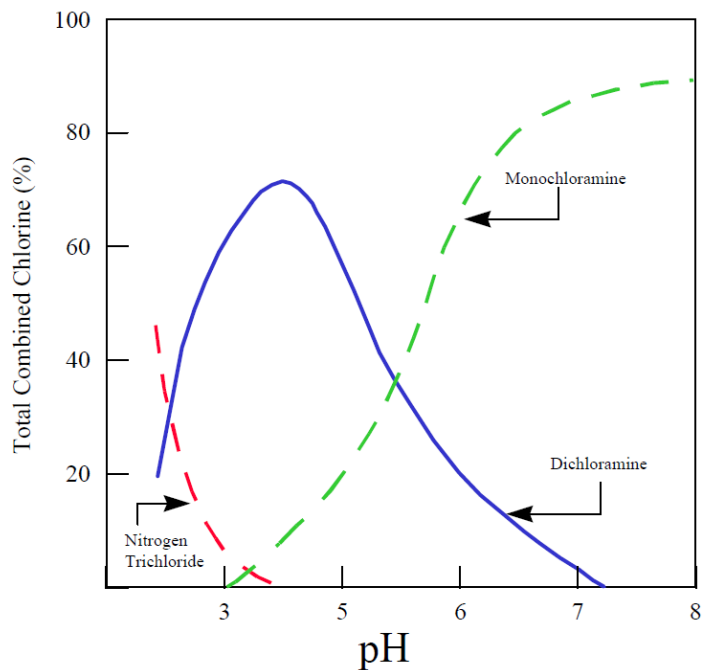

Figure S7.1. Distribution of chloramine species with pH.

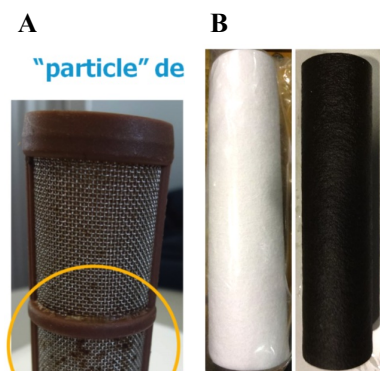

Figure S7.2. (A) 50 μm strainer installed before the RO membranes in the full-scale treatment plant, (B) 1 μm pore size cartridge filter before and after 1 month operation installed after the 50 μm strainer during the lab-scale MFS experiments. Both (A) and (B) clearly show particle deposition.

Scanning Electron Microscopy (SEM) with Energy Dispersive X-Ray Analysis (EDX)

SEM-EDX was performed on the clean and fouled cartridge filters. The fouled filter results revealed mainly deposition of organics with manganese as the main inorganic present.

Fouled filter:

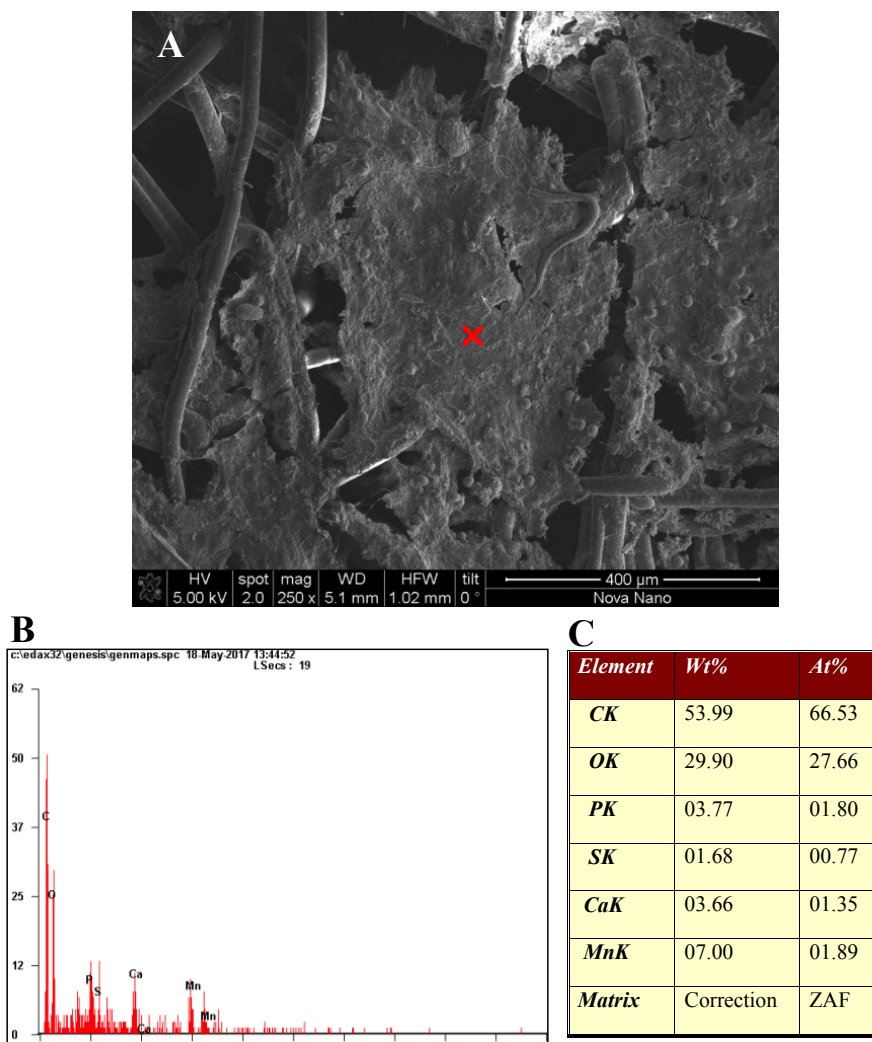
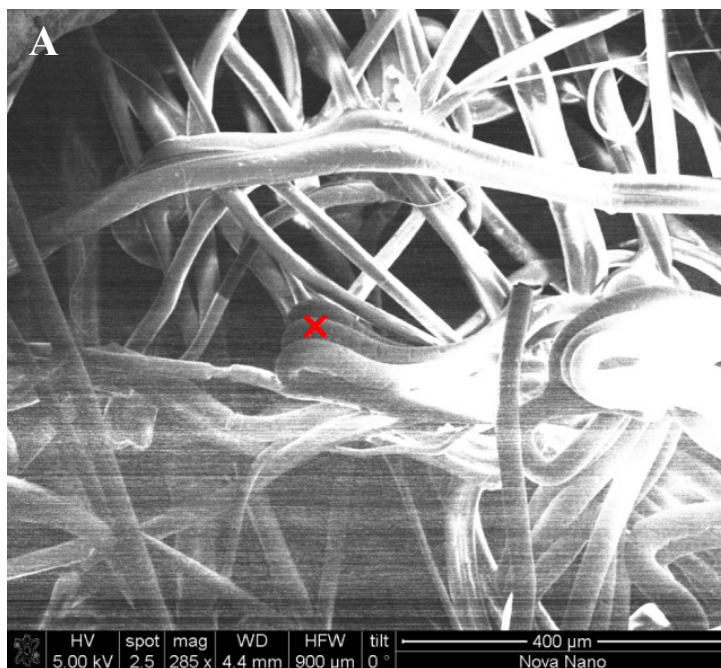
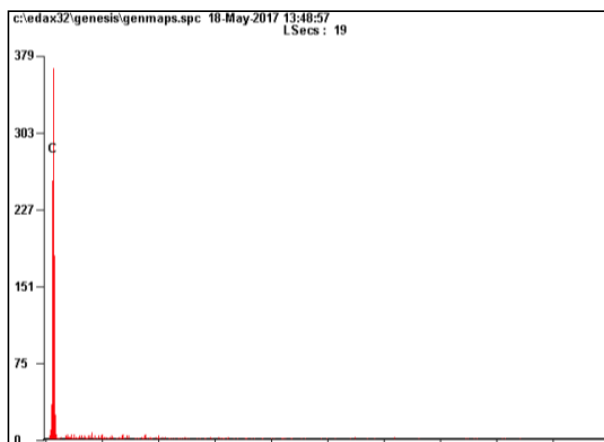

Figure S7.3. (A) SEM image of the fouled cartridge filter, (B) EDX spectrum plot, (C) Table summarizing the elemental analysis using EDX at the location shown in A.

Clean filter:**B****C**

<i>Element</i>	<i>Wt%</i>	<i>At%</i>
<i>CK</i>	100.00	100.00
<i>Matrix</i>	Correction	ZAF

Figure S7.4. (A) SEM image of the clean cartridge filter, (B) EDX spectrum plot, (C) Table summarizing the elemental analysis using EDX at the location shown in A.

Inductively coupled plasma mass spectrometry (ICP-MS)

ICP-MS was also used to analyze the inorganics present on the clean and fouled cartridge filters. Filter coupons were placed in 5mL nitric acid solution and vortexed to suspend foulants attached to the coupons. 20 mL demineralized water was added. Samples were filtered using a 0.45 μ m filter.

Table S7.1. Inorganic analysis using ICP-MS.

CATION	UNIT	CLEAN	FOULED
Na (23)	μ g/L	173	8,045
Mg (24)	μ g/L	38	6,877
Al (27)	μ g/L	32	45,810
K (39)	μ g/L	6,705	14,380
Ca (44)	μ g/L	42	3,326
Mn (55)	μ g/L	< 0.1	103,100
Cu (63)	μ g/L	12	1,404
Cd (111)	μ g/L	< 0.1	1

Organic carbon determination

An autopsy of the clean and fouled cartridge filter was performed. A coupon of 8 cm \times 2 cm \times 0.05 cm was placed in 35mL of demineralized water. The sample was vortexed to remove the fouled material from the filter and later filtered using a 0.45 μ m filter. The non- purgeable organic carbon was determined.

Table S7.2. Inorganic analysis using ICP-MS.

	NPOC (mg/cm^3)
Clean filter	0.12
Fouled filter	6.34

Bibliography

Agenson, K.O., Urase, T., 2007. Change in membrane performance due to organic fouling in nanofiltration (nf)/reverse osmosis (ro) applications. *Separation and Purification Technology* 55(2), 147-156.

Agus, E., Sedlak, D.L., 2010. Formation and fate of chlorination by-products in reverse osmosis desalination systems. *Water Research* 44(5), 1616-1626.

Al-Ahmad, M., Aleem, F.A.A., Mutiri, A., Ubaisy, A., 2000. Biofouling in ro membrane systems part 1: Fundamentals and control. *Desalination* 132(1-3), 173-179.

Alturki, A.A., Tadkaew, N., McDonald, J.A., Khan, S.J., Price, W.E., Nghiem, L.D., 2010. Combining mbr and nf/ro membrane filtration for the removal of trace organics in indirect potable water reuse applications. *Journal of Membrane Science* 365(1-2), 206-215.

Baker, J.S., Dudley, L.Y., 1998. Biofouling in membrane systems - a review. *Desalination* 118(1-3), 81-89.

Bartels, C.R., Wilf, M., Andes, K., Jong, J., 2005. Design considerations for wastewater treatment by reverse osmosis. *Water Science and Technology* 51(6-7), 473-482.

Bond, T., Huang, J., Templeton, M.R., Graham, N., 2011. Occurrence and control of nitrogenous disinfection by-products in drinking water - a review. *Water Research* 45(15), 4341-4354.

Bougeard, C.M.M., Goslan, E.H., Jefferson, B., Parsons, S.A., 2010. Comparison of the disinfection by-product formation potential of treated waters exposed to chlorine and monochloramine. *Water Research* 44(3), 729-740.

Bremer, P.J., Webster, B.J., Wells, D.B., 2001. Biocorrosion of copper in potable water. *Journal American Water Works Association* 93(8), 82-91.

Bucs, S.S., Valladares Linares, R., Marston, J.O., Radu, A.I., Vrouwenvelder, J.S., Picioreanu, C., 2015. Experimental and numerical characterization of the water flow in spacer-filled channels of spiral-wound membranes. *Water Research* 87, 299-310.

Chu, W.-H., Gao, N.-Y., Deng, Y., Krasner, S.W., 2010. Precursors of dichloroacetamide, an emerging nitrogenous dbp formed during chlorination or chloramination. *Environmental Science & Technology* 44(10), 3908-3912.

da Silva, M.K., Tessaro, I.C., Wada, K., 2006. Investigation of oxidative degradation of polyamide reverse osmosis membranes by monochloramine solutions. *Journal of Membrane Science* 282(1-2), 375-382.

Doederer, K., Farre, M.J., Pidou, M., Weinberg, H.S., Gernjak, W., 2014a. Rejection of disinfection by-products by ro and nf membranes: Influence of solute properties and operational parameters. *Journal of Membrane Science* 467, 195-205.

Doederer, K., Gernjak, W., Weinberg, H.S., Farre, M.J., 2014b. Factors affecting the formation of disinfection by-products during chlorination and chloramination of secondary effluent for the production of high quality recycled water. *Water Research* 48, 218-228.

Douterelo, I., Boxall, J.B., Deines, P., Sekar, R., Fish, K.E., Biggs, C.A., 2014. Methodological approaches for studying the microbial ecology of drinking water distribution systems. *Water Research* 65, 134-156.

El-Chakhtoura, J., Prest, E., Saikaly, P., Van Loosdrecht, M., Hammes, F., Vrouwenvelder, H., 2015. Dynamics of bacterial communities before and after distribution in a full-scale drinking water network. *Water Research* 74, 180-190.

EPA (2012) Guidelines for water reuse <https://watereuse.Org/wp-content/uploads/2015/04/epa-2012-guidelines-for-water-reuse>.

Falcioni, T., Papa, S., Gasol, J.M., 2008. Evaluating the flow-cytometric nucleic acid double-staining protocol in realistic situations of planktonic bacterial death. *Applied and Environmental Microbiology* 74(6), 1767-1779.

Farré, M.J., Keller, J., Holling, N., Poussade, Y., Gernjak, W., 2011. Occurrence of n-nitrosodimethylamine precursors in wastewater treatment plant effluent and their fate during ultrafiltration-reverse osmosis membrane treatment. *Water Science and Technology* 63(4), 605-612.

Flemming, H.C., 2003. Role and levels of real-time monitoring for successful anti-fouling strategies--an overview. *Water Sci Technol* 47(5), 1-8.

Fujioka, T., Khan, S.J., McDonald, J.A., Roux, A., Poussade, Y., Drewes, J.E., Nghiem, L.D., 2013. N-nitrosamine rejection by reverse osmosis membranes: A full-scale study. *Water Research* 47(16), 6141-6148.

Gabelich, C.J., Frankin, J.C., Gerringer, F.W., Ishida, K.P., Suffet, I.H., 2005. Enhanced oxidation of polyamide membranes using monochloramine and ferrous iron. *Journal of Membrane Science* 258(1-2), 64-70.

Gomez-Alvarez, V., Revetta, R.P., Domingo, J.W.S., 2012. Metagenomic analyses of drinking water receiving different disinfection treatments. *Applied and Environmental Microbiology* 78(17), 6095-6102.

Griebe, T., Chen, C.I., Srinivasan, R., Stewart, P.S., 1994. Analysis of biofilm disinfection by monochloramine and free chlorine. *Biofouling and Biocorrosion in Industrial Water Systems*, 151-160.

Hammes, F.A., Egli, T., 2005. New method for assimilable organic carbon determination using flow-cytometric enumeration and a natural microbial consortium as inoculum. *Environmental Science & Technology* 39(9), 3289-3294.

Hrudey, S.E., 2009. Chlorination disinfection by-products, public health risk tradeoffs and me. *Water Research* 43(8), 2057-2092.

Hu, M., Wang, X.H., Wen, X.H., Xia, Y., 2012. Microbial community structures in different wastewater treatment plants as revealed by 454-pyrosequencing analysis. *Bioresource Technology* 117, 72-79.

Hua, G.H., Reckhow, D.A., Abusallout, I., 2015. Correlation between suva and dbp formation during chlorination and chloramination of NOM fractions from different sources. *Chemosphere* 130, 82-89.

Huiting, H., Kappelhof, J.W.N.M., Bosklopper, T.G.J., 2001. Operation of nf/ro plants: From reactive to proactive. *Desalination* 139(1-3), 183-189.

Jiang, S., Li, Y., Ladewig, B.P., 2017. A review of reverse osmosis membrane fouling and control strategies. *Science of the Total Environment* 595, 567-583.

Kang, G.D., Gao, C.J., Chen, W.D., Jie, X.M., Cao, Y.M., Yuan, Q., 2007. Study on hypochlorite degradation of aromatic polyamide reverse osmosis membrane. *Journal of Membrane Science* 300(1-2), 165-171.

Kelly, J.J., Minalt, N., Culotti, A., Pryor, M., Packman, A., 2014. Temporal variations in the abundance and composition of biofilm communities colonizing drinking water distribution pipes. *Plos One* 9(5), 11.

Kwon, Y.N., Joksimovic, R., Kim, I.C., Leckie, J.O., 2011. Effect of bromide on the chlorination of a polyamide membrane. *Desalination* 280(1-3), 80-86.

Kwon, Y.N., Leckie, J.O., 2006. Hypochlorite degradation of crosslinked polyamide membranes - ii. Changes in hydrogen bonding behavior and performance. *Journal of Membrane Science* 282(1-2), 456-464.

Lautenschlager, K., Hwang, C., Liu, W.T., Boon, N., Koster, O., Vrouwenvelder, H., Egli, T., Hammes, F., 2013. A microbiology-based multi-parametric approach towards assessing biological stability in drinking water distribution networks. *Water Research* 47(9), 3015-3025.

Le Chevallier, M.W., Cawthon, C.D., Lee, R.G., 1988. Inactivation of biofilm bacteria. *Applied and Environmental Microbiology* 54(10), 2492-2499.

Le Roux, J., Nihemaiti, M., Croue, J.P., 2016. The role of aromatic precursors in the formation of haloacetamides by chloramination of dissolved organic matter. *Water Research* 88, 371-379.

Linge, K.L., Blythe, J.W., Busetti, F., Blair, P., Rodriguez, C., Heitz, A., 2013. Formation of halogenated disinfection by-products during microfiltration and reverse osmosis treatment: Implications for water recycling. *Separation and Purification Technology* 104, 221-228.

Liu, G., Verberk, J.Q., Van Dijk, J.C., 2013. Bacteriology of drinking water distribution systems: An integral and multidimensional review. *Appl Microbiol Biotechnol* 97(21), 9265-9276.

Liu, S., Gunawan, C., Barraud, N., Rice, S.A., Harry, E.J., Amal, R., 2016. Understanding, monitoring, and controlling biofilm growth in drinking water distribution systems. *Environmental Science & Technology* 50(17), 8954-8976.

Liu, X.L., Wang, J.Q., Liu, T.T., Kong, W.W., He, X.Q., Jin, Y., Zhang, B.L., 2015. Effects of assimilable organic carbon and free chlorine on bacterial growth in drinking water. *Plos One* 10(6).

Marchesi, I., Cencetti, S., Marchegiano, P., Frezza, G., Borella, P., Bargellini, A., 2012. Control of legionella contamination in a hospital water distribution system by monochloramine. *American Journal of Infection Control* 40(3), 279-281.

Mazloomi, S., Nabizadh, R., Nasser, S., Naddafi, K., Nazmara, S., Mahvi, A.H., 2009. Efficiency of domestic reverse osmosis (ro) in removal of trihalomethanes (thms) from drinking water. *Iranian Journal of Environmental Health Science & Engineering* 6(4), 301-306.

McLellan, S.L., Huse, S.M., Mueller-Spitz, S.R., Andreishcheva, E.N., Sogin, M.L., 2010. Diversity and population structure of sewage-derived microorganisms in wastewater treatment plant influent (vol 12, pg 378, 2010). *Environmental Microbiology* 12(5), 1376-1376.

Mitch, W.A., Sedlak, D.L., 2002. Formation of n-nitrosodimethylamine (ndma) from dimethylamine during chlorination. *Environmental Science & Technology* 36(4), 588-595.

Muellner, M.G., Wagner, E.D., McCalla, K., Richardson, S.D., Woo, Y.-T., Plewa, M.J., 2007. Haloacetonitriles vs. Regulated haloacetic acids: Are nitrogen-containing dbps more toxic? *Environmental Science & Technology* 41(2), 645-651.

Norberg, D., Hong, S., Taylor, J., Zhao, Y., 2007. Surface characterization and performance evaluation of commercial fouling resistant low-pressure ro membranes. *Desalination* 202(1-3), 45-52.

Owens, E., Geringer, F., Trussell, S., Lauri, P., Trussell, R. (2011) Critical elements in the manufacture and application of preformed chloramines, pp. 1932-1951.

Pinto, A.J., Schroeder, J., Lunn, M., Sloan, W., Raskin, L., 2014. Spatial-temporal survey and occupancy-abundance modeling to predict bacterial community dynamics in the drinking water microbiome. *Mbio* 5(3), 13.

Pizarro, G.E., Vargas, I.T., 2016. Biocorrosion in drinking water pipes. *Water Science and Technology-Water Supply* 16(4), 881-887.

Plewa, M.J., Wagner, E.D., Jazwierska, P., Richardson, S.D., Chen, P.H., McKague, A.B., 2004. Halonitromethane drinking water disinfection byproducts: Chemical characterization and mammalian cell cytotoxicity and genotoxicity. *Environ Sci Technol* 38(1), 62-68.

Prest, E.I., El-Chakhtoura, J., Hammes, F., Saikaly, P.E., Van Loosdrecht, M.C.M., Vrouwenvelder, J.S., 2014. Combining flow cytometry and 16s rRNA gene pyrosequencing: A promising approach for drinking water monitoring and characterization. *Water Research* 63, 179-189.

Prest, E.I., Hammes, F., Kotsch, S., van Loosdrecht, M.C.M., Vrouwenvelder, J.S., 2013. Monitoring microbiological changes in drinking water systems using a fast and reproducible flow cytometric method. *Water Research* 47(19), 7131-7142.

Rajamohan, R., Venugopalan, V.P., Mal, D., Natesan, U., 2014. Efficiency of reverse osmosis in removal of total organic carbon and trihalomethane from drinking water. *Research Journal of Chemistry and Environment* 18(12), 1-6.

Ramseier, M.K., von Gunten, U., Freihofer, P., Hammes, F., 2011. Kinetics of membrane damage to high (hna) and low (lna) nucleic acid bacterial clusters in drinking water by ozone, chlorine, chlorine dioxide, monochloramine, ferrate(vi), and permanganate. *Water Research* 45(3), 1490-1500.

Richardson, S.D., Plewa, M.J., Wagner, E.D., Schoeny, R., DeMarini, D.M., 2007. Occurrence, genotoxicity, and carcinogenicity of regulated and emerging disinfection by-products in drinking water: A review and roadmap for research. *Mutation Research-Reviews in Mutation Research* 636(1-3), 178-242.

Rittman, B.E., Snoeyink, V.L., 1984. Achieving biologically stable drinking-water. *Journal American Water Works Association* 76(4), 63-63.

Sedlak, D.L., von Gunten, U., 2011. The chlorine dilemma. *Science* 331(6013), 42-43.

Shang, C., Qi, Y., Lo, I.M.C., 2005. Factors affecting inactivation behavior in the monochloramination range. *Journal of Environmental Engineering* 131(1), 119-129.

Shannon, M.A., Bohn, P.W., Elimelech, M., Georgiadis, J.G., Marinas, B.J., Mayes, A.M., 2008. Science and technology for water purification in the coming decades. *Nature* 452(7185), 301-310.

Shemer, H., Semiat, R., 2011. Impact of halogen based disinfectants in seawater on polyamide RO membranes. *Desalination* 273(1), 179-183.

Steinle-Darling, E., Zedda, M., Plumlee, M.H., Ridgway, H.F., Reinhard, M., 2007. Evaluating the impacts of membrane type, coating, fouling, chemical properties and water chemistry on reverse osmosis rejection of seven nitrosoalkylamines, including ndma. *Water Research* 41(17), 3959-3967.

Valentino, L., Renkens, T., Maugin, T., Croue, J.P., Marinas, B.J., 2015. Changes in physicochemical and transport properties of a reverse osmosis membrane exposed to chloraminated seawater. *Environmental Science & Technology* 49(4), 2301-2309.

Van der Kooij, D., 2000. Biological stability: A multidimensional quality aspect of treated water. *Water Air and Soil Pollution* 123(1-4), 25-34.

Van der Wielen, P.W.J.J., Heijnen, L., Van der Kooij, D., 2013. Pyrosequence analysis of the hsp65 genes of nontuberculous mycobacterium communities in unchlorinated drinking water in the netherlands. *Applied and Environmental Microbiology* 79(19), 6160-6166.

Van Houtte, E., Verbauwheide, J., 2013. Long-time membrane experience at torreele's water re-use facility in belgium. *Desalination and Water Treatment* 51(22-24), 4253-4262.

Vila-Costa, M., Gasol, J.M., Sharma, S., Moran, M.A., 2012. Community analysis of high- and low-nucleic acid-containing bacteria in nw mediterranean coastal waters using 16s rdna pyrosequencing. *Environmental Microbiology* 14(6), 1390-1402.

Vrouwenvelder, J.S., Bakker, S.M., Cauchard, M., Le Grand, R., Apacandie, M., Idrissi, M., Lagrave, S., Wessels, L.P., van Paassen, J.A.M., Kruithof, J.C., van Loosdrecht, M.C.M., 2007a. The membrane fouling simulator: A suitable tool for prediction and characterisation of membrane fouling. *Water Science and Technology* 55(8-9), 197-205.

Vrouwenvelder, J.S., Bakker, S.M., Wessels, L.P., van Paassen, J.A.M., 2007b. The membrane fouling simulator as a new tool for biofouling control of spiral-wound membranes. *Desalination* 204(1-3), 170-174.

Vrouwenvelder, J.S., Hinrichs, C., Van der Meer, W.G.J., Van Loosdrecht, M.C.M., Kruithof, J.C., 2009a. Pressure drop increase by biofilm accumulation in spiral wound ro and nf membrane systems: Role of substrate concentration, flow velocity, substrate load and flow direction. *Biofouling* 25(6), 543-555.

Vrouwenvelder, J.S., Manolarakis, S.A., van der Hoek, J.P., van Paassen, J.A.M., van der Meer, W.G.J., van Agtmaal, J.M.C., Prummel, H.D.M., Kruithof, J.C., van Loosdrecht, M.C.M., 2008. Quantitative biofouling diagnosis in full scale nanofiltration and reverse osmosis installations. *Water Research* 42(19), 4856-4868.

Vrouwenvelder, J.S., van Paassen, J.A.M., Kruithof, J.C., van Loosdrecht, M.C.M., 2009b. Sensitive pressure drop measurements of individual lead membrane elements for accurate early biofouling detection. *Journal of Membrane Science* 338(1-2), 92-99.

Wang, Y.Y., Hammes, F., Boon, N., Chami, M., Egli, T., 2009. Isolation and characterization of low nucleic acid (lna)-content bacteria. *Isme Journal* 3(8), 889-902.

Ward, N.R., Wolfe, R.L., Olson, B.H., 1984. Effect of ph, application technique, and chlorine-to-nitrogen ratio on disinfectant activity of inorganic chloramines with pure culture bacteria. *Applied and Environmental Microbiology* 48(3), 508-514.

Weil, I., Morris, C., 1949. Kinetic studies on the chloramines .1. The rates of formation of monochloramine, n-chlormethylamine and n-chlordimethylamine. *Journal of the American Chemical Society* 71(5), 1664-1671.

Zhang, M., Semmens, M.J., Schuler, D., Hozalski, R.M., 2002. Biostability and microbiological quality in a chloraminated distribution system. *Journal American Water Works Association* 94(9), 112-122.

Chapter 8

Conclusions and research prospects

8.1 Key Conclusions

The following main conclusions were drawn from the various studies:

- Combining 16S rRNA gene pyrosequencing with flow cytometry effectively provided data on water microbial community composition, structure and concentrations. The method worked well with potable water (all chapters), water samples during treatment (Chapters 5 and 6), as well as wastewater membrane bioreactor (MBR) effluent (Chapter 7).
- Most of the changes detected in bacterial communities with 16S rRNA gene pyrosequencing and flow cytometry were not picked up by the heterotrophic plate count method (Chapters 2, 3 and 7).
- When low-AOC drinking water was distributed without disinfectant residual temporal variations (at different minutes/hours/days) in the bacterial community were insignificant (Chapters 2 and 3).
- When low-AOC drinking water was distributed without disinfectant residual the bacterial community structure changed after distribution, primarily due to rare phylotypes, with greater bacterial richness and diversity found in the networks. A significant fraction of the microbiome was still shared between the treated and transported water (Chapters 3 and 4). This shared fraction was lower in a distribution system transporting water with chlorine residual (Chapter 6).
- In drinking water distribution systems (DWDSs) lacking disinfectant residuals residence time or distance to the water treatment plant (WTP) did not significantly impact the bacterial community and invertebrate profile (Chapter 4). In DWDSs transporting water with chlorine residual the eukaryotic community structure changed with distance (Chapter 6).
- In a reverse osmosis (RO)-based desalination plant pre-chlorination did not inhibit microbial growth in the membrane module. Chlorination was an

important process together with RO treatment that shaped the effluent water bacterial and eukaryotic communities (Chapters 5 and 6).

- In an MBR-RO plant treating wastewater a monochloramine residual resulted in biologically stable bacterial communities during transport and also restricted biofouling (Chapter 7).
- RO membrane treatment did not produce sterile water (Chapters 5, 6 and 7).
- A unique and diverse core drinking water microbiome was found predominantly constituting *Gammaproteobacteria*, *Betaproteobacteria*, *Bacteroidetes*, *Planctomycetes* and *Actinobacteria* (classes/phyla) or *Planctomycetaceae*, *Pseudomonadaceae*, OP3, *Comamonadaceae*, *Rhodospirillaceae* and *Caldilineaceae* families (in the Dutch systems) (Chapters 3 and 4). In the desalinated drinking water *Betaproteobacteria* also dominated the community followed by *Bacteroidetes* and *Firmicutes* (Chapter 5).
- Network flushing resulted in a change in the water microbiology, particularly an increase in microbial parameter values (Chapter 4).
- The (Dutch) tap water bacterial profile highly resembled that of the flushed water - and to a lesser extent that of the treatment plant effluent - highlighting the important role biofilm and particle-associated communities play in driving network bacterial processes and shaping final tap water microbial quality (Chapter 4).
- Network flushing could be a rapid and simple method to assess tap water microbiology and hence contamination risk (Chapter 4).
- Tap and flushed water microbiota from distinct (Dutch) systems remarkably converged attenuating the impact of water source and treatment strategy while stressing the importance of local DWDS conditions (Chapter 4).
- The (KAUST) tap water eukaryotic community constituted a significant number of unique microbes absent in the plant effluent, highlighting the

importance of the distribution network in shaping the eukaryotic community of the final drinking water (Chapter 6).

- A highly diverse eukaryotic community was found from source to tap (in the KAUST system). In the desalination plant *Ascomycota* was the dominant eukaryotic phylum followed by *Alveolata*, an unclassified fungi clade and *Porifera*. In the DWDS, an uncultured fungi phylum was the major group followed by *Chordata*, *Ascomycota* and *Arthropoda*. (Chapter 6)
- Sheer biological stability is difficult to attain in large-scale DWDSs that are inherently dynamic and complex. Biological stability is not a measure of safety and this concept needs to be revised and quantified in alignment with evolving culture-independent, highly sensitive techniques (all chapters).
- The detection of *Legionellaceae* in high abundance in the (Dutch) DWDSs requires further investigation at species level (Chapter 4).
- The detection of fungi as the major eukaryotic group in the (KAUST) DWDS requires further investigation (Chapter 6).

8.2 Molecular Biology Approaches

Despite the vast information provided by high-throughput sequencing the technology entails some limitations. High-throughput amplicon sequencing data is not always suitable or reliable for species-level identification because of short sequence reads. This precludes an accurate detection of pathogenic species. The technology is also relatively costly and time-consuming. Cheaper and faster sequencing platforms with higher throughput are continuously being developed though. One such advancement is nanopore sequencing, embedded in a few recently commercialized devices such as the MinION, a pocket-sized DNA/RNA sequencer that is inexpensive and can be plugged into a USB port on a computer (Fig. 8.1). It has achieved reads exceeding 150 kb with a 92% accuracy and it

permits real-time analysis in a few hours. It has been successfully used in clinical applications and even allowed the detection of pathogens within a few minutes (Jain et al., 2016). An even smaller sequencer that can be plugged into a smartphone is also currently being developed (the SmidgION). Other limitations to sequencing techniques include the biases that may arise e.g. from: DNA extraction protocols or kits, target 16S rRNA gene hypervariable region or primer choice, PCR amplification and sequencing platforms. Moreover, DNA-based sequencing does not always provide information on viability status. Choosing PCR primers that generate large amplicons can selectively discriminate between intact and damaged DNA (McCarty and Atlas, 1993; Eischeid et al., 2009). Targeting RNA instead of DNA can also limit the detection to active bacteria. Other methods based on membrane damage (Nocker et al., 2007; Chiao et al., 2014) or enzymatic activity (Hoefel et al., 2005a) can be applied to discriminate between live and dead cells.



Figure 8.1. MinION sequencing. A protein nanopore is set in an electrically resistant polymer membrane and an ionic current is passed through it. After the DNA sample is added to the flow cell the current is disrupted as the nucleotide bases pass through in different combinations, measured by a sensor. The data streams are passed to an integrated circuit and a software that generates the signal-level data. *Adapted from: nanoporetech.com, 2017*

Besides characterizing drinking water microbial community structure and diversity, understanding microbial functions and processes is essential for a full picture of the microbiome. This can be accomplished via several approaches (Douterelo et al., 2014). In (i) metatranscriptomics actively transcribed rRNA and mRNA are studied. RNA is extracted and then complementary DNA is synthesized by reverse transcription and is used to measure the expression of functional genes by methods such as real-time PCR or functional arrays. The former is highly sensitive and accurate and has been applied to DWDS research in the analysis of metabolic or catabolic pathway genes such as *dsrB* genes to study sulphate-reducing bacteria (Li et al., 2010) and *amoA* genes to study ammonia-oxidizing bacteria (Hoefel et al., 2005b). Functional arrays such as GeoChip (He et al., 2007) covers 200,393 coding sequences for genes involved in different biogeochemical cycles and can assess simultaneously the expression of thousands of mRNAs. It has not been applied yet in drinking water research. In (ii) (meta)proteomics protein is extracted, separated and/or fractioned, identified and quantified (Siggins et al., 2012), which enables a link with specific microbial activities. The proteins can be separated by different methods e.g. liquid chromatography and identified by mass spectrometry, then compared with databases. Metaproteomics has been used to study microbial community functions in marine environments (Morris et al., 2010) and fresh water ecosystems (Lauro et al., 2011) but not in DWDS research. In (iii) metabolomics cell metabolites are examined that can provide knowledge on functional genomics and cell-to-cell communication mechanisms (Mapelli et al., 2008). Specific metabolite profiles can be linked with different microbial activities using techniques such as gas chromatography–mass spectrometry, and this has been demonstrated in DWDS biofilm studies (Beale et al., 2012). (iv) Other molecular approaches that can be explored for the study of functionality in drinking water ecosystems include metagenomics (described in Chapter 1), stable isotope

probing (SIP) that has been generally used to study microbes which utilize carbon and nitrogen compounds (Radajewski et al., 2000), Bromodeoxyuridine (BrdU) incorporation that can be combined with FISH or DGGE to identify active and DNA-synthesizing cells (Pernthaler et al., 2002; Hamasaki et al., 2007), and microautoradiography (MAR)-FISH which can reveal the physiology of targeted microorganisms (Wagner et al., 2006).

8.3 Research Outlook

In addition to the need to discern microbial function and processes in DWDSs, the findings presented in this dissertation open doors to various research questions and opportunities:

- What is the degree of biological instability that is acceptable during drinking water distribution? Once a core microbiome is established for a particular DWDS (by analyzing large data sets), deviations from the standard could be monitored. Delineating “normal” deviations in terms of microbial cell concentrations, community composition or structure is a challenging task and such guidelines are likely to be system-specific.
- Are disinfectant residuals necessary in well-maintained DWDSs generally transporting good-quality water? Compared to the systems lacking disinfectant residuals, the change in water microbiology during distribution was more pronounced in the system using chlorine residual but was less evident in the system using monochloramine residual. Disinfection exerts a selective pressure on the water microbial community. For instance, generally higher abundance of *Legionella* and *Nitrospira* genera has been detected in disinfectant residual-free DWDSs while higher abundance of *Mycobacterium* and *Pseudomonas* genera has been found in disinfected systems (Fig. 8.2) (Bautista-de los Santos et al., 2016). Research is needed at species level to

determine whether each disinfection strategy (or the lack thereof) favors the growth of particular pathogenic microorganisms, and if it leads to disinfectant resistance.

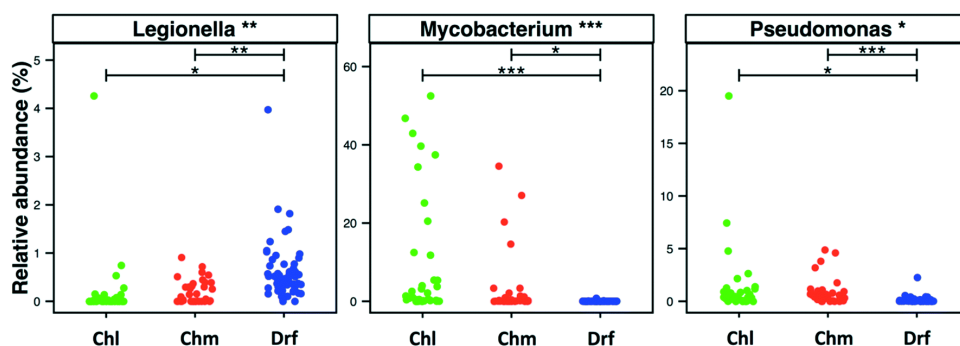

Figure 8.2. Relative abundance of OTUs classified as *Legionella*, *Mycobacterium* and *Pseudomonas* in samples from 14 global data sets, visualized by disinfection strategy. (Chl: chlorinated, Chm: chloraminated, Drf: disinfectant residual-free) Significant differences between groups, evaluated by ANOVA, are indicated by bars (p-value legend: * = <0.01, ** = <0.001, *** = <0.0001). Adapted from: Bautista-de los Santos et al., 2016 (Fig.5)

- What is the role of viruses, fungi and protozoa in the DWDS ecosystem? While bacteria constitute the primary microbial community (Bautista-de los Santos et al., 2016) and have been the subject of the majority of DWDS studies, these members are commonly present and their role is poorly understood when it comes to ecological interactions such as competition, symbiosis and commensalism, as well as their relation to waterborne illnesses.
- How do drinking water microbial communities affect the human microbiome? This subject has not been investigated especially with respect to benign microbiota. It is also important to note that microorganisms which are

dormant within a DWDS may become active outside it, e.g. in a human host (Pinto et al., 2012).

- Which properties of the DWDS have the strongest effect on the water microbial quality? Since it was found that biofilm and particle-associated communities govern the final tap water quality regardless of water source and treatment scheme, then determining the local network conditions that shape the biofilm and deposit communities is vital. Miniature network studies can be conducted to evaluate the impact of e.g. flow velocity, pressure, pipe material, age and diameter. A relevant research opportunity involves designing self-flushing networks based on optimal hydraulic conditions and physical components that limit sedimentation and biofilm formation (and rejuvenation).
- Is it plausible to manipulate the microbial ecology of drinking water via a probiotic approach in order to alter the behaviour and survival of opportunistic pathogens? Intentionally inoculating beneficial microbiota into the DWDS that control pathogens via their ecological interactions (Wang et al., 2013) may seem like an extreme approach but is a strategy essentially employed during biofiltration in many European treatment systems.

Linking the different PhD results raises a broader research question: What is a healthy and sustainable drinking water system in terms of microbial ecology and infrastructure? It is important to note that rising temperatures and deteriorating raw water quality driven by climate change, together with the anticipated surge in water consumption, will alter the microbial communities indigenous to water systems in ways that cannot be predicted. Water conservation and efficiency technologies used in green buildings nowadays may have inadvertent consequences pertaining to microbial water quality due to elevated water age (Rhoads et al., 2016). New materials, sensor tools and the

expansion of decentralized treatment applying novel technologies will change the way water networks are built and operated (World Economic Forum, 2017), hence impacting the microbiome. It is important to keep in mind that the “drinking” water microbiome in many developing and undeveloped countries may be substantially different from the microbiome characterized in this dissertation. More than 40% of people do not have water piped to their homes to begin with; therefore the conclusions and research opportunities presented herein most likely only apply to industrialized countries that benefit from centralized water treatment and distribution systems.

Bibliography

Bautista-de los Santos, Q.M., Schroeder, J.L., Sevillano-Rivera, M.C., Sunghong, R., Ijaz, U.Z., Sloan, W.T., Pinto, A.J., 2016. Emerging investigators series: microbial communities in full-scale drinking water distribution systems- a meta-analysis. *Environ. Sci.: Water Res. Technol.* 2, 631-644.

Beale, D.J., Dunn, M.S., Morrison, P.D., Porter, N.A., Marlow, D.R., 2012. Characterisation of bulk water samples from copper pipes undergoing microbially influenced corrosion by diagnostic metabolomic profiling. *Corros. Sci.* 55, 272-279.

Chiao, T.H., Clancy, T.M., Pinto, A., Xi, C., Raskin, L., 2014. Differential resistance of drinking water bacterial populations to monochloramine disinfection. *Environ. Sci. Technol.* 48 (7), 4038-4047.

Douterelo, I., Boxall, J.B., Deines, P., Sekar, R., Fish, K.E., Biggs, C.A., 2014. Methodological approaches for studying the microbial ecology of drinking water distribution systems. *Water Res.* 65, 134-156.

Eischeid, A.C., Meyer, J.N., Linden, K.G., 2009. UV disinfection of adenoviruses: Molecular indications of DNA damage efficiency. *Appl. Environ. Microbiol.* 75 (1), 23-28.

Hamasaki, K., Taniguchi, A., Tada, Y., Long, R.A., Azam, F., 2007. Actively growing bacteria in the Inland Sea of Japan, identified by combined bromodeoxyuridine immunocapture and denaturing gradient gel electrophoresis. *Appl. Environ. Microb.* 73 (9), 2787-2798.

He, Z., Gentry, T.J., Schadt, C.W., Wu, L., Liebich, J., Chong, S.C., Huang, Z. et al., 2007. GeoChip: a comprehensive microarray for investigating biogeochemical, ecological and environmental processes. *ISME J.* 1 (1), 67-77.

Hoefel, D., Monis, P.T., Grooby, W.L., Andrews, S., Saint, C.P., 2005a. Profiling bacterial survival through a water treatment process and subsequent distribution system. *J. Appl. Microbiol.* 99 (1), 175-186.

Hoefel, D., Monis, P.T., Grooby, W.L., Andrews, S., Saint, C.P., 2005b. Culture-independent techniques for rapid detection of bacteria associated with loss of chloramine residual in a drinking water system. *Appl. Environ. Microb.* 71 (11), 6479-6488.

Jain, M., Olsen, H.E., Paten, B., Akeson, M., 2016. The Oxford Nanopore MinION: delivery of nanopore sequencing to the genomics community. *Genome Biol.* 17, 239.

Lauro, F.M., DeMaere, M.Z., Yau, S., Brown, M.V., Ng, C., Wilkins, D., Raftery, M.J., Gibson, J.A., Andrews-Pfannkoch, C., Lewis, M., Hoffman, J.M., Thomas, T., Cavicchioli, R., 2011. An integrative study of a meromictic lake ecosystem in Antarctica. *ISME J.* 5 (5), 879–895.

Li, D., Li, Z., Yu, J., Cao, N., Liu, R., Yang, M., 2010. Characterization of bacterial community structure in a drinking water distribution system during an occurrence of red water. *Appl. Environ. Microb.* 76 (21), 7171–7180.

Mapelli, V., Olsson, L., Nielsen, J., 2008. Metabolic footprinting in microbiology: methods and applications in functional genomics and biotechnology. *Trends Biotechnol.* 26 (9), 490–497.

McCarty, S.C., Atlas, R.M., 1993. Effect of amplicon size on PCR detection of bacteria exposed to chlorine. *Genome Res.* 3 (3), 181–185.

Morris, R.M., Nunn, B.L., Frazar, C., Goodlett, D.R., Ting, Y.S., Rocap, G., 2010. Comparative metaproteomics reveals ocean-scale shifts in microbial nutrient utilization and energy transduction. *ISME J.* 4 (5), 673–685.

Nocker, A., Sossa-Fernandez, P., Burr, M.D., Camper, A.K., 2007. Use of propidium monoazide for live/dead distinction in microbial ecology. *Appl. Environ. Microbiol.* 73 (16), 5111–5117.

Pernthaler, A., Pernthaler, J., Schattenhofer, M., Amann, R., 2002. Identification of DNA-synthesizing bacterial cells in coastal North sea plankton. *Appl. Environ. Microb.* 68 (11), 5728–5736.

Pinto, A.J., Xi, C., Raskin, L., 2012. Bacterial community structure in the drinking water microbiome is governed by filtration processes. *Environ. Sci. Technol.* 46 (16), 8851–8859.

Radajewski, S., Ineson, P., Parekh, N.R., Murrell, J.C., 2000. Stable-isotope probing as a tool in microbial ecology. *Nature* 403 (6770), 646–649.

Rhoads, W.J., Pruden, A., Edwards, M.A., 2016. Survey of green building water systems reveals elevated water age and water quality concerns. *Environ. Sci.: Water Res. Technol.* 2, 164-173.

Siggins, A., Gunnigle, E., Abram, F., 2012. Exploring mixed microbial community functioning: recent advances in metaproteomics. *FEMS Microb. Ecol.* 80 (2), 265-280.

Wagner, M., Nielsen, P.H., Loy, A., Nielsen, J.L., Daims, H., 2006. Linking microbial community structure with function: fluorescence in situ hybridization microautoradiography and isotope arrays. *Curr. Opin. Biotechnol.* 17 (1), 83-91.

Wang, H., Edwards, M.A., Falkinham, J.O., Pruden, A., 2013. Probiotic approach to pathogen control in premise plumbing systems? A review. *Environ. Sci. Technol.* 47 (18), 10117-10128.

World Economic Forum, 2017. *The Global Risks Report 2017*. Geneva, Switzerland.

Abbreviations

AC	asbestos cement
ANOSIM	analysis of similarity
AOC	assimilable organic carbon
ATP	adenosine triphosphate
a.u.	arbitrary unit
bp	base pair
BWRO	brackish water reverse osmosis
CFU	colony-forming unit
DBP	disinfection by-product
DGGE	denaturing gradient gel electrophoresis
DWDS	drinking water distribution system
FCM	flow cytomet(ry)(er)
FISH	fluorescent in situ hybridization
HAA	haloacetic acid
HD-PE	high-density polyethylene
HNA	high nucleic acid
HPC	heterotrophic plate count
HTS	high-throughput sequencing
LNA	low nucleic acid
LSI	Langelier saturation index
MBR	membrane bioreactor
MDS	multidimensional scaling
MFS	membrane fouling simulator
N-DBP	Nitrogenous disinfection by-product
NF	nanofiltration

NTU	Nephelometric turbidity unit
OTU	operational taxonomic unit
PCoA	principal coordinate analysis
PCR	polymerase chain reaction
PVC	polyvinyl chloride
RO	reverse osmosis
SBS	sodium bisulphite
SD	standard deviation
SMF	spruce multi-media filter
SWRO	seawater reverse osmosis
TCC	total cell count
THM	trihalomethane
TOC	total organic carbon
WTP	water treatment plant

About the author



Joline El-Chakhtoura was born on May 17, 1986 in Brummana, Lebanon. She graduated with Honors from Brummana High School and received a merit scholarship from the American University of Beirut awarded to ten students from Lebanon each year. After receiving her B.S. degree in Biology, El-Chakhtoura completed her M.S. degree in Environmental Technology at the American University of Beirut and her thesis "Harvesting electricity from the organic fraction of municipal solid waste using microbial fuel cells" won the Dow Sustainability and Innovation Award. In 2011 El-Chakhtoura was one of seventeen scholars selected by NASA to participate in a school on Mars exploration. She then enrolled at TU Delft (Ph.D., Biotechnology department) and KAUST (Ph.D., Environmental Engineering department) whereby she regularly traveled between the Netherlands and Saudi Arabia, supervised by Dr. Hans Vrouwenvelder and co-supervised by Dr. Pascal Saikaly and Dr. Mark van Loosdrecht. In the Netherlands El-Chakhtoura collaborated with Evides Waterbedrijf company and she has served since 2015 on the advisory board of Difaf, a water consultancy firm based in Lebanon. El-Chakhtoura has published many peer-reviewed articles, contributed to many national and international conferences, and received many awards, some of which are listed below.

Science publications

J. El-Chakhtoura, P.E. Saikaly, M.C.M. van Loosdrecht and J.S. Vrouwenvelder (2018). Impact of distribution and network flushing on the drinking water microbiome. *Frontiers in Microbiology* 9, 2205.

N.M. Farhat, E. Loubineaud, E.I. Prest, J. El-Chakhtoura, C. Salles, Sz.S. Bucs, J. Trampé, W.B.P. van den Broek, J.M.C. van Agtmaal, M.C.M. van Loosdrecht, J.C. Kruithof and J.S. Vrouwenvelder (2018). Application of monochloramine for wastewater reuse: Effect on biostability during transport and biofouling in RO membranes. *Journal of Membrane Science* 551, 243–253.

A. Belila, J. El-Chakhtoura, P.E. Saikaly, M.C.M. van Loosdrecht and J.S. Vrouwenvelder (2017). Eukaryotic community diversity and spatial variation during drinking water production (by seawater desalination) and distribution in a full-scale network. *Environmental Science: Water Research and Technology* 3, 92–105.

A. Belila, J. El-Chakhtoura, N. Otaibi, G. Muyzer, G. Gonzalez-Gil, P.E. Saikaly, M.C.M. van Loosdrecht and J.S. Vrouwenvelder (2016). Bacterial community structure and

variation in a full-scale seawater desalination plant for drinking water production. *Water Research* 94, 62–72.

J. El-Chakhtoura, E.I. Prest, P.E. Saikaly, M.C.M. van Loosdrecht, F. Hammes and J.S. Vrouwenvelder (2015). Dynamics of bacterial communities before and after distribution in a full-scale drinking water network. *Water Research* 74, 180–190.

E.I. Prest, J. El-Chakhtoura, F. Hammes, P.E. Saikaly, M.C.M. van Loosdrecht and J.S. Vrouwenvelder (2014). Combining flow cytometry and 16S rRNA gene pyrosequencing: A promising approach for drinking water monitoring and characterization. *Water Research* 63, 179–189.

J. El-Chakhtoura, M. El-Fadel, H.A. Rao, D. Li, S. Ghanimeh and P.E. Saikaly (2014). Electricity generation and microbial community structure of air-cathode microbial fuel cells powered with the organic fraction of municipal solid waste and inoculated with different seeds. *Biomass and Bioenergy* 67, 24–31.

J. El-Chakhtoura and R.S. Talhouk (2007). The impact of biotechnology advances on quality and marketing of agricultural products. *Journal of Agricultural Investment* 5, 18–23.

Conference presentations

Microbiology of the Built Environment Symposium, Washington, D.C., U.S.A., 2017
Poster presentation: *Core microbiome of drinking water distribution systems*

Wetsus Congress, Leeuwarden, Netherlands, 2017
Platform presentation: *Biological stability of drinking water distribution systems*

AWWA Water Quality Technology Conference, New Orleans, LA, U.S.A., 2014
Platform presentation: *Short-term variations in the bacterial community of a Dutch drinking water distribution system*
Poster presentation: *Biological stability of drinking water: Impact of distribution and network flushing*

IWA 2nd Water Research Conference, Singapore, 2013
Poster presentation: *Characterization of bacterial community in drinking water prepared by reverse osmosis desalination of seawater using 454 pyrosequencing*

4th International Symposium on Energy from Biomass and Waste, Venice, Italy, 2012
Platform presentation: *Electricity generation by microbial fuel cells fuelled with the organic fraction of municipal solid waste*

3rd International Microbial Fuel Cell Conference, Leeuwarden, Netherlands, 2011

Platform presentation: *Harvesting electricity from the organic fraction of municipal solid waste using microbial fuel cells*

IFI-AUB Middle East Policy and Society Symposium, Beirut, Lebanon, 2009

Platform presentation: *Photobioreactor systems for concentrating solar energy in the lipids of photosynthetic algae: A renewable source of biodiesel*

Awards

Alfred P. Sloan Foundation Young Career Scientist Travel Award, 2017

Brummana High School 24th Alumni Convention Young Achiever Award, 2015

American Water Works Association Best Research Paper Award, 2014

The Dow Chemical Company Sustainability and Innovation Award, 2013

NASA Astrobiology Institute Scholarship, 2011

American University of Beirut Academic Excellence Scholarship, 2005-6-7

Acknowledgments

During the past six years over 500 water samples were collected, processed and analyzed while traveling back and forth between the Netherlands and Saudi Arabia, participating in fantastic conferences worldwide, collaborating with very bright scientists from various institutions, and cultivating friendships with people from all walks of life. Now that this marvelous (at times arduous) journey is coming to an end, I would like to thank those who contributed to its success.

Hans: You are such a hard-working, ambitious and giving person and I count myself lucky for having had you as an advisor and friend. Sharing a thorough, detail-oriented personality type with you was a bonus. Thank you for your ceaseless enthusiasm, care, motivating and enjoyable discussions, and for granting me the freedom to do what I want to do, the way I want it to be done. I have learned so much from your leadership style. Pascal: I am grateful to you for encouraging me to join this program. You were always the “go-to” person when things were not right and your advice throughout graduate school is appreciated. Thank you for genuinely caring and for introducing me to environmental biotechnology in the first place. Mark: Thank you for always making time despite being very busy and for truly trying your best to help, be it with little or big things. Your kindness, always ‘thinking outside the box’ capability, vast knowledge and accomplishments are inspiring. Frederik: You practice science so well and I have learned a lot from you. Thank you for fervently sharing your ideas and findings, providing rigorous comments, and always uplifting my mood with your cheerfulness.

I would like to thank Georgiy Stenchikov, Luuk Rietveld, Walter van der Meer, Gertjan Medema and Ameet Pinto for their time, having accepted to serve on my Ph.D.(s) committee. I highly appreciate the technical and financial assistance offered by KAUST and Evides Waterbedrijf and thank Henk Ketelaars and Sjack van Agtmaal for their support all the way, Rinnert Schurer, Jan Bahlman and all WDRC members for their help in any inquiry I might have had. I owe a big thank you to Emmanuelle Prest and Abdelaziz Belila for their significant contributions to this dissertation and their friendship. I would like to thank Prof. David Keys for his kindness, brilliant talks and for convincing me to write poetry again. Others to whom I am grateful are my friends from KAUST, Delft, Lebanon, Difaf s.a.l., and so many other parts of this small planet.

Finally, I am profoundly grateful to my precious family, my greatest joy. Thank you for everything- I am so lucky to have you close at heart no matter where I am.

Propositions

to be defended by the Ph.D. candidate

Joline El-Chakhtoura

1. Economist Ronald Coase's quote on torturing data enough for nature to confess, but not long enough for it to confess to anything, is a fundamental skill needed to practice science.
2. Teamwork is overrated. Modern culture's mania for stimulating, interactive classrooms and open offices leads to a decline in productivity and innovation.
3. While liquid hydrogen or water shelters can protect Mars travelers from solar particle events, no material can shield against galactic cosmic rays.
4. Neuroscientist James Fallon's finding that psychopathology is primarily linked to structural or functional damage to the orbital prefrontal cortex validates Socrates' statement "He who knows what good is will do good"^a.
(^aAnn Long, *Making God: A New Materialist Theory of the Person*, 2007)
5. Around 3000 gallons are used to water the grass for one golf game^b, while 4 billion people experience severe water scarcity during at least part of the year^c; golf players are therefore selfish people.
(^bNational Geographic, *Water- Our Thirsty World*, 2010;
^cMekonnen and Hoekstra, *Four billion people facing severe water scarcity*, *Science Advances*, 2016)

6. Biological instability is not indicative of poor water quality. (this dissertation)
7. Drinking water quality is not determined by water source or treatment efficacy. (this dissertation)
8. Dutch systems that transport low-AOC drinking water without disinfectant residuals are more biologically stable than systems transporting RO-treated water containing chlorine residual. (this dissertation)
9. Mathematical models that predict tap water microbiology based on biofilter or treatment plant effluent microbiology are useless. (this dissertation)
10. If humans fail to curb climate change the drinking water microbiome depicted in this dissertation will no longer be relevant in a hundred years.

These propositions are regarded as opposable and defensible and have been approved as such by the promoters Prof.dr. J.S. Vrouwenvelder and Prof.dr.dr.h.c.ir. M.C.M. van Loosdrecht.