

A modified bias-extension test method for the characterisation of intra-ply shear deformability of hybrid metal-composite laminates

Liu, Shichen; Sinke, Jos; Dransfeld, Clemens

DOI

[10.1016/j.compstruct.2023.116964](https://doi.org/10.1016/j.compstruct.2023.116964)

Publication date

2023

Document Version

Final published version

Published in

Composite Structures

Citation (APA)

Liu, S., Sinke, J., & Dransfeld, C. (2023). A modified bias-extension test method for the characterisation of intra-ply shear deformability of hybrid metal-composite laminates. *Composite Structures*, 314, Article 116964. <https://doi.org/10.1016/j.compstruct.2023.116964>

Important note

To cite this publication, please use the final published version (if applicable). Please check the document version above.

Copyright

Other than for strictly personal use, it is not permitted to download, forward or distribute the text or part of it, without the consent of the author(s) and/or copyright holder(s), unless the work is under an open content license such as Creative Commons.

Takedown policy

Please contact us and provide details if you believe this document breaches copyrights. We will remove access to the work immediately and investigate your claim.



A modified bias-extension test method for the characterisation of intra-ply shear deformability of hybrid metal-composite laminates

Shichen Liu^{*}, Jos Sinke, Clemens Dransfeld

Faculty of Aerospace Engineering, Aerospace Manufacturing Technologies, Delft University of Technology, Delft, The Netherlands

ARTICLE INFO

Keywords:

Modified bias-extension test
Intra-ply shear angles
Material constituents
Processing parameters
Metal-composite laminates

ABSTRACT

The bias-extension test is one of the test methods to characterise the intra-ply shear behaviour of continuous fibre reinforced composites including fabrics and unidirectional (UD) materials. For the determination of the major mechanical properties of metals, often a uniaxial tensile test is used. Combination of these two methods for the shear deformation of hybrid metal-composite laminates is proposed comparing the method for cross-plyed unidirectional prepregs and woven fabric prepregs. The effects of material constituent, shear rate, preheat temperature and normal pressure on the intra-ply shear behaviour are investigated. The results indicate that the material constituents and the frictional responses depending on processing parameters play a critical role in the shear characterisation of the hybrid laminate. The shear angle measurement at four typical strains demonstrates that the support of metal layers improves the shear deformability by delaying the onset of fibre wrinkling. This modified intra-ply shear test contributes to a better understanding of the process design for wet (uncured) hybrid metal-composite laminate manufacturing.

1. Introduction

The hybrid metal-composite laminate consists of alternating thin sheets of metal alloys and layers of fibre reinforced polymers. A wide range of combinations are available based on the type of metal sheets, the architecture of fibres and resins, the number and thickness of layers, etc [1]. Advantages of such lightweight hybrid materials compared with the monolithic metal sheets are a better resistance to damage in case of impact, fatigue and corrosion [2]. However, one of the main difficulties of producing parts made of hybrid metal-composite laminates, appears in its complex deformation mechanisms, which may result in tears, folds, wrinkles, etc [3–5]. One promising method for the forming of the hybrid material is a hot-pressing process especially designed for thermoset based metal-composite laminates. The proposed process steps are shown in Fig. 1 which involves a laminate preheating process, forming of the uncured laminate, consolidation and (partial) curing in the same mould. Temperature and preheating time need to be carefully controlled to decrease the resin viscosity and thus increase the ease of deformation. This method improves the laminate deformability based on the understanding of the deformation mechanisms for both material constituents. The metal sheets are usually deformed into three-dimensional shapes by bending and in-plane plastic deformation [6,7]. The deformation of fibre

reinforced composites is achieved by inter-ply sliding between the layers and intra-ply shear within the prepreg layers [8–10]. Both mechanisms need to be combined in the proposed hot-pressing process.

Intra-ply shear of the individual plies of a composite laminate is recognised as the dominant mode of fibre deformation for shaping three-dimensional parts. This mechanism has been investigated by many researchers [11–15] especially for the woven fabrics which are highly shear dominated and deform as modelled by the pin-jointed net (PjN) theory. The PjN theory assumes that yarns are inextensible without any slippage at the cross-overs and free rotations are allowed for the fibre tows between warp and weft. The shear resistance gradually grows during deformation as the yarns rotate over each other. The deformation causes a sharp increase in shear force at a point and beyond which fibre wrinkling phenomena occur. This point, often called ‘locking angle’, depends largely on the properties of textile reinforcement, like type of fibre, type of weave, weave density, etc (Fig. 2). Potter [16,17] found some similarities on the shear behaviour between woven fabrics and cross-plyed unidirectional plies although the complete deformation is more complex for UD materials than for cross-plyes because of the lacking of physical interlocking constraints. He concluded that the shear deformation for cross-plyed UD prepregs can be modelled through the same PjN assumption that was used for woven fabric prepregs and an

^{*} Corresponding author.

E-mail address: S.Liu-7@tudelft.nl (S. Liu).

improved forming capability can be obtained by controlling the linkage between the UD plies. However, there is no equivalent test standard to measure the shear angle of cross-ply UD prepreg and the limit of shear deformation can be either wrinkling or the splitting within the fibre layers [18,19].

The shear behaviour of dry fabrics or preregs is typically characterised using the well-known intra-ply shear tests with a picture frame (PF) test or a bias-extension (BE) test [20–23]. In the picture frame test, the fabric specimen is clamped with the yarns aligned parallel and perpendicular to the four clamping bars. The shear deformation is developed by fixing one hinge of the frame while imposing a tensile load on the hinge at the opposite end of the frame. The main advantage of the PF method is the uniformly induced shear on all sample regions which allows a direct measurement of the shear deformation. The limitation, however, is the sensitivity of misalignments in the direction of fibres and the accuracy needed when cutting the sample and clamping in the frame. Also, the low intra-ply shear stiffness for the fabric prepreg at higher temperatures results in poor signal-to-noise ratios at early shear deformation stages [20,21]. At the start of a bias-extension (BE) test, the fibre orientations of the specimen are $\pm 45^\circ$ with respect to the tensile direction. The test sample is cut into a rectangular shape with the specimen length typically more than two times its width to obtain a suitable shear region. Normally, there are three distinct regions: ‘pure shear’, ‘half shear’ and ‘un-deformed’. The BE test shows mainly intra-ply sliding for dry fabrics or preregs (both in fabrics/weaves and UD), but as they reach higher shear angles the PJN approach may not be applicable anymore because of other deformation mechanisms involved [22,23]. Rashidi et al. [24] proposed a slip-bias extension test to investigate the influence of slip conditions during the forming process of the woven fabric preregs. They developed a modified shear stress formulation for the fast 3D simulations considering the effects of frictional interactions at different shear angles, normal pressures and asymmetric gripping conditions.

The PF and BE methods can both be used to characterise the intra-ply shear behaviour of the unidirectional preregs. Picture frame tests are usually not adopted for the UD preregs because the difficulty of tight clamping of specimens, the tendency of ply splitting and the adverse fibre tension under the combined effects of slight fibre misalignment [18]. Larberg et al. [25] proposed a bias-extension test on different cross-ply UD preregs and found that intra-ply shear only dominates at small deformations while intra-ply and inter-ply friction together plays

an important role at large deformations. The research also demonstrated that prepreg systems and temperature distributions were important factors affecting the degree of fibre rotation and the deformation modes as well as their limits. Brands et al. [26] conducted bias-extension experiments on cross-ply laminates of thermoplastic UD tapes under various processing conditions and showed that the deformation is consistent with a PJN up to a shear angle of 25° . Haanappel and Akkerman [18] proposed a torsion bar test to characterise the shear mechanisms of unidirectional thermoplastic melts and developed a non-linear material model for carbon UD/PEEK under small strains. Wang et al. [27] conducted the intra-ply shear characterisation of UD preregs using a 10° off-axis BE test under various temperature distributions and test rates. The results validated that the shear stress and strain can be obtained using the off-axis BE test and the material response under these testing parameters provides robust models for composite manufacturing simulation.

The mechanical response of metal sheets is usually performed through uniaxial tensile test where the material properties like yield and ultimate tensile strength, uniform and total elongation in a standard gauge length can be measured. Dog-bone shapes are primarily used for the tensile test samples to eliminate the influence of stress concentration in the clamping region and to ensure the highest probability that the sample fails in the standard gauge region [28]. A biaxial tensile test is also becoming prevalent for evaluating the mechanical properties of metal sheets as the standard tensile test only determines the performance in one direction while not applicable to multi-directional forming processes like deep-drawing [29]. Unlike the classical tensile tests, the shear behaviour of metal sheets is difficult to obtain through simple shear tests as the shear stress distribution is usually inhomogeneous and no intrinsic gauge length can be applied to define the local strain [30]. Also, the shear tests of complex geometrical specimens are designed for some experimental setups but they are shown to be inconvenient for dynamic testing [31,32]. Besides, the in-plane torsion tests prove to be inappropriate for obtaining the shear behaviours of metal sheets due to their high plastic deformation and possible fracture occurrence at free edges [33].

As for the evaluation of in-plane deformation behaviour for hybrid materials like metal-composite laminates, most researchers prefer the same uniaxial tensile test as the metal sheets [34–38]. The samples were consolidated following a standard curing cycle before the test and the shape of the specimen can either be rectangular or dog-bone. Through

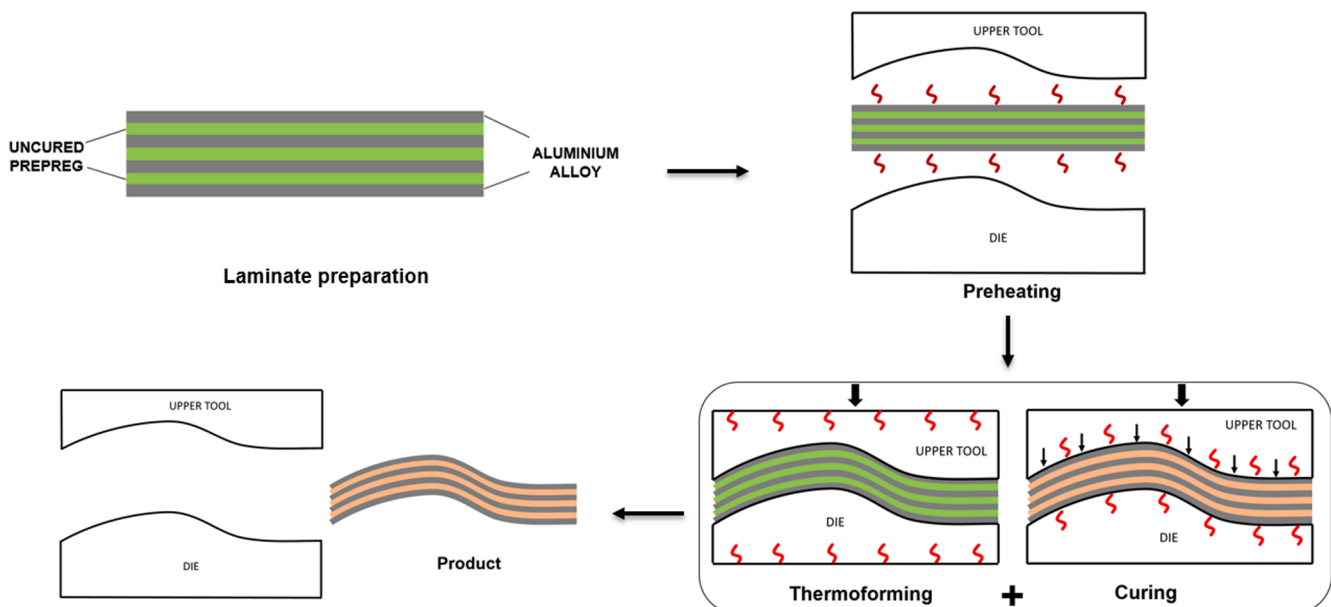

Fig. 1. Proposed hot-pressing process for the manufacturing of fibre metal laminate parts.

the modification of metal surfaces and the adjustment of layup sequences or orientations, the in-plane mechanical properties such as ultimate tensile strength can be greatly improved. The results also indicated that the in-plane deformability of metal-composite laminates mainly depends on the maximum failure strain and the interlaminar shear strength of composite layers. Due to the high bonding strength after consolidation and the limited fibre failure strain, the deformation of the hybrid laminates is constrained and the higher elastic–plastic deformability of metal sheets cannot be fully exploited. Therefore, the investigation on the role of metal sheet which affect the biaxial deformation of the uncured fibre prepreg becomes a meaningful topic. In addition, there is an increasing interest for many researchers in the intra-ply shear behaviour of the uncured fibre prepreg inside the hybrid laminates during deformation. However, there are few related studies on discovering the shear properties of the uncured hybrid laminates due to the lack of efficient manufacturing and testing methods.

This work aims to characterise the intra-ply shear properties of the uncured hybrid metal-composite laminate under various processing conditions of shear rate, preheat temperature and normal pressure. The hybrid material systems consisting of the metal sheet of aluminium alloy and stainless steel, as well as the uncured carbon fibre prepreg of woven fabric and cross-ply UD, are tested to understand the effect of metal sheet layer on the shear deformability of the prepreg layer. Furthermore, The novelty of the research presented herein is to observe the deformation mechanisms occurred during shear and compare the behaviour with theoretical PJN approach. This will be achieved through a modified bias-extension test in combination with a digital microscopic measurement which enables the evaluation of the fibre angle shearing. Finally, the research aims to analyse the shear angle evolution of each uncured prepreg system and its corresponding metal-composite laminate which contribute to the better understanding of material selection and process optimization for the hot-pressing of metal-composite laminates.

2. Materials and methods

2.1. Material constituents

The hybrid material systems used in this research consist of two metal alloys and two types of fibre reinforced prepregs. For the metal alloy materials, aluminium alloy 2024-T3 and AISI 304 stainless steel are selected for their different failure strains [39]. The aluminium alloy 2024-T3 is widely used in aircraft structures because of its high strength and fatigue resistance, but the elongation at break is relatively low at around 15–18 %. AISI 304 stainless steel can withstand 45–50 % maximum tensile strain, which greatly increases the deformability of the entire hybrid laminates. Both metal sheets are machined to a dog-bone shape with specific dimensions and thickness of 0.5 mm. The woven and UD architectures for the fibre reinforced prepregs are based on the same epoxy resin and chosen for their different shear properties. Fig. 3 displays the image of the two prepregs in undeformed state. The materials are commercially available from SHD composites (UK). The SHD-TW is a T-700 carbon reinforced prepreg with 3 k tow size and Twill Weave (2X2) fabric having a thickness of 0.2 mm and fibre volume content of 58 %, while SHD-UD is a T-700 carbon reinforced prepreg

with the unidirectional reinforcement having a thickness of 0.15 mm and fibre volume content of 63 %. The MTC510 epoxy system for both prepregs is designed to cure between 80 °C and 120 °C allowing flexibility in component manufacturing. The viscosity profile of MTC510 as a function of temperature at a ramp rate of 2 °C/min as provided by the material supplier [40] is shown in Fig. 4.

2.2. Modified bias-extension test

The uniaxial tensile test aims to obtain the tensile behaviour of the metal sheets while the bias-extension test is used to measure the in-plane intra-ply shear behaviour of fabrics or prepregs. A combination of these two test methods with dog bone shaped metal sheets and rectangular shaped fibre prepregs, referred as a modified bias-extension test, is proposed to investigate how the support of metal sheet influences the shear properties of the prepreg layer under different conditions. The modified BE test with idealised shear regions is illustrated in Fig. 5, with dimensions and schematics of the undeformed and deformed specimens according to the pin-joint net (PJN) approach. The geometry of fibre prepreg is rectangular where the sample length is 6.5 times the width to acquire a suitable state of shearing. The initial orientation of the fibre tows is at $\pm 45^\circ$ to the loading direction for both cross-ply UD and woven fabric prepreg. In the modified bias-extension test, the PJN behaviour is assumed, predicting three shear zones within the specimen: A, B and C. Zone A is the pure shear region where the shear is uniform and a theoretical shear angle, γ , can be calculated through Eq.(1) [22,23].

$$\gamma = 90^\circ - 2 \cdot \cos^{-1} \left(\frac{L + \delta}{\sqrt{2} \times L} \right) \quad (1)$$

Here, δ is the shear deformation length and $L = H - W$, where H and W are the original length and width of the specimen between the clamps, respectively. The shear angle in zone B is supposed to be half the value of zone A while zone C ideally has no effect on the overall deformation of the specimen. During deformation of the uncured laminate in the modified BE test, the strain in length direction for both materials is the same. In the transverse direction, however, the contraction of the metal sheet is (isotropy assumed) half of the lengthwise extension, but the contraction for the prepreg layer is equal to the lengthwise extension. This difference induces friction between the metal sheet and prepreg layer along both length and transverse direction. In addition, if a local pressure is applied on the central part of the pure shear region ($40 \times 40 \text{ mm}^2$) as indicated in Fig. 5, the effect is twofold: possible wrinkling or wrinkling of the prepreg is suppressed, but also the intra-ply shear movement is hindered.

3. Experimental setups

3.1. Test conditions

The modified bias-extension tests were performed on a Zwick-250kN tensile-compression machine equipped with a temperature chamber. The sample with the shape and size shown in Fig. 5 was put into the tensile machine and clamped by the grips at two ends. Extensometers for measuring the tensile strains of metal sheets were also used to determine

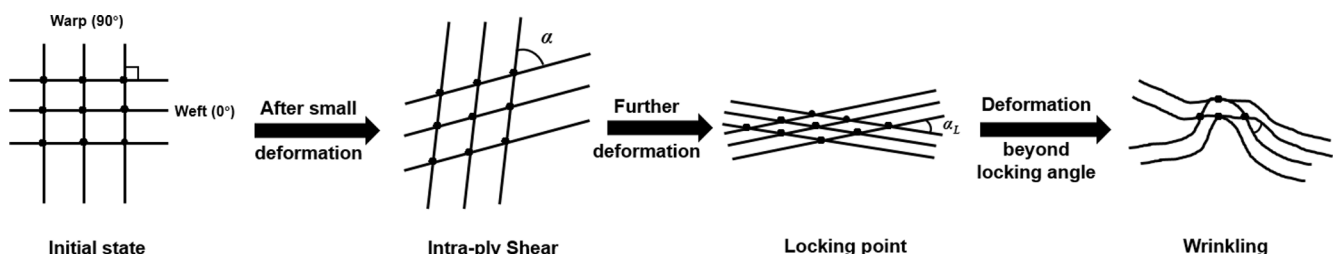

Fig. 2. Typical intra-ply shear deformation behaviour of textile reinforcement materials.

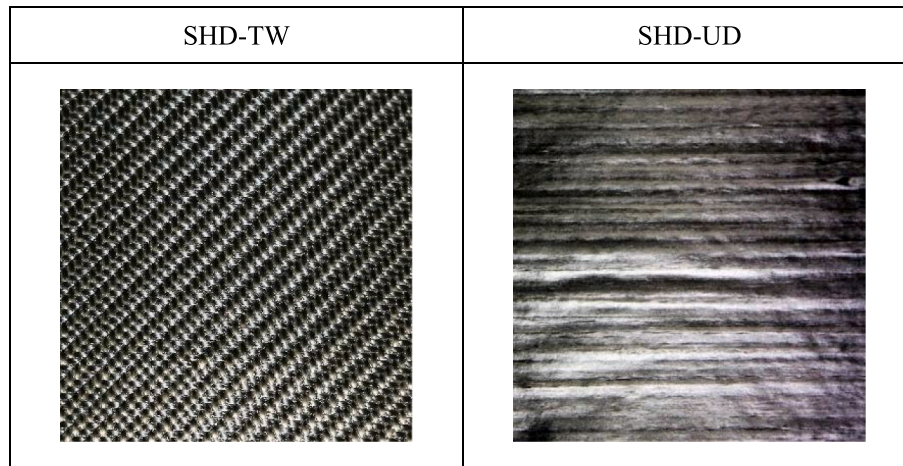

Fig. 3. Two types of fibre reinforced prepgs used for the intra-ply shear tests.

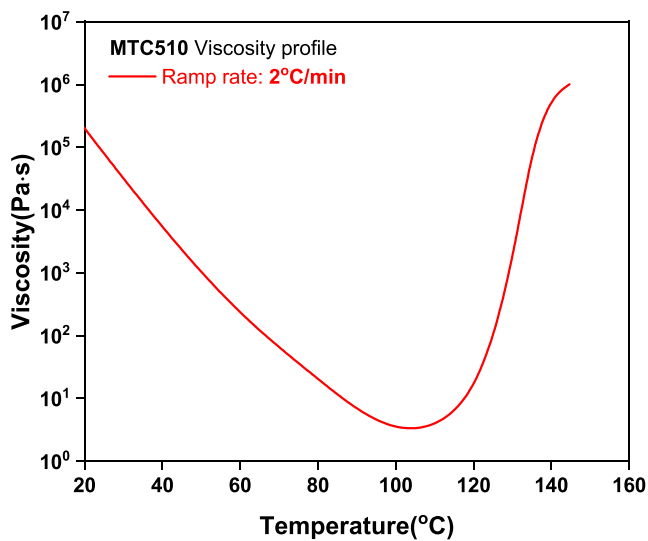

Fig. 4. Viscosity profile for MTC510 matrix system used for SHD-TW and SHD-UD prepreg as a function of temperature.

the yield and elongation values at lower strains (<5 %) of the specimen. The load–displacement curve for a given parameter combination can be obtained through the measurement system of the machine. The test temperature inside the chamber was preset at a ramp of 2 °C/min and the real-time temperature was recorded by thermocouples. Other test parameters like shear rate and normal pressure can be altered by manual input and addition of an external tool. Fig. 6 exhibits the experimental setups and apparatus for the modified BE tests used for three different pressure conditions. Next to the standard condition with no pressure applied on the forming region, the vacuum condition of 0.1 MPa and the autoclave condition of 0.6 MPa were conducted through a vacuum pump and a clamping loadcell, respectively [5], to put pressure on the forming regions.

The material configurations and test conditions used for the modified bias-extension test are summarised in Table 1 and 2. The test for hybrid metal-composite laminate was performed with four combinations of material constituents and three different shear rates, three typical temperatures and three applied normal pressures. The tests were conducted varying one parameter at a time while keeping the other two parameters at their baseline value, and at least three samples were tested for each configuration. The two different fibre reinforced prepgs were characterised using the corresponding bias extension test geometry under

the same shear rate and preheat temperature conditions. These selected experimental conditions were based on the industrial conditions in material processing [4,5] and were applied to investigate the influence of process parameters on the intra-ply shear performance, in particular the shear angle evolution during the modified BE test.

3.2. Shear angle measurement

The characterisation of the intra-ply shear behaviour of hybrid metal-composite laminates as well as their corresponding woven fabric and cross-ply UD prepgs depend on an accurate shear angle measurement during the in-plane shear deformation. It has been expected that the prediction of shear angles in simulated bias-extension tests deviate from the experimentally measured shear angles during the course of shear deformation. Therefore, as the shear angle cannot directly be observed on the hybrid samples because of the metal sheets on the outside, it was critical to develop an experimental method which could measure the shear angle, particularly in the ‘pure shear region’ of the test specimens. For the pure fibre reinforced prepreg, the shear angle γ was obtained using a DIC (digital image correlation) measurement [23,24]. This optical method is well suited for woven fabrics as the strain and fibre rotation on the specimen surface can be calibrated by the dual camera system in DIC. It is also applied for measuring the shear of cross-ply UD prepreg as the strain and shear angle of the surface layer can be measured, assuming that the shear at the non-visible backside layer is symmetrical.

However, it is difficult to measure the intra-ply shear angles of the hybrid laminates because of the metal sheets covering the outer surfaces. One possible solution is to separate the layers after shear tests as the hybrid laminate is still uncured with low bonding performance. However, this method can only be performed at room temperature when no normal pressure was applied, since the degree of cure as well as the application of pressure may affect the fibre distributions and the surfaces. To visualise and evaluate the shear characterisation using the traditional measuring methodology, one side of metal sheet is removed from the sample after the tests. A second solution which is mainly applied in the study is the application of Alkaline Etching Method after curing [7,41,42]. The tested samples are first placed in a vacuum bag and transferred into an autoclave, and will undergo a standard curing cycle with a maximum temperature of 120 °C and a minimum cure time of an hour. After curing, the pure shear region (40 × 40 mm²) of the sample is cut and one of the metal sheet layers is removed by etching using a 15 % NaOH solution. To obtain a clear vision of fibre distributions, the dissolved specimens are ground and finally put on a digital microscope for the measurement of shear angle. The latter method is rather robust because the movement of the fibres is minimal, and as the

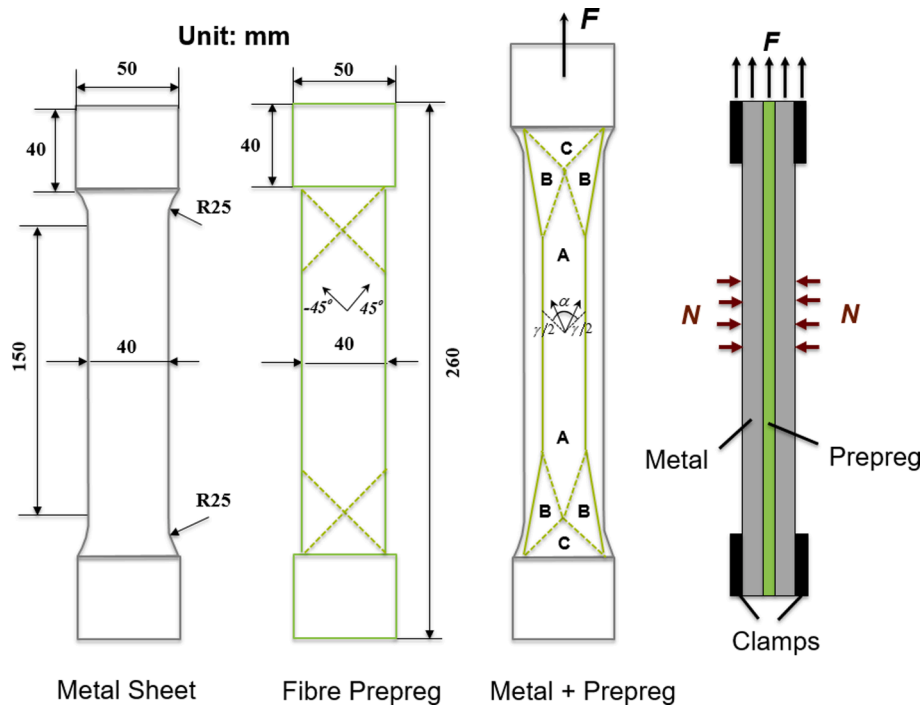

Fig. 5. Schematic diagram and dimension for the modified bias-extension test of hybrid metal-composite laminate.

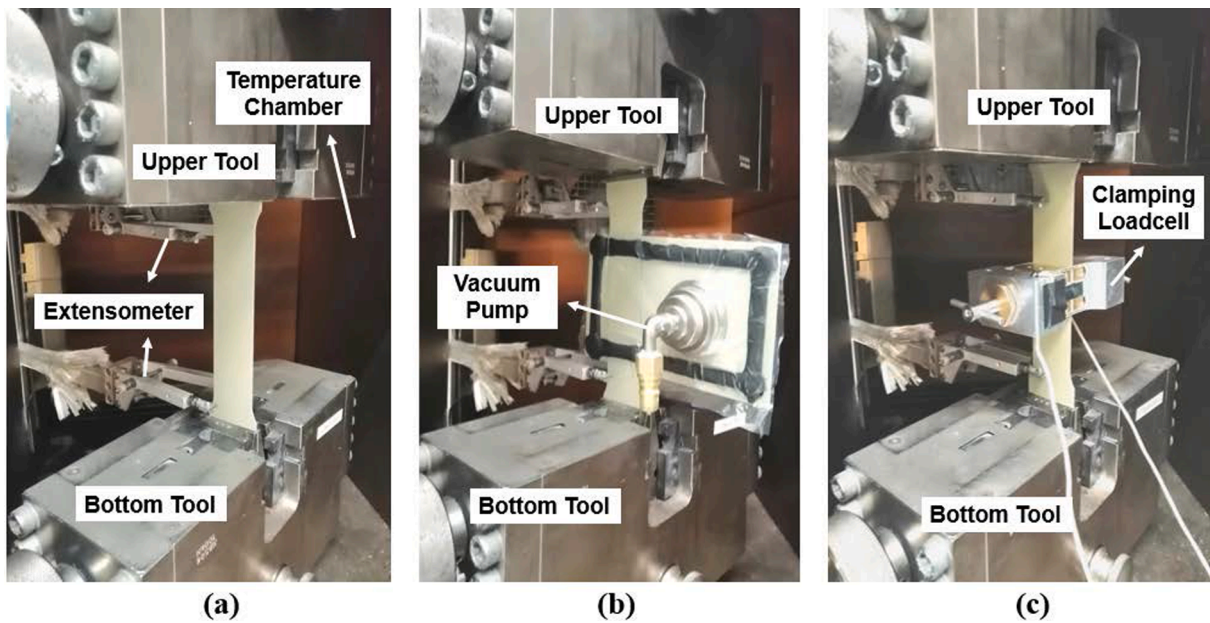

Fig. 6. Experimental setups and apparatus for modified BE test used under various normal pressure conditions: (a) Standard condition; (b) Vacuum condition of 0.1 MPa; (c) Autoclave condition of 0.6 MPa.

Table 1
Material configurations used for modified bias-extension test.

Structure	Metal sheet	Fibre reinforced prepreg
Hybrid laminate 2/1	Aluminium	Cross-ply UD
	Stainless steel	Woven fabric

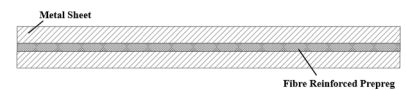

Table 2

Test conditions used for modified bias-extension test.

Test Parameter	Baseline value	Additional values investigated
Shear rate (mm/min)	10	2, 20
Preheat temperature (°C)	23	50, 80
Normal pressure (MPa)	0	0.1, 0.6

composite layers are cured and the outer metal layer is removed by etching, only rough grinding or other poor treatment could influence the fixed fibre shear angles. The entire testing sequence is presented in Fig. 7 and the shear angles for various material constituents and processing parameters can be measured and compared from the samples.

4. Results and discussion

4.1. Failure mode

The intra-ply shear behaviour for four metal-composite laminate combinations are analysed, and compared with their pure woven fabric and cross-plyed UD counterparts. The shear stress–strain curves for various material combinations under the condition of room temperature and 10 mm/min shear rate are shown in Fig. 8. It is noted that the main failure mode for both prepregs was fibre wrinkling even though the deformation mechanisms for woven fabric and cross-plyed UD fibres are different. However, the onset strain for wrinkling, which also relates to the locking angle, was different although the strain value was affected by test parameters such as shear rate and temperature as well as the difficulties for accurately define out-of-plane wrinkles in DIC. The two tangential slopes in the curve represent the shear modulus in the intra-ply shear and fibre wrinkling state. Thus, the slope change occurs at the shear-wrinkling transition point that defines the onset of fibre wrinkling. The result showed that the cross-plyed UD prepreg buckles earlier than the woven fabric prepreg under the same conditions. This indicated that lacking of cross-over points and absence of bundles for cross-plyed UD prepreg may result in the earlier formation of wrinkling. As the strain continues to increase after wrinkling, the final deformation limit for the cross-plyed UD prepreg was fibre splitting (greater than 50%), which occurs when the shear force required for in-plane rotation was larger than the load transfer between the UD layers or within the fibre tows in a layer.

The failure mode for hybrid metal-composite laminates as shown in the figure mainly depends on the metal sheet as the single layer of aluminium alloy 2024-T3 and AISI 304 stainless steel exhibits the failure strain of around 16% and 50%, respectively. The hybrid materials with aluminium alloy 2024-T3 fracture along 55 ~ 60° direction corresponding to the direction of its maximum shear stresses. When replacing

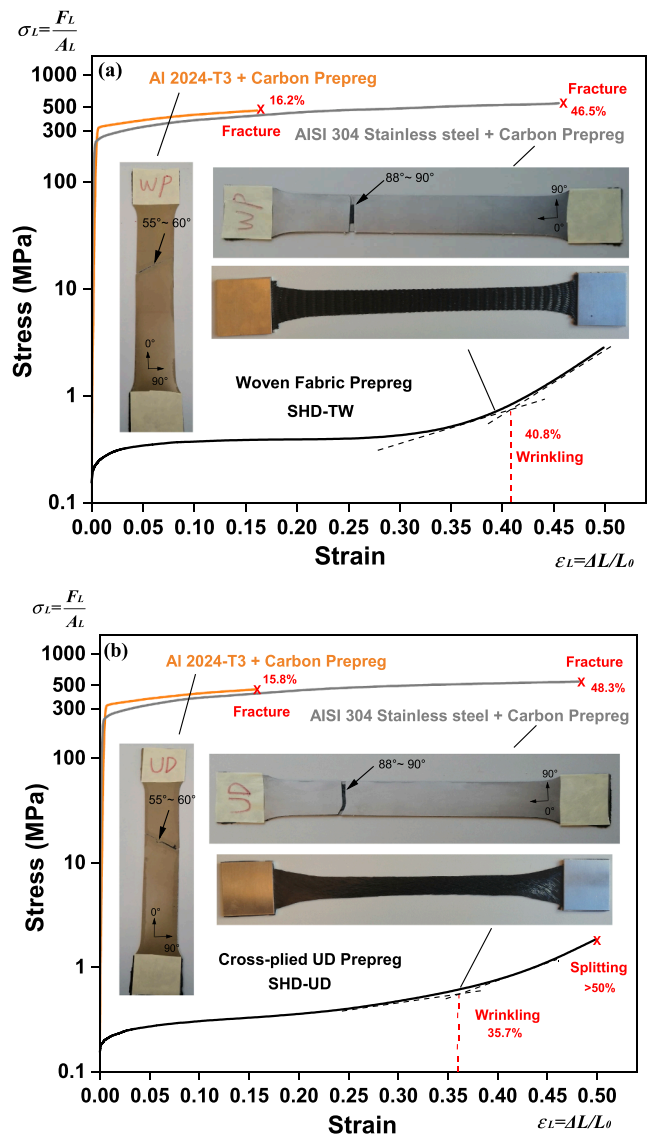

Fig. 8. Shear stress and strain curves for different combination of hybrid as well as composite materials under the condition of room temperature and 10 mm/min shear rate: (a) Based on woven fabric reinforced laminates; (b) Based on cross-plyed UD fibre reinforced laminates.

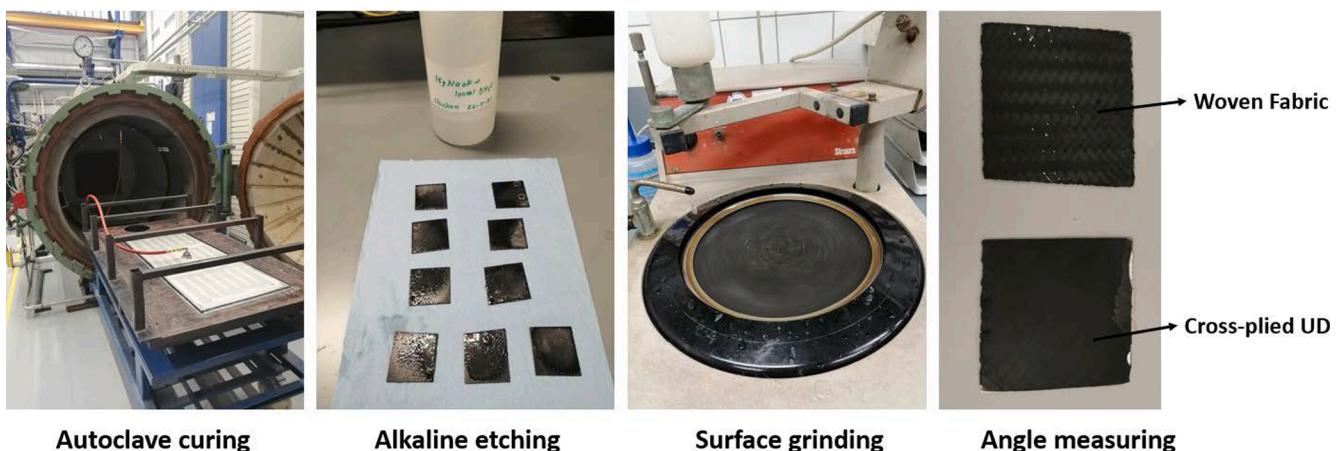

Fig. 7. Whole process for the shear angle measurement of hybrid metal-composite laminates.

the type of metal sheet for the hybrid materials to AISI 304 stainless steel, the laminate undergoes a fracture nearly perpendicular to the tensile stress direction as plastic deformation grows in that region. Besides, due to the lower failure strain of aluminium alloy 2024-T3, the aluminium-fibre reinforced laminate also fractures at the strain of around 16 % and the value of maximum strain had no obvious difference for the two different prepregs in the middle. While for AISI 304 stainless steel with higher failure strain, the combination with cross-ply UD prepreg undergoes 48.3 % strain on average until failure while the value goes down to 46.5 % on average for woven fabric reinforced stainless steel laminate. This indicates that cross-ply UD prepreg has higher shear limits at large strain for its hybrid constituents. The reason will be further explained in next chapters on shear angle investigations.

4.2. Material constituent

The intra-ply shear angle in pure shear region in the modified bias-extension test is the most significant index for evaluating the intra-ply shear behaviour of hybrid metal-composite laminates. Fig. 9 presents the intra-ply rotation angle evolution for aluminium-fibre reinforced laminate at five typical strain stages under the condition of room temperature and 10 mm/min shear rate using microscopic measurement. The increase of strain decreases the rotation angle α between two initially perpendicular fibre tows, and thereby increasing the shear angle γ where $\gamma = 90^\circ - \alpha$. The result α reveals that the hybrid woven fabric structure has a slightly large decrease of rotation angle α , compared to the hybrid cross-ply UD structures. This is attributed to the different shear deformation mechanism of the two prepregs presented in Fig. 10. Shearing of woven fabrics mainly involve in-plane rotation of the fibre tows at cross-over points of the weave especially under small strain and room temperature conditions. However, the kinematics of shear angle in cross-ply UD fibres are different from woven fabrics where the adjacent plies of the prepreg rotate and slide over each other and are only coupled through a viscous resin. Therefore, the shear deformation for cross-ply UD fibres is unable to follow the same PJN assumption that is used for woven fabrics as suggested by Potter [16,17], and the higher in-plane sliding ratio for cross-ply UD fibres results in a lower shear angle

at the same strain.

Same trends are found when replacing the metal sheet from aluminium alloy to stainless steel and the value of shear angle γ even witnesses a more significant difference at higher shear strains. Fig. 11 exhibits the average shear angle values for different combinations of hybrid metal-composite laminates each at four shear strains within their respective strain ranges at room temperature and shear rate of 10 mm/min. The results demonstrate that hybrid materials with woven fabric prepreg experience higher shear angles than hybrid materials with cross-ply UD prepreg at same shear strains. When the strain reaches 30 % or even 45 %, the measured shear angle for stainless steel-woven fabric reinforced laminate is almost twice the value for the same cross-ply UD type. The increasing gap of shear angles indicates that inter-ply sliding has a large influence at large strain for cross-ply UD prepregs. Even though both prepregs within the hybrid laminates have not reached their corresponding onset of wrinkling at 45 % of strain, pure stretching instead of inter-tow rotation may occur for woven fabrics when the shear strain increases. This kind of stretching greatly affects the deformability of the woven fabric reinforced stainless steel laminate and that explains why the stainless steel combined with cross-ply UD prepreg has larger failure strain. Besides, the four combinations which were all measured at 5 % and 15 % strain reveal that the stainless steel with both woven fabric prepreg and cross-ply UD prepreg exhibits somewhat lower shear angle when replacing the metal sheet to aluminium alloy. This can be seen in the stress-strain curve of the hybrid metal-composite materials shown in Fig. 8. At these two specific strains of 5 % and 15 %, the stress required to deform is also higher for the aluminium alloy which increases the force transfer from metal sheet to the prepreg. As the force goes up with the increase of strain, the intra-ply shear angle is higher for aluminium-fibre reinforced laminate although the difference is small or even negligible.

4.3. Shear rate

Figs. 12 and 13 show the influence of shear rate for different combinations of material constituents compared with the theoretical PJN approach calculated by Eq.(1). Shear angles for hybrid materials with

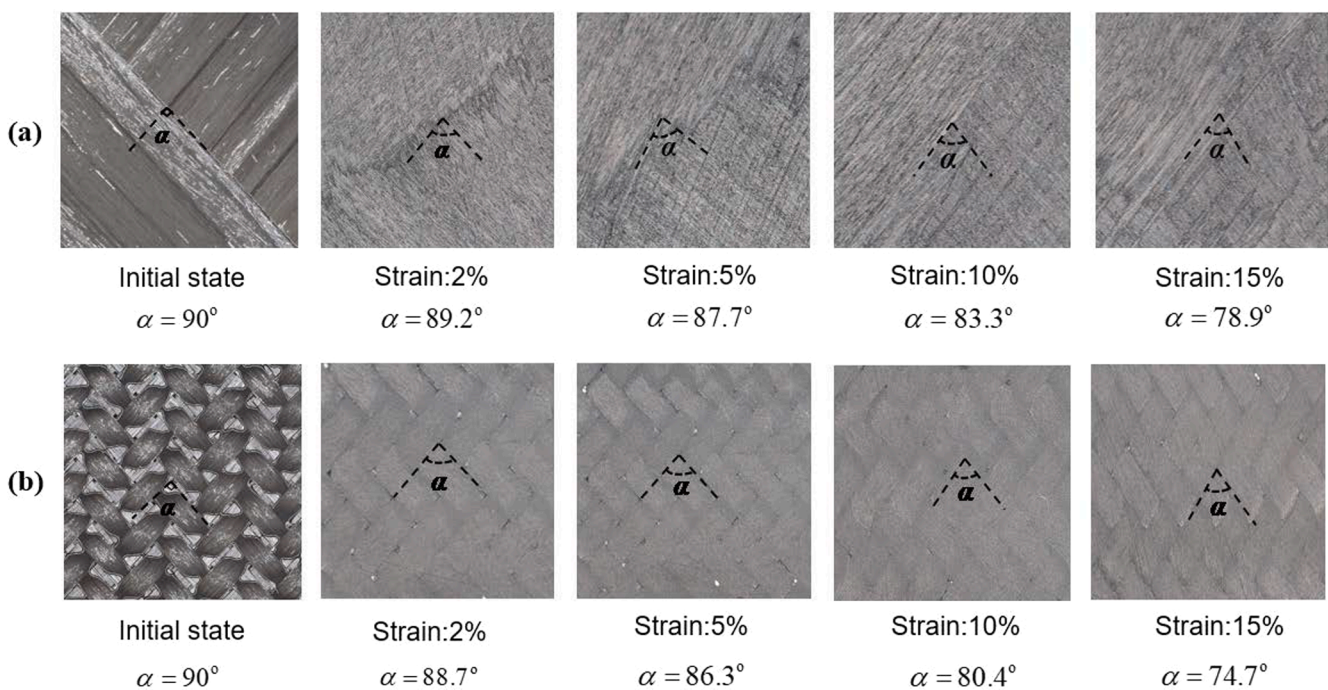

Fig. 9. Microscopic measurements of the rotation angle (α) evolution for aluminium-fibre reinforced laminate under the condition of room temperature and 10 mm/min shear rate: (a) Cross-ply UD structure; (b) Woven fabric structure.

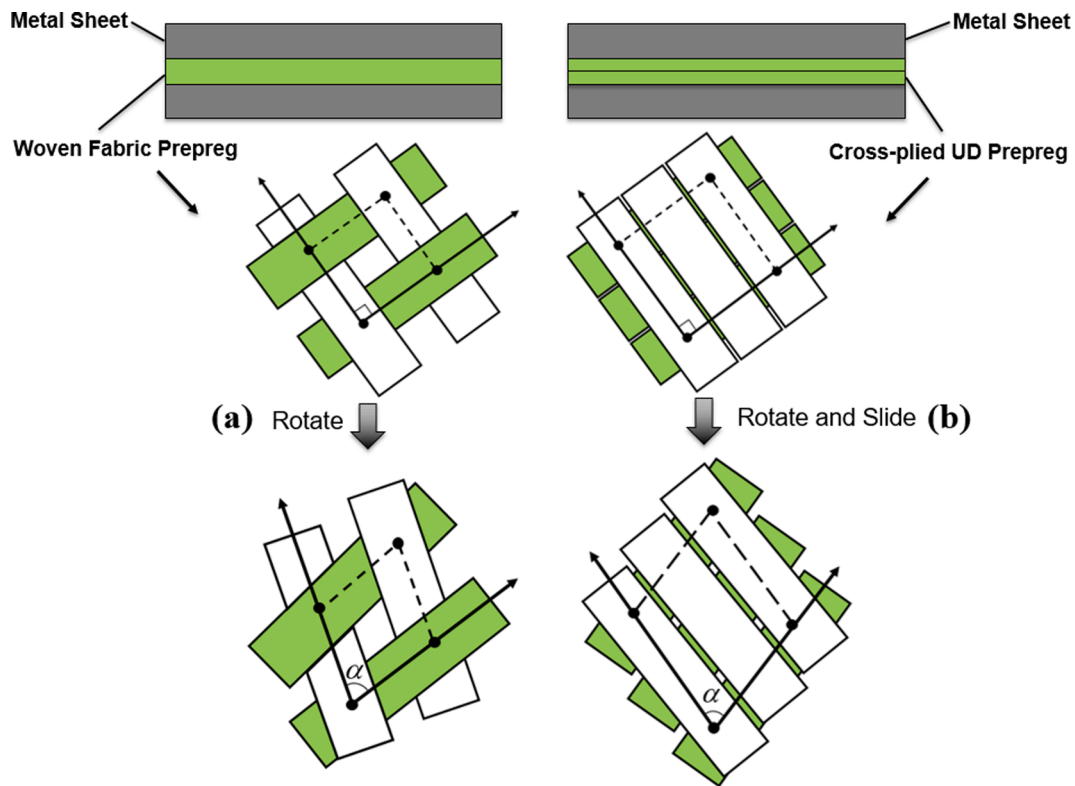

Fig.10. Shear deformation mechanism schematic of two different prepregs:(a) Woven fabric; (b) Cross-ply UD.

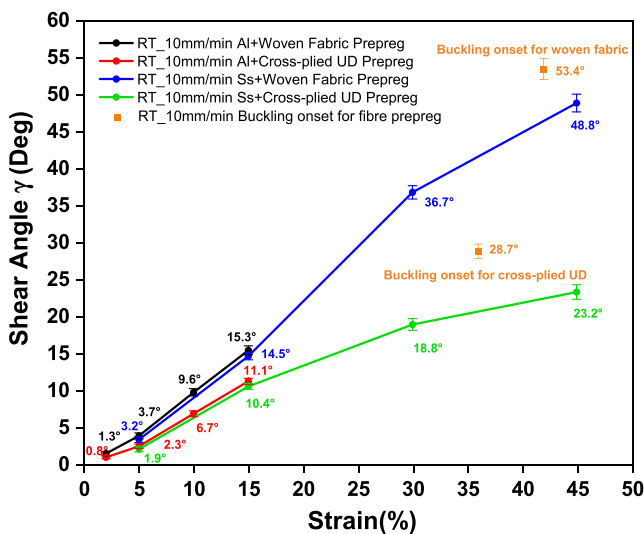

Fig. 11. Shear angle and strain curves for different combinations of hybrid metal-composite laminates under the condition of room temperature and 10 mm/min shear rate.

aluminium alloy are measured at a lower strain range while the stainless steel-fibre reinforced laminates show a larger range of shear angles due to its higher failure strain. The figures reveal that PJN assumptions seem to be valid only for woven fabric prepreg up to 20–25° which follows the result of Brands [26] and when the intra-ply shear angle reaches more than 25°, the theoretical and experimental values deviate from each other. For the cross-ply UD prepreg, the shear angle deviates significantly under all ranges of shear strain because of the contribution of sliding at prepreg-prepreg interfaces as explained in Fig. 10(b). However, the dominance of inter-ply sliding and the occurrence of pure

stretching after the onset of wrinkling for woven fabric and cross-ply UD prepreg causes the stabilization of shear angles at large strains. Also, the results indicate that the shear angle increases with the increase of shear rate for different combinations of material constituents. This can be explained by the characterisation of viscous contribution of epoxy matrix where the shear stress increases with the increase of shear rate, and higher shear stress promotes more rotations of fibres to achieve the specified deformation. The result from Larberg [25] proves that the shear force increases with the increase of shear rate for cross-ply UD prepregs and woven fabric prepregs [11,14]. However, the effect of shear rate for the metal-composite laminate seems less sensitive compared to their corresponding prepreg. The reason can be attributed to the presence of a different force-transmitting mechanism and the increase of contact surfaces. For pure fibre reinforced prepreg like woven fabrics, the shear forces are transferred through fibre tows where very small variations in shear force lead to deformation of the prepreg. However, the shear forces for hybrid laminate are mainly transmitted from metal sheet to the woven fabric prepreg at the metal-prepreg interfaces. The intrinsic slow force response of the metal sheet and the increased contact surfaces make it hard for the fibre tows to deform sensitively within the studied shear rate ranges as shown in Fig. 14.

Another conclusion from the figures is that shear angle values at specific strains for hybrid metal-composite laminates are lower than their corresponding prepregs. This indicates that the support of metal sheets reduces the shear deformation of fibre tows and thereby delays the onset of wrinkling. The decrease of shear angles for hybrid laminates is mainly due to the occurrence of friction at metal-prepreg interfaces and the different strain state for the two materials during shearing. Fig. 15 shows the test specimens for the pure prepreg and a one-side metal-composite laminate at the shear strain of 30%. The initial band width for all materials on the pure shear zone is 40 mm, but it changes as the shear strain increases. The band width for the stainless steel drops to 36.7 mm, while the attached cross-ply UD and woven fabric prepreg width drops to 31.8 mm and 28.9 mm, respectively. After comparing to their corresponding pure prepreg shear under the same condition, it is

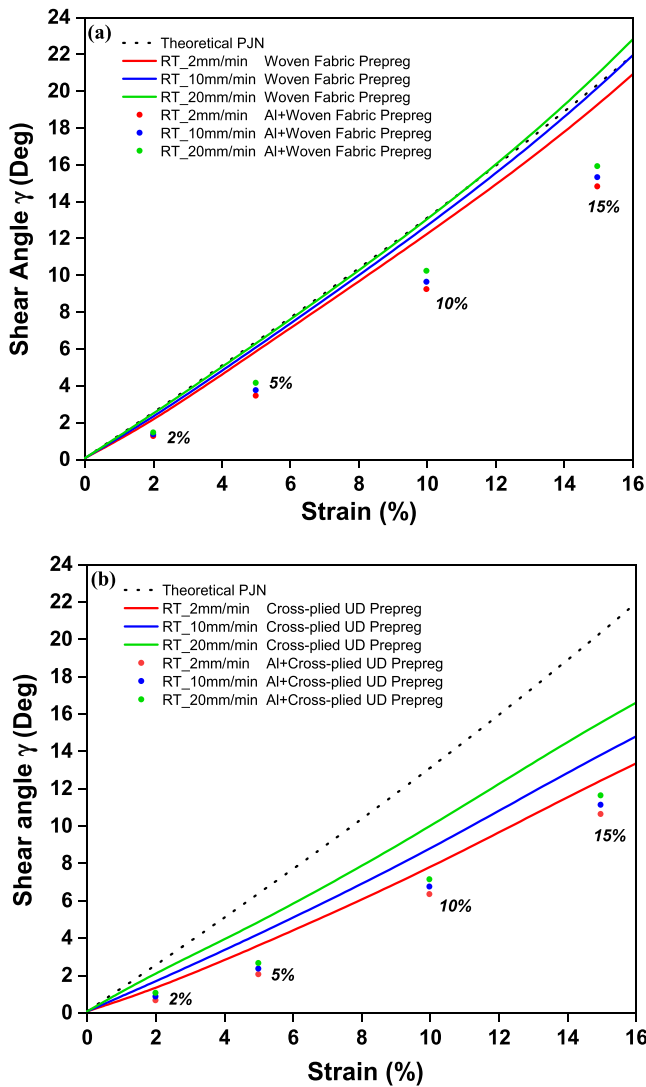

Fig. 12. Shear angle and strain curves of aluminium-fibre reinforced laminate and its pure prepreg under different shear rates without normal pressure: (a) Woven fabric structure; (b) Cross-ply UD structure.

obvious to validate the fact that the outer metal sheet limits the fibre deformation by inducing the inter-ply friction. Meanwhile, the pure prepregs are free to move or deform through the thickness direction which are greatly constrained for the hybrid structures. Moreover, another interesting phenomenon for woven fabric reinforced stainless steel laminate in Fig. 15 is that the shear of woven fabric does not seem to follow the theoretical PJN approach, where the band widths of the assumed ‘half shear’ and ‘undeformed’ regions (circled in the figure) are smaller than the ‘pure shear’ region. The lesser band width which results in a higher shear angle can be attributed to the fact that the fibre tows are clamped close to the tabs where a tensile force can be transmitted, while the fibres in the middle of the specimen have freedom to move as both ends are not clamped. Therefore, due to the relatively low force transfer in the assumed ‘pure shear’ region of the woven fabric, the displacement of the prepreg become less in this region under the same friction conditions. Furthermore, the smaller band width for woven fabric prepreg shown in the figure further validates that cross-ply UD fibres are even more ‘free’ than the woven fabrics.

4.4. Preheat temperature

Preheat temperature is also one of the key factors which influences

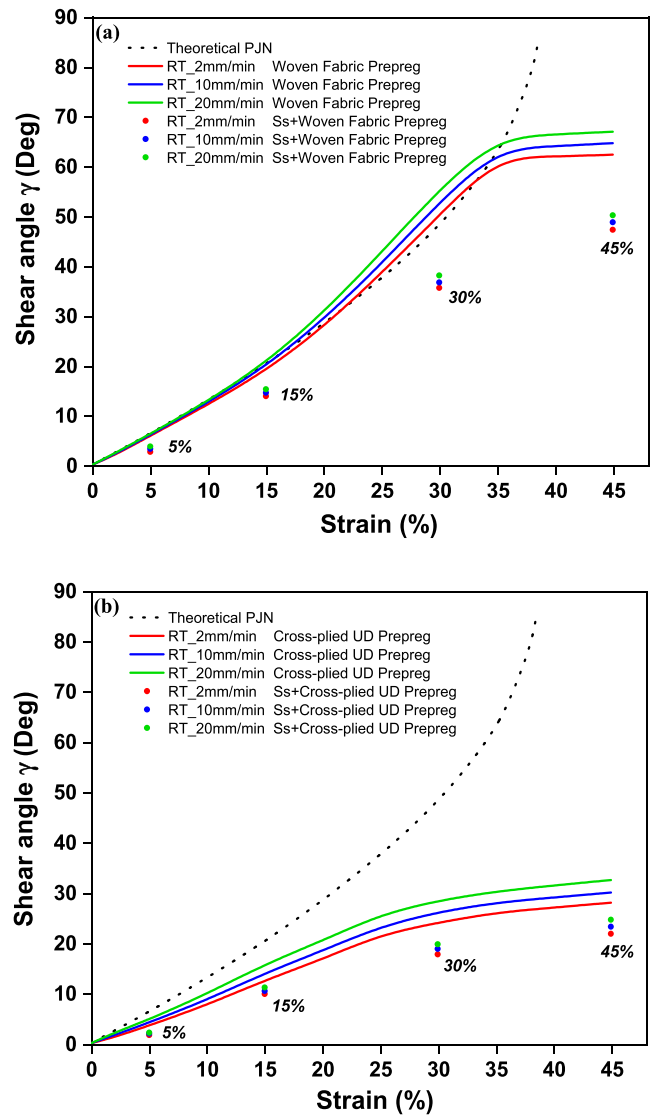

Fig. 13. Shear angle and strain curves of stainless steel-fibre reinforced laminate and its pure prepreg under different shear rates without normal pressure: (a) Woven fabric structure; (b) Cross-ply UD structure.

the intra-ply shear performance by altering the epoxy resin viscosity. In this research, the resin viscosity decreases with the increase of preheat temperature from room temperature (23 °C) to the temperature of 80 °C. The residual thermal effects are ignored as the degree of cure is low under these temperatures. Fig. 16 exhibits the effect of preheat temperature on shear angles for woven fabric prepreg and its reinforced hybrid laminates compared to the theoretical PJN assumption calculated by Eq.(1). The deviation of PJN behaviour for woven fabric prepreg gradually increases at high temperature and is even larger for its reinforced hybrid laminate with aluminium alloy and stainless steel structure. The increased deviation suggests that the dramatic drop in resin viscosity at high temperatures triggers other deformation mechanisms than just pure shear. As the intra-ply shear angle decreases with the increase of preheat temperature for woven fabric reinforced metal laminates and their prepreg constituent, it can be concluded that an increased inter-tow slippage at higher temperature for the woven fabric prepreg affects the shear. This can also be found from Khan’s research [15] that the elevated temperature testing of woven prepreg promotes inter-tow slippage and higher temperature leads to earlier deviation from PJN assumptions. As depicted in Fig. 17(a), the kinematic assumption of PJN theory is well maintained at room temperature for

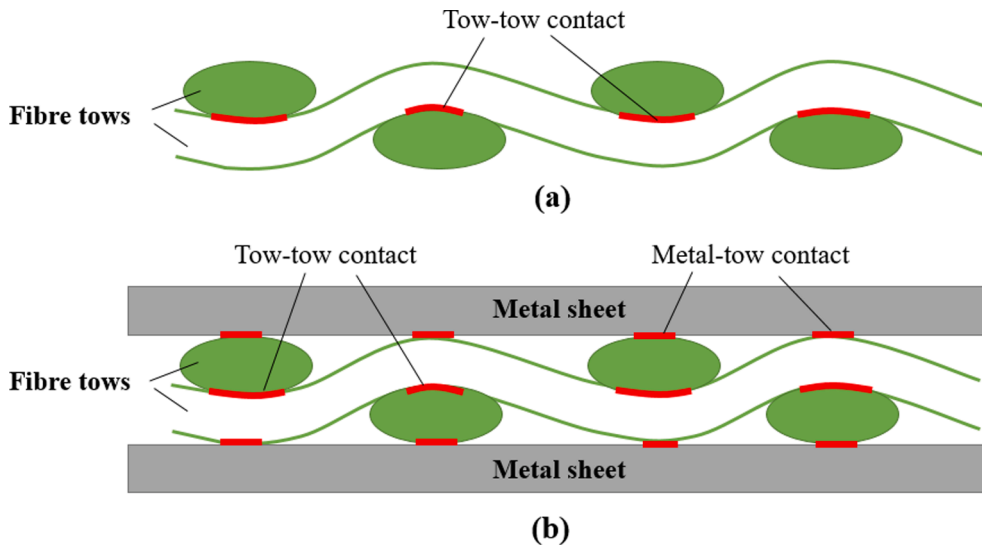

Fig. 14. Schematic of the force transmitting and contact surfaces: (a) Woven fabric prepreg; (b) Metal-composite laminate.

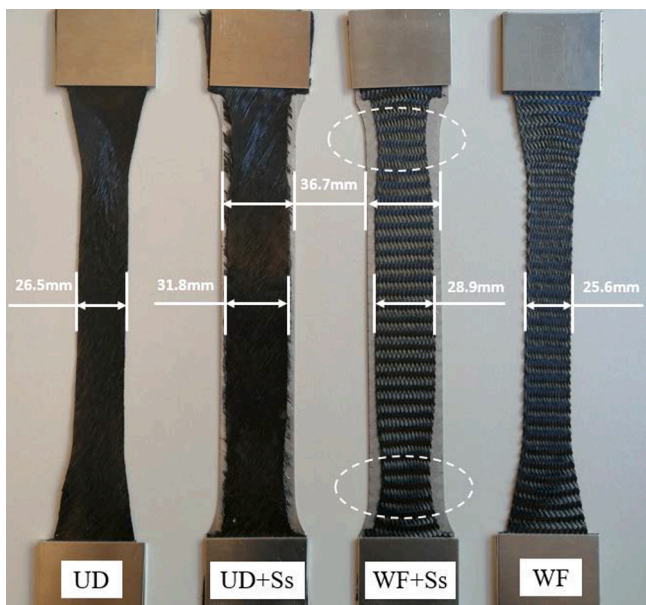

Fig. 15. Picture of test-specimens to the shear strain of 30 % at room temperature for different material combinations without normal pressure (UD-Cross-plyed unidirectional fibre prepreg, WF-Woven fabric prepreg, Ss-Stainless steel).

the woven fabric prepreg as the viscous resin can act like a pin at cross-over points and the inter-tow slippage is limited. When increasing the temperature, the decreasing resin viscosity lowers the stiffness of the material in shear deformation and inter-tow slippage tends to occur. In order to validate the existence of inter-tow slippage at high temperature, test specimens in actual shear response of 30 % strain for woven fabric prepreg at room temperature (RT) and 80 °C are presented on the right side of Fig. 18. It is found that the band width on the pure shear region at RT is relatively small compared to the width when tested at 80 °C. A close-up view of the central shear region shows that the intra-ply rotation angle α is higher at higher temperature (80 °C) and this indicates that inter-tow slippage becomes much easier with more viscous resin displacing out of the fibre tows and the overall resistance towards intra-ply shear decreases. Furthermore, Fig. 16 reveals that the values of shear angle at specific strains for hybrid laminates with woven fabric are lower and the effect of preheat temperature seems to be more sensitive

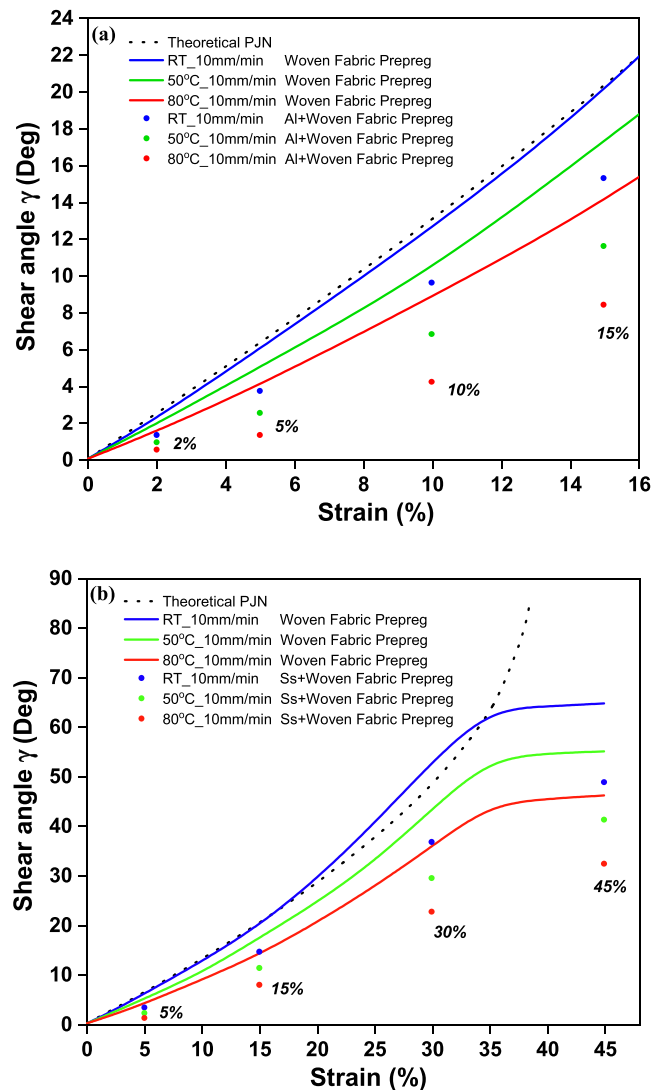

Fig. 16. Shear angle and strain curves of woven fabric reinforced-metal laminate and its pure prepreg under different preheat temperatures without normal pressure: (a) Aluminium alloy structure; (b) Stainless steel structure.

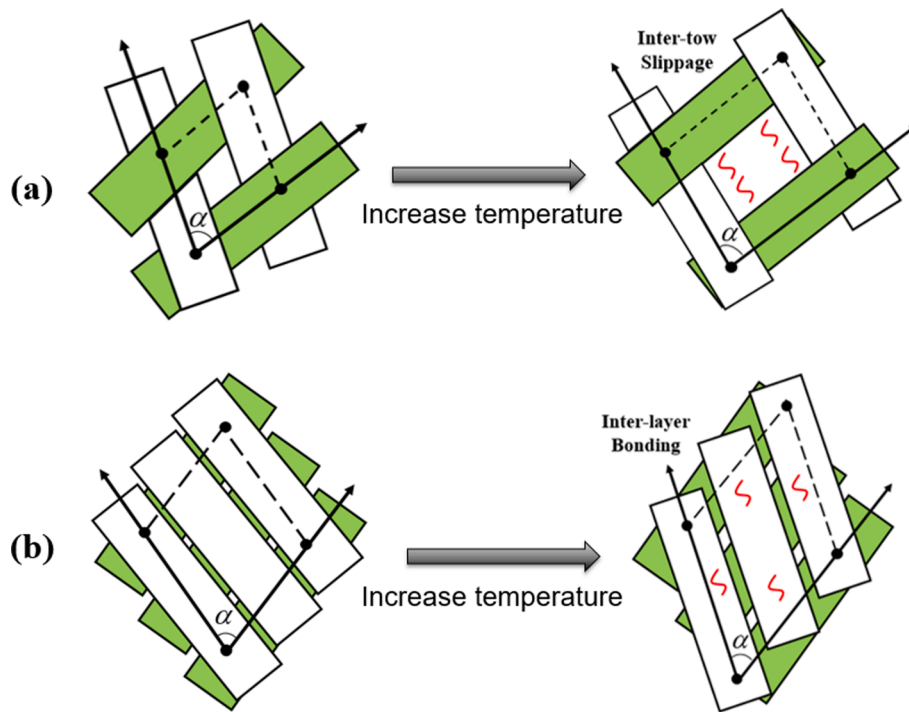

Fig. 17. Shear deformation of two different prepregs at higher temperature:(a) Woven fabric; (b) Cross-ply UD.

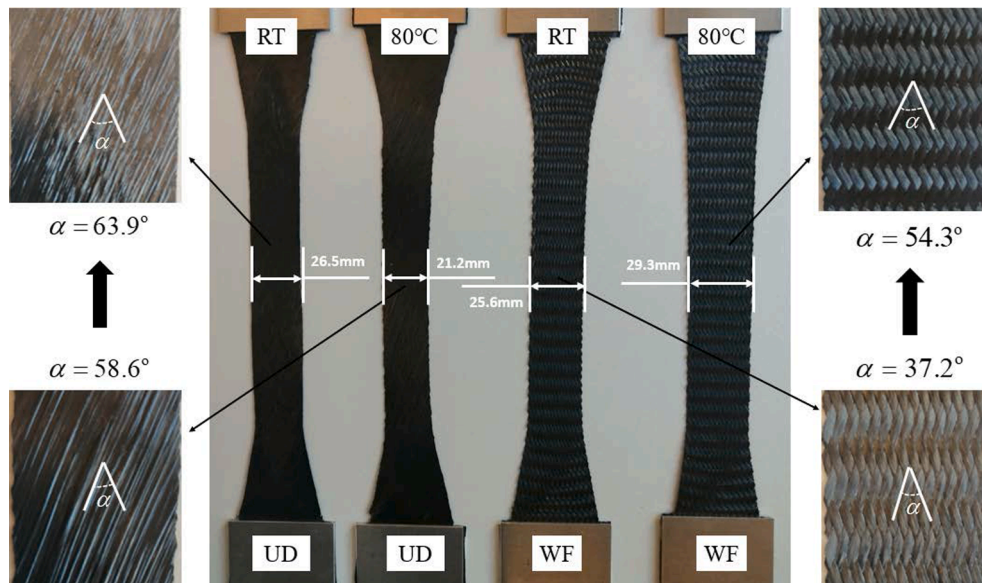

Fig. 18. Picture of test-specimens to the shear strain of 30 % at room temperature and 80 °C for pure composite prepregs (UD-Cross-ply unidirectional fibre prepreg, WF-Woven fabric prepreg).

compared to the pure woven fabric prepreg. It has already been shown that the support of metal sheet creates more friction at metal-prepreg interfaces which restricts the rotation of fibre tows. However, the elevation of temperature lowers such inter-ply friction and thus further decreases the intra-ply shear angles.

The temperature trends are interestingly contrasting for the cross-ply UD prepreg and its reinforced metal laminates under the same conditions. As shown in Fig. 19, the PJN behaviours are invalid for all cross-ply UD type of materials while the increase of preheat temperature makes it more closer to the theoretical PJN curve. The increase in shear angle as the temperature increases is mainly due to the different shear behaviour of UD materials compared to woven fabrics. As

mentioned in the previous section, there are no physical links enabling the PJN kinematics for the cross-ply UD layers at room temperature and rotation as well as sliding is allowed through the viscous resin. At higher temperature like 80 °C, the viscosity of the resin decreases and reduces its capability as a lubricant between the plies, and thus providing more opportunities for the frictional interaction between the cross-ply UD fibres. This kind of quasi-physical linking can act like PJN approach, and increase the shear angle at higher temperature. The same observation is found in the literature [15] that maximum shear angles at elevated temperature are higher than those at RT as the viscous resin provides more contact between UD layers. The schematic graph shown in Fig. 17 (b) shows that although the increasing temperature

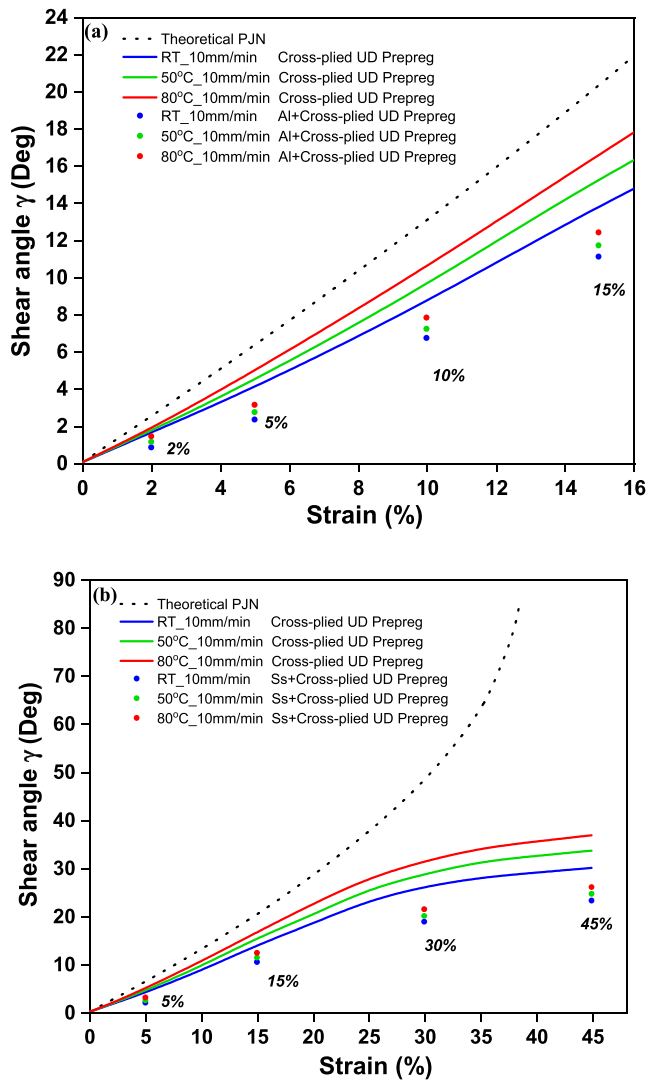

Fig. 19. Shear angle and strain curves of cross-ply UD reinforced-metal laminate and its pure prepreg under different preheat temperatures without normal pressure: (a) Aluminium alloy structure; (b) Stainless steel structure.

accelerates the slide at prepreg-prepreg interfaces, the dominance of inter-layer bonding increases the shear angle. The test specimens for cross-ply UD prepreg shown in Fig. 18 exhibit that the intra-ply rotation angle α decreases as the temperature increases. Meanwhile, it is measured that the specimen width is narrow for cross-ply UD prepreg at 80 °C and a close-up view of the central shear region witnesses obvious fibre wrinkling due to the occurrence of higher shear angle γ at this temperature. The shear angle of the cross-ply UD fibre reinforced metal laminates follows the same trend as their pure cross-ply UD prepreg, despite the lower value of intra-ply shear angle at specific strains. The reason can also be explained by the less fibre rotation because the occurrence of friction at the metal-prepreg interfaces. However, the result from Fig. 19 reveals that the effect of temperature is no longer sensitive for the cross-ply UD fibre reinforced metal laminates as the decreasing friction at the metal-prepreg and prepreg-prepreg interfaces conflicts with the inter-ply bonding of UD fibres at high temperatures.

4.5. Normal pressure

Normal pressure is not taken into account for the shearing of fibre reinforced prepregs through bias-extension test, while the effect of

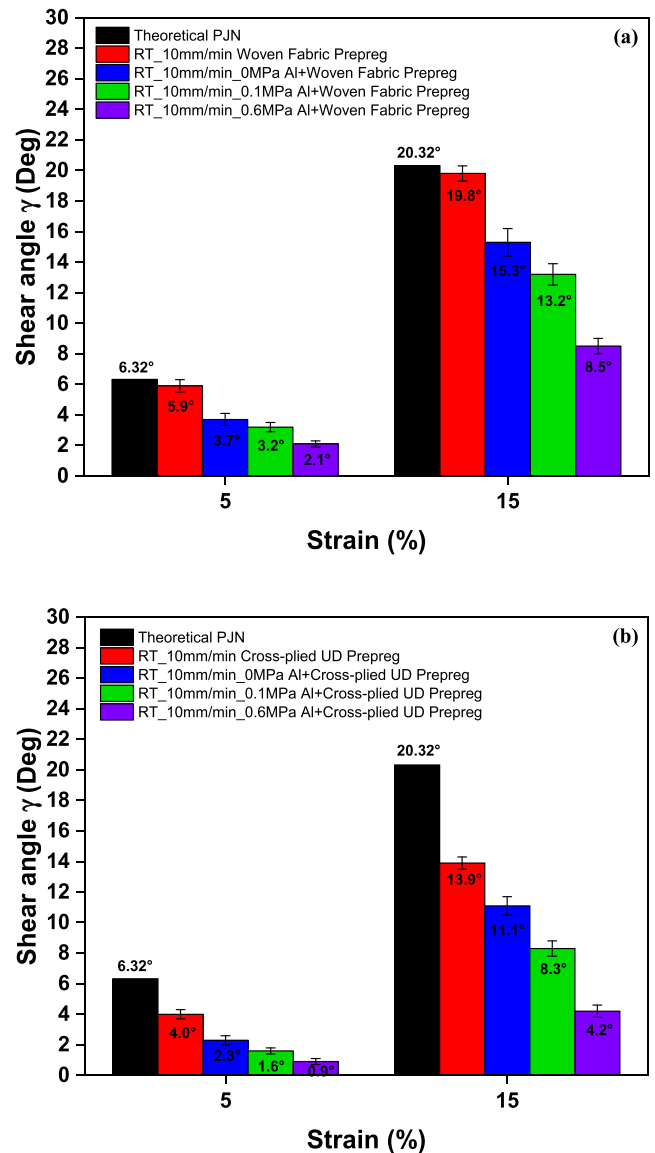

Fig. 20. Shear angle values at two strains for aluminium alloy-fibre reinforced laminate and its pure prepreg under different normal pressures: (a) Woven fabric structure; (b) Cross-ply UD structure.

normal pressure is vital for the investigation of intra-ply shear characterisation of hybrid metal-composite laminates to obtain a situation which will be relevant for forming experiments. Figs. 20 and 21 exhibits the values of shear angle at two different shear strains for the aluminium alloy and stainless steel based fibre reinforced laminates under different normal pressure conditions. The results are also compared with the theoretical PJN method and their pure fibre reinforced prepreg to understand how it affects the intra-ply shear behaviour. The result indicates that the support of metal sheet and normal pressure greatly decrease the shear angle of fibre reinforced prepregs for both woven fabric and cross-ply UD types at the same strain. As stated in previous section that the outer metal sheet induces friction between the metal and prepreg layers, the increase of normal pressure further increases the friction and lowers the shear deformation of the prepreg layers. Besides, the hybrid metal-composite laminates with cross-ply UD structure shown in Fig. 20(b) and 21(b) seem to be more sensitive to normal pressure at different levels of strain as compared with hybrid woven fabric structures shown in Fig. 20(a) and 21(a). The decrease of shear angle for woven fabric reinforced metal laminate is $<15\%$ and 45% under the normal pressure of 0.1 MPa and 0.6 MPa, while the shear

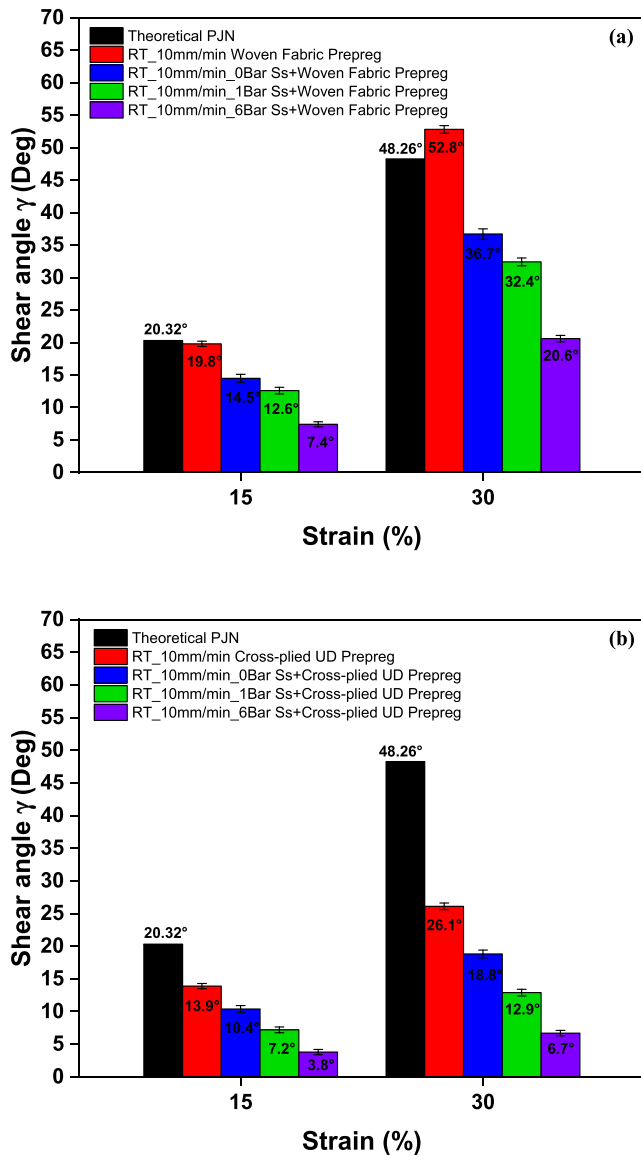

Fig. 21. Shear angle values at two strains for stainless steel-fibre reinforced laminate and its pure prepreg under different normal pressures: (a) Woven fabric structure; (b) Cross-ply UD structure.

angle reduction for the hybrid cross-ply UD structures is more than 30 % and 60 %, respectively. This demonstrates that the frictional response is much higher for the hybrid cross-ply UD structures as more resin squeezes out from the prepreg-prepreg interface to the metal-prepreg interface as the normal pressure increases. Therefore, further compaction of the hybrid laminates seems impossible because the inter-ply friction would largely increase and damage may occur when the resin is squeezed out and the fibres have direct contact with the metal surface. The specimens shown in Fig. 22 corroborate the explanation that the two cross-ply UD layers undergo higher friction resulting in a larger band width coupled with the hard-to-move fibre tows. Furthermore, the unpressurised shear regions (Circled in the figure) undergo higher shear deformation than the specimen applied with zero normal pressure; in this situation the shear deformation is concentrated in these regions. The result makes it abundantly clear that the application of normal pressure has a huge effect on the shear properties of metal-composite laminates.

5. Conclusions

The intra-ply shear angle which is the evaluation parameter in the

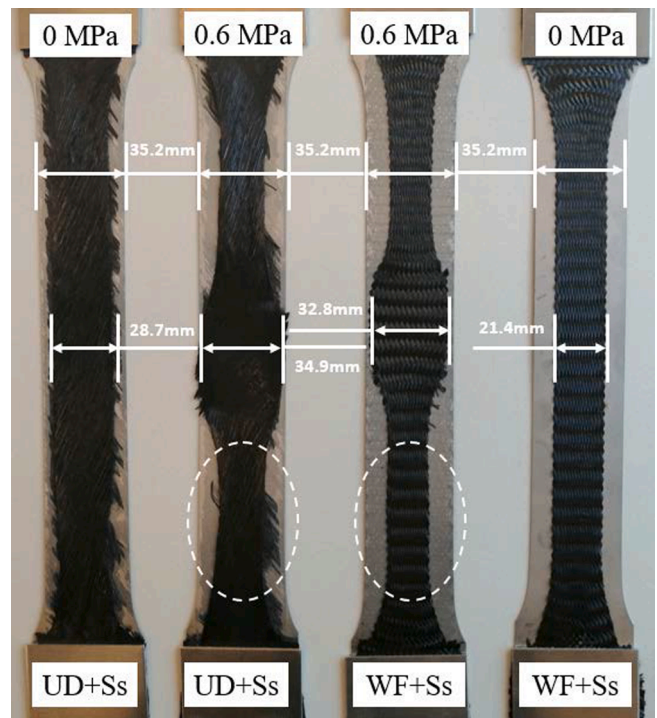

Fig. 22. Picture of test-specimens to the shear strain of 45 % at RT under two normal pressures for hybrid laminates (UD-Cross-ply UD fibre prepreg, WF-Woven fabric prepreg, Ss-Stainless steel).

shear characterisation for hybrid metal-composite laminate has been measured using a modified bias-extension test. Various combinations of material constituents as well as the influenced processing parameters such as shear rate, preheat temperature and normal pressure were investigated and compared. The results indicate that the shear mechanism of woven fabrics and cross-ply UD fibres is affected and intra-ply shear deformability of the hybrid materials is highly controlled by the viscosity state of epoxy resin and the application of external normal pressure. These parameters have significant influence on a number of output parameters like shear stress, shear angle, inter-tow and inter-ply sliding. This paper contributes to the material selection, process design and modelling for the forming of double-curved products using hybrid metal-composite laminates. It can be concluded that:

- (1) The support of metal sheets generally reduce the shear angles in the modified BE test due to the differences in contraction between metal sheet and composite layers, and the variations in shear angles for hybrid laminates are mainly caused by the friction at the metal-prepreg interface. The intra-ply shear deformability of the fibre reinforced stainless steel laminate can be greatly improved as the failure strain increases 5–10 % with the delay of fibre wrinkling.
- (2) The effects of shear rate and preheat temperature on the shear angles of hybrid metal-composite laminate follow the trends of their corresponding prepreps. The shear angles increase with the increasing shear rate for all material combinations while the growth is less sensitive (<5 %) at different shear strains especially for hybrid laminates. However, the effect of preheat temperature differs in two prepreg systems. The shear angles decrease with the increasing preheat temperature for pure woven fabrics and the reduction for woven fabric reinforced metal laminate is becoming larger (greater than 20 %). But the shear angle undergoes a small increase as the temperature increases for cross-ply UD structures especially for the cross-ply UD reinforced metal laminates (<10 %).

- (3) The shear angles show a sharp decrease when applying the normal pressure on the central shear region. The decrease of shear angle for woven fabric reinforced metal laminate is 15 % and 45 % under the normal pressure of 0.1 MPa and 0.6 MPa, while the shear angle reduction for the hybrid cross-ply UD structures is 30 % and 60 %, respectively. The maximum value for the applied normal pressure is 6 bar as it may cause defects or even damages for the hybrid materials. Besides, it is better to apply the normal pressure on the entire shear region rather than the central region, which is more realistic for practical applications.
- (4) The pure PJN theory is only valid for the woven fabric prepreg up to 20–25° and the woven fabric reinforced metal laminates are more suitable to deform under low strain conditions. And for the hybrid material deforming under large strain conditions, cross-ply UD reinforced metal laminates are more favourable. Even though the size and edge effects of the metal sheet and fibre prepreg are not considered in the modified bias-extension test, the work provides good insights on the press forming of uncured hybrid laminates which is relevant for material selection and process optimization.

CRediT authorship contribution statement

Shichen Liu: Conceptualization, Methodology, Writing – original draft. **Jos Sinke:** Supervision, Methodology, Writing – review & editing. **Clemens Dransfeld:** Supervision, Writing – review & editing.

Declaration of Competing Interest

The authors declare that they have no known competing financial interests or personal relationships that could have appeared to influence the work reported in this paper.

Data availability

No data was used for the research described in the article.

Acknowledgements

The authors would like to thank the financial supports of China Scholarship Council (No.201906040174).

References

- Sinmazçelik T, Avcu E, Bora MÖ, Çoban O. A review: Fibre metal laminates, background, bonding types and applied test methods. *Mater Des* 2011;32(7):3671–85.
- Nardi D, Abouhamzeh M, Leonard R, Sinke J. Investigation of kink induced defect in aluminium sheets for Glare manufacturing. *Compos Part A Appl Sci Manuf* 2019;125:105531.
- Khan MA, Reynolds N, Williams G, Kendall KN. Processing of thermoset prepregs for high-volume applications and their numerical analysis using superimposed finite elements. *Compos Struct* 2015;131:917–26.
- Sinke J. Feasibility of tailoring of press formed thermoplastic composite parts. *AIP Conf Proc*. May, 2018.
- Liu S, Sinke J, Dransfeld C. An inter-ply friction model for thermoset based fibre metal laminate in a hot-pressing process. *Compos Part B Eng* 2021;227:109400.
- Kubit A, Trzpiecinski T, Klonica M, Hebda M. The influence of temperature gradient thermal shock cycles on the interlaminar shear strength of fibre metal laminate composite determined by the short beam test. *Compos Part B Eng* 2019;176:107217.
- Megahed M, Abd El-baky MA, Alsaedy AM. An experimental investigation on the effect of incorporation of different nanofillers on the mechanical characterization of fiber metal laminate. *Compos Part B Eng* 2019;176:107277.
- Chen Q, Boisse P, Park CH, Saouab A. Intra-/inter-ply shear behaviours of continuous fiber reinforced thermoplastic composites in thermoforming processes. *Compos Struct* 2011;93(7):1692–703.
- Erland S, Dodwell TJ. Quantifying inter- and intra-ply shear in the deformation of uncured composite laminates. *Adv Manuf Polym Compos Sci* 2021;7(2):25–35.
- Mattner T, Wrench M, Drummer D. Shear behavior of woven and non-crimp fabric based thermoplastic composites at near-processing conditions. *Compos Part B Eng* 2020;185:107761.
- Cao J, Akkerman R, Boisse P. Characterisation of mechanical behaviour of woven fabrics: Experimental methods and benchmark results. *Compos Part A Appl Sci Manuf* 2008;39(6):1037–53.
- Alshahrani H, Rahul M. Experimental Investigation of In-Plane Shear Deformation of Out-of-Autoclave Prepreg. *Int J Compos Mater* 2015;5(4):81–7.
- Wang P, Legrand X, Boisse P, Hamila N, Soulat D. Experimental and numerical analyses of manufacturing process of a composite square box part: Comparison between textile reinforcement forming and surface 3D weaving. *Compos Part B Eng* 2015;78:26–34.
- Khan MA, Pasco C, Reynolds N, Kendall K. Shear deformability characteristics of a rapid-cure woven prepreg fabric. *Int J Mater Form* 2021;14(1):133–42.
- Khan MA, Pasco C, Reynolds N. On the validity of bias-extension test method for the characterisation of in-plane shear properties of rapid-cure prepregs. *Compos Struct* 2020;vol. 246, no. April:112399.
- Potter K. Bias extension measurements on cross-ply unidirectional thermoset prepreg. *Compos Part A Appl Sci Manuf* 2002;33(1):63–73.
- Potter K. Beyond the pin-jointed net: maximising the deformability of aligned continuous Fibre reinforcements. *Compos Part A Appl Sci Manuf* 2002;33(1):677–89.
- Haanappel SP, Akkerman R. Shear characterisation of uni-directional fibre reinforced thermoplastic melts by means of torsion. *Compos Part A Appl Sci Manuf* 2014;56:8–26.
- Larberg Y, Åkermo M. In-plane deformation of multi-layered unidirectional thermoset prepreg: Modelling and experimental verification. *Compos Part A Appl Sci Manuf* 2014;56:203–12.
- Lebrun G, Bureau MN, Denault J. Evaluation of bias-extension and picture-frame test methods for the measurement of intraply shear properties of PP/glass commingled fabrics. *Compos Struct* 2003;61(4):341–52.
- Harrison P, Clifford MJ, Long AC. Shear characterisation of viscous woven textile composites: A comparison between picture frame and bias extension experiments. *Compos Sci Technol* 2004;64(10–11):1453–65.
- Taha I, Abdin Y, Ebeid S. Comparison of picture frame and Bias-Extension tests for the characterisation of shear behaviour in natural fibre woven fabrics. *Fibers Polym* 2013;14(2):338–44.
- Boisse P, Hamila N, Guzman-Maldonado E, Hivet G. The bias-extension test for the analysis of in-plane shear properties of textile composite reinforcements and prepregs: a review. *Int J Mater Form* 2017;10(4):473–92.
- Rashidi A, Montazerian H, Milani AS. Slip-bias extension test: A characterisation tool for understanding and modeling the effect of clamping conditions in forming of woven fabrics. *Compos Struct* 2021;260:113529.
- Larberg YR, Åkermo M, Norrby M. On the in-plane deformability of cross-ply unidirectional prepreg. *J Compos Mater* 2012;46(8):929–39.
- Brands D, Grouve W, Wijskamp S, Akkerman R. Intra-ply shear characterisation of unidirectional fiber reinforced thermoplastic tape using the bias-extension method. *ESAFORM MS02(Composites)* 2021;02:1–10.
- Wang Y, Chea MK, Kratz J, Ivanov DS, Hallett SR. Experimental characterisation of the in-plane shear behaviour of UD thermoset prepregs under processing conditions. *Compos Part A Appl Sci Manuf* 2020;133:105865.
- ASTM E8/E8M. Standard test methods for tension testing of metallic materials. *Annu B ASTM Stand* 4. 2010;(C):1–27.
- Hannon A, Tiernan P. A review of planar biaxial tensile test systems for sheet metal. *J Mater Process Technol* 2008;198(1–3):1–13.
- Abedini A, Noder J, Kohar CP, Butcher C. Accounting for Shear Anisotropy and Material Frame Rotation on the Constitutive Characterisation of Automotive Alloys using Simple Shear Tests. *Mech Mater* 2020;148:103419.
- Peirs J, Verleysen P, Degriek J. Novel Technique for Static and Dynamic Shear Testing of Ti6Al4V Sheet. *Exp Mech* 2012;52(7):729–41.
- Rahmaan T, Abedini A, Butcher C, Pathak N, Worswick MJ. Investigation into the shear stress, localization and fracture behaviour of DP600 and AA5182-O sheet metal alloys under elevated strain rates. *Int J Impact Eng* 2017;108:303–21.
- Yin Q, Soyarslan C, Isik K, Tekkaya AE. A grooved in-plane torsion test for the investigation of shear fracture in sheet materials. *Int J Solids Struct* 2015;66:121–32.
- Lee BE, Park ET, Kim J, Kang BS, Song WJ. Analytical evaluation on uniaxial tensile deformation behavior of fiber metal laminate based on SRPP and its experimental confirmation. *Compos Part B Eng* 2014;67:154–9.
- Sharma AP, Khan SH, Parameswaran V. Experimental and numerical investigation on the uni-axial tensile response and failure of fiber metal laminates. *Compos Part B Eng* 2017;125:259–74.
- Shamohammadi Maryam M, Ebrahimnezhad-Khaljiri H, Eslami-Farsani R. The experimental assessment of the various surface modifications on the tensile and fatigue behaviors of laminated aluminium/aramid fibers-epoxy composites. *Int J Fatigue* 2022;154:106560.
- Chen Y, Wang Y, Wang H. Research Progress on Interlaminar Failure Behavior of Fiber Metal Laminates. *Adv Polym Technol* 2020;3097839.
- Rajpurohit A, Joannès S. Hybrid effect in in-plane loading of carbon/glass fibre based inter- and intraply hybrid composites. *J Compos Sci* 2020;4(1):1–20.
- Do H, Weon J, Song O, Oh D. Determination of true stress-strain curve of type 304 and 316 stainless steels using a typical tensile test and finite element analysis. *Nucl Eng Technol* 2021;53(2):647–56.

- [40] SHD Composites. MTC510 epoxy prepreg datasheet. 2018;01:1-3. <https://shdcomposites.com/admin/resources/mtc510-tds.pdf>.
- [41] Mamalis D, Obande W, Koutsos V, Ray D. Novel thermoplastic fibre-metal laminates manufactured by vacuum resin infusion: The effect of surface treatments on interfacial bonding. *Mater Des* 2019;162:331–44.
- [42] Zhao Y, Gu Y, Zhang T, Li H, Zhang B, Zhang Z. Characterization of intra-ply shear behaviors of unidirectional prepregs during hot diaphragm forming process. *Polym Compos* 2021;42(2):1008–20.