

## Journey of a PocketQube: Concept to Orbit

Uludag, M.S.; Speretta, S.; Menicucci, A.; Gill, E.K.A.

**Publication date**  
2023

**Published in**  
Proceedings of the International Symposium on Space Technology and Science, Kurume (Japan), June 3rd-9th, 2023

**Citation (APA)**  
Uludag, M. S., Speretta, S., Menicucci, A., & Gill, E. K. A. (2023). Journey of a PocketQube: Concept to Orbit. In *Proceedings of the International Symposium on Space Technology and Science, Kurume (Japan), June 3rd-9th, 2023* Article 2023-f-06

**Important note**  
To cite this publication, please use the final published version (if applicable).  
Please check the document version above.

**Copyright**  
Other than for strictly personal use, it is not permitted to download, forward or distribute the text or part of it, without the consent of the author(s) and/or copyright holder(s), unless the work is under an open content license such as Creative Commons.

**Takedown policy**  
Please contact us and provide details if you believe this document breaches copyrights.  
We will remove access to the work immediately and investigate your claim.

# Journey of a PocketQube: Concept to Orbit

By Mehmet Sevket ULUDAG\*,<sup>1)</sup> Stefano SPERETTA,<sup>1)</sup> Alessandra MENICUCCI<sup>1)</sup> and Eberhard GILL<sup>1)</sup>

<sup>1)</sup>Faculty of Aerospace Engineering, Delft University of Technology, Delft, The Netherlands

(Received May 8th, 2023)

The Delft University of Technology has been working on Delfi-PQ, a 3P PocketQube developed by Aerospace Engineering students during their education. The satellite, while being only 50x50x178 mm and having a mass of 545 g, shares the same problems and requirements of bigger satellites. This paper presents the design concept, development, and testing of Delfi-PQ to help other teams in their development. All the combined information will help to generate a big picture for institutions to start their own small satellite mission.

**Key Words:** Delfi-PQ, PocketQube, Miniaturization, Bottom-Up Engineering, Pico-Satellite

## 1. Introduction

PocketQubes (PQs) represent a new type of cuboid-shaped modular platform with dimensions of 50x50x50 mm and a mass of 250 g per each “unit”. Like the CubeSats, these platforms are split into units referred to as 1P.<sup>1)</sup> The Delft University of Technology has been working on a 3P PocketQube with dimensions of 50x50x178 mm since 2017, considering this new form factor as a stepping stone towards even more miniaturized satellites. As a result of its very small size, subsystems and payloads will be constrained, forcing a radical change in mission concepts, and forming complex missions out of many smaller ones. Thanks to their size, PQs can be developed economically; launching in large numbers to build a distributed swarm of sensors will even further reduce the total mission costs. The main goal of Delfi-PQ<sup>3,5)</sup> is to design, demonstrate and create the very first step for a series of PocketQubes developed in Delft.

This paper presents the end-to-end development of Delfi-PQ, shown in Fig. 1. In Section 2. idea and conceptualization of the satellite are explained. Design choices and agile design approach of the satellite are explained in Section 3.. As part of the satellite development that took place during the pandemic, creating very unique challenges, strategies to tackle such challenges are explained in Section 4.. Delfi-PQ was launched on January 13<sup>th</sup> 2022 and it has been operational ever since. Finally, conclusions and future works are summarized in Section 5..

This brief description of the Delfi-PQ project from concept to orbit will provide a basis for other institutions who would like to build their own PocketQube and even scratch the mind of the ones who are planning to build a CubeSat. A PocketQube might just be enough and they can actually build it quicker and cheaper.

## 2. Reason, Idea, Concept

The idea of this new form factor, PocketQube, was first presented and proposed in 2009 by Prof. Robert J. Twiggs in collaboration with Morehead State University and Kentucky Space.<sup>6,7)</sup> As first showcased, the so-called PocketQubes represent a cuboid-shaped platform of 50x50x50 mm with an approximated mass of 250 g. The first launched PQs were through



Fig. 1. The Delfi-PQ flight model.

the UniSat5 mission<sup>6,7)</sup> in 2013.

In 2017, the Delft University of Technology Space Department decided to re-focus on space technology miniaturization and started the development of very small satellites, almost an order of magnitude smaller than the CubeSat standard. PocketQubes and/or pico-satellites (satellites with a mass between 100 g and 1 kg) are still in their infancy. Like in the early days of CubeSats, many people now regard PocketQubes as merely educational platforms. At the Delft University of Technology, the goal was to demonstrate that this is a misconception. The small size of PocketQubes will force us to think differently about space technology and the development thereof. This can create interesting spin-outs and spin-offs to larger spacecraft. A PocketQube-sized spacecraft bus or part thereof might also be implemented in for instance a CubeSat, leaving more space for payloads. But also on itself, PocketQubes (or even further miniaturized spacecraft) may have their value-to-cost advantages, especially when deployed in vast networks which go beyond the scope and scale of the current CubeSats networks which are foreseen. In short, at the Delft University of Technology, we want to be pioneers in a relatively under-explored class of satellites and a point of reference to everyone interested in this field in the years ahead.<sup>8)</sup>

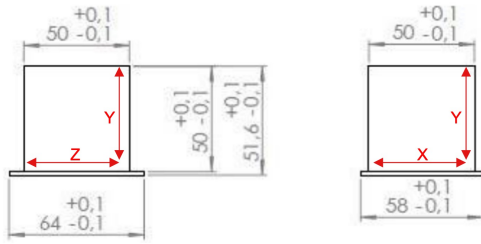

Fig. 2. 1P Mechanical Drawing.

The second decision the team faced was the size of our PocketQube. We have decided to build a 3P PocketQube, as it will be the boundary between CubeSats (1U or 0.5U) and PocketQubes. One 3P PocketQube is 445 cm<sup>3</sup> and a 1U and 0.5U CubeSats would be 1000 cm<sup>3</sup> and 500 cm<sup>3</sup> respectively. If we can match the performance of a 1U CubeSat in a shorter period of time and relatively cheaper than a CubeSat, we would be able to prove the capabilities of a PocketQube which in return will enable bigger projects for us. Eventually, the goal is to have a swarm of PocketQubes, that is when they really become cost-effective and of course, this depends on the mission, which might be our next project.

Another feature we took into account was to create a mechanical standard and electrical standard for the PocketQubes. The former<sup>1)</sup> was built on the original PocketQube concept and mostly used to define a common deployer to allow more players to join the market: this new version was created in collaboration with Alba Orbital and Gauss Srl. which is publicly available.<sup>1)</sup>

Table 1. PQ external dimensions.

Number of units (P)	External Dimensions w/o backplate (mm)	Sliding backplate dimensions (mm)
1P	50x50x50	58x64x1,6
2P	50x50x114	58x128x1,6
3P	50x50x178	58x192x1,6

The electrical standard was developed independently and it is called PQ-9, due to the standard connect number of available pins. The starting point was to creating a stacking connector just like the one in CubeSats to enable interchangeable subsystems with the addition of mechanical dimensions, shown in Fig. 3. The main purpose was to make collaborations easier and enable the independent development of interchangeable components possible. CubeSats took advantage of such standardization by relaying initially on a common connector, called PC104, to allow for components built by multiple entities to be integrated into the same satellite.

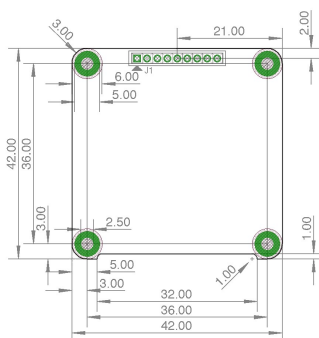

Fig. 3. PQ9 Printed Circuit Board (PCB) dimensions.

### 3. Design

The satellite development cycle was designed to cope with the typical educational calendar to ensure students' participation in the project. Turnover was a key issue as students could not be involved for multiple years but often only for three to six months. This meant that developments taking a long time should have been broken up into self-contained tasks to be carried out by students. The team decided thus to follow an iterative approach, where the goal of each assignment was to deliver a minimum viable product (starting from scratch or from a previous deliverable) and sometimes the deliverable would not be completed. This forced us to enforce modularity such that a very clear interface was defined early and all systems could be considered independent such that changes to one of them would not ripple on any other. In total, it took 3 years to finalize the design, also due to changes in the launch requirements and schedule, which was used to our advantage to develop another iteration of the subsystems. This enabled us to design the complete satellite twice while some systems were updated four times. After the satellite was completed, it took another 2 years to launch due to changes with the launch vehicle which also provided us with additional time to streamline our software and improve our ground systems.

A bottom-up approach was used for swift development: Several high-level requirements were considered before starting the design of subsystems.

- Satellite should be less than 750 grams: this came from the launch adapter qualification and provided the team with ample margin for design;
- It should be a 3P PocketQube: this was an initial team choice not related to the systems to be fitted;
- Power buses should be unregulated (battery/solar panel voltage) and should carry a maximum of 4.5 W (1.5 A maximum): this choice was mostly driven by the low power available and the need for modularity, not designing the power system to fit specific requirements from the rest of the satellite;
- Every subsystem should regulate its own power: this choice was made to ensure modularity in the design;
- A protection circuitry to protect against single even upsets should be available on every subsystem.
- The mission should use amateur frequencies and be compatible with our existing ground station.

The development of the subsystems was mostly sequential, also taking advantage of developments that could be carried from one sub-system to the other like improvements to the core electronics or software, with the exception of the Communication System (COMMS) and the structure running in paral-

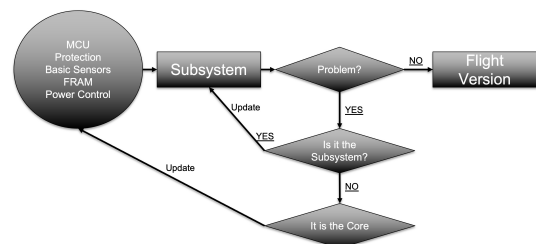

Fig. 4. Subsystem Core Development Cycle.

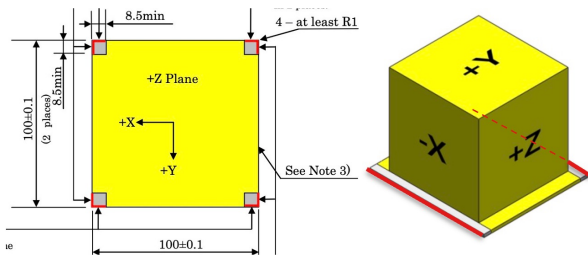

Fig. 5. (Left) CubeSat rails<sup>10)</sup> (Right) PocketQube back plate.<sup>1)</sup> Not to scale.

relative to the rest of the development. In this section, subsystems are listed in their respective development order. An initial revision of the Electrical Power System (EPS) was designed but, at a later stage, it was decided to create a common core set of components for every subsystem and then add the extra specific functionality depending on the tasks to be carried out by each of the specific subsystems, as described in Fig. 4.

### 3.1. Structure

Due to its design, unlike a CubeSat being held from 4 rails/edges, a PQ is being held down from its sliding/back plate along its Z-axis. A direct side-by-side comparison of the two satellite types is shown in Fig. 5. Launch vehicle loads are carried onto the satellite via the back plate, which enables us to use the solar panel Printed Circuit Board (PCB) itself as part of the structure. The structure consists of four main elements; bottom rib, middle rib (also laser reflector holder, see Sect. 3.8.3. for further details), top rib, and rods (4, M2x183 mm). All the mentioned components are shown in Fig. 6.

This is a cautious approach to keep the structure weight low while still complying with the launch load requirements. The satellite final mass, measured after the final assembly, is 545 g, of which the structural parts weigh 93.319 g. The difference between the mass budget total, 536.047 g, and the final measured weight is due to the use of epoxy and thread-lock.

### 3.2. Defining The Core of Every Subsystem

With respect to PQ-9 standard,<sup>2)</sup> a PQ board is 42x42 mm, as shown in Fig. 3. Even though the footprint of the systems is getting smaller, core functions and components are still the same with respect to traditional CubeSat systems, increasing the density on each board. To maintain modularity, each subsystem requires an Micro-Controller (MCU), a DC-DC converter, and specific software. In order to streamline and shorten the development process, we have come up with the “core” concept for every subsystem, containing the basic common functionality. Figure 4 summarizes this development cycle and highlights the decision process.

A standardized PQ core consists of an MCU, a DC-DC converter, a voltage-current monitor circuit, a protection circuit, a temperature sensor, an RS485 transceiver, a watchdog, and a persistent parameter memory (a Ferroelectric memory was used for this functionality as it allows random access, persistent storage and millions of writing cycles). Once the core was developed, updating a new subsystem with its specific functions took only 1 month, including production and testing.

This standardized PQ core also creates a baseline for the required software. Most of the software can be reused as only system-specific functionality needs to be written.

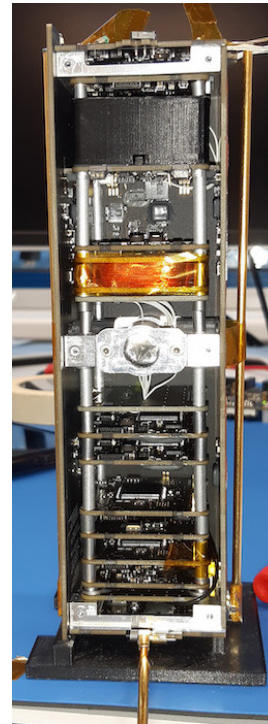

Fig. 6. Delfi-PQ interval view (-X panel removed), subsystem stack (upside down).

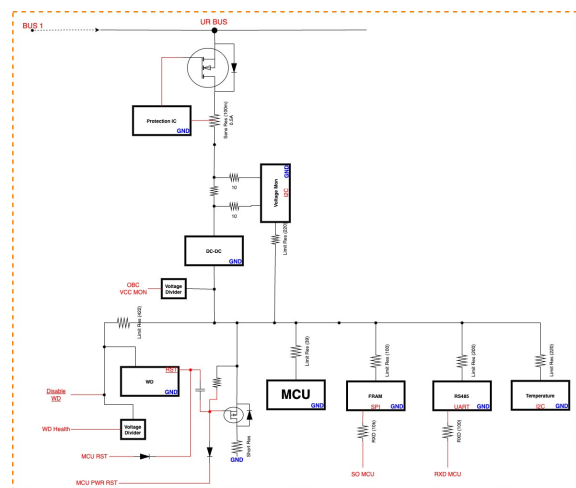

Fig. 7. Delfi-PQ, core electronics block diagram.

#### 3.2.1. Protection Circuit

One of the critical functions of the standardized PQ core is protection against radiation-induced effects in space. Components used in university satellite projects and even at commercial companies are not always radiation-hardened: in order to reduce the development cost, the use of Commercial Off-The-Shelf (COTS) components, and so not radiation-hardened, is a common practice. The price difference varies between various considerably but, as an example, a widely used MCU family, MSP430,<sup>12)</sup> has a radiation-hardened version which can be 500 times more expensive than a standard version.<sup>13-16)</sup> This becomes a significant obstacle, considering that one of the main selling points of nano/pico satellites is their cost-effectiveness.

Single-event latch-up is a common problem for space applications, causing a sudden and irreversible power consumption increase as a result of high energy particles: this could lead to a



component (or a small part of it) to overheat and eventually being irreparably damaged. A cost-effective approach to solve this problem is limiting the current each sensitive component can draw such that the heating is limited within its safe operating margins. In Figure 7, a limiting resistor is shown limiting the maximum current for many Integrated Circuits (ICs): these are calculated according to nominal & maximum current consumption, and respective voltage drop on the resistors to make sure the IC can still be operational. Once a latch-up occurs, the component will require to be power-cycled to allow the latch-up to naturally extinguish and the IC to eventually go back to its nominal functionality. A dedicated re-triggerable circuit breaker has been implemented to interrupt ongoing latch-ups if the current rises beyond a pre-determined threshold. A proper off-time has also been provided to ensure the latch-up can be extinguished, considering all the circuit capacitance. As the size and complexity of adding a dedicated protection circuit per every IC would be prohibitive, groups of ICs are monitored by one protection circuit while each IC has a protection resistor.

As latch-ups sometimes might only affect a small portion of the IC and lead to no major current consumption increase but to the interruption of the circuit functionality, each board MCU also can monitor the systems for functionality and, in case of non-nominal behaviors it can trigger a system or satellite full power-cycle.

This approach proved so far successful in orbit with the satellite automatically detecting interrupted functionalities and re-establishing it autonomously.

### 3.3. Software

Multiple different sub-systems have been developed and, as mentioned already in Sect. 3.2., a set of common hardware components was defined early in the project to limit development time and improve on testing effectiveness. The embedded software followed the exact same logic, also thanks to the selection of a single MCU type for the whole satellite. Low-level libraries were developed in such a way that they could be shared among different sub-systems and a real-time operating system was also developed (based on the underlying FreeRTOS) to be used on all systems. Test applications also re-used the same principle, defining a hierarchical set of tests to be re-used on multiple systems.

One of the key choices made during the development process was to allow for in-flight software update capabilities to be available for all sub-systems. This meant that a basic software package was loaded into the satellite before launch implementing a set of basic (and well-tested) functionalities while leaving the possibility of new features to be added at a later stage. This is a common practice for many systems used nowadays but the limited access we have for a satellite, as compared to distributed sensors or mobile devices, means that no "manual restore" possibilities were available: this means our software update service would be able to tolerate or prevent update failures as they would lead to mission failure. We then decided to divide the available memory space on each MCU in 3 separate regions, where the first one would be programmed at launch time and made write-protected for the full duration of the mission. Two new memory slots would be available for future updates and every failure to operate or boot from these two slots would lead the system to revert to the original, pre-programmed memory

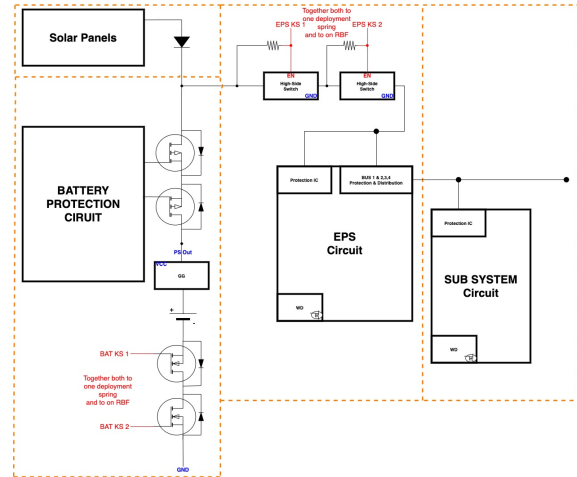

Fig. 8. Delfi-PQ high-level protection and inhibit switches.

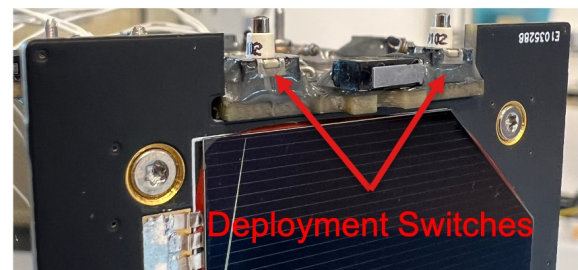

Fig. 9. Delfi-PQ deployment/separation switches.

image. This solution allowed us to shorten the development life-cycle as more advanced functionality was deemed for future usage.

### 3.4. Electrical Power System

The electrical power system consists of three individual components: the main and battery boards and the solar panels. The system contains high-level current protections and the inhibit switches, as shown in Fig. 8.<sup>10,17,18</sup> They are required in order to isolate the battery and the loads while handling the satellite (controlled by the Remove Before Flight (RBF) tag) and while the satellite is integrated into the deployer. In Figure 9, two separate deployment switches are shown, on the -Z side of the satellite. These switches act in case of separation springs (KSU213WLFG), with  $0.7 \pm 0.5$  N force, and as deployment switches.<sup>19</sup> One high-side inhibit on EPS and one low-side inhibit on the battery is connected to one and the other two inhibits are connected to the switch.

In order to bring flexibility to other subsystems and to save space on EPS, a regulated bus voltage approach was not used. EPS controls and measures four unregulated buses. Per bus, the unregulated voltage is 3 V - 4.2 V and the maximum continuous power consumption of the satellite can be 4.5 W. In addition, due to limited surface area, as seen in Fig. 10, Maximum Power Point Tracking (MPPT) circuits are placed on each solar panel, shown in Fig. 12.

EPS collects data via internal 3 Inter-Integrated Circuit (I2C) buses: One for the main board itself which collects data related to board temperature (1 TMP100), 1 overall power consumption of the whole satellite, internal power consumption, and bus (1 to 4) power consumption. The second I2C line is dedicated to the battery system, to read out 1 Gas Gauge and 1 INA for battery cell charge levels/states. The third I2C bus is for the

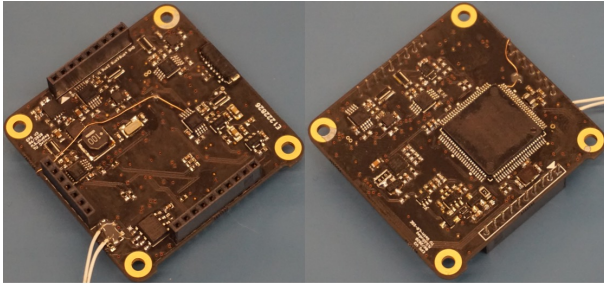

Fig. 10. EPS top(left) and bottom(right) view.

solar panels, there are 15 INA226 current/power monitors and 4 TMP100 temperature sensors. A separate stacking connector for the battery connection, consisting of I2Cs, power from the battery, and solar panel, and another connector for RBF and Kill Switch (KS) are present on the board.

### 3.4.1. Battery

The battery board includes 2 Lithium-Ion cells (with a capacity of 750 mAh each), a battery protection circuit, power monitor of solar panels and it provides a path for power transfer from solar panels to the main EPS board. The system does not have a heater, due to limited time during development and with respect to thermal analysis, it was not necessary. Our calculations were 30 degrees off, which is causing minor problems resulting in shorter operational duration per orbit.

Board has two inhibit switches, that disconnect the batteries along the power line from the negative terminal to the ground, Fig. 8. This is a requirement from launch providers. In addition, there are protections against various events on the battery. When the battery voltage drops below 2.8 V system disables discharging. When the battery voltage reaches 4.2 V or the battery cells' temperature reaches 0°C (low-temperature protection) or 40°C (high-temperature protection) protection circuit disables charging to protect the battery.

Although the protection system work for the events that we have mentioned, we have encountered a problem with bypass diodes of the protection MOSFETs. As an example, when the battery triggers the protection for low-temperature or high-temperature, it disables the charging MOSFET, although the satellite can still discharge, due to the voltage drop on the bypass diode of charging MOSFET, the system turns on with 0.7 V lower than the actual battery voltage. This issue creates an extra problem where EPS cuts the power on the BUS. As an example, when the battery is actually 3.7 V, charging MOSFET is disabled so the voltage is 3.0 V, and due to the extra protection on the EPS against the low-voltage system goes into a brownout. Especially when the COMMS is about the transmit, it draws extra current which causes extra voltage drop and triggers the protection on EPS and turns the whole satellite off. Thus satellite works properly during sunlight or if it is also warm enough.

The battery board itself is the "connector" for the solar panels. In order to simplify integration and reduce the number of cables in the satellite, spring-loaded connectors, Fig. 11, were used. The mating of these connectors is strips of bare copper on the solar panels. In Figure 12, on the bottom view, these bare copper stripes are shown. As seen in Fig. 11, the bus connector is in between the spring-loaded connectors. Not to use multiple individual parts and to have symmetry in the design two 3-pin spring-loaded connectors were used on each side of the board.

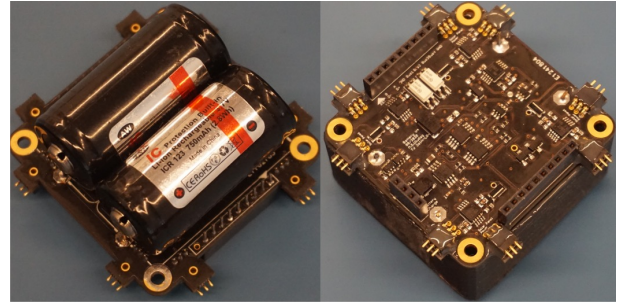

Fig. 11. Battery board top(left) and bottom(right) view.

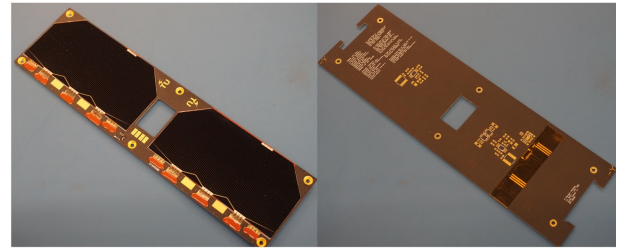

Fig. 12. Solar Panel top(left) and bottom(right) view.

One is solar panel power, ground, and 3.3 V (supply for sensors on the solar panel) and the other connector is for interface I2C pins and ground in between.

### 3.4.2. Solar Panels

The satellite has 4 solar panels along X and Y axes. These panels are also part of the structure by design with the combination of three structural ribs mentioned in Section 3.1. Each panel contains two solar cells and every cell has its own MPPT circuit. A circuit per cell was placed to measure power generation per cell before and after MPPT for characterization and to track performance, and to reduce the load current per MPPT thus allowing us to use a low-profile inductor.

In addition, every panel has a cutout for the laser reflector, Section 3.8.3., a temperature sensor, and three power monitoring circuits. In orbit data shows that solar panel temperatures swing between -40°C and 40°C. Temperature is measured from the external side of the solar panel.

### 3.5. Communication System

The COMMS system is composed of three separate boards to make the design modular and accommodate for system changes in an easier way: a receiver/transmitter board interfacing directly with the satellite bus and modulating / demodulating the radio signals; an amplifier board containing the low-noise and power amplifier; an antenna phasing board to connect the single antenna elements on the satellite to form the uplink/downlink antennas.

The main board, shown in Fig. 13, is used to interface with

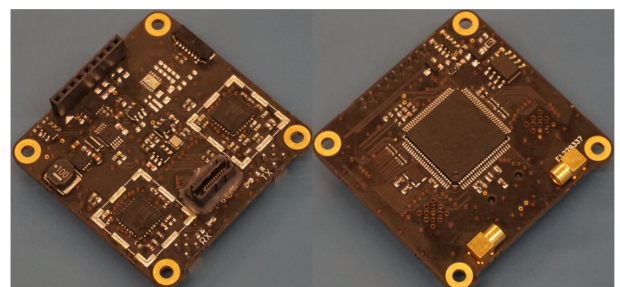

Fig. 13. COMMS top(left) and bottom(right) view.



the satellite bus and modulate/demodulate the radio signals. The transmission/reception is carried out by two commercial integrated circuits (SX1276 from Semtech), performing modulation/demodulation and clock generation and recovery. The MCU present on the board is responsible instead to encode and decode the bit-stream to/from messages to be handled by the satellite. This solution was selected to allow protocol flexibility and not be limited by the solutions implemented in the integrated circuits: this solution is also ideal for an educational mission where freedom is left to try out new solutions. The system operates in amateur bands, particularly transmitting in the 435 - 438 MHz band and receiving in the 145.9 - 146 MHz band and using 25 kHz wide channels. This, together with the limited required throughput, makes the trade-off for the modulation selection simple: Gaussian Minimum Shift Keying (GMSK) with a Bandwidth - Time product (BT) of 0.5 was selected as it provides excellent bandwidth usage, allowing a communication speed up to 9600 bps with a good link margin and allows for an efficient non-linear power amplifier, not being sensitive to distortion. Boosting power efficiency in the communication system is also a key advantage of our design as the radio is the heaviest load in the satellite and it is also almost continuously operated.

The radio is implemented as a fully independent system, being able to operate (eventually) also autonomously from the On-Board Computer (OBC): received messages are stored in an internal queue (with a capacity of almost 200 messages) so that they can be queried without a critical polling interval. The system also includes a command processor, capable of interpreting the radio messages to execute critical commands. This includes the possibility of sending commands on the satellite bus and forwarding the replies to ground to eventually bypass the OBC in case of failure. A direct connection to the EPS is also present to allow for a full-satellite power-cycle upon radio command, again providing a backdoor to recover a satellite with an eventual malfunctioning OBC.

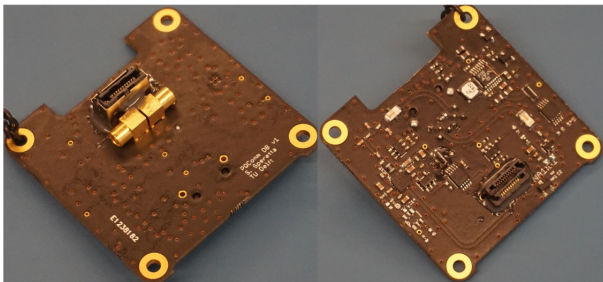

Fig. 14. COMMS daughter board top(left) and bottom(right) view.

All Radio Frequency (RF) amplifiers, shown in Figure 14 are located on a daughter-board attached directly connected on the communication system main board. This allows for a very compact system and makes the design modular, an ideal feature for an educational project where all functionalities can be assigned to different team members. In this way, after a simple interface is defined, work can flow independently and multiple implementations can be realized and easily swapped to verify performances without major system modifications. The radio daughter-board features a 1 W peak power amplifier (RFPA0133 from Qorvo) capable to also be operated at lower power levels (nominally 0.25 W but also 0.5 and 1 W)

during the different mission phases and providing an efficiency of 55 - 65 %. A dedicated power supply, specifically designed to maximize the power amplifier's overall efficiency was also designed, directly connected to the satellite power bus in order not to break the modularity. A Low-Noise Amplifier (LNA) is also present to improve the receiver sensitivity while still suppressing the transmitter signal to allow full-duplex operations.

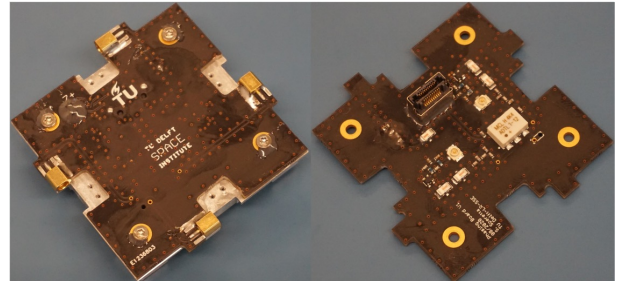

Fig. 15. COMMS phasing board top (left) and bottom (right) view.

The last component of the communications system is the phasing board, located on the satellite edge, and used to connect the single antenna elements together and produce the required radiation patterns. This board is visible in Figure 15 and at the top of Figure 1 while integrated on the satellite. The antenna system features:<sup>4)</sup>

- a low-frequency antenna (see Section 3.8.2. for further details) directly attached to the payload to limit stray capacitance;
- a monopole operating at 145 MHz for the uplink receiver, connected to the LNA on the communication system daughter-board;
- a dipole antenna operating at 435 MHz, built by combining two monopoles on the two satellite sides, used for downlink and directly connected to the communication system daughter-board;
- two independent antennas, built using the monopoles used for downlink, to feed two separate Global Navigation Satellite System (GNSS) receivers operating in the GPS L1 and L2 bands.

The GNSS receivers were supposed to be flown as payloads to demonstrate a differential GNSS system for formation flying with the two receivers being directly attached to the satellite and featuring a fixed baseline to verify the full functionality. Unfortunately, such payload could not be flown and the final satellite integration happened in the summer of 2020 and the COVID pandemic led to considerable delays in the deliveries of satellite components. Further details on this can be found in Section 4.

Given the operational frequencies of the antenna system, the antennas are too big to fit on a satellite without being stowed during launch: this means that the phasing board also has to include elbows to allow for the rotation of all the monopoles and a mechanism to ensure they are kept in position after deployment. MMCX connectors are used as rotating elbows as they conjugate a very small size together with a possibility to rotate for a limited amount of times (typically 10 - 100 rotations cause no degradation in RF performances). Moreover, each antenna element also includes a spring and a stop mechanism to ensure the antenna is kept in a fixed position after deployment.

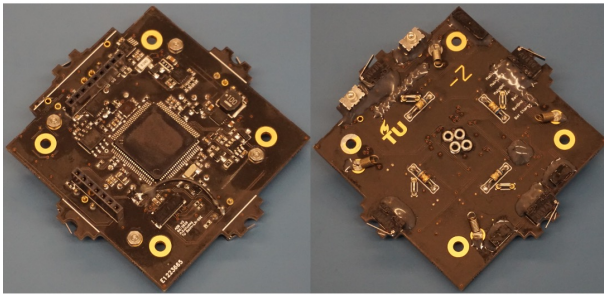

Fig. 16. Antenna Deployment Board top (left) and bottom (right) view.

### 3.6. Antenna Deployment Board

As mentioned in Section 3.5., the antenna system is too big to fit on the spacecraft in the nominal operational configuration while integrated into the deployment canister: this requires the deployment of the 4 separate monopoles and this task is performed by the antenna deployment board, which can be seen in Fig. 16. This board is expected to be used only in the initial mission phases to release, using 4 thermal knives, each monopole in sequence. The deployment sequence is initiated by the OBC after the satellite is released from the rocket's upper stage: a 15 minute delay has been used to ensure the satellite is far enough from any other object to avoid both radio interference and eventual collisions. At this stage, the OBC initiated the deployment sequence and it verifies first the battery status: a too-low battery charge status might cause the satellite to reboot during such sequence and could cause the mission failure. But an infinite delay (because of, for example, a faulty battery voltage sensor) could also lead to mission failure so a maximum timeout of 2 hours was implemented (which had been demonstrated on the ground to be sufficient to charge the batteries to the required level starting from a full empty state). After the satellite battery status of charge has been verified, the OBC verifies the temperature of the deployment system and (eventually) delays the deployment if the temperature is below 0°C. Based on ground testing in a vacuum, the thermal knives would require a few seconds to cut the restraining wires, freeing up the antennas, if the environment temperature is about 0°C, but this time might increase to more than 30 s under -20°C. This situation, considering 4 antennas have to be deployed, could lead to excessive power consumption, discharging the battery and causing the sequence to be interrupted: because if this the minimum deployment temperature threshold was introduced as the total battery capacity is limited. As a safety precaution, a 2 hours timeout was also used to ensure deployment.

The deployment process is performed by four 0.25 W resistors which are provided approximately 3.5 W of power, causing them to overheat to 160°C and melting the restraining wire: a typical temperature of 120 - 140°C is required for the wire to melt so our system provides a considerable safety margin. A thermal infrared image during the antenna deployment process is shown in Fig. 17 to clarify the process.

### 3.7. On-Board Computer

The OBC is the brain of the satellite. Its main purpose is to be the interface between multiple subsystems as well as data acquisition&storage. Its architecture is based on the core, mentioned in Sec. 7 and Fig. 3.2.. The FRAM, from the core design, is used for parameter storage. In addition to the core components

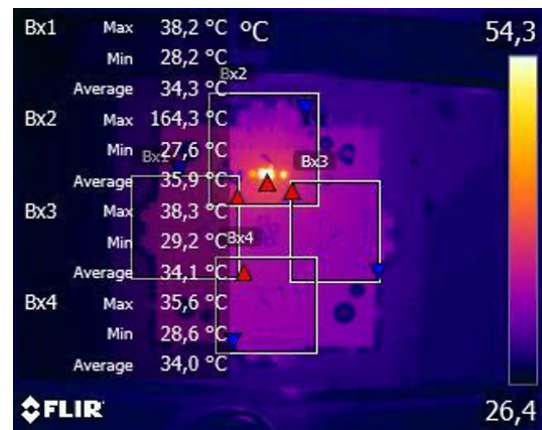

Fig. 17. Thermal infrared image of the Antenna Deployment Board during deployment.

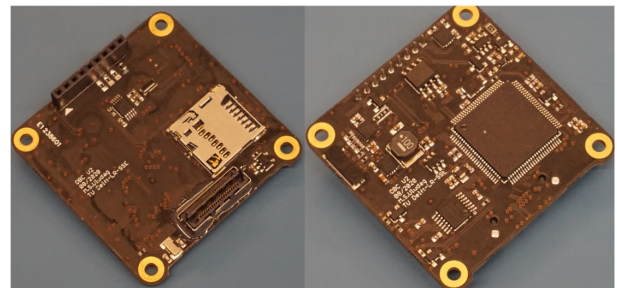

Fig. 18. OBC top (left) and bottom (right) view.

OBC has an additional micro SD card for mass data storage and a daughter board connector for future payload developments, Fig. 18. The daughter board connector has 40 pins, it features; 1 unregulated bus, 1 I2C line, 2 optional I2Cs, 2 optional Serial Peripheral Interfaces (SPIs), and various analog&digital pins. One of these payloads was going to be the GNSS, details about this payload will be given in Sect. 3.8.4., later on, this system was turned into secondary OBC, Sec. 3.8.5.. The subsystem has been designed in a way to allow complete software change, see Sect. 3.3. for further details, thus allowing for future improvements in operations.

### 3.8. Payloads

This section presents the different satellite payloads developed by students as part of their academic curriculum: the whole satellite was considered as a demonstration but systems have been split between fundamental ones, without whom the satellite would not be operational (classified as core) and payloads, presented in this section. Four payloads were expected to fly on Delfi-PQ but, unfortunately, one of them could not be delivered in time for the flight.

#### 3.8.1. Attitude Determination and Control System

The Attitude Determination and Control System (ADCS) system, Fig. 19 has been designed to slow down the satellite tumbling after deployment using magnetic torquers, Fig. 20 only and, potentially, obtain coarse pointing, within an accuracy of 20°, even if the latter would not be strictly required by any of the on-board systems. Satellite attitude control is a core topic in Aerospace Engineering education and, as such, this system offers to directly demonstrate in space some of the core competencies of students. In this sense, this system is seen as a lab-in-space where students, as part of their curricular activities, deal with the problem and propose improved algorithms to



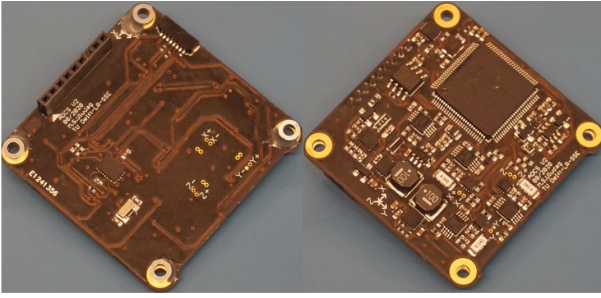

Fig. 19. ADCS top(left) and bottom(right) view.

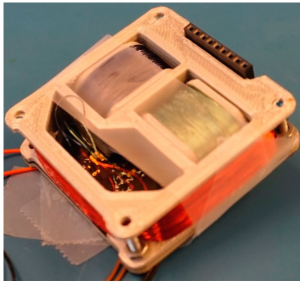

Fig. 20. Fully assembled ADCS with 3 axis magnetorquers.

be tried in space. Thanks to the in-flight software update capabilities (see Sect. 3.3. for more details) this system is being actively used in education also after the satellite launch, as compared to many other student projects where development stops at satellite delivery.

The system features a Bosch BMX055 9 degrees of freedom Inertial Measurement Unit (IMU), featuring a 3-axis magnetometer, accelerometer, and gyro for sensing and 3 air-core torquers for actuation. The torque coils<sup>11)</sup> have been designed without an iron core to limit hysteresis problems on one side, but also due to the difficulties in manufacturing a proper low-hysteresis core. Materials are available in standard sizes which are not compatible with the satellite dimensions and the team could not cut them to shape and thermally treat them afterwards. These air-core coils provide a more limited torque, impacting the set of maneuvers that could be carried out. As the key mission need was only detumbling, a lower actuation torque would simply slow down the process and be acceptable for the first mission.

Due to the size constraints, coils had to be designed to fit within the available volume and shape and this brought the team to select 3D additive manufacturing for production, using UL-TEM 9085<sup>20)</sup> for manufacturing the spools. This material has limited outgassing with a total mass loss of less than 0.5% while also having a wide operational temperature range. This allowed us to customize the coils' design for the available space and obtain a mass of only 10 g. Figure 19 shows the ADCS board while Fig. 20 also shows the integrated coils assembled on the board.

### 3.8.2. Low-Frequency - Low Noise Amplifier

This payload was designed as a demonstrator for a future in-space radio-astronomy mission that would listen to frequencies between 500 kHz and 1 MHz, which correspond to the first emissions of ionized Hydrogen atoms after the formation of the universe and would have been re-shifted by now to such low-frequency range.<sup>21)</sup> As the Earth's atmosphere is attenuating such frequencies and the planet emits noise (mostly due

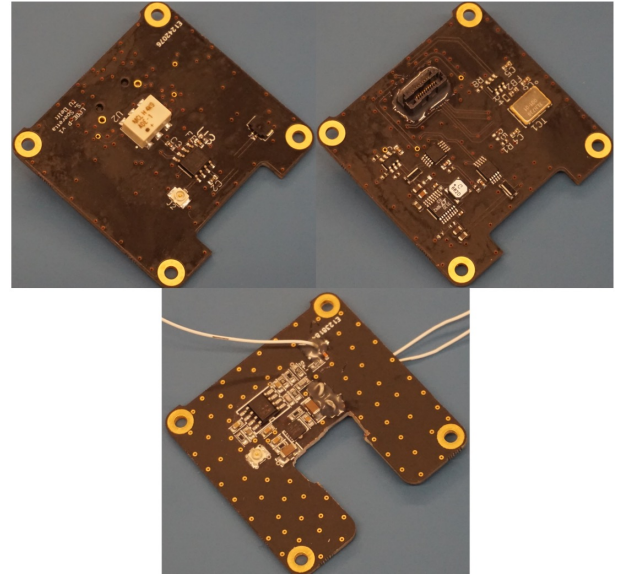

Fig. 21. LNA mixer board (top) and LNA itself (bottom).

to man-made systems), the reception of such frequencies is not possible in Earth's vicinity, but this demonstration focuses on the LNA part only, shown in Fig. 21 to advance its technology readiness level. This payload would not be capable of radio-astronomic grade observations but only to demonstrate that the design can survive the space environment while using Earth interferences as signals of interest. The antenna used (as described in Sect. 3.5.) is only 17 cm long and not enough to efficiently capture low-frequency signals, it is capable enough to capture strong man-made signals.

The purpose of this payload is thus to collect and record the strength of low-frequency signals using a simple RF channel power estimator (using a Semtech SX1276) and sweeping the frequency spectrum using a custom-made up-converter that translates the input signals spectrum up to the operational band of the receiver.

### 3.8.3. Laser Reflectors

Very small satellites are often said to be harder to track than bigger ones, especially as the radar measurements signal-to-noise ratios could be lower and this could lead to higher orbit uncertainties<sup>22)</sup> but reference measurements are lacking to back this up. To address this problem, the satellite carries four laser reflectors, located on separate faces of the satellite, to be laser-tracked. This could provide a reference orbit to compare to radar measurements and assess the actual accuracy of the orbital elements.

The laser reflectors are assembled on an Aluminium holder, as seen in Fig. 22, very close to the geometric center of the satellite's long faces. As the satellite will likely present a small tumbling along the major axis, this will ensure the satellite could be visible by laser stations despite the small viewing angle of such reflectors.

A laser-tracking campaign is currently expected to be carried out by the end of 2023.

### 3.8.4. GNSS receivers

The Delfi-PQ mission is considered as a precursor for a future satellite formation and used to de-risk some of the critical systems, two GNSS receivers were supposed to be flown. Such receivers, configured to perform relative-GNSS measurements

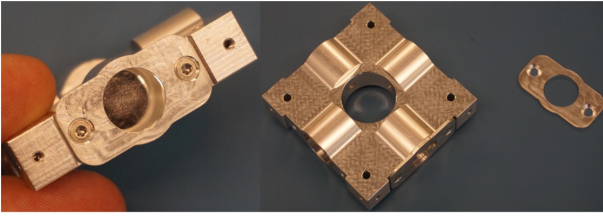

Fig. 22. Laser Reflector, its holder and lid.

to determine the relative position down to an accuracy of a few centimeters (even if the position accuracy for the single receiver is only a few meters) were supposed to be mounted with a fixed baseline. This would have allowed us to estimate the system errors (considering the fact the distance between the two receiver antennas was perfectly known and fixed) and validate a concept for the future mission.

Unfortunately, due to an extended lead time during the COVID pandemic in 2020 (see Sect. 4. for further details), the receivers could not be integrated on time on the spacecraft and they could not be flown. The payload also included an OBC board used as a data recorder: this board was ready on time and, as such, was flown as described in Section 3.8.5..

### 3.8.5. Secondary OBC

The secondary OBC payload was initially conceived as the data-recorder used in conjunction with the GNSS payload (described in Sect. 3.8.4.): as the receivers had not been delivered on time for integration, they were removed but the second OBC was still integrated and left without flight software for future experimentation. After launch, the board was found a second purpose: allow student-developed projects to be run in space in a safe way, without impacting the existing OBC. The first project (still in development as of the summer of 2023) entails running neural networks on-board to forecast satellite telemetry and eventually fully predict the satellite behavior in orbit: this could allow the spacecraft to become aware of its status without ground interventions. This could eventually allow satellites to stop downloading telemetry in case this matches with the expected values, freeing up precious communication bandwidth.

## 4. COVID Pandemic effects

The project started at the beginning of 2017 with the usual mission definition and preliminary design phases and, towards the end of 2019, reached a milestone with the first satellite integration, with satellite systems being at an engineering model stage while a few of the payloads were not complete yet. By that time, the team had a clear timeline in mind for the completion of the remaining tasks and the assembly of the flight models, expecting the satellite to undergo environmental testing around September 2020. The launch procurement process was then started and, around the beginning of March 2020 the contract was about to be signed and the first payment milestone was reached. The team did not expect that, as of March 16th, The Netherlands would go into a strict lockdown due to the COVID pandemic: the whole university campus was then closed, all students and staff members were forced to remain at home and the project was paused. Luckily, a few weeks later, 3 staff members were allowed to continue working on the university campus while all students were still forced to work from home: this

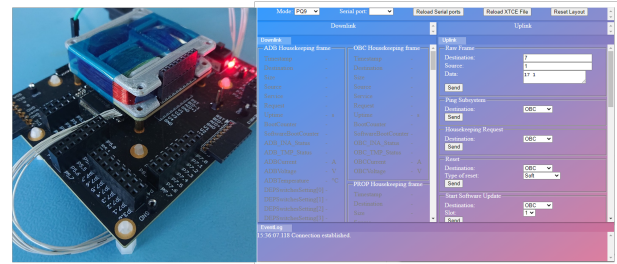

Fig. 23. Delfi-PQ flatsat (left) and web-based control interface (right).

reversed completely the satellite integration strategy, where students from home would be instructing staff members on how to operate and integrate their projects in the satellite. Delivery of services and components had been also heavily impacted with some components having months of delay: a notable example where the two GNSS receivers that were meant to demonstrate differential navigation for future missions. These receivers, initially supposed to be delivered in April, were delivered finally at the end of August 2020, within a few weeks from the satellite environmental testing. This timeline proved to be too tight to fully test the receivers and they were in the end not integrated into the satellite.

Several parts of the development could not be carried out in person due to the lockdown and this required an alternative strategy to be developed. The team developed thus an interface board, capable of interfacing the satellite internal bus to a computer and also providing controlled stimuli (like power or input signals) to the different satellite boards and created a dedicated web application to command such setup. Students, while working from home, were then able again to run most of the tests they could not finish before the lockdown and help debug the different satellite sub-systems. This approach proved so successful that it was also included in some of the courses part of the MSc curriculum in Aerospace Systems: this web system provided a simple and universal interface for students to use the different systems remotely, or simply from a different room. This also simplified data acquisition for the different educational assignments and allowed students to focus on more interesting aspects in their courses. Such an approach is still in use today and it is expected to be extended by adding more hardware platforms. An example of the hardware used can be seen in Figure 23, together with the web interface that was developed.

## 5. Conclusion and Future Work

This paper presents the design and assembly of Delfi-PQ, a 3P PocketQube developed by the Delft University of Technology and launched to space in January 2022. The mission was developed as part of the educational curriculum in Aerospace Engineering between 2017 and 2020, with the final satellite integration and delivery for launch happening in September 2020, during the COVID pandemic. Many of the activities have been carried out while The Netherlands was in lockdown (see Sect.4. for further details), driving several mission decisions to still meet the delivery and launch timelines.

This paper presents the overall satellite structure and all of its sub-systems, including a high-level description of the architec-

tural choices made during development. Delfi-PQ was always considered a demonstrator for technologies to be used in future missions, so it is natural that after the first demonstration phase, a second mission would come. This is currently the focus of the team, which has successfully demonstrated a single very small satellite could be developed and launched by Aerospace Engineering students. A second mission, which kicked off in early 2023 is currently taking its lessons learned from Delfi-PQ, addressing the identified weaknesses and focusing on delivering two satellites for a formation-flying demonstration to be flown by the end of 2025.

## References

- 1) Radu, S., Uludag, M. S., Speretta, S., Bouwmeester, J., Menicucci, A., Cervone, A., Dunn, A., Walkinshaw, T., Kaled Da Cas, P. L., Cappelletti, C., and Graziani, F. : PocketQube Mechanical Interface Standard, <https://dataverse.nl/api/access/datafile/11680>, (accessed April 20, 2023).
- 2) Radu, S., Uludag, M. S., Speretta, S., Bouwmeester, J., Menicucci, A. : PQ9 and CS14 Electrical and Mechanical Subsystem Interface Standard for PocketQubes and CubeSats, <https://doi.org/10.34894/6MVBCZ>, (accessed April 20, 2023).
- 3) Bouwmeester, Jasper, Gill, E., Speretta, S. and Uludag, S. : A New Approach on the Physical Architecture of CubeSats & PocketQubes, Proceedings of the 15th Reinventing Space Conference, Glasgow, UK, 2017.
- 4) Speretta, Stefano, Uludag, S., Karunanithi, V., Radu, S., Chronas Foteinakis, N., Bouwmeester, J., Menicucci, A. and Gill, E. : A Multi Frequency Deployable Antenna System for Delfi-PQ, Proceedings of the International Symposium on Space Technology and Science, Fukui, Japan, 2019.
- 5) Radu, S., Uludag M. S., Speretta, S., Bouwmeester, J., Gill, E. and Foteinakis, N. : Delfi-PQ: the first PocketQube of Delft University of Technology, 69th International Astronautical Congress, Bremen, Germany, IAC-18-B4.6B.5, 2018.
- 6) Cappelletti, Chantal and Battistini, Simone and Graziani, Filippo; Advances in Space Research- "Small Launch Platforms for Microsatellites"
- 7) Cappelletti, C., 2018. "Femto, pico, nano: an overview of new satellite standards and applications." In: Advances in Astronautical Sciences, Proceedings of the 4th IAA Conference on University Satellite Missions and CubeSat Workshop, vol. 163, pp. 503–510.
- 8) Delfi Space: Delfi Program, Vision, <https://www.tudelft.nl/lr/delfi-space/delfi-program> (accessed April 20, 2023)
- 9) Azure Space, Space Solar Cells, [https://www.azurespace.com/images/products/0003401-01-01\\_DB\\_3G30A.pdf](https://www.azurespace.com/images/products/0003401-01-01_DB_3G30A.pdf) (accessed April 20, 2023)
- 10) JAXA.: JEM Payload Accommodation Handbook, Vol. 8-Small Satellite Deployment Interface Control Document, JX-ESPC-101133-B, <https://iss.jaxa.jp>, (accessed April 20, 2023)
- 11) van den Bos, M.: Design and Testing of Magnetic Torquers for Pico Satellite Attitude Control, M.Sc. Thesis, Delft University of Technology, 2019.
- 12) Texas Instruments: MSP430 microcontrollers, <https://www.ti.com>, (accessed April 23, 2023)
- 13) Mouser, Texas Instruments M4FR5969SPHPT-MLS, <https://nl.mouser.com>, (accessed May 14, 2023)
- 14) Mouser, Texas Instruments MSP430FR5969IRGZR, <https://nl.mouser.com>, (accessed May 14, 2023)
- 15) DigiKey, Texas Instruments M4FR5969SPHPT-MLS, component, <https://www.digikey.nl>, (accessed May 14, 2023)
- 16) DigiKey, Texas Instruments MSP430FR5969IRGZR, component, <https://www.digikey.nl>, (accessed May 14, 2023)
- 17) NanoRacks: NanoRacks CubeSat Deployer(NRCSD), Interface Definition Document(IDD), <https://nanoracks.com>, (accessed May 16, 2023)
- 18) Cal Poly: CubeSat Design Specification Rev. 14.1, The CubeSat Program, Cal Poly – San Luis Obispo, Feb 2022, (accessed May 16, 2023)
- 19) C&K Switches, KSU213WLFQ Datasheet, <https://www.ckswitches.com/>, (accessed May 22, 2023)
- 20) Materialise: 3D Printing Materials, ULTEM 9085, <https://www.materialise.com/>, (accessed May 22, 2023)
- 21) Bentum, Marinus Jan, Verhoeven, C. J. M. and Boonstra, A. J. : OLFAR-orbiting low frequency antennas for radio astronomy, Proceedings of the ProRISC 2009, Annual Workshop on Circuits, Systems and Signal Processing, Veldhoven, NL, 2009.
- 22) Speretta, Stefano, Sundaramoorthy, P. and Gill, E. : Long-Term Performance Analysis of NORAD Two-Line Elements for CubeSats and PocketQubes, Proceedings of the 11th IAA Symposium on Small Satellites for Earth Observation, Berlin, DE, 2017.