



Delft University of Technology

## DeepPick

### A Deep Learning Approach to Unveil Outstanding Users Ranking with Public Attainable Features

Li, Wanda; Xu, Zhiwei; Sun, Yi; Gong, Qingyuan; Chen, Yang; Ding, Aaron Yi; Wang, Xin; Hui, Pan

#### DOI

[10.1109/TKDE.2021.3091503](https://doi.org/10.1109/TKDE.2021.3091503)

#### Publication date

2023

#### Document Version

Final published version

#### Published in

IEEE Transactions on Knowledge and Data Engineering

#### Citation (APA)

Li, W., Xu, Z., Sun, Y., Gong, Q., Chen, Y., Ding, A. Y., Wang, X., & Hui, P. (2023). DeepPick: A Deep Learning Approach to Unveil Outstanding Users Ranking with Public Attainable Features. *IEEE Transactions on Knowledge and Data Engineering*, 35(1), 291-306. <https://doi.org/10.1109/TKDE.2021.3091503>

#### Important note

To cite this publication, please use the final published version (if applicable). Please check the document version above.

#### Copyright

Other than for strictly personal use, it is not permitted to download, forward or distribute the text or part of it, without the consent of the author(s) and/or copyright holder(s), unless the work is under an open content license such as Creative Commons.

#### Takedown policy

Please contact us and provide details if you believe this document breaches copyrights. We will remove access to the work immediately and investigate your claim.

***Green Open Access added to TU Delft Institutional Repository***

***'You share, we take care!' - Taverne project***

**<https://www.openaccess.nl/en/you-share-we-take-care>**

Otherwise as indicated in the copyright section: the publisher is the copyright holder of this work and the author uses the Dutch legislation to make this work public.

# DeepPick: A Deep Learning Approach to Unveil Outstanding Users With Public Attainable Features

Wanda Li<sup>1</sup>, Zhiwei Xu<sup>1</sup>, *Student Member, IEEE*, Yi Sun, Qingyuan Gong<sup>1</sup>,  
Yang Chen<sup>1</sup>, *Senior Member, IEEE*, Aaron Yi Ding<sup>2</sup>, *Member, IEEE*,  
Xin Wang, *Member, IEEE*, and Pan Hui<sup>3</sup>, *Fellow, IEEE*

**Abstract**—Outstanding users (OUs) denote the influential, “core” or “bridge” users in online social networks. How to accurately detect and rank them is an important problem for third-party online service providers and researchers. Conventional efforts, ranging from early graph-based algorithms to recent machine learning-based approaches, typically rely on an entire social network’s information. However, for privacy-conscious users or newly-registered users, such information is not easily accessible. To address this issue, we present DeepPick, a novel framework that considers both the generalization and specialization in the detection task of OUs. For generalization, we introduce deep neural networks to capture dynamic features of the users. For specialization, we leverage the traditional descriptive features to make use of public information about users. Extensive experiments based on real-world datasets demonstrate that our approach achieves a high efficacy of detection performance against the state-of-the-art.

**Index Terms**—Deep neural networks, online social networks, outstanding user detection

## 1 INTRODUCTION

THE rapid growth of online social networks (OSNs) brings a surge in user-generated contents (UGC). On one hand, the massive base of UGC is of great help for people to make decisions about their daily lives. On the other hand, however, it also troubles people when they are trying to decide what to read, especially in popular platforms like Yelp [1], [2], [3] and Foursquare [4], [5], [6]. Generally, a user tends to be influenced by the *outstanding users* (OUs) in the network, since they always play a critical role in online communities

[7], [8]. Based on the popular independent cascade (IC) model [9], OUs may have better capabilities of information dissemination. Representative examples of OUs are structural hole spanners [10], [11], influential users (e.g., high degree centrality or ego-betweenness centrality [12]), and elite users in the network.

OUs have long been shown to be one of the fundamental building blocks of many business problems and social applications, e.g., recommender systems [13], [14], viral marketing [15], and information diffusion [16], [17]. Thus, there are various methods of OU detection in recent literature [13], [18], [19], [20], [21]. However, existing methods suffer from one or more of the three following drawbacks: 1) The network structure sometimes is fragmentary due to users’ privacy configurations. A user may choose to hide her friend list or follow someone privately. Thus, obtaining the entire social graph is very difficult, if not impossible, for third-party service providers or researchers. 2) The UGC and other types of user features are usually abundant in real-world scenarios and can provide idiographic information to depict a user. Ignoring these features can cause inaccuracy in the task of distinguishing particular types of OUs. 3) Modern OSNs usually contain millions of users or even more, and general deep learning solutions may introduce complexity to the identification process.

To resolve these issues, we design and implement DeepPick, a novel framework that detects OUs without referring to the social connectivity information of the entire network. DeepPick only adopts the publicly-visible information to extract users’ social graph-related characteristics. Such information could be the reviews, visited Points of Interests (POIs), and profiles. The features DeepPick leverages include five types: sentiment, temporal, linguistic, spatial,

- Wanda Li, Zhiwei Xu, Yi Sun, Qingyuan Gong, Yang Chen, and Xin Wang are with the School of Computer Science, Fudan University, Shanghai 200438, China, and with the Shanghai Key Lab of Intelligent Information Processing, Fudan University, Shanghai 200438, China, and also with Peng Cheng Laboratory, Shenzhen 518066, China. E-mail: {wdli16, gongqingyuan, chenyang, xinw}@fudan.edu.cn, zhiweixu@shu.edu.cn, syj827@163.com.
- Aaron Yi Ding is with the Department of Engineering Systems and Services, Delft University of Technology, 2628 Delft, The Netherlands. E-mail: Aaron.Ding@tudelft.nl.
- Pan Hui is with the Department of Computer Science, University of Helsinki, 00014 Helsinki, Finland, and also with the Department of Computer Science and Engineering, Hong Kong University of Science and Technology, Clear Water Bay, Kowloon, Hong Kong. E-mail: panhui@cse.ust.hk.

Manuscript received 24 July 2020; revised 28 April 2021; accepted 27 May 2021.  
Date of publication 22 June 2021; date of current version 7 December 2022.

This work was supported in part by the National Natural Science Foundation of China under Grants 62072115, 71731004, 62102094, 61602122, and 61971145, in part by China Postdoctoral Science Foundation under Grant 2021M690667, in part by the Research Grants Council of Hong Kong under Grant 16214817, in part by the 5GEAR project and FIT project from the Academy of Finland, the European Union’s Horizon 2020 Research and Innovation Programme under Grant 101021808, and iSafe Project funded by TU Delft Safety & Security Institute. (Corresponding author: Yang Chen.)

Recommended for acceptance by S. S. Bhowmick.

Digital Object Identifier no. 10.1109/TKDE.2021.3091503

and demographic. Sentiment features indicate the inner characteristics of a user's attitude. To get those implicit features, we propose the TextCNN Long-Short Term Memory (TC-LSTM) structure, which uses the users' reviews to detect OUs. Apart from the sentiment view, reviews could provide recognizable features from other particular perspectives, i.e., temporal and linguistic. We extract those features by analyzing the users' reviews. Spatial features are the users' visited POIs' attributes, revealing users' social status by their visited real-world POIs. Demographic features are conventional material for user analysis and have been shown helpful. Most times, they can be obtained from a user's profile. In short, we have made three key contributions:

- We formulate the concept of OUs to represent the nodes with high diffusion capability in the information cascade (IC) model, then design and implement a framework, DeepPick, to distinguish those OUs with the information of just a few users for training.
- We propose a mixed feature selection strategy of combining deep neural networks and traditional feature selection methods, which can be conveniently applied in detecting OUs in OSNs.
- Our framework can validate whether a user is outstanding by public attainable information instead of the whole network's structure. Exhaustive evaluations of the performance based on real-world datasets demonstrate the advantage of our approach against the state-of-the-art.

The rest of this paper is organized as follows. Section 2 defines the OUs, presents the dataset, and shows the location-related metrics. In Section 3, we expound on the idea of DeepPick, the OU detection framework. Section 4 describes the architecture of the sentiment features extractor, TC-LSTM, which is the review processing module of our framework. Section 5 provides a thorough explanation of implementing details and evaluation of DeepPick. Section 6 outlines previous studies related to our work. Section 7 discusses more about model designs, the time complexity, and OUs' relationship with "active users". In the last section, we summarize our work and give some future directions.

## 2 BACKGROUND AND DATASET

In this section, we illustrate the background of our study. We first formally define the outstanding users (Section 2.1) and then overview the two datasets we used in this work (Section 2.2). After that, we introduce how to depict the role of locations in OU detection (Section 2.3).

### 2.1 Definition of Outstanding Users

As Gladwell states in "The Tipping Point" [22], outstanding users are the 20% participants who occupy 80% of social capital. Although there are diverse styles of argument [23], [24], [25] of social capital, in short, it is the metaphor about social advantages, i.e., the advantages include information, influential power, and trust. Several studies have validated that a set of users are especially related to positive indicators of social capital, including social impact [26] and information diffusion [27], [28]. According to [29], social benefits can be attained by occupying some unique positions in the

network. In this paper, we refer to this group of important users as outstanding users.

We define the outstanding users based on one of the most widely used models of information diffusion, the independent cascade (IC) model [9], [30], [31]. In the IC model, an activated node  $a$  in set  $A_i$  will activate its neighbors  $W$  with a probability of diffusion  $p_{a,W}$  defined by their social connections. This procedure is iterated in discrete steps (i.e.,  $i = 0, 1, \dots$ ). The initial set,  $A_0$ , represents the first activated node set responsible for starting the information diffusion process. High information diffusion speed preferred by the marketing services can be reached by choosing nodes with higher social impact as  $A_0$ . Following this, we formally define outstanding users as:

**Definition 1 Outstanding Users.** *Given a social network  $G = (V, E)$ , where  $V$  is the set of all users,  $E \subseteq V \times V$  is the set of all social connections between users, outstanding users (OUs) are a group of users who have higher diffusion capability than others. OUs can widen and speed up information dissemination if they are considered as the first activated node set  $A_0$  of the IC model.*

These nodes can be selected by the criteria of information dissemination capabilities, including the spread speed within or between communities or specific nodes' information influence. Typical examples of OUs are structural hole spanners, influential users, and elite users. They are defined as follows:

**Definition 2 Structural Hole Spanners.** *The structural hole theory [11], [29] shows that people will benefit from acting as the "bridge" of different people or communities that are otherwise disconnected. Known as structural hole spanners (SHS), those people become non-trivial because they have more control over the information transmitted among communities [11], [32], [33].*

SHS is a good choice for  $A_0$  as they are the bridges of information flow between communities. They can be selected by four ego network-based metrics, i.e., effective size, efficiency, constraint, and hierarchy [10].

Another example of structure-based OUs is the influential users:

**Definition 3 Influential Users.** *Influential users are a group of users with the highest influence on others. The users' influence in a network can be measured by the user centrality values [34].*

Centrality metrics include degree centrality, closeness centrality, and betweenness centrality. They can measure the importance of individuals [13], [35], [36]. Selecting the influential users as  $A_0$  will maximize the information diffusion speed inside a community.

As literature [37] shows, the above-mentioned widespread norms are correlated with cascades' properties. Most existing discovery methods of OUs rely on social connectivity information of the entire social network [21], [38], [39], but getting such information could be challenging due to users' privacy configurations. To deal with possible data famine, we use a subset of nodes' ego network structures to draw statistically significant conclusions about the whole population. Those metrics of ego network are shown useful in works like [10], [12], [40], [41].

Despite the structure-based methods, a user can be identified as an OU based on other standards. A representative example of this type of OUs is the elite users.

**Definition 4 Elite Users.** *Elite users are selected by OSNs. The standard of elite users varies from one platform to another. For example, on Yelp, users who have well-written reviews, high-quality photos, a detailed personal profile, and a history of playing well with others are more likely to be recognized as elite users.*

Using elite users as  $A_0$  emphasizes the role of UGC in spreading information.

These specific types of OUs show characteristics related, but not limited to, network structure information, demographic features, and temporal patterns. In the following sections, we explore OUs' characteristics in these aspects and leverage them to design a model for OU detection.

## 2.2 Dataset Description

We employ the data of Yelp as our primary dataset to discover OUs and include data from Foursquare to ensure our results are generalizable. Both of them have attracted tens of millions of users all around the world, and are widely referred to in related studies of OSNs [3], [4], [5], [6], [42].

The Yelp dataset<sup>1</sup> is publicly available and spans from October 2004 to November 2018 in ten cities of North America. It comprises 1.6 million users, with their 1.9 million reviews and tips of 192 thousand businesses. The Foursquare dataset is a subset of data in [42], spans from October 2008 to February 2016 with spots all around the world. It has 2.9 million users and 630 thousand tips from 210 thousand venues.

The data entries of users vary from one platform to another. There will be demographic information like ID, name, review numbers, friend list. In some cases, the platform also has the average number of the rated stars and other comprehensive assessments of the reviews and tips<sup>2</sup>, which are a great resource for extracting the location visit histories of users as described in [3]. On the other hand, the related locations also provide social information of users. In both datasets, locations are the real-world POIs, to which people could post check-ins and write reviews. Their IDs, locations, categories, attributes, stars, and review details are accessible to the public.

We select several types of OUs as examples in this work:

- **Structural Hole Spanners:** We rank them by effective size (in descending order), constraint (in ascending order), and hierarchy (in ascending order) separately [10], and label the top-K users as structural hole spanners. They are denoted as SHS (E), SHS (C), SHS (H).
- **Influential Users:** We employ degree centrality (noted as Degree later) [43] and ego betweenness centrality (noted as Ego-Betw later) [40] as two independent measurements.
- **Elite Users:** We use the users in "Elite Squad" of Yelp as the labeled elite users in the Yelp dataset.

Each group comprises 10,000 users, with an equal number of OUs and their counterparts (noted as normal users).

1. <https://www.yelp.com/dataset>, obtained in July 2019  
2. hereinafter called "reviews".

For each user type, we randomly choose the normal ones from the non-OUs. All the users are from the largest connected component of the social graph.

## 2.3 Measuring the Role of Locations

Both Yelp and Foursquare are location-based social networks (LBSNs), where geo-social networks provide an informative view to distinguish between OUs and normal users. Taking the reviewed POIs (named locations in this work) of users into account could lead to higher accuracy when detecting OUs. Here we first set up the geo-social network model, then describe measures of the social diversity associated with a location through its social network of visitors.

### 2.3.1 Interconnected Geo-Social Network

The model of an interconnected geo-social network carries rich information about both users and locations. Locations have the property of connecting people, and their visitors may share similar attributes [44]. An individual's social neighborhood,  $N^h(b)$ , denotes its social network links to a location  $b$  at distance  $h$ . The 1-hop social neighborhood of location  $b$  would be composed of  $b$ 's direct visitors; the 2-hop social neighborhood would include all individuals in the 1-hop neighborhood and their friends. In this work, we count in second-hand redundancy brought with friendships of visitors to a location, so we set hop  $h$  to 2.

### 2.3.2 Homogeneity

The homogeneity of a place expresses to what extent its visitors are homogeneous in location preferences. A user is more likely to be outstanding in her online community if the locations she reviewed have a wider range of homogeneity scores. Following the definition in [44], we measure the overall social homogeneity of a location by the mean cosine distance of every pair of its visitors' place preference vectors as

$$H(b) = \frac{\sum_{u,v \in N^h(b)} \frac{\mathbf{U} \cdot \mathbf{V}}{\|\mathbf{U}\| \|\mathbf{V}\|}}{|N^h(b)|(|N^h(b)| - 1)}, \quad (1)$$

where  $|N^h(b)|$  is the size of the network, and  $\mathbf{U}, \mathbf{V}$  is the preference vectors of two users  $u$  and  $v$ , separately. One's preference vector represents the percentage of each category of locations she had visited. The length of the preference vector is equal to the number of location categories. The homogeneity value ranges from 0 to 1, proportional to the homogeneous level of the categories reviewed by pairs of location visitors.

### 2.3.3 Entropy

The entropy of a place describes its diversity of visits. By far, it is the most common notion for quantifying a location's popularity [45]. As OUs tend to visit popular places [46], it helps in the detection process. Entropy is defined by Shannon entropy value

$$E(b) = - \sum_{u \in N^h(b)} \frac{|r(u, b)|}{|r(b)|} \log \frac{|r(u, b)|}{|r(b)|}, \quad (2)$$

where  $|r(u, b)|$  is the user  $u$ 's number of reviews at location  $b$  and  $|r(b)|$  is the total number of reviews of location  $b$ .

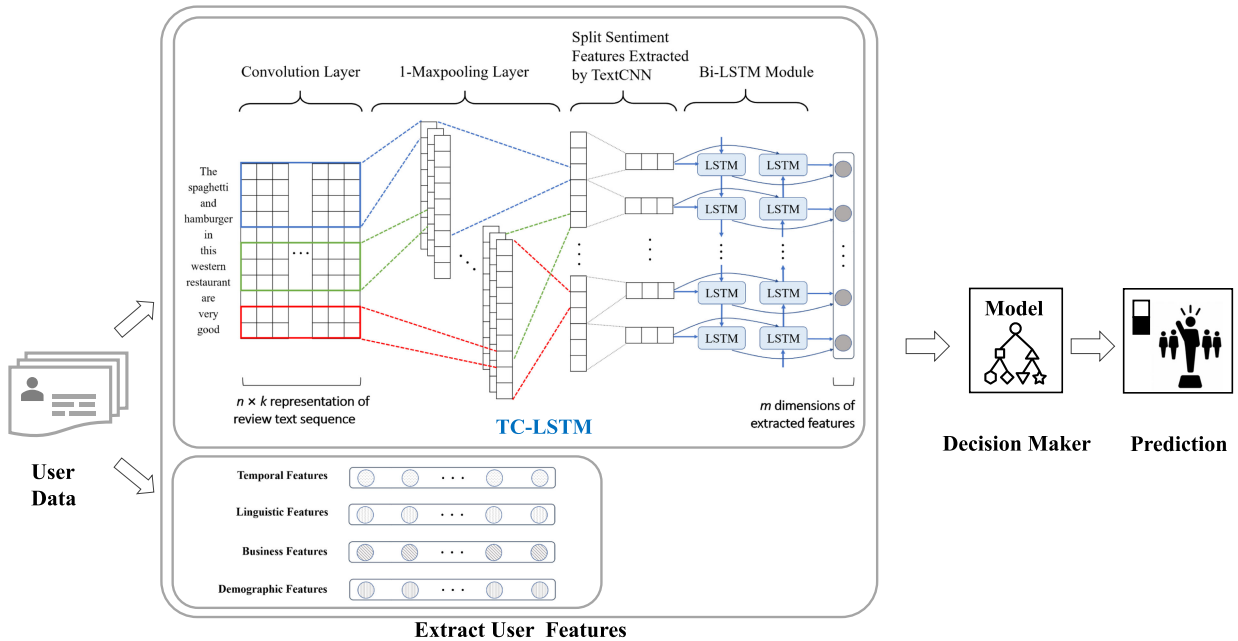

Fig. 1. DeepPick framework. For each user's information in the input sequence, DeepPick extracts the sentiment features by using TC-LSTM, the review processing module. Then, it extracts and normalizes other descriptive features to incorporate with the sentiment ones. After being aggregated together, these feature sets are fed into the machine learning-based classifier for prediction.

Entropy has been exploited in mobility studies to describe a location's popularity and its visitors' geographical diversity level [45], [47], [48]. More specifically, locations that are reviewed by highly diverse visitors will have higher entropy.

### 3 DESIGN OF THE OUTSTANDING USER DETECTION FRAMEWORK

In this section, we introduce our OU detection framework, DeepPick. We restrict our discussion to the setting of OU detection in OSNs. We demonstrate the overall structure of DeepPick in Section 3.1, and introduce input (i.e., reviews and descriptive data of both users and locations) in Sections 3.2 and 3.3. The choice of machine learning-based classifier (the decision maker) is discussed in Section 3.4.

#### 3.1 System Overview

DeepPick has three modules, namely the review processing module, conventional feature extraction module, and the decision maker module. The framework is shown in Fig. 1.

We utilize deep neural networks to characterize the users' sentiment features. Deep neural networks are now successful in many fields, but their palatable performance in generalizing may still require some theoretical explanation [49]. To remedy the shortcoming, we also introduce descriptive features to our framework. This heuristic method is helpful in enhancing the interpretability of our model. Before feeding the review processing module, we order all review texts of each user chronologically, remove stopwords/punctuations, and conduct lemmatization. For the descriptive features, we leverage each user's descriptive profile and the attributes of the reviewed locations to describe the user from the perspective of demographic and location. Putting the subsets of features in Table 1 together, the decision maker applies a supervised machine learning-based classifier to predict whether a user is an OU or not.

In the following subsections, we introduce the building blocks of DeepPick and discuss their contributions to the final decision.

#### 3.2 Review Processing

The reviews provide rich information over the users' lifecycle from different perspectives, revealing the difference between outstanding and normal users from a comprehensive view. In DeepPick, all reviews of a user are analyzed mainly from three angles: sentiment, linguistic, and temporal. We leverage the TC-LSTM framework (see Section 4) as the review processing module for sentimental analysis. Two other analytical views are represented as follows.

##### 3.2.1 Linguistic Features of Reviews

User-generated contents have long been used in understanding OSNs users, such as [50], [51]. Using the review text, we investigate how linguistic aspects affect users' outstanding status. Herein we adopt the users' language patterns as a proxy to look into their online actions and engagement patterns in the community. LIWC [52], or Linguistic Inquiry and Word Count, is our tool to demonstrate the word-level characteristics of user reviews. LIWC counts words in psychologically meaningful categories. It has been widely used to detect how people's daily spoken and written text like, to reveal their social relationships, thinking styles, and individual differences [52].

Some selected review linguistic features are exhibited in Table 2. The values represent the average occurrence frequency of each specific set of words. Note that all types of OUs share the same LIWC-based statistical features compared with normal ones. The first column is the average word count (WC) of the reviews, which correlates with psychological meanings like talkativeness and verbal fluency [52]. We can see that OUs' average review length is longer

TABLE 1  
Subsets of Features of the Classification Model

Sentiment Features	
$S_i$	Sentiment analysis results output by the review processing module structure ( $i \in [1, 30]$ )
Temporal Features	
Review1	The number of reviews a user has posted in her first period of lifecycle
Review2	The number of reviews a user has posted in her second period of lifecycle
Review3	The number of reviews a user has posted in her third period of lifecycle
Review4	The number of reviews a user has posted in her fourth period of lifecycle
Review5	The number of reviews a user has posted in her last period of lifecycle
Location Features	
Entropy	The diversity of visits with respect to visitors
Homogeneity	The extent to which a location's visitors are homogeneous in their location preferences
Linguistic Features	
WC	The number of words per review
Analytic	The degree to which people use words that suggest formal, logical, and hierarchical thinking patterns
focuspast	The extent of using past focus words like "ago", "talked", "did"
social	The extent of using social processes words like "mate", "talk", "they"
Leisure	Frequency of occurrence of words in "Leisure" category, like "cook", "chat", "movie"
Demographic Features	
Review_count	The number of reviews the user have written
start_time	When the user posted the first review
$B_k$	In Foursquare, this metric is the user's $k$ th demographic attribute (e.g., number of venue lists)
$C_j$	In Yelp, this metric means the number of times the user has received the $j$ th category of compliments. Possible compliment categories $j$ include hot, cool, funny

than normal users'. Also, as we show in Fig. 3, OUs always post more reviews than others. This means OUs are more proactive in online communities. The "Analytic" metric captures the degree to which people use words that suggest formal, logical, and hierarchical thinking patterns. OUs are constantly higher in analytical, showing their tendency to write and think in more categorical ways [53]. The "focuspast" metric measures the frequency of using words and past tenses that express past tense. OUs write more about the past times, which indicates they are more practiced in flashing back. With regard to the "social" (words referring to social relationships, such as "family" and "friends") metric, OUs appear to have lower scores. The frequency of words about leisure activities like "cook", "chat", and "movie",

which belong to the "Leisure" category, is presented in the last column. They are prone to appear more in OUs' reviews.

### 3.2.2 Review Temporal Features

Reviews, as the major part of UGC, serve as a proxy of users' psychological and behavioral patterns. The content shows how people think while the review time sequence indicates the life span of their publishers. In this work, we define that a user's lifecycle starts when she posts the first review on the platform and reaches the final stage when she posts the last review. We divide the life span into five segments based on the time duration. Each segment could be interpreted as a life stage of real human life [3]. Figs. 2 and 3 show the average number of reviews people have written in each life stage. Regardless of categories, OUs share the same review patterns. All subsets of OUs write more reviews in all of their life stages. They also share a similar style in developing patterns: the contributing pace of most OUs shows a consistent tendency of slowing down in the first few stages but rising in the last stage. Normal users also contribute more in their final life stage, which means they are slightly engaging more in the communities.

### 3.3 Analysis of Descriptive Features

The geo-social network and users' demographic features are informative in user distinguishing. Hristova *et al.* [44] validated that the bridging and bonding role of places could reveal special attributes in social networks. On the other hand, users' descriptive information in their profiles is a conventional feature in user classification tasks [3], [54], [55]. They are easy to access and beneficial.

TABLE 2  
Occurrence Frequency of Different Categories of Words in OUs' and Normal Users' Reviews

	User Type	WC	Analytic	focuspast	social	leisure
Yelp	SHS (E)	103.20	60.41	4.71	7.50	2.14
	NU (E)	100.66	55.81	5.58	8.12	1.81
	Degree	138.09	62.43	4.87	7.00	2.38
	NU (D)	93.13	55.08	5.93	8.32	1.75
	Elite	148.57	63.69	5.35	6.55	2.35
	NU (EL)	95.46	54.31	6.33	9.14	1.55
Foursquare	SHS (C)	48.57	82.52	1.35	5.05	3.00
	NU (C)	13.06	79.95	1.11	5.23	2.51
	SHS (H)	27.79	81.46	12.93	5.87	2.84
	NU (H)	13.11	80.14	12.15	6.25	2.61
	Ego-Betw	20.30	78.91	1.41	5.64	2.91
	NU (B)	12.52	76.75	1.54	6.49	1.99

NUs (Normal Users) are marked with corresponding OUs' category.



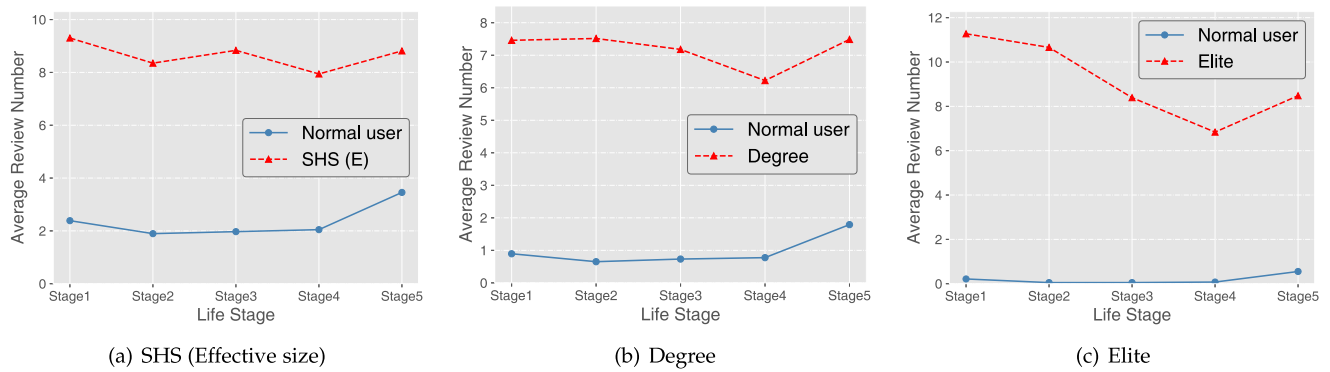

Fig. 2. Yelp OUs' review tendency. OUs in Yelp are much more active than normal users throughout their life span. The level of OUs' engagement keeps fluctuating but still sticks to a relatively high level, which indicates that the OUs in Yelp might be detected from a very early stage of their lifecycle.

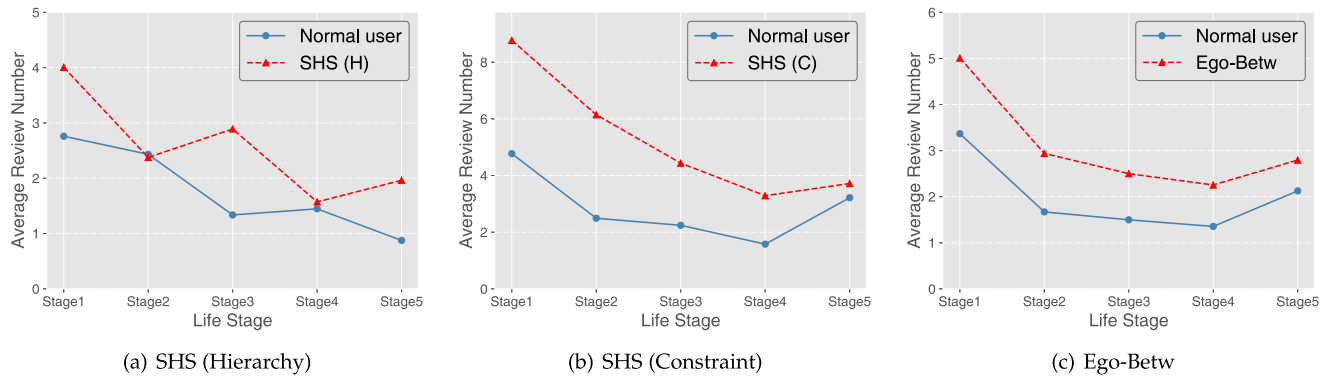

Fig. 3. Foursquare OUs' review tendency. In Foursquare, the gap between OUs and normal users is smaller but still significant, especially at the beginning of the lifecycle. Most of the Foursquare users show a tendency to become inactive.

### 3.3.1 Measurement of the Social Diversity of Locations

One of the fundamental social roles of locations is bonding hubs. Some tend to bring along friends to interact with each other, while some are more likely to gather otherwise disconnected individuals. Pieces of literature show that visitors' diversity is in proportion to a place's social roles. For example, the visitors' composition and social network connectivity comply with the score of homogeneity [44].

We obtain the homogeneity of a place as in Equation (1). In this work, we use statistics (i.e., the mean, median, maximum, minimum, and quartiles) of all locations a user reviewed to depict her location preferences.

### 3.3.2 Demographic Features

Demographic features could be extracted from each user's basic profile information. Different online platforms have different feature sets. Introducing carefully selected features will strengthen the detection framework. In our case, the demographic features include the time when the user conducted the first activity on the platform (i.e., post the first review), how many reviews she has given and some platform-specific metrics. Specifically, Yelp describes users by a large number of accomplished items (all started by "compliment\_"), which are helpful to find out whether a user is outstanding.

## 3.4 Decision Maker

DeepPick leverages a decision maker to conduct the final judgment. The decision maker could be a classifier using

supervised machine learning algorithms such as CART decision tree [56], Random Forest [57], or boosting systems such as XGBoost [58] and CatBoost [59]. Using the aggregated features from both the review processing module and conventional feature extraction module as input, the decision maker is trained to classify whether a user is an OU or not.

## 4 TC-LSTM: USER REVIEW ANALYSIS FRAMEWORK

The reviews reveal what a user is thinking. It shows the personal characteristics of users, which greatly help in distinguishing OUs. A user may produce thousands of reviews, forming an interrelated text sequence with timestamps. Such sequences are hard to interpret via traditional methods and existing basic deep learning methods. To make the best use of the information of reviews, we propose TC-LSTM to extract sentiment features. It takes the review text sequence produced by one user and is trained to predict the user label. We then leverage the outputs of the LSTM layer as sentiment features to depict the user. TC-LSTM (Section 4.1) combines the advantages of TextCNN (Section 4.2) and Long Short-Term Memory (LSTM) (Section 4.3) frameworks, and performs better than both of them.

### 4.1 The Proposed Network Architecture

The middle part of Fig. 1 shows the network architecture of TC-LSTM. It has two key components: TextCNN [60] and LSTM [61], but can be trained with one loss function jointly.



In the training, the label for each user is whether she is outstanding or not. TC-LSTM and the following machine learning algorithm share the same training/validation and test subsets.

Before being fed into TC-LSTM, the sequence of user reviews will be represented by trained word2vec vectors in a “Bag of Words” architecture [62] and padded to the same length. Then, we extract reviews’ sentiment features via the TextCNN component, which is constructed by taking the convolutional and max-over-time pooling layers from a standard TextCNN model (fully-connected layers are removed). It needs little tuning of hyper-parameters and performs well in sentiment analysis. After the convolution operation, we perform a nonlinear transformation on the output. To maintain the nonlinear characteristics after the max-pooling operation, we use *ReLU* function to compress the feature map output by the TextCNN component into hidden variables.

The variables are later represented by sequences in order to be invariant to the length variation of sequence-like objects. By using the Bi-LSTM component, retained latent sequential information could be captured. Bi-LSTM views a sentence as a sequence of tokens and uses two LSTMs to represent each token of the sequence based on both past and future contexts. We employ it for its advantages in dealing with long-distance dependency and successes in natural language processing tasks [63].

## 4.2 Text Feature Extraction

For the TextCNN component, it first generates a word matrix for each segment of words. It introduces a  $k$ -dimensional word vector as  $\mathbf{x}_i \in \mathbb{R}^k$ . Such a vector is corresponding to the  $i$ th word in the sentence. After padding to  $n$ -length, a sentence could be represented as

$$\mathbf{x}_{1:n} = \mathbf{x}_1 \oplus \mathbf{x}_2 \oplus \cdots \oplus \mathbf{x}_n, \quad (3)$$

where  $\oplus$  is the concatenation operator. After concatenation, the word matrix will have a shape of  $n \times k$ .

Second, TC-LSTM extracts sentiment features from word matrix by involving *filters* for a window of  $h$  words in convolution operations. A *filter* is represented by  $\mathbf{w} \in \mathbb{R}^{h \times k}$ . The model uses multiple filters (with varying window sizes) to obtain multiple features. In general, let  $\mathbf{x}_{i:i+j}$  refer to the concatenation of words  $\mathbf{x}_i, \mathbf{x}_{i+1}, \dots, \mathbf{x}_{i+j}$ . A feature  $c_i$  is generated from a window of words  $\mathbf{x}_{i:i+h-1}$  by

$$c_i = f(\mathbf{w} \cdot \mathbf{x}_{i:i+h-1} + b). \quad (4)$$

Here  $b \in \mathbb{R}$  is a bias term and  $f$  is a nonlinear function such as the hyperbolic tangent. A *filter* will be applied to each possible window of words in the sentence  $\{\mathbf{x}_{1:h}, \mathbf{x}_{2:h+1}, \dots, \mathbf{x}_{n-h+1:n}\}$  to produce a *feature map*

$$\mathbf{c} = [c_1, c_2, \dots, c_{n-h+1}], \quad (5)$$

with  $\mathbf{c} \in \mathbb{R}^{n-h+1}$ .

The next step is to apply a pooling scheme to get the corresponding features of each particular filter. In this step, a max-over-time pooling function is applied over the feature map and the maximum value  $\hat{c} = \max(\mathbf{c})$  is used as the target feature. In this paper, the fully connected layers in TextCNN are removed to make the model more compact and efficient.

## 4.3 Sequence-Based Classification

Recurrent neural network (RNN) has a strong capability of capturing contextual information within a sequence. Traditional RNN units, however, suffer from the vanishing gradient problem [64]. It limits the range of context RNN can store and adds burden to the training process. Fortunately, the LSTM structure can handle the long-distance dependency between elements in a time sequence [61] better than standard RNN. In particular, we choose bidirectional LSTM (Bi-LSTM), which consists of forward (left to right) and backward (right to left) LSTMs. According to the study in [65], Bi-LSTMs outperform unidirectional LSTMs for classifying acoustic data into phonemes.

Furthermore, we apply Back-Propagation Through Time (BPTT) in TC-LSTM. The sequence of propagated differentials is concatenated into maps at the input of the Bi-LSTM component. Then we invert the operation of converting feature maps into feature sequences and feed them back to TextCNN. To connect the two main components, we split the output sequence of TextCNN into shorter segments as the input of Bi-LSTM.

After the review processing, the LSTM component finally outputs  $m$  features, each represented by  $S_i, \forall i \in [1 \dots m]$ . The value of  $m$  could be adjusted.

## 5 IMPLEMENTATION AND EVALUATION

Having explained how DeepPick is designed, we turn to study what parameters and building blocks should be chosen to ensure the best performance of the OU detection task. We present the details of training and implementing DeepPick in Section 5.1. In Section 5.2, we conduct thorough experiments to show the impact of equipping different components on our framework’s detection performance, the contributions of different feature groups and individual features, and the most discriminative features for detecting various types of OUs. Finally, we compare the results with several state-of-the-art solutions. In Section 5.3, we present a case study to figure out the difference between individuals of different types.

### 5.1 Dataset Setup and Evaluation Metrics

To train DeepPick, we construct a training/validation subset for each dataset with 80% users, and employ the rest 20% as the test subset. Both subsets have the same distribution of user type as the total population. We use 5-fold cross-validation for the training/validation subset. We define the loss function as

$$L = - \frac{\sum_{i=1}^N (y_i \log(p_i) + (1 - y_i) \log(1 - p_i))}{N}, \quad (6)$$

where  $N$  is the total number of users,  $p_i$  is the probability that the classifier makes a correct judgement on  $i$ th user. We optimize the parameters by grid searching. At the end of training, the set of parameters that keeps the lowest  $L$  value will be chosen for the decision maker.

To complete the review classification task, we use PyTorch, a widely-used open-source machine learning framework implemented in Python. In the preprocessing period, we employ Continuous Bag-of-Words (CBOW) of

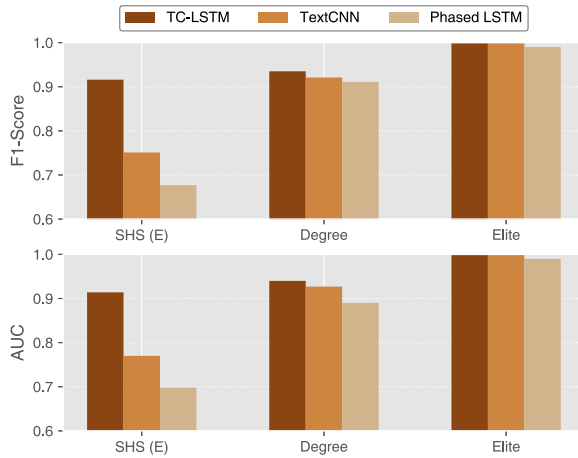

Fig. 4. Comparison of how different neural network structures work on the Yelp dataset. TC-LSTM performs the best in all cases.

Word2Vec [66] to embed each sentence into 100 dimensions. Concerning the parameters of TC-LSTM, for both datasets we use: filter windows ( $h$ ) of 2, 3, 4 with 10 feature maps each, dropout rate ( $p$ ) of 0.7. For the RNN layer, we set the hidden size as 15, and two layers of Bi-LSTM are added. The network is then trained with stochastic gradient descent (SGD). The output number of dimensions,  $m$ , is set to 30. To implement the decision maker, we use scikit-learn [67], a Python-based machine learning library.

We adopt the following classic metrics to evaluate the detection performance.

- Precision: the fraction of detected OUs who are really outstanding in the OSN.
- Recall: the percentage of OUs that have been uncovered correctly.
- F1-score: the harmonic mean value of Precision and Recall.
- AUC [68]: the probability that the classifier will rank a randomly chosen OU more outstanding than a randomly chosen normal user.
- Mean Average Precision (MAP) [69]: Mean value of average precision ( $AP(K)$ ), which is the average of the precision value obtained for the set of top- $K$  OUs. MAP is given by

$$MAP = \frac{\sum_{k=1}^K AP(k)}{K}. \quad (7)$$

## 5.2 Experiment Results

In the evaluation, we study different constructions of DeepPick by equipping it with different neural network models and decision makers to optimize the performance. We then show the contributions of separate features to the final decision and compare DeepPick with some state-of-the-art solutions.

### 5.2.1 Comparison of Different Neural Network Models

Kim [60] proposed to use TextCNN to achieve good performance when processing language. Also, Phased LSTM [70], a recently emerging RNN for sparse sequences, reaches the best result in the work of Gong *et al.* [55]. For comparison, we measure the detection performance of these networks in our dataset using SHS (E), degree centrality, and elite users in Yelp.

We feed TextCNN and TC-LSTM with the same preprocessed reviews of users and the Phased LSTM framework with the time sequence of user reviews. Their detection performance is compared in Fig. 4. From the result, we find that TC-LSTM performs the best in all cases.

### 5.2.2 Comparison of Different Decision Makers

Several algorithms could work as the decision maker of DeepPick. Classifiers, including tree boosting systems such as CatBoost and XGBoost, classic machine learning algorithms such as Random Forest (RF) and decision tree (CART), are tested for DeepPick. We show the detection performance and the corresponding parameters of all algorithms in Table 3. Overall, the boosting methods perform better than others. We utilize McNemar's test [71] to examine whether there exists a difference between two classification algorithms by evaluating the statistical significance. We find that XGBoost is different from the others. From the detection performance concerning both F1-score and AUC value, we see that XGBoost gets the best performance. In the following experiments, we use XGBoost as the decision maker in DeepPick.

### 5.2.3 Contributions of Different Feature Subsets

In this part of the experiments, we show which types of features are more discriminative through ablation experiments on different feature subsets. As a case study, we conduct experiments on different types of OUs on both platforms. F1-score is applied to evaluate the detection performance of different approaches. First, we compare the performance of

TABLE 3  
Evaluation of Different Decision Makers on the Yelp Dataset

Models	Parameters	SHS (E)				Degree				Elite			
		Precision	Recall	F1-score	AUC	Precision	Recall	F1-score	AUC	Precision	Recall	F1-score	AUC
XGBoost	learning_rate=0.01, seed=0, n_estimators=900, gamma=0.1, max_depth=3, reg_lambda=1, subsample=0.6, reg_alpha=1, min_child_weight=1, colsample_bytree=0.6	0.915	0.917	<b>0.916</b>	<b>0.914</b>	0.953	0.919	<b>0.935</b>	<b>0.940</b>	1.000	1.000	<b>1.000</b>	<b>1.000</b>
CatBoost	l2_leaf_reg=9, iterations=1000, one_hot_max_size=3, depth=4, learning_rate=0.1	0.915	0.912	0.914	0.912	0.948	0.918	0.933	0.937	0.999	1.000	1.000	0.999
CART	criterion='gini', max_depth=5	0.837	0.838	0.838	0.834	0.889	0.898	0.893	0.901	0.999	1.000	1.000	0.999
RF	max_depth=7, n_estimators=130	0.919	0.910	0.914	0.913	0.954	0.907	0.930	0.935	1.000	1.000	1.000	1.000

TABLE 4  
Ablation Study on Different Feature Subsets (F1-score)

Approach	Yelp			Foursquare		
	SHS (C)	Degree	Elite	SHS (C)	SHS (H)	Ego-Betw
DeepPick	0.975	0.935	1.000	0.922	0.876	0.922
- Sentiment Features	0.898	0.926	0.991	0.872	0.716	0.755
- Temporal Features	0.972	0.857	0.991	0.912	0.837	0.867
- Location Features	0.962	0.846	0.995	0.910	0.828	0.862
- Linguistic Features	0.973	0.855	0.997	0.912	0.835	0.868
- Demographic Features	0.963	0.687	0.919	0.836	0.807	0.824
Random Guess	0.491	0.490	0.508	0.522	0.493	0.490
+ Sentiment Features	0.756	0.673	1.000	0.834	0.801	0.739
+ Temporal Features	0.837	0.811	0.932	0.666	0.582	0.562
+ Location Features	0.853	0.832	1.000	0.662	0.618	0.607
+ Linguistic Features	0.845	0.833	0.991	0.682	0.586	0.568
+ Demographic Features	0.889	0.933	1.000	0.867	0.699	0.755

DeepPick without each type of features. We subtract one subset at a time and validate the performance degradation accordingly. Table 4 shows that for the majority types of OUs, sentiment features are the most discriminative in the detection process, as the F1-score decreases the most when the sentiment features are removed. In other cases, i.e., for OUs judged by degree centrality and elite label in Yelp, the set of demographic features is the critical subset. Second, we start from a random guess classifier and add one feature subset to it each time. This time, F1-score increase the most when demographic features are considered in most cases. Correspondingly, sentiment features enhance the detection performance most when demographic features are not the best choice. The result implies that combining sentiment features and demographic features into distinguishing processes is able to increase the detection performance.

#### 5.2.4 Contributions of Different Individual Features

We validate the importance of individual features in all feature subsets by XGBoost. It calculates the importance of the features according to their contributions to the detection result. We plot the importance of each feature for the classification in Figs. 5 and 6. We can see that in many OU subsets, sentiment features extracted by using TC-LSTM play

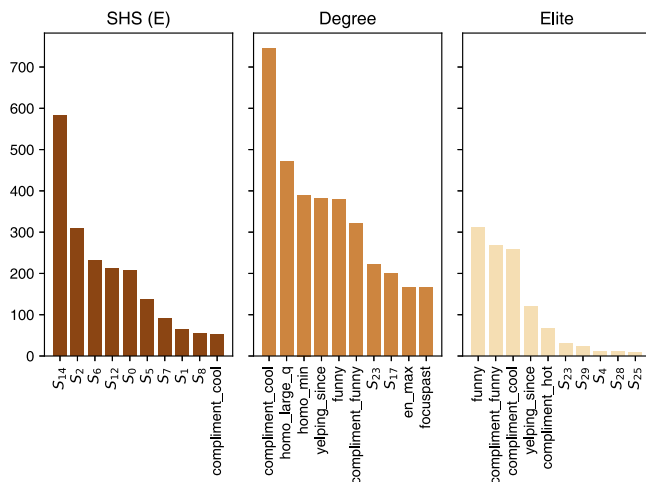

Fig. 5. Comparison of distinct features' contributions in different types of Yelp OUs. Sentiment features are represented by  $S_i, \forall i \in [1 \dots m]$ . In this paper,  $m$  is set to 30.

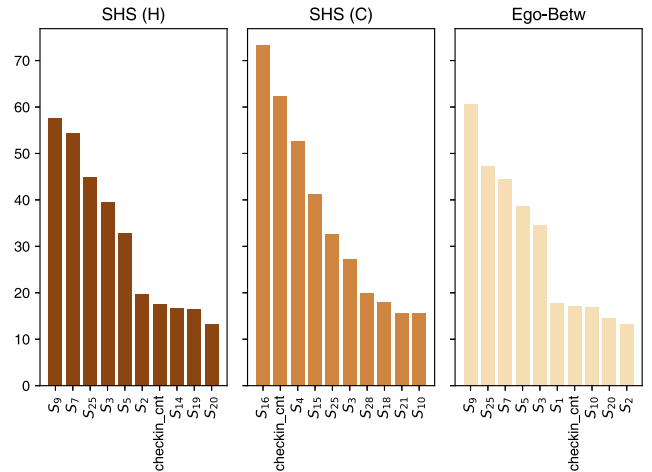

Fig. 6. Comparison of distinct features' contributions in different types of Foursquare OUs.  $checkin\_cnt$ , one of the user's basic attributes, is the number of people's reviews. Sentiment features are  $S_i, \forall i \in [1 \dots m]$ , where  $m = 30$ . The results show that they are among the most decisive features for the three types of Foursquare OUs.

an essential role. For structural hole spanners on Foursquare, no matter what metric they are ranked by and which dataset they come from, most top-10 features that contribute to identify them are sentiment features. Also, demographic features from Yelp user profiles like "compliments\_cool" and visited location features like "homo\_min" (which means the minimal value of visited locations' homogeneity) contribute a lot to the final decision.

#### 5.2.5 Detection Performance on Both Datasets

The detection performance of DeepPick (evaluated by F1-score) in both datasets is shown in Table 5. It maintains high accuracy in all subsets. In the case of elite users, the system makes no error. The reason lies in that elite users usually have some distinguishing demographic features in Yelp, such as "funny" ( $C_f$ ) and "compliment\_cool" ( $C_c$ ). Those attributes make them especially recognizable. According to Yelp<sup>3</sup>, their judging criteria of elites includes quality of reviews and photos, truthfulness of user identity, and user age. The detection performance shows no explicit difference between different types of OUs in the same dataset, which shows the practicability of DeepPick.

#### 5.2.6 Comparison with State-of-the-Art Solutions

We compare the performance of DeepPick with the following special user detection algorithms for online communities by both F1-score and a ranking-based performance metric, MAP.

- Ma *et al.* [72]: This work develops an RNN-based method to detect rumors and the users who spread them in OSNs. RNN is used for learning the hidden representations that capture the variation of contextual information of users' relevant posts over time.
- Katsimpras *et al.* [73]: This work ranks users according to their topic-sensitive influence, basically based

3. [https://www.yelp-support.com/article/What-is-Yelps-Elite-Squad?l=en\\_US](https://www.yelp-support.com/article/What-is-Yelps-Elite-Squad?l=en_US)

TABLE 5  
Experiment Results of the Two Datasets

	Subset	Precision	Recall	F1-score	AUC
Yelp	SHS (E)	0.915	0.917	0.916	0.914
	SHS (C)	0.976	0.975	0.975	0.975
	SHS (H)	0.928	0.934	0.931	0.931
	Degree	0.953	0.919	0.935	0.940
	Ego-Betw	0.973	0.953	0.963	0.963
	Elite	1.000	1.000	1.000	1.000
Foursquare	SHS (C)	0.915	0.929	0.922	0.915
	SHS (H)	0.876	0.901	0.892	0.844
	Ego-Betw	0.916	0.925	0.921	0.886

on supervised random walks. Topics are extracted by LDA [74].

- MCDE [75]: MCDE identifies high spreading power nodes in social networks by mixing the value of a node’s k-shell [26], degree, and entropy (represented by the diversity of neighbors in different shells). To equate the effect of these measures, the amounts of these three parameters are configured as in the original paper.
- DeepInf [76]: DeepInf predicts users’ social influence in OSNs. It first performs a random walk with a restart probability  $\gamma$ , and the size of the sampled sub-network is set to be  $w$ . Then, DeepInf uses a three-layer GAT/GCN structure with  $r$  hidden units in both the first and second GAT/GCN layers, while the output layer contains 2 hidden units for binary prediction.

The result of the comparisons by F1-score is shown in Table 6. Evaluations based on ranking-based performance metric (MAP) are also shown in Table 7. We can see that the other solutions normally perform well in identifying one type of OUs but fall behind in others. Even in the case they are most good at, DeepPick achieves higher performance than them.

As the available data might only contains a limited part of the social graph, many related methods could not work in this situation, including traditional structural hole spanners detection algorithms [18], [32], GNNs [76], [77], and structure learning methods [78], [79]. Specifically, we take DeepInf [76] as an example. In our experiments, we apply DeepInf-GCN instead of DeepInf-GAT because DeepInf-GCN performs better in our dataset. We select  $\gamma = 0.8$ ,  $w = 10$ ,  $r = 256$ . For the embedding layer, a 64-dimension network embedding is pre-trained. To minimize the effect of

TABLE 6  
Performance Comparison with Existing Methods (F1-score)

Models	Yelp			Foursquare		
	SHS (E)	Degree	Elite	SHS (C)	SHS (H)	Ego-Betw
Ma <i>et al.</i>	0.751	0.613	0.811	0.795	0.620	0.693
Katsimpras <i>et al.</i>	0.677	0.696	0.835	0.723	0.681	0.571
MCDE	0.611	0.908	0.673	0.916	0.568	0.474
DeepPick (100OUs)	0.903	0.910	0.999	0.903	0.816	0.835
DeepPick (1,000OUs)	0.913	0.925	0.999	0.911	0.824	0.858
DeepPick	<b>0.916</b>	<b>0.935</b>	<b>1.000</b>	<b>0.922</b>	<b>0.876</b>	<b>0.922</b>

TABLE 7  
Performance Comparison with Existing Methods (MAP)

Models	Yelp			Foursquare		
	SHS (E)	Degree	Elite	SHS (C)	SHS (H)	Ego-Betw
Ma <i>et al.</i>	0.697	0.622	0.791	0.770	0.698	0.688
Katsimpras <i>et al.</i>	0.643	0.610	0.815	0.769	0.684	0.625
MCDE	0.576	0.808	0.602	0.852	0.521	0.545
DeepPick (100OUs)	0.880	0.877	0.881	0.859	0.757	0.775
DeepPick (1,000OUs)	0.910	0.894	0.896	0.875	0.764	0.811
DeepPick	<b>0.919</b>	<b>0.988</b>	<b>0.999</b>	<b>0.884</b>	<b>0.771</b>	<b>0.819</b>

missing the connection information, we feed DeepInf with a subgraph of the largest connectivity in the dataset, which contains 10,000 edges and 7,549 nodes. The OUs in the sampled dataset are the SHS ranked by effective size. As in [76], we allow DeepInf to run at most 1,000 epochs over the training/validation subset and select the best model by early stopping. However, DeepInf only reaches AUC=0.613, Precision=0.228, Recall=0.669, and F1-score=0.340. We attribute the inferiority to the limited sizes of sampled networks, which cannot be very large due to the scant number of nodes in 1-hop neighborhood (i.e., ego network). Unfortunately, as some users choose to hide their friend lists from the public nowadays, it would be much more difficult to acquire neighborhoods larger than 1-hop for third-party service providers and researchers.

So far, the experiments are conducted based on datasets containing 10,000 OUs. However, some platforms might not be able to provide so many OUs’ information. We conduct more experiments to validate the practicability of our proposed framework when the given outstanding user set is small, i.e., 100 and 1,000. The results are also shown in Tables 6 and 7. The deduction in training OU numbers will slightly degrade the performance. However, by comparison, our method still performs better than the baselines even with less OUs.

### 5.3 Case Study

Since we have already illustrated that DeepPick outperforms existing approaches and shown the contributions of different features, we look into the detailed feature difference of different types of OUs by case studies. We randomly select 100 OUs and 100 corresponding normal users of each type to compare their features. We choose one feature that shows the most significant difference from each category of features in Fig. 7. Normal users in Yelp hardly write reviews and tips, thus win almost no points on the features of compliments like “funny”. The average entropy of the places they visit is only about 30% of that of OUs. The value of sentiment features ( $S_i$ ) also exhibits a vast difference between normal users and OUs. In general, sentiment features have opposite trends, i.e., normal users are scored higher on sentiment features than OUs. In Foursquare, normal users prefer locations whose homogeneity metric values are 6-8 times higher than OUs. They write fewer words in their reviews, have shorter lists, and post reviews in a lower frequency. Foursquare’s normal users show the same pattern as Yelp’s when it comes to sentiment features. This result indicates that the OUs and normal users are quite distinguishable by those features. Besides, OUs valued by different strategies may share the

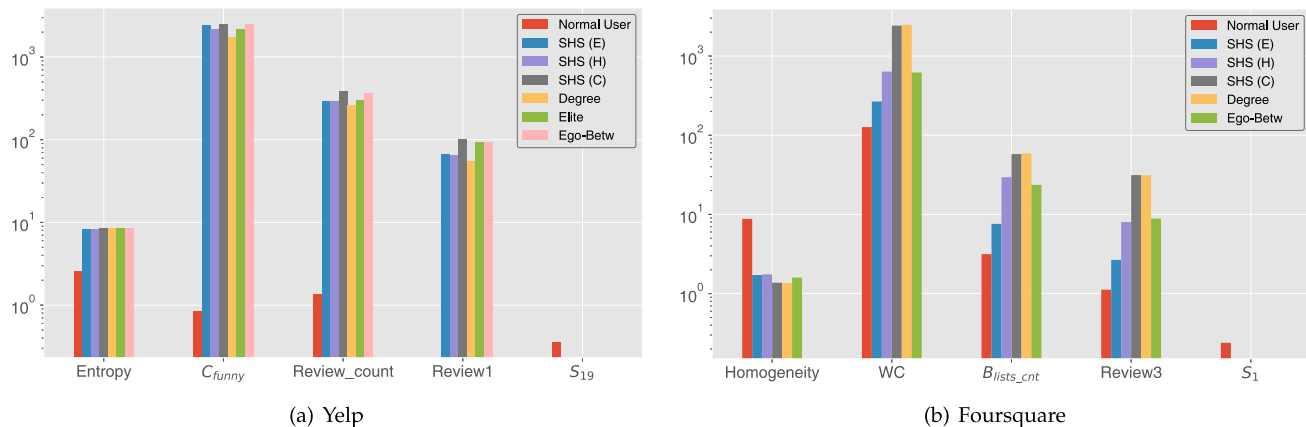

Fig. 7. Case study of each type of OUs compared with all normal users. The  $y$ -axis is in log scale. This graph shows the mean value of randomly selected 100 users of each category. In Yelp, the value of essential features is similar for different types of OUs, while normal users show low scores. In Foursquare, the gap between OUs and normal users is also apparent.

same pattern compared with normal users. The outcome confirms that users with rich information in the service are more likely to be outstanding.

## 6 RELATED WORK

### 6.1 Social Graph-Based User Detection

Identifying the most efficient “spreaders” in a network is essential in many real-world applications, such as optimizing the use of resources and ensuring that the information spreads more efficiently. The most straightforward and prevalent detecting strategy is to make use of the structure of the social graph.

For detecting SHS, Lou *et al.* [32] designed algorithms to identify SHS based on given communities. This solution is not able to work when community boundaries are missing or blurred, which is not unusual. Inspired by the intermingled nature of SHS and user communities, He *et al.* [20] proposed a harmonic modularity method to detect them simultaneously. However, their algorithms only fit small graphs due to the high space complexity ( $O(n^2)$ ) and time complexity ( $O(cn^3)$ ) [18]. To reduce the running time, Xu *et al.* [18] later adopted filtering techniques to estimate SHS from articulation points.

For detecting influential users, the criteria are generally based on the network structure [34], such as PageRank, degree, and betweenness centrality [80]. In applications such as citation impact analysis, measurements like H-index [81] could also be used. Works using methods like Hyperlink-Induced Topic Search (HITS) [39] and PageRank [82] equipped one of the measurements mentioned above to find the most influential set of users. However, when the network is large, a collection of different nodes is likely to be ranked the same by a single metric. Thus, some works like [75] consider multiple metrics together to select top-K influentials.

Many previous works [18], [20], [32] discover users of the target category by analyzing network structure features of nodes. Calculating those features, however, requires the structural information of the entire social network. The computation will become time-consuming as the network grows larger while fail to be launched when the available network information is incomplete. Instead, our framework merely requires the ego network structures of less than 1% of users

in the network, which is easier to acquire. Once trained, our framework could predict whether a user is an OU only through accessible information like UGC and user profile.

### 6.2 Deep Learning-Based User Detection with Social Networks

Another line of research on user detection benefits from the emergence of deep learning methods. Generally, researchers make use of either or both of the network structure and the UGC. Several related approaches have been proposed to find some specific types of OUs.

On one hand, the graph structure is widely utilized. For example, Wei *et al.* [83] used network representation learning to find overlapping communities in the network, then combined the community information and node topology to rank influential nodes. Keikha *et al.* [84] proposed DeepIM algorithm to detect the most influential nodes inside and between interconnected social networks by their local and global structural properties. These works learn to represent the structure of the whole graph by feature vectors. If the input graph is fragmentary, their neural network can not learn network representations accurately. Different from those works, DeepPick utilizes neural networks to deal with existing UGC and only needs some users’ local network information in the training process, which enhances its feasibility.

On the other hand, user actions on online platforms also provide rich information for distinguishing OUs. Such information includes various respects of a user’s online lifestyle, e.g., information cascades [19], [76], [85], user interest [86], and user interactions [77], [87]. Deep learning methods are effective in extracting latent key information, e.g., text and time series. To make the best use of all dimensions of data, we propose to incorporate accessible node-level features with UGC, which enhances the scalability of our method.

### 6.3 Graph Neural Networks

Recently, there has been a surge of interest in graph neural network (GNN) approaches. For each node, GNN recursively updates its representation by aggregating the representation of its neighborhood. After  $K$  iterations, the  $K$ -hop neighborhood’s structural and representation information

will be aggregated into the current node's representation. GNNs have been successfully applied to social network mining, including social influence prediction [76], [88], node popularity detection [89], and diffusion prediction [90]. These works all take the embedding vectors to solve the link prediction tasks, which is related to our work.

User interaction information is significant to GNN-based works. For instance, Inf-VAE [90] predicts diffusion by modeling the joint effect of temporal embeddings and social embeddings, which are learned from users' social connections. Differently, CoupledGNN [89] does not rely on temporal information, but still emphasizes the role of the interacting network, i.e., the cascading effect along with users' interactions, in popularity prediction problems. CoupledGNN aggregates the expected influence a user receives from her neighborhood as the evidence in popularity prediction. These works achieve good performance in predicting influence, but do not launch well in the incomplete graphs. We will further discuss the practicability of applying GNN in Section 7.1.

## 7 DISCUSSION

In this section, we discuss some design issues of our proposed framework. In Section 7.1, we present the possibility of adopting GNNs in this task. In Section 7.2, we compare the computational efficiency of our method and several other algorithms. We show the extent to which OUs is overlapping with active users in the platforms in Section 7.3.

### 7.1 Practicability of Graph Neural Network

In our model, the ego network is introduced as a replacement of GNN. The learning process of DeepPick is inspired by GNNs but relies much less on the knowledge of network structure to perform well. As GNN does, we also aggregate the features of nodes' neighborhood, but adopt multimodal data of the nodes instead of leveraging the structural information of nodes only.

Two obstacles are preventing the direct application of GNNs in this task. First, GNNs represent each node by aggregating its neighborhood's representation via methods like random walks [76], matrix factorization [91], or GCN [92]. The aggregation expands along with the underlying network edges. If there is a partial absence of the network structure, the detection performance will be degraded [89]. Although some approaches show applicability with the dropout of the network under the premise of network connectivity (e.g., CoupledGNN [89]), they are not applicable when only isolated ego networks are provided, which is common due to users' privacy concerns. Second, all the embeddings of nodes are required to be well-trained in GNN. For third-party service providers who desire a quick user distinguishing process, GNN's computation complexity is still high and unacceptable using large-scale OSN data. Thus, a tradeoff between detection performance and efficiency is urgently needed.

### 7.2 Time Complexity Analysis

As stated above, we analyze the computational complexity of our approach in the style of GNNs. Let  $|V|$  be the number of nodes in network  $G$ ,  $K$  be the dimension of embedding

vectors,  $L$  be the number of layers,  $D$  be the average degree, and  $s$  be the number of sampled nodes per layer. For simplicity, assume  $s$  remains equivalent across all layers of GCN. For other graph-based algorithms like PageRank, all nodes are required for the calculation. The time complexity of convergence could be  $O(t(\epsilon)|V|^2)$ , where  $t(\epsilon)$  is the number of iterations with convergence threshold  $\epsilon$ . For the GCN-based algorithms, the training process is about importance sampling. Take node-wise sampling techniques with minibatch training as an example. The sampling algorithm iteratively samples nodes of each layer to form minibatches, then propagates forward and backward among the sampled GCN. In the forward process, for each batch of  $b$  nodes, we update  $O(s^{L-1})$  activations for each node. As each new activation requires to aggregate  $s$  embeddings in previous layers, the computation cost for neighborhood propagation in one batch is  $O(bKs^{L-1})$ . The time complexity of the representative sampling process, e.g., constructing an alias table [93], is  $O(D)$ . Thus, the overall forward time complexity is  $O(bDKs^{L-1})$ . In the backward propagation, GCN also needs  $O(s^{L-1})$  to update parameters. For DeepPick, only the current central node is sampled to conduct the gradient descent process ( $L = 1$ ), which largely reduces the number of nodes taking part in the training. In that sense, the backward propagation time is reduced to  $O(1)$ .

### 7.3 Overlap with Active Users

Here we want to illustrate the difference between OUs and another highly-mentioned type of users in OSNs, the active users. Active users are often those who post more UGC in OSNs [94]. In contrast, the OUs are the first activated node group in the IC model, denoted as  $A_0$  in our paper. When acting as the information source, OUs can spread information in social networks faster than others. However, active users will not be able to spread information widely if their UGC are not popular.

Here we define overlap rate as the proportion of active users in OUs and correlation index as the Pearson correlation coefficient between review number sequences of OUs and active users. We rank the users by their numbers of reviews and select the top 10,000 as active users, which is of the same number as sampled OUs and normal users. The fraction of users who are both active users and OUs simultaneously is shown in Fig. 8. Yelp's active users are more likely to become OUs, as Yelp offers many awards to encourage posting reviews. We notice that OUs with high degree centrality overlaps the most with active users in both datasets. Furthermore, the correlation index values between different types of OUs and active users are small and negative. Thus, we could find that being an active user and being an OU are not highly correlated. Overall, some weak relationships exist between being an active user and being an OU, but publishing many UGC is not a guarantee to become an OU.

## 8 CONCLUSION AND FUTURE WORK

In this paper, we defined the concept of OUs in OSNs and proposed a mixed metric selection strategy to discover them. To manifest its detection performance, we designed and implemented DeepPick, a deep learning-based OU



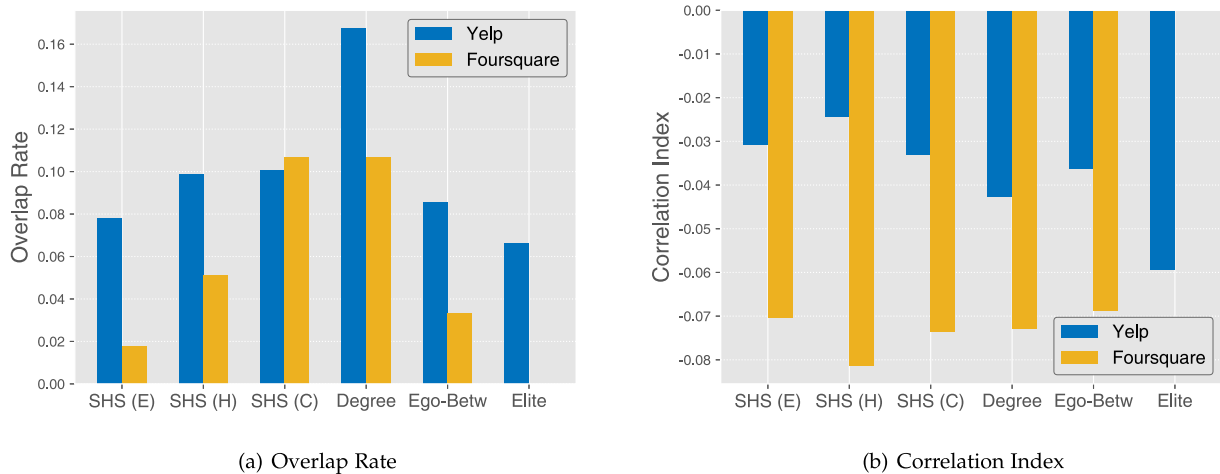

Fig. 8. Overlap rate and correlation index of top OUs and active users in both datasets. Although a small part of OUs are also active users, the two groups' review number sequences show a slightly negative correlation.

detection framework. DeepPick only needs a small fraction of users' information (i.e., ego networks, demographic data, UGC, and visited POIs) to train. After bootstrapping, it will be able to detect OUs by using the users' publicly visible information. Extensive experiments on representative OSNs validate the effectiveness of our strategy. Also, DeepPick is compatible with different types of OUs, which is indeed an advantage of our system. According to our evaluation on several example definitions of OUs, DeepPick outperforms the existing solutions. This study sheds light on the path to unveil OUs in OSNs when the network structure is not fully accessible, which is a common case. It is useful for different relevant entities, such as OSN operators, third-party service providers, and academic researchers.

In future work, we will further study the effectiveness of combining more features in the framework. There are two types of features that can be considered. First, in the fields of diffusion prediction, social homophily and temporal influence are shown to be crucial indicators [90]. We would like to examine if they are also likely to provide more information about the OUs. Second, popularity evaluation [89] of OUs is also worth exploration. We will study how the users' popularity level correlated with their outstanding features.

## REFERENCES

- [1] A. Hicks, S. Comp, J. Horovitz, M. Hovarter, M. Miki, and J. L. Bevan, "Why people use Yelp.com: An exploration of uses and gratifications," *Comput. Hum. Behav.*, vol. 28, no. 6, pp. 2274–2279, 2012.
- [2] J. W. Byers, M. Mitzenmacher, and G. Zervas, "The Groupon effect on Yelp ratings: A root cause analysis," in *Proc. 13th ACM Conf. Electron. Commerce*, 2012, pp. 248–265.
- [3] Y. D. Kwon, D. Chatzopoulos, E. ul Haq, R. C.-W. Wong, and P. Hui, "GeoLifecycle: User engagement of geographical exploration and churn prediction in LBSNs," *Proc. ACM Interactive Mobile Wearable Ubiquitous Technol.*, vol. 3, no. 3, 2019, Art. no. 92.
- [4] Q. Gong, Y. Chen, J. Hu, Q. Cao, P. Hui, and X. Wang, "Understanding cross-site linking in online social networks," *ACM Trans. Web*, vol. 12, no. 4, pp. 25:1–25:29, 2018.
- [5] A. Noulas, B. Shaw, R. Lambiotte, and C. Mascolo, "Topological properties and temporal dynamics of place networks in urban environments," in *Proc. 24th Int. Conf. World Wide Web*, 2015, pp. 431–441.
- [6] G. Wang, S. Y. Schoenebeck, H. Zheng, and B. Y. Zhao, "Will check-in for badges": Understanding bias and misbehavior on location-based social networks," in *Proc. 10th Int. AAAI Conf. Web Soc. Media*, 2016, pp. 417–426.
- [7] M. Cha, H. Haddadi, F. Benevenuto, and K. P. Gummadi, "Measuring user influence in Twitter: The million follower fallacy," in *Proc. 4th Int. AAAI Conf. Weblogs Soc. Media*, 2010, pp. 10–17.
- [8] H. Wang et al., "Social influence does matter: User action prediction for in-feed advertising," in *Proc. AAAI Conf. Artif. Intell.*, 2020, pp. 246–253.
- [9] J. Goldenberg, B. Libai, and E. Muller, "Talk of the network: A complex systems look at the underlying process of word-of-mouth," *Marketing Lett.*, vol. 12, no. 3, pp. 211–223, 2001.
- [10] R. S. Burt, *Structural Holes: The Social Structure of Competition*. Cambridge, MA, USA: Harvard Univ. Press, 1992.
- [11] Z. Lin, Y. Zhang, Q. Gong, Y. Chen, A. Oksanen, and A. Y. Ding, "Structural hole theory in social network analysis: A review," *IEEE Trans. Computat. Social Syst.*, early access, Apr. 16, 2021, doi: 10.1109/TCSS.2021.3070321.
- [12] L. C. Freeman, "Centrality in social networks conceptual clarification," *Soc. Netw.*, vol. 1, no. 3, pp. 215–239, 1978.
- [13] F. Riquelme and P. González-Cantergiani, "Measuring user influence on Twitter: A survey," *Inf. Process. Manage.*, vol. 52, no. 5, pp. 949–975, 2016.
- [14] M. Moricz, Y. Dosbayev, and M. Berlyant, "PYMK: Friend recommendation at MySpace," in *Proc. ACM SIGMOD Int. Conf. Manage. Data*, 2010, pp. 999–1002.
- [15] X. Hu, S. Liu, Y. Zhang, G. Zhao, and C. Jiang, "Identifying top persuaders in mixed trust networks for electronic marketing based on word-of-mouth," *Knowl.-Based Syst.*, vol. 182, 2019, Art. no. 104803.
- [16] Q. Li, B. Kailkhura, J. Thiagarajan, Z. Zhang, and P. Varshney, "Influential node detection in implicit social networks using multi-task Gaussian copula models," in *Proc. NIPS Time Ser. Workshop*, 2016, pp. 27–37.
- [17] H. Kwak, C. Lee, H. Park, and S. Moon, "What is Twitter, a social network or a news media?," in *Proc. 19th Int. Conf. World Wide Web*, 2010, pp. 591–600.
- [18] W. Xu, M. Rezvani, W. Liang, J. X. Yu, and C. Liu, "Efficient algorithms for the identification of top-k structural hole spanners in large social networks," *IEEE Trans. Knowl. Data Eng.*, vol. 29, no. 5, pp. 1017–1030, 2017.
- [19] A. K. Bhowmick, M. Gueuning, J.-C. Delvenne, R. Lambiotte, and B. Mitra, "Temporal sequence of retweets help to detect influential nodes in social networks," *IEEE Trans. Computat. Social Syst.*, vol. 6, no. 3, pp. 441–455, 2019.
- [20] L. He, C.-T. Lu, J. Ma, J. Cao, L. Shen, and P. S. Yu, "Joint community and structural hole spanner detection via harmonic modularity," in *Proc. 22nd ACM SIGKDD Int. Conf. Knowl. Discov. Data Mining*, 2016, pp. 875–884.
- [21] K. Musiał, P. Kazienko, and P. Bródka, "User position measures in social networks," in *Proc. 3rd Workshop Soc. Netw. Mining Anal.*, 2009, pp. 1–9.
- [22] M. Gladwell, *The Tipping Point: How Little Things Can Make a Big Difference*. New York, NY, USA: Little, Brown and Company, 2006.
- [23] J. S. Coleman, *Foundations of Social Theory*. Cambridge, MA, USA: Harvard Univ. Press, 1994.



- [24] J. Nahapiet and S. Ghoshal, "Social capital, intellectual capital, and the organizational advantage," *Acad. Manage. Rev.*, vol. 23, no. 2, pp. 242–266, 1998.
- [25] R. S. Burt, *Structural Holes versus Network Closure as Social Capital*. New York, NY, USA: Aldine de Gruyter, 2001.
- [26] M. Kitsak *et al.*, "Identification of influential spreaders in complex networks," *Nat. Phys.*, vol. 6, no. 11, pp. 888–893, 2010.
- [27] J. M. Podolny and J. N. Baron, "Resources and relationships: Social networks and mobility in the workplace," *Amer. Sociol. Rev.*, vol. 62, no. 5, pp. 673–693, 1997.
- [28] R. S. Burt, "Secondhand brokerage: Evidence on the importance of local structure for managers, bankers, and analysts," *Acad. Manage. J.*, vol. 50, no. 1, pp. 119–148, 2007.
- [29] R. S. Burt, "Structural holes and good ideas," *Amer. J. Sociol.*, vol. 110, no. 2, pp. 349–399, 2004.
- [30] D. Kempe, J. Kleinberg, and É. Tardos, "Maximizing the spread of influence through a social network," in *Proc. 9th ACM SIGKDD Int. Conf. Knowl. Discov. Data Mining*, 2003, pp. 137–146.
- [31] Y. Li, J. Fan, Y. Wang, and K.-L. Tan, "Influence maximization on social graphs: A survey," *IEEE Trans. Knowl. Data Eng.*, vol. 30, no. 10, pp. 1852–1872, 2018.
- [32] T. Lou and J. Tang, "Mining structural hole spanners through information diffusion in social networks," in *Proc. 22nd Int. Conf. World Wide Web*, 2013, pp. 825–836.
- [33] M. P. Van Den Heuvel and O. Sporns, "Rich-club organization of the human connectome," *J. Neurosci.*, vol. 31, no. 44, pp. 15 775–15 786, 2011.
- [34] A. Raychaudhuri, S. Mallick, A. Sircar, and S. Singh, "Identifying influential nodes based on network topology: A comparative study," in *Information, Photonics and Communication*. Berlin, Germany: Springer, 2020, pp. 65–76.
- [35] S. Chechik, E. Cohen, and H. Kaplan, "Average distance queries through weighted samples in graphs and metric spaces: High scalability with tight statistical guarantees," in *Proc. Approximation Randomization Combinatorial Optim. Algorithms Techn. (APPROX/RANDOM)*, 2015, pp. 659–679.
- [36] S. Goyal and F. Vega-Redondo, "Structural holes in social networks," *J. Econ. Theory*, vol. 137, no. 1, pp. 460–492, 2007.
- [37] V. Arnaboldi, M. Conti, M. La Gala, A. Passarella, and F. Pezzoni, "Information diffusion in OSNs: The impact of nodes' sociality," in *Proc. 29th Annu. ACM Symp. Appl. Comput.*, 2014, pp. 616–621.
- [38] Y. Yang, Z. Wang, T. Jin, J. Pei, and E. Chen, "Tracking top-k influential users with relative errors," in *Proc. 28th ACM Int. Conf. Inf. Knowl. Manage.*, 2019, pp. 1783–1792.
- [39] C. S. Campbell, P. P. Maglio, A. Cozzi, and B. Dom, "Expertise identification using email communications," in *Proc. 12th Int. Conf. Inf. Knowl. Manage.*, 2003, pp. 528–531.
- [40] M. Everett and S. P. Borgatti, "Ego network betweenness," *Soc. Netw.*, vol. 27, no. 1, pp. 31–38, 2005.
- [41] P. V. Marsden, "Egocentric and sociocentric measures of network centrality," *Soc. Netw.*, vol. 24, no. 4, pp. 407–422, 2002.
- [42] Y. Chen, J. Hu, Y. Xiao, X. Li, and P. Hui, "Understanding the user behavior of Foursquare: A data-driven study on a global scale," *IEEE Trans. Computat. Soc. Syst.*, vol. 7, no. 4, pp. 1019–1032, 2020.
- [43] G. Ghoshal and A.-L. Barabási, "Ranking stability and super-stable nodes in complex networks," *Nat. Commun.*, vol. 2, 2011, Art. no. 394.
- [44] D. Hristova, M. J. Williams, M. Musolesi, P. Panzarasa, and C. Mascolo, "Measuring urban social diversity using interconnected geo-social networks," in *Proc. 25th Int. Conf. World Wide Web*, 2016, pp. 21–30.
- [45] J. Cranshaw, E. Toch, J. Hong, A. Kittur, and N. Sadeh, "Bridging the gap between physical location and online social networks," in *Proc. 12th ACM Int. Conf. Ubiquitous Comput.*, 2010, pp. 119–128.
- [46] A. Chin and D. Zhang, *Mobile Social Networking. An Innovative Approach*. New York, NY, USA: Springer-Verlag, 2013.
- [47] E. Cho, S. A. Myers, and J. Leskovec, "Friendship and mobility: User movement in location-based social networks," in *Proc. 17th ACM SIGKDD Int. Conf. Knowl. Discov. Data Mining*, 2011, pp. 1082–1090.
- [48] J. Pang and Y. Zhang, "Quantifying location sociality," in *Proc. 28th ACM Conf. Hypertext Soc. Media*, 2017, pp. 145–154.
- [49] C. Zhang, S. Bengio, M. Hardt, B. Recht, and O. Vinyals, "Understanding deep learning (still) requires rethinking generalization," *Commun. ACM*, vol. 64, no. 3, pp. 107–115, 2021.
- [50] J. McAuley and J. Leskovec, "Hidden factors and hidden topics: Understanding rating dimensions with review text," in *Proc. 7th ACM Conf. Recommender Syst.*, 2013, pp. 165–172.
- [51] Y. Yao, B. Viswanath, J. Cryan, H. Zheng, and B. Y. Zhao, "Automated crowdturfing attacks and defenses in online review systems," in *Proc. ACM SIGSAC Conf. Comput. Commun. Secur.*, 2017, pp. 1143–1158.
- [52] Y. R. Tausczik and J. W. Pennebaker, "The psychological meaning of words: LIWC and computerized text analysis methods," *J. Lang. Soc. Psychol.*, vol. 29, no. 1, pp. 24–54, 2010.
- [53] J. W. Pennebaker, C. K. Chung, J. Frazee, G. M. Lavergne, and D. I. Beaver, "When small words foretell academic success: The case of college admissions essays," *PLoS One*, vol. 9, no. 12, 2014, Art. no. e115844.
- [54] Q. Gong *et al.*, "DeepScan: Exploiting deep learning for malicious account detection in location-based social networks," *IEEE Commun. Mag.*, vol. 56, no. 11, pp. 21–27, 2018.
- [55] Q. Gong *et al.*, "Detecting malicious accounts in online developer communities using deep learning," in *Proc. 28th ACM Int. Conf. Inf. Knowl. Manage.*, 2019, pp. 1251–1260.
- [56] L. Breiman, *Classification and Regression Trees*. Evanston, IL, USA: Routledge, 2017.
- [57] L. Breiman, "Random forests," *Mach. Learn.*, vol. 45, no. 1, pp. 5–32, 2001.
- [58] T. Chen and C. Guestrin, "XGBoost: A scalable tree boosting system," in *Proc. 22nd ACM SIGKDD Int. Conf. Knowl. Discov. Data Mining*, 2016, pp. 785–794.
- [59] L. Prokhorenkova, G. Gusev, A. Vorobev, A. V. Dorogush, and A. Gulin, "CatBoost: Unbiased boosting with categorical features," in *Proc. Int. Conf. Neural Inf. Process. Syst.*, 2018, pp. 6638–6648.
- [60] Y. Kim, "Convolutional neural networks for sentence classification," in *Proc. Conf. Empir. Methods Natural Lang. Process.*, 2014, pp. 1746–1751.
- [61] S. Hochreiter and J. Schmidhuber, "Long short-term memory," *Neural Comput.*, vol. 9, no. 8, pp. 1735–1780, 1997.
- [62] T. Mikolov, I. Sutskever, K. Chen, G. S. Corrado, and J. Dean, "Distributed representations of words and phrases and their compositionality," in *Proc. Int. Conf. Neural Inf. Process. Syst.*, 2013, pp. 3111–3119.
- [63] T. Chen, R. Xu, Y. He, and X. Wang, "Improving sentiment analysis via sentence type classification using BiLSTM-CRF and CNN," *Expert Syst. Appl.*, vol. 72, pp. 221–230, 2017.
- [64] Y. Bengio, P. Simard, and P. Frasconi, "Learning long-term dependencies with gradient descent is difficult," *IEEE Trans. Neural Netw.*, vol. 5, no. 2, pp. 157–166, 1994.
- [65] A. Graves and J. Schmidhuber, "Frame-wise phoneme classification with bidirectional LSTM and other neural network architectures," *Neural Netw.*, vol. 18, no. 5/6, pp. 602–610, 2005.
- [66] T. Mikolov, K. Chen, G. Corrado, and J. Dean, "Efficient estimation of word representations in vector space," in *Proc. 1st Int. Conf. Learn. Representations (Workshop)*, 2013.
- [67] F. Pedregosa *et al.*, "Scikit-learn: Machine learning in Python," *J. Mach. Learn. Res.*, vol. 12, pp. 2825–2830, 2011.
- [68] T. Fawcett, "An introduction to ROC analysis," *Pattern Recognit. Lett.*, vol. 27, no. 8, pp. 861–874, 2006.
- [69] C. D. Manning, H. Schütze, and P. Raghavan, *Introduction to Information Retrieval*. New York, NY, USA: Cambridge Univ. Press, 2008.
- [70] D. Neil, M. Pfeiffer, and S.-C. Liu, "Phased LSTM: Accelerating recurrent network training for long or event-based sequences," in *Proc. Int. Conf. Neural Inf. Process. Syst.*, 2016, pp. 3882–3890.
- [71] Q. McNemar, "Note on the sampling error of the difference between correlated proportions or percentages," *Psychometrika*, vol. 12, no. 2, pp. 153–157, 1947.
- [72] J. Ma *et al.*, "Detecting rumors from microblogs with recurrent neural networks," in *Proc. 25th Int. Joint Conf. Artif. Intell.*, 2016, pp. 3818–3824.
- [73] G. Katsimpras, D. Vogiatzis, and G. Paliouras, "Determining influential users with supervised random walks," in *Proc. 24th Int. Conf. World Wide Web*, 2015, pp. 787–792.
- [74] D. M. Blei, A. Y. Ng, and M. I. Jordan, "Latent Dirichlet Allocation," *J. Mach. Learn. Res.*, vol. 3, pp. 993–1022, 2003.
- [75] A. Sheikahmadi and M. A. Nematbakhsh, "Identification of multi-spreader users in social networks for viral marketing," *J. Inf. Sci.*, vol. 43, no. 3, pp. 412–423, 2017.

- [76] J. Qiu, J. Tang, H. Ma, Y. Dong, K. Wang, and J. Tang, "DeepInf: Social influence prediction with deep learning," in *Proc. 24th ACM SIGKDD Int. Conf. Knowl. Discov. Data Mining*, 2018, pp. 2110–2119.
- [77] H. Bo, R. McConville, J. Hong, and W. Liu, "Social network influence ranking via embedding network interactions for user recommendation," in *Proc. Companion Web Conf.*, 2020, pp. 379–384.
- [78] L. F. Ribeiro, P. H. Saverese, and D. R. Figueiredo, "struc2vec: Learning node representations from structural identity," in *Proc. 23rd ACM SIGKDD Int. Conf. Knowl. Discov. Data Mining*, 2017, pp. 385–394.
- [79] C. Donnat, M. Zitnik, D. Hallac, and J. Leskovec, "Learning structural node embeddings via diffusion wavelets," in *Proc. 24th ACM SIGKDD Int. Conf. Knowl. Discov. Data Mining*, 2018, pp. 1320–1329.
- [80] G. Amati, S. Angelini, G. Gambosi, G. Rossi, and P. Vocca, "Influential users in Twitter: Detection and evolution analysis," *Multimedia Tools Appl.*, vol. 78, no. 3, pp. 3395–3407, 2019.
- [81] J. E. Hirsch, "An index to quantify an individual's scientific research output," *Proc. Nat. Acad. Sci. USA*, vol. 102, no. 46, pp. 16 569–16 572, 2005.
- [82] Y. Ding, E. Yan, A. Frazho, and J. Caverlee, "PageRank for ranking authors in co-citation networks," *J. Amer. Soc. Inf. Sci. Technol.*, vol. 60, no. 11, pp. 2229–2243, 2009.
- [83] H. Wei *et al.*, "Identifying influential nodes based on network representation learning in complex networks," *PLoS One*, vol. 13, no. 7, 2018, Art. no. e0200091.
- [84] M. M. Keikha, M. Rahgozar, M. Asadpour, and M. F. Abdollahi, "Influence maximization across heterogeneous interconnected networks based on deep learning," *Expert Syst. Appl.*, vol. 140, 2020, Art. no. 112905.
- [85] C. K. Leung, A. Cuzzocrea, J. J. Mai, D. Deng, and F. Jiang, "Personalized DeepInf: Enhanced social influence prediction with deep learning and transfer learning," in *Proc. IEEE Int. Conf. Big Data*, 2019, pp. 2871–2880.
- [86] F. Erlandsson, P. Bródka, A. Borg, and H. Johnson, "Finding influential users in social media using association rule learning," *Entropy*, vol. 18, no. 5, 2016, Art. no. 164.
- [87] A. Guille, H. Hacid, C. Favre, and D. A. Zighed, "Information diffusion in online social networks: A survey," *ACM SIGMOD Rec.*, vol. 42, no. 2, pp. 17–28, 2013.
- [88] G. Zhao, P. Jia, A. Zhou, and B. Zhang, "InfGCN: Identifying influential nodes in complex networks with graph convolutional networks," *Neurocomputing*, vol. 414, pp. 18–26, 2020.
- [89] Q. Cao, H. Shen, J. Gao, B. Wei, and X. Cheng, "Popularity prediction on social platforms with coupled graph neural networks," in *Proc. 13th Int. Conf. Web Search Data Mining*, 2020, pp. 70–78.
- [90] A. Sankar, X. Zhang, A. Krishnan, and J. Han, "Inf-VAE: A variational autoencoder framework to integrate homophily and influence in diffusion prediction," in *Proc. 13th Int. Conf. Web Search Data Mining*, 2020, pp. 510–518.
- [91] M. Ou, P. Cui, J. Pei, Z. Zhang, and W. Zhu, "Asymmetric transitivity preserving graph embedding," in *Proc. 22nd ACM SIGKDD Int. Conf. Knowl. Discov. Data Mining*, 2016, pp. 1105–1114.
- [92] M. Schlichtkrull, T. N. Kipf, P. Bloem, R. Van Den Berg, I. Titov, and M. Welling, "Modeling relational data with graph convolutional networks," in *Proc. Eur. Semantic Web Conf.*, 2018, pp. 593–607.
- [93] A. J. Walker, "An efficient method for generating discrete random variables with general distributions," *ACM Trans. Math. Softw.*, vol. 3, no. 3, pp. 253–256, 1977.
- [94] A. Chen, Y. Lu, P. Y. Chau, and S. Gupta, "Classifying, measuring, and predicting users' overall active behavior on social networking sites," *J. Manage. Inf. Syst.*, vol. 31, no. 3, pp. 213–253, 2014.



**Wanda Li** received the BS (with honors) degree from the School of Computer Science, Fudan University, Shanghai, China. She is currently working toward the graduate degree in data science and information technology at Tsinghua-Berkeley Shenzhen Institute (TBSI), Shenzhen, China. She has been a research assistant with the Mobile Systems and Networking (MSN) Group since 2018. Her research interests include data mining, machine learning, and user behavior analysis.



**Zhiwei Xu** (Student Member, IEEE) is currently working toward the bachelor's degree in the School of Computer Engineering and Science, Shanghai University, Shanghai, China. He has been a research intern with the Mobile Systems and Networking (MSN) Group, Fudan University since 2019. His research interests include online social network mining, user behavior modeling, and machine learning systems.



**Yi Sun** is currently working toward the undergraduate degree in computer science at the Huazhong University of Science and Technology, Wuhan, China. She has been a research intern with the Mobile Systems and Networking (MSN) Group, Fudan University since 2019. Her research interests include online social network mining and deep learning.

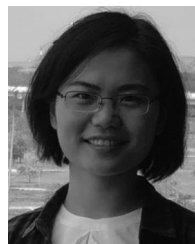

**Qingyuan Gong** received the PhD degree in computer science from Fudan University, Shanghai, China, in 2020. She is currently working as a postdoc at Fudan University. Her research interests include network security, user behavior analysis, and computational social systems. She published refereed papers in the *IEEE Communications Magazine*, *ACM Transactions on the Web*, *IEEE Transactions on Dependable and Secure Computing*, *Springer World Wide Web Journal*, *ACM CIKM*, and *ICPP*. She has been a visiting student with the University of Göttingen in 2015 and 2019, also with the University of Chicago in 2018.



**Yang Chen** (Senior Member, IEEE) received the BS and PhD degrees from the Department of Electronic Engineering, Tsinghua University, Beijing, China, in 2004 and 2009, respectively. He is currently an associate professor within the School of Computer Science, Fudan University, China. He leads the Mobile Systems and Networking (MSN) Group since 2014. Before joining Fudan, he was a postdoctoral associate with the Department of Computer Science, Duke University, USA, where he served as senior personnel in the NSF MobilityFirst Project. From September 2009 to April 2011, he has been a research associate and the deputy head of Computer Networks Group, Institute of Computer Science, University of Göttingen, Germany. He visited Stanford University (in 2007) and Microsoft Research Asia (2006–2008) as a visiting student. His research interests include online social networks, Internet architecture, and mobile computing. He serves as an associate editor-in-chief of the *Journal of Social Computing*.

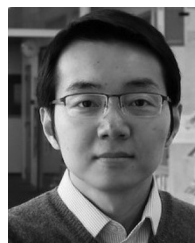

**Aaron Yi Ding** (Member, IEEE) received the PhD degree from the Department of Computer Science, University of Helsinki, Helsinki, Finland. He is leading the Cyber-Physical Intelligence (CPI) Lab, TU Delft as tenured asst professor and adjunct professor (permanent) in computer science with the University of Helsinki. Prior to TU Delft, he has worked with TU Munich, Germany, Columbia University, USA, and the University of Cambridge, U.K. His research focuses on edge computing, edge AI, and data-driven IoT services. His research work has received best paper awards and recognition from ACM SIGCOMM, ACM EdgeSys, ACM SenSys CCIoT, and IEEE INFOCOM. He is a two-time recipient of the Nokia Foundation Scholarships.



**Xin Wang** (Member, IEEE) received the BS degree in information theory and the MS degree in communication and electronic systems from Xidian University, Xi'an, China, in 1994 and 1997, respectively, and the PhD degree in computer science from Shizuoka University, Shizuoka, Japan, in 2002. He is a professor with Fudan University, Shanghai, China. His research interests include quality of network service, next-generation network architecture, mobile Internet, and network coding.



**Pan Hui** (Fellow, IEEE) received the BEng and MPhil degrees from the Department of Electrical and Electronic Engineering, University of Hong Kong, Hong Kong, and the PhD degree from the Computer Laboratory, University of Cambridge, Cambridge, U.K. He is the Nokia chair in data science and a full professor in computer science with the University of Helsinki since September 2017. He is also a faculty member of the Department of Computer Science and Engineering, Hong Kong University of Science and Technology since 2013 and an adjunct professor of social computing and networking with Aalto University, Finland since 2012. He has published more than 250 research papers and with more than 16,000 citations. He has 30 granted and filed European and US patents in the areas of augmented reality, mobile computing, and data science. He is an associate editor of the *IEEE Transactions on Mobile Computing* and the *Springer Journal of Computational Social Networks*. He has also served as associate editor of the *IEEE Transactions on Cloud Computing* and guest editor for various journals including the *IEEE Journal on Selected Areas in Communications* (JSAC), *IEEE Transactions on Secure and Dependable Computing*, *IEEE Communications Magazine*, and *ACM Transactions on Multimedia Computing, Communications, and Applications*. He is an ACM distinguished scientist, an International fellow of the Royal Academy of Engineering (FREng), and a member of Academia Europaea (Academy of Europe).

▷ For more information on this or any other computing topic, please visit our Digital Library at [www.computer.org/csdl](http://www.computer.org/csdl).