

**Alternative pool water treatment  
and the influence of swimmers on pool water quality**

Keuten, Maarten

**DOI**

[10.4233/uuid:bccca021-5e2e-49f2-9e51-2ede359203fd](https://doi.org/10.4233/uuid:bccca021-5e2e-49f2-9e51-2ede359203fd)

**Publication date**

2018

**Document Version**

Final published version

**Citation (APA)**

Keuten, M. (2018). *Alternative pool water treatment: and the influence of swimmers on pool water quality*. [Dissertation (TU Delft), Delft University of Technology]. <https://doi.org/10.4233/uuid:bccca021-5e2e-49f2-9e51-2ede359203fd>

**Important note**

To cite this publication, please use the final published version (if applicable).  
Please check the document version above.

**Copyright**

Other than for strictly personal use, it is not permitted to download, forward or distribute the text or part of it, without the consent of the author(s) and/or copyright holder(s), unless the work is under an open content license such as Creative Commons.

**Takedown policy**

Please contact us and provide details if you believe this document breaches copyrights.  
We will remove access to the work immediately and investigate your claim.



Cover design and layout by           Maarten Keuten  
Printed by                                   Ipskamp Printing, Enschede  
ISBN:                                       978-94-6186-975-3

©2018 Maarten Keuten, the Netherlands. All rights reserved. No part of this thesis may be reproduced or transmitted in any form by any means, without permission in writing of the copyright owner.



# **Alternative pool water treatment and the influence of swimmers on pool water quality**

## **Alternatieve waterbehandeling voor zwembaden en de invloed van zwemmers op de waterkwaliteit**

Proefschrift

ter verkrijging van de graad van doctor

aan de Technische Universiteit Delft

op gezag van de Rector Magnificus prof.dr.ir. T.H.J.J. van der Hagen,

voorzitter van het College voor Promoties

in het openbaar te verdedigen op

vrijdag 9 november 2018 om 10 uur

door

**Martinus Gerardus Antoinette KEUTEN**

Civiel ingenieur, Universiteit Delft, Nederland

geboren te Venray, Nederland



Dit proefschrift is goedgekeurd door de promotoren.

Samenstelling promotiecommissie bestaat uit:

Rector Magnificus	voorzitter
Prof.dr.ir. L.C. Rietveld	Technische Universiteit Delft, promotor
Prof.dr.dr.h.c.ir. M.C.M. van Loosdrecht	Technische Universiteit Delft, promotor
Prof.dr.ir. J.C. van Dijk	Technische Universiteit Delft

Onafhankelijke leden:

Prof.dr.ir. A. Vantarakis	Universiteit van Patras, Griekenland
Prof.dr. A.M. de Roda Husman	Universiteit Utrecht
Prof.dr. M.D. Kennedy	IHE Delft
Ir. N. Visser	Sportfondsen Nederland B.V.

Reserve lid:

Prof.dr.ir. M.K. de Kreuk	Technische Universiteit Delft
---------------------------	-------------------------------

Het onderzoek in dit proefschrift was onderdeel van het DIPool project. Dit project werd gedragen en gefinancierd door de project partners TU Delft, Hellebrekers Technieken, Akzonobel industrial Chemicals B.V., Van Remmen UV-techniek B.V., Coram International B.V. en Sportfondsen Nederland B.V.. Aanvullende financiering is verkregen door bijdragen van de INNOwator regeling, EFRO - Europees Fonds voor Regionale Ontwikkeling en GO - Gelderland & Overijssel, Gebundelde Innovatiekracht.



**Trefwoorden:** Initiele antropogene vervuiling, continue antropogene vervuiling, douchen, zwembad hygiëne, voorspellend model, zweet ratio, zweet samenstelling, biofilm vormings potentie, microbiologische vervuilingssimulator, microbiologische kwaliteit, chlorering, UV-desinfectie, biologische zand filtratie, ultrafiltratie, ureum, nitraat, TN, NPOC, biologisch geactiveerde kool filtratie, zwembad

**Keywords:** Initial anthropogenic pollutants, continual anthropogenic pollutants, showering, pre-swim hygiene, predictive model, sweat rate, sweat composition, biofilm formation potential, microbial fouling simulator, microbial quality, chlorination, UV-disinfection, biological sand filtration, ultra-filtration, urea, nitrate, TN, NPOC, biological activated carbon filtration, swimming pool

**Drukker:** Ipskamp Printing, Enschede

**Voorkant:** Maarten Keuten

**Copyright** © 2018 Maarten Keuten

**ISBN** 978-94-6186-975-3

Een elektronische versie van dit proefschrift is beschikbaar op <https://repository.tudelft.nl/>

*... life is what happens to you  
while you're busy making other plans ...*

From: Beautiful boy, John Lennon 1980

Voor Joris en Edith





# Contents

	Page
Summary	ii
Samenvatting	vi
Chapter 1 General introduction	1
Chapter 2 Definition and quantification of initial anthropogenic pollutant release in swimming pools	17
Chapter 3 Quantification of continual anthropogenic pollutants released in swimming pools	41
Chapter 4 Biofilm formation potential and microbial water quality of simulated swimming pool water with different types of disinfection	73
Chapter 5 Microbial reduction of urea in simulated swimming pool water with different types of disinfection	111
Chapter 6 Conclusions, remarks and recommendations	131
Dankwoord (word of gratitude)	139
Photografy and painting	145
References of propositions	145
List of publications	147
Curriculum vitea	153
Cover Design	154
Omslag ontwerp	155

# Summary

In the past ten thousand years, swimming has evolved into a popular leisure activity which is enjoyed by all ages, social classes and ability levels. In order to safeguard the health and safety of swimmers, all pools need to comply with national swimming pool legislation. Besides hygienic terms, such as water quality parameters, safety requirements for materials and equipment are mandatory. In order to provide hygienic and safe swimming pool water, the pool water needs to be treated, mainly with filtration and disinfection. Filtration is needed to keep the water clear so submerged obstacles can be detected easily, while disinfection is needed to inactivate harmful viruses and bacteria. Chlorination is without doubt the world's most frequently used disinfection method for swimming pools, but has some unwanted side effects. Besides disinfection, the chlorine also reacts with pollutants released by swimmers, to form the so-called disinfection by-products (DBPs). While some DBPs just irritate the skin or eyes, other DBPs are possibly related to more severe health risks with genotoxic or carcinogenic effects. Therefore, the overall positive health effect of swimming will increase when the potential negative health impact of DBPs is reduced. Removal of DBPs, or reduction of the DBP formation can be achieved with the use of advanced treatment techniques, but they are often complex to operate and come with high operational costs. Pollution introduced by swimmers in pools is a relatively unknown factor, as are the tools to manage these pollutants. This is also true for the use of alternative disinfection, or biological filtration in swimming pool water treatment. The DIPool project was started to explore alternative disinfection, the use of biological filtration and the influence of swimmers on pool water quality.

Little was known about the introduction of pollutants by swimmers. Few studies were done in bathing tubs and pool basins. As there was no clear definition of pollutants from swimmers, different types of anthropogenic pollutants were defined. Although it was obvious that pre-swim showering would reduce the release of pollutants, it was not known to what extent these pollutants would be reduced and how long a pre-swim shower should take. So the initial anthropogenic pollutant release was defined as the amount of pollutants that are rinsed off from a subject's body during a pre-swim shower. Time-series experiments with a standardised shower cabin resulted in a definition of the initial anthropogenic pollutant release: *the amount of pollutants released from a person in a standardised shower cabin during the first 60 seconds of showering*. The data were also used to create a model of the pollutant release, which can be used to predict the initial anthropogenic pollutant release as well as the effects of showering. On-site experiments were done at four different swimming pools, including one outdoor pool. Results of these on-site showering experiments correspond with the time-series and model outcomes. Anthropogenic pollutant release (both chemical and microbiological) in swimming pool water can be reduced by pre-swim showering, very likely resulting in decreased formation of DBPs and decreased chlorine demand.

Besides the initial anthropogenic pollutant release, swimmers also release pollutants during swimming, this was defined as the continual anthropogenic pollutant release. Although there had been several publications describing the amount of sweat loss during swimming, little was known about the actual release of pollutants during submerged sweating and the effect of different levels of exercise. Several laboratory pool tank experiments, with standardised

submerged exercises were done to collect time-series data for the pollutant release from different subjects at different water temperatures. On-site experiments were used to validate the laboratory findings. The sweat released during both the laboratory and the on-site experiments was very similar. The sweat rate found was 0.1-0.2 L/m<sup>2</sup>/h at water temperatures below 29 °C and increased linearly with increasing water temperatures to 0.8 L/m<sup>2</sup>/h at 35 °C. Besides sweat, the continual anthropogenic pollutant release also contained particles (mainly skin fragments and hair) and micro-organisms. The release of most components could be explained by the composition of sweat. The average release during 30 minutes of exercise was 250 mg/bather non-purgeable organic carbon (NPOC), 77.3 mg/bather total nitrogen, 37.1 mg/bather urea and 10.1 mg/bather ammonium. The release of NPOC cannot be explained by the known composition of sweat and is most probably due to the release of sebum, which has not been considered before. The average release of other components was 1.31×10<sup>9</sup> # particles/bather (2-50µm), 5.2 µg/bather intracellular adenosine triphosphate (cATP) and 9.3×10<sup>6</sup> intact cell count/bather (iCC). The pool water temperature was the main parameter to restrain the continual anthropogenic pollutant release. The study also showed that a significant amount of the total anthropogenic pollutants release is due to unhygienic behaviour of bathers; not having a pre-swim shower and not using a toilet when nature calls.

After the release of anthropogenic pollutants, alternative disinfection was investigated. It was likely that in the absence of a residual disinfectant, as is the case with alternative disinfection like ultrafiltration and UV-disinfection, biofilms would have been formed more rapidly and pathogenic bacteria would have been more likely to survive compared to a system with a residual disinfectant. Although there was some scientific information on biofilm formation at chlorinated swimming pool conditions, there was no publication found describing the biofilm formation at swimming pool conditions in the absence of a residual disinfectant. And while ultrafiltration and UV-disinfection were common disinfection steps for drinking water treatment, no publications were found about the effect of these technologies on disinfection performance for swimming pool water, in the absence of a residual disinfectant. Therefore, the biofilm formation potential and microbial water quality of simulated swimming pool water was investigated along with the influence of different treatment methods: without disinfection, disinfection by ultrafiltration, with UV-disinfection and disinfection by chlorination. Microbial fouling simulators were used to monitor microbial growth, by measuring intracellular adenosine triphosphate and intact cell counts of the biofilm inside microbial fouling simulators and adenosine triphosphate. Water quality was monitored for worst case and maximum allowed pollution with body fluid analogue during 23 days experiments. The lowest biofilm formation potential and best microbial water quality was found with chlorination. In the absence of a residual disinfectant, multiple treatment steps were needed to reduce the biofilm forming potential of pool water to levels similar to heated tap water. Only biological sand filtration combined with ultrafiltration and UV- treatment was able to reduce the biofilm formation potential and improve the microbial water quality close to the level of chlorinated pool water. During experiments with recirculation and chlorination, biofilm forming potential and microbial water quality were comparable with or without phosphate addition, while in the absence of a residual disinfectant, thus biological sand filtration combined with with ultrafiltration and UV-treatment, the lowest biofilm forming potential was found with phosphate addition, with a slightly reduced microbial water quality.



It was known that urea was the predominant nitrogen compound released by bathers and both urea and NPOC were important precursors for the unwanted formation of DBPs in swimming pools. Although the chemical oxidation of urea has been described before, the biological reduction at swimming pool conditions was not described, while it could be performed with a biological filtration in the absence of a residual disinfectant like a biological activated carbon filtration. This study focussed on the removal of urea and the formation of nitrate for different types of treatment and disinfection of pool water. In a pilot plant pool set-up, treatment without disinfection, and with disinfection by ultrafiltration, UV or chlorination were compared, all in combination with biological filtration. Regardless of the type of treatment, urea was not completely removed above 8 mg/L, which, in the absence of chlorination, leads to the accumulation of ammonium. Chlorination negatively impacted ammonium oxidation and formation of nitrate was reduced, which may result in an increased formation of nitrogen containing DBPs. Biological activated carbon filtration increased the removal of urea in a chlorinated treatment, resulting in less nitrogen available for DBP formation. In the absence of a residual disinfectant, the reduction of urea improved with an increased number of treatment steps. All urea was completely hydrolysed and completely oxidised towards nitrate during biological sand filtration combined with ultrafiltration and UV-treatment of recirculated pool water. It was thus concluded that microbial reduction of urea was not dependent on the type of disinfection, but mainly influenced by the presence of a microbial treatment step in the pool water treatment.

This thesis showed the potential improvements to pool water by focussing on hygienic behaviour and the technical feasibility of pool water treatment without a residual disinfectant. Many questions remain on up-sizing to full scale, regulating limits, quality management and social acceptance. All can be tested in a full scale pilot study, which will be the Proof of the Pudding!!



# Samenvatting

In de laatste tienduizend jaar is zwemmen uitgegroeid tot een populaire vrijetijdsbesteding die wordt uitgeoefend door mensen van alle leeftijdsgroepen, sociale klassen, zelfs met uiteenlopende handicaps. Om de gezondheid en veiligheid van zwemmers te waarborgen, moeten alle zwembaden voldoen aan nationale regelgeving. Naast hygiënische normen, zoals waterkwaliteit, zijn veiligheidsnormen voor materialen en apparatuur ook verplicht. Om hygiënisch en veilig zwembadwater te kunnen maken, moet het zwembadwater worden behandeld, voornamelijk met filtratie en desinfectie. Filtratie is nodig om het water helder te houden, zodat obstakels onder water goed zichtbaar zijn, terwijl desinfectie nodig is om schadelijke virussen en bacteriën te inactiveren. Chlorering is zonder twijfel 's werelds meest gebruikte desinfectiemethode voor zwembaden, echter met enkele ongewenste bijwerkingen. Naast desinfectie reageert het vrij chloor ook met vervuilende stoffen die worden afgegeven door zwemmers, waarbij de desinfectiebijproducten (DBP's) gevormd worden. Terwijl sommige DBP's alleen de huid of ogen irriteren, wordt aangenomen dat andere DBP's verband houden met ernstigere gezondheidsrisico's met mogelijk genotoxische of carcinogene effecten. Het algeheel positieve gezondheidseffect van zwemmen zal daarom toenemen wanneer de potentiële negatieve gevolgen voor de gezondheid van DBP's worden verminderd. Verwijdering van DBP's of vermindering van de DBP-formatie kan worden gedaan met behulp van geavanceerde waterbehandelingstechnieken, maar deze zijn vaak complex om te bedienen en hebben hoge operationele kosten. Kennis inzake de afgifte van verontreinigende stoffen door zwemmers en de mogelijkheden om deze afgifte te beheersen is beperkt. Dat geldt ook voor het gebruik van alternatieve desinfectie of biologische filtratie bij de behandeling van zwembadwater. Het DIPool-project is gestart om deze alternatieve desinfectie, het gebruik van biologische filtratie en de invloed van zwemmers op de kwaliteit van zwembadwater te onderzoeken.

Er was weinig bekend over de uitstoot van verontreinigende stoffen door zwemmers. Enkele studies zijn gedaan in badkuipen en bassins. Door het ontbreken van een duidelijke definitie van zwemmersvuil, zijn eerst verschillende soorten antropogene vervuiling gedefinieerd. Hoewel het duidelijk is dat douchen voor het zwemmen de uitstoot van zwemmersvuil vermindert, de mate waarin het zwemmersvuil vermindert en hoe lang vooraf-douchen zou moeten duren was onbekend. Het initiële antropogene zwemmersvuil is als eerste onderzocht als de hoeveelheid vervuilende stoffen die tijdens het zwemmen van het lichaam van een zwemmer afspoelen. Tijdreeksexperimenten met een gestandaardiseerde douchecabine resulteerden in de definitie van de initiële zwemmersvuil afgifte: *de totale hoeveelheid verontreinigende stoffen die afspoelt van een persoon in een gestandaardiseerde douchecabine gedurende de eerste 60 seconden van het douchen*. De gegevens werden ook gebruikt om een model voor de afgifte van het zwemmersvuil te maken, wat kan worden gebruikt om de afgifte van initiële zwemmersvuil en de effecten van douchen te voorspellen. Validatie experimenten werden bij vier verschillende zwembaden uitgevoerd, waaronder één buitenbad. De resultaten van deze validatie experimenten komen overeen met de tijdreeks en modeluitkomsten. De afgifte van zwemmersvuil (zowel chemisch als microbiologisch) in zwembadwater kan worden verminderd door vooraf-douchen, wat zeer waarschijnlijk, resulteert in een verminderde DBP-vorming en een verminderde vraag naar chloor.



Naast het initiële zwemmersvuil bij aanvang van het zwemmen, geven zwemmers tijdens het zwemmen ook vervuilende stoffen af, dit is gedefinieerd als de continue zwemmersvuil afgifte. Hoewel er verschillende publicaties zijn die het zweetverlies tijdens het zwemmen beschrijven, was er weinig bekend over de daadwerkelijke afgifte van vervuilende stoffen tijdens zweten-onder-water en het effect van verschillende inspanningsniveaus daarop. Verschillende badkuipexperimenten werden uitgevoerd met gestandaardiseerde ondergedompelde inspanningen. Tijdreeksgegevens werden gebruikt voor de afgifte van het continue zwemmersvuil door verschillende personen bij verschillende watertemperaturen te bepalen. Experimenten bij zwembaden werden gebruikt om de laboratoriumresultaten te valideren. De afgifte van zweet tijdens tijdreeks experimenten in het laboratorium was vergelijkbaar met de daadwerkelijke afgifte in een zwembad. De zweethoeveelheid was 0,1-0,2 L/m<sup>2</sup>/h bij watertemperaturen onder 29 °C, met een lineaire toename met stijgende watertemperaturen tot 0,8 L/m<sup>2</sup>/h bij 35 °C. Naast het zweet bevatte het continue zwemmersvuil ook deeltjes (voornamelijk huidfragmenten en haar) en micro-organismen. De gemiddelde afgifte van non purgeable organic carbon (NPOC) gedurende 30 minuten lichaamsbeweging was 250 mg NPOC per zwemmer, stikstof 77,3 mg N per zwemmer, ureum 37,1 mg per zwemmer en 10,1 mg ammonium per zwemmer. De afgifte van de meeste componenten kon worden verklaard door de samenstelling van zweet, behalve de afgifte van NPOC. De meest waarschijnlijk verklaring hiervoor is de afgifte van huidvetten, wat nog niet eerder genoemd is in publicaties. De gemiddelde afgifte van andere componenten was 1,31 x10<sup>9</sup> # deeltjes/zwemmer (2-50 µm), 5,2 µg intracellulair adenosinetriofosfaat (cATP) per zwemmer en 9,3 x10<sup>6</sup> intacte cellen per zwemmer (iCC). De badwatertemperatuur was de belangrijkste parameter om de continue antropogene uitstoot van verontreinigende stoffen te beperken. Het onderzoek toonde ook aan dat een aanzienlijk deel van de totale uitstoot van zwemmersvuil te wijten is aan onhygiënisch gedrag van zwemmers; niet vooraf-douchen en niet het-toilet-gebruiken tijdens het zwemmen.

Na het zwemmersvuil werd alternatieve desinfectie onderzocht. In afwezigheid van een residueel desinfectiemiddel, zoals het geval is bij alternatieve desinfectie met ultrafiltratie of UV-desinfectie, werd verwacht dat biofilms sneller gevormd worden en pathogene bacteriën meer kans hebben om te overleven in vergelijking met een systeem met een residueel desinfectiemiddel. Hoewel er weinig wetenschappelijke informatie over biofilmvorming onder gechloroerde zwembadomstandigheden is, werd er geen publicatie gevonden die de biofilmvorming bij zwembadcondities beschrijft in afwezigheid van een residueel desinfectiemiddel. Ook over het effect van ultrafiltratie en UV-desinfectie op de desinfectie van zwembadwater zonder residueel desinfectiemiddel, zijn er geen publicaties gevonden, terwijl daar veel over bekend is bij de drinkwaterbereiding. De biofilmvormingspotentialiteit en de microbiële waterkwaliteit van gesimuleerd zwembadwater werden daarom onderzocht, samen met de invloed van verschillende behandelingsmethoden: zonder desinfectie, desinfectie door ultrafiltratie, met UV-desinfectie en desinfectie door chlorering. Microbiële fouling-simulatoren (MFS) werden gebruikt om biofilmvorming te onderzoeken, door het meten van intracellulair adenosinetriofosfaat (cATP) en het aantal intacte cellen (iCC) van de biofilm in een MFS. De waterkwaliteit werd gedurende experimenten van 23 dagen gevolgd tijdens gesimuleerde slechtst denkbare en maximaal toegestane zwemmersvuil condities. Het laagste biofilmvormingspotentialiteit en de beste microbiële waterkwaliteit werd gevonden met chlorering. Bij afwezigheid van een residueel desinfectiemiddel waren meerdere behandelingsstappen nodig om de biofilmvorming van zwembadwater te verminderen tot niveaus die vergelijkbaar

zijn met verwarmd kraanwater. Alleen de combinatie van biologische zandfiltratie met ultrafiltratie en UV-behandeling was in staat de biofilmvorming te verminderen en de microbiële waterkwaliteit te verbeteren tot een niveau vergelijkbaar met dat van gechloreerd zwembadwater. Tijdens experimenten met recirculatie en chlorering waren het biofilmvorming en de microbiële waterkwaliteit vergelijkbaar met of zonder fosfaattoevoeging, terwijl bij afwezigheid van een residueel desinfectiemiddel, bij het gebruik van biologische zandfiltratie in combinatie met ultrafiltratie en UV-behandeling, de minste biofilmvorming werd gevonden met fosfaattoevoeging, met een enigszins verminderde microbiële waterkwaliteit.

Het is bekend dat ureum de overheersende stikstofverbinding is die afgegeven wordt door zwemmers en dat zowel ureum als NPOC, belangrijke bouwstenen zijn voor de vorming van ongewenste DBP's in zwembaden. Hoewel de chemische oxidatie van ureum eerder is beschreven, werd de biologische reductie bij zwembadomstandigheden niet beschreven. Biologische afbraak is mogelijk met biologische filtratie in afwezigheid van een residueel desinfectiemiddel zoals een biologische actieve koolfiltratie. Dit onderzoek richtte zich op de verwijdering van ureum en de vorming van nitraat voor verschillende soorten behandeling en desinfectie van zwembadwater. In een proefopstelling werden afwezigheid van desinfectie, desinfectie door ultrafiltratie, UV of chlorering vergeleken, in combinatie met biologische filtratie. Ongeacht het type behandeling werd ureum niet volledig verwijderd boven 8 mg/L, wat, bij afwezigheid van chlorering, leidt tot de ophoping van ammonium. Chlorering had een negatieve invloed op de ammoniumoxidatie en de vorming van nitraat was verminderd, wat kan resulteren in een verhoogde vorming van stikstofhoudende DBP's. Biologische actieve koolfiltratie verhoogde de verwijdering van ureum in de gechloreerde situatie, waardoor minder stikstof beschikbaar was voor DBP-vorming. Bij afwezigheid van een residueel desinfectiemiddel verbeterde de reductie van ureum met een toenemend aantal behandelingsstappen. Tijdens recirculatie was ureum volledig gehydrolyseerd en volledig geoxideerd naar nitraat tijdens biologische zandfiltratie in combinatie met ultrafiltratie en UV-behandeling. Er werd daarom geconcludeerd dat microbiële reductie van ureum niet afhankelijk was van het type desinfectie, maar vooral beïnvloed wordt door de aanwezigheid van een microbiële behandelingsstap in de zwembadwaterbehandeling.

Dit proefschrift laat de mogelijke verbeteringen aan zwembadwater zien door te focussen op hygiënisch gedrag en de technische haalbaarheid van zwembadwaterbehandeling zonder een residueel desinfectiemiddel. Er blijven veel vragen over het opschalen, het reguleren van limieten, kwaliteitsbeheer en sociale acceptatie. Alles kan worden getest in een demonstratieproject op ware grootte, wat de Proof of the Pudding zal zijn!!







# Chapter 1

## General introduction



## 1.1 Swimming pools

Swimming is one of the world's oldest leisure activity (Ayar and Kop 1992) which is enjoyed by people of all ages, social classes and ability levels (Werf van der and Breedveld 2013). Rock paintings found in the so called "Cave of Swimmers" in southwestern Egypt that seem to show swim strokes, are believed to be the oldest swimming remains which date back 10 millennia. The oldest known pool, Great Bath, was excavated among the ruins of an ancient Indus Valley Civilisation at Mohenjo-daro in Pakistan and dates almost five millennia back (Keay 2000). Other pool ruins were found in the ancient Egyptian and Greek civilisations, and the Roman empire (PWTAG 2009). These pools show that water and bathing played an important role in ancient cultures. Although this bathing culture has evolved as centuries passed by, pools still serve modern societies. Besides the ancient religious and personal hygiene function, today's swimming pools are also used for education, recreation, competition, health care, and even in the European space programs of NASA and ESA (ESA 2015, Hutchinson 2013). In the Netherlands, there are over 1,500 swimming pools, with over 3,300 pool basins, of which one third are outdoor pools and the rest are indoor or combination of indoor-outdoor pools (Werf van der et al. 2012). These pools serve 80–90 million swimmers on a yearly basis, which makes swimming one of the most popular solo-sport activities in the Netherlands (Werf van der and Breedveld 2013). On average, there is one swimming pool on 10,800 inhabitants. This popularity might be explained by the early age that Dutch children start to swim. Over 90% of the children become qualified swimmers before the age of five (Hol 2015). It is expected that this high degree of swimming skills is one of the main reasons why the drowning incidence among children, or any other group, is among the world's lowest, despite the presence of many canals, ponds, coastal areas and other bodies of water (Meddings et al. 2014).

## 1.2 Pool regulations

All Dutch pools, with exception of residential pools, need to comply with national swimming pool legislation. Primarily, hygienic terms are described, such as water quality parameters, material and equipment requirements, and operational guidelines. Secondary, safety requirements are described, with terms for materials, equipment, cleaning and supervision (VROM 2000). The water quality parameters are checked monthly, unannounced, by a certified laboratory, and the results are sent to governmental organisations, which are authorised to close down a swimming pool if the requirements of the legislation are not met.

The current swimming pool legislation is rather directive, describing how a swimming pool should be built, maintained and operated (VROM 2000). This leaves little room for innovations or self-regulation. Therefore, new legislation, based on risk assessment of hygiene and safety, is in preparation (IenW 2018). Unacceptable risks should be addressed by the pool management and should lead to follow-up actions of which the effect needs to be monitored, with additional improvements when the risks remain high, similar to the Deming Circle (Zangwill and Kantor 1998). By using this 'new' management tool, the risks for hygiene and safety in pools should constantly be assessed and reduced. The draft version of this new swimming pool legislation has been published (I&M 2015) and it is planned to become active in 2021. The new legislation will neither have material and equipment requirements,

nor operational guidelines and safety requirements for materials, equipment, cleaning and supervision, which is a considerable reduction in legal requirements. However, water and air quality parameters will still be checked on a monthly basis by a certified laboratory and be used as a safeguard for hygiene and safety.

### **1.3 Pool water treatment**

In order to meet the national swimming pool legislation for water quality, all Dutch swimming pools have a water treatment system (Ayar and Kop 1992). In addition, in current legislation, maximum turnover times for different water depths are mandatory, which results in a specific treated pool water recirculation flow (VROM 2000). In order to maintain a low turbidity of the pool water, filtration steps are used, such as a strainer to remove hair and large particles that might damage pumps, valves or other sensitive equipment, and granular media filtration to remove suspended and colloidal solids (Hagens and Van Straaten 1981). Mostly single layer sand filtration is installed, but also multi-media filtration (sand and anthracite, or sand and activated carbon) is used (Boere et al. 1990). The dosage of flocculants and chemicals for disinfection and pH control is normal practice in most swimming pools (Van der Hoeve et al. 1986). In addition, biological activated carbon filtration is frequently used to reduce the urea concentration (Boere et al. 1990). Although UV-treatment is applied more and more for chloramine reduction, it is not used for disinfection. The use of (advanced) oxidation processes for degradation of disinfection by-products and micro-pollutants is still rare (Keyl 2016). In addition, to improve sustainability, several pools have a filter backwash water recuperation unit that, in most cases, consists of a combination of ultrafiltration (UF) and reverse osmosis (RO) (Keyl 2016). After the treatment, the water is returned to the pool basin, using a vertical or horizontal circulation system (Ayar 1988). Horizontal circulation has wall inlets on one side and wall outlets on the opposite side of the pool, combined with surface water removal through overflow channels or skimmers. Surface water removal should at least be 30% of the total water recirculation for removal of the most polluted top layer. Vertical circulation has floor inlets and surface water removal through overflow channels or skimmers. With this kind of circulation, all recirculating pool water is skimmed off in practically all instances. Removal of pollutants from the pool water is best with pure plug flow, which removes all pollutants from the pool within one turnover, with exception of settled particles. In practice, pure plug flow cannot be reached. Although mixing of added chlorine is best in vertically circulated pools, after one turnover only 30% of the non-settling-pollutants are removed in a mixed pool (Ayar 1988).

### **1.4 Developments in pool water treatment**

While swimming, bathers release microbiological and chemical pollutants into the pool water. The shared use of pool water by various individuals thus imposes a health risk. In order to reduce this health risk by microbiological pollution, swimming pool water is disinfected, traditionally, with chlorine based products like sodium hypochlorite. A side effect of chlorination is the oxidation reaction with dissolved pollutants of anthropogenic and natural origin, e.g. urea, skin lipids, humic acids and personal care products, during which disinfection by-products (DBPs) are formed (Florentin et al. 2011, Font-Ribera et al. 2010, Glauner et al. 2005b, Kogevinas et al. 2010, Kramer et al. 2009, Plewa et al. 2011, Richardson et al. 2010).

Swimmers, pool staff and pool visitors are exposed to these DBPs, mainly by inhalation, ingestion and dermal uptake. While some DBPs just irritate the skin, eyes or respiratory tract, other DBPs are suspected to be related to more severe health risks with genotoxic or carcinogenic effects (Eichelsdörfer et al. 1975, Erdinger et al. 1998, Font–Ribera et al. 2010, Glauner et al. 2005b, Kogevinas et al. 2010, Lakind et al. 2010). Therefore, the overall positive health effect of swimming will increase when the potential negative health impacts from DBPs in pool water are reduced (Kogevinas et al. 2010).

Although DBPs can be removed or DBP formation can be reduced with the use of advanced treatment technologies like activated carbon filtration (Uhl and Hartmann 2005), UV–treatment (Hansen et al. 2013), advanced oxidation (Glauner et al. 2005a) and membrane filtration (Glauner et al. 2005b), the operational costs of these technologies are large. Knowledge lacks, on how to prevent the formation of DBPs by reducing pollutants–release by bathers. In addition, little is known about the use of alternative disinfection methods for swimming pools, in the absence of a residual disinfectant, and the removal of urea, as dominant nitrogen–pollutant, from the recirculation flow .

## 1.5 The DIPool project

Alternative disinfection with UV and hydrogen peroxide as residual disinfectant has been investigated before (Crandall 1986, Dingman 1990, Savino et al. 1993). Although the results of these studies seemed promising, it did not lead to a change in treatment approach in modern swimming pools. However, in drinking water treatment, UV/H<sub>2</sub>O<sub>2</sub> is successfully used as an advanced oxidation method for the removal of organic micropollutants (Lekkerkerker et al. 2009). UV–treatment alone and ultrafiltration are used in the production of drinking water as alternative disinfection steps, without the use of residual disinfectants (Hijnen et al. 2006, Van der Bruggen et al. 2003), and might be useful for pool water treatment too, to avoid the formation of DBPs. Disinfection of pool water with UV–treatment was investigated before, (Caramello and Amisano 2001, Sobotka and Kryzstofik 1984), however, in combination with a residual disinfectant like chlorine or H<sub>2</sub>O<sub>2</sub>. In Germany, ultrafiltration is used in pool water treatment for improved removal of particles to replace sand filtration, but a residual disinfectant is still mandatory (DIN 2012).

Nowadays, swimming water without a residual disinfectant is increasingly popular, as can be observed by the growing number of (natural) swimming ponds (Weilandt 2015), but health risks for bathers are a concern (Giampaoli et al. 2014). The combination of ultrafiltration and UV–disinfection for pool water treatment, without a residual disinfectant, is a promising alternative treatment approach, but has not been published about. To explore this new treatment concept, to study its applicability for swimming pools, and to verify system design specifications, a research project, called the Dutch Innovative Pool project (DIPool) started in 2009. The DIPool project resulted in two research lines. The first research line, by Marjolein Peters, focussed on the microbiology in simulated swimming pool water and the response to chlorination and UV–disinfection, with the use of different swimming pool materials and a determination of the remaining yearly risks with a QMRA (Peters 2016).



The second research line, this thesis, focussed on the means to control the release of anthropogenic pollutants, but also the effect of different treatment and disinfection technologies on the potential for biofilm formation, the microbial pool water quality, and the concentration of anthropogenic pollutants.

## 1.6 This thesis, research questions and approach

### 1.6.1 *The influence of showering*

Little was known about the release of pollutants by bathers. Few studies were done in bathing tubs (Eichelsdörfer et al. 1980, Van der Hoeve et al. 1985) and pool basins (Gunkel and Jessen 1986). However, in order to simulate anthropogenic pollutant release in scientific studies, a body fluid analogue (BFA) has been used, based on the assumption that a bather releases 200 ml of sweat and 50 ml of urine (Judd and Black 2000). Although it is obvious that pre-swim showering will reduce the release of anthropogenic pollutants during swimming, it was not known to what extent these pollutants would be reduced and how long a pre-swim shower should take.

As there was no clear definition of anthropogenic pollutant release, three different types of anthropogenic pollutants were defined. First, the initial anthropogenic pollutant release was defined as the amount of pollutants that are rinsed off from a subject's body during a pre-swim shower. Secondly, the continual anthropogenic pollutant release was defined as the amount of pollutants that are released during a swimming exercise, like sweat, a carrier for various pollutants, micro-organisms and skin cells. The third part was the incidental anthropogenic pollutant release which is the result of human excreta such as urine, vomit or faecal material entering the pool water, either accidentally or on purpose. A standardised shower cabin (Figure 1) and a standardised shower protocol were used in a laboratory setting to

### **What is the effect of pre-swim showering on anthropogenic pollutant release? (Chapter 2)**

### **RESEARCH QUESTION**

study the removal of pollutants in time frames, in order to determine the effect of pre-swim showering and to find an optimum shower duration. The data were validated during on-site experiments in several swimming pools.



**Figure 1:** Photo of the standardised shower cabin during field experiments

### 1.6.2 Submerged sweating

Although there have been several publications describing the amount of sweat loss during swimming (Cox et al. 2002, Henkin et al. 2010, Kounalakis et al. 2010, McMurray and Horvath 1979), few reports exist on the anthropogenic pollutant release during swimming as a result of this sweating (De Laat et al. 2011, Gunkel and Jessen 1986, Weng and Blatchley 2011). However, the submerged sweat rate at different exercise levels and water temperatures was not known.

## RESEARCH QUESTION

**What is the sweat release during swimming at different levels of exercise and different water temperatures? (Chapter 3)**

Because the heat–balance of the human body is an important parameter for sweat release, a pool tank study was chosen as the experimental setup. Subjects performed a standardised exercise on a submerged cross–trainer in a temperature conditioned pool tank (Figure 2). To concentrate the pollutants, the sweat release was collected in a small water volume inside a water–filled suit that the subjects wore during the experiments. Laboratory experiments were performed to study the pollutant release in time–frames and the effect of different



**Figure 2:** Sweat exercise in preconditioned tank on submerged cross-trainer

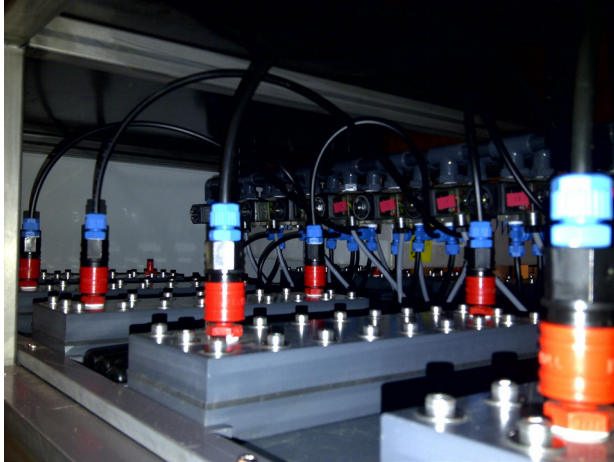
temperatures. On-site experiments in a swimming pool were executed to validate the laboratory findings.

### *1.6.3 Biofilm formation potential and microbial activity*

It is likely that in the absence of a residual disinfectant, as is the case with alternative disinfection like ultrafiltration and UV-disinfection, biofilms are formed more rapidly and pathogenic bacteria are more likely to survive compared to a system with a residual disinfectant. The formation of biofilms on the pool walls and piping can, besides causing an aesthetic problem, lead to the growth of pathogens, re-contaminating the pool water. The elevated temperature of swimming pool water combined with the presence of anthropogenic pollutants (nutrients), are likely to cause increased biofilm formation in pool water without a residual disinfectant. Although there is some scientific information on biofilm formation at chlorinated swimming pool conditions (Goeres et al. 2004, Goeres et al. 2007), no publication was found describing the biofilm formation at swimming pool conditions in the absence of a residual disinfectant. Although ultrafiltration and UV-disinfection are common disinfection steps for drinking water treatment (Hijnen et al. 2006, Van der Bruggen et al. 2003), no publications were found about the effect of these technologies on disinfection performance for swimming pool water, in the absence of a residual disinfectant.

**What is the biofilm formation potential and microbial water quality of swimming pool water with ultrafiltration and/ or UV-disinfection in the absence of a residual disinfectant, compared to chlorination? (Chapter 4)**

**RESEARCH  
QUESTION**



**Figure 3:** Microbial fouling simulators to study the biofilm formation potential

The biofilm formation potential was determined with microbial fouling simulators (Vrouwenvelder et al. 2006) before and after each treatment step in an experimental setup (Figure 3). The microbial water quality was also determined before and after each



**Figure 4:** Experimental setup to investigate the influence of treatment steps

treatment step with intracellular adenosine triphosphate (cATP) and intact cell count (iCC) measurements.

It was expected that different nutrient levels would influence biofilm formation and microbial water quality, so three different nutrient conditions were studied; worst case, maximum allowed and a high occupancy level. It was also expected that different treatment steps would influence biofilm formation and microbial water quality, so treatment without disinfection, disinfection by ultrafiltration, UV–disinfection and chlorination were investigated. The research was done with a laboratory pilot–plant using simulated swimming pool water (Figure 4).

### 1.6.4 The removal of urea

It is known that anthropogenic pollutants lead to the formation of DBPs in chlorinated swimming pool water and nitrogen–containing DBPs have special interest because they are more irritating and raise health concerns (Eichelsdörfer et al. 1975, Erdinger et al. 1998, Font–Ribera et al. 2010, Lakind et al. 2010, Weng and Blatchley 2011). It is also known that nitrogen is mainly introduced in pool water in the form of urea (De Laat et al. 2011, Gunkel and Jessen 1986). Although the chemical oxidation of urea has been described before (Blatchley and Cheng 2010), the biological reduction at swimming pool conditions has not been described. Nevertheless, urea can be reduced with a biological filtration in the absence of a residual disinfectant like a biological activated carbon filtration.

**What is the reduction of urea in swimming pool water with biological filtration in the absence of a residual disinfectant, compared to chlorination? (Chapter 5)**

**RESEARCH**

**QUESTION**

The reduction of urea was studied with biological filtration on a laboratory pilot plant with simulated pool water. Different nutrient conditions were investigated, as well as different treatment approaches, with and without a residual disinfectant. The biological filtration at chlorinated conditions was studied using a biological activated carbon filtration in a side–stream filtration (Figure 5).





**Figure 5:** Biological activated carbon filtration as side-stream filtration

## References

- Ayar, A. (1988) Experimentaal onderzoek naar verblijftijden in een zwembad (Experimental study on turnover times in swimming pools), Delft University of Technology, Delft.
- Ayar, A. and Kop, J.H. (1992) *Zwembaden (Swimming Pools)*, p. 270, TU Delft.
- Blatchley, E.R. and Cheng, M. (2010) Reaction mechanism for chlorination of urea. *Environmental science & technology* 44(22), 8529–8534.
- Boere, J.A., van Straaten, D.G.J., van Leengoed, L.P.M. and van der Hoeve, A. (1990) Verbetering van het zuiveringsrendement bij zwembadwaterbehandeling door toepassing van dubbellaagsfiltratie (Improvement of pool water treatment efficacy with the use of multilayer filtration). Ministry of Housing, S.P.a.t.E. (ed), p. 136, SdU, The Hague.
- Caramello, S. and Amisano, G. (2001) Study of disinfection of swimming pool water with U.V. radiation: Laboratory tests. *Igiene moderna* 116(5), 257–275.
- Cox, G.R., Broad, E.M., Riley, M.D. and Burke, L.M. (2002) Body mass changes and voluntary fluid intakes of elite level water polo players and swimmers. *Journal of Science and Medicine in Sport* 5(3), 183–193.

- Crandall, R.A. (1986) The use of ultraviolet light in the treatment of water in public spas and hot tubs. *Journal of Environmental Health* 49(1), 16–23.
- De Laat, J., Feng, W., Freyfer, D.A. and Dossier–Berne, F. (2011) Concentration levels of urea in swimming pool water and reactivity with urea. *Water Research* 45(3), 1139–1146.
- DIN (2012) Aufbereitung von Schwimm– und Badebeckenwasser – Teil 4: Verfahrenskombinationen mit Ultrafiltration (Treatment of water of swimming pools and baths – Part 4: Combinations of process with ultrafiltration) Beuth Verlag GmbH.
- Dingman, J.D. (1990) The effectiveness of ultraviolet light/hydrogen peroxide. *Journal of Environmental Health* 52(6), 341–343.
- Eichelsdörfer, D., Slovak, J., Dirnagl, K. and Schmid, K. (1975) Zur Reizwirkung (Konjunktivitis) von Chlorn und Chloraminen im Schwimmbeckenwasser. *Vom Wasser* 45, 17–28.
- Eichelsdörfer, D., Jandik, J. and Weil, W. (1980) Organische Halogenverbindungen im Schwimmbeckenwasser II. Mitteilung: Modellversuche zur Bildung leichtflüchtiger Halogenkohlenwasserstoffe. *Z. Wasser Abwasser Forschung* 13(5), 165–169.
- Erdinger, L., Kirsch, F. and Sonntag, H.G. (1998) Irritierende Wirkung von Nebenprodukten der Schwimmbadwasserdesinfektion. *Zentralblatt für Hygiene und Umweltmedizin* 200(5–6), 491–503.
- ESA (2015) Astronaut candidates in pool, p. [http://www.esa.int/Our\\_Activities/Human\\_Spaceflight/Astronaut\\_candidates\\_in\\_pool/\(ipp\)/9/\(start\)/0](http://www.esa.int/Our_Activities/Human_Spaceflight/Astronaut_candidates_in_pool/(ipp)/9/(start)/0).
- Florentin, A., Hautemanière, A. and Hartemann, P. (2011) Health effects of disinfection by–products in chlorinated swimming pools. *International Journal of Hygiene and Environmental Health* 214(6), 461–469.
- Font–Ribera, L., Kogevinas, M., Zock, J.P., Gómez, F.P., Barreiro, E., Nieuwenhuijsen, M.J., Fernandez, P., Lourencetti, C., Pérez–Olabarria, M., Bustamante, M., Marcos, R., Grimalt, J.O. and Villanueva, C.M. (2010) Short–Term Changes in Respiratory Biomarkers after Swimming in a Chlorinated Pool. *Environmental Health Perspectives* 118(11), 1538–1544.
- Giampaoli, S., Garrec, N., Donzé, G., Valeriani, F., Erdinger, L. and Romano Spica, V. (2014) Regulations concerning natural swimming ponds in Europe: considerations on public health issues. *Journal of Water and Health* 12(3), 564–572.
- Glauner, T., Kunz, F., Zwiener, C. and Frimmel, F.H. (2005a) Elimination of swimming pool water disinfection by–products with advanced oxidation processes (AOPs). *Acta Hydrochimica et Hydrobiologica* 33(6), 585–594.
- Glauner, T., Waldmann, P., Frimmel, F. and Zwiener, C. (2005b) Swimming pool water—fractionation and genotoxicological characterization of organic constituents. *Water Research* 39, 4494–4502.
- Goeres, D.M., Palys, T., Sandel, B.B. and Geiger, J. (2004) Evaluation of disinfectant efficacy against biofilm and suspended bacteria in a laboratory swimming pool model. *Water Research* 38(13), 3103–3109.
- Goeres, D.M., Loetterle, L.R. and Hamilton, M.A. (2007) A laboratory hot tub model for disinfectant efficacy evaluation. *Journal of Microbiological Methods* 68(1), 184–192.
- Gunkel, K. and Jessen, H.J. (1986) Untersuchungen über den Harnstoffeintrag in das Badewasser (Study on urea release by bathers). *Acta Hydrochimica et Hydrobiologica* 14(5), 451–461.
- Hagens, T. and Van Straaten, D.G.J. (1981) Waterbehandeling in circuitiebaden (Water treatment in circulation pools). *Environment*, C.W.t.C.p.M.o.H.a.t. (ed), SdU, The Hague.
- Hansen, K.M.S., Zortea, R., Piketty, A., Vega, S.R. and Andersen, H.R. (2013) Photolytic removal of DBPs by medium pressure UV in swimming pool water. *Science of The Total Environment* 443, 850–856.
- Henkin, S.D., Sehl, P.L. and Meyer, F. (2010) Sweat rate and electrolyte concentration in swimmers, runners and nonathletes. *International Journal of Sports Physiology and Performance* 5(3), 359–366.
- Hijnen, W.A.M., Beerendonk, E.F. and Medema, G.J. (2006) Inactivation credit of UV radiation for viruses, bacteria and protozoan (oo)cysts in water: A review. *Water Research* 40(1), 3–22.



- Hol, M. (2015) *Swimming Education in The Netherlands*, Amsterdam.
- Hutchinson, L. (2013) *Swimming with spacemen: training for spacewalks at NASA's giant pool*.
- IenW (2018) *Besluit houdende wijziging van het Besluit activiteiten leefomgeving met betrekking tot het gelegenheid bieden tot het zwemmen of baden in een waterbassin, versie internetconsultatie mei 2018 (Draft document to change swimming pool guidelines)*, Ministry of Infrastructure and Water management, The Hague.
- Judd, S.J. and Black, S.H. (2000) Disinfection by-product formation in swimming pool waters: a simple mass balance. *Water Research* 34(5), 1611–1619.
- Keay, J. (2000) *India: A History*, Grove Press.
- Keyl, E. (2016) UV-treatment, advanced oxidation and backwash water recuperation in Dutch swimming pools, Nunspeet.
- Kogevinas, M., Villanueva, C.M., Font-Ribera, L., Liviak, D., Bustamante, M., Espinoza, F., Nieuwenhuijsen, M.J., Espinosa, A., Fernandez, P., DeMarini, D.M., Grimalt, J.O., Grummt, T. and Marcos, R. (2010) Genotoxic Effects in Swimmers Exposed to Disinfection By-products in Indoor Swimming Pools. *Environmental Health Perspectives* 118(11), 1531–1537.
- Kounalakis, S.N., Botonis, P.G., Koskolou, M.D. and Geladas, N.D. (2010) The effect of menthol application to the skin on sweating rate response during exercise in swimmers and controls. *European Journal of Applied Physiology* 109(2), 183–189.
- Kramer, M., Hübner, I., Rörden, O. and Schmidt, C.K. (2009) Haloacetonitriles – another important group of disinfection byproducts in swimming pool water, RheinEnergie AG, Water Laboratory, Germany, London.
- Lakind, J.S., Richardson, S.D. and Blount, B.C. (2010) The good, the bad, and the volatile: Can we have both healthy pools and healthy people? *Environmental Science and Technology* 44(9), 3205–3210.
- Lekkerkerker, K., Scheideler, J., Maeng, S.K., Ried, A., Verberk, J.Q.J.C., Knol, A.H., Amy, G. and Van Dijk, J.C. (2009) Advanced oxidation and artificial recharge: A synergistic hybrid system for removal of organic micropollutants. *Water science and Technology: Water Supply* 9(6), 643–651.
- McMurray, R.G. and Horvath, S.M. (1979) Thermoregulation in swimmers and runners. *Journal of Applied Physiology* 46(6), 1086–1092.
- Meddings, D., Hyder, A.A., Ozanne-Smith, J. and Rahman, A. (2014) *Global report on drowning*, WHO, Geneva.
- Peters, M.C.F.M. (2016) *Microbiology in swimming pools; UV-based treatment versus chlorination*, Delft University of technology, Delft.
- Plewa, M.J., Wagner, E.D. and Mitch, W.A. (2011) Comparative mammalian cell cytotoxicity of water concentrates from disinfected recreational pools. *Environmental science & technology* 45(9), 4159–4165.
- PWTAG (2009) *Swimming pool water*, Pool Water Treatment Advisory Group.
- Richardson, S.D., DeMarini, D.M., Kogevinas, M., Fernandez, P., Marco, E., Lourencetti, C., Ballesté, C., Heederik, D., Meliefste, K., McKague, B., Marcos, R., Font-Ribera, L.G., J.O. and Villanueva, C.M. (2010) What's in the Pool? A Comprehensive Identification of Disinfection By-products and Assessment of Mutagenicity of Chlorinated and Brominated Swimming Pool Water. *Environmental Health Perspectives* 118(11), 1523–1530.
- Savino, A., Pitzurra, M., Pasquarella, C., Balestrino, A., Cerbini, I., Isa, D. and Costarelli, D. (1993) The treatment of swimming pool water with ultraviolet rays and hydrogen peroxide. Experiences in the laboratory and in the field. *Annali di igiene : medicina preventiva e di comunita* 5(2), 137–151.
- Sobotka, J. and Kryzstofik, B. (1984) Biochemical changes occurring in swimming pool water during UV disinfection. *Aqua* 3, 170–172.
- Uhl, W. and Hartmann, C. (2005) Disinfection by-products and microbial contamination in the treatment of pool water with granular activated carbon. *Water Science and Technology* 52(8), 71–76.

- Van der Bruggen, B., Vandecasteele, C., Van Gestel, T., Doyen, W. and Leysen, R. (2003) A review of pressure-driven membrane processes in wastewater treatment and drinking water production. *Environmental Progress* 22(1), 46–56.
- Van der Hoeve, A., Van Straaten, D.G.J. and Hagens, T. (1985) Onderzoek naar filterinstallaties en waterbehandelingssystemen in zwembaden (Study on filtration and water treatment in swimming pools), p. 43, Ministry of Housing, Spatial Planning and the Environment, Den Haag (The Hague).
- Van der Hoeve, A., Van Straaten, D.G.J., Boere, J.A., Beckers, F., Beynum, J.R. and Hagens, T. (1986) Meten en regelen van de pH en het chloorgehalte in zwembaden (Measurement and control of pH and chlorine in swimming pools). Ministry of Housing, S.P.a.t.E. (ed), SdU, The Hague.
- VROM (2000) Besluit Hygiëne en Veiligheid Badinrichtingen en Zwemgelegenheden (Resolution Hygiene and Safety Bathing Accommodations and Swim Places). Ministry of Housing, s.p.a.t.E. (ed), Ministry of Housing, Spatial Planning and the Environment (VROM), The Hague.
- Vrouwenvelder, J.S., Paassen van, J.A.M., Wessels, L.P., Dam van, A.F. and Bakker, S.M. (2006) The membrane fouling simulator: A practical tool for fouling prediction and control. *Journal of Membrane Science* 281(1–2), 316–324.
- Weilandt, M. (2015) Swimming ponds, p. 45, 6th International Conference Swimming Pool and Spa, Amsterdam.
- Weng, S. and Blatchley, E.R.I. (2011) Disinfection by-product dynamics in a chlorinated, indoor swimming pool under conditions of heavy use: National swimming competition. *Water Research* 45(16), 5241–5248.
- Werf van der, H., Bedaf van, A., Hoenderkamp, K. and Breedveld, K. (2012) *Zwemmonitor 2012 (Swim monitor 2012)*, Mulier Instituut, Utrecht.
- Werf van der, H. and Breedveld, K. (2013) *Zwemmen in Nederland 2013 (Swimming in The Netherlands 2013)*, Mulier Instituut, Utrecht.
- Zangwill, W.I. and Kantor, P.B. (1998) Toward a Theory of Continuous Improvement and the Learning Curve. *Management Science* 44(7), 910–920.





# Chapter 2

## Definition and quantification of initial anthropogenic pollutant release in swimming pools

M.G.A. Keuten<sup>1,2</sup>, F.M. Schets<sup>3</sup>, J.F. Schijven<sup>4</sup>, J.Q.J.C. Verberk<sup>1</sup>, J.C. van Dijk<sup>1</sup>

Water Research 46 (2012)

doi: [10.1016/j.watres.2012.04.012](https://doi.org/10.1016/j.watres.2012.04.012)

Corrigendum WaterResearch 2014 included

doi: [10.1016/j.watres.2013.12.007](https://doi.org/10.1016/j.watres.2013.12.007)

---

1 Section Sanitary Engineering, Delft University of Technology, Delft, The Netherlands

2 Hellebrekers Technieken, Nunspeet, the Netherlands

3 National Institute for Public Health and the Environment, Laboratory for Zoonoses and Environmental Microbiology, Bilthoven, The Netherlands

4 National Institute for Public Health and the Environment, Expert Centre for Methodology and Information Services, Bilthoven, The Netherlands

## Abstract

Pollutants, brought into a swimming pool by bathers, will react with chlorine to form disinfection by-products (DBPs). Some of these DBPs are found to be respiratory and ocular irritant and might be associated with asthma, or might even be carcinogenic. As DBPs in swimming pools are formed from bather-shed-pollutants, a reduction of these pollutants will lead to a reduction of DBPs. Until now, however, the release of pollutants by bathers has not been studied in detail. The study described in this paper focuses on the release of these pollutants, further called anthropogenic pollutants. The objective was to define and quantify the initial anthropogenic pollutants, by using a standardised shower cabin and a standardised showering protocol in laboratory time-series experiments and on-site experiments in swimming pools. The time-series experiments resulted in a definition of the initial anthropogenic pollutant release: the amount of pollutants released from a person in a standardised shower cabin during the first 60 seconds of showering. The data from the time-series experiments were used to create a model of pollutant release. The model can be used to predict the initial anthropogenic pollutant release as well as the effects of showering. On-site experiments were performed at four different swimming pools, including one outdoor pool. Results of these on-site showering experiments correspond with the time-series and model outcomes. anthropogenic pollutant release (both chemical and microbiological) in swimming pool water can be reduced by pre-swim showering, very likely resulting in decreased DBPs formation and chlorine demand.

### Keywords:

- Initial anthropogenic
- pollutant release
- Anthropogenic pollutants
- Showering
- Pre-swim hygiene
- Predictive model
- Swimming pool

## 2.1 Introduction

Swimmers in swimming pools introduce pollutants into the pool water. These pollutants can be suspended and colloidal compounds, micro-organisms, as well as soluble substances (Powick 1989). Suspended and colloidal compounds include particles such as organic and inorganic substances that float, suspend or settle in the swimming pool water, such as hair, skin cells, dust and fibres from clothes and swimwear. Micro-organisms may enter the pool water through different routes. Micro-organisms of non-faecal origin, like *Pseudomonas* spp., *Staphylococcus aureus* and adenoviruses can enter the pool water while being washed from the skin or from released saliva, mucus or vomit (WHO 2006), whereas faecally-derived micro-organisms like, *Escherichia coli*, *Cryptosporidium* and enteric viruses may be washed from swimmers bodies or enter the water when a person has an (accidental) faecal release (WHO 2006). Soluble substances can be organic or inorganic. Soluble organic substances include urea, creatinine, lactic acid and amino acids. Soluble inorganic material includes ions like ammonium, chloride, sodium, potassium, calcium and sulphate (Kuno 1956).

The shared use of swimming pool water by many people requires pool water treatment to remove pollutants and disinfect the pool water to inactivate possible human pathogenic micro-organisms. Generally, swimming pool water is disinfected with chlorine-based products. However, the organic material introduced into the pool water by swimmers reacts with the chlorine, leading to the formation of a variety of disinfection by-products (DBPs) (Aggazzotti et al. 1995, Richardson et al. 2010, Zwiener et al. 2007).

Some of these DBPs are associated with impaired respiratory health and possibly asthma while others might be carcinogenic (Font-Ribera et al. 2010, Glauner et al. 2005, Lakind et al. 2010). Other DBPs are associated with having potential genotoxic effects (Kogevinas et al. 2010), and still other DBPs are irritating to the skin, eyes or respiratory tract (Eichelsdörfer et al. 1975, Erdinger et al. 1998). The overall health effects of swimming might be increasingly positive when the potential health risks from DBPs in pool water are reduced (Kogevinas et al. 2010).

It is assumed that a reduction in the amount of pollutants that swimmers introduce into the pool water will result in reduced DBPs and chlorine demand. Pollutants brought into the pool water by swimmers are called the anthropogenic pollutants.

Although many papers emphasise the importance of reducing the anthropogenic pollutant release to decrease the number of DBPs formed (Borgmann-Strahsen 2003, Eichelsdörfer et al. 1980, Hery et al. 1995, Lahl et al. 1981, WHO 2006, Zwiener et al. 2007), there are no recent scientific reports or studies that have demonstrated the actual effect of anthropogenic pollutant reduction on the level of DBPs formed.

To establish whether anthropogenic pollutant reduction strategies results in decreased DBPs formation or not, information is required about the anthropogenic pollutant release of un-showered swimmers and about the anthropogenic pollutant release of swimmers who took a pre-swim shower, a procedure that is assumed to reduce anthropogenic pollutants. The limited number of published papers that address anthropogenic pollutant release in swimming pools merely describe bathtub and pool basin studies and do not present data on



the effect of pre-swim showering (Althaus and Pacik 1981, Eichelsdörfer et al. 1980, Gunkel and Jessen 1986, VROM 1985). In one study performed in the Netherlands in the nineteen eighties, the shower water from pre-swim showering activities was analysed; an initial permanganate value of 720 mg  $\text{KMnO}_4$  per bather was found (Keltjens 1987), which is low compared to the results found in this study.

This study focuses on the anthropogenic pollutant release, which comprises three components: initial, continuous, and incidental anthropogenic pollutant release. The initial anthropogenic pollutant release is introduced into the pool water during the first minutes of body contact with the water and consists of the residue of evaporated sweat, micro-organisms and pollutants on the swimmer's skin, as well as any cosmetics on the skin.

The continuous anthropogenic pollutant release is continuously produced during swimming activities and it is assumed that it mainly consists of sweat and skin cells.

The incidental anthropogenic pollutant release is the result of human excreta such as urine, vomit or faecal material entering the pool water, either accidentally or on purpose, like most urine and some faecal releases.

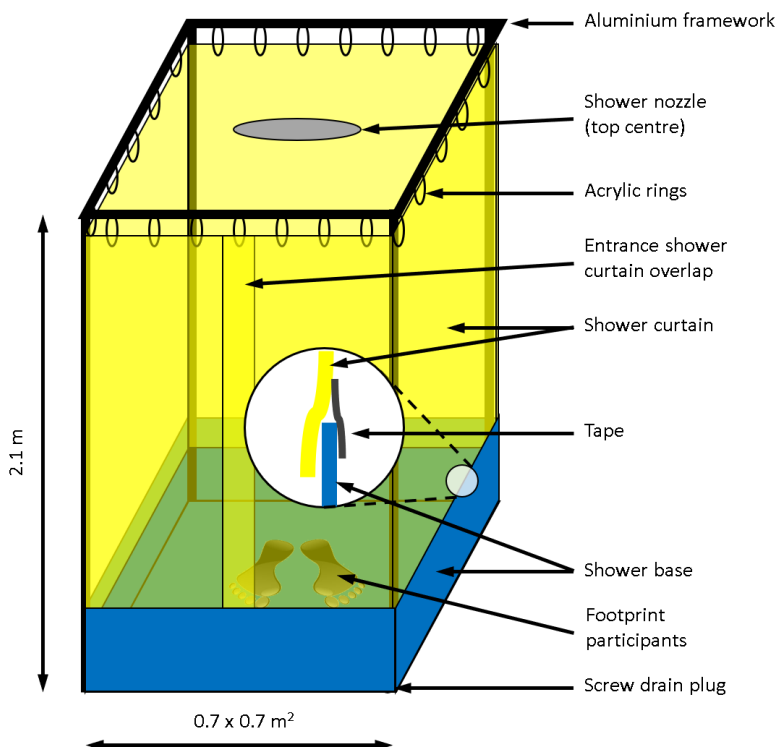
Anthropogenic pollutant release can be determined through basin-studies, bath-tub experiments and shower experiments. Since the anthropogenic pollutant release into the pool water is reduced by pre-swim showering, shower experiments were performed to determine the level of anthropogenic pollutant release. The objective of this study was to define and quantify the initial anthropogenic pollutant release, by using a standardised shower cabin and a standardised showering protocol in laboratory time-series experiments and on-site experiments in swimming pools.

## 2.2 Material and Methods

### 2.2.1 Standardised shower cabin

To determine the initial anthropogenic pollutant release, standardised shower experiments were performed, both in a laboratory setting and on-site at swimming pools. In both settings, a specially constructed shower cabin was used (Figure 1). This shower cabin (Hellebrekers Technieken, Nunspeet, the Netherlands) consisted of a polypropylene shower base with a footprint of 0.7 x 0.7 m and a height of 0.2 m, and an aluminium framework for supporting a shower curtain and a shower nozzle. The shower base had a drain fitted with a screw plug. The top mounted standard shower nozzle (Raindance AIR 180 mm, Hansgrohe) was installed at a height of 2.1 m from the shower base and produced a rain shower to simulate a rain wash/rinse, instead of a jet wash from a jet shower. The water flow through the shower nozzle was monitored with a flow indicator (DFM 350 150–1,500 L/h, ASV Stübbe).

### 2.2.2 Shower water



**Figure 1:** Schematic diagram of the standardised shower cabin used in laboratory and field experiments

The water used for showering was standard Dutch drinking water which is distributed by drinking water companies in the Netherlands without a chlorine residue (VROM 2001), resulting in the absence of DBPs in the water. The cold and hot tap water used during the shower experiments was mixed using a thermostatic valve, ensuring a constant water temperature, fluctuating  $\pm 0.5$  °C from the fixed set point. The set-point for the water temperature varied between 36.5–40.5 °C during both the time-series and on-site experiments.

### *2.2.3 Pre-shower procedure*

Before using the standardised shower cabin for an experiment, the shower hose, shower nozzle, rinsing hose and sampling scoop were thermally disinfected (5 min, 70 °C). Before a participant entered the shower cabin, in the laboratory as well as at the pool sites, the shower cabin was prepared according to a standard procedure. This procedure consisted of draining the cabin by tilting it towards the drain until only a few drops of water came out, followed by rinsing with shower water using a hose, after which the cabin was drained again. This rinsing step was repeated once. Next, the shower base of the shower cabin, the lowest 0.30 m of the shower curtain, the sampling scoop and the window squeegee were disinfected. This disinfection was done by spraying a 70% alcohol solution onto the surfaces and leaving it to disinfect for 2 minutes, after which the alcohol was removed by three rinsing and draining steps. After draining, most of the remaining water droplets were removed from the shower base using the window squeegee. Multiple rinsings and removal of the last water droplets were necessary to avoid interference to total organic carbon (TOC) analyses from the disinfection alcohol.

### *2.2.4 Time-series experiments in the laboratory*

#### **Selection of participants**

Participants were randomly selected from staff and students at Delft University of Technology. All participants took part in the experiment after performing their normal hygiene procedures at home, and did not take an extra shower before joining the experiment. The participants wore normal swim wear and were barefoot. To avoid introduction of dust and dirt from laboratory floors, participants wore slippers before entering the shower cabin.

#### **Shower procedure**

After a participant entered the shower cabin and stood in the middle of the shower base, directly under the shower nozzle, the shower curtain was closed and placed inside the shower base. The water flow was activated by one of the researchers. Some participants were asked to rub their skin intensely during showering, while others were asked to stand still. Whether participants rubbed or not was included in the questionnaire. Total showering time was 2 minutes, set by the researchers. During one of the experiments, shower time was extended to 5 minutes to study the effect of prolonged showering.

#### **Sampling procedure**

The standardised shower cabin was set on a slight slope (2%) towards the shower base drain to avoid water build-up in the shower base during the experiments. All shower water was collected in sample bottles, without spillage. The sample volume of the first 10 samples was approximately 500 mL, whereas the sample volume of subsequent samples was approximately 1L. The sample volumes were not exact as a result of rapid sampling during the experiment. Exact sample volumes were determined after sampling by weighing the sample bottles. The sampling of the 500 mL volumes took approximately 6 seconds per sample. To allow rapid sampling, switching to subsequent sample bottles and to avoid spillage, a hose with a valve attached to the shower base was used to collect the samples. The valve was closed briefly while switching to the next sample bottle. The short time interval between the first 10 samples allowed detection of rapid changes in pollutants released during the first minute of showering. The last sample volumes were larger to extend the sampling period, without taking extra samples. Per participant, 18–20 water samples were taken. All samples were placed in cold storage (3–5 °C) immediately after sampling. Control samples were taken daily, before and after the experiments, according to the same protocol, without any participant in the shower cabin.

### *2.2.5 On-site experiments at swimming pools*

#### **Sites**

For the on-site experiments, the standardised shower cabin was placed in the shower area at four public swimming pools (A through D in the Netherlands). Swimming pool D was an outdoor pool, however, the shower cabin was placed inside because outdoor showers only provided cold water. During all experiments, the shower cabin was connected to the pool's automated shower system. To avoid contamination from nearby pool showers, the shower curtain was securely taped to the outside of the shower base, while hanging inside, as shown in Figure 1.

#### **Selection of participants**

The on-site experiments were not previously announced, so visitors at the selected pools had no knowledge of what was going to happen in advance. At the entry, pool visitors were randomly asked to participate and use the shower cabin before they started swimming, according to instructions given. The aim was to include an equal number of men and women and of adults and children. All participants were enrolled anonymously and were given a code number that identified both the water samples and the questionnaire relating to this specific participant. During the outdoor experiment in Hengelo, some participants were enrolled after they had been swimming.

#### **Shower procedure**

For each participant, the shower cabin was prepared according to the pre-shower procedure (see 2.3), after which the shower base was closed with the drain plug. All participants followed their normal routine: some entered the shower area barefoot whereas others wore slippers. However, all participants entered the shower cabin barefoot. After a participant entered the shower cabin and stood in the middle of the shower base, directly under the shower nozzle, the shower curtain was closed and the bottom of the curtain was placed

inside the shower base. Some participants were asked to rub their skin intensely during showering, while others were asked to stand still. Whether participants rubbed or not was included in the questionnaire. The water flow was subsequently started by one of the researchers and it stopped automatically after the programmed shower time had elapsed. Shower time was different at all four locations due to location-specific set points.

### **Sample procedure**

Immediately after each participant left the shower cabin, the water collected in the shower base was mixed by turn movements of the sampling scoop for a few seconds. Samples (1 L) were taken using the sampling scoop, and subsequently marked with a unique serial number, and promptly stored in a cooler with ice packs. Samples were transported to a laboratory within 24 hours of sampling. Control samples were taken at each location at the start and end of each day according to the same procedures, but with no participant in the shower cabin.

### **2.2.6 Questionnaire**

After showering, all participants, both in laboratory experiments and in field studies, were asked to fill out a questionnaire. The questionnaire was comprised of four parts. Part I contained questions about gender, age, weight, hair length, and wearing underwear underneath swim wear. Part II contained questions related to personal hygiene, such as how many hours since last shower or last hair wash, and recent physical activity or exercise since last shower. Part III comprised questions related to the use of cosmetics, e.g. make-up, hair products, body or suntan lotion, deodorant and perfume. In Part IV participants were questioned about their general health and specific, possibly water-related, health issues such as skin conditions, gastroenteritis and ear conditions. Questions about age, weight, hair length, hours since last shower, and hours since last hair wash required numerical answers, whereas wide boxes were provided for the other questions. The answer for a participants weight or hair length was estimated if recent measurement data was not available. Each questionnaire was marked with the unique sample serial number, and the date and time of the participant's experiment.

### **2.2.7 Analytical methods**

Samples were analysed for chemical and microbiological parameters. In order to find the best set of parameters to describe the anthropogenic pollutant release, a wide range of parameters was examined. These parameters included TOC, dissolved organic carbon (DOC), total nitrogen (TN), dissolved nitrogen (DN), intracellular Adenosinetriphosphate (cATP), permanganate value, urea, Kjehldal-N, chloride, UV254, temperature, turbidity, particle count, total plate counts, *E. coli*, enterococci and staphylococci. The permanganate value is often used in swimming pools as a measure of organic components. As permanganate is a strong oxidiser, the level will be 3–4 times higher than the TOC level. The parameters that were found relevant to describe the anthropogenic pollutant release were: TOC, TN, cATP, UV254, temperature, turbidity and particle count, and the microbiological parameters *E. coli*, intestinal enterococci and staphylococci. We will only describe the methods used to determine these parameters.

TOC was determined according to NEN–EN 1484 (NEN 1997) using a Shimadzu TOC–Vcph analyser. After acidifying and purging, the samples were injected into the combustion chamber at 680°C to oxidise all carbon into CO<sub>2</sub>, which was subsequently detected by using infrared spectrometry. Samples with high particle concentration were analysed with a stirring rod in the analysing vial, ensuring a homogeneous sample at the time of analysis. TOC results are presented as mg C per litre. TN was determined according to NEN–EN 12260 (NEN 2003) using a Shimadzu TNM–1 analyser connected to the Shimadzu TOC–Vcph analyser. The samples were injected into the combustion chamber at 720 °C where nitrogen compounds were converted to nitric oxide and subsequently exposed to ozone to induce emission of light which was detected by a chemiluminescent detector. Results are presented as mg N per litre. Determination of cATP was based on bioluminescence. Water samples were filtered through a glass fibre filter, 0.7 µm to concentrate all cATP. Subsequently the cATP was extracted from the filter with a trisodiumphosphate solution (UltraLyte 7), and collected in a 12 mL cuvette. The extracted cATP was diluted with Ultralute (ATP dilution buffer), added to a luciferine/luciferase complex to induce the emission of light and then placed directly into a Luminometer (Kikkoman C–110) to measure the generated light signal (Relative Light Units, RLU). The concentration of cATP was calculated from the RLU values using a conversion factor determined from calibration measurements. Results are presented as pg cATP per millilitre. For UV adsorption, the water samples were placed in a lab analyser (spectrolyser A-2100-485p0t00-sNO, mf. S::can) which measured UV adsorption at 254 nm. Highly concentrated samples were diluted with demineralised water. Results are presented as Abs/m. Turbidity was determined according to ISO 7027 (ISO 1999) using a Hach 2100p turbidity analyser. Results are presented as FNU. Particle count distribution was determined with a Pacific scientific particle counter using a syringe operated sampler Hiac Royco Model 3000 with a sensor Hiac HRCD–400 HC (2–400 µm) and sizing counter Hiac Royco Model 9064. Results are presented as the total number of particles per millilitre in the size range 2–50 µm. Highly concentrated samples were diluted with demineralised water.

Water samples for microbiological analyses were taken during the field experiments at pools C and D according to ISO 19458 (ISO 2006), cooled in ice boxes, transported to the laboratory, and analysed within 24 hours after sampling. Water sample volumes of 100, 10 and 1 ml were analysed in duplicate for *E. coli* and intestinal enterococci using the membrane filtration methods described in ISO 9308–1 (rapid test) (ISO 2000a) and ISO 7899–2 (ISO 2000b), respectively.

Coagulase–positive staphylococci were enumerated by using a membrane filtration method based on ISO 6888–1 (ISO 1999). In brief, sample volumes of 1, 0.1 and 0.01 ml were filtered through Tuffryn membrane filters (Gelman, HT–450–66223) which were placed face–down on Baird Parker agar plates (prepared according to ISO 6888–1) and subsequently incubated for 24 ± 2 h at 36 ± 2 °C. After incubation, membrane filters were lifted off the agar plates after marking their position, and typical black or grey colonies that were surrounded by a clear zone in the agar were enumerated.

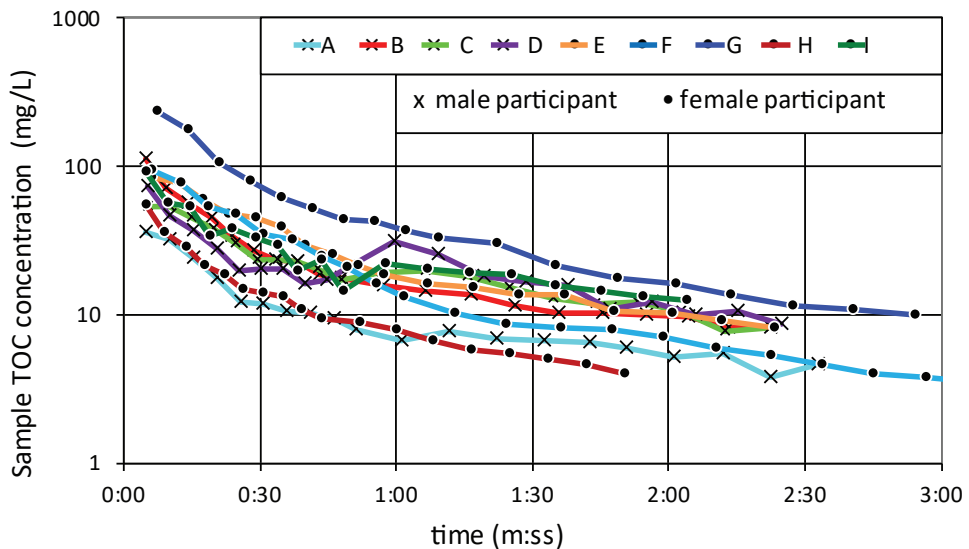
### 2.2.8 Statistical analyses

The results of the time–series experiments were used to compose a model for the pollutants released by swimmers. The results from the on–site experiments were not included in the

model because they provide cumulative release results, instead of time-series. Both the analytical data and the questionnaire data were used in this model. The effects of the variables and their interactions were analysed by means of linear model fitting using the statistical package R (version 2.13.0). By means of stepwise model selection by Akaike's Information Criterion (AIC) with  $k$ , the multiple of the number of degrees of freedom used for the penalty in AIC set to 3.84, the best model describing the data was selected. A  $k$  value of 3.84 corresponds to the Chi-square value with 95 % confidence and one degree of freedom. All used variables and interactions were statistically significant. Between person variation (random effects) was tested by means of comparing likelihood values of the linear model with that of a mixed linear effect model using an exact likelihood ratio test (exactLRT in R). The between person variation was found to be very small and insignificant and did not affect the values of the fixed effects.

The best model selected in R was transferred to Mathematica 8.0.1.0 (Wolfram Inc, Champaign, Illinois), where it was implemented in a function for abstracting the linear equations for combinations of values of the categorical variables. This empirical model was integrated in Mathematica to estimate the release of TOC, TN and cATP within chosen time-frames, including so-called mean and single prediction bands. In the case of TN and cATP,

Table 1: General and hygienic information on participants in laboratory time-series experiments.				
	Age (Year)	Hair length (cm)	Water temperature (°C)	Time since last shower (h)
Average	31	16.4	37.3	39.4
Range	23–39	3–40	36.5–40.5	3–72



**Figure 2:** Sample TOC concentration corrected for control TOC values in laboratory time-series experiments; each line displays the results of one individual participant

the zero concentrations were not included in the analyses. The box plots are created using predicted means and 95% prediction intervals.

## 2.3 Results and discussion

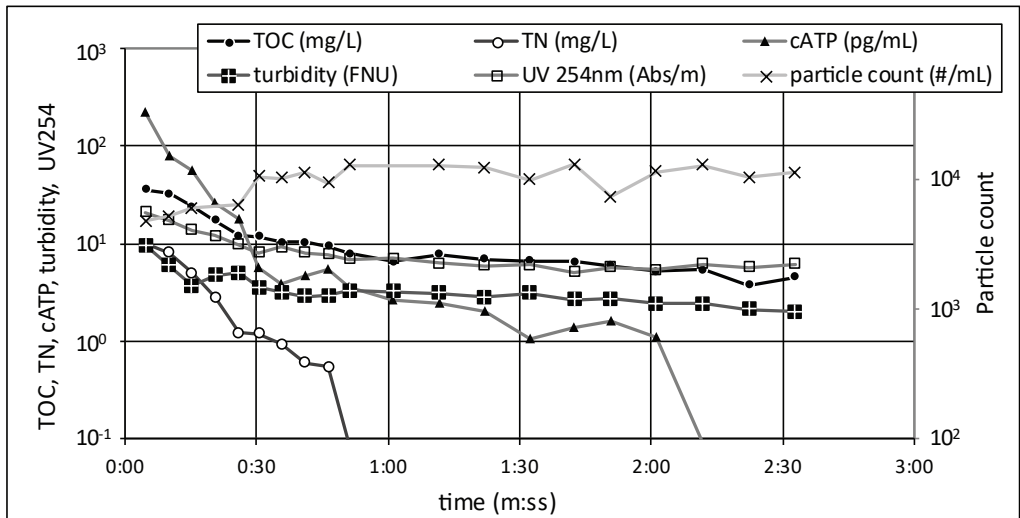
### 2.3.1 Time-series experiments

In the time-series experiments, shower data of ten participants (5 men, 5 women) was collected. The general characteristics of these participants are shown in Table 1.

For all participants, the decrease in released TOC was almost linear on a logarithmic vertical scale (Figure 2). The parameters UV-254 and turbidity showed a similar reduction, whereas the release of TN and cATP declined more rapidly, and the release of particles seemed to level off at a constant release rate as shown in Figure 3, which displays the results for participant A

**Table 2: Pearson Correlation coefficient (r) between parameters in laboratory time-series experiments.**

	TOC	TN	cATP	Turbidity	UV-254	Particle count
TOC	1	0.958	0.386	0.838	0.226	0.544
TN	0.958	1	0.445	0.798	0.316	0.433
cATP	0.386	0.445	1	0.355	0.316	0.083
Turbidity	0.838	0.798	0.355	1	0.682	0.750
UV-254	0.226	0.316	0.316	0.682	1	0.004



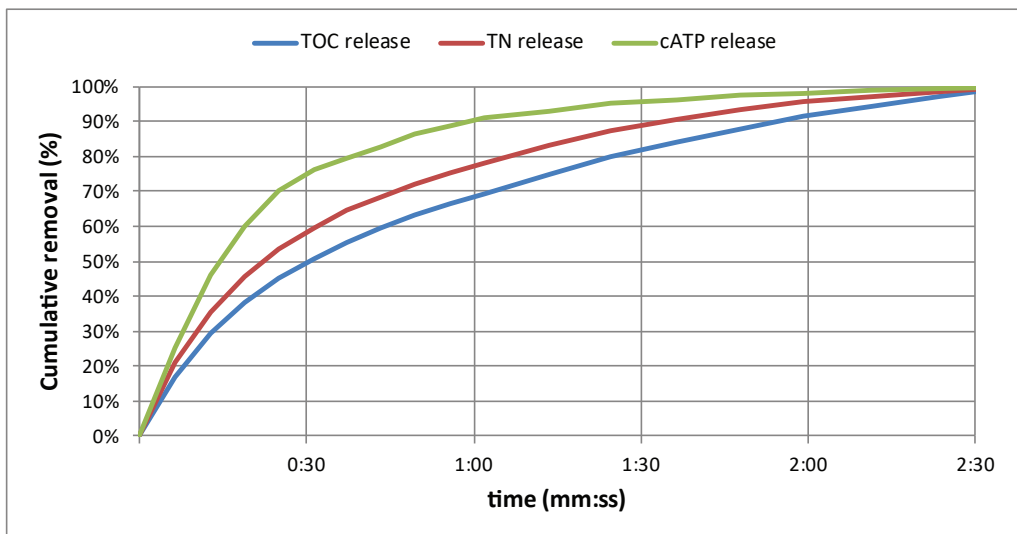
**Figure 3:** Water quality parameters in laboratory time-series experiments; Results for participant A



as an example. For all other participants, these parameters show similar trends, with exception of the steep drop of cATP after 2 minutes, which only occurred for participant A.

Based on the results of the time-series experiments, the initial anthropogenic pollutant release was defined as: the amount of pollutants released from a person in a standardised shower cabin during the first 60 seconds of showering. The 60-second timeframe was chosen because most of the pollutants are released within this period, as shown in Figure 4, but also because of its practical usability. The pollutants rinsed off during these 60 seconds can be described as easily removable pollutants. Although prolonged showering does remove an additional amount of pollutants, this amount should not be addressed as initial anthropogenic pollutant release. Figure 3 shows that the release of the pollutants levelled off after 30–60 seconds to a more or less constant level. It is assumed that this constant release is caused by sweat production during the shower experiment. As the shower temperature was close to human body temperature and high humidity inside the shower inhibits evaporation, which is the natural human cooling mechanism, prolonged showering at these conditions tends to increase the body temperature. Subsequently, an increase in body temperature will lead to an increase in sweat production (Kuno 1956). The amount of pollutants related to sweat production caused by environmental conditions or physical exercise is addressed as the continuous anthropogenic pollutant release. The average initial anthropogenic pollutant release measured during the time-series experiments for TOC, TN, cATP and particle counts are, respectively, 211 mg TOC/person, 46 mg TN/person, 1.6 µg cATP/person, and  $0.155 \times 10^9$  particles/person.

All parameters measured during the time-series experiments are correlated ( $r > 0.05$ ) (Table 2). The highest Pearson correlation coefficient ( $r > 0.8$ ) was found between TOC, TN, and turbidity. The parameters TOC, TN and cATP were combined with the results of the



**Figure 4:** Cumulative plot of initial anthropogenic pollutant release during first minutes of showering

questionnaires to constitute a model that describes the initial release of TOC, TN and cATP during showering. Each of the three models represents a typical part of the anthropogenic pollutant release. The organic compounds are represented by the TOC–model, the N–compounds are represented by the TN–model and the microbiological release is represented by the cATP model. The initial anthropogenic pollutant release models give actual concentrations after ‘t’ minutes of showering.

The model that described TOC release is as follows:

$$\ln(\text{TOC}) = c_0 + a_0 \cdot a + h_0 \cdot h + T_0 \cdot T + g_0 \cdot g + s_0 \cdot s + r_0 \cdot r + e_0 \cdot e + (c_1 + h_1 \cdot h + T_1 \cdot T + s_1 \cdot s + r_1 \cdot r + e_1 \cdot e) \cdot \sqrt{t} \quad (1)$$

Where:

TOC = TOC release of unshowered person in a standardised shower cabin (mg TOC/min)

a = age (year)

h = hair length (cm)

T = water temperature (°C)

g = gender factor (female; g=1 / male; g=0)

s = hours since last shower (hour)

r = rubbing factor (yes; r=0 / no; r=1)

e = recent exercise factor (yes; e=0 / no; e=1)

t = shower time (minutes) with a maximum of 1 minute

$c_0, a_0, h_0, T_0, g_0, s_0, r_0, e_0, c_1, h_1, T_1, s_1, r_1$  and  $e_1$  are TOC release specific constants.

The TOC–model has an  $r^2$  of 0,97.

The model that describes the TN release is as follows:

$$\ln(\text{TN}) = c_0 + a_0 \cdot a + h_0 \cdot h + T_0 \cdot T + g_0 \cdot g + s_0 \cdot s + r_0 \cdot r + e_0 \cdot e + (c_1 + h_1 \cdot h + g_1 \cdot g + s_1 \cdot s + r_1 \cdot r + e_1 \cdot e) \cdot \sqrt{t} \quad (2)$$

Where:

TN = initial TN release of unshowered person in a standardised shower cabin (mg TN/min)

$c_0, a_0, h_0, T_0, g_0, s_0, r_0, e_0, c_1, h_1, g_1, s_1, r_1$  and  $e_1$  are TN release specific constants.

Compared to the TOC–model, the TN–model seems to lack a temperature–shower time related release, instead, in the TN–model there is a gender–shower time related release. The TN–model has an  $r^2$  of 0,96.

The model that describes the cATP release is as follows:

$$\ln(\text{cATP}) = c_0 + a_0 \cdot a + h_0 \cdot h + T_0 \cdot T + g_0 \cdot g + s_0 \cdot s + r_0 \cdot r + e_0 \cdot e + (c_1 + a_1 \cdot a + h_1 \cdot h + T_1 \cdot T + g_1 \cdot g + s_1 \cdot s + r_1 \cdot r + e_1 \cdot e) \cdot \sqrt{t} \quad (3)$$

Where:

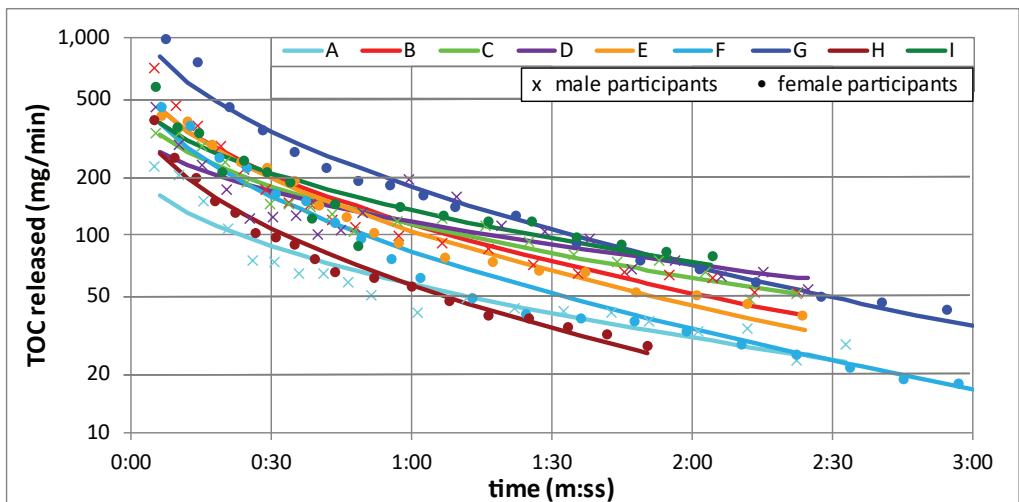
cATP = initial cATP release of person in a standardised shower cabin (pg cATP/min)

$c_0, a_0, h_0, T_0, g_0, s_0, r_0, e_0, c_1, a_1, h_1, T_1, g_1, s_1, r_1$  and  $e_1$  are cATP release specific constants.

Compared to the TOC–model, the cATP–model has a age–shower time and gender–shower time related release. The cATP–model has an  $r^2$  of 0,95.

The model parameter estimates are not reported in this manuscript because they can only be used within the parameter ranges of the ten participants in the time-series experiments. Since the parameter ranges are small for some parameters, usage of the model outside this parameter range can lead to obscure results. These models can be used to gain a better understanding of the parameters influencing the initial bathing load. The age range of the participants within the time-series experiments was rather narrow (23–39). Within this range, the younger participants had a higher TOC release and a lower cATP release. There was no clear explanation for this age effect. Hair length has a double influence on TOC release. First, persons with longer hair tend to have a higher TOC release and, secondly, having longer hair seems to decrease the release (or removal) of TOC during a shower. Long hair seems to act like a buffer where TOC is stored and slowly released. Other parameters with a double influence on TOC release are: hours since last shower, rubbing, and exercise. Females tend to have a slower TN release, but this could also be caused by other parameters like hair length. The release of cATP tend to slow down when the shower temperature decreases. The initial anthropogenic pollutant release (TOC, TN and cATP) is higher for persons who did not have a recent shower, or had a recent exercise, or were rubbing while showering. The release-rate of TOC tends to slow down at longer times since last showering, and the release-rate tends to increase when rubbing while showering and when exercise was recent. Males tend to release slightly more TOC than females. Figure 5 shows both the results of the time-series experiments and the model results for TOC, using formula (1). Although the measurements during the time-series experiments reflect a three minute period, the model can be used to predict the initial anthropogenic pollutant release during the first two minutes of showering.

As the previously described models are based on a small group of participants within the time-series experiments, a simplified model was made for general use. This general model can be used to predict the initial TOC release for unshowered pool visitors during the first



**Figure 5:** Experimental data (markers) and model results (lines) for TOC in laboratory time-series experiments; each line displays the results of one individual participant.

minute of showering. In this general TOC model, the only variable parameter is the shower time. The general TOC model is described as:

$$\ln(\text{TOC}) = 6.516 - 1.949 \cdot \sqrt{t} \quad (4)$$

The general TOC-model has an  $r^2$  of 0.81 compared to the results of the time-series experiments.

The general model for TN release is described as:

$$\ln(\text{TN}) = 5.128 - 2.514 \cdot \sqrt{t} \quad (5)$$

The general TN-model has an  $r^2$  of 0.59 compared to the results of the time-series experiments.

The general model for cATP release is described as:

$$\ln(\text{cATP}) = 8.234 - 3.029 \cdot \sqrt{t} \quad (6)$$

The general TN-model has an  $r^2$  of 0.33 compared to the results of the time-series experiments.

These models show that the initial anthropogenic pollutant release can be calculated from a combination of general and hygienic information. In order to calculate the initial TOC release, for example during the first 30 seconds of showering, the following integral must be solved:

$$\int_{t=0}^{0.5} e^{6.516 - 1.949 \cdot \sqrt{t}} \quad (7)$$

For 15, 30 and 60 seconds, the calculated TOC load equals 95, 149 and 217 mg per bather, respectively. The initial TN and cATP load can be calculated correspondingly. For 15, 30 and 60 seconds, the calculated TN load equals 36, 47 and 57 mg per bather, respectively. And for cATP, the calculated load equals 1.1, 1.4 and 1.7  $\mu\text{g}$  per bather for 15, 30 and 60 seconds, respectively.

The model can be used to predict the average initial anthropogenic pollutant release for persons who do or do not take a pre-swim shower. General response variables like age, gender and shower temperature give information about initial anthropogenic pollutant release of different age and gender groups visiting a swimming pool. While hygienic response variables like hair length, hours since last shower, rubbing and recent exercise give information about personal initial anthropogenic pollutant release, this information can be used to advise pool operators and pool visitors about the effect of their shower behaviour on pool water.

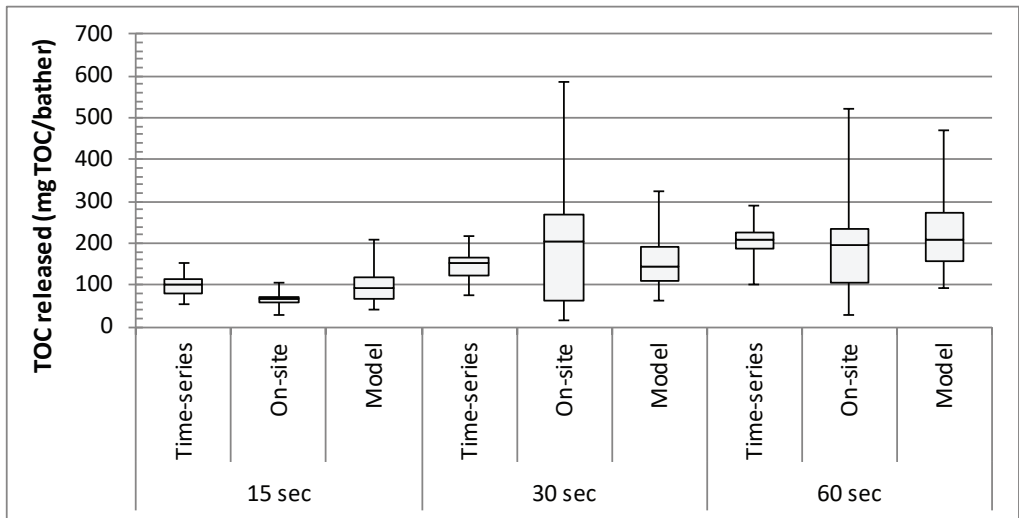
First of all, it is important that all pool visitors have a shower before entering the pool basin, a so-called pre-swim shower. It is important that people rub their body during this pre-swim shower to remove pollutants more rapidly. The average duration of a pre-swim shower

should be 60 seconds or more, but no less, as demonstrated in this study. Depending on a person’s hygiene status, the pre–swim shower must be longer, e.g. when pool visitors have long hair (>10cm), had recently exercised (without subsequent shower), or did not have a recent home shower (>24h). The pre–swim shower may be shorter when pool visitors have short hair (< 3 cm), are wearing a swimming cap, or had a recent home shower (<8 h). Although the appliance of a shower protocol based on the previously described guidelines is an important first step to inform pool visitors about their personal influence on the pool water quality showering protocols alone might not be enough.. The aquatic staff also needs to be aware of the necessity of pre–swim showering. And finally, supportive policies (e.g., maintaining clean, well–stock bathroom facilities that not only encourage showering but toileting as well) should be established, implemented, and enforced.

### 2.3.2 On–site experiments

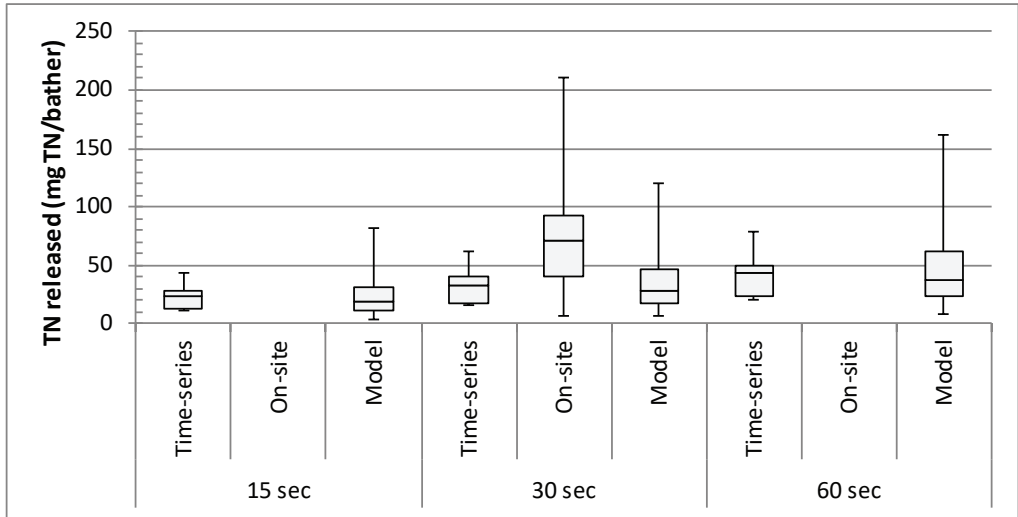
At the three indoor pools, 106 persons participated in the study (58 men, 42 women, 6 women and their babies), whereas 27 persons participated in the study at the Hengelo outdoor pool (15 men, 12 women). Some general and hygienic participant information is shown in Table 3.

		Age (y)	Hair length (cm)	Water temperature (°C)	Time since last shower (h)
indoor pools	average	44	7.8	37	18.5
	range	4-84	2-30	36.5-38	2-65.5
outdoor pools	average	27	16.7	37.5	6.4
	range	9-64	2-60	n.a.	0.1-28

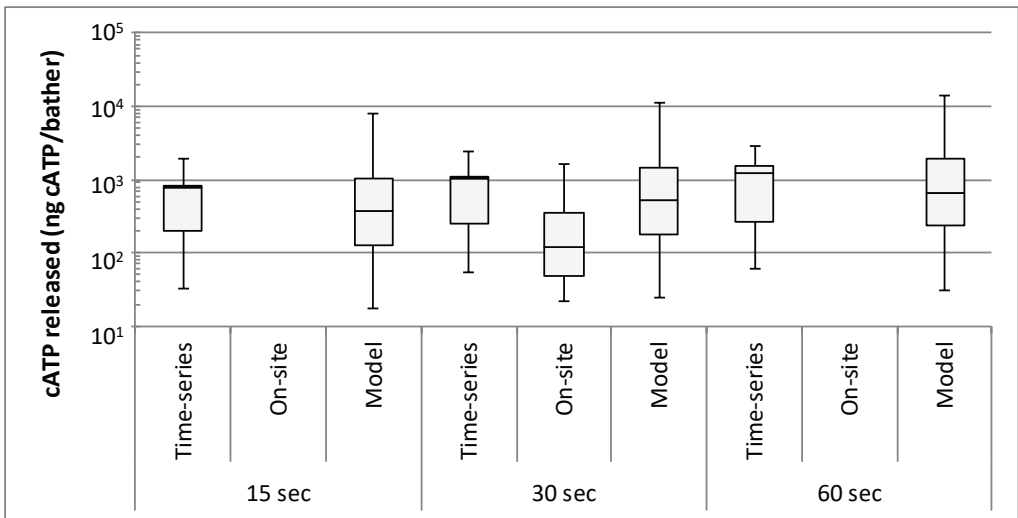


**Figure 6:** Box plots of laboratory time-series experiments, on-site experiments, and general model predictions for initial TOC released per person in different time frames.

The shower time at the four swimming pools differed due to different shower time set-points; it was either 15, 30 or 60 seconds. Therefore, anthropogenic pollutant releases obtained from the on-site experiments as well as those obtained from the laboratory time-series experiments are displayed for these different time intervals (Figures 6–8). Although the results were more scattered during the on-site experiments, there is a good correlation between the laboratory and on-site anthropogenic pollutant releases. The scatter during the on-site experiments was most probably caused by diversity within the large group of



**Figure 7:** Box plots of laboratory time-series experiments, on-site experiments, and general model predictions for initial TN released per person in different time frames.



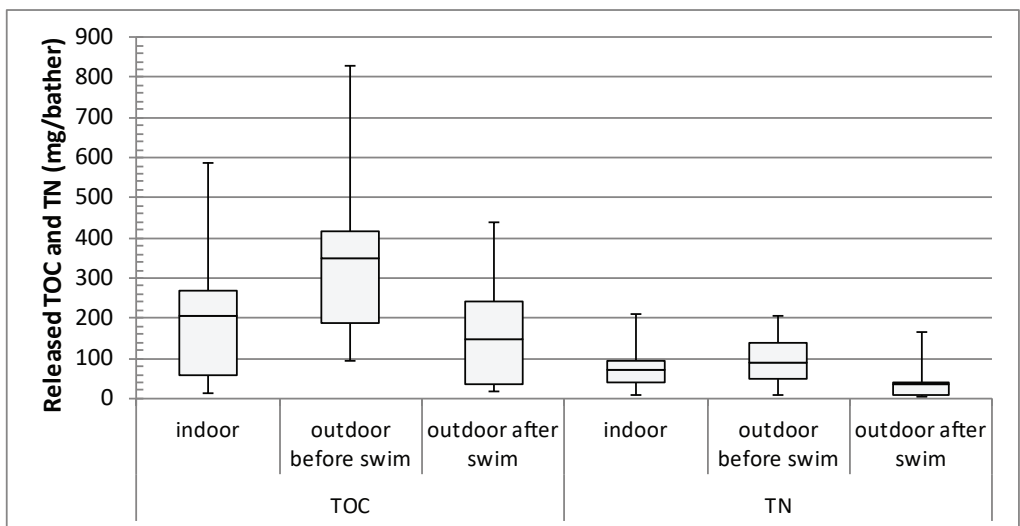
**Figure 8:** Box plots of laboratory time-series experiments, on-site experiments, and general model predictions for initial cATP released per person in different time frames.

participants. For TOC, the model is a good predictor of the initial anthropogenic pollutant release. Although for TN and cATP the model is a little less accurate, based on  $r^2$ , it is still a very useful tool (Figure 6–8).

The experiments by Keltjens were the only experiments found in scientific literature that focussed on the effect of showering and anthropogenic pollutant release. Keltjens used a shower experiment as well as a bath tub experiment and showed that showering has a significant influence on anthropogenic pollutant release reduction. During a 15 minute bath tub experiment, the release of  $\text{KMnO}_4$  consuming substances was reduced over 60% by pre-swim showering (Keltjens 1987).

Anthropogenic pollutant releases for male and female participants were only slightly different. These results confirm previous results by Keltjens (1987), Althaus (1981) and Gunkel and Jensen (1986). However, the actual values found in these studies cannot be used for comparison with the present results because (most parts of) these studies were performed in other swimming pool environments (hot tubs and saunas) than the present study and focussed on different parameters ( $\text{KMnO}_4$ , Kjeldahl-N). Nevertheless, Keltjens

Table 4: Influence of hygienic parameters on initial anthropogenic pollutants released in 30 s during on-site experiments.				
	TOC (mg/bather)	TN (mg/bather)	cATP (ng/bather)	Particle count (#/bather)
Last shower <12 h	252	66	538	$38 \times 10^9$
Last shower >12 h	327	84	887	$63 \times 10^9$
Recent activity none or light	355	91	340	$0.97 \times 10^9$
Recent activity medium or high	387	102	292	$1.3 \times 10^9$



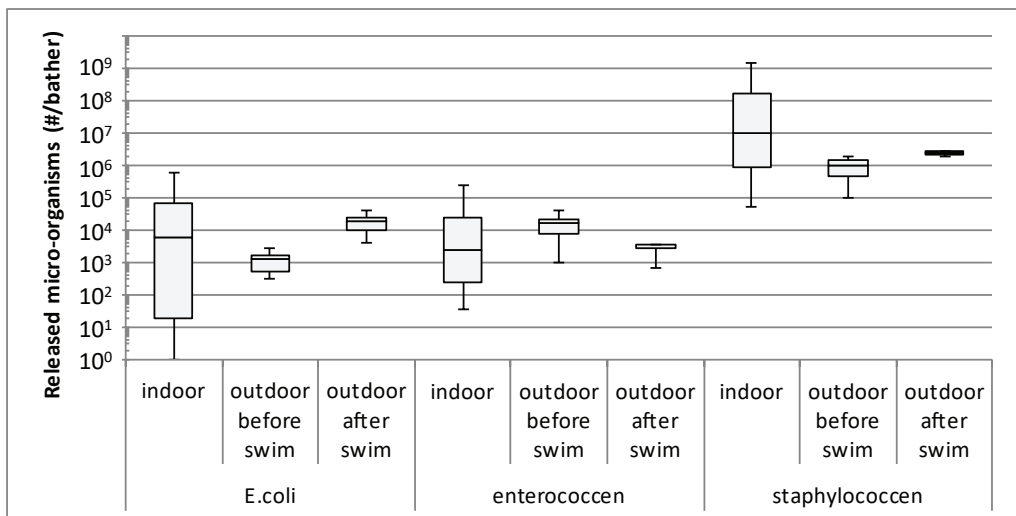
**Figure 9:** Box plots of on-site indoor and outdoor experiments for released TOC and TN.

(1987) was the only one that previously demonstrated that showering had a significant influence on anthropogenic pollutant release reduction. During a 15 minute bath tub experiment, the release of KMnO<sub>4</sub> consuming substances was reduced over 60% by pre-swim showering.

Weng and Blatchley (2011) estimated the release of urea during a national swimming competition to be 0.56–1.20 g urea / person. This urea release corresponds with a TN release of 260–560 mg TN/person. Assuming that most of the competitors in the Weng and Blatchley study did not have a pre-swim shower, which seems common practise for competitive swimmers (personal observation), the initial TN release found in the current study (70 mg TN/person) is 12.5–27 % of the total TN release reported by Weng and Blatchley. This suggests that it is important to advise competitive swimmers to have a pre-swim shower to reduce the chemical and biological anthropogenic pollutant release.

The importance of hygienic parameters like ‘hours since last shower’, or ‘recent physical activity’ was shown during the laboratory time-series experiments. In the on-site experiments, hygienic parameters in general also had a significant effect on anthropogenic pollutant release as shown in Table 4. However, on the level of individuals, this effect was less clear, mostly because the amount of washable pollutants people carry is determined by multiple factors. To determine which general and hygienic characteristics determine and/or influence anthropogenic pollutant release, a larger database with experimental and questionnaire results is needed.

During the outdoor pool experiment, some participants joined the experiment before swimming, while others had been swimming before they joined. The release of pollutants of swimmers that did not swim before showering was similar to the release found for participants during the indoor pool experiments (Figure 9). The release of pollutants for those who had a swim before showering was again on a comparable level, suggesting that even



**Figure 10:** Box plots of on-site indoor and outdoor experiments for released micro-organisms.



if swimmers had been swimming in the outdoor pool, the amount of pollutants was regenerated over a short timeframe (0.5–1.5h). The continuous generation of pollutants is most probably the result of a combination of the use of body- and suntan lotion and outdoor pool environmental conditions such as grass and sand, but also the tropical temperature (34°C) on that particular day, resulting in increased sweat production. The hygienic parameters from the questionnaires show a rather few 'hours since last shower' for these participants which is most likely due to the tropical weather conditions during the period preceding and including the experiment. Although there was an increased use of body and suntan lotion compared to the indoor pool experiments, assumable also because of the weather, persons using body or suntan lotion did not have an increased anthropogenic pollutant release. Although assumed otherwise before preparing the experiments, it is now assumed that the influence of body and suntan lotion on the release of anthropogenic pollutants is correlated to a time factor. The use of body and suntan lotion might slow down the release-rate of anthropogenic pollutants because the thin film of lotion on the skin is prohibiting the release.

On the other hand, the lotion itself will also be released into the pool water increasing the anthropogenic pollutants. It is assumed that both processes neutralise each other during the short timeframe of a pre-swim shower. It is likely, however, that general use of body- and suntan lotion will increase the anthropogenic pollutant release, even after a short pre-swim shower. This study at an outdoor pool clearly shows the importance of showering, even if a bather has been swimming. The availability of a warm-water shower near the pool entrance is important. The outdoor pool used for the experiment was not equipped with outdoor warm-water showers. Although there were a few outdoor cold-water showers, these showers were mostly used to clean hands and feet. This situation is similar at many Dutch outdoor swimming pools. As indoor swimming pools are carefully designed and the showers are placed in the route between the changing rooms and the pool basin, outdoor pools seem to lack this careful design aspect. In addition to the shower recommendations mentioned earlier in this paper, outdoor pool visitors should shower before entering (or re-entering) the pool.

Microbiological data were collected for 25 participants at indoor pool C and for 8 participants at outdoor pool D. For all these participants, higher numbers of staphylococci (range  $1.0 \times 10^4$  –  $2.2 \times 10^9$  per 100 ml shower water) than of *E. coli* (range  $2.5 \times 10^1$  –  $1.9 \times 10^6$  per 100 ml of shower water) and intestinal enterococci (range  $1.7 \times 10^1$  –  $7.0 \times 10^5$  per 100 ml of shower water) were detected in the shower water (Figure 10). The higher number of staphylococci in the shower water suggests that pre-swim showering as it was done in these experiments is more effective in removing possible skin pathogens than it is in removing possible faecal pathogens, which is easily explained by the fact that the shower procedure was of short duration and swimmers were wearing their full swimwear. Diapered children, and those learning toileting skills might have shed more enterococci into the shower water, but were not used as participants in this study for practical reasons. Less toileting skilled bathers should be advised to clean the anal and perianal area as part of their pre-swim shower. The presence of private showers will make them feel more comfortable to do so.

Four of the 8 participants at pool D had been swimming before showering in the standardised shower cabin. The number of *E. coli* and the number of staphylococci that were washed from the bodies of these participants was higher than the numbers washed from the bodies of

the participants that had not been swimming before taking part in the shower experiment. Since the number of participants in this part of the study is very low, it is not possible to draw solid conclusions from these findings. For some participants, the number of micro-organisms washed from their bodies was much higher than for others, however, these results did not correspond to any of the information provided in the questionnaires about personal hygiene.

During the on-site experiment at pool A, four participants were asked to wear a swimming cap while showering in the standardised shower cabin. The TOC and TN values measured for these participants were respectively 19% and 70% lower than the values measured for the other participants who were not wearing swimming caps. Although wearing a swimming cap is not mandatory in Dutch pools, it does reduce the anthropogenic pollutant release.

This research clearly shows the importance of pre-swim showering. The initial anthropogenic pollutant release was defined to show how some swimmers' pollutants can easily be removed with a pre-swim shower. The removal efficiency is a function of different parameters. The duration of the shower has the largest influence on the removal of pollutants. Most pollutants are removed within a 60-second shower. Although prolonged showering does remove some additional pollutants, it is at a low rate. All pollutants, both chemical and microbial, removed from swimmers during a pre-swim shower will not end up in the swimming pool. Once introduced into the swimming pool water, pollutants will be highly diluted and hard to remove with water treatment. Dissolved pollutants will also react with disinfectants like chlorine, resulting in the formation of DBPs. As a result, pre-swim showering will very likely reduce the level of DBPs in a chlorinated swimming pool, and also reduce the chlorine demand. The results of this study can be used to point out the importance of pre-swim showering to swimmers and may be used in future models describing the amount of DBPs formed in swimming pools.

## 2.4 Conclusions

Shower experiments, both in laboratory and in field studies, showed that the amount of pollutants that is washed from the human body rapidly declines during the first minutes of showering. Since the decline is most profound during the first 60 seconds, we defined the amount of pollutants released in a standardised shower cabin during 60 seconds of showering as the initial anthropogenic pollutant release. The initial anthropogenic pollutant release measured in the field studies was comparable to the initial anthropogenic pollutant release found in laboratory experiments, suggesting that the laboratory experiments are a good proxy for field studies. Anthropogenic pollutant release is best described by the parameters TOC, TN and cATP. The model to describe anthropogenic pollutant release composed in this study yielded calculated values for anthropogenic pollutant release that matched experimental data very well, indicating that the model can be used to predict initial anthropogenic pollutant release when experimental data are lacking. Pre-swim showering is an important tool to reduce both chemical and microbiological pollutants introduced into swimming pool water by swimmers which most likely reduces DBPs formation and chlorine demand.

## Acknowledgements

The study was funded by communal subsidies from AgentschapNL and EFRO in combination with private funding from Delft University of Technology, Hellebrekers Technieken, Akzo Nobel Industrial Chemicals B.V., Van Remmen UV Techniek, Coram International B.V. and Sportfondsen Nederland N.V.. Special thanks to the swimming pools that cooperated in this study: Sportfondsenbad Delft, Sportfondsenbad Meerkampsering, Sportfondsenbad Dol-fijn and Twentebad. The authors thank Olga Pneumeeke, Jim van Spengen, Elodie Laurent, Gaelle Collet, Zeinab Pasdar Yazd, Francois Astier and Antoine Neveu who helped perform the experiments. Harold van den Berg and Arieke Docters van Leeuwen (RIVM) are acknowledged for doing the microbiological analyses. Thanks to Adele Sanders for reviewing the language and spelling. And last but not least, many thanks to all swimmers who volunteered to participate in this study.

## 2.5 References

- Aggazzotti, G., Fantuzzi, G., Righi, E. and Predieri, G. (1995) Environmental and biological monitoring of chloroform in indoor swimming pools. *Journal of Chromatography* 710, 181–190.
- Althaus, H. and Pacik, D. (1981) Antropogene Belastungsstoffe in Hot Whirlpools (Warmsprudelbecken). *Archiv des Badewesens* (34), 417–420.
- Borgmann–Strahsen, R. (2003) Comparative assessment of different biocides in swimming pool water. *International Biodeterioration & Biodegradation* 51(4), 291–297.
- Eichelsdörfer, D., Slovak, J., Dirnagl, K. and Schmid, K. (1975) Zur Reizwirkung (Konjunktivitis) von Chlör und Chloraminen im Schwimmbeckenwasser. *Vom Wasser* 45, 17–28.
- Eichelsdörfer, D., Jandik, J. and Weil, W. (1980) Organische Halogenverbindungen im Schwimmbeckenwasser II. Mitteilung: Modellversuche zur Bildung leichtflüchtiger Halogenkohlenwasserstoffe. *Z. Wasser Abwasser Forschung* 13(5), 165–169.
- Erdinger, L., Kirsch, F. and Sonntag, H.G. (1998) Irritierende Wirkung von Nebenprodukten der Schwimmbadwasserdesinfektion. *Zentralblatt für Hygiene und Umweltmedizin* 200(5–6), 491–503.
- Font–Ribera, L., Kogevinas, M., Zock, J.P., Gómez, F.P., Barreiro, E., Nieuwenhuijsen, M.J., Fernandez, P., Lourencetti, C., Pérez–Olabarria, M., Bustamante, M., Marcos, R., Grimalt, J.O. and Villanueva, C.M. (2010) Short–Term Changes in Respiratory Biomarkers after Swimming in a Chlorinated Pool. *Environmental Health Perspectives* 118(11), 1538–1544.
- Glauner, T., Waldmann, P., Frimmel, F. and Zwiener, C. (2005) Swimming pool water—fractionation and genotoxicological characterization of organic constituents. *Water Research* 39, 4494–4502.
- Gunkel, K. and Jessen, H.J. (1986) Untersuchungen über den Harnstoffeintrag in das Badewasser. *Acta Hydrochimica et Hydrobiologica* 14(5), 451–461.
- Hery, M., Hecht, G., Gerber, J.M., Gendre, J.C., Hubert, G. and Rebuffaud, J. (1995) Exposure to chloramines in the atmosphere of indoor swimming pools. *Annals of Occupational Hygiene* 39(4), 427–439.
- ISO (1999) Microbiology of food and animal feeding stuffs – Horizontal method for the enumeration of coagulase–positive staphylococci (*Staphylococcus aureus* and other species) – Part 1: Technique using Baird–Parker agar medium, ISO 6888–1, International Organization for Standardization, Geneva, Switzerland.
- ISO (2000a) Water quality – Detection and enumeration of *Escherichia coli* and coliform bacteria – Part 1: Membrane filtration method, ISO 9308–01, International Organization for Standardization, Geneva, Switzerland.
- ISO (2000b) Water quality – Detection and enumeration of intestinal enterococci – Part 2: Membrane filtration method, ISO 7899–2, International Organization for Standardization, Geneva, Switzerland.

- ISO (2006) Water quality – Sampling for microbiological analysis, ISO 19458, International Organisation for Standardization, Geneva, Switzerland.
- Keltjens, L.L.M. (1987) Optimalisering van de bedrijfsvoering in overdekte zwemgelegenheden (Optimisation of management in indoor swimming pools), p. 153, Ministry of VROM, Den Haag (The Hague).
- Kogevinas, M., Villanueva, C.M., Font-Ribera, L., Liviac, D., Bustamante, M., Espinoza, F., Nieuwenhuijsen, M.J., Espinosa, A., Fernandez, P., DeMarini, D.M., Grimalt, J.O., Grummt, T. and Marcos, R. (2010) Genotoxic Effects in Swimmers Exposed to Disinfection By-products in Indoor Swimming Pools. *Environmental Health Perspectives* 118(11), 1531–1537.
- Kuno, Y. (1956) Human perspiration, Charles C. Thomas, Springfield, Illinois, U.S.A.
- Lahl, U., Batjer, K., Duszeln, J.V., Gabel, B., Stachel, B. and Thiemann, W. (1981) Distribution and balance of volatile halogenated hydrocarbons in the water and air of covered swimming pools using chlorine for water disinfection. *Water Research* 15(7), 803–814.
- Lakind, J.S., Richardson, S.D. and Blount, B.C. (2010) The good, the bad, and the volatile: Can we have both healthy pools and healthy people? *Environmental Science and Technology* 44(9), 3205–3210.
- NEN (1997) Water analysis – Guidelines for determination of total organic carbon (TOC) and dissolved organic carbon (DOC), NEN.
- NEN (2003) Water quality – Determination of nitrogen – Determination of bound nitrogen (TN sub b), following oxidation to nitrogen oxides.
- Powick, D.E.J. (1989) Swimming pools – Brief outline of water treatment and management. *Water Science and Technology* 21(2), 151–160.
- Richardson, S.D., DeMarini, D.M., Kogevinas, M., Fernandez, P., Marco, E., Lourencetti, C., Ballesté, C., Heederik, D., Meliefste, K., McKague, B., Marcos, R., Grimalt, L.F.–R.J.O. and Villanueva, C.M. (2010) What's in the Pool? A Comprehensive Identification of Disinfection By-products and Assessment of Mutagenicity of Chlorinated and Brominated Swimming Pool Water. *Environmental Health Perspectives* 118(11), 1523–1530.
- VROM (1985) Onderzoek naar filterinstallaties en waterbehandelingsystemen in zwembaden, p. 43, Den Haag (The Hague).
- VROM (2001) Dutch drinking water act. Ministry of Housing, s.p.a.h. (ed), The Hague, Netherlands.
- Weng, S. and Blatchley, E.R. (2011) Disinfection by-product dynamics in a chlorinated, indoor swimming pool under conditions of heavy use: National swimming competition. *Water Research* 45, 5241–5248.
- WHO (2006) Guidelines for safe recreational water environments  
Volume 2; Swimming pools and similar environments, WHO.
- Zwiener, C., Richardson, S., De Marini, D., Grummt, T., Glauner, T. and Frimmel, F. (2007) Drowning in Disinfection Byproducts? Assessing Swimming Pool Water. *Environmental science & technology* 41(2), 363–372.



# Chapter 3

## Quantification of continual anthropogenic pollutants released in swimming pools

M.G.A. Keuten<sup>1,2</sup>, M.C.F.M. Peters<sup>1</sup>, H.A.M. Daanen<sup>3,4</sup>, M.K. de Kreuk<sup>1</sup>, L.C. Rietveld<sup>1</sup>, J.C. van Dijk<sup>1</sup>

Water Research 2014

doi: [10.1016/j.watres.2012.04.012](https://doi.org/10.1016/j.watres.2012.04.012)

Corrigendum WaterResearch 2014 included

doi: [10.1016/j.watres.2013.12.007](https://doi.org/10.1016/j.watres.2013.12.007)

---

1 Section Sanitary Engineering, Delft University of Technology, Delft, The Netherlands

2 Hellebrekers Technieken, Nunspeet, the Netherlands

3 TNO, Soesterberg, The Netherlands

4 MOVE Research Institute Amsterdam and Faculty of Human Movement Sciences, VU University, Amsterdam, The Netherlands



## Abstract

Disinfection in swimming pools is often performed by chlorination, However, anthropogenic pollutants from swimmers will react with chlorine and form disinfection by-products (DBPs). DBPs are unwanted from a health point of view, because some are irritating, while others might be carcinogenic. The reduction of anthropogenic pollutants will lead to a reduction in DBPs. This paper investigates the continual release of anthropogenic pollutants by means of controlled sweat experiments in a pool tank during laboratory time-series experiments and also during on-site experiments in a swimming pool. The sweat released during the on-site and laboratory time-series experiments was very similar. The sweat rate found was 0.1-0.2 L/m<sup>2</sup>/h at water temperatures below 29 °C and increased linearly with increasing water temperatures to 0.8 L/m<sup>2</sup>/h at 35 °C. The continual anthropogenic pollutant release not only consisted of sweat, particles (mainly skin fragments and hair) and micro-organisms, but also sebum (skin lipids) has to be considered. The release of most components can be explained by the composition of sweat. The average release during 30 minutes of exercise is 250mg/bather non-purgeable organic carbon (NPOC), 77.3 mg/bather total nitrogen (TN), 37.1mg/bather urea and 10.1 mg/bather ammonium. The release of NPOC cannot be explained by the composition of sweat and is most probably a result of sebum release. The average release of other components was 1.31×10<sup>9</sup> # particles/bather (2-50 μm), 5.2 μg/bather intracellular adenosine triphosphate (cATP) and 9.3×10<sup>6</sup> intact cell count/bather (iCC). The pool water temperature was the main parameter to restrain the continual anthropogenic pollutant release. This study showed that a significant amount of the total anthropogenic pollutants release is due to unhygienic behaviour of bathers.

### Keywords:

- continual anthropogenic pollutant release
- anthropogenic pollutants
- sweat rate
- sweat composition
- swimming pool

### 3.1 Introduction

Swimming is a popular activity all over the world for all age and social classes. The provision of safe and hygienic swimming water is an important health issue. Anthropogenic pollutants, that are introduced into swimming pool water by bathers, can be divided into suspended and colloidal matter, micro-organisms, and soluble substances (Powick 1989). Suspended and colloidal matter include particles such as organic and inorganic substances that float, suspend or settle in the swimming pool water and include hair, skin cells, dust and fibres from clothes and swimwear. Micro-organisms enter the pool water through different routes. Micro-organisms of non-faecal origin, like *Pseudomonas* spp., *Staphylococcus aureus* and adenoviruses enter the pool water while being washed from the skin or from released saliva, mucus or vomit, whereas faecally-derived micro-organisms like *Escherichia coli*, *Cryptosporidium* and enteric viruses are washed from swimmers bodies or enter the water when a person has an (accidental) faecal release (WHO 2006). Soluble substances can be organic or inorganic. Soluble organic substances include urea, creatinine, lactic acid and amino acids. Soluble inorganic material includes ions such as ammonium, chloride, sodium, potassium, calcium and sulphate (Kuno 1956).

The shared use of swimming pool water by different individuals requires pool water treatment to remove pollutants and disinfect the water to inactivate possible anthropogenic pathogenic micro-organisms. Swimming pool water is generally disinfected with chlorine-based products. However, the anthropogenic pollutants, introduced in the pool water by swimmers, react with chlorine, leading to the formation of a variety of disinfection by-products (DBPs) (Aggazzotti et al. 1995, Florentin et al. 2011, Richardson et al. 2010, Zwiener et al. 2007).

Some of these DBPs are associated with impaired respiratory health and possibly asthma, while others may be carcinogenic (Font-Ribera et al. 2010, Glauner et al. 2005, Lakind et al. 2010). Other DBPs are associated with potential genotoxic effects (Kogevinas et al. 2010), whereas other DBPs are irritating to the skin, eyes or respiratory tract (Eichelsdörfer et al. 1975, Erdinger et al. 1998). The overall health effects of swimming might be increasingly positive when the potential negative health risks from DBPs in pool water are reduced (Kogevinas et al. 2010). It is expected that a reduction in the amount of anthropogenic pollutants in the pool water will result in reduced concentrations of DBPs and chlorine demand.

Many papers emphasise the importance of reducing the anthropogenic pollutants released to decrease the formation of DBPs formed (Borgmann-Strahsen 2003, Eichelsdörfer et al. 1980, Hansen et al. 2013, Hery et al. 1995, Keuten et al. 2012, Lahl et al. 1981, Lakind et al. 2010, WHO 2006). Although it is obvious that reduction of anthropogenic pollutants will lead to reduction of DBPs, there are no recent scientific reports or studies known to the authors, that have demonstrated the actual effect of anthropogenic pollutant reduction on the level of DBPs.

To establish whether anthropogenic pollutant reduction results in decreased DBP formation, information is required about anthropogenic pollutant release. The anthropogenic pollutants release can be divided into three parts (Keuten et al. 2012). The first part is the initial anthropogenic pollutant release, defined as the amount of anthropogenic pollutants that are



rinsed off from a subject's body during a 60-second shower. The second part is the continual anthropogenic pollutants release during the subsequent swimming exercise. The continual anthropogenic pollutant release is assumed to consist mainly of sweat, micro-organisms and skin cells. The third part is the incidental anthropogenic pollutant release which is the result of human excreta such as urine, vomit or faecal material entering the pool water, either accidentally or on purpose.

continual anthropogenic pollutant release was the focus for this study and it was assumed that sweat is its main component. Several studies reporting sweat rates for swimmers focussed on the temperature regulation during swimming (Kounalakis et al. 2010, McMurray and Horvath 1979, Robinson and Somers 1971, Taimura et al. 1998), while other studies focussed on the water and/or swimmers' salt balance (Cox et al. 2002, Henkin et al. 2010, Macaluso et al. 2011, Maughan et al. 2009, Taimura and Sugahara 1996), or even muscle damage during swimming (Cade et al. 1991). Few studies have been found on anthropogenic pollutant release (De Laat et al. 2011, Gunkel and Jessen 1986, Weng and Blatchley 2011): one study focussed on blood plasma urea concentration (Lemon et al. 1989), and one study focussed on sebum (skin lipids) released during swimming (Gardinier et al. 2009). Previous scientific publications report sweat rates of 0.08-1.62L/h at various swimming pool conditions (20-35°C) and at different exercise levels (Lemon et al. 1989, Macaluso et al. 2011, Maughan et al. 2009, McMurray and Horvath 1979, Nielsen et al. 1984, Robinson and Somers 1971). The normalised sweat release rate, calculated from the sweat rates reported in these publications, was 0.04-0.91 L/m<sup>2</sup>/h. Urea and NPOC were the two reported parameters. The released urea varied from 0.40-1.20 g urea/bather (Gunkel and Jessen 1986, Weng and Blatchley 2011) to 11.1 g urea/bather (De Laat et al. 2011). The released NPOC was 12.4 g NPOC/bather. In addition to continual anthropogenic pollutant release, these previous urea and NPOC results might also include initial and incidental anthropogenic pollutants release. Before policies can be developed to restrain anthropogenic pollutants release, more information is needed on the continual anthropogenic pollutant release and its main influencing parameters.

Anthropogenic pollutant release can be determined through basin-studies, and bath-tub and shower experiments. It was expected that the continual anthropogenic pollutant release was mainly determined by the pool water temperature and the level of exercise. Because the heat-balance is an important parameter for sweat release, a pool tank study was chosen as the experimental setup. Preliminary trials showed that the dilution in a 3 m<sup>3</sup> pool tank was too much to observe differences with a 5-minute sampling interval and it was, therefore, decided to conduct the experiment in a water-filled suit inside the pool tank (Figures S1 and 1) with laboratory time-series experiments. On-site experiments were used to validate the laboratory findings.

## 3.2. Materials and methods

### 3.2.1 Subjects

#### Subjects in laboratory time-series experiments

Four subjects joined the laboratory time-series experiments, two male and two female. General information of the subjects is shown in Table 1.

	Participant A	Participant B	Participant C	Participant D
Gender	female	female	male	male
Age (y)	29	24	43	42
Height (m)	1.70	1.79	1.91	1.86
Weight (kg)	52.4	64.3	87.5	74.0
VO <sub>2</sub> max (L/min) <sup>1</sup>	2.5	2.6	4.2	3.4
1 (Shvartz and Reibold 1990)				

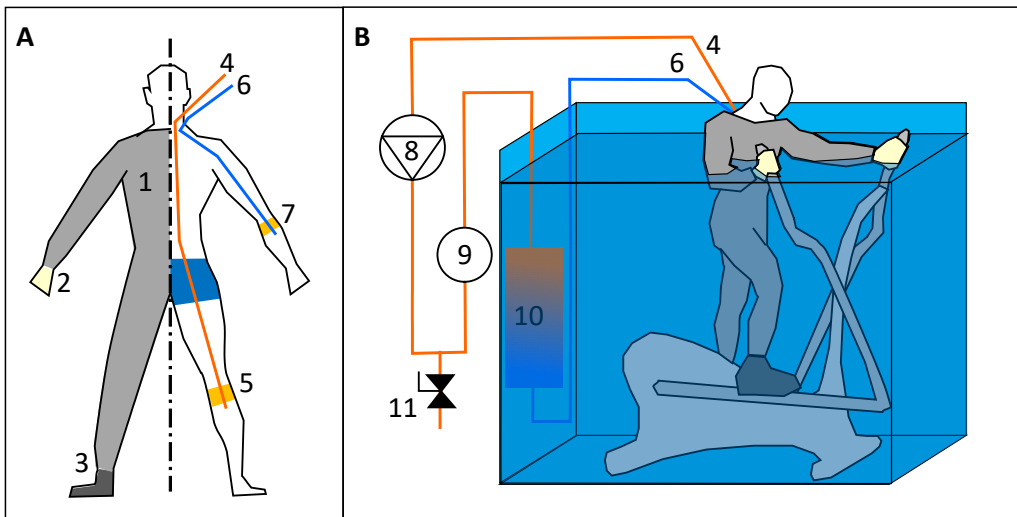
#### Subjects in on-site experiments

The different subject groups for the on-site experiments and experiment conditions are described in Table 2.

Subject groups	Males	Females	Watertemp.	Level of exercise
1 <sup>st</sup> lane swim group	16	12	28 (°C)	Light or moderate effort
2 <sup>nd</sup> lane swim group	2	1	28 (°C)	Light or moderate effort
1 <sup>st</sup> triathlete group	12	3	28 (°C)	Vigorous swimming
2 <sup>nd</sup> triathlete group	12	1	28 (°C)	Vigorous swimming
Laboratory time-series experiments group	2	2	32 (°C)	Sitting, leisure swimming and aqua spinning

### 3.2.2 Experimental set-up: tank, shower and suit

To determine continual anthropogenic pollutant release, standardised experiments were performed in a laboratory setting in a specially constructed pool tank (Figure S1). The water in the pool tank was circulated and heated with electric heaters and controlled to maintain a constant water temperature. A standardised shower cabin (Keuten et al. 2012) was used for showering before and after the experiment. During the experiment, the subjects wore a polyester rain overall with a polyurethane coating (M Wear 5400 Warona) (Figure 1A). The suit was prepared for recirculation by connecting tubes to subjects' arms and legs (Figure 1B). The subjects' feet were wrapped in plastic bags and connected to the trouser legs of the rain overall. To prevent the plastic foot bags from damage, diving shoes were worn over them. The subjects wore lab gloves connected to the sleeves of the rain overall. The zipper of the rain overall was closed with waterproof tape. The neck part of the suit was closed but not sealed, for easy passage of the four tubes. Because the suit had a good fit at the neck, it was assumed that the evaporation of water and volatile components during the experiment was negligible. The suit water was recirculated inside the suit to ensure proper mixing and to control the water temperature. The suit water was circulated with two pumps at a rate of 150L/h each and entered at the arms and left at the legs (Figure 1A). Heat exchanging coils, made from copper piping and situated in the pool tank, were used to ensure a constant water temperature of the suit water (Figure 1B).



**Figure 1:** A. Subjects were wearing a rain overall (1) connected to gloves (2) and plastic bags (3). Suit water was extracted with a tube (4) connected just below the subjects knees (5). Suit water was re-injected with a tube (6) connected just below the elbow (7).

B. Water inside suit extracted from suit legs with tubes (4) using circulation pumps (8), led through flow indicators (9) and heat exchanging coils (10) to the suit sleeves with tubes (6). Regular samples were taken from a sampling valve (11).

### 3.2.3 Tank, shower and suit water

The water used for the pool tank, the pre-swim shower and for filling the suit was standard Dutch drinking water (tap water) which is distributed without a chlorine residual (VROM 2001). The water used for the pre-swim shower was additionally pasteurised (70 °C during  $\geq 5$  minutes) to inactivate all micro-organisms. Cold and hot tap water was used for the shower and was mixed using a thermostatic valve to ensure a constant water temperature of  $37 \pm 0.5$  °C. The suit was filled with 25-30 L preheated tap water, using the heat exchanging coils from the suit circulation. A volumetric water meter (Sensus 620C, QN1.5) was used to measure the amount of tap water added to the suit.

### 3.2.4 Equipment preparation

The suit was rinsed with tap water. The suit recirculation loop was disinfected by recirculating a 10 ppm chlorine solution for 10 minutes. After disinfection, the recirculation loop was thoroughly rinsed with tap water and drained. The shower cabin was thermally disinfected with tap water at 70 °C for  $\geq 5$  minutes, rinsed with shower water and drained. Between the pre-shower and the after-shower, the shower cabin was rinsed with shower water and

**Table 3: Average fractions of weight loss during 30 min of laboratory time-series and on-site experiments.**

Parameter	laboratory time-series experiments	on-site experiments				
		Sitting	Leisure swim	Aqua spin	Lane swim	Vigorous swim
VO <sub>2</sub> (L/min)	2.1 <sup>a</sup>	0.3 <sup>b</sup>	1.3 <sup>b</sup>	2.5 <sup>b</sup>	2.1 <sup>b</sup>	3.3 <sup>b</sup>
Water temperature (°C)	25-30-35	32	32	32	28	28
P <sub>a</sub> (mm Hg)	17	37	34	34	30	30
% BSA submerged	77%	94%	94%	52%	94%	94%
Total weight loss (g)	279	7	58	349	133	337
Ingested water (g) <sup>c</sup>	0	0	3.1	0	3.2	3.2
Skin hydration (g) <sup>d</sup>	2.1	1.8	1.8	1.0	1.9	2.0
Substrate oxidation (g) <sup>e</sup>	13.9	1.3	6.9	16.9	19.2	38.1
Respiratory water (g) <sup>f</sup>	44.1	1.4	6.3	9.7	16.3	25.4
Data points (subjects)	12 (4) <sup>g</sup>	12 (4) <sup>g</sup>	12 (4) <sup>g</sup>	12 (4) <sup>g</sup>	3 (3)	13 (13)

a (Ainsworth et al., 1993, 2000; Shvartz and Reibold, 1990).

b Calculated from actual heart rate.

c (Suppes et al., 2013).

d (Scheuplein and Blank, 1971).

e (Maughan et al., 2007).

f (Mitchell et al., 1972).

g The same 4 subjects.

drained. The pool tank was filled with approximately 3 m<sup>3</sup> of water. The pool tank water was recirculated and heated at the selected temperature (25, 30 or 35 °C).

### *3.2.5 Pool site during on-site experiments*

The on-site experiments were performed in an indoor swimming pool 'Het Sterrenbad' in Wassenaar, The Netherlands. General pool characteristics, pool water quality and environmental conditions are shown in Table S1. The experiments were performed in different pool basins with temperatures of 28, 32 and 34 °C.

### *3.2.6 Experimental procedures*

#### **laboratory time-series experiments**

Each subject had a pre-swim shower (60 seconds) to remove all initial anthropogenic pollutants. After the pre-swim shower, the subjects dried themselves with a clean dry towel and their before-weight was determined ( $\pm 5$  g) on a scale (JBS loadcell, fabr. BWT, Boxtel, The Netherlands). Subsequently, the subjects were dressed in the suit, as described in Section 2.1 and shown in Figure 1A. They entered the pool tank and the filling of the suit was started. After approximately five minutes, the suit recirculation was started. During the first 15 minutes, the subjects rested in the tank. During the subsequent 30 minutes, the subjects performed an exercise on a submerged cross-trainer, an Aqua Nordic Walker (Kodin, Gundelsheim, Germany). The energy consumption during the exercise was similar in all laboratory time-series experiments and was estimated at 60-70 %VO<sub>2</sub>max with the use of the Compendium of Physical Activities (Ainsworth et al. 1993, Ainsworth et al. 2000). Each subject did the experiment at three different temperatures (25, 30 and 35 °C  $\pm 0.5$  °C) and they were each asked not to drink during the experiment. During the experiment, samples were taken from the suit water every five minutes, starting simultaneously with the filling of the suit. The volume of all samples was determined by weighing, assuming a density of 1,000 g/L. After the experiment, all suit water was removed and collected to complete a mass balance as a check for leakages. After emptying the suit, the subjects had an after-shower, followed by drying with a clean dry towel and stepping on a scale to measure their after-weight.

#### **on-site experiments in a swimming pool**

Continual anthropogenic pollutant release was determined on-site by weighing the subjects on a scale (JBS loadcell, fabr. BWT,  $\pm 5$  g) before and after their swimming activity and by measuring their height. After full submersion in pool water, subjects dried themselves with a clean dry towel before the weights were determined. They were asked not to drink during the experiment. The initial weight was also used to calculate the subjects' body surface area.

The subjects from the laboratory time-series experiments also participated in on-site experiments. During the on-site experiments, the continual anthropogenic pollutant release for the four subjects was determined in a 32 °C pool, at three different exercise levels: 30 minutes at rest, 30 minutes of leisure swimming and 30 minutes of aqua spinning. The resistance of the aqua spin bike (Waterfly, Regalbuto Italy) could be adjusted using rotatable perpendicular

paddles on the crank axle that lead to water displacement. This resistance was set to the maximum.

### 3.2.7 Analytical methods

Samples were analysed for chemical and microbiological parameters. A wide range of parameters was examined to describe the continual anthropogenic pollutant release. These parameters included non-purgeable organic carbon (NPOC), total nitrogen (TN), intracellular adenosine triphosphate (cATP), ammonium, urea, phosphate, nitrate, ultraviolet spectrophotometry, particle distribution, total and intact cells. The parameters that were found most relevant to describe the anthropogenic pollutant release were NPOC, TN, urea, ammonium, cATP, particle distribution, and intact cell count (iCC). A short description of the methods used to determine the relevant parameters shown in section 3 of the supplementary data.

Each subject's heart rate was measured by counting the pulse.

### 3.2.8 Calculations used in this study

The level of exercise during the exercises was estimated using the Compendium of Physical Activities (Ainsworth et al. 1993, Ainsworth et al. 2000). To estimate the individual energy consumption ( $VO_2$ ), the level of exercise was multiplied by the individual  $VO_{2max}$ . The individual  $VO_{2max}$  was determined from fitness norms for males and females (Shvartz and Reibold 1990). The average energy consumption ( $VO_2$ ) during the different experiments is shown in Table 3.

The sweat release was calculated from the body mass loss, corrected for substrate oxidation and respiratory water loss, unless noted otherwise (Maughan et al. 2007). Other parameters like ingested fluid, skin hydration and urine and faecal losses were found to be smaller than 5g and therefore not included, unless noted otherwise. This resulted in a simplified equation:

$$\text{Sweat release} = \Delta M_b - M_{so} - M_{rw} \quad (1)$$

Where:

$\Delta M_b$  = body mass loss = before-weight – after-weight

$M_{so}$  = mass substrate oxidation

$M_{rw}$  = respiratory water loss

The body mass loss was determined on a scale and presented as kg weight loss. During the oxidation of substrates,  $O_2$  and substrates are consumed and  $CO_2$  and water are produced. Substrate oxidation is primarily determined by the exercise intensity, the aerobic fitness of the individual, the preceding exercise and diet regimen (Maughan et al. 2007). The production of  $CO_2$  depends on the type of substrate that is used. At a high level of exercise, carbohydrates will be used as substrate; at a low level of exercise, fat will also be used. During the laboratory time-series experiments, estimated at 60-70 % $VO_{2max}$  (Ainsworth et al. 1993, Ainsworth et al. 2000) carbohydrates contribute to 67-75% in the energy consumption (Maughan et al. 2007).

The respiratory water was calculated according to Mitchell et al.(1972):

$$M_{rw} = 0.019 \times VO_2 \times (44 - P_a) \quad (2)$$

Where:

$VO_2$  = oxygen uptake in L/min

$P_a$  = ambient water vapour pressure in mm Hg

Table 3 shows the calculated weight loss of the different fractions during 30 minutes of laboratory time-series and on-site experiments.

For a comparison between different subjects, all sweat release results are given as normalised sweat release per body surface area in L/m<sup>2</sup>/h. An approximation of the body surface area of the subjects was determined using Mosteller's empirical equation (1987):

$$BSA = \sqrt{W \times H} / 6 \quad (3)$$

Where:

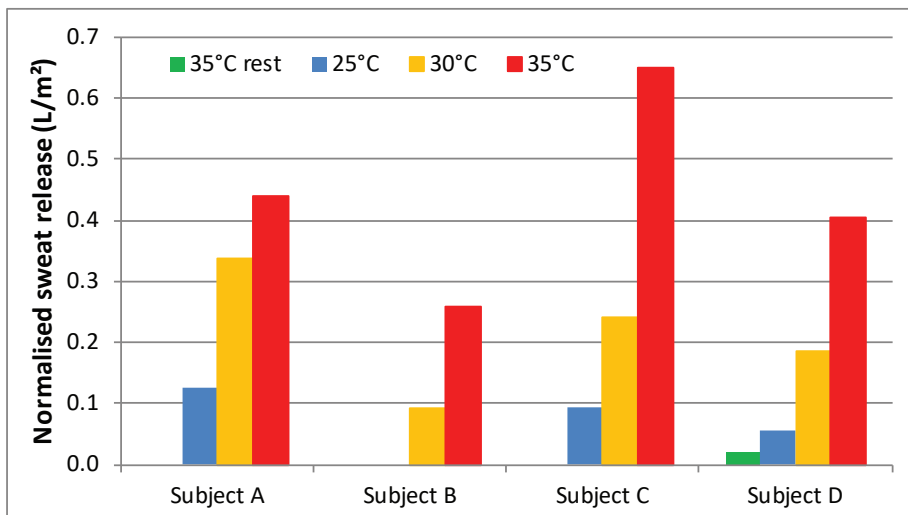
BSA = body surface area (m<sup>2</sup>)

W = body weight (kg)

H = body height (m)

### 3.2.9 Excluded data

The calculated sweat release for subject B during the 25 °C laboratory time-series experiment resulted in a negative normalised sweat release. Although it was not clear what caused this negative result, negative sweating is not possible, and the weight data of this experiment was



**Figure 2:** Normalised sweat release during laboratory time-series experiments after 30 min of exercise at 60-70 %VO<sub>2</sub>max at different temperatures.

therefore excluded from this paper. The analytical data of the water quality parameters of this experiment were not excluded.

During some trial experiments, some subjects also had a negative weight loss. These negative values could have been caused by drinking during the experiment, skin hydration or inaccurate wetting procedures at the start of the experiment, resulting in a too low before-weight. All subjects with negative weight loss were excluded from this study, 24 subjects in total.

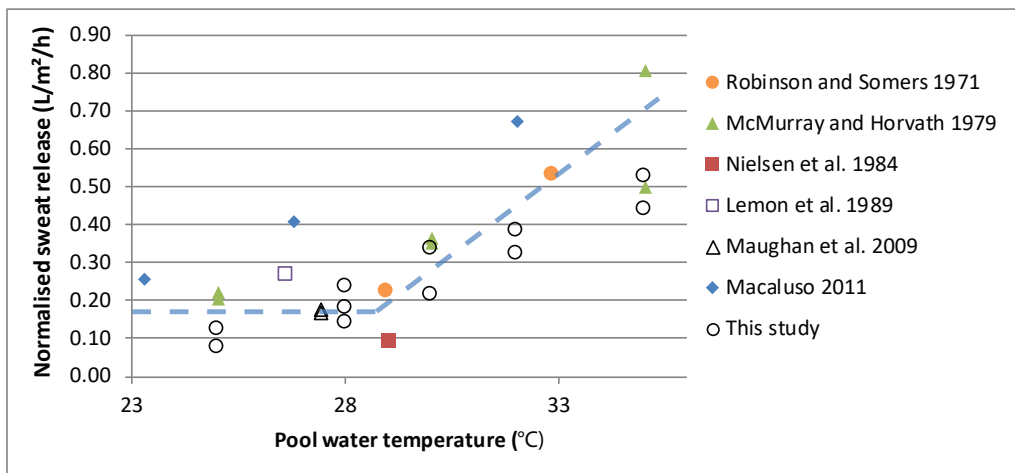
Within a group of elderly swimmers there were three subjects that had a weight loss >450grams. It was assumed that besides sweating also some incidental urine release occurred. These three subjects were therefore excluded from this study.

### 3.3 Results

#### 3.3.1 Sweat release rate

During the laboratory time-series experiments, continual anthropogenic pollutant release data from four subjects (two men, two women) were collected. The sweat release rate was calculated from the total weight loss (Table 3). The amount of ingested water, skin hydration, substrate oxidation and respiratory water is also shown in Table 3. All subjects had an increased sweat release at increasing experiment temperatures (Figure 2). Starting at 25 °C, the average sweat release of 0.1 L/m<sup>2</sup> increased to 0.22 L/m<sup>2</sup> and 0.46 L/m<sup>2</sup> at 5 and 10 °C temperature increase, respectively. One subject did a resting experiment at a temperature of 35 °C, resulting in a normalised sweat release of 0.02 L/m<sup>2</sup>/h (Figure 2).

Similar sweat releases are reported in literature, see Figure 3. To calculate the normalised sweat release from the Robinson and Somers' data, the body surface area for the Olympic and World Champion medal winners was estimated at 2.0 m<sup>2</sup>. Except for the subjects in this study, all subjects in literature were well-trained swimmers. Although the level of exercise



**Figure 3:** Normalised sweat release in scientific literature at exercise levels >60 %VO<sub>2max</sub>.

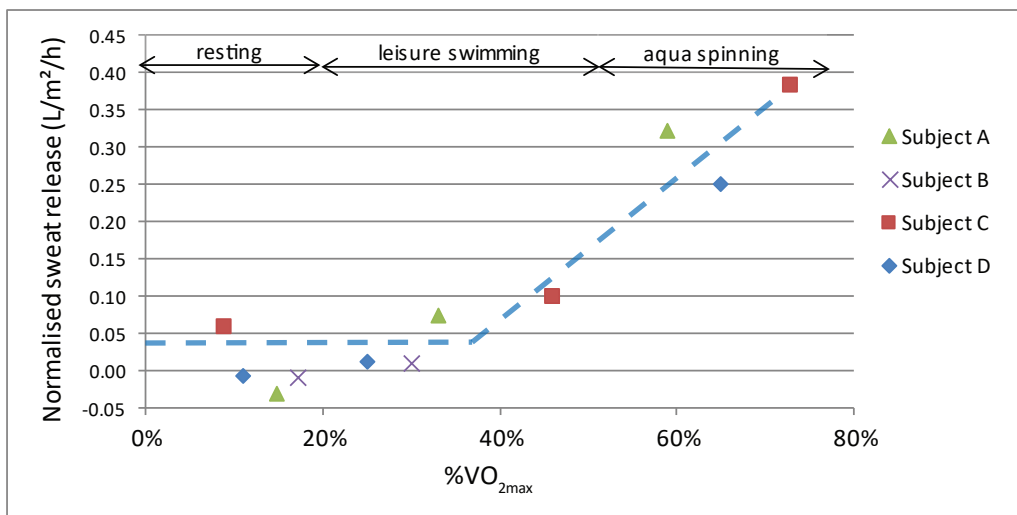


was not the same for all experiments, the level was described as  $>60\% \text{VO}_{2\text{max}}$ . The subjects in the Macaluso experiment had a high level of exercise, estimated at  $90\% \text{VO}_{2\text{max}}$  which resulted in higher normalised sweat releases (Macaluso et al. 2011).

The time-series subjects also participated in the on-site experiments at different levels of exercise. Figure 4 shows an increasing sweat release at increasing levels of exercise in a pool with a constant water temperature ( $32\text{ }^{\circ}\text{C}$ ). The sweat release was low ( $<0.1\text{ L/m}^2/\text{h}$ ) at an exercise level  $<40\% \text{VO}_{2\text{max}}$  and it increased linearly to  $0.37\text{ L/m}^2/\text{h}$  at increasing exercise rates  $>40\% \text{VO}_{2\text{max}}$ . During aqua spinning, the subjects were only partially submerged due to the limited pool depth. The level of submersion for all experiments is shown in Table 3.

During on-site experiments, two groups of lane swimmers did a moderate lap swimming exercise in a  $28\text{ }^{\circ}\text{C}$  competition pool. The first exercise, estimated at  $60\text{-}70\% \text{VO}_{2\text{max}}$  (Ainsworth et al. 1993, Ainsworth et al. 2000), had an average normalised sweat release of  $0.12\text{ L/m}^2/\text{h}$ , not corrected for substrate oxidation and respiratory water. The second lane swim group, with a measured level of exercise by taking their pulse, had an average normalised sweat release of  $0.18\text{ L/m}^2/\text{h}$ , corrected for substrate oxidation and respiratory water (Figure 5).

During other on-site experiments in a  $28\text{ }^{\circ}\text{C}$  competition pool, two groups of triathletes performed a heavy exercise. During the first experiment, estimated at  $70\text{-}90\% \text{VO}_{2\text{max}}$  (Ainsworth et al. 1993, Ainsworth et al. 2000), the normalised sweat release was determined at  $0.04\text{-}0.39\text{ L/m}^2/\text{h}$  (including correction for ingested water, substrate oxidation and respiratory water). For the second triathlete group, with a measured level of exercise by taking their pulse, the normalised sweat release was determined at  $0.07\text{-}0.83\text{ L/m}^2/\text{h}$ , including correction for ingested water, substrate oxidation and respiratory water (Figure 5). The actual  $\text{VO}_2$  was calculated from the maximum heart rate percentage and the estimated  $\text{VO}_{2\text{max}}$  (Shvartz and Reibold 1990).



**Figure 4:** Individual normalised sweat release during on-site experiments in  $32\text{ }^{\circ}\text{C}$  pool water at different exercise levels.

### 3.3.2 Continual anthropogenic pollutant composition

During the laboratory time-series experiments, four subjects (two females and two males) were studied in water-proof suits to determine the anthropogenic pollutants composition at each three different water temperatures (25-30-35 °C). The level of exercise was similar during all experiments. Descriptive parameters of the anthropogenic pollutants released during 30 minutes of exercise are shown in Table 4. The chemical components (NPOC, TN, urea and ammonium) showed a more-or-less steady release over time (Figure 6). The release of the particle-related components (particle count, cATP and iCC) dropped over time (Figure 7).

There was a clear difference in the release of chemical anthropogenic pollutants at 25 °C compared to 35 °C, both during exercise and rest (Figure 8). At 35 °C during rest the release was 20-40 % of that at 25 °C during exercise while at 35 °C during exercise the release was 170 % of that at 25 °C for NPOC, TN and urea. The release of ammonium decreased at higher temperatures (Figure 8). There was no clear relation between the release of particle-related components and different temperatures (Figure 8).

Although the release of most chemical anthropogenic pollutants increased at higher temperatures, the increase was much lower compared to the sweat release during exercise at elevated water temperatures. The sweat release increased 2.3 and 4.6 times at 5 and 10 °C temperature increase, respectively, while the pollutants release increased by a factor 1.1 to 1.7 (Figure 2).

## 3.4 Discussion

This experiment was designed to be a static (in position) submerged exercise. Some of the conditions during the test were equal to swimming and some were not. For heat transfer during submerged exercise, important aspects are: the water temperature, the hydraulics, the type of exercise (which muscles are used), the level of exercise and the level of submersion. The water temperature was equal to swimming conditions and the water temperature in the suit was controlled and frequently measured. The hydraulics were not equal to

**Table 4: Release of anthropogenic pollutants during 30 min of exercise for each of 4 subjects at 3 different water temperatures during laboratory time-series experiments.**

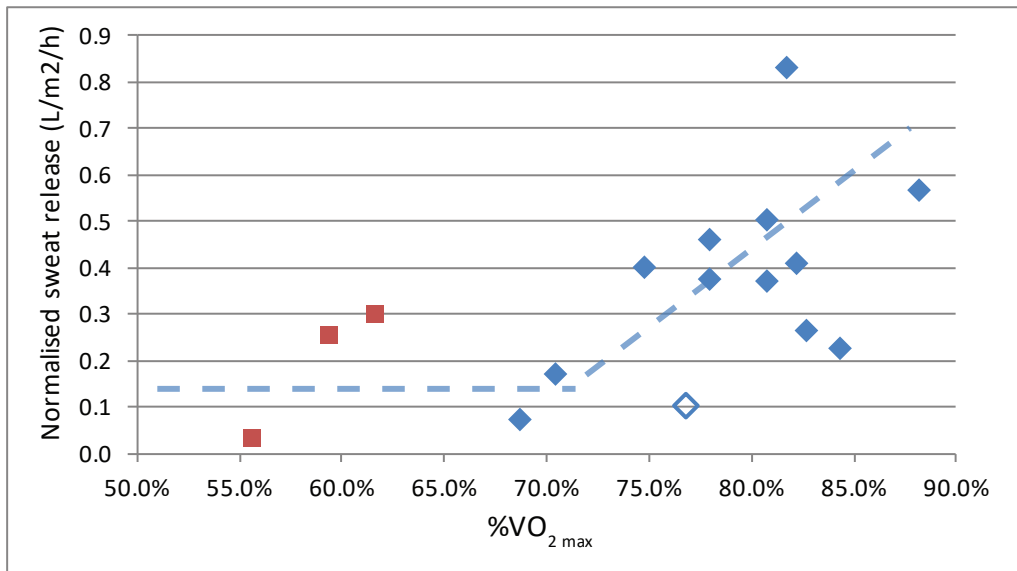
Parameter	Range	Average	St.deviation	n
NPOC (mg)	30-503	250	91.6	12
TN (mg)	44-161	77.3	31.5	12
Urea (mg)	14-76	37.1	16.7	11
NH <sub>4</sub> (mg)	4.5-17	10.1	4.1	11
Particles 2-50 µm (x10 <sup>9</sup> #)	0.22-2.3	1.31	0.61	12
cATP (µg)	1.17-20.6	5.24	5.17	12
Intact cell count (x10 <sup>6</sup> #)	1.02-21.9	9.30	6.48	12

swimming conditions, but the flow inside the suit was turbulent which is important for an optimal heat transfer. Most probably the heat transfer from the skin to the water was similar to swimming because the direction of the flow near the skin is not important for heat transfer and the water temperature in the suit was kept at a constant level. The type of muscles used was not similar to swimming. The level of exercise was chosen to be similar to swimming. And the level of submersion was limited due to the limitations of the suite and was therefore also not exactly the same as during swimming. However, the level of submersion was estimated (Table 3) and the results were calculated and presented as sweat released per surface area submerged skin.

### 3.4.1 Sweat rate

It was assumed that sweat is the main contributor to the continual anthropogenic pollutant release. Heat production from the physical exercise was assumed to be the same during all laboratory time-series experiments, while the cooling efficiency of the water differed at the three temperature settings. As the cooling efficiency of the pool water was reduced at higher temperatures, the sweat release was increased (Figure 2). Being submerged, the cooling mechanism from evaporating sweat appeared to be not effective, except for the unsubmerged body parts, in this case the head. A growing increase of sweat release is a logical result of the ineffective sweat mechanisms during submerged physical exercise in heated pool water (Kuno 1956).

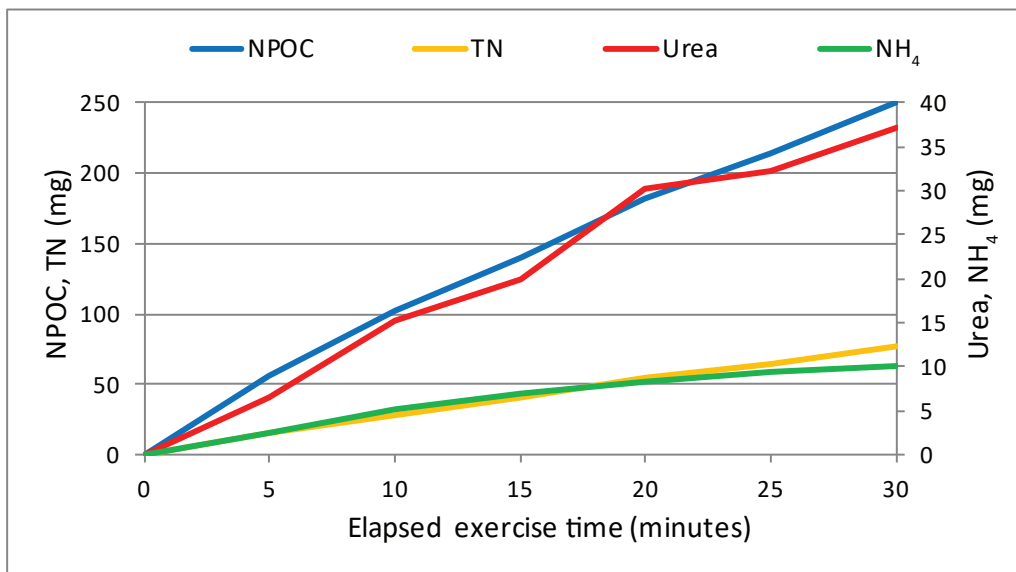
The sweat release shown in Figure 3 can be explained by the sweat mechanism which is triggered by an increase of a subject’s core temperature (Kuno 1956, McMurray and Horvath



**Figure 5:** Normalised sweat release for on-site experiments in a 28 °C competition pool with triathletes (diamond markers) and lane swimmers (square markers). The subject with the open marker admitted ingestion of an unknown amount of pool water during the experiment.

1979, Robinson and Somers 1971). The body temperature is the net result of the difference between heat production and heat loss. Colder water enhances heat loss and thus blunts the increase in body core temperature. At a pool water temperature of 23 °C, and a medium exercise level, the sweat release will be low and it will not increase at water temperatures slightly higher than 23 °C due to the high cooling efficiency of the water. If the pool water temperature rises, there will be a temperature threshold at which the muscular heat production and pool water cooling are in equilibrium. Above this threshold, the subject's core temperature will rise at increasing water temperatures (Nadel 1979). The type of swim clothing and % body fat also influences the sweat release because insulation from swim wear or body fat will interfere with the heat exchange between the pool water and the human body (McMurray and Horvath 1979). A high percentage of body fat and insulated full-body swim wear will reduce the threshold and increase sweat release at lower water temperatures. The threshold is a function of the level of exercise and the pool water temperature. Due to training, a swimmer's threshold may become lower (Ichinose et al. 2009) and the sweat rate above the threshold may increase (Nadel 1979). Figure 3 shows the influence of pool water temperature. At pool water temperatures below 29 °C combined with a  $\geq 60\% \text{VO}_{2\text{max}}$  exercise level, the sweat release is more or less stable at 0.10-0.20 L/m<sup>2</sup>/h. At pool water temperatures above 29 °C, there is a linear increase in the normalised sweat release to 0.45-0.80L/m<sup>2</sup>/h at 35 °C. Figure 5 shows the influence of exercise level. The sweat release is 0.1-0.2 L/m<sup>2</sup>/h at an exercise level  $< 70\% \text{VO}_{2\text{max}}$  and it increases at increasing exercise levels to 0.83 L/m<sup>2</sup>/h (Figure 5).

Most swimming pool activities in recreational pool water ( $\geq 30\text{ °C}$ ) will remain  $\leq 60\% \text{VO}_{2\text{max}}$  and most activities in competition pool water ( $\leq 29\text{ °C}$ ) will be  $\geq 70\% \text{VO}_{2\text{max}}$  (Table S2). The low-sweating threshold is shown in Figures 3, 4 and 5. The sweat rate is 0.1-0.2 L/m<sup>2</sup>/h at water temperatures  $< 29\text{ °C}$  and  $< 70\% \text{VO}_{2\text{max}}$  level of exercise and increases linearly with



**Figure 6:** Average release of anthropogenic pollutants during all laboratory time-series experiments (genders and temperature levels combined).

increasing water temperatures and exercise level to 0.8 L/m<sup>2</sup>/h at 35 °C and >60-70 %VO<sub>2max</sub> level of exercise (Figures 3, 4 and 5). Sweat release in swimming pools cannot be avoided. To reduce the sweat release to a minimum, it is recommended that pool operators maintain a low pool water temperature in pools with high exercise levels, preferably ≤ 27 °C for competition pools. It is also recommended to avoid a high level of exercise activities in pools with elevated water temperatures (≥ 30 °C).

### 3.4.2 Continual anthropogenic pollutants

The water temperature showed a strong influence on the release of some anthropogenic pollutants as well as the level of exercise (Figure 8). The release of chemical components (NPOC, TN and urea) is increased by a factor 1.7 at 10 °C temperature increase and it is increased by a factor 5-7 if resting is compared with the laboratory time-series exercise. If all anthropogenic pollutants from the laboratory time-series experiments originate from sweat, the sweat composition could be calculated by dividing the amount of anthropogenic pollutants by the corresponding sweat release. In Table 5, this sweat composition for the chemical components is compared with sweat compositions from other studies. For ammonium, urea and TN, the calculated sweat concentrations were within the same range as the results from previous studies. It is therefore very likely that sweat was the main source for the measured TN, urea and ammonium. The release of ammonium at elevated temperatures during the laboratory time-series experiment was different compared to the release of TN and urea (Fig 8). It is not clear why ammonium was reduced at higher temperatures while TN and urea increased. This could be due to the fact that ammonium is a volatile component and the experiment was done during an exercise in a suit, where the suit water was constantly circulating and evaporation of ammonium may have occurred, especially at elevated temperatures that reduce the solubility of ammonium.

For NPOC, the results in Table 5 were not comparable with previous studies on sweat composition. Very little information has been published on the NPOC content of sweat because sweat samples from human skin are easily contaminated with skin lipids, thereby disturbing the NPOC measurement (Kuno 1956). The calculated NPOC value from reported sweat

Publication	Concentrations (mg/L sweat)			
	NPOC	TN	Urea	Ammonia
(Craig et al., 2010)			655	105
(Stefaniak and Harvey, 2006)	965*	493*	601	102
(Eichelsdörfer et al., 1975)		992	1,447	220
(Kuno, 1956)		170-1,960	456	30-100
(Mosher, 1933)			240-1,120	40-200
This study	444-4,402	119-1,281	80-445	20-184

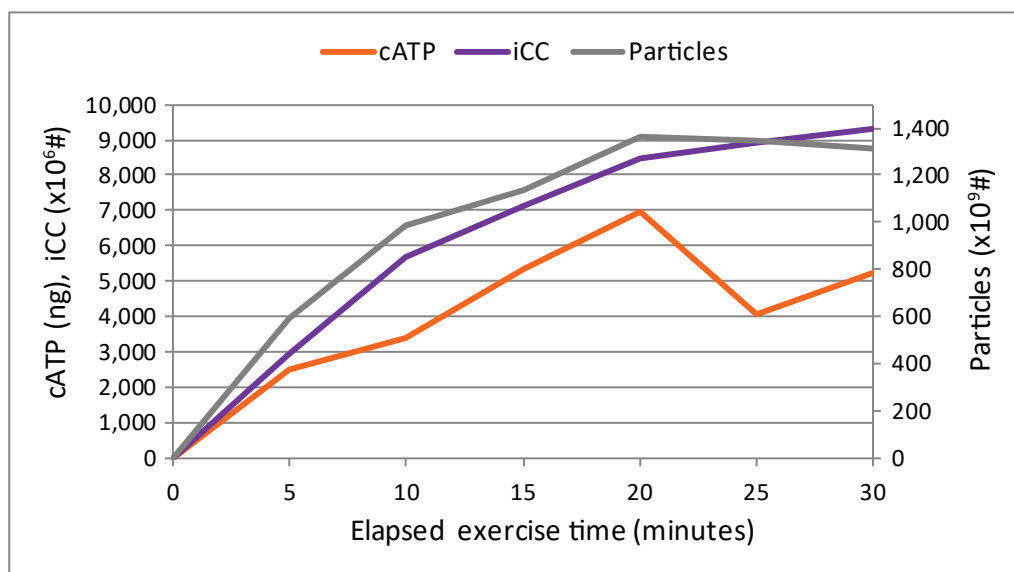
\* Calculated from the sweat composition without vitamins and ionic components.

components is much lower than the maximum value found in this study (Table 5). The release of sebum (skin lipids) is an explanation for the elevated NPOC concentrations, because sebum mainly contains carbon-strains (Downing et al. 1983). The sebum on human skin is washed off during swimming at a rate of 0.24 mg/m<sup>2</sup>/h (Gardinier et al. 2009). When the skin surface is defatted, fresh sebum is rapidly secreted from the sebum reservoir in an attempt to restore the surface lipid film. This sebum will not stay on the skin surface, but will be released into the water. Secretion from the sebum reservoir appears at a greater rate than sebum is actually being produced by the sebaceous glands (Downing et al. 1983). The average sustainable sebum secretion rate is 0.27 mg/m<sup>2</sup>/h in healthy subjects and can be 0.84 mg/m<sup>2</sup>/h for subjects with acne (Harris et al. 1983).

It can be concluded that most TN compounds originated from sweat and it is likely that most NPOC compounds originated from sebum.

Although the laboratory time-series experiments only focussed on a 30 minute exercise period, the release of sweat will most probably continue at prolonged exercise periods. It is therefore assumed that the chemical related continual anthropogenic pollutant release will also continue after 30 minutes of exercise at a similar rate.

The particle-related anthropogenic pollutants (iCC, cATP and PC) seemed to be less temperature related, but there was an influence from the level of exercise (Figure 8). During exercise, the microbiological components (iCC and cATP) fluctuated at different temperatures; this might be due to individual (hygienic) differences. This also explains the large variance within the microbiological data (Table 4). Although the average data show a temperature influence on the particle release (Figure 8), the individual data show that the temperature influence was not consistent during all laboratory time-series experiments (Figure S8).



**Figure 7:** Average microbiological and particle release of all laboratory time-series experiments (genders and temperature levels combined).

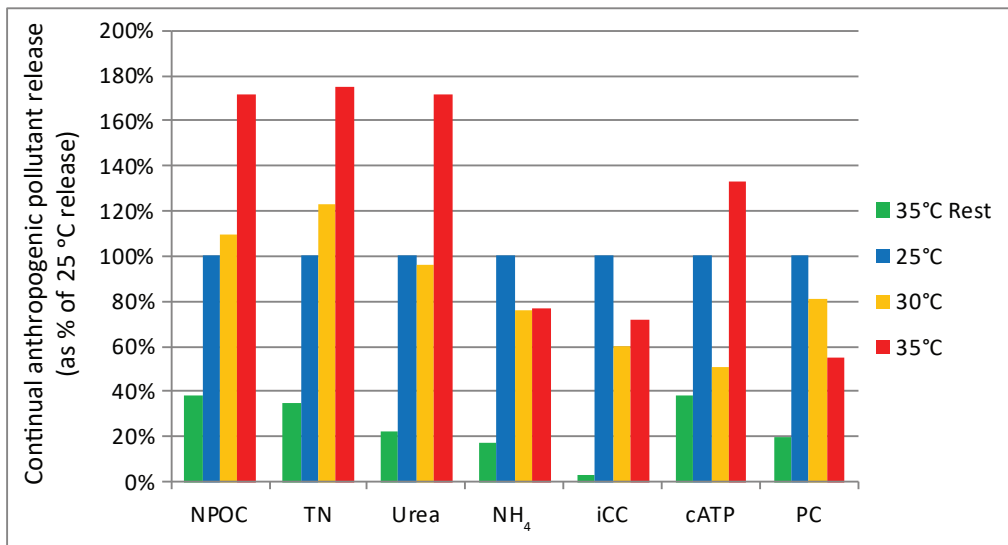
While the chemical components of continual anthropogenic pollutant release were more-or-less constantly released over time, the release of the microbiological components (cATP and iCC) dropped over time. This can be explained by the fact that chemical components originate from sweat and sebum glands and are constantly produced by the human skin, while the microbiological components are attached to the human skin or hair. It is nevertheless assumed that the release of microbiological components will continue after 30 minutes of exercise, but at a reduced rate.

The release of particles dropped earlier in time compared to the microbiological components. Besides micro-organisms, the particles released by bathers also contain skin cells, hair, textile fibres, dust/sand and other particles attached to the human skin. The individual graphs show that the release of 2-50µm particles became more-or-less negligible after 30 minutes of exercise (Figure S8).

Although the water temperature had an influence on the anthropogenic pollutants released from bathers (Figure 8), individual differences and duration of the exercise had a more dominant influence (Figure S2-S8). Nevertheless, the pool water temperature was the only parameter that can be controlled by pool operators and is, therefore, the main parameter to restrain the continual anthropogenic pollutant release.

A study with more subjects is needed to investigate the effects of temperature and exercise on the continual anthropogenic pollutant release. During future laboratory time-series experiments, the level of exercise should be closely monitored by measuring VO<sub>2</sub> and the water temperature and the level of exercise can easily be varied.

Other publications did not report what part of the reported anthropogenic pollutant releases is related to the continual anthropogenic pollutant release. There is no information on



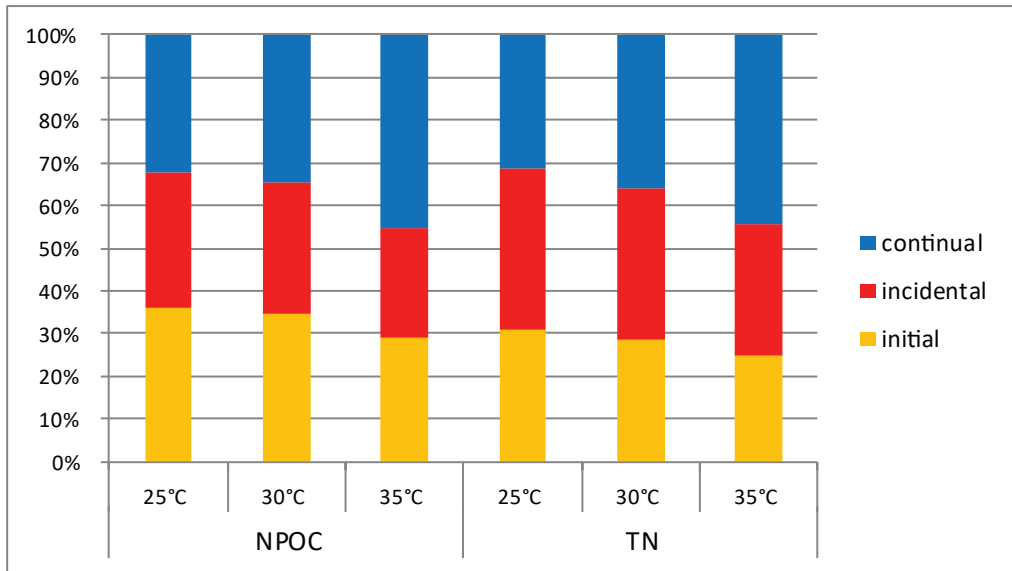
**Figure 8:** Release of anthropogenic pollutants during laboratory time-series experiments compared to the release at 25 °C.



whether subjects in these studies had a pre-swim shower or, if they did, what the duration of the shower was. And it is also not clear what part of the reported data is due to incidental anthropogenic pollutants released. The existing literature data, therefore, cannot be used for comparison with this study.

Combining the results from this study with a previous study on the initial anthropogenic pollutant release (Keuten et al. 2012), the overall picture of anthropogenic pollutants released by bathers becomes clearer. Table 6 shows the NPOC, TN and cATP for the initial, continual and incidental pollutants released. At this exercise level, the continual anthropogenic pollutant release for NPOC and TN, equalled 37 % of the total anthropogenic pollutant release. The remaining part of the total anthropogenic pollutant release, 63 %, is a result of unhygienic behaviour, meaning not having a pre-swim shower, 31 %, and not using a toilet “when nature calls”, 32 % (figure 9). While the continual release of NPOC and TN was reduced at lower exercise levels and lower water temperatures, at the same time the remaining unhygienic portion of the anthropogenic pollutants released increased from 55 % at high temperatures to 68 % at low temperatures for NPOC and TN (Figure 9). Reduction of the unhygienic part of the released anthropogenic pollutants has the potential to reduce the DBP formation by 55 % in 35 °C water and 68 % in 25 °C water, both at high exercise levels. The reduction potential is assumed to be >68 % for recreational and leisure pools.

Although the level of exercise in competition pools is similar to the level of exercise investigated in this study, the level of exercise in other pool types (recreational pools, therapeutic pools, toddler pools, whirlpools etc.) is not expected to exceed the 60 % $VO_{2max}$  level. It is assumed that the continual anthropogenic pollutant release will be smaller at lower exercise levels. A smaller portion of the continual pollutants means a larger share of the unhygienic



**Figure 9:** Fractions of initial, continual and incidental anthropogenic pollutants release at different temperatures during laboratory time-series experiments at 60-70 % $VO_{2max}$ .

pollutants in these pool types. It is therefore important to investigate the continual anthropogenic pollutant release at these conditions in future studies.

### 3.5 Conclusions

laboratory time-series experiments with controlled exercise conditions (level of exercise and water temperature) showed to be a good way to determine the continual anthropogenic pollutant release. The continual anthropogenic pollutant release consisted of sweat, sebum, particles and micro-organisms. By weight, sweat is the main component of continual anthropogenic pollutant release. The net weight loss caused by a submerged exercise was strongly related to the water temperature and the level of exercise. At low water temperatures (<29 °C), the cooling effect of the water was large, and only a vigorous level of exercise induced a sizable continual anthropogenic pollutant release. The sweat rate was 0.1-0.2 L/m<sup>2</sup>/h at water temperatures below 29 °C and increased linearly with increasing water temperatures to 0.8L/m<sup>2</sup>/h at 35°C. The sweat rates found in this study were comparable to the results from recent scientific publications.

Although water temperature and level of exercise had important roles in anthropogenic release, the duration of the swim visit is, logically, the main parameter determining continual anthropogenic pollutant release. Nevertheless, the pool water temperature is the only parameter that can be controlled by pool operators and is therefore the main parameter to restrain the continual anthropogenic pollutant release.

Chemical pollutants were continuously released during a swim visit, while the release of particles seemed to become negligible after 30 minutes of swimming. The release of most components could be explained with the reported composition of sweat. The average releases during 30 minutes of exercise for the different components are 77.3 mg/bather TN, 37.1 mg/bather urea and 10.1 mg/bather ammonium. The release of NPOC could not be explained by the composition of sweat and was, most probably, a result of sebum release and was determined at 250 mg/bather NPOC. The release of particles (2-50 µm) was measured at an average of  $1.31 \times 10^9$  particles/bather. And, the average release of cATP and ICC was measured at 5.2 µg cATP/bather and  $9.3 \times 10^6$  intact cells/bather.

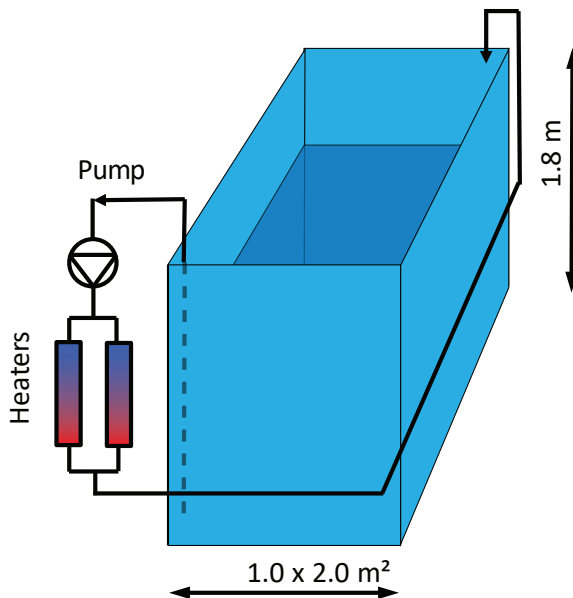
The continual anthropogenic pollutant release is a significant part of the total anthropogenic pollutants released and therefore also plays a role in the production of DBPs. At a 60-70 % maximum exercise level, 37 % of the total released pollutants were released as continual anthropogenic pollutant release. This means that 63 % of the total released pollutants are due to unhygienic behaviour such as no pre-swim shower and no use of toilets “when nature calls”. At lower exercise levels, the percentage unhygienic release is expected to be even larger. It is recommended that future studies focus on the continual anthropogenic pollutant release at lower exercise levels.

## 3.6 Supplementary Material

### 3.6.1 General pool characteristics

Table S1: General characteristics of pool basins, water quality and environmental conditions at test location; Sterrenbad in Wassenaar, The Netherlands.			
Parameter	Competition pool	Recreational pool	Therapeutic pool
Pool water surface	375 m <sup>2</sup>	167 m <sup>2</sup>	355 m <sup>2</sup>
Pool basin content	1,111 m <sup>3</sup>	210 m <sup>3</sup>	169 m <sup>3</sup>
Pool recirculation	225 m <sup>3</sup> /h	200 m <sup>3</sup> /h	175 m <sup>3</sup> /h
Set point water temperature	28 °C	32 °C	34 °C
Set point air temperature	30 °C	34 °C	36 °C
Set point humidity	50 %RH	50% RH	50 %RH
Set point free chlorine	0.9 mg/L	0.8 mg/L	0.9 mg/L
Set point acidity	7.2 pH	7.2 pH	7.2 pH
Average combined chlorine	0.3 mg/L	0.3 mg/L	0.3 mg/L

### 3.6.2 Experimental setup



**Figure S1:** Schematic diagram of the pool tank, tank circulation and tank heating (Fabr. Hellebrekers Technieken, Nunspeet, The Netherlands).

### 3.6.3 Short description of analytical methods

NPOC was determined according to NEN-EN 1484 (1997) using a Shimadzu TOC-Vcph analyser. After acidifying and purging, the samples were injected into the combustion chamber at 680 °C to oxidise all carbon into CO<sub>2</sub>, which was subsequently detected by using infrared spectrometry.

TN was determined according to NEN-EN 12260 (2003) using a Shimadzu TNM-1 analyser connected to the Shimadzu TOC-Vcph analyser. The samples were injected into the combustion chamber at 720 °C where nitrogen compounds were converted into nitric oxide and subsequently exposed to ozone to induce emission of light, which was detected by a chemiluminescent detector.

Ammonium was analysed according to ISO 7150/1 (2002) with an ammonium test kit (Merck, Darmstadt, Germany), which can be used for non-chlorinated water. For ammonium analysis, samples were alkalised with sodium hydroxide to transform all ammonium nitrogen into ammonia. After chlorination and formation of monochloramine, thymol was added to form a blue indophenol derivative that was determined photometrically (Spectroquant Nova 60, Merck, Darmstadt, Germany).

Urea was analysed with a test kit (Merck, Darmstadt, Germany). After adding urease, urea was cleaved into carbon dioxide and ammonia. The subsequent ammonia analysis was similar to the ammonia analysis described above. A deviation from the test kit manual was the semi-quantitative measurement done with a visual comparator; samples were determined photometrically (Spectroquant Nova 60, Merck, Darmstadt, Germany). A 4-point calibration curve was made to calibrate the method.

Determination of cATP was based on bioluminescence (van der Wielen and van der Kooij 2010). Water samples were filtered through a glass fibre filter, 0.7 µm, to remove all extracellular ATP. Subsequently, the cATP was extracted from the filter with a trisodiumphosphate solution (UltraLyse 7) and collected in a 15 mL cuvette. The extracted cATP was diluted with Ultralute (ATP dilution buffer), added to a luciferine/luciferase complex to induce the emission of light, and then placed directly into a Luminometer (Junior LB 9509, fabr. Aqua-tools) to measure the generated light signal (Relative Light Units, RLU). The concentration of cATP was calculated from the RLU values using a conversion factor determined from calibration measurements.

Particle distribution was determined with a Pacific scientific particle counter using a syringe-operated sampler Hiac Royco Model 3000 with a sensor Hiac HRCD-400 HC (2-400 µm) and sizing counter Hiac Royco Model 9064. Highly concentrated samples (>18×10<sup>3</sup> particles/mL) were diluted with demineralised water.

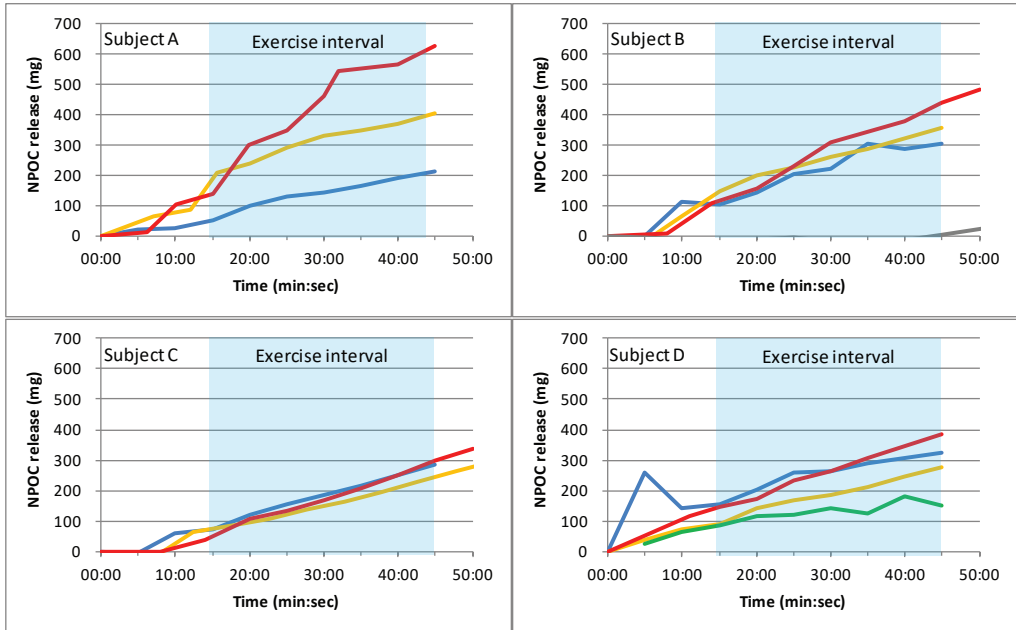
The number of total and intact cells was measured with a flow cytometer (FCM) as described previously (Prest et al. 2013). Two types of staining solutions were used to highlight either all cells with SYBR<sup>®</sup> Green I, or only intact cells with SYBR<sup>®</sup> Green Propidium Iodide. Where necessary, samples were diluted just before measurement with filtered (0.22 µm; Millex-GP, Millipore) bottled mineral water (EVIAN, France). Measurements were performed using a BD

Accuri C6® flow cytometer (BD Accuri cytometers, Belgium). Equipment settings and protocol were all according to Prest et al. (2013).

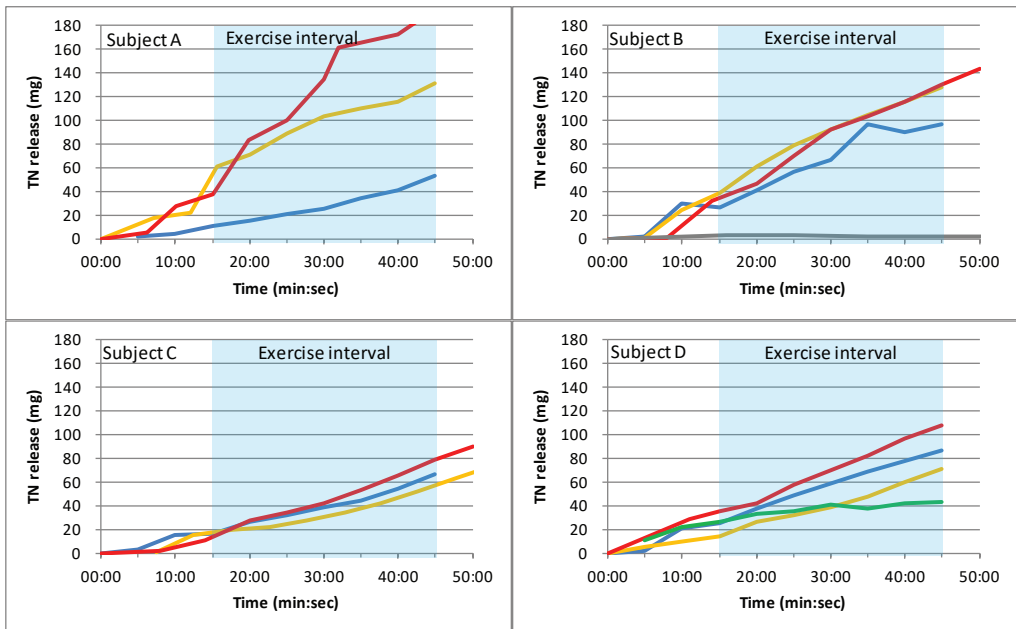
### 3.6.4 Energy consumption during swimming pool activities

Table S2: Specific swimming pool activities and their energy consumption (Ainsworth et al. 1993, Ainsworth et al. 2000).	
Activity	%VO <sub>2max</sub>
Whirlpool sitting	10%
Standing still	18%
Walking lifeguard	23%
Water volleyball	30%
Swimming, treading water, moderate effort, general	40%
Water aerobics, water calisthenics	40%
Swimming - lake, ocean, river	60%
Swimming, leisurely, not lap swimming, general	60%
Lap swimming, freestyle, slow, moderate or light effort	70%
Swimming, backstroke, general	70%
Swimming, crawl, slow (25m in 32.8 seconds), moderate or light effort	80%
Swimming, sidestroke, general	80%
Swimming, synchronised	80%
Water jogging	80%
Lap swimming, freestyle, fast, vigorous effort	100%
Swimming, breaststroke, general	100%
Swimming, treading water, fast vigorous effort	100%
Water polo	110%
Swimming, butterfly, general	110%
Swimming, crawl, fast (25m in 21.9 seconds), vigorous effort	110%

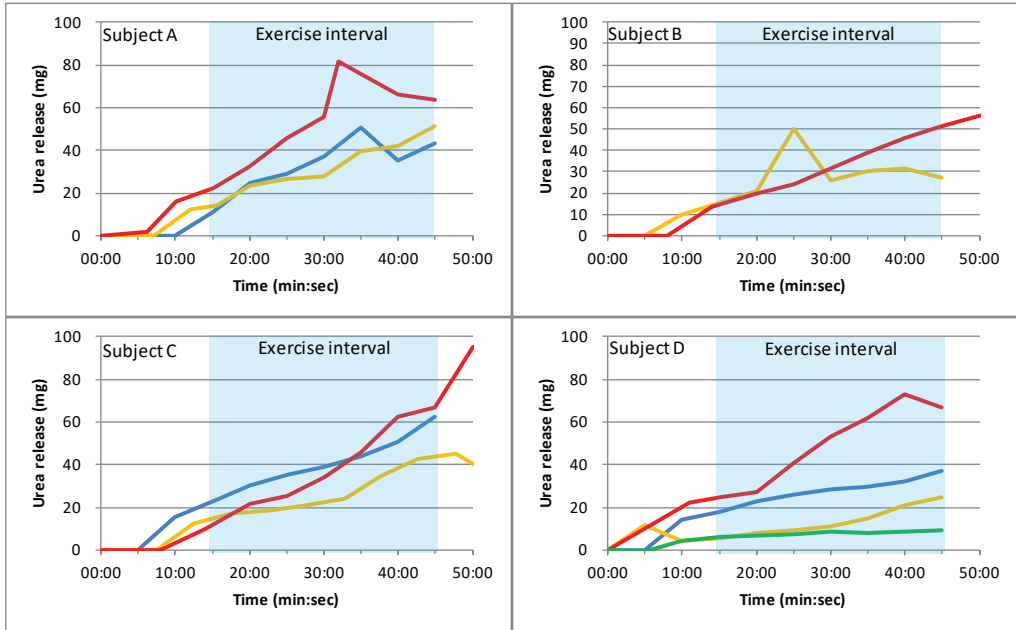
### 3.6.5 Individual pollutants release during laboratory experiments



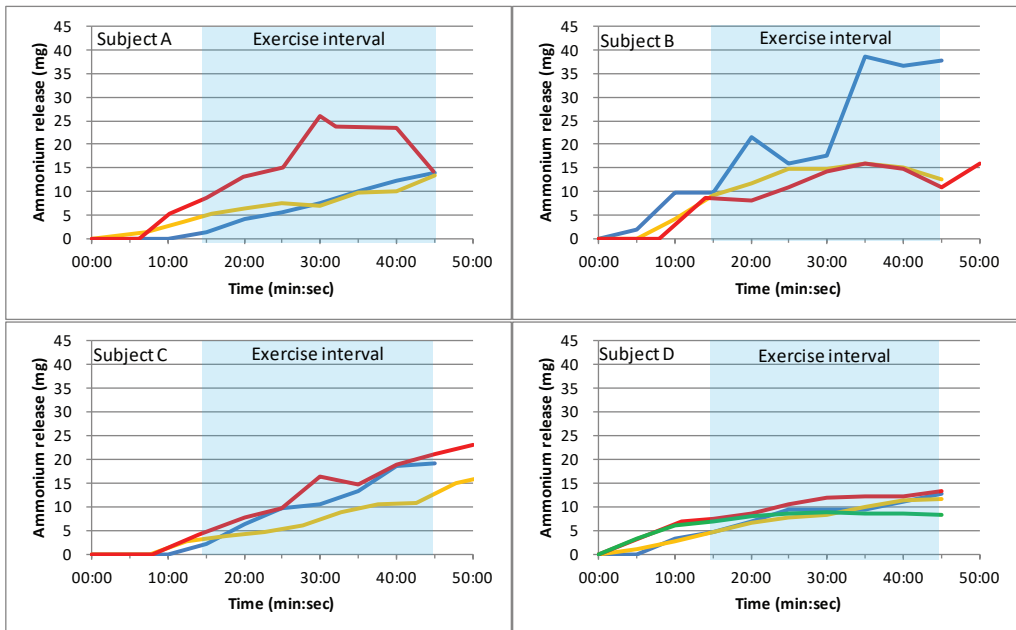
**Figure S2:** Individual NPOC release (mg) during laboratory time-series experiments at different temperatures (– 25°C, – 30°C, – 35°C, – 35°C rest, – 35°C suit only).



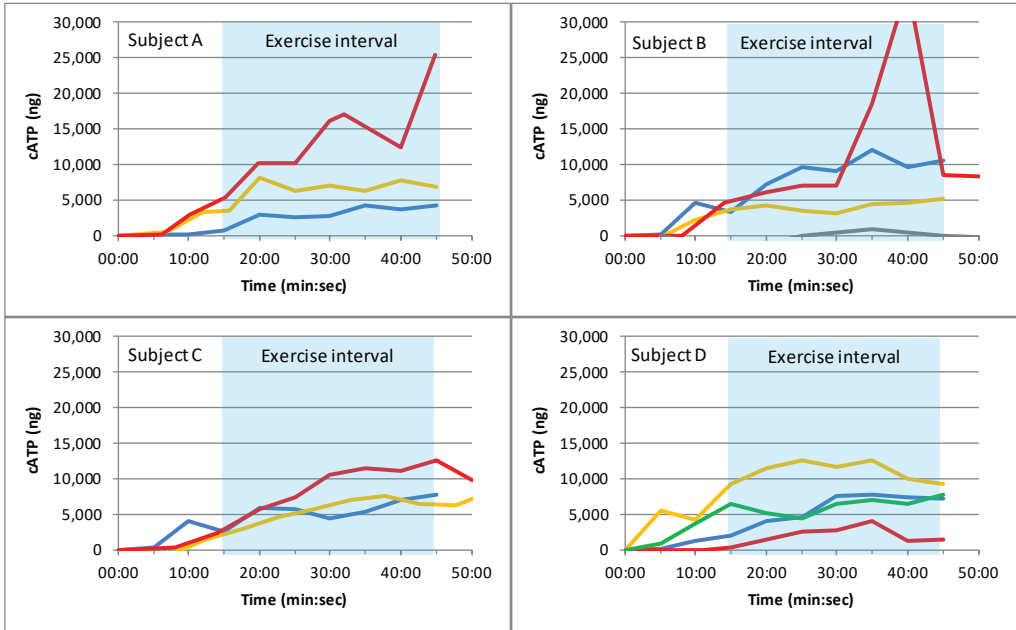
**Figure S3:** Individual TN release (mg) during laboratory time-series experiments at different temperatures (– 25°C, – 30°C, – 35°C, – 35°C rest, – 35°C suit only).



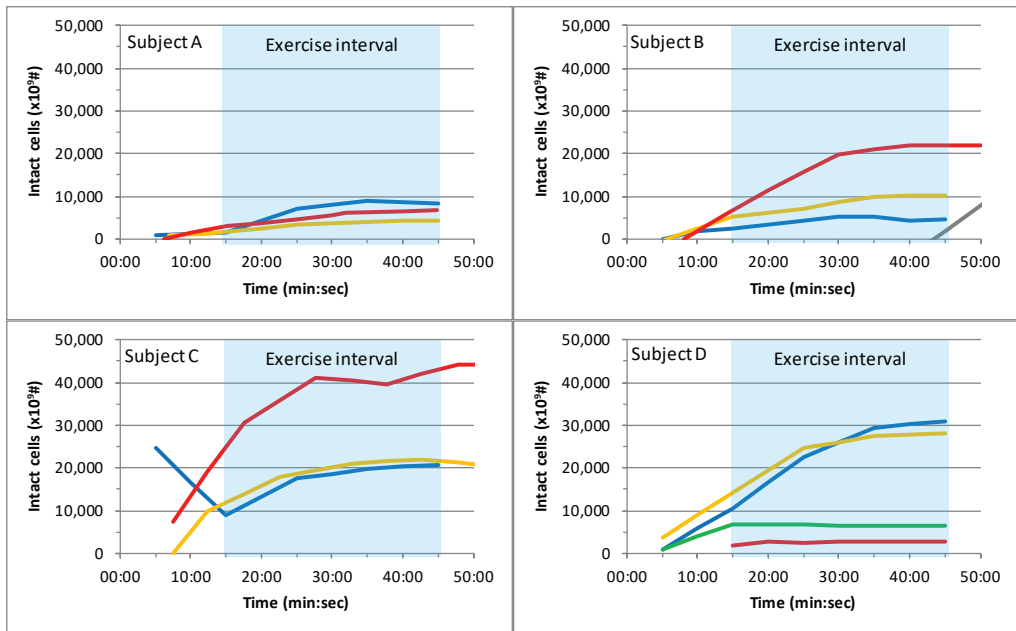
**Figure S4:** Individual urea release (mg) during laboratory time-series experiments at different temperatures (– 25°C, – 30°C, – 35°C, – 35°C rest, – 35°C suit only).



**Figure S5:** Individual ammonium release (mg) during laboratory time-series experiments at different temperatures (– 25°C, – 30°C, – 35°C, – 35°C rest, – 35°C suit only).

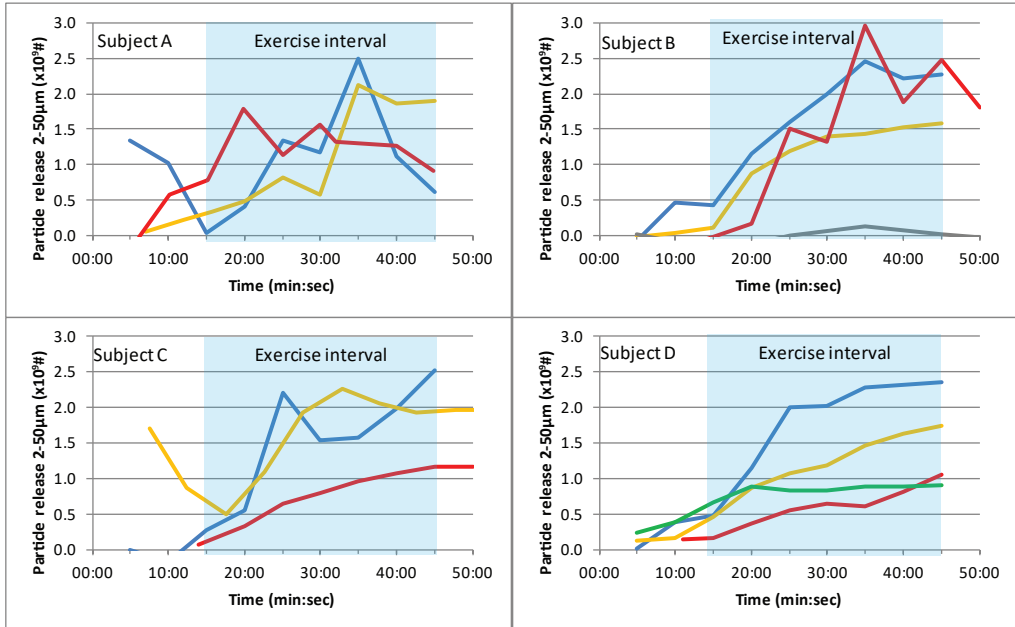


**Figure S6:** Individual cATP release (ng) during laboratory time-series experiments at different temperatures (– 25°C, – 30°C, – 35°C, – 35°C rest, – 35°C suit only).



**Figure S7:** Individual release of intact cells (#) during laboratory time-series experiments at different temperatures (– 25°C, – 30°C, – 35°C, – 35°C rest, – 35°C suit only).





**Figure S8:** Individual particle release (# particles 2-50  $\mu\text{m}$ ) during laboratory time-series experiments at different temperatures ( $-25^{\circ}\text{C}$ ,  $-30^{\circ}\text{C}$ ,  $-35^{\circ}\text{C}$ ,  $-35^{\circ}\text{C}$  rest,  $-35^{\circ}\text{C}$  suit only).

## Acknowledgements

The study was funded by communal subsidies from Agentschap NL and EFRO in combination with private funding from Delft University of Technology, Hellebrekers Technieken, Akzo Nobel Industrial Chemicals B.V., Van Remmen UV Techniek, Coram International B.V. and Sportfondsen Nederland B.V.. Special thanks to the swimming pool that cooperated in this study: Sterrenbad Wassenaar. The authors thank, Elodie Laurent, Gaele Collet, Joost van der Zwet, Simon Bouvier, Anthonie Hogendoorn and Marleen Heidekamp who helped to perform the experiments. Thanks to Stephan Bakker for his help with the sweat gland mechanism. Thanks to Adele Sanders for reviewing the language and spelling. And last but not least, special thanks to the four subjects in the laboratory time-series experiments and many thanks to all swimmers who volunteered to participate in this study.

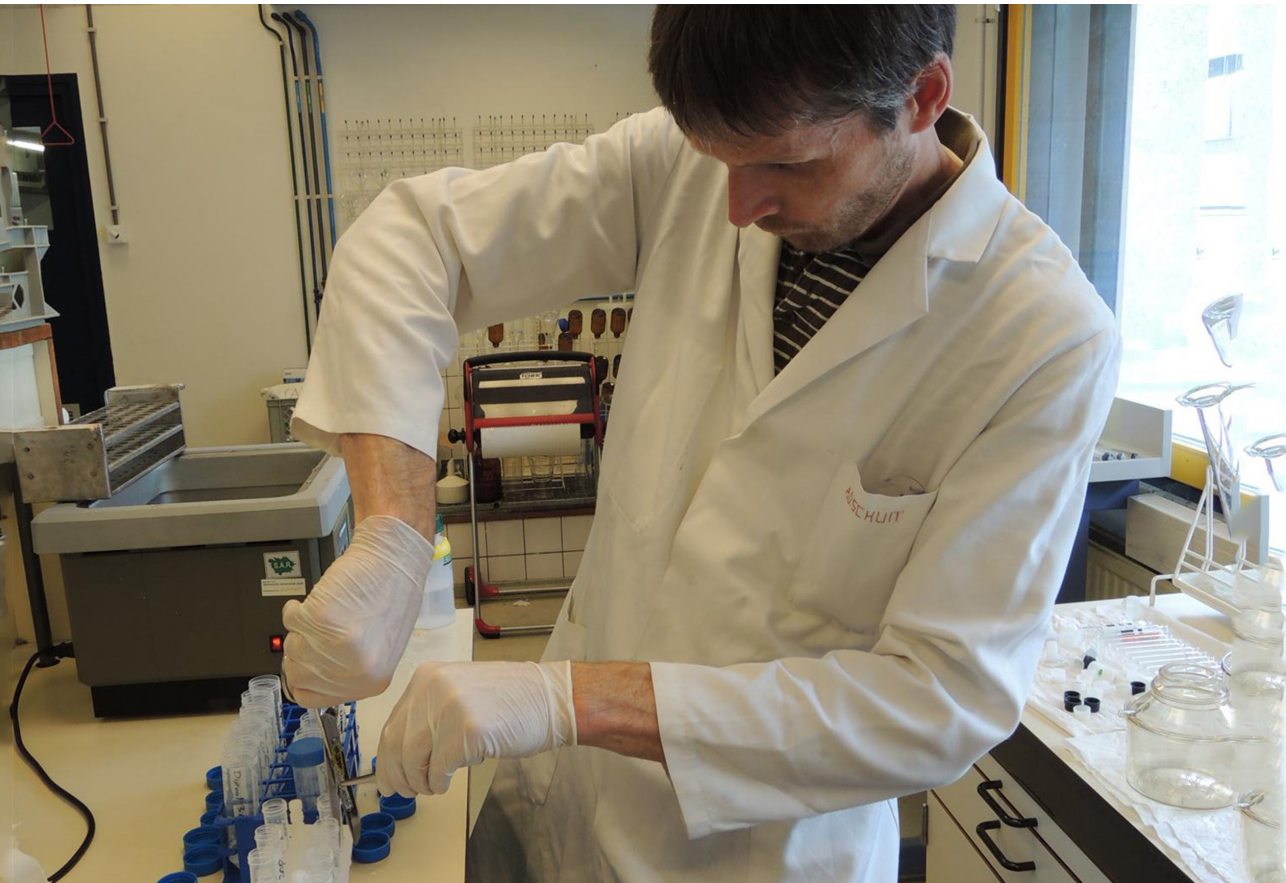
# References

- Aggazzotti, G., Fantuzzi, G., Righi, E. and Predieri, G. (1995) Environmental and biological monitoring of chloroform in indoor swimming pools. *Journal of Chromatography* 710, 181-190.
- Ainsworth, B.E., Haskell, W.L., Leon, A.S., Jacobs jr, D.R., Montoye, H.J., Sallis, J.F. and Paffenbarger jr, R.S. (1993) Compendium of physical activities: energy costs of human movement. *Medicine and Science in Sports and Exercise* 25(1), 71-80.
- Ainsworth, B.E., Haskell, W.L., Whitt, M.C., Irwin, M.L., Swartz, A.M., Strath, S.J., O'Brien, W.L., Bassett, j., D.R., Schmitz, K.H., Emplaincourt, P.O., Jacobs, D.R. and Leon, A.S. (2000) Compendium of Physical Activities: an update of activity codes and MET intensities. *Medicine and Science in Sports and Exercise* 32(9, Suppl.), S498-S516.
- Borgmann-Strahsen, R. (2003) Comparative assessment of different biocides in swimming pool water. *International Biodeterioration & Biodegradation* 51(4), 291-297.
- Cade, J.R., Reese, R.H., Privette, R.M., Hommen, N.M., Rogers, J.L. and Fregly, M.J. (1991) Dietary intervention and training in swimmers. *European Journal of Applied Physiology and Occupational Physiology* 63(3-4), 210-215.
- Cox, G.R., Broad, E.M., Riley, M.D. and Burke, L.M. (2002) Body mass changes and voluntary fluid intakes of elite level water polo players and swimmers. *Journal of Science and Medicine in Sport* 5(3), 183-193.
- Craig, S.S., Craig, S.A.S., Ganio, M.S., Maresh, C.M., Horrace, G., Costa, K.-A.d. and Zeisel, S.H. (2010) The betaine content of sweat from adolescent females. *Journal of the International Society of Sports Nutrition* 7.
- De Laat, J., Feng, W., Freyfer, D.A. and Dossier-Berne, F. (2011) Concentration levels of urea in swimming pool water and reactivity with urea. *Water Research* 45(3), 1139-1146.
- Downing, D.T., Stewart, M.E., Wertz, P.W., Colton, S.C., VI and Strauss, J.S. (1983) Skin Lipids. Comparative Biochemistry and Physiology - part B: Biochemistry and Molecular Biology 76B(4), 673-678.
- Eichelsdörfer, D., Jandik, J. and Weil, W. (1980) Organische Halogenverbindungen im Schwimmbeckenwasser II. Mitteilung: Modellversuche zur Bildung leichtflüchtiger Halogenkohlenwasserstoffe. *Z. Wasser Abwasser Forschung* 13(5), 165-169.
- Eichelsdörfer, D., Slovak, J., Dirnagl, K. and Schmid, K. (1975) Zur Reizwirkung (Konjunctivitis) von Chlör und Chloraminen im Schwimmbeckenwasser. *Vom Wasser* 45, 17-28.
- Erdinger, L., Kirsch, F. and Sonntag, H.G. (1998) Irritierende Wirkung von Nebenprodukten der Schwimmbadwasserdesinfektion. *Zentralblatt für Hygiene und Umweltmedizin* 200(5-6), 491-503.
- Florentin, A., Hautemanière, A. and Hartemann, P. (2011) Health effects of disinfection by-products in chlorinated swimming pools. *International Journal of Hygiene and Environmental Health* 214(6), 461-469.
- Font-Ribera, L., Kogevinas, M., Zock, J.P., Gómez, F.P., Barreiro, E., Nieuwenhuijsen, M.J., Fernandez, P., Lourencetti, C., Pérez-Olabarría, M., Bustamante, M., Marcos, R., Grimalt, J.O. and Villanueva, C.M. (2010) Short-Term Changes in Respiratory Biomarkers after Swimming in a Chlorinated Pool. *Environmental Health Perspectives* 118(11), 1538-1544.
- Gardinier, S., Guéhenneux, S., Latreille, J., Guino, C. and Tschachler, E. (2009) Variations of skin biophysical properties after recreational swimming. *Skin Research and Technology* 15(4), 427-432.
- Glauner, T., Waldmann, P., Frimmel, F. and Zwiener, C. (2005) Swimming pool water—fractionation and genotoxicological characterization of organic constituents. *Water Research* 39, 4494-4502.
- Gunkel, K. and Jessen, H.J. (1986) Untersuchungen über den Harnstoffeintrag in das Badewasser. *Acta Hydrochimica et Hydrobiologica* 14(5), 451-461.
- Hansen, K.M.S., Zortea, R., Piketty, A., Vega, S.R. and Andersen, H.R. (2013) Photolytic removal of DBPs by medium pressure UV in swimming pool water. *Science of The Total Environment* 443, 850-856.
- Harris, H.H., Downing, D.T., Stewart, M.E. and Strauss, J.S. (1983) Sustainable rates of sebum secretion in acne patients and matched normal control subjects. *Journal of the American Academy of Dermatology* 8(2), 200-203.

- Henkin, S.D., Sehl, P.L. and Meyer, F. (2010) Sweat rate and electrolyte concentration in swimmers, runners and nonathletes. *International Journal of Sports Physiology and Performance* 5(3), 359-366.
- Hery, M., Hecht, G., Gerber, J.M., Gendre, J.C., Hubert, G. and Rebuffaud, J. (1995) Exposure to chloramines in the atmosphere of indoor swimming pools. *Annals of Occupational Hygiene* 39(4), 427-439.
- Ichinose, T.K., Inoue, Y., Hirata, M., Shamsuddin, A.K.M. and Kondo, N. (2009) Enhanced heat loss responses induced by short-term endurance training in exercising women. *Experimental Physiology* 94(1), 90-102.
- ISO (2002) Water quality - Determination of ammonium - Part 1: Manual spectrometric method - ISO 7150-1, p. 7, International Organization for Standardization, Geneva, Switzerland.
- Keuten, M.G.A., Schets, F.M., Schijven, J.F., Verberk, J.Q.J.C. and van Dijk, J.C. (2012) Definition and quantification of initial anthropogenic pollutant release in swimming pools. *Water Research* 46(11), 11.
- Keuten, M.G.A., Schets, F.M., Schijven, J.F., Verberk, J.Q.J.C. and van Dijk, J.C. (2013) Corrigendum to "Definition and quantification of initial anthropogenic pollutant release in swimming pools". *Water Research In Press*, Corrected Proof, Available online 23 December 2013.
- Kogevinas, M., Villanueva, C.M., Font-Ribera, L., Liviak, D., Bustamante, M., Espinoza, F., Nieuwenhuijsen, M.J., Espinosa, A., Fernandez, P., DeMarini, D.M., Grimalt, J.O., Grummt, T. and Marcos, R. (2010) Genotoxic Effects in Swimmers Exposed to Disinfection By-products in Indoor Swimming Pools. *Environmental Health Perspectives* 118(11), 1531-1537.
- Kounalakis, S.N., Botonis, P.G., Koskolou, M.D. and Geladas, N.D. (2010) The effect of menthol application to the skin on sweating rate response during exercise in swimmers and controls. *European Journal of Applied Physiology* 109(2), 183-189.
- Kuno, Y. (1956) Human perspiration, Charles C. Thomas, Springfield, Illinois, U.S.A.
- Lahl, U., Batjer, K., Duszeln, J.V., Gabel, B., Stachel, B. and Thiemann, W. (1981) Distribution and balance of volatile halogenated hydrocarbons in the water and air of covered swimming pools using chlorine for water disinfection. *Water Research* 15(7), 803-814.
- Lakind, J.S., Richardson, S.D. and Blount, B.C. (2010) The good, the bad, and the volatile: Can we have both healthy pools and healthy people? *Environmental Science and Technology* 44(9), 3205-3210.
- Lemon, P.W.R., Deutsch, D.T. and Payne, W.R. (1989) Urea production during prolonged swimming. *Journal of Sports Sciences* 7(3), 241-246.
- Macaluso, F., Felice, D., V., Boscaino, G., Bosignore, G., Stampone, T., Farina, F. and Morici, G. (2011) Effects of three different water temperatures on dehydration in competitive swimmers. *Science and Sport* 26(5), 265-271.
- Maughan, R.J., Dargavel, L.A., Hares, R. and Shirreffs, S.M. (2009) Water and salt balance of well-trained swimmers in training. *International Journal of Sport Nutrition and Exercise metabolism* 19(6), 598-606.
- Maughan, R.J., Shirreffs, S.M. and Leiper, J.B. (2007) Errors in the estimation of hydration status from changes in body mass. *Journal of Sports Sciences* 25(7), 797-804.
- McMurray, R.G. and Horvath, S.M. (1979) Thermoregulation in swimmers and runners. *Journal of Applied Physiology* 46(6), 1086-1092.
- Mitchell, J.W., Nadel, E.R. and Stolwijk, J.A. (1972) Respiratory weight losses during exercise. *Journal of Applied Physiology* 32(4), 474-476.
- Mosher, H.H. (1933) Simultaneous study of constituents of urine and perspiration. *The Journal of Biological Chemistry* 99(3), 781-790.
- Mosteller, R.D. (1987) Simplified calculation of body-surface area. *New England Journal of Medicine* 317(17), 1.
- Nadel, E.R. (1979) Control of sweating rate while exercising in the heat. *Medicine and Science in Sports and Exercise* 11(1), 31-35.
- NEN (1997) Water analysis - Guidelines for determination of total organic carbon (TOC) and dissolved organic carbon (DOC), NEN.

- NEN (2003) Water quality - Determination of nitrogen - Determination of bound nitrogen (TN sub b), following oxidation to nitrogen oxides.
- Nielsen, B., Sjøgaard, G. and Bonde-Petersen, F. (1984) Cardiovascular, hormonal and body fluid changes during prolonged exercise. *European Journal of Applied Physiology and Occupational Physiology* 53(1), 63-70.
- Powick, D.E.J. (1989) Swimming pools - Brief outline of water treatment and management. *Water Science and Technology* 21(2), 151-160.
- Prest, E.I., Hammes, F., Kötzsch, S., van Loosdrecht, M.C.M. and Vrouwenvelder, J.S. (2013) Monitoring microbiological changes in drinking water systems using a fast and reproducible flow cytometric method *Water Research* In Press, Corrected Proof.
- Richardson, S.D., DeMarini, D.M., Kogevinas, M., Fernandez, P., Marco, E., Lourencetti, C., Ballesté, C., Heederik, D., Meliefste, K., McKague, B., Marcos, R., Font-Ribera, L.G., J.O. and Villanueva, C.M. (2010) What's in the Pool? A Comprehensive Identification of Disinfection By-products and Assessment of Mutagenicity of Chlorinated and Brominated Swimming Pool Water. *Environmental Health Perspectives* 118(11), 1523-1530.
- Robinson, S. and Somers, A. (1971) Temperature regulation in swimming. *Journal of Physiology* 63(3), 406-409.
- Scheuplein, R.J. and Blank, I.H. (1971) Permeability of the skin. *Physiological Reviews* 51(4), 702-747.
- Shvartz, E. and Reibold, R.C. (1990) Aerobic fitness norms for males and females aged 6 to 75 years: A review. *Aviation Space and Environmental Medicine* 61(1), 3-11.
- Stefaniak, A.B. and Harvey, C.J. (2006) Dissolution of materials in artificial skin surface film liquids. *Toxicology in Vitro* 20(8), 1265-1283.
- Suppes, L.M., Abrell, L., Dufour, A.P. and Reynolds, K.A. (2013) Assessment of Swimmer Behaviors on Pool Water Ingestion. *Journal of Water and Health* 11(4).
- Taimura, A. and Sugahara, M. (1996) Effect of fluid intake on performance, body temperature, and body weight loss during swimming training. *Medicine and Science in Sports and Exercise* 28(5), 158.
- Taimura, A. and Sugahara, M. (1996) Effect of fluid intake on performance, body temperature, and body weight loss during swimming training. *Medicine and Science in Sports and Exercise* 28(5), 158.
- Taimura, A., Sugahara, M., Yamauchi, M., Lee, J.B., Matsumoto, T. and Kosaka, M. (1998) Thermal sweating responses in swimmers. *Medicine and Science in Sports and Exercise* 30(5 suppl.), 283.
- van der Wielen, P.W.J.J. and van der Kooij, D. (2010) Effect of water composition, distance and season on the adenine triphosphate concentration in unchlorinated drinking water in the Netherlands. *Water Research* 44(17), 4860-4867.
- VROM (2001) Dutch drinking water act. Ministry of Housing, s.p.a.h. (ed), The Hague, The Netherlands.
- Weng, S. and Blatchley, E.R.I. (2011) Disinfection by-product dynamics in a chlorinated, indoor swimming pool under conditions of heavy use: National swimming competition. *Water Research* 45(16), 5241-5248.
- WHO (2006) Guidelines for safe recreational water environments, Volume 2; Swimming pools and similar environments, WHO.
- Zwiener, C., Richardson, S., De Marini, D., Grummt, T., Glauner, T. and Frimmel, F. (2007) Drowning in Disinfection Byproducts? Assessing Swimming Pool Water. *Environmental science & technology* 41(2), 363-372.





# Chapter 4

## Biofilm formation potential and microbial water quality of simulated swimming pool water with different types of disinfection

M.G.A. Keuten<sup>1,2</sup>, M.C.F.M. Peters<sup>1</sup>, J.C. van Dijk<sup>1</sup>, L.C. Rietveld<sup>1</sup>,  
M.C.M. van Loosdrecht<sup>3</sup>

This chapter is in preparation for publication as: M.G.A. Keuten, M.C.F.M. Peters, J.C. van Dijk, L.C. Rietveld, M.C.M. van Loosdrecht (2018) Biofilm formation potential and microbial water quality of simulated swimming pool water with different types of disinfection.

---

1 Section Sanitary Engineering, Delft University of Technology, Delft, The Netherlands  
2 Hellebrekers Technieken, Nunspeet, the Netherlands  
3 Department of Biotechnology, Delft University of Technology, Delft, The Netherlands

## Abstract

The goal of this study was to determine the biofilm formation potential and microbial water quality of simulated swimming pool water and the influence of different treatment methods: without disinfection, disinfection by ultrafiltration, with UV-disinfection and disinfection by chlorination. Microbial fouling simulators were used to monitor the presence of organic material allowing microbial growth, by measuring intracellular adenosine triphosphate and intact cell counts of the biofilm inside microbial fouling simulators and adenosine triphosphate. The water quality was monitored for worst case and maximum allowed pollution with body fluid analogue during 23 days experiments. The lowest biofilm formation potential and best microbial water quality was found with chlorination. In the absence of a residual disinfectant, multiple treatment steps were needed to reduce the biofilm forming potential of pool water to levels similar to heated tap water. Only the combination of biological sand filtration with ultrafiltration and UV- treatment reduced the biofilm formation potential and improved the microbial water quality close to the level of chlorinated pool water. During experiments with recirculation and chlorination, biofilm forming potential and microbial water quality were comparable with or without phosphate addition, while in the absence of a residual disinfectant, with the combination of biological sand filtration with ultrafiltration and UV-treatment, the lowest biofilm forming potential was found with phosphate addition, with a slightly reduced microbial water quality.

### Keywords:

- biofilm formation potential
- microbial fouling simulator
- microbial quality
- chlorination
- UV-disinfection
- biological sand filtration
- ultra-filtration
- swimming pool



## 4.1 Introduction

Swimming is a worldwide popular activity for all ages and social classes and swimming in pool water with chlorination is known to be a healthy activity (Font-Ribera et al. 2016, Kogevinas et al. 2010, Lachocki 2011). The formation of unwanted disinfection by-products during chlorination can at least lead to irritation or nuisance (Eichelsdörfer et al. 1975, Erdinger et al. 1998). In recent publications, questions have been raised about more severe health hazards induced by DBPs (Font-Ribera et al. 2010, Glauner et al. 2005, Kogevinas et al. 2010, Lakind et al. 2010).

Alternative disinfection with UV-treatment has been studied before (Caramello and Amisano 2001, Crandall 1986, Dingman 1990, Savino et al. 1993). Although the results of these studies seemed promising, it did not lead to a useful alternative in modern swimming pools. The reason why UV-treatment is not used in pool water treatment is most probably related to the general belief that a residual disinfectant is needed in the pool water. In Germany, ultrafiltration is used in pool water treatment for improved removal of particles and microorganisms to replace sand filtration, but a residual disinfectant is still mandatory (DIN 2012b). Both UV-treatment and ultrafiltration are used in the production of drinking water as disinfection steps, without the need of residual disinfectants to guarantee safe drinking water (Hijnen et al. 2006, Van der Bruggen et al. 2003). A similar approach of extensive cleaning of the water to prevent microbial growth might be useful for pool water treatment. Disinfection of pool water with UV-treatment was investigated before, with good results (Caramello and Amisano 2001, Sobotka and Kryzstofik 1984), but the use of a residual disinfectant like chlorine was still recommended. Nowadays, swimming water without a residual disinfectant is increasingly popular, as is demonstrated by the growing number of (natural) swimming ponds (Weilandt 2015), but health risks for bathers raise concerns for these type of pools. Therefore, some form of disinfection is still assumed to be needed (Giampaoli et al. 2014).

It is expected that bacteria will survive and multiply more rapidly in the absence of a residual disinfectant, even if water is regularly exposed to disinfection, as is the case with ultrafiltration or UV-disinfection in a recycle loop. Formation of biofilms on the pool walls and piping can, besides of causing an aesthetic problem, lead to the growth of pathogens, re-contaminating the pool water. Growth in biofilms has been demonstrated for various pathogenic micro-organisms like: *Legionella pneumophila* (Barna and Kádár 2012, Ruscoe et al. 2006), *Pseudomonas aeruginosa* (Barna and Kádár 2012, Rice et al. 2012, Schets et al. 2014), *Mycobacterium avium* (Barna and Kádár 2012, Whiley et al. 2012), *Dichogaster bolau* (Rota and Schmidt 2006), and amoeba (Barna and Kádár 2012, Cateau et al. 2014). The presence of biofilms was studied in various pool types, all with chlorination, like: swimming pools (Guida et al. 2016), hospital therapy pools (Angenent et al. 2005), spas (Briancesco et al. 2014) and water parks (Davis et al. 2009).

In drinking water systems the biofilm growth can be minimised by extensive treatment, e.g. by minimising the concentration of assimilable organic carbon (Kooij van der 1992). However, in pools swimmers continuously release body fluids (e.g. sweat) that provide nutrients such as assimilable organic carbon, potentially leading to enhanced biofilm formation.

As known from studies on tap water, biofilm formation can be reduced with biological filtration (Volk and LeChevallier 1999), reducing organic nutrients and phosphate, in combination with coagulation (Vrouwenvelder et al. 2010), or by restraining all bacterial activity with a residual disinfectant like chlorine (Wende van der et al. 1989).

For pool water treatment, there is a lack of knowledge on the effect of different treatment steps on biofilm formation at swimming pool conditions. Therefore we set-up an experiment to investigate biofilm formation and microbial water quality. Biofilm formation is influenced by specific conditions like: the water composition (chemical and physical), surface conditions of substrate material, hydraulic conditions and time (Hammes et al. 2010, Kooij van der 2000, Miettinen et al. 1997, Rittmann and Snoeyink 1984, Srinivasan and Harrington 2007). The influence of treatment steps on microbial water quality was investigated at worst case and maximum allowed conditions with single use of water. The influence of repetitive treatment was investigated in experiments with recirculation of the water, similar to nowadays pools. The study focussed on microbial water quality of swimming pool water without disinfection, disinfection by ultrafiltration, with UV-based disinfection, and with disinfection by chlorination. The addition of a biological activated carbon filtration to a treatment with chlorination was also investigated to determine the influence of this urea removal step on the overall microbial quality.

## 4.2 Materials and methods

### 4.2.1 *Experiment philosophy*

The experiments were designed to compare different treatment concepts for pool water treatment, without disinfection, disinfection by ultrafiltration, with UV-disinfection and disinfection by chlorination, all with various configurations of treatment steps. For pool water treatment without disinfection, a treatment with only biological sand filtration was used. For disinfection by ultrafiltration, the combination biological sand filtration with ultrafiltration was used. For pool water with UV disinfection, the combination of biological sand filtration with ultrafiltration and UV was used and for pool water with chlorination, sand filtration (SF) and the combination of SF with bypass biological activated carbon filtration was used. Biological filtration is known to reduce the biofilm formation potential during the production of drinking water (Emelko et al. 2006, Servais et al. 1996). Ultrafiltration was chosen as a barrier for bacteria with enhanced particle removal (Hammes et al. 2010, Iannelli et al. 2014). UV-treatment was chosen for disinfection (Hijnen et al. 2006), and both chlorination and heated tap water were chosen as references. Biological activated carbon filtration was used as it is frequently used in Dutch swimming pools to remove urea (Boere et al. 1990). A body fluid analogue (BFA) was used to simulate pool occupancy. The experimental settings were selected to simulate a high swimming pool occupancy level during experiments with and without recirculation, with “worst case” and maximum allowed conditions to investigate the influence of single treatment steps. During recirculation, the settings were selected to simulate a high bathing load in relation to the pool content and capacity of the treatment plant. The composition of the BFA, containing non-purgeable organic carbon (NPOC), total nitrogen (TN) and phosphate is shown in Table 1.

Table 1: Addition of BFA components during all experiments.				
BFA components	Experiments without circulation		Experiments with recirculation	
	Worst case (mg/L)	Maximum allowed (mg/L)	with PO <sub>4</sub> (µg/L)	without PO <sub>4</sub> (µg/L)
Urea	8.15	2.04	130.3	130.3
Creatinine monohydrate	0.71	0.18	11.4	11.4
Citrate	0.58	0.15	9.3	9.3
PO <sub>4</sub> -P	0.17	0.17	2.4	0.0
Nitrogen and Carbon from BFA components				
Urea-N	3.80	0.95	60.8	60.8
Creatinine-N	0.20	0.05	3.2	3.2
TN (urea + creatinine)	4.00	1.00	64	64
Urea-C	1.63	0.41	26.1	26.1
Creatinine-C	0.23	0.06	3.7	3.7
Citrate-C	0.14	0.04	2.3	2.3
NPOC (urea + creatinine + citrate)	2.00	0.50	32	32

### 4.2.2 Biofilm Formation Potential

Microbial fouling simulators, originally designed by Vrouwenvelder et al. (2006) to study biofouling in spiral wound membranes, were used to measure biofilm formation potential. They already have been used to study biofilm formation of different water types (Araújo et al. 2012a, Araújo et al. 2012b, Liu et al. 2013a, Miller et al. 2012). The microbial fouling simulators can be operated under variable dynamic water conditions, without loss of biofilm during sampling. The biofilm formation potential in a pre-determined time frame was quantified as pressure difference ( $\Delta P$ ), intracellular adenosine triphosphate /cm<sup>2</sup>, or intact cell count /cm<sup>2</sup>.

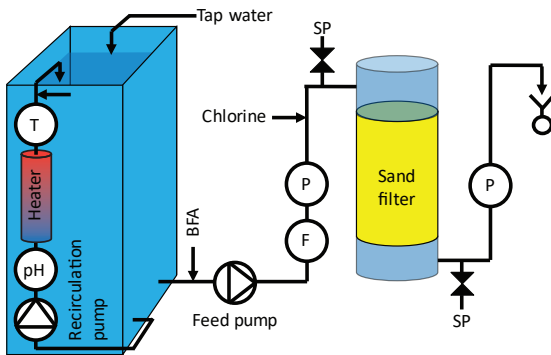
### 4.2.3 Equipment

The experimental setups (Fabr. Hellebrekers Technieken, Nunspeet, The Netherlands) are shown in Figures 1 (experiments without disinfection), 2 (experiments with ultrafiltration), 3 (experiments with UV-disinfection) and 4 (experiments with chlorination). The water levels in each setup were controlled and automatically adjusted to correct for water losses from sampling, backwashing and evaporation using standard Dutch drinking water (tap water) which is distributed without a residual disinfectant (IenM 2011). Tap water intake was constantly monitored with a flow meter (Itron, Aquadis+, QN1.5). All granular filters (sand filtration, biological sand filtration and biological activated carbon filtration) had a filter nozzle underdrain with supportive layers and were not backwashed during the experiments. The ultrafiltration had two parallel 4100/UF/MB/TAP membrane elements (fabr.

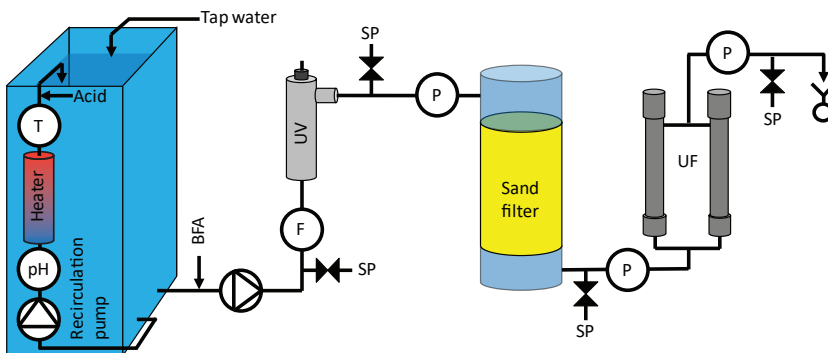
IMT B.V., Zeewolde, the Netherlands) operated in a dead-end mode (Figures 2 and 3). Other design specifications of the filter components are shown in Table S1 (Annex A). All dosing pumps (tube pumps; DULCOflex DF4a, ProMinent) were flow-adjusted for accurate chemical addition.

### Equipment for experiments without recirculation

The setups for experiments without recirculation (Figures 1, 2, 3a and 4a) were equipped with a pre-conditioning tank to prepare pool water. The pre-conditioning tank (200 L) was recirculated at a high rate (2.4 m<sup>3</sup>/h) for enhanced mixing, to ensure stable temperature and pH conditions. The pH was controlled by a pH sensor (RB instruments, HGK-gel-2hd/sv), combined with an acid dosing pump, and temperature was controlled by a temperature sensor (Regin, PT100), combined with an electrical heater.



**Figure 1:** Schematic diagram of setup to study pool water without disinfection. The setup was equipped with biological sand filtration, online sensors for pH (pH), temperature (T), flow (F), pressure (P), addition of acid and BFA and provided with different sampling points (SP).



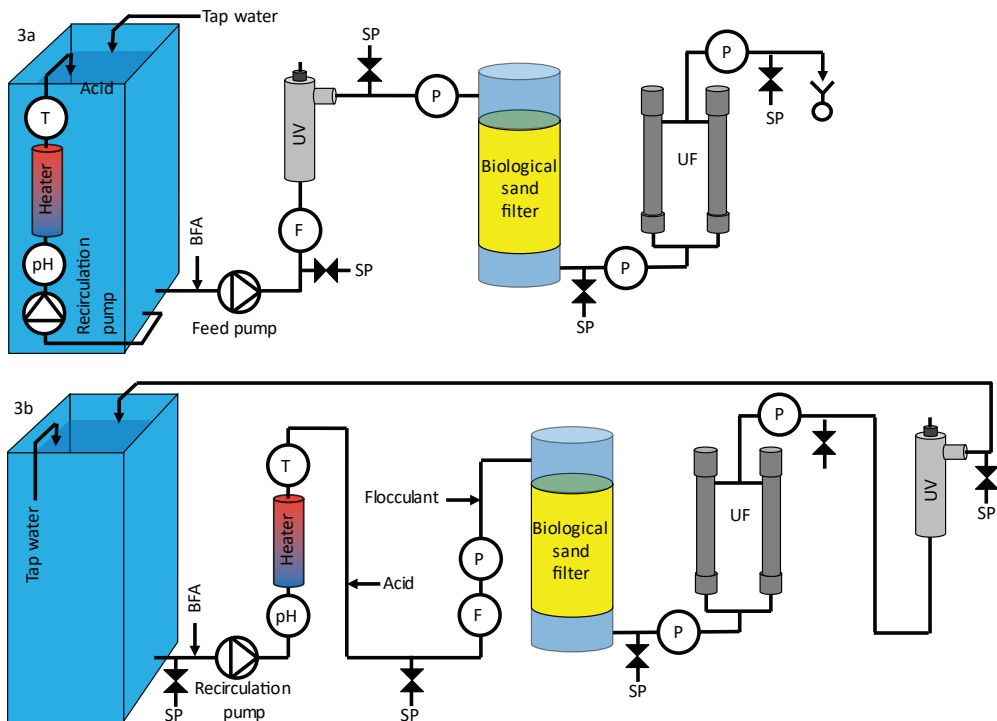
**Figure 2:** Schematic diagram of setup to study pool water with ultrafiltration. The setup was equipped with biological sand filtration, ultrafiltration, online sensors for pH (pH), temperature (T), flow (F), pressure (P), addition of acid and BFA and provided with different sampling points (SP).

The feed pump (1 m<sup>3</sup>/h) was flow-controlled with the use of a flow sensor (IFM, SM7000), combined with a frequency converter to ensure a constant flow during all experiments. The chlorine dosing pump was set manually, without sensor control (Figure 4a).

The experiments with UV (Figure 2) used a low-pressure UV-treatment with a dose of 400 J/m<sup>2</sup> (type D1, fabr. Van Remmen UV-Techniek, Wijhe, the Netherlands). During the experiments UV-treatment was used as a pre-treatment before the biological sand filtration to improve removal of anthropogenic pollutants.

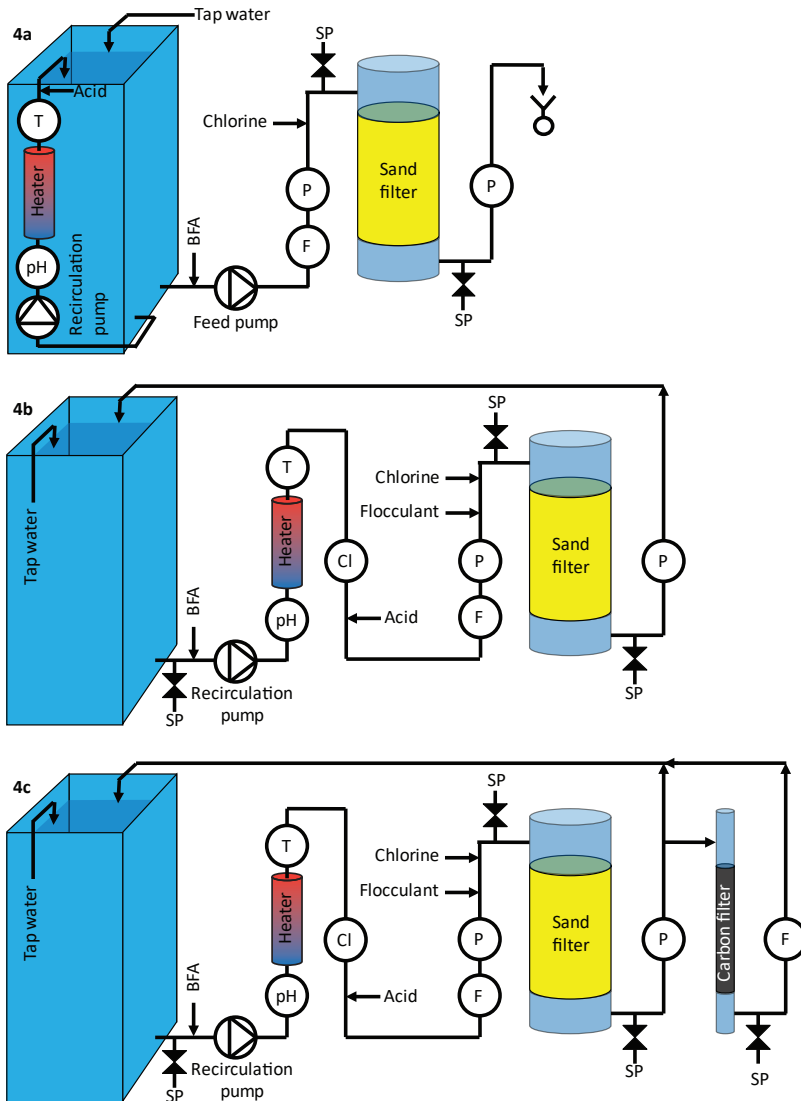
### Equipment for experiments with recirculation

The setups were slightly modified for the experiments with recirculation. The recirculation was designed with a 30-minute turnover. The pre-conditioning tank was used as a pool tank and the content was increased to 500 L. The hydraulics of the pool tank were designed as plug flow for optimal pollutant removal. Additionally, coagulation by aluminium hydroxide chloride was added to the treatment prior to granular filtration for phosphate removal (Figures 3b, 4b and 4c).



**Figure 3:** Schematic diagram of setup to study pool water with UV-disinfection, without recirculation (Figure 3a), and with recirculation (Figure 3b). The setup contained UV treatment (UV), biological sand filtration, ultra-filtration (UF), equipped with online sensors for pH (pH), temperature (T), flow (F), pressure (P), addition of acid and BFA and provided with different sampling points (SP).

For the experimental setup with UV-treatment and recirculation, the configuration of the treatment steps was changed because i) disinfection efficiency of UV-treatment is known to be best after a ultrafiltration and ii) results of the experiments without recirculation showed that all added pollutants were easily biodegradable and pre-treatment with UV-treatment



**Figure 4:** Schematic diagram of setup to study pool water with chlorination, without recirculation (Figure 4a) and with recirculation (Figure 4b). The setup was equipped with chlorination and sand filtration, online sensors for pH (pH), emperature (T), flow (F), pressure (P), addition of acid, BFA, and chlorine and provided with different sampling points (SP). During the second recirculation experiment, a by-pass biological activated carbon filtration was added (Figure 4c).

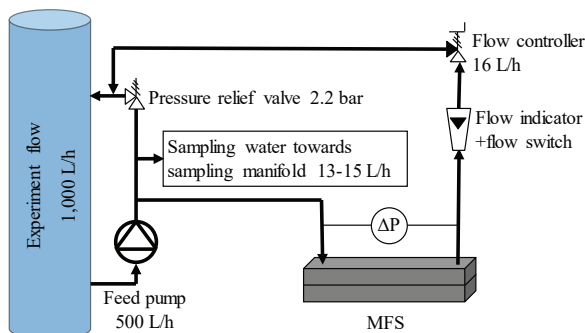
(before biological sand filtration) was not needed. The dimensions and characteristics of the treatment steps were as described in Section 2.1.1. (Table S1).

For the setup with chlorination (Figure 4b and 4c), the chlorine level was measured by a chlorine sensor (Depolox IV, fabr. Wallace & Tiernan) and a sodium hypochlorite solution was dosed to keep the free chlorine concentration at a constant level of 0.5 mg Cl<sub>2</sub>/L. A 10 % bypass biological activated carbon filtration was added during the second experiment with chlorination and recirculation (Figure 4c). The biological activated carbon filtration was filled with activated carbon (Norit PK1-3).

### Microbial fouling simulator

Originally, a microbial fouling simulator contains a feed-spacer section (40×200 mm) from a nanofiltration membrane (Trisep TS80), fixed between two membrane layers in a flow chamber (Vrouwenvelder et al. 2006), to facilitate the removal of the feed-spacer section for subsequent analysis, without loss of biofilm. For practical reasons the membrane layers were replaced by transparent PVC layers. The microbial fouling simulators were continuously fed with 16 L/h water from the experimental setup, controlled with a flow controller (Brooks, FC8805B2A), monitored with a flow indicator and guarded with a flow switch. The microbial fouling simulator was equipped with a pressure difference ( $\Delta P$ ) meter to monitor changes in resistance caused by biofilm formation in the spacer (Vrouwenvelder et al. 2006). The duration of the experiments, equal for all experiments, was set at 23 days because during trail experiments at worst case conditions, the  $\Delta P$  exceeded the measuring range of the  $\Delta P$ -meter at a longer duration of the experiments.

The sampling tubes used for transporting water from the sampling points to the microbial fouling simulators and back were chemically cleaned before each new experiment. Dummy microbial fouling simulators were used during cleaning to avoid stagnant zones in the tubes and connectors. Chemical cleaning started with an alkaline cleaning at a pH of 12 at 40 °C, recirculating at 500 L/h for the recirculation loop (Figure 5) and 100 L/h for the microbial fouling simulator tubes over a 5  $\mu\text{m}$  cartridge filter, followed by rinsing with cold tap water for 30 s.



**Figure 5:** Schematic diagram of recirculation loop with connected microbial fouling simulator (MFS), pressure difference meter ( $\Delta P$ ), flow indicator, flow controller and discharge of sampling water towards sampling manifold.

The microbial fouling simulators were prepared before each new experiment with an unused membrane spacer and unused PVC layers. The membrane spacer, PVC layers and the inside of the flow chamber were subsequently rinsed with hot and cold tap water, followed by demineralised water and drying and, subsequently, disinfection with a 70 % ethanol solution for at least 2 min. After assembling each microbial fouling simulator, its connectors were sealed with aluminium foil, to avoid recontamination, and stored in a refrigerator at 4 °C for a maximum of 48 h until usage in the experiment.

The biofilm inside the microbial fouling simulators was determined as described by Vrouwenvelder (2006). Directly after opening the simulators, digital pictures of the biofilm were made, as seen in the examples in Annex B, Figures S1 to S5. Sections of the PVC layers with the membrane spacer near the inlet and outlet of each simulator were used for analysis. The first and last 10 mm of the membrane spacer and PVC layers were not sampled, to avoid border influences. All equipment used to grasp or cut the PVC layers with the membrane spacer were disinfected with 70 % ethanol before each subsequent use. Each removed section was placed in 10 mL of autoclaved tap water in a capped tube. To remove the biofilm from the sections, the tubes were placed in a low energy ultrasonic bath (Ney300, ultrasonic 11QT, 210 W) for 2 min. Sonic treatment was repeated four times, each time using a new batch of 10 mL autoclaved tap water. All four batches from each membrane section were combined in one 40 mL mixed sample for cATP and iCC analysis. Results were calculated as the amount of cATP or iCC per cm<sup>2</sup> of membrane spacer.

#### *4.2.4 Experimental settings*

To simulate anthropogenic pollutant release, a BFA was added to the tap water. The used BFA was a mixture of urea, creatine monohydrate, and sodium citrate, all of technical grade and supplied by VWR international, with exception of creatine monohydrate which was supplied by Sportfood.nl. The composition was based on previous studies (Judd and Black 2000) and practical experiences (Annex C) and varied between the different experiments (Table 1) to study worst case and maximum allowed concentrations and the influence of phosphate. The addition of BFA during the experiments without recirculation was chosen to be the maximum concentration that can be expected in pool water. Whereas the daily amount of dissolved anthropogenic pollutants added during the experiments with recirculation was equal to the sum of the continual and incidental anthropogenic pollutant amount of 147.3 mg N/bather/30 min (Keuten et al. 2014) released during 10 h per day, calculated at a recirculation rate of 2 m<sup>3</sup>/bather/h, which can be classified as a high occupancy level.

During all experiments without recirculation, the addition of non-purgeable organic carbon (NPOC) was 2.0 mg/L, the total nitrogen (TN) addition was 4.0 mg/L and the phosphate addition was 0.5 mg/L, all at a worst case level, except for the second UV-biological sand filtration-ultrafiltration experiment where NPOC and TN addition were at a maximum allowed level of 0.5 mg/L and 1.0 mg/L respectively (Table 1).

During all experiments with recirculation, the NPOC addition was 32 µg/L, the TN addition was 64 µg/L and the phosphate-P addition was 2.4 µg/L. To study the influence of phosphate addition, phosphate was not added during a second set of experiments with recirculation. Aluminium hydroxide chloride was used as flocculant during all experiments with



recirculation, added at a rate of 30 µg Al/L, and controlled by measuring the concentration of aluminium, not exceeding a concentration of 50 µg Al/L in the tank water, in accordance with DIN 19643-2 (2012a).

With chlorination, the disinfection capacity decreases with increasing pH, because OCl<sup>-</sup> has a lower oxidation (disinfection) potential than HOCl (VROM 2000, WHO 2006), above a pH of 7.4, OCl<sup>-</sup> prevails. Therefore, to simulate worst case conditions for chlorination, a pH of 7.4 was chosen for all experiments. During worst case and maximum allowed conditions, free chlorine was in accordance with lowest acceptable levels in legislation (DIN 2012a), while with recirculation, free chlorine was in accordance with Dutch regulations and WHO guidelines (VROM 2000, WHO 2006). The pool water temperature was set to 30-32 °C, because microbial activity was expected to be sufficiently high at these pool water temperatures.

The ultrafiltration was automatically backwashed every 45 min, using its own permeate water, at a rate of 250 L/m<sup>2</sup>/h for 25 s. During the backwash of one ultrafiltration element, the other element remained operational at 0.5 m<sup>3</sup>/h. During the recirculation experiments, the flow over the preceding biological sand filtration was also reduced during backwashing of the ultrafiltration. Balance tanks were used as buffers for flow fluctuations in order to maintain a constant flow of 1 m<sup>3</sup>/h over the UV-treatment to remain a constant UV-dose.

During the experiments with chlorination without recirculation, the desired free chlorine concentration was set at the lowest acceptable level according to DIN standards, 0.3 mg Cl<sub>2</sub>/L (DIN 2012a). These settings were chosen to study the microbial water quality at high dissolved anthropogenic pollutant conditions combined with lowest acceptable free chlorine levels. During the experiments with recirculation, the free chlorine level was increased to 0.5 mg Cl<sub>2</sub>/L, in accordance with minimum Dutch swimming pool regulations (VROM 2000) and WHO swimming pool guidelines (WHO 2006).

#### 4.2.5 Equipment preparation

Several procedures for cleaning and disinfection were used in between the experiments to ensure equal starting conditions for all experiments. Before each new experiment, the ultrafiltration was chemically cleaned, starting with an alkaline cleaning at a pH of 12 followed by an acidic cleaning at a pH of 2, both at 40 °C. Alkaline and acidic solutions recirculated for 2 min at a rate of 250 L/m<sup>2</sup>/h over the membranes, preceded by a 5 µm cartridge filter, and the membranes were subsequently left to soak for ≥ 5 min. After this chemical cleaning, the ultrafiltration was drained and a chemical-enhanced backwash with chlorine (100 mg Cl<sub>2</sub>/L) was performed three times for 30 s at a rate of 250 L/m<sup>2</sup>/h, followed by a fresh water backwash to remove all residual chlorine.

All sampling tubes, used for transporting water from the sampling points, were also chemically cleaned before each new experiment. Chemical cleaning was done with an alkaline cleaning at a pH of 12 at 40 °C, recirculating at a flow rate of 500 L/h per sampling tube for 2 min over a cartridge filter (5 µm), finally followed by rinsing with cold tap water for 30 s.

At least one week before the start of each new experiment, the experimental setup was started at specific experimental settings, including the BFA addition to initiate bioactivity,

without operating the microbial fouling simulators and sampling tubes. During the experiment with biological activated carbon filtration, this period was prolonged to three weeks and chlorination was started in the final week before the actual experiment to improve initiation of bioactivity in the biological activated carbon filtration. Within 48 h before each experiment, the microbial fouling simulators were prepared. The water content of the experimental setup, exclusively for the experiments with recirculation, was refreshed by increasing the fresh tap water supply within 10 h prior to the start of each experiment. Within 4 h before the start of each experiment, online measuring equipment for the pH and free chlorine were calibrated. Within 2 h prior to the start of each experiment, all granular filters (sand filtration, biological sand filtration and biological activated carbon filtration) were backwashed with cold tap water at 25 % bed expansion for 6 min and the increased fresh water intake was switched back to automatic control. Within 1 h prior to the start of each experiment, fresh BFA solutions were prepared and the weight of these BFA solutions was determined for dosage control and subsequently, the circulation of the microbial fouling simulator sampling tubes was started with microbial fouling simulator dummies. At the start of each experiment, the BFA solution was refreshed, to monitor the exact amount of BFA added during each experiment and microbial fouling simulator dummies were replaced by the prepared microbial fouling simulators.

#### *4.2.6 Preparation of chemicals*

The BFA solution was prepared shortly before starting each experiment and was stored in a refrigerator at 4 °C during the experiment and refreshed weekly. Before use, the tanks for the BFA solution were thoroughly rinsed with hot tap water ( $\geq 70$  °C), cold tap water ( $\leq 20$  °C) and demineralised water before refreshing the stock solution. The BFA solution was prepared with tap water and the dosed amount was checked by determining the weight difference between the start and end of each period.

The sodium hypochlorite solution used during the experiments with chlorination was made by diluting sodium hypochlorite (12.5 %, technical grade, VWR international) with demineralised water. This sodium hypochlorite solution was stored in a refrigerator at 4 °C during the experiment and refreshed monthly. For pH control, sulphuric acid (25 %, technical grade, VWR international) was used. Aluminium hydroxide chloride was used as a flocculant (Nuscofloc, Hydrotec) during the experiments with recirculation. A stock solution was prepared with demineralised water and stored at pH<4.

All following chemicals were of technical grade and supplied by VWR international. Sodium hydroxide (32 %) was used for alkaline cleaning, hydrochloric acid (25 %) was used for acidic cleaning, sodium hypochlorite (12.5 %) was used for disinfection after cleaning, and ethanol (70 %) was used for the disinfection of surfaces.

#### *4.2.7 Sampling and analytical methods*

Sampling water, used for all analytical parameters, was extracted from the setup and led to sampling manifolds at a constant flow of 13-15 L/h, controlled by orifices (figure 5). All circulating sampling water was returned to the tank of the corresponding setup to minimise water losses. Water samples were taken twice a week at all sampling points, including the tap water. For microbial activity, only the results of day 16, 21 and 23 were presented, because microbial activity was highest after two weeks of experiments. Samples from the setup with chlorination were neutralized with an excess of sodium thiosulfate (5 mL of a 1 M solution), with exception of samples for free and total chlorine analysis. Directly after sampling, all samples were stored in a refrigerator at 4 °C. Free and total chlorine were analysed directly after sampling. All samples for the microbial parameters cATP, iCC and NPOC were taken in duplicate and analysed within 4 h after sampling. All tap water samples were taken directly at the cold water tap after 5 min of flushing. Tap water was not treated or heated before sampling.

Traditionally, microbial water quality is measured with heterotrophic plate counts (HPCs), but this method is known to detect only a small fraction of the microbial cells and measurement is time consuming (Allen et al. 2004, Hoefel et al. 2003). Alternatively, more sensitive and rapid methods like Flow cytometry and Adenosine-tri-phosphate (ATP) measurement have been used (Hammes et al. 2008, Liu et al. 2013b, Prest et al. 2016, Siebel et al. 2008).

To minimise misinterpretations, intracellular ATP (cATP) and intact cell count (iCC) were used as they can be related to viable cells. Nevertheless, disinfection steps like chlorination and UV-treatment can inactivate microbial cells, without immediately disturbing the cell integrity, or cATP (Hammes et al. 2008, Kong et al. 2015, Vital et al. 2012). Therefore, the ATP content per cell is also an important parameter that gives information about a cell's metabolic state.

Determination of cATP was based on bioluminescence (Wielen van der and Kooij van der 2010). Water samples were filtered through a glass fibre filter, 0.7 µm, to collect all micro-organisms containing cATP. Subsequently, the cATP was extracted with a triphosphate solution (UltraLyse 7) and collected in a 15 mL cuvette. The extracted cATP was diluted with Ultralute (ATP dilution buffer), added to a luciferine/luciferase complex (Luminase) to induce the emission of light, and placed directly into a Luminometer (Junior LB 9509, fabr. Aqua-tools) to measure the generated light signal (Relative Light Units, RLU). The concentration of cATP was calculated from the RLU values using a conversion factor determined from calibration measurements with a standard solution after every 5-6 analyses with an ATP standard (UltraCheck). All chemicals and equipment used for the ATP analyses were manufactured by Aqua-tools, France.

iCC was measured with a flow cytometer (FCM) as described by (Prest et al. 2013). Two types of staining solutions were used to highlight either all cells with SYBR® Green I, or only cells without an intact cell membrane with SYBR® Green I and Propidium Iodide. All data were processed with the BD Accuri CFlow® software, and electronic gating was used to separate cells without an intact cell membrane from all cells and to remove instrument and water sample background. Where necessary, samples were diluted just before measurement with filtered (0.22 µm; Millex-GP, Millipore) bottled mineral water (EVIAN, France). Measurements were performed using a BD Accuri C6® flow cytometer (BD Accuri cytometers, Belgium). Equipment settings and protocol were all according to Prest et al. (2013).

The ATP content per cell, as measure for a cells metabolic activity, was calculated by dividing cATP by iCC results.

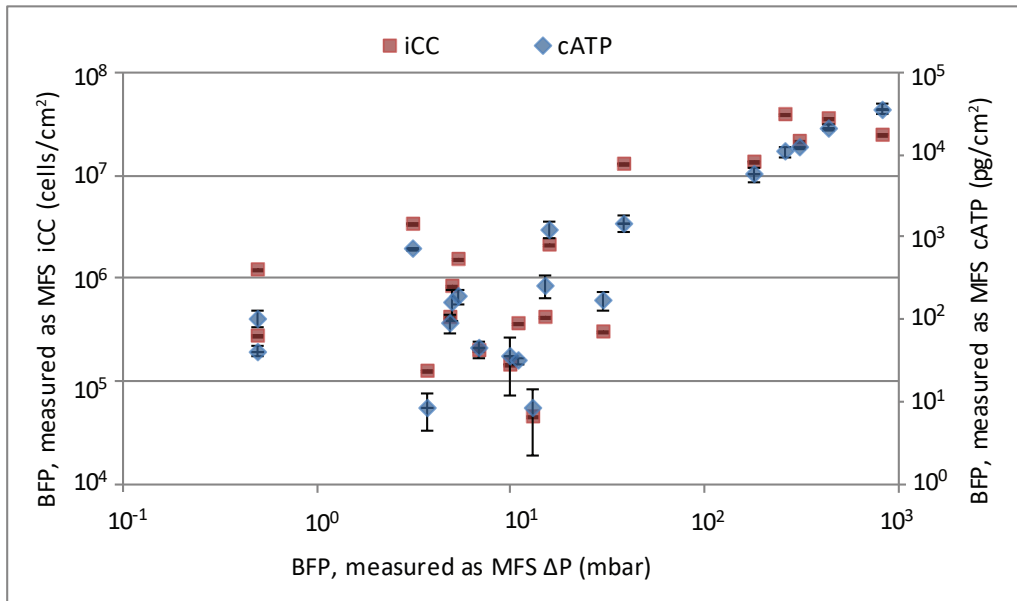
NPOC was determined according to NEN-EN 1484 (NEN, 1997) using a Shimadzu TOC-Vcph analyser. After acidifying and purging, the samples were injected into the combustion chamber at 720 °C to oxidise all carbon into CO<sub>2</sub>, which was subsequently detected by using infrared spectrometry. Samples with high particle concentration were analysed with a stirring rod in the analysing vial, ensuring a homogeneous sample at the time of analysis. NPOC results are presented as mg C per litre. Free chlorine was analysed with the DPD-method according to NEN-EN-ISO 7393-2 (NEN 2000). Phosphate was analysed colorimetrically with the Phosphomolybdenum blue method using a NOVA 60 spectrophotometer and Merck reagents (method 1.14848).

#### 4.2.8 Tap water reference

For the tap water reference, the tap water was heated to 32 °C by a water bath heater and led through a microbial fouling simulator, without the addition of nutrients or treatment. All tap water samples, for cATP, total and intact cell count, phosphate and NPOC analysis, were taken from the cold tap water before heating.

#### 4.2.9 Statistical analysis

The significance levels of the results could not be calculated statistically due to the small amount of results per experiment (2 to 6 data points). The significance levels of the influence

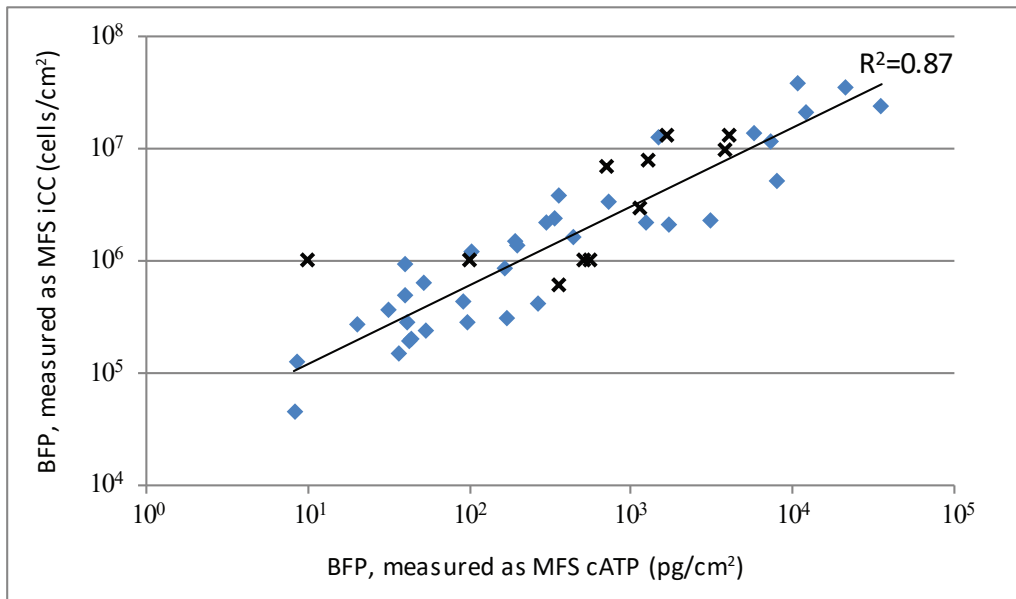


of the treatment steps were therefore determined by the accuracy levels of the analysis ( $\pm 10\%$ ). The influence of treatment steps was defined as weakly significant at a difference of 0.1-0.3 log units, moderately significant at a difference of 0.3-1 log units and strongly significant at a difference above 1 log unit. The influence of treatment steps was defined as insignificant if the difference was 0-0.1 log units.

## 4.3 Results

### 4.3.1 Microbial fouling simulator measurements

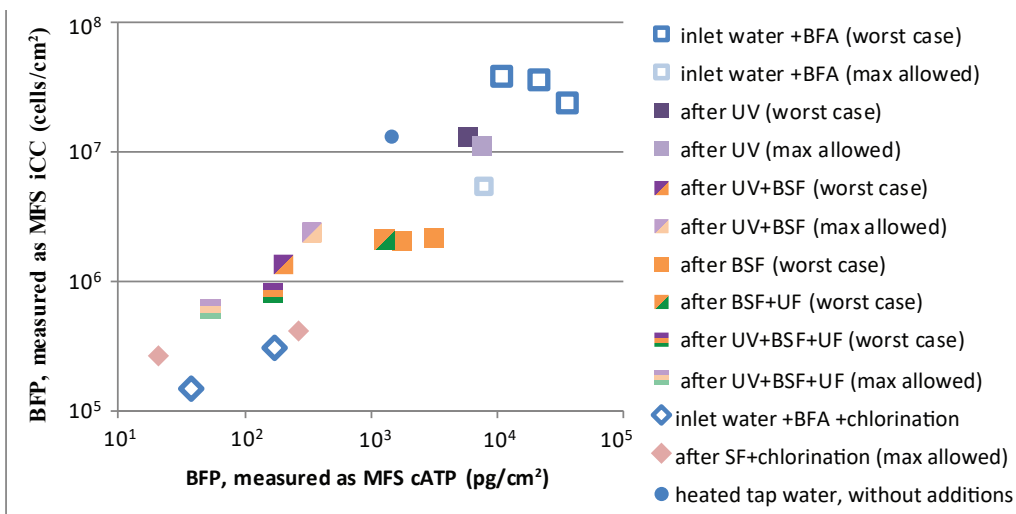
The pilot swimming pool was operated for 23 days with regular addition of body fluid analogues. The accumulation of microbial growth substrates in the pool system was monitored by on-line microbial fouling simulators in the form of the build-up of a pressure difference ( $\Delta P$ ) over the flow cell during all experiments. At the end of the experiments the formed fouling layer was assessed as iCC and cATP of the membrane spacer with PVC layers inside the microbial fouling simulator. The relationship between  $\Delta P$ , iCC and cATP of the microbial fouling simulator after 23 d for all experiments is shown in Figure 6. At high  $\Delta P$  levels, both the cATP and iCC were also high, and at low  $\Delta P$  levels, the cATP and iCC were lower. However, at low  $\Delta P$  levels  $< 50$  mbar, the relation between  $\Delta P$  and both cATP and iCC was scattered (Figure 6), while all iCC and cATP results of the biofilm inside the microbial



**Figure 7:** Correlation between iCC and cATP of biofilm from microbial fouling simulator after 23 d of operation during all experiments (blue diamond markers). Black x markers represent results found by Lehtola et.al. (2004a, 2004b, 2006). Trendline represents results from this study only.

Table 2a: Biofilm formation potential at worst case and maximum allowed conditions after 23 days of operation.				
Treatment steps	cATP ( $\times 10^2$ pg/cm <sup>2</sup> )		iCC ( $\times 10^6$ intact cells/cm <sup>2</sup> )	
	Worst case	Max allowed	Worst case	Max allowed
Inlet water with BFA, without chlorination	224	80	33	5.3
After UV	57	74	14	12
after BSF	24	-	2.2	-
After BSF with UF	12	-	2.2	-
After UV with BSF	2.0	3.3	1.4	2.4
After UV with BSF and UF	1.6	0.52	0.85	0.63
Inlet water with BFA and chlorination	1.0	-	0.23	-
After SF with chlorination	1.4	-	0.34	-
Heated tap water, without additions	15	-	13	-

UV = UV-treatment, BSF = biological sand filtration, UF = ultrafiltration, SF = sand filtration



**Figure 8:** Biofilm formation potential from microbial fouling simulator results at worst case and maximum allowed conditions after 23 d of operation. All square marker represent treatment without a residual disinfectant, all with different treatment configurations. All diamond markers represent treatment with chlorination. The circular blue marker represents the tap water reference experiment.

fouling simulators were well correlated (Figure 7). As a large part of the results was found within this scatter area, the  $\Delta P$  results were not further used.

### *4.3.2 Biofilm formation potential and microbial water quality of simulated swimming pool water*

For worst case conditions, lowest biofilm formation potential was found after sand filtration-chlorination and after UV-treatment-biological sand filtration-ultrafiltration (Table 2a, Figure 8). The use of UV-treatment or biological sand filtration alone was not enough to produce a higher biofilm forming potential as compared to heated tap water (Table 2a, Figure 8). At maximum allowed conditions after treatment, the biofilm formation potential was comparable to the worst case conditions (Table 2a, Figure 8). Similar results were found for the microbial water quality, during worst case conditions, which was lowest during UV-treatment-biological sand filtration-ultrafiltration and treatment with chlorination. Slightly reduced microbial water quality was found in the cold tap water without additions (Table 2b, Figure 9).

When the water was recirculated over the pool, treatment with chlorination had the lowest biofilm formation potential, and treatment with biological sand filtration-ultrafiltration-UV-treatment had a slightly higher biofilm formation potential (Table 3a, Figure 10). Both these treatments had biofilm formation potential even lower than the biofilm formation potential of the tap water reference (Table 2a, Figure 8). Similar results were found for microbial activity, lowest microbial activity was found with chlorination and, without phosphate addition, treatment with biological sand filtration-ultrafiltration-UV-treatment had a similar microbial activity to chlorination (Table 3b, Figure 9).

The level of free chlorine was found to influence the biofilm formation potential (Figure 11) and the microbial water quality (Figure 12). The biofilm formation potential decreased with increasing concentration of free chlorine until 0.3 mg/L  $\text{Cl}_2$ , above which it remained more or less stable at 40 pg cATP/cm<sup>2</sup>. Similarly, the microbial water quality also improved with increasing levels of chlorine, but a stabilised level was not reached.

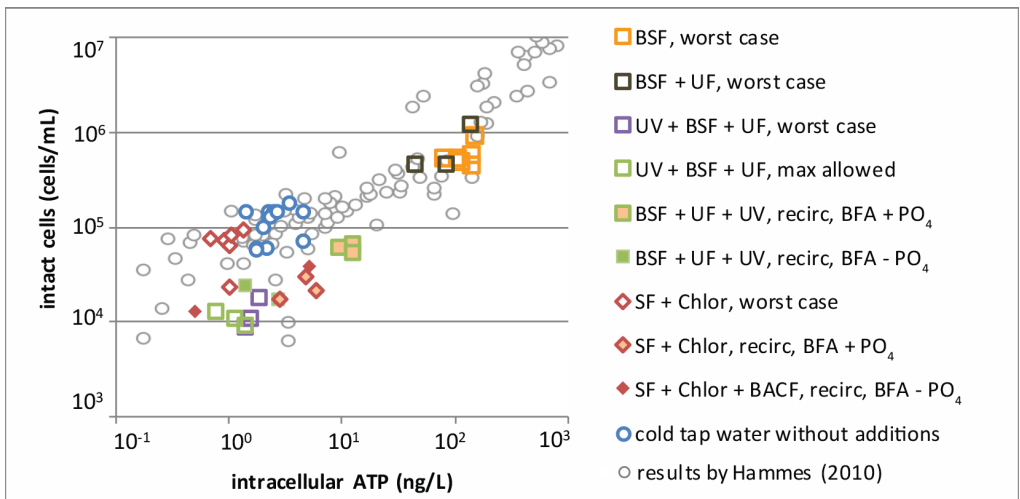
### *4.3.3 Influence of treatment steps, chemical addition and pool basin residence on biofilm formation potential and microbial water quality*

The influence of different treatment steps was calculated as  $-\log(\text{BFP}/\text{BFP}_0)$  and is shown in Tables 4a and 5a. The results of the worst case and maximum allowed conditions were combined because they were comparable (Tables 4a, Figure 8). At these conditions, biological sand filtration reduced the biofilm formation potential by approximately one log. The influence of ultrafiltration was slightly smaller and the influence of UV-treatment was smallest (Table 4a). During chlorination, sand filtration had a slightly negative influence on the biofilm forming potential (Table 4a). The influence of treatment steps on microbial activity was

**Table 2b: Microbial water quality at worst case and maximum allowed conditions after 23 days of operation.**

Water quality parameters Experiment conditions		cATP (pg/mL)		iCC (x10 <sup>3</sup> cells/mL)	
		Worst case	Max allowed	Worst case	Max allowed
Inlet water with BFA, without chlorination		139	68	422	367
After UV		65	52	457	390
after BSF		123	-	583	-
After BSF with UF		64	-	460	-
After UV with BSF		65	36	300	400
After UV with BSF and UF		1.6	1.1	13	11
Inlet water with BFA and chlorination		0.5	-	124	-
After SF with chlorination		1.0	-	68	-
Cold tap water, without additions		2.6	-	132	-

UV = UV-treatment, BSF = biological sand filtration, UF = ultrafiltration, SF = sand filtration



**Figure 9:** Microbiological water quality, quantified as concentration intact cells and cATP, during all experiments, with and without recirculation, both with different treatment steps: sand filtration (SF) + chlorination (Chlor), SF + Chlor + biological activated carbon filtration (BACF), biological sand filtration (BSF), BSF + ultrafiltration (UF), UV-treatment (UV) + BSF + UF and with different BFA compositions.

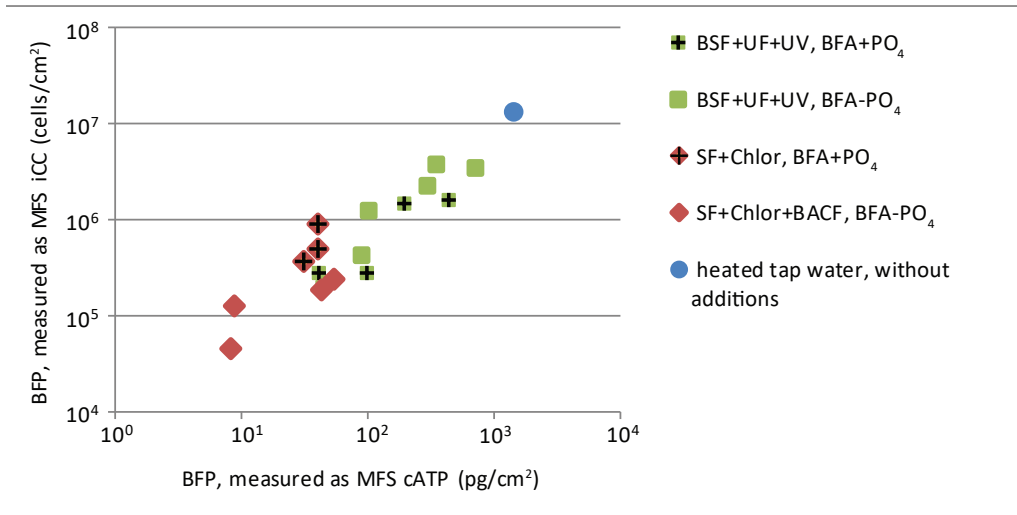


different. Represented as  $-\log(\text{ATP}/\text{ATP}_0)$  and  $-\log(\text{iCC}/\text{iCC}_0)$ , the influence of ultrafiltration was found to reduce the microbial activity by one log at combined worst case/maximum allowed conditions (Table 4b). Treatment with UV-treatment and biological sand filtration had little to no influence on the microbial activity (Table 4b).

When the water was recirculated over the pool treatment with biological sand filtration combined with ultrafiltration and UV-treatment, ultrafiltration had the largest influence on reducing the biofilm forming potential (Table 5a). When the water was recirculated with chlorination, chlorination itself had the largest influence on reducing the biofilm formation potential (Table 5a). Similarly, the microbial activity was also reduced mostly by ultrafiltration and chlorination (Table 5b).

The influence of phosphate addition was also investigated. The effect of biological sand filtration on the reduction of biofilm formation potential was larger with phosphate addition, while the influence of phosphate addition on ultrafiltration performance was negligible (Table 5a). During pool basin residence, addition of phosphate reduced the biofilm forming potential, while the potential increased during pool basin residence when there was no phosphate added (Table 5a). During chlorination, the influence of phosphate addition was less pronounced, although, with phosphate addition, the biofilm formation potential increased during pool basin residence. Similarly, the microbial activity was also influenced by phosphate addition. Biological sand filtration reduced the microbial activity when there was phosphate added, while the microbial activity increased after biological sand filtration without

Table 3a: Influence of phosphate addition on biofilm formation potential during experiments with recirculation after 23 days of operation.					
Experiment, treatment steps and pool residence		cATP ( $\times 10^2$ pg/cm <sup>2</sup> )		iCC ( $\times 10^6$ intact cells/cm <sup>2</sup> )	
		+ PO <sub>4</sub>	-PO <sub>4</sub>	+ PO <sub>4</sub>	-PO <sub>4</sub>
UV + UF + BSF	After pool basin residence	0.41	7.30	0.28	3.4
	After BFA addition	4.36	2.98	1.6	2.2
	After BSF	1.93	3.55	1.5	3.8
	After BSF with UF	0.44	0.92	0.20	0.43
	After BSF with UF and UV	0.98	1.04	0.28	1.2
	Average of BSF with UF and UV	1.62	3.16	0.78	2.2
Chlorination	After pool basin residence	0.40	0.42	0.92	0.19
	After BFA with chlorine addition	0.40	0.08	0.49	0.045
	After SF	0.31	0.09	0.37	0.13
	After BACF	-	4.58	-	1.3
	After SF with BACF (calculated)*	-	0.54	-	0.24
	Average with chlorination	0.37	0.28	0.59	0.16
* calculated proportional to the size of the side stream (100 % SF + 10 % BACF)					
UV = UV-treatment, BSF = biological sand filtration, UF = ultrafiltration, SF = sand filtration, BACF = biological activated carbon filtration					



**Figure 10:** Biofilm formation potential from microbial fouling simulator results at recirculation conditions after 23 d of operation. The square marker represent treatment combination of biological sand filtration with ultrafiltration and UV-treatment and the red diamond markers represent treatment with chlorination. The circular marker represents the tap water reference experiment. All markers highlighted with a + represent conditions with phosphate addition.

Table 3b: Influence of phosphate addition on microbial water quality during experiments with recirculation after 23 days of operation.					
Water quality parameters		cATP (pg/mL)		iCC (x10 <sup>3</sup> cells/mL)	
Treatment steps	Experiment conditions	+ PO <sub>4</sub>	-PO <sub>4</sub>	+ PO <sub>4</sub>	-PO <sub>4</sub>
BSF + UF + UV	After pool basin residence	11	2.7	60	24
	After BFA addition	3.0	4.5	31	48
	After BSF	1.8	5.3	21	39
	After BSF with UF	1.2	0.8	6.3	3.2
	After BSF with UF and UV	1.0	0.9	8.2	4.0
	Average of BSF with UF and UV	3.7	2.7	25	16.8
Chlorination	After pool basin residence	4.5	4.2	23	30
	After BFA with chlorine addition	1.3	2.8	9.8	24
	After SF	1.7	1.3	3.5	9.8
	After BACF	-	57	-	214
	After SF with BACF (calculated)*	-	6.8	-	30
	Average with chlorination	2.1	9.7	12	67
* calculated proportional to the size of the side stream (100% SF + 10% BACF)					
UV = UV-treatment, BSF = biological sand filtration, UF = ultrafiltration, SF = sand filtration, BACF = biological activated carbon filtration					

phosphate addition (Table 5b). Unlike, the reduction of microbial activity after ultrafiltration was better without phosphate addition (Table 5b). During chlorination, the microbial activity increased after pool basin residence when there was phosphate added (Table 5b).

#### 4.3.4 Concentration of NPOC, phosphate -P and free chlorine

The concentrations of NPOC, phosphate -P and free chlorine was measured during the experiments. During the worst case and maximum allowed conditions, without chlorination, the NPOC concentration of the simulated pool water was higher than the NPOC of the feed tap water, while during the experiments with recirculation without chlorination it was vice versa (Table 6). The phosphate -P concentration was more or less equal during the worst case and maximum allowed conditions at 70-100 µg/L, while phosphate -P was below the detection limit of 30 µg/L during the experiments with recirculation, despite the constant addition of 2.4 µg/L phosphate -P during one of the recirculation experiments. This constant addition would have exceeded the detection limit of 30 µg/L within 13 hours after the start of the experiment. In all measurements of the feeding tap water, phosphate -P was <30 µg/L. The free chlorine concentration was on average 0.34 mg/L Cl<sub>2</sub> during the worst case conditions, 0.54 mg/L Cl<sub>2</sub> during recirculation with phosphate addition and 0.42 mg/L Cl<sub>2</sub> during recirculation without phosphate addition.

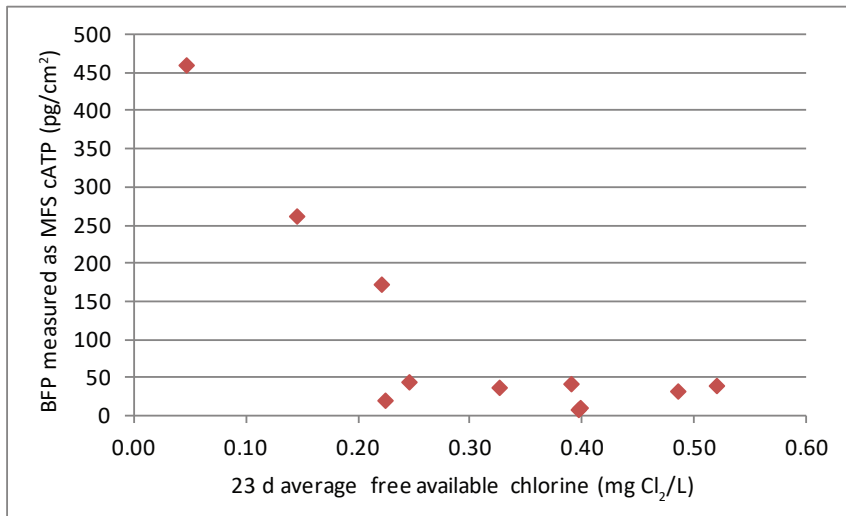
Treatment step	Intracellular ATP			Intact cell count		
	-log (BFP/BFP <sub>0</sub> )	St.d.	n	-log (BFP/BFP <sub>0</sub> )	St.d.	n
UV-treatment	0.15	0.12	2	0.06	0.40	2
Biological sand filtration	1.21	0.20	4	0.96	0.17	4
Ultrafiltration	0.35	0.33	3	0.27	0.25	3
Sand filtration (chlorinated)	0.04	0.22	2	0.07	0.07	2

Treatment step	Intracellular ATP			Intact cell count		
	-log (ATP/ATP <sub>0</sub> )	St.d.	n	-log (iCC/iCC <sub>0</sub> )	St.d.	n
UV-treatment	0.19	0.12	6	-0.04	0.03	6
Biological sand filtration	0.14	0.16	9	0.04	0.12	9
Ultrafiltration	1.01	0.61	9	0.75	0.75	9
Sand filtration (chlorinated)	-0.28	0.06	5	0.27	0.31	6

## 4.4. Discussion

### 4.4.1 Microbial fouling simulator measurements

Microbial fouling simulators are originally designed to control biofouling of spiral wound membranes, but they have been used before to study the biofilm formation potential of different waters (Hijnen et al. 2009, Liu et al. 2013a, Vrouwenvelder et al. 2006). Although originally equipped with an  $\Delta P$ -meter, in this study biofilms inside the fouling simulators were also used to analyse cATP and iCC. The scatter from the  $\Delta P$  measurement (Figure 6) increased with decreasing levels of  $\Delta P$ . Similarly, the calculated inaccuracy of the  $\Delta P$  measurement also increased at decreasing levels of  $\Delta P$ . At a  $\Delta P$  of  $\geq 50$  mbar, the calculated inaccuracy was 1 mbar, at a  $\Delta P$  of 10 mbar, the inaccuracy increased to 2 mbar and increased further to an inaccuracy of 4 and 8 mbar at a  $\Delta P$  of 5 and 2 mbar respectively (E&H 2016). Although it was expected that the  $\Delta P$  measurements would increase to above 100mbar, as found in previous studies (Liu et al. 2013a, Vrouwenvelder et al. 2010), the opposite occurred in the absence of a residual disinfectant as a large part of the  $\Delta P$  measurements were found to be near the 10 mbar level, which explains the scatter. Previous studies with microbial fouling simulators did not report this scatter at low  $\Delta P$  levels, the use of different  $\Delta P$  sensors with lower measuring range and therefore a higher accuracy at low levels explains this. Nevertheless, the results for both cATP and iCC from the microbial fouling simulators are comparable to previous biofilm studies of tap water before and after chlorination reported by Lehtola et.al. (2004a, 2004b, 2006), see Figure 7.

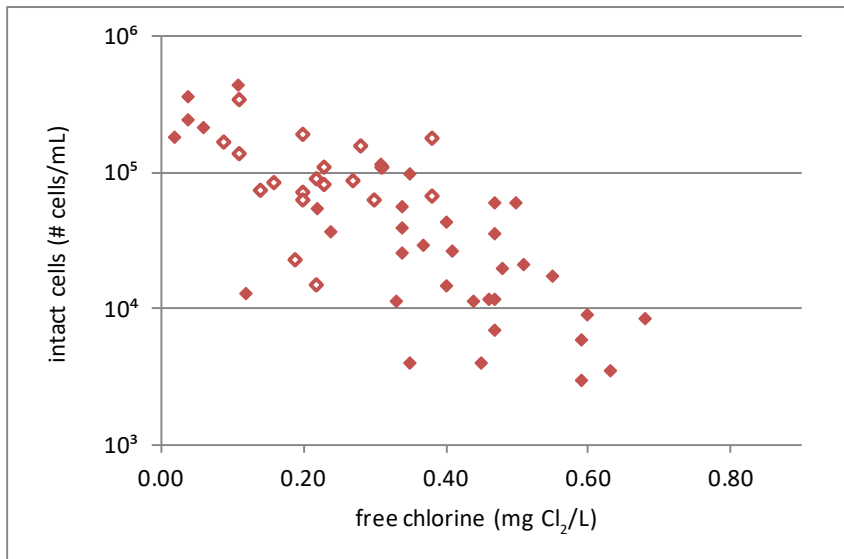


**Figure 11:** Influence of free available chlorine concentration on biofilm formation potential during experiments with chlorination and high nutrient addition, measured as cATP in biofilms from microbial fouling simulators after 23 d of operation for all treatment steps.

#### 4.4.2 Biofilm formation potential and microbial water quality of simulated swimming pool water

An acceptable level of biofilm formation potential for swimming pool water has not been discussed in literature before. Although, other studies investigated biofilm formation in pool water (Briancesco et al. 2014, Goeres et al. 2004), they used different biofilm collection techniques like swapping and submerged coupons, and both used a different microbial analysis method, so the results cannot be used as reference for this study. Therefore, in this study, chlorinated pool water and tap water were used as reference.

At worst case conditions, all treatment had a higher biofilm formation potential than the chlorinated reference (Table 2, Figure 8). Previous studies that used microbial fouling simulators for biofilm collection found results in the same range compared to this study (Liu et al. 2013a, Vrouwenvelder et al. 2010), as did studies that investigated biofilm formation on pipe segments (Lehtola et al. 2004a, Lehtola et al. 2004b, Lehtola et al. 2006). Although the previous studies had many similarities with this study like the dimensions of the microbial fouling simulator, feed flow and water type, comparison is still difficult because of remaining variables duration of the experiments like; 23-40-11 days, water temperature; 31-12-17 °C, addition and composition of nutrients; body fluid analogue - none - organic substrate, and analysis methods; intracellular ATP with intact cells –  $\Delta P$  –  $\Delta P$  with total ATP and TOC during this study - the study by Liu et al. (2013a) - and the study by Vrouwenvelder et al. (2010) respectively. A large part of the biofilm results of Lehtola et al. (2004a, 2004b and 2006) was from chlorinated tap water, collected after 2 years, which could explain the high results compared to this study. While Liu et al. (2013a) only used  $\Delta P$  measurements, which could not be compared to the  $\Delta P$  results of this study, because of the scatter. Vrouwenvelder et



**Figure 12:** Relation between the biological activity and free available chlorine during all chlorinated experiments without recirculation (open markers) and with recirculation (closed markers) after 16, 21 and 23 days of operation.

al. (2010) studied tap water without a residual disinfectant and found a similar ATP level in the microbial fouling simulators compared to the tap water reference in this study;  $1.8 \times 10^3$  pg ATP/cm<sup>2</sup> and  $1.5 \times 10^3$  pg cATP/cm<sup>2</sup> respectively. Although the duration of the experiments was much longer during this study, 23 days, versus 15 days during the study by Vrouwenvelder et al. (2010), in both cases, the  $\Delta P$  results increased only a little, 38 mbar and near 10 mbar during this study and the study by Vrouwenvelder et al. (2010) respectively, which could be explained by the longer runtime during this study. So the results of this study are comparable to previous studies, even though no good reference was found.

The combination of UV-treatment with biological sand filtration and ultrafiltration was found to give a biofilm formation potential closest to chlorination at worst case conditions (Table 2a, Figure 8). At maximum allowed conditions, the biofilm forming potential after the combination of UV-treatment with biological sand filtration and ultrafiltration was even lower than the biofilm formation potential found in tap water studies (Lehtola et al. 2004a, Lehtola et al. 2004b, Lehtola et al. 2006, Liu et al. 2013a, Vrouwenvelder et al. 2010). When the water was recirculated, the biofilm formation potential of both the chlorinated pool water and treatment combination of biological sand filtration with ultrafiltration and UV-treatment was further reduced compared to the worst case conditions (Table 3a, Figure 9). It was expected that the use of biological filtration would reduce the biofilm formation potential because this has been shown before in tap water studies (Urfer et al. 1997). The influence of ultrafiltration on biofilm formation potential was not expected and is discussed in the next section. As biofilm formation is constantly restrained by a residual disinfectant in the treatment with

Table 5a: Influence of treatment steps, chemical additions and pool basin residence on biofilm formation potential at recirculation conditions after 23 days of operation.					
Type of disinfection and sampling point	cATP ( $\times 10^2$ pg/cm <sup>2</sup> ) -log (BFP/BFP <sub>0</sub> )		iCC ( $\times 10^6$ intact cells/cm <sup>2</sup> ) -log (BFP/BFP <sub>0</sub> )		
	+ PO <sub>4</sub>	-PO <sub>4</sub>	+ PO <sub>4</sub>	-PO <sub>4</sub>	
BSF + UF + UV	pool basin residence	0.38	-0.85	0.00	-0.45
	BFA addition	-1.02	0.39	-0.75	0.19
	Biological sand filtration	0.35	-0.08	0.03	-0.24
	Ultrafiltration	0.64	0.59	0.87	0.95
	UV-treatment	-0.35	-0.06	-0.14	-0.45
Chlorination	After pool basin residence	-0.11	0.10	-0.39	0.10
	BFA with chlorine addition	0.00	0.71	0.27	0.62
	Sand filtration	0.10	-0.02	0.12	-0.45
	BACF	-	-1.72	-	-0.99
	SF + BACF (calculated)*	-	-0.81	-	-0.72
* calculated proportional to the size of the side stream (100 % SF + 10 % BACF)					
BACF = biological activated carbon filtration					

chlorination (Goeres et al. 2004), it was not expected that in the absence of a residual disinfectant, as was the case with the combination of biological sand filtration with ultrafiltration and UV-treatment, the biofilm formation potential would be so close to chlorinated pool water.

The microbial water quality of the tap water reference was found to be similar to previous study by Prest et al. (2016). As expected, the addition of nutrients at worst case conditions reduced the microbial water quality, while addition of treatment steps improved the microbial water quality. Previous studies showed the influence of ultrafiltration (Hammes et al. 2010, Iannelli et al. 2014), UV-treatment (Hijnen et al. 2006), and chlorination (Borgmann-Strahsen 2003). Similar results were also found when the water was recirculated.

#### 4.4.3 The influence of treatment steps on biofilm formation potential

During the worst case conditions, the addition of treatment steps gradually reduced the biofilm formation potential (Table 2a, Figure 8). Biological sand filtration resulted in the biggest reduction of biofilm formation potential (Table 4a), however, when the pool water was recirculated, ultrafiltration was found to have the biggest reduction (Table 5a). The positive effect of biological sand filtration on the biofilm forming potential was probably due to the removal of biodegradable matter, so less nutrients were available after biological sand filtration, which results in a lower biofilm forming potential (Urfer et al. 1997). When the pool water was recirculated, NPOC was reduced to a lower level compared to the worst case

Type of disinfection and sampling point		cATP (pg/mL) -log (ATP/ATP <sub>0</sub> )		iCC (x10 <sup>3</sup> cells/mL) -log (iCC/iCC <sub>0</sub> )	
		+ PO <sub>4</sub>	-PO <sub>4</sub>	+ PO <sub>4</sub>	-PO <sub>4</sub>
BSF + UF + UV	pool basin residence	-1.06	-0.75	-0.87	-0.45
	BFA addition	0.59	-0.38	0.30	0.19
	Biological sand filtration	0.22	-0.08	0.16	-0.24
	Ultrafiltration	0.15	1.01	0.53	0.95
	UV-treatment	0.09	0.19	-0.11	-0.45
Chlorination	After pool basin residence	-0.81	0.43	-0.81	0.10
	BFA with chlorine addition	0.54	0.02	0.36	0.62
	Sand filtration	0.27	0.12	0.45	-0.45
	BACF	-	-1.45	-	-0.99
	SF + BACF (calculated)*	-	-0.45	-	-0.72
* calculated proportional to the size of the side stream (100 % SF + 10 % BACF)					
BACF = biological activated carbon filtration					

conditions without recirculation (Table 6), even below the NPOC of the feeding tap water, despite the constant addition of nutrients (Table 1). It is expected that micro-organisms were at the level of starvation, which increases biofilm detachment (Dawson et al. 1981, Hunt et al. 2004), which explains the reduced efficiency of the biological sand filtration. Whether micro-organisms are at a level of starvation can be seen at a cells metabolic state, that can be measured by the cells ATP/cell level, which, below  $10^{-7}$  ng ATP/cell is reported for starving cells (Webster et al. 1985). The metabolic state was calculated by dividing the measured cATP level by the intact cell count. During the worst case conditions, the ATP/cell level after biological sand filtration was  $2.2 \times 10^{-7}$  ng ATP/cell, not a starvation level, while during the recirculation experiments it was  $0.9 \times 10^{-7}$  ng ATP/cell after biological sand filtration, which is a starvation level. Apparently, the biological filtration removed all nutrients, creating a state of starvation after the biological filtration, despite the constant addition of nutrients. At a starvation level, micro-organisms are more likely to detach from biofilms (Hunt et al. 2004), after which they are transported with the bulk water, passing all treatment steps, but they cannot pass the ultrafiltration, probably growing and removing nutrients. This probably explains the increased biofilm formation potential-removal by the ultrafiltration when the water was recirculated. Although detachment can also be triggered by accumulation of metabolic products (Hunt et al. 2004), it is not likely that accumulation occurred during the conditions with recirculation because the water refreshment rate at 16.8 L/h was rather high for a 500 L system content due to the frequent backwashes of the ultrafiltration.

UV-disinfection alone had little influence on the biofilm formation potential (Tables 4a and 5a). At worst case conditions, UV-treatment slightly reduced the biofilm formation potential, while during recirculation, UV-treatment increased the biofilm formation potential. It is known that UV-treatment can cleave large NPOC molecules into smaller fractions, but without an increase of assimilable organic matter (AOC) (Choi and Choi 2010, Shaw et al. 2000). In this study, the UV-dose was even lower compared to the experiments by Choi and Shaw, so influence on AOC was not expected and UV-treatment was mainly used as disinfection.

During chlorination, the biofilm formation potential was found to be lowest, but treatment steps like sand filtration or biological activated carbon filtration increased the biofilm formation potential (Tables 4a and 5a). This can be explained by the free chlorine concentrations. Directly after sand filtration, free chlorine was lower most likely due to the free chlorine

**Table 6: Average concentrations of NPOC and phosphate-P at worst case and maximum allowed conditions in tap water and simulated pool water without chlorination.**

Experiment conditions	tap water	Simulated pool water		
	NPOC (mg/L)	NPOC inlet (mg/L)	NPOC outlet (mg/L)	PO <sub>4</sub> -P (µg/L)
Worst case conditions	2.93	4.44	3.08	70
Max allowed conditions	3.11	3.60	3.37	100
Recirculation with phosphate addition	1.87	1.19	1.11	<30
Recirculation without phosphate addition	2.29	1.82	1.79	<30



consumption of the retained pollutants in the filter bed. As shown in Figure 11, lower free chlorine levels led to a higher biofilm formation potential. A similar explanation can be used for the biological activated carbon filtration, where all free chlorine is removed during filtration and biofilm formation potential in the effluent was found to be highest for all samples from the chlorinated treatment (Table 5a). Higher biofilm reduction at higher free chlorine was also found by Goeres et al. (2004).

#### *4.4.4 The influence of treatment steps on the microbial water quality*

The use of ultrafiltration in combination with biological sand filtration was not enough to improve the microbial water quality to a desired level (Table 2b), while ultrafiltration has been reported to reach log removals, up to 7 log units, for removal of *Cryptosporidium* and viruses (Jacangelo et al. 1995), with similar ultrafiltration membranes as used in this study. Here, removal was restricted by the detection limit of the analytic measurements, combined with the low level of microbial counts, so log reductions above 1.8 log units could not be detected. Nevertheless, ultrafiltration, when used in combination with biological sand filtration and UV-treatment, resulted in the best microbial water quality of all treatment steps (Tables 4b and 5b).

Other treatment steps seemed to have a small influence on the microbial water quality (Tables 4b and 5b). Biological sand filtration did not reduce the microbial count, as the biological community inside the biological sand filtration mainly removes dissolved substances like urea and parts of the NPOC (Rogalla et al. 1990, Urfer et al. 1997). Granular filtration, like sand filtration, is capable of removing micro-organisms, with higher retentions at lower filtration rates (Amburgey et al. 2011) and in combination with a well-functioning coagulation (Amburgey et al. 2011, Rajala et al. 2003). It is also known, that micro-organisms are released from these filters near the end of a filter run (Harrington et al. 2003) and detachment from biofilms is increased near starvation conditions (Dawson et al. 1981, Hunt et al. 2004). It is therefore expected that both the removal of nutrients and release of micro-organisms can explain the results found for the biological sand filtration.

The weak to moderate effect of UV-treatment and chlorination (Table 4b) is probably due to the chosen analytical methods. It has been found before that cells could be in the process of starving, but still show up during analysis after chlorination or UV-treatment (Hammes et al. 2008, Kong et al. 2015, Zhang et al. 2015), because cell membrane is not ruptured immediately during treatment and cells still contain cATP directly after treatment. Therefore, these methods tend to overestimate the microbial count (Kong et al. 2015). Both UV-treatment and chlorination are well known for their disinfection capacity (Desiderio and Nibbering 2010, Hijnen et al. 2006) and it is expected that the low microbial counts found when the water was recirculated were due to UV-treatment and chlorination.

#### *4.4.5 The influence of phosphate on biofilm formation potential and microbial water quality*

When the water was recirculated combined with chlorination, biofilm formation potential was more or less equal after pool basin residence with or without phosphate addition (Table 3a). This means that free chlorine is the dominant restraining parameter for biofilm formation potential and limitation of phosphate does not further reduce the biofilm formation potential.

In the absence of a residual disinfectant, as was the case with the combination of biological sand filtration with ultrafiltration and UV-treatment, there is not a restraining environmental parameter, such as the free chlorine level. Therefore, the efficiency of this treatment is mainly based on microbial processes. As shown before by Vrouwenvelder et al. (2010), it was expected that reduction of phosphate would reduce biofilm formation and, as a result, also the microbial number would reduce. However, there was little difference with or without phosphate addition, although after pool basin residence, biofilm formation potential was lowest with phosphate addition (Table 3a), while microbial count was highest. A probable explanation is that due to the increased NPOC reduction with phosphate addition (Table 6), the metabolic state of the cells, as shown before, was at starvation level, which resulted in the detachment of micro-organisms from the biofilm (Hunt et al. 2004), increasing the microbial count after pool basin residence (Table 3b), which explains the higher microbial count with phosphate addition.

## **4.5 Conclusions**

This study aimed to investigate the effect of different treatment steps for swimming pool water in the context of a development towards a chlorine free swimming pool. Treatment of a simulated pool water system with biological sand filtration-ultrafiltration-UV-treatment combination can control the biofilm forming potential and give a low microbial count, without the use of a residual disinfectant.

It can be concluded that the biofilm formation found in the tap water reference in this study was comparable with previous studies. At worst case conditions, highest reduction of biofilm formation was found after treatment with the combination of biological sand filtration-ultrafiltration-UV-treatment, much lower than the tap water reference, which was similar when the water was recirculated. Nevertheless, treatment with chlorination was found to have an even lower biofilm formation potential.

In the absence of a residual disinfectant, multiple treatment steps were needed to reduce the biofilm forming potential and improve the microbial water quality of simulated swimming pool water to levels observed in drinking water. Ultrafiltration played an important role in maintaining a low concentration of micro-organisms. In a chlorinated treatment, the presence of a minimum free chlorine level was sufficient to maintain a low biofilm formation potential and a low microbial count.

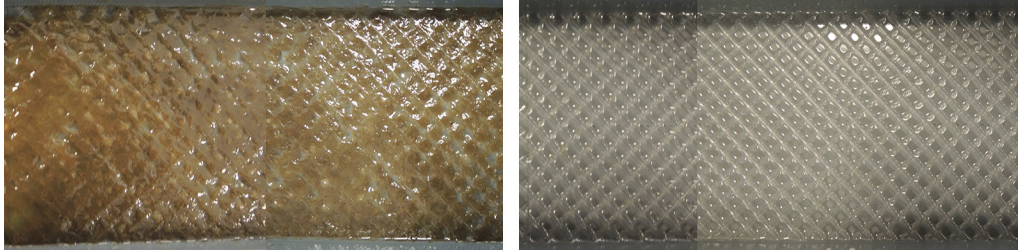
Experiments with and without phosphate addition showed that in a chlorinated treatment, free chlorine is the main controlling parameter for biofilm formation potential, while in a treatment with biological sand filtration-ultrafiltration-UV-treatment, the addition of phosphate improved the efficiency of the treatment, reducing the biofilm formation potential, but reduced the microbial water quality.

## 4.6 Supplementary Material

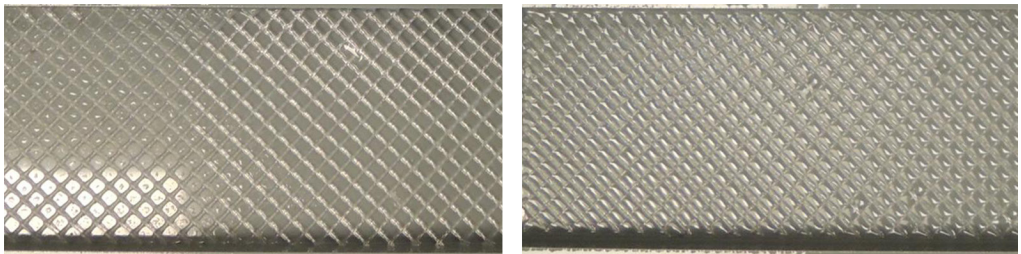
### *Annex A. Experimental setup*

Table S1: Design specifications filter components of experimental setup					
Figure	Component	Filter diameter / membrane surface	Filtration rate	Grain size / MWCO	Bed height / inside diameter fibres
S1	Biological Sand Filtration	306 mm	13.6 m/h	0.80-1.25 mm	1.0 m
S2	Biological Sand Filtration	269 mm	17.6 m/h	1.0-2.0 mm	1.0 m
	Ultra Filtration (SevenBore® fibres)	2 x 5.8 m <sup>2</sup>	86 L/m <sup>2</sup> /h	100-150 KD MWCO	0.9 mm
S3	Biological Sand Filtration	269 mm	17.6 m/h	1.0-2.0 mm	1.0 m
	Ultra Filtration (SevenBore® fibres)	2 x 5.8 m <sup>2</sup>	86 L/m <sup>2</sup> /h	100-150 KD MWCO	0.9 mm
S4	Sand Filter	306 mm	13.6 /h	0.80-1.25 mm	1.0 m
S4c	Biological Activated Carbon Filtration	90 mm	19.2 m/h	1.0-3.0 mm	0.9 m

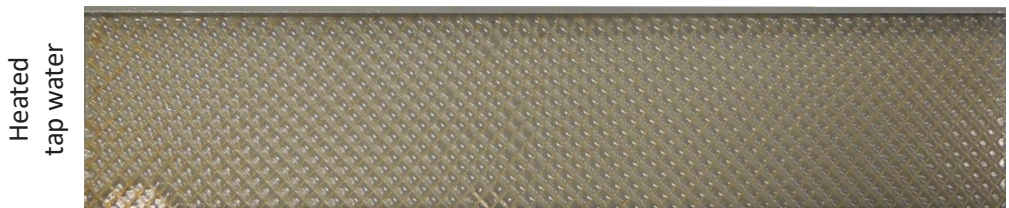
## Annex B. Pictures of biofilm inside MFS units



**Figure S1:** Membrane spacer inside MFS unit (first 8 cm) at inlet (left) and outlet (right) of biological sand filtration during worst case conditions after 23 d of operation. Flow direction was left to right.

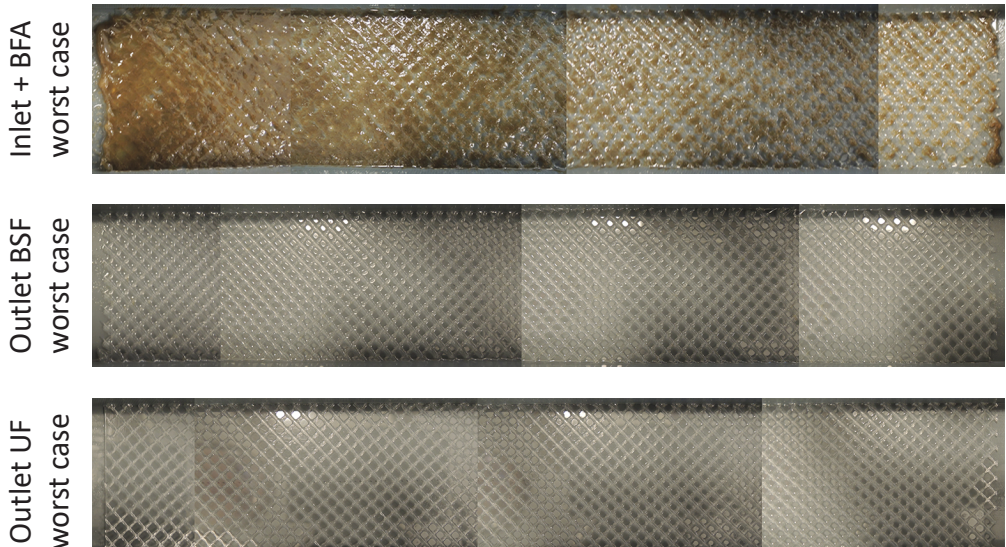


**Figure S2:** Membrane spacer inside MFS unit (first 8 cm) during experiment with chlorination (left) and experiment with UV-disinfection (right), both with recirculation after 23 d of operation. Flow direction was left to right.



**Figure S3:** Membrane spacer inside MFS units of heated tap water after 23 d duration. Flow direction was left to right.





**Figure S4:** Membrane spacer inside MFS units after different treatment steps during worst case conditions after 23 d duration. Flow direction was left to right.



**Figure S5:** Membrane spacer inside MFS units at recirculation conditions after 23 d duration. Flow direction was left to right.

## Annex C. Composition of the Body Fluid Analogue

A Body Fluid Analogue (BFA) is a mixture of different anthropogenic pollutants which is used in many swimming pool studies to investigate the formation of disinfection by-products from anthropogenic pollutants (Bradford 2014). The mixture described by Judd and Black (2000) is often used in scientific studies and was based on the assumption that bathers release 50 ml of urine and 200 ml of sweat per cubic metre of pool water.

Previous research (Keuten et al. 2012, Keuten et al. 2014) showed that the anthropogenic pollutants released by bathers were not similar to the estimations done by Judd and Black (2000). The main difference was the carbon-to-nitrogen ratio, described as C/N and calculated by dividing the concentration of non-purgeable organic carbon (NPOC) by the concentration of total nitrogen (TN). The C/N ratio calculated from its chemical composition of the Judd-BFA was at 0.58 (Judd and Black 2000), whereas Keuten et al. found a C/N ratio of 3.23 (2012, 2014) calculated from NPOC and TN measurements.

To increase the organic load of the BFA from the level described by Judd et al. to the level described by Keuten et al., a C/N ratio of 3.23, different organic carbons were added to the BFA composition during trial experiments. During all these trial experiments, with C/N ratio 3.23, the feed pressure of the sand filters increased rapidly after initiating the BFA addition up to  $\geq 1$  bar within 6 h of operation. It was not clear what caused this clogging of the sand filters. It was observed that a cake-layer was formed with the top 1-2 cm of the media inside. This was strange because no particles were added to the experimental setup. It was expected that the cake-layer was formed as a result of the high carbon content of the BFA which seemed to act as glue. Proper mixing of the added BFA could not have been the cause of this problem because the BFA was added before the centrifugal pumps that acted as mixers. The clogging of the sand filters did not occur at lower organic loads near the Judd C/N ratio of 0.58, therefore, these lower C/N ratios were used during this study.

BFA composition	Experiments without recirculation		Experiments with recirculation	
	high BFA	low BFA	with PO <sub>4</sub>	without PO <sub>4</sub>
Urea (g/L)	137	34.3	5.27	5.27
Creatine monohydrate (g/L)	12.3	3.08	0.47	0.47
Sodium citrate (g/L)	9.72	2.43	0.37	0.37
K <sub>2</sub> HPO <sub>4</sub> (g/L)	15.4	15.4	0.54	0.00
Dosing rate (mL/h)	60	60	25	25

## Acknowledgements

This study was part of the DIPool project (Dutch Innovative Pool). The project was funded by communal subsidies from the Netherlands Enterprise Agency and EFRO in combination with private funding from Delft University of Technology, Hellebrekers Technieken, Akzo Nobel Industrial Chemicals B.V., Van Remmen UV Techniek, Coram International B.V. and Sportfondsen Nederland B.V. The authors thank Het Waterlaboratorium for their help with microbiological analyses and thanks to Adele Sanders for reviewing the language and spelling.

## 4.7 References

- Allen, M.J., Edberg, S.C. and Reasoner, D.J. (2004) Heterotrophic plate count bacteria—what is their significance in drinking water? *International journal of Food microbiology* 92(3), 265-274.
- Amburgey, J.E., Goodman, J.M., Aborisade, O., Lu, P., Peeler, C.L., Shull, W.H., Fielding, R.R., Arrowood, M.J., Murphy, J.L. and Hill, V.R. (2011) Are swimming pool filters really removing *Cryptosporidium*. Beleza, V.M. and Brás Pereira, I.M. (eds), pp. 132-142, Fourth International Conference Swimming Pool & Spa, Porto.
- Angenent, L.T., Kelley, S.T., St. Amand, A., Pace, N.R. and Hernandez, M.T. (2005) Molecular identification of potential pathogens in water and air of a hospital therapy pool. *Proceedings of the National Academy of Sciences of the United States of America* 102(13), 4860-4865.
- Araújo, P.A., Miller, D.J., Correia, P.B., van Loosdrecht, M.C.M., Kruijthof, J.C., Freeman, B.D., Paul, D.R. and Vrouwenvelder, J.S. (2012a) Impact of feed spacer and membrane modification by hydrophilic, bactericidal and biocidal coating on biofouling control. *Desalination* 295, 1-10.
- Araújo, P.A., Kruijthof, J.C., van Loosdrecht, M.C.M. and Vrouwenvelder, J.S. (2012b) The potential of standard and modified feed spacers for biofouling control. *Journal of Membrane Science* 403-404, 58-70.
- Barna, Z. and Kádár, M. (2012) The risk of contracting infectious diseases in public swimming pools. A review. *Annali dell'Istituto Superiore di Sanita* 48(4), 374-386.
- Boere, J.A., van Straaten, D.G.J., van Leengoed, L.P.M. and van der Hoeve, A. (1990) Verbetering van het zuiveringsrendement bij zwembadwaterbehandeling door toepassing van dubbellaagsfiltratie (Improvement of pool water treatment efficacy with the use of multilayer filtration). Ministry of Housing, S.P.a.t.E. (ed), p. 136, SdU, The Hague.
- Borgmann-Strahsen, R. (2003) Comparative assessment of different biocides in swimming pool water. *International Biodeterioration & Biodegradation* 51(4), 291-297.
- Bradford, W.L. (2014) What bathers put into a pool: A critical review of body fluids and a body fluid analog. *International journal of Aquatic Research and Educatiaon* 8(2), 168-181.
- Briancesco, R., Meloni, P., Semproni, M. and Bonadonna, L. (2014) Non-tuberculous mycobacteria, amoebae and bacterial indicators in swimming pool and spa. *Microchemical Journal* 113, 48-52.
- Caramello, S. and Amisano, G. (2001) Study of disinfection of swimming pool water with U.V. radiation: Laboratory tests. *Igiena moderna* 116(5), 257-275.
- Cateau, E., Delafont, V., Hechard, Y. and Rodier, M.H. (2014) Free-living amoebae: What part do they play in health-care-associated infections? *Journal of Hospital Infections* 87(3), 131-140.
- Choi, Y. and Choi, Y.-j. (2010) The effects of UV disinfection on drinking water quality in distribution systems. *Water Research* 44(1), 115-122.
- Crandall, R.A. (1986) The use of ultraviolet light in the treatment of water in public spas and hot tubs. *Journal of Environmental Health* 49(1), 16-23.

- Davis, T.L., Standridge, J.H. and Degnan, A.J. (2009) Bacteriological analysis of indoor and outdoor water parks in Wisconsin. *Journal of Water and Health* 7(3), 452-463.
- Dawson, M.P., B.A., H. and Marshall, K.C. (1981) Adhesion: A Tactic in the Survival Strategy of a Marine *Vibrio* During Starvation. *Current Microbiology* 6(4), 195-199.
- Desiderio, D.M. and Nibbering, N.M.M. (2010) *White's Handbook of Chlorination and Alternative Disinfectants: Fifth Edition*.
- DIN (2012a) *Aufbereitung von Schwimm- und Badebeckenwasser, Teil 2: Festbett- / Anschwemmfilter (Treatment of water of swimming pools and baths - Part 2: Combinations of process with fixed bed filters and precoat filters)*, Beuth Verlag GmbH.
- DIN (2012b) *Aufbereitung von Schwimm- und Badebeckenwasser - Teil 4: Verfahrenskombinationen mit Ultrafiltration (Treatment of water of swimming pools and baths - Part 4: Combinations of process with ultrafiltration)* Beuth Verlag GmbH.
- Dingman, J.D. (1990) The effectiveness of ultraviolet light/hydrogen peroxide. *Journal of Environmental Health* 52(6), 341-343.
- E&H (2016) *Technical information Deltabar M PMD55*, E&H, Reinach.
- Eichelsdörfer, D., Slovak, J., Dirnagl, K. and Schmid, K. (1975) Zur Reizwirkung (Konjunctivitis) von Cholra und Chloraminen im Schwimmbeckenwasser. *Vom Wasser* 45, 17-28.
- Emlko, M.B., Huck, P.M., Coffey, B.M. and Smith, E.F. (2006) Effects of media, backwash, and temperature on full-scale biological filtration *Journal of American Water Works Association* 98(12), 61-73.
- Erdinger, L., Kirsch, F. and Sonntag, H.G. (1998) Irritierende Wirkung von Nebenprodukten der Schwimmbadwasserdesinfektion. *Zentralblatt für Hygiene und Umweltmedizin* 200(5-6), 491-503.
- Font-Ribera, L., Kogevinas, M., Zock, J.P., Gómez, F.P., Barreiro, E., Nieuwenhuijsen, M.J., Fernandez, P., Lourencetti, C., Pérez-Olabarría, M., Bustamante, M., Marcos, R., Grimalt, J.O. and Villanueva, C.M. (2010) Short-Term Changes in Respiratory Biomarkers after Swimming in a Chlorinated Pool. *Environmental Health Perspectives* 118(11), 1538-1544.
- Font-Ribera, L., Kogevinas, M., Schmalz, C., Zwiener, C., Marco, E., Grimalt, J.O., Liu, J., Zhang, X., Mitch, W.A., Critelli, R., Naccarati, A., Heederik, D., Spithoven, J., Arjona, L., De Bont, J., Gracia-Lavedan, E. and Villanueva, C.M. (2016) Environmental and personal determinants of the uptake of disinfection by-products during swimming. *Environmental Research* 149, 206-215.
- Giampaoli, S., Garrec, N., Donzé, G., Valeriani, F., Erdinger, L. and Romano Spica, V. (2014) Regulations concerning natural swimming ponds in Europe: considerations on public health issues. *Journal of Water and Health* 12(3), 564-572.
- Glauner, T., Waldmann, P., Frimmel, F. and Zwiener, C. (2005) Swimming pool water—fractionation and genotoxicological characterization of organic constituents. *Water Research* 39, 4494-4502.
- Goeres, D.M., Palys, T., Sandel, B.B. and Geiger, J. (2004) Evaluation of disinfectant efficacy against biofilm and suspended bacteria in a laboratory swimming pool model. *Water Research* 38(13), 3103-3109.
- Guida, M., Di Onofrio, V., Gallè, F., Gesuele, R., Valeriani, F., Liguori, R., Romano Spica, V. and Liguori, G. (2016) *Pseudomonas aeruginosa* in swimming pool water: Evidences and perspectives for a new control strategy. *International Journal of Environmental Research and Public Health* 13(9).
- Hammes, F., Berney, M., Wang, Y., Vital, M., Köster, O. and Egli, T. (2008) Flow-cytometric total bacterial cell counts as a descriptive microbiological parameter for drinking water treatment processes. *Water Research* 42(1-2), 269-277.
- Hammes, F., Berger, F., Köster, O. and Egli, T. (2010) Assessing biological stability of drinking water without disinfectant residuals in a full-scale water supply system. *Journal Water Supply Res* 59(1), 31-40.
- Harrington, G.W., Xagorarakis, I., Assavasivasukul, P. and Standridge, J.H. (2003) Effect of Filtration Conditions on removal of emerging waterborne pathogens. *Journal of American Water Works Association* 95(12), 95-104.



- Hijnen, W.A.M., Beerendonk, E.F. and Medema, G.J. (2006) Inactivation credit of UV radiation for viruses, bacteria and protozoan (oo)cysts in water: A review. *Water Research* 40(1), 3-22.
- Hijnen, W.A.M., Biraud, D., Cornelissen, E.R. and Kooij van der, D. (2009) Threshold concentration of easily assimilable organic carbon in feedwater for biofouling of spiral-wound membranes. *Environmental science & technology* 43(13), 4890-4895.
- Hoefel, D., Grooby, W.L., Monis, P.T., S., A. and Saint, C.P. (2003) Enumeration of water-borne bacteria using viability assays and flow cytometry: a comparison to culture-based techniques. *Journal of Microbiological Methods* 55(3), 585-597.
- Hunt, S.M., Werner, E.M., Huang, B., Hamilton, M.A. and Stewart, P.S. (2004) Hypothesis for the Role of Nutrient Starvation in Biofilm Detachment. *Applied and Environmental Microbiology* 70(12), 7418-7425.
- Iannelli, R., Ripari, S., Casini, B., Buzzigoli, A., Privitera, G., Verani, M. and Carducci, A. (2014) Feasibility assessment of surface water disinfection by ultrafiltration. *Water science and Technology: Water Supply* 14(4), 522-531.
- IenM (2011) Drinkwaterbesluit (Dutch Drinking water Regulation). Environment, M.o.I.a.T. (ed), SdU, Ministry of Infrastructure and the Environment, The Hague, The Netherlands.
- Jacangelo, J.G., Adham, S.S. and Laïné, J.M. (1995) Mechanism of Cryptosporidium, Giardia, and MS2 Virus Removal by MF and UF. *Journal of American Water Works Association* 87(9), 107-121.
- Judd, S.J. and Black, S.H. (2000) Disinfection by-product formation in swimming pool waters: a simple mass balance. *Water Research* 34(5), 1611-1619.
- Keuten, M.G.A., Schets, F.M., Schijven, J.F., Verberk, J.Q.J.C. and van Dijk, J.C. (2012) Definition and quantification of initial anthropogenic pollutant release in swimming pools. *Water Research* 46(11), 11.
- Keuten, M.G.A., Peters, M.C.F.M., Daanen, H.A.M., de Kreuk, M.K., Rietveld, L.C. and van Dijk, J.C. (2014) Quantification of continual anthropogenic pollutants released in swimming pools. *Water Research* 53, 259-270.
- Kogevinas, M., Villanueva, C.M., Font-Ribera, L., Liviak, D., Bustamante, M., Espinoza, F., Nieuwenhuijsen, M.J., Espinosa, A., Fernandez, P., DeMarini, D.M., Grimalt, J.O., Grummt, T. and Marcos, R. (2010) Genotoxic Effects in Swimmers Exposed to Disinfection By-products in Indoor Swimming Pools. *Environmental Health Perspectives* 118(11), 1531-1537.
- Kong, X., Ma, J., Wen, G. and Wei, Y. (2015) Considerable discrepancies among HPC, ATP, and FCM detection methods in evaluating the disinfection efficiency of Gram-positive and -negative bacterium by ultraviolet radiation and chlorination. *Desalination and Water Treatment* 57(37), 17537-17546.
- Kooij van der, D. (1992) Assimilable organic carbon as an indicator of bacterial regrowth. *Journal of American Water Works Association* 84(2), 57-65.
- Kooij van der, D. (2000) Biological stability: a multidimensional quality aspect of treated water. *Water, air, soil poll* 123(1-4), 25-34.
- Lachocki, T. (2011) Why society needs aquatics and why society does not know it, Fourth International Conference Swimming Pool & Spa, Porto.
- Lakind, J.S., Richardson, S.D. and Blount, B.C. (2010) The good, the bad, and the volatile: Can we have both healthy pools and healthy people? *Environmental Science and Technology* 44(9), 3205-3210.
- Lehtola, M.J., Juhna, T., Miettinen, I.T., Vartiainen, T. and Martikainen, P.J. (2004a) Formation of biofilms in drinking water distribution networks, a case study in two cities in Finland and Latvia. *Journal of Industrial Microbiology & Biotechnology* 31(11), 489-494.
- Lehtola, M.J., Miettinen, I.T., Keinänen, M.M., Kekki, T.K., Liane, O., Hirvonen, A., Vartiainen, T. and Martikainen, P.J. (2004b) Microbiology, chemistry and biofilm development in a pilot drinking water distribution system with copper and plastic pipes. *Water Research* 38(17), 3769-3779.
- Lehtola, M.J., Laxander, M., Miettinen, I.T., Hirvonen, A., Vartiainen, T. and Martikainen, P.J. (2006) The effects of changing water flow velocity on the formation of biofilms and water quality in pilot distribution system consisting of copper or polyethylene pipes. *Water Research* 40(11), 2151-2160.

- Liu, G., Lut, M.C., Verberk, J.Q.J.C. and van Dijk, J.C. (2013a) A comparison of additional treatment processes to limit particle accumulation and microbial growth during drinking water distribution. *Water Research* 47(8), 2719-2728.
- Liu, G., Mark van der, E.J., Verberk, J.Q.J.C. and Dijk van, J.C. (2013b) Flow Cytometry Total Cell Counts: A Field Study Assessing Microbiological Water Quality and Growth in Unchlorinated Drinking Water Distribution Systems. *BioMed Research International* 2013, 595872.
- Miettinen, I.T., Vartiainen, T. and P.J., M. (1997) Phosphorus and bacterial growth in drinking water. *Appl. Environ. Microbiol.* 63(8), 3242-3245.
- Miller, D.J., Araújo, P.A., Correia, P.B., Ramsey, M.M., Kruithof, J.C., van Loosdrecht, M.C.M., Freeman, B.D., Paul, D.R., Whiteley, M. and Vrouwenvelder, J.S. (2012) Short-term adhesion and long-term biofouling testing of polydopamine and poly(ethylene glycol) surface modifications of membranes and feed spacers for biofouling control. *Water Research* 46(12), 3737-3753.
- NEN (2000) Water quality - Determination of free chlorine and total chlorine - Part 2: Colorimetric method using N,N-diethyl-1,4-phenylenediamine, for routine control purposes, NEN, Delft.
- Prest, E.I., Hammes, F., Köttsch, S., van Loosdrecht, M.C.M. and Vrouwenvelder, J.S. (2013) Monitoring microbiological changes in drinking water systems using a fast and reproducible flow cytometric method *Water Research* 47(19), 7131-7142.
- Prest, E.I., Weissbrodt, D.G., Hammes, F., van Loosdrecht, M.C.M. and Vrouwenvelder, J.S. (2016) Long-Term Bacterial Dynamics in a Full-Scale Drinking Water Distribution System. *PLoS ONE* 11(10), e0164445.
- Rajala, R.L., Pulkkanen, M., Pessi, M. and Heinonen-Tanski, H. (2003) Removal of microbes from municipal wastewater effluent by rapid sand filtration and subsequent UV irradiation. *Water Science and Technology* 47(3), 157-162.
- Rice, S.A., van den Akker, B., Pomati, F. and Roser, D. (2012) A risk assessment of *Pseudomonas aeruginosa* in swimming pools: a review. *Journal of Water and Health* 10(2), 181-196.
- Rittmann, B.E. and Snoeyink, V.L. (1984) Achieving biologically stable drinking water. *Journal of American Water Works Association* 76(10), 106-114.
- Rogalla, F., Ravarini, P., De Larminat, G.D. and Couttelle, J. (1990) Large-Scale Biological Nitrate and Ammonia Removal. *Water and Environment Journal* 4(4), 319-328.
- Rota, E. and Schmidt, O. (2006) *Dichogaster bolau* (Oligochaeta: Octochaetidae), an unusual invader in a swimming pool in Ireland. *Journal of Natural History* 40(3-4), 161-167.
- Ruscoe, Q., Hill, S., Blackmore, T. and McLean, M. (2006) An outbreak of *Legionella pneumophila* suspected to be associated with spa pools on display at a retail store in New Zealand. *New Zealand Medical Journal* 119(1243).
- Savino, A., Pitzurra, M., Pasquarella, C., Balestrino, A., Cerbini, I., Isa, D. and Costarelli, D. (1993) The treatment of swimming pool water with ultraviolet rays and hydrogen peroxide. Experiences in the laboratory and in the field. *Annali di igiene : medicina preventiva e di comunità* 5(2), 137-151.
- Schets, F.M., Berg, H.H.J.L.v.d., Baan, R., Lynch, G. and Roda Husman, A.M.d. (2014) *Pseudomonas aeruginosa* on vinyl-canvas inflatables and foam teaching aids in swimming pools. *Journal of Water and Health* 12(4), 772-781.
- Servais, P., Cauchi, B. and Billen, G. (1996) Experimental study and modelling bacterial activity in biological activated carbon filters. *Water Supply* 14(2), 223-231.
- Shaw, J.P., Malley Jr., J.P. and Willoughsby, S.A. (2000) Effects of UV irradiation on organic matter *Journal of American Water Works Association* 92(4), 157-167.
- Siebel, E., Wang, Y., Egli, T. and Hammes, F. (2008) Correlations between total cell concentration, total adenosine tri-phosphate concentration and heterotrophic plate counts during microbial. *Drinking Water Engineering and Science* 1(1), 1-6.
- Sobotka, J. and Kryzstofik, B. (1984) Biochemical changes occurring in swimming pool water during UV disinfection. *Aqua* 3, 170-172.

- Srinivasan, S. and Harrington, G.W. (2007) Biostability analysis for drinking water distribution systems. *Water Research* 41(10), 2127-2138.
- Urfer, D., Huck, P.M., Booth, S.D.J. and Coffey, B.M. (1997) Biological filtration for BOM and particle removal: A critical review. *Journal of American Water Works Association* 89(12), 83-98.
- Van der Bruggen, B., Vandecasteele, C., Van Gestel, T., Doyen, W. and Leysen, R. (2003) A review of pressure-driven membrane processes in wastewater treatment and drinking water production. *Environmental Progress* 22(1), 46-56.
- Vital, M., Dignum, M., Magic-Knezev, A., Ross, P., Rietveld, L.C. and Hammes, F. (2012) Flow cytometry and adenosine tri-phosphate analysis: Alternative possibilities to evaluate major bacteriological changes in drinking water treatment and distribution systems. *Water Research* 46(15), 4665-4676.
- Volk, C.J. and LeChevallier, M.W. (1999) Impacts of the Reduction of Nutrient Levels on Bacterial Water Quality in Distribution Systems. *Applied and Environmental Microbiology* 65(11), 4957-4966.
- VROM (2000) Besluit Hygiëne en Veiligheid Badinrichtingen en Zwemgelegenheden (Resolution Hygiene and Safety Bathing Accommodations and Swim Places). Ministry of Housing, s.p.a.t.E. (ed), Ministry of Housing, Spatial Planning and the Environment (VROM), The Hague.
- Vrouwenvelder, J.S., Paassen van, J.A.M., Wessels, L.P., Dam van, A.F. and Bakker, S.M. (2006) The membrane fouling simulator: A practical tool for fouling prediction and control. *Journal of Membrane Science* 281(1-2), 316-324.
- Vrouwenvelder, J.S., Beyer, F., Dahmani, K., Hasan, N., Galjaard, G., Kruithof, J.C. and van Loosdrecht, M.C.M. (2010) Phosphate limitation to control biofouling. *Water Research* 44(11), 3454-3466.
- Webster, J.J., Hampton, G.J., Wilson, J.T., Ghiorse, W.C. and Leach, F.R. (1985) Determination of microbial cell numbers in subsurface samples. *Ground Water* 23(1), 17-25.
- Weilandt, M. (2015) Swimming ponds, p. 45, 6th International Conference Swimming Pool and Spa, Amsterdam.
- Wende van der, E., Characklis, W.G. and Smith, D.B. (1989) Biofilms and bacterial drinking water quality. *Water Research* 23(10), 1313-1322.
- Whiley, H., Keegan, A., Giglio, S. and Bentham, R. (2012) Mycobacterium avium complex - the role of potable water in disease transmission. *Journal of applied microbiology* 113(2), 223-232.
- WHO (2006) Guidelines for safe recreational water environments, Volume 2; Swimming pools and similar environments, WHO.
- Wielen van der, P.W.J.J. and Kooij van der, D. (2010) Effect of water composition, distance and season on the adenosine triphosphate concentration in unchlorinated drinking water in the Netherlands. *Water Research* 44(17), 4860-4867.
- Zhang, S., Ye, C., Lin, H., Lv, L. and Yu, X. (2015) UV Disinfection Induces a Vbnc State in Escherichia coli and Pseudomonas aeruginosa. *Environmental science & technology* 49(3), 1721-1728.



# Chapter 5

## Microbial reduction of urea in simulated swimming pool water with different types of disinfection

M.G.A. Keuten<sup>1,2</sup>, M.C.F.M. Peters<sup>1</sup>, J.C. van Dijk<sup>1</sup>, M.C.M. van Loosdrecht<sup>3</sup>, L.C. Rietveld<sup>1</sup>

This chapter is in preparation as: M.G.A. Keuten, M.C.F.M. Peters, J.C. van Dijk, L.C. Rietveld, M.C.M. van Loosdrecht (2018) Microbial reduction of urea in simulated swimming pool water with different types of disinfection.

---

1 Section Sanitary Engineering, Delft University of Technology, Delft, The Netherlands

2 Hellebrekers Technieken, Nunspeet, the Netherlands

3 Department of Biotechnology, Delft University of Technology, Delft, The Netherlands

## Abstract

Urea is the predominant nitrogen compound released by bathers and both urea and non-purgeable organic carbon (NPOC) are important precursors for the unwanted formation of disinfection by-products (DBPs) in swimming pools. This study focussed on the removal of urea and the formation of nitrate for different types of treatment and disinfection of pool water. In a pilot plant pool set-up, treatment without disinfection, and with disinfection by ultrafiltration, UV or chlorination were compared, all in combination with biological filtration. Regardless of the type of treatment, urea was not completely removed above 8 mg/L, which, in the absence of chlorination, leads to the accumulation of ammonium. Chlorination negatively impacted ammonium oxidation and formation of nitrate was reduced, which may result in an increased formation of nitrogen containing DBPs. Biological activated carbon filtration increased the removal of urea in a chlorinated treatment, resulting in less nitrogen available for DBP formation. In the absence of a residual disinfectant, the reduction of urea improved with an increased number of treatment steps. All urea was completely hydrolysed and completely oxidised towards nitrate during biological sand filtration combined with ultrafiltration and UV treatment of recirculated pool water. It was thus concluded that microbial reduction of urea was not dependent on the type of disinfection, but mainly influenced by the presence of a microbial treatment step in the pool water treatment.

### Keywords:

- chlorination
- urea
- nitrate
- TN
- NPOC
- UV-disinfection
- biological sand filtration
- biological activated carbon filtration
- ultrafiltration
- swimming pool



## 5.1 Introduction

Urea is the predominant nitrogen compound released by bathers (Erdinger et al. 1998, Gunkel and Jessen 1986, Keuten et al. 2014) and is an important precursor for the formation of trichloramines in chlorinated water (Blatchley and Cheng 2010). The removal of urea during chlorination was studied previously and was found to be rather slow (Blatchley and Cheng 2010, De Laat et al. 2011). However, urea can also be removed biologically, and, therefore, biological activated carbon filtration (BACF) has been used in Dutch swimming pools since Dutch pool legislation restricted the maximum urea concentration (VROM 1984). While chlorine is removed in the top-layers of the BACF, the subsequent layers provide an environment for micro-organisms to reduce urea (Boere et al. 1990). As is known from experience in Dutch pools, urea can be completely removed during one single BACF passage, hydrolysing urea to ammonium and subsequently oxidising to nitrite and nitrate by nitrifying organisms (Boere et al. 1990).

Besides urea, non-purgeable organic matter (NPOC) is also an important precursor for DBPs (Glauner et al. 2005, Zwiener et al. 2007) and the biodegradable fraction of NPOC is an important nutrient for micro-organisms (Kooij van der 2000, Liu et al. 2013). NPOC in pools, among which also biodegradable NPOC, mainly originates from bathers (Keuten et al. 2012, Keuten et al. 2014), but is also introduced in pool water with the supplement water, in the form of humic acids and similar compounds (Liu et al. 2013). Biological filtration could be used to reduce NPOC in swimming pools (Urfer et al. 1997). Therefore, the objective in this study was to find alternative treatment set-ups, based on biological filtration, to remove urea from (chlorinated) swimming pool water.

The fate of urea and its derivatives ammonia and nitrate, total nitrogen (TN) and NPOC was investigated during this study under controlled conditions at a pilot-plant pool facility, with simulated anthropogenic pollutant release. The effect on urea and NPOC was studied with different types of treatment: without disinfection, disinfection by ultrafiltration, with UV-disinfection or disinfection by chlorination. Treatment with only chlorination, without biofiltration, was used as reference. All other types of disinfection were combined with a biological filtration step, either a biological sand filtration in the absence of a residual disinfectant or a BACF in the presence of a residual disinfectant.

## 5.2 Materials and methods

### 5.2.1 Experimental philosophy

To investigate the urea removal, different configurations of treatment steps were used. For pool water treatment without disinfection, biological sand filtration was used as sand is known as a non-adsorptive medium for biological filtration (Urfer et al. 1997). In addition, the combination of biological sand filtration and disinfection by ultrafiltration was used, because ultrafiltration is known for its improved particle removal, including bacteria and viruses compared to traditional sand filtration (Jacangelo et al. 1995). Further, the combination of biological sand filtration, ultrafiltration and UV-disinfection was tested because UV-treatment is known for its disinfection capacity (Hijnen et al. 2006). Finally, for pool water

with chlorination, sand filtration and the combination of sand filtration and bypass biological activated carbon filtration was used, because biological activated carbon filtration is known for maintaining biological processes even in chlorinated swimming pools (Boere et al. 1990).

The experimental settings were selected to simulate different occupancy levels during experiments with and without recirculation. Experiments without recirculation were done to study the influence of individual treatment steps, and settings were selected to simulate worst case and maximum allowed concentrations of urea and NPOC. Experiments with recirculation were done to study the effect of repetitive treatment and accumulation, with settings to simulate a high occupancy level in relation to the treatment capacity.

A body fluid analogue (BFA) was added to Dutch tap water, which is distributed without a residual disinfectant, to simulate pool water. The BFA composition and addition of NPOC, TN and  $PO_4$  are shown in Table 1.

<b>Table 1: Addition of BFA components during all experiments.</b>				
BFA components	Experiments without circulation		Experiments with recirculation	
	Worst case (mg/L)	Maximum allowed (mg/L)	with $PO_4$ ( $\mu\text{g/L}$ )	without $PO_4$ ( $\mu\text{g/L}$ )
Urea	8.15	2.04	130.3	130.3
Creatinine monohydrate	0.71	0.18	11.4	11.4
Citrate	0.58	0.15	9.3	9.3
$PO_4$ -P	0.17	0.17	2.4	0.0
Nitrogen and Carbon from BFA components				
Urea-N	3.80	0.95	60.8	60.8
Creatinine-N	0.20	0.05	3.2	3.2
TN (urea + creatinine)	4.00	1.00	64	64
Urea-C	1.63	0.41	26.1	26.1
Creatinine-C	0.23	0.06	3.7	3.7
Citrate-C	0.14	0.04	2.3	2.3
NPOC (urea + creatinine + citrate)	2.00	0.50	32	32

### 5.2.2 Experimental settings

In chlorinated swimming pool water, the worst microbial water quality can be found at the lowest chlorine concentrations. Therefore, to simulate worst case chlorination conditions, the free chlorine level was set at the lowest acceptable level according to DIN standards, 0.3 mg  $Cl_2$ /L (DIN 2012). During the experiments with recirculation, the chlorine level was increased to 0.50 mg  $Cl_2$ /L, in accordance with the lowest acceptable level described in Dutch swimming pool regulation (VROM 2000) and WHO swimming pool guidelines (WHO 2006).



To simulate anthropogenic pollutant release, a BFA was added to the tap water. The used BFA was a mixture of urea, creatine monohydrate, and sodium citrate (Table 1), all of technical grade and supplied by VWR international, with exception of creatine monohydrate which was supplied by Sportfood.nl. Urea was used as main component to compose the BFA. At worst case conditions, addition of urea was near 8 mg/L, at maximum allowed conditions, urea addition was near 2 mg/L and during high bathing load conditions urea addition was similar to a calculated high occupancy level. According to Dutch legislation, for each bather, 2 m<sup>3</sup> pool water should be recirculated and treated, so the high level of occupancy was calculated from the recirculation rate of the experimental setup. The individual pollutant release during the high occupancy level was calculated as the sum of the continual and incidental anthropogenic pollutant release of 147.3 mg N/bather/30 min (Keuten et al. 2014) during 10 h bathing time per day. The other BFA components were related to urea, with a ratio based on previous studies (Judd and Black 2000) and own experiences (Annex A), with varying concentrations between the different experiments (Table 1). The effect of phosphate addition was also investigated, as phosphate limitation is known to restrain biological activity (Vrouwenvelder et al. 2010) and phosphate is restrained by coagulation (Wen et al. 2014), which is widely used in Dutch swimming pools.

Aluminium hydroxide chloride (NuscoFloc, Hydrotech) was used as flocculant during all experiments with recirculation, added at a concentration of 0.03 mg Al/L, and controlled by measuring the concentration of aluminium, after filtration, not exceeding a concentration of 0.05 mg Al/L (DIN 2012).

During all experiments, the treatment rate was 1 m<sup>3</sup>/h. To ensure a 30 minutes turnover time during the experiments with recirculation, the pool tank content was 500 L. At high pH levels, disinfection capacity by chlorination is reduced because OCl<sup>-</sup> has a lower oxidation (disinfection) potential than HOCl, but is still acceptable up to a pH of 7.8 (VROM 2000, WHO 2006), but above a pH of 7.4, the flocculation efficiency by aluminium hydroxide chloride is reduced, so a pH of 7.4 was chosen for all experiments. Online monitoring and control equipment was used to keep the recirculation flow, pH and temperature constant. The water temperature was set at 30-32 °C. The duration of all experiments was 23 d because longer duration proved to cause biofouling problems at measuring equipment during trial experiments at worst case conditions.

The UF unit was automatically backwashed every 45 min, using its own permeate water, at a rate of 250 L/m<sup>2</sup>/h for 25 s. During the backwash of one ultrafiltration element, the other ultrafiltration element remained operational at 0.5 m<sup>3</sup>/h. During the experiments with recirculation, the flow over the preceding biological sand filtration was also reduced accordingly during backwashing of the ultrafiltration. Balance tanks were used as buffers for flow fluctuations in order to maintain a constant flow of 1 m<sup>3</sup>/h over the UV-treatment, maintaining a constant UV-dose. After backwashing of the ultrafiltration, the flow of the biological sand filtration and the ultrafiltration was increased for a short period to a maximum of 110 % of the original flow, to refill the balance tanks.

### 5.2.3 Analytical methods

Water for all analytical sampling was extracted from the setup and led to sampling manifolds at a constant flow of 13-15 L/h. All circulating sampling water was returned to the pool tank of the corresponding pilot plant to minimise water losses. Water samples were taken twice a week, including samples of tap water. Directly after sampling, all samples were stored in a refrigerator at 4 °C. All samples were analysed for urea, nitrate, ammonium, TN, NPOC, aluminium, pH, dissolved oxygen and free and combined chlorine. NPOC and TN were sampled and analysed in duplo. The pH and dissolved oxygen were measured with sensors (pH; WTW innolab multi720, sensor WTW PH sentix 81) (O<sub>2</sub>; WTW multi3420, sensor WTW FDO925), in a beaker with constant flow through.

NPOC was determined according to NEN-EN 1484 (NEN, 1997) using a Shimadzu TOC-Vcph analyser. After acidifying and purging, the samples were injected into the combustion chamber at 720 °C to oxidise all carbon into CO<sub>2</sub>, which was subsequently detected by using infrared spectrometry.

TN was determined according to NEN-EN 12260 (NEN 2003) using a Shimadzu TNM-1 analyser connected to the Shimadzu TOC-Vcph analyser. The samples were injected into the combustion chamber at 720 °C where nitrogen compounds were converted into nitric oxide and exposed to ozone to induce the emission of light, which was detected by a chemiluminescent detector.

Ammonium was analysed according to ISO 7150/1 (2002) with an ammonium test kit (Merck, Darmstadt, Germany), which could not be used for chlorinated water. Samples were alkalised with sodium hydroxide to transform all ammonium nitrogen into ammonia. After chlorination of the samples and formation of monochloramine, thymol was added to form a blue indophenol derivative that was determined photometrically (Spectroquant Nova 60, Merck, Darmstadt, Germany).

Urea was analysed with a test kit (Merck, Darmstadt, Germany), mentioned to be the most reliable method for urea quantification in chlorinated swimming pool samples (Spiliotopoulou et al. 2013). After adding urease, urea was hydrolysed to ammonia. The subsequent ammonia analysis was similar to the ammonium analysis described above.

Nitrate was analysed with a colorimetric test kit (Merck, Darmstadt, Germany). The sample was added to a concentrated sulphuric acid solution with benzoic acid derivate to form a red nitro compound that was determined photometrically (Spectroquant Nova 60, Merck, Darmstadt, Germany).

Free chlorine and total chlorine were analysed with the DPD-method according to NEN-EN-ISO 7393-2 (NEN 2000). Combined chlorine was calculated from the results, by subtracting FC from TC. Phosphate was analysed colorimetrically with the Phosphomolybdenum blue method using a NOVA 60 spectrophotometer and Merck reagents (method 114848).

## 5.3 Results

### 5.3.1 Urea and nitrate without recirculation

During chlorination and a worst case BFA addition, sand filtration removed urea at a very low level. The urea removal reached only 0.3 mg/L urea-N removal after 23 d (Table 2). In the absence of disinfection, urea removal increased by biological sand filtration. However, at worst case conditions, urea was not completely removed during one filter passage, but only for 73 % of the urea was removed, i.e. 2.4 mg/L. The addition of treatment steps did not improve the removal of urea at worst case conditions considerably. The combination of biological sand filtration with ultrafiltration and UV-treatment combined with biological sand filtration and ultrafiltration removed urea by 83 % and 74 % respectively, i.e. 2.6 and 2.1 mg/L removal respectively. At maximum allowed urea concentration, the removal of urea was even at 100 %, i.e. 0.43 mg/L (Table 2).

Table 2: Urea-N concentrations in simulated pool water after 23 days experiment duration.				
Treatment	Anthropogenic pollutant addition	Urea-N (mg/L)		
		inlet / outlet	removal	removal %
Chlorination	Worst case	2.9 / 2.6	0.30	7.5 %
Only BSF	Worst case	3.2 / 0.87	2.4	73 %
BSF with UF	Worst case	3.1 / 0.48	2.6	83 %
UV with BSF and UF	Worst case	2.9 / 0.77	2.1	74 %
	Max allowed	0.43 / 0.00	0.43	100 %

BSF = biological sand filtration, UF = ultrafiltration, UV= UV-treatment

Concomitant with urea removal nitrate was formed, likely by nitrifying bacteria. The nitrate formation was lowest during chlorination with worst case conditions, near 20% of the removed urea-N was found as an increase in NO<sub>3</sub>-N (Table 3). In the absence of a residual disinfectant, formation of nitrate-N increased to nearly 50% with only biological sand

Table 3: Nitrate-N concentrations in simulated pool water after 23 days experiment duration.				
Treatment	Anthropogenic pollutant addition	NO <sub>3</sub> -N (mg/L)		
		inlet / outlet	removal	$\frac{\text{NO}_3\text{-N formation}}{\text{urea-N removal}}$
Chlorination	Worst case	2.5 / 2.5	0.06	0.22
Only BSF	Worst case	2.6 / 3.8	1.2	0.49
BSF with UF	Worst case	3.2 / 5.0	1.8	0.76
UV with BSF and UF	Worst case	2.7 / 4.0	1.3	0.61
	Max allowed	2.5 / 3.0	0.5	1.16

BSF = biological sand filtration, UF = ultrafiltration, UV= UV-treatment

filtration. The addition of treatment steps further increased the nitrate-N formation to nearly 75 % with biological sand filtration combined with ultrafiltration, and to nearly 60 % with UV-treatment combined with biological sand filtration and ultrafiltration (Table 3). During maximum allowed urea concentration, formation of nitrate-N was near 100 % (Table 3). So formation of nitrate and removal of urea was in balance.

### 5.3.2 Ammonium and oxygen without recirculation

Under worst case urea conditions, ammonium was formed during treatment. The concentration increased with 0.5 and 0.2 mg/L NH<sub>4</sub>-N during biological sand filtration, and biological sand filtration combined with ultrafiltration, respectively. During UV-treatment combined with biological sand filtration and ultrafiltration NH<sub>4</sub>-N increased to 0.7 mg/L. At maximum allowed urea concentrations, there was no ammonium detected (Table 4).

The oxygen concentration was reduced during treatment. At chlorinated conditions with worst case urea concentration, O<sub>2</sub> reduction was only 0.4 mg/L. However in the absence of a residual disinfectant, the reduction of O<sub>2</sub> increased from 4.0 mg/L to 7.0 and 5.7 mg/L during biological sand filtration, biological sand filtration combined with ultrafiltration, and UV-treatment combined with biological sand filtration and ultrafiltration, respectively. At maximum allowed urea concentration, O<sub>2</sub> reduction was 2.4 mg/L (Table 4).

Treatment	Anthropogenic pollutant addition	Urea-N (mg/L)		O <sub>2</sub> (mg/L)	
		inlet	outlet	inlet	Usage
Chlorination	Worst case	n.a.	n.a.	8.5	0.47
Only BSF	Worst case	0.16	0.66	6.1	4.0
BSF with UF	Worst case	0.15	0.30	7.3	7.0
UV with BSF and UF	Worst case	0.11	0.83	5.9	5.7
	Max allowed	0.0	0.0	7.3	2.4

n.a. = not analysed  
BSF = biological sand filtration, UF = ultrafiltration, UV= UV-treatment

### 5.3.3 Total nitrogen, natural organic matter and combined chlorine without recirculation

Concentrations of TN were more or less equal, within accuracy levels of the analysis, at inlet and outlet of the treatment, during all experiments with worst case and maximum allowed conditions. The inlet/outlet concentrations of NPOC were also equal during chlorination, but for the biological sand filtration at worst case conditions, NPOC was reduced by 0.8 mg/L. During biological sand filtration combined with ultrafiltration, and UV-treatment combined with biological sand filtration and ultrafiltration, at worst case conditions, the reduction of NPOC increased to 1.2 and 1.1 mg/L, respectively. During UV-treatment combined with both

biological sand filtration and ultrafiltration, at max allowed conditions, the NPOC reduction was 0.2 mg/L. Combined chlorine was equal at the inlet and outlet of the chlorinated treatment at worst case conditions.

### 5.3.4 The influence of recirculation

Experiments with recirculation showed similar results as without recirculation. During chlorination, urea slowly increased to 0.26 mg/L urea-N, the addition of a biological activated carbon filtration increased the removal of urea and only 0.16 mg/L urea-N remained in the mixed effluent at the end of the experiments. Addition of a biological activated carbon filtration resulted in accumulation of NO<sub>3</sub>-N, which increased to 63.1 mg/L, while NPOC was reduced to 2.9 mg/L (Table 5). Oxygen was 7.4 and 7.2 mg/L during chlorination with and without a biological activated carbon filtration, respectively. However, in the side stream after the biological activated carbon filtration, oxygen was, due to the biological processes, 5.2 mg/L at the end of the experiment.

Removal of urea was highest in the absence of a residual disinfectant, all urea was removed after the combination of biological sand filtration with ultrafiltration and UV-treatment, after 16 and 23 d of both experiments. During the combination of biological sand filtration with ultrafiltration and UV-treatment with phosphate addition, more NO<sub>3</sub>-N and less NPOC was found compared to the same treatment without phosphate addition (Table 5). Oxygen concentration was similar during both experiments with biological sand filtration with ultrafiltration and UV-treatment.

**Table 5: Concentrations of Urea-N, nitrate-N, TN and NPOC in simulated pool water with recirculation after 23 days of experiment duration.**

Treatment	BFA	Urea-N (mg/L)	NO <sub>3</sub> -N (mg/L)	TN (mg/L)	NPOC (mg/L)
Chlorination	with phosphate	0.2	11	34	9.6
Chlorination with BACF	without phosphate	0.1	56	50	2.1
BSF with UF and UV	with phosphate	0.0	5.7	7.2	1.0
	without phosphate	0.0	5.1	4.4	2.0
Tap water * (i)	-	0.0	2.7	3.2	1.8
Tap water * (ii)	-	0.0	3.1	3.0	2.5

\* during experiments with phosphate addition (i) and without phosphate addition (ii)  
BACF = biological activated carbon filtration, BSF = biological sand filtration, UF = ultrafiltration, UV= UV-treatment

## 5.4 Discussion

The removal of urea can either be done biologically or chemically. In the biological path, urea is first enzymatically hydrolysed to ammonium and subsequently oxidised to nitrite and nitrate (Boere et al. 1990, Mobley et al. 1995, Udert et al. 2002). Denitrification of nitrate towards nitrogen gas occurs mainly at anaerobic/anoxic conditions, which is not likely to be expected in swimming pool water, however it is possible in biofilms (Loosdrecht van and Jetten 1998). Since chlorinated swimming pools are a hostile environment for microbial communities (Goeres et al. 2004), biofilms are constantly restrained and therefore it is often expected that the removal of urea is following the chemical path in chlorinated pools. The chemical hydrolysis and oxidation of urea leads to the formation of nitrogen-containing DBPs like trichloramine, nitrate and nitrogen gas (Blatchley and Cheng 2010, De Laat et al. 2011).

### 5.4.1 Chlorinated conditions without recirculation

When chlorine dosage was applied as disinfection method, urea was poorly reduced, as 93% of dosed urea-N remained after treatment (Table 2). Chemical hydrolysis and oxidation of urea is a slow process as was earlier revealed (Blatchley and Cheng 2010, De Laat et al. 2011). In addition, biofilm formation is restrained in the presence of free chlorine (Lund and Ormerod 1995), and thus biological hydrolysis and oxidation is restrained by chlorination. As a result, it was observed that, at worst case conditions, only a small part (22 %) of the removed urea-N was converted into nitrate-N (Table 3), while TN was more or less equal at inlet and outlet of the treatment, so no nitrogen was lost by evaporation of volatile substances. So if nitrogen is present, but not in the form of urea from which it originated, there must be some substitutes. It is therefore expected that the reduced urea-N besides the nitrate-N formation resulted in substitutes of the chemical oxidation of urea, as was hypothesized by Blatchley and Cheng (2010) as  $\text{CO}(\text{NH}_2)_2$  (urea)  $\rightarrow$   $\text{H}_2\text{NCONHCl}$  (N-chlorourea)  $\rightarrow$   $\text{CO}(\text{NHCl})_2$   $\rightarrow$   $\text{Cl}_2\text{NCONHCl}$   $\rightarrow$   $\text{CO}(\text{NCl}_2)_2$   $\rightarrow$   $\text{NCl}_3 + \text{NCl}$   $\rightarrow$   $\text{NOH}$   $\rightarrow$   $\text{H}_2\text{N}_2\text{O}_2$   $\rightarrow$   $\text{N}_2\text{O}$   $\rightarrow$   $\text{NO}_3$ . Moreover, as the chemical oxidation of urea is a slow process which takes days rather than minutes (Blatchley and Cheng 2010, De Laat et al. 2011), while during the worst case conditions, the simulated pool water was drained away, directly after treatment, so treatment only took a few minutes, which is too short for complete chemical oxidation, so substitutes must have been present.

### 5.4.2 Biological sand filtration without recirculation

In the absence of a residual disinfectant, the removal of urea increased, most likely due to biological hydrolysis and oxidation. It is expected that within the biofilms, where the actual microbial activity takes place, anaerobicity occurred, which reduced the reduction of urea and ammonium explaining the release of both after treatment. Also, TN was unchanged after treatment, which means that nitrogen containing substances were equally present at inlet/outlet of the treatment. Nevertheless, from the nitrogen balance, urea-N reduction minus nitrate-N and ammonium-N formation, suggests that the missing 0.54 mg N/L (2.4-1.2-0.66) could have been from nitrite,  $\text{N}_2\text{O}$ , NO or  $\text{N}_2$  (Loosdrecht van and Jetten 1998). Although  $\text{N}_2\text{O}$  is a gas, it is highly soluble in water and is not easily stripped out during purging of the samples (Loosdrecht van and Jetten 1998). The presence of  $\text{N}_2$  and NO is unlikely because they are removed during purging of the samples and do not show up during TN analysis, yet TN was unchanged, so nitrite remains as most likely explanation for the missing nitrogen

part. The release of nitrite is possible when oxygen is limiting during oxidation of ammonium. Although oxygen was not limited (Table 4), it could have been limited in the biofilms, which also explains the release of urea and ammonium. The ratio between the NPOC reduction and the urea-N reduction was similar to the C/N ratio of urea itself. So the reduction of NPOC can be explained by the reduction of urea. During hydrolysis of urea, all carbon is released as CO<sub>2</sub> (Mobley et al. 1995), which does not show up during NPOC analysis.

#### ***5.4.3 Biological sand filtration in combination with ultrafiltration without recirculation***

Compared to biological sand filtration only, the combination of biological sand filtration and ultrafiltration increased the removal of urea slightly (Table 2). The reduction mainly occurred in the biological sand filtration. A slight increase of the oxygen concentration at the inlet of the treatment explains the increased removal. This fluctuation in oxygen concentration is due to seasonal changes in the tap water temperature, which varies between 6.5-18.5 °C in winter and summer time respectively (Prest et al. 2016) and oxygen concentration will be reciprocal to water temperature. Nevertheless, oxygen consumption increased compared to biological sand filtration only most likely due to improved conversion of ammonium to nitrate, as the release of ammonium was reduced and formation of nitrate increased (Tables 3 and 4). The influence of ultrafiltration on removal of urea, formation of ammonium, formation of nitrate and oxygen consumption was negligible, as expected, because ultrafiltration mainly removes particles and not dissolved substances like urea and ammonium (Jacangelo et al. 1995).

With these results, the nitrogen mass-balance could be completed, within accuracy levels of the different analyses. The concentration of NPOC was reduced during the combination of biological sand filtration with ultrafiltration with 1.2 mg/L. From the urea reduction, 0.6 mg C/L could be explained. The remaining 0.6 mg C/L is expected to originate from the dosed creatine and citrate, so the NPOC mass balance was fitted within accuracy levels of the analyses.

#### ***5.4.4 UV-treatment in combination with biological sand filtration and ultrafiltration without recirculation***

With the addition of UV-treatment to the before mentioned combination of biological sand filtration and ultrafiltration, the removal of urea did not overall improve at worst case conditions (Table 2). This was expected, because UV from low-pressure lamps, as used in these experiments, is not known to reduce urea. The only known reduction of urea by UV is with the use of Ag-loaded titanium dioxide in combination with medium-pressure lamps, which showed a 83 % urea reduction in 12 minutes (Kondo and Jardim 1991). Personal experience from the application of low-pressure UV in swimming pools also learned that urea is not affected. Again, urea was mainly reduced during biological sand filtration. Although UV-treatment seemed to reduce urea-N by 0.34 mg/L, it is expected that this was due to biofilms on the wall of the piping leading to and from the UV-treatment, rather than the influence of UV-treatment itself.

The formation of nitrate-N was only 61 %, which was lower than during the combination of biological sand filtration with ultrafiltration. Nevertheless, oxygen was reduced to 0.2 mg/L, which was similar to the combination of biological sand filtration with ultrafiltration. Without sufficient oxygen, nitrate formation was limited. As a result, the concentration of  $\text{NH}_4\text{-N}$  increased to 0.8 mg/L (Table 4). Again, the nitrogen mass-balance was fitted within the accuracy level of the analyses.

The reduction of NPOC was 1.1 mg/L, of which 0.9 mg/L could be explained by the reduced urea. It is expected that the remaining 0.2 mg/L NPOC reduction was due to reduction of carbon from the dosed creatine and citrate.

At maximum allowed conditions, urea was completely removed during the combination of UV-treatment with biological sand filtration and ultrafiltration (Table 2) while there was no change in TN concentration. Also, there was no release of ammonium (Table 4) and oxygen was not reduced to a limiting level (Table 4). The formation of nitrate-N was 116% of the reduced urea-N, so all urea was hydrolysed to ammonium and subsequently oxidised towards nitrate, while, additionally, also part of the nitrogen from dosed creatine was oxidised towards nitrate. The nitrogen mass-balance was fitted at these conditions. Similarly, the reduction of 0.2 mg/L NPOC could be explained by the 0.43 mg/L urea-N, which corresponds with 0.18 mg/L urea-C.

#### *5.4.5 The influence of recirculation*

During treatment with chlorination and recirculation, which can be seen as reference, urea was not completely removed. The accumulation of TN was partly due to nitrate (32 %). The remaining part, i.e. 67 %, could not have been from urea, ammonium or chloramines because the concentrations were found to be below 1 % of TN. Nitrite from biological degradation of urea is not expected because of the presence of free chlorine and also because oxygen consumption was very small. Therefore it is expected that the remaining 67 % of TN consisted of nitrogen containing DBPs, as suggested by (Blatchley and Cheng 2010). Besides TN, NPOC also accumulated after 23d of recirculation with constant treatment. Calculated from the mass-balance, 23 % of the added NPOC accumulated, while 50 % of the added TN accumulated and within TN, only 13 % of the added nitrogen accumulated as  $\text{NO}_3\text{-N}$ . The lower accumulation percentage of NPOC accumulation can be explained by the formation of  $\text{CO}_2$  and chloroform (Blatchley and Cheng 2010, Kanan and Karanfil 2011), which can easily evaporate during the 23 d experiment and also do not show up during NPOC analysis.

It is therefore concluded that at chlorinated conditions with recirculation, urea is poorly reduced, as also reported in previous research (Blatchley and Cheng 2010, De Laat et al. 2011). The reduction that took place is expected to be a chemical reaction, which, in a chlorinated treatment with recirculation, mainly leads to the formation of nitrogen and carbon containing DBPs.

The addition of a biological activated carbon filtration to the chlorinated treatment increased the removal of urea, which was reduced to 0.1 mg/L urea-N instead of 0.2 mg/L without a biological activated carbon filtration. Moreover, the formation of nitrate increased strongly and accumulated to 56 mg/L  $\text{NO}_3\text{-N}$ , which was more or less equal to the TN level (Table 5).



The observed differences were within the inaccuracy levels of the analyses. From the mass balance, on average, 82 % of the added nitrogen accumulated as TN in the form of  $\text{NO}_3\text{-N}$ . Biological activated carbon filtration, as expected (Boere et al. 1990), was indeed confirmed to be able to effectively convert urea into nitrate in a chlorinated pool water, and, as more nitrogen ends up as nitrate, less nitrogen is available for DBP formation, so it is expected that there was less accumulation of disinfection by-products.

In the absence of a residual disinfectant, urea was completely removed during the combination of biological sand filtration with ultrafiltration and UV-treatment with recirculation (Table 5). Mass balance calculations showed that 80 % of the added nitrogen accumulated as TN almost completely in the form of  $\text{NO}_3\text{-N}$ . Due to the regular backwashes of the ultrafiltration, the refreshment rate of the pool water was much higher compared to the chlorinated treatment, which is the main reason why the TN concentration was much lower during the combination of biological sand filtration with ultrafiltration and UV-treatment compared to chlorination. Nevertheless, this cannot explain the missing 20 % from the mass balance. Other intermediates of the biological degradation of urea are  $\text{N}_2\text{O}$  and  $\text{N}_2$ , which are volatile. Although  $\text{N}_2\text{O}$  is highly soluble in water (Loosdrecht van and Jetten 1998), evaporation could have occurred due to the long duration of the experiment; 23 days, while  $\text{N}_2$  is easily evaporated into the atmosphere. It is therefore expected that the missing 20 % from the mass balance was due to evaporation of volatile nitrogen compounds.

#### *5.4.6 The influence of phosphate addition during recirculation*

Limitation of phosphate is known to limit microbial activity, as so, it can also limit the microbial urea reduction (Vrouwenvelder et al. 2010). Phosphate addition to systems without residual disinfectants indeed led to an increased conversion of urea into nitrate (Table 5). Mass balance evaluation shows that 70 % of the added nitrogen accumulated as TN. Phosphate addition also induced extra NPOC reduction. All added NPOC was removed and additionally, also 46 % of the NPOC of the feeding tap water, while this was 19 % without phosphate addition (Table 5). Phosphate-P was found to be below the detection limit of 0.03 mg/L in all samples, including the conditions with phosphate addition, which was due to the continuous removal of phosphate by coagulation (Jacobson et al. 2009). It is concluded that phosphate is an essential nutrient in the treatment of pool water in the absence of a residual disinfectant. Limitation of phosphate, will lead to a reduced microbial activity, and so, a reduced treatment efficiency and possible accumulation of nutrients like urea and ammonium.

At chlorinated conditions with recirculation, the influence of phosphate addition was investigated simultaneously with the influence of a biological activated carbon filtration. In systems without a biological activated carbon filtration with the addition of phosphate, TN was accumulating which is partly explained by the accumulated nitrate, so it was assumed that nitrogen containing DBPs were formed, as discussed before. In the presence of a biological activated carbon filtration, an increase of biological activity was expected (Crittenden et al. 2012). The increased formation of nitrate also showed the increased biological activity. Simultaneous with the addition of a biological activated carbon filtration, the addition of phosphate was stopped. As shown before, less phosphate is known to reduce biological activity (Vrouwenvelder et al. 2010) rather than increase it, yet an increase of biological

activity was measured. It is therefore expected that the addition of a biological carbon filtration rather than the reduction of phosphate addition was responsible for the increased biological activity.

## 5.5 Conclusions

A laboratory pilot plant swimming pool setup was used to study the microbial conversion of urea and some substitutes in simulated pool water with biological filtration and different types of disinfection: without disinfection, with disinfection by ultra-filtration, with UV-disinfection or disinfection by chlorination. It was concluded that:

- urea reduction is limited at urea concentrations above 8 mg/L and free chlorine level of 0.3 mg/L;
- in the absence of a residual disinfectant at urea concentrations above 8 mg/L, urea is mainly reduced by biological sand filtration; at higher urea/ammonium concentrations biological filters can become easily oxygen limited;
- the addition of a biological activated carbon filtration to a chlorinated treatment improves the microbial oxidation of urea and subsequent formation of nitrate, probably minimising the formation of nitrogen containing disinfection byproducts;
- in the absence of a residual disinfectant with recirculation, urea is completely oxidised, mainly towards nitrate.

## Acknowledgements

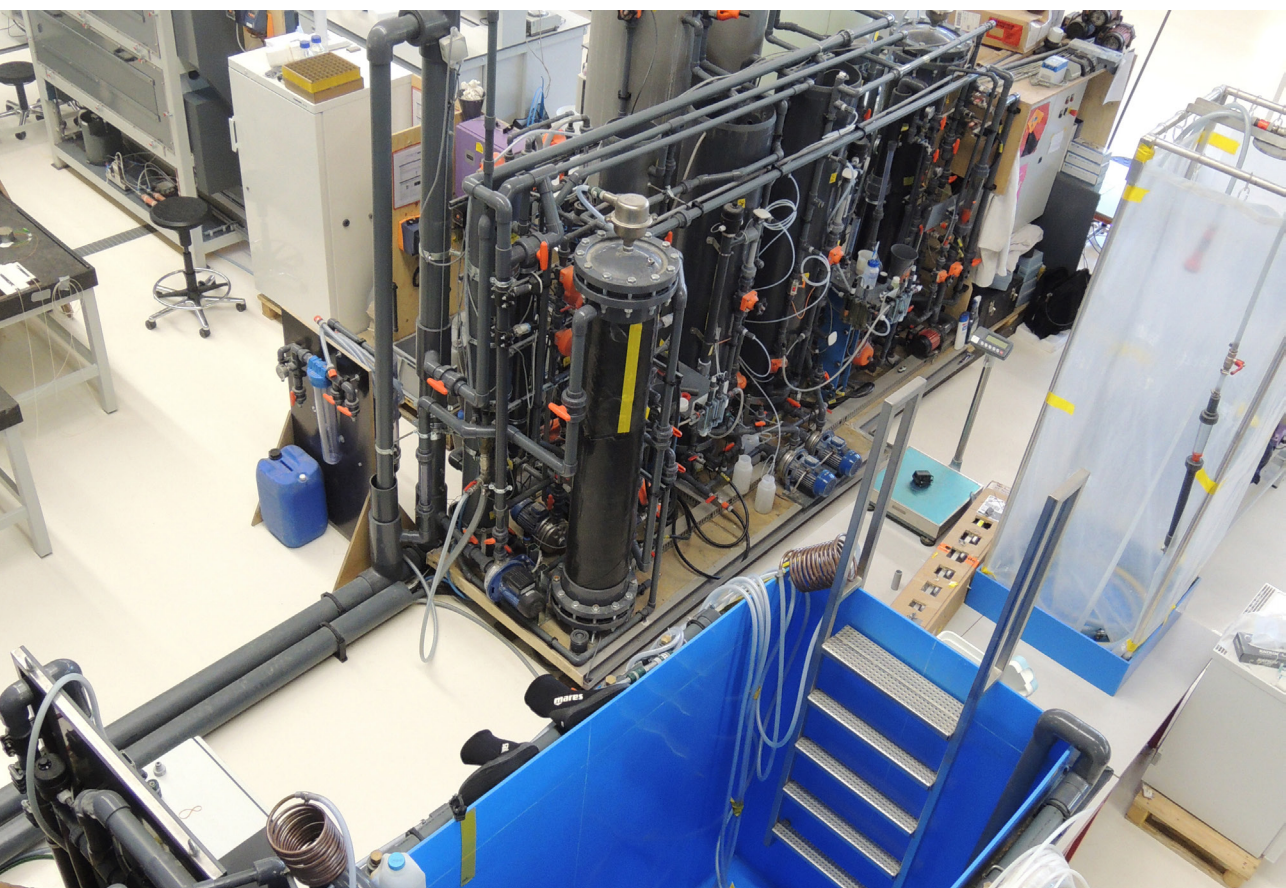
This study was part of the DIPool project (Dutch Innovative Pool). The project was funded by communal subsidies from the Netherlands Enterprise Agency and EFRO-GO in combination with private funding from Delft University of Technology, Hellebrekers Technieken, Akzo Nobel Industrial Chemicals B.V., Van Remmen UV Techniek, Coram International B.V. and Sportfondsen Nederland B.V.. Thanks to Adele Sanders for reviewing the language and spelling.

## 5.6 References

- Blatchley, E.R. and Cheng, M. (2010) Reaction mechanism for chlorination of urea. *Environmental science & technology* 44(22), 8529-8534.
- Boere, J.A., van Straaten, D.G.J., van Leengoed, L.P.M. and van der Hoeve, A. (1990) Verbetering van het zuiveringsrendement bij zwembadwaterbehandeling door toepassing van dubbellaagsfiltratie (Improvement of pool water treatment efficacy with the use of multilayer filtration). Ministry of Housing, S.P.a.t.E. (ed), p. 136, SdU, The Hague.
- Crittenden, J.C., Trussel, R.R., Hand, D.W., Howe, K.J. and Tchobanoglous, G. (2012) *Water Treatment - Principles and design* (3rd edition), John Wiley & Sons.
- De Laat, J., Feng, W., Freyfer, D.A. and Dossier-Berne, F. (2011) Concentration levels of urea in swimming pool water and reactivity with urea. *Water Research* 45(3), 1139-1146.
- DIN (2012) *Aufbereitung von Schwimm- und Badebeckenwasser, Teil 2: Festbett- / Anschwemmfilter* (Treatment of water of swimming pools and baths - Part 2: Combinations of process with fixed bed filters and precoat filters), Beuth Verlag GmbH.
- Erdinger, L., Kirsch, F. and Sonntag, H.G. (1998) Irritierende Wirkung von Nebenprodukten der Schwimmbadwasserdesinfektion. *Zentralblatt für Hygiene und Umweltmedizin* 200(5-6), 491-503.
- Glauner, T., Waldmann, P., Frimmel, F. and Zwiener, C. (2005) Swimming pool water—fractionation and genotoxicological characterization of organic constituents. *Water Research* 39, 4494-4502.
- Goeres, D.M., Palys, T., Sandel, B.B. and Geiger, J. (2004) Evaluation of disinfectant efficacy against biofilm and suspended bacteria in a laboratory swimming pool model. *Water Research* 38(13), 3103-3109.
- Gunkel, K. and Jessen, H.J. (1986) Untersuchungen über den Harnstoffeintrag in das Badewasser (Study on urea release by bathers). *Acta Hydrochimica et Hydrobiologica* 14(5), 451-461.
- Hijnen, W.A.M., Beerendonk, E.F. and Medema, G.J. (2006) Inactivation credit of UV radiation for viruses, bacteria and protozoan (oo)cysts in water: A review. *Water Research* 40(1), 3-22.
- ISO (2002) *Water quality - Determination of ammonium - Part 1: Manual spectrometric method - ISO 7150-1*, p. 7, International Organization for Standardization, Geneva, Switzerland.
- Jacangelo, J.G., Adham, S.S. and Laïné, J.M. (1995) Mechanism of Cryptosporidium, Giardia, and MS2 Virus Removal by MF and UF. *Journal of American Water Works Association* 87(9), 107-121.
- Jacobson, J.D., Kennedy, M.D., Amy, G. and Schippers, J.C. (2009) Phosphate limitation in reverse osmosis: An option to control biofouling? *Desalination and Water Treatment* 5(1-3), 198-206.
- Judd, S.J. and Black, S.H. (2000) Disinfection by-product formation in swimming pool waters: a simple mass balance. *Water Research* 34(5), 1611-1619.
- Kanan, A. and Karanfil, T. (2011) Formation of disinfection by-products in indoor swimming pool water: The contribution from filling water natural organic matter and swimmer body fluids. *Water Research* 45(2), 926-932.
- Keuten, M.G.A., Schets, F.M., Schijven, J.F., Verberk, J.Q.J.C. and van Dijk, J.C. (2012) Definition and quantification of initial anthropogenic pollutant release in swimming pools. *Water Research* 46(11), 11.
- Keuten, M.G.A., Peters, M.C.F.M., Daanen, H.A.M., de Kreuk, M.K., Rietveld, L.C. and van Dijk, J.C. (2014) Quantification of continual anthropogenic pollutants released in swimming pools. *Water Research* 53, 259-270.
- Kondo, M.M. and Jardim, W.F. (1991) Photodegradation of chloroform and urea using Ag-loaded titanium dioxide as catalyst. *Water Research* 25(7), 823-827.
- Kooij van der, D. (2000) Biological stability: a multidimensional quality aspect of treated water. *Water, air, soil pollution* 123(1-4), 25-34.
- Liu, G., Verberk, J.Q.J.C. and Dijk van, J.C. (2013) Bacteriology of drinking water distribution systems: an integral and multidimensional review. *Applied Microbiology and Biotechnology* 97(21), 9265-9276.

- Loosdrecht van, M.C.M. and Jetten, M.S.M. (1998) Microbial conversions in nitrogen removal. *Water Science and Technology* 38(1), 1-7.
- Lund, V. and Ormerod, K. (1995) The influence of disinfection processes on biofilm formation in water distribution systems. *Water Research* 29(4), 1013-1021.
- Mobley, H.L.T., Island, M.D. and Hausinger, R.B. (1995) Molecular Biology of Microbial Ureases. *Microbiological Reviews* 59(3), 451-480.
- NEN (2000) Water quality - Determination of free chlorine and total chlorine - Part 2: Colorimetric method using N,N-diethyl-1,4-phenylenediamine, for routine control purposes, NEN, Delft.
- Prest, E.I., Weissbrodt, D.G., Hammes, F., van Loosdrecht, M.C.M. and Vrouwenvelder, J.S. (2016) Long-Term Bacterial Dynamics in a Full-Scale Drinking Water Distribution System. *PLoS ONE* 11(10), e0164445.
- Spiliotopoulou, A., Hansen, K.M.S. and Andersen, H.R. (2013) Comparison of analytical methods for the quantification of urea in pool water, Rome.
- Udert, K.M., Larsen, T.A. and Gujer, W. (2002) The fate of nitrogen and phosphorus in source-separated urine, Swiss federal institute of technology zurich, Zurich.
- Urfer, D., Huck, P.M., Booth, S.D.J. and Coffey, B.M. (1997) Biological filtration for BOM and particle removal: A critical review. *Journal of American Water Works Association* 89(12), 83-98.
- VROM (1984) Besluit Hygiëne en Veiligheid Zwemgelegenheden (Resolution Hygiene and Safety Swim Places), Ministry of Housing, Spatial Planning and the Environment (VROM), The Hague.
- VROM (2000) Besluit Hygiëne en Veiligheid Badinrichtingen en Zwemgelegenheden (Resolution Hygiene and Safety Bathing Accommodations and Swim Places). Ministry of Housing, s.p.a.t.E. (ed), Ministry of Housing, Spatial Planning and the Environment (VROM), The Hague.
- Vrouwenvelder, J.S., Beyer, F., Dahmani, K., Hasan, N., Galjaard, G., Kruithof, J.C. and van Loosdrecht, M.C.M. (2010) Phosphate limitation to control biofouling. *Water Research* 44(11), 3454-3466.
- Wen, G., Ma, J., Huang, T.-L. and Egli, T. (2014) Using coagulation to restrict microbial re-growth in tap water by phosphate limitation in water treatment. *Journal of Hazardous Materials* 280, 348-355.
- WHO (2006) Guidelines for safe recreational water environments, Volume 2; Swimming pools and similar environments, WHO.
- Zwiener, C., Richardson, S., De Marini, D., Grummt, T., Glauner, T. and Frimmel, F. (2007) Drowning in Disinfection Byproducts? Assessing Swimming Pool Water. *Environmental science & technology* 41(2), 363-372.





# Chapter 6

## Conclusions, remarks and recommendations

M.G.A. Keuten





## 6.1 Introduction

This thesis focussed on the release of anthropogenic pollutants by bathers and the means to control them, the effect of different treatment and disinfection techniques on the potential for biofilm formation, the microbial pool water quality and the concentration of anthropogenic pollutants. Anthropogenic pollutant release was investigated with a standardised shower cabin and a temperature conditioned pool tank with a submerged cross-trainer and different treatment and disinfection techniques were investigated with an experimental pilot plant at Delft university of Technology.

## 6.2 Anthropogenic pollutant release; showering and submerged sweating

The initial anthropogenic pollutant release was defined as all pollutants that can be rinsed off a human body during a 60 seconds pre-swim shower. Pre-swim showering was found to be an important tool to reduce soluble substances, particles and micro-organisms introduced into swimming pool water by swimmers. Most likely, reduction of dissolved anthropogenic pollutants will also lead to a reduced disinfection by-products (DBPs) formation in chlorinated pools.

During swimming, bathers constantly release anthropogenic pollutants, so called submerged sweating, containing sweat, pathogenic micro-organisms, particles and skin lipids. The level of submerged sweating is mainly depending on the duration of the swim, but also on the bather's level of exercise in combination with the pool water temperature.

For competition swimmers, the initial anthropogenic pollutant release was found to be 31% and continual anthropogenic pollutant release 37% of the total amount of released pollutants. The remaining part, calculated with 30 mL urine release per bather, (Gunkel and Jessen 1986) the so-called incidental anthropogenic pollutant release, was thus 32%.

### *Remarks*

Thus, both the use of a pre-swim shower as well as the use of a toilet “when nature calls”, accountable for 63% of the anthropogenic pollutant release by competition swimmers, will considerably decrease the pollutant load. It was found that recreational swimmers have a much lower level of exercise (chapter 3) and therefore also a lower sweat rate, which means that for recreational swimmers the influence of “unhygienic” behaviour accounts for 90% of the total released pollutants. Changing this hygienic behaviour is therefore an important tool to improve pool water quality. Parallel to this project, therefore, three behaviour studies were done, but not included in this thesis. A first observational study to improve pre-swim showering showed that an information-based approach had the best effect, but it also showed that “carrying belongings” plays an important role in not having a pre-swim shower (Zwilling 2014). A second observational study, therefore, also focussed on proper facilities, e.g. for storing belongings, and found that improving these facilities increased pre-swim showering, but an injunctive normative message was the most effective way in improving pre-swim showering (Stronks 2015). A third observational study focussed on the influence

of “Watching eyes” and found that the presence of watching eyes was not the best way to improve pre-swim showering, but the absence of watching eyes (from other bathers) strongly increased the incidental anthropogenic pollutant release, most probably peeing “incidents” (Ribbers 2016). As swimming pools nowadays are multifunctional, they serve not only competition swimmers but a wide range of users like toddlers, recreational swimmers, children following swimming lessons, elderly people, and practitioners of all sorts of aqua-gym or aqua-robics. Each type of user has a different level of exercise and therefore also a different optimal comfort temperature. So planning a level of exercise to a specific pool water temperature, like aqua-robics in cold pool water rather than in warm pool water, could be a measure to reduce anthropogenic pollution.

### **6.3 Biofilm formation potential and microbial water quality**

The biofilm formation potential (BFP) and microbial water quality was controlled with the combination of biological sand filtration with ultrafiltration and UV-treatment in swimming pool water, without the use of a residual disinfectant, although not to the same low level as obtained in swimming pool water with chlorination. In the absence of a residual disinfectant, multiple treatment steps were needed to reduce the biofilm forming potential of simulated swimming pool water, while ultrafiltration played an important role in maintaining a low number of micro-organisms. When applying chlorine disinfection, the presence of a minimum free chlorine level (0.3 mg/L) was sufficient to maintain a low biofouling potential and a low microbial number. Experiments with and without phosphate addition showed that in a chlorinated treatment, free chlorine is the main controlling parameter for biofilm formation. In a treatment based on biological sand filtration + ultrafiltration + UV-treatment, the addition of phosphate improved the efficiency of the treatment, reducing the biofilm formation potential, but increased the microbial number.

#### *Remarks*

Although biological filtration was found to be important towards reducing the biofilm formation potential, the biological filtration did not operate optimally during the biological sand filtration + ultrafiltration + UV-treatment. Therefore, improvement of the biological filtration is needed in future studies. The design of the biological sand filtration in this study was based on a fixed bed reactor, which was possible because only soluble anthropogenic pollutants were added as BFA. In the presence of particles, in a full-scale swimming pool, the use of a moving-bed reactor (Bassin et al. 2012) might be a better choice. The challenge is to enhance biofilm formation in the moving-bed reactor, while inhibiting biofilm formation outside the pool water treatment.

In the absence of a residual disinfectant, the lowest microbial number was found without phosphate addition, however, this condition resulted in the pool basin with a higher biofilm formation potential. The use of specific materials can reduce biofilm formation on the pool walls and also cleaning methods were studied, in a parallel research line, to reduce biofilm formation on the walls and remove biofilms from the wall of the pool basin. It was found that the lowest biofilm formation occurred on polypropylene (Peters 2016b), and formed biofilms

can be minimised with the use of regular brushing and UV-treatment (Peters 2016a). The idea behind this study was to develop a cleaning robot, similar to the already existing cleaning robots (Yuan et al. 2011), equipped with brushes and UV-lamps which can clean the pool basin walls on weekly intervals. Future studies can further develop this cleaning robot, which might also be improved with an ultrasonic transponder to improve biofilm removal.

## 6.4 The removal of urea

At conditions above 8 mg/L urea with 0.3-0.5 mg/L free chlorine, urea reduction was limited due to the presence of free chlorine which limits microbial urea hydrolysis. In the absence of a residual disinfectant, oxygen availability limited the oxidation of ammonium towards nitrate in the biological filtration step. This resulted in the only partial removal of ammonium.

At conditions with 2.0 mg/L urea (maximally allowed concentration), the removal of urea increased, with less accumulation of ammonium.

The addition of treatment steps increased the urea removal at both chlorinated and non-chlorinated conditions. At chlorinated conditions, the addition of biological activated carbon filtration increased removal of urea and formation of nitrate. As a result, it was expected that less nitrogen was available for the formation of nitrogen containing disinfection by-products. At recirculation conditions with biological sand filtration + ultrafiltration + UV-treatment urea was completely oxidised, mainly towards nitrate.

### *Remarks*

In the suggested treatment with biological sand filtration combined with ultrafiltration and UV-treatment, two microbial barriers were in place to retain pathogens released from the biological filtration. However, in a pool with chlorine disinfection with biological activated carbon filtration, the effluent of the biological filtration is normally completely dechlorinated by the activated carbon with the potential to release pathogens from this biological filter. In addition, because of the narrow technical rooms in swimming pools, the effluent of the biological activated carbon filtration is generally, rapidly mixed with the main recirculation loop and returned to the pool basin. In many cases, the treated pool water re-enters the pool basin within 1-2 minutes after treatment, potentially leading to unhygienic circumstances (Jacangelo et al. 2002). So the combination of a chlorinated pool with a biological filtration can have microbial risks when specific design issues to minimise the microbial risks are not met.

The composition of the body fluid analogue (BFA) used in this study had a different C/N ratio compared to the real anthropogenic pollutant release. Nevertheless, urea is known to be the predominant nitrogen compound released by bathers (Erdinger et al. 1998, Gunkel and Jessen 1986) and can be well removed during pool water treatment. However, other nitrogen containing compounds are also released by bathers, such as creatinine, ammonium and amino-acids, which can also lead to the formation of unwanted disinfection by-products (Kanan and Karanfil 2011). A more realistic BFA composition is needed to get a more realistic picture of the DBP formation from anthropogenic pollutants. Besides nitrogen containing compounds, also carbon containing compounds are released, by bathers, most probably

through skin lipids (Keuten et al. 2014). These skin lipids were not part of the BFA used in this study, nor in other recent studies in pool water treatment (Kim et al. 2017, Yang et al. 2016, Yue et al. 2016). It is known that some skin lipids can even have an antimicrobial effect, which might interfere with the microbial degradation (Thormar et al. 2013). Therefore, additional study on the removal of these skin lipids by pool water treatment is also needed.

## **6.5 Overall conclusions, general remarks and recommendations for future research**

### *6.5.1 Overall conclusions*

The thesis was part of a larger project, called DIPool. The goal of the DIPool project was to explore the use of alternative disinfection for pool water treatment, without the use of a residual disinfectant. The thesis showed that biological sand filtration combined with ultrafiltration and UV-treatment can be a feasible alternative for treatment based on chlorination as a residual disinfectant in swimming pool water. Biological filtration is a necessary treatment step to reduce nutrients like urea to maintain a low biofilm formation potential. Ultrafiltration is necessary to remove particles and maintain a low microbial number and UV-treatment acts as a second barrier to safeguard the microbial water quality. The performance of the biological sand filtration combined with ultrafiltration and UV-treatment was good at both simulated high occupancy and maximum allowed conditions, however, at extreme (worst case) conditions, the anaerobicity in the biological filtration led to a reduced efficiency of the treatment. The research described in this thesis also showed that chlorinated pool water treatment can be improved with the addition of a biological activated carbon filtration, which will reduce the building blocks for disinfection by-products, like urea, and promote nitrate formation. Additional improvements can be made to combine biological sand filtration with ultrafiltration and UV-treatment with modest chlorination, if the anthropogenic pollutant release cannot be controlled. Pre-swim showering can reduce the total pollutant release by 31% and using toilets by 32%. However, changing this hygienic behaviour will be a considerable task.

### *6.5.2 General remarks and future research*

#### **Full scale study**

The experiments of the DIPool project were done at simulated swimming pool conditions at a laboratory pilot plant. Additional research is needed to study the performance of this treatment at more realistic conditions, with the addition of anthropogenic pollutants, particles and micro-organisms included. However before this follow-up study can start, acceptable limits for microbial indicators need to be discussed with health officials.

#### **Health effects**

The absence of disinfection by-products is an advantage of the treatment combination of biological sand filtration with ultrafiltration and UV-treatment compared to chlorination. It is

expected that this is mainly an improvement in comfort by removing irritations like red eyes, respiratory complaints and skin irritations.

In a parallel research line, within the DIPool project, the microbial pool water quality was assessed for the combination of biological sand filtration with ultrafiltration and UV-treatment versus chlorination with the use of a Quantitative Microbial Risk Assessment (QMRA). For *Escherichia coli* and *Salmonella enterica*, the yearly risk of infection in a pool without residual disinfectant was found to be lower than  $10^{-4}$ , which is known to be an acceptable level for consumption of drinking water, but for *Campylobacter jejuni*, the yearly risk was above the  $10^{-4}$  level (Peters 2016c), although there is no guideline level for swimming pool water. More recently, *Cryptosporidium* contamination was added to the QMRA, and it was found that in both cases, with and without a residual disinfectant, the yearly risk for *Cryptosporidium* was above the  $10^{-4}$  level, but treatment with the combination of biological sand filtration with ultrafiltration and UV-treatment in the absence of a residual disinfectant, had a lower yearly risk compared to treatment with chlorination (Peters et al. 2017).

### **Safeguard disinfection**

Presently, alternative disinfection for public swimming pools is prohibited (VROM 2000), but regulations for swimming ponds, also without a residual disinfectant, are in preparation (IenW 2018). In chlorinated swimming pools, the indicator organisms are checked on a monthly basis and disinfection is safeguarded by a bidaily check of free chlorine and pH. In the absence of a residual disinfectant, weekly controls of microbial water quality are suggested for swimming ponds (IenW 2018), but this may not be feasible in the practice of unchlorinated pools. Therefore, it is suggested to use bidaily checks on disinfection. This can be done with the use of indicators such as intracellular adenosine triphosphate (cATP), which is present in all forms of life for energy transfer (Knowles 1980). The results of this thesis, amongst others, have shown that cATP is well correlated with the concentration of intact cells and is therefore a good measure for the general microbial water quality within the pool water (Nevel van et al. 2017).

### **Environmental issues**

The proposed alternative pool water treatment also has environmental advantages, because no chlorine is used, no disinfection by-products are released to the environment. Furthermore, the backwash water of the ultrafiltration can easily be regenerated as supplement water leading to water savings and concurrently reduction of fossil fuel usage for heating the supplement water. Also air conditioning of the swimming pool hall can change with the use of the combination of biological filtration with ultrafiltration and UV-treatment because more air can be recirculated, which will also lead to a reduction of fossil fuel usage for heating the air. Finally, because the swimming pool air will be less corrosive due to the absence of volatile disinfection by-products, there will also be constructional benefits due to less chlorides-induced corrosion.

## **Hydraulic design**

Optimisations of the hydraulic design can also improve the DIPool concept. The hydraulic design of a swimming pool without a residual disinfectant should be different from a pool with a residual disinfectant because of different objectives. In a chlorinated pool, the objective is to mix the added chlorine as quickly as possible over the pool content in order to have equal disinfection throughout the whole pool content, a vertically circulated hydraulic design suits this objective best (Ayar 1988). In the absence of a residual disinfectant, the main objective is to remove (microbial) contaminations to the pool water treatment, a plug flow circulated hydraulic design is therefore best for these types of pools (Ayar 1988). Although different attempts were made to study the hydraulic design with CFD, a reliable solution was not found yet (Barut 2009, Briffod 2010, Rabiller 2012, Vié 2011). Therefore, some practical experiments have been done to study horizontally circulated hydraulics and the influence of swimmers on the hydraulic design (Keuten et al. 2011). The idea was to remove the most polluted top layer of the pool at a higher frequency than the deeper layers, so not all pool water needs to be recirculated in this short turnover time. Natural stratification of the two water layers by inducing a temperature difference, might be a feasible option for practical implementation. However, more research is needed to study this option in more detail.

## **Social acceptance**

Although many people have stated that they would like to swim in pool water without chlorination, it is unclear what the psychological effect will be when bathers don't smell "chlorine" anymore. It is expected that the typical swimming pool odour, unconsciously tells bathers that the pool water is microbially safe. Although speculative, it is very likely that pool water treated with biological sand filtration combined with ultrafiltration and UV-treatment will smell like an aquarium, so social acceptance needs to be rebuilt.

## **General**

This thesis showed the technical feasibility of pool water treatment without a residual disinfectant. Many questions remain on up-sizing to full scale, regulating limits, quality management and social acceptance. All can be tested in a full scale pilot study, which will be the Proof of the Pudding!!

## 6.6 References

- Ayar, A. (1988) Experimentaal onderzoek naar verblijftijden in een zwembad (Experimental study on turnover times in swimming pools), Delft University of Technology, Delft.
- Barut, M. (2009) Rapport de stage scientifique. Innovative Hydraulic Design, Ecole des Ponts Paristech, Paris.
- Bassin, J.P., Kleerebezem, R., Rosado, A.S., Van Loosdrecht, M.C.M. and Dezotti, M. (2012) Effect of Different Operational Conditions on Biofilm Development, Nitrification, and Nitrifying Microbial Population in Moving-Bed Biofilm Reactors. *Environmental science & technology* 46(3), 1546-1555.
- Briffod, F. (2010) Rapport de Stage Scientifique. Innovative Hydraulic Design, Ecole des Ponts Paristech, Paris.
- Erdinger, L., Kirsch, F. and Sonntag, H.G. (1998) Irritierende Wirkung von Nebenprodukten der Schwimmbadwasserdesinfektion. *Zentralblatt für Hygiene und Umweltmedizin* 200(5-6), 491-503.
- Gunkel, K. and Jessen, H.J. (1986) Untersuchungen über den Harnstoffeintrag in das Badewasser (Study on urea release by bathers). *Acta Hydrochimica et Hydrobiologica* 14(5), 451-461.
- lenW (2018) Besluit houdende wijziging van het Besluit activiteiten leefomgeving met betrekking tot het gelegenheid bieden tot het zwemmen of baden in een waterbassin, versie internetconsultatie mei 2018 (Draft document to change swimming pool guidelines), Ministry of Infrastructure and Water management, The Hague.
- Jacangelo, J.G., Patania, N.L., Trussel, R.R., Haas, C.N. and Gerba, C. (2002) Inactivation of Waterborne Emerging Pathogens by Selected Disinfectants, AWWA Research Foundation and American Water Works Association, Denver.
- Kanan, A. and Karanfil, T. (2011) Formation of disinfection by-products in indoor swimming pool water: The contribution from filling water natural organic matter and swimmer body fluids. *Water Research* 45(2), 926-932.
- Keuten, M.G.A., Verberk, J.Q.J.C. and Dijk van, J.C. (2011) CFD modelling, swimming pools and swimmers, ISEP, Porto.
- Keuten, M.G.A., Peters, M.C.F.M., Daanen, H.A.M., de Kreuk, M.K., Rietveld, L.C. and van Dijk, J.C. (2014) Quantification of continual anthropogenic pollutants released in swimming pools. *Water Research* 53, 259-270.
- Kim, D., Ates, N., Kaplan Bekaroglu, S.S., Selbes, M. and Karanfil, T. (2017) Impact of combining chlorine dioxide and chlorine on DBP formation in simulated indoor swimming pools. *Journal of environmental Sciences* in press.
- Knowles, J.R. (1980) Enzyme-catalyzed phosphoryl transfer reactions. *Annual Review of Biochemistry* 49, 877-919.
- Nevel van, S., Koetzsch, S., Proctor, C.R., Besmer, M.D., Prest, E.I., Vrouwenwelder, J.S., Knezev, A., Boon, N. and Hammes, F. (2017) Flow cytometric bacterial cell counts challenge conventional heterotrophic plate counts for routine microbiological drinking water monitoring. *Water Research* 113, 191-206.
- Peters, M.C.F.M. (2016a) Microbiology in swimming pools; UV-based treatment versus chlorination, Delft University of Technology, Delft.
- Peters, M.C.F.M. (2016b) Microbiology in swimming pools; UV-based treatment versus chlorination, Delft University of Technology, Delft.
- Peters, M.C.F.M. (2016c) Microbiology in swimming pools; UV-based treatment versus chlorination, pp. 113-125, Delft University of Technology, Delft.
- Peters, M.C.F.M., Keuten, M.G.A., de Kreuk, M.K., Vrouwenwelder, J.S., Rietveld, L.C. and Medema, G. (2017) Quantitative microbial risk assessment for an indoor swimming pool with chlorination compared to a UV-based treatment, Kos Island, Greece.
- Rabiller, E. (2012) Rapport de Stage, Innovative Hydraulic Design, Ecole des Ponts Paristech, Paris.
- Ribbers, J. (2016) I spy, I spy with my little eye; a research about the effects of watching eyes on pre-swim shower behaviour, University of Twente, Enschede.

- Stronks, I. (2015) A minimal intervention field experiment: Pre-swim shower behaviour in holiday parks, University of Twente, Enschede.
- Thormar, H., Hilmarsson, H. and Bergsson, G. (2013) Antimicrobial lipids: Role in innate immunity and potential use in prevention and treatment of infection. *Microbial pathogens and strategies for combating them: science, technology and education* 3, 1474-1488.
- Vié, M. (2011) Rapport de Stage Scientifique. Innovative Hydraulic Design, Ecole des Ponts Paristech, Paris.
- VROM (2000) Besluit Hygiëne en Veiligheid Badinrichtingen en Zwemgelegenheden (Resolution Hygiene and Safety Bathing Accommodations and Swim Places). Ministry of Housing, s.p.a.t.E. (ed), Ministry of Housing, Spatial Planning and the Environment (VROM), The Hague.
- Yang, L., Schmalz, C., Zhou, J., Zwiener, C., Chang, V.W.-C., Ge, L. and Wan, M.P. (2016) An insight of disinfection by-product (DBP) formation by alternative disinfectants for swimming pool disinfection under tropical conditions. *Water Research* 101, 535-546.
- Yuan, F.-C., Sun, H.-L., Hu, S.-J. and Wang, L.-Z. (2011) Design of cleaning robot for swimming pools, pp. 1175-1178, IEEE, Harbin, China.
- Yue, E., Bai, H., Lian, L., Li, J. and Blatchley, E.R. (2016) Effect of chloride on the formation of volatile disinfection byproducts in chlorinated swimming pools. *Water Research* 105, 413-420.
- Zwilling, N. (2014) Influencing hygienic behaviour of recreational swimmers; a field experiment on the effect of minimal interventions on pre-swim showering in swimming pools, University of twente, Enschede.



## Dankwoord

Ik heb dit dankwoord tot het allerlaatste moment bewaard. Morgen gaat mijn proefschrift naar de drukker. Voor mij is het daarom nu een mooi moment om terug te kijken op de afgelopen ruim 13 jaar want in 2005 ontstond het eerste idee voor dit project. Ik ben veel dank schuldig aan de mensen die mij geholpen hebben met het werven van projectpartners en fondsen, het opzetten en uitvoeren van de experimenten, het analyseren van de data en het verwerken van de resultaten in publicaties. Maar ook de diverse tussentijdse rapportages voor de subsidieverstrekkers en aan het eind het afronden van dit proefschrift. Maar ook voorafgaand aan het project hebben veel mensen mij geholpen om mij te brengen waar ik nu ben. Ik heb veel geleerd over het zwemwatervak van mijn naaste collega's en directe relaties uit mijn nationale en internationale werkveld. Maar ik ben ook heel dankbaar voor het vertrouwen dat veel mensen mij gegeven hebben bij de aanvang van dit project, dat vertrouwen heb ik ook tijdens het project altijd gevoeld en dat was heel prettig. Aan dit project hebben zoveel mensen meegewerkt dat ik pagina's te kort kom om ze allemaal te bedanken. Ook ben ik bang dat ik misschien mensen zal vergeten, daarvoor alvast bij voorbaat mijn excuus.

Ten eerste wil ik Marjolein bedanken, tijdens een groot deel van dit project hebben we veel samengewerkt. Als ik hulp nodig had bij een experiment, of bij een publicatie, of het organiseren van een congresje, dan was je altijd bereid om daarbij te helpen, met enige regelmaat ook als proefpersoon, daarvoor dank. Daarnaast wil ik natuurlijk Jasper bedanken, voor elk probleem wist je wel een oplossing. Gaan we het lab verbouwen en staat mijn proefopstelling in de weg, dan gaan we die opstelling toch verhuizen. En was er een ingewikkeld experiment met zweten onder water, dan regelde je daar zelfs publiek bij. Jammer dat je bij de TUDelft weg ging voordat ik klaar was met mijn proefschrift.

Hans, ik heb veel van je geleerd. Ik denk dat je gelijk had toen je zei dat ik meer een praktijkman ben dan een wetenschapper. Als ik nu terug kijk naar de eerste versies van mijn publicaties, dan zat daar weinig lijn en veel tekst in en je hebt het toch voor elkaar gekregen om mij te laten zien hoe een wetenschappelijke publicatie in elkaar hoort te zitten. Dank ook dat ik, nadat je al weg was bij de TUDelft, bij jou thuis langs mocht komen om mijn publicaties te bespreken.

Luuk en Mark namen het stokje over van Hans. Luuk, ondanks je overvolle agenda heb je me altijd goed geholpen en wist je ook vaak een vrolijke noot in te brengen, dank daarvoor. De laatste hoofdstukken heb ik veel hulp van Luuk en Mark gehad en jullie hebben mij laten zien dat *kill your darlings* soms nodig is om het geheel beter te maken. Heel veel dank voor jullie bijdrage.

Ik wil natuurlijk ook mijn collega's bij hellebrekers bedanken. Om te beginnen Eddy Vlijm en eigenlijk ook Louis Hellebrekers, dank voor jullie steun en vertrouwen gedurende het hele project. Ik heb veel respect voor de manier waarop jullie leiding geven (en gegeven hebben) aan het mooie bedrijf Hellebrekers Technieken, hier werken voelt echt als een warme deken. Erik Keyl, ook jou moet ik bedanken voor het vele werk dat je als projectleider binnen dit project gedaan hebt zodat ik mij vooral kon richten op de wetenschappelijke inhoud.

Alle collega's bij de projectpartners ben ik ook dankbaar voor hun bijdrage en vertrouwen. Ton van Remmen en Janine Wanders-Dijk, als wij bij elkaar waren ging het altijd over UV. Jullie stonden altijd klaar om mee te denken en oplossingen aan te dragen waar dat nodig was. Bij veel grote bedrijven worden beslissingen over verschillende lagen genomen, wat erg vertragend kan werken in een project als dit. Het is dan heerlijk om te werken met kleine gespecialiseerde bedrijven die meteen kunnen zeggen of ze iets wel of niet zien zitten, dank daarvoor. Maarten Uiterwijk, als expert van SFN wist je altijd goed de praktijk bij zwembaden in het oog te houden. Later werd jou rol over genomen door Chris van Veluwen, beiden dank voor jullie bijdrage. Ook heb ik veel ondersteuning gehad van Akzonobel base chemicals. Marianne Reedijk, later Huzaifa Das, en weer later Maarten Remmerswaal, dank daarvoor, maar ook jullie collega's die mij vooral geholpen hebben bij het voortraject, Johan Visser, Hans ten Haaf, Doke Sweere en Aart Ek, dank voor jullie bijdrage en vertrouwen. Van Coram international wil ik John Geurts, Tarek Bayoumy en Christian Wouters bedankt voor jullie bijdrage en vertrouwen. hierbij hoort ook een vermelding voor het ministerie van VROM en Wilfred Reinhold, die een bijdrage hebben geleverd in het voortraject van dit project.

Voor de bouw en het ontwerp van de proefopstellingen ben ik veel dank verschuldigd aan Olivier van 't Hof, Jan Bouman, Freek Wullink (die het eind van dit project helaas niet meer mee kan maken), Bertus Beekhuizen, Marius Smit, Ruben Huisman, Erik Aarsen, Jan Huizinga, Ben Koster en Egbert Kolthoorn. Ik zal nooit vergeten dat ik het jullie best lastig heb gemaakt toen ik douche-experimenten aan het doen was met studenten in zwemkleding en jullie daarnaast je aandacht bij het werk aan de proefopstelling moesten houden.

Dans le cadre de ces expériences, les étudiants m'ont beaucoup aidé, notamment grâce à Elodie Laurent, Gaëlle Collet, Mael Barut, Fabien Briffod, François Astier, Antoine Neveu et Estelle Rabiller-Kermorvant. Also many thanks to Zeinab Pasdar Yazd, who performed the first experiments with the shower cabin in the water-lab in Delft. Hoewel in de minderheid, maar er waren ook Nederlandse studenten, die ook geholpen hebben met het onderzoek naar de afgifte van zwemmersvuil: Olga Pleumeekers, Jim van Spengen en Joost van der Zwet ook veel dank daarvoor. In het lab waren daar ook altijd Tonny Schuit, Patrick Andeweg, Robbert Kleerebezem, Marco Casola, Amer El-Kaliny, Udo van Dongen, Jos Lispet, Sander de Vree, Armand Middendorp en Mohammed Jafar om te helpen, veel dank daarvoor.

Bij veel zwembaden was ik welkom om experimenten in het veld uit te voeren. Veel resultaten van die experimenten hebben een belangrijke bijdrage geleverd aan dit proefschrift. Toch waren er ook experimenten die minder succesvol waren en daarom geen plek in dit proefschrift gekregen hebben, maar dat betekent niet dat ik daar minder van geleerd heb, integendeel zelfs. Ook daarvoor veel dank aan Piet Reedijk, Michel Boerhouders, Ilija Melisie, Mattijs Craamer, Edwin Groeneveld, Luciene van de Graaf, John Kruitbos, Stefan Bruinings, Anton van den Berg, Hans Egberts, Bert Lans, Dennis Hendriks, Wim Westdorp, Rutger Cruiming en Jan-Theo Hoeksema.

Aan het eind van het project ging de focus meer richting gedragswetenschappen. Ik heb veel geleerd van Mark van Vuuren, Pascal Wilhelm, Joris van Kampen en Thomas van Rompay van de Universiteit Twente. Ook dank aan Nadja Zwilling, Ilse Stronks en Joyce Ribbers die het uitvoerende werk voor dit deel van het onderzoek gedaan hebben. De resultaten van die

onderzoeken zijn niet opgenomen in dit proefschrift, maar het was wel baanbrekend werk waarvan ik hoop nog een aantal publicaties te kunnen schrijven.

Het Waterlaboratorium in Haarlem heeft geholpen met diverse microbiologische bepalingen. Dank daarvoor aan Aleksandra Magic-Knezev, Bas Remmerswaal, Marco Vos en Ramon Imamdi. Andere bedrijven hebben ook een bijdrage geleverd in onderdelen voor de proefopstelling of de laboratorium apparatuur. Dank daarvoor aan Joran Paets voor hulp bij de zuurstof sensoren, Nikàj de Vries voor hulp bij de TOC/TN analyser. Ich möchte auch Sabine Dick dafür danken, dass sie uns den Aqua Nordic Walker für die Experimente zum Schwitzen unter Wasser geliehen hat.

Ook wil ik de coauteurs bedanken voor hun bijdrage aan mijn publicaties; Ciska Schets, Jack Schijven, Hein Daanen, Merle de Kreuk, Hans Vrouwenvelder, GertJan Medema, Leo Keltjens en Dany Traksel. And I would like to say many thanks to Adele Sanders for correcting my English writing.

And my international colleagues, I only see you every two years during the intentional conferences, but these conferences are among the few times that I can discuss with swimming pool experts that really understand what I am doing. Your encourages and enthusiastic response to my work makes it therefore extra special for me, thanks for that to Michael Beach, Michelle Hlavsa, Vincent Hill, Christiane Höller, Wolfgang Uhl, Bertram Skibinksi, Stephan Uhlig, Henrik Andersen, Kamila Kaarsholm-Hansen, Lothar Erdinger, Athena Mavridou, Jean-Luc Boudenne, Tarek Manasfi, Regina Sommer, Kathy Pond, Vincenzo Romano Spica, Guglielmina Fantuzzi, Ernest Blatchley III, Thomas Lachocki, Ernst Stottmeister, Tamara Grummt, James Amburgey, Laura Suppes, and Mihály Kádár. Some of you probably also reviewed some of my papers, as you did, know that it always improved my writing, many thanks for that. Also thanks to the independent members of the doctoral committee for adding final suggestions for improvement to my thesis: Nancy Visser, Ana Maria de Rode Husman, Maria Kennedy and Apostolos Vantarakis.

Meer langs de zijlijn hebben ook veel mensen een bijdrage geleverd. De mensen bij Evers+Manders wil ik bedanken voor hun werk bij de subsidiewerving en tussentijdse rapportages naar de subsidieverstrekkers. Johan Evers, Paul Manders, Gisela Tjaberinga en ook Claudia Nicolaije veel dank daarvoor. Mieke Hubert, Jennifer Duiverdam, Ruth Lokhorst, Ruby de Mots, Willeke van de kolk-de Kaste en Marleen Kroondijk-Schouten van het secretariaat bij de TUDelft en Hellebrekers ook dank voor jullie bijdrage. Voor de financiële afhandelingen, dank aan Petra Jorritsma, Kees Hoekerd, Gea van Dorp, Charl Foppen en Rene van de Laan. Voor hulp bij mijn altijd terugkomende computerproblemen dank aan Arjan Mensink, Stephan Drost, Patrick Zeeboer en de ICT mensen bij citg. Ook Coert Schemmekes en Alfred Bultman veel dank voor de materiaal voorziening binnen dit project en Ariën Schouten ook als manusje van alles.

Also thanks to my room mates and colleagues who enriched my time at TUDelft during the many coffee breaks and section-uitjes; Wilfred van der Horst, David de Ridder, Ivo Pothof, Sam Olivero, Ryan Shang, Peter Lu, Xuedong Zhang, David Moed, Yasmina Bennani, Bas Heijman, Peter de Moel, Bas Wols, Annelies Aarts, Anke Grefte, Petra Ross, Gang Liu, Maria

Lousade Ferreira, Kerusha Lutchmiah, Sandra Borges Freitas, Karin Lekkerkerker-Teunissen, Guido Kooijman, Jojanneke Dirksen, Matthieu Spekkers en Cheryl Bertelkamp.

Veel dank ook aan mijn collega's die misschien niet direct bij het project betrokken waren, maar die wel veel voor mij betekenen hebben en mij daar waar mogelijk gesteund hebben de afgelopen jaren, enerzijds door mij aan te moedigen om door te gaan en anderzijds om mijn agenda zo veel mogelijk vrij te houden zodat ik mij kon focussen. Klaas Pul, Rob Kuijper, Rob de Bie, Louis Boon, Marcel van den Berg, Fokke Drijfhout en Elizabeth de Groot dank daarvoor. Ook buiten Hellebrekers heb ik veel geleerd over het zwembadvak, veel dank daarvoor aan Dick van Straaten, Lodewijk van Leengoed, Paul Blom, Ger Hulshof, Cees Colle, Piet Cuijpers, Jerry van Druuten, Ans Versteegh, Jan Bakker, Joost Bierens, Dick Heederick, Ronald ter Hoeven, Marcel Jagersma, Evert-Jan Hulshof, Mariska Hol, Jarno Hilhorst, Koen Breedveld, Floris Godfriedt, Hans Schoon, Ludo Feyen, Peter Appel, Kjell Galteland, Dick Bastenhof, Rene Stender en ook Jan Heselmans.

Mijn wekelijkse tennisavonden waren mijn schaarse momenten van ontspanning. Dank aan Frans, Piet, Dennis, Peter, So, Johan, Ben en Mika om mij telkens alle hoeken van de baan te laten zien zodat ik met mijn hoofd even ergens anders kon zijn, dat heeft zeker geholpen.

Ook dank aan de collega's van de teken en schilder cursus, mijn nieuwe hobby om het voor-spelde zwarte gat mee op te vullen. Het afgelopen half jaar hebben jullie mij geïnspireerd om de omslag van mijn proefschrift te schilderen. Jullie hebben mij veel tips gegeven en aangemoedigd en ik ben heel blij met het eindresultaat. Daarvoor dank aan Monica, Sylvia, Karin, Carolien, Nienke, Noortje, Wim, Astrid, René, Leanne, Rob, Valentine en natuurlijk ook Jaap.

Doordat ik veel vrije tijd in dit project geïnvesteerd heb, heb ik minder tijd gehad voor mijn familie en vrienden. Toch ben ik heel blij dat ik op momenten als ik in de put zat bij jullie terecht kon voor advies. Manou, als ervaringsexpert kon jij mij altijd goed helpen als ik een dipje had bij het schrijven, dank daarvoor. Als ik dan weer en stuk af had, dan kreeg ik van mezelf een nieuwe LEGO doos als beloning. Simon, de momenten die wij samen hebben doorgebracht met het bouwen van die LEGO zijn mij erg dierbaar, ik hoop dat we dat nog jaren blijven doen, ik heb de eerste nieuwe doos al klaar staan voor als dit document naar de drukker gaat. En Frans, als ik dan zelf niet eens in de gaten had dat ik hulp nodig had, dan stond jij al bij mij op de stoep, onze vriendschap is mij heel dierbaar, ontzettend bedankt voor al je steun.

Mijn schoonfamilie, Ans, Rien, Anjo, Pascal, Thomas en Siem jullie hebben mij vaak moeten missen als ik dan keuzes moest maken tussen werken of familiebezoekjes. Toch hebben jullie mij altijd aangemoedigd en gesteund bij mijn werk, en als het dan echt niet anders kon, dan kwamen jullie in alle vroegte naar Hoogland om op Joris en Edith te passen zodat ik mijn werk kon doen, heel veel dank daarvoor.

En dan mijn directe familie, ik kan mij voorstellen dat jullie vaak niet konden volgen waar ik mee bezig was en misschien vaker uit de media moesten horen over mijn vooruitgang dan van mijzelf. Nard en Karsten, mijn broers, en Petra, Birgit, Rowena, Tom, Jord, Maud, Jolisa en Matthijs en Loïs en Kyra (jullie horen daar ook bij), dank voor jullie steun de afgelopen jaren. En pap en mam, wat ben ik trots op jullie. Jullie hebben je hele leven kei hard gewerkt om je

bedrijf op te bouwen en hoopten dat ik dat zou over nemen. Vanaf de lagere school wist ik al dat ik dat het liefste wilde, maar in Delft werd ik verliefd op het watervak en dat heeft mij uiteindelijk doen besluiten de zaak niet over te nemen. Pap, je hebt nog wel een paar keer aangedrongen of ik zeker wist dat ik de zaak niet wilde overnemen, maar je hebt daarna mijn besluit geaccepteerd en mij altijd gesteund en aangemoedigd in mijn werk. Na jou overlijden hoorde ik voor het eerst bepaalde details uit jou jeugd en hoe jou relatie met je vader was. Ik ben in die periode pas gaan inzien dat wij veel meer op elkaar lijken dan ik ooit gedacht had. Ik snap nu pas waarom jij ogenschijnlijk zonder moeite je levenswerk links kon laten liggen en mij kon aanmoedigen in mijn werk zonder daar vervelende gevoelens op na te houden, *because there's something inside so strong*. Het doet mij heel veel verdriet dat ik je dit niet meer persoonlijk kan vertellen, dat had ik willen doen op de feestavond na mijn verdediging, maar ja, *...live is wat happens to you while youre busy making other plans*. Mam, jou kan ik nog wel bedanken, jij hebt mij opgevoed, pap was altijd aan het werk (net als ik nu). Je hebt mij altijd vrij gelaten en hier en daar wat bijgestuurd. Ik was vroeger vaak boos op je omdat er zaken miste in het huishouden, maar ik besef nu pas hoe moeilijk het is om een drukke baan te combineren met een gezin, dat lukt niet zonder steken te laten vallen. Dank voor al jou liefde en goede zorgen, jij hebt mij geboetseerd tot de mens die ik nu ben.

Mijn aller aller allergrootste dank is aan Marloes. Jij hebt zonder enige twijfel het meeste voor mij gedaan tijdens de afgelopen 13 jaar. Telkens als ik avonden, weekenden en vakantiedagen op zolder zat te werken loste jij alle problemen op rondom ons huis, de school, de kinderen, de boekhouding en nog veel meer. Ik weet niet of ik die schuld ooit nog kan inlossen, ik ga het in elk geval proberen, misschien als je ooit zelf nog eens gaat promoveren, ik hou van je.

En Joris en Edith, jullie zijn mij het meest dierbaar. Jullie zijn allebei in de loop van dit project geboren en weten niet beter dan dat je vader zijn vrije tijd op zolder door brengt, daar ben ik niet trots op. Joris, één van jou eerste woordjes was *poefinstatie* en Edith wist altijd precies met welk hoofdstuk ik bezig was en wat ik nog moest doen. Waar mogelijk kwamen jullie mij een kopje thee of wat fruit brengen op zolder, of gewoon een kletspraatje maken, dat heeft mij altijd heel veel goed gedaan, ook al kwam dat misschien niet altijd zo over. Ik heb mijn best gedaan om de afgelopen jaren niet teveel kostbare momenten met jullie te verliezen, maar ik weet dat me dat niet altijd gelukt is. De afgelopen zomervakantie heb ik daar hopelijk weer wat van goed kunnen maken en ik doe mijn best om dat de komende jaren ook vol te blijven houden. Ik wil dit proefschrift aan jullie opdragen omdat de toekomst van deze wereld in jullie handen is, gelukkig krijg je daarbij hulp van je leeftijdsgenoten, maak er wat moois van.

En tot slot, iedereen die ik nog vergeten ben, bedankt, en denk eraan ... *zwemmen is gezond*.

Maarten



## Photografy and painting

- Cover: painting by Maarten Keuten
- Page 0: Great Bath, Mohenjo Daro, Indus Valley Pakistan (Picture by Saqib Qayyum)
- Page 7: Shower cabin during on-site experiments (Picture by Maarten Keuten)
- Page 8: Pool tank experiment in Water-lab TUDelft (Picture Marjolein Peters)
- Page 9: Microbial fouling simulators (Picture Maarten Keuten)
- Page 10: Experimental setup at water-lab TUDelft (Picture Maarten Keuten)
- Page 11: Biological activated carbon filtration (Picture Maarten Keuten)
- Page 16: Swimming pool shower (Picture Jolisa Keuten - de Zeeuw)
- Page 40: Lane swimmers (Picture Jolisa Keuten - de Zeeuw)
- Page 72: Preparing biofilm samples from Microbial Fouling Simulators at Water-lab TUDelft (Picture Marjolein Peters)
- Page 103: Biofilms on membrane spacers inside Microbial Fouling Simulators (Picture Maarten Keuten)
- Page 104: Biofilms on membrane spacers inside Microbial Fouling Simulators (Picture Maarten Keuten)
- Page 112: Sand filtration (L) and side stream biological activated carbon filtration (R) at a swimming pool (Picture Jolisa Keuten - de Zeeuw)
- Page 130: Experimental setup at water-lab TUDelft (Picture Maarten Keuten)
- Page 152: Maarten Keuten (Picture Stephan Jansen)

## References of propositions

- Blom, P., van Veluwen, C., Lans, B., Keuten, M.G.A., Schoon, H., Godfriedt, F., Verbeek, T. and van den Beld, M. (2016) Opleidingen Zwembad Techniek (Swimming pools Technical courses), NPZ|NRZ (National Swimming Pool Platform), Ede.
- Expert groep sanitaire technieken TVVL (2013) kwaliteit leidingwater staat onder druk, (Quality of drinking water is under pressure) <https://www.stichtingveteranenziekte.nl/nieuws/kwaliteit-leidingwater-staat-onder-druk>
- Lachocki, T. (2011) Why society needs aquatics and why society does not know it, Fourth International Conference Swimming Pool & Spa, Porto.
- Polder, R.B. and Snijder, H.H. (2013) Deskundigenrapport toepassing en inspectie van roestvaststaal (RVS) in zwembaden (Expertopinion use and inspection of stainless steel in swimming pools), TNO, Delft.





## List of publications

### *Peer-reviewed publications*

Keuten, M.G.A., Schets, F.M., Schijven, J.F., Verberk, J.Q.J.C. and van Dijk, J.C. (2012) Definition and quantification of initial anthropogenic pollutant release in swimming pools. *Water Research* 46(11), 11.

Keuten, M.G.A., Schets, F.M., Schijven, J.F., Verberk, J.Q.J.C. and van Dijk, J.C. (2013) Corrigendum to "Definition and quantification of initial anthropogenic pollutant release in swimming pools". *Water Research In Press, Corrected Proof, Available online 23 December 2013.*

Keuten, M.G.A., Peters, M.C.F.M., Daanen, H.A.M., de Kreuk, M.K., Rietveld, L.C. and van Dijk, J.C. (2014) Quantification of continual anthropogenic pollutants released in swimming pools. *Water Research* 53, 259-270.

Peters, M.C.F.M., Keuten, M.G.A., Knezev, A., van Loosdrecht, M.C.M., Vrouwenvelder, J.S., Rietveld, L.C., de Kreuk, M.K. (2018) Characterization of the bacterial community in shower water before and after chlorination, *Journal of Water and Health* 16 (2), 233-243.

### *Peer-reviewed papers in preparation*

Peters, M.C.F.M., Keuten, M.G.A., Knezev, A., van Loosdrecht, M.C.M., Vrouwenvelder, J.S., Rietveld, L.C., de Kreuk, M.K. (submitted) Impact of chlorination and UV irradiation on an anthropogenic microbial community from bathers, *Escherichia coli* and *Pseudomonas fluorescens*.

Peters, M.C.F.M., Keuten, M.G.A., Zuiddam, M.R., Verliefde, A.R.D., Vrouwenvelder, J.S., Rietveld, J.C., de Kreuk, M.K. (submitted) Biofouling in swimming pools: role of material characteristics and nutrients.

Peters, M.C.F.M., Keuten, M.G.A., Vrouwenvelder, J.S., Rietveld, L.C., de Kreuk, M.K. (in preparation) Biofilm disinfection by UV irradiation and removal by brushing.

Peters, M.C.F.M., Keuten, M.G.A., Vrouwenvelder, J.S., Rietveld, L.C., Medema, G. (in preparation) Quantitative microbial risk assessment for an indoor swimming pool with chlorination and UV-based treatment.

Keuten, M.G.A., Peters, M.C.F.M., van Dijk, J.C., Rietveld, L.C., van Loosdrecht, M.C.M. (in preparation) Biofilm formation potential and microbial water quality of simulated swimming pool water with different types of disinfection.

Keuten, M.G.A., Peters, M.C.F.M., van Dijk, J.C., Rietveld, L.C., van Loosdrecht, M.C.M. (in preparation) Microbial reduction of urea in simulated swimming pool water with different types of disinfection.

## *Oral and poster presentations at international conferences*

Keuten, M.G.A. (2006) Developments in poolwater treatment, Antwerpen.

Keuten, M.G.A., Keltjens, L.L.M., Traksel, D., van Dijk, J.C. (2007) Traditional and future pool water treatment, International conference on Swimming pools and Spa's, Munich.

Keuten, M.G.A., Verberk, J.Q.J.C., Pleumeekers, O., van Spengen, J., van Dijk, J.C. (2009) Determination and reduction of bathing loads in public swimming pools, 3<sup>rd</sup> pool and spa conference, London.

Keuten, M.G.A., Verberk, J.Q.J.C., van Remmen, T., van Dijk, J.C. (2009) Biofilm formation at non chlorinated swimming pool conditions, 3<sup>rd</sup> pool and spa conference, London.

Keuten, M.G.A., Verberk, J.Q.J.C., van Dijk, J.C. (2011) Definition and quantification of anthropogenic initial and continual biochemical bathing load in swimming pools, fourth international conference swimming pool & spa, Porto.

Keuten, M.G.A., Verberk, J.Q.J.C. and Dijk van, J.C. (2011) CFD modelling, swimming pools and swimmers, fourth international conference swimming pool & spa, Porto.

Peters, M.C.F.M., Keuten, M.G.A., (2011) Microbiological safe swimming pools without chlorine (poster), Young water professionals BeNeLux, Amsterdam

Keuten, M.G.A., Peters, M.C.F.M., Verberk, J.Q.J.C., Rietveld, L.C. (2012) Initial bathing load, Pools12, Delft

Keuten, M.G.A., Peters, M.C.F.M., Verberk, J.Q.J.C., Rietveld, L.C. (2012) Continual bathing load, Pools12, Delft

Keuten, M.G.A., Peters, M.C.F.M., Verberk, J.Q.J.C., Rietveld, L.C. (2012) BFA composition, Pools12, Delft

Keuten, M.G.A., Peters, M.C.F.M., Daanen, H., de Kreuk, M.K., Rietveld, L.C., van Loosdrecht, M.C.M., van Dijk, J.C. (2012) Quantification of continual anthropogenic pollutant release in swimming pools (poster), Young Water Professionals, Luxembourg

Peters, M.C.F.M., Keuten, M.G.A., de Kreuk, M.K., van Loosdrecht, M.C.M., Rietveld L.C. (2012) Chlorine cell disinfection determination with flow cell cytometry and plate count, Young Water Professionals (poster), Luxembourg

Keuten, M.G.A., Peters, M.C.F.M., Rietveld, L.C., van Dijk, J.C. (2013) Removal efficiency of anthropogenic pollutants in different poolwater treatment steps (poster), 5<sup>th</sup> international conference swimming pool & spa, Rome

Peters, M.C.F.M., Keuten, M.G.A., de Kreuk, M.K., van Loosdrecht, M.C.M., Rietveld, L.C. (2013) Chlorine inactivation of mixed population versus indicator micro-organism, 5<sup>th</sup> international conference swimming pool & spa, Rome

Keuten, M.G.A., Peters, M.C.F.M., Daanen, H., de Kreuk, M.K., Rietveld, L.C., van Loosdrecht, M.C.M., van Dijk, J.C. (2013) Quantification of continual anthropogenic pollutant release in swimming pools, 5<sup>th</sup> international conference swimming pool & spa, Rome

Peters, M.C.F.M., Keuten, M.G.A., de Kreuk, M.K., van Loosdrecht, M.C.M., Rietveld L.C. (2013) Minimum chlorine concentration to ensure disinfection - Chlorine inactivation of the mixed population versus indicator micro-organism, 5<sup>th</sup> international conference swimming pool & spa, Rome

Keuten, M.G.A., Peters, M.C.F.M., Rietveld, L.C., van Dijk, J.C., van Loosdrecht, M.C.M. (2015) Biofilm formation potential, 6<sup>th</sup> international conference swimming pool & spa, Amsterdam

Keuten, M.G.A., Peters, M.C.F.M., Rietveld, L.C., van Loosdrecht, M.C.M., van Dijk, J.C. (2015) Urea removal in chlorinated and non-chlorinated pool water treatment, 6<sup>th</sup> international conference swimming pool & spa, Amsterdam

Peters, M.C.F.M., Keuten, M.G.A., de Kreuk, M.K., Magic-Knezev, A., van Loosdrecht, M.C.M., Rietveld, L.C. (2015) Responce of a shower population versus indicator organisms after chlorination, 6<sup>th</sup> international conference swimming pool & spa, Amsterdam

Peters, M.C.F.M., Keuten, M.G.A., de Kreuk, M.K., van Loosdrecht, M.C.M., Rietveld, L.C. (2015) Biofilm growth on swimming pool material, 6<sup>th</sup> international conference swimming pool & spa, Amsterdam

Zwilling, N. Keuten, M.G.A., Wilhelm, P. van Vuuren, M. (2015) Taking a pre-swim shower, 6<sup>th</sup> international conference swimming pool & spa, Amsterdam

Stronks, I., Keuten, M.G.A., van Vuuren, M. (2016) How to improve pre-swim shower behaviour, Symposium on improving pool water quality, Zell am See

Ribbers, J. Keuten, M.G.A., van Rompay, T. (2017) I spy, I spy, with my little eye; the effect of watching eyes on pre-swim shower behaviour, Swimming pools & spa 7<sup>th</sup> international conference, Kos

Keuten, M.G.A., Peters, M.C.F.M., van Dijk, J.C., van Loosdrecht, M.C.M., Rietveld, L.C. (2017) Microbial quality of swimming pool water, Swimming pools & spa 7<sup>th</sup> international conference, Kos

Peters, M.C.F.M., Keuten, M.G.A., de Kreuk, M.K., Vrouwenvelder, J.S., Rietveld, L.C., Medema, G. (2017) QMRA of an indoor swimming pool, Swimming pools & spa 7<sup>th</sup> international conference, Kos

## *Oral and poster presentations at national conferences*

Keuten, M.G.A. (2001) Legionella in swimming pools, PAO conference swimming pools, Delft

Keuten, M.G.A. (2001) State of the art in pool water treatment, PAO conference swimming pools, Delft

Keuten, M.G.A. (2003) State of the art in pool water treatment, PAO conference swimming pools, Delft

Keuten, M.G.A. (2007) Hydraulic design of swimming pools, PAO conference swimming pools, Delft

Keuten, M.G.A. (2007) Summary of ICSPS Munich, PAO conference swimming pools, Delft

Keuten, M.G.A., Verberk, J.Q.J.C., van Dijk, J.C. (2009) Determination and reduction of pollutant release in swimming pools, PAO conference swimming pools, Delft

Keuten, M.G.A. (2009) Hydraulic design of swimming pools, PAO conference swimming pools, Delft

Keuten, M.G.A. (2009) State of the art in swimming pools and spa's, PAO conference swimming pools, Delft

Keuten, M.G.A. (2009) Pool water treatment and sustainability, managersmeeting NPZ|NRZ, Kraggenburg

Keuten, M.G.A. (2012) Summary of fourth international pool & spa conference, PAO conference swimming pools, Delft

Keuten, M.G.A. (2014) Swimming pool hygiene, PAO conference swimming pools, Nootdorp

Keuten, M.G.A. (2015) How to control disinfection by-products, National swimming pool conference, Amsterdam

Stronks, I., Keuten, M.G.A. (2015) Showering, not just after, but also before swimming, Workshop pool water treatment, Utrecht

Keuten, M.G.A., (2016) PDCA circle, is dat enough?, National swimming pool conference, Utrecht

Keuten, M.G.A. (2017) New legislation, recent incidents and more hygiene and safety, Managersmeeting NPZ, Amersfoort

van Veluwen, C., Verbeek, T., Keuten, M.G.A. (2017) Teaching in hygienic and safe swimming pool water, National swimming pool conference, Nieuwegein

Ribbers, J., Keuten, M.G.A., van Rompay, T. (2017) I spy, I spy with my little eye; the influence of watching eyes on pre-swim shower behaviour of swimmers, Workshop pool water treatment, Utrecht

Keuten, M.G.A. (2017) Swimming ponds, workshop swimming ponds, Veghel

Blom, P., Keuten, M.G.A. (2018) Teaching in hygienic and safe swimming pool water, workshop lifeguards, Kamerik

Keuten, M.G.A., (2018) Future pool water treatment; poolwater treatment without chemicals, Technical workshop poolwater treatment, Nijmegen

van Veluwen, C., Keuten, M.G.A. (2018) New pool legislation, Technical workshop swimming pools, Utrecht

Keuten, M.G.A. (2018) Developments in poolwater treatment, Technical workshop swimming pools, Utrecht

Keuten, M.G.A. (2018) Alternative pool water treatment, Technical workshop swimming pools, Utrecht



## Curriculum vitae

Maarten Keuten was born on June 17th in 1970 in Venray, the Netherlands, and grew up in the former village Merselo. After obtaining his HAVO in 1987 at Boschveld College in Venray, he started to study at Larenstein Garden & Landscape Architecture in Boskoop, to follow in his fathers footsteps. At Larenstein, Maarten specialised in technical design and finished his bachelor in 1991. After that he wanted to expand his technical knowledge, so he started studying civil engineering at Delft University of Technology.

At TUDelft, Maarten specialised in sanitary engineering. In 1995, Maarten started his master thesis; a study on the occurrence, the risks and the prevention of chloroform in Dutch swimming pools. This was the first step of his current career path in swimming pools. After finishing his Master in 1996, he started working at Hellebrekers Technieken on research and development projects. His first task was to design a plate aerator for THM removal in swimming pools, which was finished in 1997 and tested in practise in 1998-1999. At Hellebrekers Technieken, Maarten developed equipment for reclamation of backwash-water, equipment for Legionella prevention and equipment for ozone-dosage in swimming pools.

Slowly his interest moved from development towards research. His research topics were catalytic removal of combined chlorine with activated carbon (2001-2003) and the removal of combined chlorine by LP-UV (2004). Besides his work on research and development, Maarten also worked as consultant for swimming pools on topics like; Legionella prevention, optimisation of energy consumption (nowadays called sustainability), chloride induced stress corrosion cracking, pool water treatment, storage and handling of chemicals and air conditioning. Because of his extensive swimming pool knowledge, Maarten is often asked as trouble shooter for various swimming pool related malfunctions and he participated in many different taskforces like pool water treatment, stainless steel, legionella, education, standardisation and legislation.

In 2005, the idea for a PhD study came about. During the first years after that, Maarten collected funding from national and European programs and combined that with financial contributions from commercial partners. In august 2008 Maarten started with the actual research, at Delft University of Technology, which was finished in May 2015. After finishing the experiments, Maarten regained his fulltime work at Hellebrekers Technieken. He expanded his knowledge towards behavioural science with projects at Twente University. As swimming pool expert, Maarten developed chemical and technical educational programs for swimming pool operators and teaches these courses since 2015.

## Cover design

During my first painting lessons, one of the tasks was to combine something old with something new in a painting. This is when I got the idea to paint the oldest known swimming pool and combine it with the results of my study. On the front cover, I wanted to tell the story of the project in hieroglyphs. Surrounded by these hieroglyphs stands Sobek, the Ancient Egyptian water God, who protects the water like a crocodile protects his offspring. Behind Sobek, you can see the modern side of the ancient Mohenjo Daro's great bath, which I painted on the back of this thesis. On the left side the ancient great bath as it looks today and on the right, the great bath as it may look filled with water with colourful pool surroundings.

The hieroglyphs on the front cover tell the story of this project. The first column represents the zodiac signs of my father, and mother, the symbol for union followed by the zodiac signs for me and my wife, our own wedding sign, again the union symbol and the zodiac signs of our children Joris and Edith. The second column represents the main ingredients of this project being water and euros. In the third column, the logos of the companies I worked for during the project are shown.

The fourth column represents different types of swimmers. The first sign is the oldest known painting of a swimmer from the cave of swimmers, the first swimmer. The second (ABC) represents the Dutch swimming licences, which is the main drive for most Dutch children to start swimming. Then the sportive swimmer, the lazy swimmer and again the ancient swimmer.

The fifth column represents the idea behind this project. First we go swimming (again a copy of the ancient rock painting from the cave of swimmers), then we release bacteria, so we need filtration and HOCl (chlorination) to do something about it, but this can result into disinfection by-products (DBPs), of which some cause eye irritations and the impact of others on human health is questioned by health experts. During the research prior to my PhD study I got the idea of an alternative pool water treatment.

The sixth column represents chapters 2 and 3, the anthropogenic pollutants. When you go swimming (with bag), you need to change clothes first, then you need to take a shower, during which you don't use soap. Shower for 30-60 seconds to get rid of all initial pollutants. After that you can dive in the pool and start swimming, but during swimming you will sweat and when nature calls you need to use the toilets.

The seventh column represents a traditional pool water treatment, started with a finish gutter, a sieve (or strainer), a circulation pump and some valves, the addition of a flocculant, sand filtration, heating, again some valves, pH-control and addition of HOCl, after which the water is sent to the pool basin.

The last column represents the alternative pool water treatment developed during this project. Starting with a basin, the water needs to pass a sieve (strainer) to remove large particles, after which a biological filtration (with bacteria) will remove dissolved pollutants, UF will remove suspended and colloidal particles and bacteria and viruses and UV will act as backup for disinfection. We also need pumps, valves and heating before we can send the water back to the pool, where a swimmer is on the starting block, ready for the proof of the pudding...



## Ontwerp omslag

Een van de eerste opdrachten tijdens mijn eerste schilderlessen was het combineren van iets ouds met iets nieuws. Toen dacht ik meteen, ik ga de omslag van mijn proefschrift maken en mijn idee was om het oudste zwembad te combineren met de nieuwste ideeën uit deze studie. Op de voorkant wilde ik het project in hiërogliefen vertellen. Omringd door de hiërogliefen staat Sobek, de oud Egyptische watergod, die het water beschermt zoals een krokodil zijn nakomelingen beschermt. Achter Sobek zie je nog een stukje van het moderne kant van het aloude Mohenjo Daro's grote bassin, die ik op de achterkant geschilderd heb. Op het linker deel van de achterkant zie je het aloude bassin zoals het er nu uit ziet en op het rechter deel zoals het er gevuld met water uitgezien zou kunnen hebben met kleurrijke perrons.

De hiërogliefen op de voorkant vertellen het verhaal van dit project. In de eerste kolom staan de sterrenbeeld tekens van mijn vader en moeder, het teken van verbintenis, het sterrenbeeld teken van mijzelf en Marloes, ons trouwsymbool en het teken voor verbintenis en de sterrenbeeld tekens van Joris en Edith. In de tweede kolom staan de belangrijkste ingrediënten van dit project, water en euro's. In de derde kolom staan de logo's van de bedrijven waar ik tijdens dit project gewerkt heb.

In de vierde kolom staan verschillende soorten zwemmers. De eerste is de oudst bekende tekening van een zwemmer uit "the cave of swimmers", eigenlijk de eerste zwemmer. De tweede (ABC) vertegenwoordigt het leeszwemmen, wat de belangrijkste reden is voor de meeste Nederlandse kinderen om te beginnen met zwemmen. De sportieve zwemmer en de recreatieve zwemmer horen natuurlijk ook in dit rijtje en de aloude zwemmer staat er als laatste nog een keer op.

De vijfde kolom beschrijft het idee achter dit project. Als we gaan zwemmen (zwemmer uit "the cave of swimmers"), geven we bacteriën af aan het water, die we met filtratie en desinfectie (HOCl) behandelen. Hierbij ontstaan DBPs, die irriterend kunnen zijn voor de ogen en mogelijk schadelijk kunnen zijn uit medisch oogpunt. Tijdens het onderzoek voorafgaand aan dit project ontstond toen het idee voor een alternatieve waterbehandeling voor zwembaden.

Kolom zes is een samenvatting van de hoofdstukken 2 en 3; de vuilafgifte door zwemmers. Als je gaat zwemmen (met tas), ga je eerst omkleden en daarna douchen zonder zeep of shampoo. Na 30-60 seconden douchen ben je schoon en kun je een duik nemen in het zwembad, om te kun zwemmen. Maar als de natuur roept, dan moet je naar het toilet.

De zevende kolom is de traditionele manier van zwemwaterbehandeling, beginnend met een Finse goot, een haarvanger, een circulatiepomp, afsluiters, dosering van vlokmiddel, filtratie, verwarming, nog meer afsluiters, zuurcorrectie en chloordosering. Daarna gaat het water terug naar het bassin.

De laatste kolom laat zien hoe de alternatieve waterbehandeling eruit ziet die tijdens dit project ontwikkeld is. Beginnend bij het bassin, volgt er een haarvanger voor grote vervuiling, een circulatiepomp, een biologisch filter (met bacteriën) voor het afvangen van opgeloste stoffen, afsluiters, ultrafiltratie voor het afvangen van gesuspendeerde en colloïdale deeltjes, bacteriën en virussen. De UV is dan als tweede desinfectiestap en na de verwarming gaat het water terug naar het bassin. Daar staat een zwemmer op het startblok klaar om voor the proof of the pudding...



