

THICKENING  
*the*  
THRESHOLD

Public spaces for encounter in  
the entry squares of Universidad  
Nacional de Colombia.

Methods & Analysis  
Graduation Studio  
5 July 2019

Agnieszka Panasiuk





Master Thesis  
Project Book  
Agnieszka Panasiuk  
TU Delft, Faculty of Architecture  
Methods and Analysis  
2019

Mentors  
Dr. ir. Klaske Havik  
Dr. Alberto Altés Arlandis  
Dr. Jorge Mejía Hernández  
Gilbert Koskamp



### **Acknowledgements**

I would like to thank my tutors Jorge, Alberto, Klaske and Gilbert for their support and challenging me during this year.

Thanks to the great friends, I have met in Delft, for the stimulating exchange of ideas and amazing memories.

Dziękuję mojej rodzinie i Krishnie za nieustające wsparcie.



<b>Introduction</b>	1
<b>Research</b>	5
Study trip observations	11
Analysis	31
Punctuation in urban space	53
Combating the univocity	59
Thickened threshold architecture	101
Conclusion of research	
<b>Design Approach and Results</b>	107
Problem statement	117
Ground oscillations	131
Design	207
<b>Conclusion</b>	207
Challenging the strategy	
Manifesto	216
<b>Appendices</b>	
Reflection	220
Bibliography	227

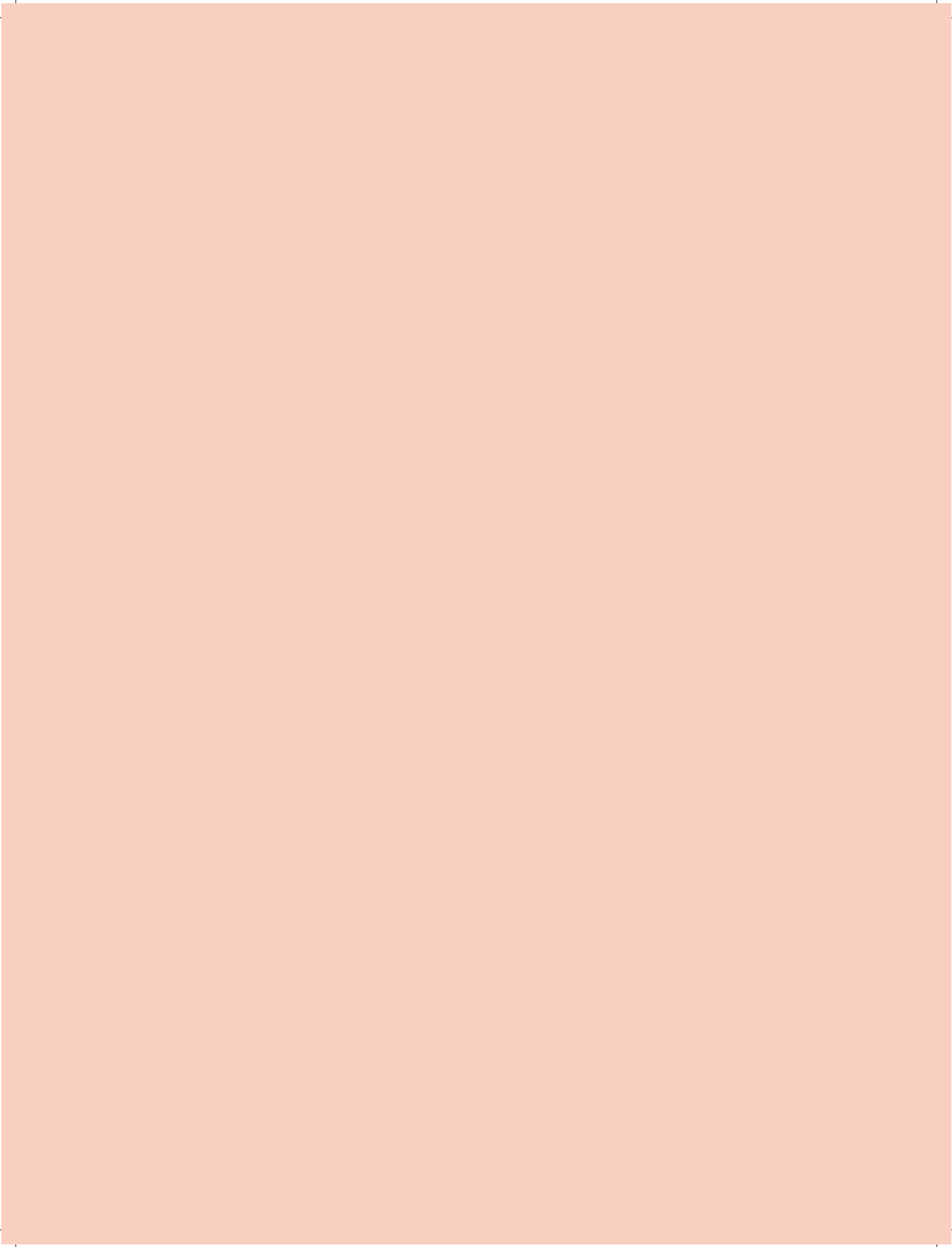

## INTRODUCTION





## INTRODUCTION

In September 2018 I have travelled to Bogota - the capital of Colombia with a group of Methods & Analysis students and teachers. The time spent in Bogota as well as the following research and design, conducted in Delft, have improved my understanding of methods of architectural research, design and the process of learning itself. This time has allowed me to expand the boundaries of my knowledge about architecture and to awaken curiosity about multiple topics. I have realized that the critical approach to the process of design, to the method itself, questioning one's own actions, can greatly help one find their role in their future work. The greatest achievement I could wish to accomplish while preparing my master thesis would be to discover or develop a work method that would be convergent with my character. I think having found that method would be equal to finding out what kind of work could bring me joy in the future.

During the trip to Bogota I have repeatedly visited the campus of Universidad Nacional de Colombia - a national higher education institution. What stayed with me the most after these visits were not the sights of the most prominent university buildings and representative spaces but quite contrastingly - pictures of the forgotten lawns and the dilapidated fence which marks the boundary of the campus.

Universidad Nacional has been isolated from the rest of the city by a fence raised in 1970's and even more severely by busy traffic arteries. In spite of the separation, the campus plays an invaluable role in the lives of the inhabitants of Bogota. Not to mention the thousands of students, who daily

cross the gates, innumerable families and groups of friends arrive at Universidad Nacional to rest and play there. The campus is a green resource for the city.

Boundary is a social contract in which the sides agree that a contradiction cannot be resolved in any way other than separating the conflicted sides. If the separation is not questioned the status quo remains. An architect - a person whose work is to introduce change - is inclined to question the division. And what happens if we transform the environment in such way that the discourse, more intensive exchange between the sides and with each other realities become possible?

The reality supplies one of the possible answers. In the present state of affairs many aspects of the functioning of the student life have been left to the informal market. In fact the informal markets flourish near the boundary. Vendors have discovered the boundary in a way that does not conform to the orthodox understanding of a boundary. The organic, unplanned, improvised erodes the stiff, regulated, formalized.

What would it take to open the gates for the other realities though?

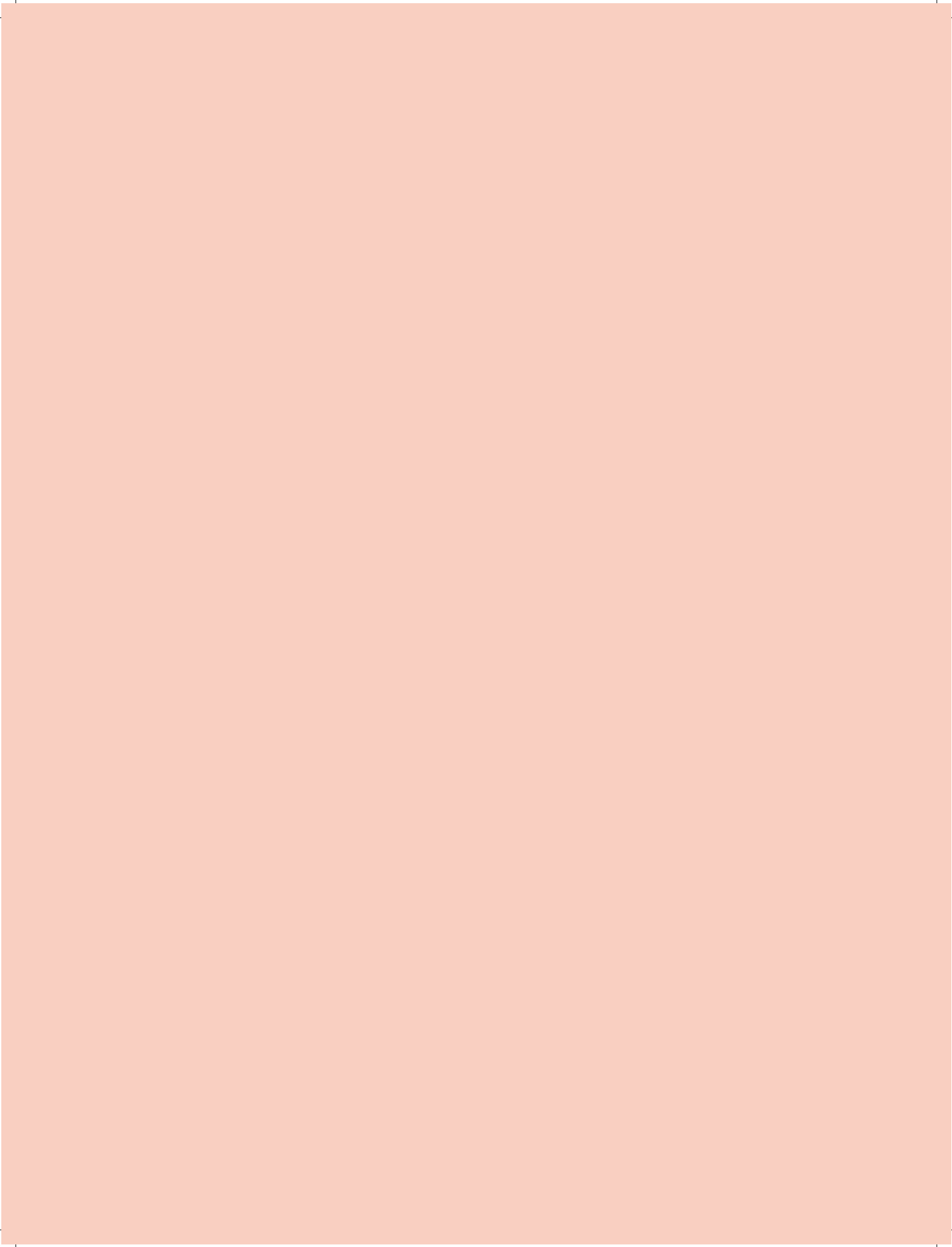

## STUDY TRIP OBSERVATIONS

## UNIVERSIDAD NACIONAL DE COLOMBIA, BOGOTA

There are around 12 entrances to the campus. They are the 'locks' where the exchange between the inside and outside happens. Movement and circulation, small often illegal merchandise, supervision and observation as well as the search for enclosure and protection blend in a fascinating potentially creative mixture.

Study trip observations

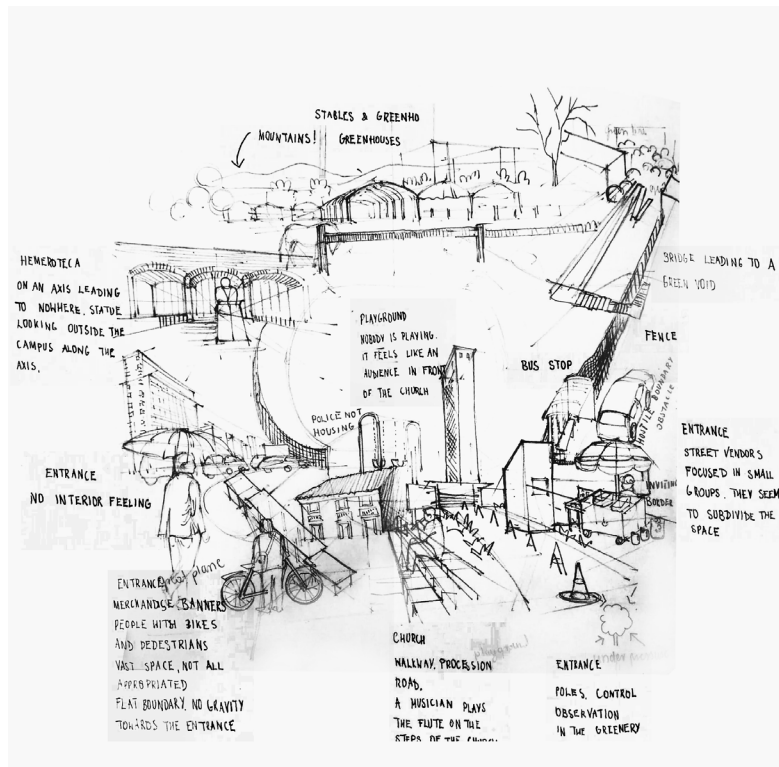

7

Location in the district of Teusaquillo, drawing by author.

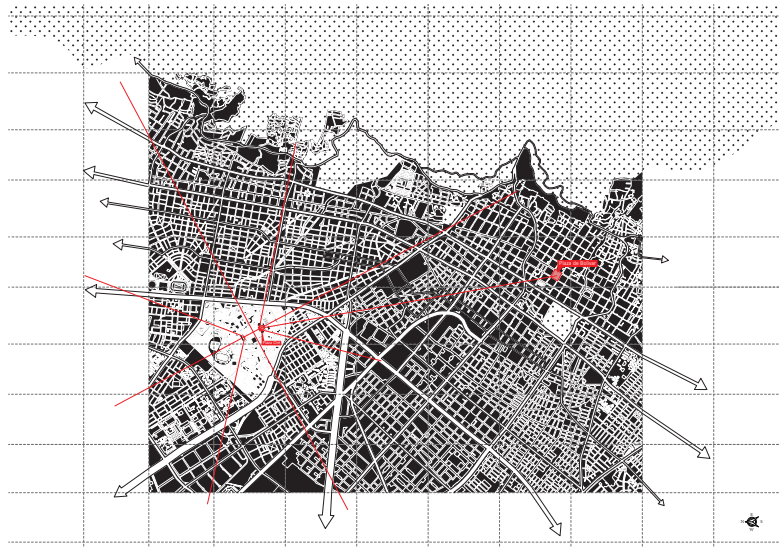

Location in the district of Teusaquillo, drawing by Alexander Petrounine.

Thickening the threshold

Study trip observations

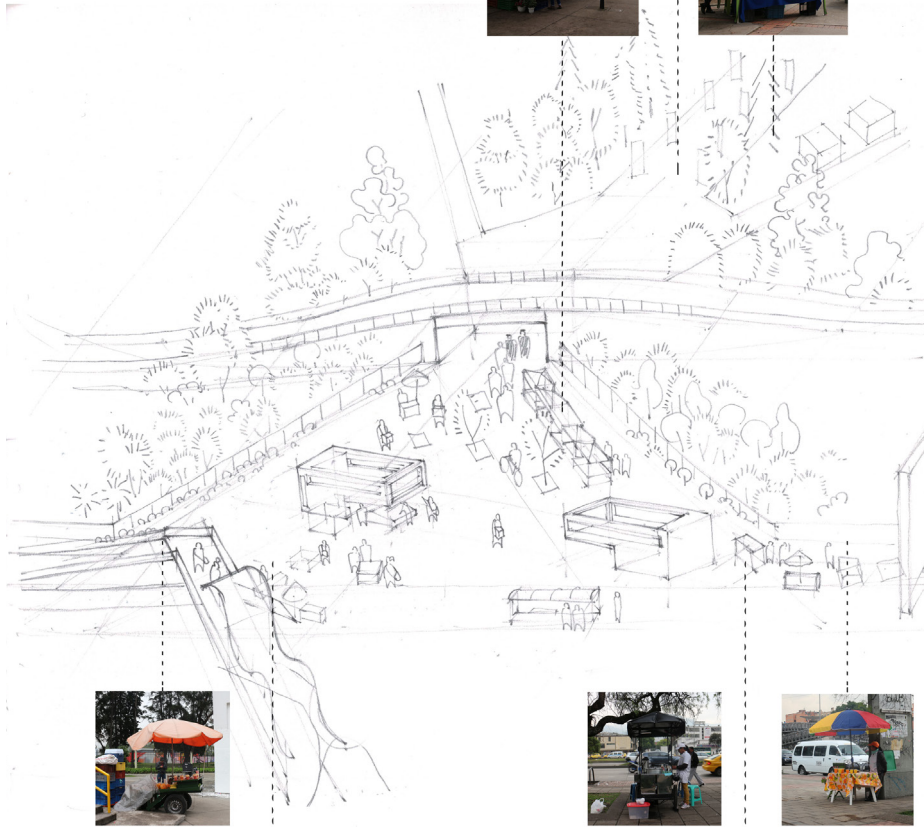

8

Range of uses.  
Entrance by Calle 45  
Axonometric view, drawing by author.

Thickening the threshold

Study trip observations

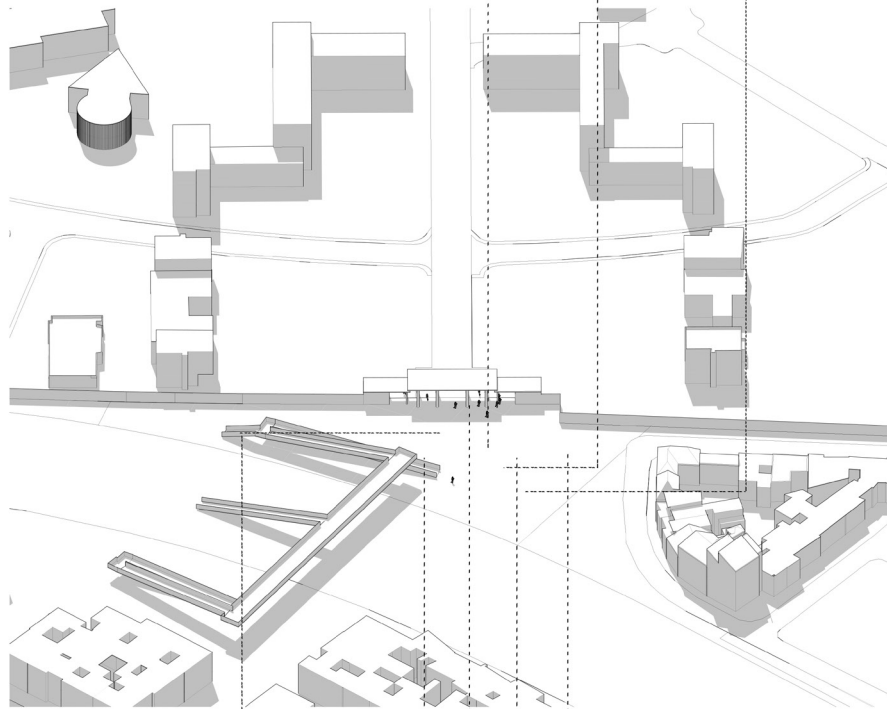

9



Range of uses.  
Entrance by Calle 26  
Axonometric view, drawing by author.

Thickening the threshold

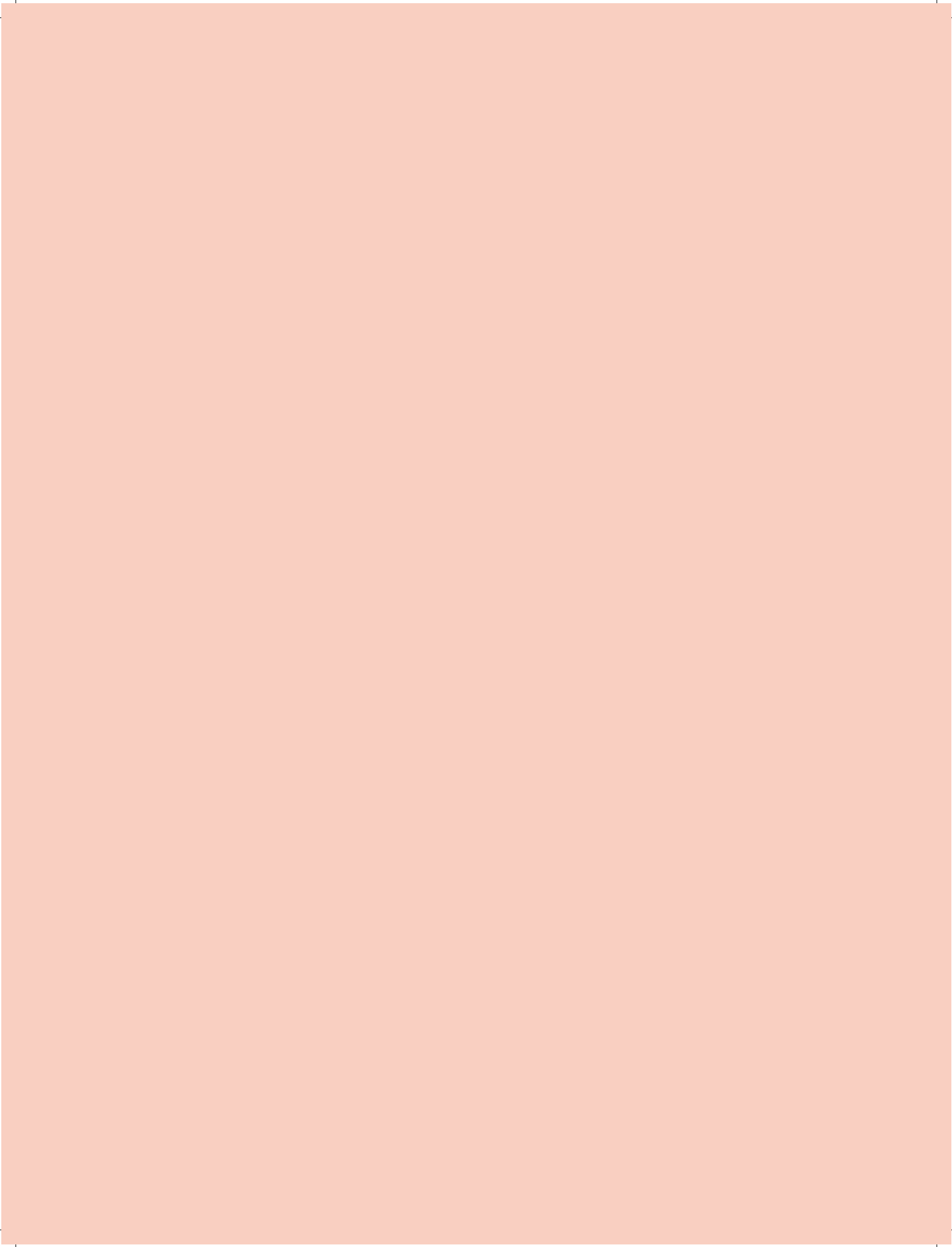



## SITE ANALYSIS

## THE HISTORY OF UNIVERSIDAD NACIONAL DE COLOMBIA

### Academic Model

First plans of the campus were prepared by Fritz Karsen and Leopold Rother in late 1930's.

Karsen studied revolutionary works of American educational reformer John Dewey. Dewey had set some practical guidelines for the functioning of a university. They included: group-work based education model, diverse well-equipped spaces tied closely to specific professors. Later on these models were included by Rother in the master plan and the design of the first buildings on the campus.

### First master plans and the still remaining principles

First master plans were developed around 1936. They were based on a very transparent geometrical principle. Remnants of this principle largely survived until today. Rother has planned a road structure consisting of two large oval routes and radial roads. Two oval-shaped routes, one of them vehicular, one more pedestrian, communicate different the parts of the campus with each other. Contrastingly, the radial roads connect the heart of the city campus – Plaza Che with the existing infrastructure of Bogota. The northern radial roads leading towards what was the borders of the 1940's Bogota, were meant to comply with the municipal strategy of encouraging the development of Bogota in the North-Western direction.

In Rother's plan the road infrastructure was accompanied by a subdivision of the campus into specialized areas: the academic area, the services area and the sports area.

The services area, reaching from the South of the campus to Plaza Che, is the meeting point of the campus with the city. It is characterized by fairly traditional urban planning. An axis connects the Plaza Che and the University Chapel. The axiality creates an impression of civil seriousness. The services area mediates between the traditional Bogotan urban planning model and the revolutionary model, the campus was planned upon.

The service area mediates between the campus and the city not only due to the characteristics of its space and buildings. Most importantly it focuses the edifices that serve the most public functions: Aula Magna, Gabriel García Márquez Central Library and Cafeteria Central. The Faculty of Agricultural Engineering and the Department of Geosciences were originally designed as student residences.

The northern part of the campus is a sports area with stadiums and playing fields. The areas between inner and outer rings were planned as expansion buffers for the faculties.

### Changes of the planning model

With the following master plan, compiled in 1937, the management of faculties was given bigger and bigger influence on the decisions regarding the planning of their edifices. From this point onwards the principles governing the development of the campus were similar to these of a city where private property dominates.

Projects were developed one by one according to very loose regulations. This situation seemed to condemn the campus of Universidad Nacional to become an aggregate of individualistic ideas unrelated to each other. The Institute of Botany designed by Eric Lange was the first building to be erected without a clear relation to the overall scheme. It ushered in the tendency to disobey the

rules of symmetry and radially that Rother had imagined.

With their next project proposed in 1938, Rother and Lange were perseveringly trying to maintain the geometric rules however in compliance with the already existing buildings.

Alterations of the Leopold Rother's plan

In 1950's new vehicular routes which lead to the faculties cutting across the oval roads were constructed. These additions discarded the oval roads and diminished their importance. During this time the campus was growing in a limitedly logical manner. Buildings were planned in accordance with the different sizes and shapes of lots and the progressively irregular road infrastructure. The so-called 'crown region' - outside the rings - was consolidated. This region was expected to accommodate the houses of professors, students, a botanical garden etc. Moreover at that time many buildings were erected: the female residences and the student residences by Calle 26.

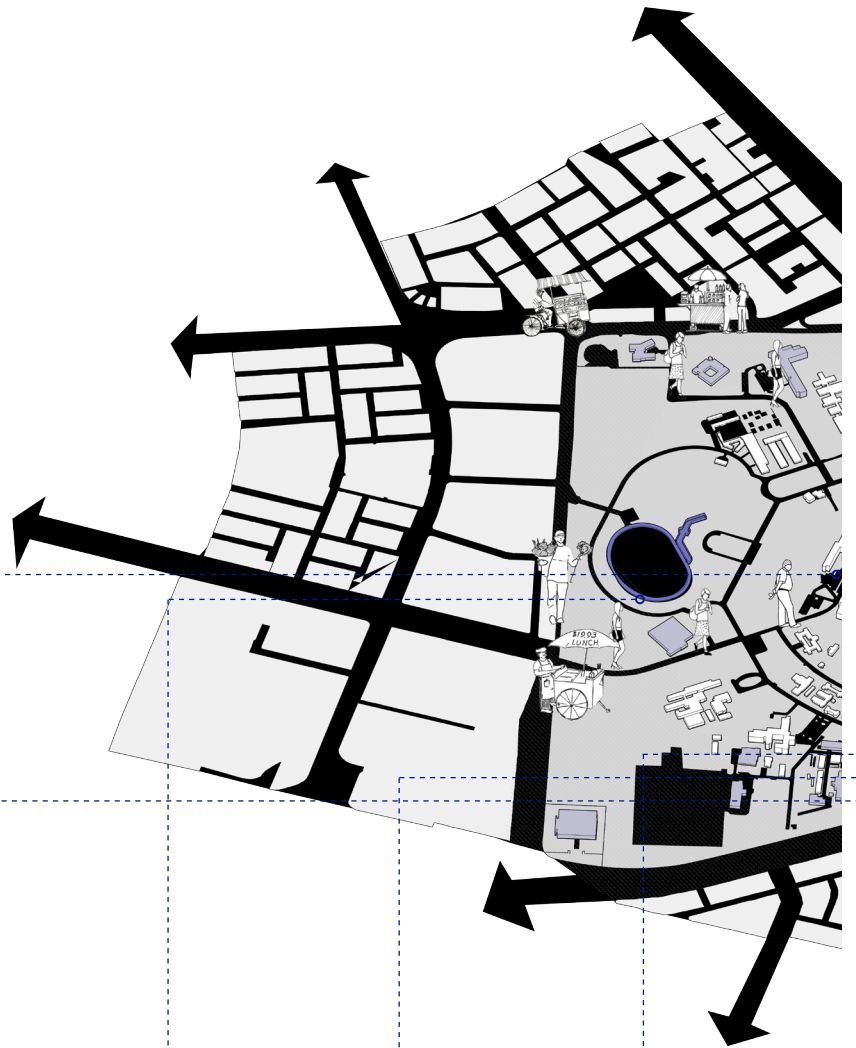

1938 - 1939  
Departamento de Lenguas Extranjeras



1939 - 1940  
Porterías by Calle 26 and Calle 45



1939  
Estadio Alfonso Lopez



1939 - 1940  
Contaduría y filosofía



1939 - 1941  
Student's apartments  
Today Antonio Narino and Design Faculty



Spatial representation of the formation of the division,  
drawing by author.

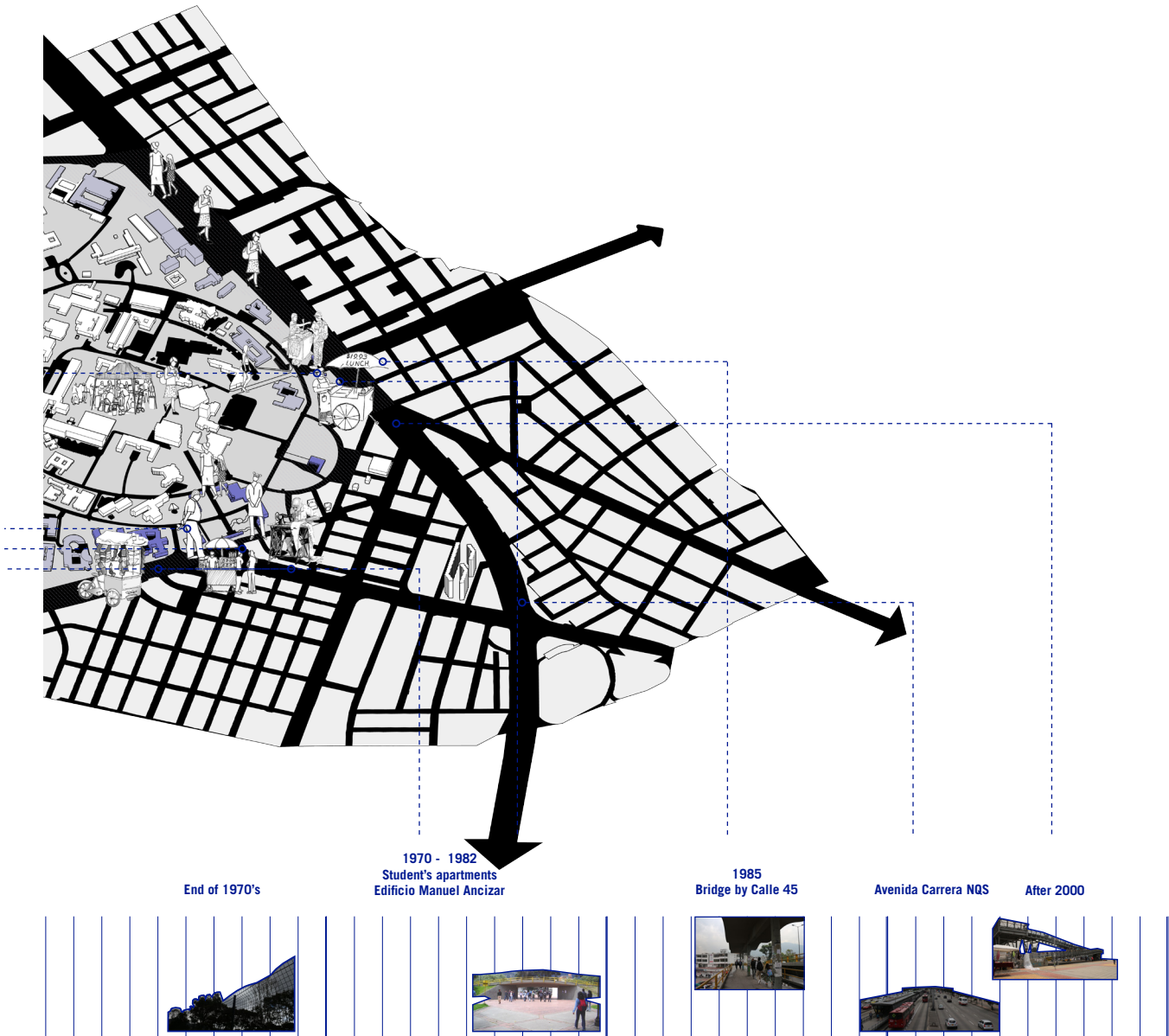

## URBAN STRUCTURE

The fundamental ideas of the original master plan have largely contributed to the current condition of the peripheries of the campus. Buildings have been organized in inward communicating clusters along the oval roads. The outdoor leisure spaces are often located in the courtyards or inside the complexes of specific faculties. Hardly ever do buildings of different complexes communicate with each other. The space between them has the characteristics of a residual space. The functional segregation of the campus entrusts its outermost areas only with a secondary role.

This spatial organization has left the entry squares marginalized by the University itself and isolated from the rest of Bogota by the busy traffic arteries.



Entrances to the campus, drawing by author.

Site analysis

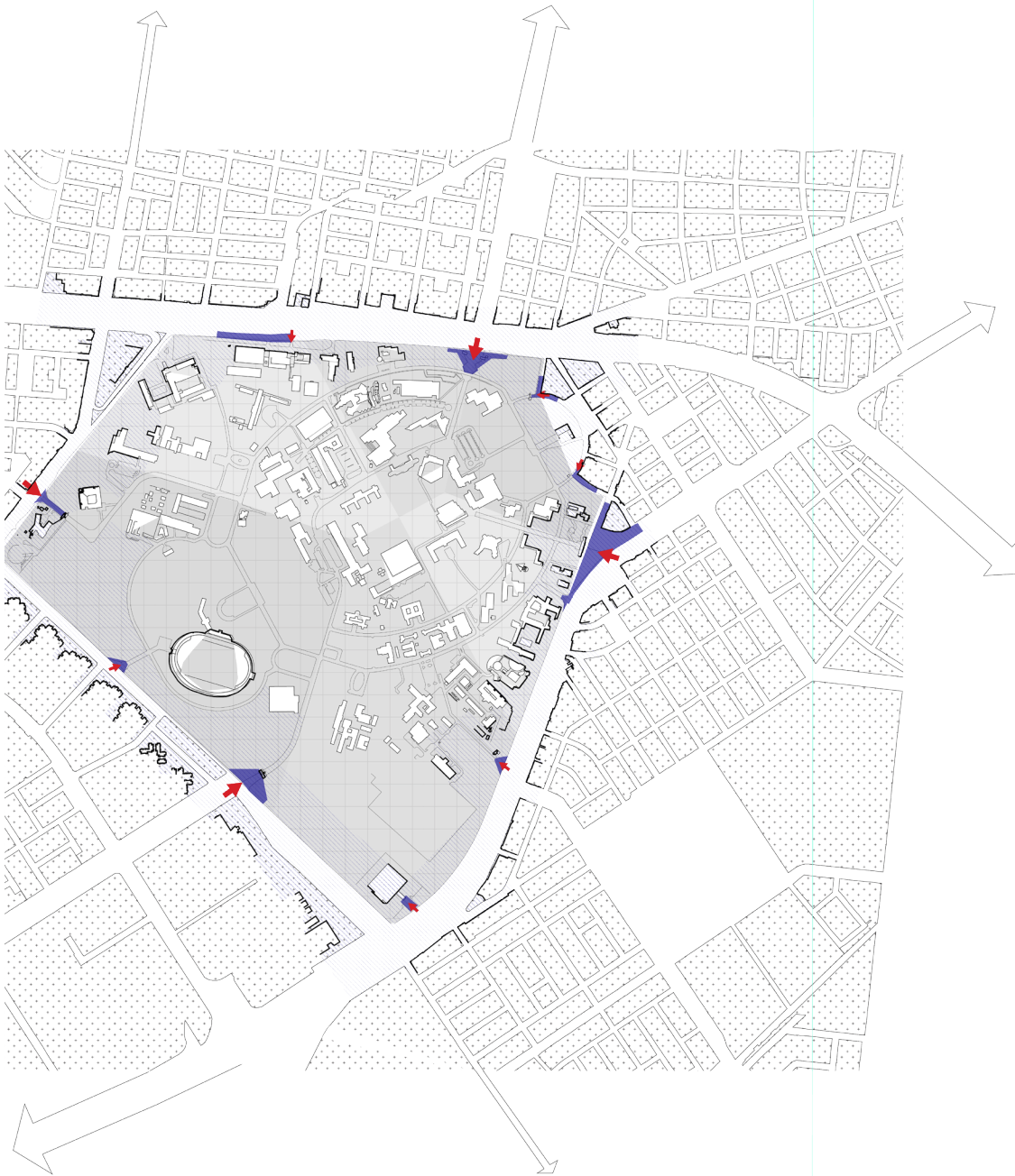

Site analysis



18

Urban relations, drawing by author.

Thickening the threshold



Site analysis



Thickening the threshold

## REMARKS ON THE ENTRY SQUARES

In total I have managed to invent 12 entrances. In his master plan Leopold Rother has conceived four main entrances to the campus. The four main entrances are strategically located on the L-shaped routes that communicate vital spaces of university with important urban spaces of Bogota. Other entrances connect the campus to the Bogotan public transport system. They increase the accessibility of otherwise poorly communicated parts of the campus.

The entrances differ greatly. They have various proportions, size, distance from the street. Some of them are wedged into the body of university campus. Others are merely strips of widened sidewalk. The first group has a large part of their outline clearly marked by the fence. The second group feels very transitional and open and often cannot be distinguished from its surroundings.

These and other properties result in different potential for use. The more spacious squares are a scenery of many activities: eating, leisure, all sorts of merchandise. Moreover they are dignified settings for entering and exiting the university campus and a recognizable symbol of the university in the consciousness of Bogotanos.

20

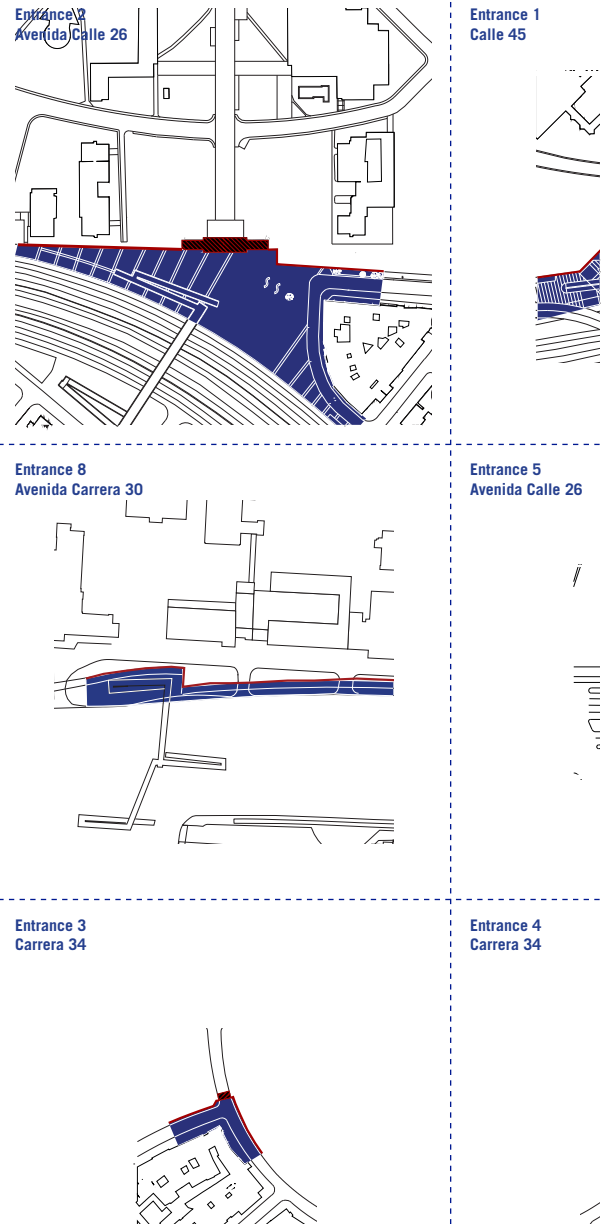

Overview of entrances in the order of growing area, drawing by author.

Site analysis

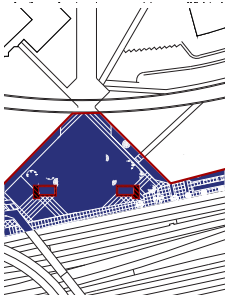

Entrance 11  
Carrera 45

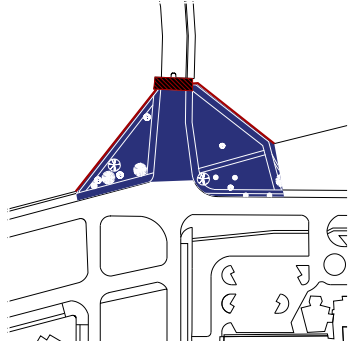

Entrance 6  
Calle 53

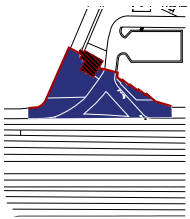
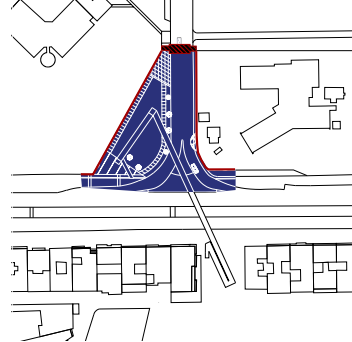

Entrance 10  
Avenida Calle 26

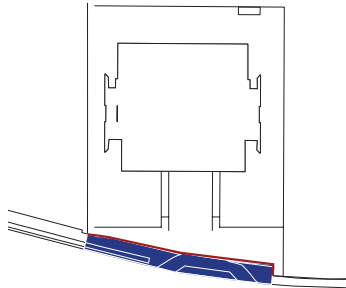

Entrance 12  
Carrera 45

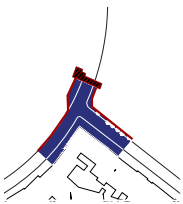
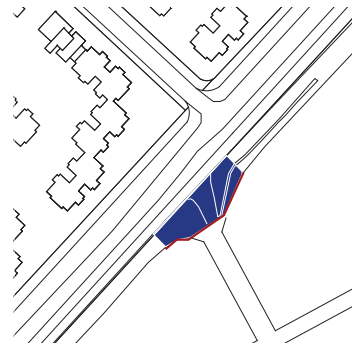

Entrance 7  
Avenida Carrera 30

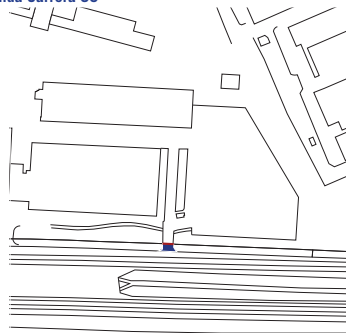

Entrance 9  
Avenida Carrera 30

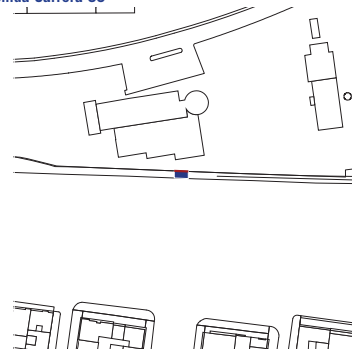

## PERIPHERAL AREAS OF THE CAMPUS STUDY OF THE BUILDINGS

Drawings depict a morphological study of the buildings and building complexes in the proximity of the boundary with a focus on rough functional organization, circulation inside and in-between the buildings as well as location of leisure areas.

- 1 Faculty of Graphic Design
- 2 Postgradual Economical Studies
- 3 Edificio Antonio Narino
- 4 Faculty of Agricultural Engineering
- 5 Department of Foreign Languages
- 6 Restaurant
- 7 Bank
- 8 Faculty of Human Sciences
- 9 Edificio Manuel Ancizar
- 10 Department of Geociences
- 11 Faculty of Dentistry
- 12 Human Sciences Graduate Studies
- 13 Laboratorio Nacional Veterinario

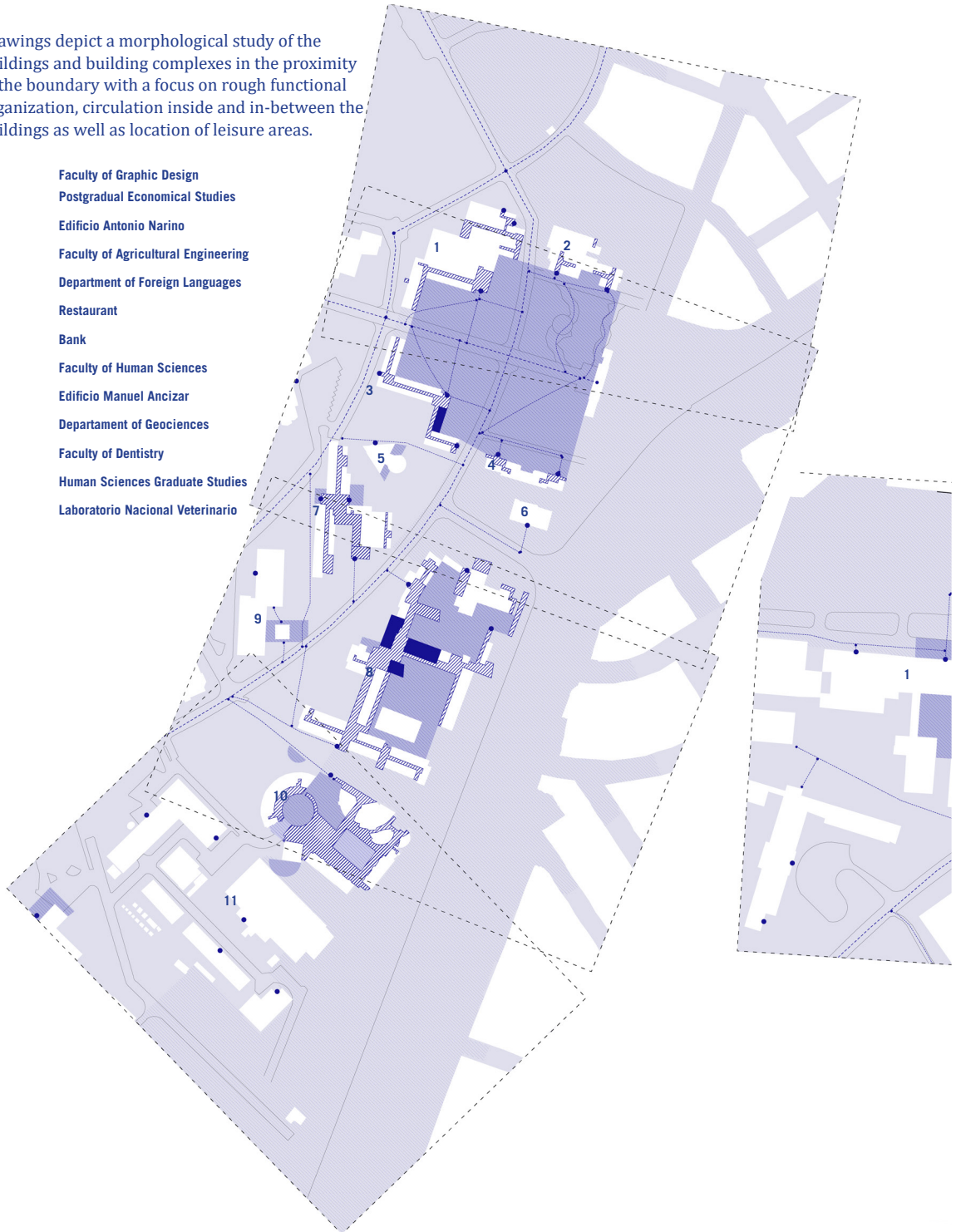



Site analysis

- 1 Institute of Geography and Statistics  
Agustin Codazzi
- 2 Medical Laboratory
- 3 Research Institute  
Laboratorio Centro de Calculo Elec  
tronico
- 4 Student Affairs Office  
Faculty of Engineering
- 5 Faculty of Economy
- 6 Cafeteria  
Faculty of Economy
- 7 Faculty of Architecture
- 8 Music Conservatory
- 9 Art Museum
- 10 Capilla Cristo Maestro

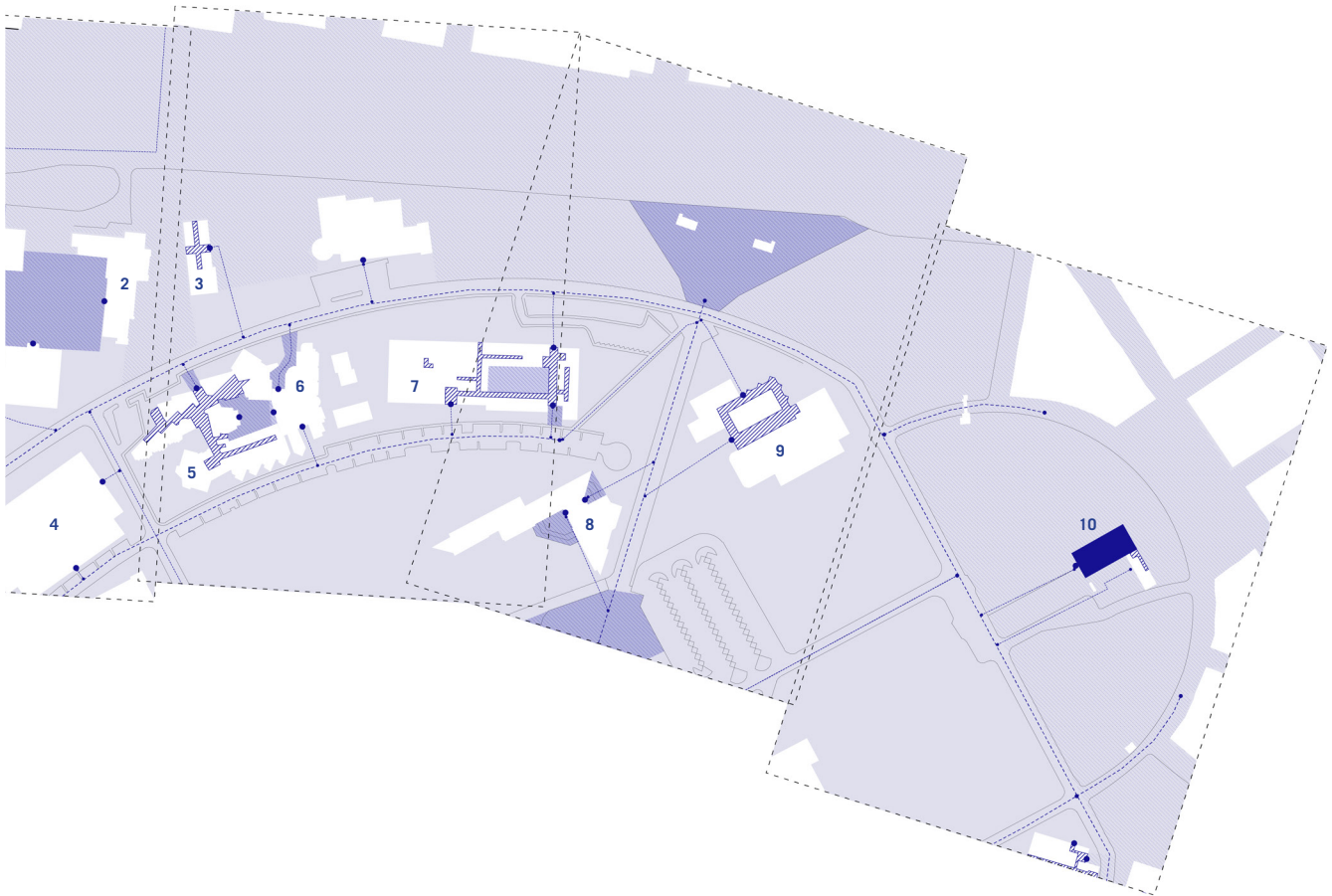

Site analysis

24



- 1 National Geological Museum Jose Royo y Gomez
- 2 Department of Biology
- 3 Biology Research Institute
- 4 Natural History Museum
- 5 Genetics Research Institute
- 6 Kindergarden
- 7 Arturo Ramirez Monutufar Pedagogical Institute
- 8 College Library IPARM
- 9 Icontec International
- Colombian Institute of Technical Norms
- 10 Kindergarden

Thickening the threshold

Site analysis

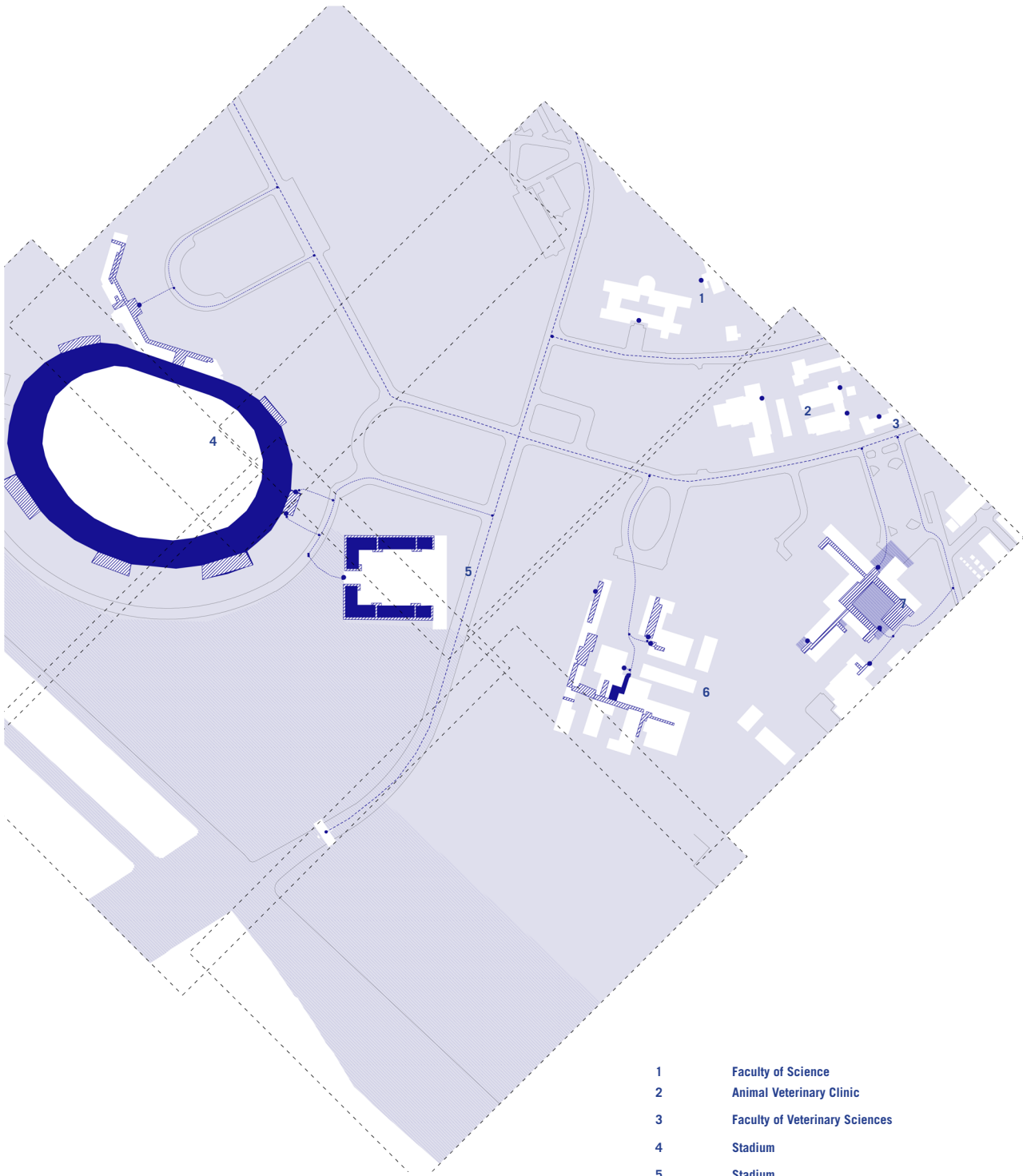

- 1 Faculty of Science
- 2 Animal Veterinary Clinic
- 3 Faculty of Veterinary Sciences
- 4 Stadium
- 5 Stadium
- 6 Auditoriums, Faculty of Microbiology
- 7 Faculty of Agrarian Sciences

Thickening the threshold

Site analysis



Calle 26

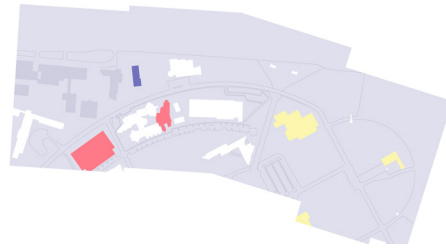

Calle 45

26



Calle 53

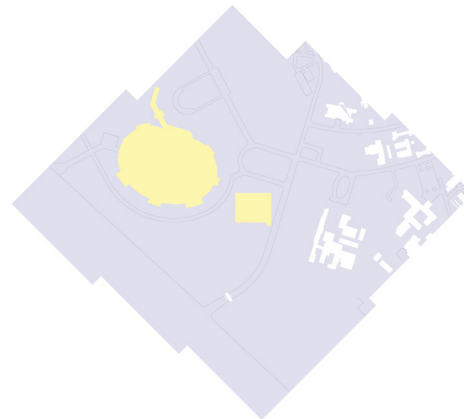

Carrera 45

Program

- Culture and Sport
- Not UNAL
- Auxiliary Functions for the University:  
Dining, Childcare
- Research
- Faculties

Thickening the threshold



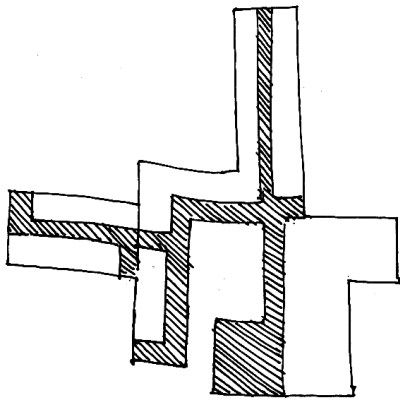

Faculty of Agrarian Sciences

Circulation inside the buildings

Buildings consisting of wings where movement is distributed with the use of corridors

Buildings with courtyards and circulation around them.

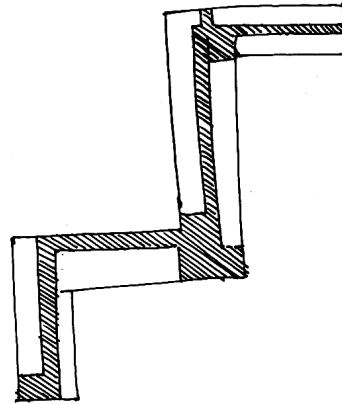

Edificio Antonio Narino

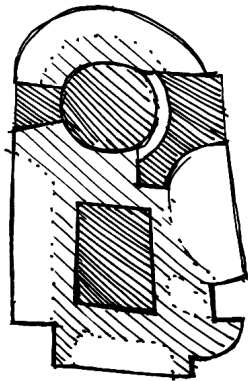

Human Sciences Graduate Studies

Outdoor leisure spaces

- in courtyards or between buildings that belong to a complex of a specific faculty,
- small spaces near entrances to buildings,
- interiors between buildings of different faculties near entrance by Calle 26
- not many leisure spaces near the ring roads, these spaces were often formed as residues after situating the buildings.

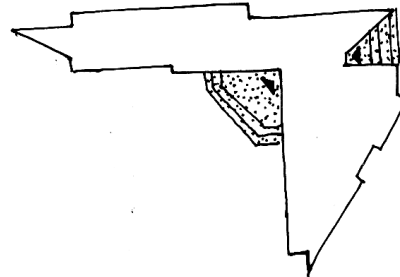

Musical Conservatory

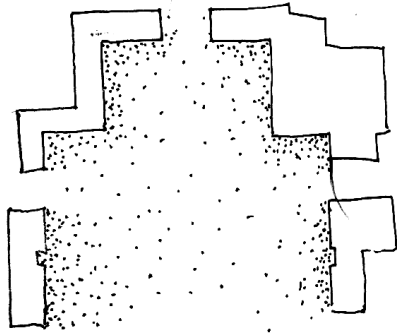

Complex of university buildings by Calle 26

The location of the buildings in relation to streets is most problematic. Due to the lack of alignment of many buildings to the ring roads their entrances are not clearly readable

Buildings do not interact with each other.

Loose arrangement of buildings works better in the northern part of the campus, where is a limited amount of road infrastructure.

Buildings grouped in complexes suit the southern part of the campus.

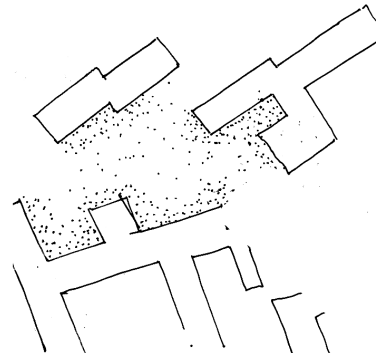

University buildings near the outer oval road.

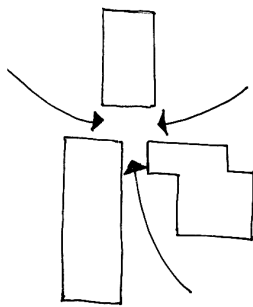

Faculty of Human Sciences

One enters the centre of the building.

Buildings where one enters the far end of the building.

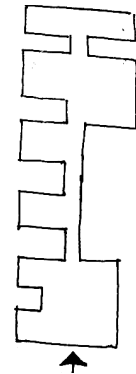

Department of Biology

One enters the far end of the building.

## CONCLUSION

The university campus is an agglomerate of disjointed buildings which belong to different faculties or institutions of the university. The university develops through accumulation. Buildings fill the primary structure established by the road infrastructure.

Similarly to the university, Bogota can be perceived as a city of enclaves. It is a city of spatial divisions that correspond to social divisions. It is full of private spaces and privatized public spaces.

In this context, it can be very interesting to explore the widespread rule of isolation in the liminal spaces. Checkpoints - the ruptures in the wall seem to be the most characteristic moments of the liminal spaces.



# PUNCTUATION IN URBAN SPACE

## PUNCTUATION

During the first part of research, we were encouraged to put our individual interests aside and research a shared topic. Me and my group mates were drawn to work together by an interest in the manifold instances of disjunction in the city. Isabel had observed the impoverished condition of the city floor and some of its buildings. Danlei was interested in the neglected pieces of land in the middle of the streets. And I held an interest in the boundary of the university.

We have performed our analysis under the umbrella name of urban commas, understood as places where some elements of the city are interrupted but some level of continuity is maintained.

In abstract terms urban commas can be interpreted as gaps, hidden spaces, distances or breaks between two existences. The connecting and separating properties of the comma lead us to the investigation of spaces on site that possess this duality. The research draws an association between the use of comma in punctuation system and spaces at pause.









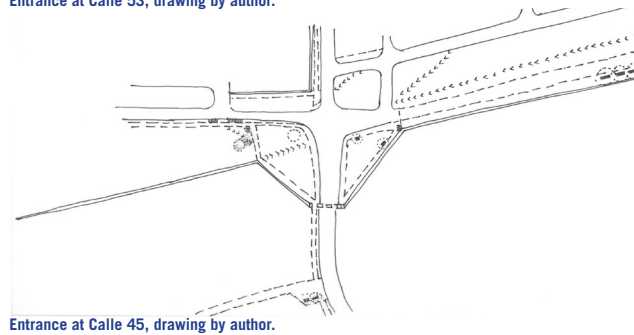
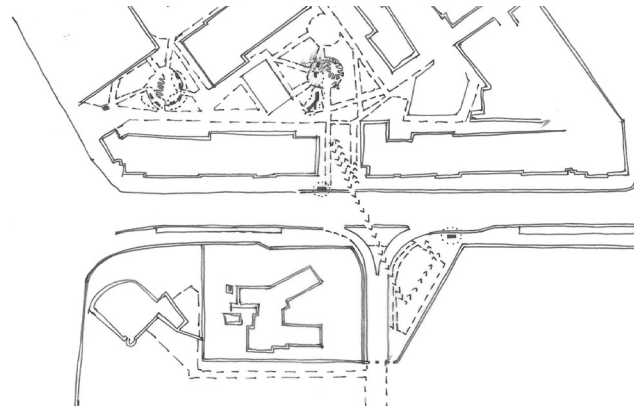
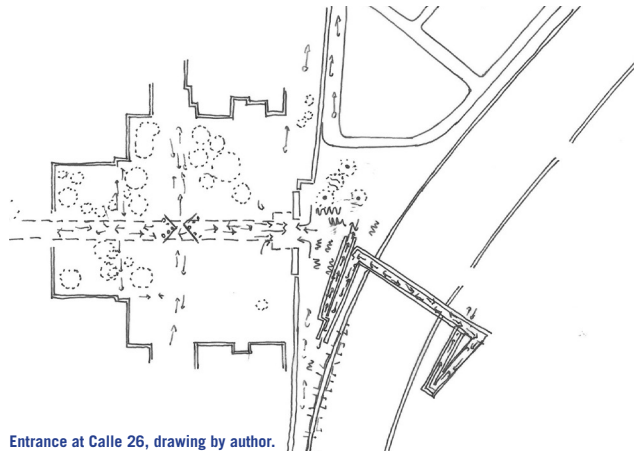

The exercises shown on the next pages are attempts of reading the entry squares with attention to what we thought the urban commas might reveal themselves as in a city. These exercises yielded many observations of compositional properties of spaces, of their modes of occupation as well as movement in these spaces. Our attention was brought to properties of space such as rhythm, repetition, pattern analogical to similar properties of a written text or a musical piece.

### Reading of punctuation at the entry squares

The exercise shown on the neighboring page was aimed at interpreting different artefacts, situations, compositions found at the entry squares with the use of the urban punctuation syntax. Various obstacles, changes of material, remains of informal modes of occupation are composed into maps of urban pauses.

Punctuation in urban space



- Pauses Key**
-  distracting pause
  -  lingering pause
  -  barrier
  -  threshold
  -  difference of material
  -  directing pause
  -  informal paths
  -  dispersing pause
  -  vehicular movement
  -  pedestrian movement

Thickening the threshold

## READING OF ENTRY SQUARE BY CALLE 45

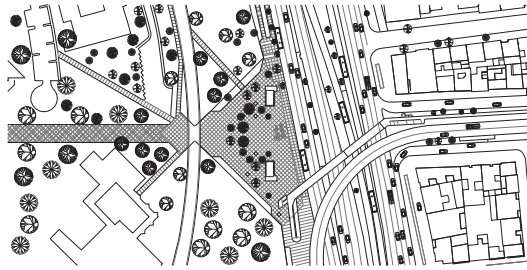

Plan.

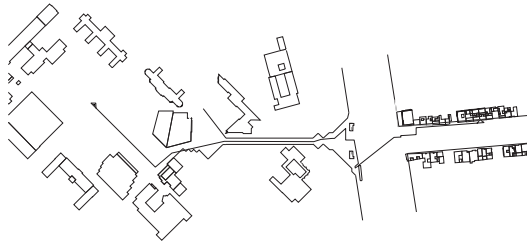

Site plan - Location of the section.



Expanded section along the route of the walk.

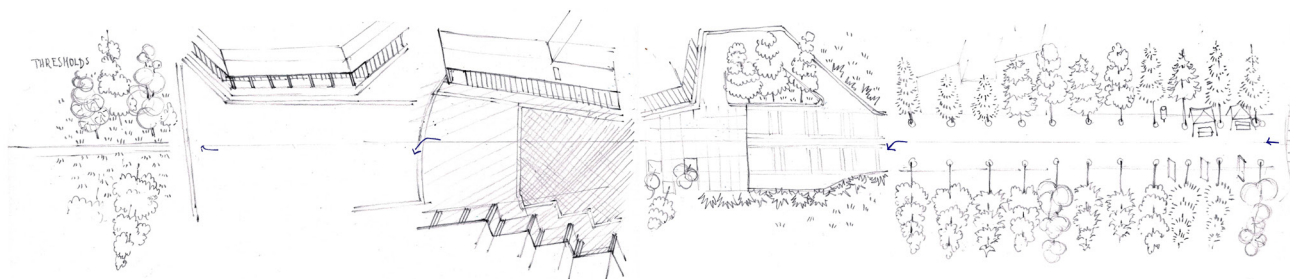

Plan along the route of the walk.

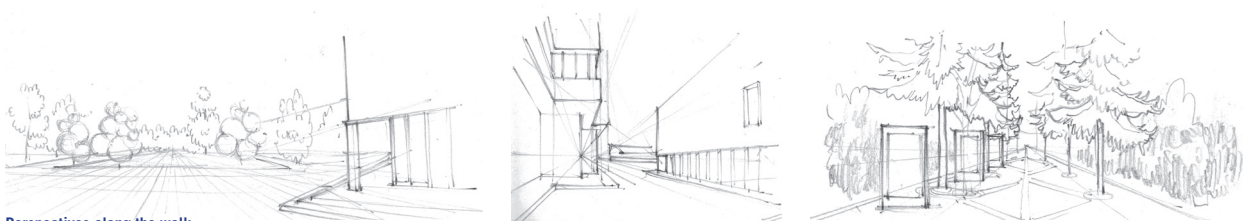

Perspectives along the walk.

Thickening the threshold

### Reading of entry square by Calle 45

University entrance by Calle 45 is situated on the route leading from more central districts of Bogota to the main square of the campus - Plaza Che.

It is one of the two most popular entry points to the campus. It is always busy with vendors and students participating in the lunch-time merchandise.

The route of a pedestrian willing to enter the University campus through the entrance by Calle 45 delivers many diverse experiences.

First of all, the spaces, opening before the pedestrian, have versatile proportions. A narrow footbridge leads over seemingly infinite Avenida Carrera 30. Entry square has a size similar to a historical city plaza. Gate is only wide enough to filter one person at a time, while the promenade behind the entrance has dimensions similar to



typical Bogotan road defined by the rows of trees on its both sides.

One can notice how the rhythm of the spaces evolves along the route. Rhythm of Calle 45 is determined by the width of city blocks and facades of buildings. Right after crossing the gate space is still highly rhythmical. This time due to evenly spaced trees. In this regard these spaces remind of a text consisting of one syllable words separated with commas. A striking feature of the promenade is the strongly articulated forward direction. On the other hand, the entry square as well as Plaza Che narrow down to almost completely close the view ahead or widen and open dynamically. The edges of these spaces act like coulisses - half-stops of flowing motion. They carry the feeling of tension and relief. The diagonal layout of buildings accentuates dynamics and contrast.

The entry square encourages one to change the direction

of movement many times. For that reason, this space is experienced in a very nuanced manner. Same elements are seen from different angles.

Entrance by Calle 45 is strongly rooted in the stanza extending from Parque Nacional to the heart of Universidad Nacional. The gate is an element of a long transition between University and Teusaquillo.

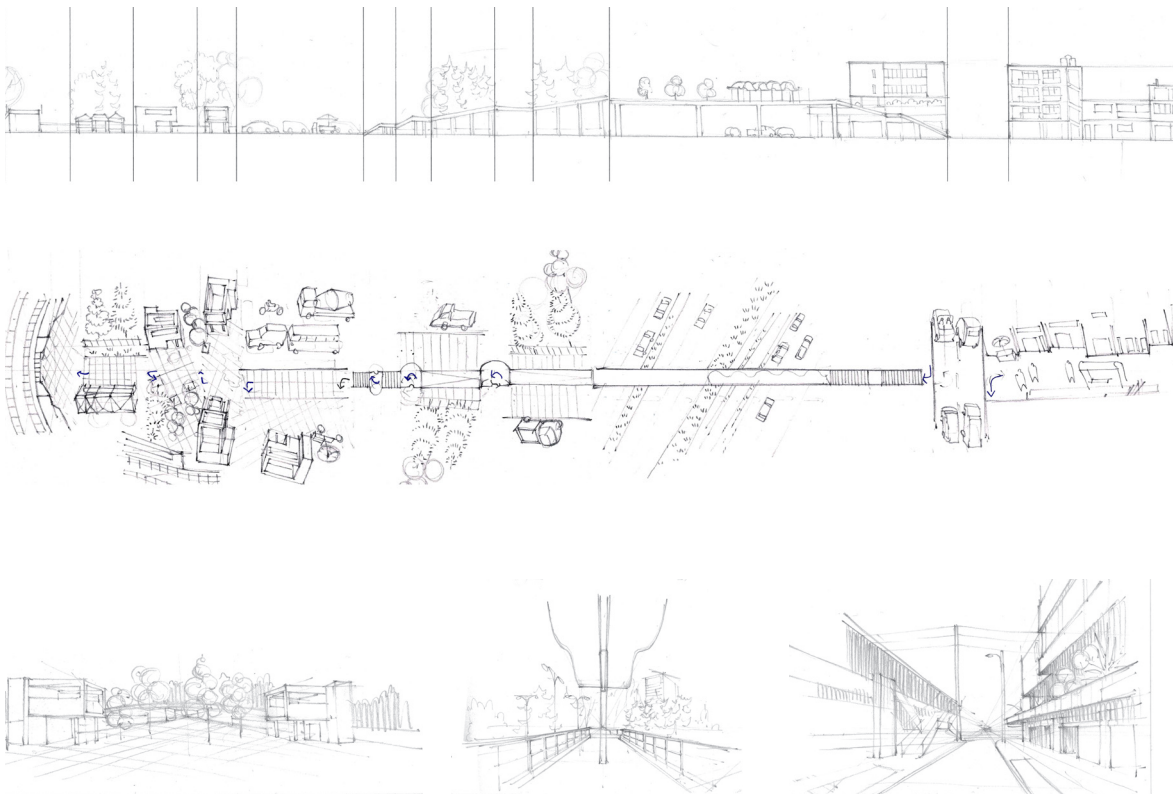

## READING OF ENTRY SQUARE BY CALLE 26

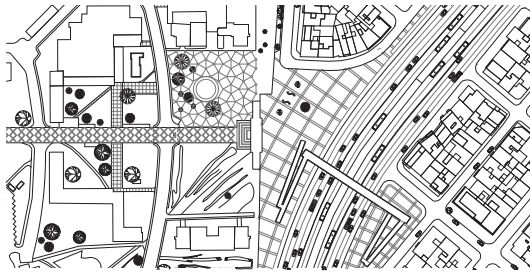

Plan.

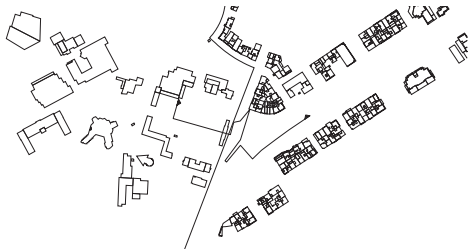

Site plan - Location of the section.

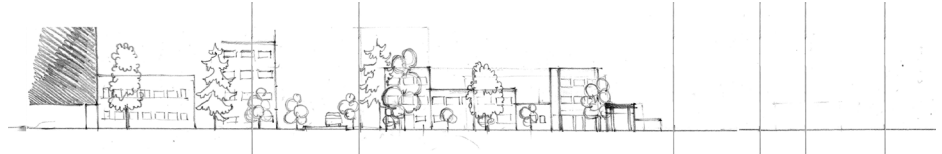

Expanded section along the route of the walk.

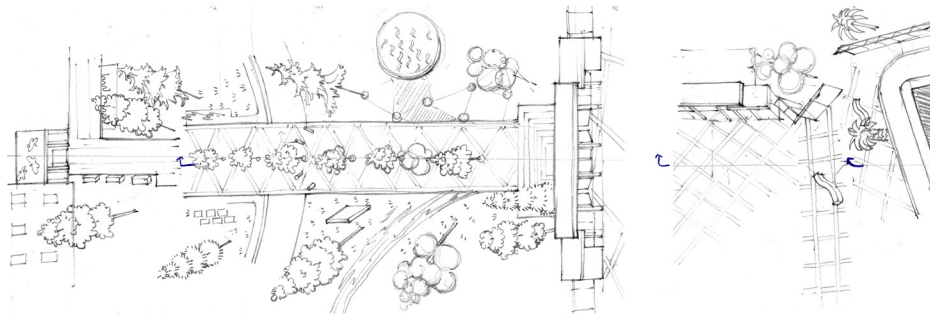

Plan along the route of the walk.

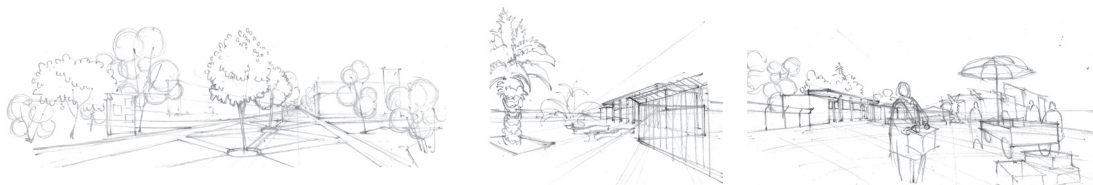

Perspectives along the walk.

### Reading of entry square by Calle 26

This entrance is the second of the two most frequently used entrances to the university. It seems less filled with activity as the entrance by Calle 45. It is not as saturated with small architecture, variations in materiality of the ground, vegetation and play of shadow and light.

The movement of a pedestrian coming to the university is highly orchestrated. One is funneled from the Transmilenio platform into the footbridge.

Rectangular grid of the entry square directs pedestrians not so much to the gate as to the north-eastern corner of the square between the fence and the tenement houses.

The perceivable edge of the space, formed by the fence, seems hard and flat.

The spaces along the section greatly vary in width. Edges

of spaces are defined rather by walls than by greenery. A sequence of trees in the middle of the promenade only strengthens the direction towards Plaza Che and does not create an interior as in the case of entrance by Calle 45. Entrance by Calle 26 contains both spaces that encourage one to remain in them for longer and ones that discourage this activity. Spaces of stay and quick transit are located close to one another. Quick pace neighbors slow pace.

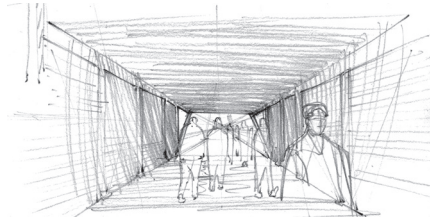
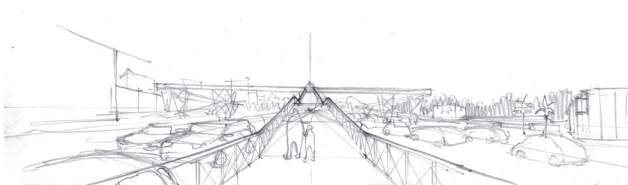
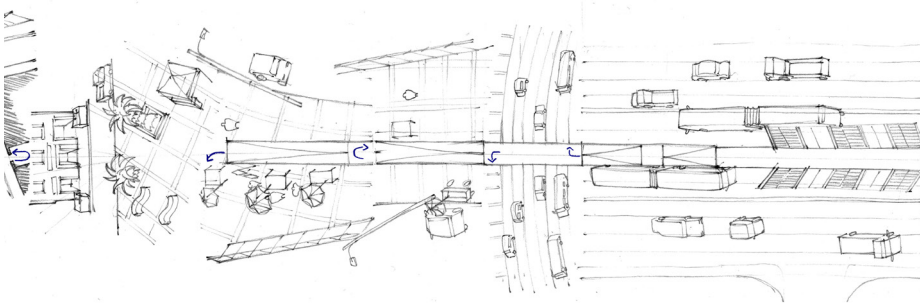
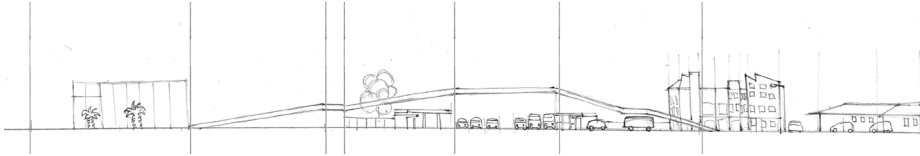





Punctuation in urban space

aida Calle 26 ance by Calle	Entry square Entrance by Calle 45	Promenade Entrance by Calle 45	Park by University Chapel	University Chapel	Restaurant behind Supermercado El Reg. Cl. 41 #21-44	Bitacora Cra. 17 #38-36	Dance School Cra 24, 37-60	Flower stand	Bike lane	Kitchen garden	Informal gathering/habita- tion	Informal path	Parking

lingering - As a
   
 reducing business
   
 filter, shadow to business
   
 sy
   
 - Dam hai
   
 ontaneous

## QUALITIES OF PAUSES

The comparative investigation allowed us to identify certain qualities of pauses. These qualities are not a complete list. In fact we do not believe that such finished collection can be drawn. Qualities of pauses are a way of pin-pointing the qualities of a site that contribute to its 'paused' condition.

The qualities of pauses we identified are: distracting, lingering, directional, spontaneous, intimate and threshold pause. For one space there can be several qualities that contribute to its 'paused' condition.

Redirecting pause						●	
Lingering pause	●						
Directional pause		●			●		
Threshold pause		●					
Intimate pause							
Spontaneous pause			●	●		●	

Table showing the extracted qualities of the studied situations, drawing by Agnieszka Panasiuk, Isabel Ulbrich and Danlei Huang.

Punctuation in urban space

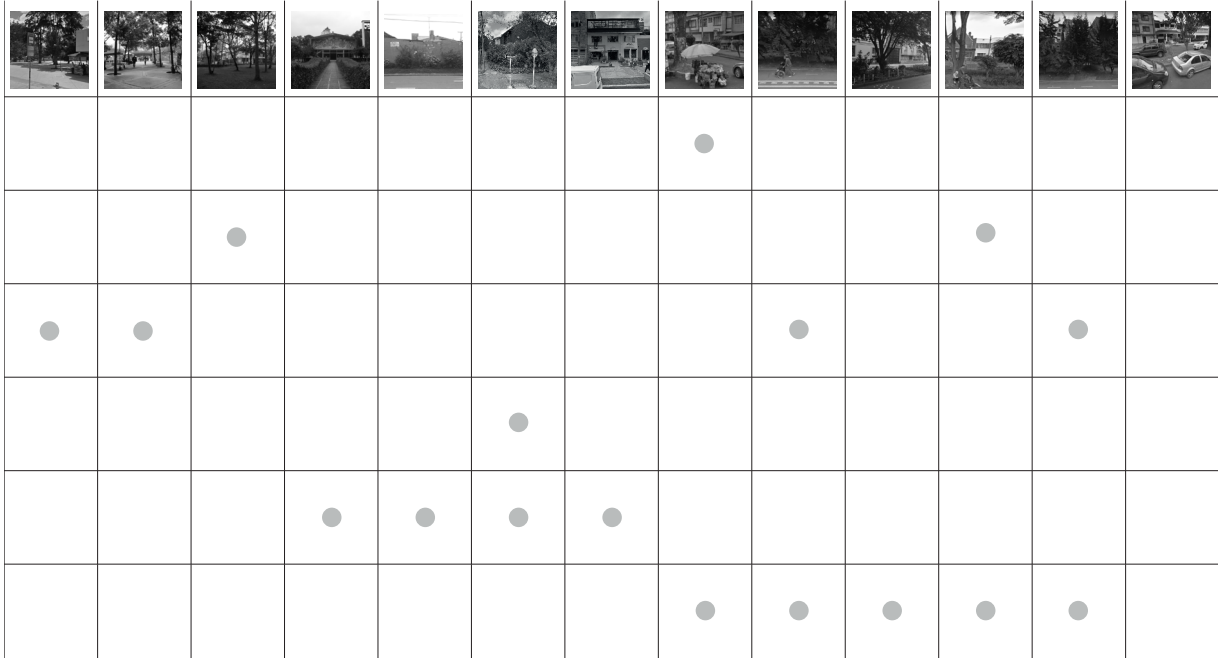

Thickening the threshold

## PAUSES AT THE CAMPUS OF UNIVERSIDAD NACIONAL

Having identified and compared different pauses we studied several examples located in Bogota in greater detail.

My intention behind this part of the research was to gain a better understanding of the entry squares while looking at them as urban pauses.

I interpreted some fragments of the entry squares at Calle 45 as a threshold pause. I reconized some qualities of a lingering pause and distracting pause at the entry by Calle 26 and I studied the proximity of the University Chapel, also located in the peripheries of the campus, as an intimate pause.

This research was a part of a deepened disciplinary study of transitional spaces.

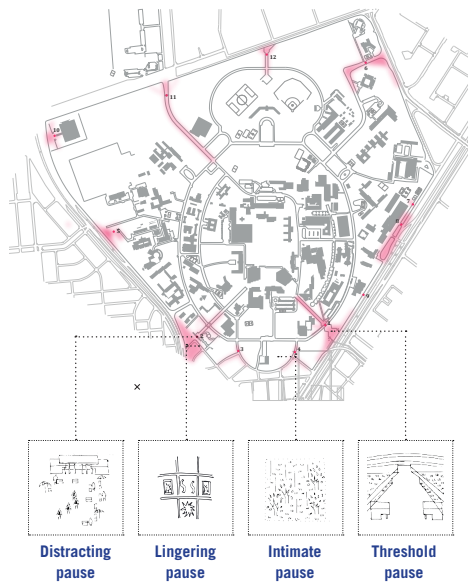



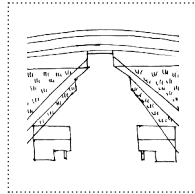

### Threshold pause

Pause that poses a small interruption in a path and can have a filtering effect or simply slow someone down for a moment. Despite its interruptive nature it does connect one entity with another.

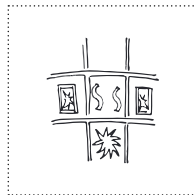

### Lingering pause

Pause that is characterized by a slow pace against the fast movement in its surroundings. It encourages one to stay and engage with it. It provides an enclosure or a filter to the business. It can portion space into smaller spaces that accommodate groups and individuals.

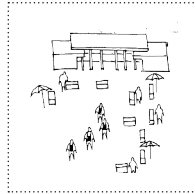

### Distracting pause

Pause that changes the direction or course of movement. It takes people away from the regular or planned trajectory briefly. It is a moment of redirecting.

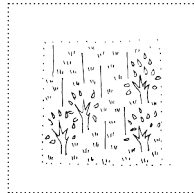

### Intimate pause

Pause that is often found in an enclosed spaces and gathers people that know each other or interact directly with each other (intentionally). Intimate pauses occur in places with higher exclusivity with some distance to the open street life.

## THRESHOLD PAUSE

### Threshold pause

Pause that poses a small interruption in a path and can have a filtering effect or simply slow someone down for a moment. Despite its interruptive nature it does connect one entity with another.

### Gate by Calle 45

Bottoms of the crowns of trees form a visual ceiling. They give the space a sense of enclosure. Moreover they break down the scale of the square by furnishing it. There are more trees on the sides of the square than in the centre. This placing of trees opens the visibility of the gate along the axis of Calle 45 and promenade leading to Plaza Che. Space on the sides of this zone is occupied by more stagnant activities of vendors.

Many spaces with fluid boundaries can be distinguished such as the space between the pavilions, closer to the road and the space in front of the gate.

Plaza on the inner side of the gate is significantly smaller to the plaza outside the gate however it is a setting to similar activity of vendors.

The pavilions and the gate below the road are some of the elements which frame an extended transition.

**keywords:** shelter provided by greenery, subdivision and reduction of the size of the space, gradual transition, extended transition.

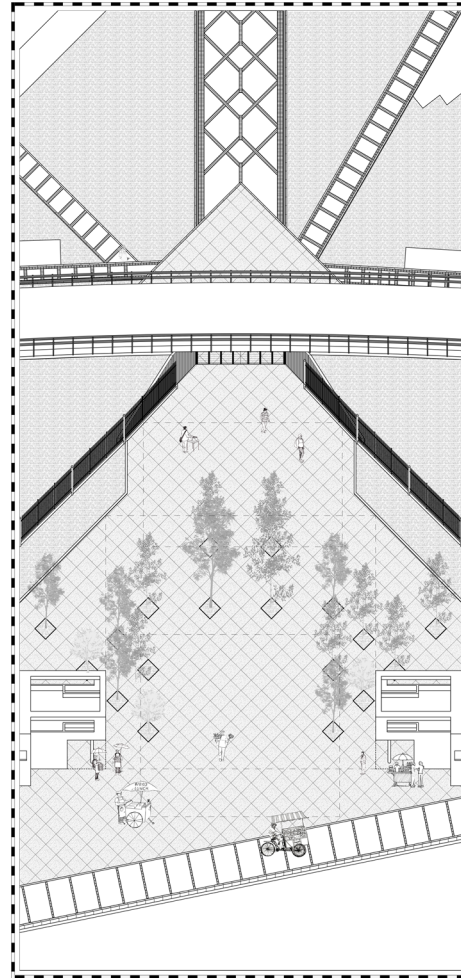

Axonometric drawing  
Threshold of gate by Calle 45, drawing by author.

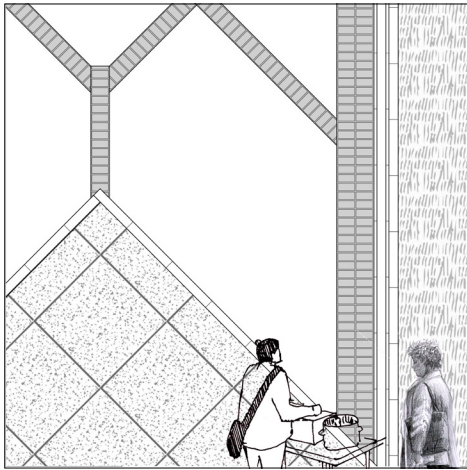

Continuity of paving, drawing by author.

The drawing above shows the paving, which varies between the alley leading to Plaza Che and the romboidal plaza in front of the gate. Paving of the plaza does not imply a direction towards the entrance and it does not vary until it encounters the promenade leading to Plaza Che, where it starts to lead one strongly forward.

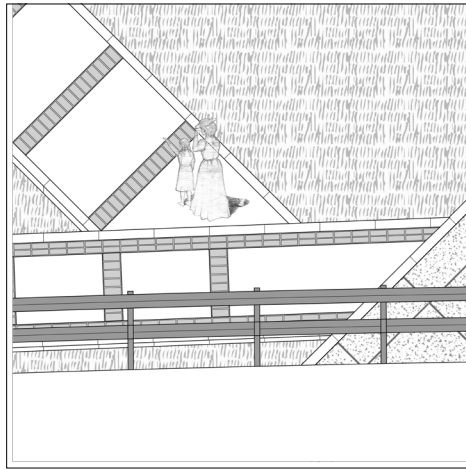

Covergence of paths, drawing by author.

Paths distributing movement of students converge and clash with the small romboidal square on the inner side of the gate. Paths are distinguished with rich diversity of materials, textures, colours and diverse alignment of elements of paving.

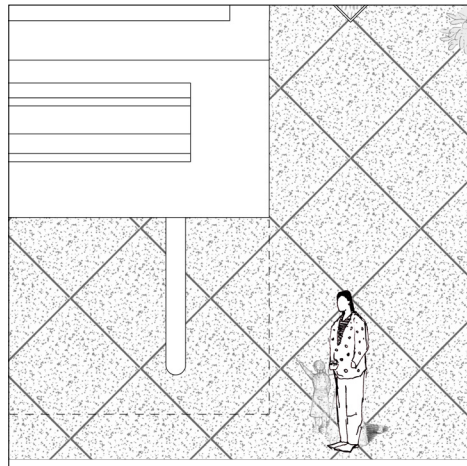

Threshold interior - exterior, drawing by author.

Pavilions designed by Leopold Rother and built in 1940's embrace the direction along the alley leading to Plaza Che and Calle 45. They accentuate the axiality of the entrance. With their form and materiality they relate to the modern ideals of architecture of Universidad Nacional. Steps and flower beds on the terrace might point to a a ceremonial function of the balconies.

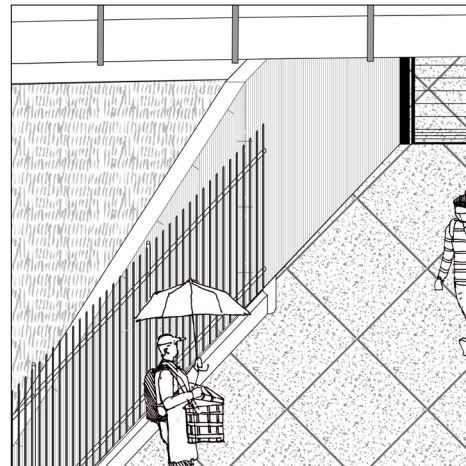

Vertical barrier, drawing by author.

Threshold is expressed in a vertical barrier. Visual link between one side of the gate and another is largely obstructed by earthwork carrying a road. Retaining walls as well as fence stand in an acute angle, narrowing down towards the entrance. Gate itself is also largely non-translucent.

## LINGERING PAUSE

46

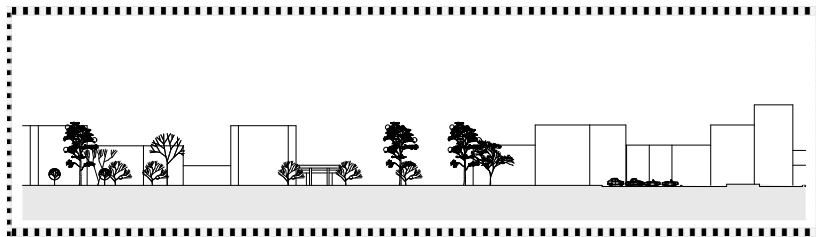
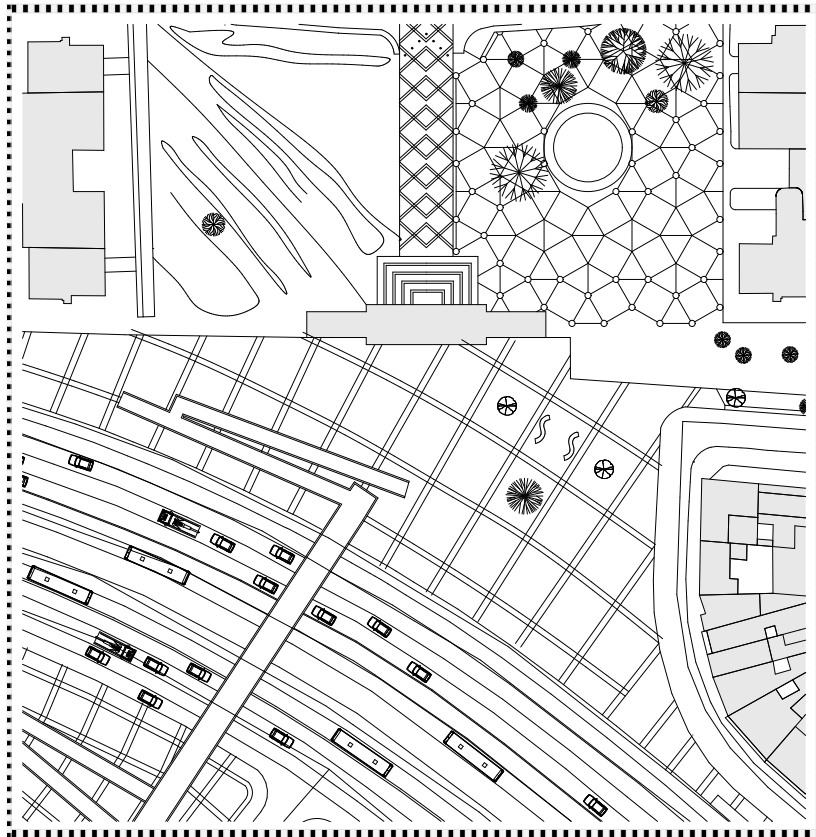

Plan Entrance by Calle 26  
Scale 1:2000, drawing by author.

### Lingering pause

Pause that is characterized by a slow pace against the fast movement in its surroundings. It encourages one to stay and engage with it. It provides an enclosure or a filter to the business. It can portion space into smaller spaces that accommodates groups and individuals.

### Sitting area by Calle 26

Plaza is divided into uniform squares of varied colour paving measuring about 10x11 meters. Grid gives one a greater understanding of distance.

Trees and in particular the flower beds, the trees have been planted in, provide certain level of enclosure. At the same time a greater part of the

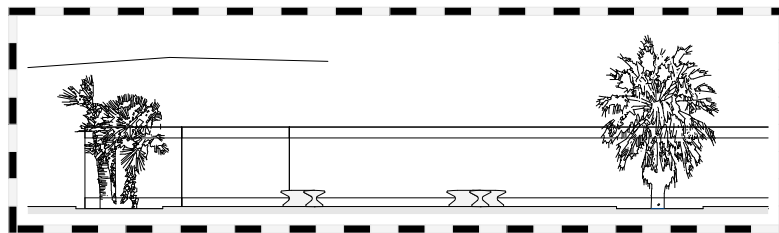
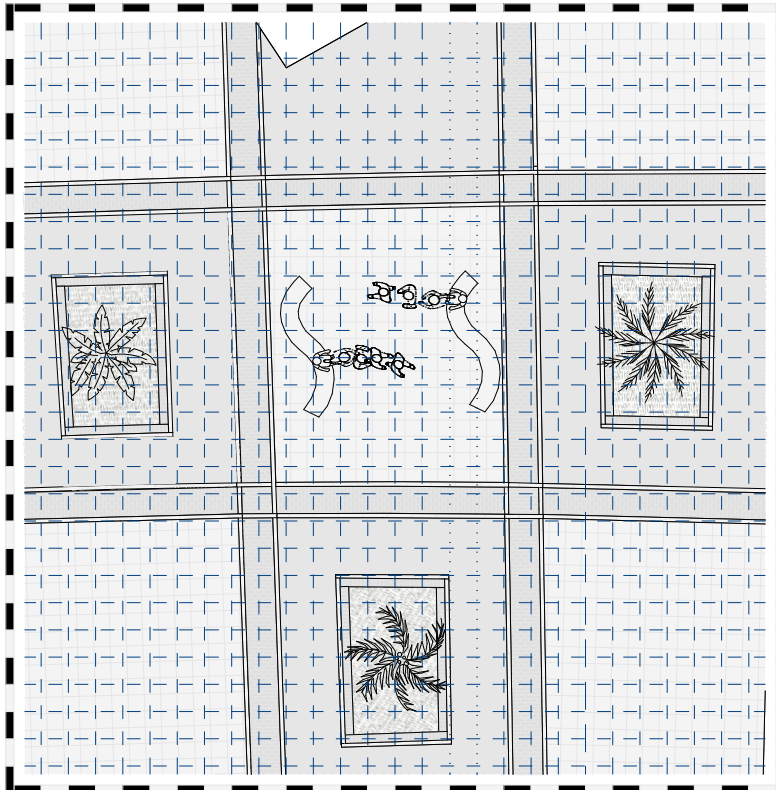

Plan Sitting area by Calle 26  
Scale 1:400, drawing by author.

perimeter of the sitting space is open, retaining transitional qualities of the sitting area.

Distance between opposing benches is too big for people sitting on them to communicate easily. It rather allows them to avoid company of others.

The distances between benches and trees are probably too big to feel shielded and inclined to remain in the sitting area for too long.

Vendor stands supply further subdivision of the space.

keywords: subdivision, open perimeter, pixel, repeatability, distance measured with grid, big social distance, feeling exposed



## DISTRACTING PAUSE

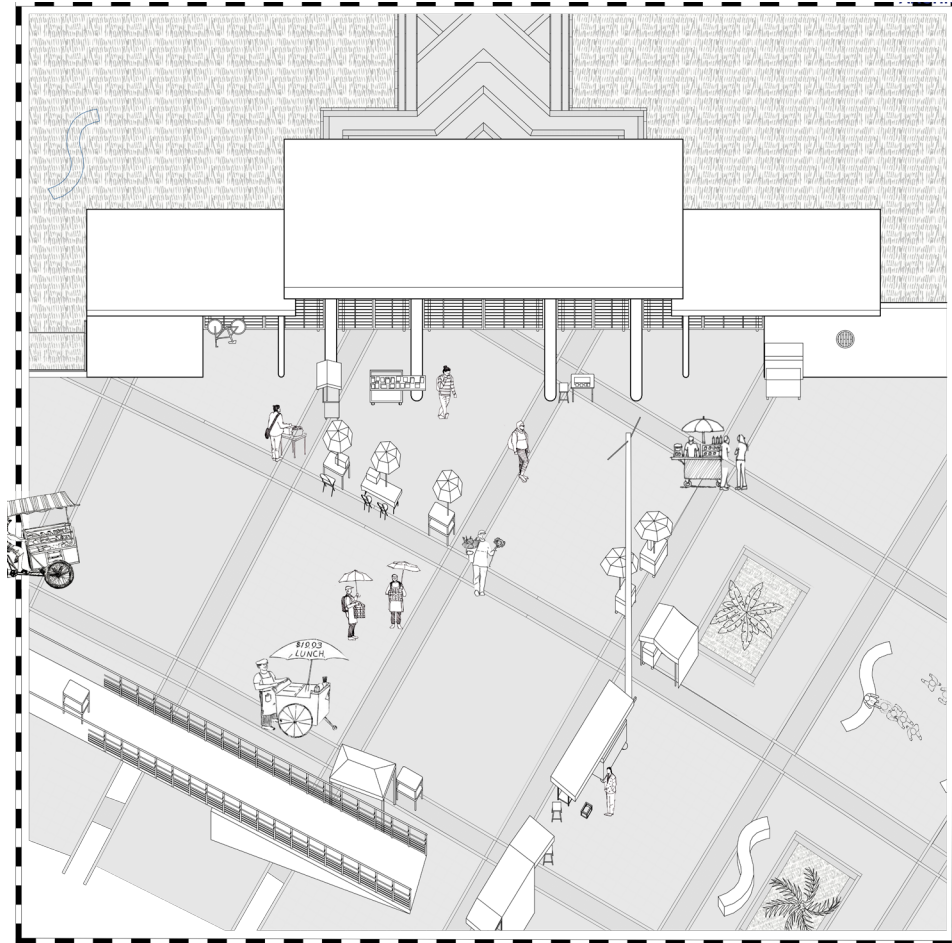

48

Axonometric drawing Vendors by Calle 26  
Scale 1:250, drawing by author.

### Distracting pause

Pause that changes the direction or course of movement. It takes people away from the regular or planned trajectory briefly. It is a moment of redirecting.

### Vendor stands by Calle 26

Vendor stands subdivide the vast entry square into smaller areas. It is very interesting to note that the vendors seem to locate their stands on the contours of paved rectangles. In this case specific use of colour and material in a flat surface is enough to induce inhabiting certain spaces more than others.

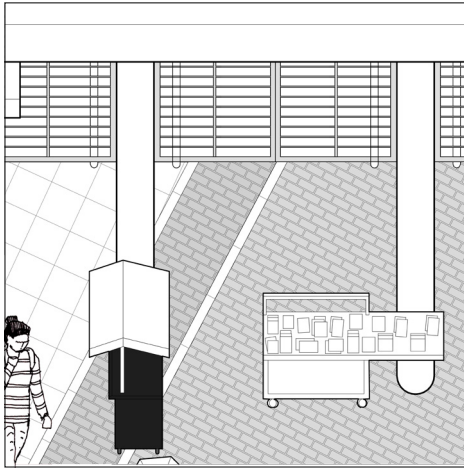

Axonometric drawing  
Vendors by Calle 26, drawing by author.

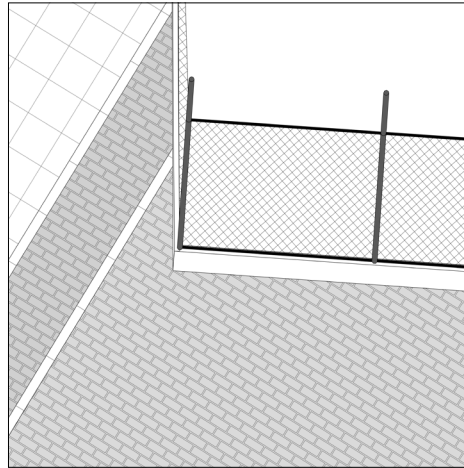

Axonometric drawing  
Vendors by Calle 26, drawing by author.

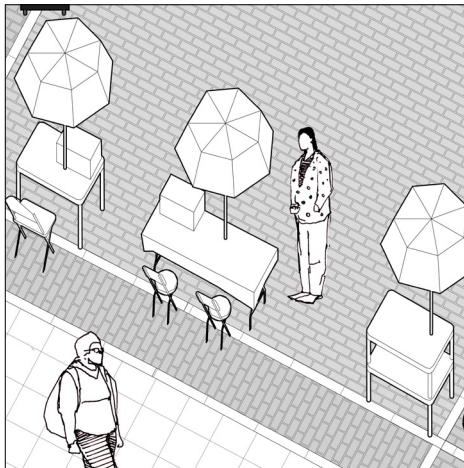

Search for shadow  
Vendors by Calle 26, drawing by author.

Many vendors search for shadow and protection from rain. Often they use mobile elements such as umbrellas and textile canopies. Some of them locate their stands under the roof of the gate structure itself.

keywords: elements of shading and protection from rain



Thick wall, drawing by author.

Life goes on in the open gates and recesses. Whenever the facade does not offer a recess, gates have been opened to create a semi public space. Most of them are open throughout the day. The sequence of facades forms a collonade. Overhangs of facades give some shelter.

## INTIMATE PAUSE

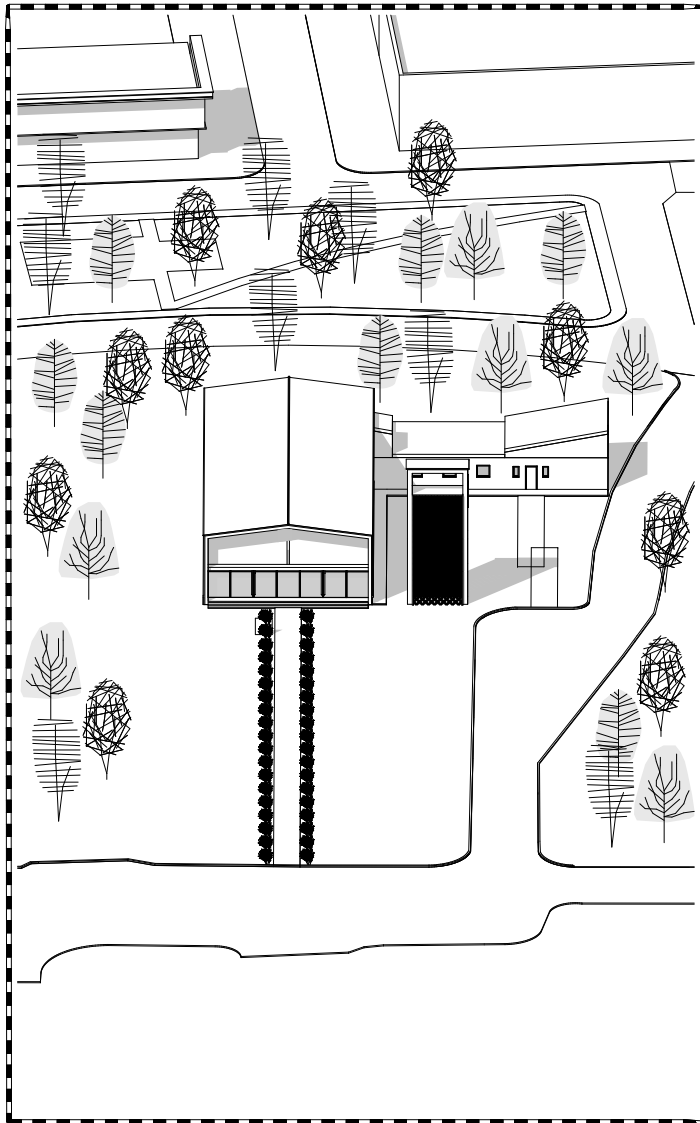

50

Axonometric drawing  
The most southern edge of campus  
Scale 1:600

### Intimate pause

Pause that is often found in an enclosed space and gathers people that know each other or interact directly with each other (intentionally). Intimate pauses occur in places with higher exclusivity with some distance to the open street life.

### Park

Park provides users with a levels of intimacy, which peak in the chapel.



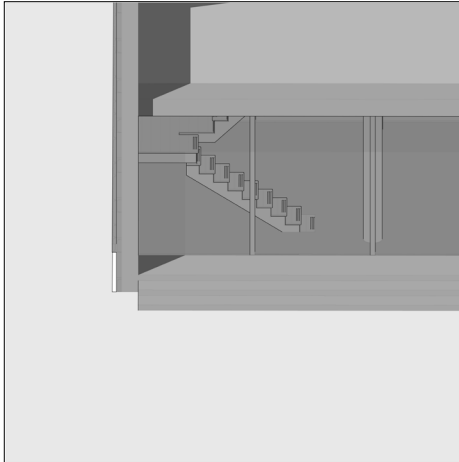

Steps of the chapel, drawing by author.

Little unevennesses of the ground encourage people to sit and stay.

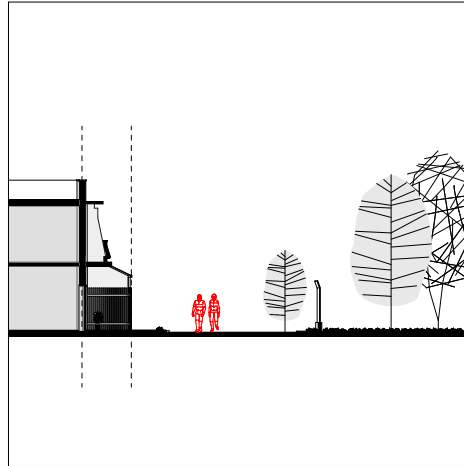

Domestic environment of the narrow streets adjacent to the campus, drawing by author.

Very intimate proportions of space achieved with modest width of the street and height of residential buildings.

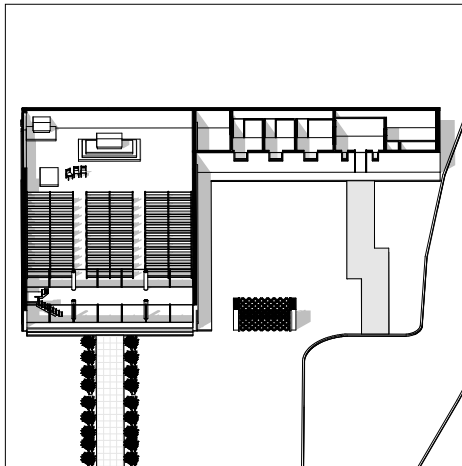

Inside the chapel, drawing by author.

The university chapel is where the intimate atmosphere is most moving. Stained-glass windows contribute to creation of an atmosphere of obscurity and isolation.

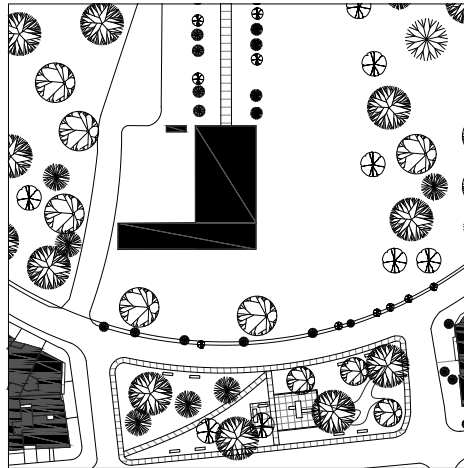

Park on the other side of the fence, drawing by author.

A little playground, used by the inhabitants of the neighborhood, is located on the outer side of the fence.

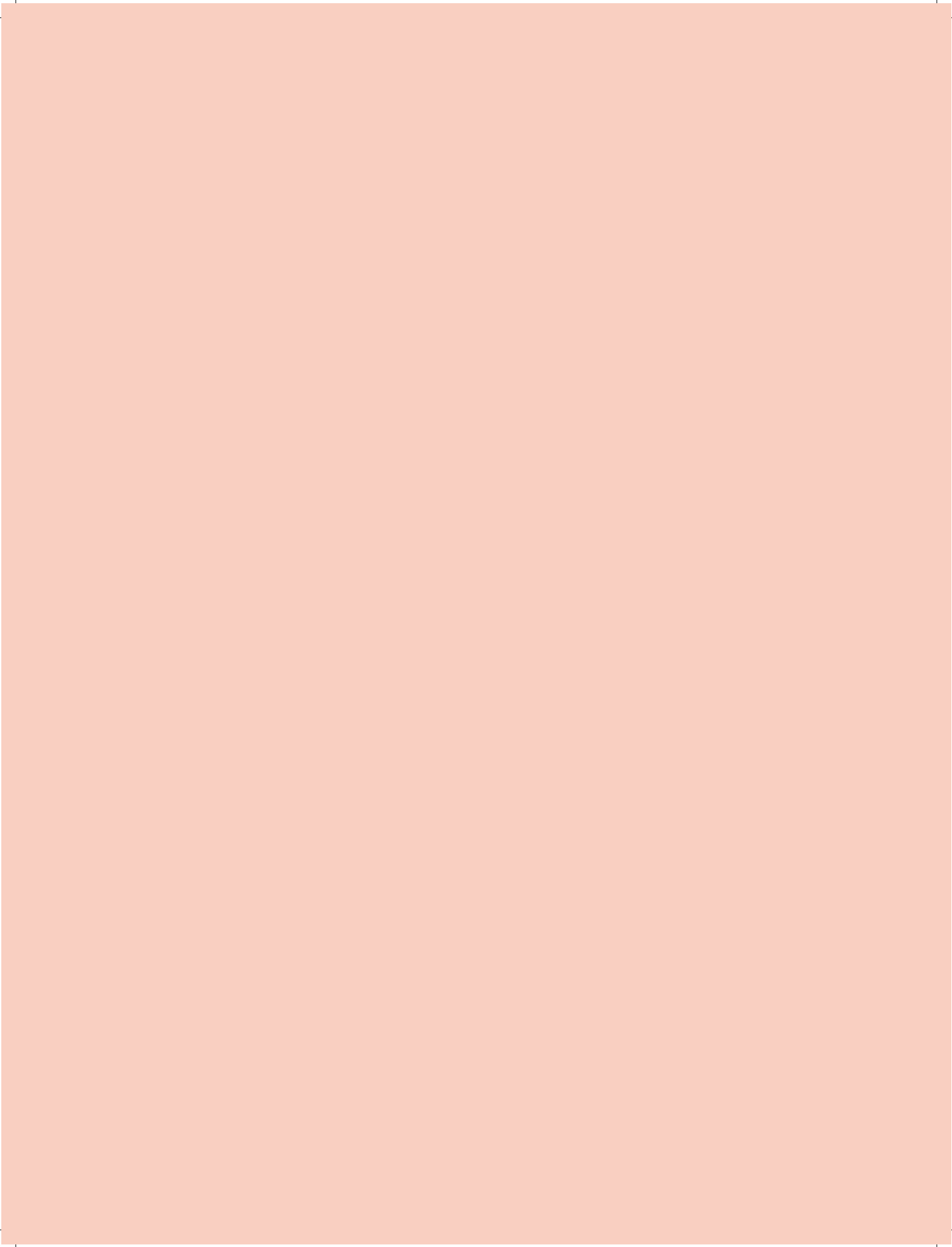

## COMBATING THE UNIVOCITY

## COMBATING THE UNIVOCITY OF THE BOUNDARY

### Concepts

I began the conceptual part of research with a study of several texts, which among others included 'The poetics of space' by Gaston Bachelard, 'The image of the city' by Kevin Lynch and 'Bridge and door' by Georg Simmel. From these texts I extracted several definitions which seemed to relate to liminal spaces such as the one I was facing.

### Boundary

Boundary seems to be a natural property of all material things. We can even say that everything that exists has a boundary. Boundary is also a natural concept in social life, where territorial animals set boundaries of areas in which they feel safe. The will to divide and separate is intrinsic to men kind.

Boundaries cut the infinite continuous space into particular finite units. The finitude of limited space gives us the sense of enclosure, safety, understanding and familiarity.

Boundaries can be appreciated for their role in maintaining diversity. Boundaries are a social contract. They can be a setting of mediation and exchange but also of hostile opposition.

### Wall

Wall is the material form of a boundary. Wall is an expression of helplessness in the situation when a contradiction is impossible to resolve.

### Connection and disconnection

These two concepts are inseparable. One is contained in the other. 'The human being is the connecting creature who must always separate and

cannot connect without separating.'<sup>1</sup> It is unimaginable in our world to create a separation without the slightest possibility of crossing it.

### Door

Door is the materialization of the possibility of crossing the separation. It is the 'hinge' in a barrier. It is essential to man in the deepest sense, who places a limit on himself, but with the freedom to take it away again, of being able to go outside it.

Door accumulates many desires and temptations. Door Ajar – the repealed door – is the one which stimulates human imagination the most. 'On May nights, when so many doors are closed, there is one that is just barely ajar. We have only to give it a very slight push! The hinges have been well oiled. And our fate becomes visible.'<sup>2</sup> Doors evoke curiosity and tempt people for no greater cause. Once the idea of opening the door has been planted in our mind it keeps returning. Checkpoints are the metaphorical doors of the university campus.

### Inside and outside

'Outside and inside form a dialectic of division, the obvious geometry of which blinds us as soon as we bring it into play in metaphorical domains. It has the sharpness of the dialectics of yes and no, which decides everything. Unless one is careful, it is made into a basis of images that govern all thoughts both positive and negative.'<sup>3</sup>

'This formal opposition is incapable of remaining calm. It is obsessed by the myth.'<sup>4</sup>

1 Stavrides S., Towards the city of thresholds, professionaldreamers, 2010, pp 14.

2 Bachelard G., The poetics of space, Penguin Group, New York, 2014, pp 238.

3 Bachelard G., The poetics of space, Penguin Group, New York, 2014, pp 227

4 Bachelard G., The poetics of space, Penguin Group, New York, 2014, pp 228

### Univocity

After having spent some time analysing the forementioned concepts I have realized that using them to build the design syntax upon would be ineffective. I have understood that I am entering a dead end of pointing out opposites and divisions and seeing the chances for unity in measures which do nothing else but confirm the division. I realized that the point of gathering the definitions should not be to define the concepts in the most accurate way or to reconsider the different interpretations. It should be to pierce the sharpness of the definitions and look at what else these words might mean.

It seems that the separation of Universidad Nacional from the rest of the city survives as long as it is understood in a very univocal way. Both users and the authorities treat them as transition points and places of control. The entry squares were designed to fulfill this purpose alone.

Use of the entry squares is controlled. It happens under regulated rhythms. The maintainance of control starts with exposal of identity of individuals and groups using the space. 'The publicly exhibited identities of the users are enacted in accordance with those rhythms that discriminate and canonize them (...) Different categories of people are allowed to enter the various enclaves and the fact that they are allowed to be there is already one crucial indicator of their identity.'<sup>1</sup> The control ritual becomes a routine and a part of life.

### Thirthing

Early in the previous semester I came across Klaske Havik's book 'Urban Literacy'. I was intrigued by the concept, she had used to structure her book - 'thirthing'. This term understood in a slightly different ways occurs in the writing of such thinkers as: Henri Lefebvre, Homi Bhabha and Edward Soja.



Cover of 'Third Space Journeys to los angeles and other real-and-imagined places', Edward Soja

Thirthing-as-othering is a critical strategy proposed by Edward Soja in 'Third space' as an alternative to thinking in binary opposites. Thirthing-as-othering is a process of restructuring information that draws from both sides and allows to notice fields of concurrence

<sup>1</sup> Stavrides S., Towards the city of thresholds, professionaldreamers, 2010, pp 14.

### 'Third space'

In 'Third space' Edward Soja describes 'thirthing' as a critical strategy. He proves that rather than thinking in binary opposites it is intellectually productive to add a third term, which provides a new balance, another perspective, 'a third possibility' or 'a third moment'. This 'third' breaks the oppositional composition which often restricts thought.

As a way of positioning himself in relation to well-known historic and contemporary architectural movements, Soja criticizes the epistemological weakness of modernism. He presents an example of the contradiction between modern and post-modern thinkers to highlight the weaknesses of thinking in opposites.

Soja criticises the 'master narratives' - total ideas which were a domain of modern thinking. According to him these generalized and simplified models of thinking, limit our ability to perceive multiple shades of a given phenomenon. Soja speaks of a reduction of architectural discourse to two simplified stances: post-modernists (diagnosed by him as anti-modernists) and anti-post-modernists. In this altercation no mixture or cross-contamination is permitted.

The critical strategy developed by Soja, namely thirthing-as-othering is a process of restructuring information. This process draws from both opposing positions to open new alternatives. Thus the binary alternatives are not entirely rejected by Soja but deeply reconsidered. This process allows the sides to notice fields of concurrence.

From this thinking strategy Soja derives a 'third space' as a place where one's identity is not fixed and where multiple identities can be continuously contested. Soja develops the idea of a 'third space' in a close dialogue with Henri Lefebvre's lived space. Lefebvre avoided forming however compelling conceptual dualisms. 'Two terms are never enough' he would write.

Echoes of similar thinking can be found in 'The poetics of space' by Gaston Bachelard, who also suggests that forgetting about the meaning we usually attribute to things can be a first step of a fruitful investigation.

### Smoothing

Another theoretical work which aided me at a later stage was an essay by Greg Lynn. He proposes an alternative to the two opposing ways in which architecture tries to relate to complex, disparate, heterogeneous situations: contradiction and reconstruction of unity.

The alternative is smoothing: creating a continuous varied field in which elements retain their individual character.

### Restoring unity and exposing contradictions

In architecture contradictions, recognized in the context, are embodied. This design approach was particularly popular among deconstructivists. As it often happens the notion of representing contradictions has provoked a counter notion - of recovering unity. Reconstructing unity is achieved either through reviving the architectural language of a place, which is isolated via historical analysis, or by identifying local consistencies resulting from climate, indigenous craft, materials etc. Unfortunately continuity achieved in this way represses contradictions and impoverishes.

Lynn presents several examples of architectures which represent contradictions. The Gehry House is said to provoke conflict as a result of its public representation of the hidden aspects of the neighbourhood. Peter Eisenman's Wexner Center is a diagonal collision of two grids.

The attempts to represent differences in conflicting forms do not allow other more complicated relations than an oppositional relation to be formed. Lynn attributes greater value to alliances between elements than to contradictions.

### Techniques of smoothing

Instead Lynn speaks of an emerging alternative practice which the reader of his essay gets to know as smoothing. 'For the first time perhaps, complexity might be aligned with neither unity nor contradiction but with smooth, pliant mixture.'<sup>1</sup>

In order to clearly explain the difference between smoothing and the already known approaches to tackling contradictions Lynn refers to culinary practice, where several types of mixing ingredients can be distinguished. First type of mixing involves manipulation of homogeneous elements: beating, whisking and whipping. These processes change the volume but not the nature of the liquid. The second type of mixing of disparate elements can be: chopping, dicing, grinding, grating, slicing, shredding and mincing. These processes disintegrate and dislocate the elements.

The third group includes: folding, creaming and blending. These processes happen through repeated gentle overturnings. Individual characteristics of elements are maintained. An example of a substance formed as a result of such process is

<sup>1</sup> Lynn, Greg, 'Architectural Curvilinearity. The Folded, the Pliant and the Supple' in *Architectural Design*, No. 63, London, Academy Editions, 1993, pp. 1.

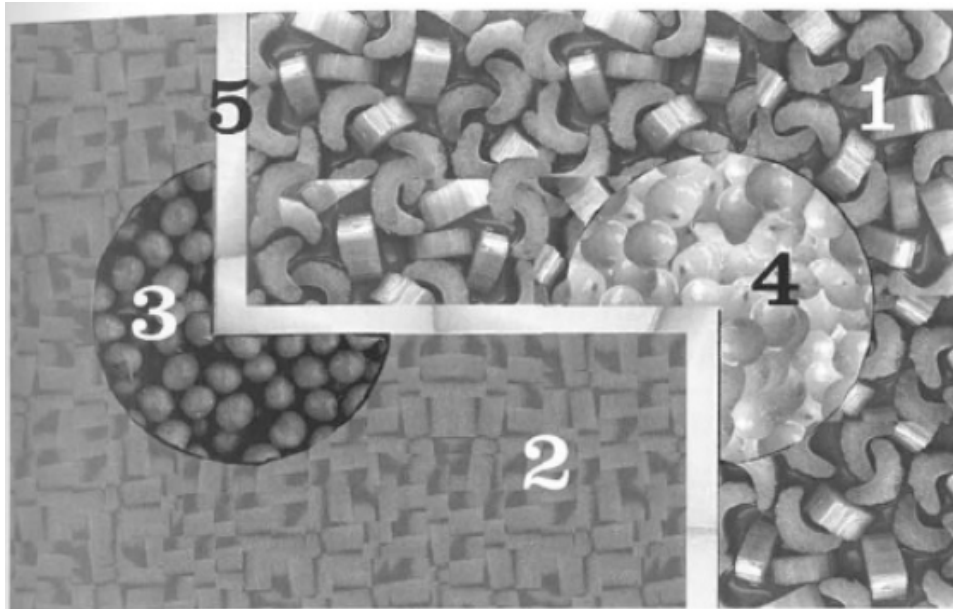

'Cubist Vegetable Patch', Paulette Singley after P.A. Saladin's description in Tommaso's Marinetti's 'The Futurist Cookbook'; in 'Eating Architecture', ed. Jamie orwitz and Paulette Singley, p.11

felt. Felt is an entanglement of fibres which are not organized in an way. It is a continuous variation.

Deconstructivist architecture evolved from representing contradictions present in highly discontinuous, fragmented contexts. At present deconstructivists attempt to work in such contexts by creating compliant, inclusive, continuous environments. These projects try to incorporate their contexts with means that cause minimal resistance. Locations, characters and programmes are folded, creamed and blended into one mixture without compromising their identity. This environment has the capability to expand through incorporation. The main quality of smooth systems lies in their ability of generating unexpected connections between elements.

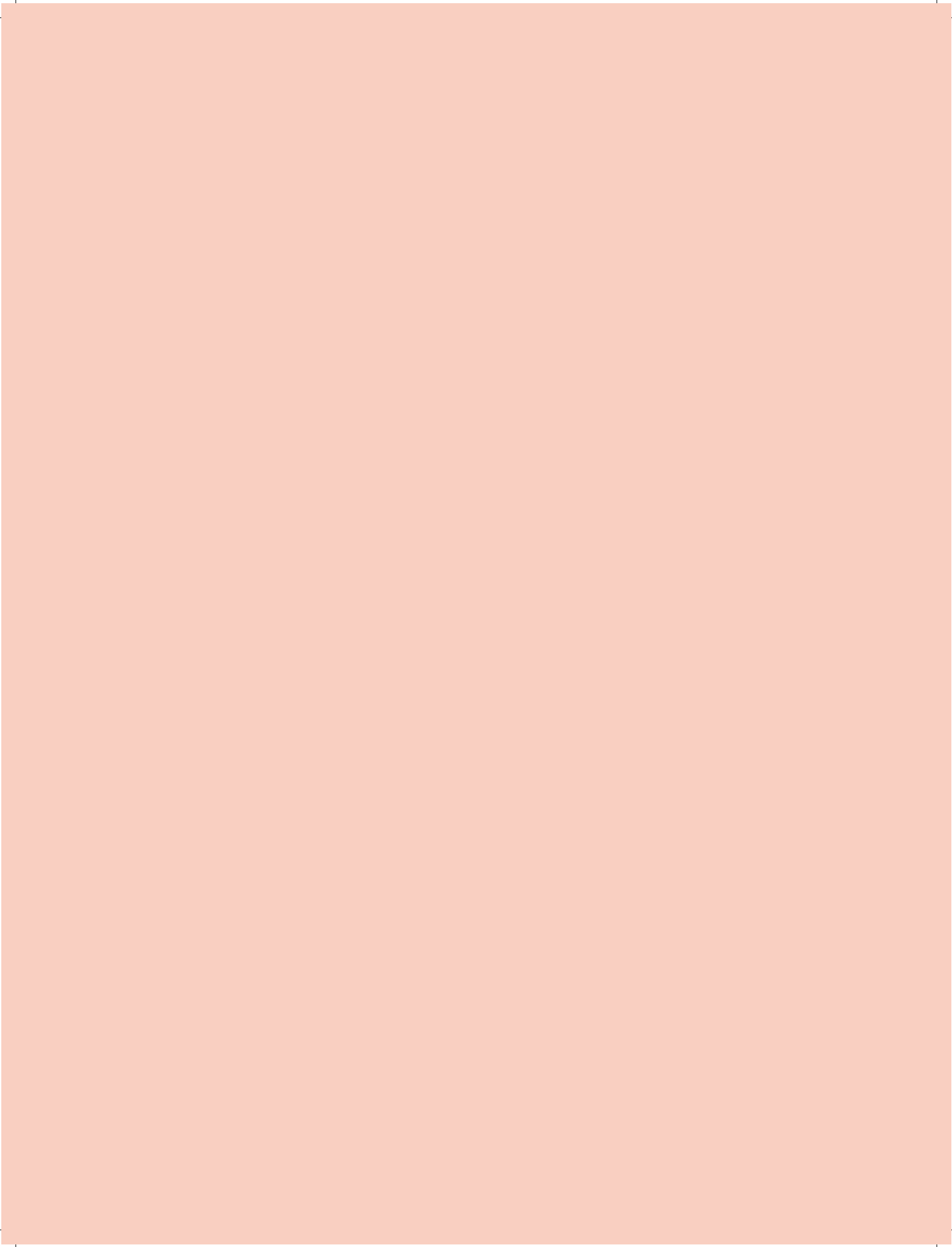



THICKENED THRESHOLD  
ARCHITECTURE

## THICKENED THRESHOLD ARCHITECTURE

During the conceptual as well as contextual research I started to think of the entry squares as thresholds.

A possibly very productive quality of thresholds is that they have a dual meaning. They can be open and closed, connect and separate. Due to that they escape the symbolic and customary meaning.

Threshold spaces are a setting of intensive activity and they can be of a very significant value for local communities and for bigger groups of users.

### Belonging

Recognizable border is one of the factors which help people find a sense of belonging to a space.

In 'Life between buildings' Jan Gehl speaks of 'soft edges'. Soft edges permit activities more prolonged more than just coming and going.

'Everywhere where people walk to and from city functions, or where the functions within a building can profit from opportunities to come outdoors, the establishment of good connections between indoors and outdoors combined with good resting places in front of the buildings must be a matter of course.'<sup>1</sup>

This value of thresholds can be exemplified with housing projects by Ralph Erskine. In his projects the transitional zone between indoors and outdoors has been meticulously designed. The fronts of these residential buildings have been equipped with terraces, benches and little roofs.

Soft edges can counter the alienation that frequently plagues the residents of contemporary

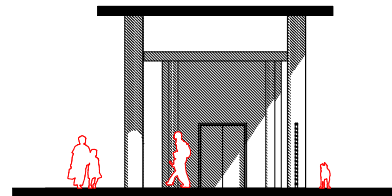

Gate at Calle 26, Bogota, drawing by author.



### Belonging

(Byker, Newcastle upon tyme, 1969-1980, Architect: Ralph Erskine)

In 'Life between buildings' Jan Gehl speaks of 'soft edges'. Soft edges permit activities more prolonged more than just coming and going. Soft edges can counter the alienation that frequently effects the residents of contemporary cities.

<sup>1</sup> Gehl J., Life between buildings. Using public space, Island Press, Washington DC, 2011, pp.195

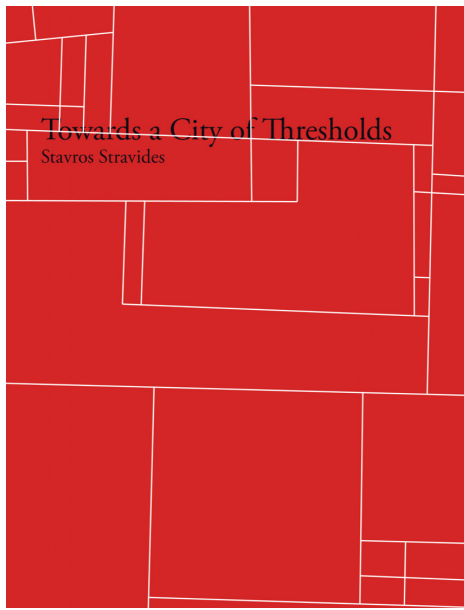

**EMANCIPATION**

Thresholds are spaces where different groups of 'others' encounter each other on equal basis. People can exercise different roles in a threshold space not based on his or her identity. Stavros Stavrides hypothesises that if space gives form to social constructs, threshold can inspire a different social world.

cities.

**Responsibility**

Obviously terms 'private' and 'public' can be translated to different levels of responsibility. Spaces at the meeting of private and public, inside and outside are where it becomes most troublesome to attribute the responsibility. Usually whoever chooses the way the space is arranged, maintained and the way it operates, is the one who feels responsible and cares for the place.

The meeting points between inside and outside - the threshold spaces - are a key design topic. Architects can propose elements which allow users to appropriate space and stimulate the formation of the feeling of responsibility for a place. Residents can then expand their influence to these spaces.



**HOSPITALITY**

(MONTESSORI SCHOOL DELFT, ARCHITECT: HERMAN HERTZBERGER)

Threshold as a place where two world overlap combats mistrust, hostility between the sides.

**Hospitality**

According to Herman Hertzberger threshold is a translation of hospitality into architectural forms.

An example of such space where two world overlap, and a feeling of transition from a safe place into a friendly world is created are the porches of the Montessori School in Delft, designed by Herman Hertzberger.

**Emancipation**

Thresholds are capable of empowering groups. In his book Stavros Stavrides persuades that in threshold spaces different identities encounter each other on equal basis and form groups.

## TYOLOGY OF THRESHOLDS

Domestic threshold, Bogota

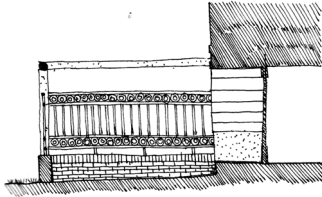

Portico  
Panteon, Rome

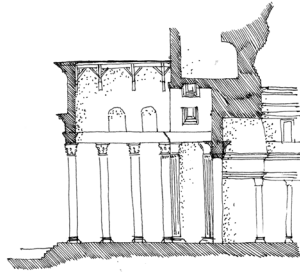

Portal  
Notre Dame Cathedral, Paris

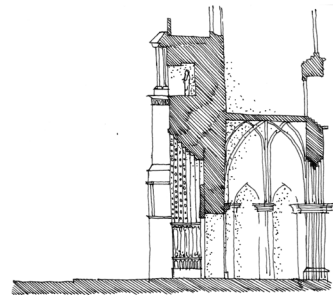

Arcades  
De Passage, Den Haag

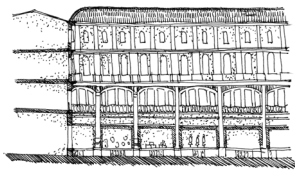

Hypostyle hall  
Mosque, Cordoba

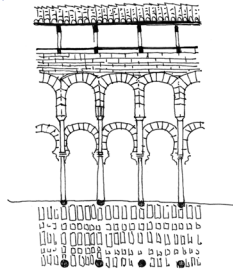

Ramp  
Rolex Learning Centre

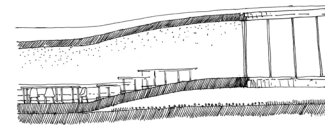

62

Gate  
Calle 26, Universidad Nacional de Colombia

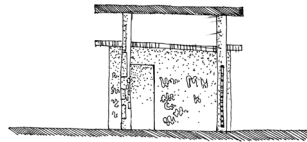

Turnpikes  
Dobrzynskie Turnpikes, Plock, Poland

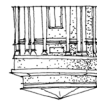

Urban Stairs  
Spanish Stairs, Piazza di Spagna, Rome

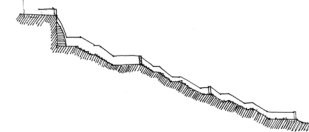

Typology of thresholds exemplary case studies, drawing by author.

Having put the concept of a thickened threshold at the core of my project, I proceeded to conduct a deepened research of this subject. Through this research I managed to learn a lot about how architects have tackled the often overlooked theme of the in-between spaces.

I drew a typology of thickened threshold spaces. It includes examples which form thresholds in cit-

ies such as the Spanish Stairs in Rome, De Passage in The Hague, Dobrzynskie Turnpikes in Plock in Poland as well as entry squares at University Campus.

The second group of case studies are architectures which have grown thickened thresholds within themselves or their entrance areas can be regarded thickened thresholds. These are: thr Rolex Centre in Lousanne, Garcia Marguez Centre in Bo-

Thickened threshold architecture

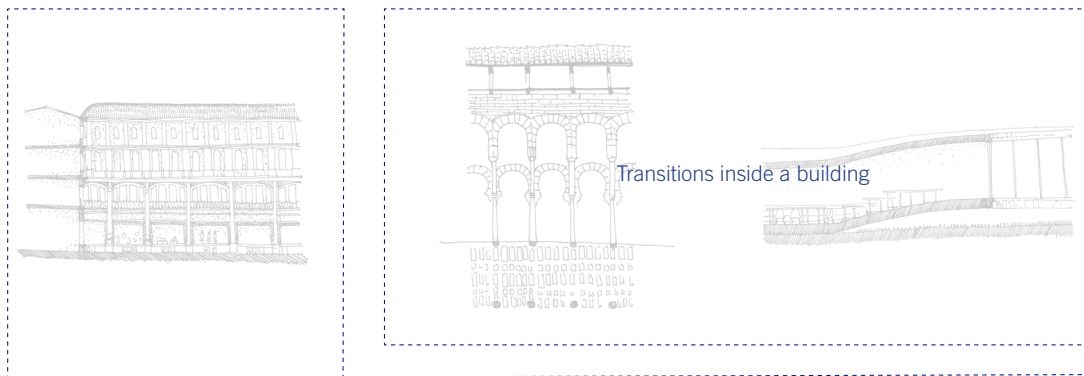
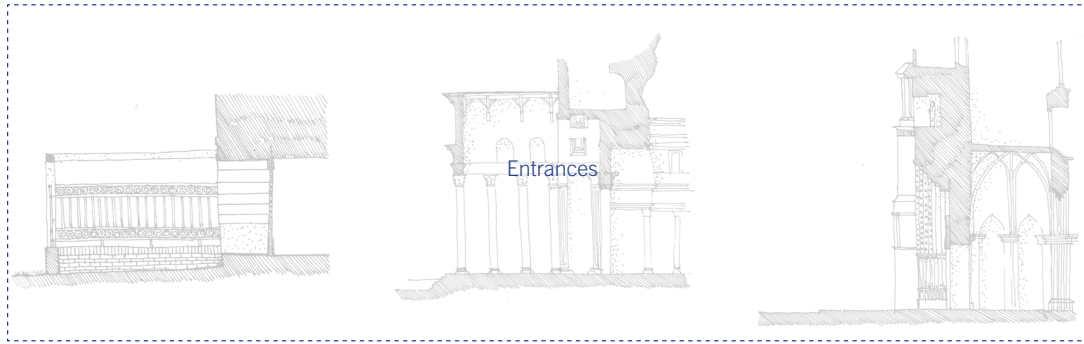

Typology of thresholds, drawing by author.

gota, Lleras Building in Bogota, a gothic portal, the portico of Panteon in Rome, a domestic threshold of a bogotan house and the hypostyle hall of the mosque in Cordoba.

Thickened threshold architecture

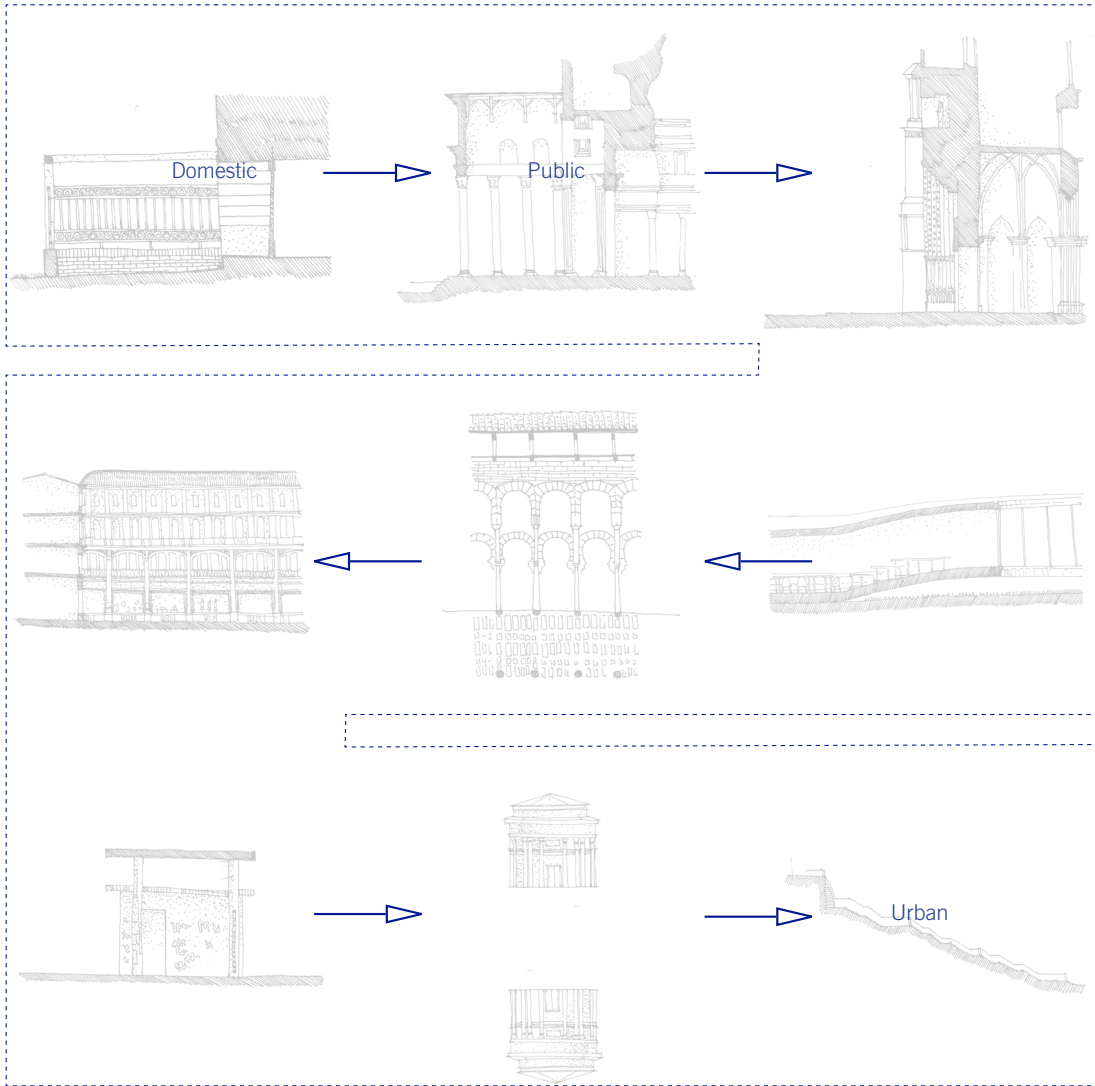

Typology of thresholds from inside of the building to the urban scale, drawing by author.



Thickened threshold architecture

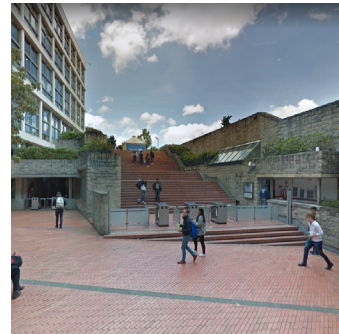
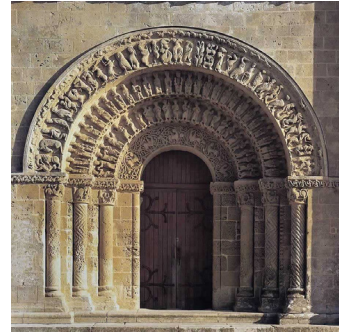

Case studies, drawings gathered online.

Thickening the threshold

## Thickened threshold architecture

Portico  
Panteon, Rome

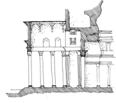

Arcades  
De Passage, Den Haag

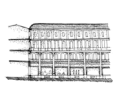

Hypostyle hall  
Mosque, Cordoba



Ramp  
Rolex Learning Centre



Gate  
Calle 26



Turnpikes  
Dobrzynskie Turnpikes



Urban stairs  
Lleras Building, Bogota



Garcia Marquez Culture  
Center, Bogota

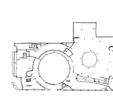

Urban scale  
Sequence of moving through the space  
Relation with other urban spaces

Architectural scale  
Relation with the surroundings

Architectural scale  
Inner composition

Detail scale

Furnishings

Function

Research plan, drawing by author.





## PORTICO PANTHEON, ROME

### Portico

Portico is a porch leading to the entrance of a building.

Pantheon was built at Piazza della Rotonda under Hadrian's rule, between AD 118 and 125. It was a temple that served the worship of seven planetary gods. Today it is a mausoleum. The transition is a sequence of three spaces: the portico, the transitional element, and the opening to the main room.

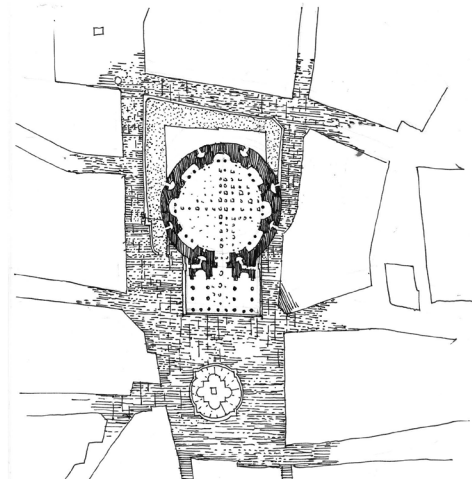

Plan of Piazza della Rotonda, drawing by author.

68

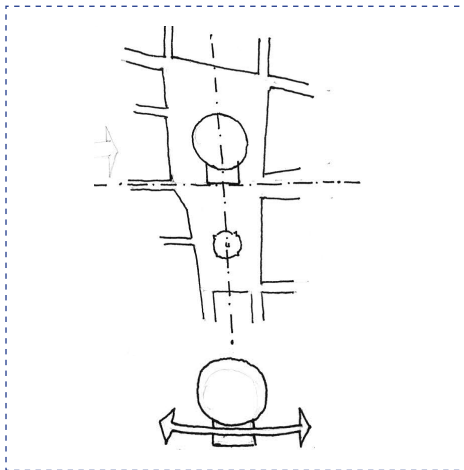

**URBAN SCALE**  
Position

Portico is located on the axis of a road crossing the square.

Front facade of the portico has a width equal to the width of Piazza della Rotonda.

Front facade of the portico lays on the axis cutting the space in two.

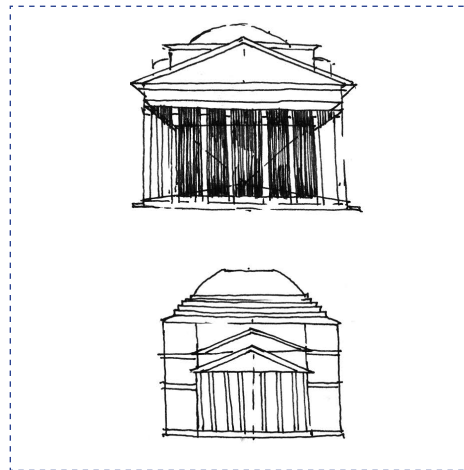

**ARCHITECTURAL SCALE**  
RELATION WITH THE SURROUNDINGS  
Scale

Facade of the portico covers the dome. Portico is hidden in shadow and perceived as a void and a room.

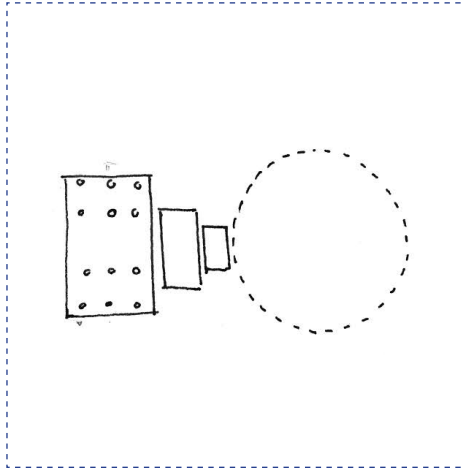

**ARCHITECTURAL SCALE**  
**INNER COMPOSITION**  
Layered

Layered transition in contrast to the symmetrical sphere of the main room.

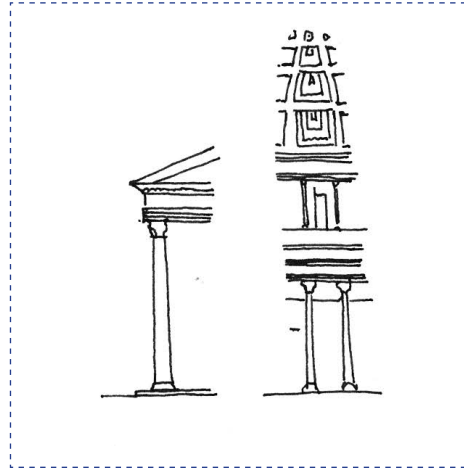

**DETAIL SCALE**  
Great order

Transition from a monumental scale to the scale of the interior. From great order to small order.  
Sequence of changing light.

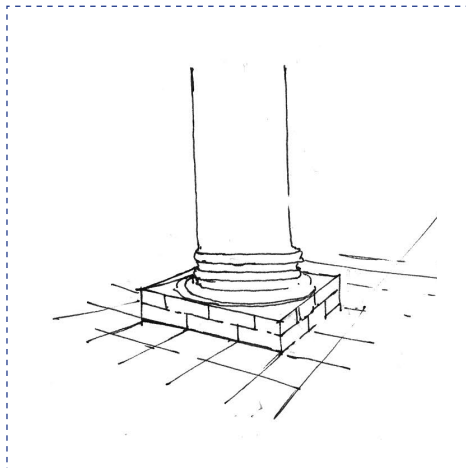

**FURNISHINGS**  
Huge scale

People sit on the huge base of the column.

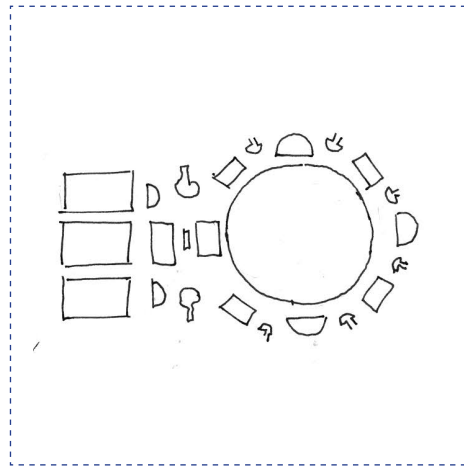

**FUNCTION**  
Circumference

Serving spaces arranged in the thick wall

## ARCADES DE PASSAGE, DEN HAAG

### Arcades

'Arcades Project' is the title of Walter Benjamin's book. 'The arcades, existing between public and private space, between street and shop, are home for the flaneur and at the same time urban phantasmagorias for the private individual.' Arcades contain an ambiguity. They are an indoor space that links outdoor spaces. Arcades combine many qualities of indoor and outdoor spaces.

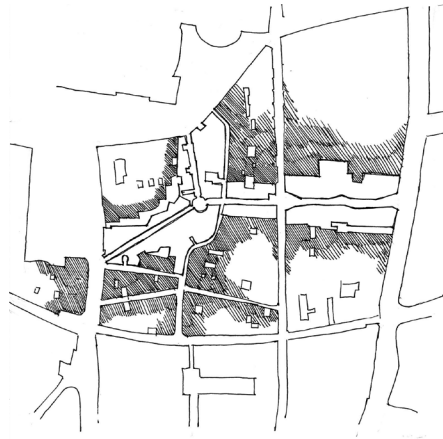

Plan of De Passage, Den Haag, drawing by author.

70

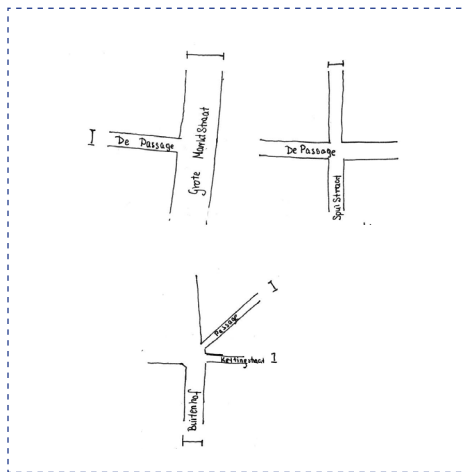

**URBAN SCALE**  
Completing the  
urban links

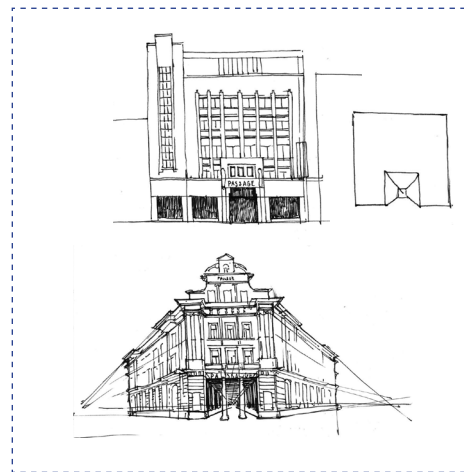

**ARCHITECTURAL SCALE**  
RELATION WITH THE SURROUNDINGS  
Proportions

Surreal deep perspective seen in the facade. Street profile resembling the profile of old streets. Continuity with the other streets. Width of the passage is similar to the old streets.

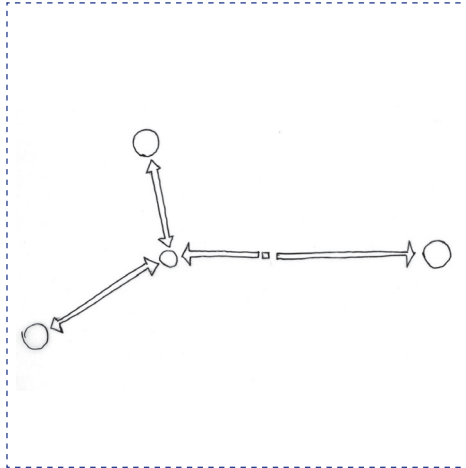

**ARCHITECTURAL SCALE**  
**INNER COMPOSITION**  
 Rhythmicity

Passages and a culmination in the shape of the central round space. Rhythmically spaced entrances to shops.

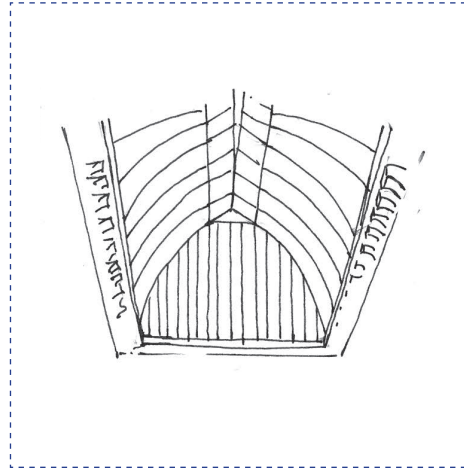

**DETAIL SCALE**  
 Daylight

Transparent canopy allows the space to maintain a moderate climate similar to interior and allows a lot of light to enter the inside like in an exterior space.

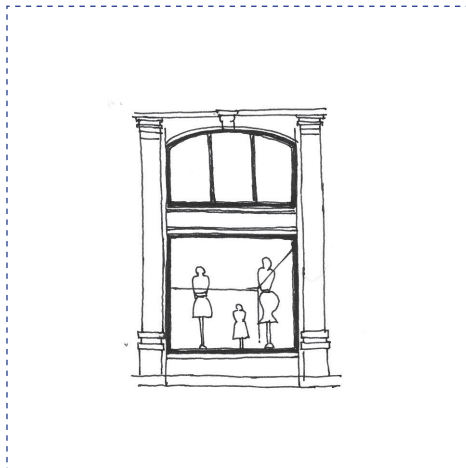

**FURNISHINGS**  
 Glass

Large glass display windows create an illusion of no barrier between the shops and the passage.

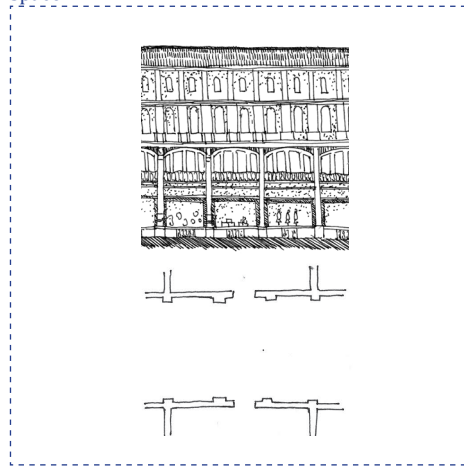

**FUNCTION**  
 Symmetrical

Circulation space in the middle, shops allocated symmetrically on both sides.

## HYPOSTYLE HALL MOSQUE, CORDOBA

### Hypostyle hall

Grid of columns continues through both inner and outer spaces. Repetitiveness of arches and columns, which overlap and resemble a barrel vault when seen from inside the building, contribute to consistency of spaces. The thickness of columns differs and results in varying degrees of transparency between spaces. Rows of columns form soft transitions. Spaces are entered through lines not points. The uncovered spaces are adjacent to galleries. Closed rooms are mostly located along the facades and strictly follow the grid. Spaces differ in height. Although the arch structure consists of many levels it is mostly experienced from the ground level.

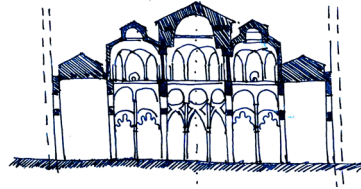

Section of 5 bays of the Mosque, drawing by author.

72

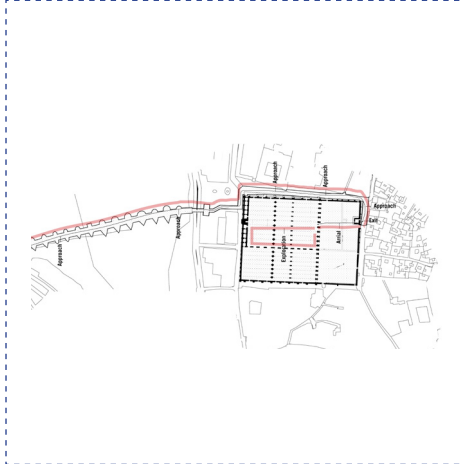

**URBAN SCALE**  
Elongated approach

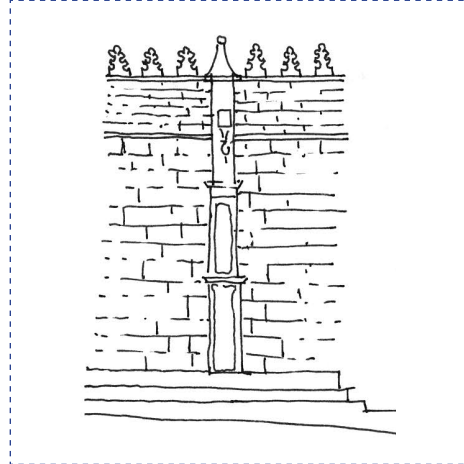

**ARCHITECTURAL SCALE**  
RELATION WITH THE SURROUNDINGS  
Seclusion

Lack of windows stresses the sacred function with requires calm atmosphere.

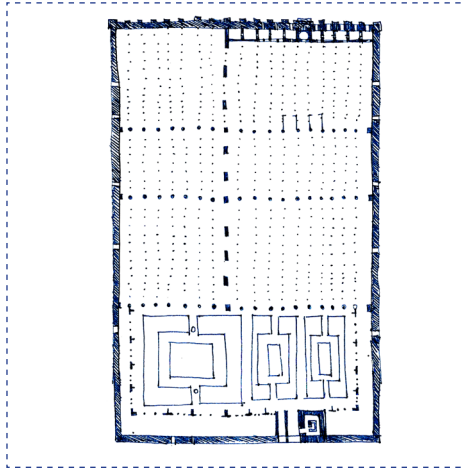

**ARCHITECTURAL SCALE**  
**INNER COMPOSITION**  
Addition

The inner composition is a result of repeated extensions and rituals of Islam. It is based on addition of bays of columns.

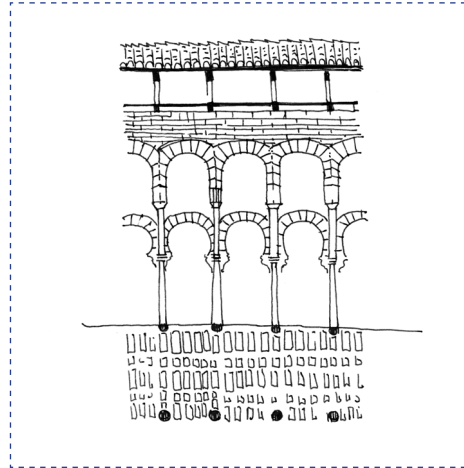

**DETAIL SCALE**  
Gradation

Gradation of translucency between spaces achieved with columns of differing width and height of arches.

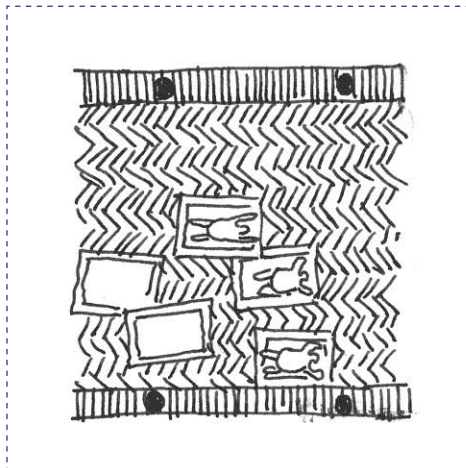

**FURNISHINGS**  
Mobile

Carpets brought by worshipers are laid on the floor during prayer.

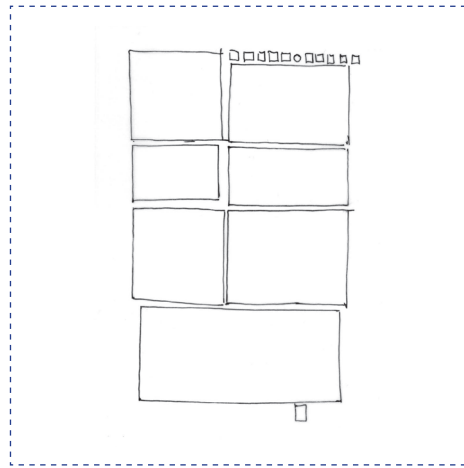

**FUNCTION**  
Ritual

Serving functions located around the perimeter of the space next to the walls.

## URBAN STAIRS EDIFICIO LLERAS, BOGOTA

### Urban stairs

Stairs offer various experiences as well as points of arrival, such as entrances to buildings and open spaces. The major arrival point is the outdoor theatre. Due to their width the stairs accommodate many activities: food fairs, extension of the adjacent canteen. Also the shifting edges of the stairs give room for these activities.

The main entrance is clearly readable. Route from the main entrance ramifies into stairs that lead in different directions: around the theatre and above to the hills, with a sequence of little terraces and stairs down a valley below. Vegetation planters separate little terraces along the stairs.

The topography created by the stairs resembles the surrounding hilly landscape. The architect uses small intermediate steps to distinguish zones

of movement and stay, movement lanes and big detention walls that lead to a disjunction between spaces. However he avoids using very tall walls without a setback.

Staircases are celebrated as very prominent elements connecting levels.

74

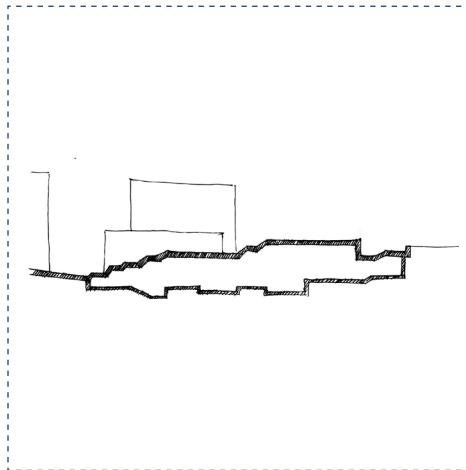

**URBAN SCALE**  
Nature/culture

It mediates between urban fabric and landscape. Different ground levels.

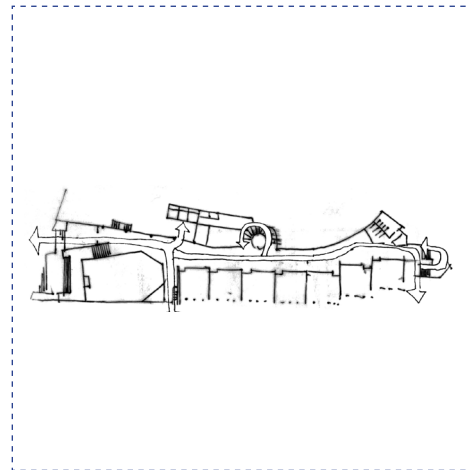

**ARCHITECTURAL SCALE**  
RELATION WITH THE SURROUNDINGS  
Circulation

It is connected to other buildings by stairs, colonades, doors, ramps and outdoor stairs.



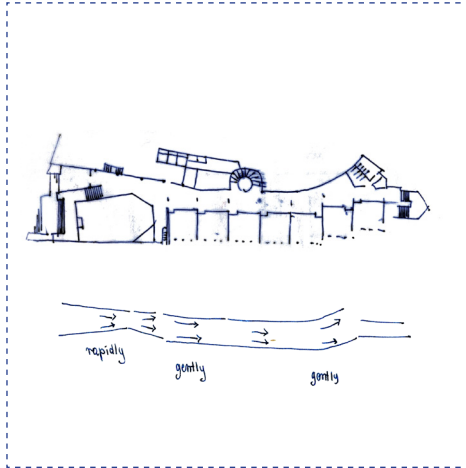

**ARCHITECTURAL SCALE**  
**INNER COMPOSITION**  
Continuous

Continuous circulation spaces and rhythmic repetitive classrooms.

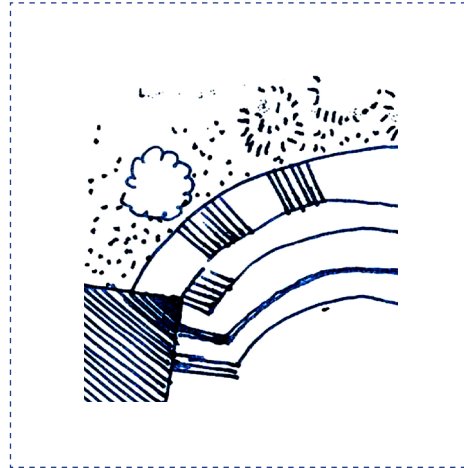

**DETAIL SCALE**  
Mediating

Mediates between the soft and hard materials, light of the skylights and darkness of the ground.

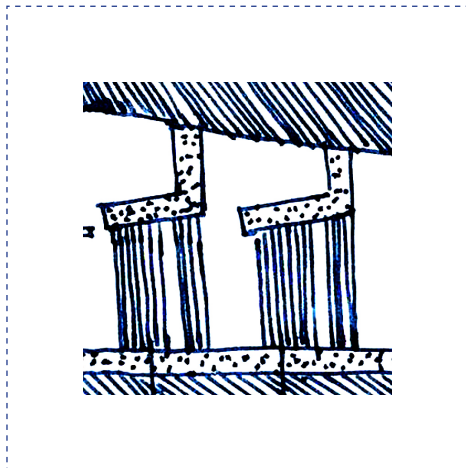

**FURNISHINGS**  
Soft/hard

Integrated furnishings: planters, audience, wide stairs, sitting spaces.

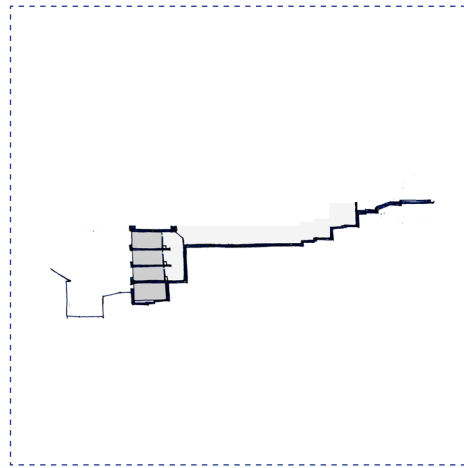

**FUNCTION**  
Ritual

Circulation - roof, corridors and staircases. Classrooms located along the corridors.

## GARCIA MARQUEZ CULTURAL CENTER, BOGOTA

### Courtyard

Centro Cultural Gabriel Garcia Marquez is very permeable similarly to the hypostyle. Terraces are raised on columns. 1/2 and 1/3 level differences between spaces are often used. Thanks to that building operates with great amount of levels and connections between them even though it climbs only to the height of 5m.

In this project outdoor spaces dominate the indoor spaces and the program of the building.

Placing of structural elements - on a radial grid.  
Cylinder cores of the staircases.

External facades consist of columns and low walls.

76

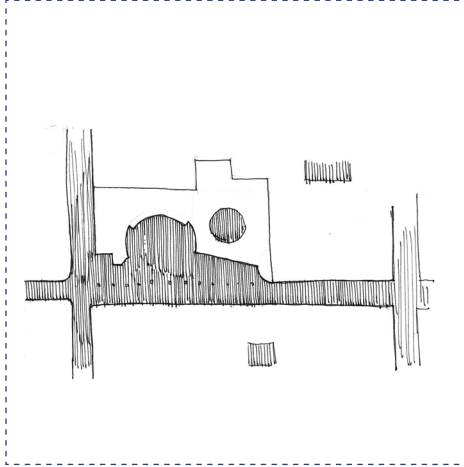

**URBAN SCALE**  
Lead

Integration of the street with the inside of the building.

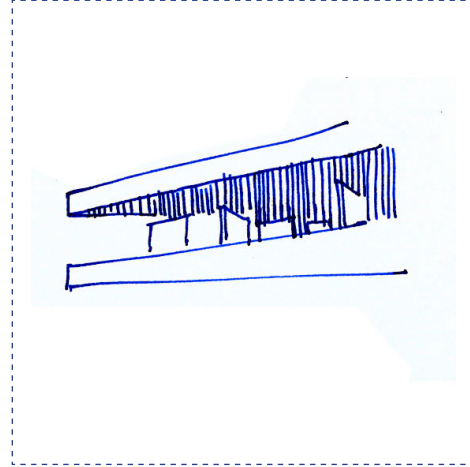

**ARCHITECTURAL SCALE**  
**RELATION WITH THE SURROUNDINGS**  
Integration inside/outside

Reevaluates the typical relation of a courtyard to the street with the use of high permeability of the facade.

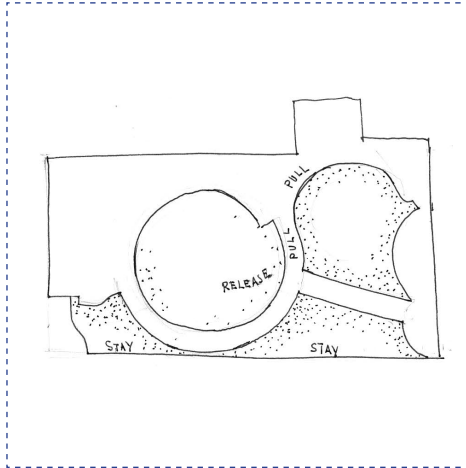

**ARCHITECTURAL SCALE**  
**INNER COMPOSITION**  
Montage

Montage of contrasting atmospheres.

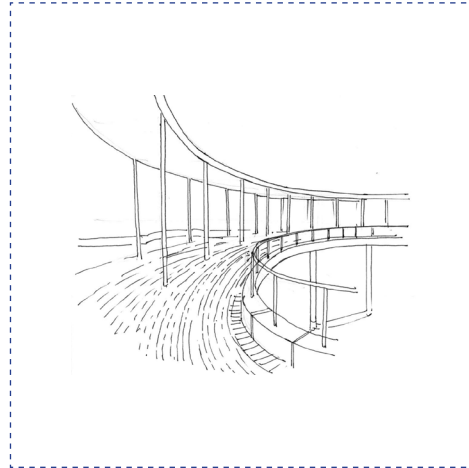

**DETAIL SCALE**  
Oval

Use of materials present in the surroundings but in more sculptural oval forms. Uniform materiality stresses the play of light.

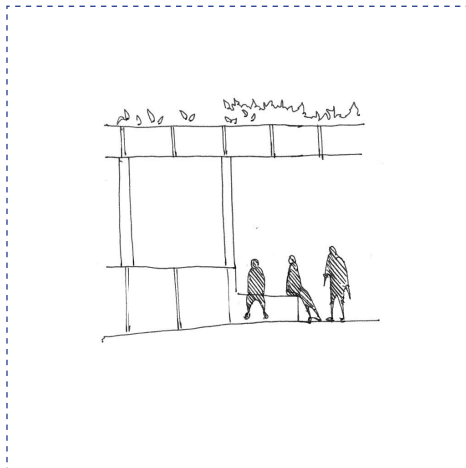

**FURNISHINGS**  
Integrated

Integrated furnishings: walls and curbs of different height.

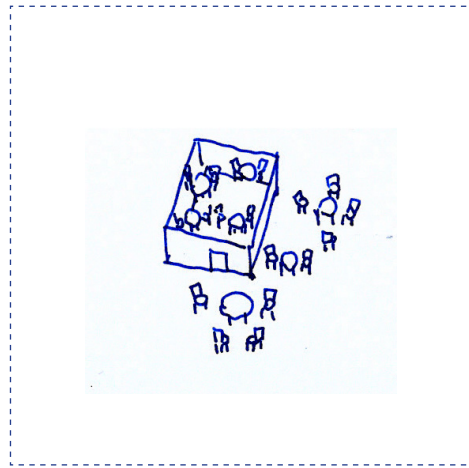

**FUNCTION**  
Transgressing

Functions continue past walls.

## RAMP ROLEX LEARNING CENTER

### Ramp

Rolex center has been designed as a curvilinear landscape. Sloping floor and ceiling is enough to subdivide the space into different spaces. Main entrance to the building is located in the center of the plan

78

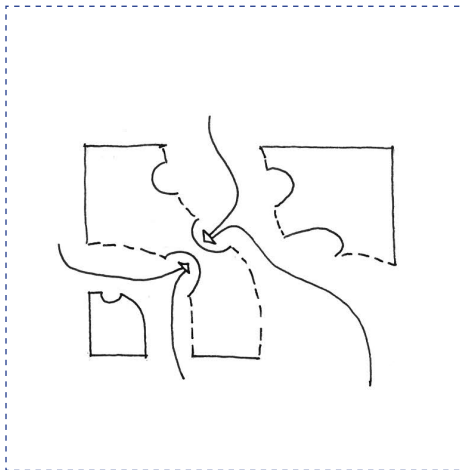

**URBAN SCALE**  
Central access

One enters the building in the centre of the plan and begins the discovery of the building from there. Undulation of the floor speeds up or slows down the body.

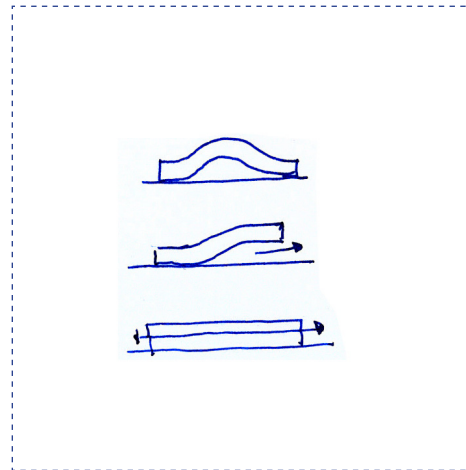

**ARCHITECTURAL SCALE**  
RELATION WITH THE SURROUNDINGS  
Undulation

Public spaces that are: enclosed by the building, open to the adjacent spaces and transitional passages.

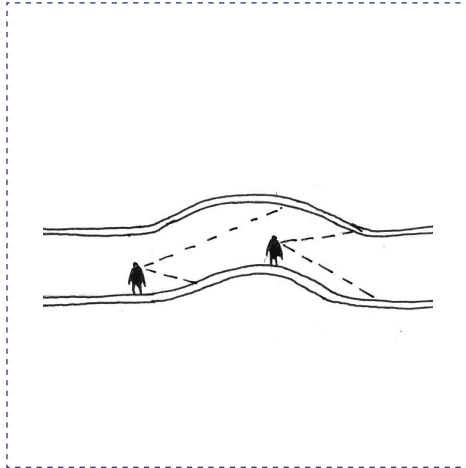

**ARCHITECTURAL SCALE**  
**INNER COMPOSITION**  
Visibility

Internal divisions established with undulation of the topography that blocks and opens the view.

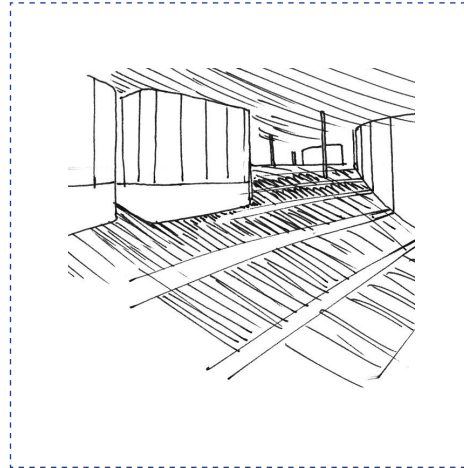

**DETAIL SCALE**  
Shadow

Uniform colour and texture of materials exposes the play of light and shadow that stresses lobed shapes of walls, floor and ceiling.

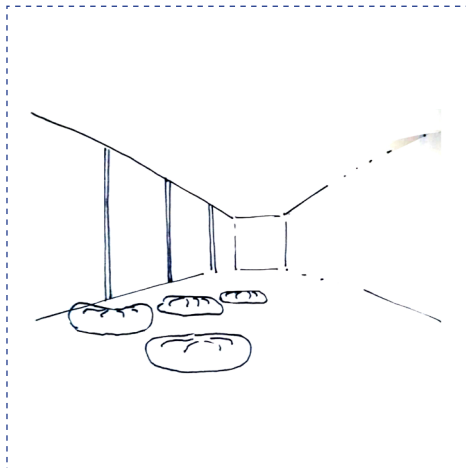

**FURNISHINGS**  
Slope

Minimal furnishings direct attention to the most important shaping measure - the undulation of the floor.

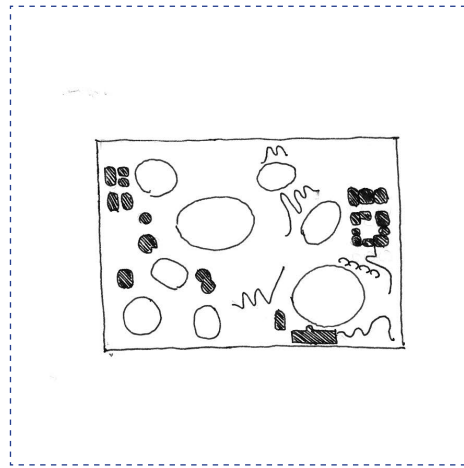

**FUNCTION**  
Clusters

Serving spaces closed in little bubbles. Narrow passages between bubbles become corridors.

## CITY GATE CALLE 26, BOGOTA

### City gate

Gate leading to Univeristy campus, located at Calle 26, represents a category of city gates. The historical examples of this type where meant to protect and control a territory of a city. Modern examples of city gates fullfil the function of framing the process of entering, frequently they are meant to impress the person crossing.

80

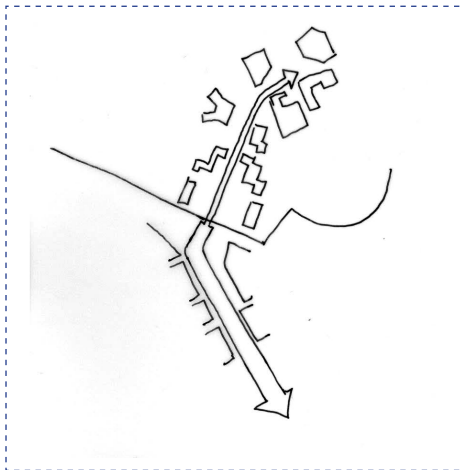

**URBAN SCALE**  
Check point

One of the unavoidable transition points that cannot be crossed without control. Directly leads to Plaza Che.

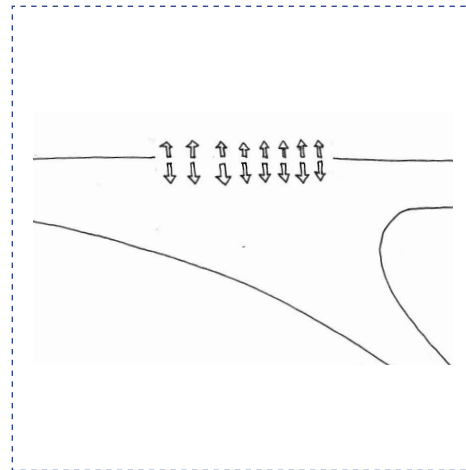

**ARCHITECTURAL SCALE**  
RELATION WITH THE SURROUNDINGS  
Markers

Singular space delimited by the pavilions, columns and a roof.

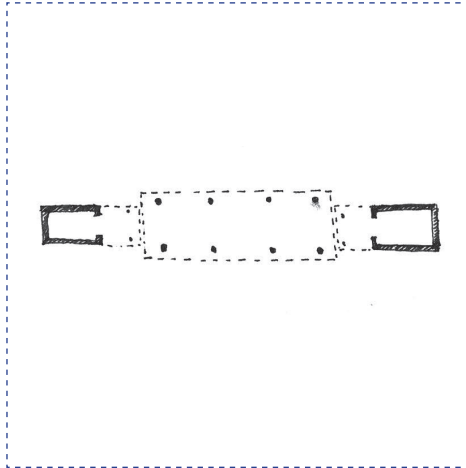

**ARCHITECTURAL SCALE**  
**INNER COMPOSITION**  
Interpenetrating

Interpenetrating spaces. Central representational space and less formal spaces for security officers on sides.

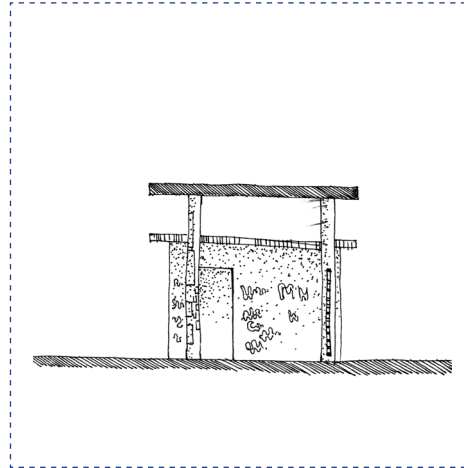

**DETAIL SCALE**  
Subordinate

Sitting space and subdivisions of the paving.

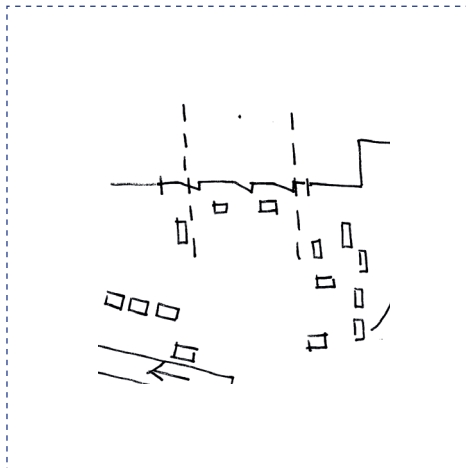

**FURNISHINGS**  
Pattern

Inaccessible pavilions. Area under the roof lies entirely on one side of the fence.

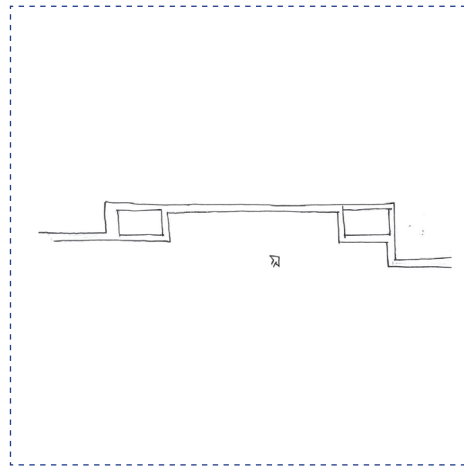

**FUNCTION**  
Clusters

Inaccessible pavilions. Area under the roof lies entirely on one side of the fence.

## TURNPIKES PLOCK, POLAND

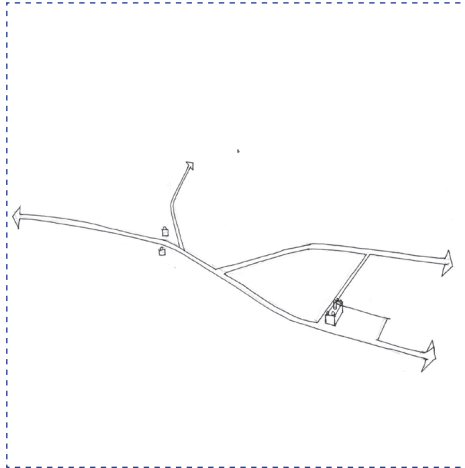

**URBAN SCALE**  
Transition point

Transition point that can be crossed without obstructions while moving by vehicle or on foot alike from other cities to the main market.

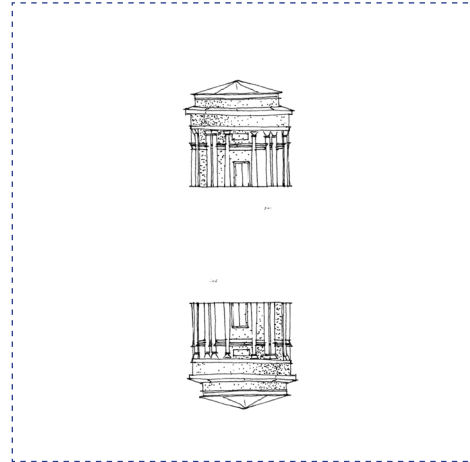

**ARCHITECTURAL SCALE**  
RELATION WITH THE SURROUNDINGS  
Markers

Pavilions serve as markers of the transition. However no distinguishable space is formed.

82

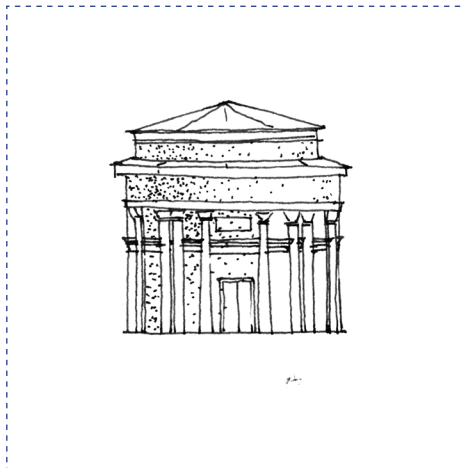

**FURNISHINGS**  
Representative

Abundant use of decoration. Neoclassicist style.

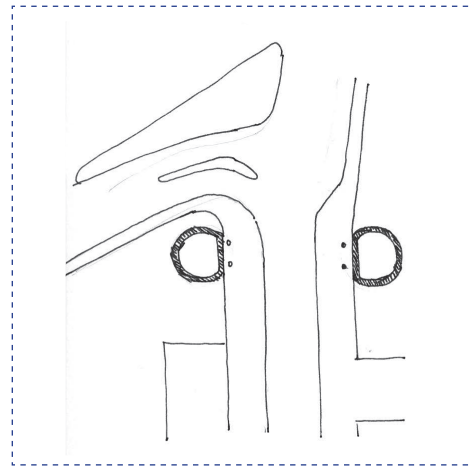











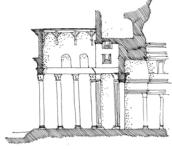
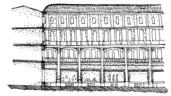
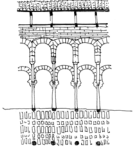

**FUNCTION**  
Clusters

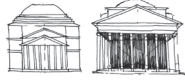
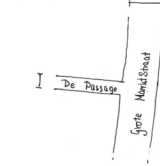
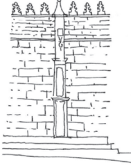
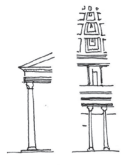
Inaccessible pavilions. Area in between is separated into pedestrian and vehicular circulation.

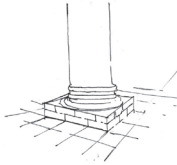

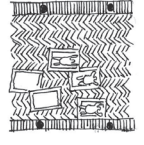

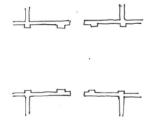
# WHAT THICKENS THE THRESHOLD?

	Portico Panteon, Rome	Arcades De Passage, Den Haag	Hypostyle hall Mosque, Cordoba
Urban scale			
Architectural scale Relation with the surroundings			
Architectural scale Inner composition			
Detail scale			
Furnishings			
Function			

Thickened threshold architecture

Ramp  
Rolex Learning Centre

Gate  
Calle 26





Turnpikes  
Dobrzynskie Turnpikes

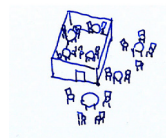
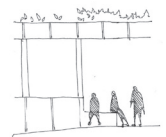
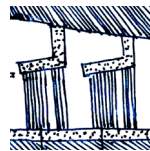
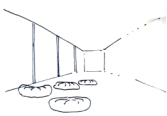
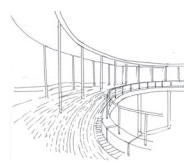
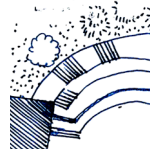
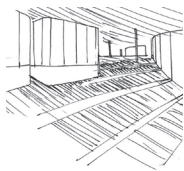
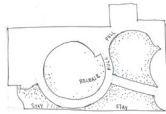
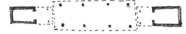
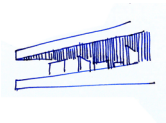
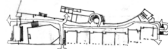
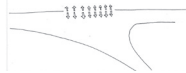
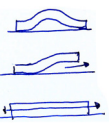
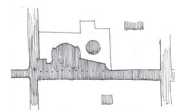
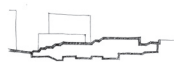
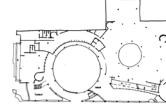
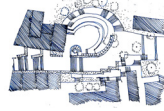
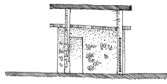
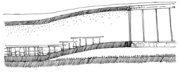



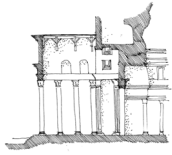

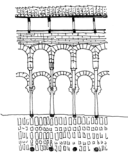



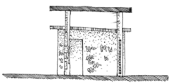

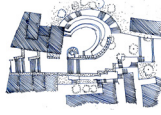
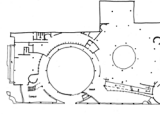
Urban stairs  
Lleras Building, Bogota

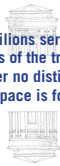
Garcia Marquez Culture Center, Bogota



# WHAT THICKENS THE THRESHOLD?

	Portico Panteon, Rome	Arcades De Passage, Den Haag	Hypostyle hall Mosque, Cordoba
			
Architectural scale Relation with the surroundings	Urban scale  Portico is located on the axis of a road crossing the square.  Front facade of the portico has a width equal to the width of Piazza della Rotonda.  Front facade of the portico lays on the axis cutting the space in two.	  Continuity with the other streets. Width of the passage is similar to the old streets.	  Elongated approach.
	  Facade of the portico covers the dome. Portico is hidden in shadow and perceived as a void and a room.	  Surreal deep perspective seen in the facade. Street profile resembling the profile of old streets.	  Lack of windows stresses the sacred function with requires calm atmosphere.
Architectural scale Inner composition	  Layered transition in contrast to the symmetrical sphere of the main room.	  Passages and a culmination in the shape of the central round space. Rhythmically spaced entrances to shops.	  The inner composition is a result of repeated extensions and rituals of Islam. It is based on addition of bays of columns.
	  Transition from a monumental scale to the scale of the interior. From great order to small order.  Sequence of changing light.	  Transparent canopy allows the space to maintain a moderate climate similar to interior and allows a lot of light to enter the inside like in an exterior space. 	  Gradation of translucency between spaces achieved with columns of differing width and height of arches.
Furnishings	  People sit on the huge base of the column.	  Large glass display windows create illusion of no barrier between the shops and the passage.	  Carpets brought by worshippers are laid on the floor during prayer.
	  Serving spaces arranged in the thick wall	  Circulation space in the middle, shops allocated symmetrically on both sides.	  Serving functions located around the perimeter of the space next to the walls.

Ramp Rolex Learning Centre	Gate Calle 26	Turnpikes Dobrzynskie Turnpikes	Urban stairs Lleras Building, Bogota	Garcia Marquez Culture Center, Bogota
				
<p>One enters the building in the centre of the plan and begins the discovery of the building from there. Undulation of the floor speeds up or slows down the body.</p>	<p>One of the unavoidable transition points that cannot be crossed without control. Directly leads to Plaza Che.</p>	<p>Transition point that can be crossed without obstructions while moving by vehicle or on foot alike from other cities to the main market.</p>	<p>It mediates between urban fabric and landscape. Different ground levels.</p>	<p>Integration of the street with the inside of the building.</p>
<p>Public spaces that are enclosed by the building, open to the adjacent spaces and transitional passages.</p> 	<p>Singular space delimited by the pavilions, columns and a roof.</p>	<p>Pavilions serve as markers of the transition. However no distinguishable space is formed.</p> 	<p>It is connected to other buildings by stairs, colonnades, doors, ramps and outdoor stairs.</p>	<p>Reevaluates the typical relation of a courtyard to the street with the use of high permeability of the facade.</p>
<p>Internal divisions established with undulation of the topography that blocks and opens the view.</p>	<p>Interpenetrating spaces. Central representational space and less formal spaces for security officers on sides.</p> 	<p>Abundant use of decoration. Neoclassicist style.</p>	<p>Continous circulation spaces and rhythmic repetitive classrooms.</p>	<p>Montage of contrasting atmospheres.</p>
<p>Uniform colour and texture of materials exposes the play of light and shadow that stresses lobed shapes of walls, floor and ceiling.</p>	<p>Subordinate and representational of the modernist architecture of the campus.</p>	<p>Abundant use of decoration. Neoclassicist style.</p>	<p>Mediates between the soft and hard materials, light of the skylights and darkness of the ground.</p> 	<p>Use of materials present in the surroundings but in more sculptural oval forms. Uniform materiality stresses the play of light.</p>
<p>Minimal furnishings direct attention to the most important shaping measure - the undulation of the floor.</p> 	<p>Sitting space and subdivisions of the paving.</p> 	<p>Abundant use of decoration. Neoclassicist style.</p>	<p>Integrated furnishings: planters, audience, wide stairs, sitting spaces.</p> 	<p>Integrated furnishings: walls and curbs of different height.</p>
<p>Serving spaces closed in little bubbles. Narrow passages between bubbles become corridors.</p>	<p>Inaccessible pavilions. Area under the roof lies entirely on one side of the fence.</p>	<p>Inaccessible pavilions. Area in between is separated into pedestrian and vehicular circulation.</p>	<p>Circulation - roof, corridors and staircases. Classrooms located along the corridors.</p> 	<p>Functions continue past walls.</p> 

# WHAT THICKENS THE THRESHOLD?

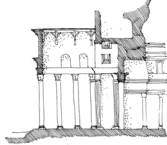
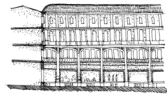
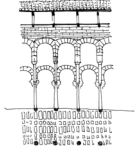
	Portico Panteon, Rome	Arcades De Passage, Den Haag	Hypostyle hall Mosque, Cordoba
			
Urban scale	Position	Completing the urban links	
Architectural scale Relation with the surroundings	scale	Proportions	Seclusion
Architectural scale Inner composition	Layers	Rhythmicity	Addition
Detail scale	Great order	Daylight	Gradation
Furnishings	Structure	Glass	Mobile
Function	Circumference	Symmetrical	Ritual

Thickened threshold architecture

Ramp  
Rolex Learning Centre

Gate  
Calle 26

Turnpikes  
Dobrzynskie Turnpikes

Urban stairs  
Lleras Building, Bogota

Garcia Marquez Culture  
Center, Bogota

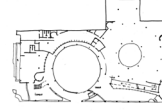
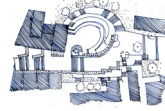
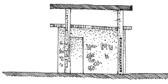

Central access

Check point

Transition point

Nature/culture

Lead

Undulation

Markers

Circulation

Integration inside/  
outside

Limiting visibility

Interpenetration

Continuity

Montage

Shadow

Subordinate

Representative

Mediating

Oval

Slope

Pattern

Soft/hard

Integrated

Clusters

Layered

Transgressing

## URBAN SCALE

Thresholds are experienced while getting from the space on one side of the threshold to the space on the other side of it. They are experienced in a sequence of events. While crossing a threshold one notices and approaches it, arrives at it, explores it and finally leaves it behind.

Threshold spaces are often first noticed from a distance before they are found. The visibility of a threshold or clues given by other elements are the driving force that leads one to the threshold. The user orients himself in the space, chooses a path and takes a trajectory towards the threshold.

As one arrives at a threshold, he slows down. During this part of the sequence the decreased speed allows one to notice more details of the threshold. One notices the tangible, bodily aspects of the space.

Having arrived in the in-between space, the user gains an overview of it. He understands it.

Finally the user leaves the threshold. In this part of the sequence the threshold often prepares the user for the next part of the journey.

90



Mosque in Cordoba, drawing by author.

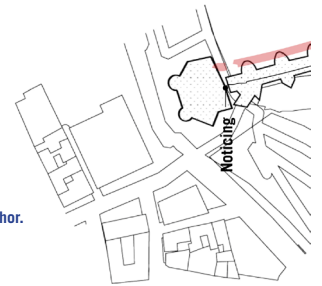

Dobrzynskie Turnpikes, drawing by author.

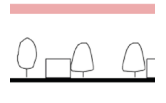

Entrance by Calle 26, drawing by author.



Approach



Thickened threshold architecture



91

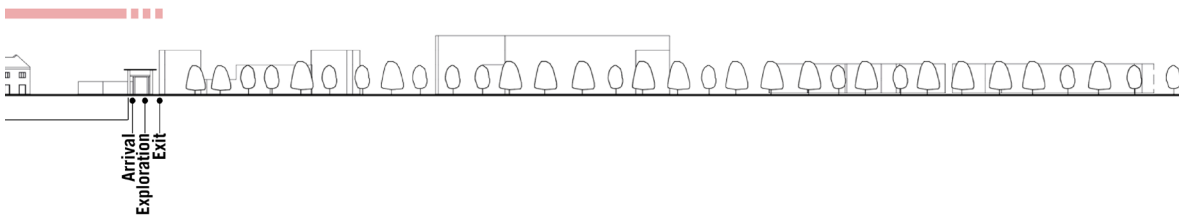
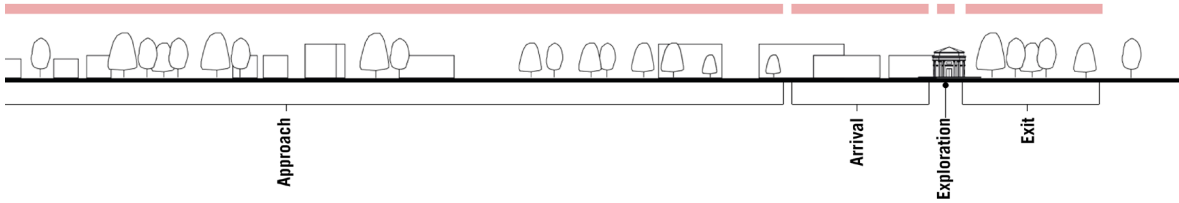

Thickening the threshold

## ARCHITECTURAL SCALE RELATION WITH THE SURROUNDINGS

Thresholds oscillate between openness and closure. A thickened threshold is not contained in a volume. Confinement negates the essence of being connected in certain places and disconnected in other. At the same time the space of a threshold needs to have some recognizable extents.

Drawings below show the tools which architects use to create the semi-open limit of a threshold.

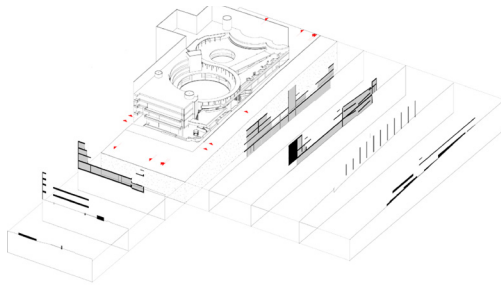

92

### INTEGRATION INSIDE/OUTSIDE

Another way of delimiting the threshold is providing it a roof cover. Cover can have different levels of solidity - from an insulating non-permeable roof to a penetrable cover composed of trees.

In the example shown on the right the space has been delimited with vertical elements. Vertical elements limit visibility through an aggregation of layers.

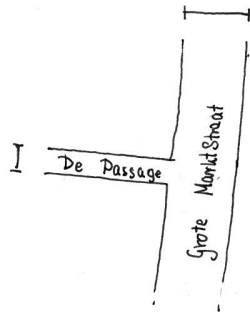

### PROPORTIONS

The transition between De Passage and Grote Marktstraat is clearly readable due to significant difference of width of the two streets.

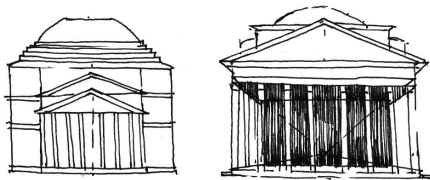

### FACADE

Deep portico conceals the outer wall of the main hall of Pantheon in shadow.

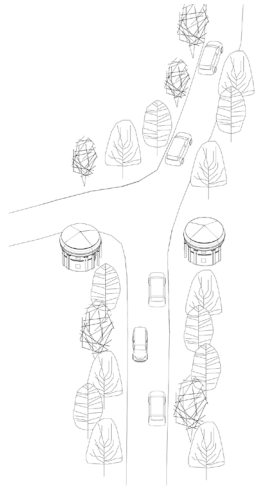

**MARKERS**

Thresholds can be delimited with markers. Examples such as road milestones or turnpikes come to one's mind. Markers enclose only a very small part of the perimeter of a space. Their function is more symbolic. If only two markers are used they signal a transition but do not give much volume to the threshold. Spreading a greater number of markers is a strategy which thickens the threshold.

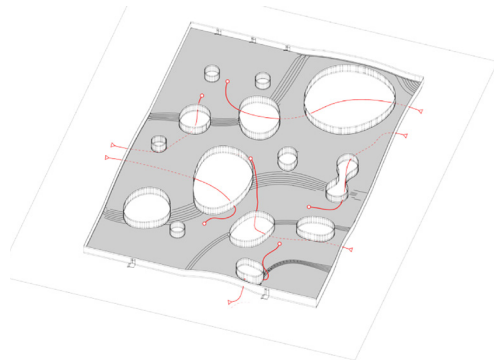

**UNDULATION**

Thresholds, which occupy exterior spaces often operate with topography. They use curbs, smaller and bigger level differences only in some areas or over large surfaces. In Rolex Learning Center thresholds are very open. The curvature of the floor induces the feeling of being in a transition and the transitional spaces are characterized by greater slopes. Transitions are also accentuated by the walls coming close to each other and spaces between them narrowing down.

## ARCHITECTURAL SCALE INNER COMPOSITION

Relations between spaces within a threshold cannot be separated from the mediating role of a threshold as a connector of other spaces.

Inner composition of a threshold relates to: scale, proportions of spaces, articulation, contrast.

A basic difference can be drawn between spaces, the inner composition of which, is based on a principle of addition and the principle of a continuity.

Thickened thresholds composed by the means of addition are often based on a minimal module. Such thresholds have a dense grid and are saturated with mass.

Thickened thresholds may also have an inner

culmination - they modulate the experience of the visitor who is being prepared for entering a space which delivers him the most intense experiences. Modulation can also be used to gradually tone down the thresholds towards its boundaries. With that tool thresholds can seamlessly penetrate the environment.

Inner composition of a threshold often implies a route or way of moving through the space. Usually successful thickened thresholds do not prescribe one route. They may regulate movement like Cordoba Mosque or Rolex Center but they leave the user with a lot of freedom.

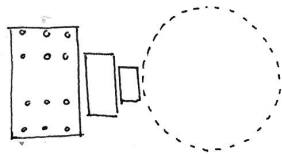

LAYERS



LIMITING VISIBILITY

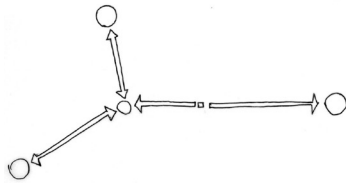

RHYTHMICITY



INTERPENETRATION

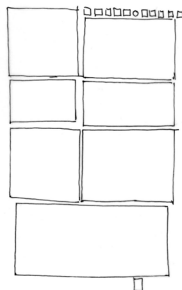

STRICT/ADDITIVE

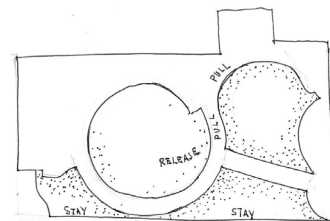

MONTAGE

Thickened threshold architecture

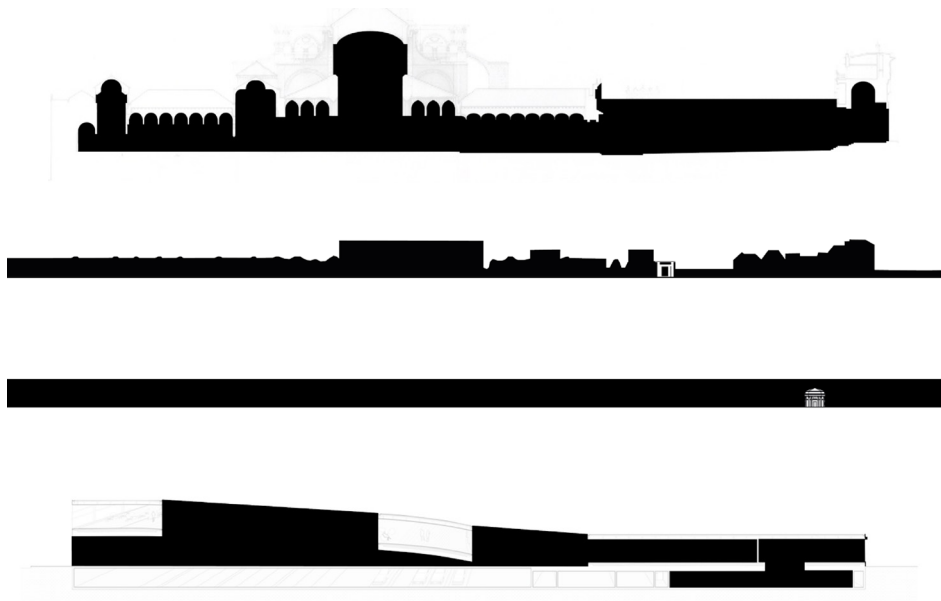

95



Negative space drawing by author.

Thickening the threshold

## DETAIL SCALE

Thickened thresholds are characterized by a precision of detailing suitable for the perception of a person moving on foot. Elements of thickened pauses are meant to be experienced from close-by.

Thick thresholds use tactile, rough materials.

Their expression is often altered by atmospheric phenomena: sun and rain alter their expression.

SUBORDINATE DETAIL

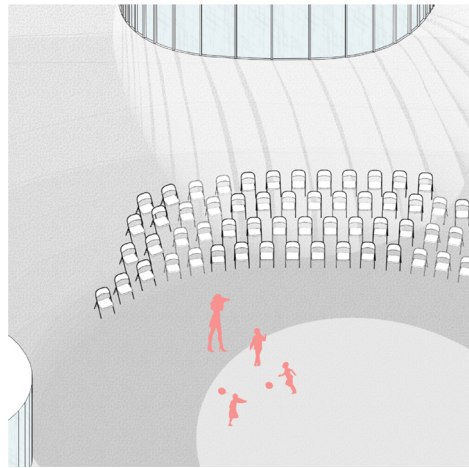

Rolex Center

Same materials are used throughout the interior spaces of Rolex Center: Ceiling, floor, walls, ramps, furnishings are white. Ceiling is covered with a more reflective white material while the floor is covered with a more absorptive white material. Light underlines the difference between the materials.

AMBIVALENT DETAIL

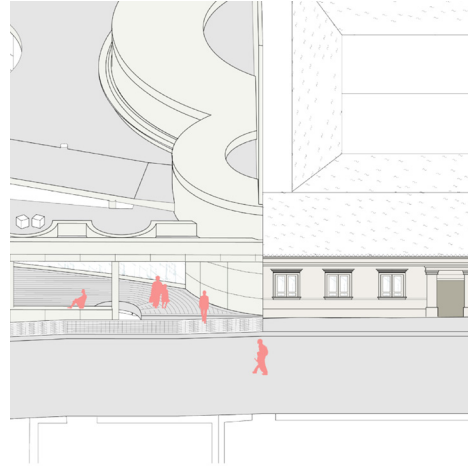

Garcia Marquez Culture Center

The Gabriel Garcia Marquez Cultural Center has been clad in materials which can be found in the surroundings of the building. Center takes up the line of the lintel of the neighboring building but uses a module which is a multiple of the width of the windows of the neighboring building to organize the openings in the facade. Due to the sculptural properties of forms, light and shadow strongly change their appearance.

## FURNISHINGS

Thickened thresholds are frequently furnished with elements which expand the range of possible uses of the threshold. Furnishing elements range from elements integrated with the structure and entirely mobile elements, which are often brought by the users.

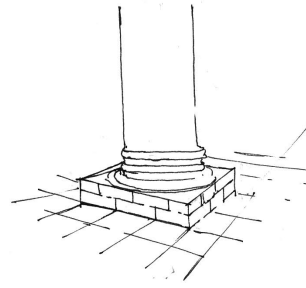

**STRUCTURE**  
Over-scaled structure elements are used as sitting furniture.



**MOBILE**  
Carpets brought by worshipers are laid on the floor during prayer times.

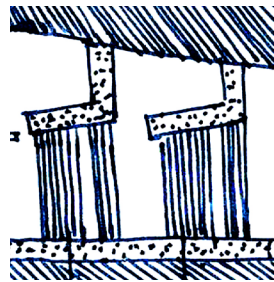

**SOFT/HARD**  
Planters, stone audience, wide stairs are all multi-functional pieces of integrated furnishing.

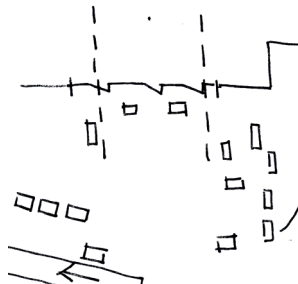

**PATTERN**  
Patterns of the paving subdivide the space into parts which are naturally occupied by different activities.

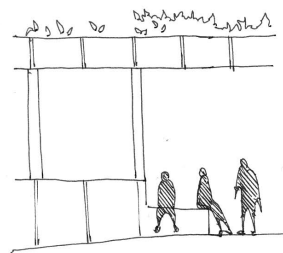

**INTEGRATED**  
Walls and curbs of different height serve as integrated furnishings.

## FUNCTION

The studied threshold spaces have extremely varied functional composition. From systems based on layers, symmetrical systems, cluster systems to radial systems and systems where different functions penetrate each other.

Usually the more areas with varied functionality user comes across on his way through the threshold the more successful the threshold is as a space that can be used for purposes other than crossing.

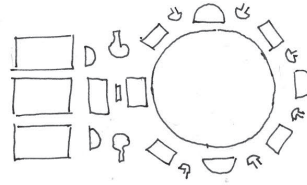

### CIRCUMFERENCE

Serving spaces are arranged in the thick wall around the circumference of the main hall of Pantheon.

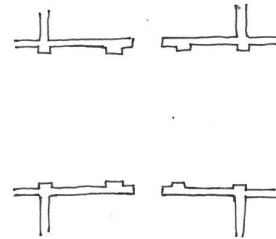

### SYMMETRICAL

Circulation space is placed in the middle, shops allocated symmetrically on both sides.

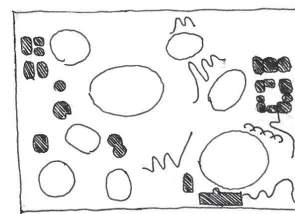

### CLUSTERS

Serving spaces are closed in little bubbles. Narrow passages between bubbles serve as circulation areas.

### LAYERED

Roof, corridors and staircases serve as circulation. Classrooms are located on the storeys below, along the corridors.

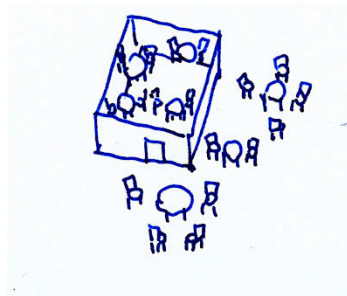

### TRANSGRESSING

Functions continue across walls in Gabriel Garcia Cultural Center.

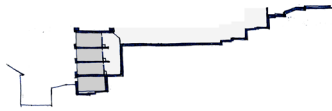







## CONCLUSION OF RESEARCH

### **Attempts at thickening the threshold**

Drawings shown on the following pages depict the design proposals with which I have concluded the analysis of thickened threshold architectures.

With the understanding of the threshold architectures gained via observations and research, I tried to recreate some of the qualities of thickened thresholds at the entry squares of the university campus. I tried to intervene in the current situation by using some of the tools extracted from the case studies in a more or less literal manner. My objective was to rearticulate the environment not by introducing unfamiliar elements but trying to enlarge the potential meaning of the components already present at the entry squares by adding, mixing, subtracting or replacing them.

Leading through the space with a montage of different tensions.

MONTAGE

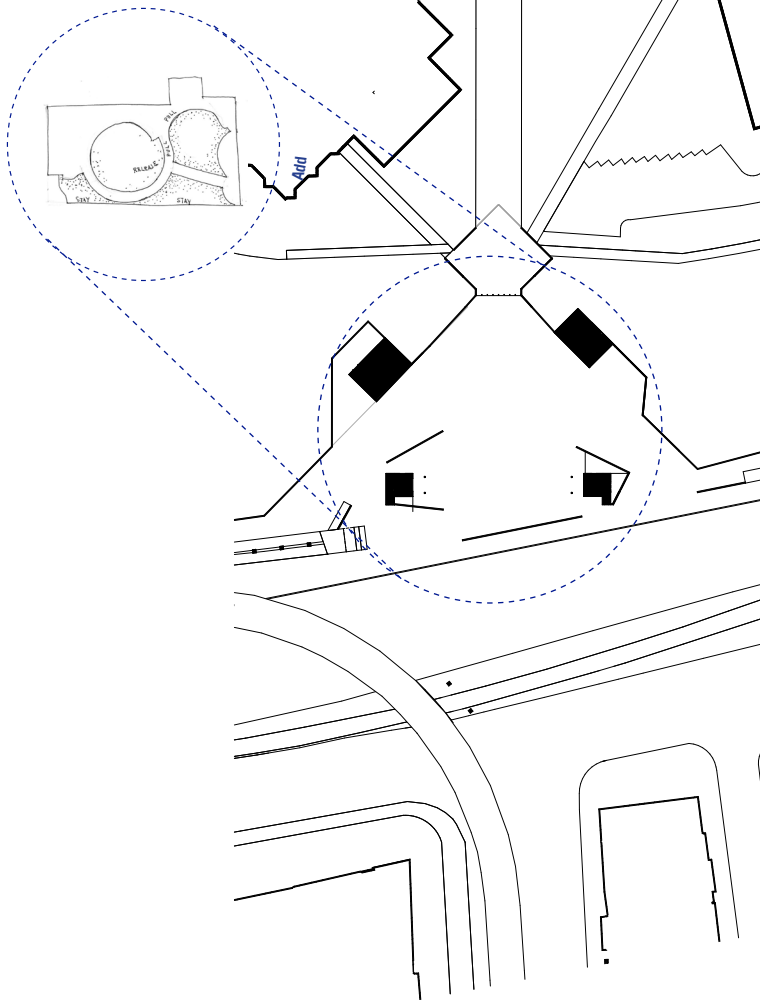

### Entry square by Calle 45

At the entry square by Calle 45 I added 2 pavilions which allowed for a reading of the existing pavilions not as a gate but as elements framing a space between them

The acute angles between the edges can be

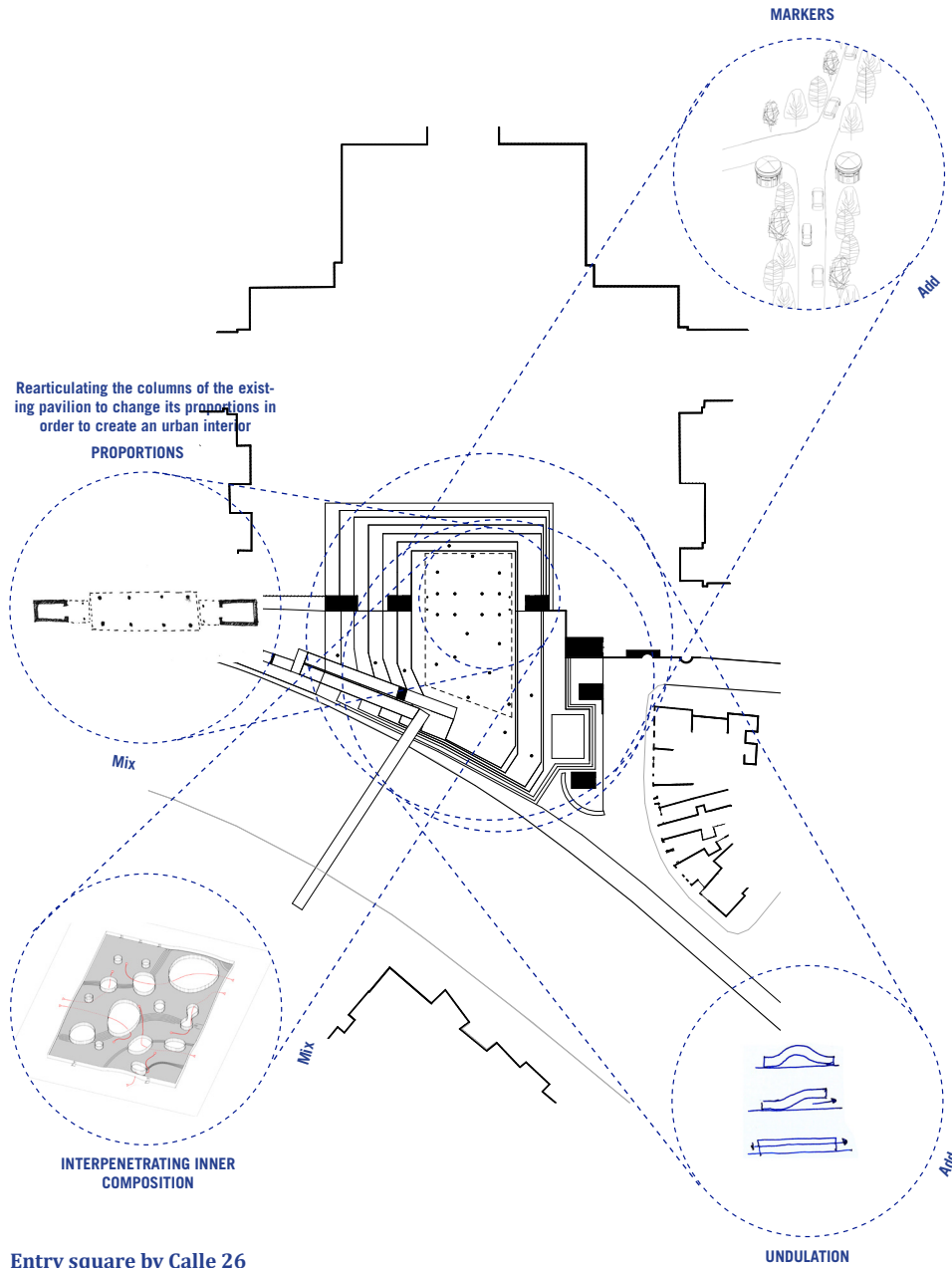

### Entry square by Calle 26

At the entrance by Calle 26 multiplying the columns transforms the shallow membrane of the gate into a deep hall. Undulation of the ground and proliferating the pavilions gives the space a permeable limit.

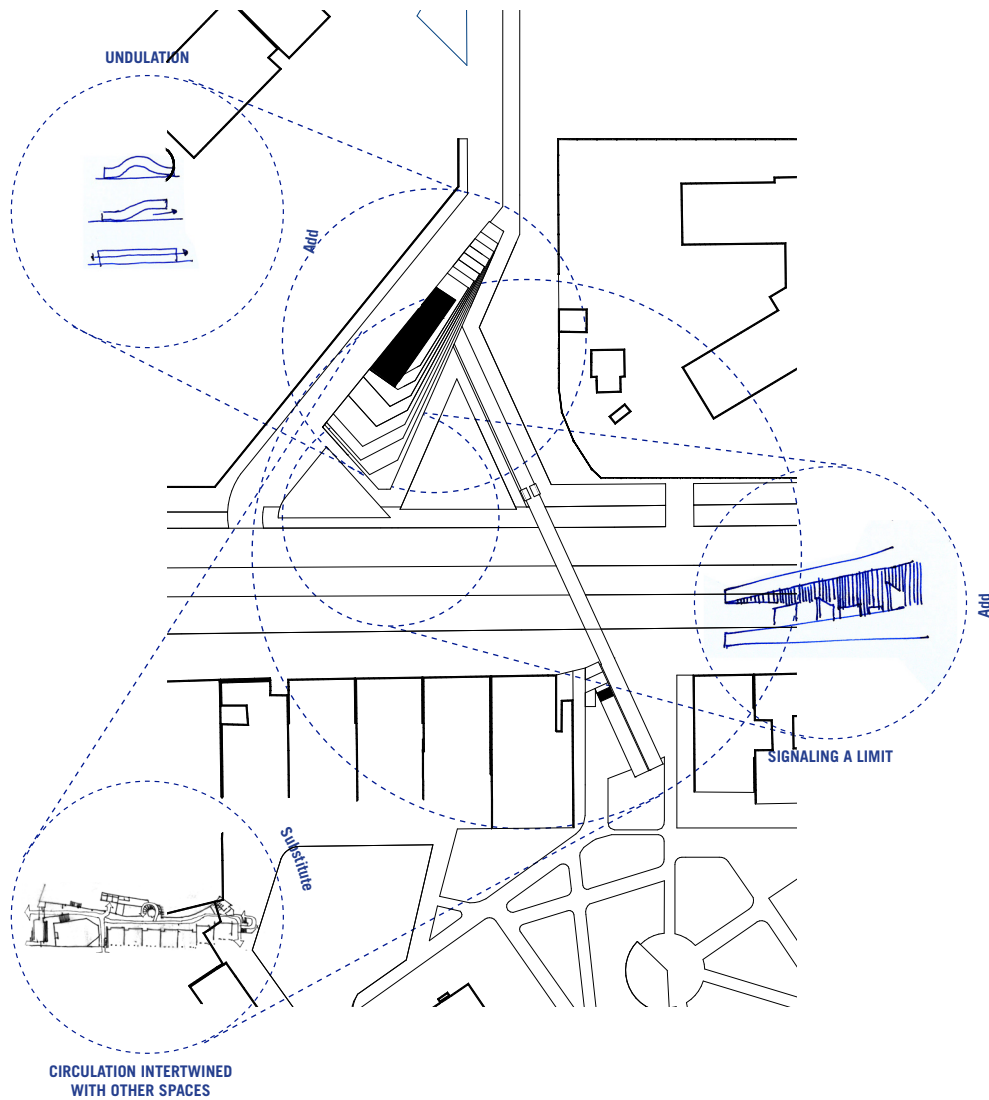

### Entry square by Calle 53

At the entry square by Calle 53 I attempted at incorporating the pedestrian bridge into an undulated landscape. As a result of widening, the meaning of the bridge is expanded beyond the utilitarian to the improvised.

Creating a public inner space that is strongly connected to the outside.

INTEGRATION INSIDE/OUTSIDE

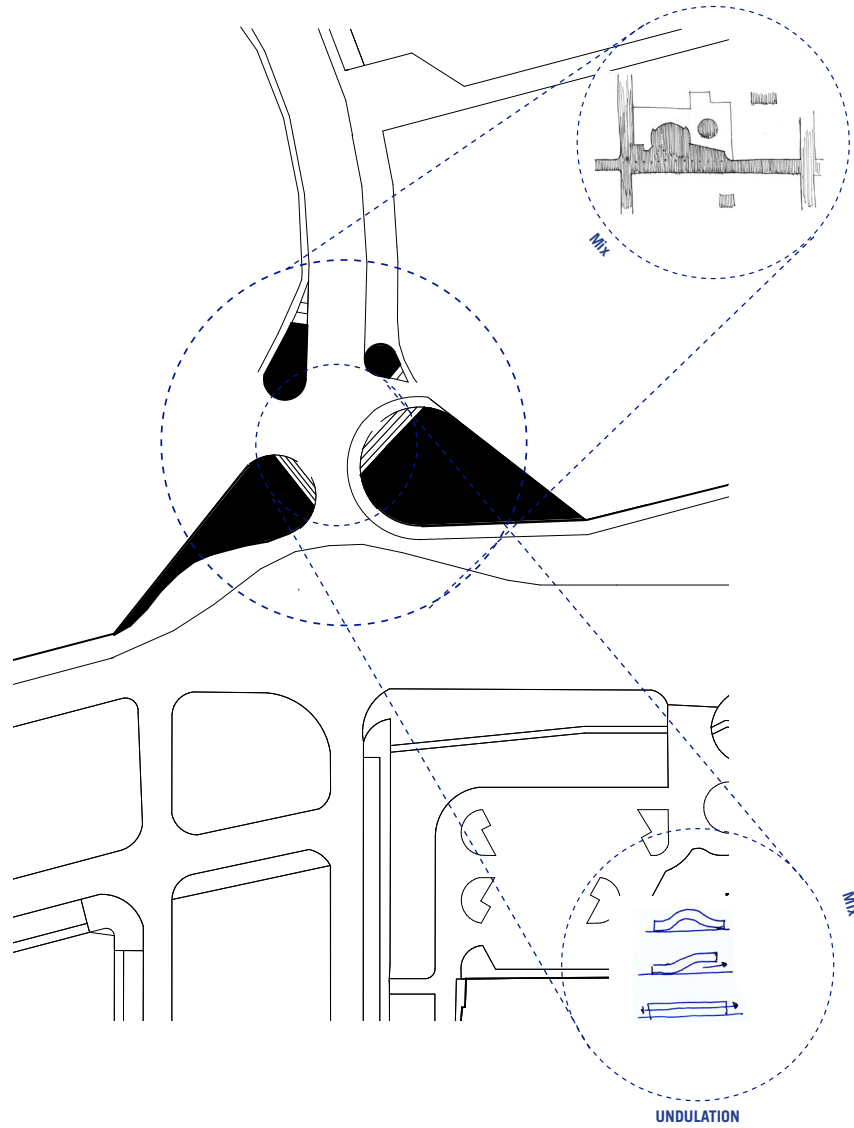

**Entry square by Carrera 45**

At the entrance by Carrera 45 I attempted at raising the floor in ways which enclose indoor spaces and create a plaza in-between the two worlds.

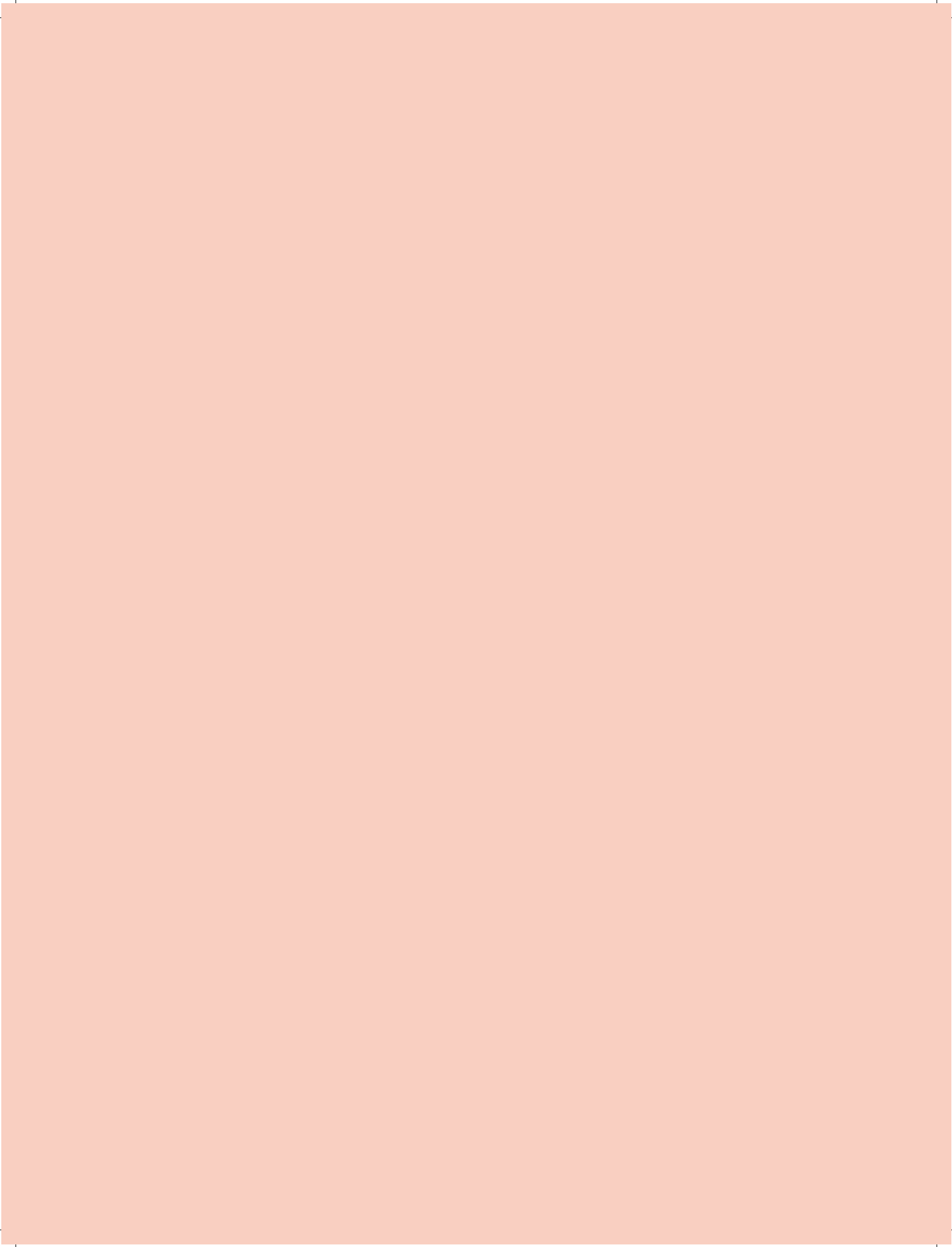



## PROBLEM STATEMENT



## PROBLEM STATEMENT

During the search of a design approach, I managed to solidify the design task around a couple of essential ambitions.

My first essential ambition was subverting and expanding the meaning attributed to the spaces over a course of time. This ambition has occurred early in the process while I was searching for alternative ways of understanding the bipolar situation of the division between the campus and the city. I recognized the division as a place dominated by an idea of control, where the relations of power and control have taken a physical form. My immediate intuition was to expose this idea to a confrontation with multiple ideas other users of the space might have.

My second ambition was to proliferate the use of the investigated spaces by the means of enhancing the activity of the third actor in the crack between the two adversaries. I believed that the informal vendors could be the glue, the stitch and the solvent that could in a long run lead to the erosion of the established relations of power and submissiveness.

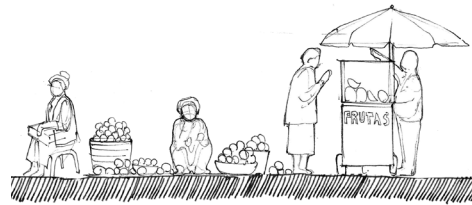

109

**What architectural means are needed to thicken the threshold of the entry squares of Universidad Nacional de Colombia?**

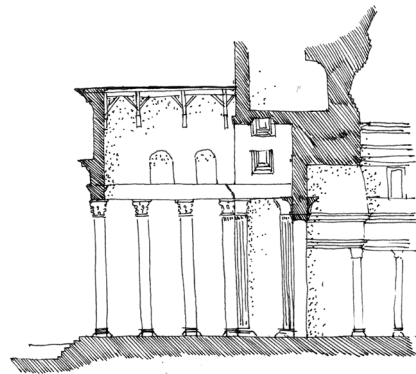

**How can architectural means be used to hand the control of a space to multiple groups of users?**

# A STORY IN FOUR THREADS

110

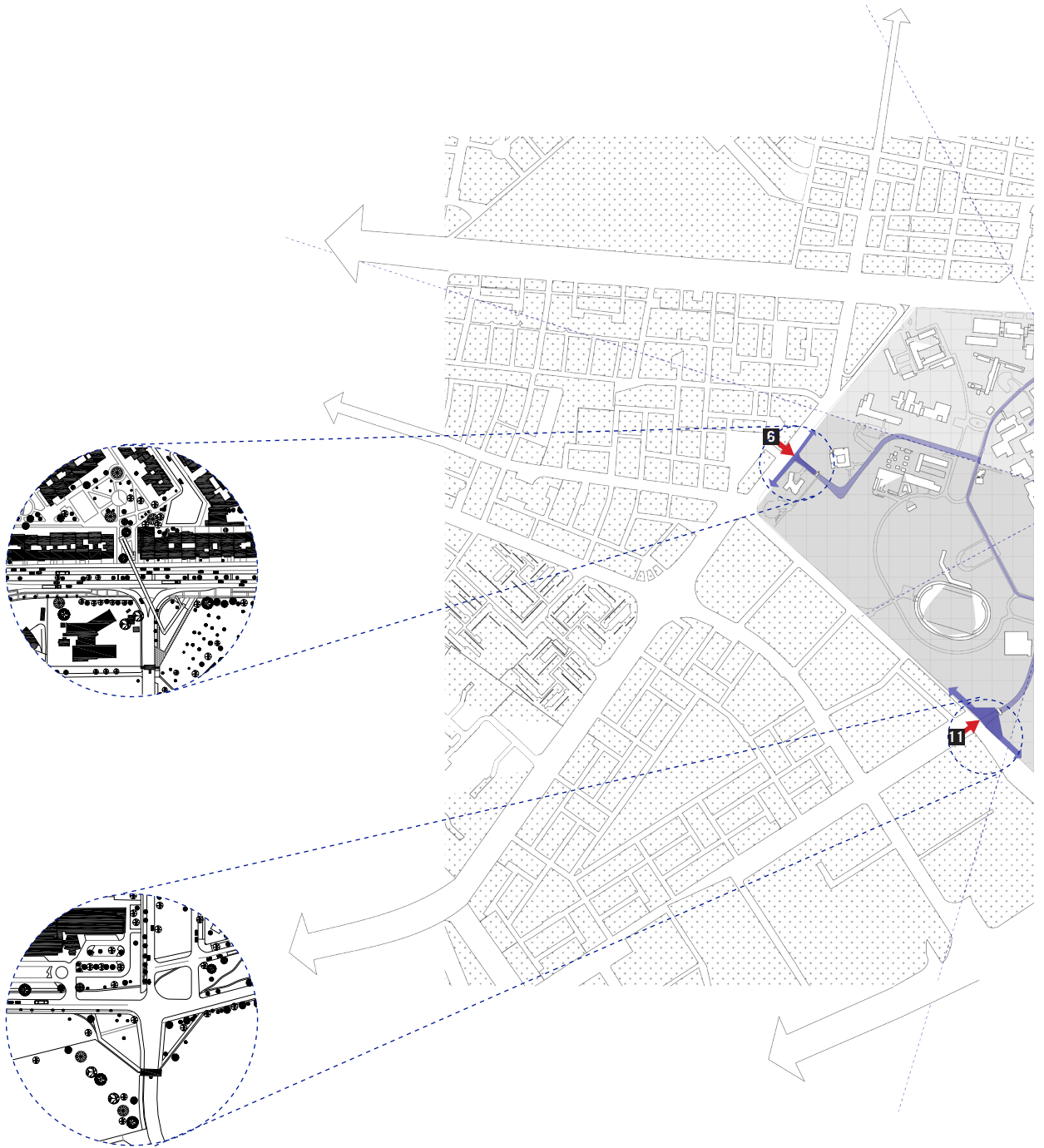

Thickening the threshold

Problem statement

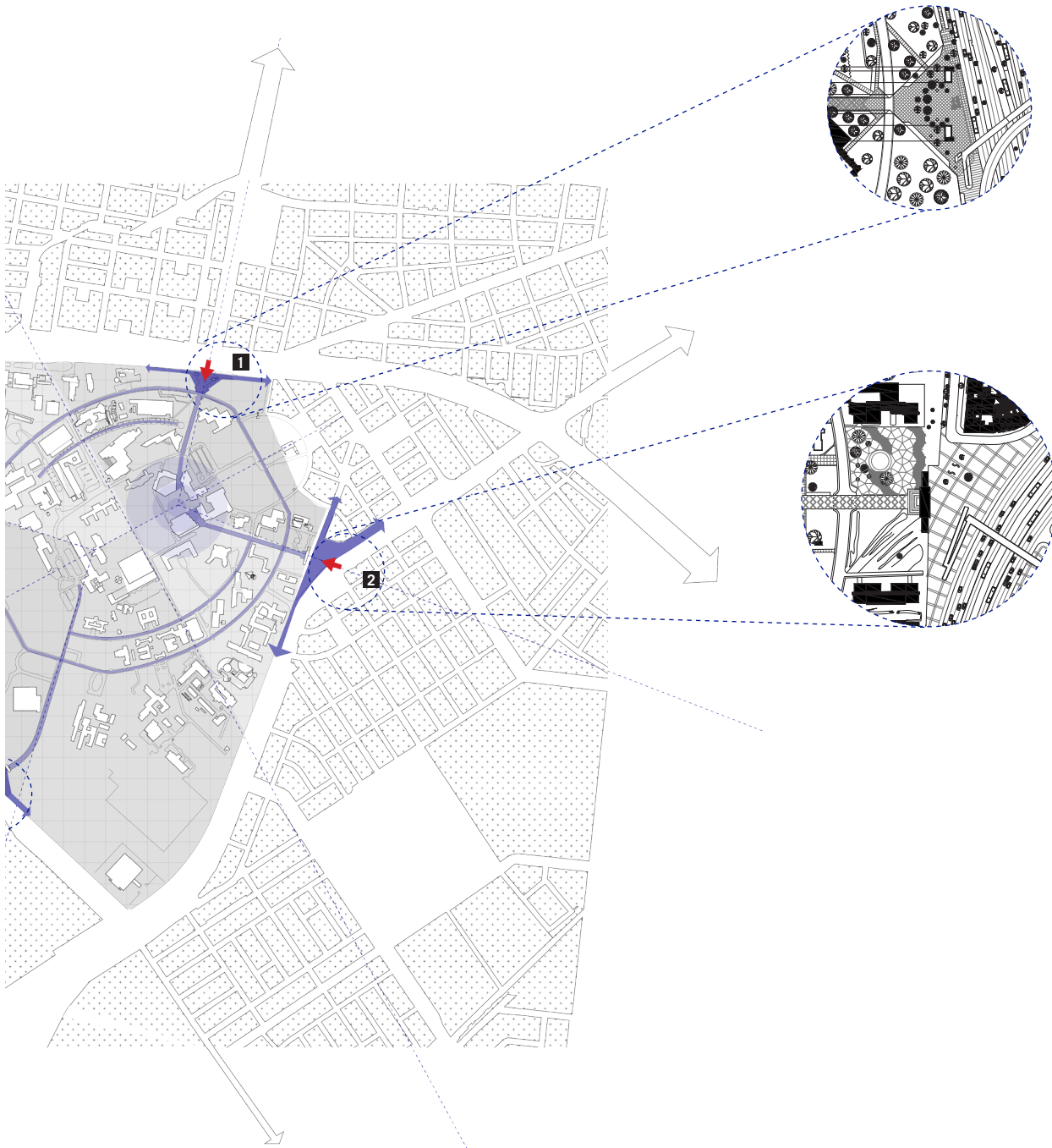

Master Plan, intervention at the four main entrances of the campus, drawing by author.

Thickening the threshold

## GROUND OSCILLATIONS

An assesment of the potentials and deficiencies of the entry squares has lead me to the following conclusion. The entry squares of Universidad Nacional de Colombia are not like traditional city squares, defined by the facades of the buildings around them or by monuments which accomodate the symbolic meaning of the squares. Their shapes result from delimiting other territories: the University Campus and Teusaquillo. In the light of the lack the above mentioned elements the floor of the squares is their most palpable element.

This realization brought the Siennese Piazza del Campo to my mind. Piazza in Sienna is a space where the main role is also played by the ground. Neither the facades of the surrounding houses nor the monuments on the square have as much importance as the floor. The floor lowers down towards Cappella di Piazza slowly and unevenly in a powerful gesture which binds the furthest ends of the square through the shared focal point at the foot of Capella di Piazza. In spite of the vast dimmensions of the square people sit just about anywhere on the inclined floor.

This inspiring example has made me wonder whether similar means could be used to extract the most from the most abundant and thus untapped resource of the entry squares. With this relalization I decided to focus on the floor in my project.



Piazza del Campo, sienna, people sitting everywhere on the inclined floor.

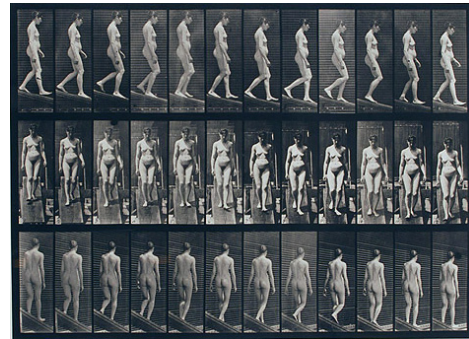

Eadweard Muybridge, Nude Woman Descending a Ramp, From The Human Figure in Motion Series (1901), Collotype, 20h x 25w in. (framed)

## RICH USE OF THE FLOOR

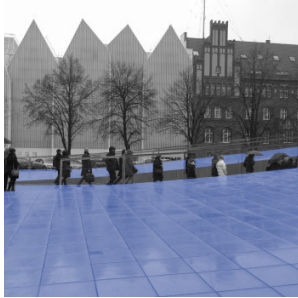

Centrum Dialogu Przetomy, Szczecin



Centre Pompidou, Paris



Plaza De Bolivar, Bogota



Piazza del Campo, Sienna



Israel Plads, Copenhagen



Landhausplatz, Innsbruck

The photographs above portray intriguing situations where the changes of the topography enrich the experience of spending time at a public square.

Thrown out of balance by the inclination of the ground the passer-by is encouraged to divert from his intended route through the space. The more he diverts the more he becomes immersed in the fluid reality around him.

Rich topography makes every visit to a space more nuanced and non-repeatable.

The gesture of inclining the floor across the space expands what is perceived as the space.

Modifications of the topography form a surface of attraction and repulsion. Inclinations form a landscape which diverts one's movement. The degree of engagement with the landscape is dependent on the submissiveness of the passer-by. A passer-by needs to negotiate the path that he takes with the ground. There is not a one obvious route.



## REFORMULATING THE PROBLEM STATEMENT

Having narrowed down my design efforts to a specific element of the built environment, I reformulated the research questions in accordance with the potentials offered by the element.



114

**What architectural means are needed to thicken the threshold of the entry squares of Universidad Nacional de Colombia?**



**How can architectural means be used to hand the control of a space to multiple groups of users?**





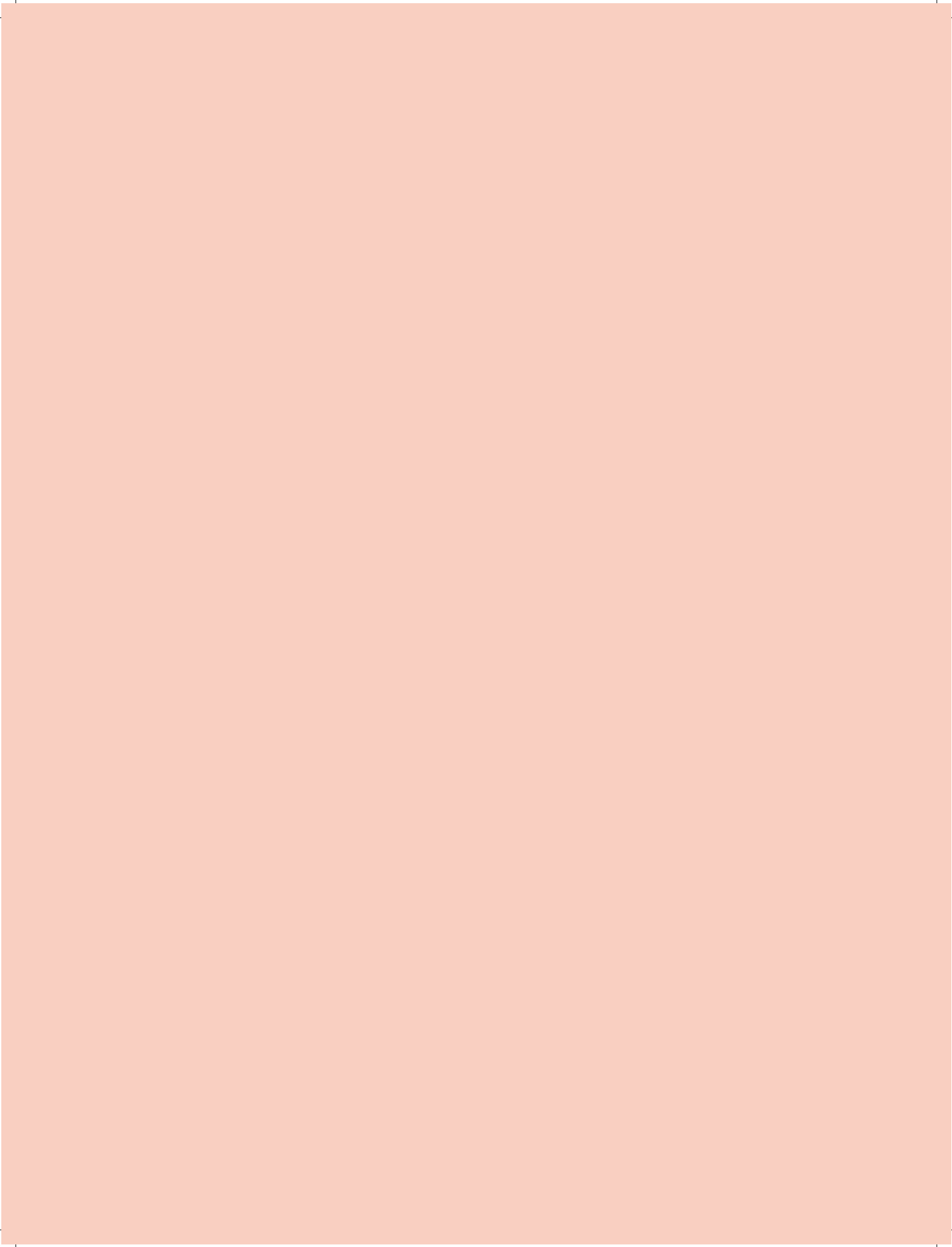

## GROUND OSCILLATIONS



## CASE STUDY ANALYSIS

I have studied the formal compositional operations which lead to the creation of an undulating floor as well as their influence on the surrounding buildings and people through an analysis of three squares: piazza del campo in sienna, campidoglio in rome and plaza de bolivar in bogota.



Plazas, drawings by author.

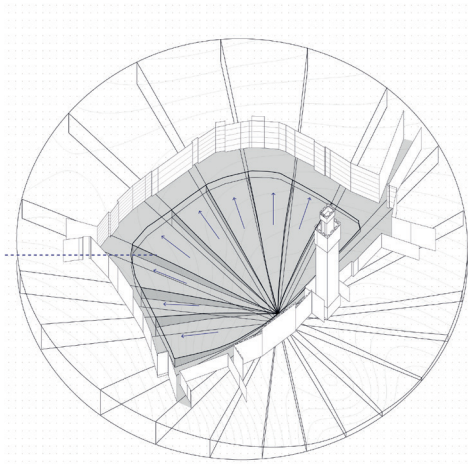

**Piazza del Campo**

Providing privacy without putting up any boundaries.

Key section: 9 sections intersecting at the focal point of the square

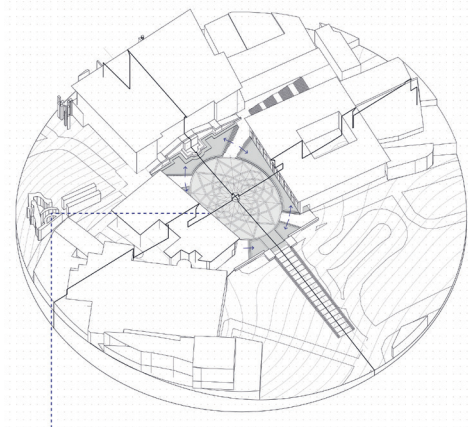

**Campidoglio**

Intersection of flat and sloping surfaces.

Key section: Symmetrical intersecting at the centre of the square.

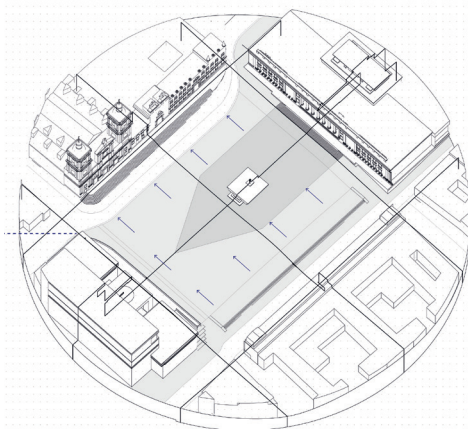

**Plaza de Bolivar**

Treatment of the ground at the meeting with the facades.

Key section: Along the facades and cutting the square in the middle.

Plazas, drawings by author.

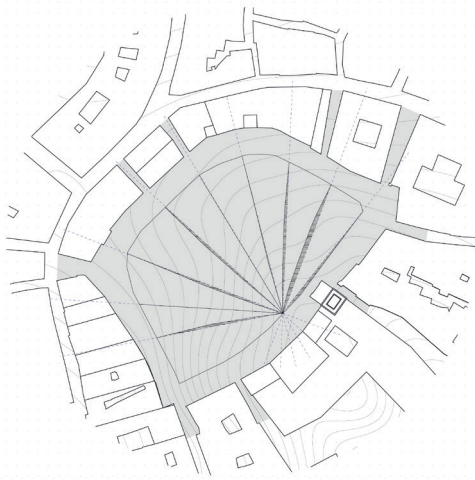

**Piazza del Campo**

The prevailing incline of the Piazza in south-eastern direction is diversified by many irregularities. Irregularities are masked in the radial paving pattern.

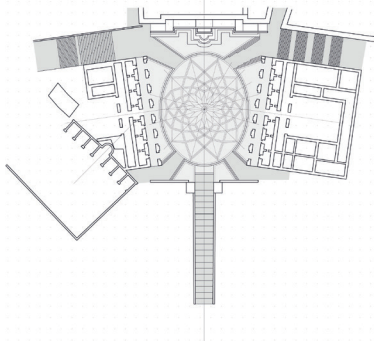

**Campidoglio**

Michaelangelo has created a regular interior with plateaus connected by steps and limited use of inclined surfaces only in the paths leading from the corners of the square to areas located at a higher or lower elevation.

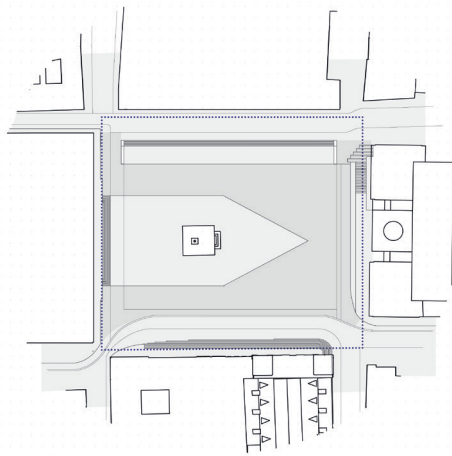

**Plaza de Bolivar**

Plaza de Bolivar lowers in north-western direction. The incline of the central part of the plaza varies gently however the differences in incline are hard to localize precisely.

Plazas, drawings by author.

## PIAZZA DEL CAMPO, SIENNA

The mastership of Piazza del Campo lies in the way it merges the naturally varied surface of the square in one gesture. The surface centers in the focal point. Reversing this case can teach how to achieve variety in a dominating gesture.

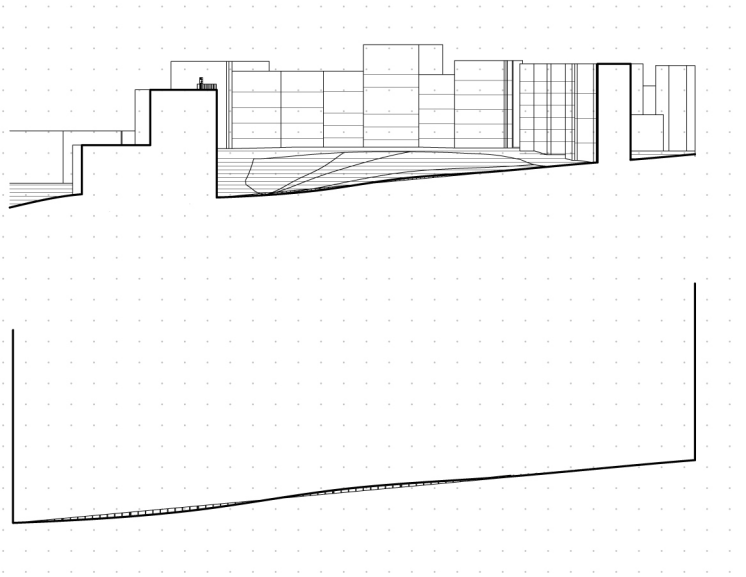

122

Non-linear slope. Differing angle along the length of the slope,  
drawing by author.



## CAMPIDOGGIO, ROME

The challenge in the design of Campidoglio was to create a flat surface in a slope. The lesson I can take from it by reversing the design process is how to create a sloped surface from a flat surface.

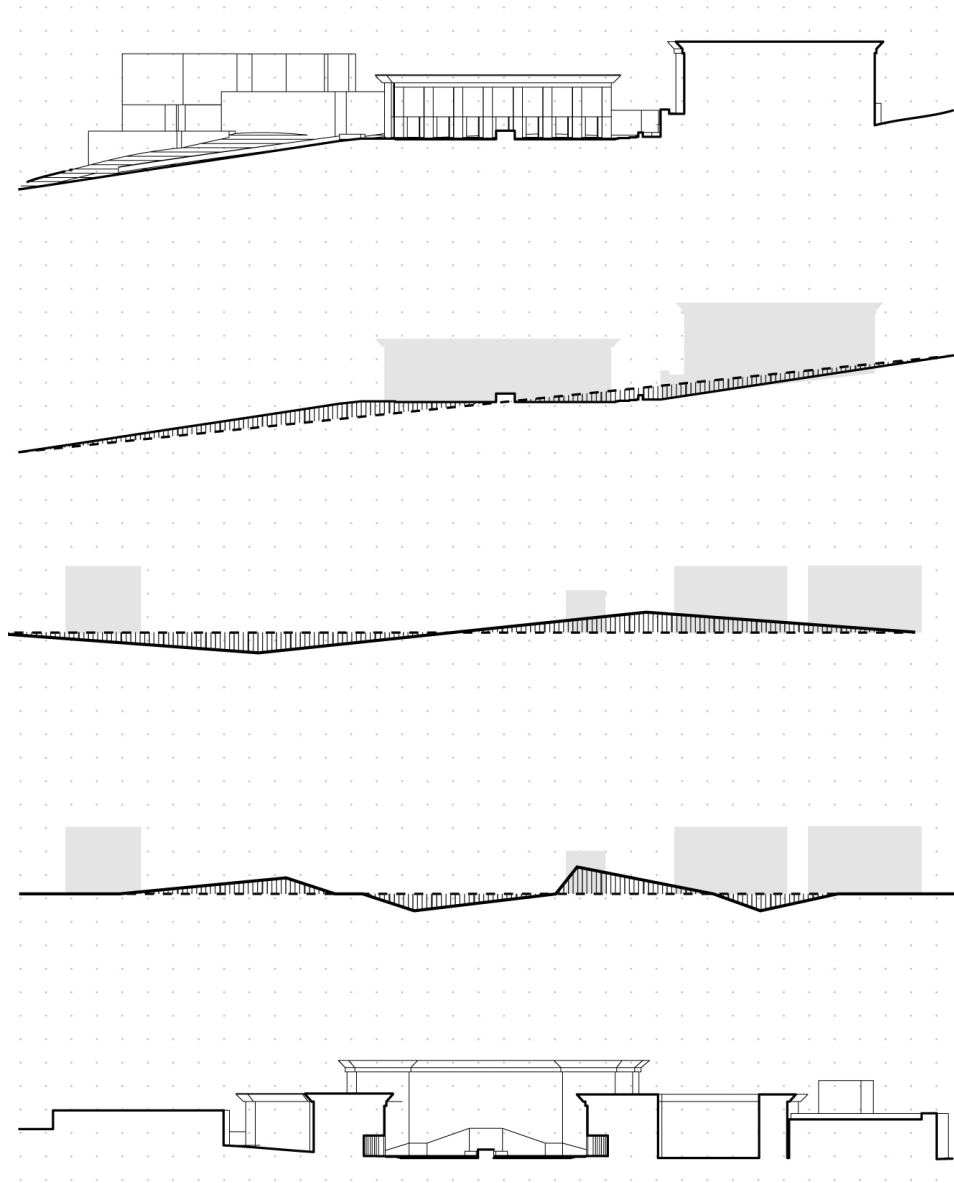

123

Sections through Campidoglio and through entry square at Calle 26,  
drawing by author.

## PLAZA DE BOLIVAR BOGOTA

Treatment of the undulated ground at the meeting with the facades.

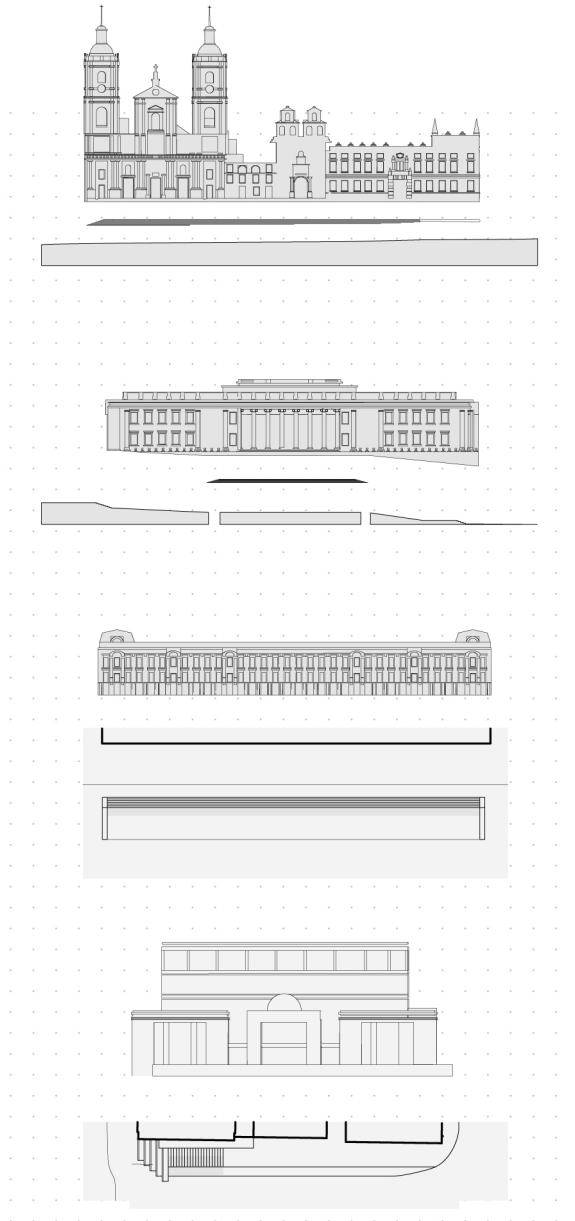

124

Elevations of Plaza de Bolívar, Bogotá,  
drawing by author.

## SEAM

The seam can be unpronounced at the surface level but pronounced in the structure. Or invisible in one scale but visible in another.

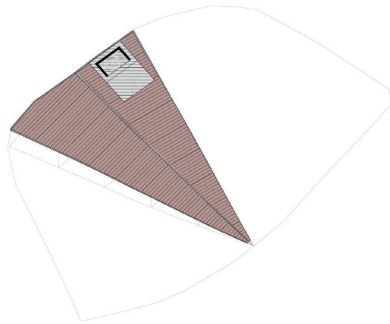

### Pronounced seam

The incline and direction of the slope are irregular. The seam accentuated in a differing paving colour, pattern and the slight concave emphasize the focal point of the square and create a seeming impression of flat triangular surfaces converging in one point.

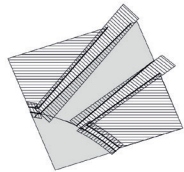
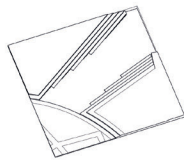

### Pronounced seam

A stepless seam delimits the edge characterized by biggest accessibility. Where access was meant to be more difficult the transition between a flat and a sloping surface was formed with the use of other directions and surfaces. The steps resulting from this operation give a subtle definition to the oval shape of the plaza.

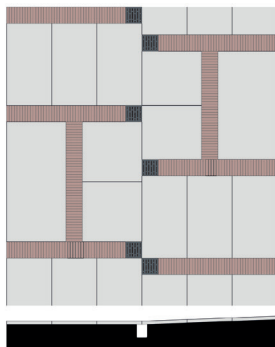

### Unpronounced seam

The seam between flat and tilted surfaces is concealed by continuous paving pattern. However some of the seams are marked by drainage pipe inlets.

Seams,  
drawing by author.

## SURFACE AND ESSENCE



### Strengthening the incline towards the focal point

Piazza del Campo

Herringbone bond. Thanks to the small differences in the alignment of bricks in each triangle, triangles are well-readable as each of them receives sunlight at a different angle. The graphite stone drainage channels have a slightly concave shape.

Piazza del Campo, source: internet.



### Highlighting the individual surfaces

Campidoglio

Graphite stone contrasts with the pastel colours of the facades. A lighter shade of stone has been used to sculpt the edges of the oval. As a result in a front view the steps are read as a podiums of the palaces. The pattern of light-colored stone is well-readable. The pattern highlights the individual surfaces that the plaza is composed of.

Campidoglio overlaid with entrance at Calle 26, source: internet.



### Concealment of folding the floor

Plaza de Bolívar

More tactile, smaller paving elements were used along the edges of the square: natural stone in two sizes along the edge where the church is, brick paving along the remaining edges. A pattern of concrete paving interlocking with rows of brick covers a major part of the square. The pattern dissolves in perspective and merges into a uniform surface. The pattern tries to conceal the folding of the floor.

Plaza de Bolívar overlaid with entrance at Calle 26, source: internet..

## SIZE COMPARISON

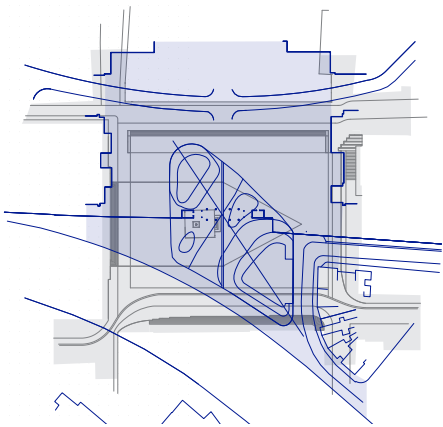
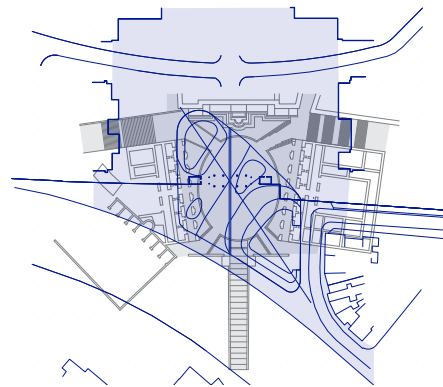
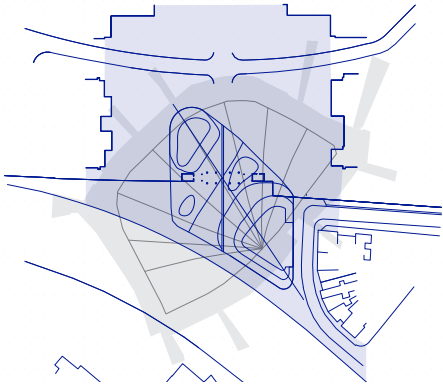

Plaza de Bolívar overlaid with entrance at Calle 26, drawing by author.

## USE PATTERNS

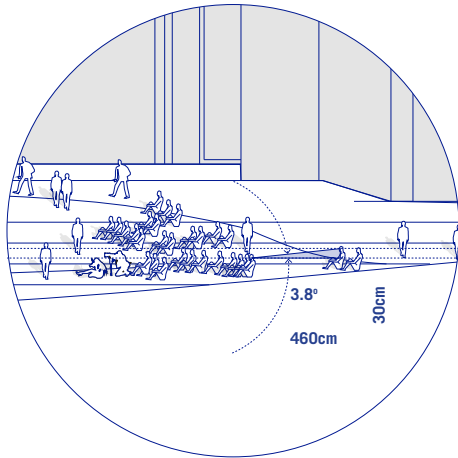

Section of Piazza del Campo in Sienna, warm afternoon, average distance between people -7,8m, drawing by author.

128

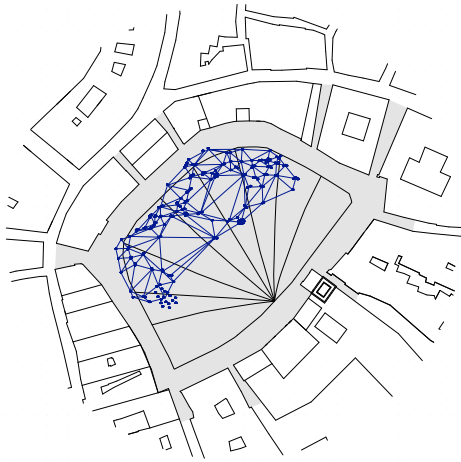

Campidoglio overlayed with entrance at Calle 26, drawing by author.



Plaza de Bolivar overlayed with entrance at Calle 26, drawing by author.



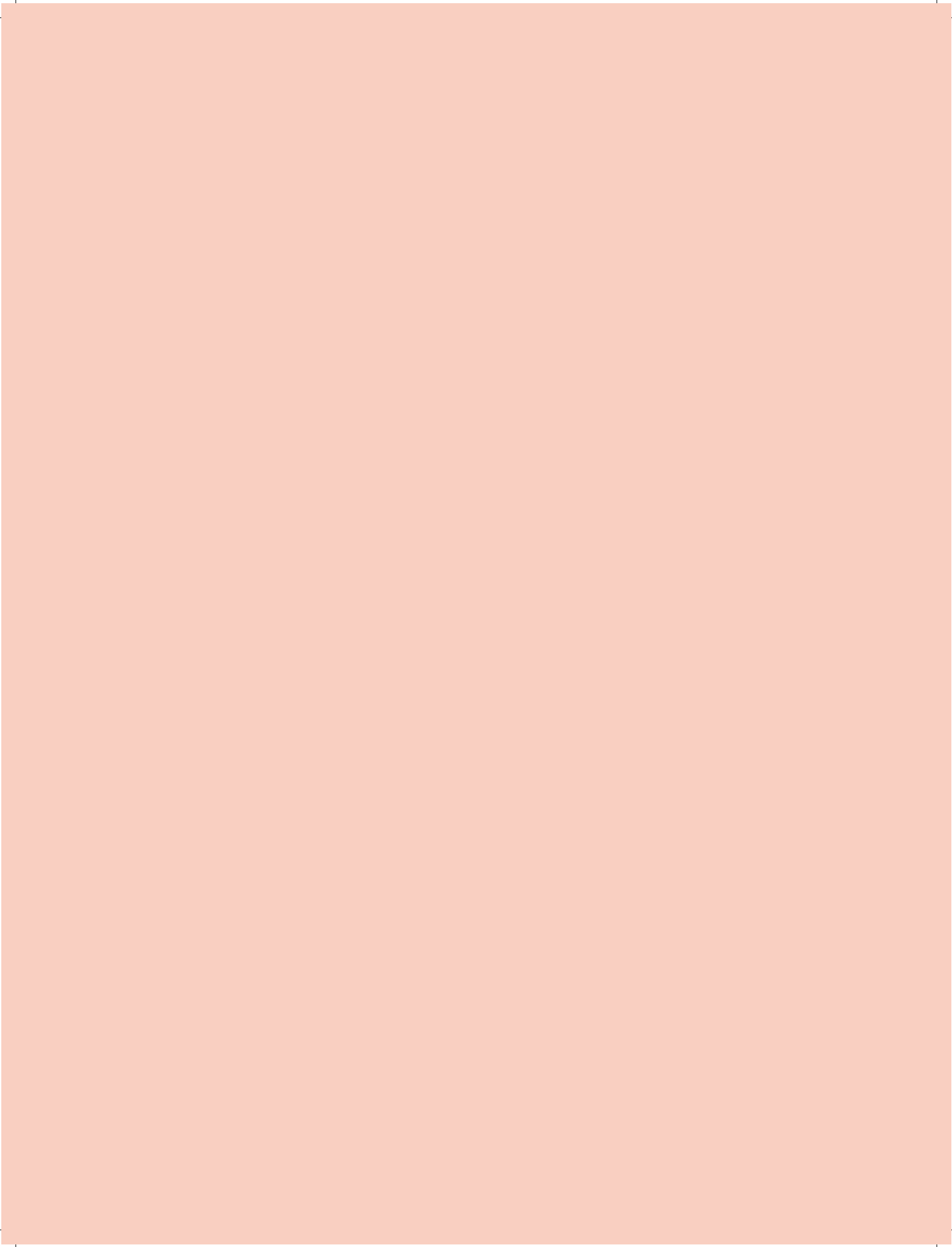



DESIGN

## PHENOMENOLOGICAL APPROACH

I have devoted a lot of attention in my project to how the topography is perceived by the body of the individual.

With an aim of understanding that better I conducted a writing exercise supported by drawing where I was trying to describe the desired bodily sensations of the individual and atmospheres.

132



### Act 2 Scene 1

I walk to the university after I get of the bus.  
Perception of the ear

As I slip on the other side of the colonnade the noise is allayed. Something else starts to prevail. It is an animated sound of people coming from many directions. It s a rattling sound of dishes and a rustle of packaging. Heated discussions happen around me. I do not hear the street any more.

Perception of the body

I run down the slope accelerated by the inline. I spring aside the people who I find in my way. My steps are erratic and my calves tense as I try to rapidly slow down and avoid collision. There are children sliding down the slope on my left. They enjoy the smoothness and coolness of the brick.

Perception of the eye

My sight range has dropped. I do not see where I am heading any more. And there is so much happening around me! Two people loudly argue on my right.

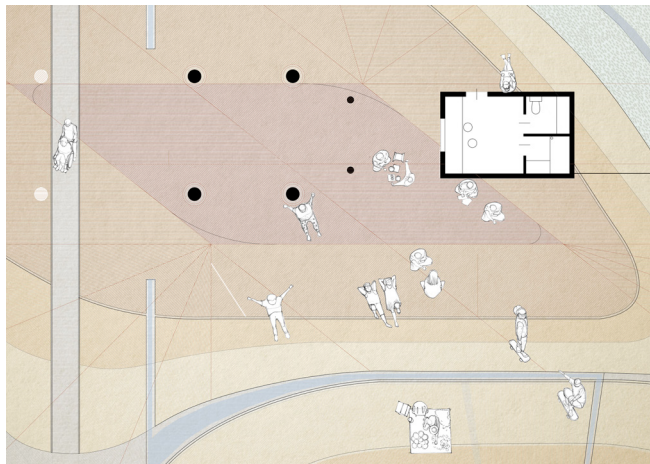

### Act 2 Scene 2

Perception of the eye

I climb up the slope. I cut the gate diagonally. I turn around to gaze at the space which I have left behind me. A group of people sits on the floor just a couple of meters away. They are having lunch, absorbed with their conversation. I can observe the entire market from the place where I am.

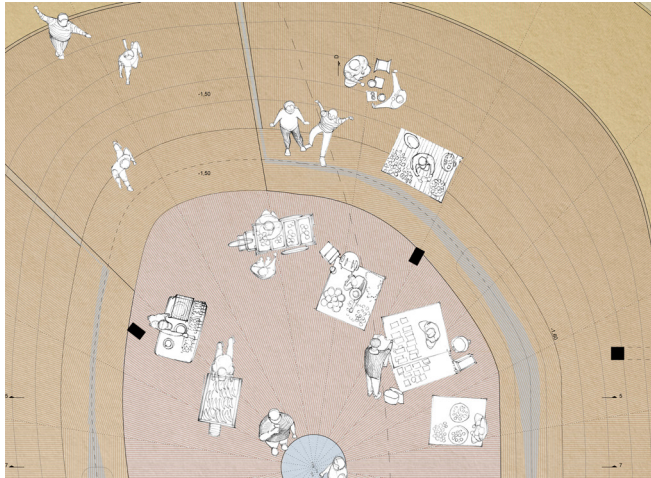

### Act 2 Scene 2

#### Perception of the body

Before I know it I find myself in the lowermost point of the landscape. I feel something has changed. My body is at ease. I do not need to resist the gravity any more. The ground is flat soft and cold.

#### Perception of the eye

This place is dark. The ceiling gravitates towards the ground. The floor and the ceiling close the perspective into a narrow gap.

When I look outside I can only see the lower part of the bodies of the people passing. It is as if the height difference has moved us away from each other.

#### Perception of the ear

I walk to the centre of the space and I squat to fill my bottle with clean water. I hear that it has started to rain. The rain is pounding on the roof. It drips down the edges of the roof and down the slopes. The gutters fill up with water and reveal the shape of the space I am in. The space gradually fills with people seeking shelter from the rain.

133



### Act 2 Scene 4

As I run down the slope, I step on the soft grass. A few steps more and I am standing on the hard concrete again. Students are enjoying their lunch break laying down on the grass or hurriedly revising for the next lesson. I am running late. I leave the place behind me.

Phenomenological exercise, drawings by author.

## GEOMETRICAL APPROACH

I have also tried an alternative, more top-down design approach where I have described formal operations which shape the topography of the floor and i tried applying these methods on my site

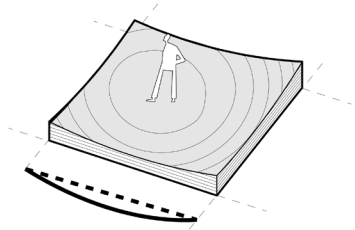

Stretching

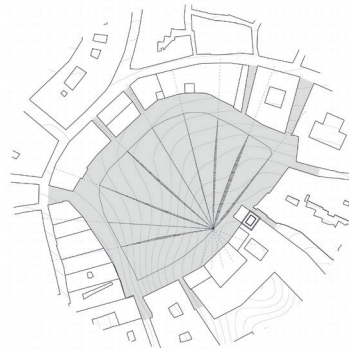

Piazza del Campo, Siena

134

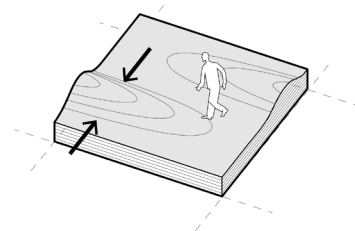

Folding

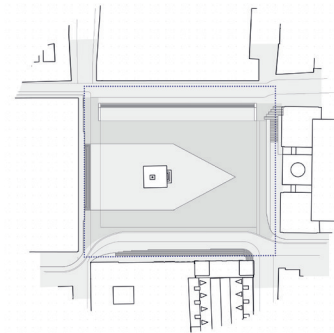

Plaza de Bolivar, Bogota

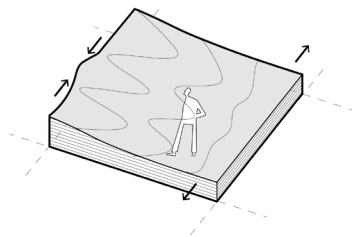

Draping



Rabalderstraede musicon, Rolskide, Denmark

Geometrical exercise, drawings by author.

Thickening the threshold

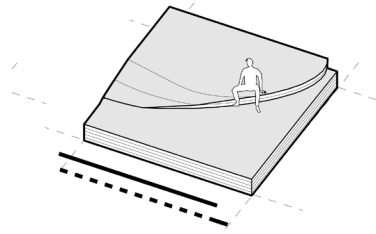

Cut

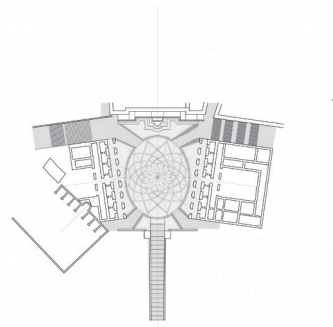

Campidoglio, Rome

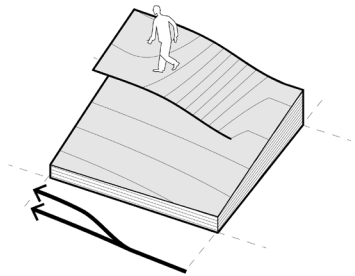

Weaving

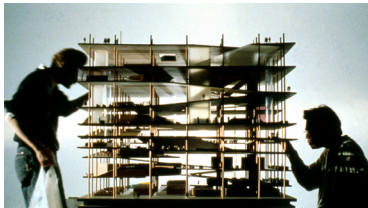

Libraries at Jussieu, Paris

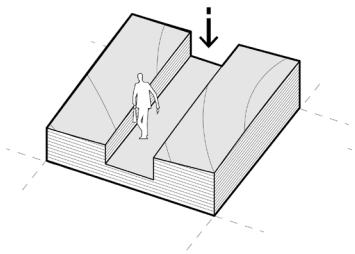

Substraction



Serpentine Pavilion, Herzog de Meuron



I applied the geometrical operations on the site by Calle 26.

In the first step shown on the left, I stretched the floor along a diagonal and across the gate. As a result of this operation two submersions and an elevation were formed. The amplitude of these ground oscillations is greatest along the diagonal line. The oscillations fade away to the sides.

In the second step I used other operations to diversify the experience of the floor.

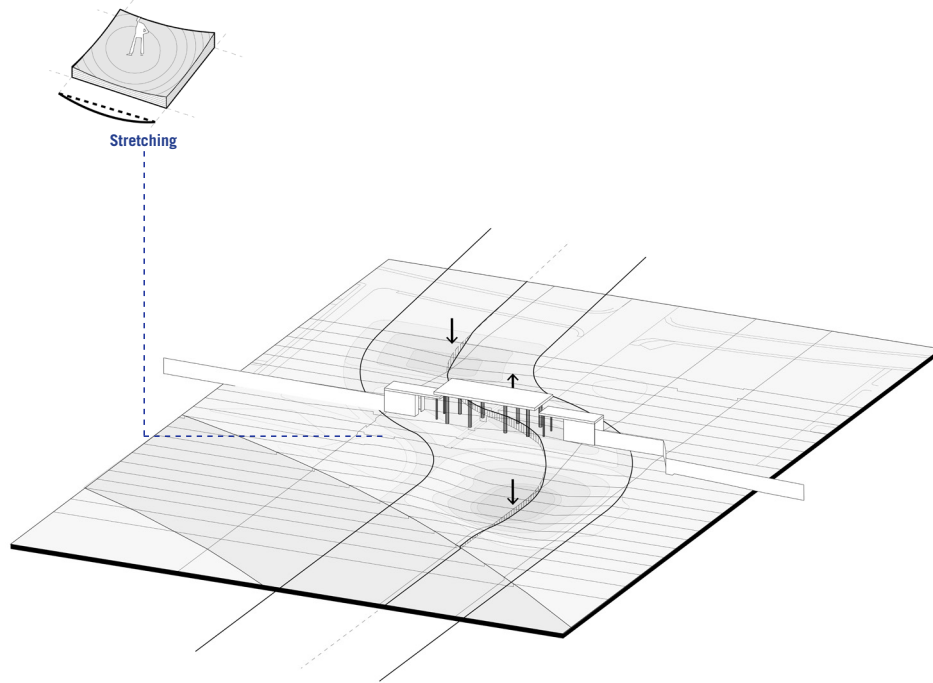

Shaping the topography, drawing by author.

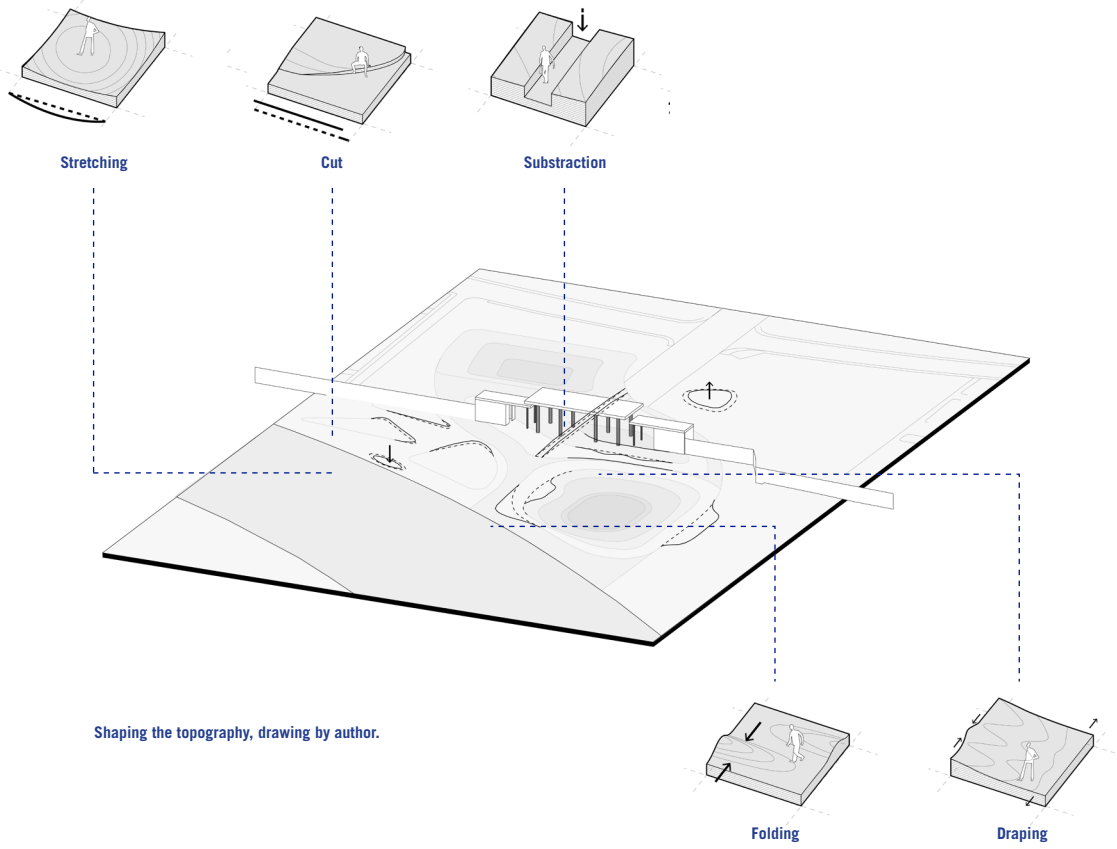

## STRATEGY

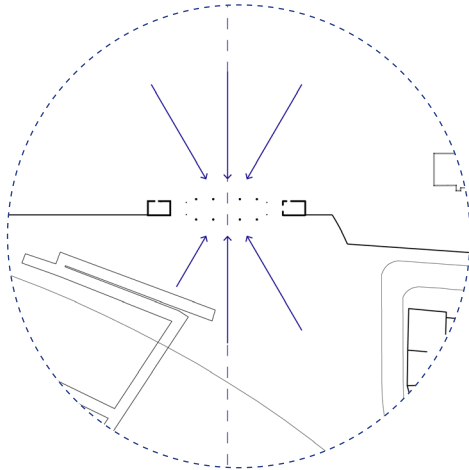

### MAIN ATTRACTOR

Gate is the main attractor of the space. At the same time for a person passing through the square the gate is a distant destination. His path is non-negotiable and he has to cross the gate according to a set routine.

138

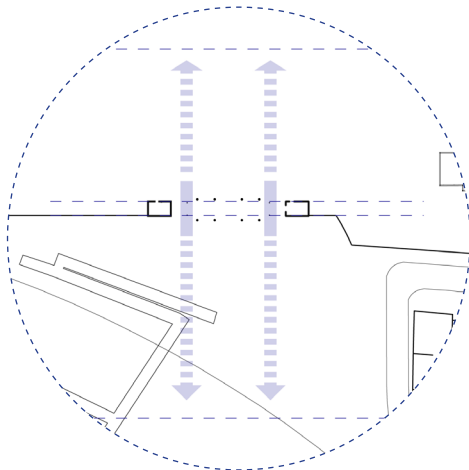

### STRETCHING THE THRESHOLD TO THE INSIDE AND OUTSIDE

I propose thickening the threshold which now is only the space between the entry pavilions to the inside of the campus and to the outside.

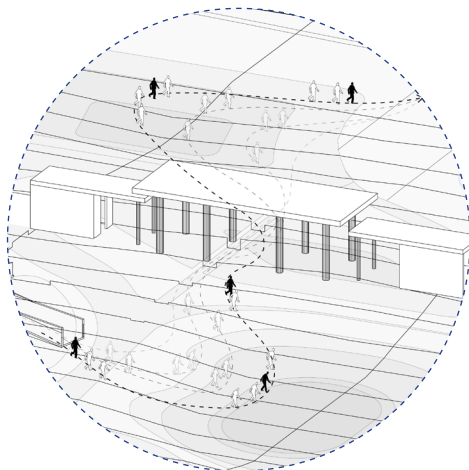

### DIVERTING THE MOVEMENT OF THE PEDESTRIAN

The landscape diverts the path of the pedestrian. The passer-by has to negotiate the path of his passage with the landscape. He is given a chance to choose his route.

Thickening the threshold



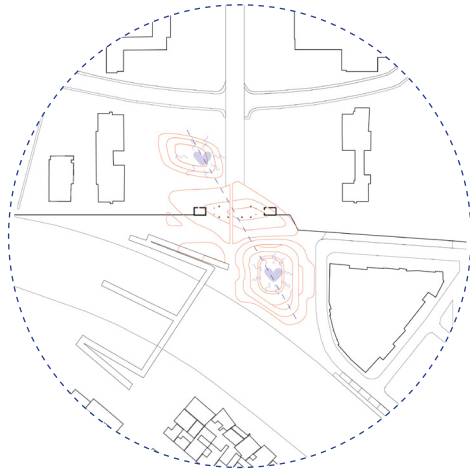

# 1.

## TOPOGRAPHY CONTINUOUSLY UNDULATED THROUGH THE GATE.

Landscape is put into an oscillating condition creating a composition based on a diagonal. Due to that the main attractors are moved beyond the gate.



# 2.

## GRADIENT

Gradient of two materials blurring the transition and defying the division of space into functional subspaces.



# 3.

## THIRDING

Challenging the dominant position of the gate with pavilions which capture the body and sight of the passer-by. The thickened threshold is a surface where many activities are enacted. Crossing the gate is of them.

## TOPOGRAPHY

### To release

At the gate the ground is lifted. Due to the undulated ground the passer-by has to negotiate his path with the landscape. Everyday experiences of crossing the gate differ slightly.

The person spending time at the gate has visual connectivity with the spaces on both sides of the fence and can take part in activities taking place there.

140

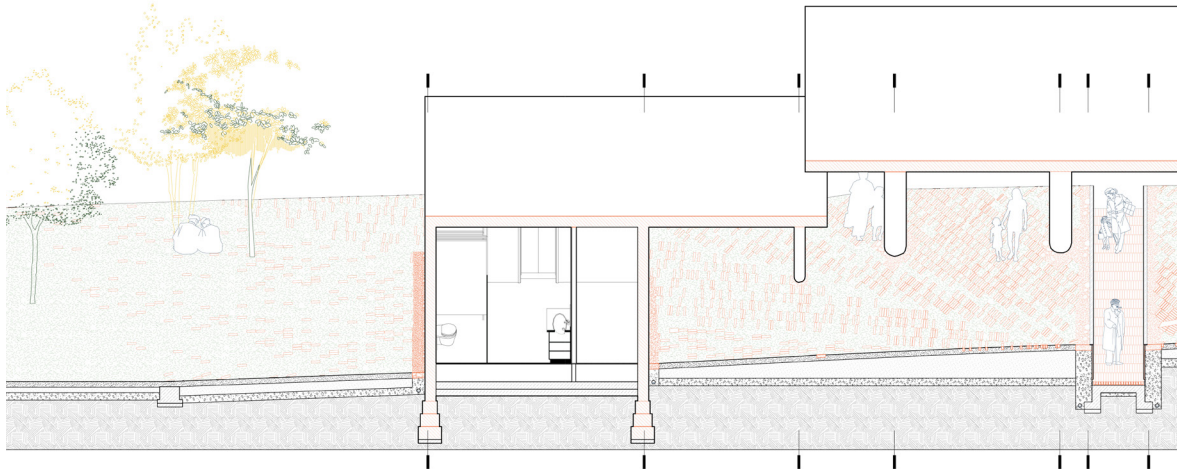

Entrance by Calle 26.  
Section 1-1 1:100, drawing by author.

Design



To release, drawing by author.



Entrance by Calle 26, Plan, drawing by author.

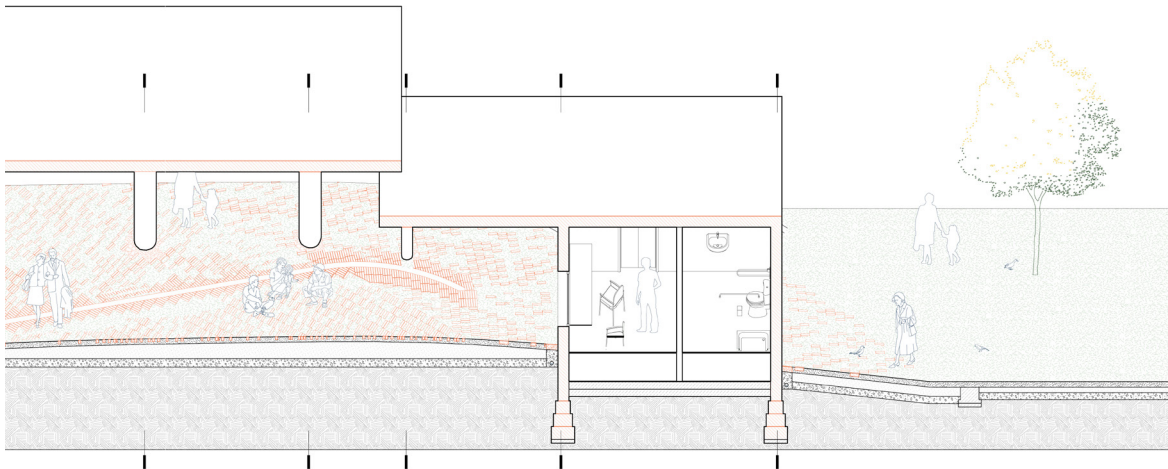

Thickening the threshold

**To divert**

The first ground oscillation is situated on the outer side of the fence. It forms a submersion. This part of the space is the heart of the activity of the informal vendors. The lowering ground diverts the path of the pedestrian encouraging him to penetrate all the way down to the center of the space

142

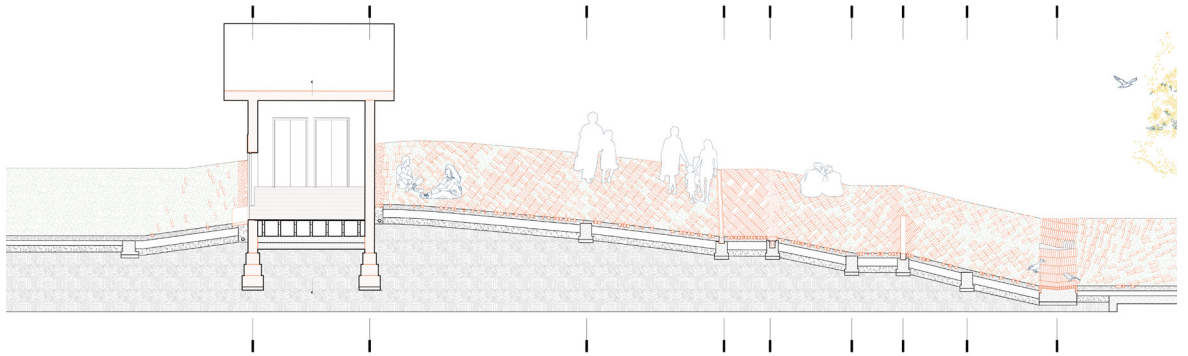

Entrance by Calle 26.  
Section B-B 1:100, drawing by author.

Design

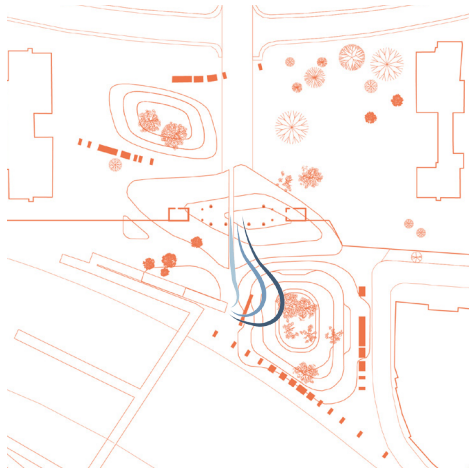

To divert, drawing by author.

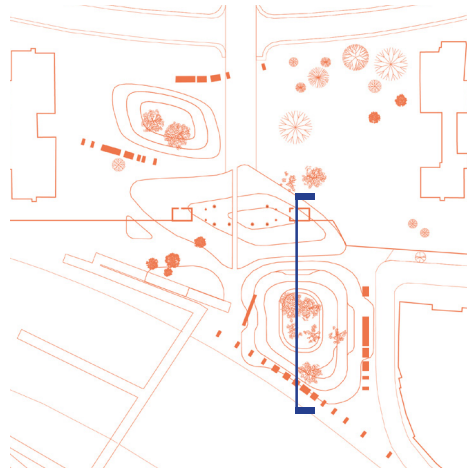

Entrance by Calle 26, Plan, drawing by author.

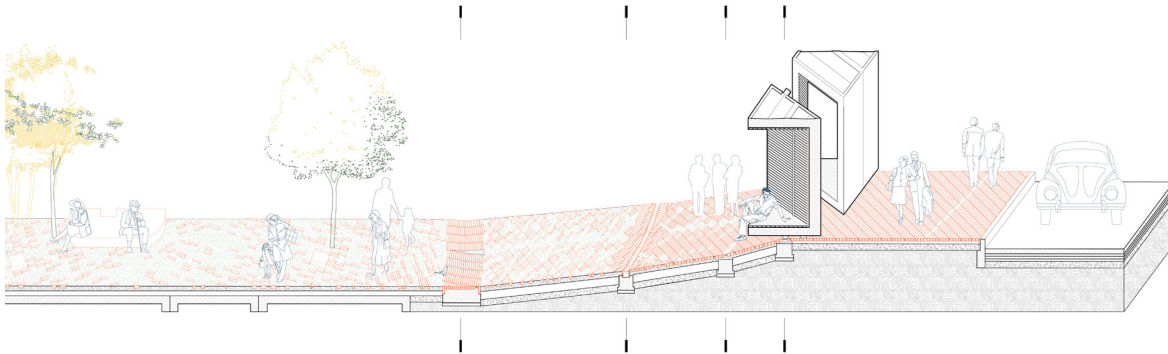

Thickening the threshold

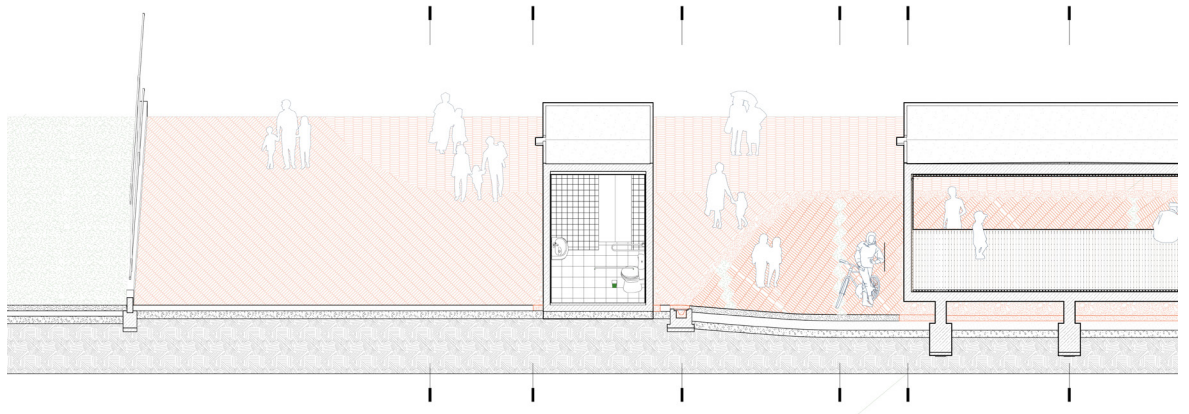

Entrance by Calle 26.  
Section C-C 1:100, drawing by author.

Design

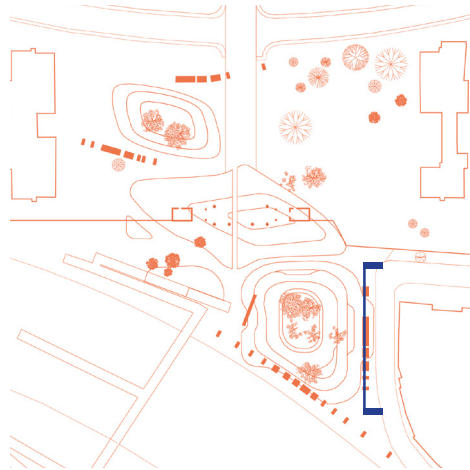

Entrance by Calle 26, Plan, drawing by author.

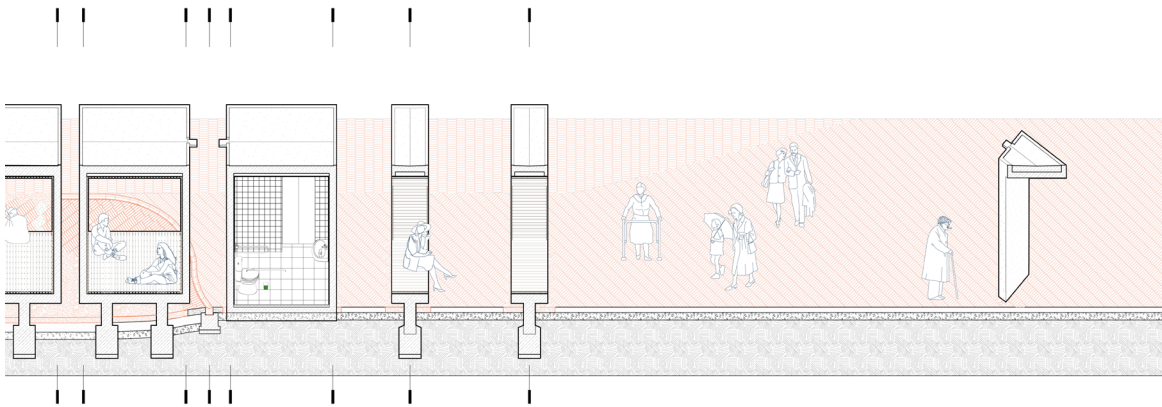

Thickening the threshold



**To lure**

Inside the campus the ground is again fluidly lowered. Due to that an element of assymetry is introduced into the regular stagnant interior between the faculties. The passer-by is lured to the space by the incline.

146

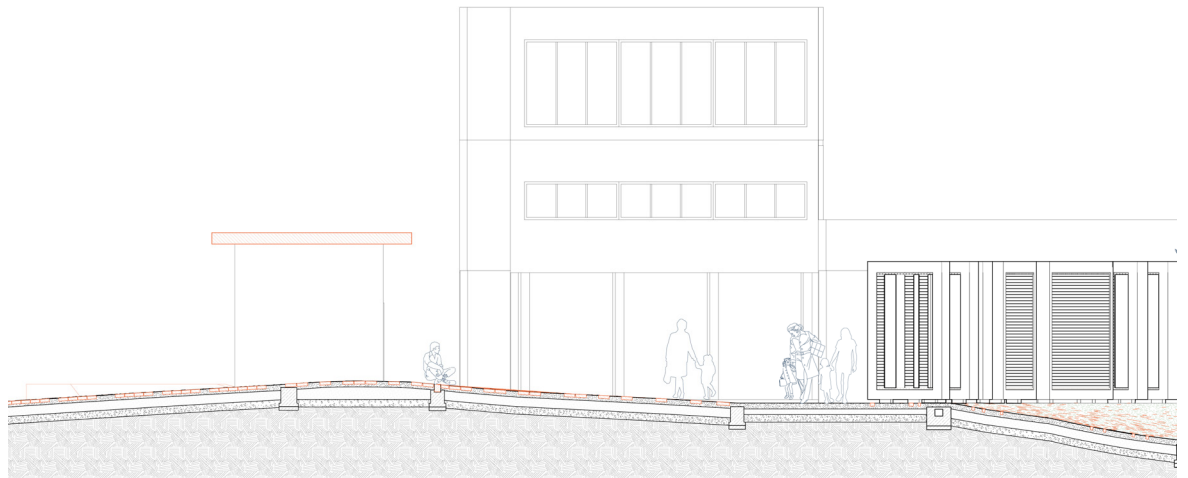

Entrance by Calle 26.  
Section C-C 1:100, drawing by author.



Design



To lure, drawing by author.



Entrance by Calle 26, Plan, drawing by author.

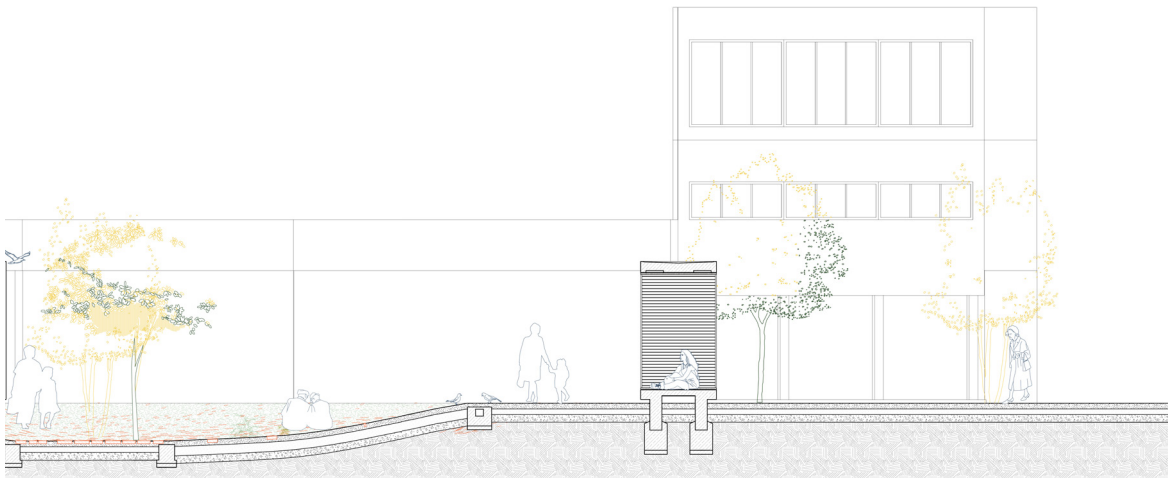

Thickening the threshold



## GRADIENT

The topography appears to have been shaped by natural processes of accumulation and erosion. So gentle are the curves. Clay is a material which seems soft and ductile. Thus I choose to use brick which is capable of recreating complex variations of shape.

The way of using the material was inspired by tapestries created by a Colombian artist Olga Amaral. Her weaves contain subtle intricate variations and escape the flatness of a work that you hang on a wall.

In the proposal for the entry square I decided to weave materials. I chose to do that with the two most characteristic materials of the two sides of the boundary - grass and brick. The floor is paved in a gradient. The share of brick becomes smaller towards the inside of the campus. There are also contrasting local variations of intensity. The center of the market is where the brick becomes more scarce, the center of the submersion on the campus side is more densely paved.



Cesta Lunar 016, Olga Amaral, source: <https://www.christies.com/lotfinder/Lot/olga-de-amaral-colombian-b-1932-5793758-details.aspx> (accessed: 30.06.2019)

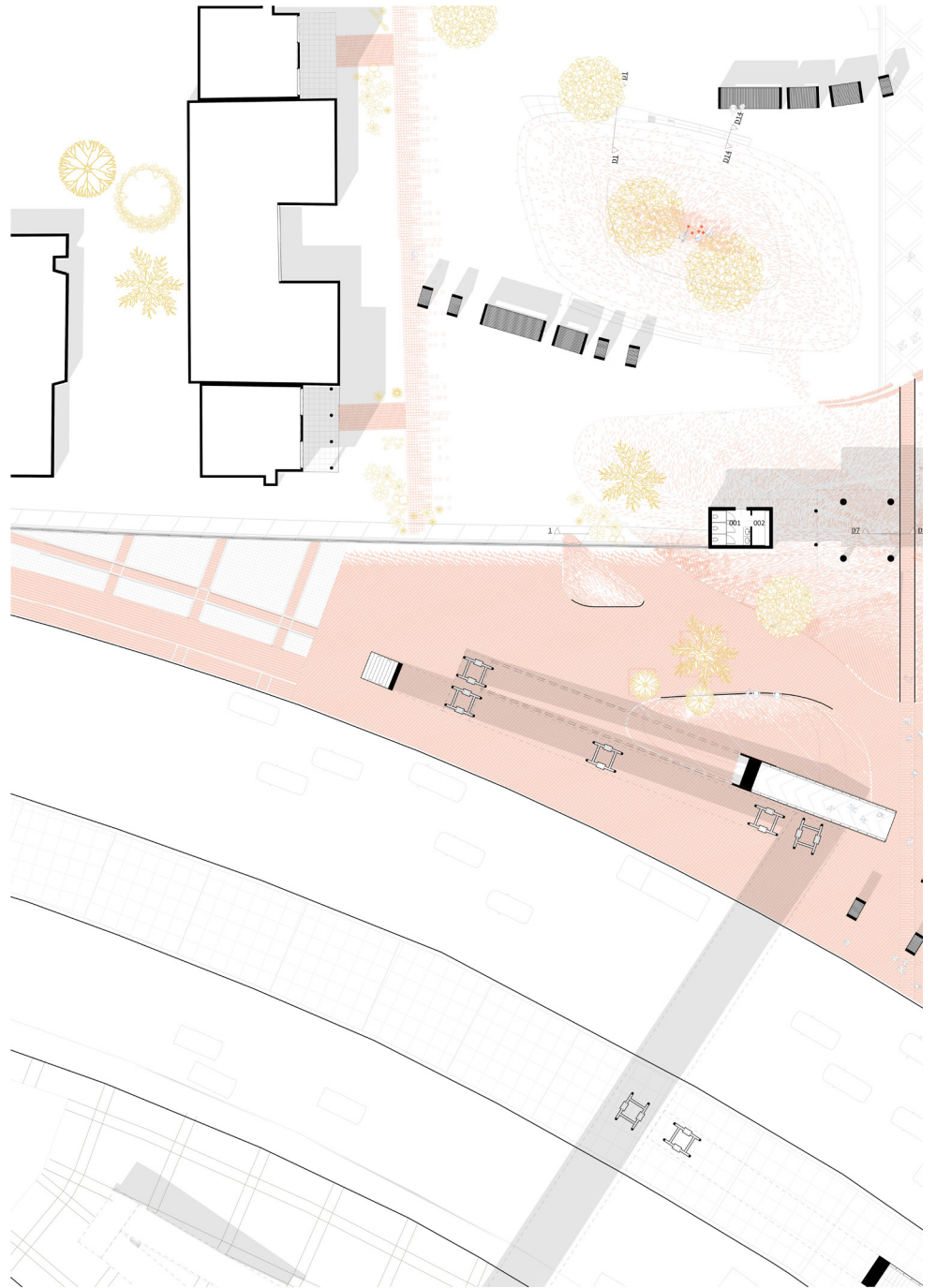

Plan of the entry square by Calle 26, drawing by author.

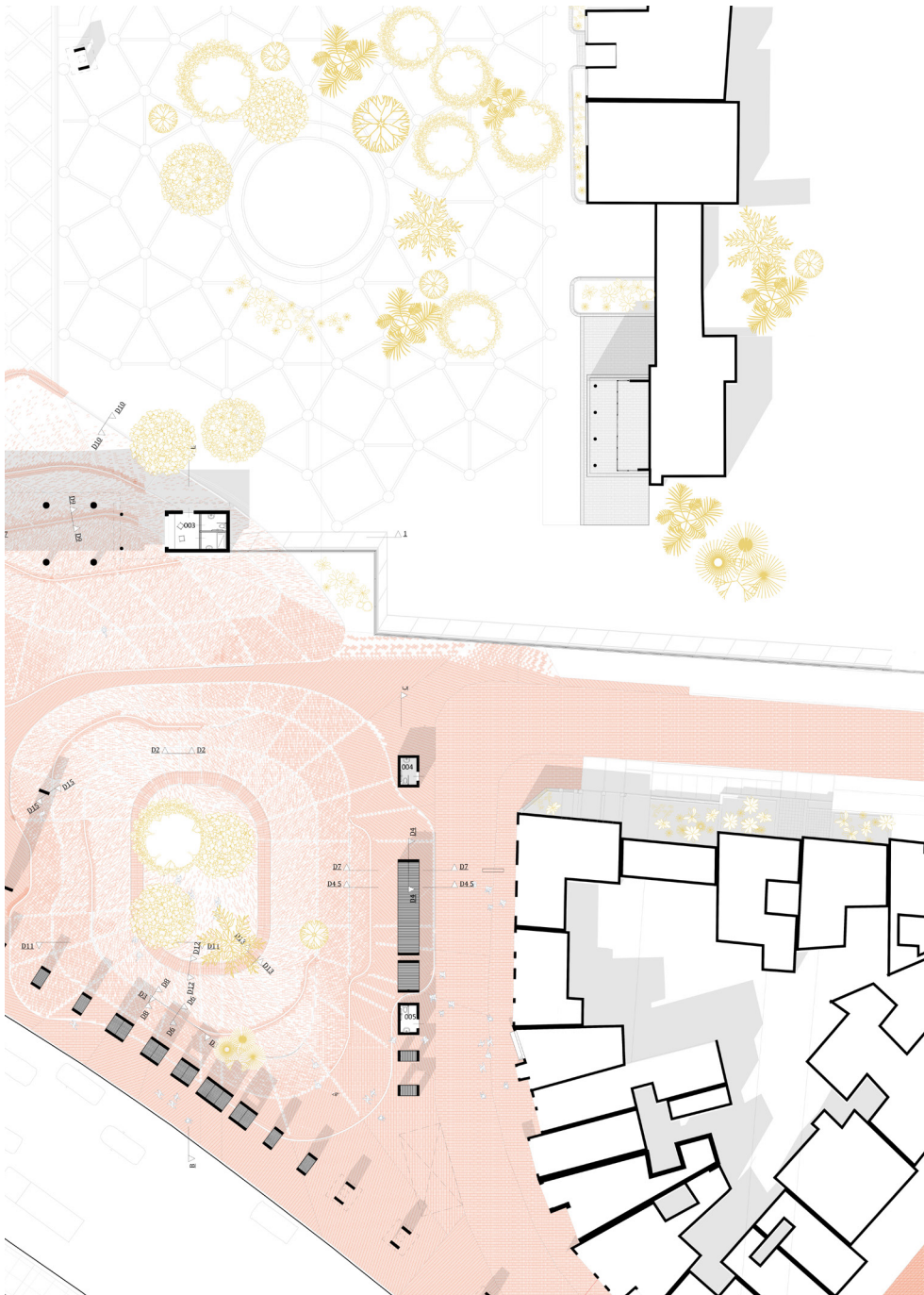





View from the bridge to the center of the market. Visible heavily paved part of the floor at the descent of the stairs, the densely paved creek surrounding the center of the market and scarcely paved center of space, drawing by author.



View from the gate to the outside of the campus. Visible increasing share of brick in the weave to the outside of the submersion, drawing by author.





## ACCENTS IN THE WEAVE

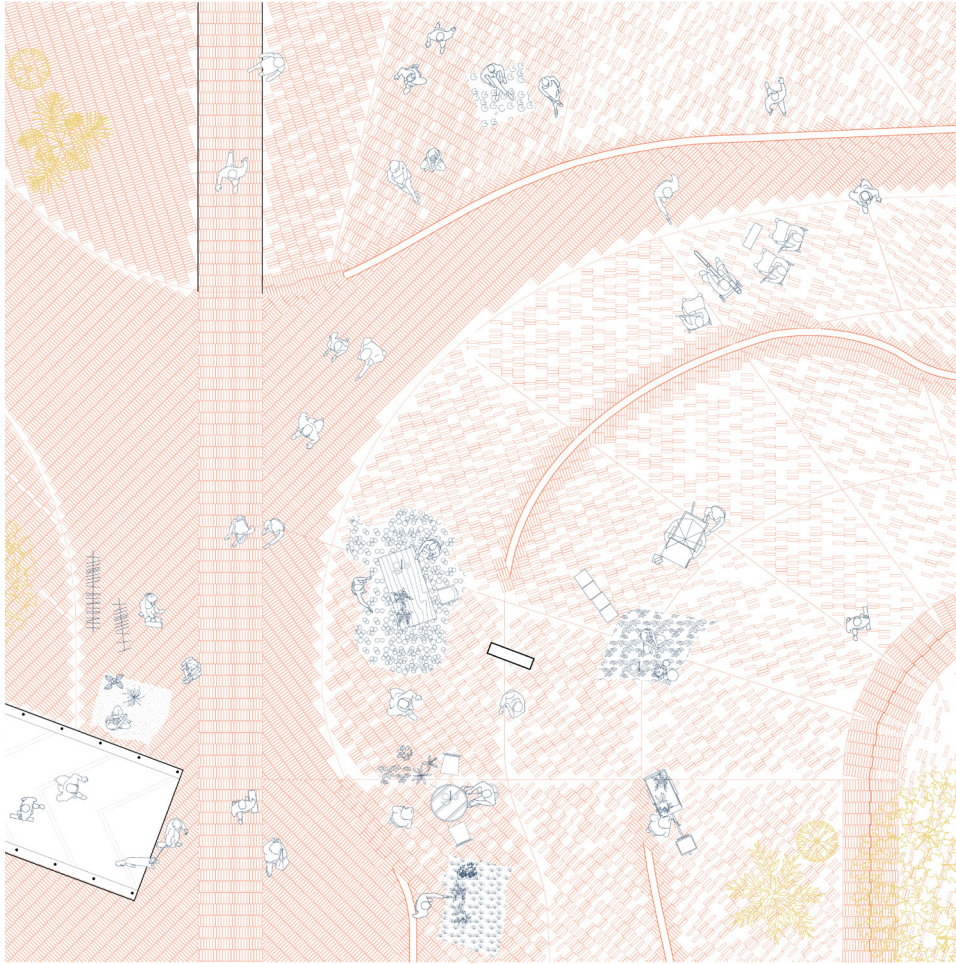

155

Fragment of the plan of the square by Calle 26, drawing by author.

In this giant weave I distributed accents, points and pauses. They are lines which underline forms, accentuate directions, they conceal.

They give the space a scale closer to the scale of a human.

## TYPES OF SEAMS

Seams are elements of the floor which make possible the functioning of the landscape in respect to aspects such as water drainage, structural stability, thermal expansibility. These types of seams were developed with a focus on their form.

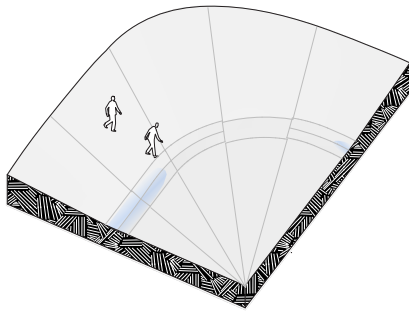

### The accentuating seam

This seam comes to existence with the use of folding or stretching. This seam highlights individual surfaces that the landscape is composed of. Seam which is periodically filled with water and reveals the shapes of the landscape with a bigger intensity.

Instances: gutter, a difference in incline

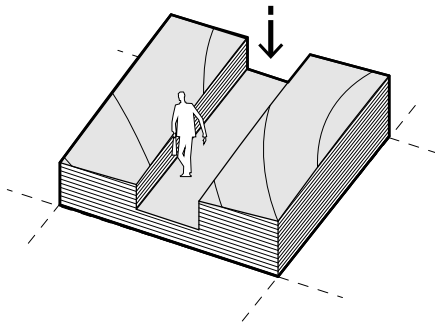

### The defiant seam

Seam which comes to being with the use of a cut. It does not obey the geometry of the landscape. It reveals the cross-section of the surface. It brings a new understanding of the surface as a volume.

Instances: the fastlane, the underground creek

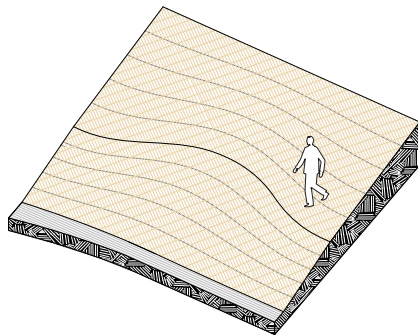

### The concealed seam

The seam in which the material speaks stronger than structural components.

Instances: intersection of two floor planes, a dilatation gap, a joint of a permeable and non-permeable floor.

Seams, drawings by author.

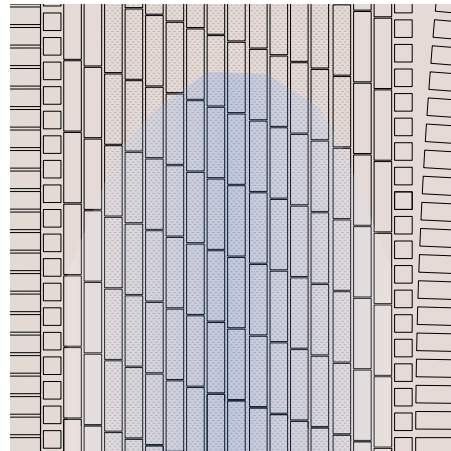
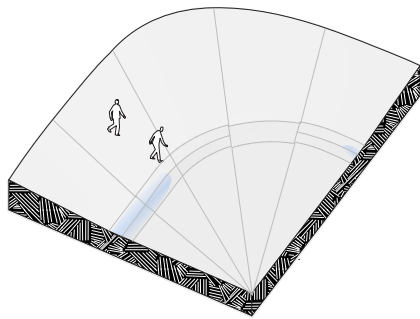

### The accentuating seam

This seam comes to existence with the use of folding or stretching. This seam highlights individual surfaces that the landscape is composed of. Seam which is periodically filled with water and reveals the shapes of the landscape with a bigger intensity.

Instances: gutter, a difference in incline

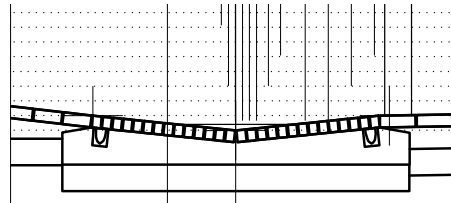

top left: axonometry, fragment of the gutter  
in the centre of the market  
top right: plan  
bottom right: section  
all drawings by author.

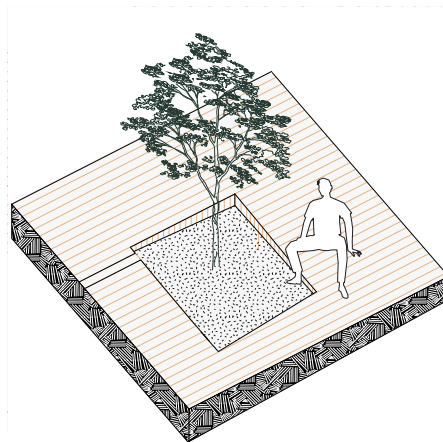
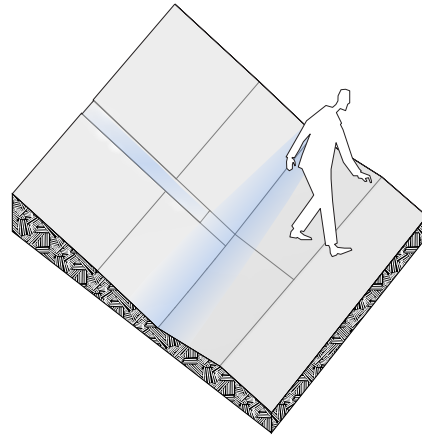
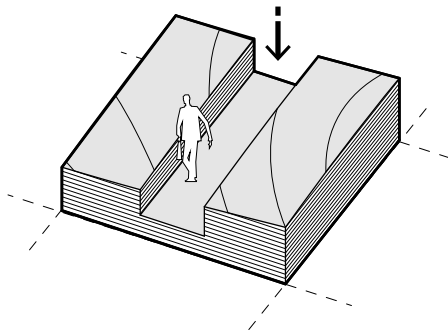

**The defiant seam**

Seam which comes to being with the use of a cut. It does not obey the geometry of the landscape. It reveals the cross-section of the surface. It brings a new understanding of the surface as a volume.

Instances: the fastlane, the water outflow

top left: the fastlane  
top right: water outflow  
bottom right: joined water outflow and tree planter  
all drawings by author.

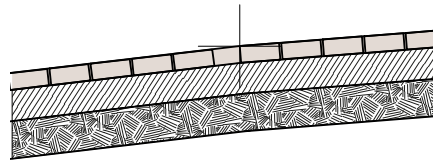
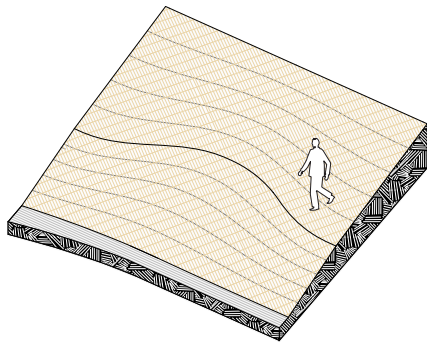

### The concealed seam

The seam in which the material speaks stronger than structural components.  
Instances: intersection of two floor planes, a dilatation gap, a joint of a permeable and non-permeable floor.

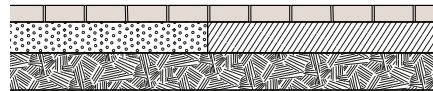

top left: axonometry, irregular incline masked by continuous paving  
top right: section intersection of two inclines  
bottom right: joint of a permeable and non-permeable floor  
all drawings by author.

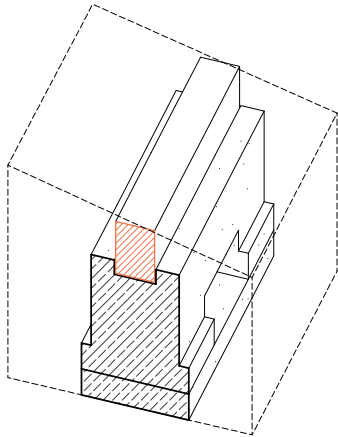
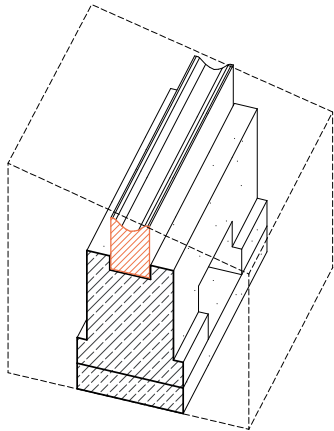
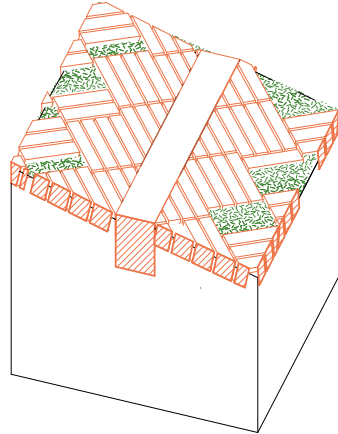
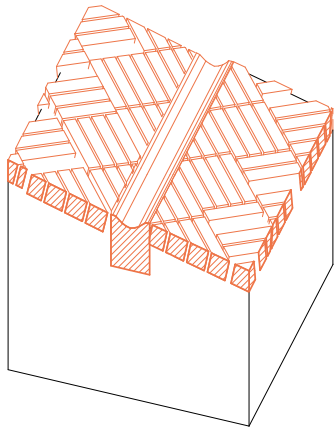

**ACCENTUATING SEAMS**

Non-permeable floor,  
all drawings by author.

Permeable floor

Thickening the threshold



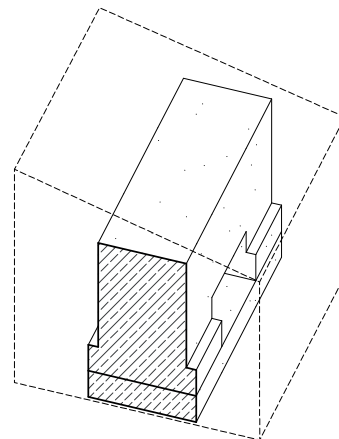
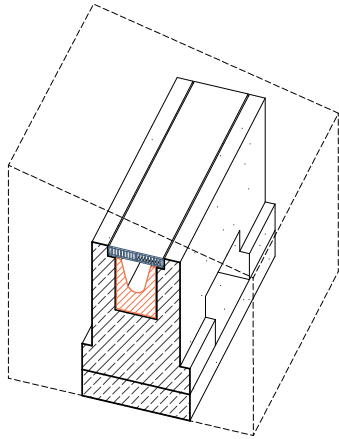
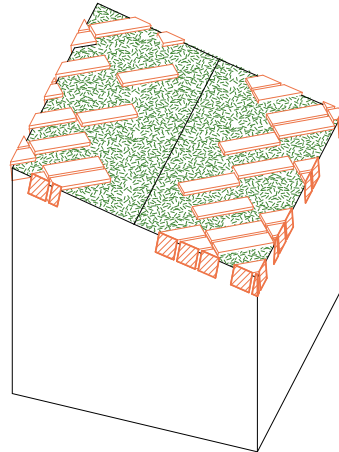
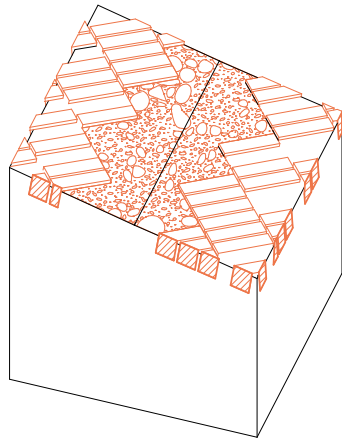

**CONCEALED SEAMS**  
Non-permeable floor  
all drawings by author.

Permeable floor

Thickening the threshold





## THE ACCENTUATING SEAM

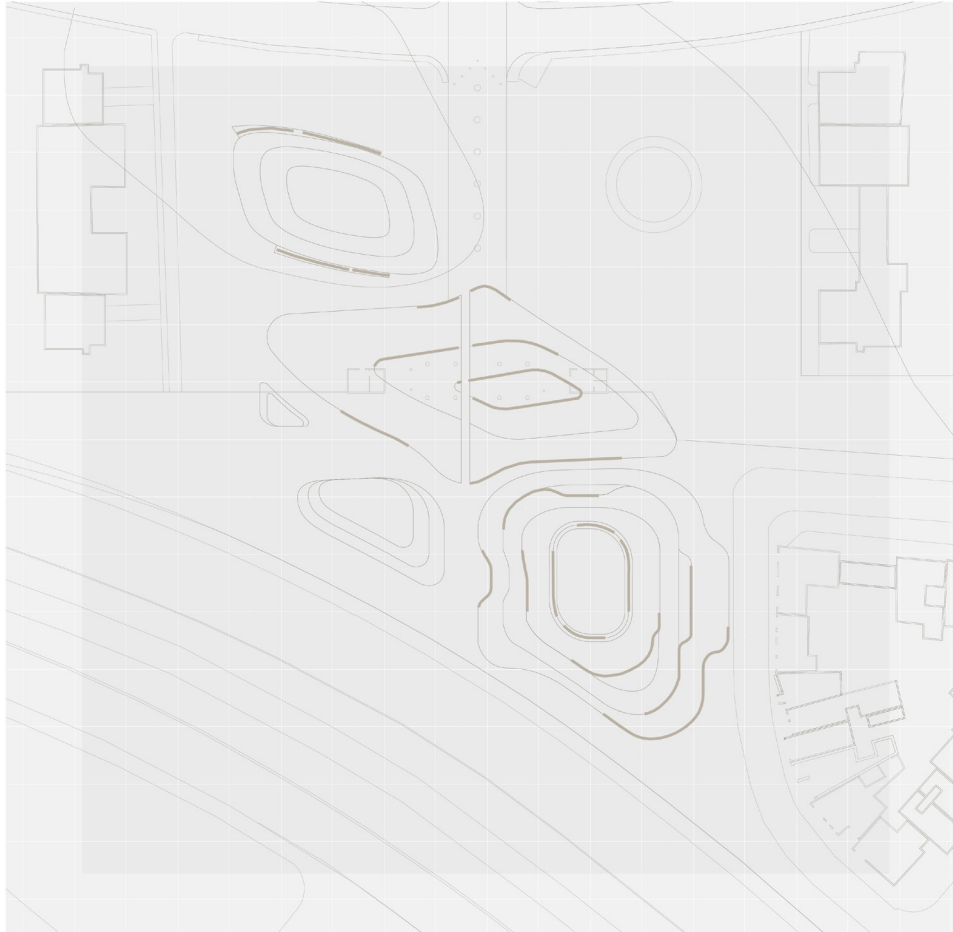

Location of accentuating seams,  
Plan, drawing by author.

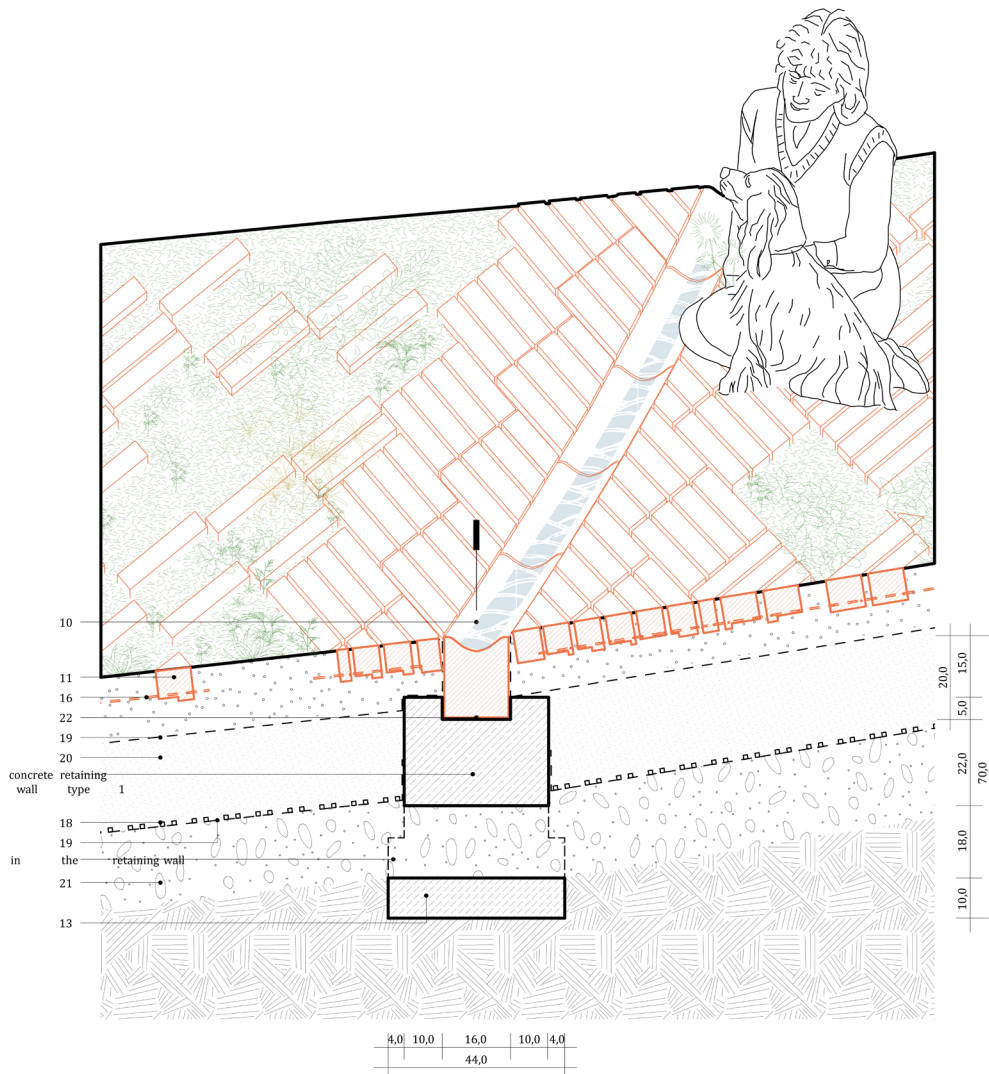

Accentuating seam,  
Detail 6, drawing by author.

**Non-permeable floor**

The accentuating seams in non-permeable parts of the floor are built of brick channels along which cut bricks have been laid.

- 10 clinker drainage channel
- 11 clinker paving brick
- 13 lean concrete 10cm
- 16 synthetic grid of the clinker fabric
- 17 hummus 150mm
- 18 triaxial monolithic geogrid polypropylene
- 19 geotextile
- 20 crushed sand levelling course 250mm
- 21 gravel 200mm
- 22 sealant
- 23 galvanized steel grated drain cover

Thickening the threshold

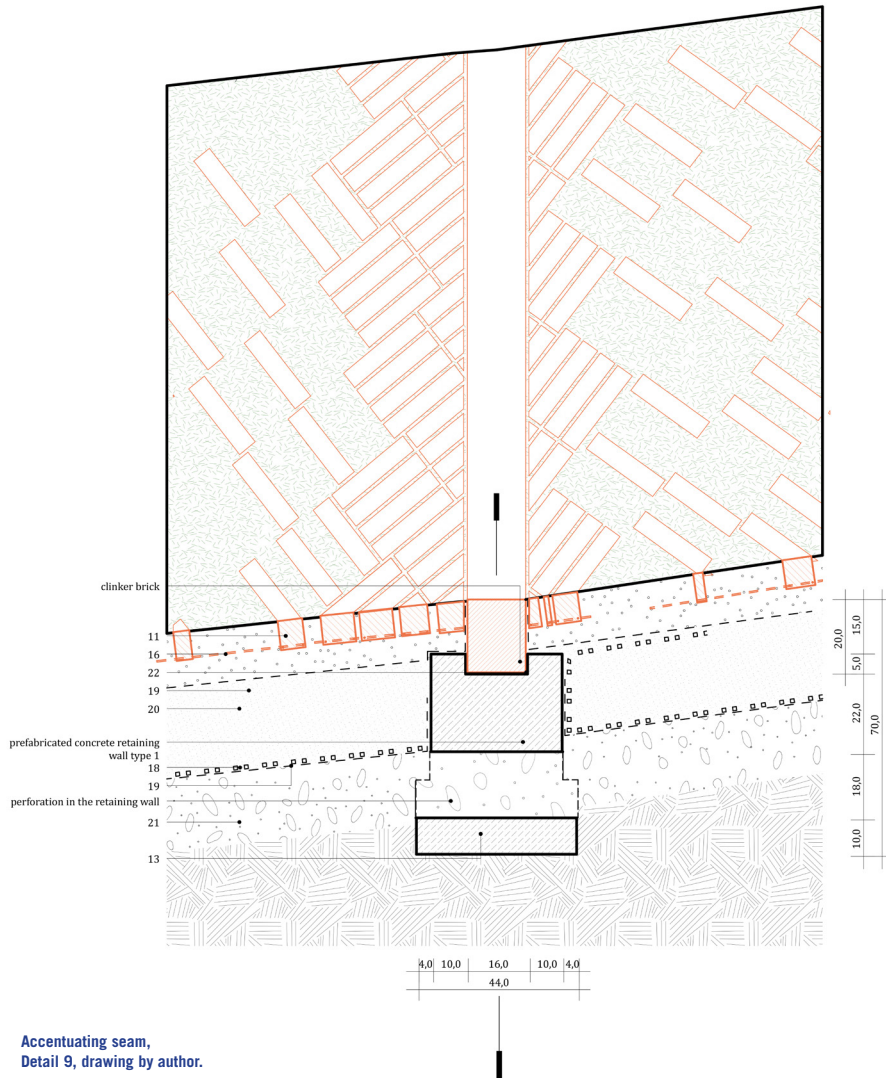

**Permeable floor**

The accentuating seams in non-permeable parts of the floor are built of full bricks along which cut bricks have been laid.

- 11 clinker paving brick
- 13 lean concrete 10cm
- 16 synthetic grid of the clinker fabric
- 17 hummus 150mm
- 18 triaxial monolithic geogrid polypropylene geotextile
- 19 crushed sand levelling course 250mm
- 20 gravel 200mm
- 21 sealant
- 22



Water feature center of the market,  
Perspective view, drawing by author.

### The creek

The creek around the center of the market is an example of an accentuating seam. It is a strong line which binds the center of the space. It varies in depth and portions of it becomes full of water and unpassable when it rains.



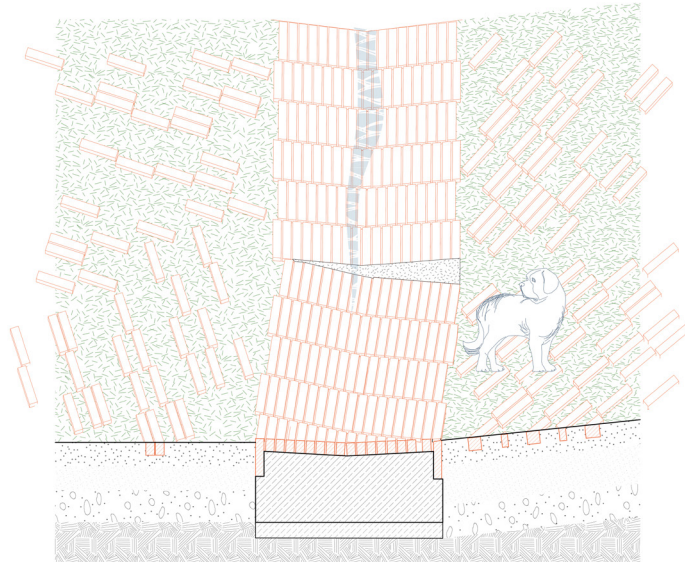
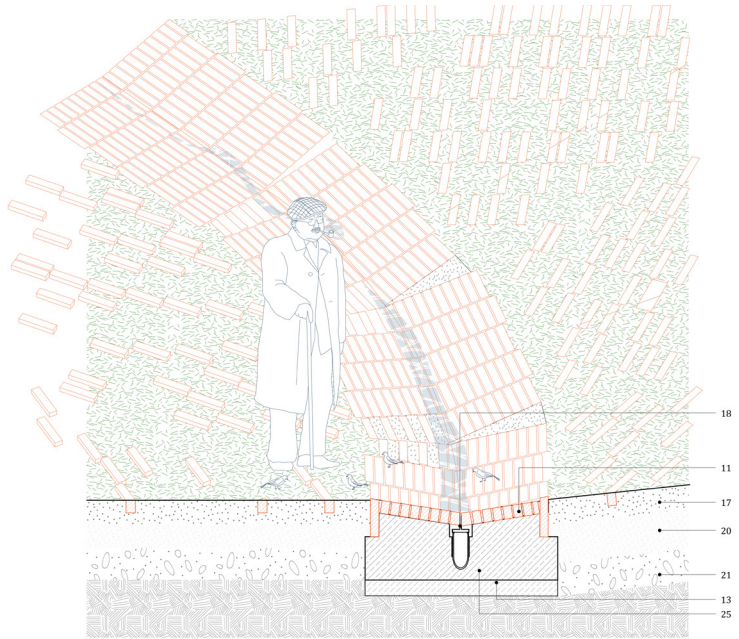

Water feature center of the market,  
Detail 12 and 13, drawing by author.



Water feature inside the campus,  
Perspective view, drawing by author.

### The water feature

The water feature around the submersion, located inside the campus, is an example of an accentuating seam. It runs under ground and becomes visible as a strong line just outside the submersion. Water can help one cool down their body or can be dranken.

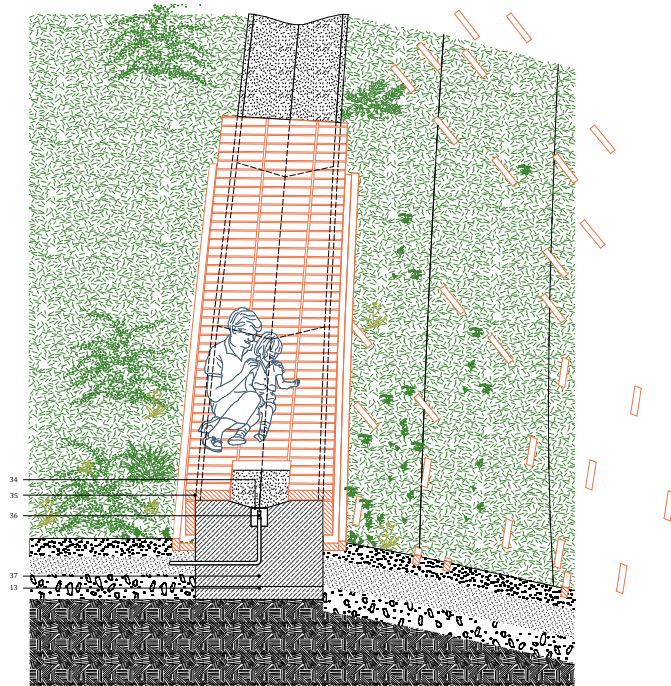
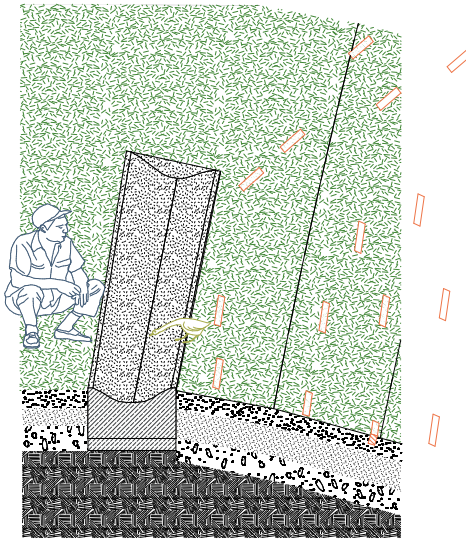

Water feature inside the campus,  
Detail 1 and 14, drawing by author.





## THE CONCEALED SEAM



Location of concealed seams,  
Plan, drawing by author.

172

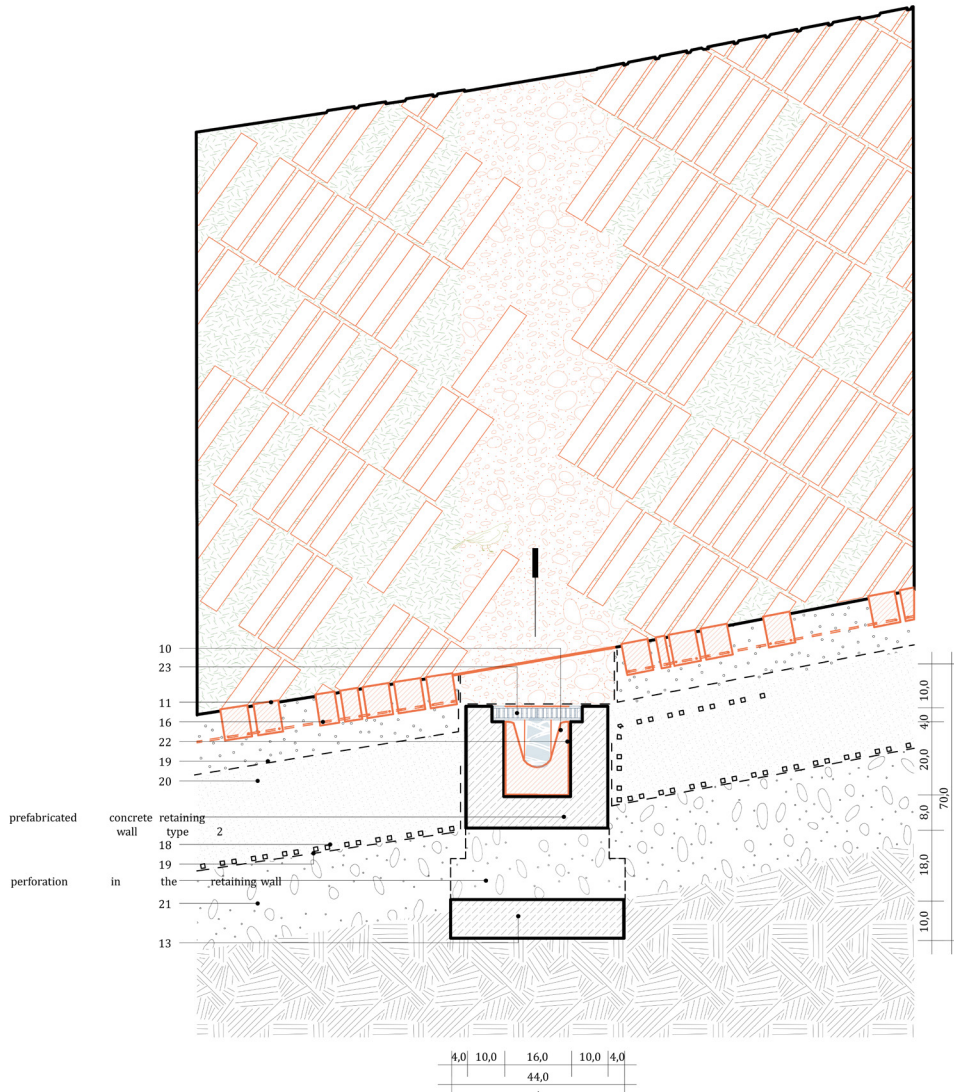

Radial seam,  
Detail 8, drawing by author.

**Non-permeable floor**

The concealed seams in the non-permeable part of the floor have drainage channels concealed under a layer of crushed brick .

- 11 clinker paving brick
- 13 lean concrete 10cm
- 16 synthetic grid of the clinker fabric
- 17 hummus 150mm
- 18 triaxial monolithic geogrid polypropylene
- 19 geotextile
- 20 crushed sand levelling course 250mm
- 21 gravel 200mm
- 22 sealant

Thickening the threshold

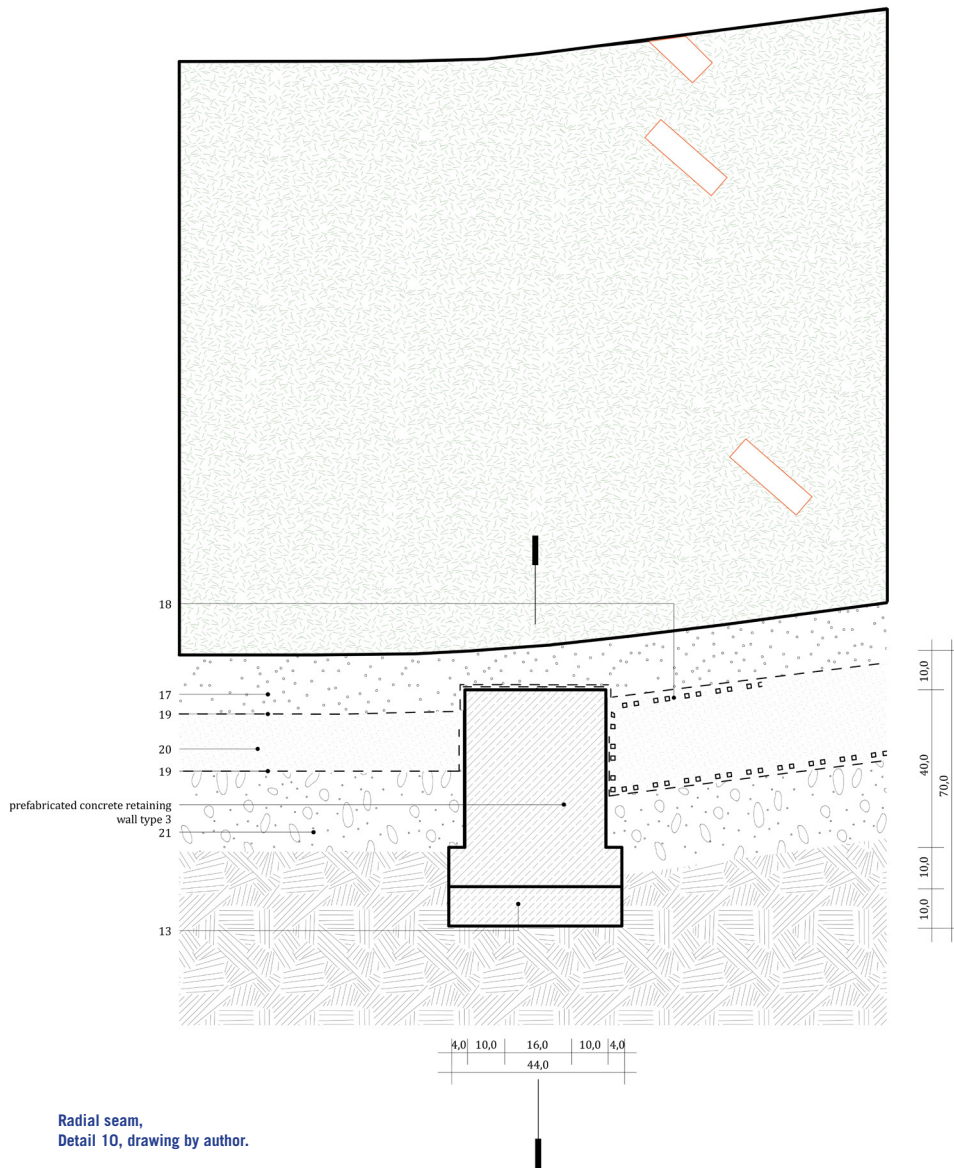

**Non-permeable floor**

In the permeable part of the floor the concealed seams have only structural purpose. On the surface they are expressed as absence of bricks, marked by continuous lines of grass.

- 13 lean concrete 10cm
- 16 synthetic grid of the clinker fabric
- 17 hummus 150mm
- 18 triaxial monolithic geogrid polypropylene
- 19 geotextile
- 20 crushed sand levelling course 250mm
- 21 gravel 200mm
- 22 sealant



Concealed seam along the highway,  
Perspective view, drawing by author.

### The blurred edge

The blurred edge along the highway conceals the edge of the submersion. A passer-by can be captured by the incline almost without noticing it consciously.







## THE RADIAL SEAM



177

Location of radial seams,  
Plan, drawing by author.





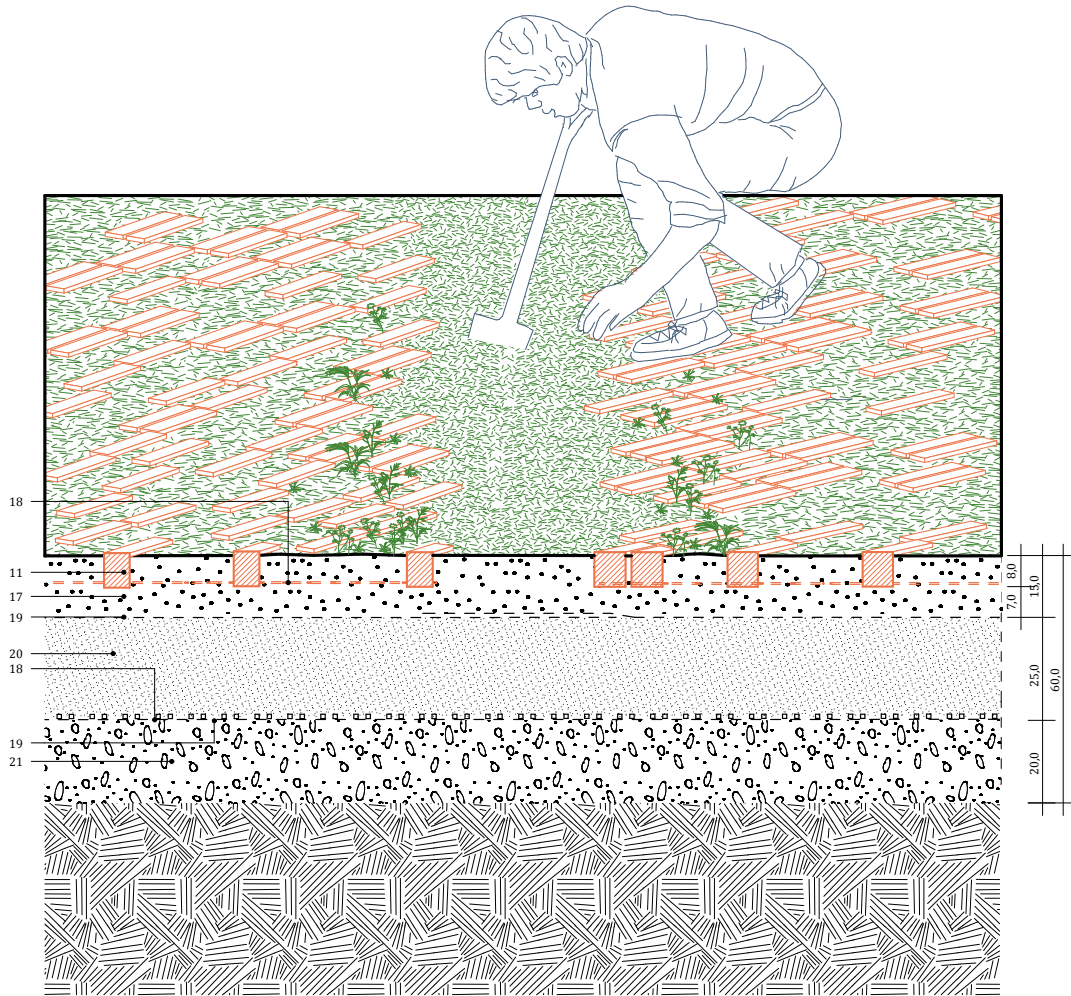

Radial seam,  
Detail 2, drawing by author.

### The radial seam

Radial seams run across the landforms. These seams do not have a structural or drainage function. Along these seams the clinker fabric is cut to match the extents of the singular plates, that the landforms are built of. Along these seams sheets of geotextile overlap.

- |    |   |
|----|---|
| 11 | clinker paving brick                      |
| 17 | humus 150mm                               |
| 18 | triaxial monolithic geogrid polypropylene |
| 19 | geotextile                                |
| 20 | crushed sand levelling course 250mm       |
| 21 | gravel 200mm                              |



## THE DEFIANT SEAM



Location of the defiant seam,  
Plan, drawing by author.

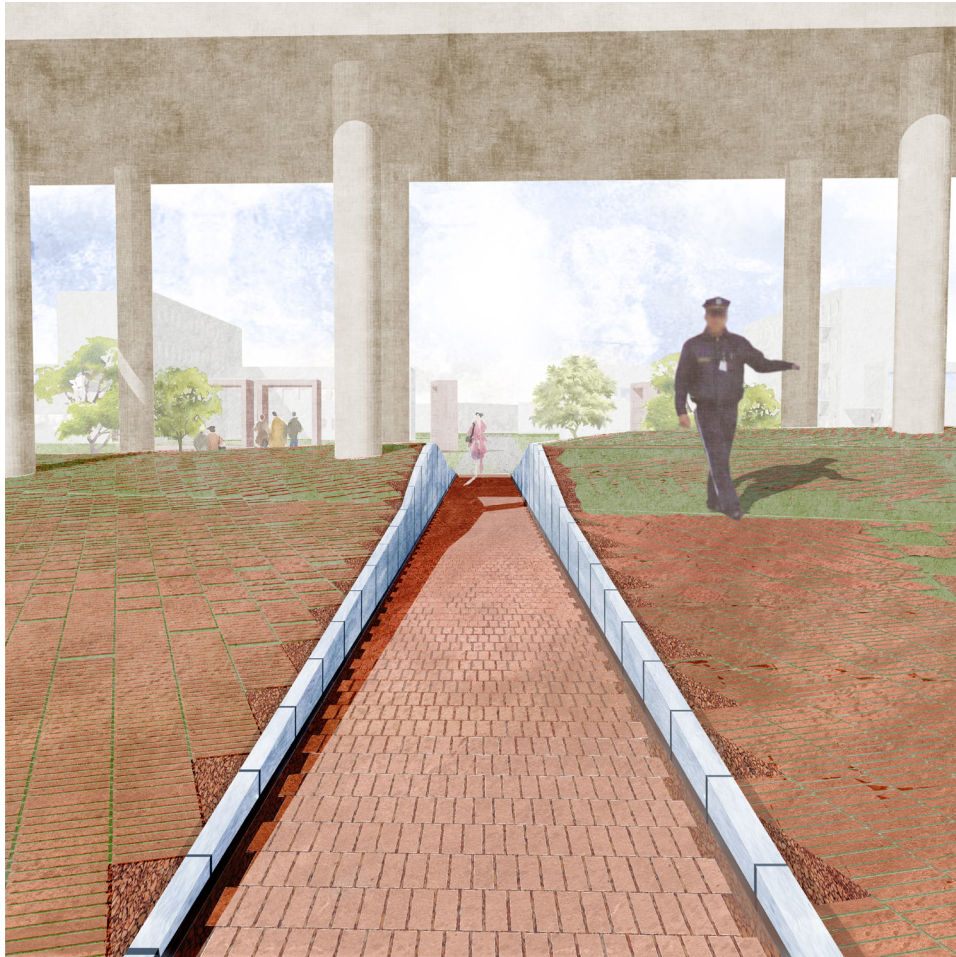

Water feature center of the market,  
Perspective view, drawing by author.

### **The defiant seam**

This example of the defiant seam is a radical narrow cut through the landform situated at the gate. It offers an alternative to taking more indirect routes through the gate which involve engagement with the floor. The walls are clad with sheets of steel painted blue.

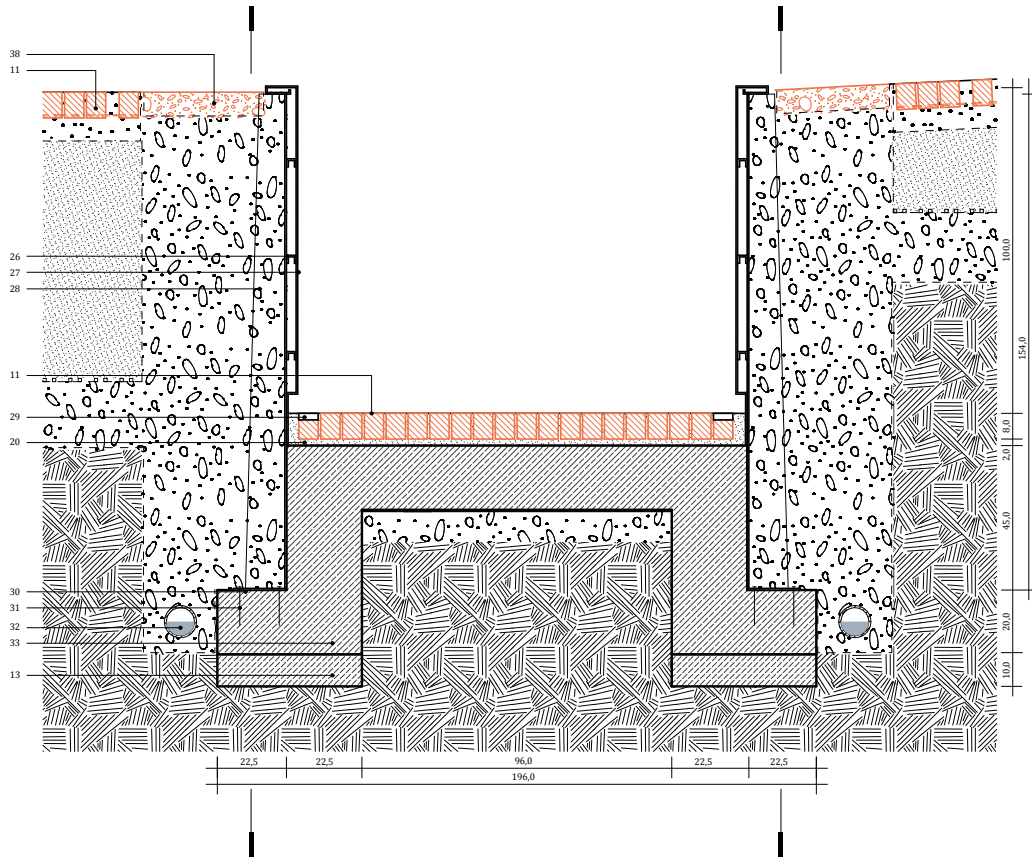

Defiant seam, Gate  
Detail 7, drawing by author.

- 11 clinker paving brick
- 13 lean concrete 10cm
- 20 crushed sand levelling course 250mm
- 26 C-shape profile, securing of the sheeting to the column
- 27 stainless steel sheeting painted blue
- 28 T-shape column
- 29 LED paving brick
- 30 steel base plate
- 31 securing of base to foundation M20 through wall anchor
- 32 drainage pipe 100mm diameter
- 33 prefabricated concrete foundation wall
- 38 crushed clinker brick

Thickening the threshold



## TRANSITION BETWEEN SEAMS

184

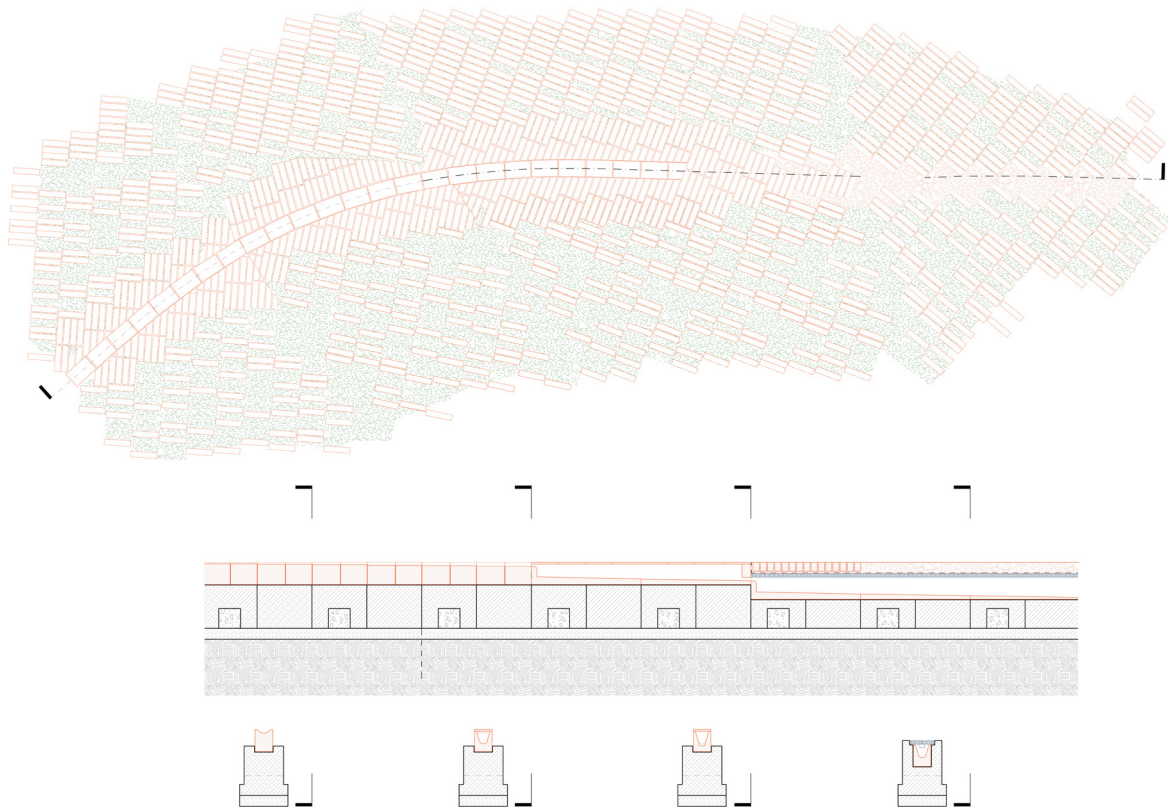

Transition between the accentuating and concealed seams in the non-permeable floor,  
Detail 3 in Section along the retaining wall and plan, drawing by author.

The key detail of the floor is the connection between the two types of seams, where the drainage channel disappears under ground. The line of bricks along the drain channel narrows down until it transforms into a line of crushed clinker.

Thickening the threshold



# WATER CYCLE

## NON-PERMEABLE FLOOR



1 Water collection in the visible and concealed drainage channels.



2 Water is intercepted by underground collection pipes.

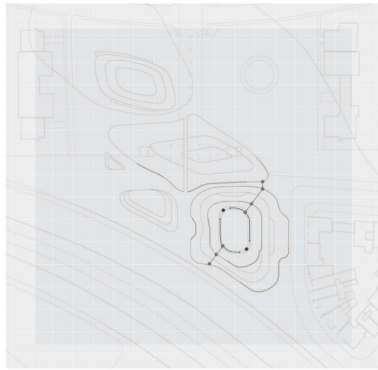

3 Water reaches the main drain surrounding the center of the market and runs down to outlets.

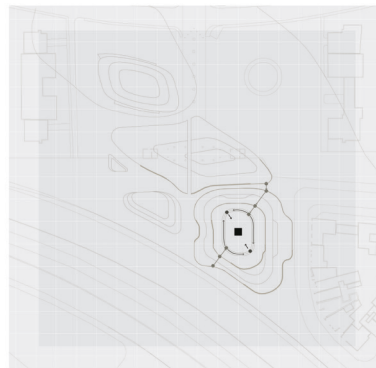

4 Water is passed to the collection tank, cleaned and reused.

## PERMEABLE FLOOR

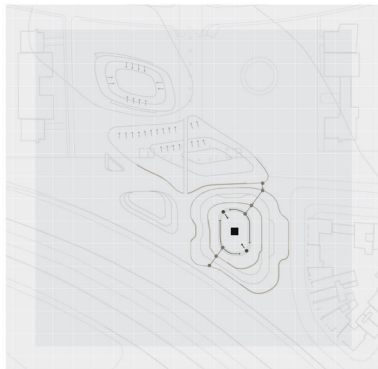

1 In the permeable part of the floor water penetrates down the ground to the layer of gravel and in the layer of gravel travels to the collection point located at the lowest place.

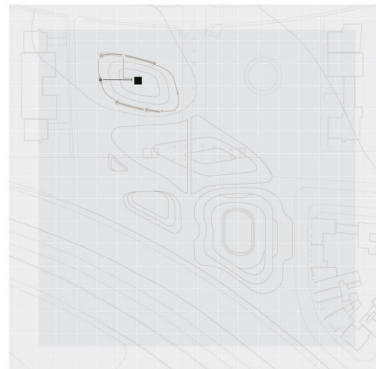

2 Water is passed to the collection tank, cleaned and reused.



Design

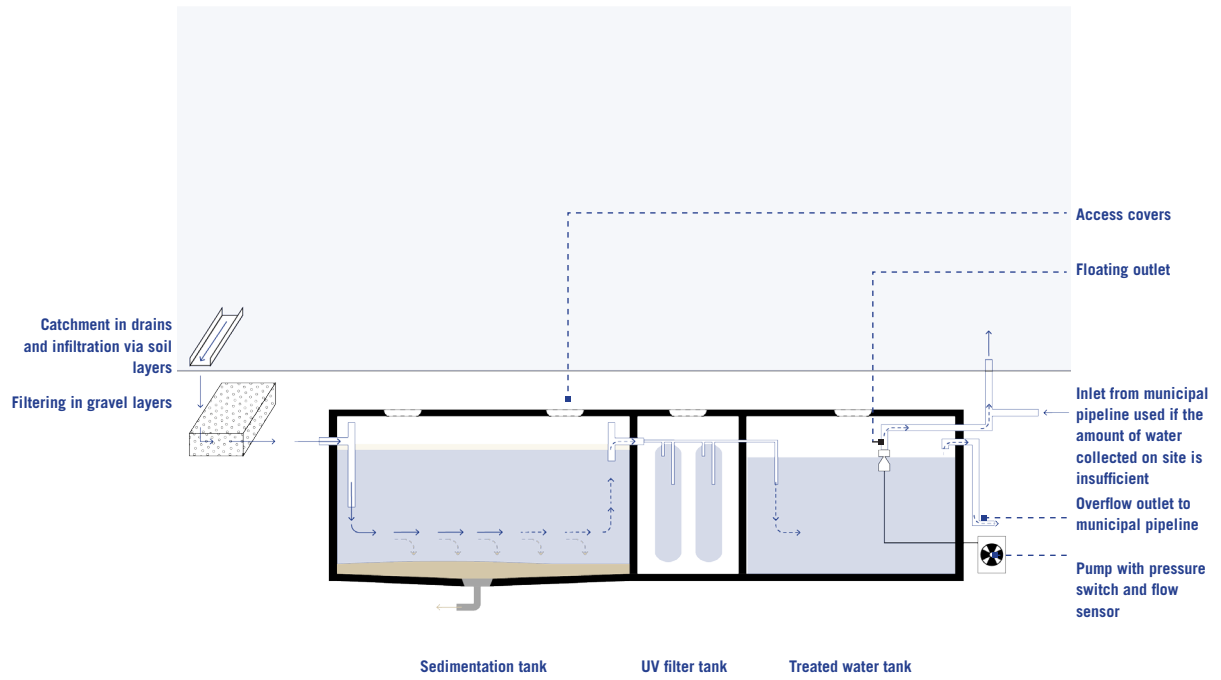

187

Water cleaning diagram, drawing by author.



## PAVILIONS



Location of the pavilions,  
Plan, drawing by author.

## PAVILIONS

### Pavilions and the floor

The key challenge which allowed to draw an outline of the design of the pavilions was their encounter with the floor. In the project for the university entry squares the transition from the curved floor to the orthogonal geometry of pavilions happens through 'both-and' qualities of the pavilions. 'Both-and' concept was defined by Robert Venturi in 'Complexity and contradiction' as a quality of a space which can have multiple readings at the same time. Spatial qualities of pavilions can be read differently when analysed on different scales. The assemblages of pavilions take the shape of gently curved arrays. They form elongated walkways and/or diaphragms. They separate spaces and act as intermediate spaces that activities can be anchored to. Contrastingly individual pavilions are characterized by sharp edges and right angles. They isolate bits of space. The reading of the pavilions as singularities and as elements of assemblages carry through ambiguous messages.

The qualities of material: brick, precast concrete and wood, that the floor and the pavilions are built of, are set in contrast. Material changes from soft to hard, from warm to cold and to warm again, from coarse to fine, from matte to shining to matte, from fragmented to monolithic, from stereotomy to ceramics.

The floor itself is heterogeneous. It is a weave of areas of brick, grass and gravel, which take different shapes. Moreover the brick elements take different shapes. Vertical abutments of the pavilions are admitted into the floor via variety.

The proposed joints admit prefabricated homog-

enous elements. The pavilions can be exchanged with time. The character of the square endures in the joint.

In the first solution of the joint, bricks move apart to give way to the vertical elements. A band of crushed clinker which surrounds the foundation of the pavilions enhances the contrast between the floor and the pavilions. The band of gravel is a coarse, rough surface strongly effected by light and shadow. The solid foundation of the pavilions sinks into it. In another solution pavilions are supported on slightly raised abutments which are perfectly fitted into the brick puzzle. Floor flows around, underneath or through the pavilions undisturbed. In the third solution bricks collide around the incursion.

Simultaneous perception of the multiple levels of meaning involves increased attention and struggles of the observer and deepens his involvement with the environment.

### Pavilions and the gate

The second key guideline for the design of the pavilions was their coexistence with the existing gate. Here the implicit aim was to transform the residual space of the entry square into a positive space.

The size and proportions of the arrays as well as the individual pavilions do not differ significantly from the existing gate pavilion. Pavilions carry the feelings of autonomy, compactness and solidity derived from the current gate.

The elongated curved arrays are preserved in the location of the abutments. In the abutments such qualities as alteration, asymmetry and irregular rhythm are contained.



Cubicle by Calle 26a,  
Perspective view, drawing by author.



Heavy granite column stands directly on lighter paving shattering it. Collonade in Copenhagen.

Steen Eiler Rasmussen, *Experiencing Architecture*, Cambridge, The MIT Press, 1962, pp 26.

Impression as if brick floor was 'sinking' under the weight of heavy granite. Materials were used for structural components without the regard for their properties.

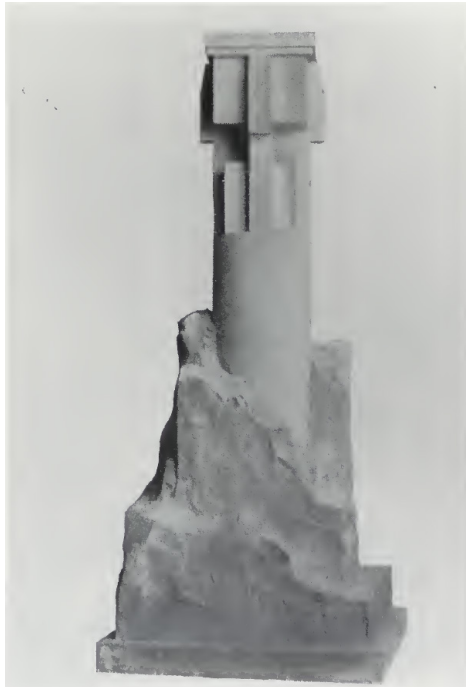

Hermann Obrist, Monument to the pillar, 1898  
Kenneth Frampton, *Studies in tectonic culture*, Cambridge, The MIT Press, 1996, pp 311.



Peter Behrens, AEG turbine factory detail, Berlin, 1909  
Kenneth Frampton, *Studies in tectonic culture*, Cambridge, The MIT Press, 1996, pp 311.

## INSPIRATIONS

### **Case studies which were reflected in the final form taken by the pavilions.**

Centro Cultural Garcia Marquez can serve as a valuable lesson on how to create an impression of gradual immersion in a reality of a building with a rich assemblage of permeable vertical partitions and height differences.

Centro Cultural Garcia Marquez uses an accumulation of layers of the facade to give an impression of depth, surprising exchange between the inside and outside and privacy growing with the number of layers.

The Visitor center in Vijversburg Park strictly follows the topography. As a result the building strengthens the expression of the uneven floor. Studying this building has brought the possibility of creating a dialectic relation between the floor and the pavilions to my attention. It has prompted experiments with forms following the landscape, colliding with it, indifferent to it, inspiring a whole series of possible design approaches.



Centro Cultural Garcia Marquez, Bogota,  
photograph by Iris van der Helde.



Visitor center in Vijversburg Park  
photograph source: internet.



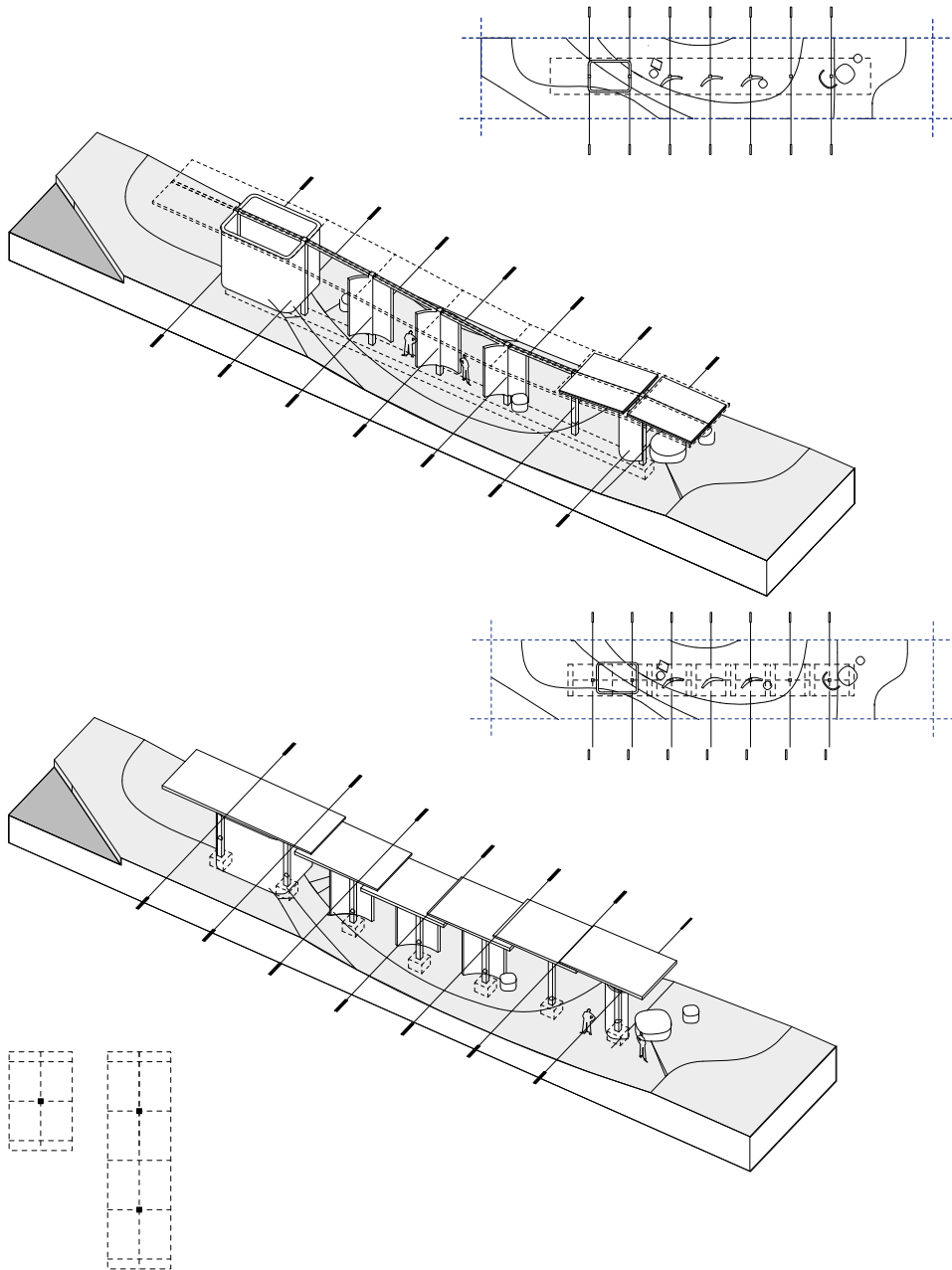

Experiments with modular system,  
drawing, by author.

## ENCOUNTER WITH THE FLOOR

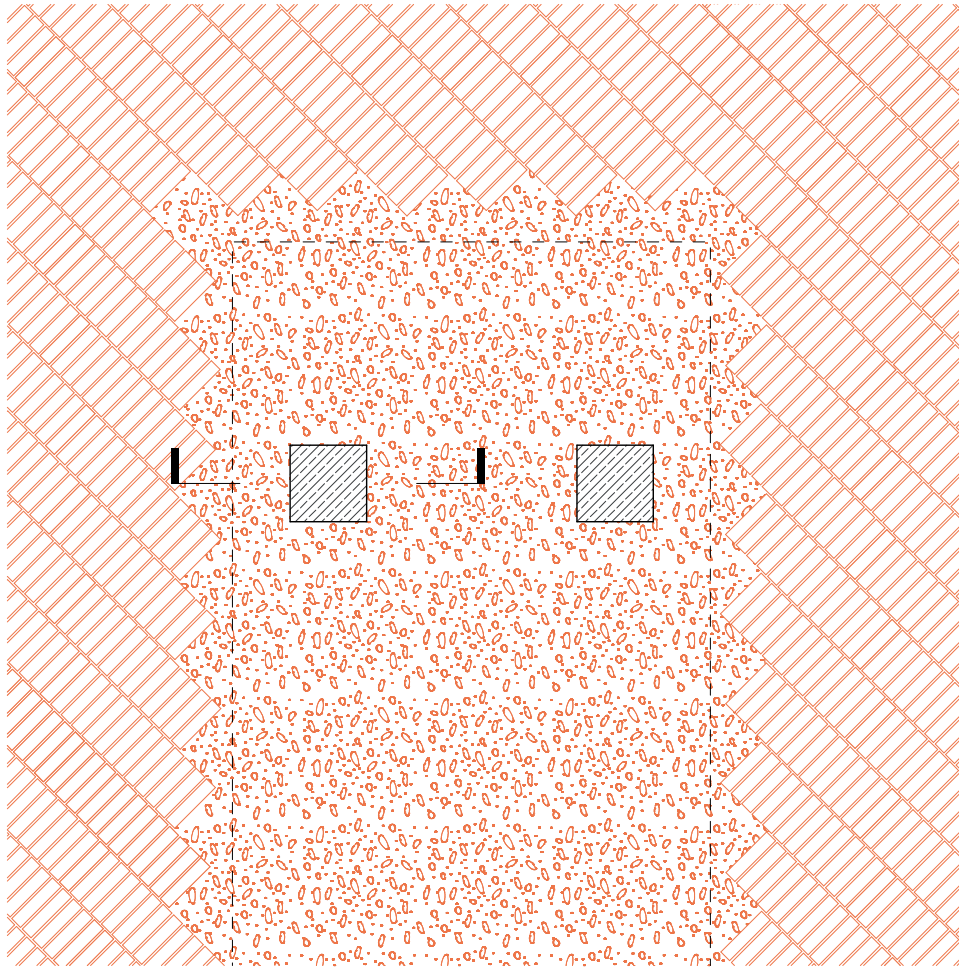

196

Detail 5, Pavilion foundation plan, drawing by author.

The continuity of paving is interrupted. Shape of the pavilion is reflected in the floor in a 'shadow' filled with crushed clinker.

Detail of the lifted bottom slab shows the foundation which can be disassembled and a light which would reveal the horizontal lines at night.

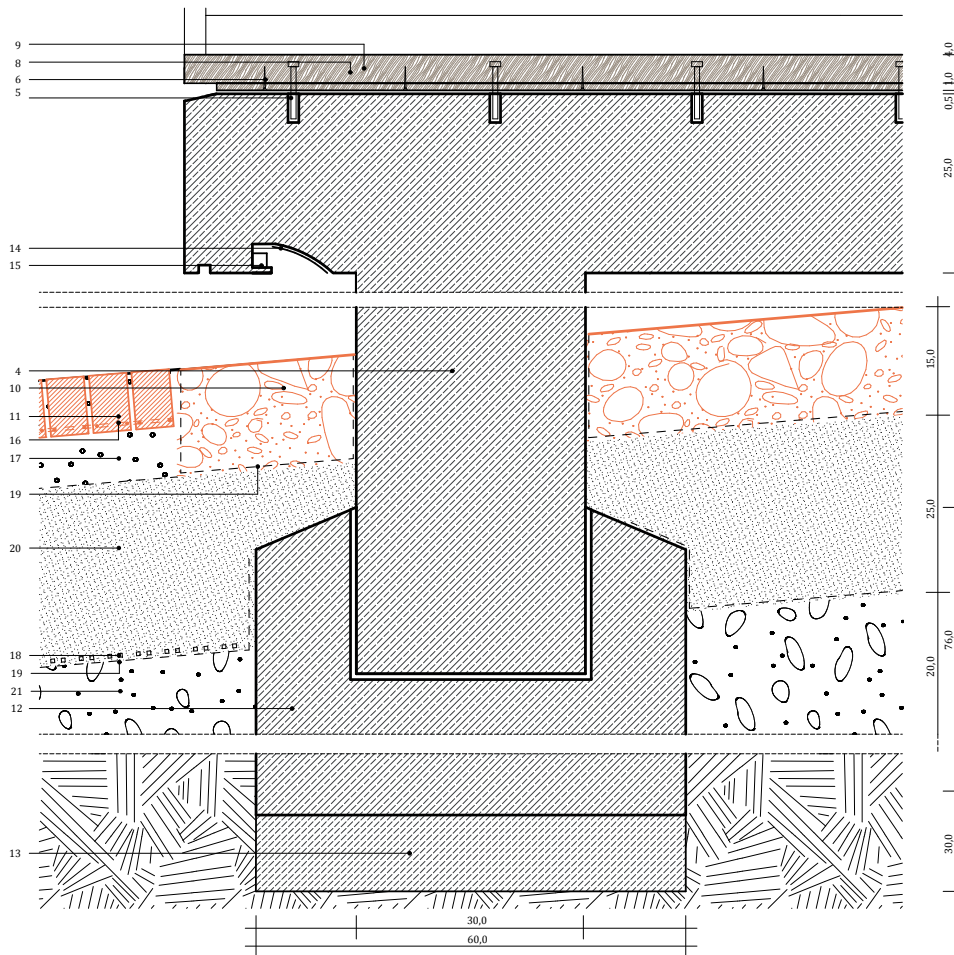
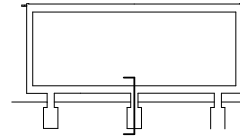

Detail 5, Pavilion foundation, drawing by author.

- |  |   |
|--|---|
| <p>4 prefabricated concrete frame beige aggregate (varying cross section)</p> <p>5 anchor with hex bolt in epoxy</p> <p>6 "lathead wood screw with slot 70mm</p> <p>8 wooden board 10mm</p> <p>9 wooden batten 30x70x200mm</p> <p>10 clinker drainage channel</p> <p>11 clinker paving brick</p> | <p>12 foundation foot prefabricated concrete</p> <p>13 lean concrete 10cm</p> <p>14 mirror</p> <p>15 LED linear light</p> <p>16 synthetic grid of the clinker fabric</p> <p>17 hummus 150mm</p> <p>18 triaxial monolithic geogrid polypropylene</p> <p>19 geotextile</p> <p>20 crushed sand levelling course 250mm</p> <p>21 gravel 200mm</p> |
|--|---|

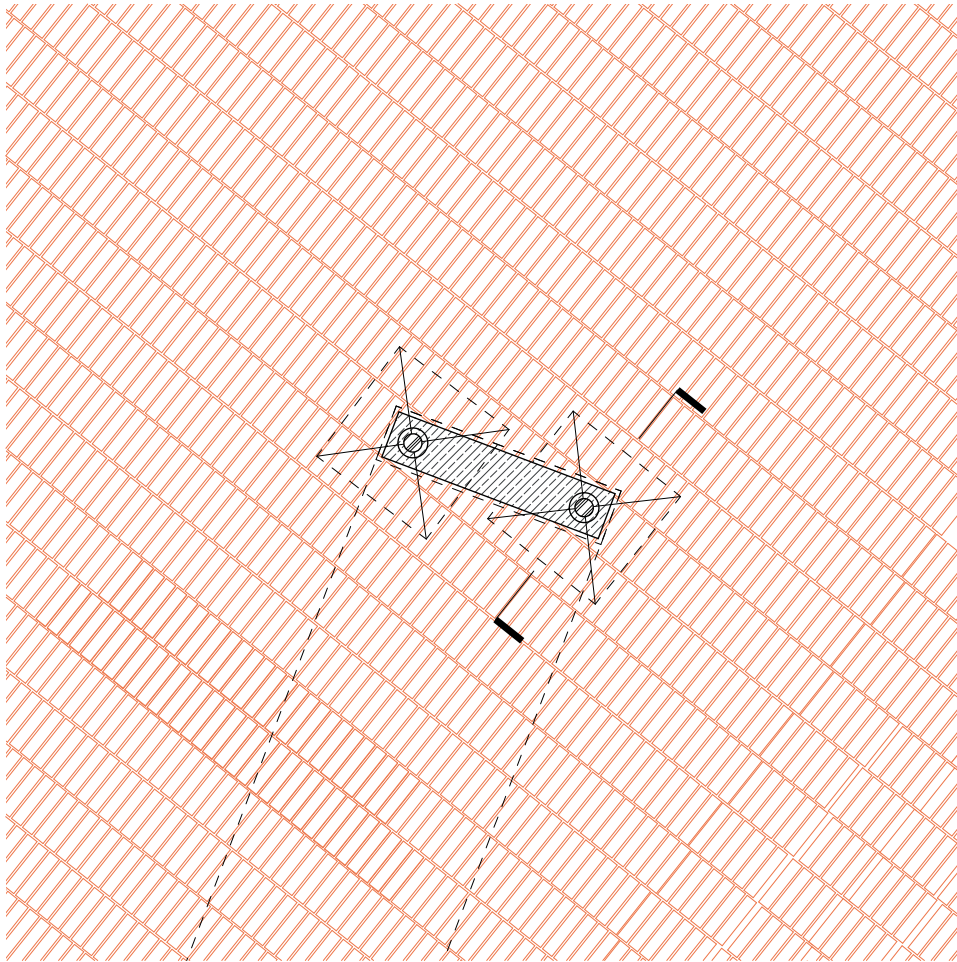

Detail 15, Pavilion foundation plan, drawing by author.

The continuity of paving is not interrupted. This is achieved with the use of a round steel pipe around which the column can be rotated.

Design

ARCHICAD WERSJA ED

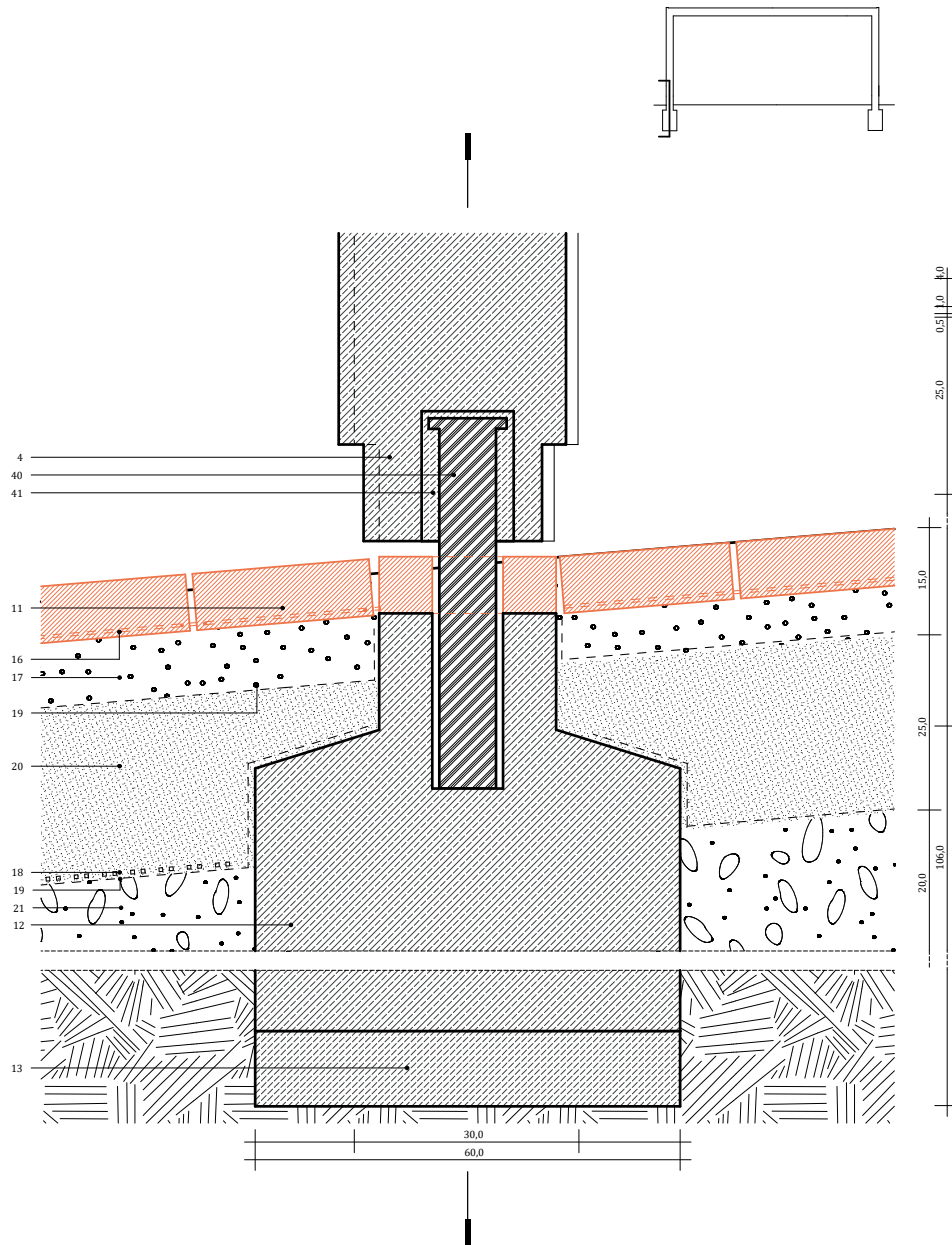

199

Detail 15, Pavilion foundation, drawing by author.

- |    |  |    |  |
|----|--|----|--|
| 4  | prefabricated concrete frame beige aggregate (varying cross section) | 19 | geotextile                             |
| 11 | clinker paving brick   | 20 | crushed sand levelling course 250mm    |
| 12 | foundation foot prefabricated concrete                               | 21 | gravel 200mm                           |
| 13 | lean concrete 10cm   | 40 | steel pipe profile $\varnothing 80$ mm |
| 16 | synthetic grid of the clinker fabric                                 | 41 | structural grout                       |
| 17 | humus 150mm  |    |  |
| 18 | triaxial monolithic geogrid polypropylene                            |    |  |

Thickening the threshold

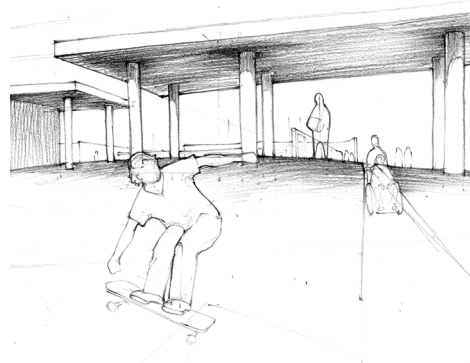
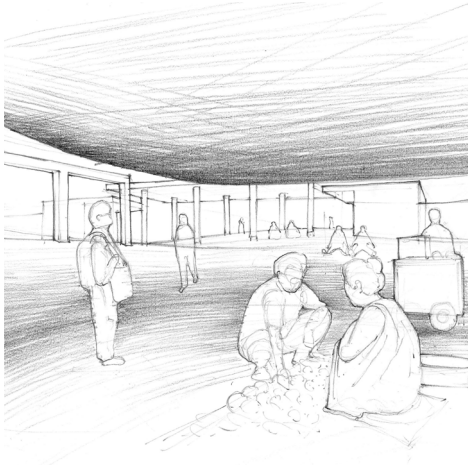

200

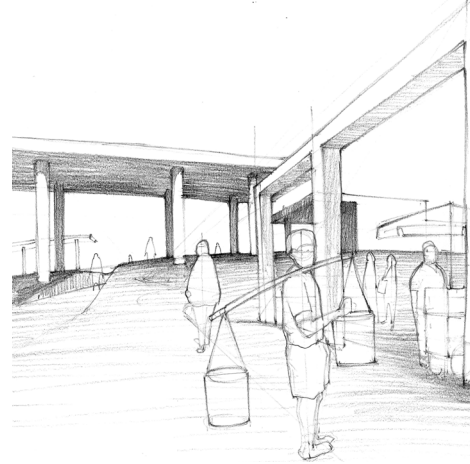
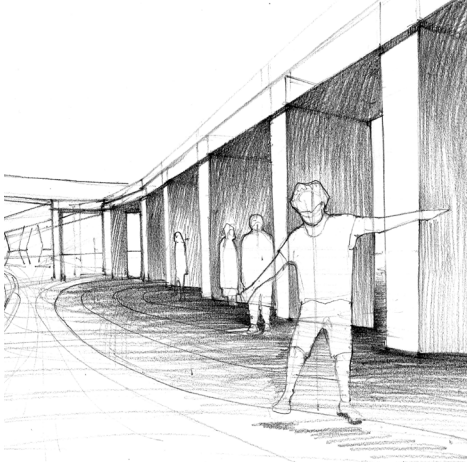

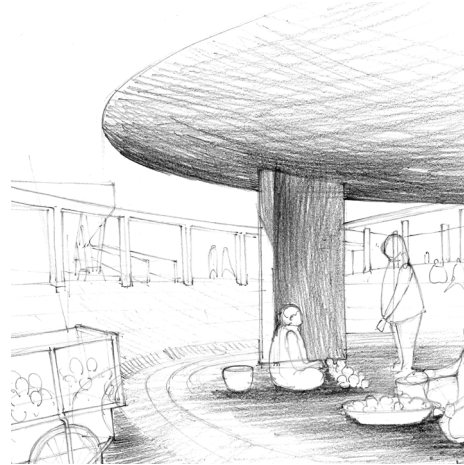
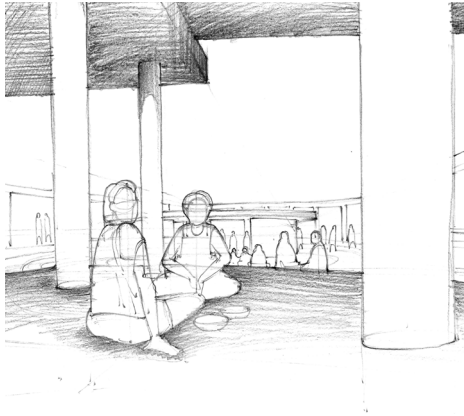

Search for desired spatial effects which could be achieved by placing pavilions in certain configurations,  
Plan, drawing by author.



## TOP DETAIL

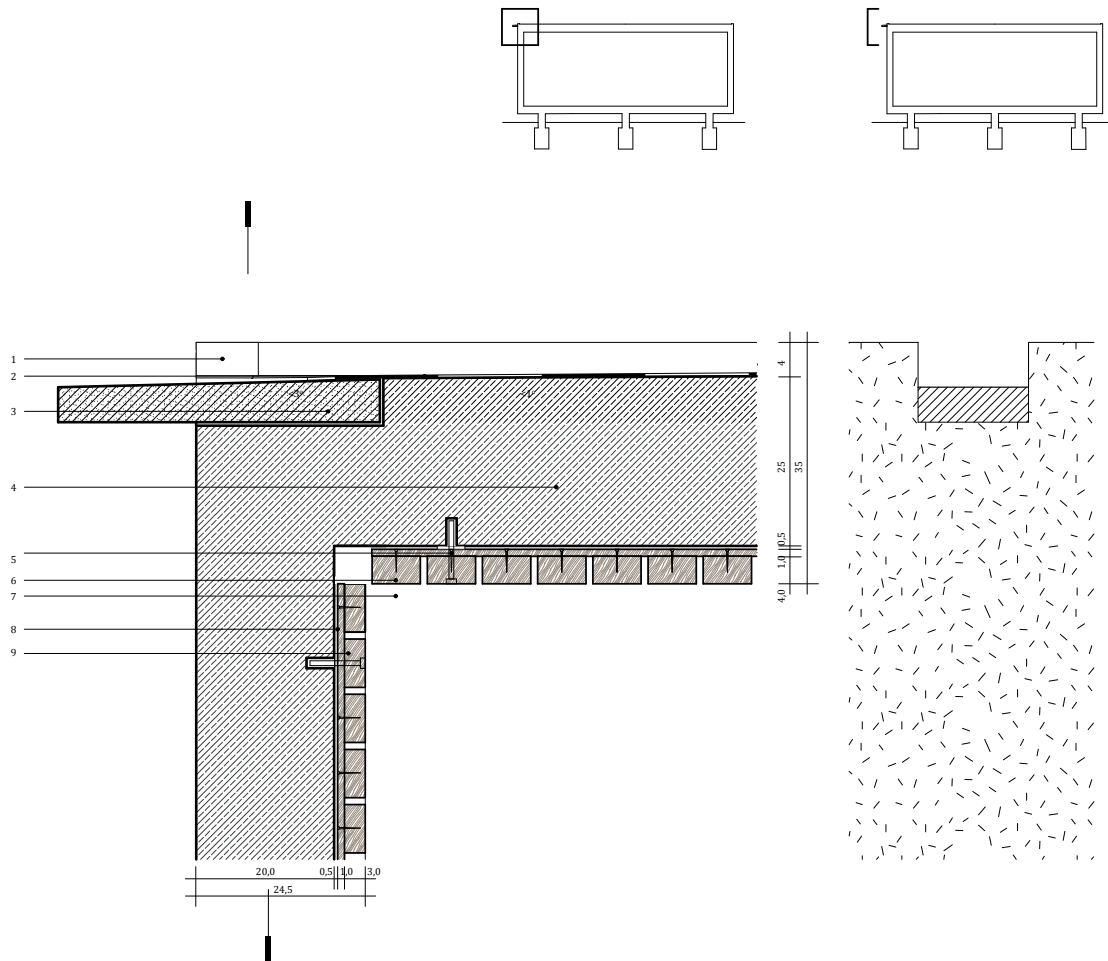

202

Detail 4, Pavilion top, drawing by author.

The top edge is also very sharp and flat. It is only broken by the intruder - gargoyle.

- 1 2.5mm aluminium sheet metal anodized
- 2 EPDM foil
- 3 natural stone gargoyle
- 4 prefabricated concrete frame beige aggregate (varying cross section)
- 5 anchor with hex bolt in epoxy
- 6 "lathead wood screw with slot 70mm
- 7 wooden batten 40x70x200mm
- 8 wooden board 10mm
- 9 wooden batten 30x70x200mm



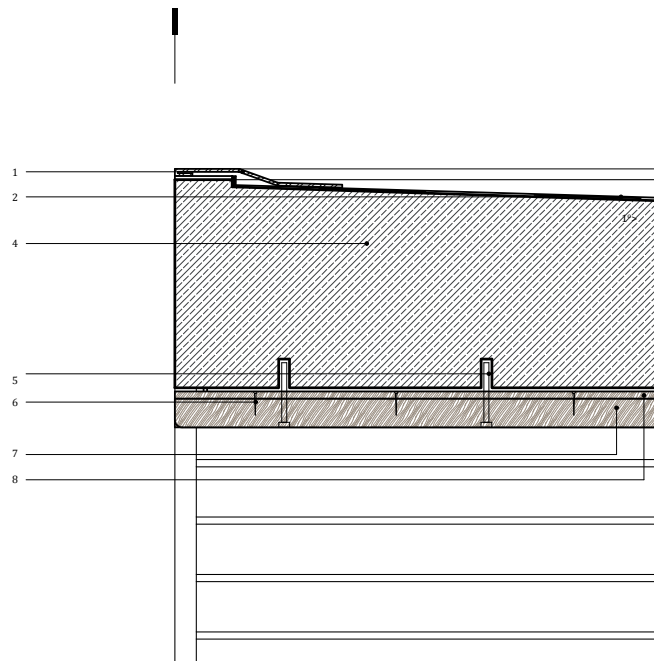
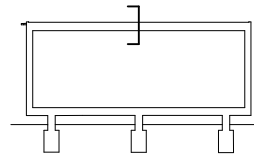

Detail 4, Pavilion top, drawing by author.

- 1 2.5mm aluminium sheet metal anodized
- 2 EPDM foil
- 3 natural stone gargyle
- 4 prefabricated concrete frame beige aggregate (varying cross section)
- 5 anchor with hex bolt in epoxy
- 6 "lathead wood screw with slot 70mm
- 7 wooden batten 40x70x200mm
- 8 wooden board 10mm

## MODULAR SYSTEM

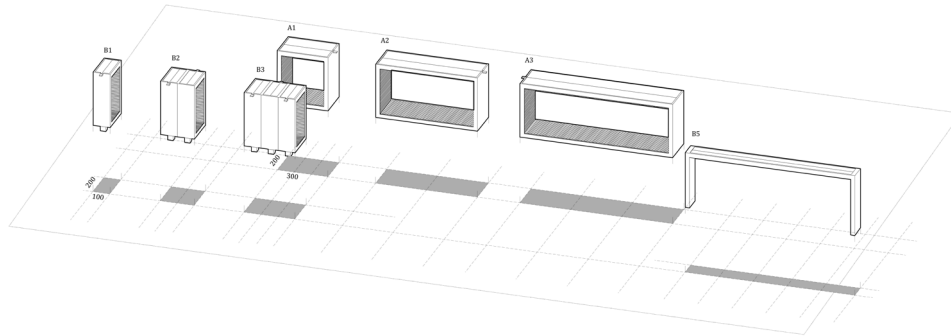

Modular system, drawing by author.

The pavilions built upon modules where the dimensions of bigger elements are a multiple of the dimensions of the smallest module hence they can easily be assembled into arrays.

204

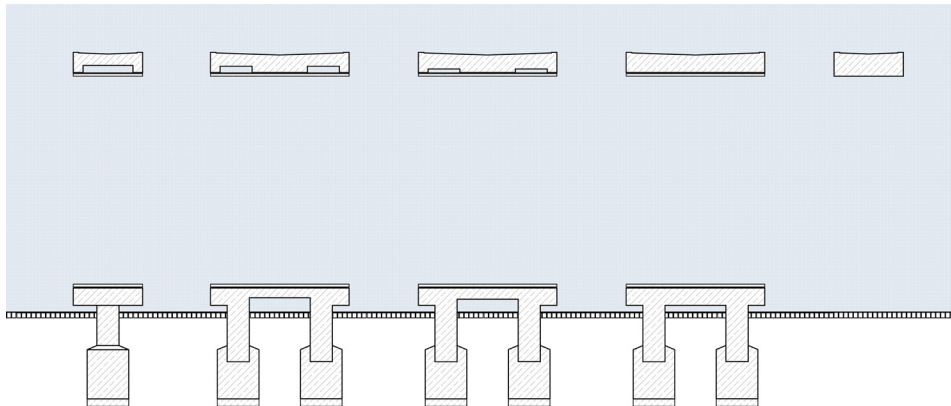

Modular system, drawing by author.

I have achieved the ambition of the continuous sharp horizontal lines suspended over the expressive floor with modifications of thicknesses of prefabricated ceilings and floor behind the front beams of equal height.





## CONCLUSION

## CHALLENGING THE STRATEGY

Having designed the entry square at Calle 26, I wanted to challenge the strategy of thickening the threshold.

In order to do that I decided to design the square at Carrera 45.

The entrance at Carrera 45 is located in the more remote part of the campus. The entry square is knitted on a very long funnel leading to the center of the campus.

Conclusion

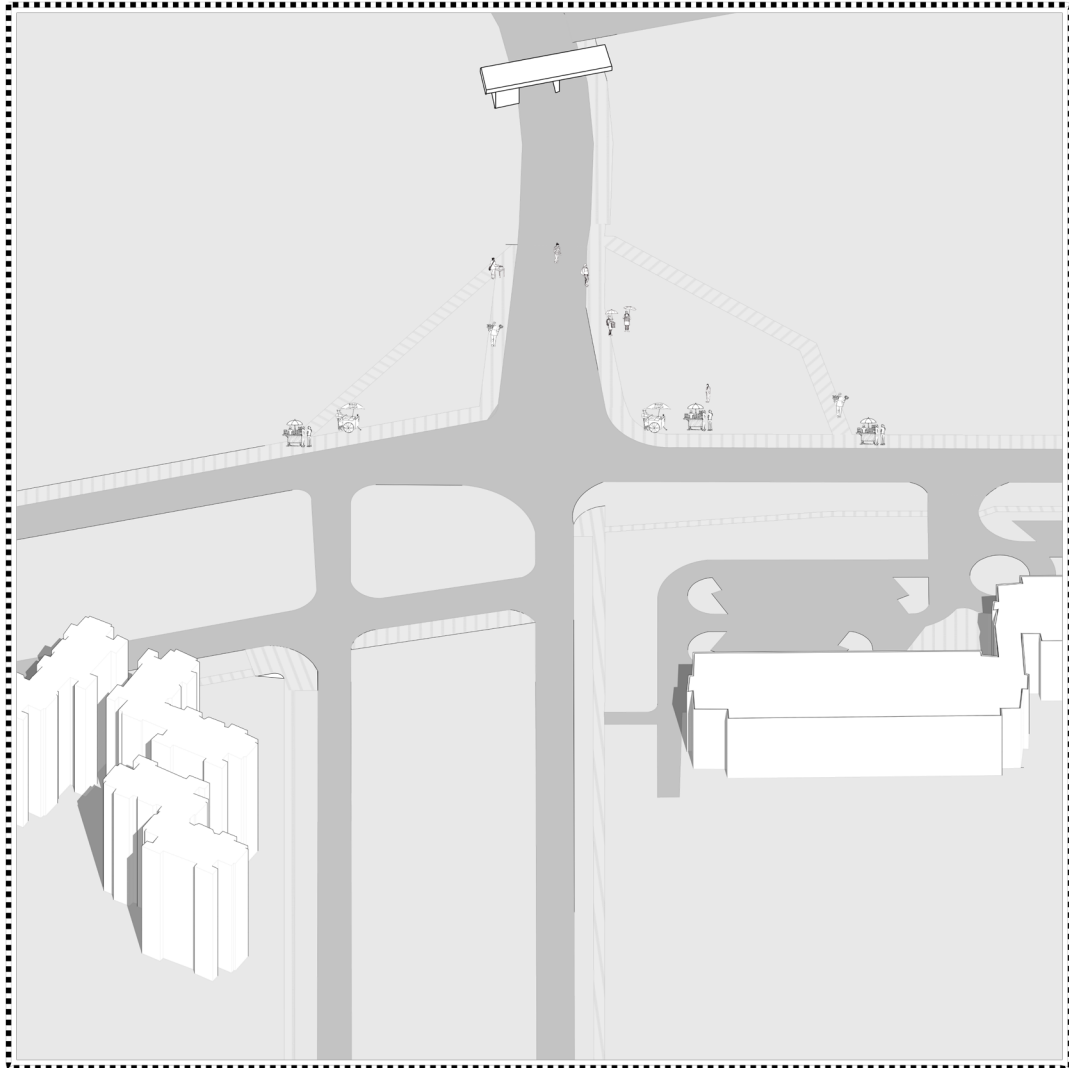

Axonometric drawing  
Scale 1:1250

## COMPONENTS OF THE STRATEGY

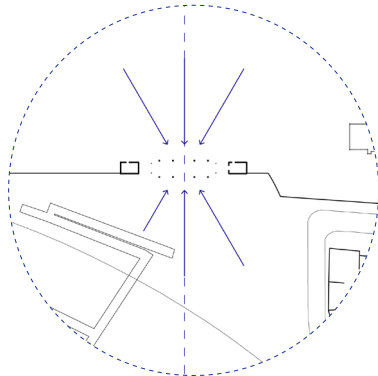

GATE AS THE ATTRACTOR

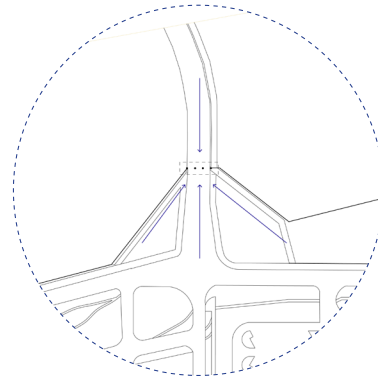

GATE AS THE CONCLUSION

210

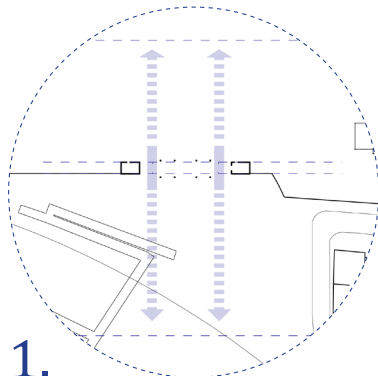

**1.**  
EXPANDING TO INSIDE AND OUTSIDE

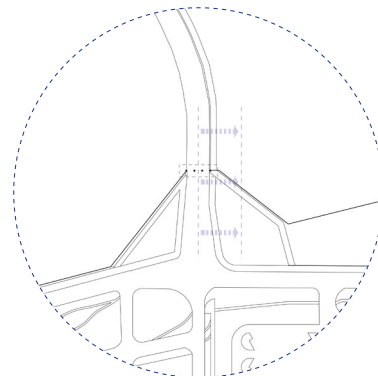

MOVING THE CENTER  
The centrality can be broken. The perceivable center of the space can be moved from the gate.

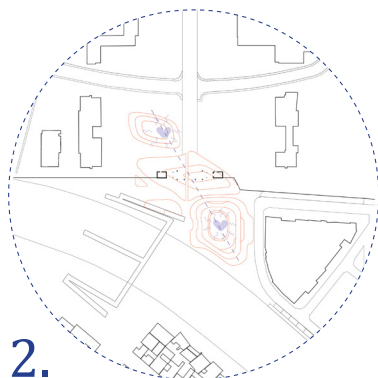

**2.**  
DIAGONAL  
Deviating the axis perpendicular to the fence. It is different to approach the gate from the front then along a slightly leaning line.

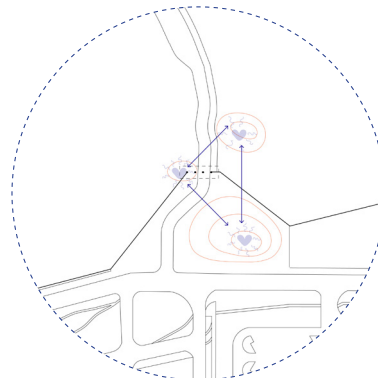

OPEN COMPOSITION  
Moving the axis beyond the gate. Creating a composition that puts the pavilion of the center. Shifting the attention. Composition which can be multiplied along the fence.



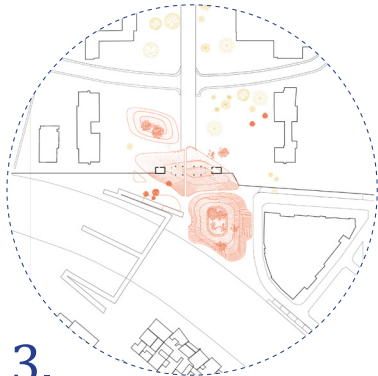

**3.**

**GRADIENT ACROSS THE FENCE**

Gradient of two materials blurring the transition and defying the division of space into functional subspaces.

**GRADIENT ALONG THE FENCE**

Paving is laid in a gradient which dissolves the vehicular road and the narrow passage of the gate.

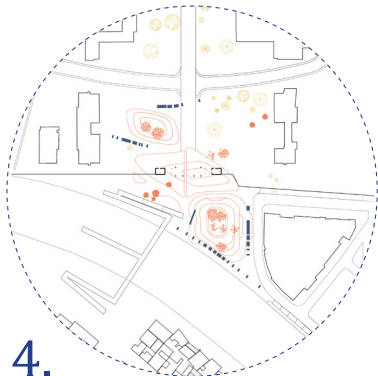

**4.**

**GATE AS ONE OF COULISSES**

A more balanced composition can be created, that the entry pavilion is a part of.

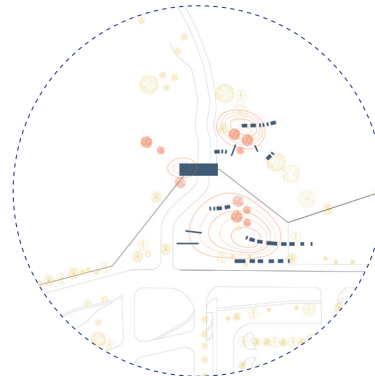

**GATE AS ONE OF EPISODES**

Changing the frontal perception of the gate pavilion by thirding it with other small buildings.

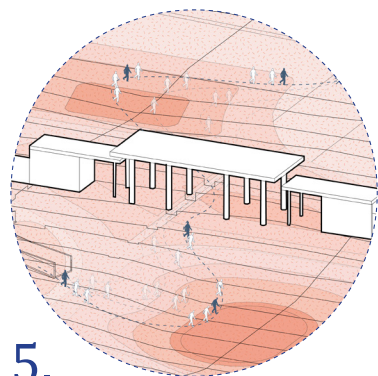

**5.**

**DVERTING  
LURING  
RELEASING**

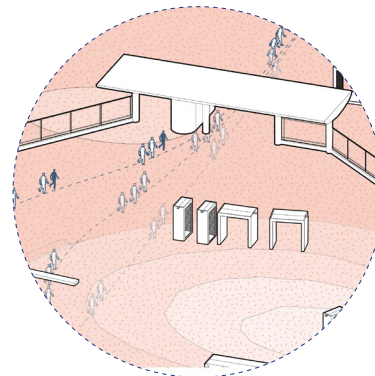

**OBSTRUCTION**

# ENTRANCE BY CARRERA 45 PLAN

212

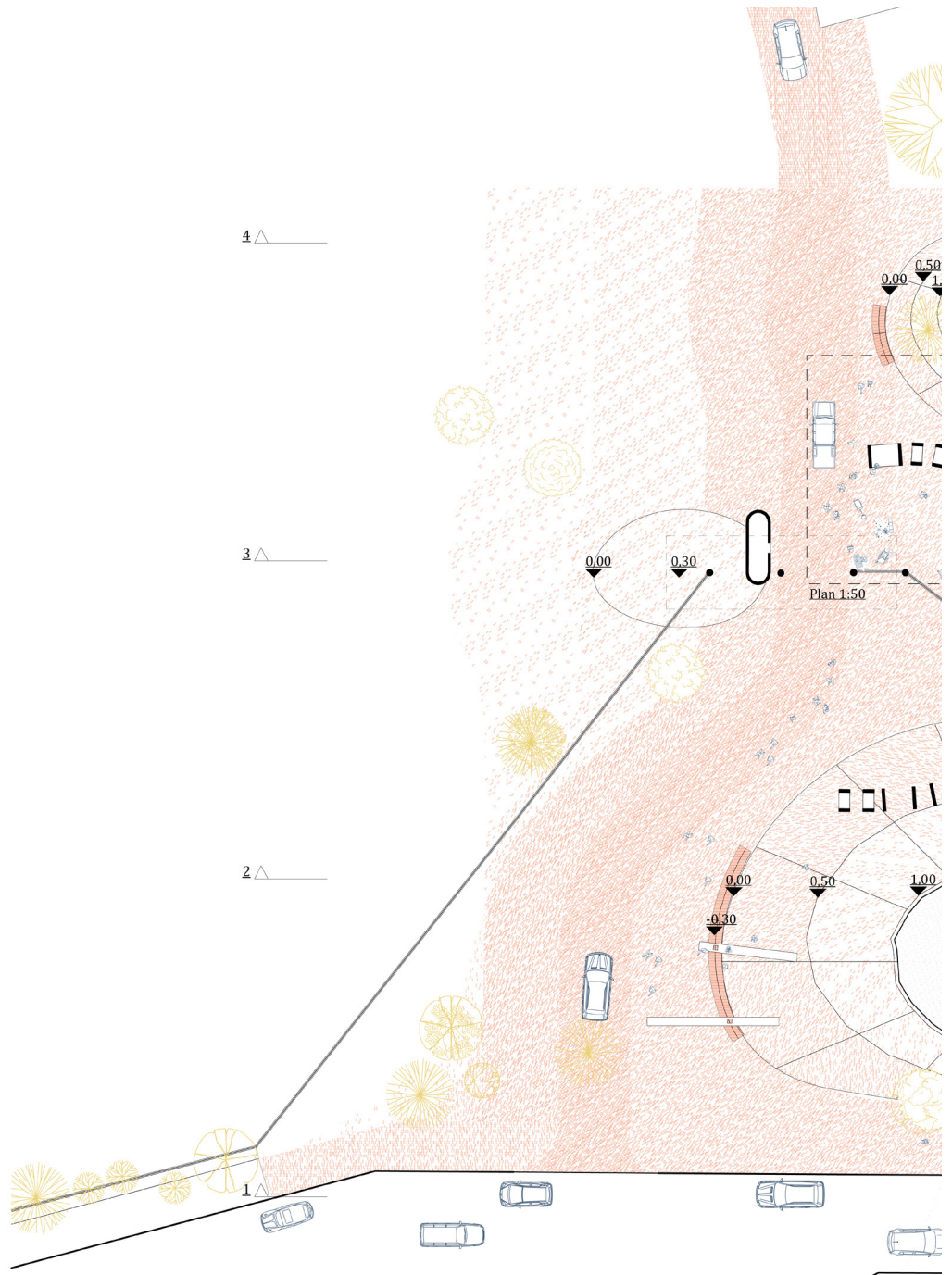

Plan entry square by Carrera 45,  
Not to scale, drawing by author.

Thickening the threshold

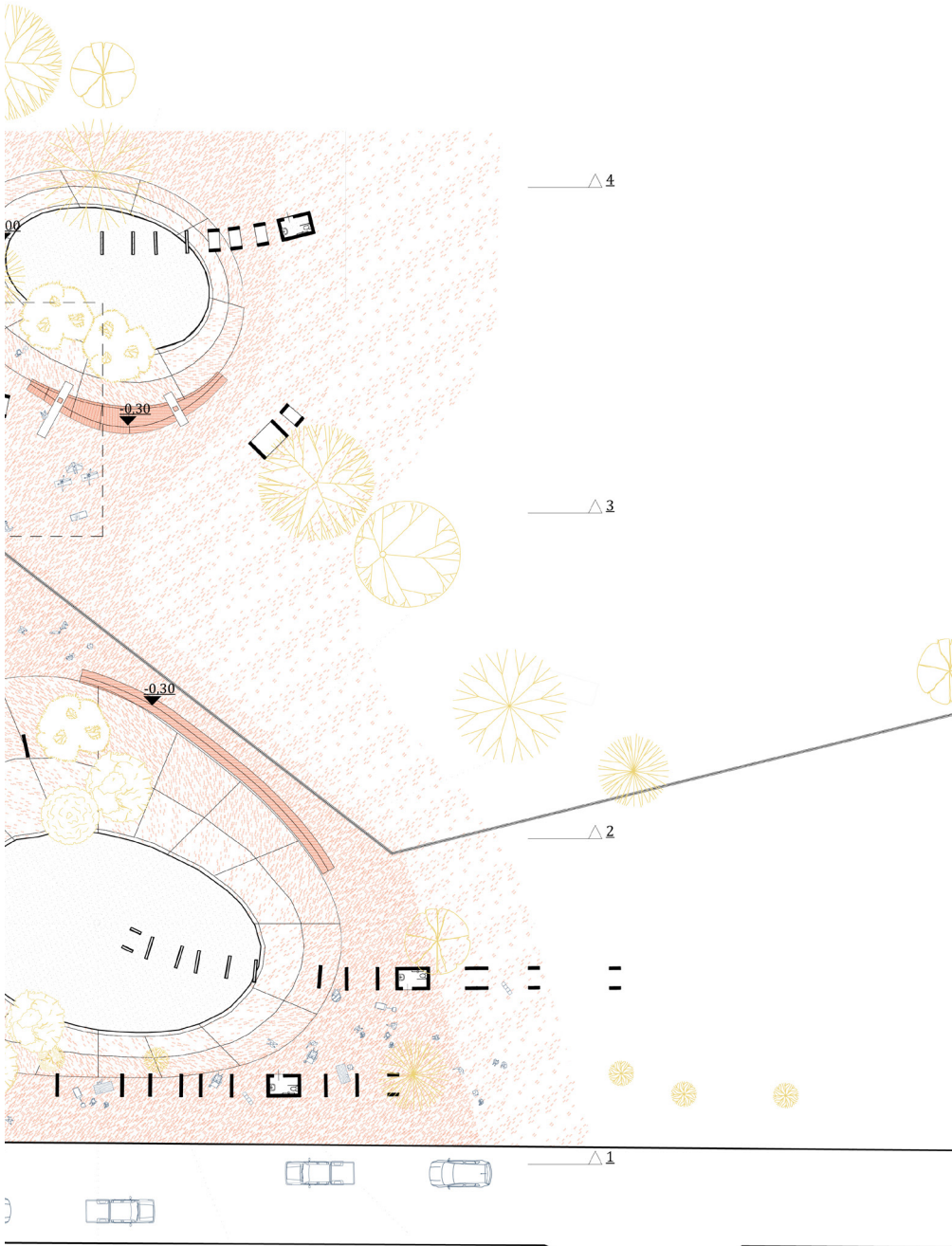





Conclusion



Entry square by Carrera 45  
Perspective view, drawing by author.

## A MANIFESTO OF A THICKENED THRESHOLD

216

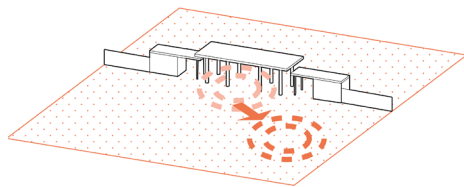

**1.**

The center of a thickened threshold does not lay at the gate.

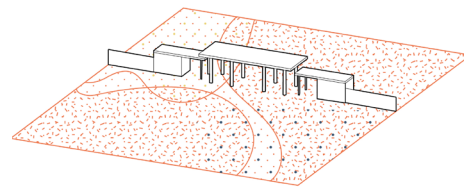

**2.**

A Field condition

In a thickened threshold functions are not represented in or assigned to specific spaces. A thickened threshold questions the idea of dividing space into functional sub-spaces.

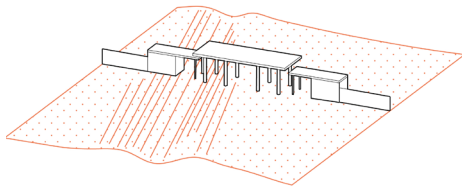

### 3.

#### Continuous gestures

of Folding, creasing, draping, cutting and weaving used upon the surface to transform it into a thickened threshold.

These gestures, when used upon the continuous fabric of the floor, have effects transmitted over large portions of the fabric. The gate, although limited in size can be changed by introducing changes in other distant parts of the fabric.

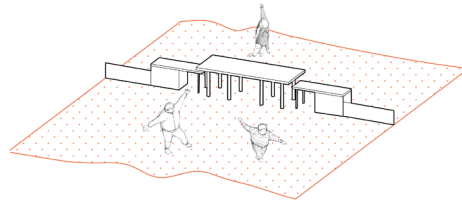

### 4.

#### Unlocking the vertical dimension

In a thickened threshold unlocking the vertical dimension influences the bodily perceptions of the user and the reactions of his body.

217

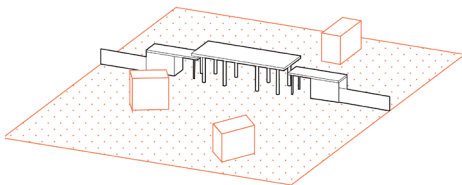

### 5.

#### Thirthing

In a thickened threshold the perception of the gate as the dominating built structure is changed by raising pavilions which capture the body and the sight of the passer-by while walking. The thickened threshold is a surface where many activities are enacted. Crossing the gate is of them.

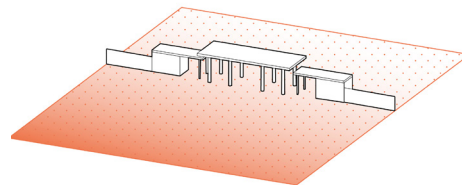

### 6.

#### Gradient

In a thickened threshold material is applied over the whole surface in a gradient pattern. Gradient merges the forms smoothly with one another. Changes of intensity and variety are achieved with gradient.





## APPENDICES

## REFLECTION

### 1| Fieldwork

In September 2018 I have travelled to Bogota - the capital of Colombia with a group of Methods & Analysis students and teachers. During the trip we have been hosted by the students and professors of two Bogotan universities: Universidad de Los Andes and Universidad Nacional de Colombia. The Bogotan students were kind and hospitable to guide us around their city and necessarily my impression of Bogota was that of a student.

We have spent most of the time in Bogota in Teusaquillo – a downtown district which is also a student district due to the presence of the biggest Colombian university – Universidad Nacional de Colombia.

During the trip to Bogota I have repeatedly visited the campus of Universidad Nacional de Colombia. As a visitor only I was condemned to experience mostly the outdoor spaces of the campus. What evoked my biggest interest after these visits were the peripheral areas of University campus.

While still in Bogota I have gathered photographic documentation, conducted interviews with students of the university among them Daniel Bernal. I have tried to absorb knowledge about the recent history and the current affairs of the university. Most importantly I tried to observe the daily life around the peripheries of the university.

### 2| P1 Group work in collaboration with Isabel Ulbrich and Danlei Huang

During the first part of research, we were encouraged to put our individual interests aside and research a shared topic. Me and my group mates

were drawn to work together by an interest in the manifold instances of disjunction in the city. Isabel had observed the impoverished condition of the city floor and some of its buildings. Danlei was interested in the neglected pieces of land in the middle of the streets. And I held an interest in the boundary of the university.

We have performed our analysis under the umbrella name of urban commas, understood as places where some elements of a city are interrupted but some level of continuity is maintained.

The analysis included conceptual, disciplinary and contextual aspects.

The contextual analysis was performed mostly with tools such as mapping and drawing impressions of the sites. We conducted the conceptual analysis by researching literature about punctuation and applying the metaphor of punctuation to architecture. Lastly the part of disciplinary analysis was analysing case studies located in boundary areas through preparing plans, sections, axonometric views of sites and case studies.

This analysis has allowed me to realize that an investigation can deliver highly nuanced results when the concept, chosen as a lense to investigate it, is equivocal and intriguing. Looking at the entry squares as commas has sensitized me to multiple properties of the entry squares, which I would not have thought of, if I were to think of the entry squares as 'full-stops'.

The most valuable result that the analysis of commas has yielded are the multiple observations of the patterns of use of the entry squares. Moreover, I was able to draw broader conclusions about the influence of voids, lacks, absences on the in-habitation of space. Nevertheless, I think that in this part of the investigation I could have spent more time analyzing urban conditions of the formation of

urban commas as well as their forms.

### 3| Probing into Precedents

My interest in the university was invigorated by the seminar Probing into Precedents. For the seminar I have worked with Alexander Petrounine. We have analyzed Plaza Che - the central plaza of Universidad Nacional de Colombia.

I was given a chance to see the peripheral entry squares in a broader light – in comparison with undeniably the most central representative space of the university.

During this course I have learnt a lot about the subtle nuances which bring a public space to life. I realized that a multitude of circumstances must correlate in a space for it to afford many uses successfully. These circumstances include qualities of architecture but also accumulated memories and a program that is inspiring instead of stiffly determined. This positive example has become a subconscious model of a lively public space, which I had the ambition to replicate near the boundary of the campus.

### 4| P1-P2 Individual work

#### Site

The first part of the individual work which I did after P2 aimed at a better understanding of the entry squares. I analyzed the entry squares through a disciplinary lens and looking at different species of pauses.

This stage of research I tried to focus my attention on the very inconspicuous architecture of the entry pavilions. On the contrary, the unexpected modes of use and appropriation have always taken over my attention. This investigation has led me down winding paths in strange directions. It was very difficult to make conclusions from this part of analysis less specific than about the sites themselves.

I concluded this part of research by sketching a draft of a design assignment for myself. I decided to design at the 4 main entrances of university campus. I wanted to formulate a strategy for an intervention on the threshold of the university campus.

#### Conceptual shift and forming the design approach.

This assignment has gone through many modifications as I gained more experience and a renewed understanding of the context of my task in the architectural discipline.

I think that the first important conclusion which has set my project on a path was to abandon the attempts of strengthening or clarifying the connection of the campus, across the highways leading to the city. This conclusion followed a

reading of Georg Simmel's essay 'Bridge and door'. In this work Simmel points out that whenever one attempts to overcome an obstacle by building a form, the division is confirmed.

During this part of work I seemed to sit in a chair of a person who needs to evaluate whether the division between the university and the city should be maintained or torn down. However this is a question I would neither be able to give answer to nor it is something that an architect should find himself responsible for. Hence I decided to exclude that question from my investigation.

I realized that instead of attempting to make crossing the boundary easier there might be something I can do to enable dialogue between the sides.

At that stage of my research, I came across Klaske Havik's book 'Urban Literacy'. Klaske uses a metaphor of 'thirding' which she borrows from Edward Soja. In 'Third space' Edward Soja describes 'thirding' as a critical strategy. He argues that rather than thinking in binary opposites it is intellectually productive to add a third term, which provides a new balance.

A reading of some of Soja's work has made me realize that the problem of the boundary between the university and the city is precisely the problem of thinking in dualities, opposites, antagonisms. Such thinking is what brings divisions to life.

My first decision, aimed at stepping aside from this unproductive thinking, reaches as far in the past as the visit to Bogota and the observation of the rich vendor activity at the university gates. Vendors have recognized the peripheries of the campus as places where they can conduct their businesses successfully. They are making use of the space, light and the proximity to everyday activity of the university.

This discovery has inspired me to design for the vendors. I began to think that enhancing their activity can improve the peripheries of the campus.

The second idea that has helped me step aside from the univocal understanding of the boundary was threshold architecture. Thresholds are spaces of dual nature. Their state changes from open to closed. Ambiguity is at the essence of the meaning of threshold. Thus threshold escapes symbolic and customary meaning.

The first proposal which I prepared has been an intuitional response to many feelings I had about the sites and the smaller and bigger problems which I have noticed.

This proposal has received criticism from my tutors. It was brought to my attention that a project based primarily on immediate responses to the problems of the site is not capable of capturing the issue of urban boundaries. Moreover following this

path would certainly not be the most interesting design trajectory.

Following this criticism I took a step back and revised the work which I have done until this point. I extracted the values and concepts which have been most important for me. I decided to put the concept of thickened threshold at the core of my project.

Thickened thresholds have been a part of my research for sometime but not until this point did I conduct a deepened research of this subject. Through this research I managed to learn a lot about how architects have tackled the often overlooked theme of in-between spaces.

The design proposal which I have prepared for the P2 presentation was an attempt to utilize some of the observations of thickened thresholds on the 4 main entry squares of the campus.

### 5| P2-P3 Individual work. Research and design

At the beginning of MSc 4 I was confronted with the task of translating the findings of my research into an architectural task. I had many ambitions and what seemed like many possible tools at my disposal. The first weeks of MSc 4 have been a time of persevere struggle to find a way to proceed.

The first important advance came unexpectedly with an realization that in the light of the lack of defined boundaries and architectural substance the most abundant and possibly most productive element of the spaces, I am dealing with, is the floor.

This realization has allowed me to focus on one element and to explore its potential of generating activity and enriching the experience of crossing the gate.

Determining the tool has set a path for investigation of the public spaces where the floor has taken a primary role. I was fascinated with Piazza del Campo in Sienna. It is a space where the floor is inspires and hosts the activity. Neither the facades of the surrounding houses nor the monuments are as important as the floor. The ground lowers down towards Cappella di Piazza slowly and unevenly. People sit just about anywhere on the incline.

With the knowledge extracted from the case studies analysis, I began modifying the topography of the squares. My intent was to make every visit to one of the squares more nuanced and non-repeatable. I was hoping that the gesture of inclining the floor across the gate could expand what is perceived as the space of the gate.

Designing by dividing was inadequate for the case of a public space. Hence instead of dividing the surface into parts devoted to one activity or another I decided to distribute stimuli. I imagine

that in the entry squares the user finds himself in an environment which contains elements that grant possibilities. He chooses what use to make of the space.

### 6| P3-P4 Individual work.

After P3 presentation I was working on developing the form of the floor. At that time I was still confused about many aspects of the project. One of them was how to assess the probability of success of a space which is not predestined to serve any strictly defined activity or fulfil a specific need. Alongside these considerations, I was trying to rationalize the irregular form. I was subtracting the unnecessary and distracting elements of the design until the main design gesture could become very powerful. Moreover, I was wondering how could my approach be transformed into a strategy. I was puzzled by whether that could be done by clearly describing the geometrical deformations which shape the continuously curved floor, or by describing the sensations of the body or the archetypal topographies: hills, valleys, plateaus.

All of these doubts were somehow dispelled as the design proposal was becoming more and more clear.

I had set of to the 4th quarter of the year with the aim of designing the remaining 3 main entry squares of Universidad Nacional. With time I reassessed the feasibility of completing this task within the given time. My interests lied in increasing my understanding of the building methods that bring the undulated floor to life. For these reasons I decided to focus mainly on one entry square.

One of the big challenges of my Master project was to find a compromise between a rational form consisting of possibly simplest geometries and a softly curved form gently influencing the user, which I had envisioned. I realized that working with curved geometries requires a great deal of sensitivity. One needs to be more considerate while drawing a curved line than while drawing a straight one. At the same time curves have a great potential of expressing feelings such as tension and relief. The presence of curves can introduce many nuances to the environment.

In the final design the inclines of the floor are very subtle. In many cases user may not be entirely able to conceive exactly how the floor behaves. The bodily sensations prevail. The body resists or complies. It falls or stretches. It is sheltered and exposed.

### 7| Craft

I chose to design the entry square as a possibly most natural system. I reduced the extensiveness and intensiveness of intervention. The project can be largely raised by reshaping the soil already

present on the site. Where possible I relayed the on capability of the ground layers to handle the processes of water circulation. The introduced system allows to capture the water, clean it and reuse it by the inhabitants of the neighborhood.

### 8| Reflection on the outcome

In order to be able to reflect on the outcome of my Master project I decided to design the entry square at Carrera 45. I chose this square as it appeared to be most unlike the square at Calle 26 and I was hoping that it would give me the broadest perspective.

While designing it I was constantly recalling the first square. I was questioning some of my decisions, wondering which actions actually lead to thickening a threshold. Moreover I was hoping to mobilize different tools than the ones I had previously used and by the means of that to formulate a conclusive set of rules.

In my proposals I have been trying not to follow the dictate of the spatial properties of the sites. Where centrality, symmetry, uniformity, parallelism, uniform rhythm were imposing themselves, I acted contrariwise. I introduced diagonals, deviations, disruptions.

The entry squares are paved in a gradient pattern. The gradient is stretched over tens of meters across the gate. This operation is aimed at achieving an effect of a blurred transition, where no edge or boundary can be distinguished. In this giant weave various accents, points, pauses and phrases are distributed. They are open to interpretation, they underline forms, accentuate directions, they conceal to allow other things reveal themselves.

These totems left in the environment do not try to force a reaction of the user, however one would not be indifferent to them. They make the form more readable. They complete the intuitions of the body.

#### A. The proposal in the context of Universidad Nacional de Colombia and the surrounding neighborhoods

The intervention by Calle 26 gives a bit of structure to the flows of people in the outer part of the entry space. At the same time it brings asymmetry, disturbance of hierarchy to the regular interior between the faculties of Graphic Design, Agricultural Engineering, Edificio Antonio Narino and the building of Postgradual Economical Studies. The submersion on the campus side fragments the mentioned interior, which in my feeling is too big and hence very stagnant. The submersion disrupts the flatness and the regularity this space. This intervention points at a possibility of giving individual character to the different parts of this space.

At Carrera 45 the intervention is knitted on a very long funnel leading to the center of the campus. The passage from Carrera 45 to Plaza Che is a sequence of multiple wide views blurred into one another. It is a city scale without the intensity of city life or city infrastructure. The proposal for this space, with the use of a shift to the side of the gate, tries to suggest an alternative direction of development, that is along the boundary of the campus.

In its early years the campus has been designed with an idea of establishing hierarchies of center and periphery by the means of road infrastructure. In the following years architects have been trying to relate the the existing situation. At present buildings are very loosely arranged along streets. The concept of thickening divisions by giving them meaning involves working with infrastructure. Thickening the threshold attempts at reintroducing the possibility of forming conjunctions between the unrelated buildings to the University Campus. It offers an alternative to a city defined as an agglomeration of identifiable enclaves.

#### B. Comma and the final project

Comma has been imprinted into this project in many ways during this year. It is present in the understanding of public space as a place that is a subject of interpretation and in particular which bestows the user with many understatements, suggestions but not many commands or directions.

Moreover, the concept of comma has left a very strong mark on my broad assumptions regarding the composition of the thickened threshold. The search for the ways of connecting which do not eradicate the individual features of neither of the parts as well do not draw an impassable line between them has been within my main line of inquiry throughout the entire year.

Finally the concept of comma has found its representation in the achieved material representation of the forms, where stronger and lighter lines expose and bring attention to the forms.

#### C. A manifesto of a thickened threshold

As a summary of my discoveries I wrote a manifesto of a thickened threshold which summarizes the conclusions, I have managed to make.

1. A thickened threshold is an action on a surface.
2. Center

The center of a thickened threshold does not lay at the gate.

3. A Field condition

In a thickened threshold functions are not articulated, represented or assigned to specific spaces. A thickened threshold questions the idea of dividing space into sub-spaces.

A thickened threshold questions functional space: of a gate as a check point, a square as an approach zone, a road as a surface destined for vehicular use, a park as a place of leisure.

In a thickened threshold the boundaries between spaces which serve strictly defined purposes are blurred. The spaces which serve different purposes are blurred into one another. Purposes are blurred. Spaces serve no purpose.

A thickened threshold questions the prevalent notion of 'efficiency'.

#### 4. Continuous gestures

Folding, creasing, draping, cutting and weaving are gestures which are used upon the surface to transform it into a thickened threshold.

These gestures, when used upon the continuous fabric of the floor, have effects transmitted over large portions of the fabric. The gate, although limited in size can be changed by introducing changes in other distant parts of the fabric.

#### 5. Unlocking the vertical dimension

In a thickened threshold unlocking the vertical dimension influences the bodily perceptions of the user and the reactions of his body.

#### Deviation

The floor deviates the movement of the pedestrian from the axis perpendicular to the fence.

#### Obstruction

The floor is like hurdles, which have to be avoided by the pedestrian.

#### 6. Thirthing

In a thickened threshold the perception of the gate as the dominating built structure is changed by raising pavilions which capture the body and the sight of the passer-by while walking. The thickened threshold is a surface where many activities are enacted. Crossing the gate is of them.

#### 7. Material

In a thickened threshold material is applied over the whole surface in a gradient pattern. Gradient merges the forms smoothly with one another. Changes of intensity and variety are achieved with gradient.

### D. Thickening anything

Finally I am intrigued by the thickening itself. What does it mean to thicken? Can anything be thickened?

My understanding of thickening has been largely influenced by Greg Lynn's work 'Architectural Curvilinearity. The Folded, the pliant and the supple'.

In architecture contradictions, which have been recognized in the context, are embodied. The two main notions either propose representing

contradictions or recovering unity. Reconstructing unity is achieved either through reviving the architectural language of a place, which is identified via historical analysis, or by identifying local consistencies resulting from climate, indigenous craft, materials etc. Unfortunately continuity extracted in this way represses contradictions and impoverishes.

Similarly the attempts to represent differences in conflicting forms do not allow other more complicated relations than the oppositional relation to be formed. Lynn attributes greater value to alliances between elements than to contradictions. Instead Lynn speaks of an emerging alternative practice which the reader of his essay gets to know as smoothing.

The exemplary projects, described by Lynn, try to incorporate their contexts with means that cause minimal resistance. Locations, characters and programs are folded, creamed and blended into one mixture without compromising their identity. This environment has the capability to expand through incorporation. The main quality of smooth systems lies in their ability of generating unexpected connections between elements.

I would propose a definition of thickening as connecting elements in a particular way. That is a way which specifically does not eradicate differences and does not represent the differences but incorporates them and uses them in the newly formed creation.

Further thickening can be understood as expanding concepts, as enabling a cross-contamination of concepts with other concepts. I find an example of such thinking in the works of architecture which question the customary programmatic understanding of things. In his design of Gabriel Garcia Marquez Cultural Center Rogelio Salmona questions the typical courtyard completely isolated from the street. He creates a courtyard visually connected with the street which can be reached via a sequence of public spaces. Therewith he develops a new completely unknown type and expands the knowledge of architectural types.

Similar thickening happens every time people find new purposes for things or places.







## BIBLIOGRAPHY

- Allen, Stan, "Field conditions", in *Point + lines*, New York, Princeton Architectural Press, 1999.
- Allen, Stan, *From object to field in AD Architecture after geometry*, No. 127, London, John Wiley and Sons Ltd, 1997, pp 24-31.
- Allen, Stan, 'Mat Urbanism: The thick 2-D' in Sakris, Hashim CASE: *Le Corbusier's Venice Hospital and the Mat building revival*. Prestel. pp. 118-126, 2002
- Bachelard, Gaston, *The poetics of space*, New York, Penguin Group, 2014.
- Boettger, Till, *Threshold Spaces*, Basel, Birkhauser, 2014.
- Cage, John, *Silence. Lectures and writings by John Cage*, Hanover, Wesleyan University Press, 1973.
- Calvino, Italo, *Invisible cities*, Orlando, Florida, Harcourt Brace and Company, 1974.
- Camacho, Sol, *Walls of air*, Sao Paulo, Bienal Sao Paulo, 2018.
- Cortes, Rodrigo (ed.), *Ciudad aparte. Proyecto y realidad en la Ciudad Universitaria de Bogota*, Bogota, Museo de Arquitectura Leopoldo Rother, 2006.
- Gehl, Jan, *Life between buildings. Using public space*, Washington DC, Island Press, 2011.
- Hertzberger Herman, *Lessons for students in Architecture*, Rotterdam, 010 Publishers, 2005.
- Holl, Steven, Juhani Pallasmaa, Alberto Perez-Gomez, *Questions of perception Phenomenology of Architecture*, San Francisco, William Stout Publishers, 1994.
- Koolhaas, Rem, "Door", in *Elements of Architecture*, Italy, Marsilio, 2014.
- Lynch, Kevin, *The image of the city*, Cambridge, Massachusetts, MIT Press, 1990.
- Lynn, Greg, 'Architectural Curvilinearity. The Folded, the Pliant and the Supple' in *Architectural Design*, No. 63, London, Academy Editions, 1993, pp. 24-31.
- Pallasmaa, Juhani, *The Eyes of the Skin. Architecture and the senses*, Chichester, West Sussex, John Wiley and Sons Ltd, 2008.
- Rossi, Aldo, *The architecture of the city*, Cambridge, Massachusetts, MIT Press, 1966.
- Sennett, Richard, *Building and Dwelling: Ethics for the City*, Penguin Books Ltd, 2018
- Sennett, Richard, *The Fall of Public Man*, USA, Penguin Group, 1977.
- Simmel, Georg, *Bridge and Door*, Sage Journals, Vol 11, Issue 1, 1994. Accessed December 21, 2018. <https://doi.org/10.1177/026327694011001002>.
- Soja, Edward, *Third Space Journeys to Los Angeles and other Real-And-Imagined Places*, Cambridge, Massachusetts, Blackwell Publishers, 1996.
- Stavrides, Stavros, *Towards the city of thresholds, professionaldreamers*, 2010.
- Tschumi Bernard, *The Manhattan Transcripts*, London, Academy Group Ltd, 1994.

