

# A building learning centre

Promoting hurricane-proof building knowledge among communities

A way to optimised and self-efficient disaster relief on Sint Maarten (and beyond)

Anna Zuzanna Bożek, 4743067

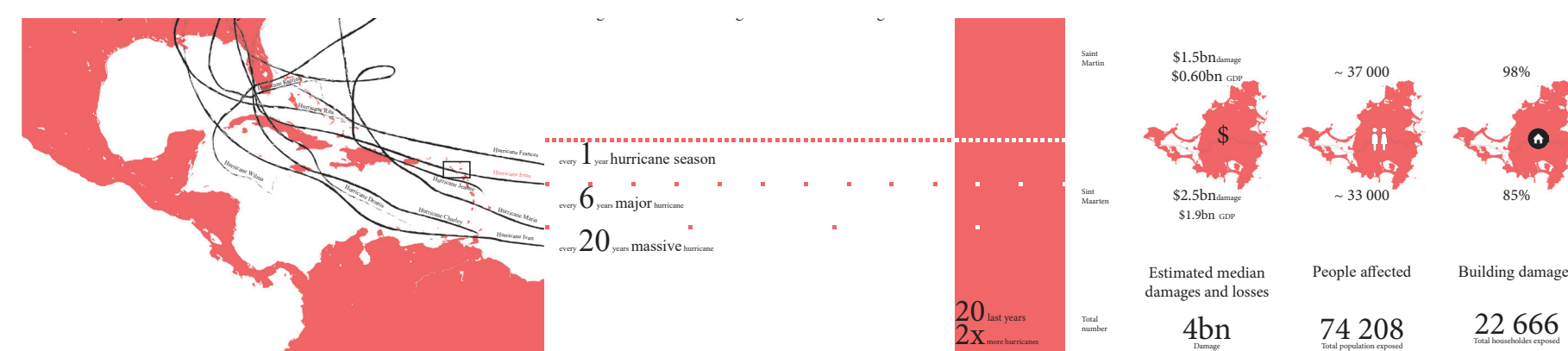

Transition\_tourism sector v construction sector\_new economic development

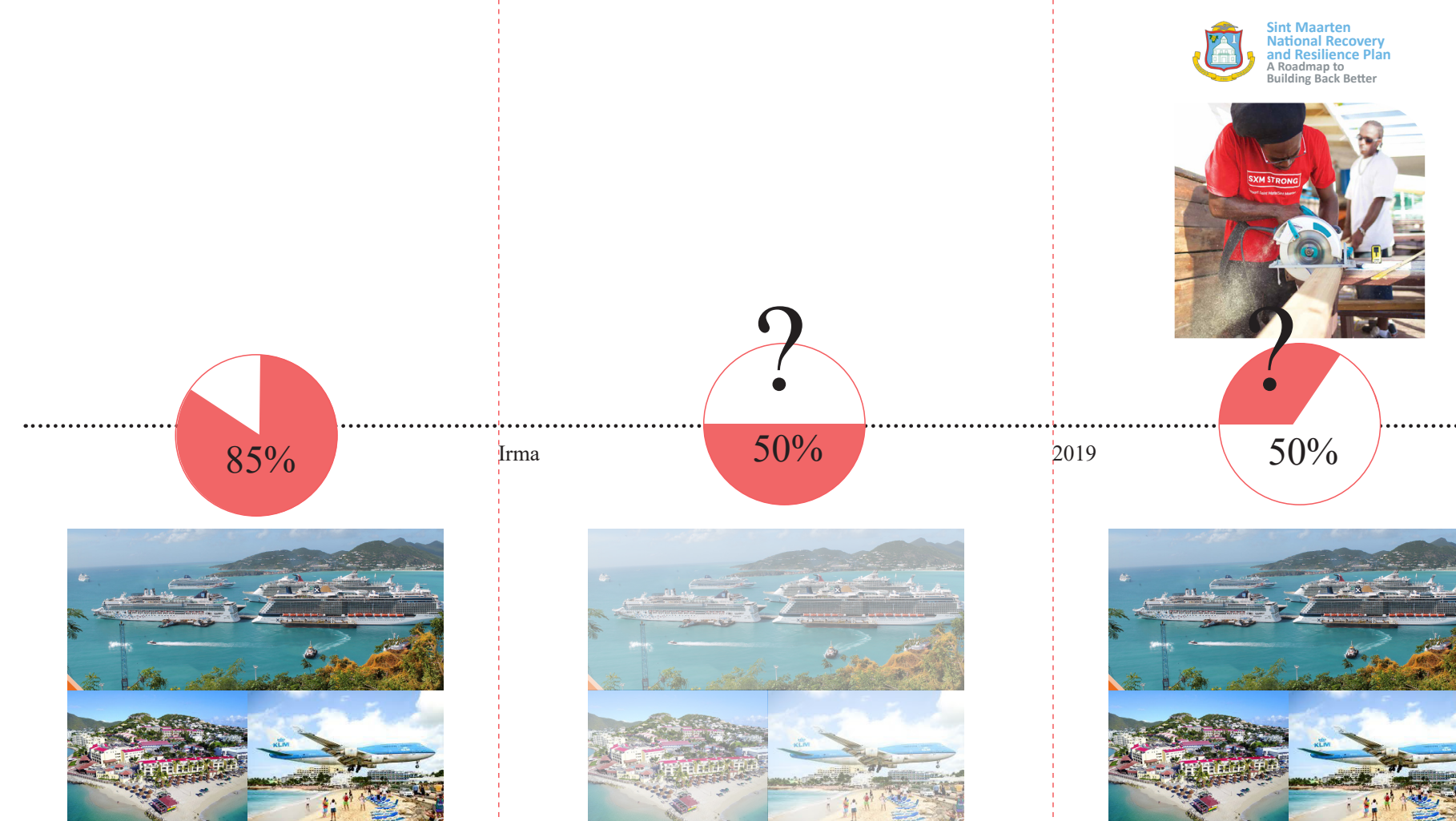

Study program of students\_the Building Learning Centre on Sint Maarten

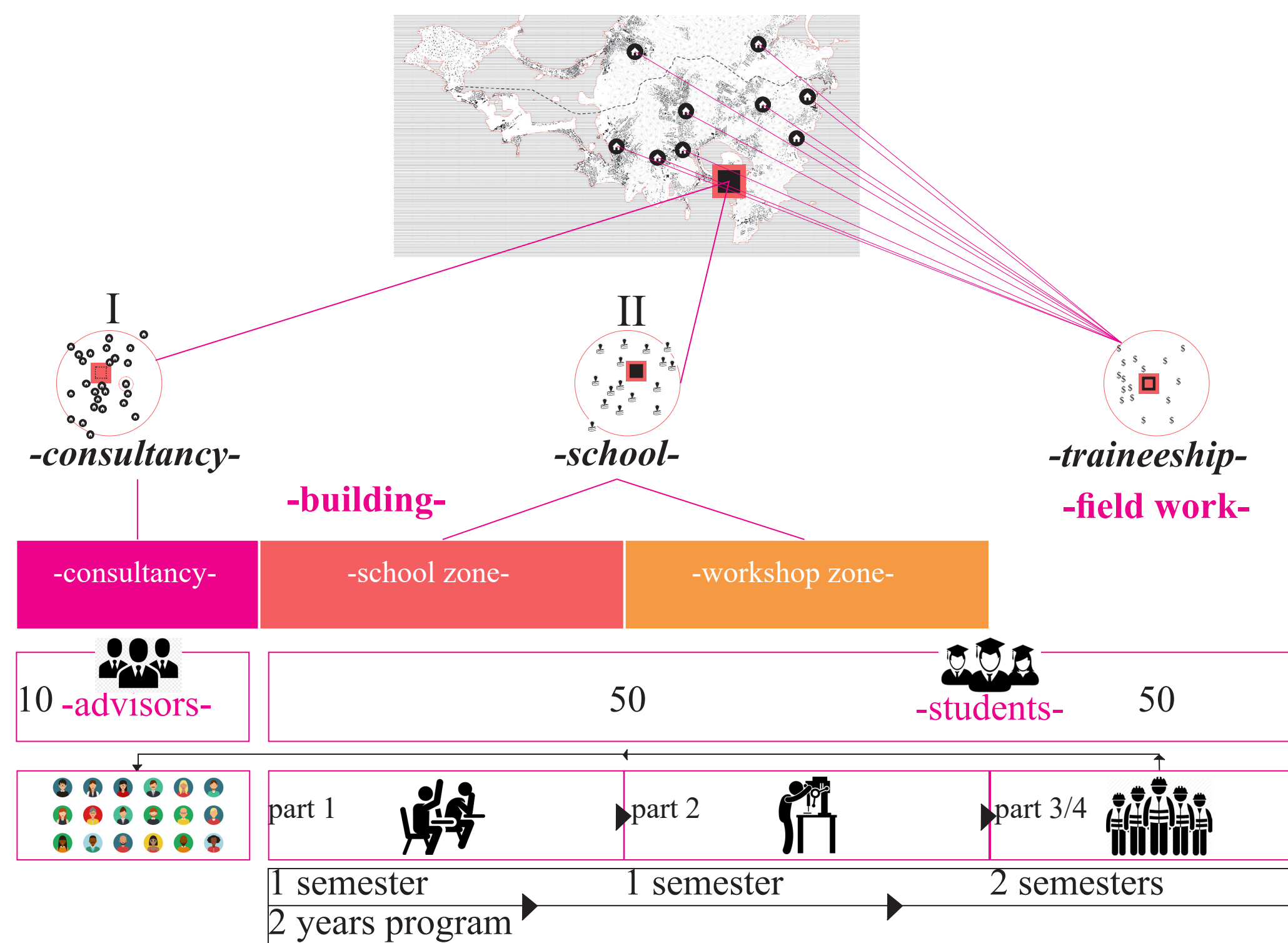

Program of the building\_Areas of functions

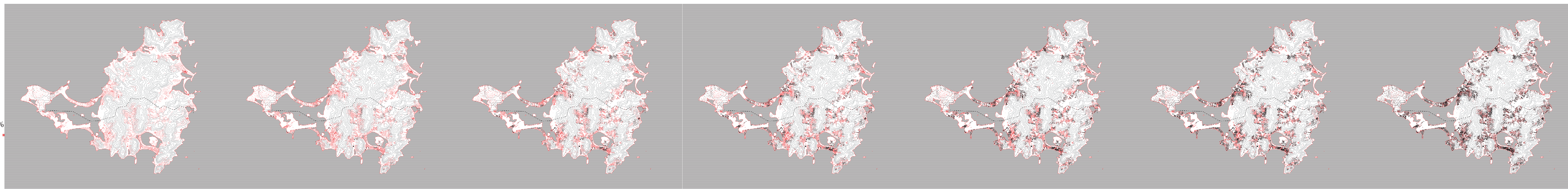
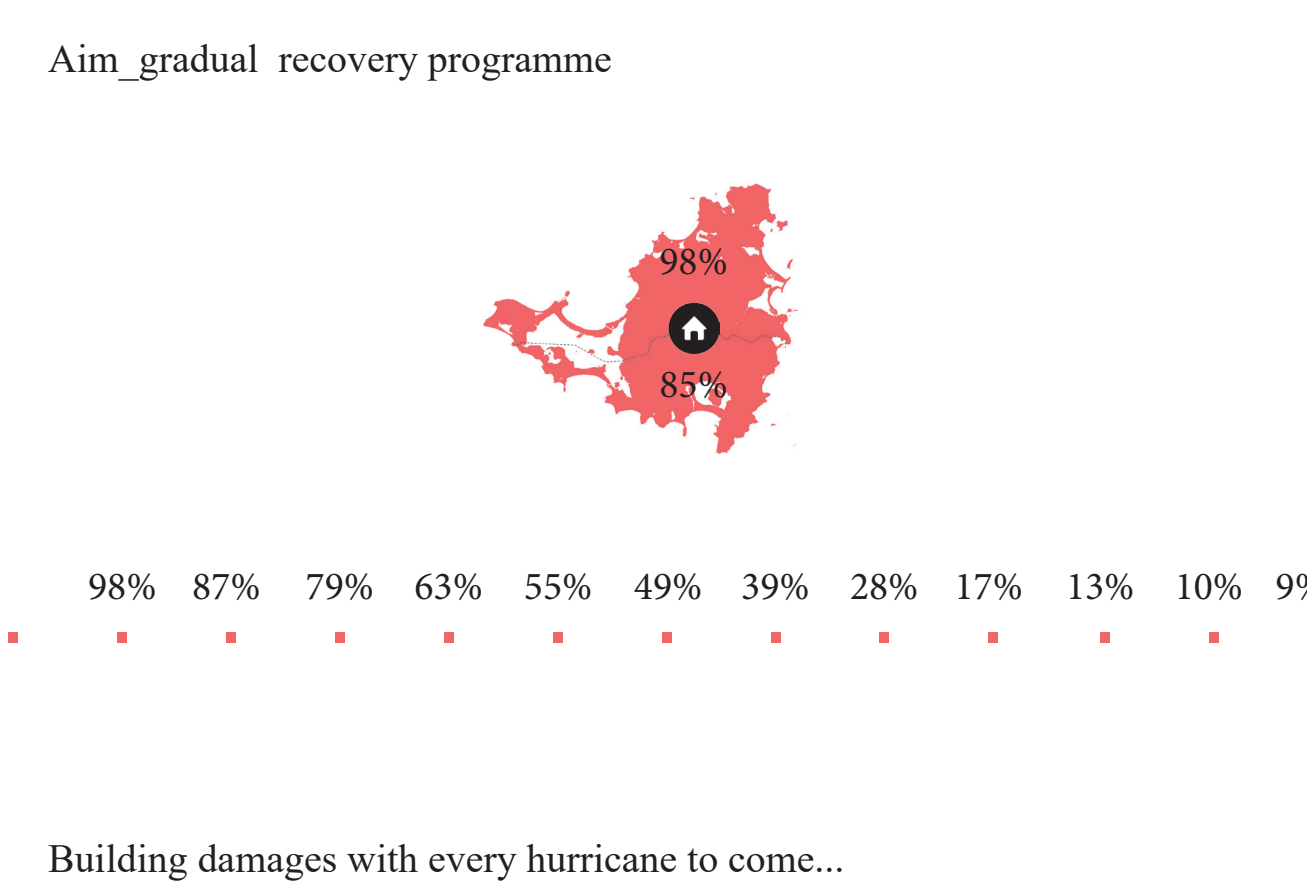
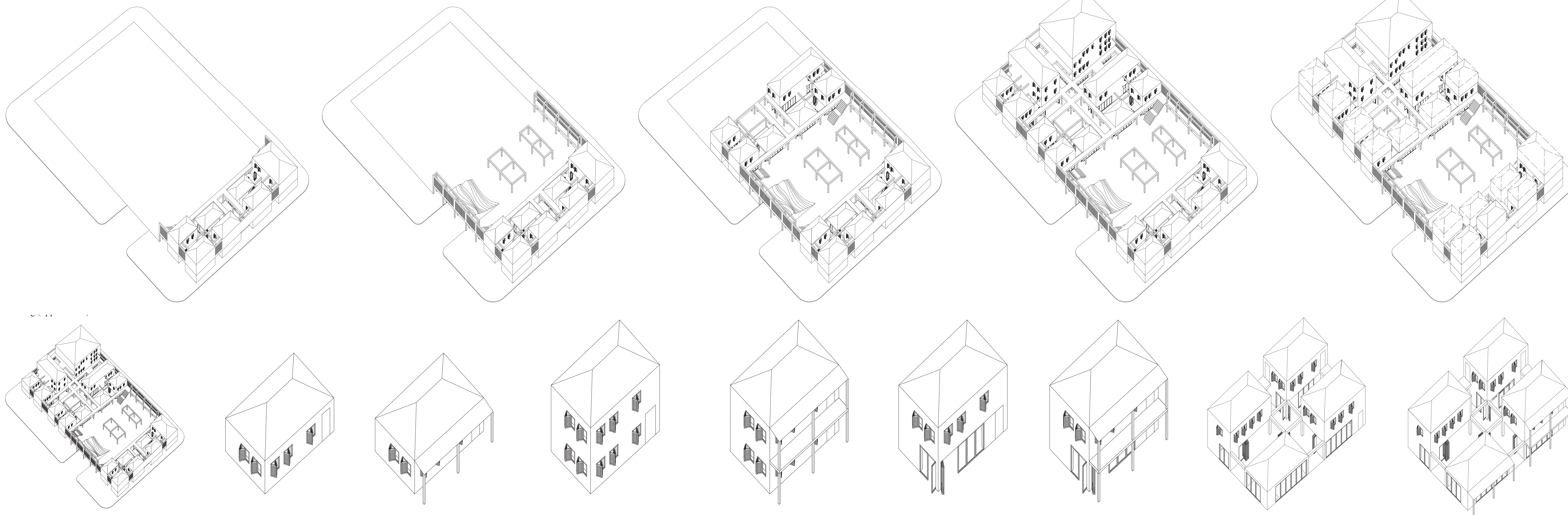
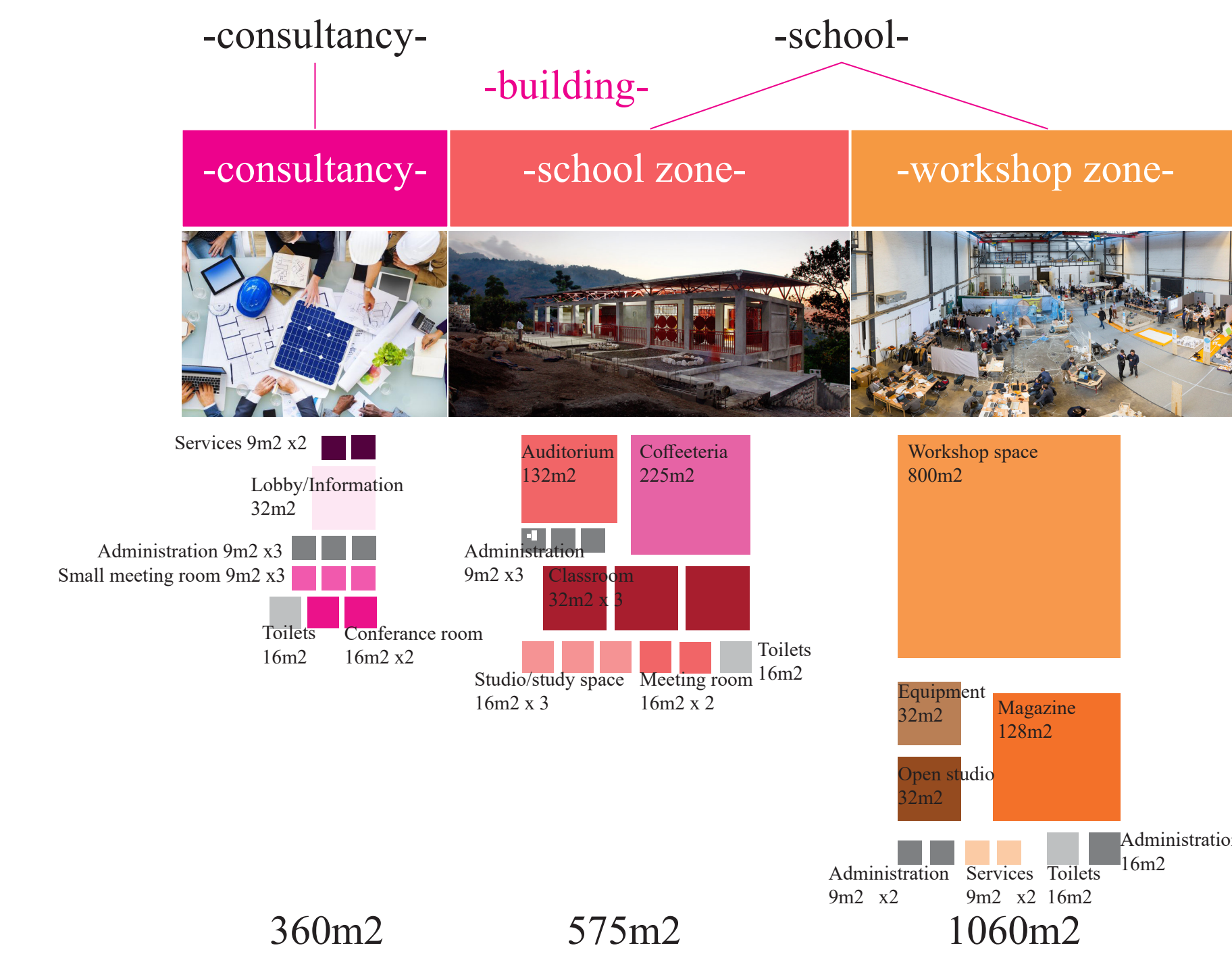



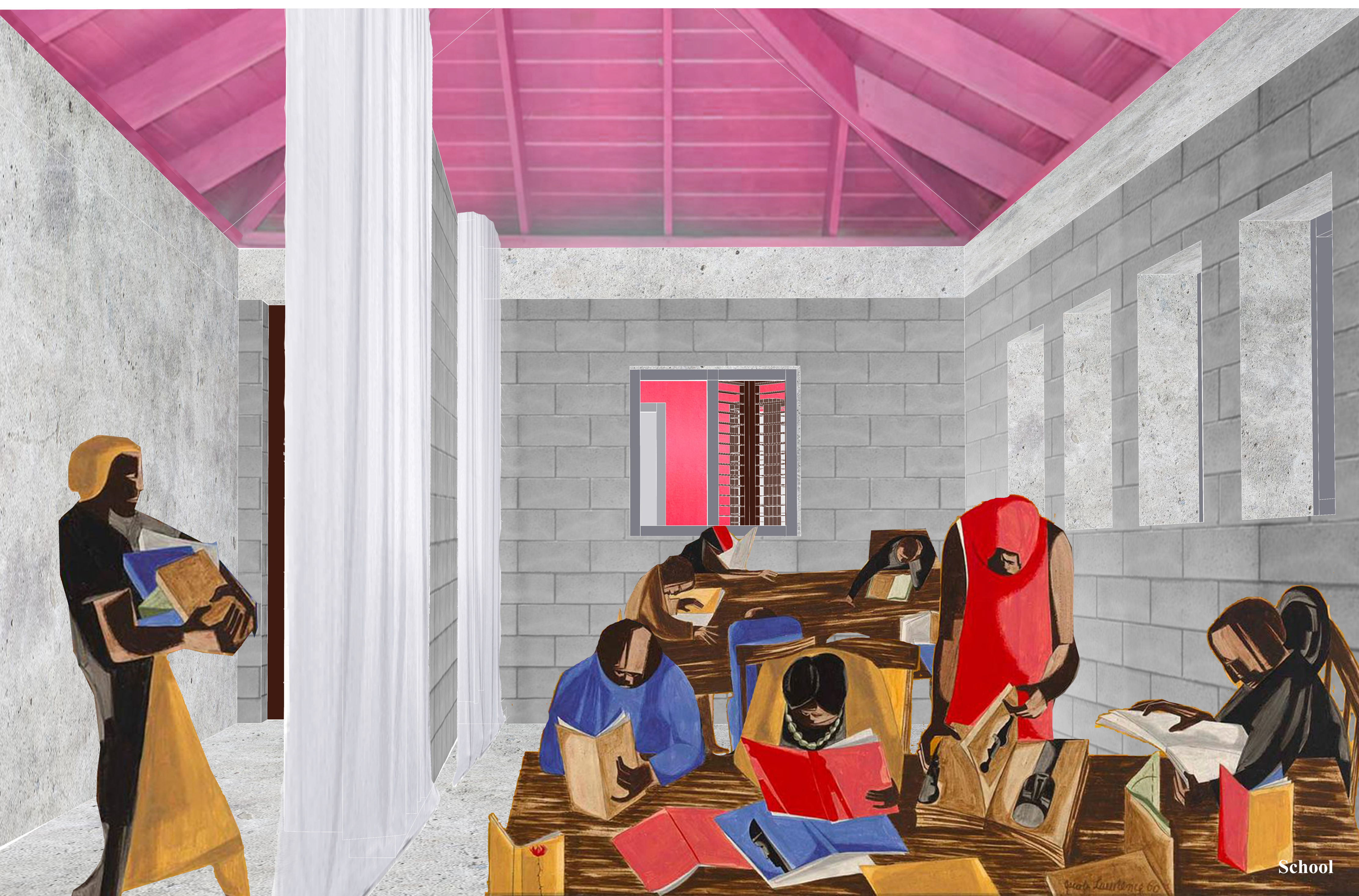



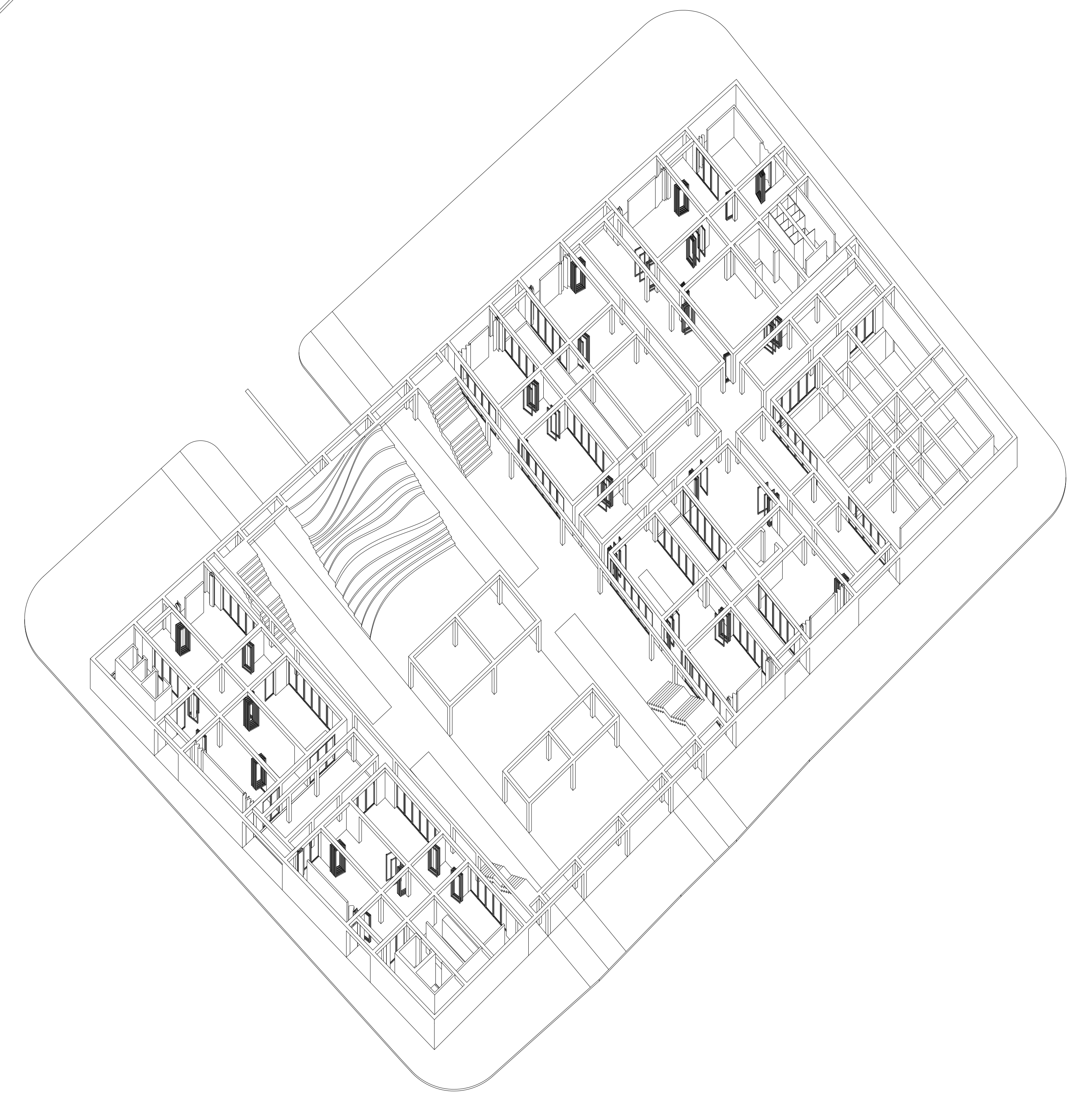
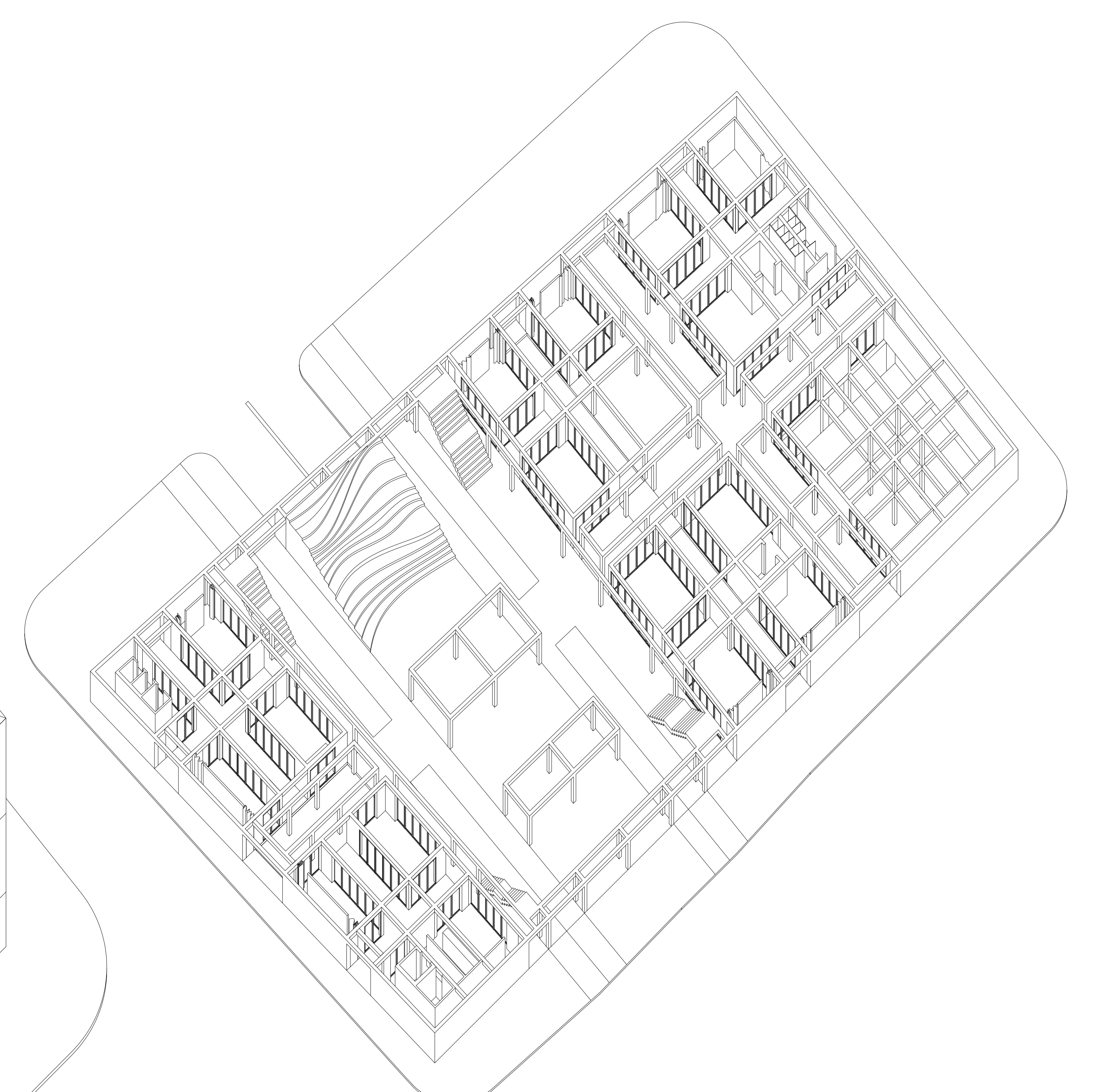
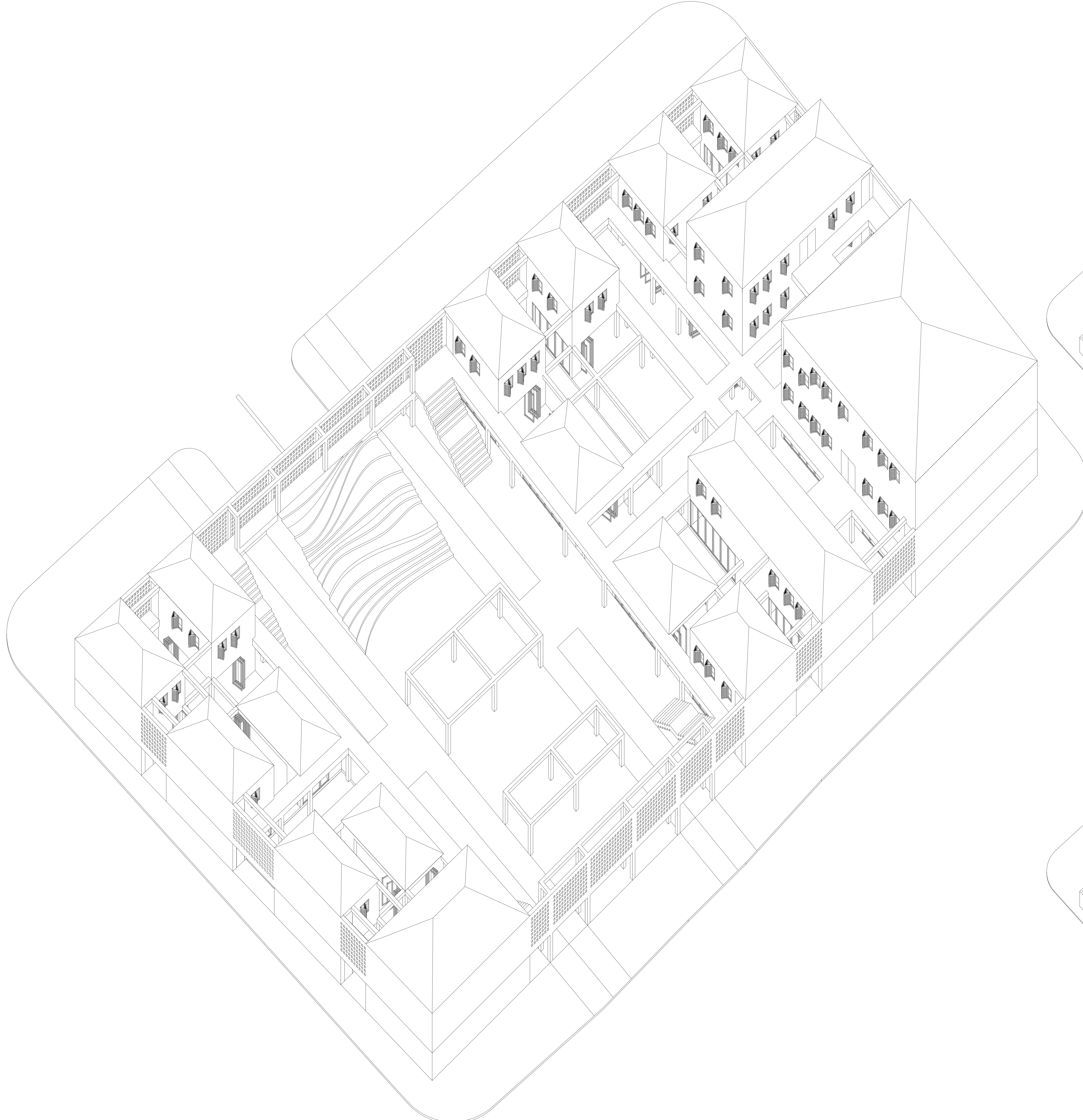



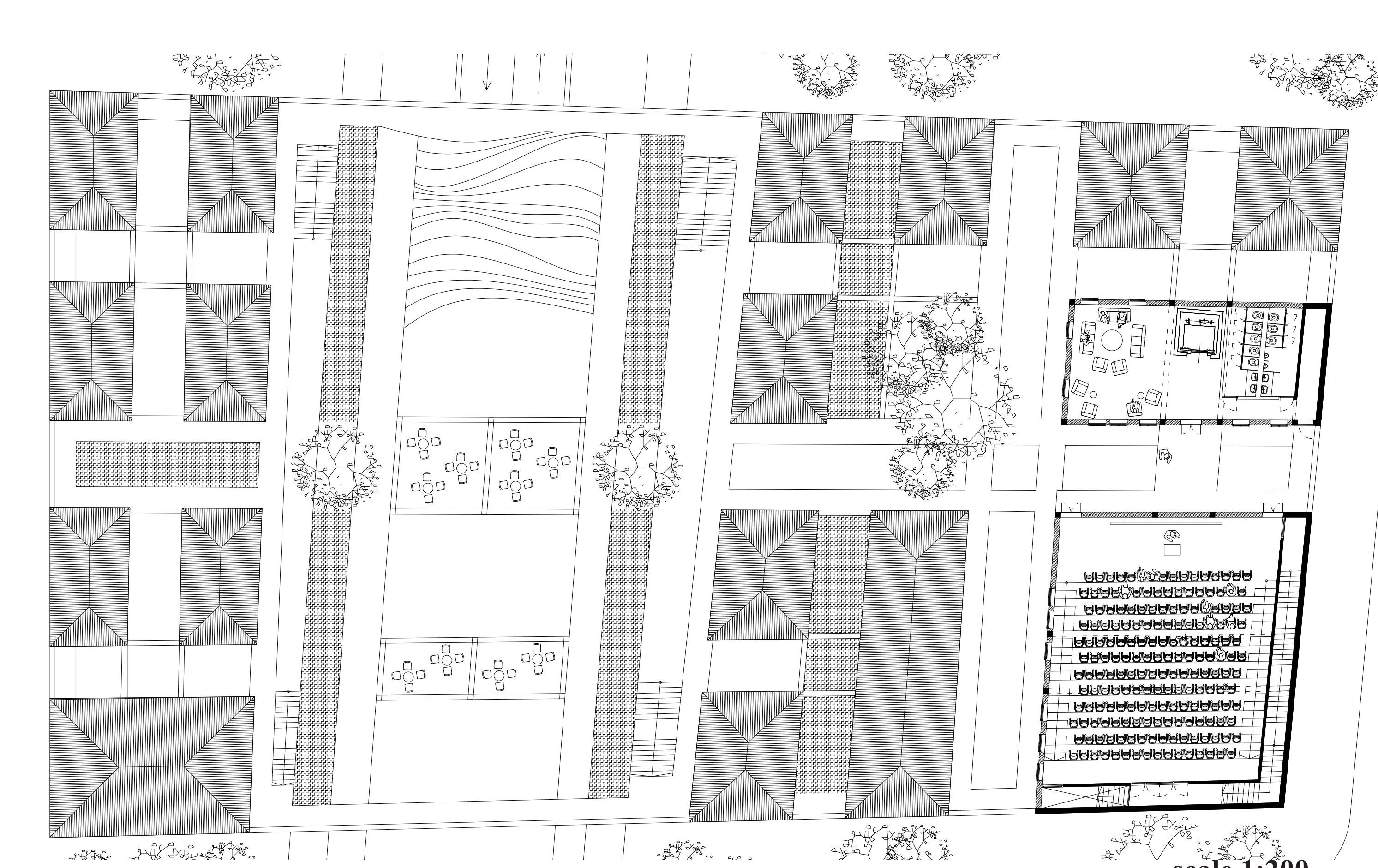
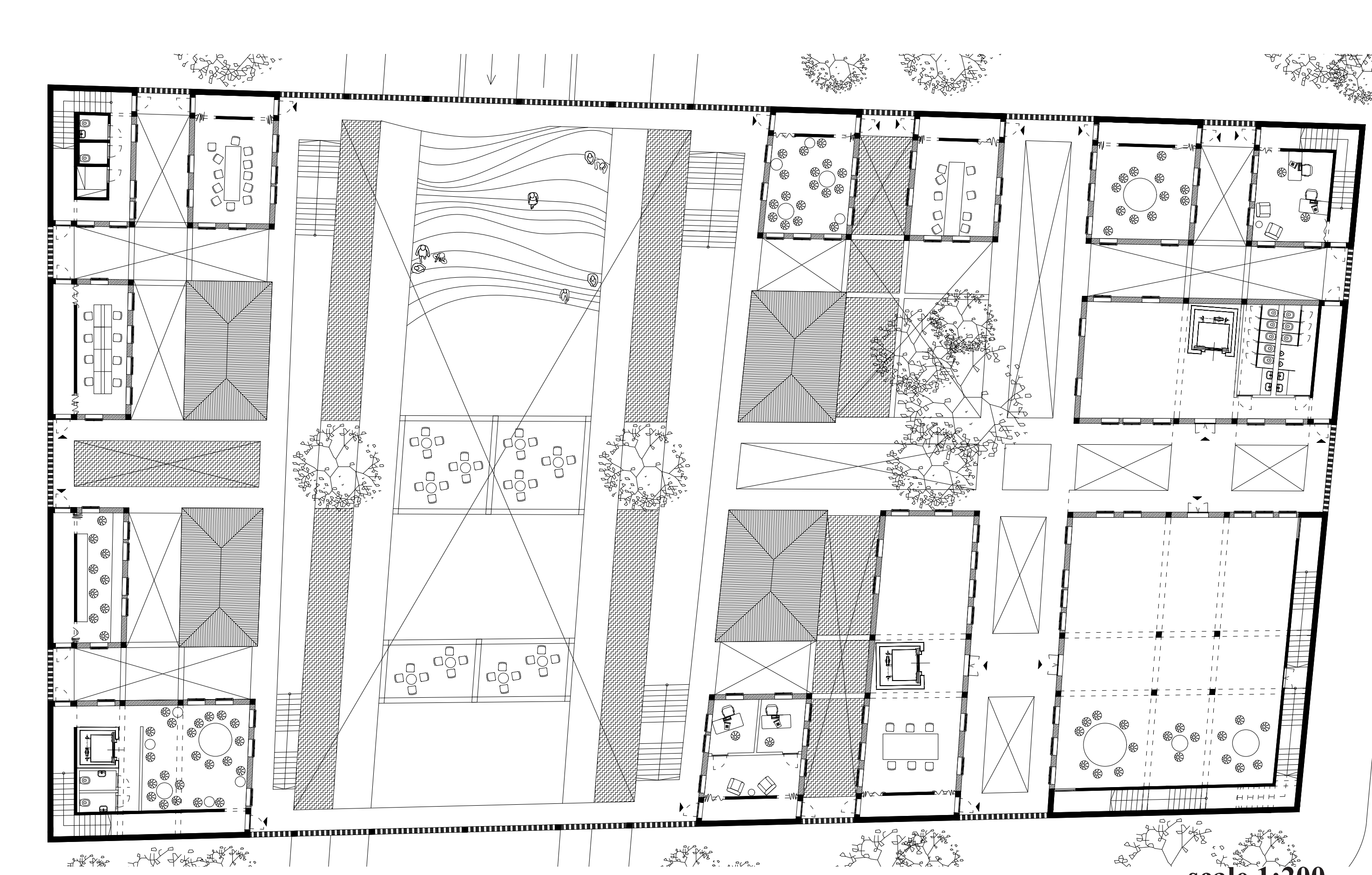
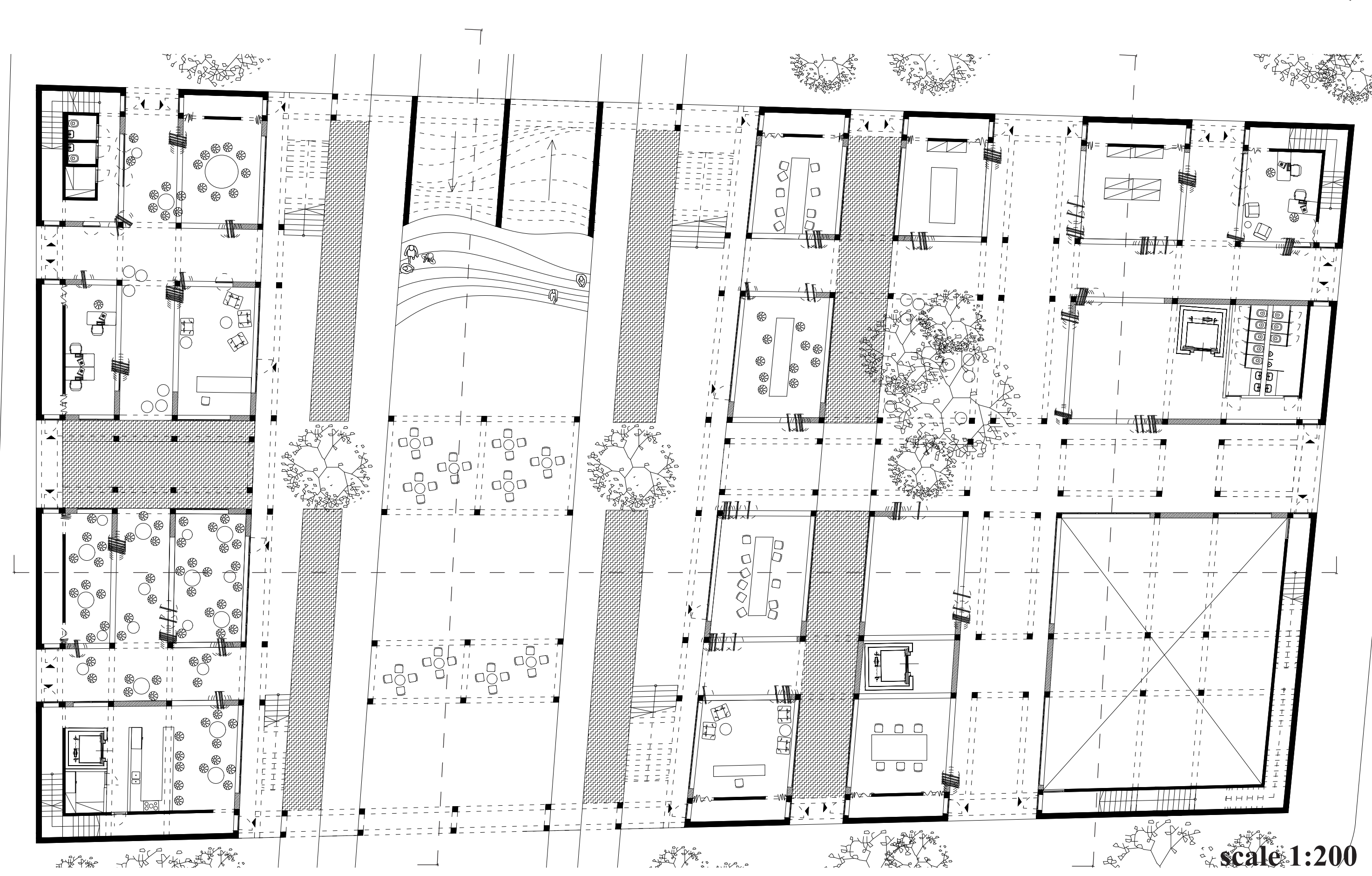
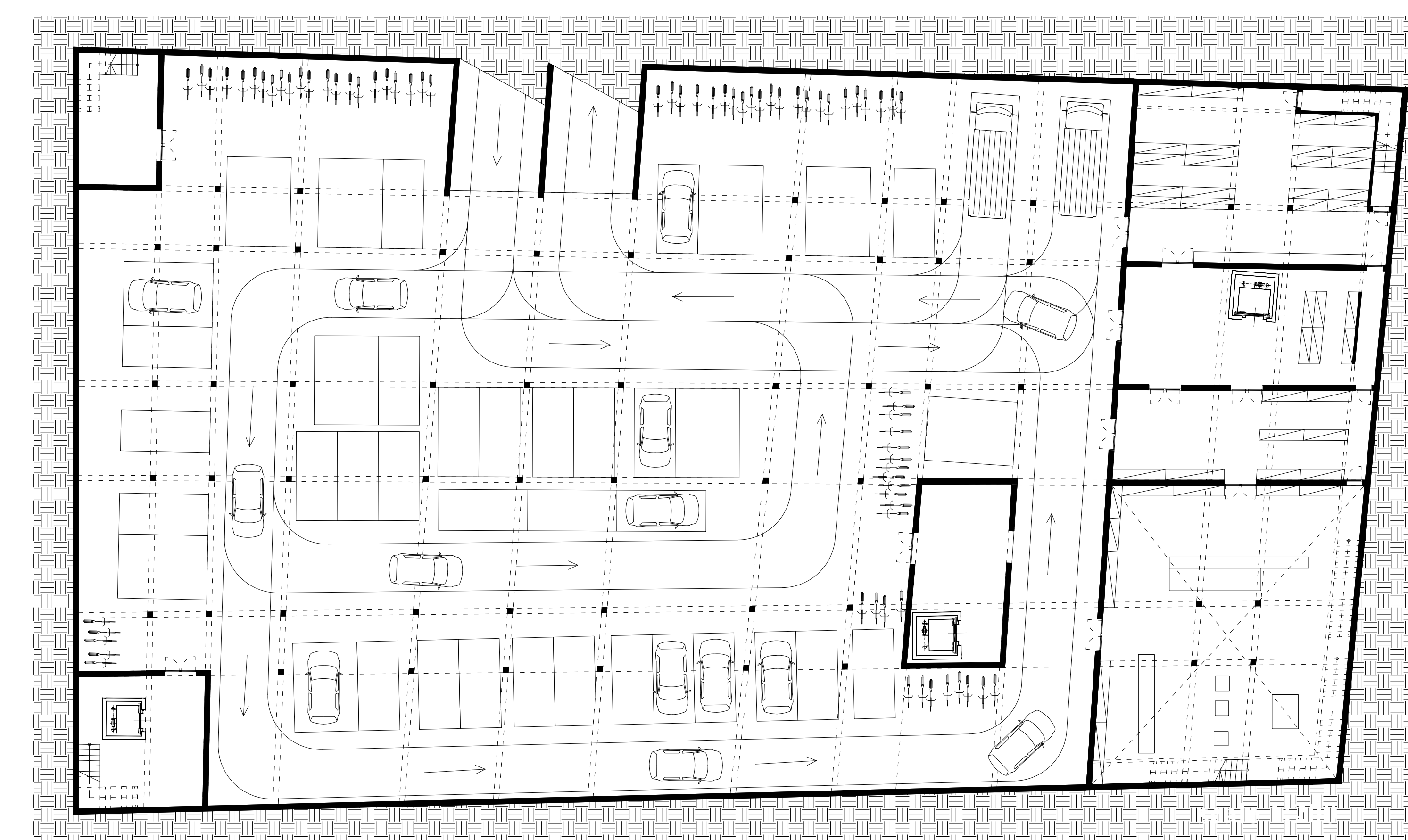
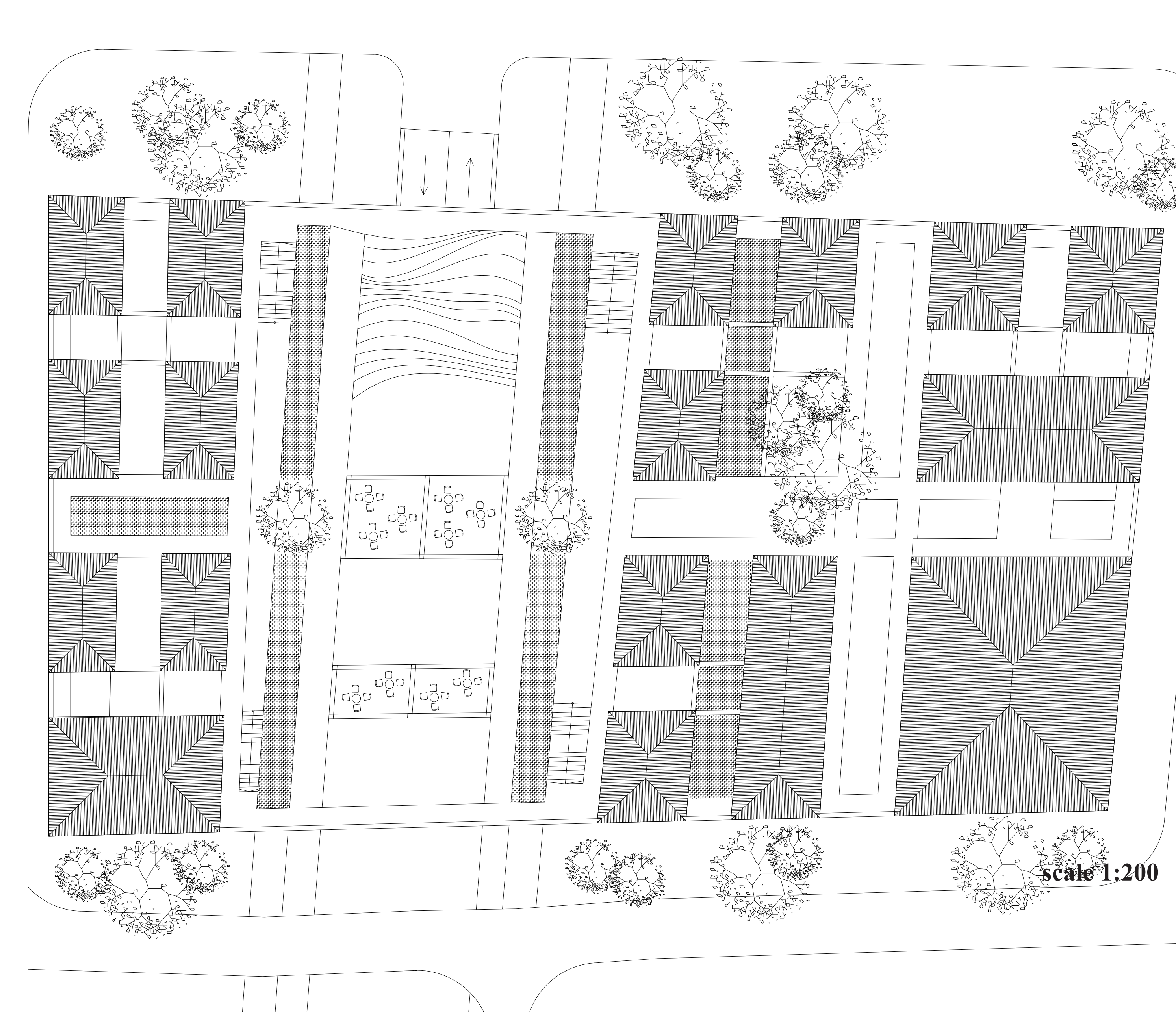
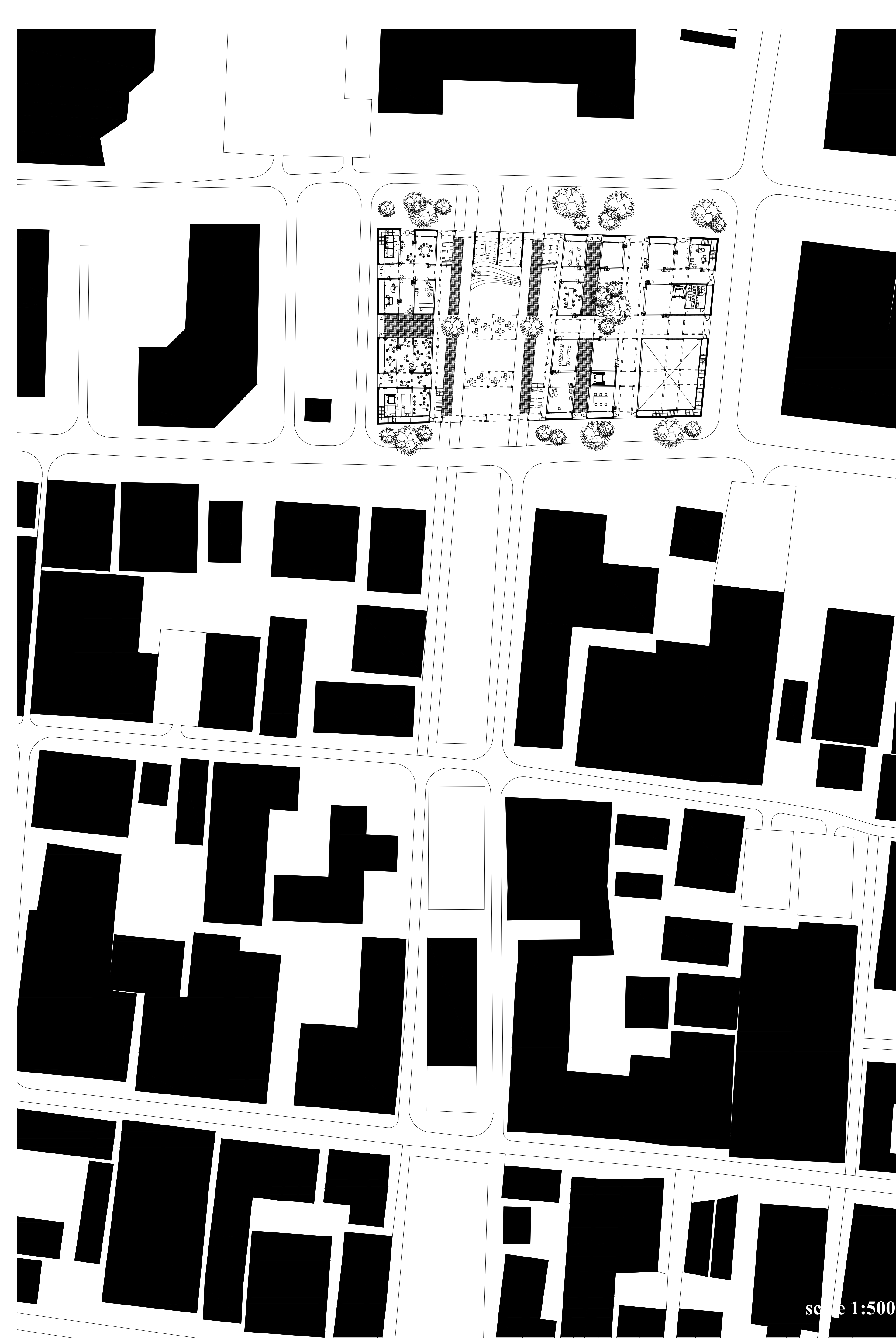



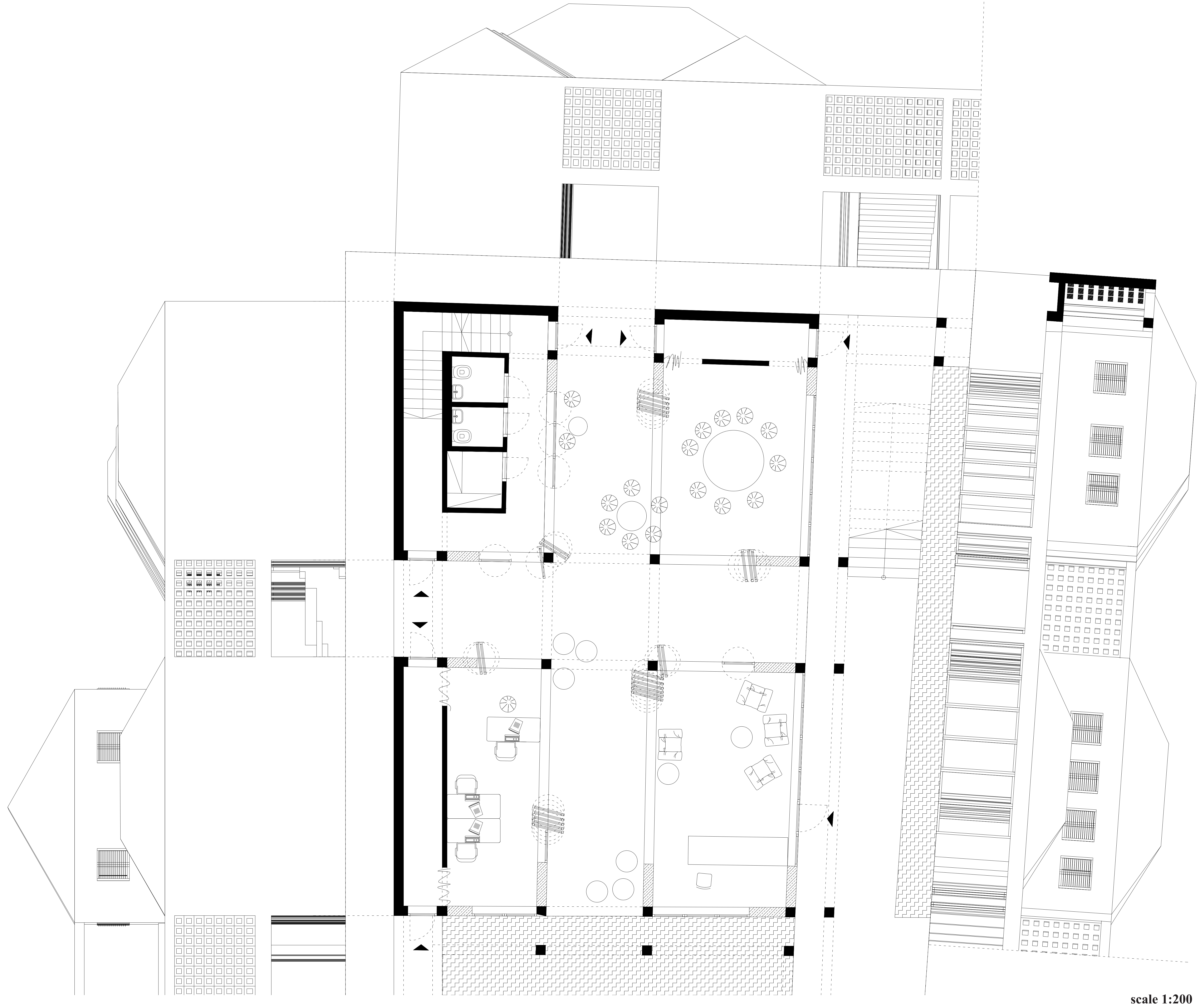
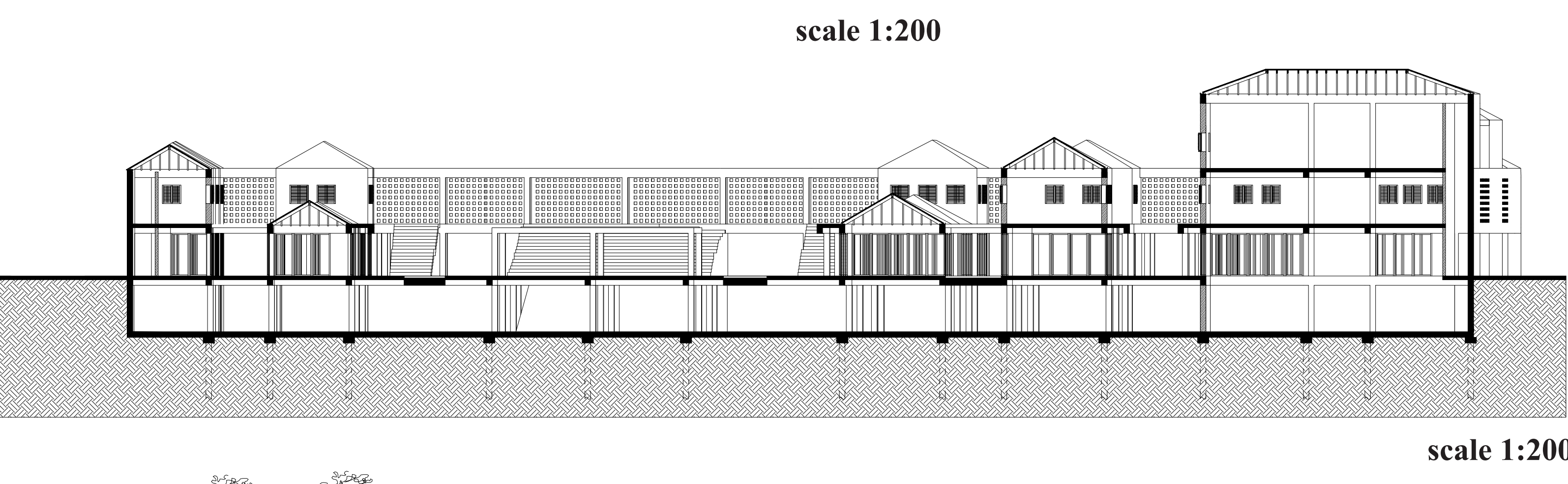
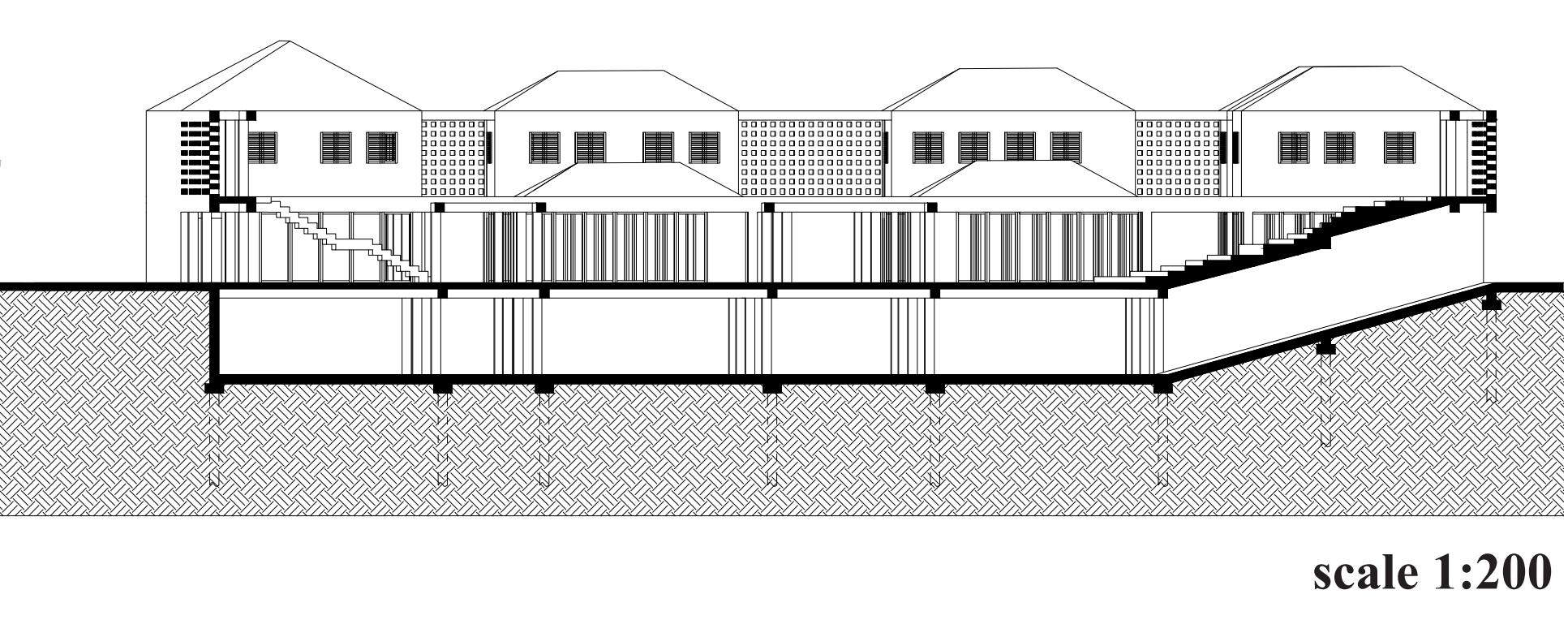
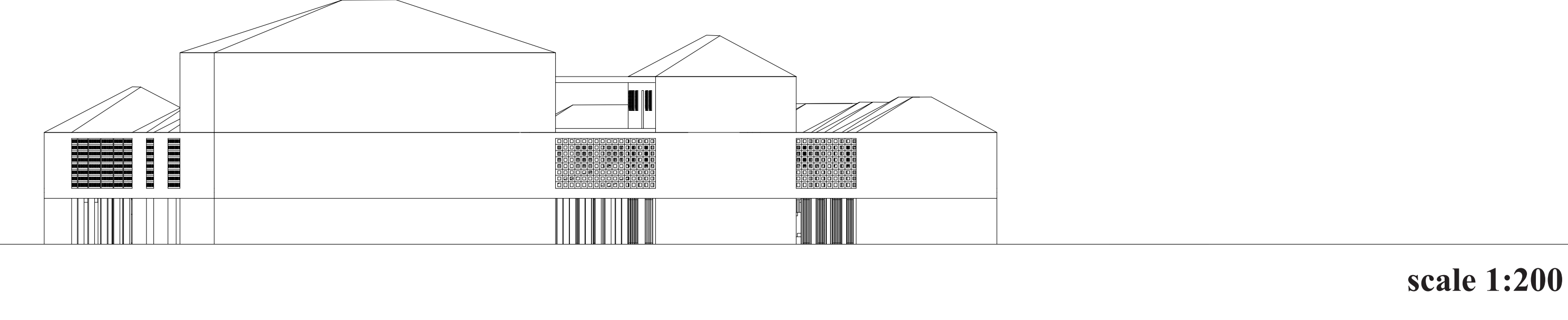
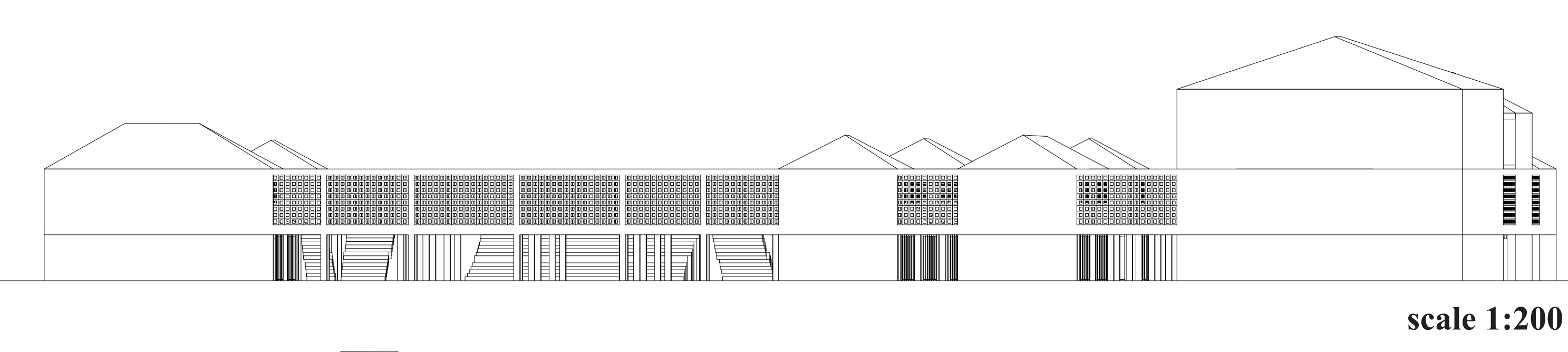
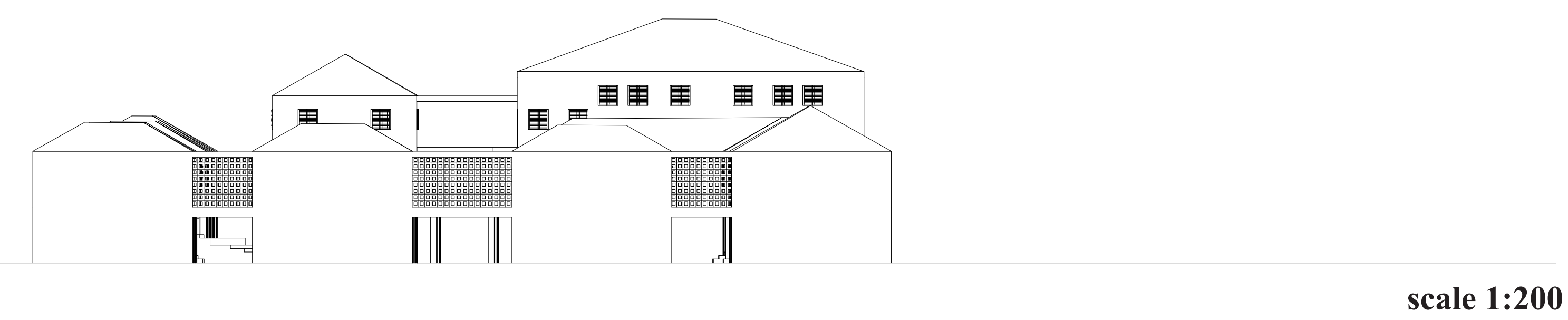
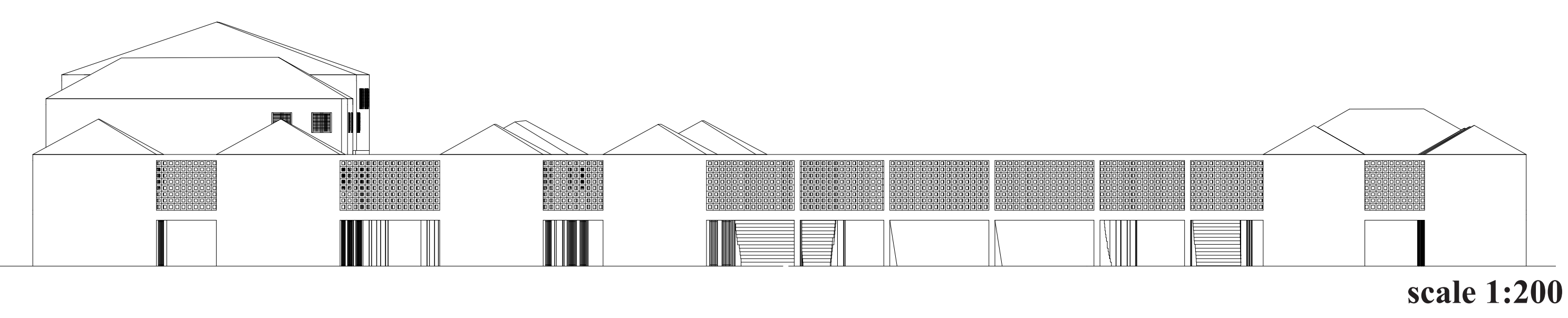



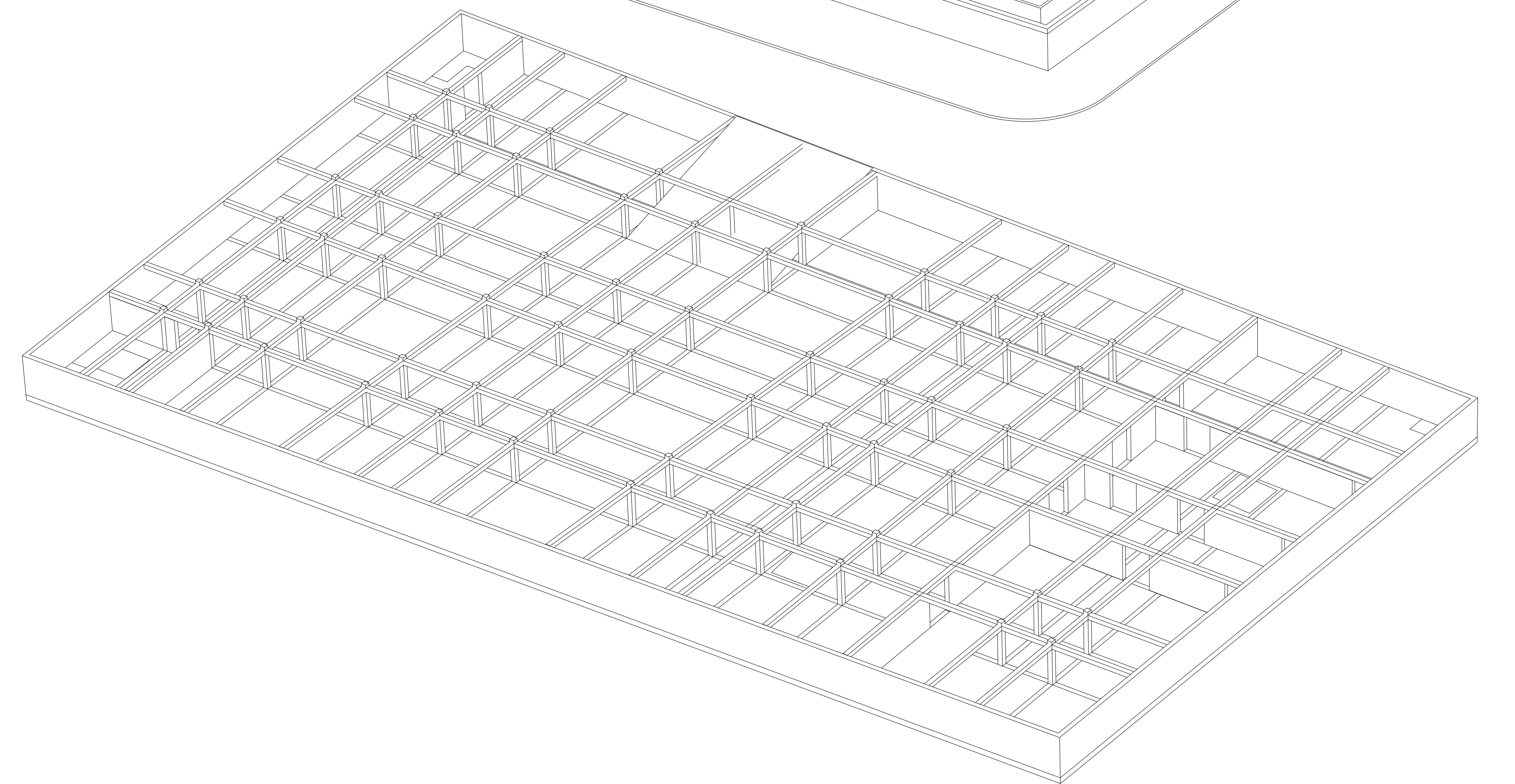
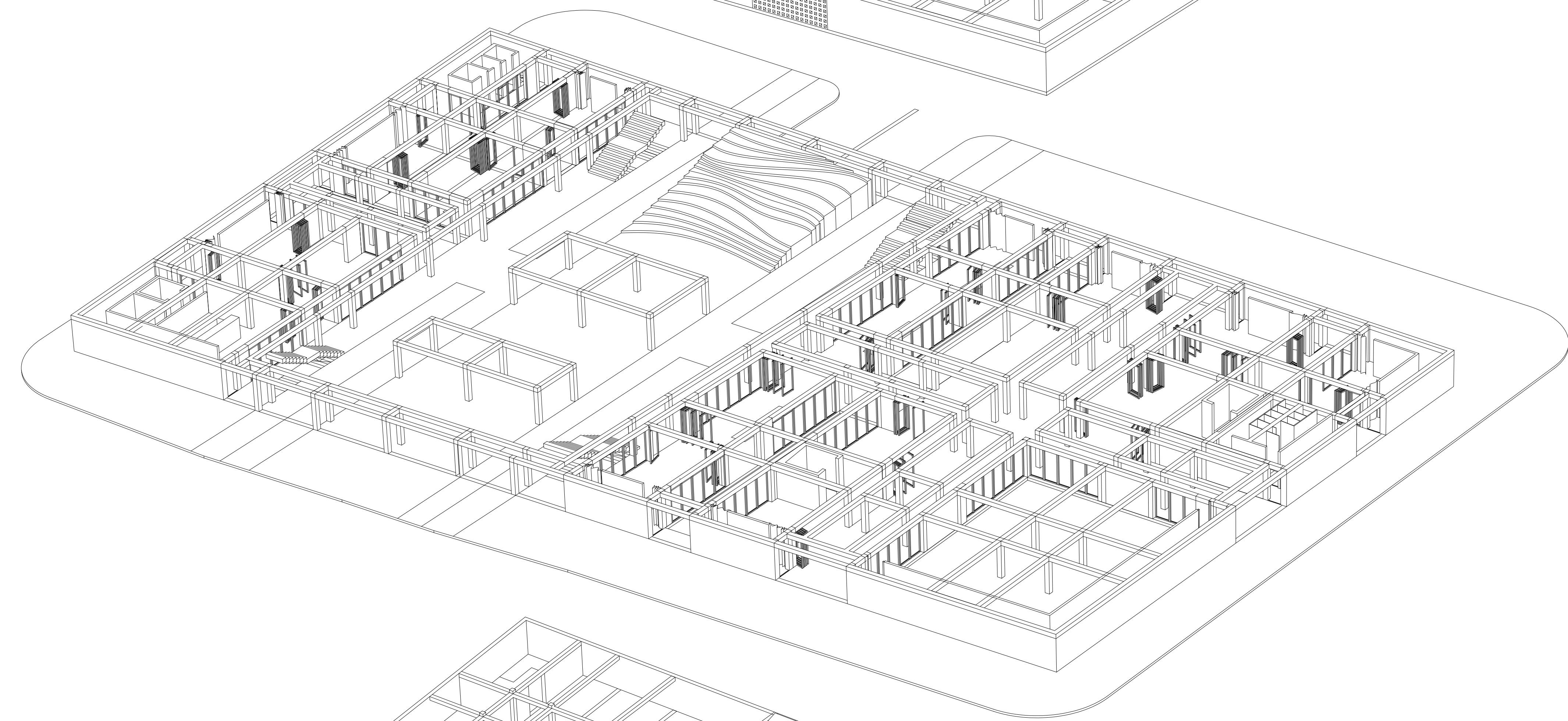
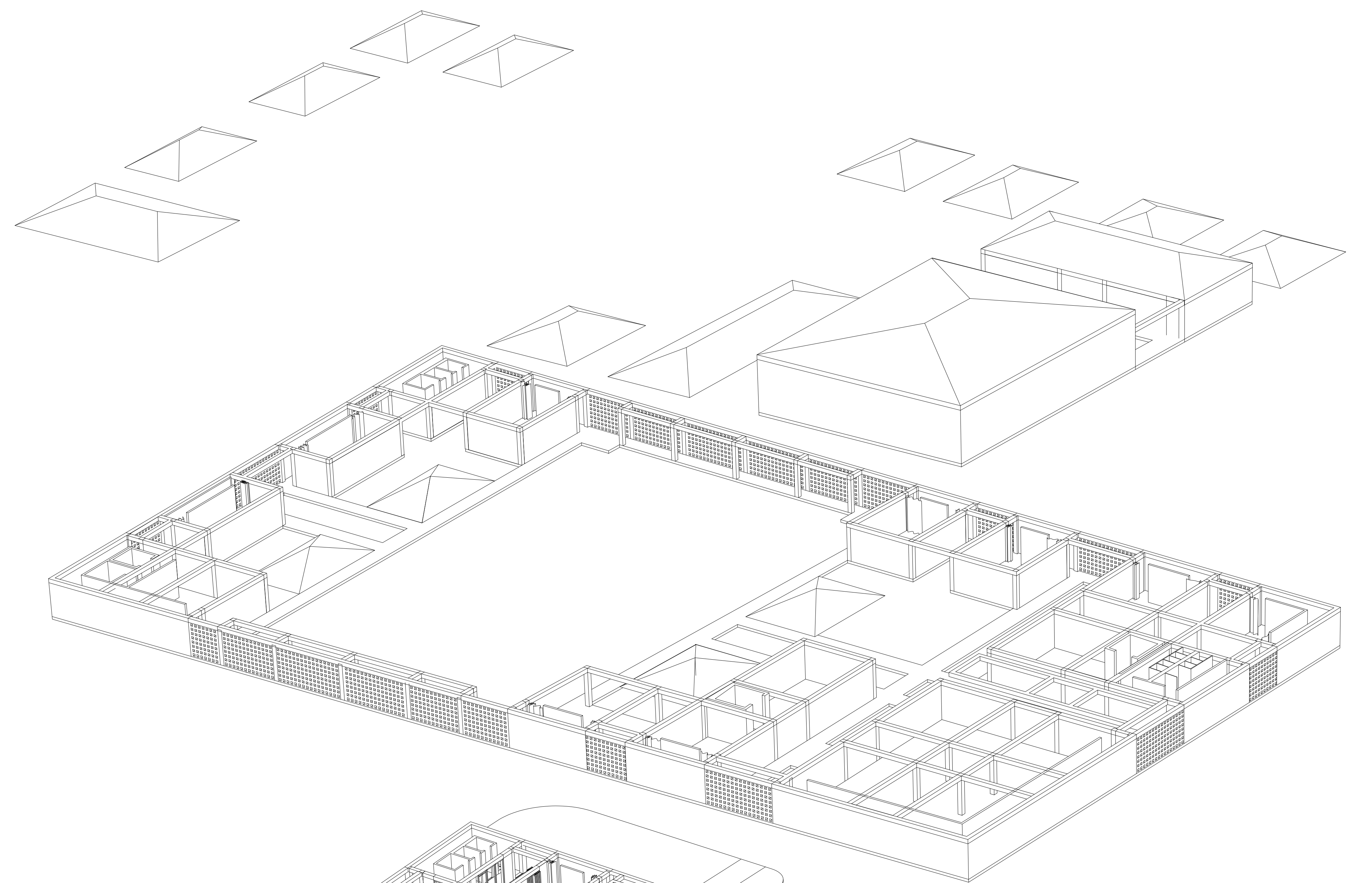
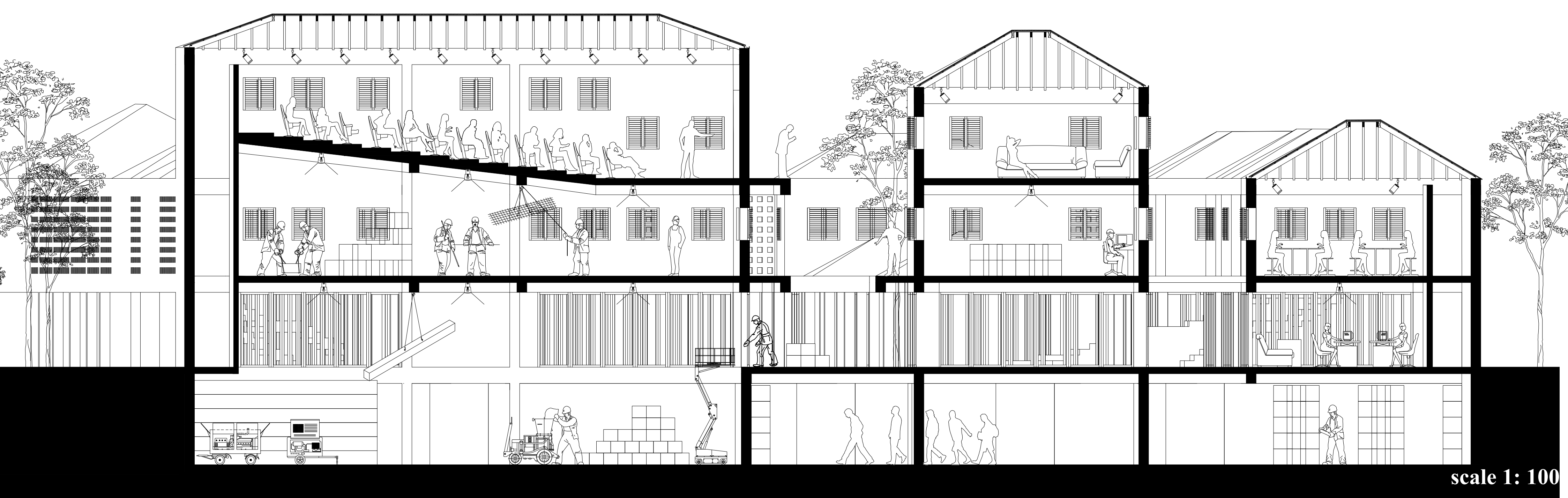
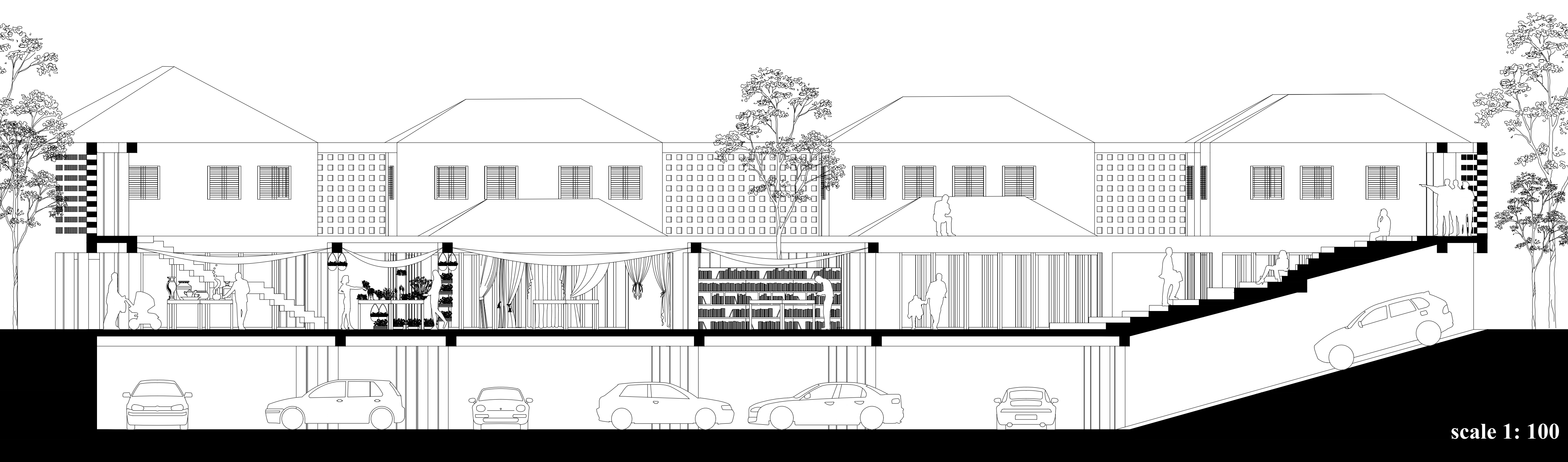
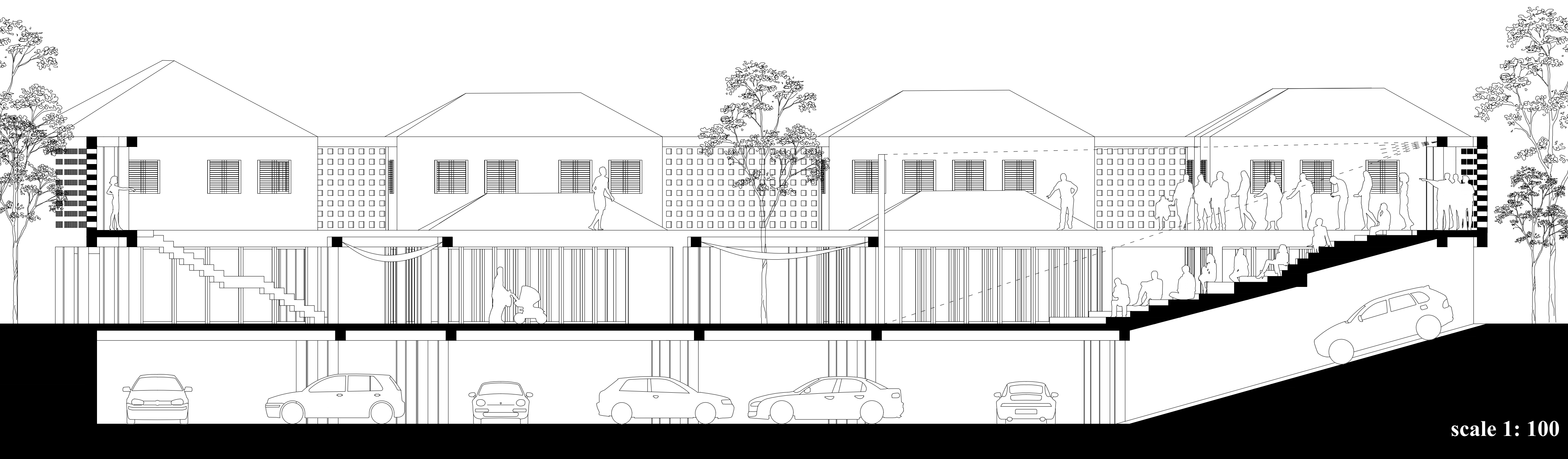
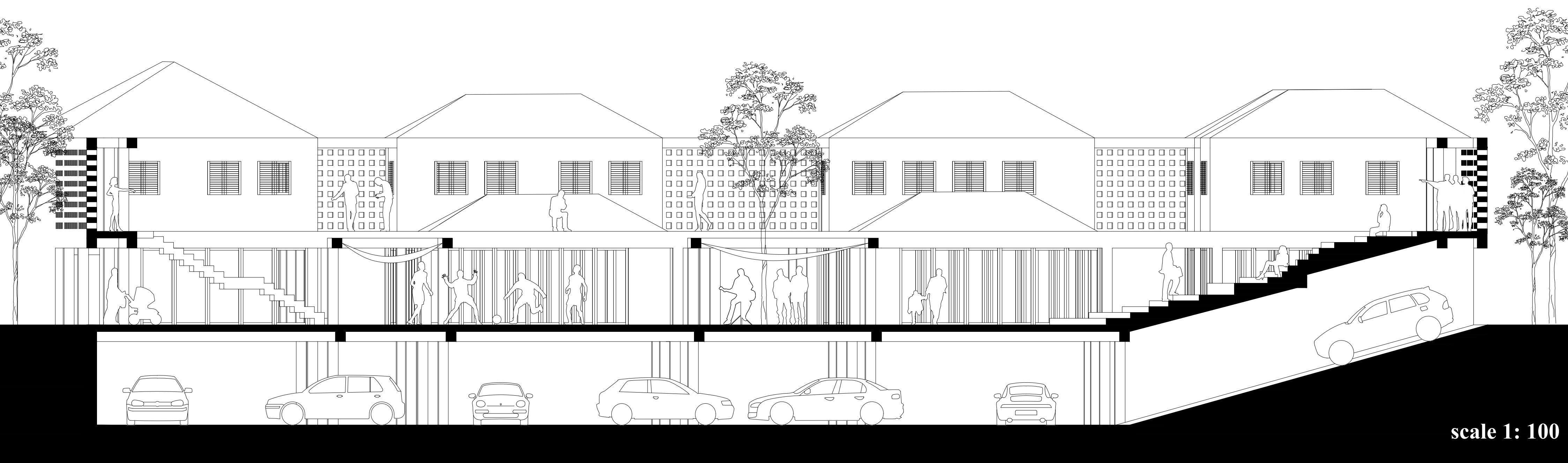



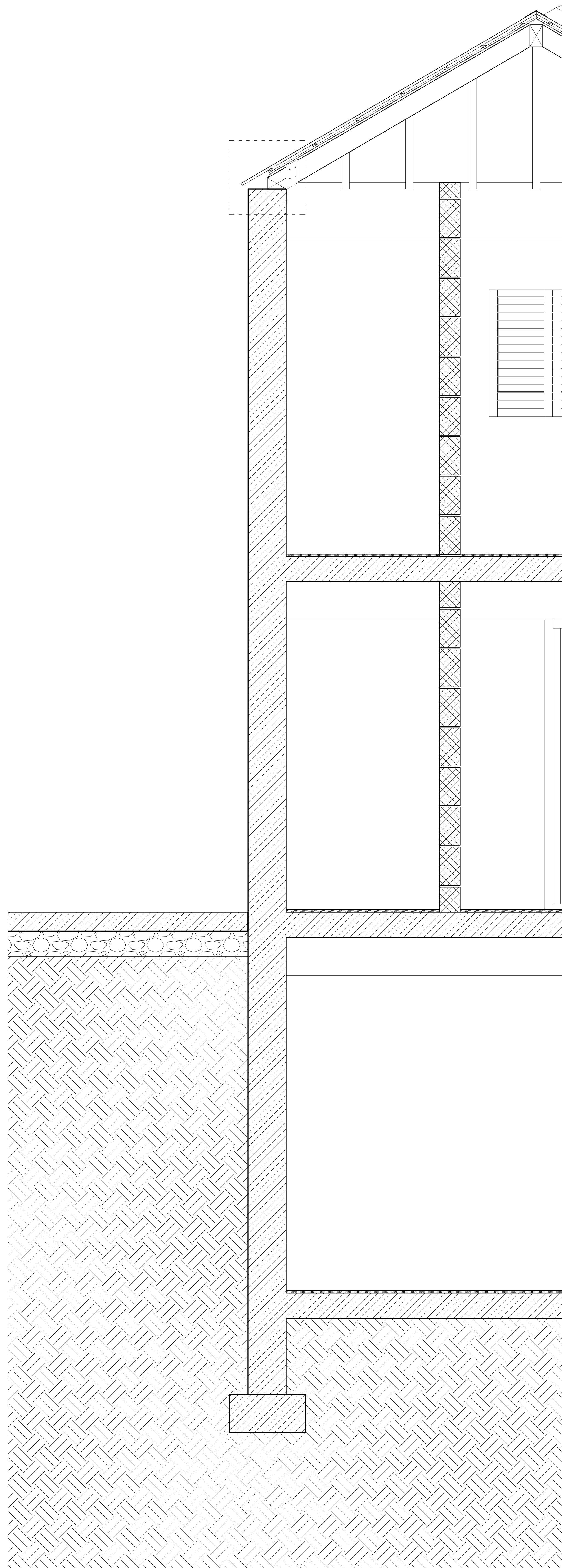
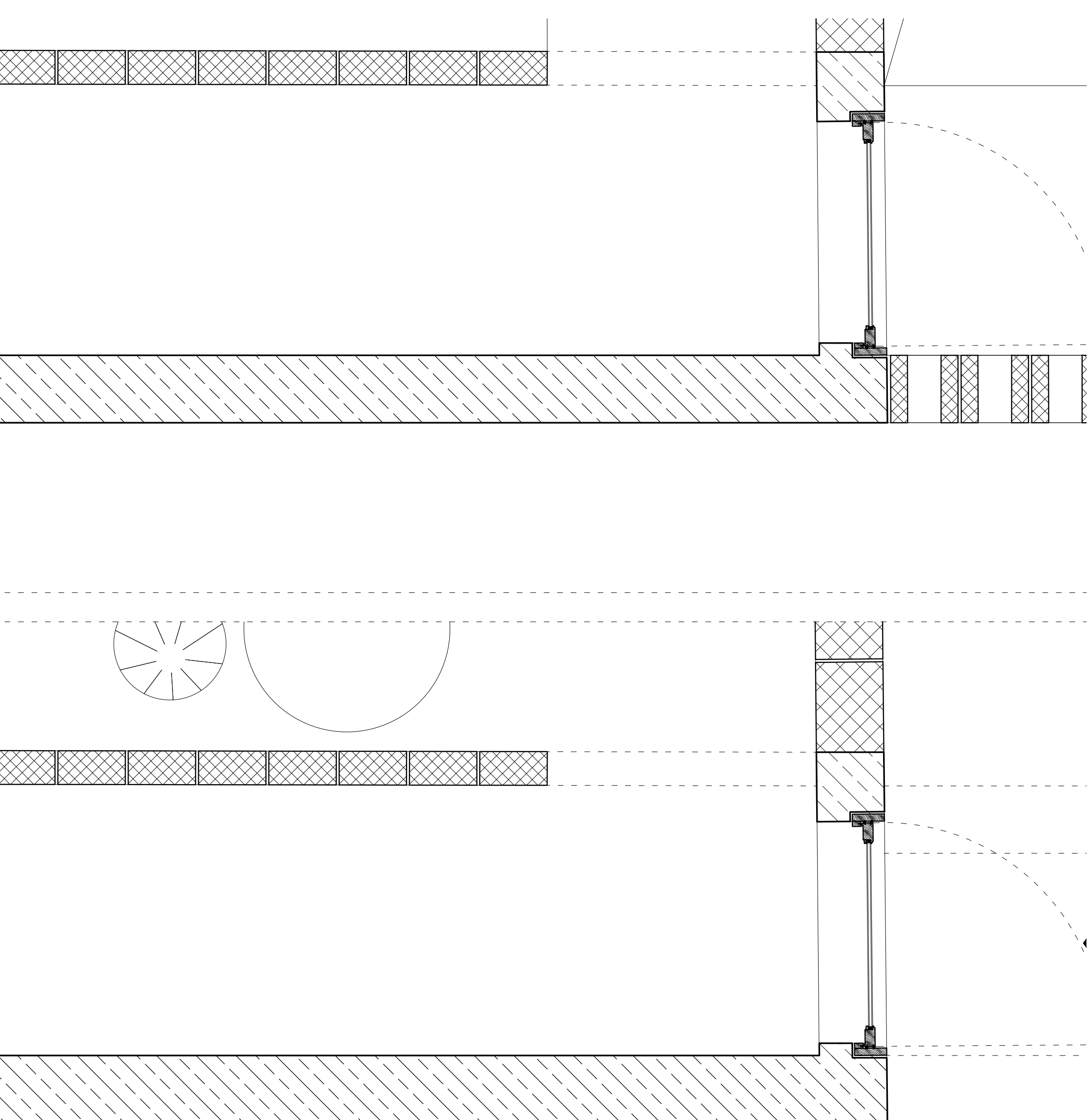
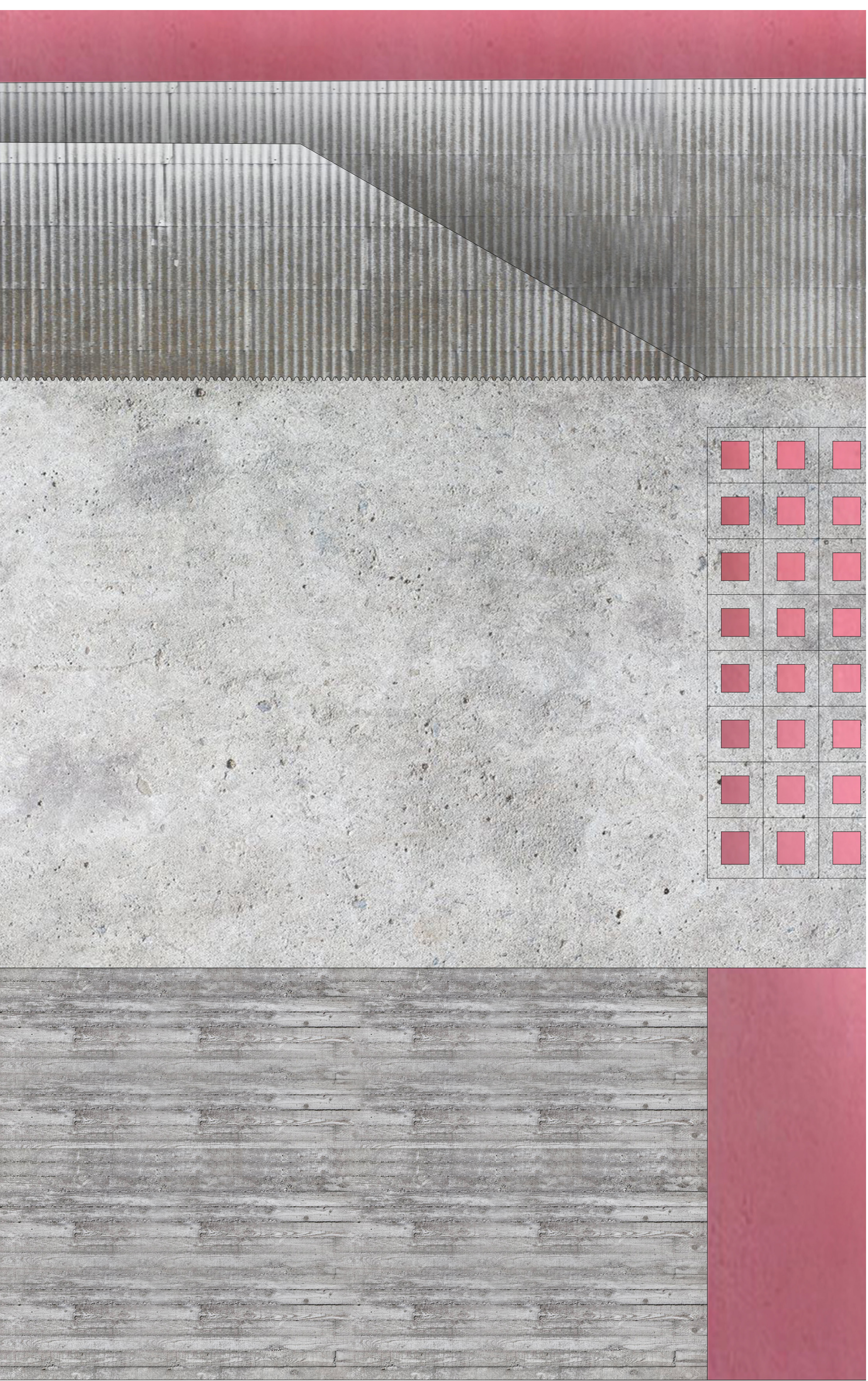

scale 1:20

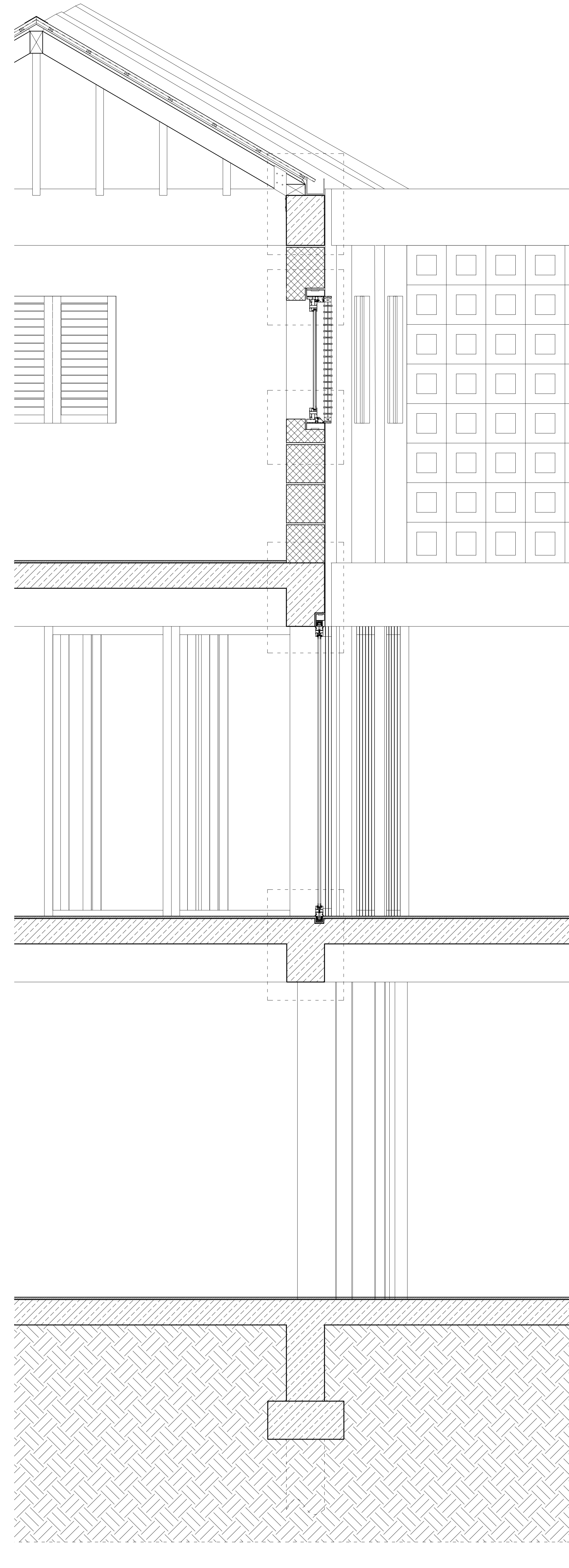
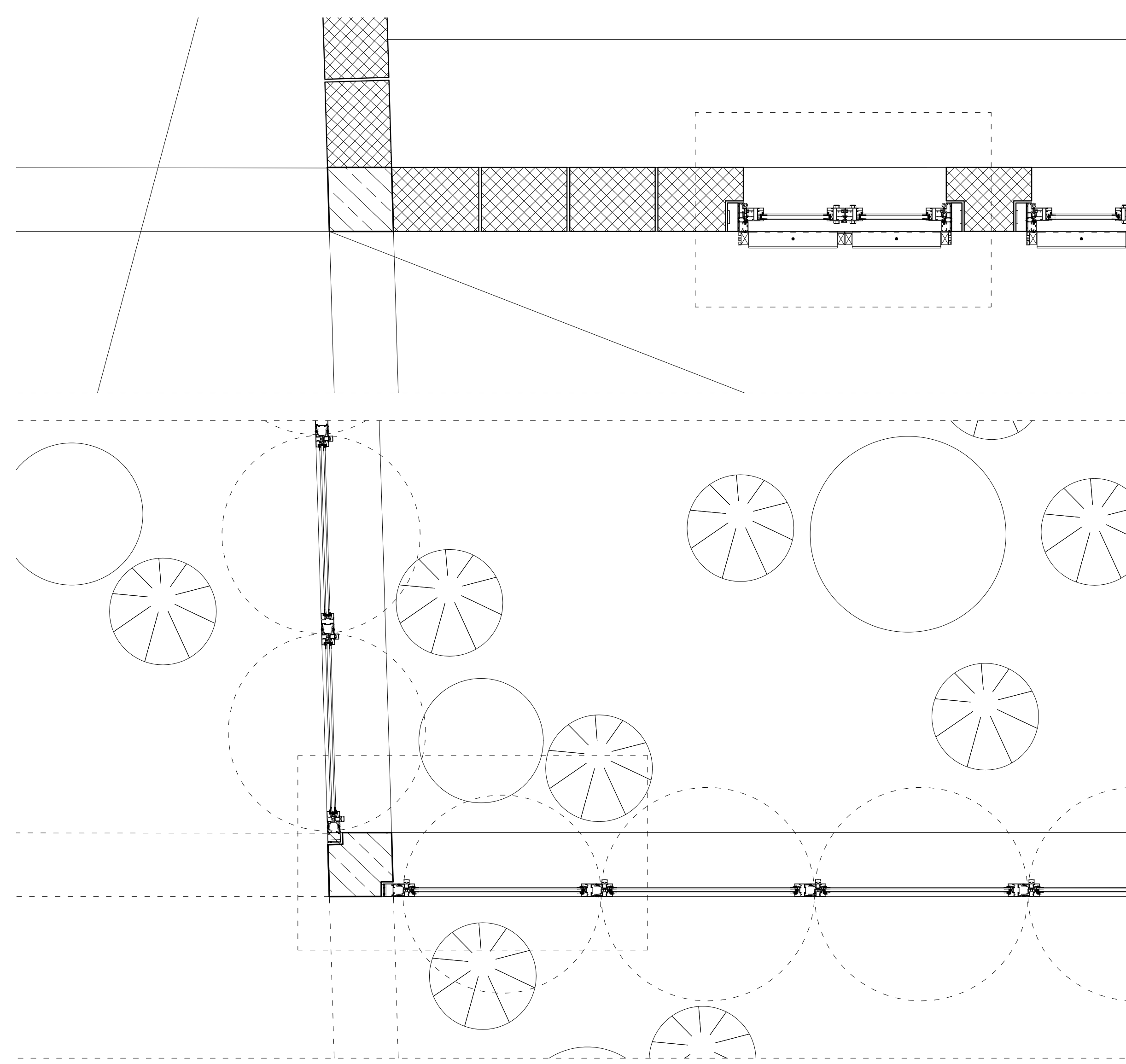
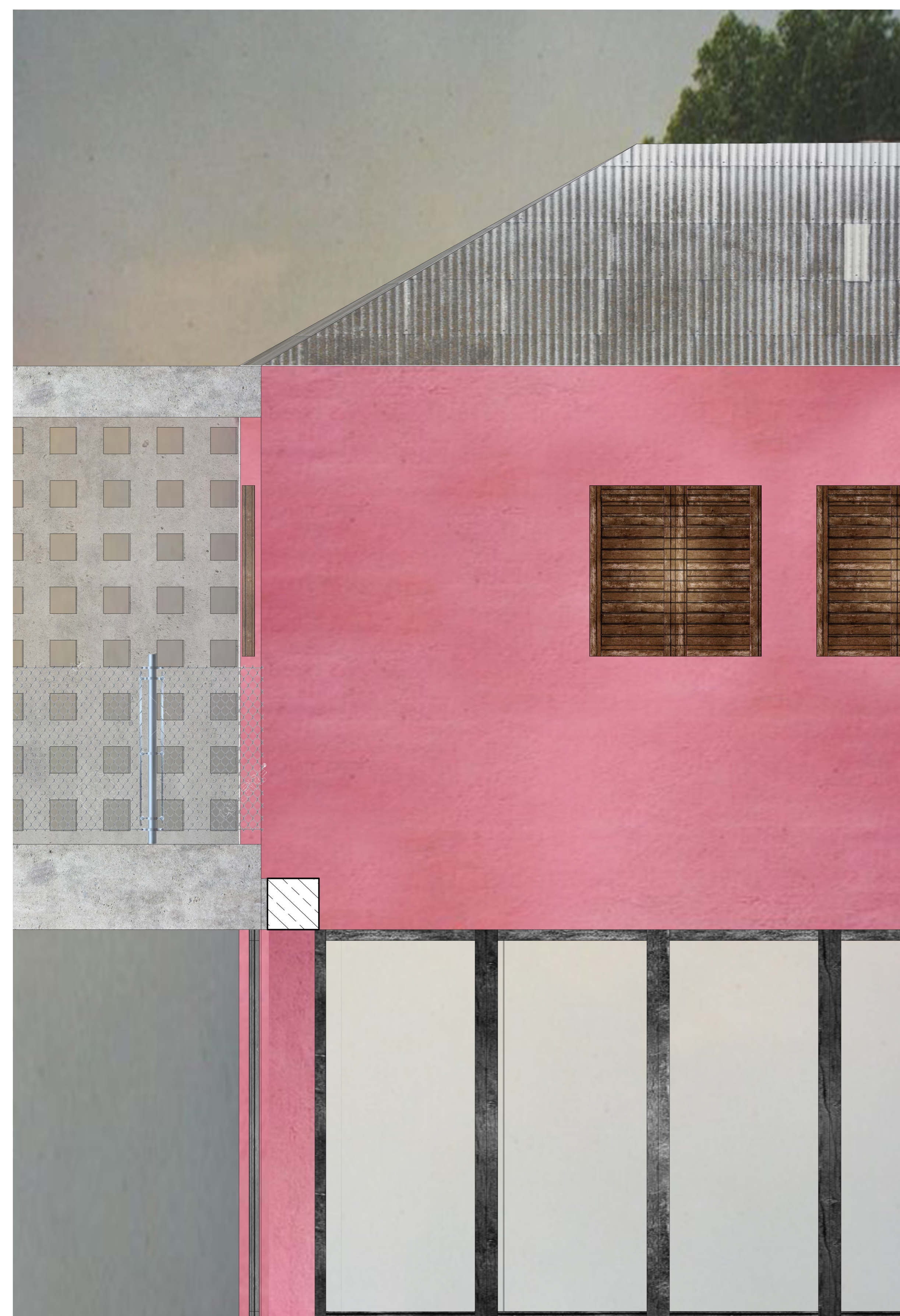

scale 1:20



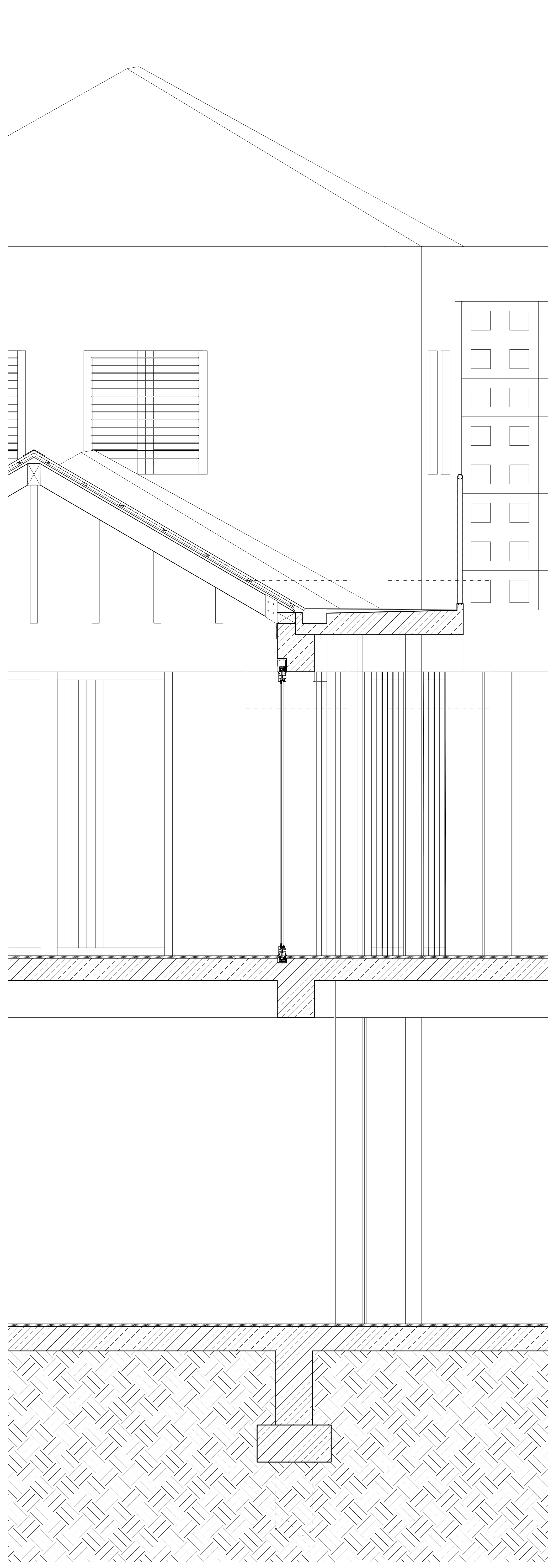
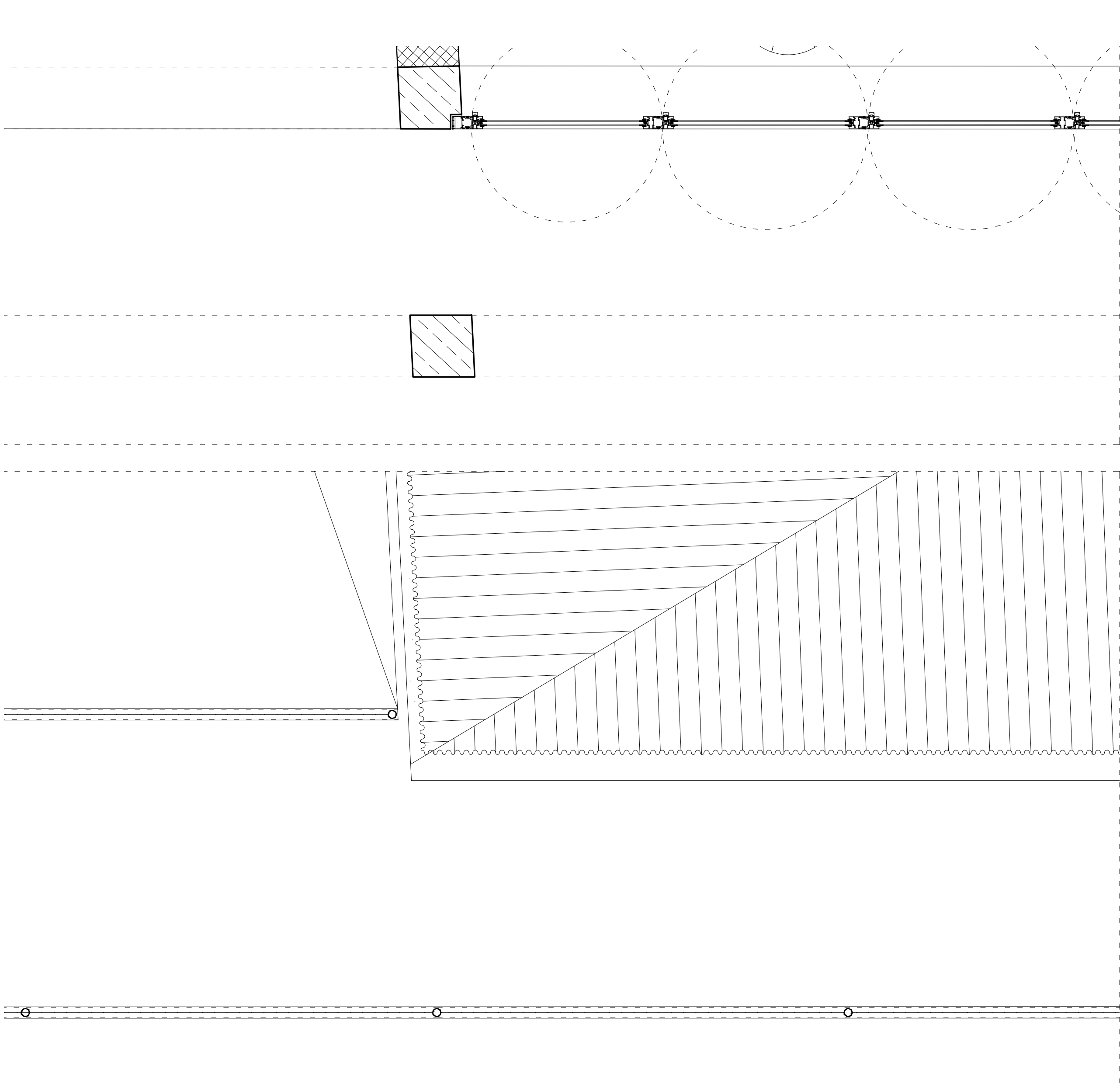

scale 1:20

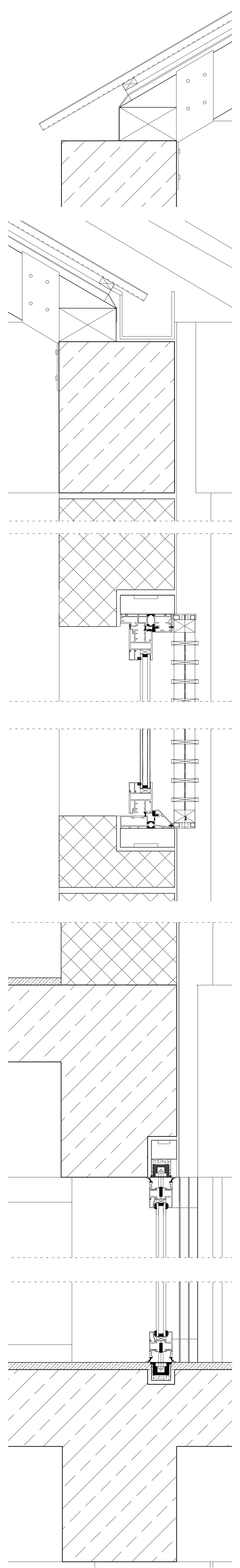

scale 1:50

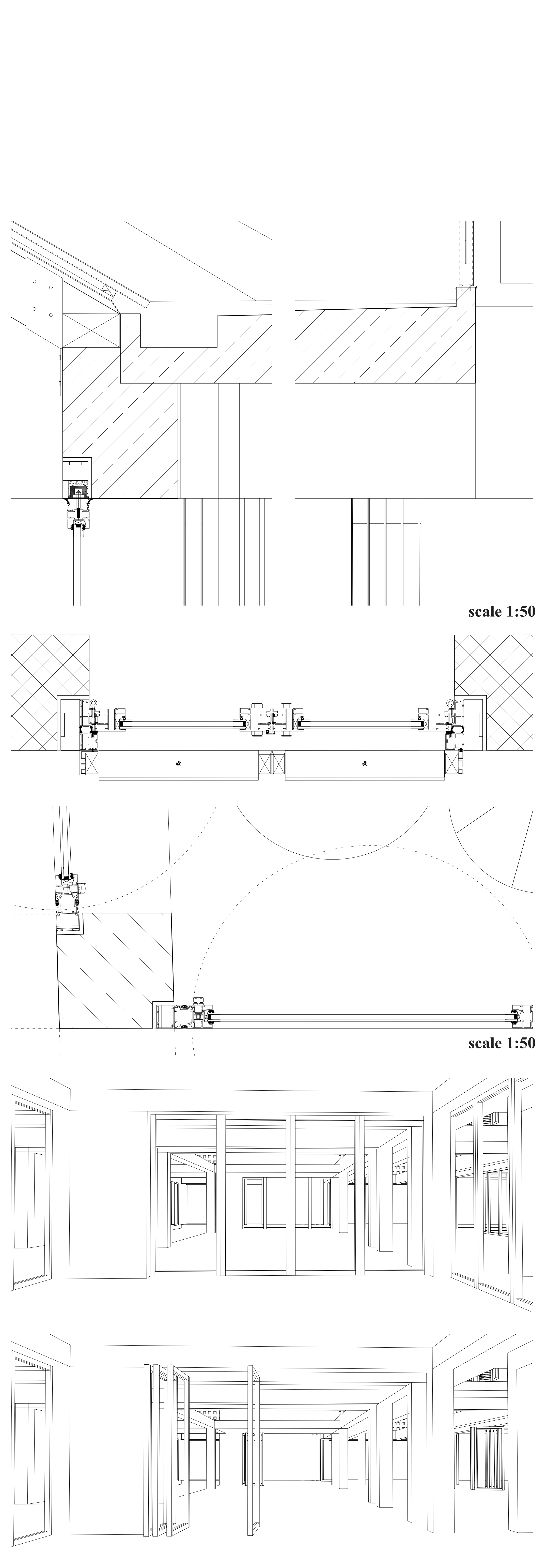

scale 1:50

scale 1:50

