

EVERYTHING REMAINS TRANSFORMED

A macro-regional strategy for the North Sea territory towards a low-carbon future

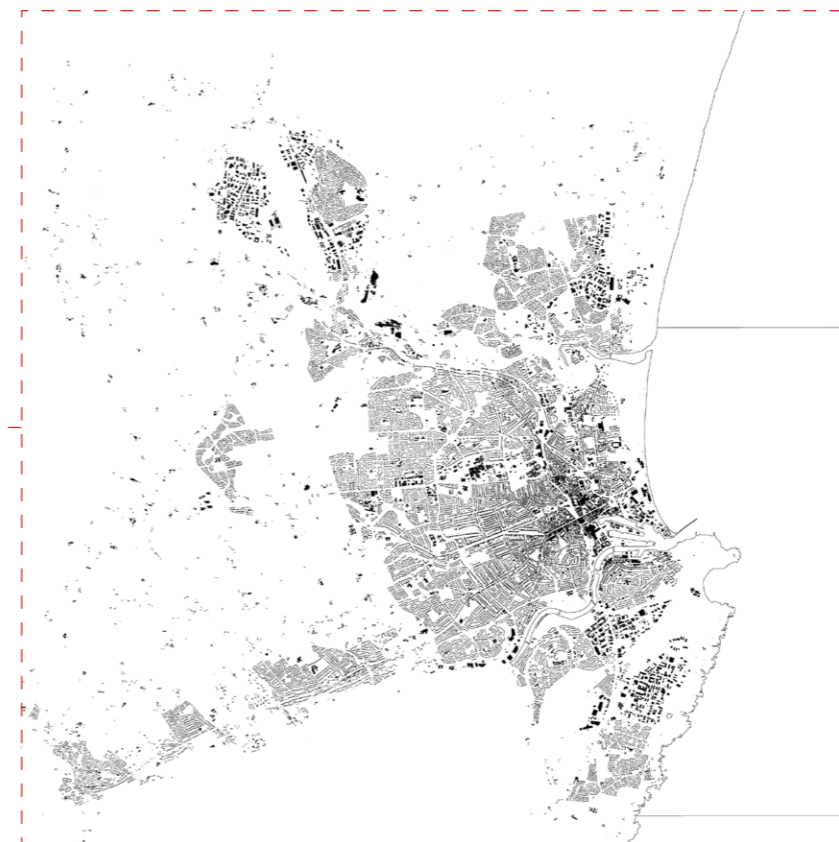

A LOOK BACK

The North Sea as
a crossroad

Roman Expeditions

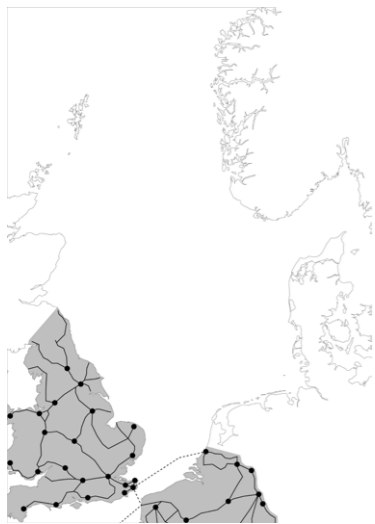

100

The Frisian Sea



400

Viking's expansion

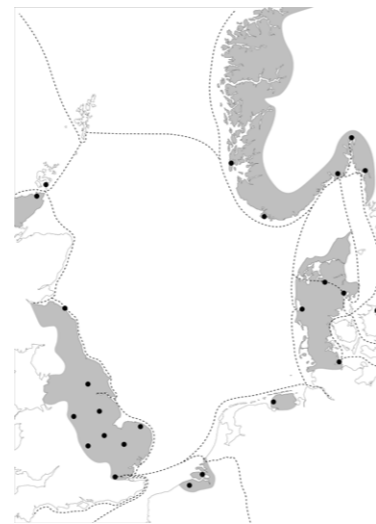

800

The Hanseatic League



1400

The Golden Age



1700

Globalisation and
Industrialisation

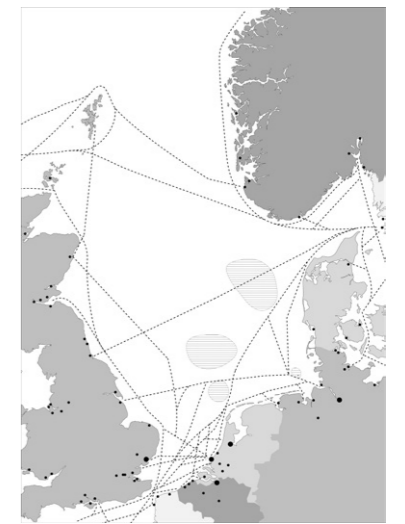

1900

A LOOK BACK

The Urbanisation of the sea



Overview of the Exclusive Economic Zones
(EEZ) and oil-license blocks

Data extracted from EUROSTAT, Thematic Mapping API, NLOG, OGA, NPD,
DEA, PETRODATA, OSPAR

KEY

- - -
-
- EEZ border
- Oil and gas platform
-
- ▲
-

Black and white colour might be inverted!



TODAY

Every nation state owns a piece of the pie



The separation into single EEZ's is resulting in various problems in terms of energy

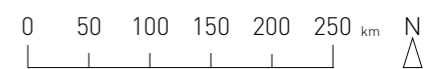

EVERYTHING REMAINS ...

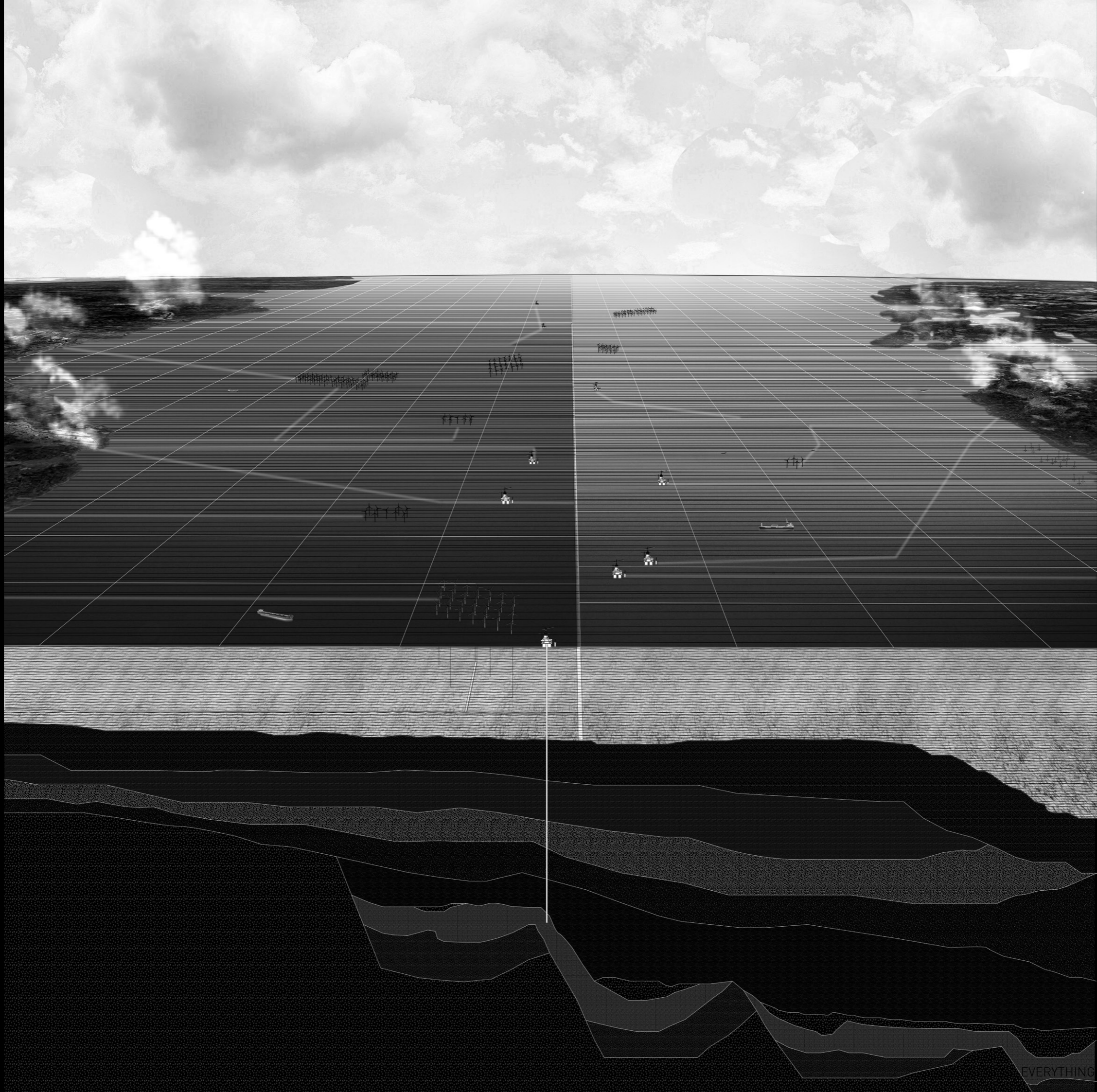

EVERYTHING REMAINS ...

The Energy Legacy



Overview of existing oil and gas rigs
and wind parks

Data extracted from EUROSTAT, Thematic Mapping API, NLOG, OGA, NPD,
DEA, PETRODATA, OSPAR

KEY

- - -
- Oil and gas pipeline
- Electricity cable
- EEZ border
- Oil and gas platform
- Oil and gas field
- Wind turbine
- Oil and gas platform
- Oil and gas field
- Wind turbine

Black and white colour might be inverted!

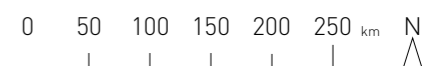

EVERYTHING REMAINS ...

The Energy Legacy

Overview of existing oil and gas rigs
and wind parks

Data extracted from EUROSTAT, Thematic Mapping API, NLOG, OGA, NPD,
DEA, PETRODATA, OSPAR



KEY

- Oil and gas pipeline
- Electricity cable
- EEZ border
- Oil and gas platform
- Oil and gas field
- Wind turbine
- Oil and gas platform
- Oil and gas field
- Wind turbine

Black and white colour might be inverted!

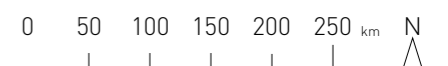

Oil and gas platforms

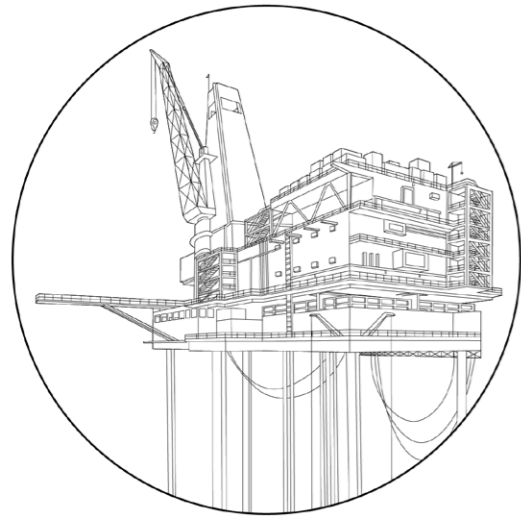

Oil and gas terminals



Refineries

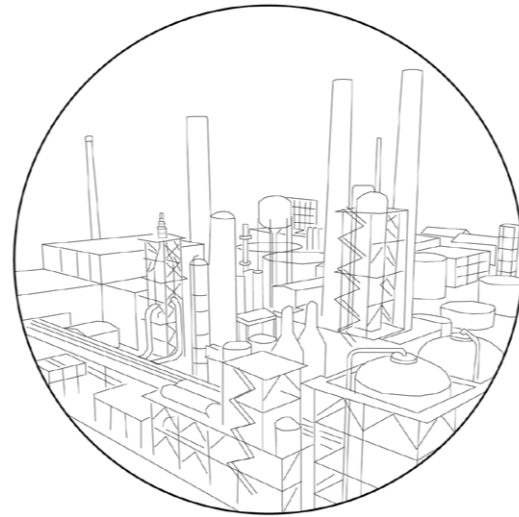

Businesses

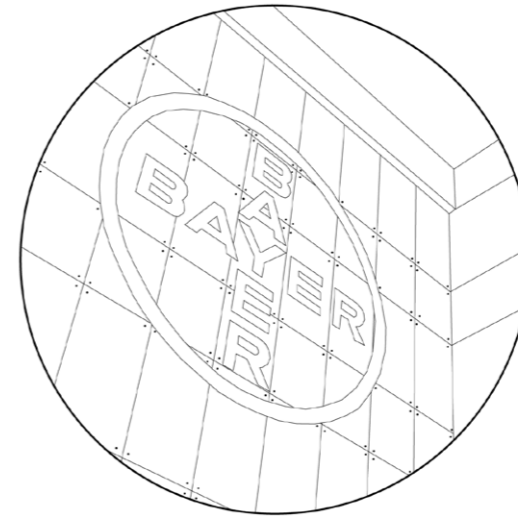

Terrestrial fossil energy sources

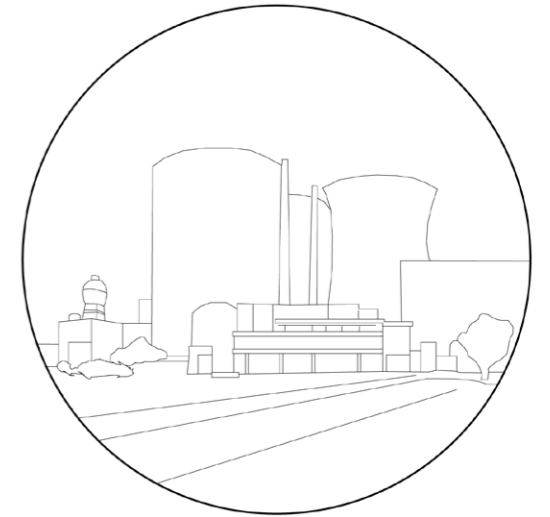

EVERYTHING REMAINS ...

The Energy Legacy

The European carbon emissions

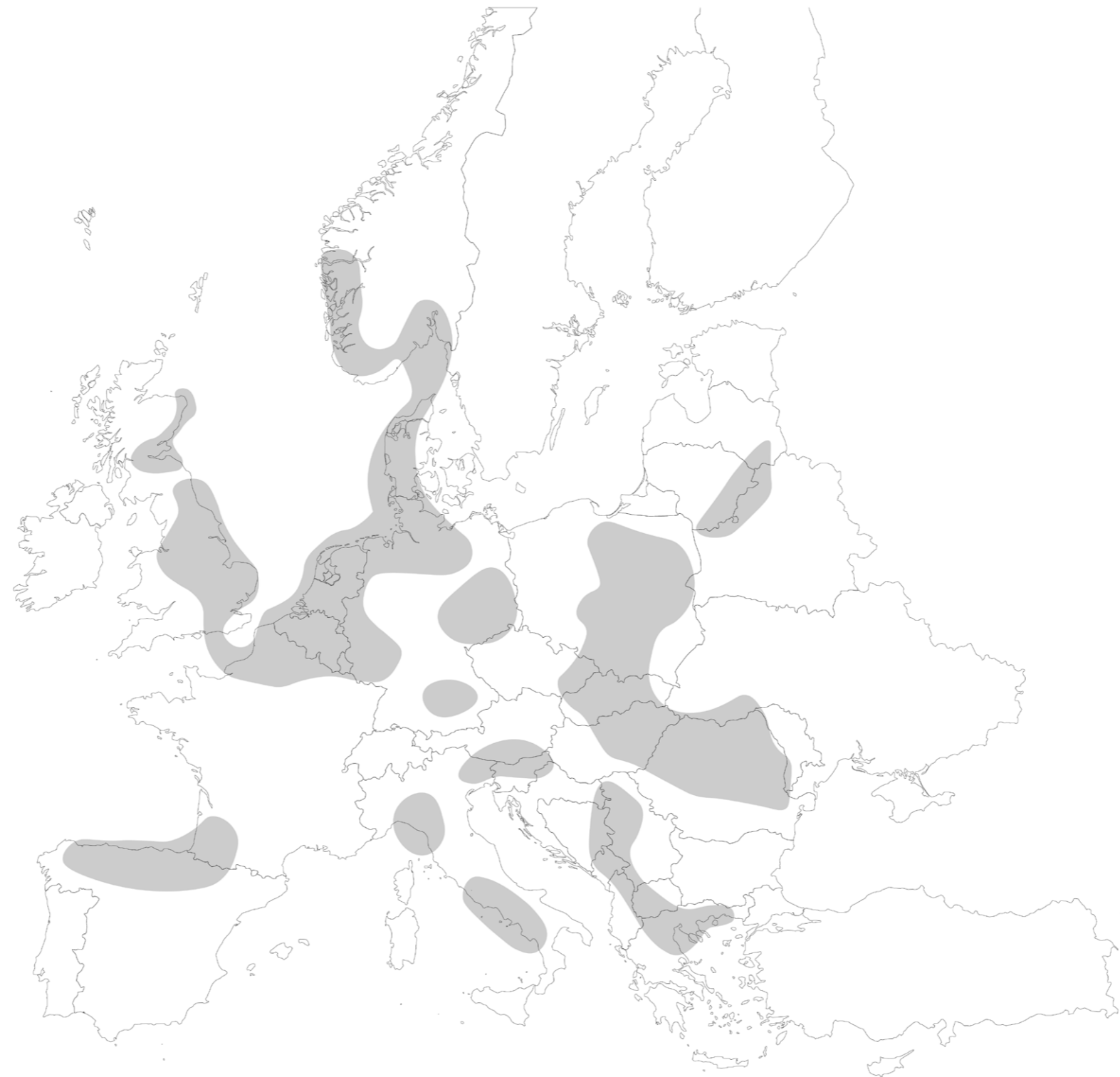

EVERYTHING REMAINS ...

The Energy Legacy

World Ecological Footprint by component

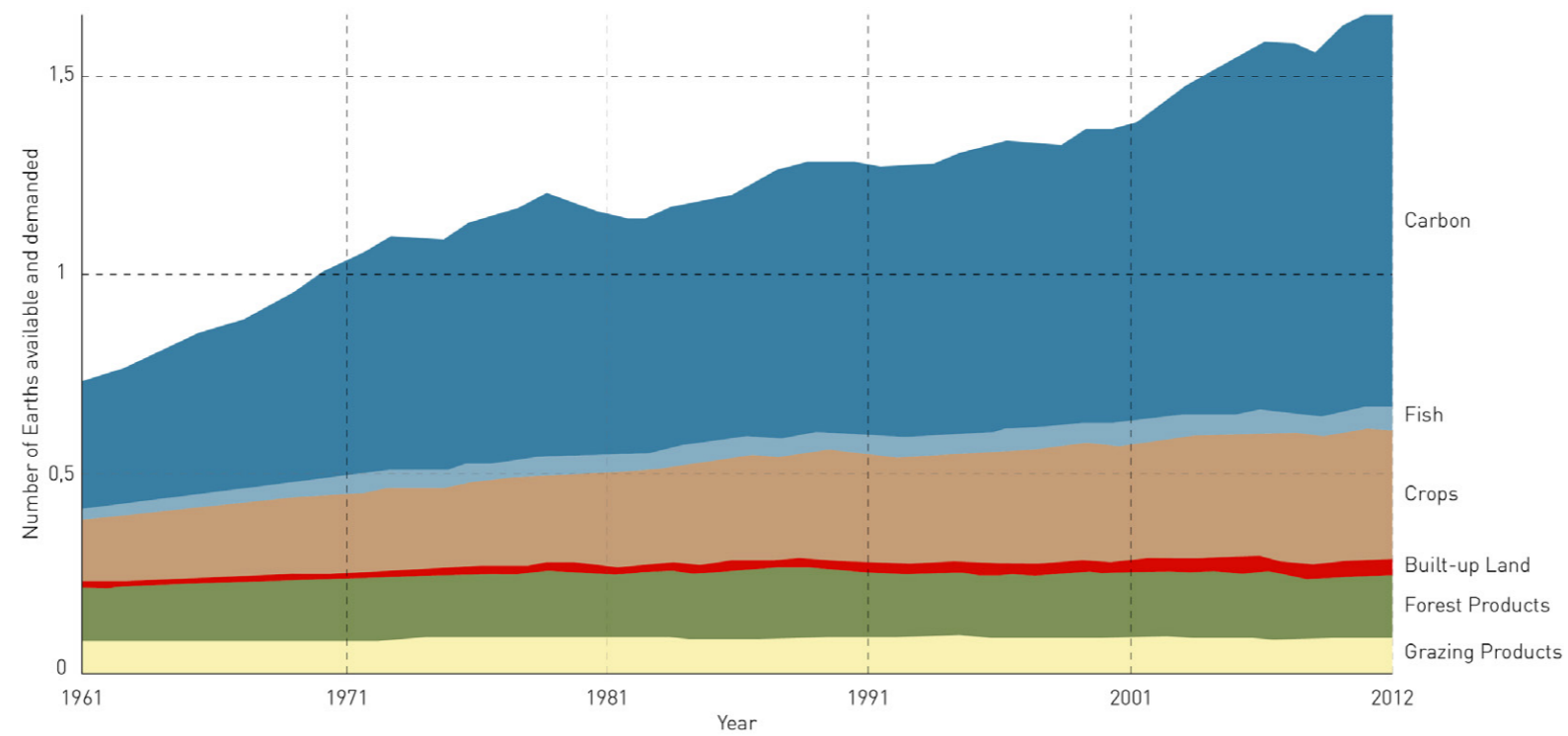

EVERYTHING REMAINS ...

Challenged by population
growth estimates

Estimated population growth by country between 2016 and 2080

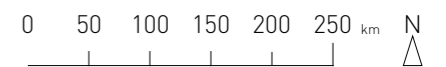
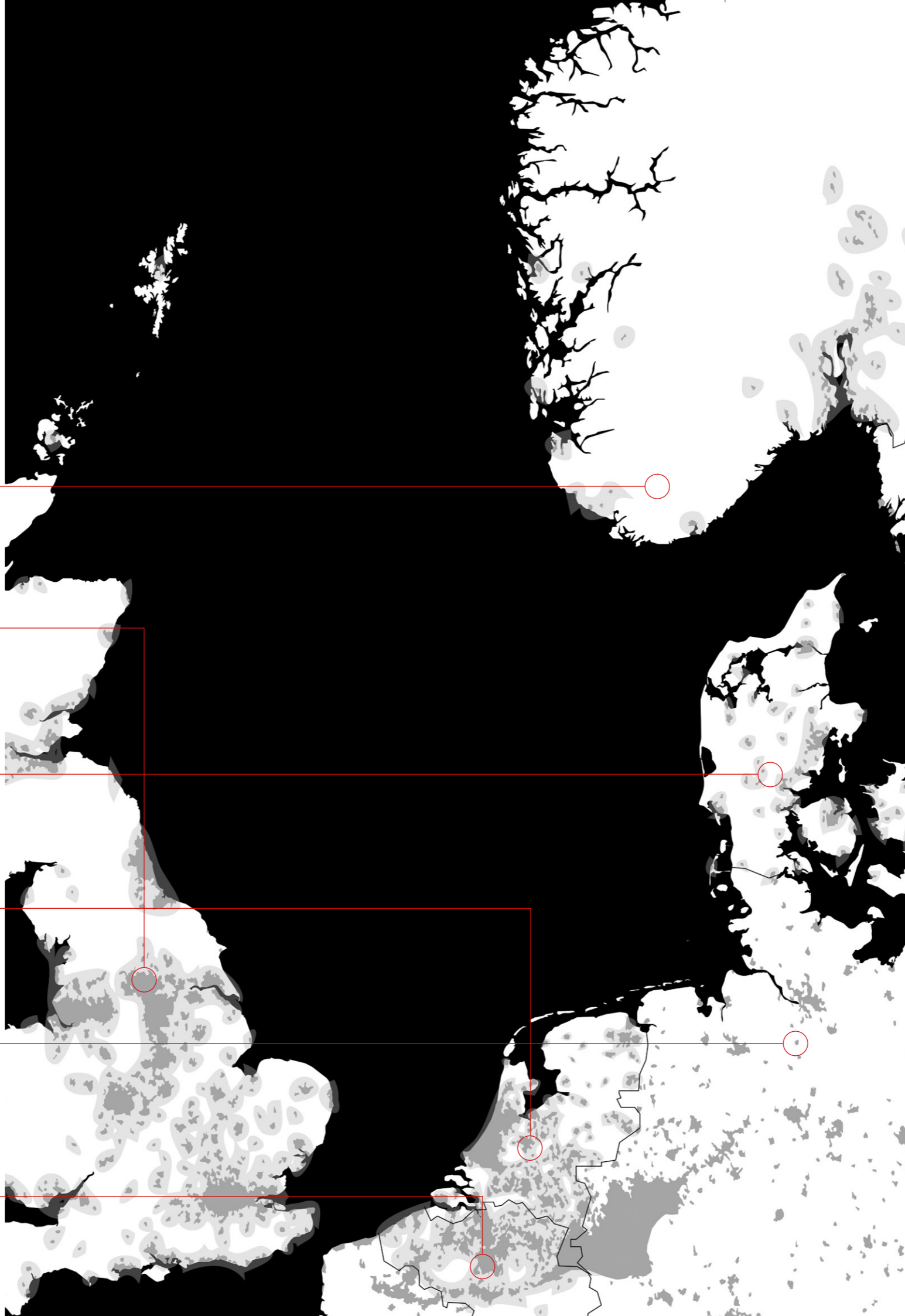
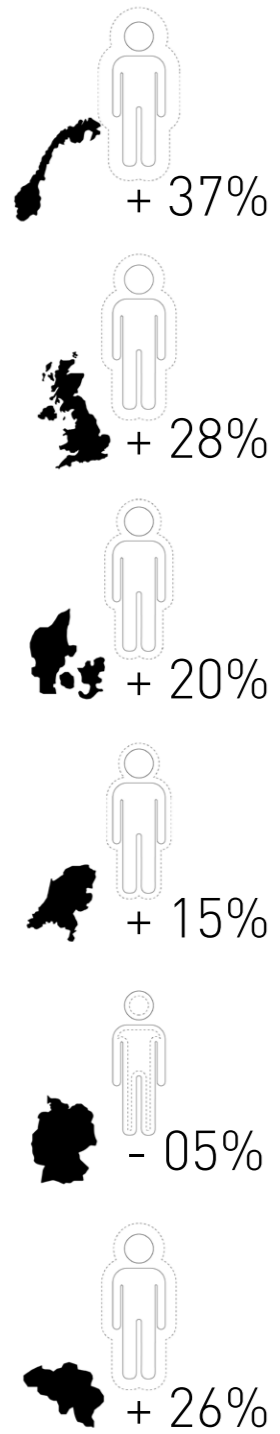

EVERYTHING REMAINS ...

Challenged by population
growth estimates

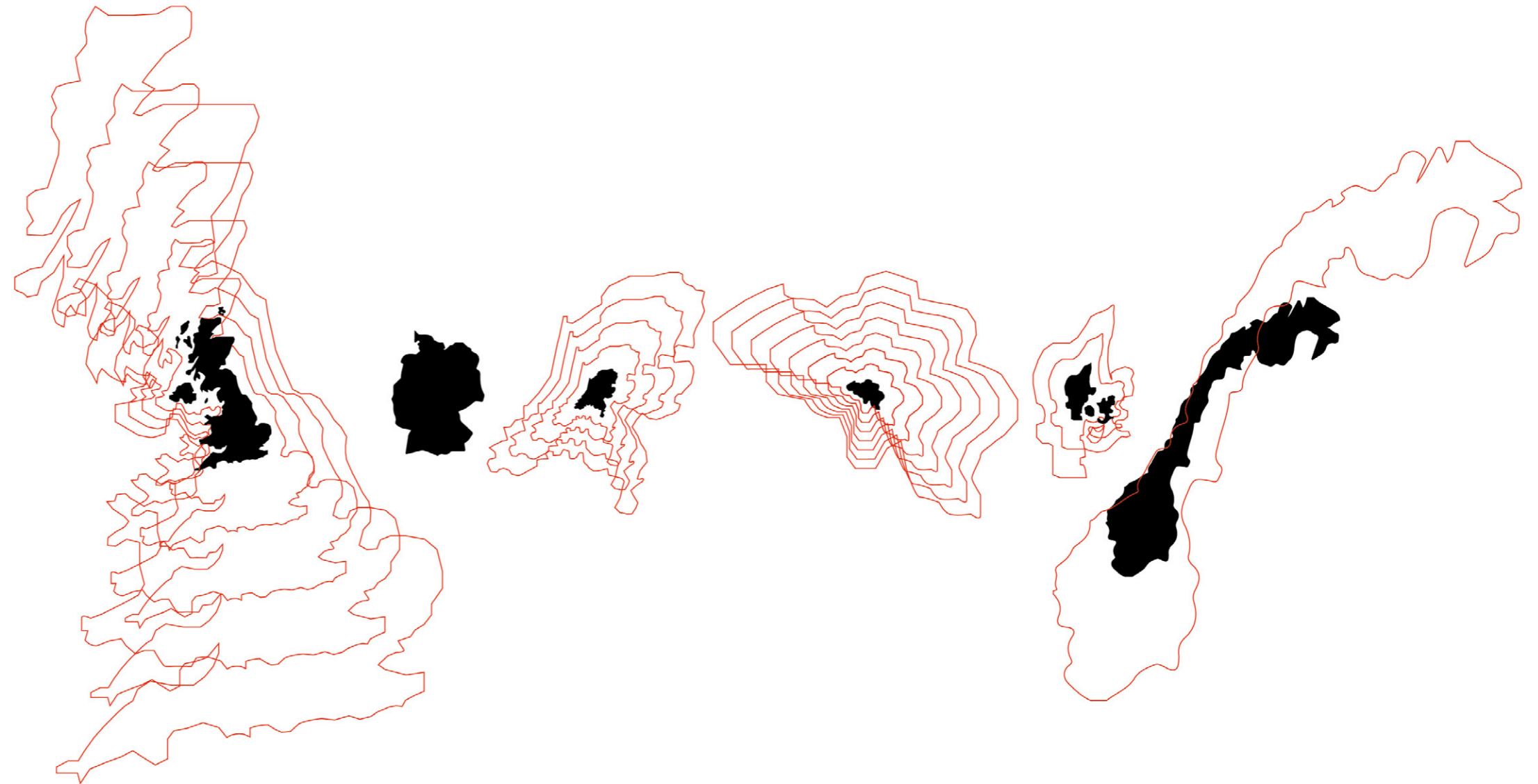

Multiple times of additional space is needed to produce the required amount of resources for the consumption of a growing population.

FROM SYSTEM OF EXTRACTION

From 6 territories and 6
high carbon footprints



TO A SYSTEM OF COLLABORATION

To 1 territory and 1 low carbon footprint

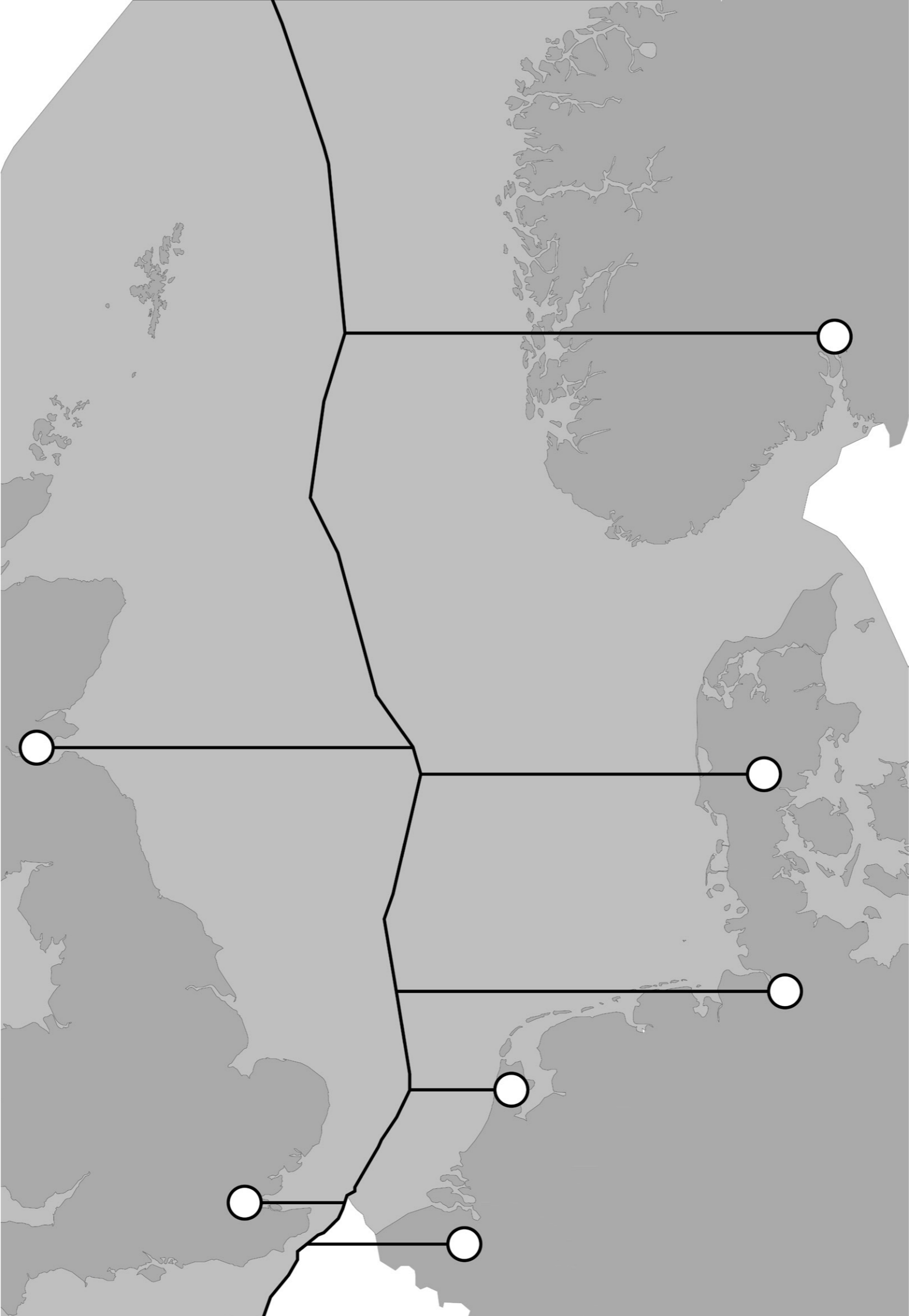

A macro-regional strategy

Overview of existing (dark) and considered (light) macro-regions in Europe

Sources: thematicmapping.org, Österreichisches Institut für Raumplanung (ÖIR)

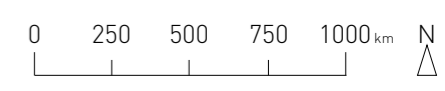
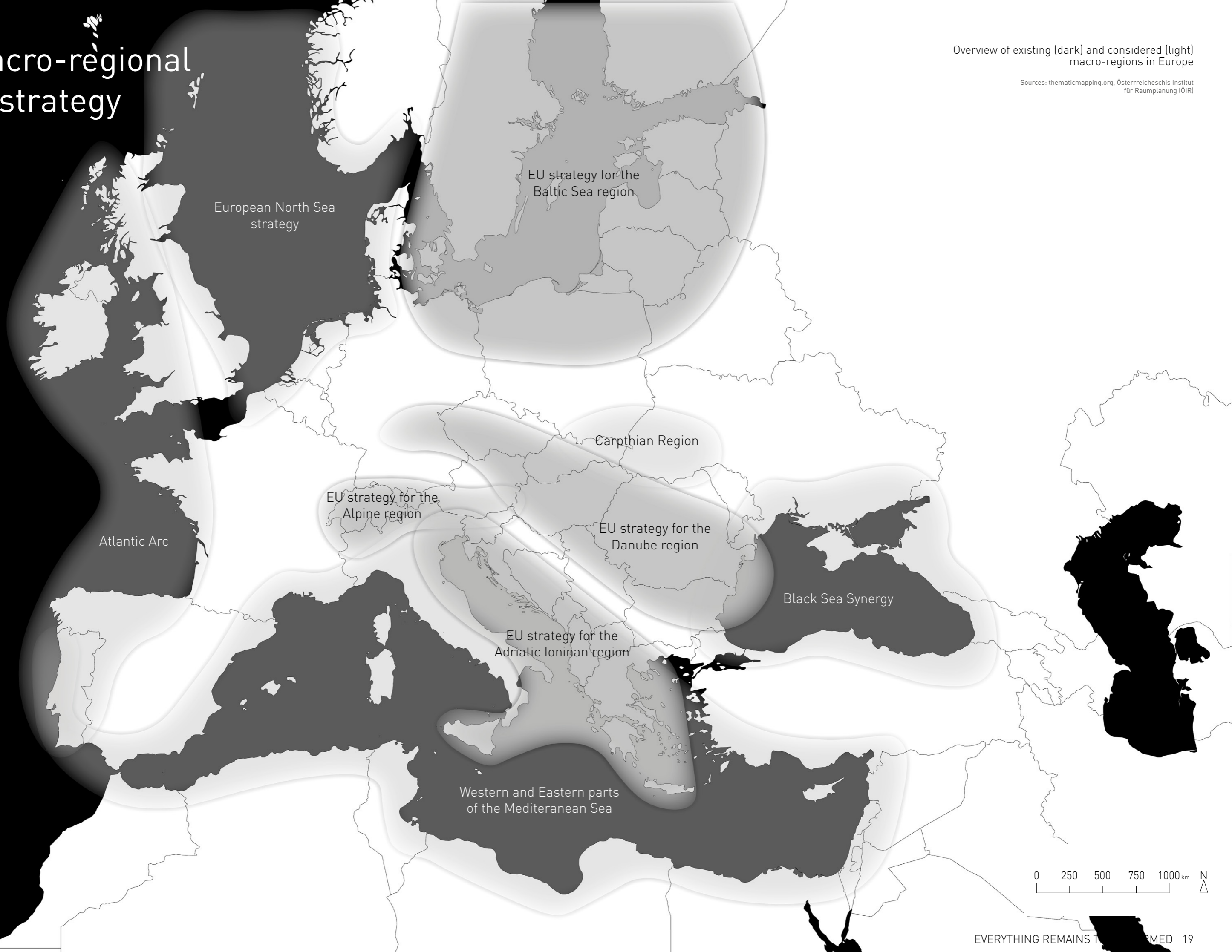

TWO REFERENCE POINTS

The potential of the North Sea for the West European energy transition

ZEEKRACHT by OMA (2008)

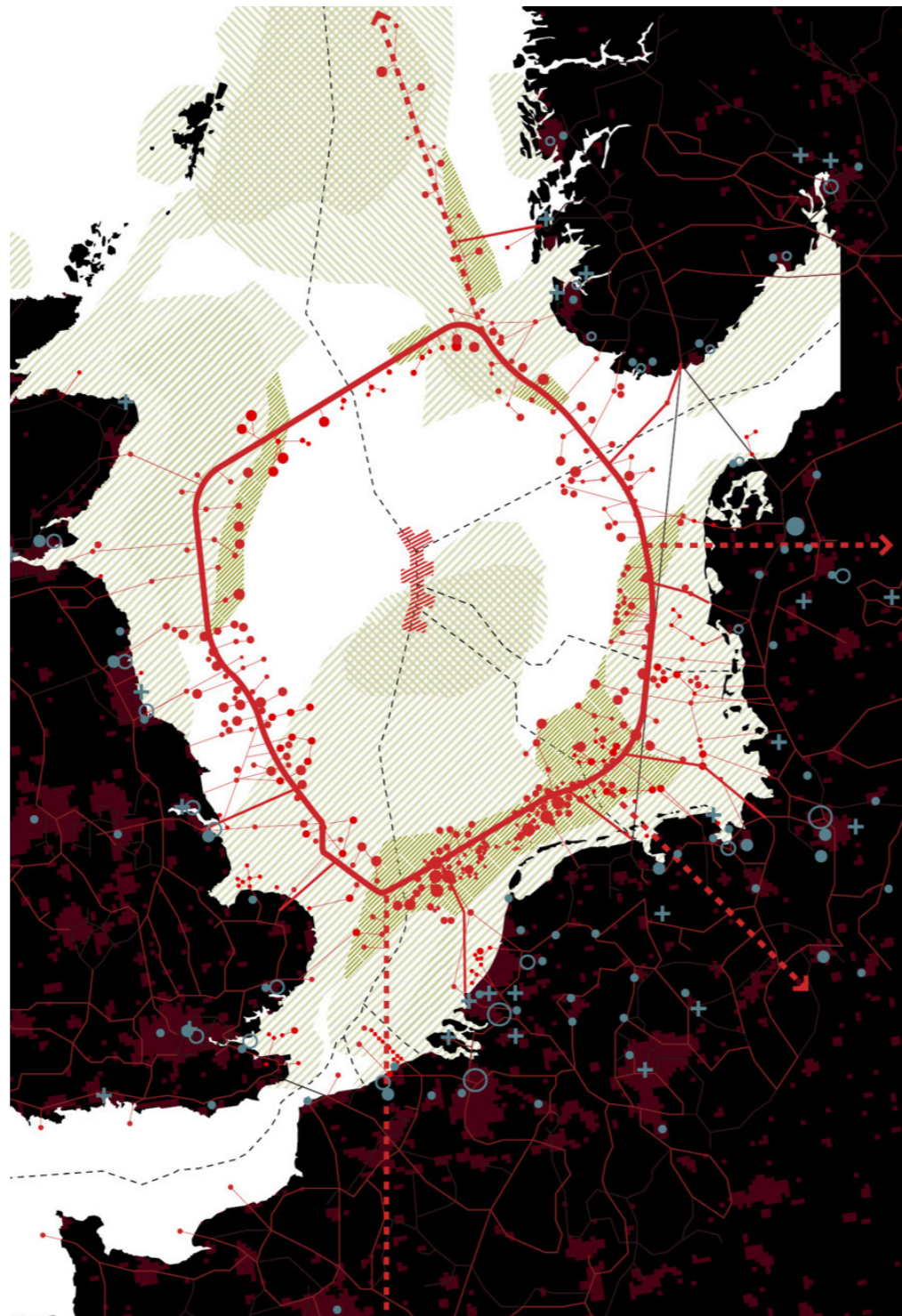

Source: <http://atlasofplaces.com/Zeekracht-OMA>

An Energetic Odyssey by H+N+S Landscape Architects (2016)

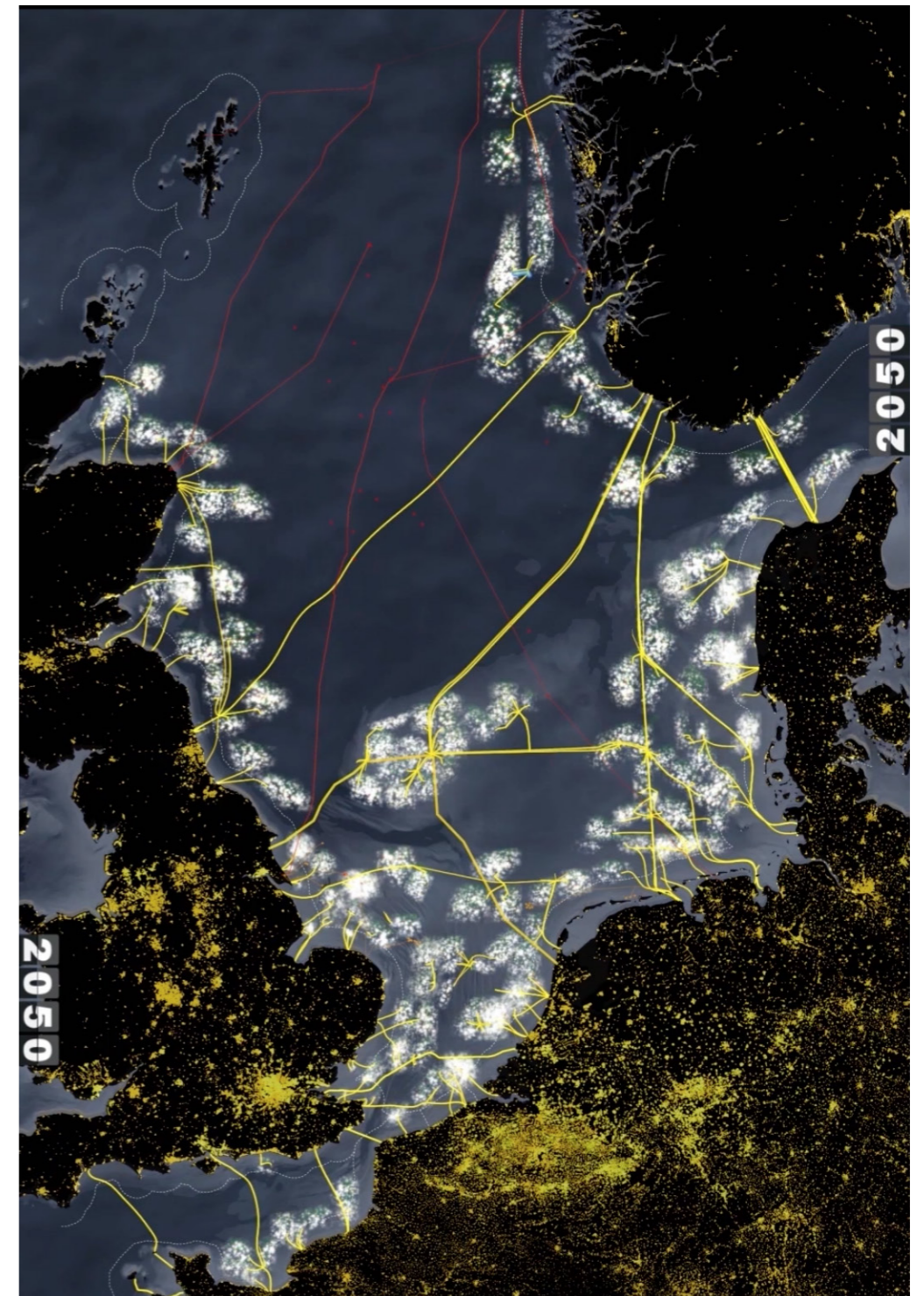

Source: <https://iabr.nl/en/projectatelier/atelier2050>

WHAT TO ADD

A multifunctional
energy infrastructure

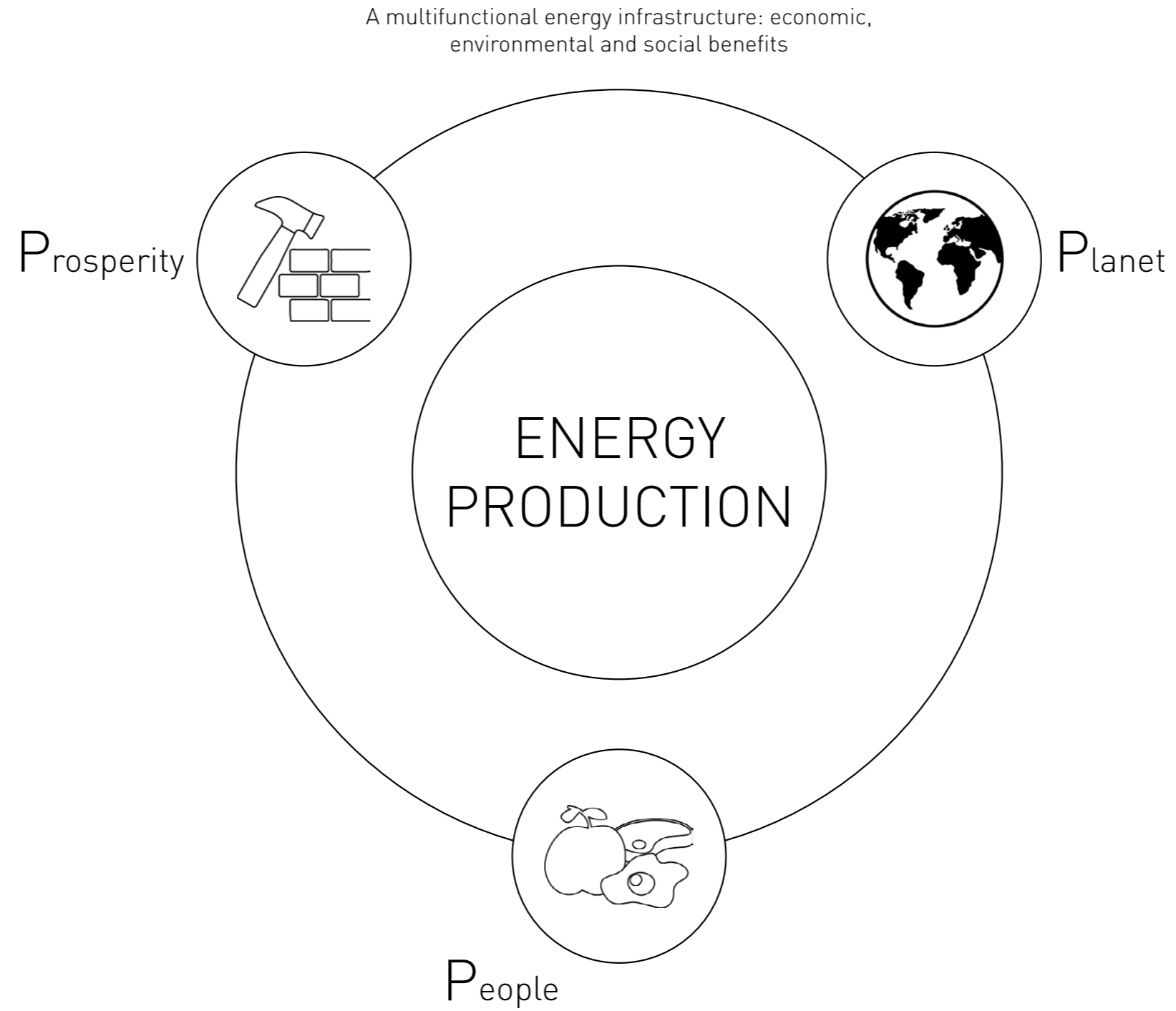

EVERYTHING REMAINS ... TRANSFORMED

EVERYTHING REMAINS TRANSFORMED

The key elements of a
multifunctional
energy infrastructure

Key elements of the strategy

- 1 Integration of the energetic legacy
(Infrastructural artefacts and
brownfields)
- 2 Territorial collaboration
- 3 Energy production



Everything Remains Transformed,
a macro-regional strategy for
the North Sea territory

KEY

	Ecological patchwork		CO2 emissions
	Protein and fuel		R&D manufacturing
	Transformed coal site		Transformed business
	Transformed terminal		Transformed refinery
	Oil and gas pipeline		Planned ecological zone
	Electricity cable		Existing ecological zone
	Regional border		Energy substation
	Oil and gas platform		transformed oil rigs
	Oil and gas field		Wave and tidal energy
	Wind turbine		Energy through carbon

Black and white colour might be inverted!

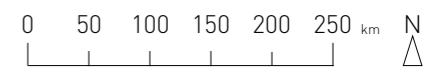

EVERYTHING REMAINS TRANSFORMED

3 main principles

The Collaborative Seascape



The Ecological Patchwork

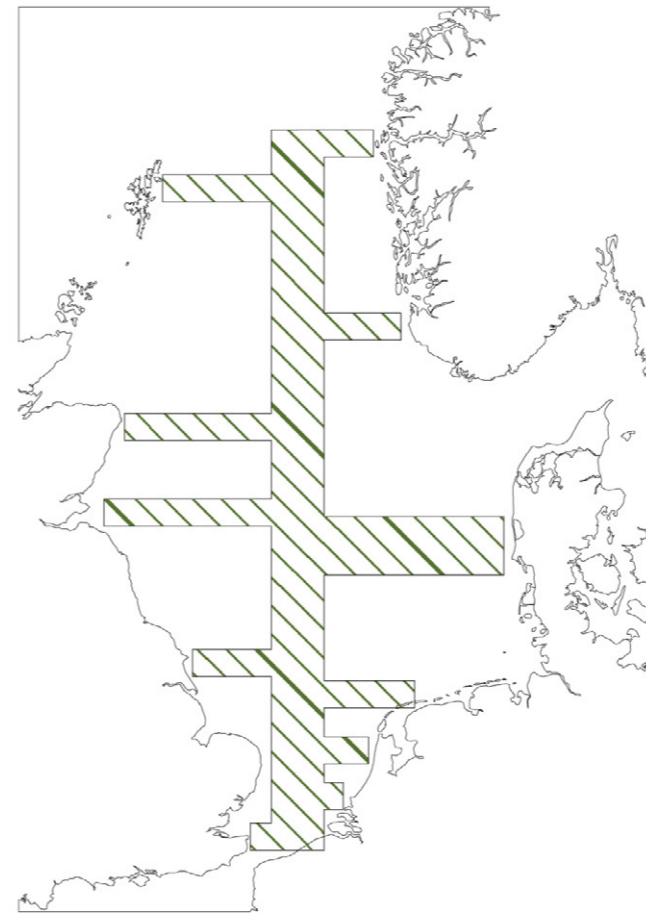

The Low-Carbon Belt

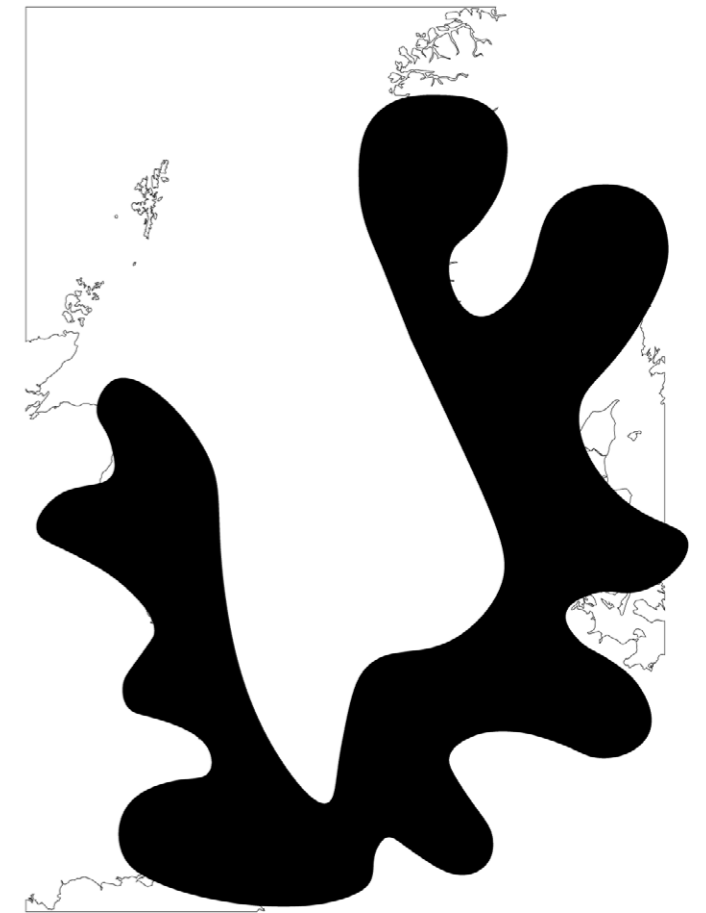

The Extractive Seascape



The Ecological Fragmentation





The High-Carbon Belt



EVERYTHING REMAINS TRANSFORMED

A macro-regional structure:
Creating a framework for
the smaller scales

Framework of the macro-regional strategy for the North Sea territory

	The Collaborative Seascape	The Ecological Patchwork	The Low-Carbon Belt
Main principles			
Spatial guidelines	<ol style="list-style-type: none"> 1 Energy security through collaboration 2 Energy security through diversification 3 From producer to consumer 4 Reusing what is already there 5 A fair division of resources and revenue 	<ol style="list-style-type: none"> 6 Ecological corridors connecting protected zones 7 Engineered artefacts as water purifiers and artificial reefs 	<ol style="list-style-type: none"> 8 Independent energy regions with an own identity 9 Centralities for energy supply and urban growth 10 Prosperity and competition through transformation 11 Prosperity and competition through research

Application at the regional scale of Aberdeen

EVERYTHING REMAINS TRANSFORMED

(1) Energy security through
collaboration

(2) Energy security through
diversification



A centralised exchange grid of electricity cables to
decrease the distance between the areas
of surplus and demand



Different technologies add to the existing system
of renewable energy production

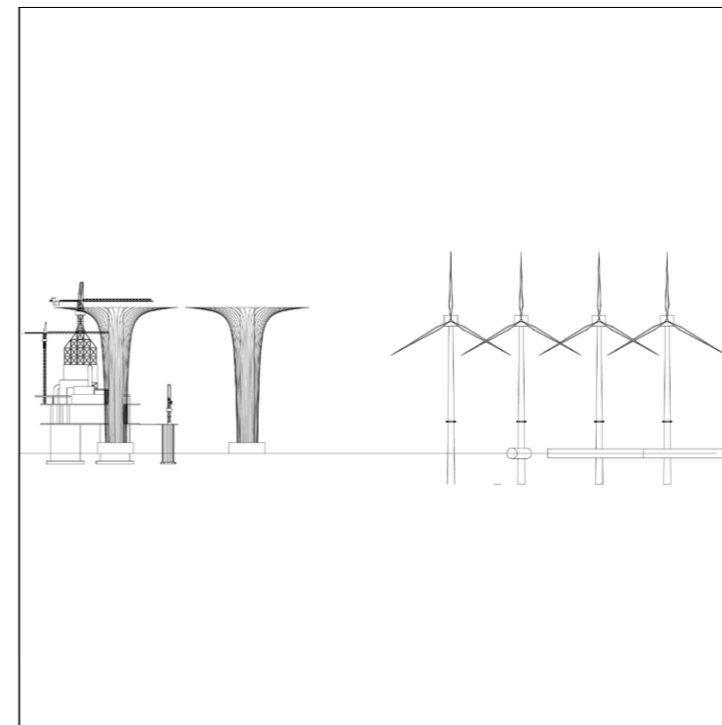

EVERYTHING REMAINS TRANSFORMED

(1) Energy security through
collaboration

(2) Energy security through
diversification

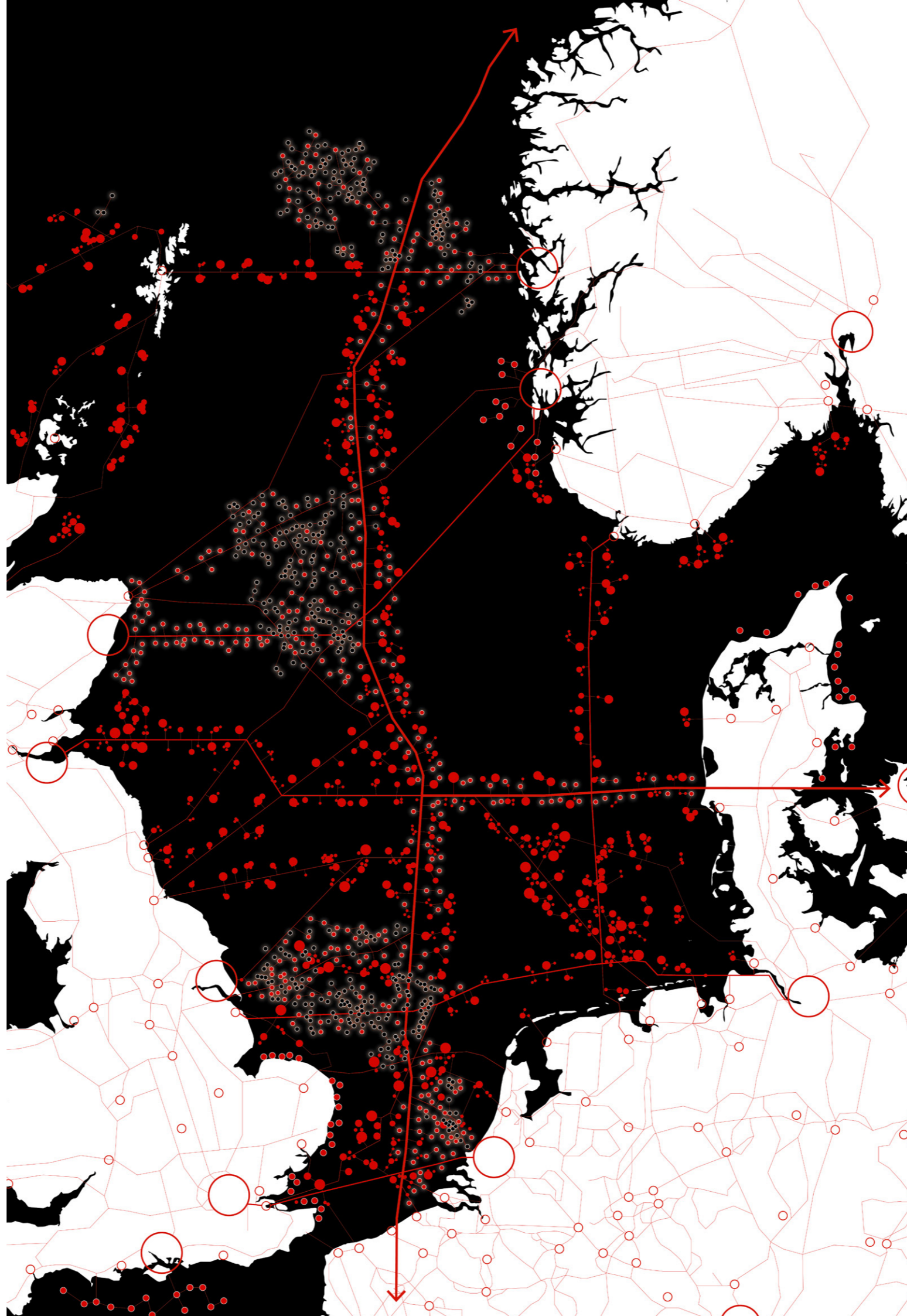

An electricity exchange grid and diverse
renewable offshore sources to secure the
territorial energy supply

KEY

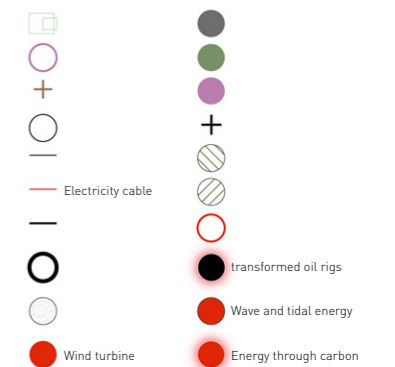

Black and white colour might be inverted!



EVERYTHING REMAINS TRANSFORMED

(3) From producer to
consumer

(4) Reusing what is already
there



Sending the carbon dioxide from the producing
regions to the carbon regions

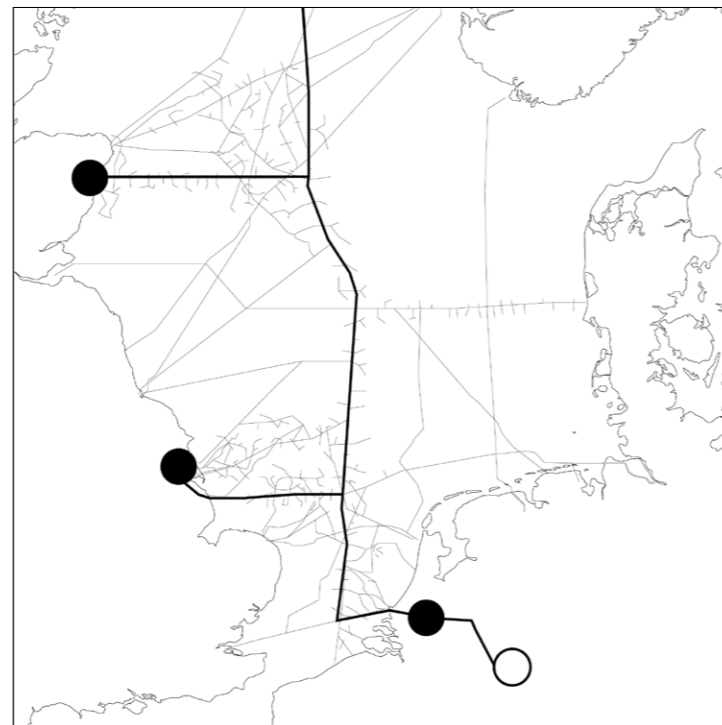

Reusing the existing infrastructure of the oil and
gas age: pipelines and platforms



EVERYTHING REMAINS TRANSFORMED

(3) From producer to
consumer

(4) Reusing what is already
there



The urban waste product, carbon dioxide, is
consumed in the carbon region in Aberdeen,
and in the region adjacent to Hull,
Bergen and Rotterdam

KEY

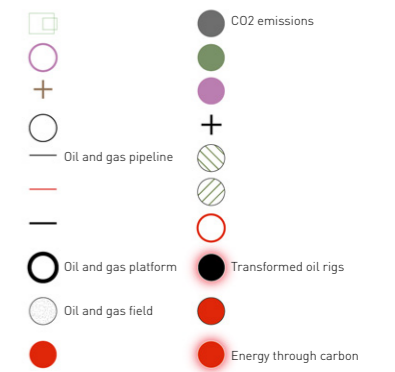

Black and white colour might be inverted!

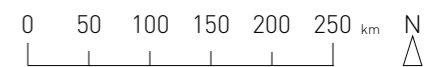

EVERYTHING REMAINS TRANSFORMED

(5) A fair division of
resources and revenue



A welfare system in the North Sea territory that is based on the exchange of carbon dioxide from the producing regions to the consuming carbon regions

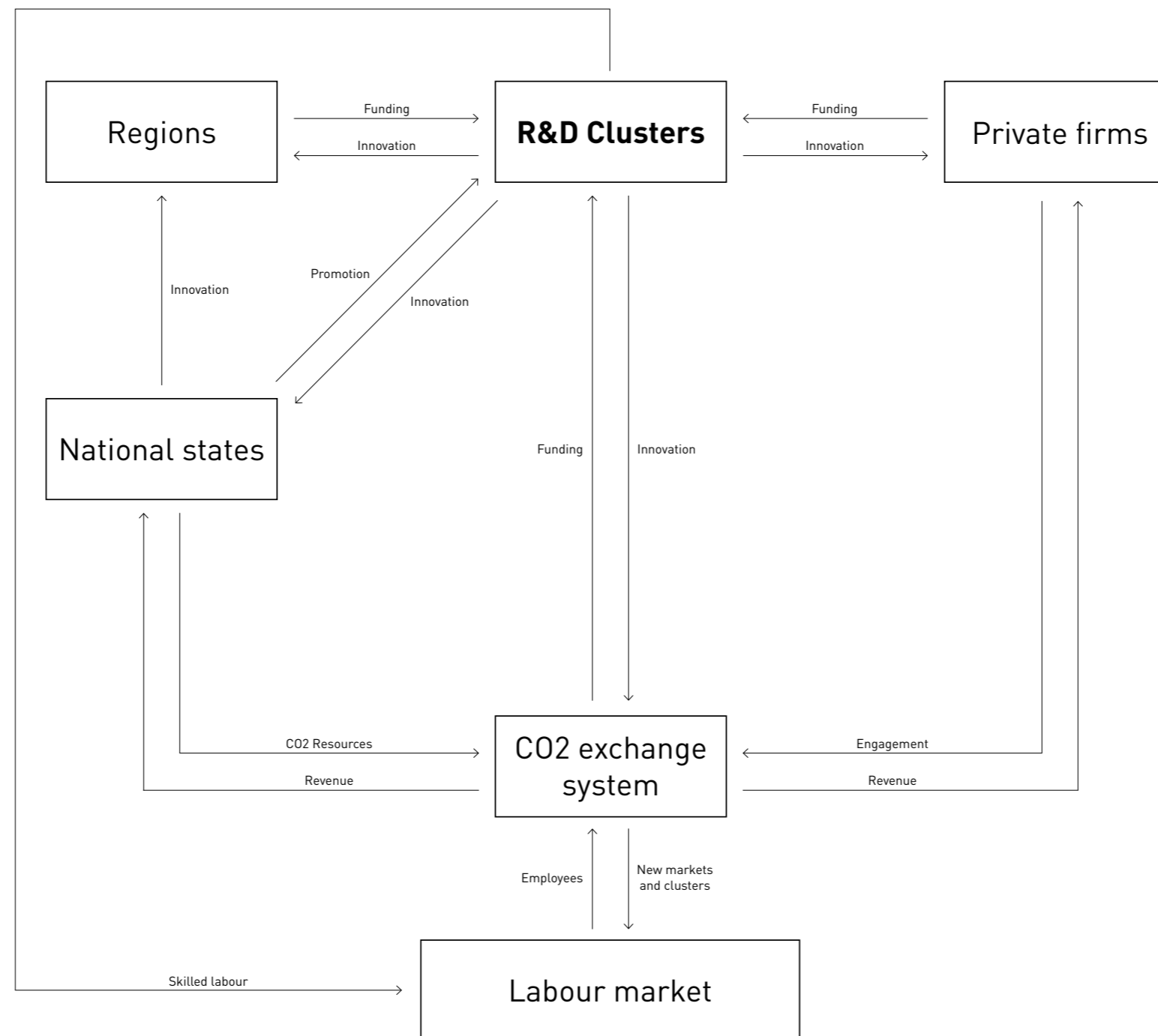

How to secure equal revenue for all
adjacent countries in the territory?

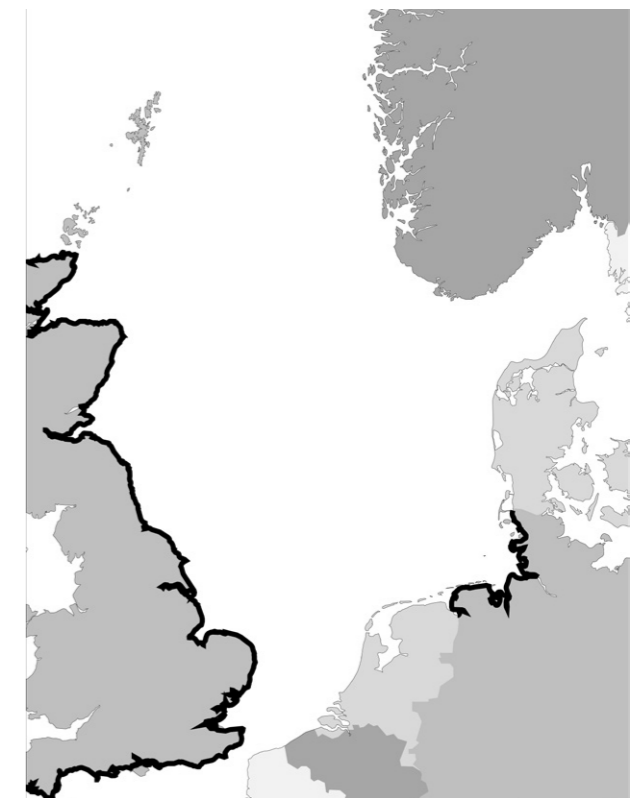

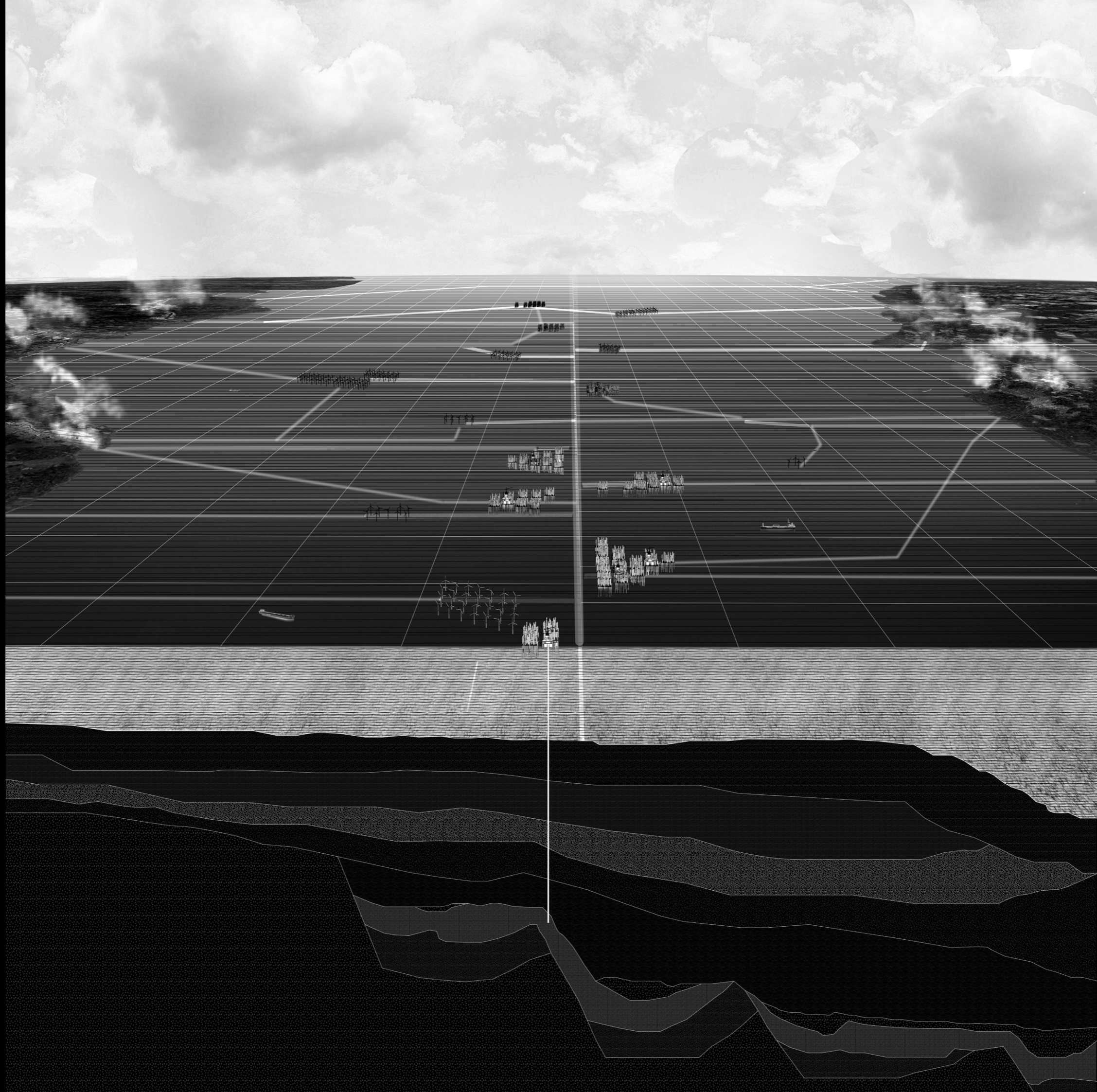

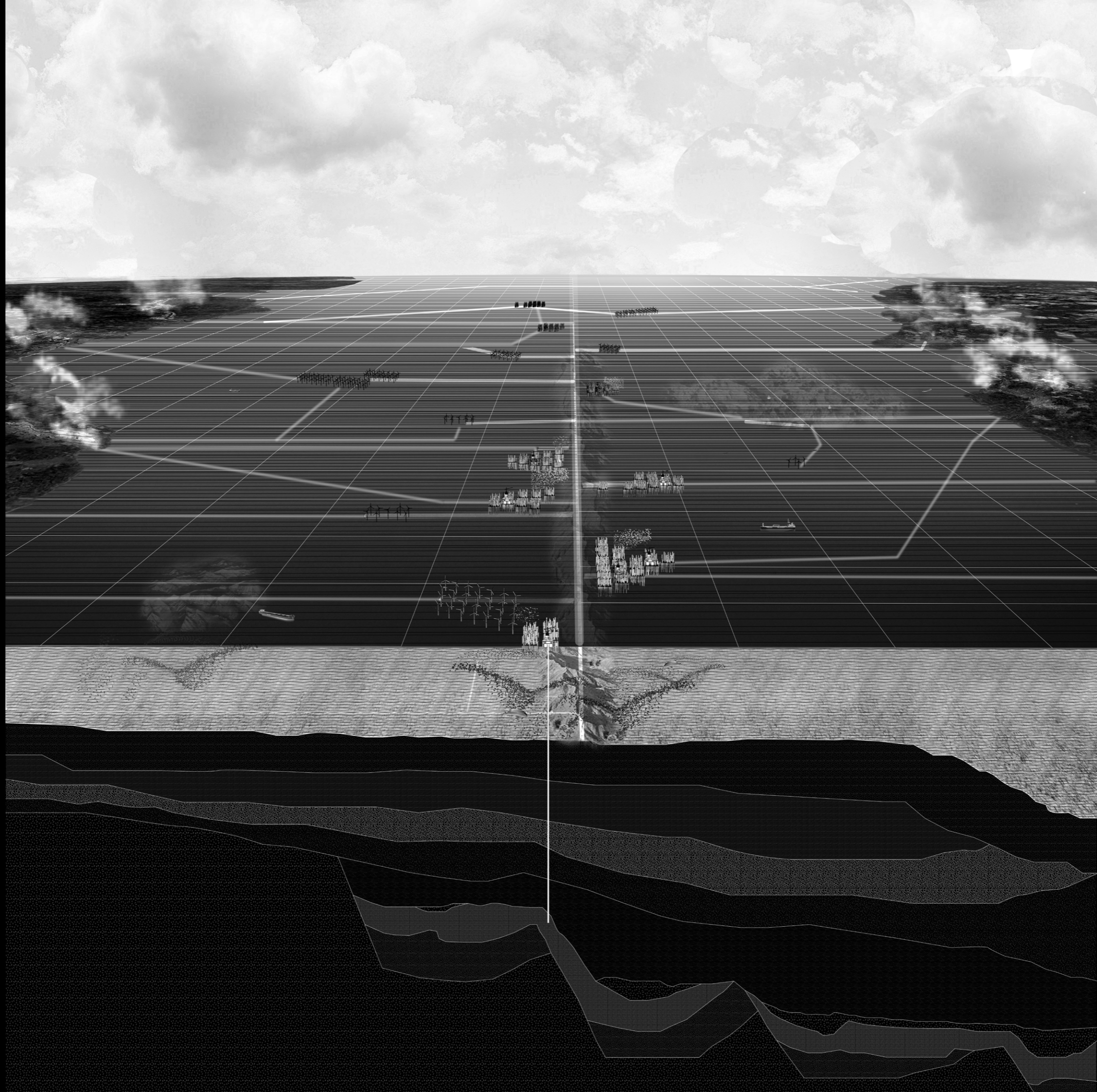

EVERYTHING REMAINS TRANSFORMED



(6) Ecological corridors connecting protected zones

(7) Engineered objects as water purifiers and artificial reefs

Objects in the sea are connecting fragmented marine protected zones and increase the marine biodiversity

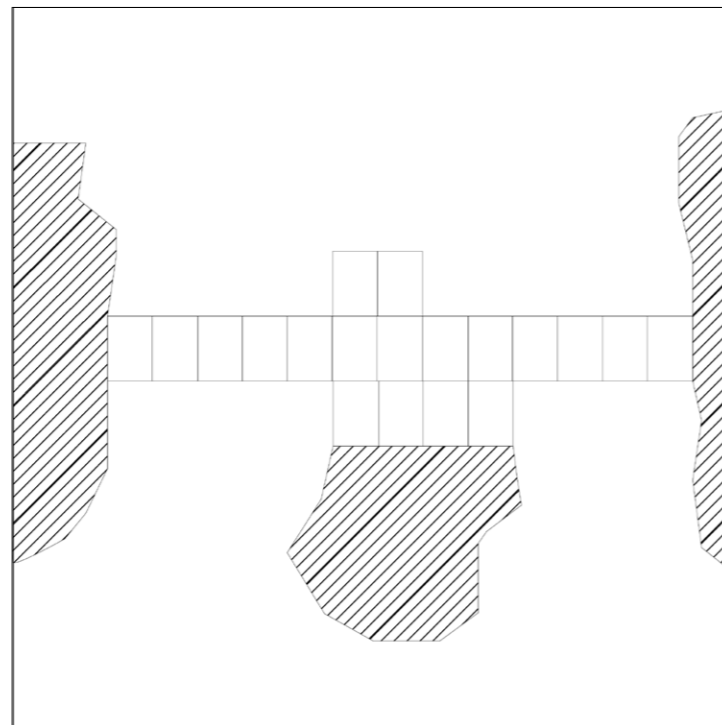

Artificial reefs attached to the energy artefacts form new ecological habitats

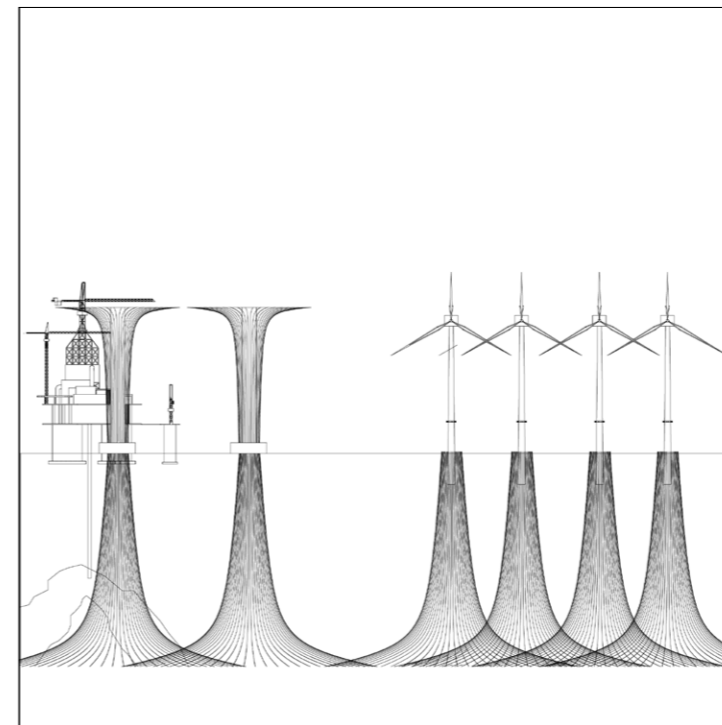

EVERYTHING REMAINS TRANSFORMED

(6) Ecological corridors connecting protected zones

(7) Engineered objects as water purifiers and artificial reefs

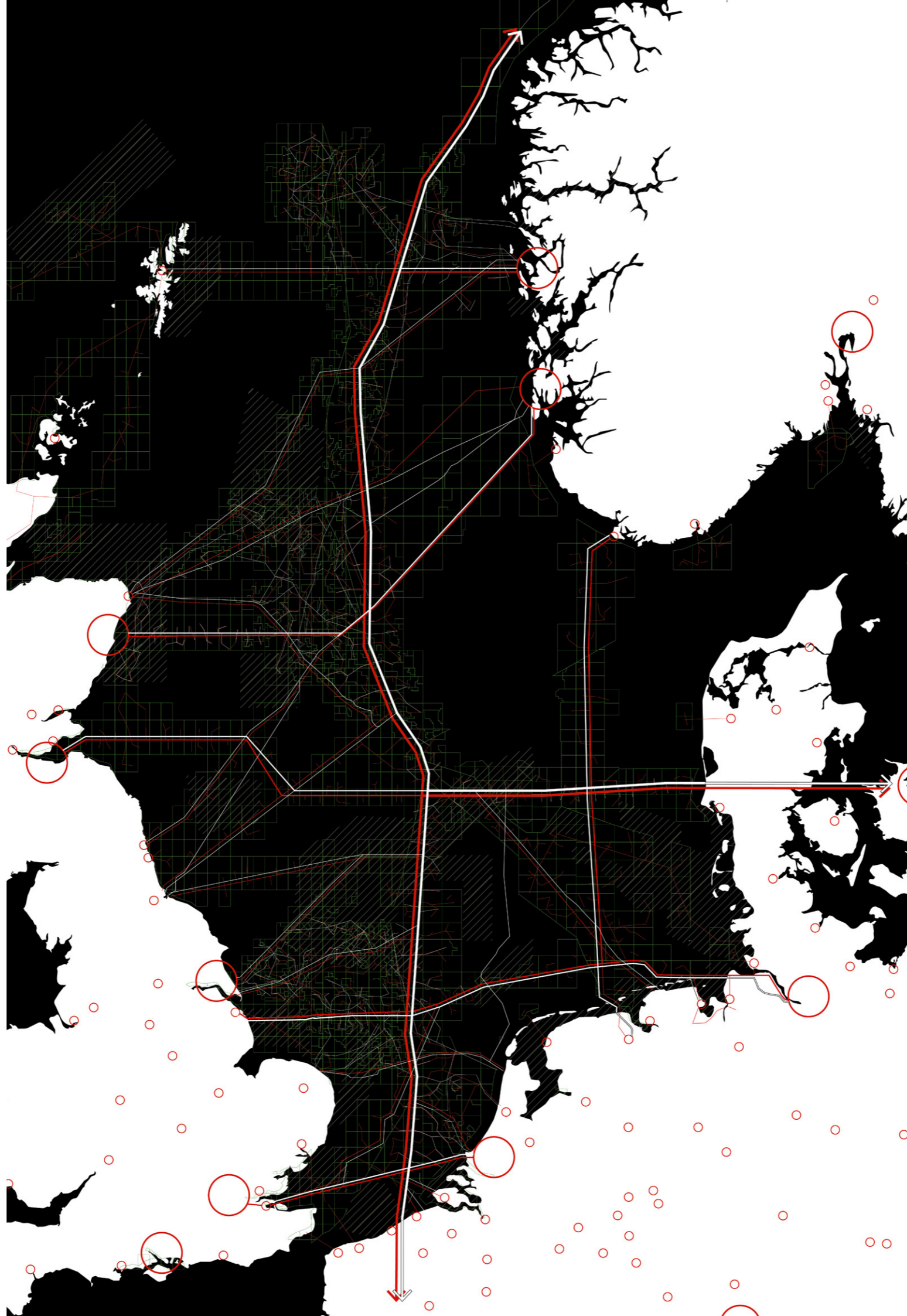

Ecological corridors develop along the infrastructural axis to increase the marine biocapacity

KEY

- | | |
|----------------------|--------------------------|
| Ecological patchwork | |
| + | + |
| + | + |
| Oil and gas pipeline | Planned ecological zone |
| Electricity cable | Existing ecological zone |
| Regional border | |
| | |
| | |
| | |

Black and white colour might be inverted!

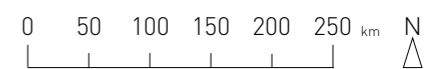

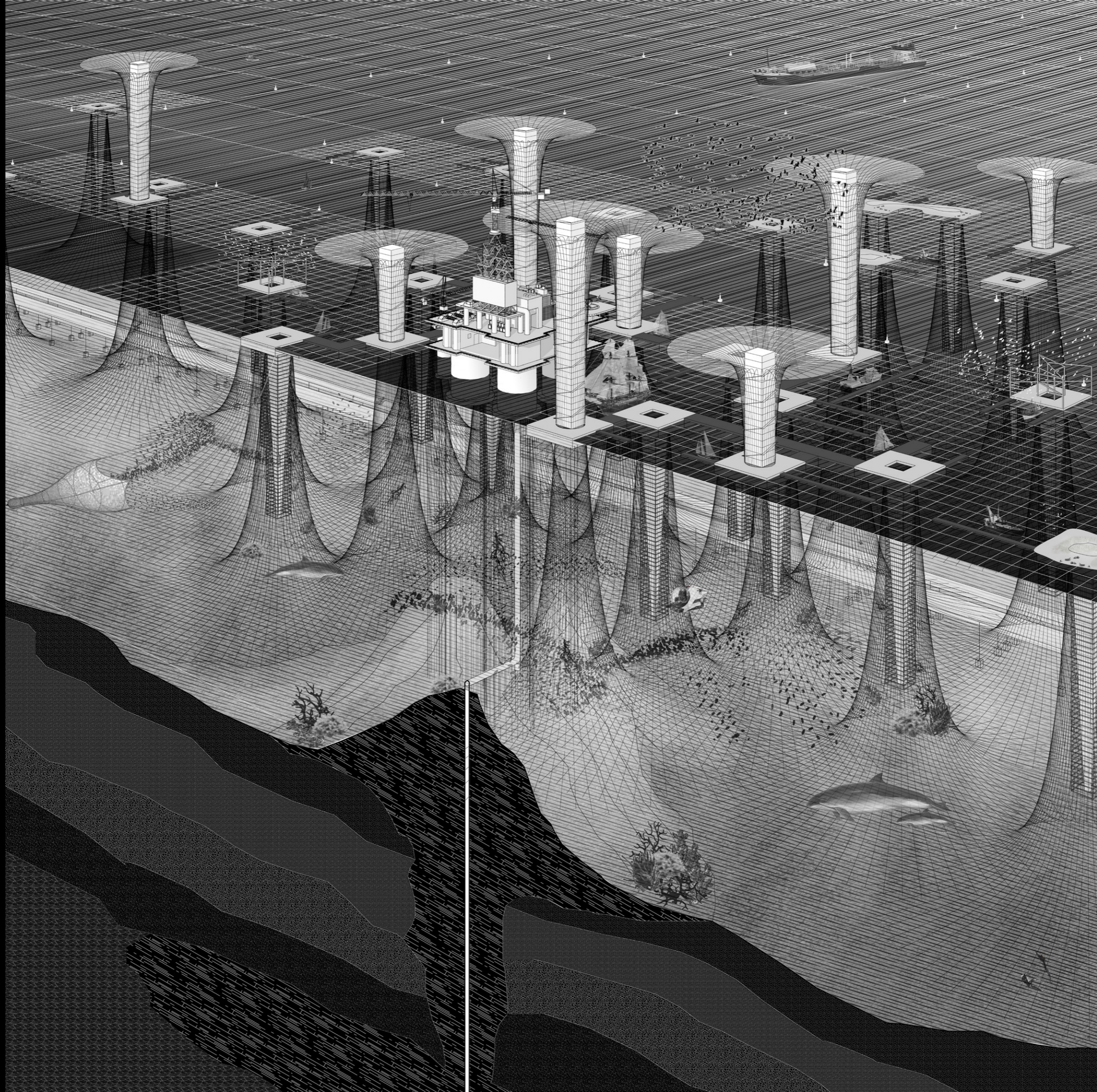

EVERYTHING REMAINS TRANSFORMED

(8) Independent energy
regions with an
own identity

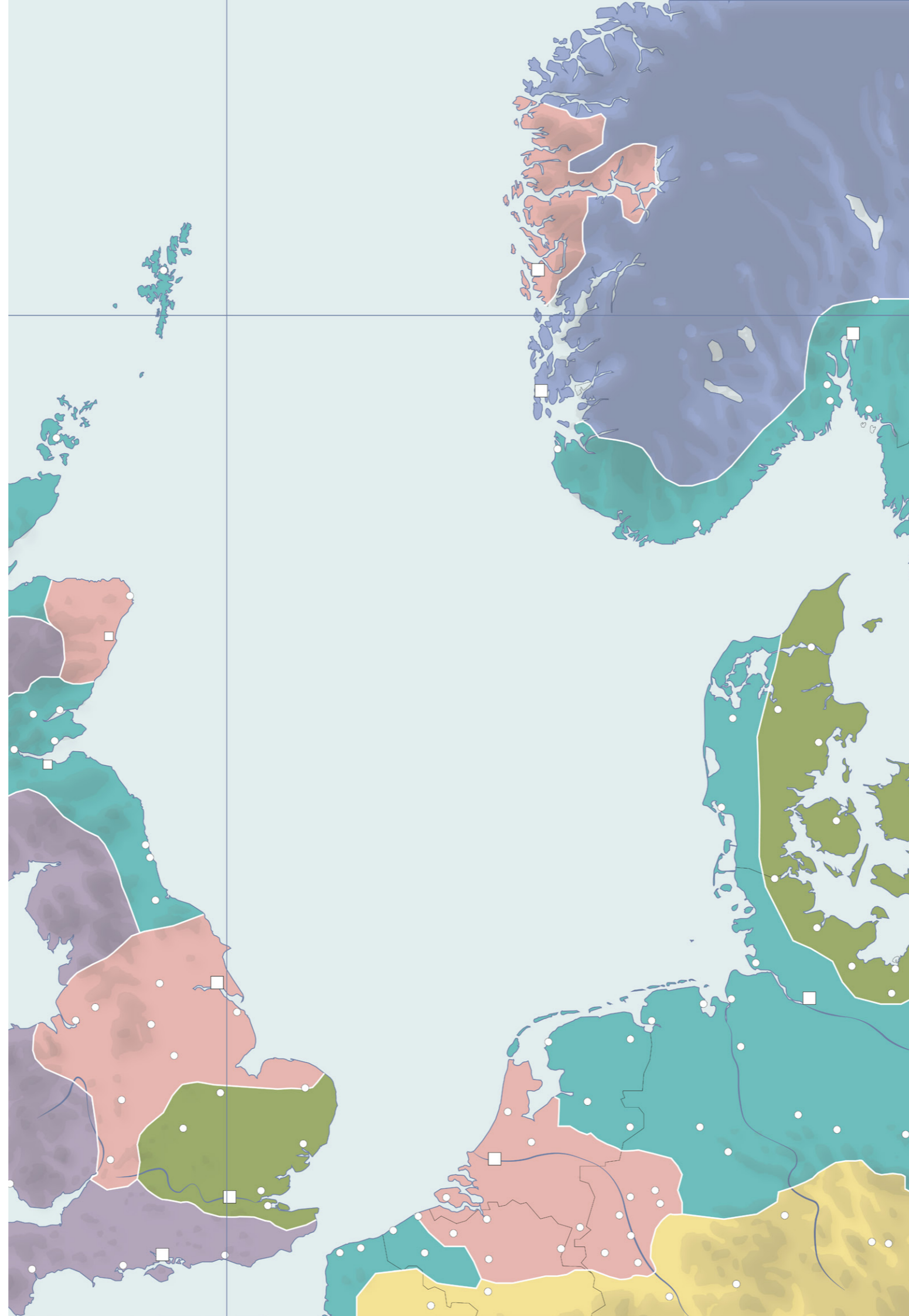

The formation of 6 different kind of energy
region: Carbo, Wind, Hydro, Tidal,
Biomass and Geothermal

KEY

- Carbon region
- Wind region
- Biomass region
- Geothermal region
- Tidal region
- Hydro region

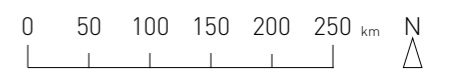

EVERYTHING REMAINS TRANSFORMED



(8) Independent energy
regions with an
own identity

The Carbon region: A consumer of carbon
dioxide through utilization and storage:
Producing electricity and fuel

KEY

- - Bio and electro fuel
- Electricity
- Carbon dioxide

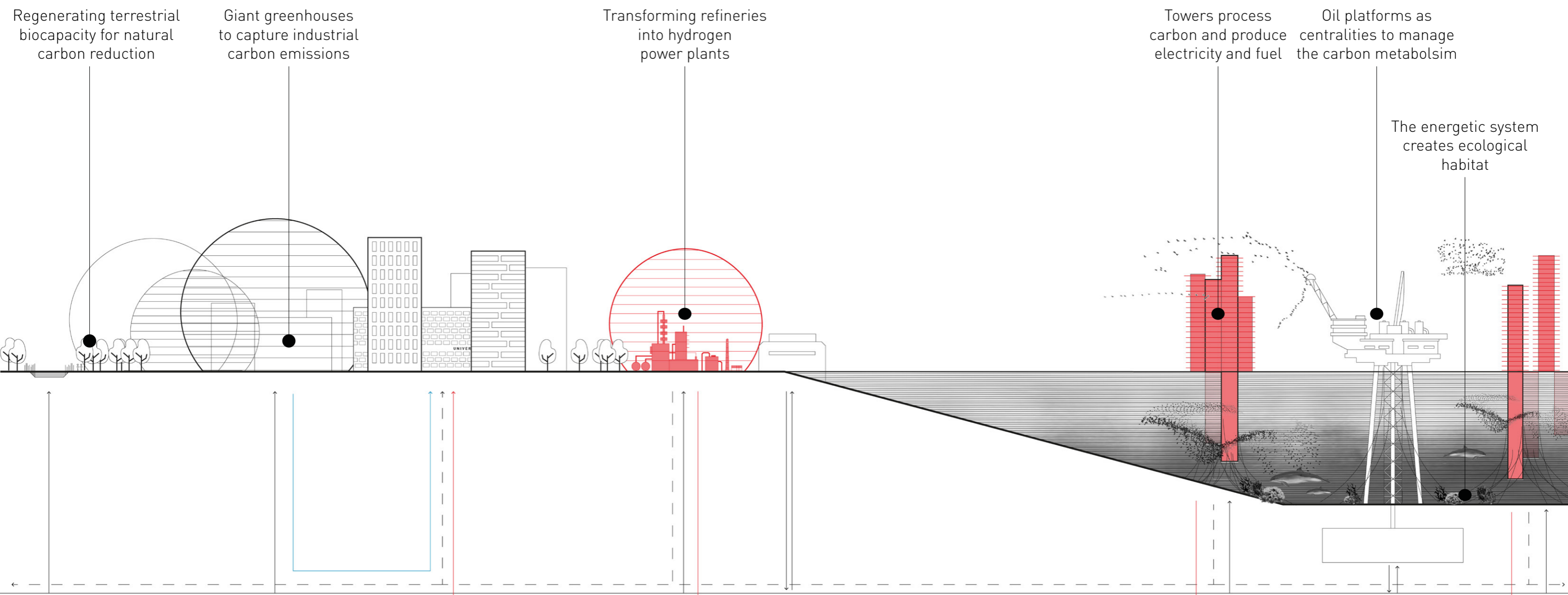

EVERYTHING REMAINS TRANSFORMED



The Wind region: Producer of wind through different kind of wind power facilities and a producer of carbon

(8) Independent energy regions with an own identity

KEY

- Protein
-
- Electricity
- Carbon dioxide

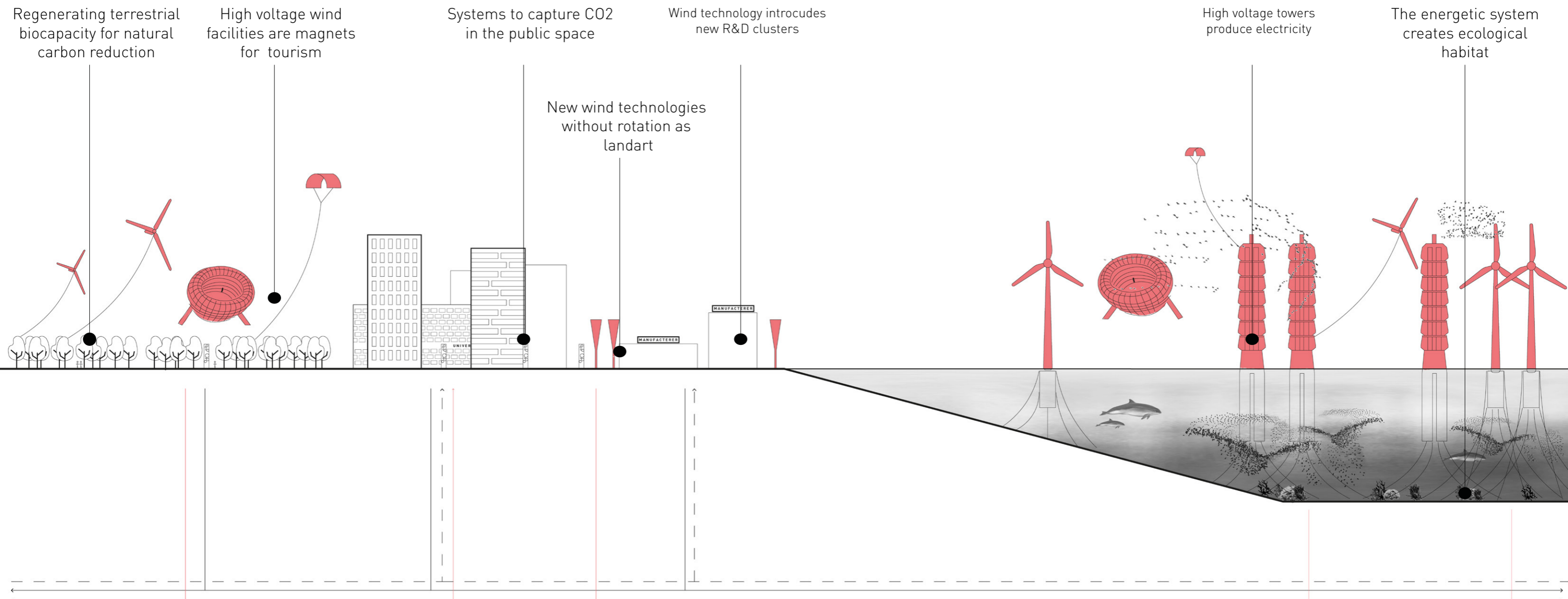

EVERYTHING REMAINS TRANSFORMED

(9) Centralities for energy
supply and urban growth



The number of infrastructural connections
determines the hierarchy of urban nodes

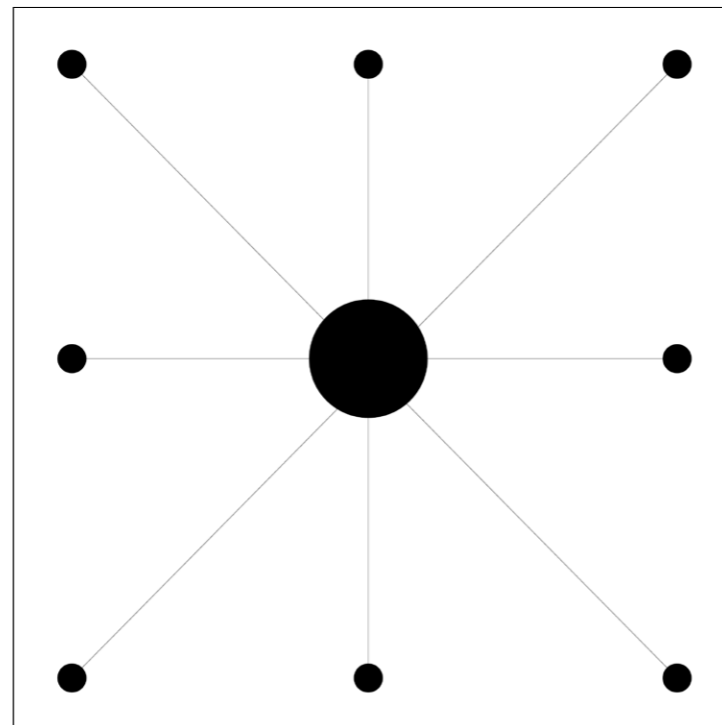

The number of potential future brownfields
determines the hierarchy of urban nodes

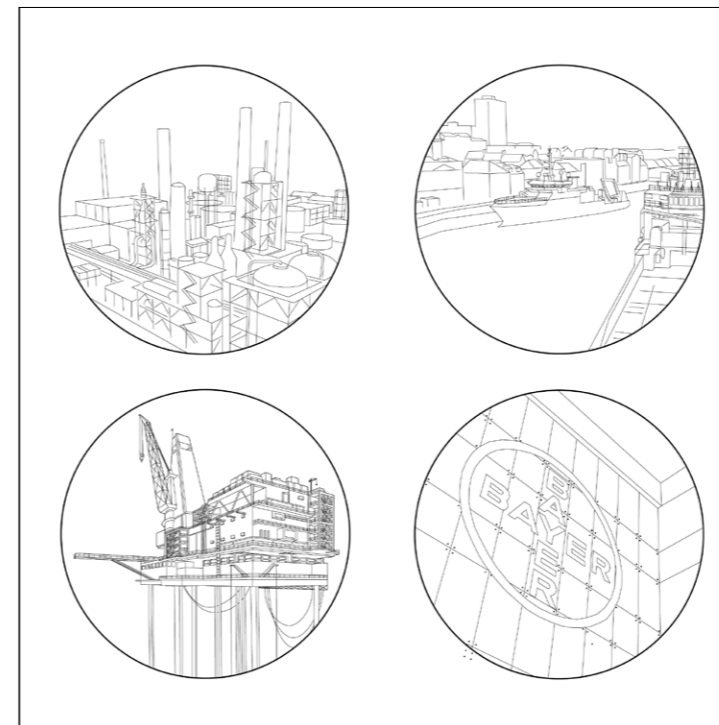

EVERYTHING REMAINS TRANSFORMED

(9) Centralities for energy supply and urban growth

(10) Prosperity and competition through transforming brownfields

(11) Prosperity and competition through transforming research



A low carbon belt is developing along the coast line of the North Sea territory

KEY

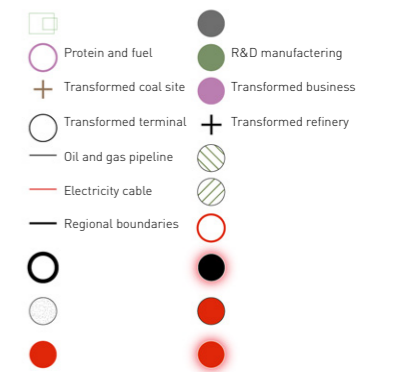

Black and white colour might be inverted!

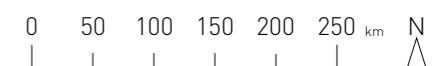

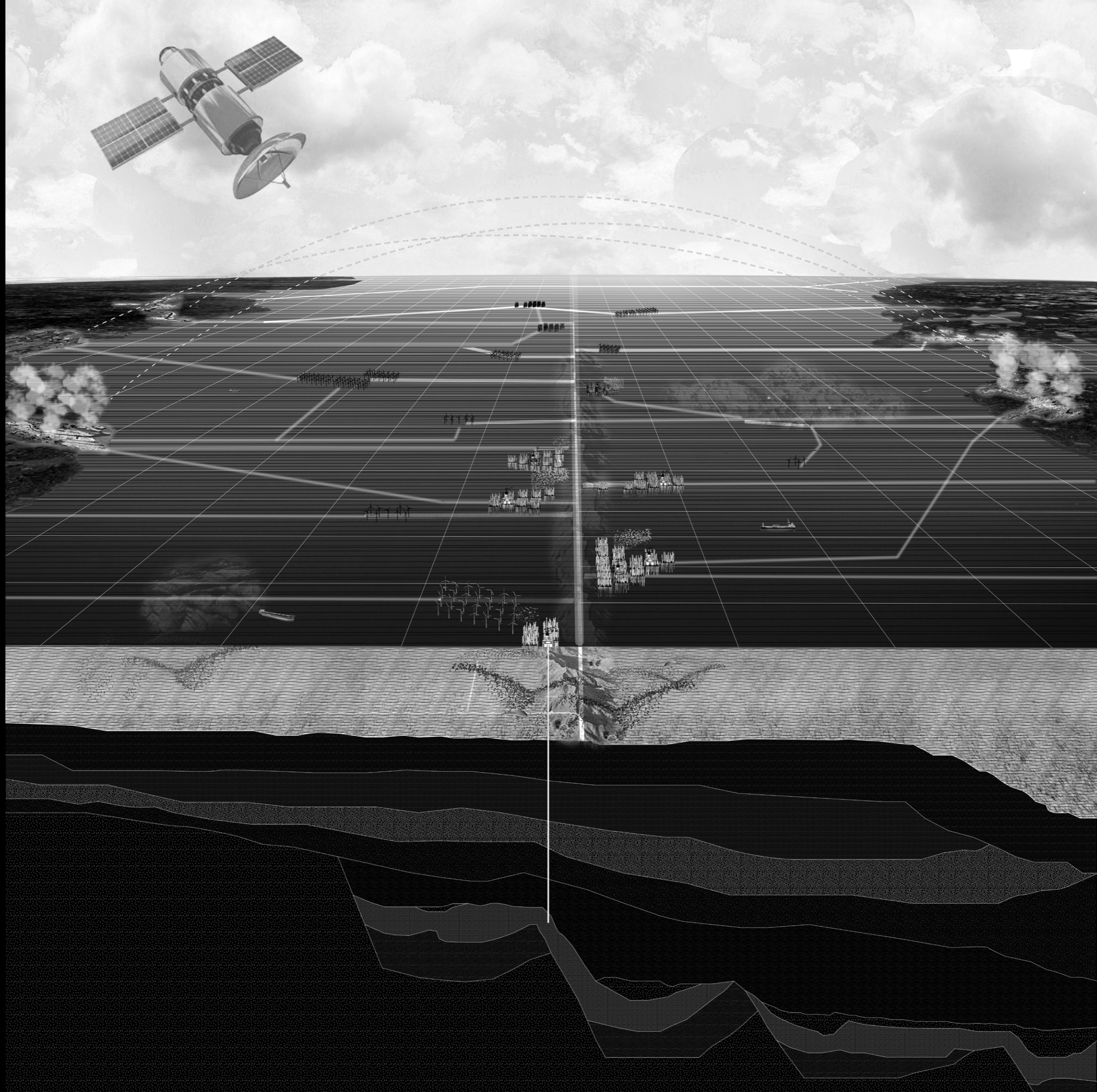



EVERYTHING REMAINS TRANSFORMED - THE APPLICATION

The current and future role
of Aberdeen in the
energetic system



Aberdeen as the major provider for crude oil
in the United Kingdom

KEY

- - -
- Oil and gas pipeline
- Electricity cable
-
-
-
-
-
- ▲ Refinery
- Harbour

Black and white colour might be inverted!

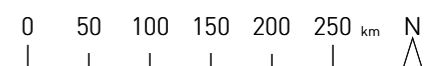

EVERYTHING REMAINS TRANSFORMED

The current and future role
of Aberdeen in the
energetic system

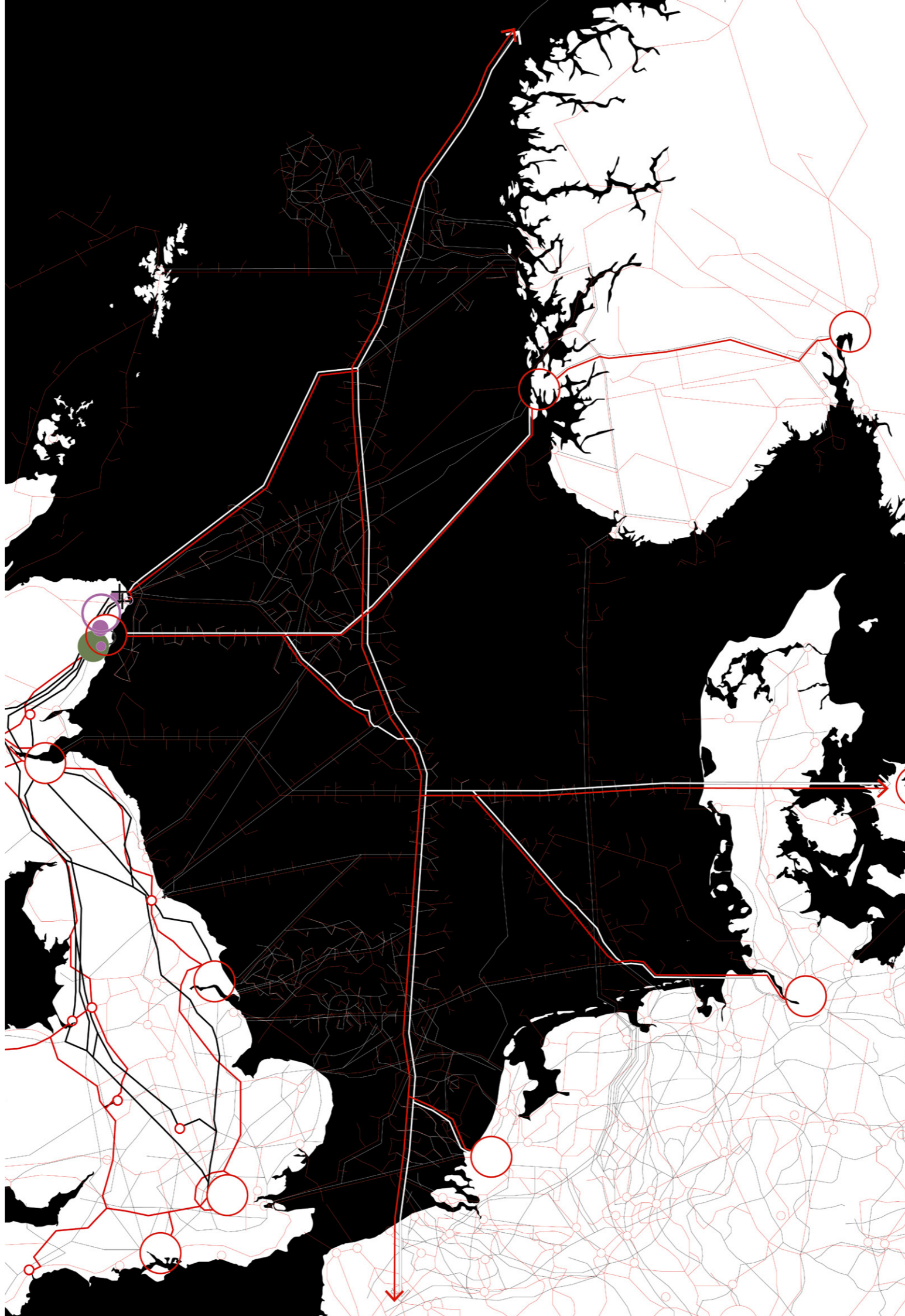

Aberdeen as the major provider for biofuel
and electrofuel in the U.K. through the
consumption of carbon dioxide

KEY

- | | |
|----------------------|----------------------|
| Protein and fuel | R&D manufacturing |
| Transformed business | Transformed refinery |
| Transformed terminal | Transformed refinery |
| Oil and gas pipeline | Electricity cable |
| Electricity cable | Transformed terminal |
| Transformed terminal | Transformed terminal |
| Transformed terminal | Transformed terminal |

Black and white colour might be inverted!

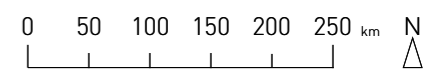

Two nodes form the regional plan of Aberdeen: the urban node and the marine node, which is consuming carbon dioxide as urban waste from Aberdeen and from the North Sea territory

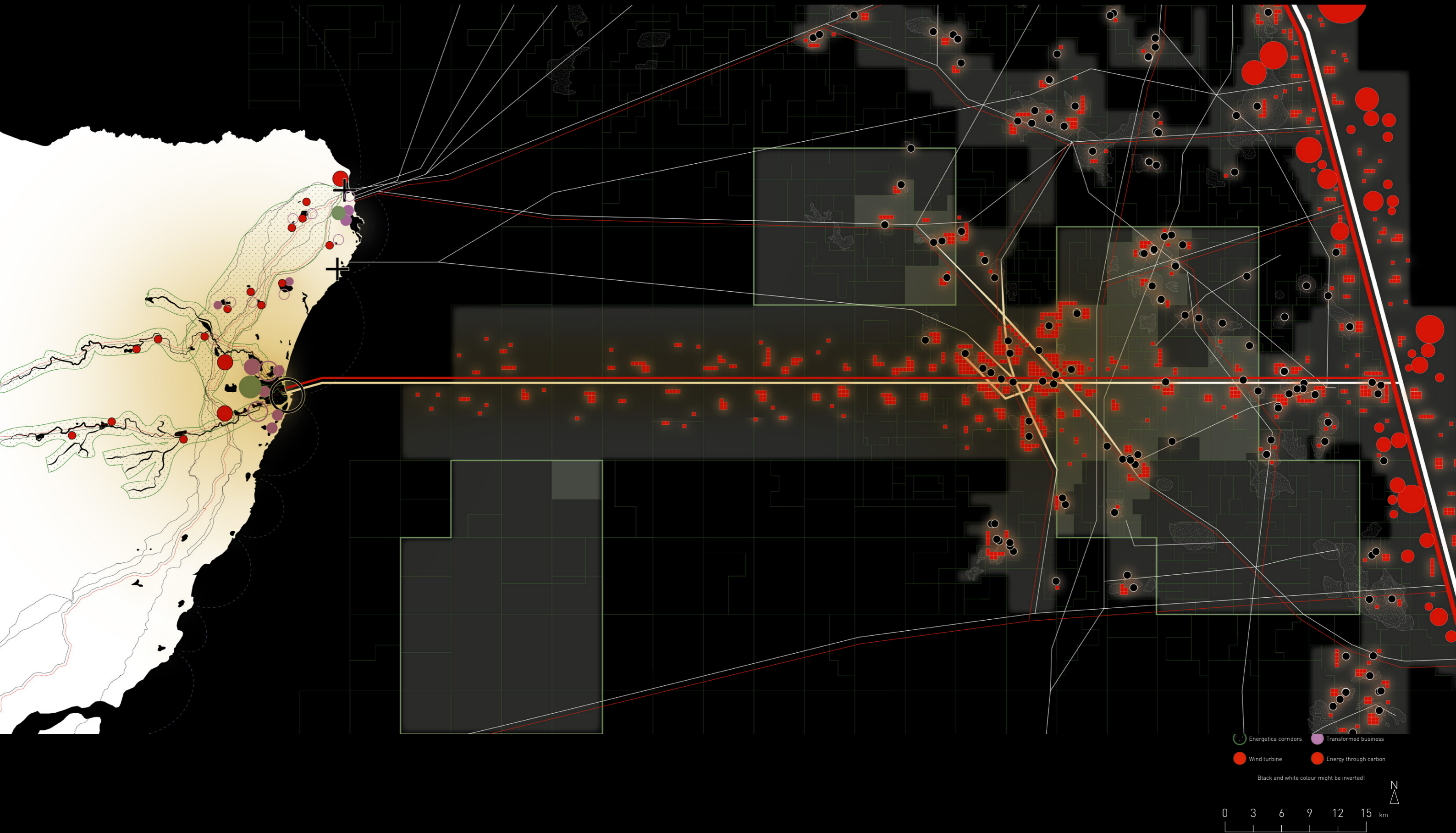

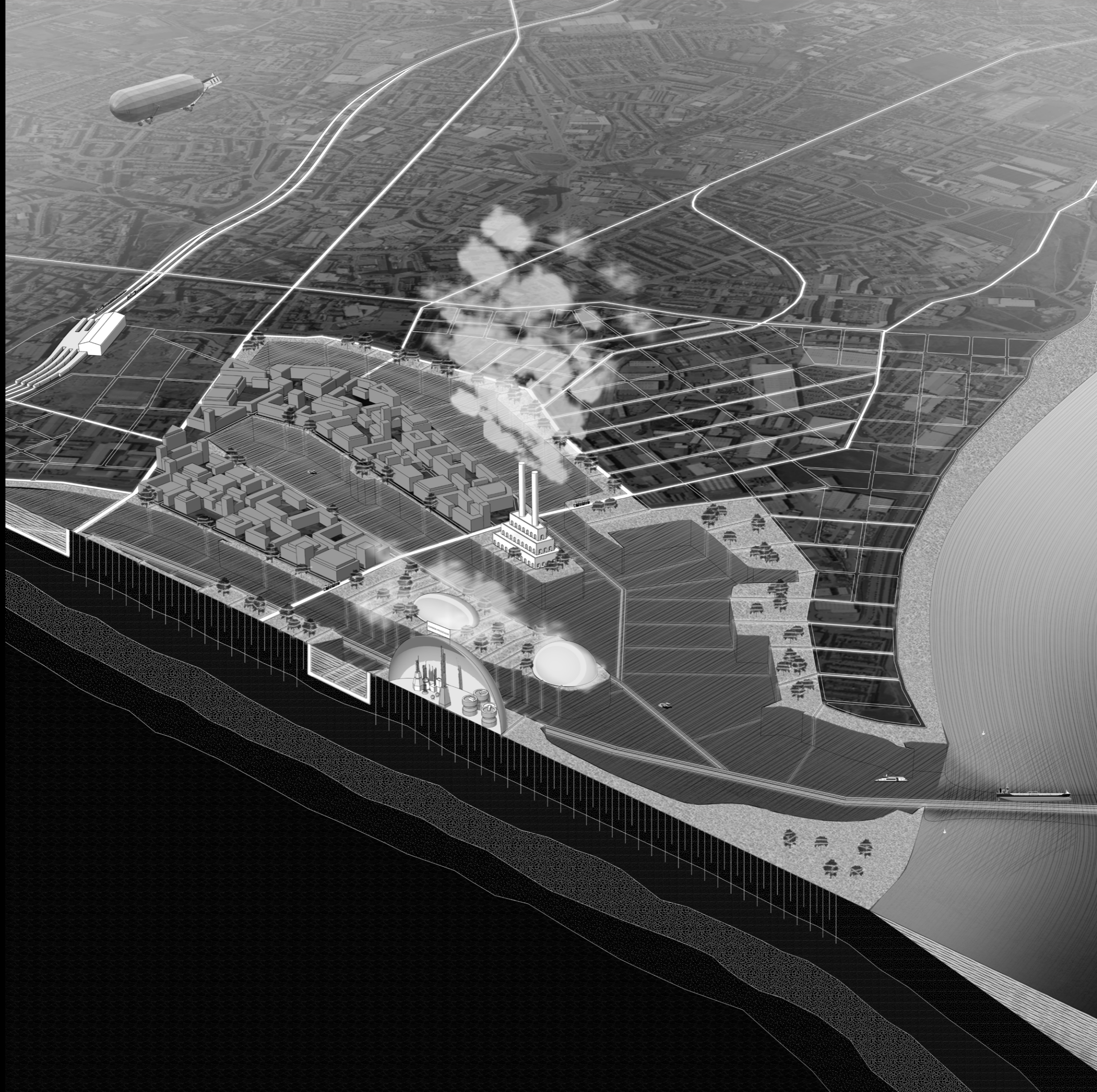

EVERYTHING REMAINS TRANSFORMED

Phase 0:
The Energy Legacy

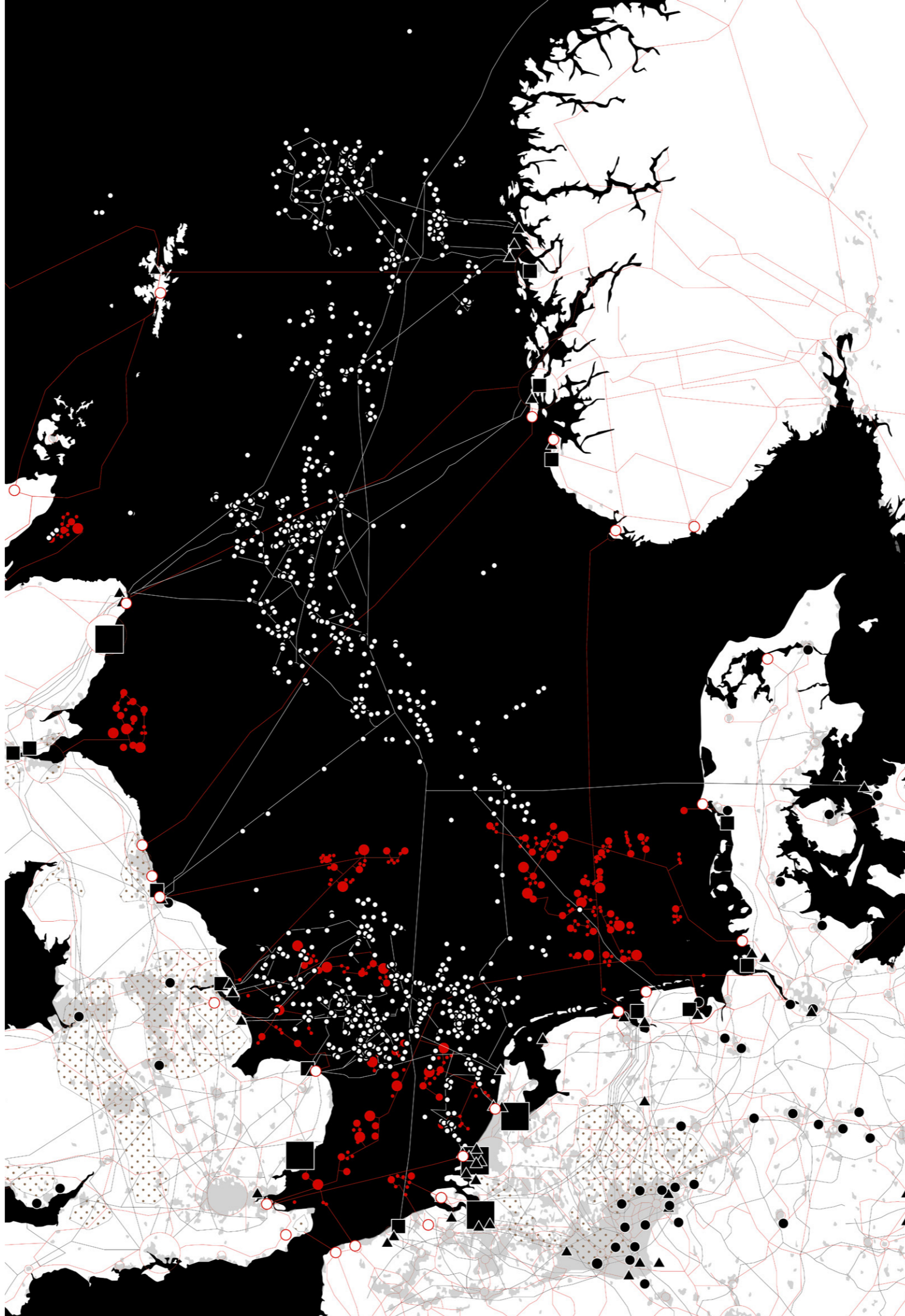

Phasing, Current Situation

KEY

- | | |
|------------------------|---------------------|
| ■ Harbour | ▲ Refinery |
| □ Oil and gas platform | ● Coal power plant |
| ○ Oil and gas platform | ● Wind turbine |
| + | ● Energy substation |
| — Oil and gas pipeline | + |
| — Electricity cable | ○ Energy substation |
| ○ Oil and gas platform | ● Energy substation |
| ○ Wind turbine | ● Energy substation |

Black and white colour might be inverted!

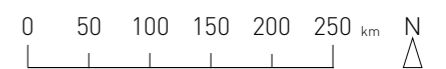

Growth principle: Reuse and integration

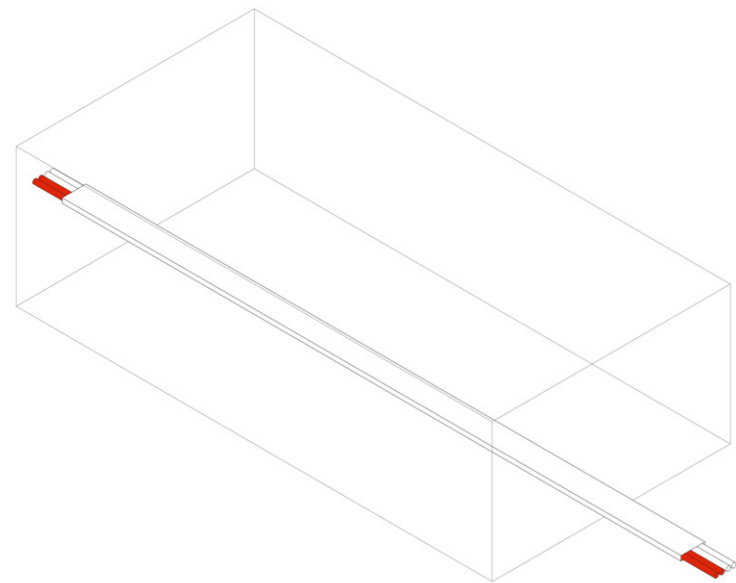

Growth principle: Plug-in

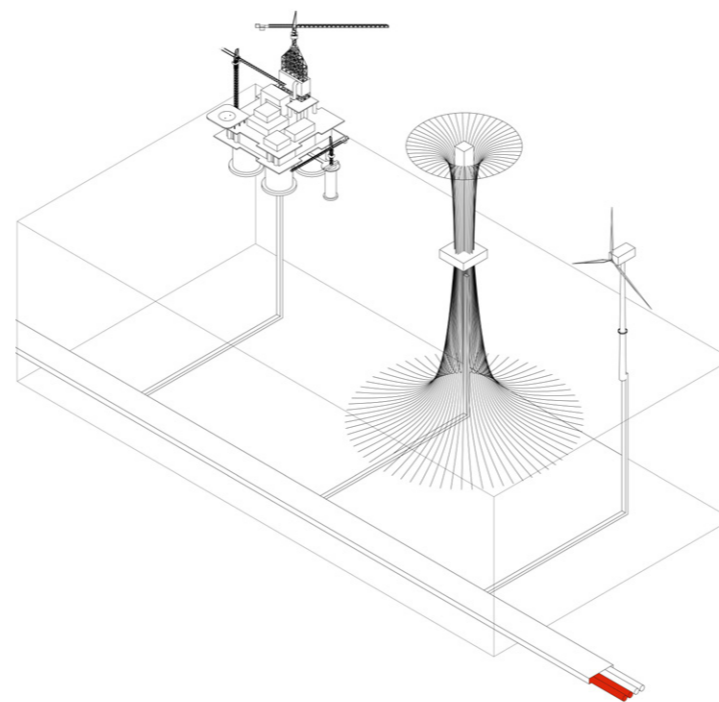

Growth principle: Pooling

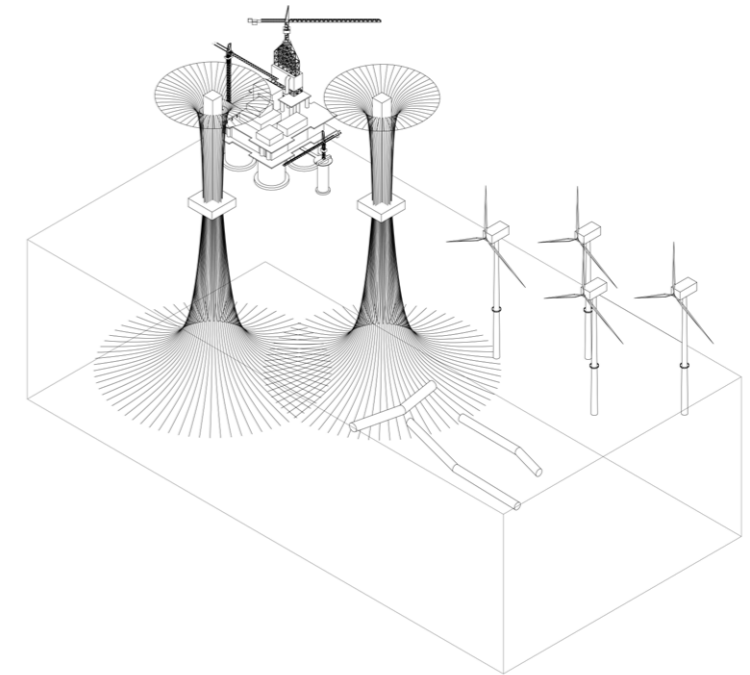

EVERYTHING REMAINS TRANSFORMED

Phase 1:
Response to national
demands and first
show case projects

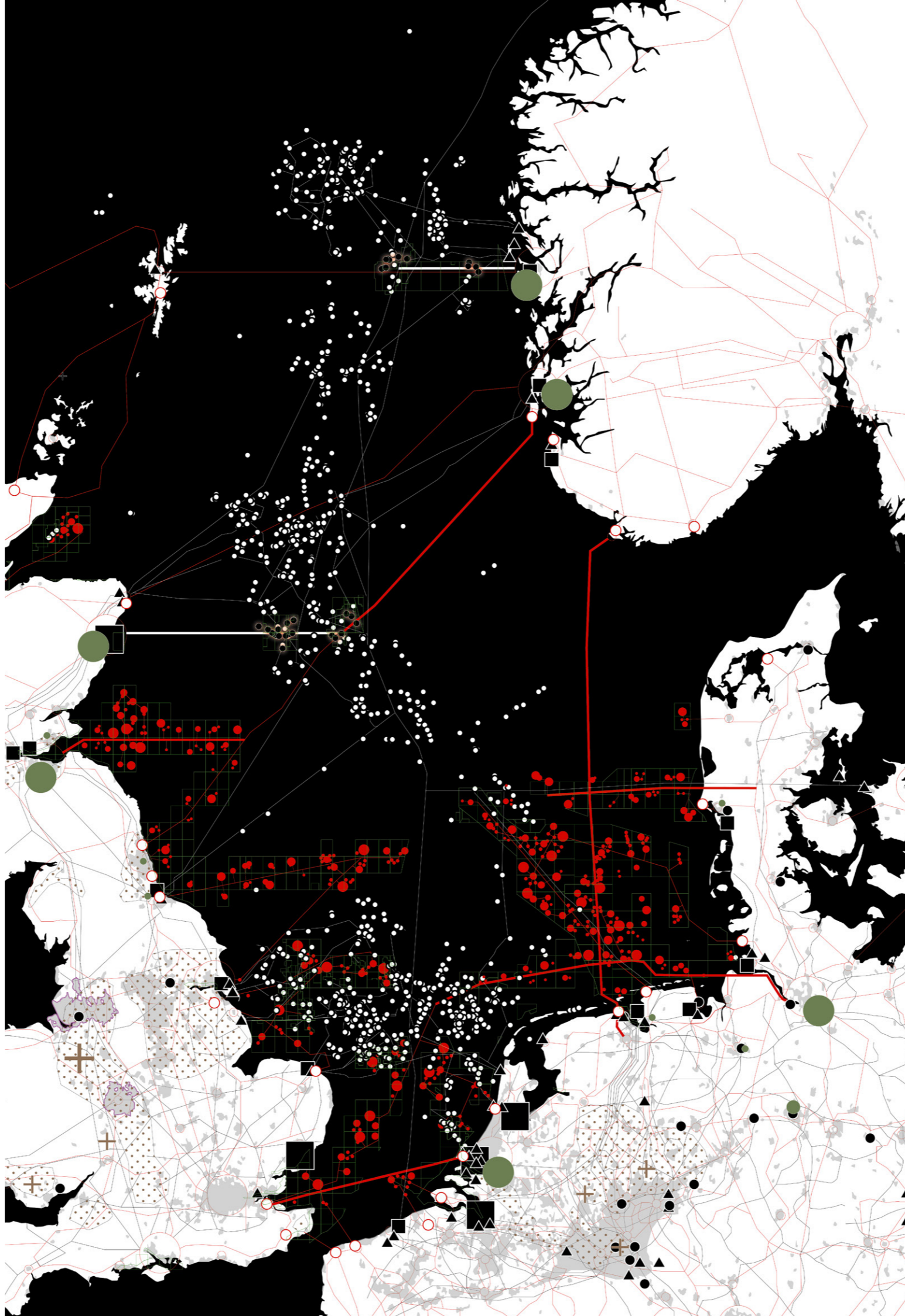

Phasing, Situation until 2020

KEY

- | | |
|-------------------------|-------------------------|
| ■ Harbour | ▲ Refinery |
| □ Ecological patchwork | ● Coal power plant |
| ○ Transformed coal site | ● R&D manufacturing |
| — Oil and gas pipeline | + |
| — Electricity cable | ○ Energy substation |
| ○ Oil and gas platform | ● Transformed oil rigs |
| ○ Wind turbine | ● Wave and tidal energy |
- Black and white colour might be inverted!

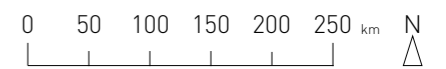

EVERYTHING REMAINS TRANSFORMED

Phase 2:
Towards national
cooperation

Phasing, Situation until 2030

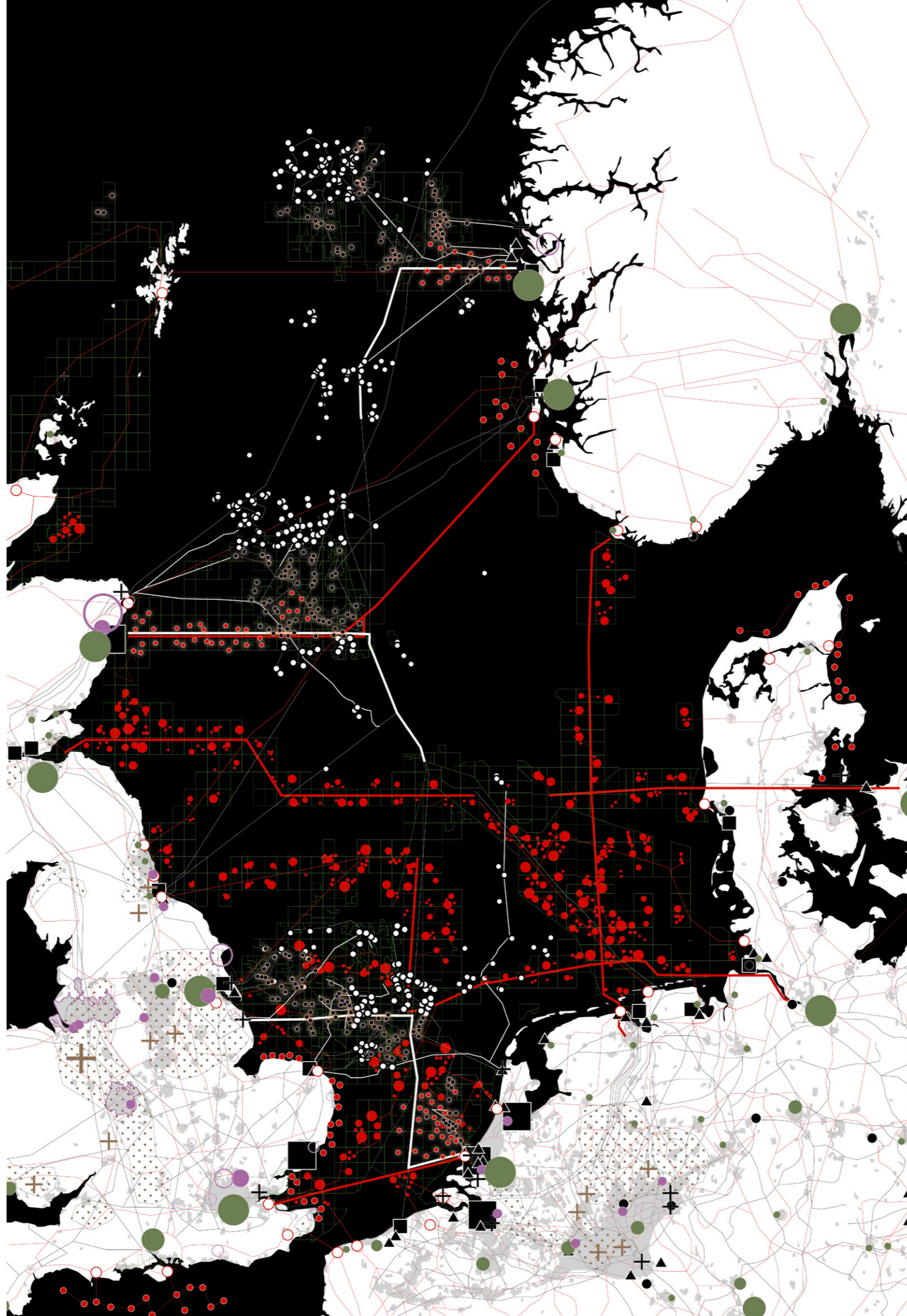

KEY

- | | |
|-------------------------|-------------------------|
| ■ Harbour | ▲ Refinery |
| □ Ecological patchwork | ● Coal power plant |
| ○ Protein and fuel | ● R&D manufacturing |
| + Transformed coal site | ● Transformed business |
| ○ Transformed terminal | + Transformed refinery |
| — Oil and gas pipeline | ○ Energy substation |
| — Electricity cable | ● Transformed oil rigs |
| ○ Oil and gas platform | ● Wave and tidal energy |
| ○ Wind turbine | ● Energy through carbon |

Black and white colour might be inverted!

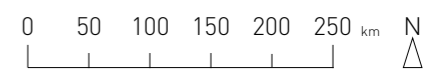

EVERYTHING REMAINS TRANSFORMED

Phase 3:
Shared energy and resources
among the North Sea
countries

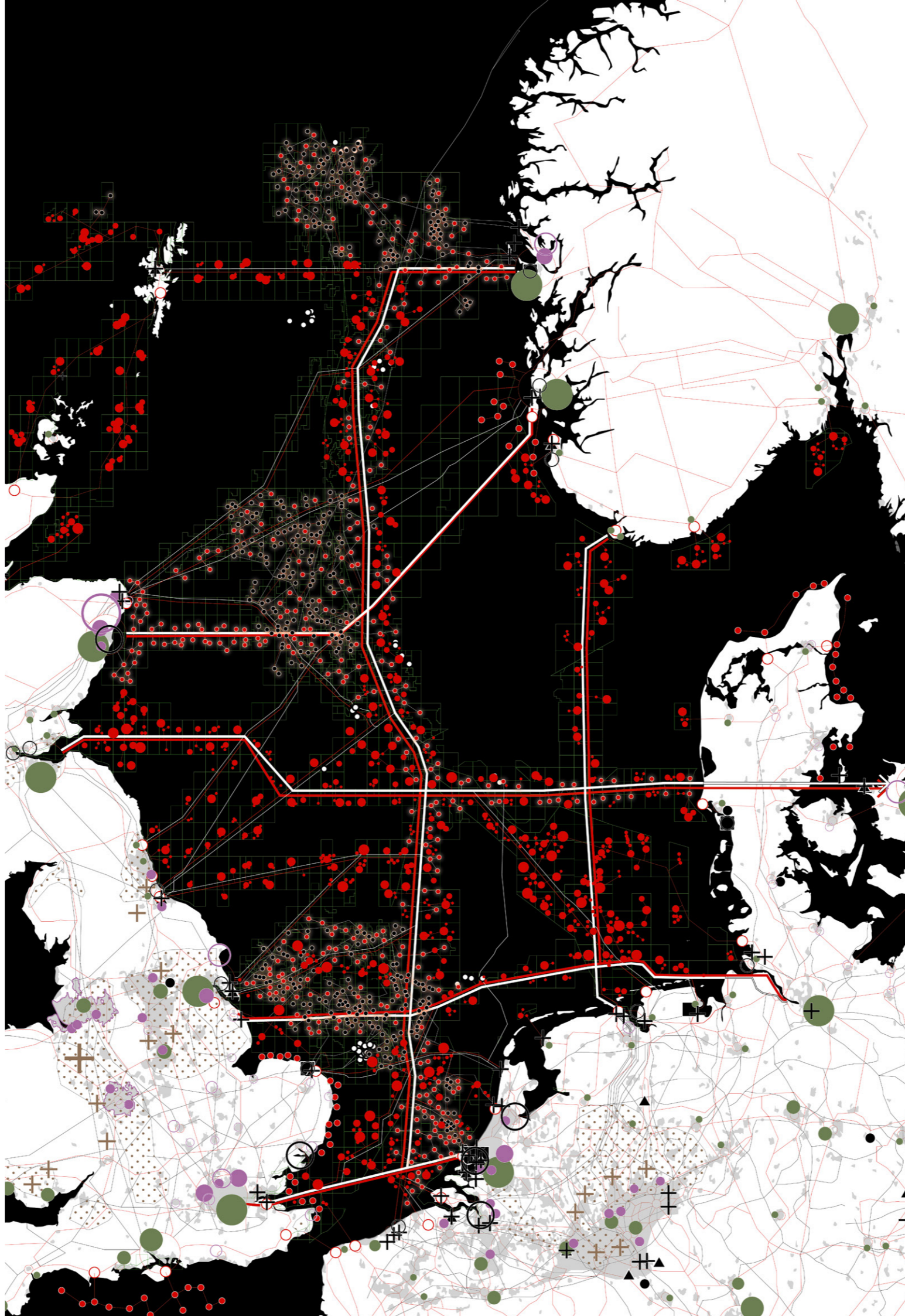

Phasing, Situation until 2050

KEY

- | | |
|-------------------------|-------------------------|
| ■ Harbour | ▲ Refinery |
| □ Ecological patchwork | ● Coal power plant |
| ○ Protein and fuel | ● R&D manufacturing |
| + Transformed coal site | ● Transformed business |
| ○ Transformed terminal | + Transformed refinery |
| — Oil and gas pipeline | ⊘ Energy substation |
| — Electricity cable | ⊘ Transformed oil rigs |
| ○ Oil and gas platform | ● Wave and tidal energy |
| ○ Wind turbine | ● Energy through carbon |

Black and white colour might be inverted!

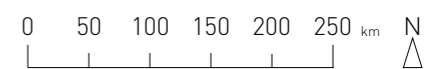

EVERYTHING REMAINS TRANSFORMED

Phase 4:
Collaboration beyond the
North Sea territory

Phasing, Situation until 2060

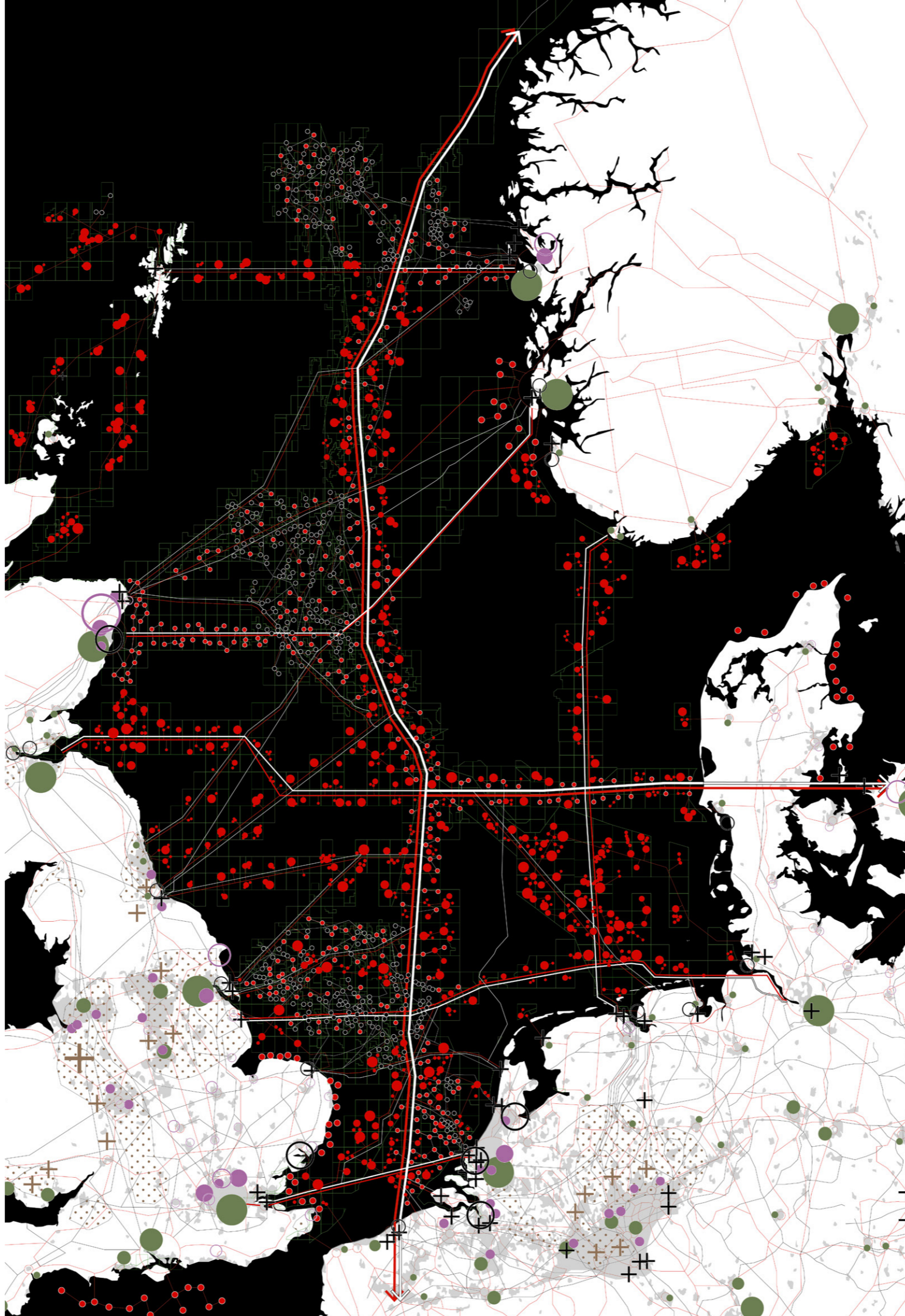

KEY

- | | |
|-------------------------|-------------------------|
| ■ Ecological patchwork | ▲ |
| ○ Protein and fuel | ● |
| + Transformed coal site | ● R&D manufacturing |
| ○ Transformed terminal | ● Transformed business |
| — Oil and gas pipeline | + Transformed refinery |
| — Electricity cable | ⊗ Energy substation |
| — | ● Transformed oil rigs |
| ○ | ● Wave and tidal energy |
| ● Wind turbine | ● Energy through carbon |

Black and white colour might be inverted!

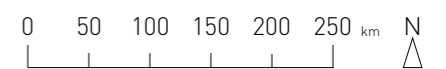

DPA, Der Spiegel, Brexit Gegner in London, <http://www.spiegel.de/politik/ausland/bild-1214412-1304741.html>



EVERYTHING REMAINS TRANSFORMED

Politic complexity:
The Brexit

Brexit scenario: a territorial energy system of
collaboration without the U.K.

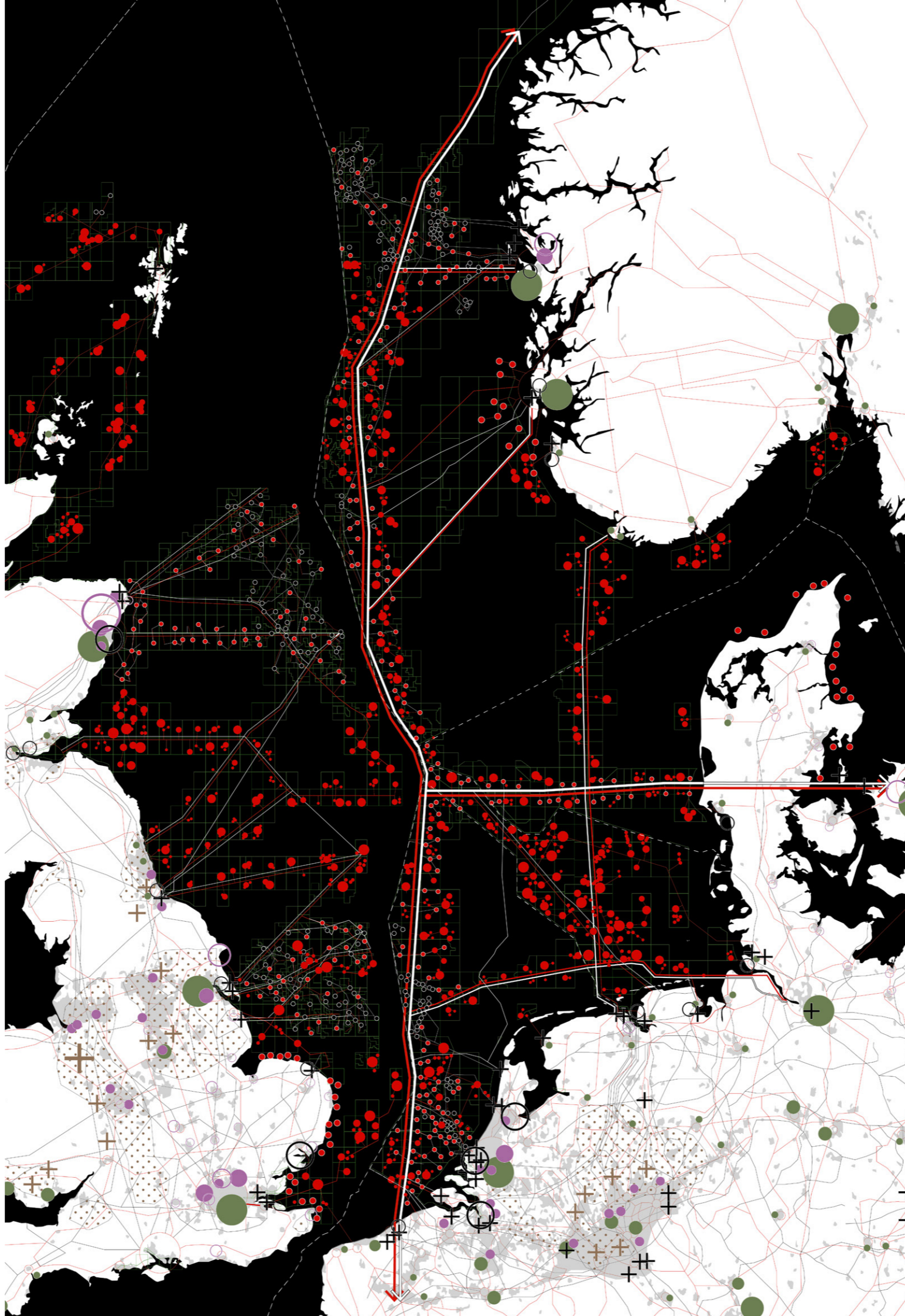

KEY

- | | |
|-----------------------|-----------------------|
| Ecological patchwork | R&D manufacturing |
| Protein and fuel | Transformed business |
| Transformed coal site | Transformed refinery |
| Transformed terminal | transformed oil rigs |
| Oil and gas pipeline | Wave and tidal energy |
| Electricity cable | Energy through carbon |
| Wind turbine | |

Black and white colour might be inverted!

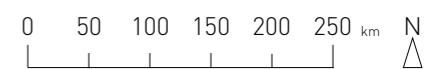

EVERYTHING REMAINS TRANSFORMED

The necessity for
collaboration

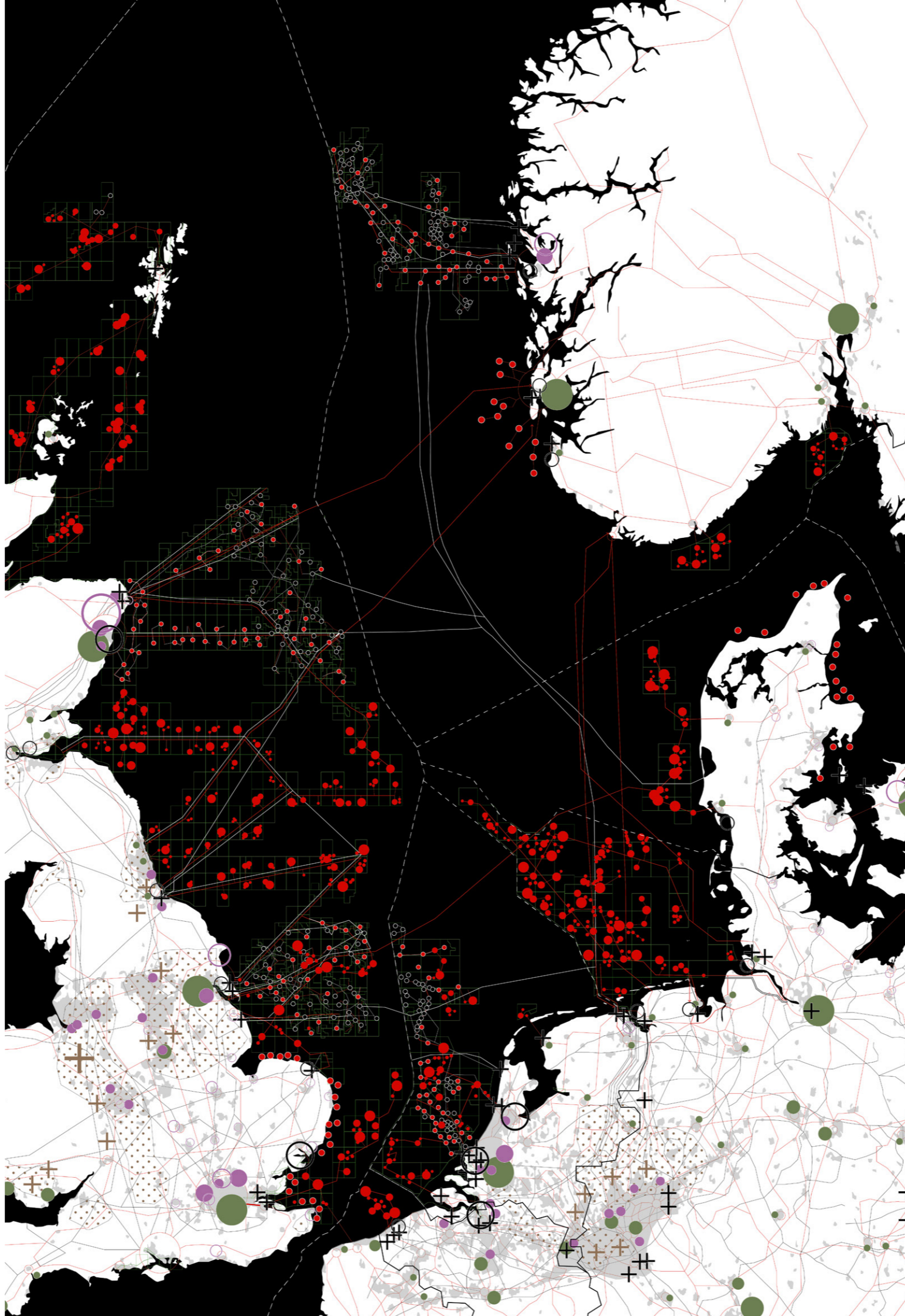

No collaboration as a scenario: What would be
the effects to deal with the energy transition
individually on the national level?

KEY

- | | | | | | | | |
|----------------------|----------------------|-----------------------|----------------------|-----------------------|-----------------------|-----------------|--------------|
| Ecological patchwork | Protein and fuel | Transformed coal site | Transformed terminal | Oil and gas pipeline | Electricity cable | National border | Wind turbine |
| R&D manufacturing | Transformed business | Transformed refinery | transformed oil rigs | Wave and tidal energy | Energy through carbon | | |

Black and white colour might be inverted!

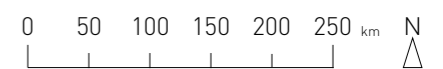

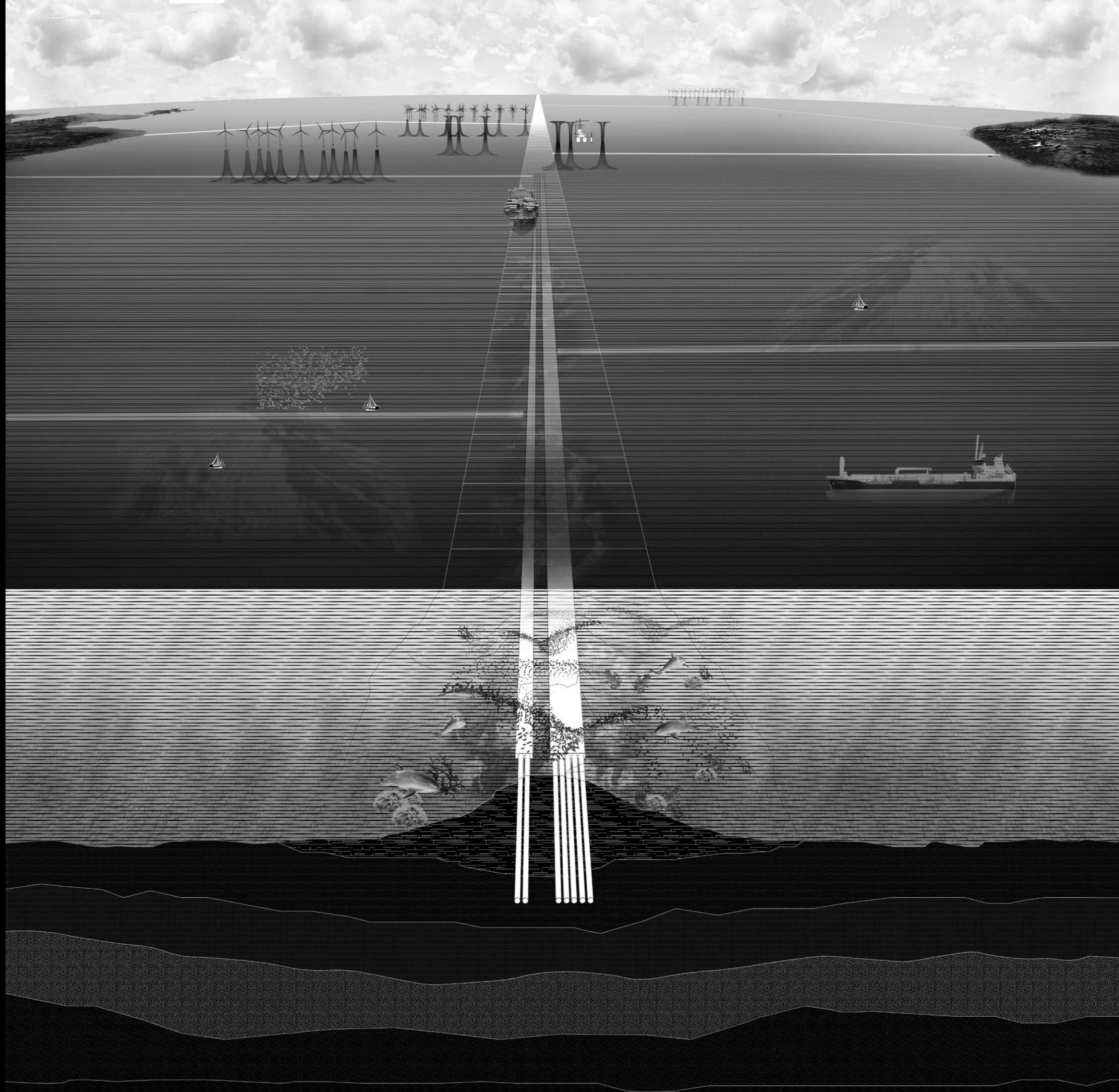

EXTENDING 'THE LINE'

The potential to exchange electricity with the
South Europe and Africa

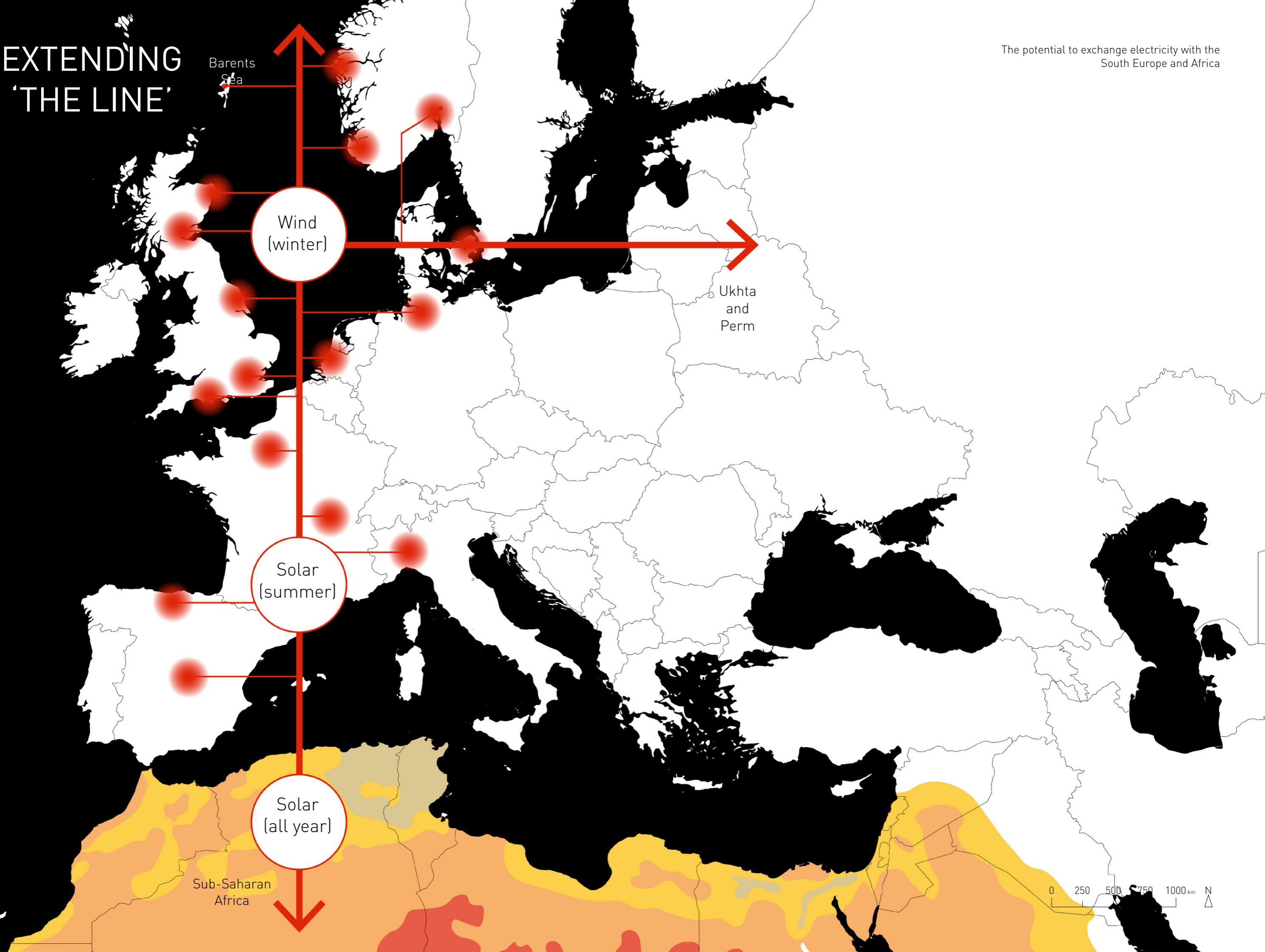

Barents
Sea

Wind
(winter)

Ukhta
and
Perm

Solar
(summer)

Solar
(all year)

Sub-Saharan
Africa



EXTENDING 'THE LINE'

Connecting the storage and consuming sites of carbon dioxide in the North Sea territory to existing clusters of the oil and gas industry inside and beyond European borders

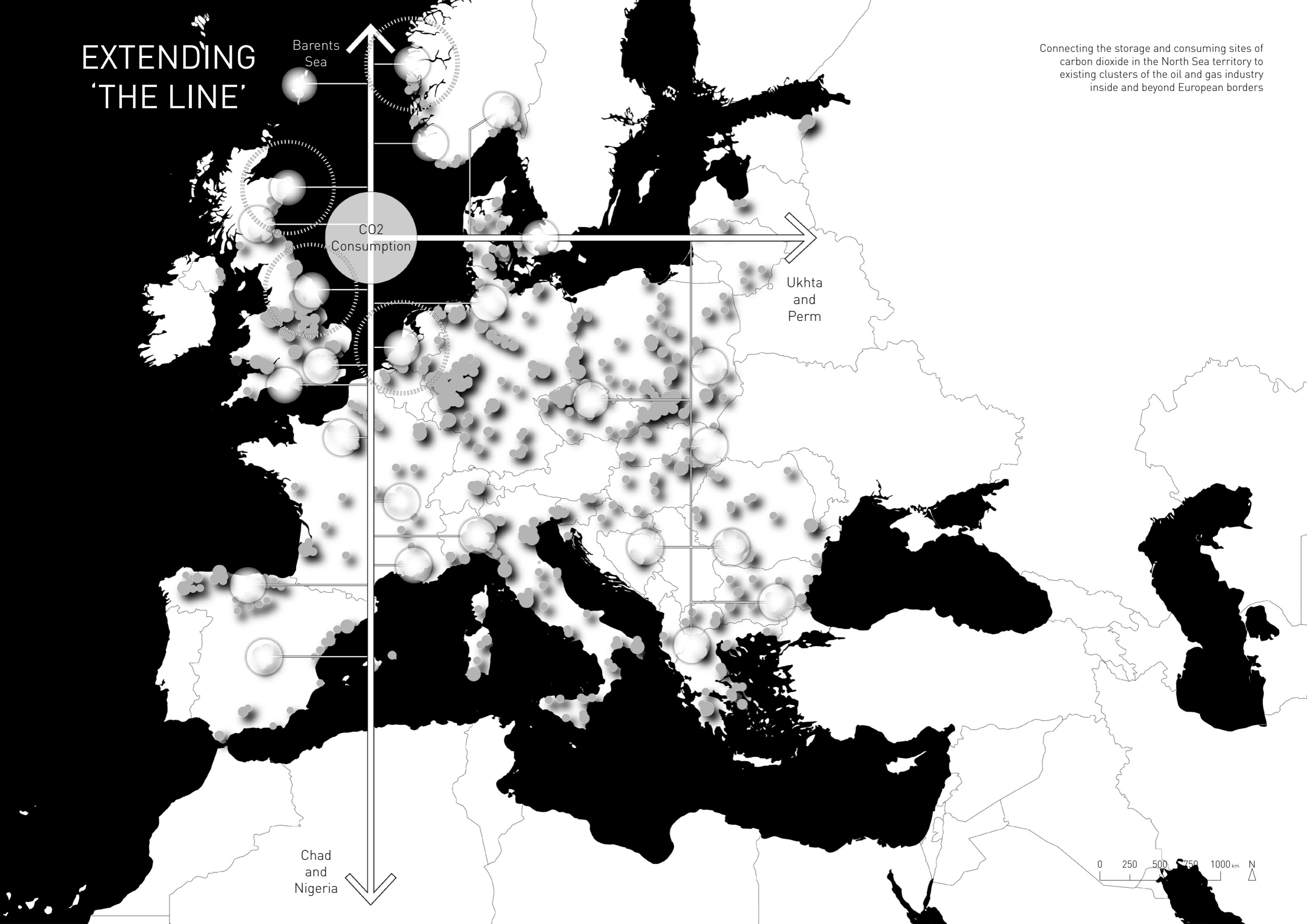

Barents
Sea

CO2
Consumption

Ukhta
and
Perm

Chad
and
Nigeria

0 250 500 750 1000 km N

