

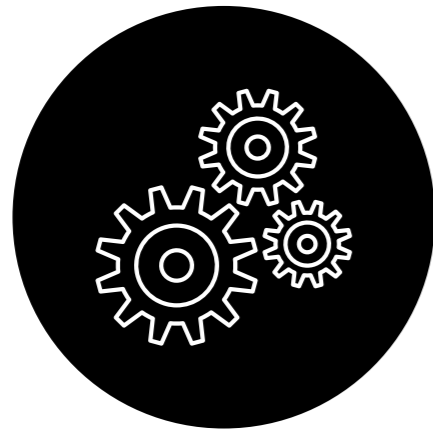

# Talent Machine

Manhattan Midtown NE, New York, NY

*Joanna Cieřlikowska, 4941918*



**1<sup>ST</sup> INDUSTRIAL  
REVOLUTION**

mechanization

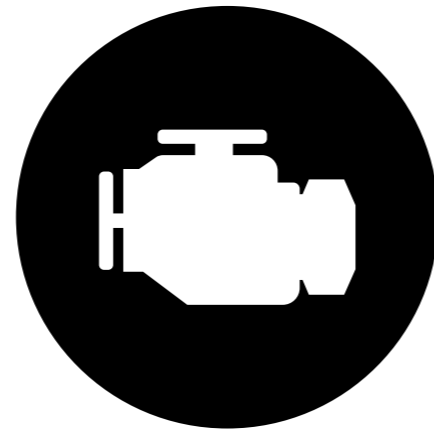

**2<sup>ND</sup> INDUSTRIAL  
REVOLUTION**

mass production

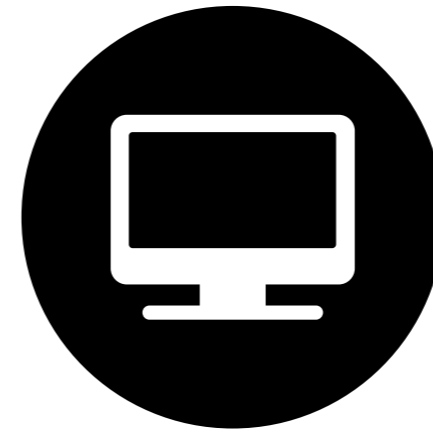

**3<sup>RD</sup> INDUSTRIAL  
REVOLUTION**

computers

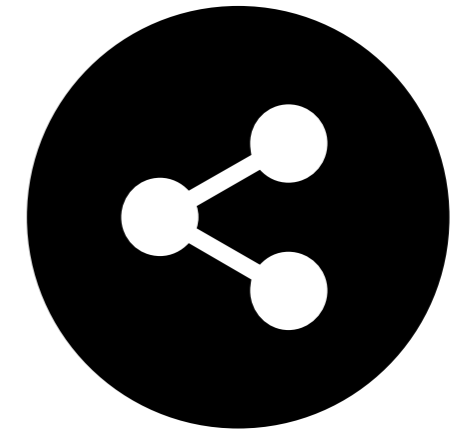

**4<sup>TH</sup> INDUSTRIAL  
REVOLUTION**

wireless network



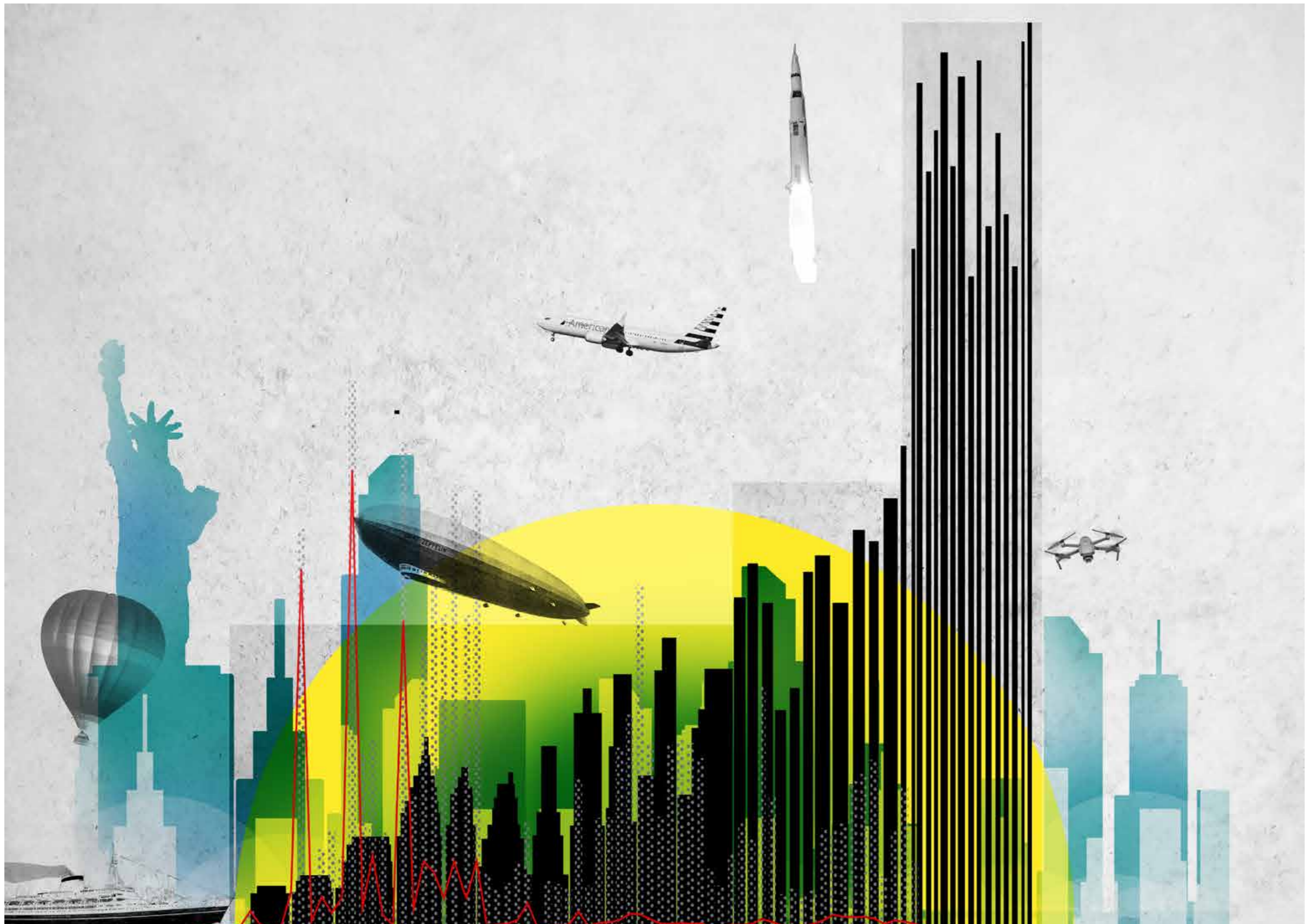



**New York** is one of the most digitally connected cities in the world

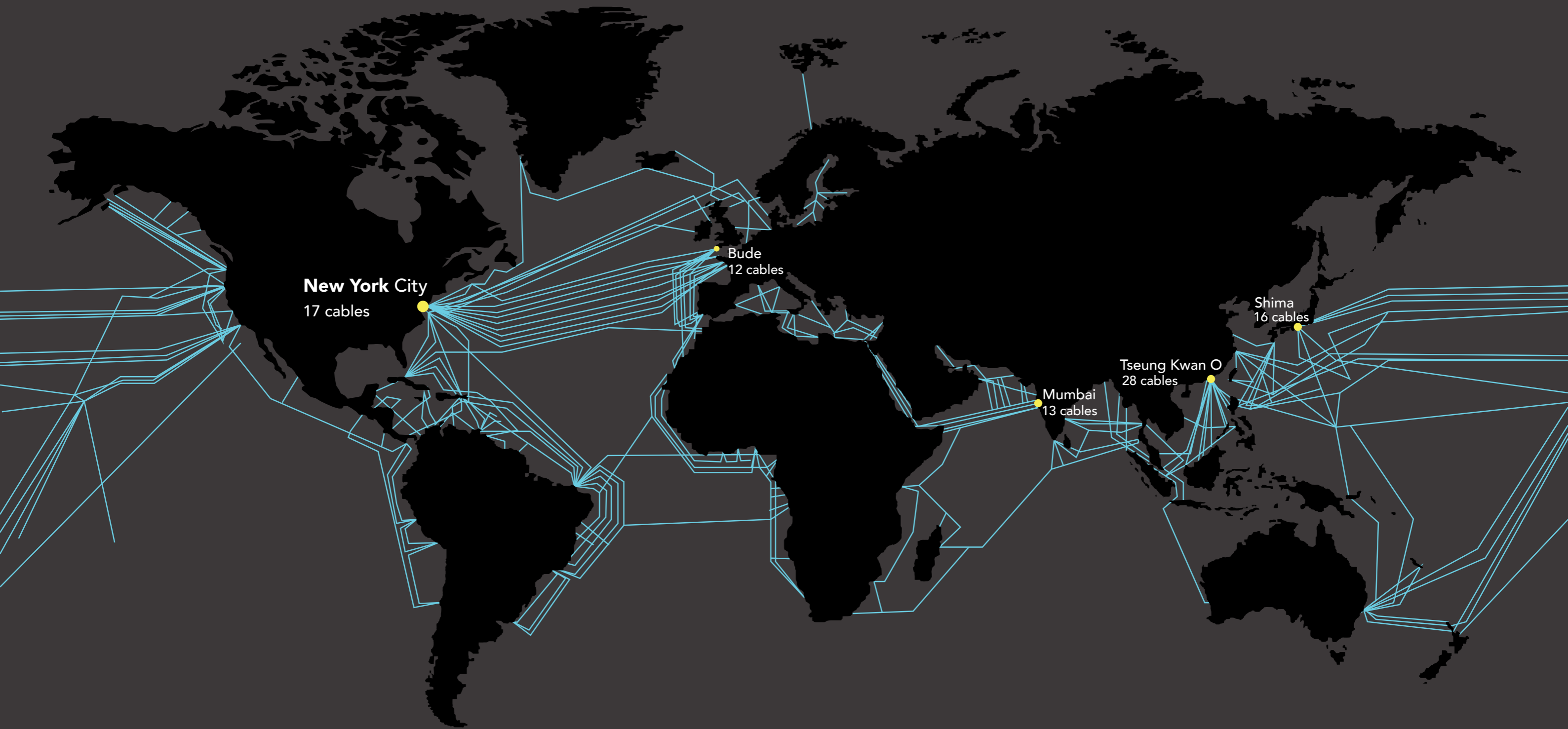





New York City







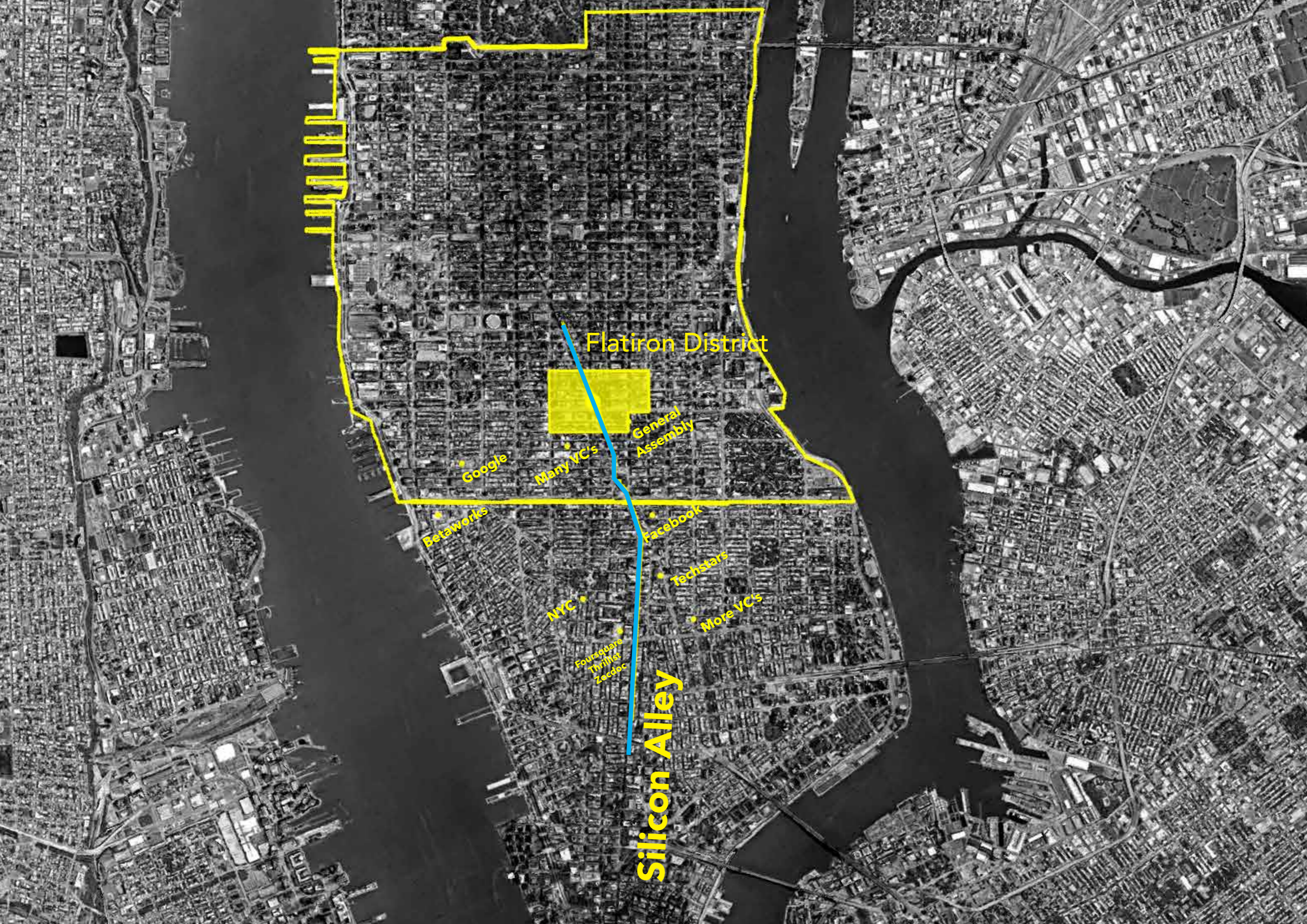

Flatiron District

Silicon Alley

General Assembly

Many VC's

Google

Betaworks

Facebook

Techstars

More VC's

NYC

Foursquare  
ThrinNet  
Zeddoc



2019

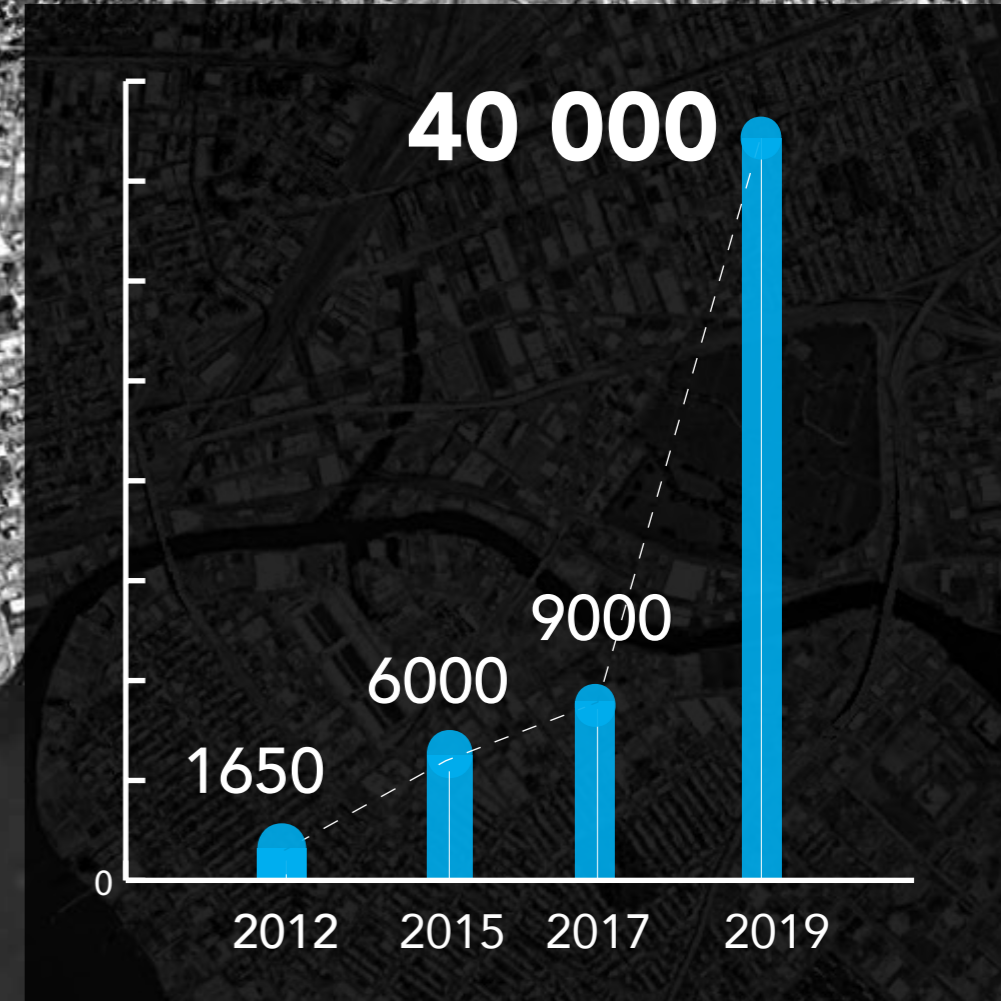
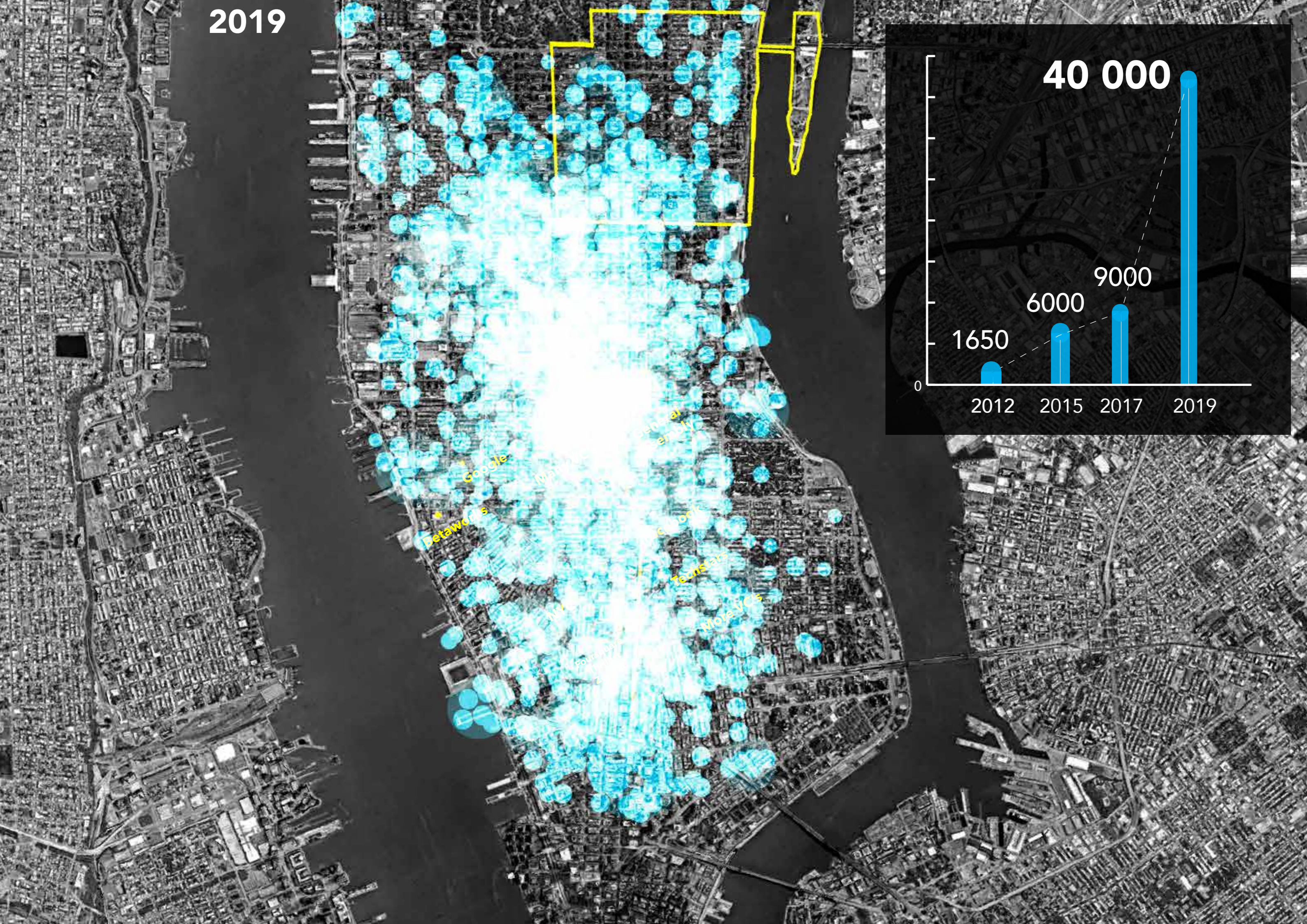



80%  
HIGHER  
EDUCATION

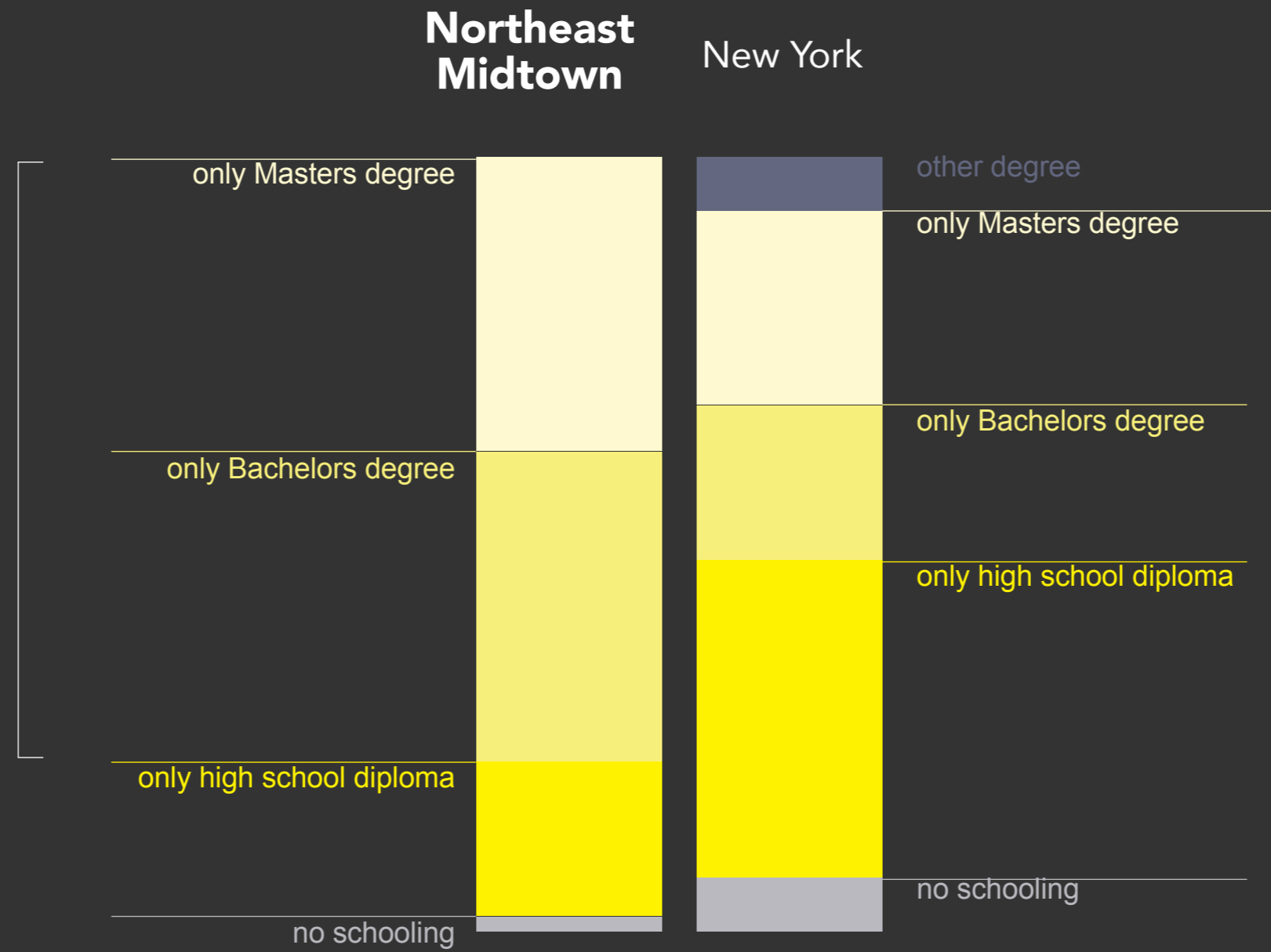

People living in Midtown  
NE are the **most educated**  
residents of New York.





KNOWLEDGE



SKILLS



TALENT







# RESEARCH QUESTION



How can the fourth industrial revolution of the digital era start a grassroots initiative for resilient development while enhancing the architectural value of Northeast Midtown?



**UNIVERSITIES**

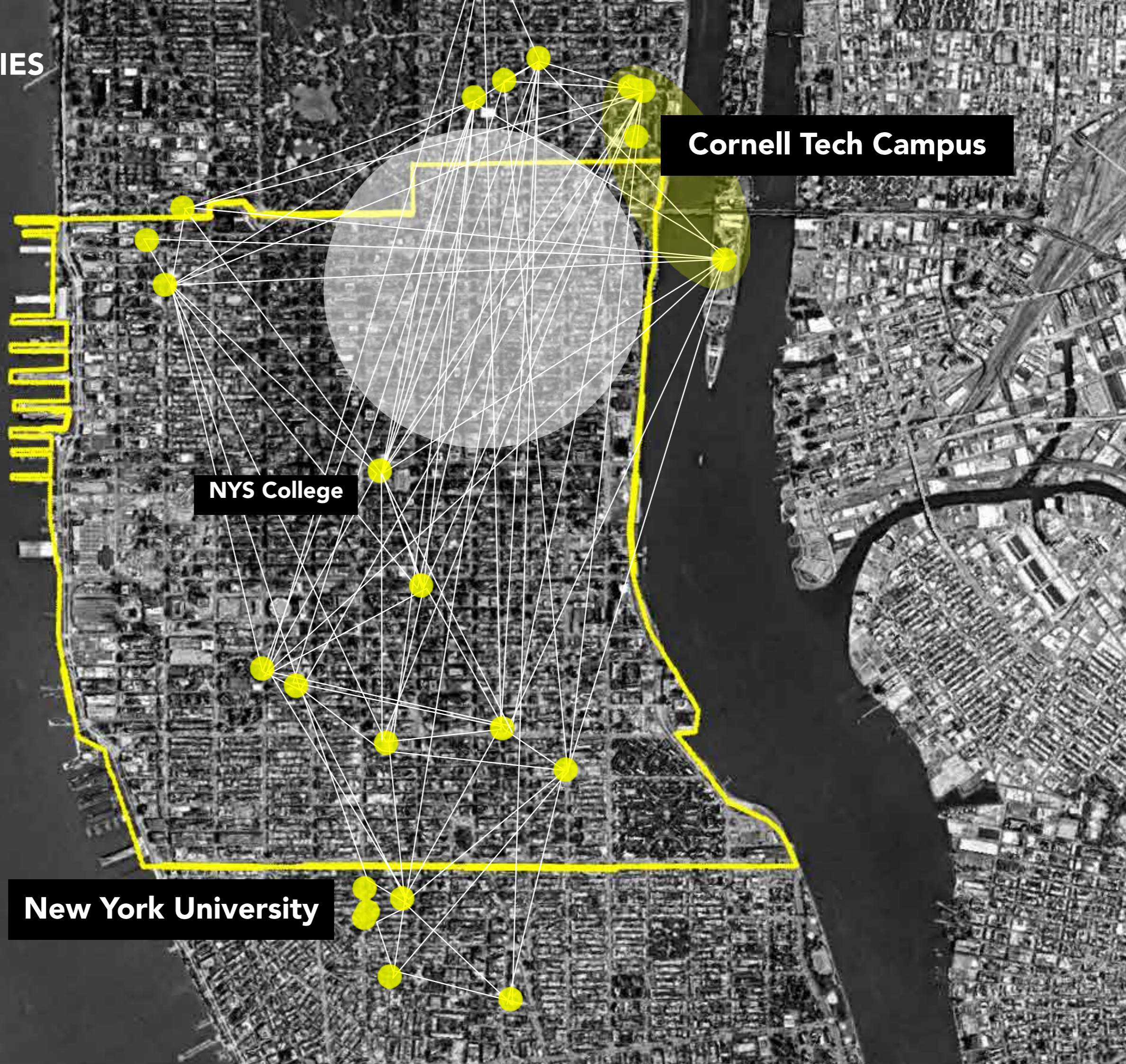

**Cornell Tech Campus**

**NYS College**

**New York University**



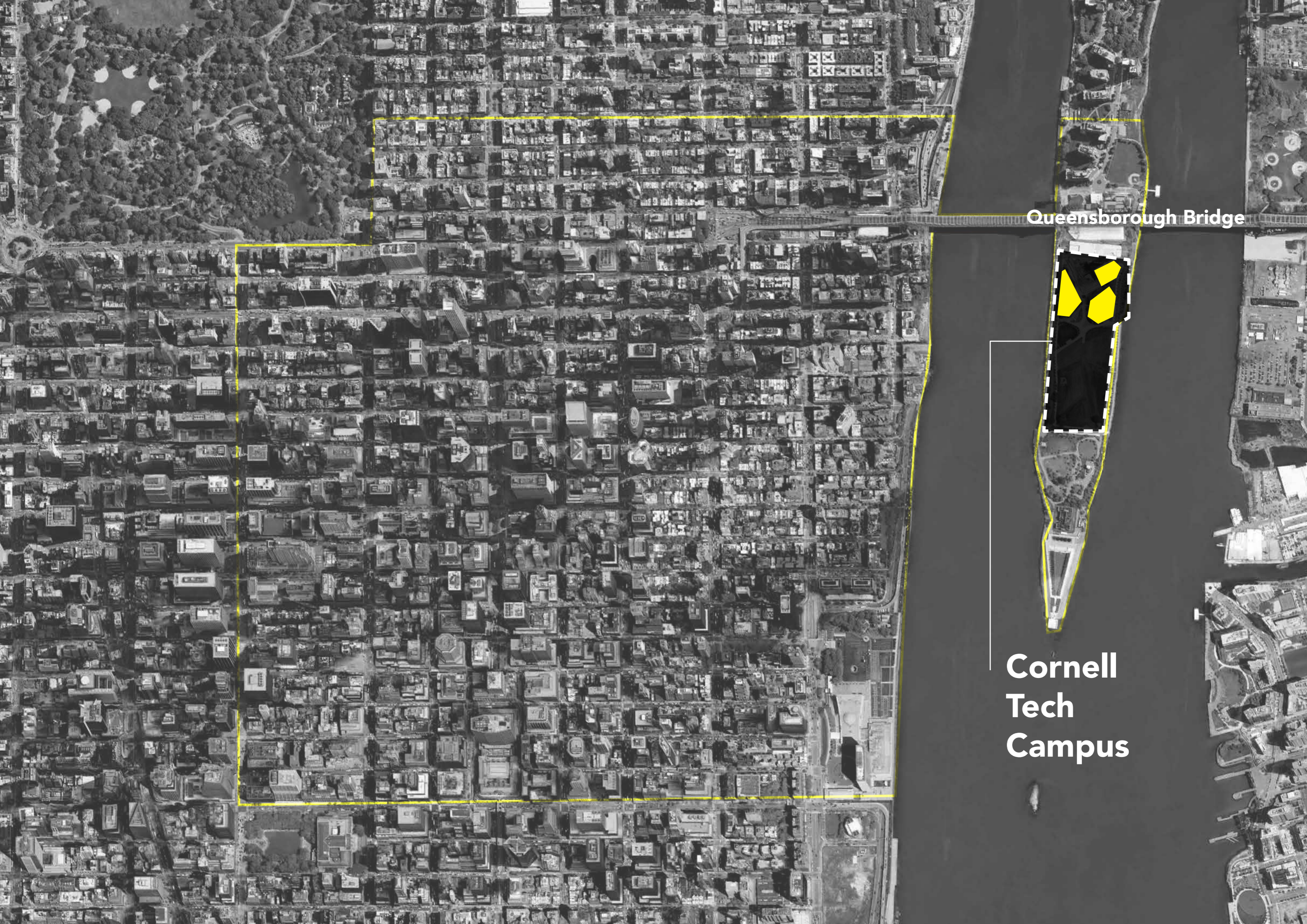

Queensborough Bridge

Cornell  
Tech  
Campus



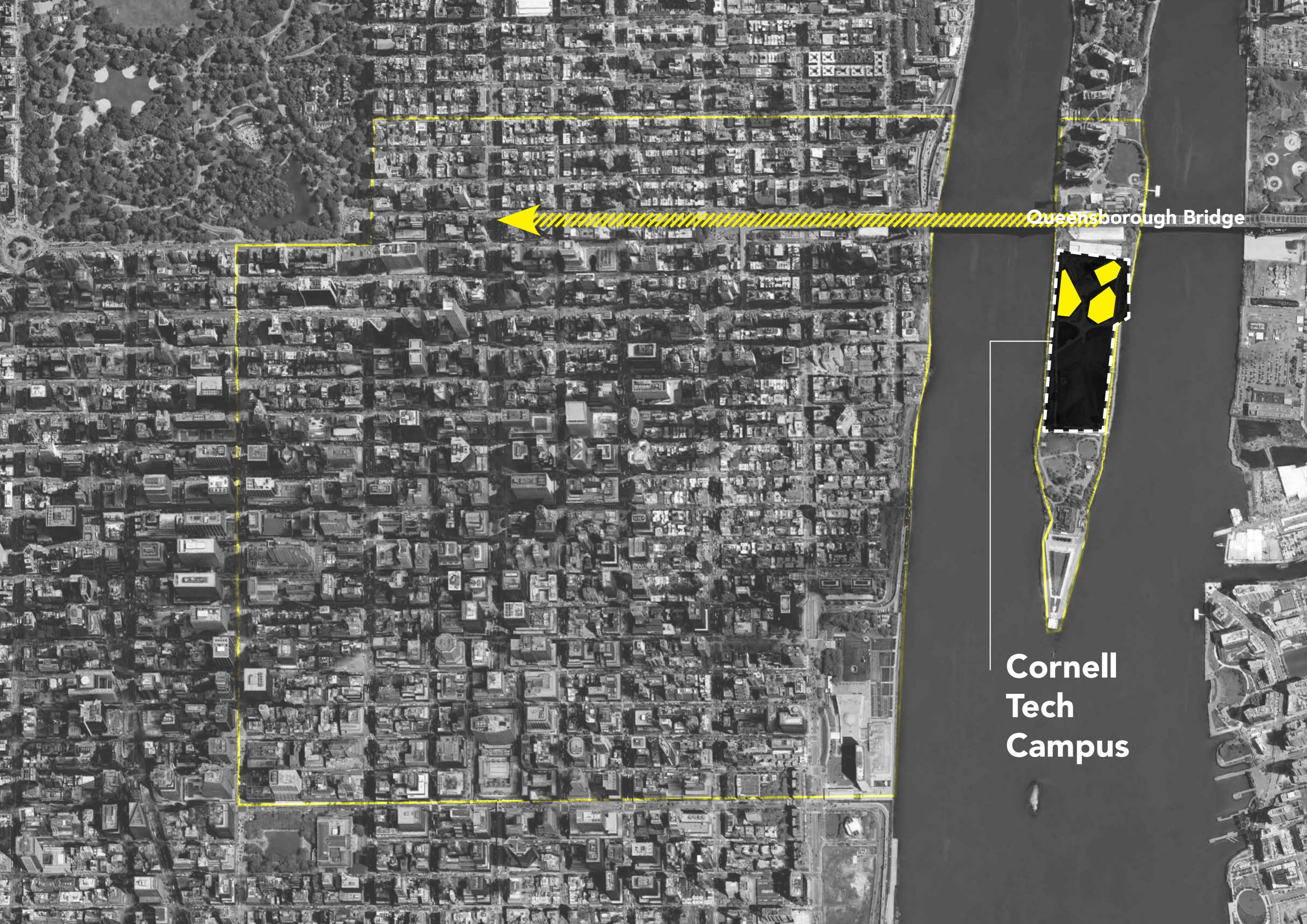

Queensborough Bridge

Cornell  
Tech  
Campus





**CORNELL  
TECH**



## WHY?



### **INTELLECTUAL CAPITAL**

highly educated people  
of diverse background



### **ECONOMIC CAPITAL**

city driven on the power of money



### **POLITICAL SUPPORT**

government supporting innovative  
ways of keeping city's wellbeing



### **VALUE OF THE VALLEY OF GIANTS**

area of a high quality of architecture  
that needs to be held up



# AMBITIONS

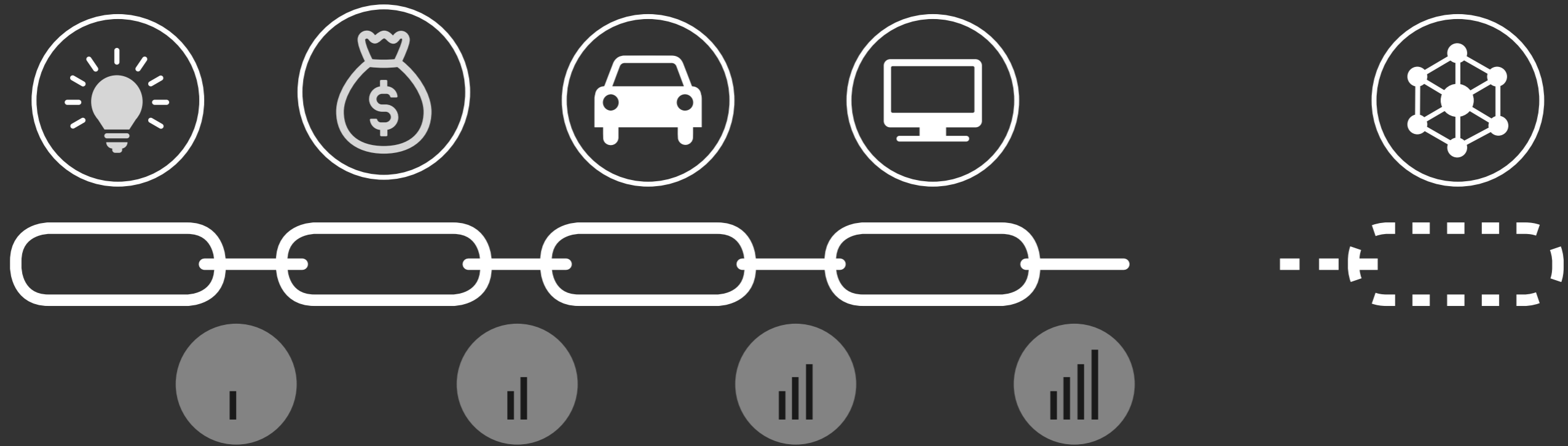



# TALENT MACHINE

A PLATFORM FOR THE EXCHANGE OF INFORMATION, SKILLS AND KNOWLEDGE





# **GROUP MASTERPLAN**



# GROUP MASTERPLAN MIDTOWN NE



**Grand Central Terminal**





# GROUP MASTERPLAN MIDTOWN NE

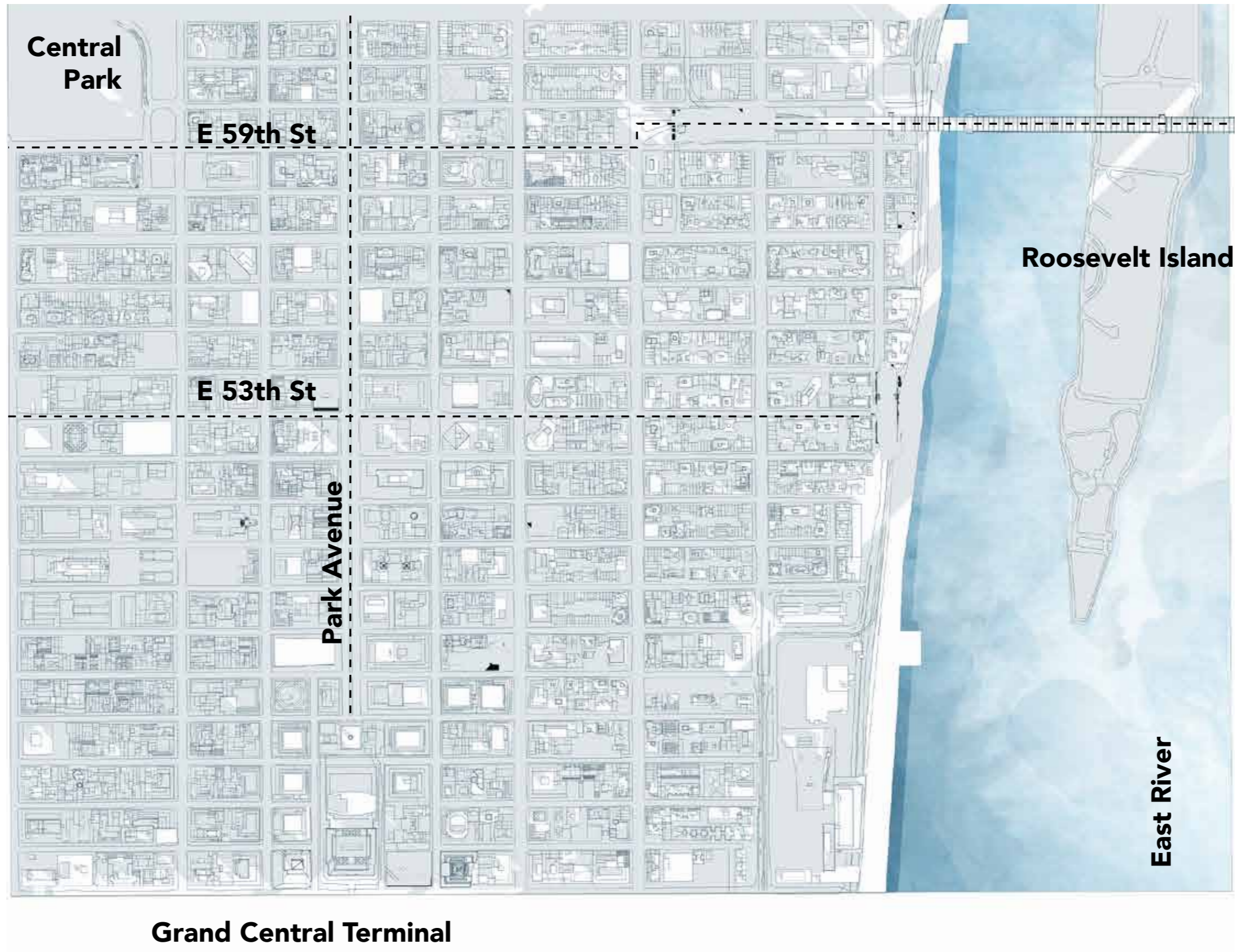



# GROUP MASTERPLAN MIDTOWN NE

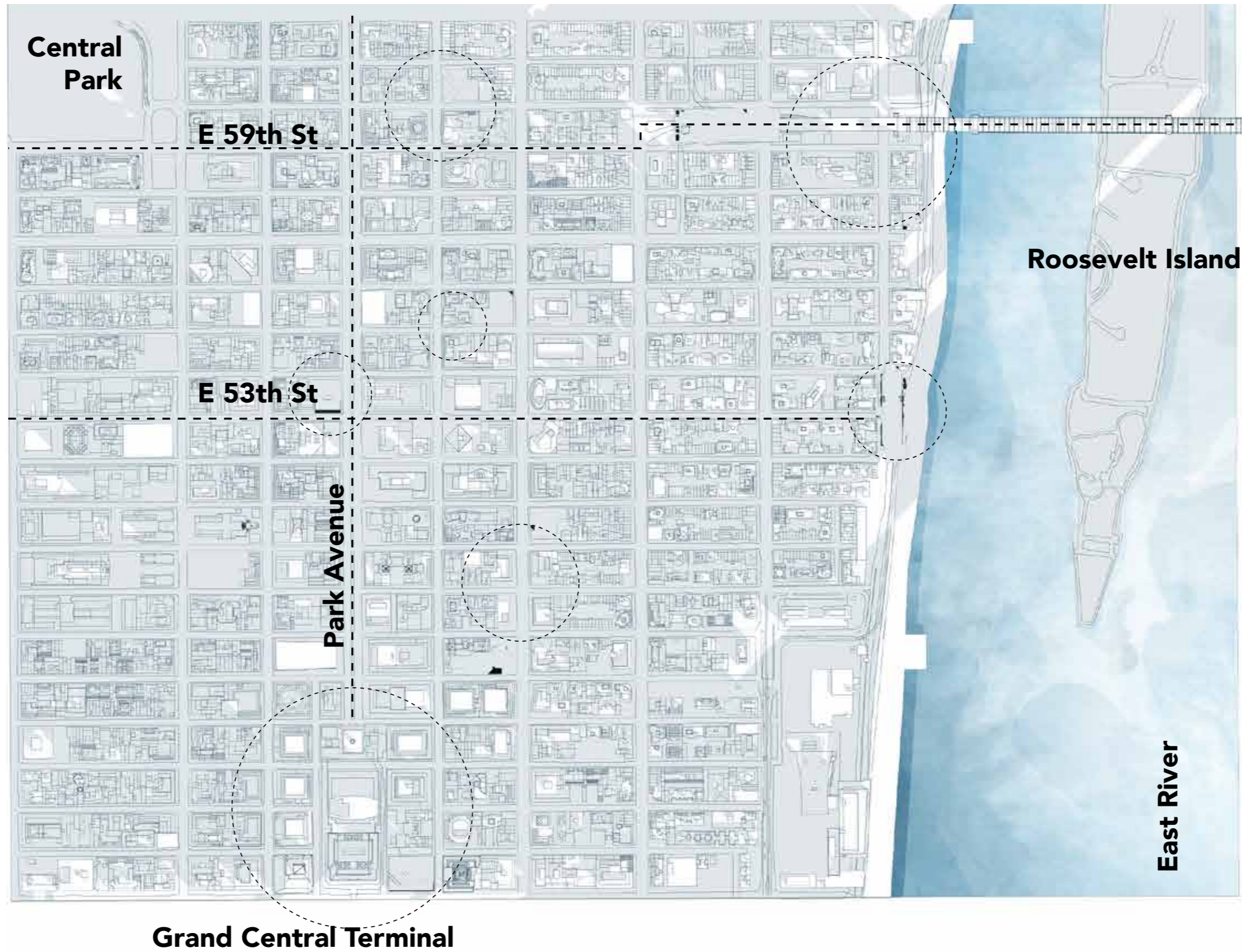



# GROUP MASTERPLAN MIDTOWN NE





# GROUP MASTERPLAN MIDTOWN NE

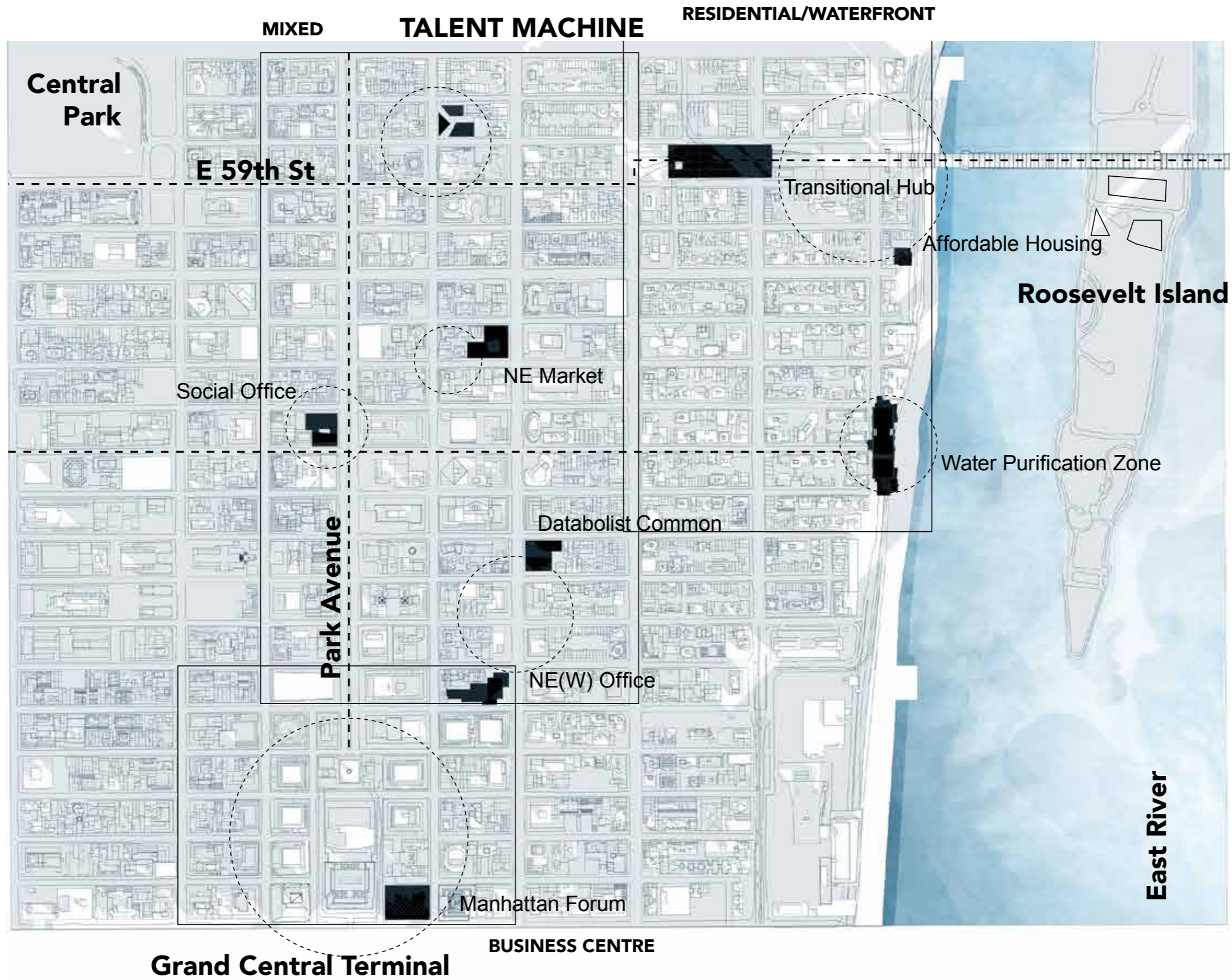



# GROUP MASTERPLAN MIDTOWN NE

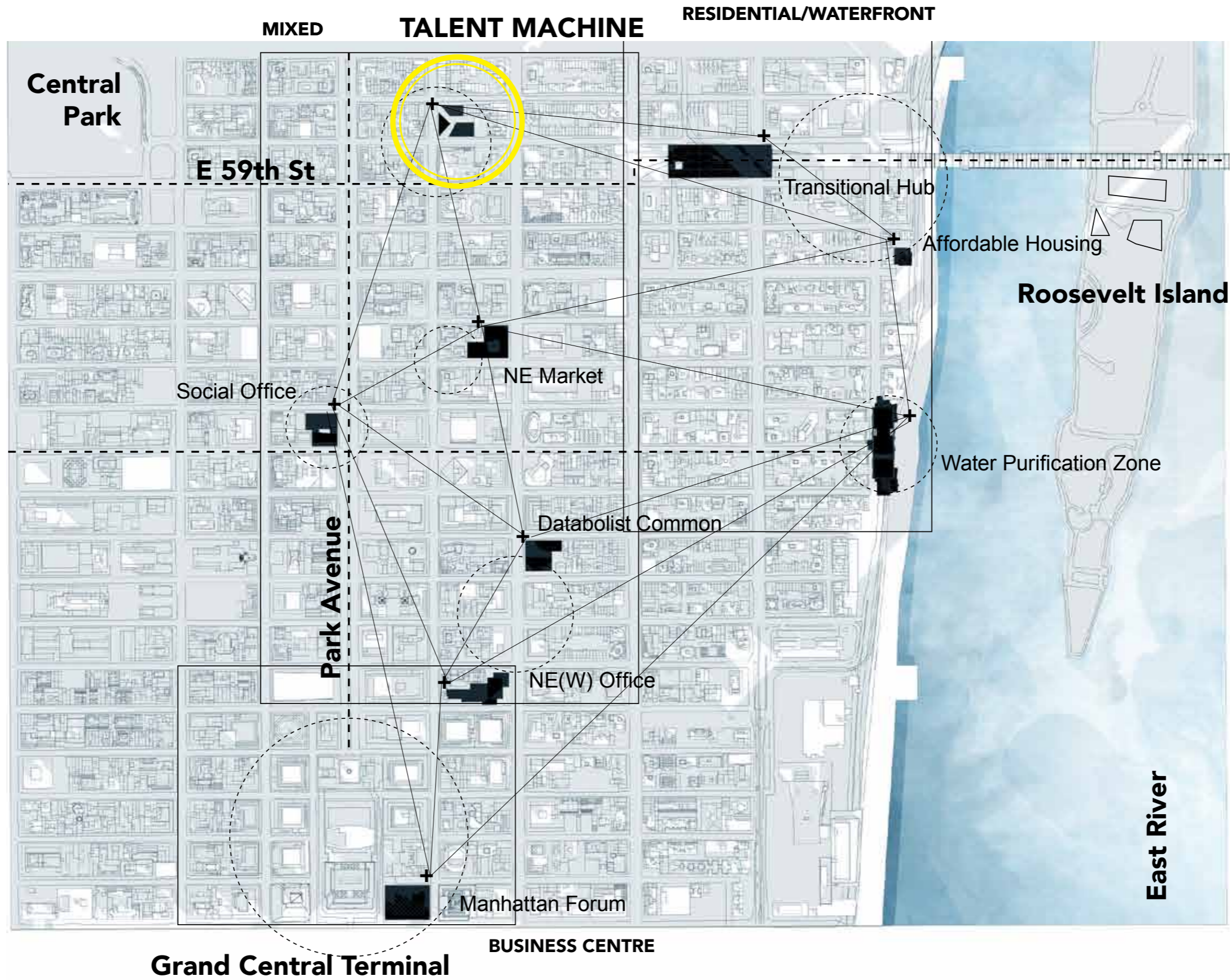



# GROUP MASTERPLAN MIDTOWN NE

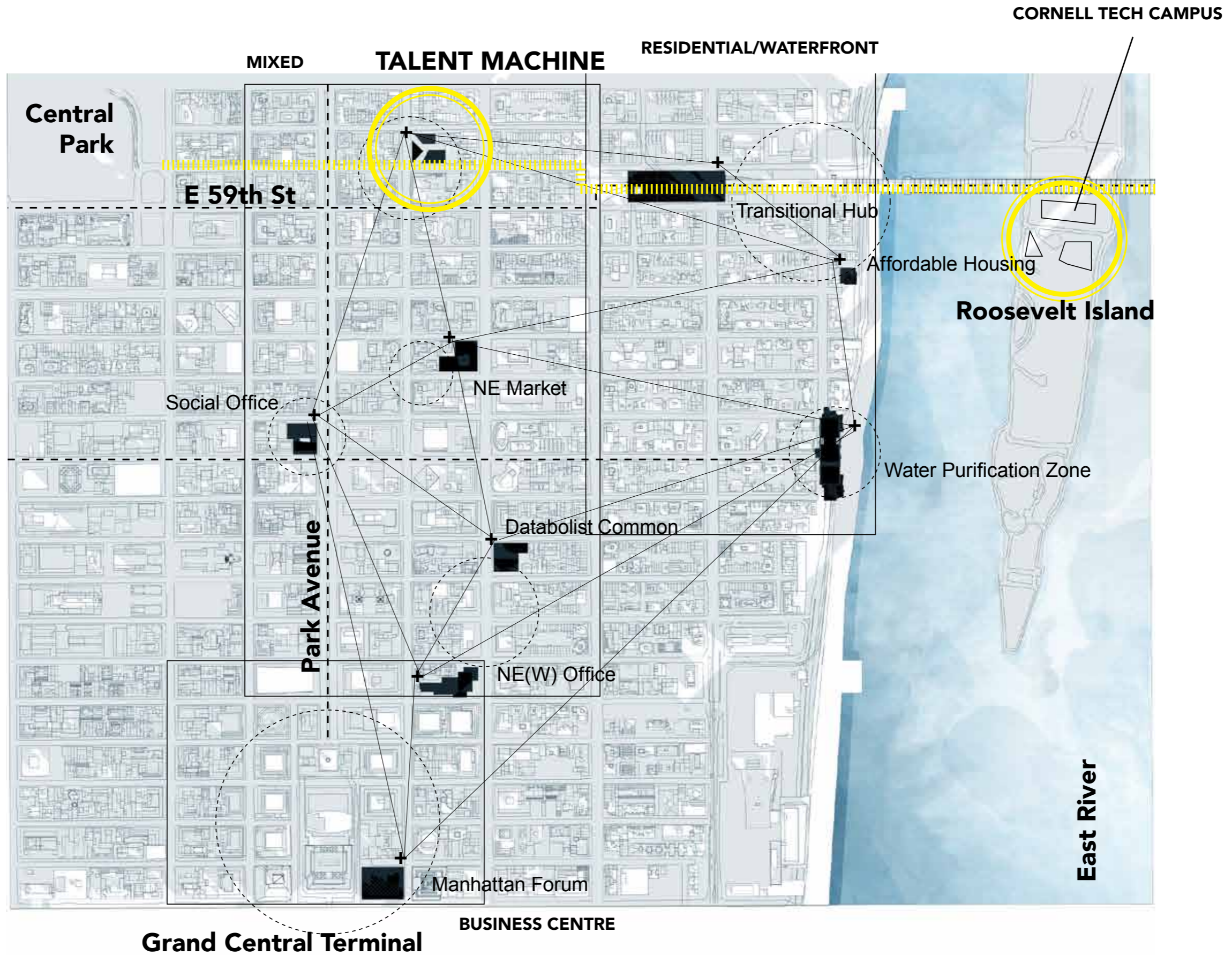



# GROUP MASTERPLAN MIDTOWN NE

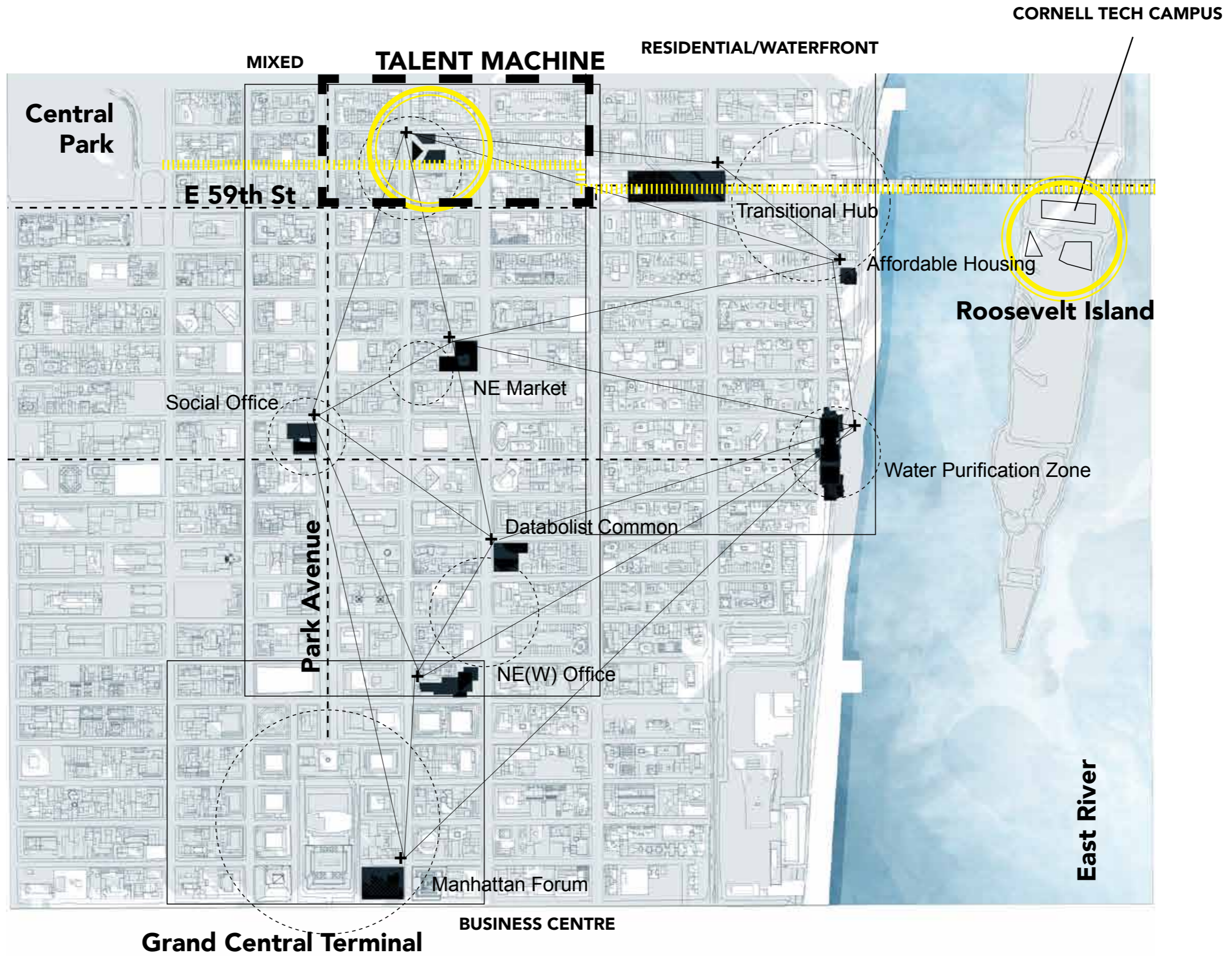



# SITE PLAN

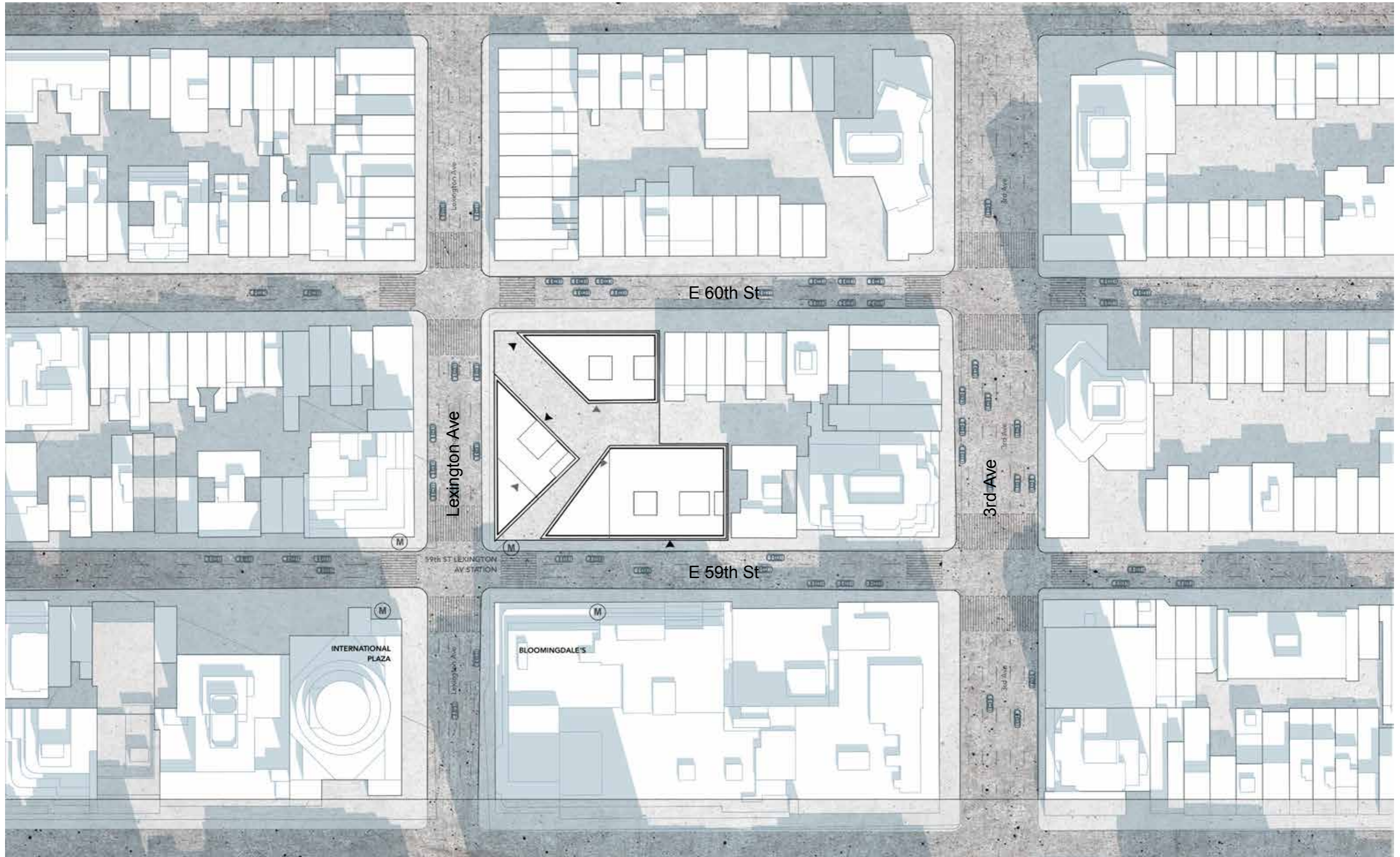



# SITE PLAN





# SITE PLAN





# SITE PLAN

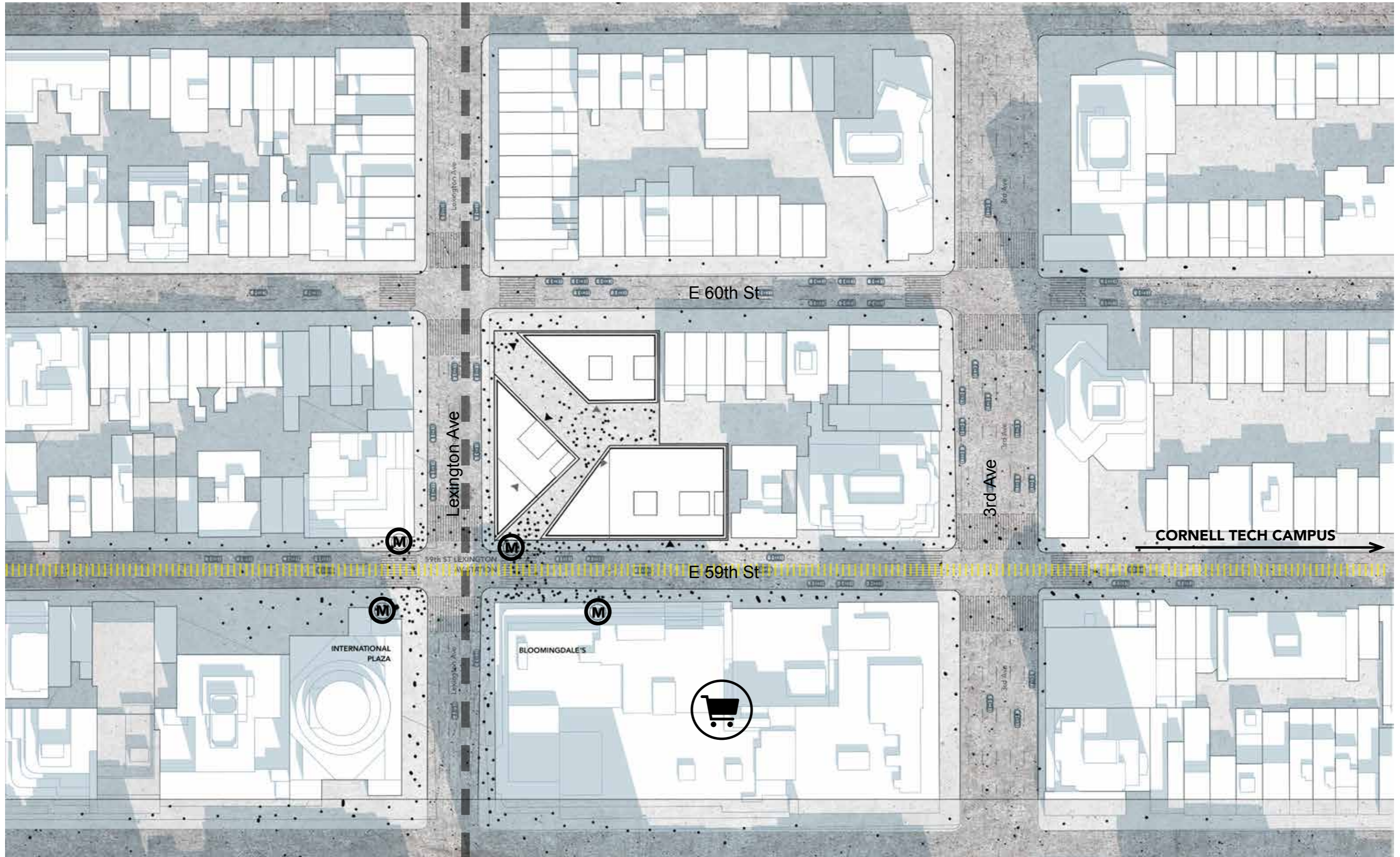



# URBAN IMPLEMENTATION

# AXONOMETRY

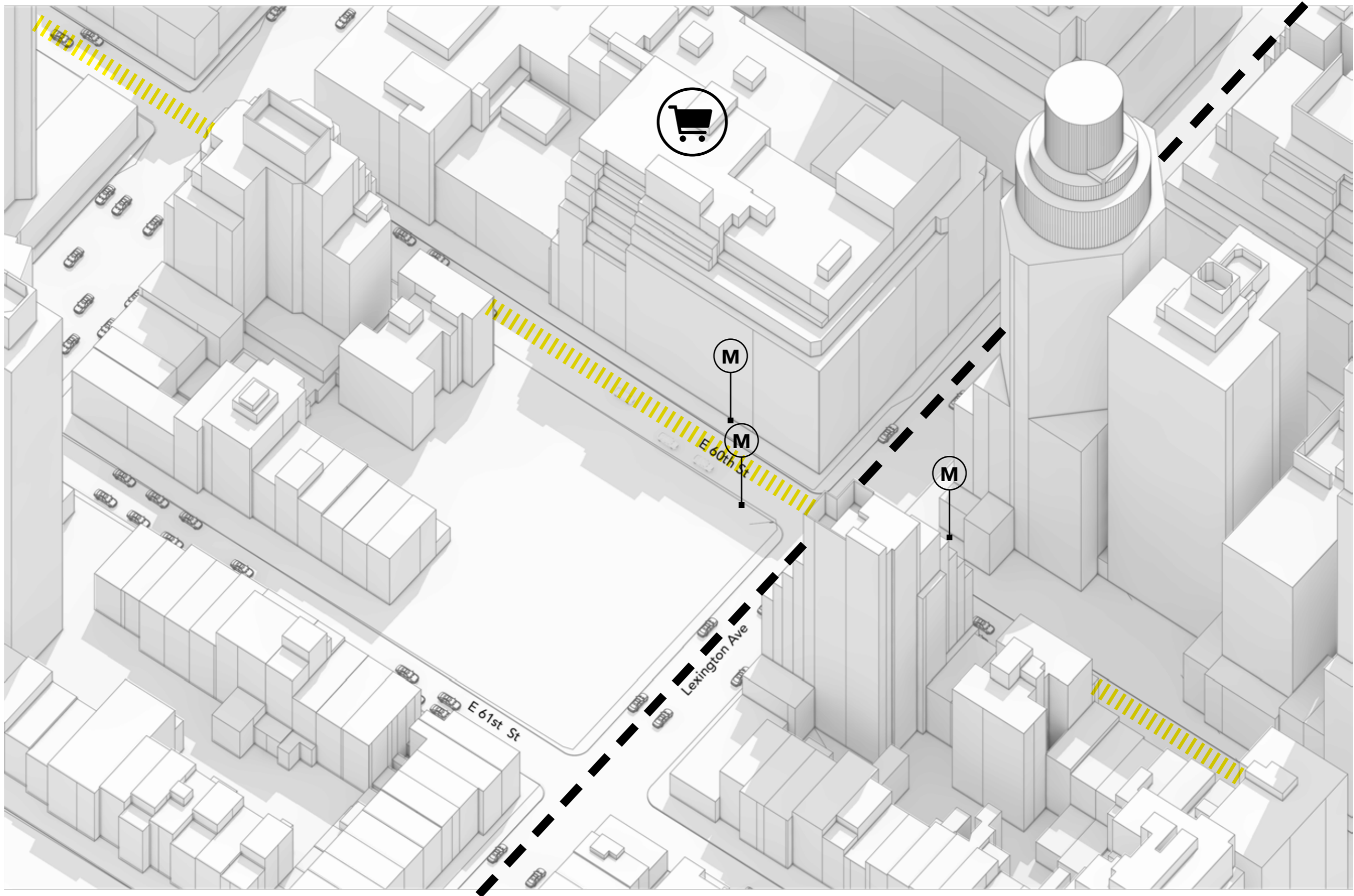



# URBAN IMPLEMENTATION

# AXONOMETRY

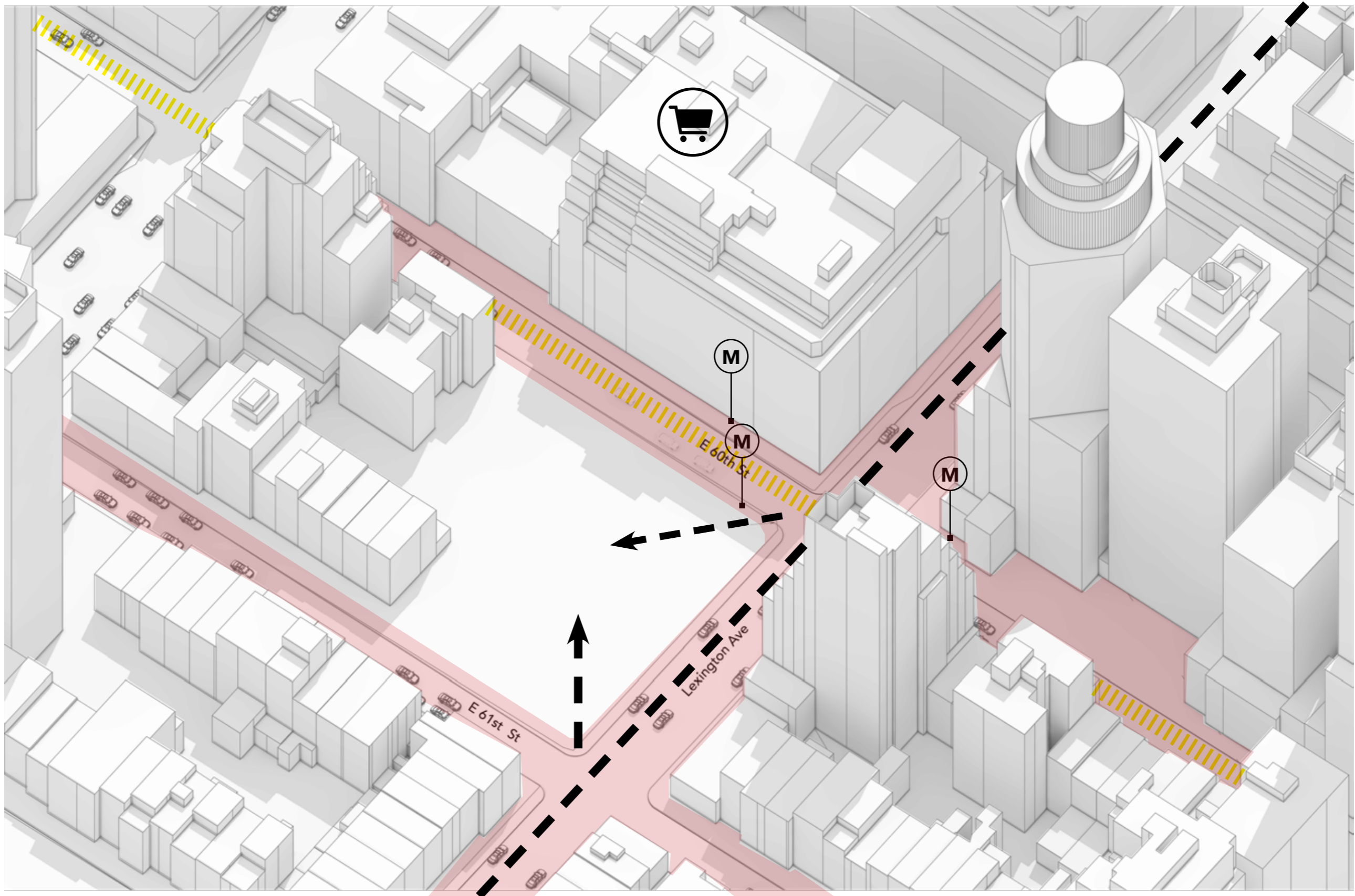



# URBAN IMPLEMENTATION

# AXONOMETRY

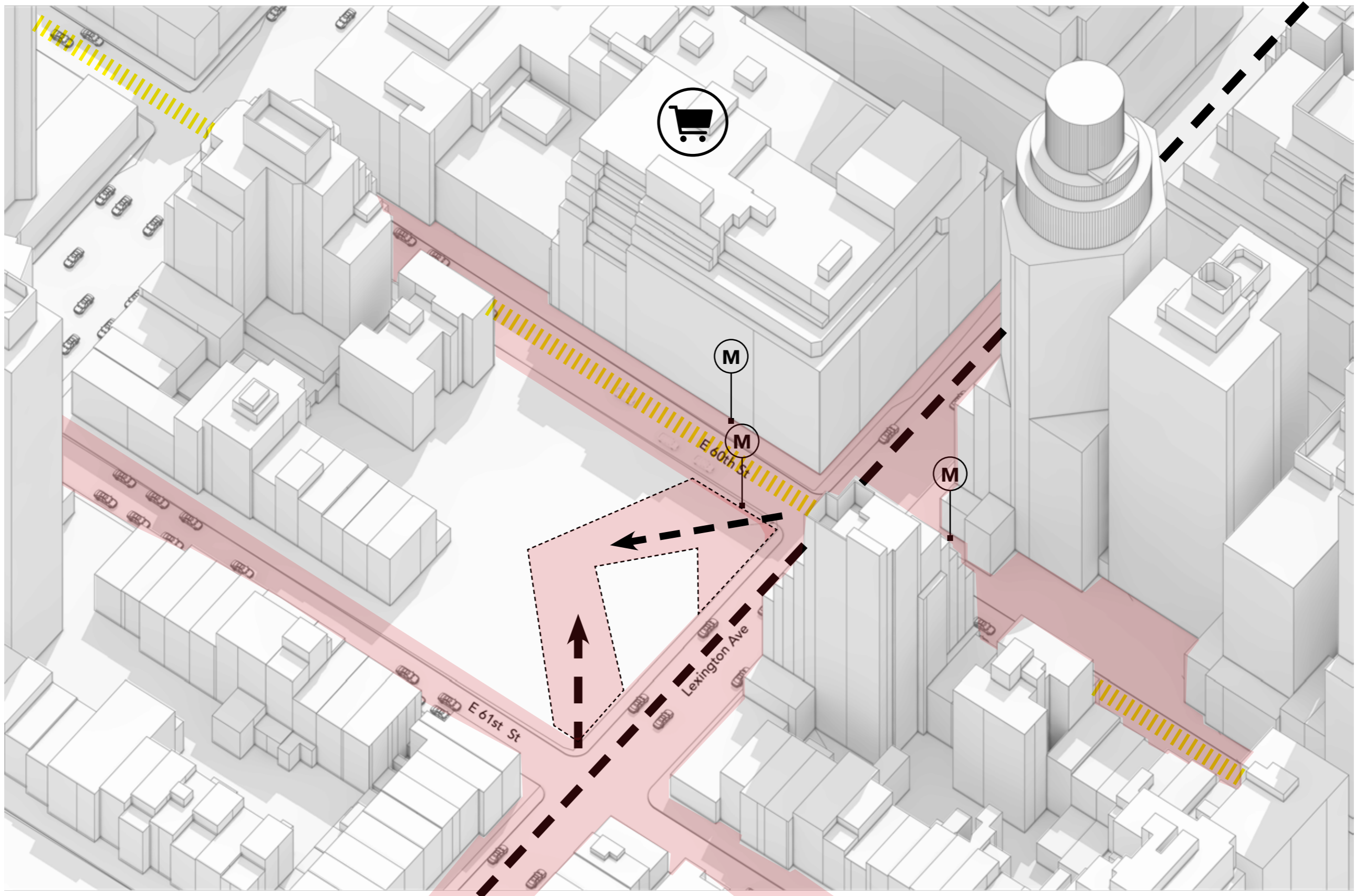



# URBAN IMPLEMENTATION

# AXONOMETRY

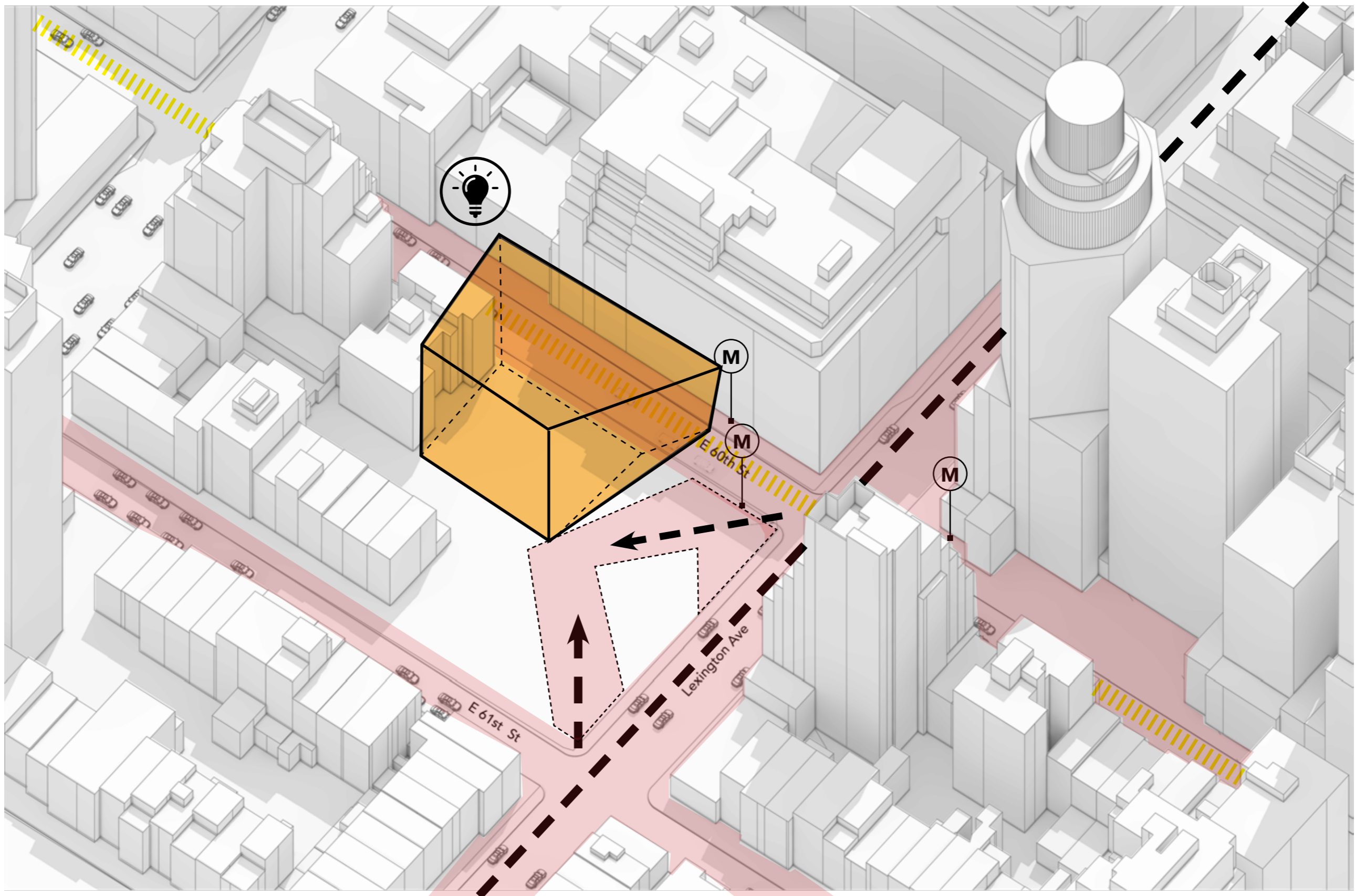



# URBAN IMPLEMENTATION

# AXONOMETRY

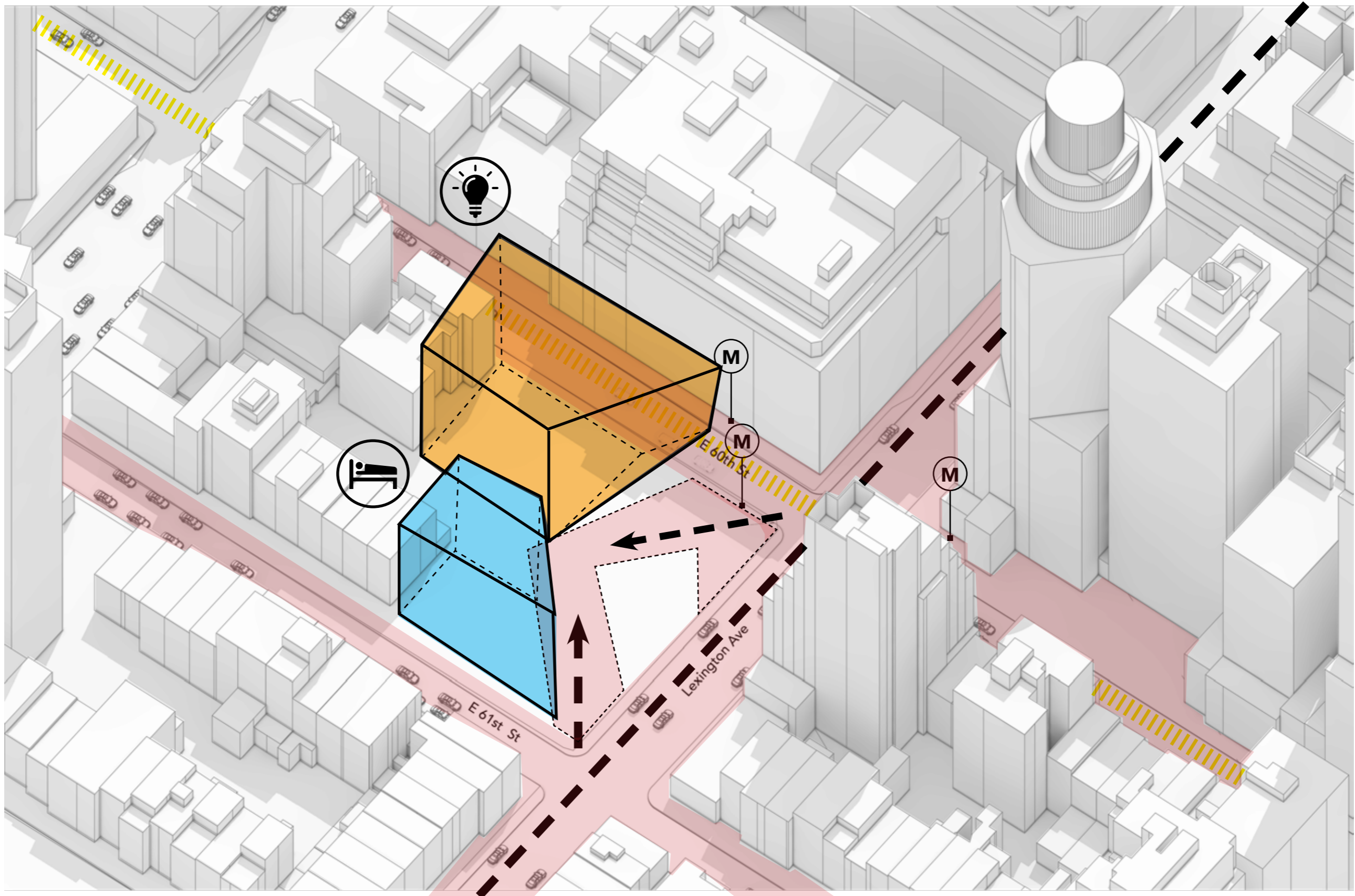



# URBAN IMPLEMENTATION

# AXONOMETRY

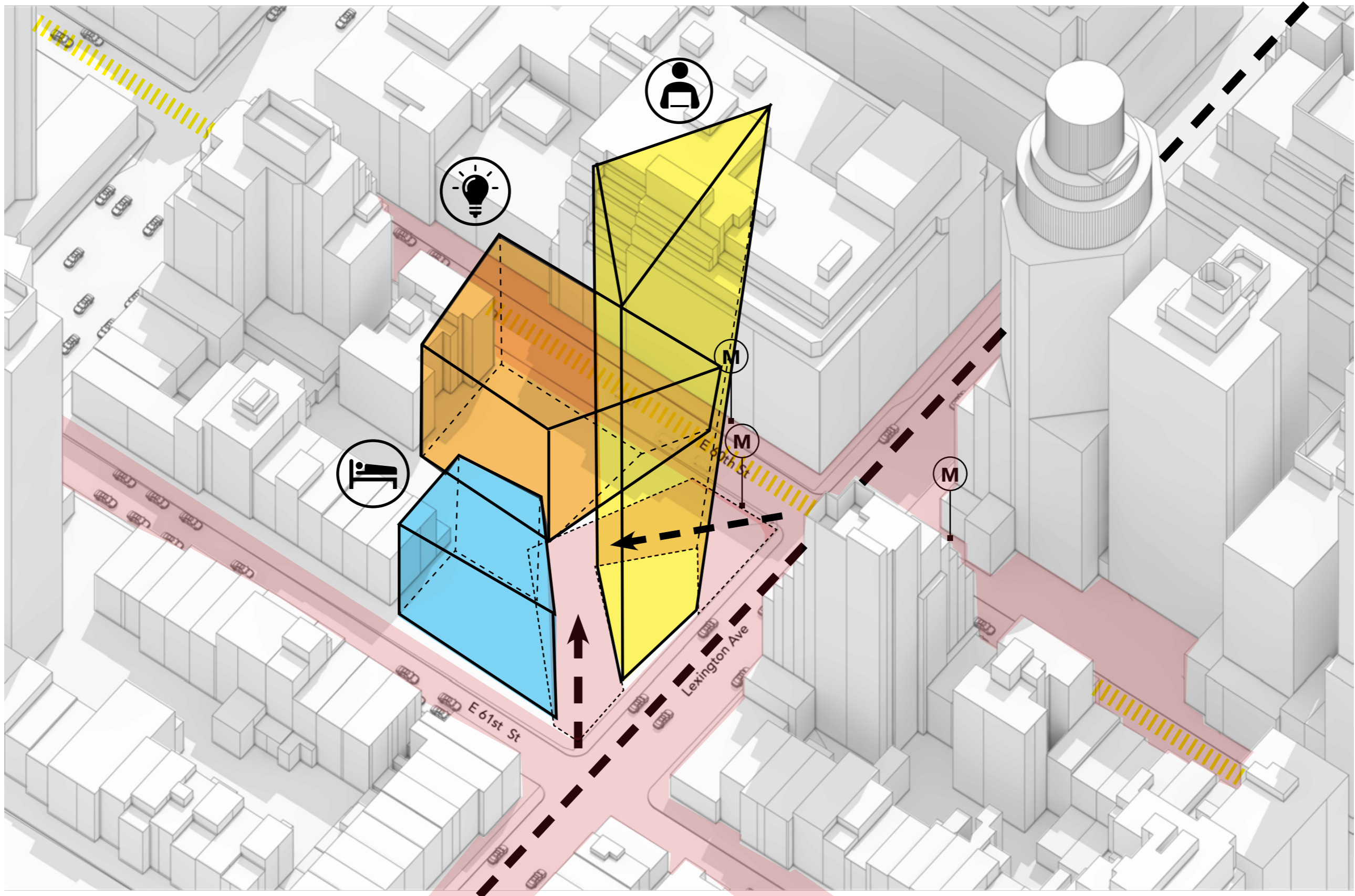



# URBAN IMPLEMENTATION

# AXONOMETRY

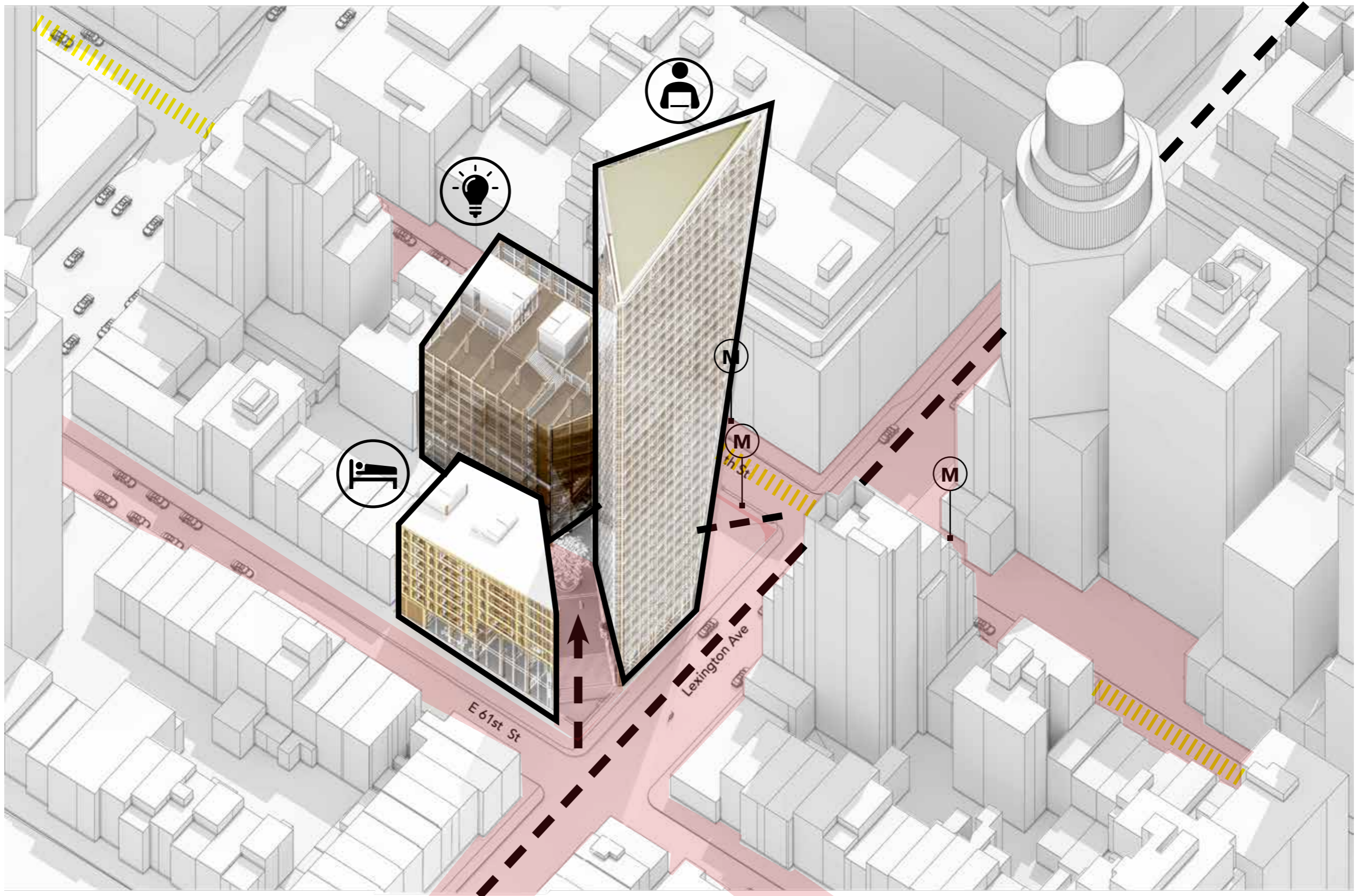



# CONTEXT

**BLOOMBERG'S TOWER**

**TALENT MACHINE**

**BLOOMINGDALE'S  
WAREHOUSE**

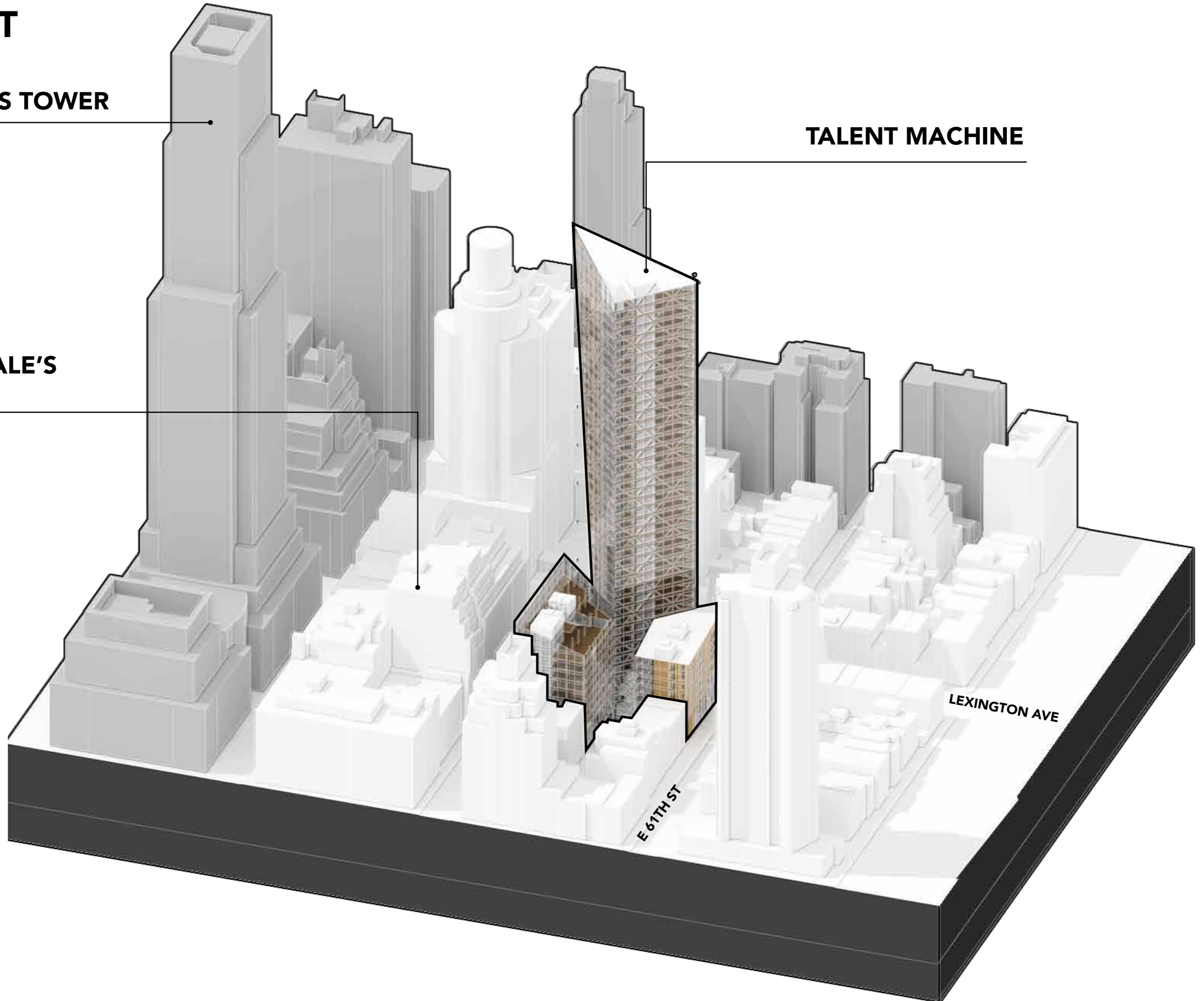



# AERIAL PERSPECTIVE





# AERIAL PERSPECTIVE

**CHRYSLER BUILDING**

**BLOOMBERG TOWER**

**EMPIRE STATE BUILDING**

**GRAND CENTRAL TERMINAL**

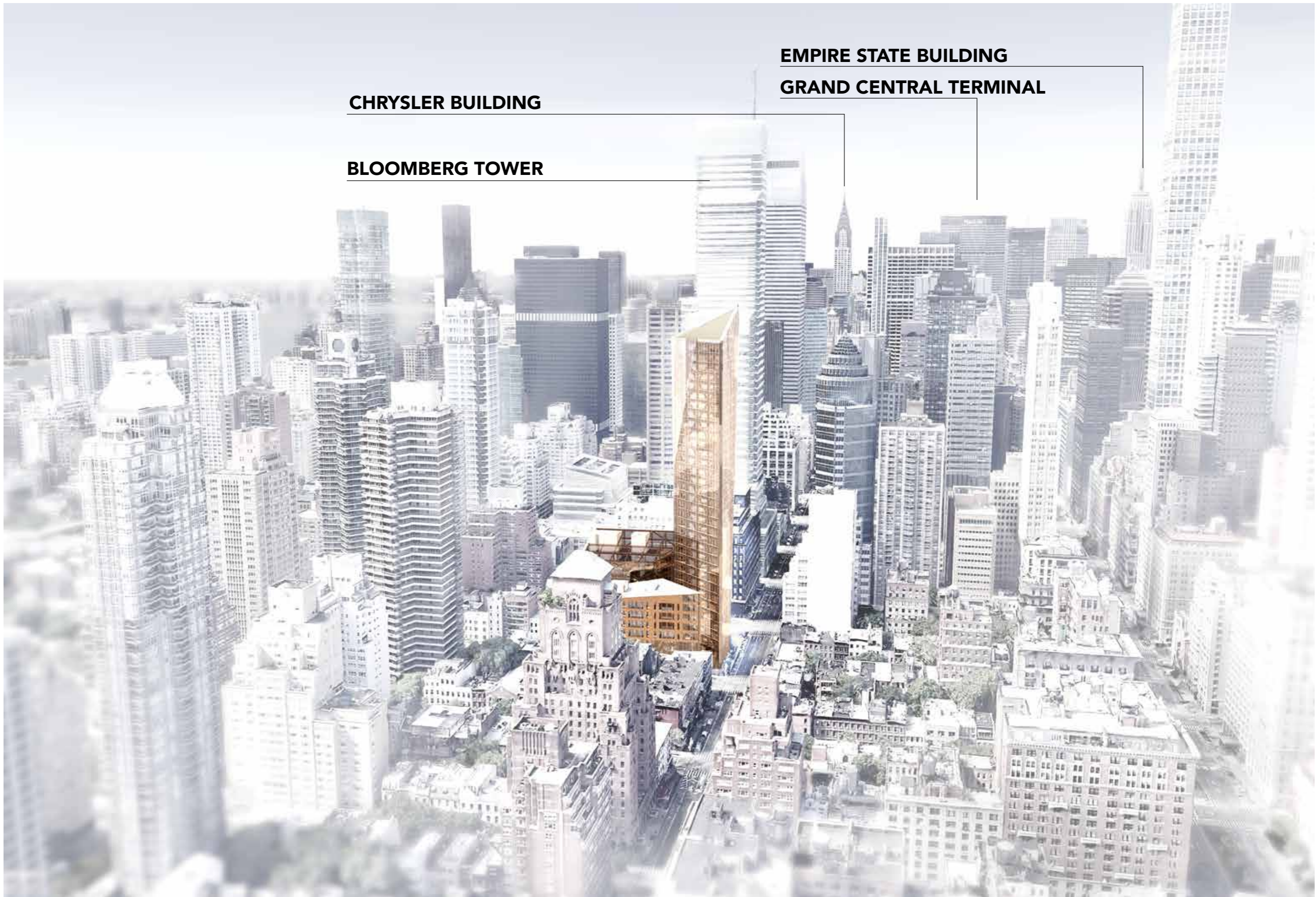



# AERIAL PERSPECTIVE

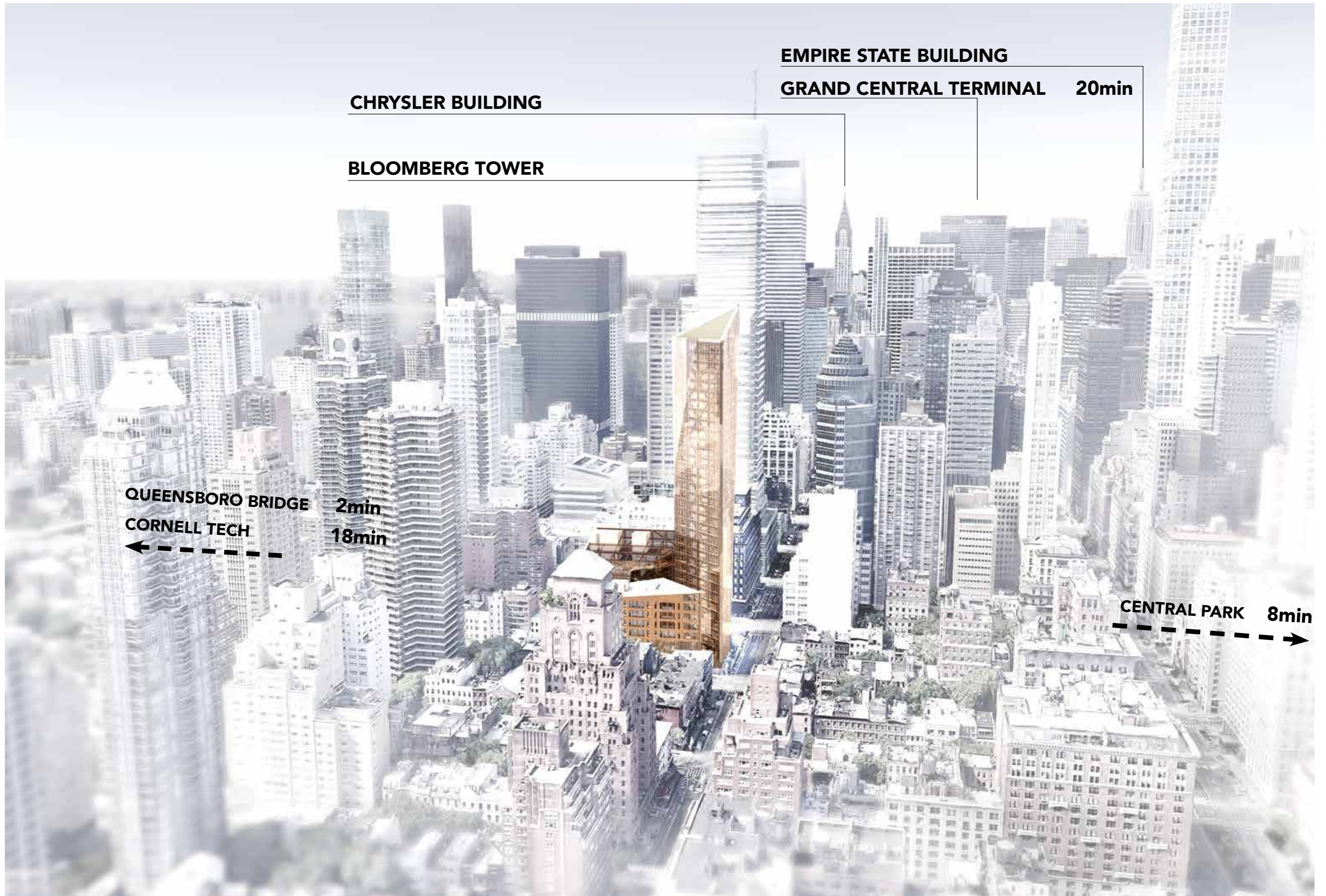

**CHRYSLER BUILDING**

**EMPIRE STATE BUILDING**

**GRAND CENTRAL TERMINAL 20min**

**BLOOMBERG TOWER**

**QUEENSBORO BRIDGE 2min**

**CORNELL TECH 18min**

**CENTRAL PARK 8min**



# PROGRAM

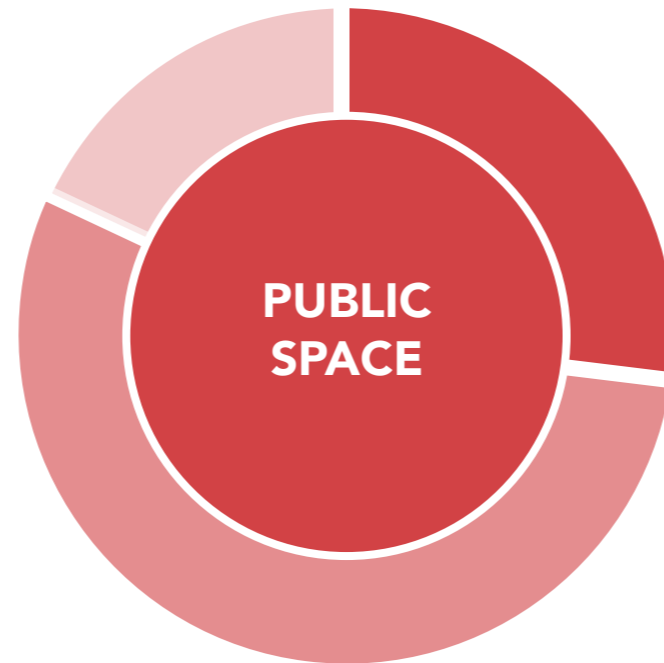



# PROGRAM

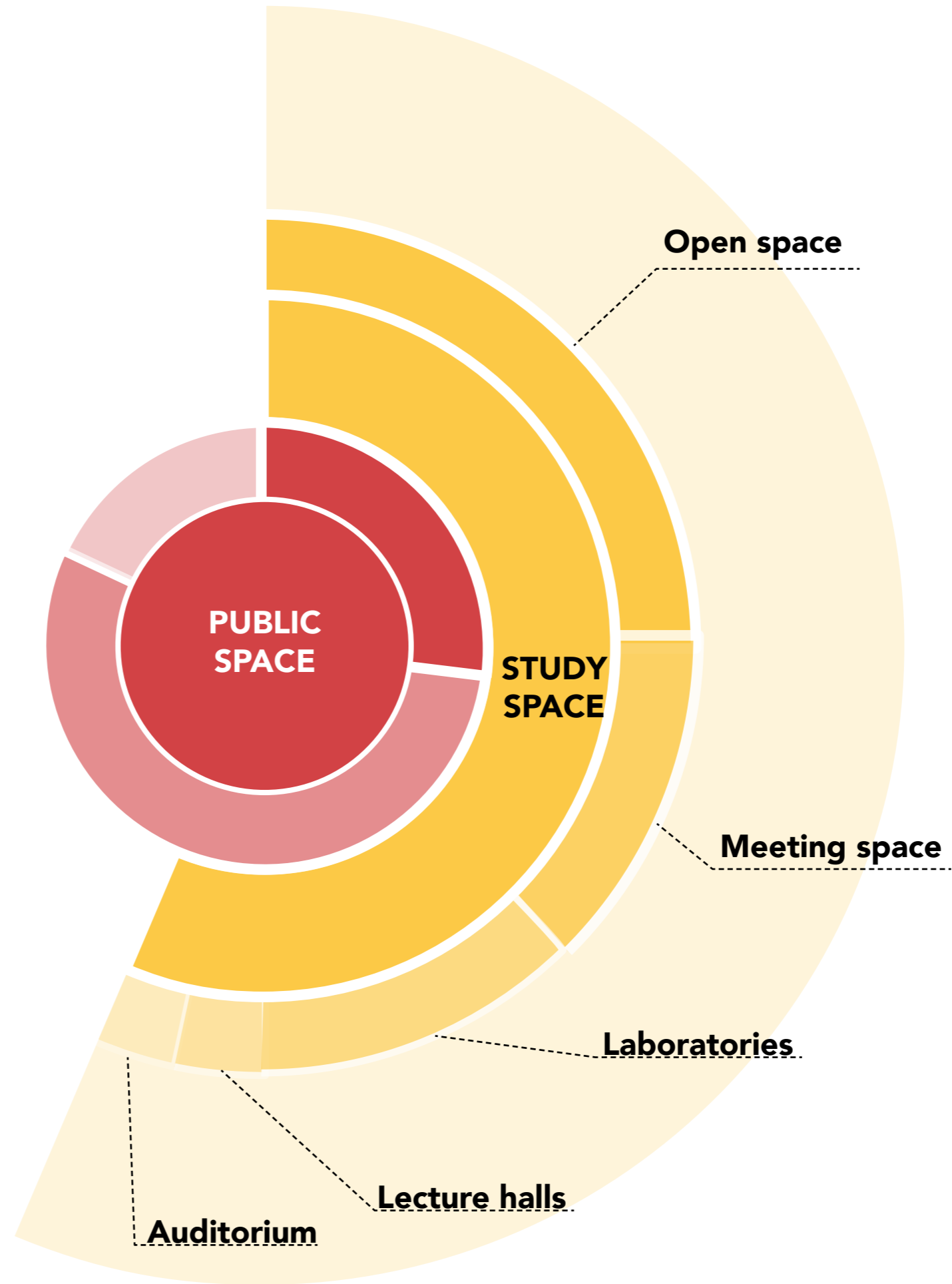



# PROGRAM

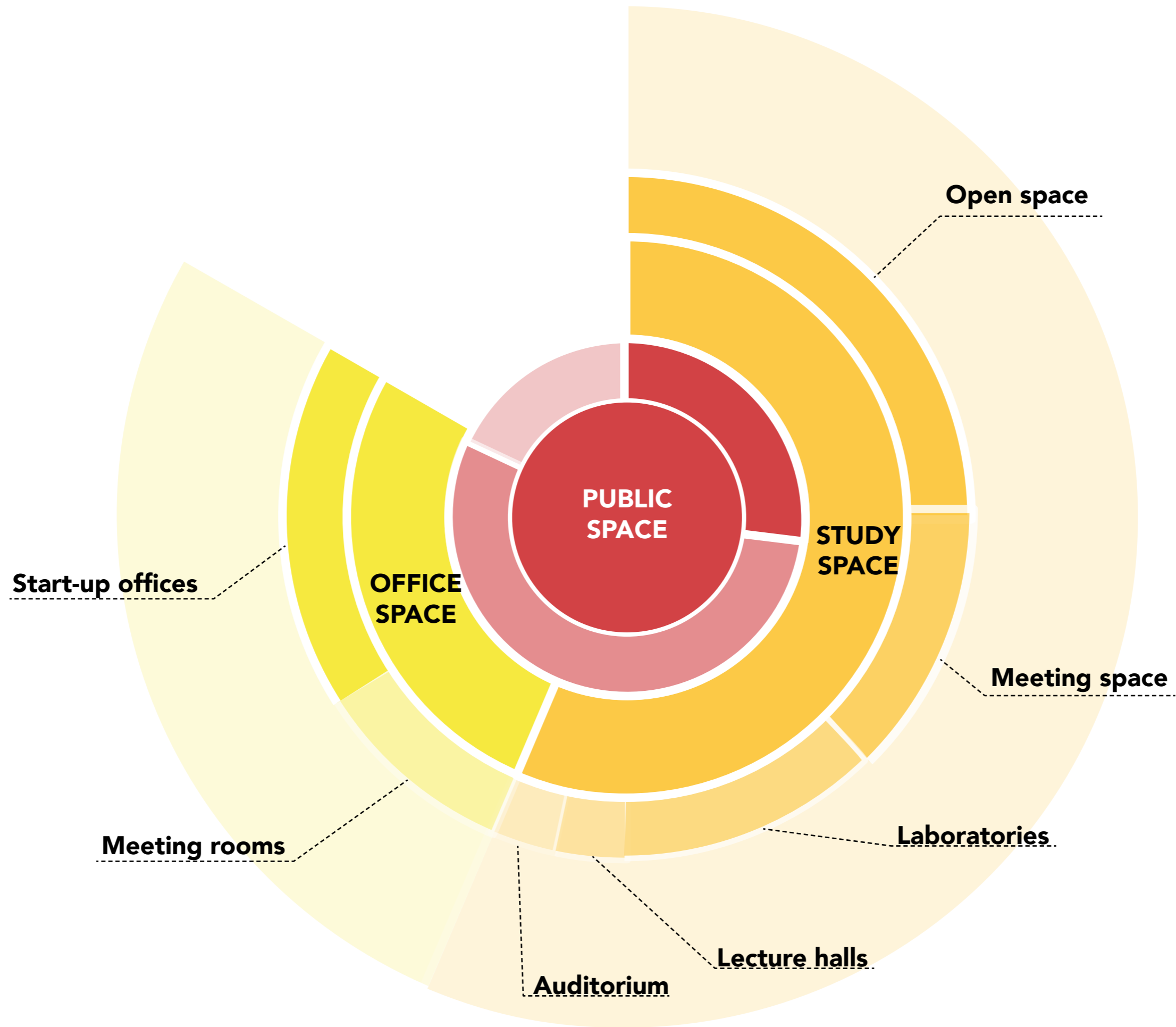





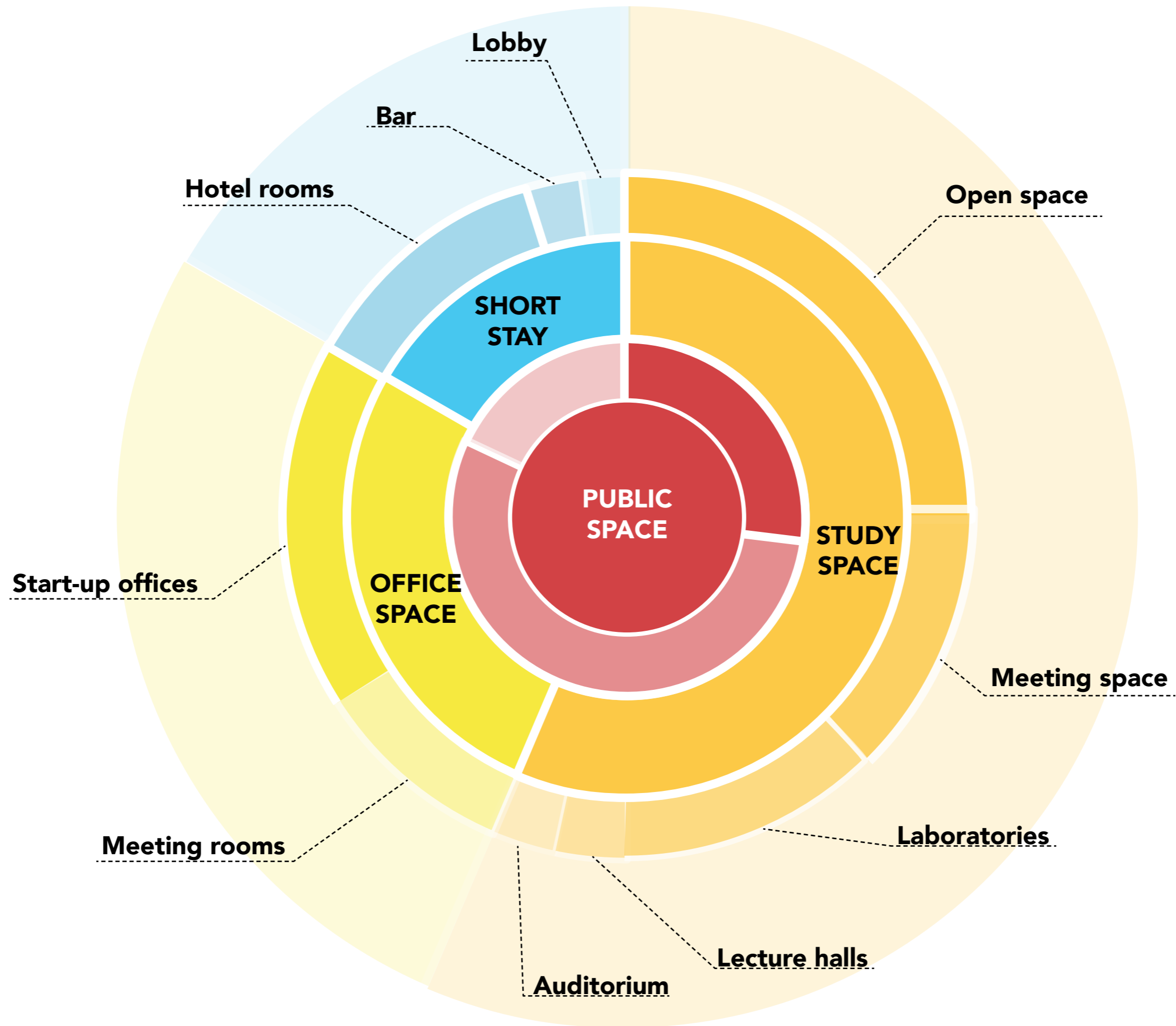

# PROGRAM



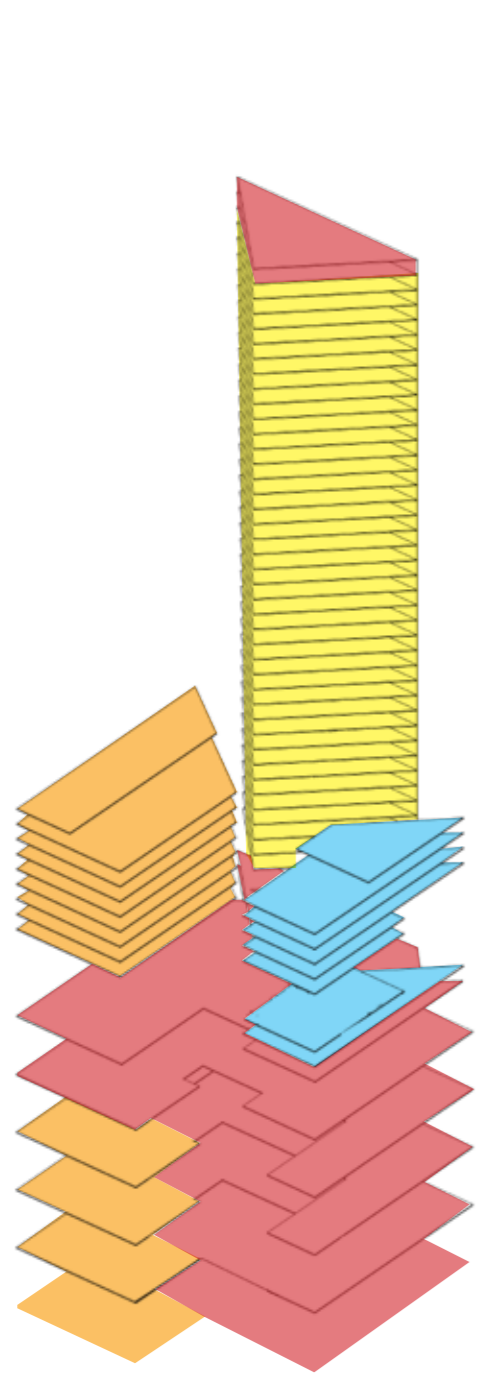

# PROGRAM DISTRIBUTION



-  SHORT-STAY HOTEL
-  OFFICES
-  INNOVATION CENTER
-  PUBLIC SPACE

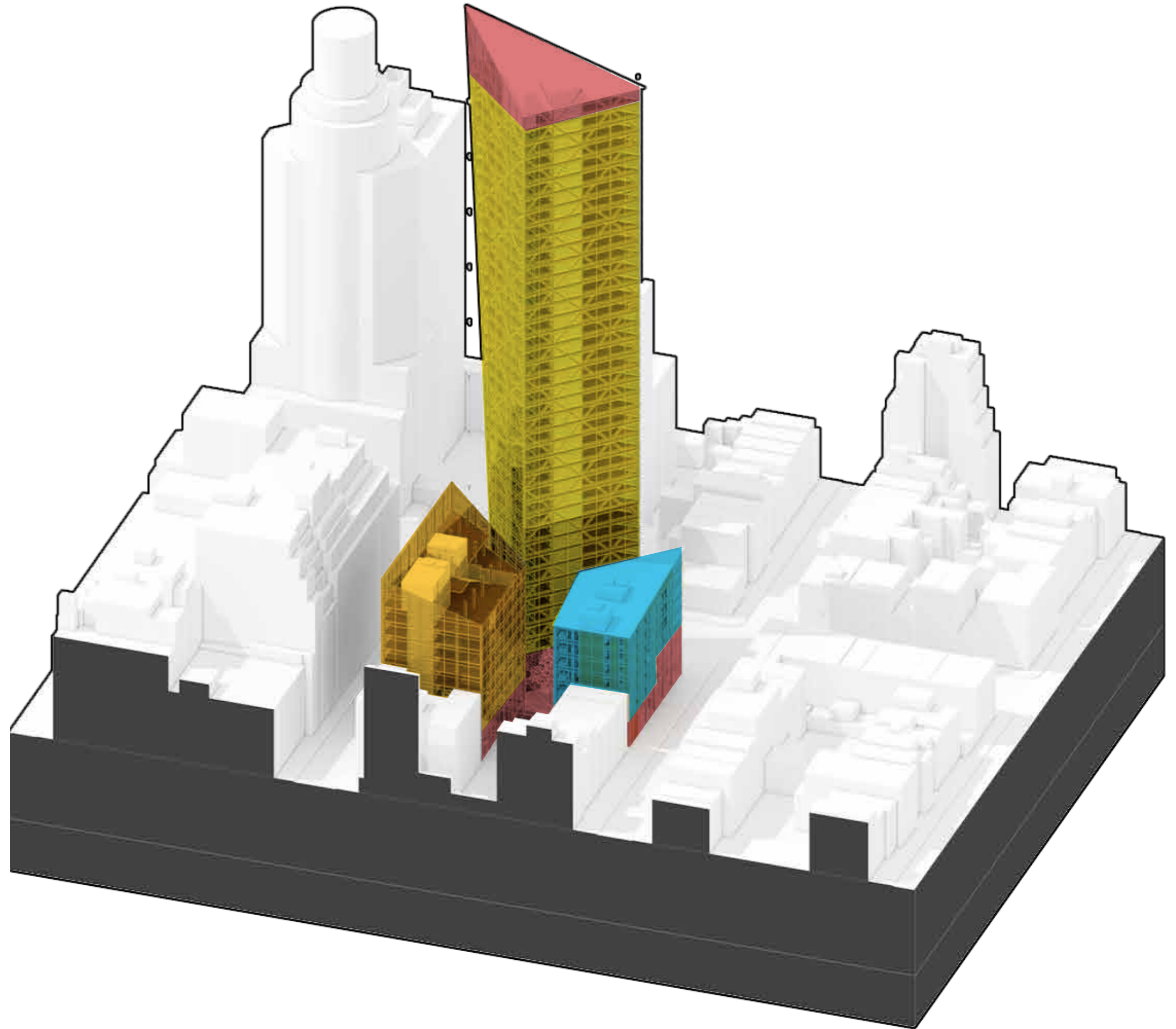



# DESIGN CONCEPT

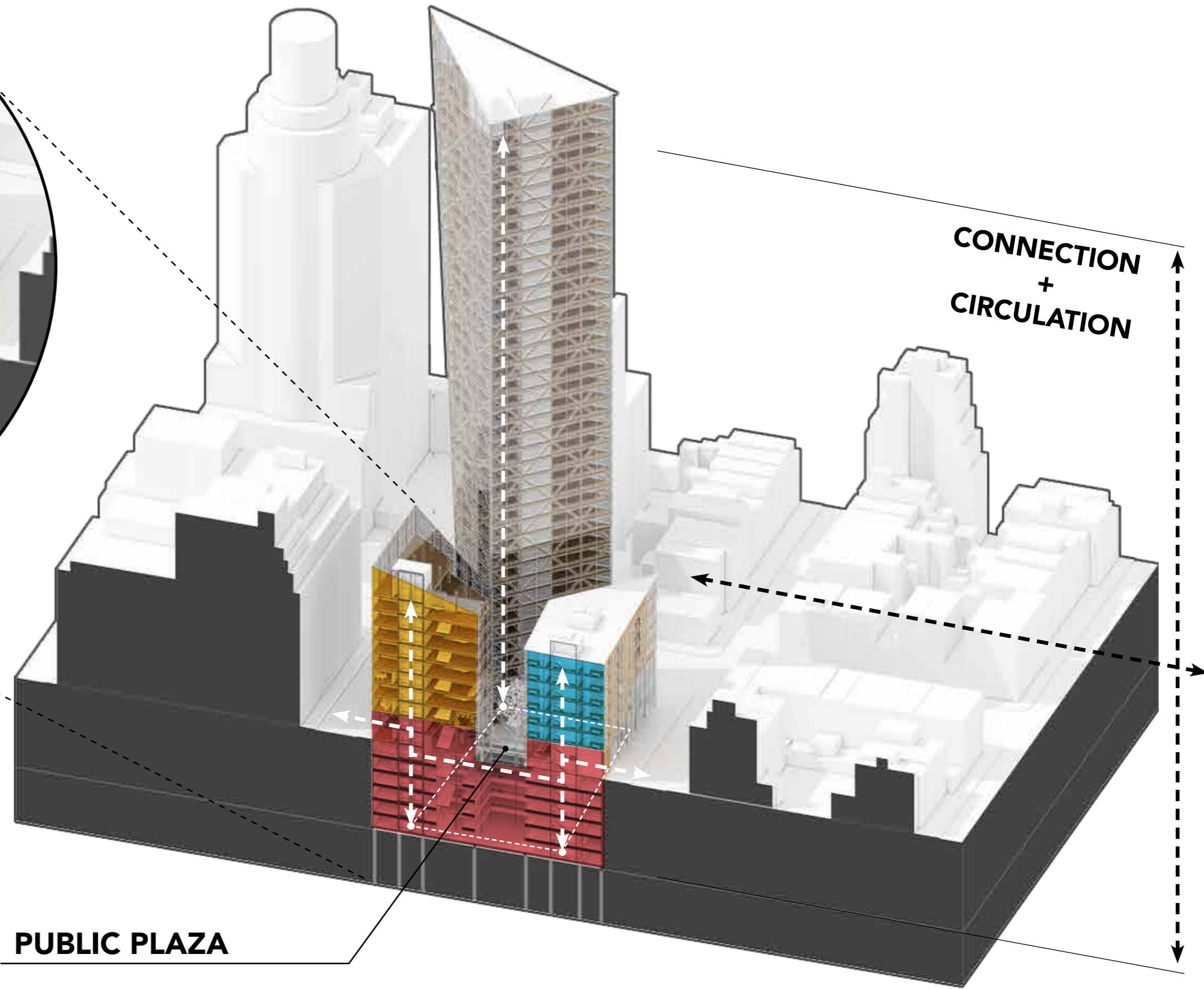
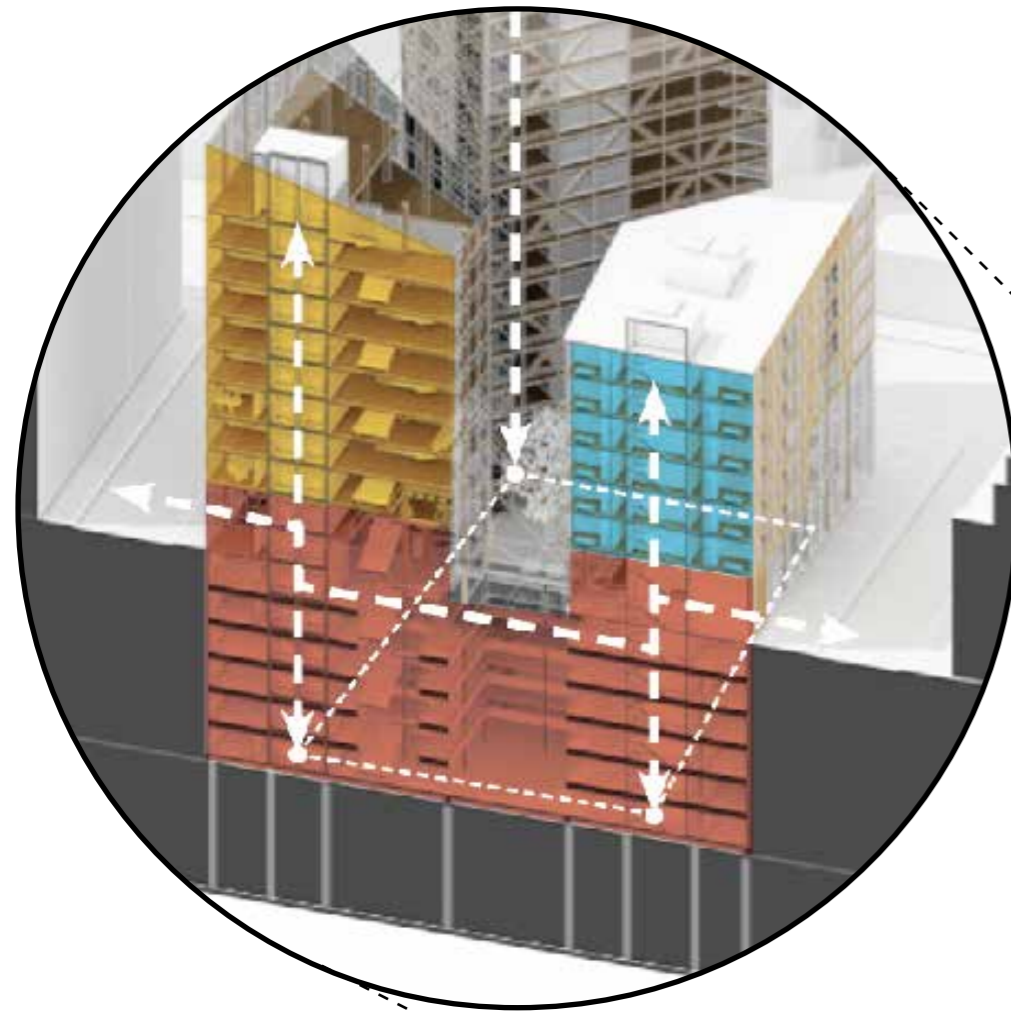

**PUBLIC PLAZA**

**CONNECTION  
+  
CIRCULATION**



# DESIGN CONCEPT

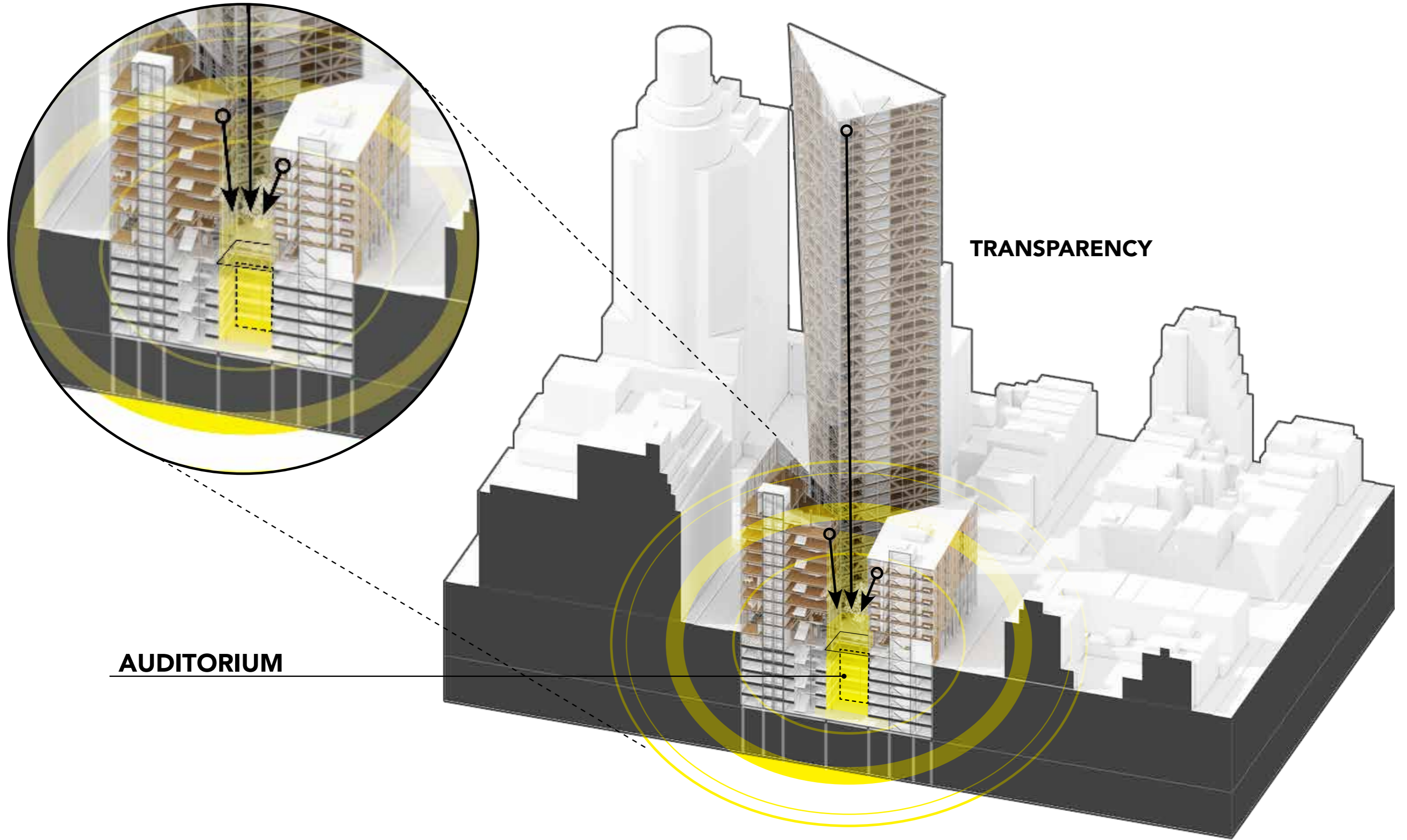







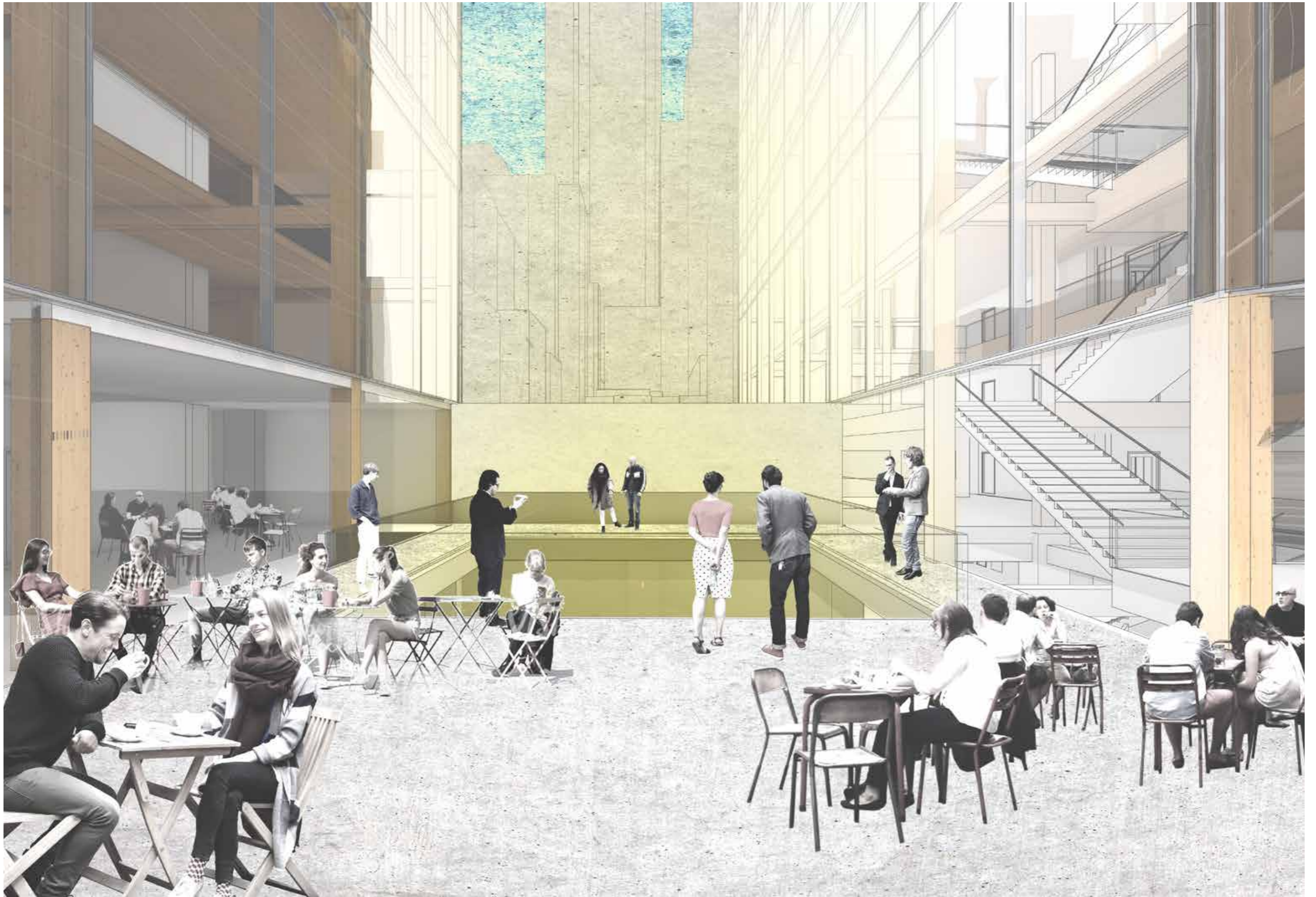











# URBAN IMPLEMENTATION

## GROUND FLOOR

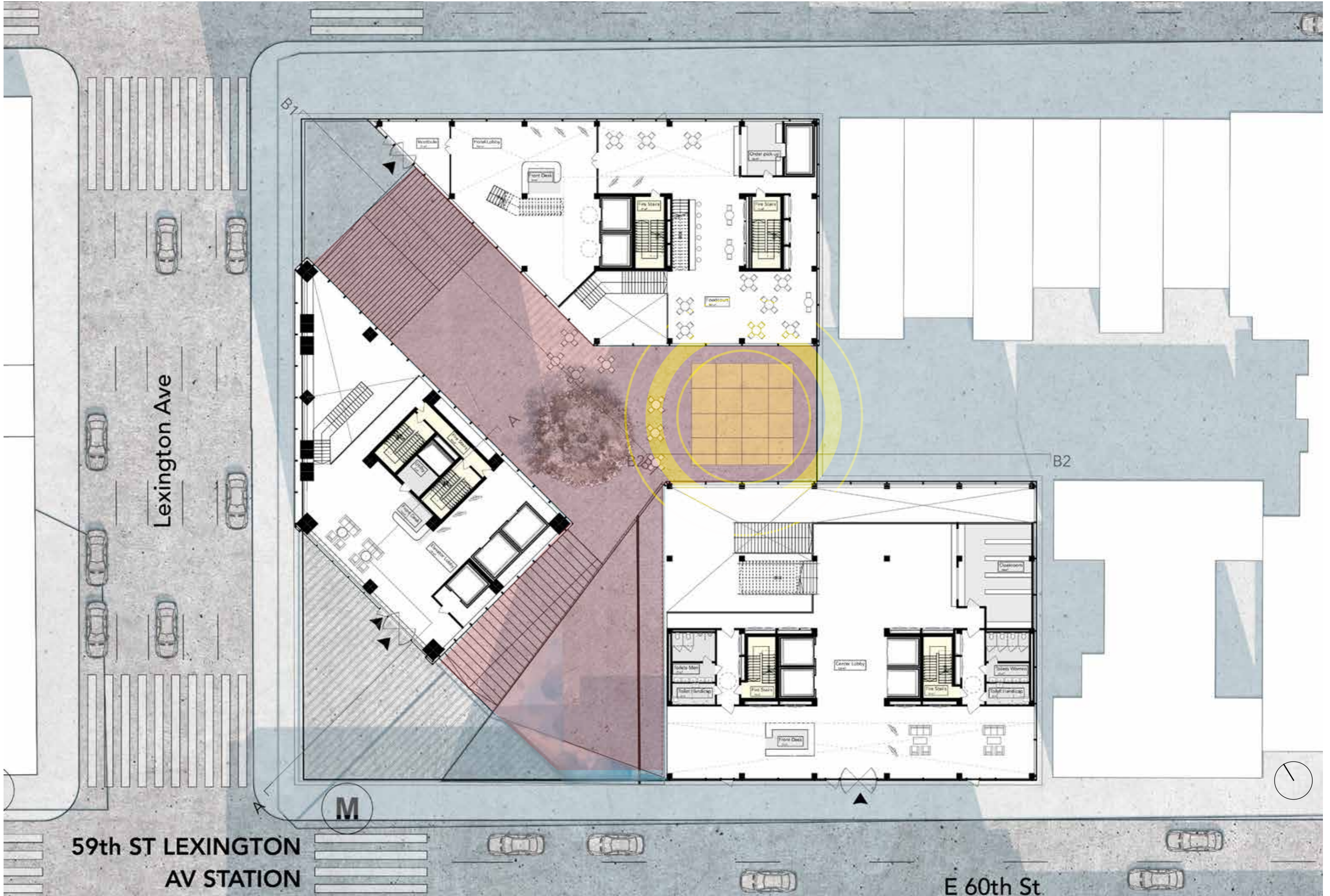



# URBAN IMPLEMENTATION

# GROUND FLOOR

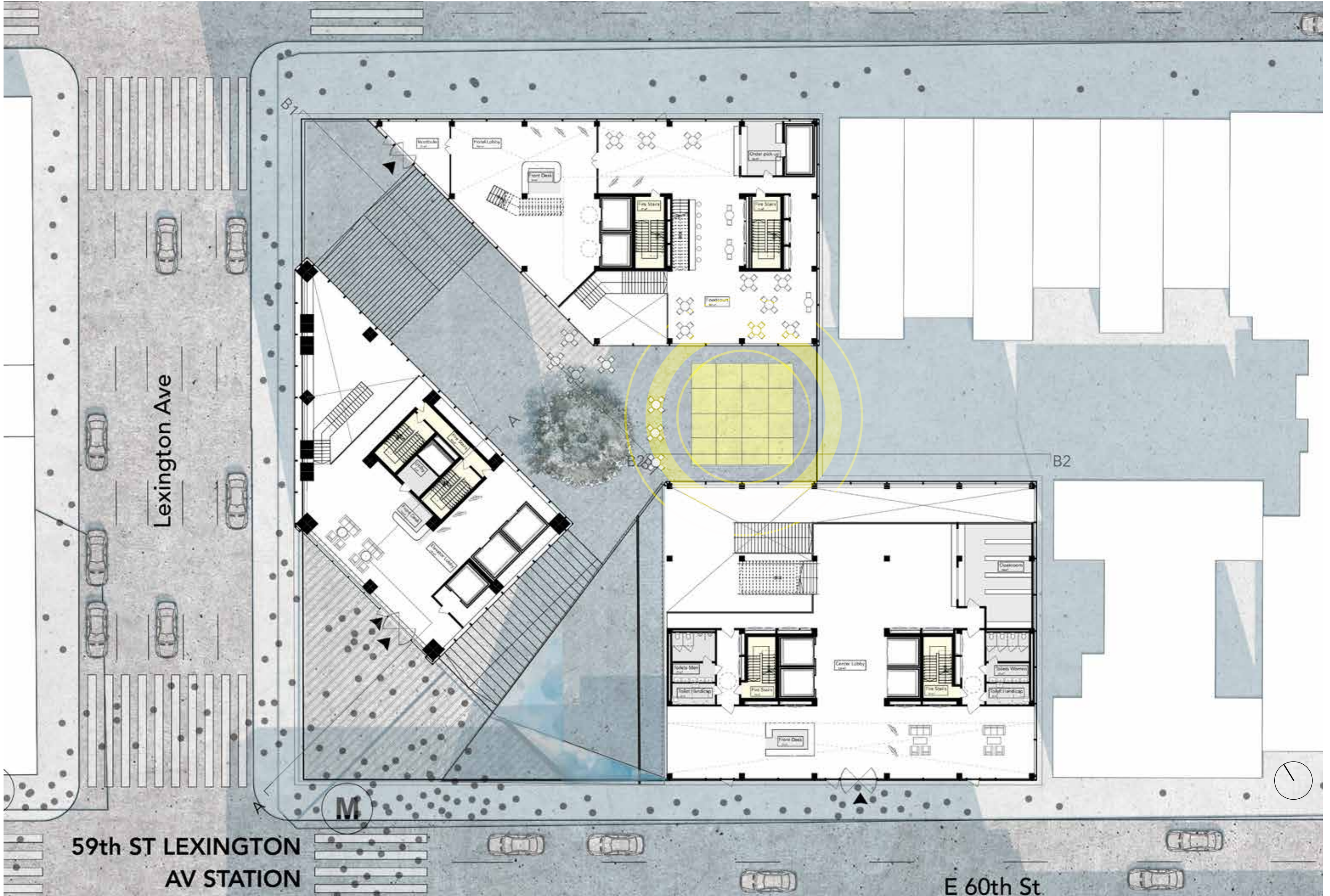







# URBAN IMPLEMENTATION

## PASSER-BY

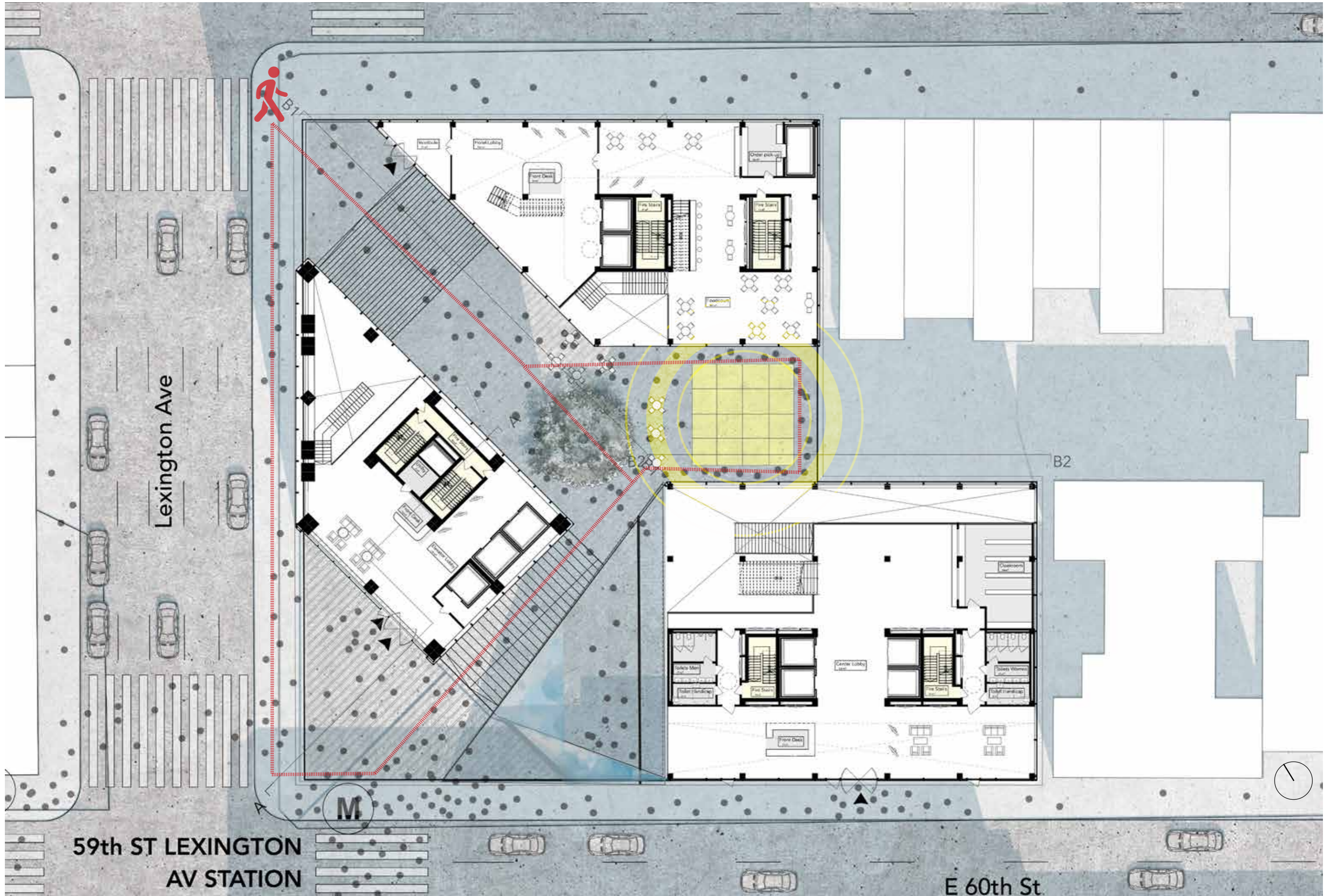



# URBAN IMPLEMENTATION

## HOTEL GUEST

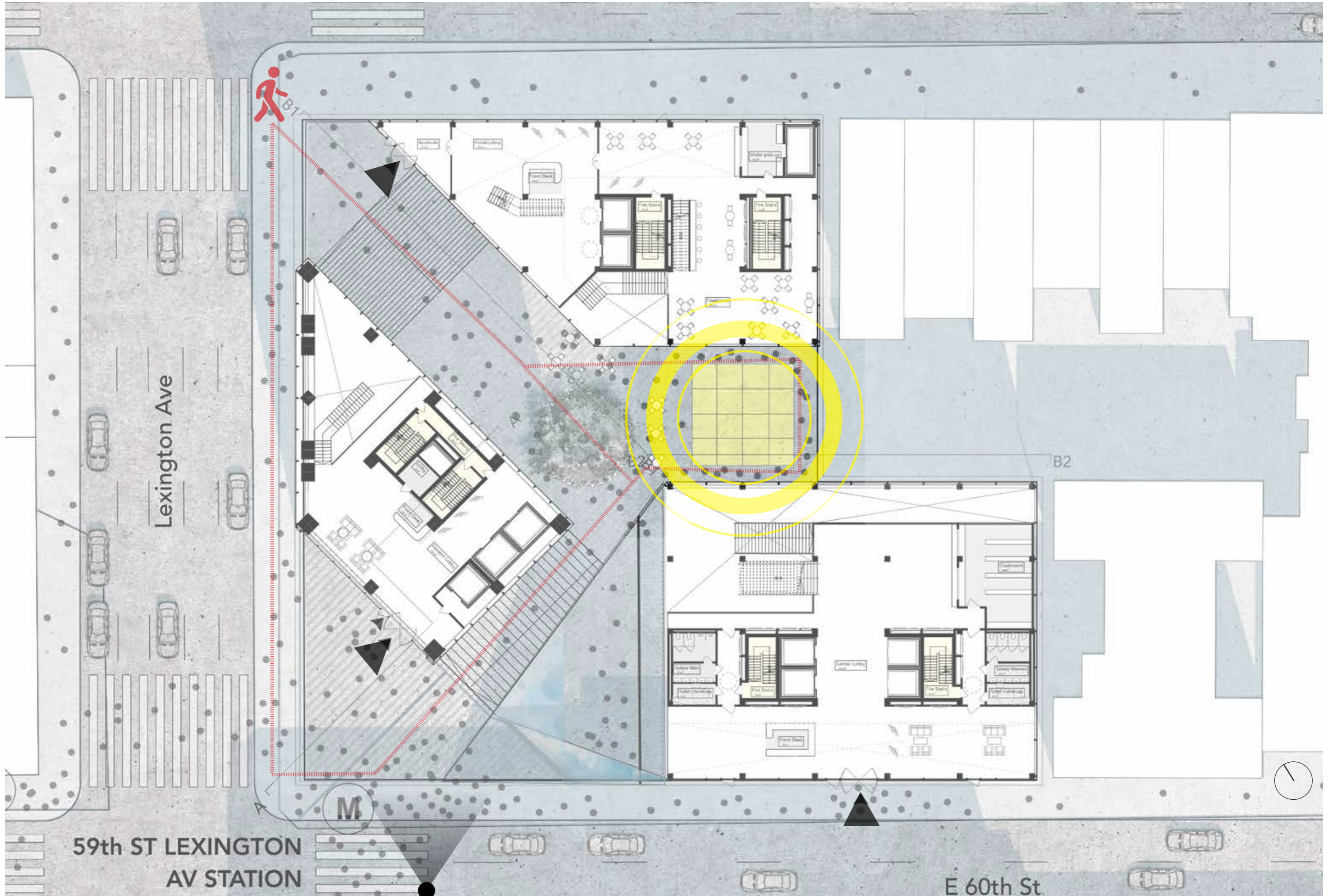



# METRO PLAZA













# URBAN IMPLEMENTATION

## HOTEL GUEST

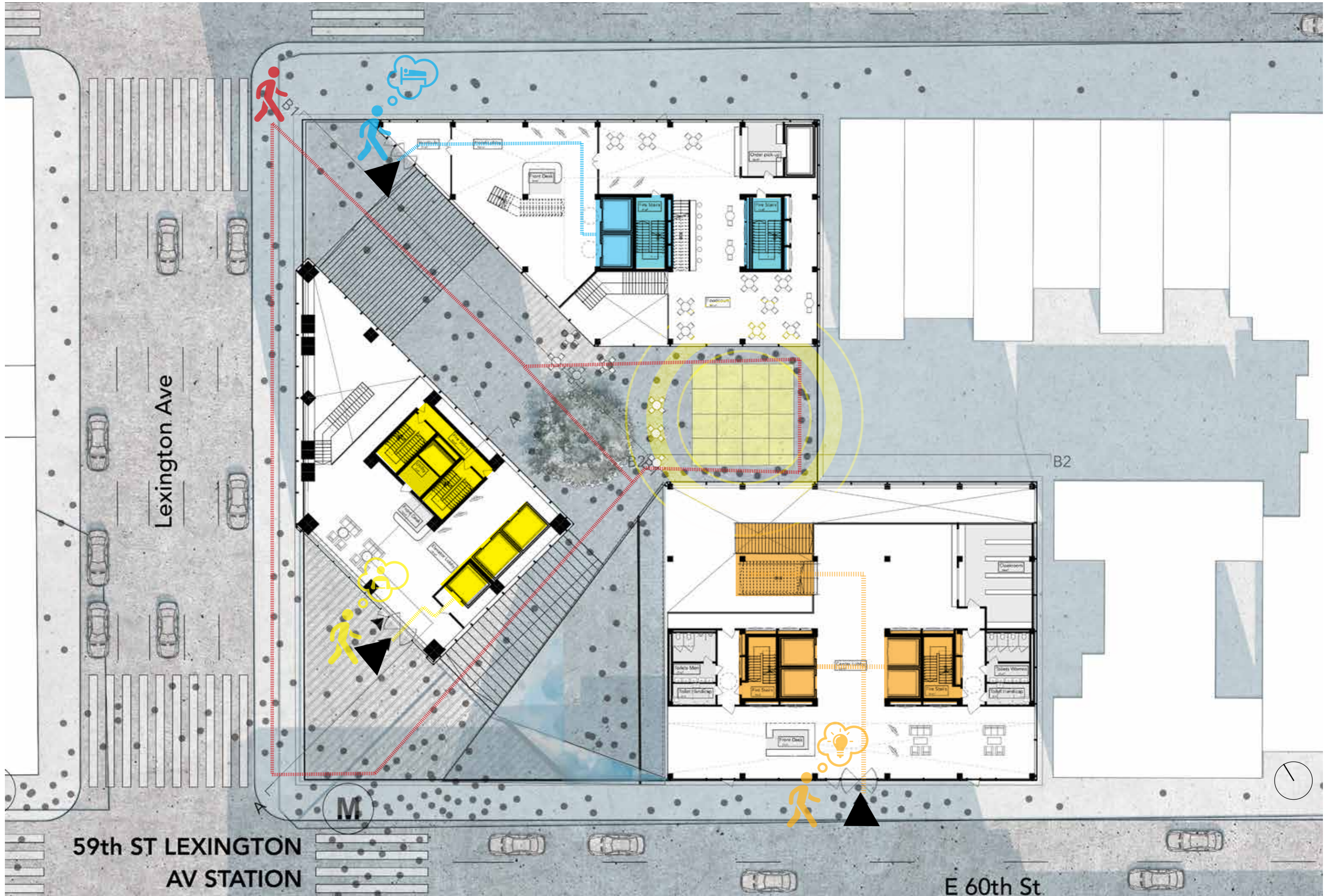



# FLOOR PLAN LEVEL -1

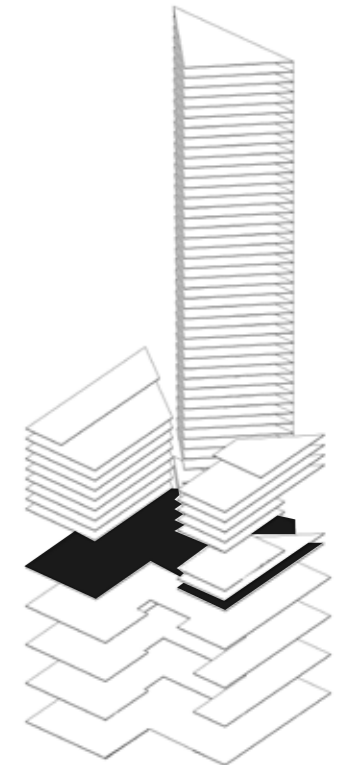

 **LEVEL -1**  
-4,00

- Short-stay**
- Foodcourt
- Kitchen
- Waste
- Cleaning
- Storage
- Cooling
- Storage
- Toilets
- Tower**
- Lobby
- Innovation Center**
- Lobby
- Cloakroom
- Toilets
- Offices
- Staff room



# FLOOR PLAN LEVEL -1

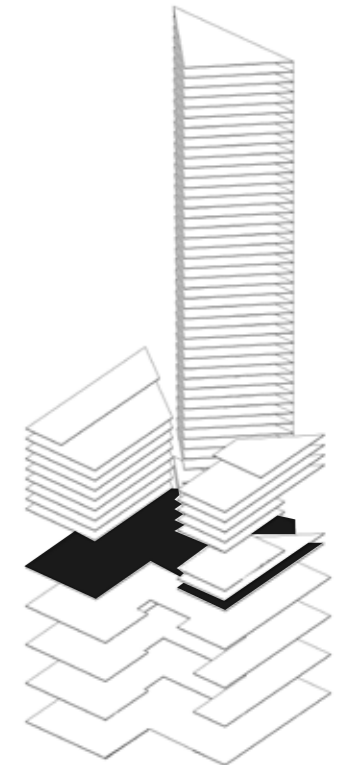
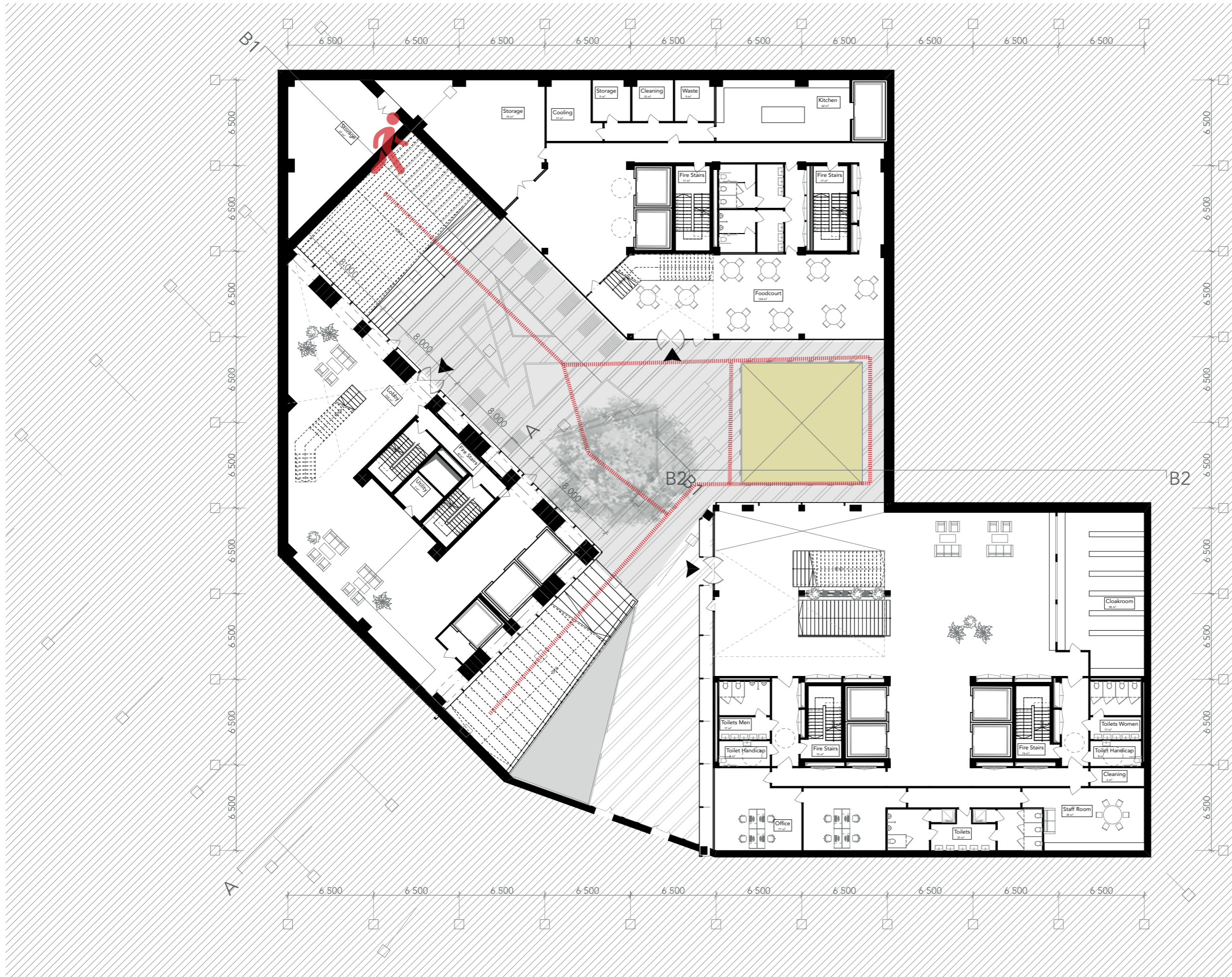

 **LEVEL -1**  
-4,00

- Short-stay**
- Foodcourt
- Kitchen
- Waste
- Cleaning
- Storage
- Cooling
- Storage
- Toilets
- Tower**
- Lobby
- Innovation Center**
- Lobby
- Cloakroom
- Toilets
- Offices
- Staff room



# FLOOR PLAN LEVEL -1

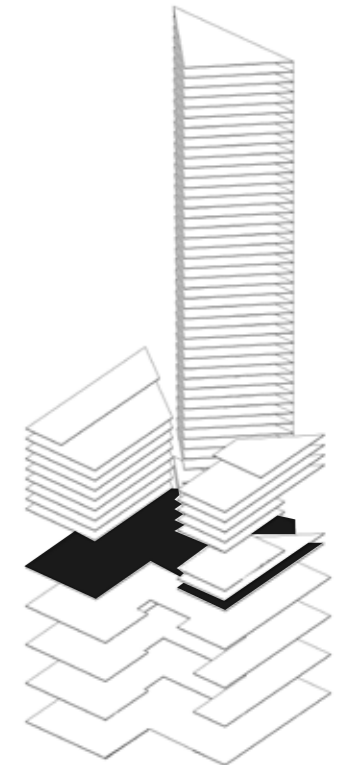

**LEVEL -1**  
 -4,00

- Short-stay**
- Foodcourt
- Kitchen
- Waste
- Cleaning
- Storage
- Cooling
- Storage
- Toilets
- Tower**
- Lobby
- Innovation Center**
- Lobby
- Cloakroom
- Toilets
- Offices
- Staff room



# SUNKEN PLAZA





# FLOOR PLAN LEVEL -1

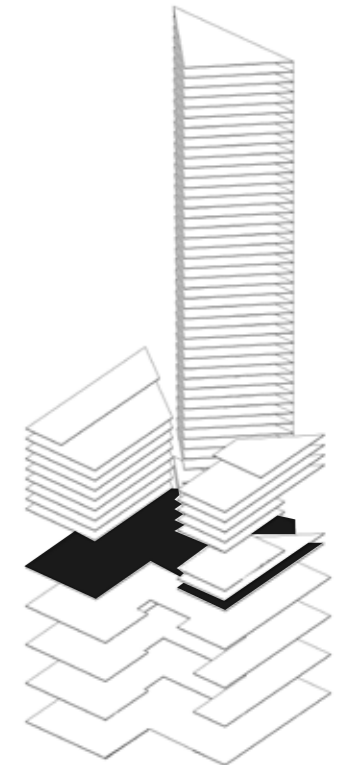
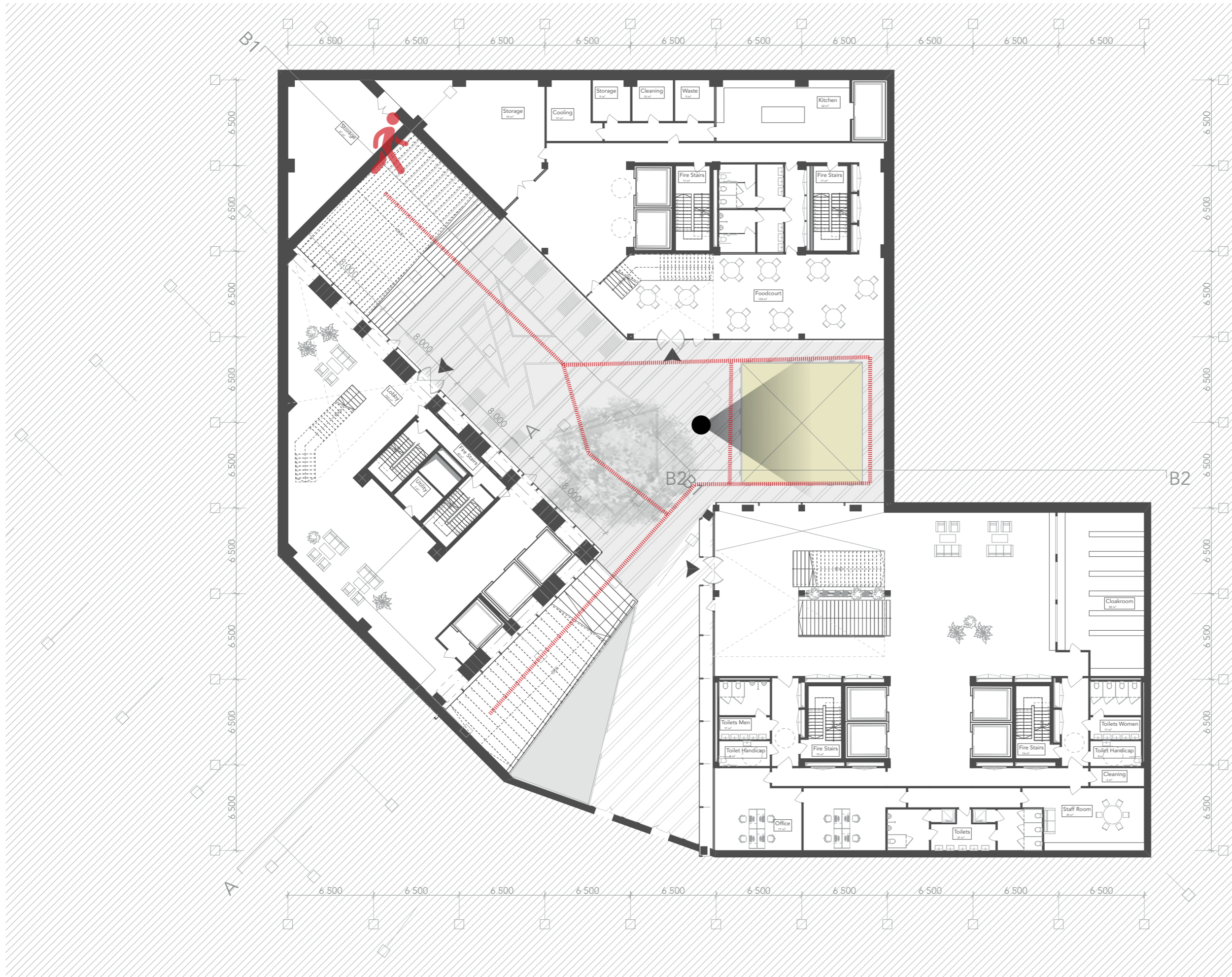

**LEVEL -1**  
 -4,00

- Short-stay**
- Foodcourt
- Kitchen
- Waste
- Cleaning
- Storage
- Cooling
- Storage
- Toilets
- Tower**
- Lobby
- Innovation Center**
- Lobby
- Cloakroom
- Toilets
- Offices
- Staff room



# LIGHT SHAFT





# FLOOR PLAN LEVEL -1

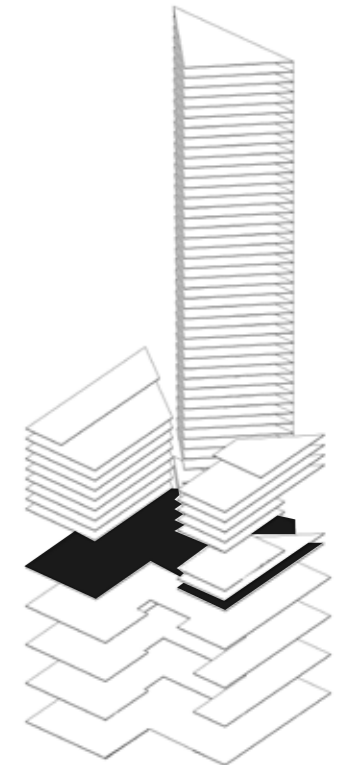



**LEVEL -1**  
 -4,00

- Short-stay**
- Foodcourt
- Kitchen
- Waste
- Cleaning
- Storage
- Cooling
- Storage
- Toilets
- Tower**
- Lobby
- Innovation Center**
- Lobby
- Cloakroom
- Toilets
- Offices
- Staff room

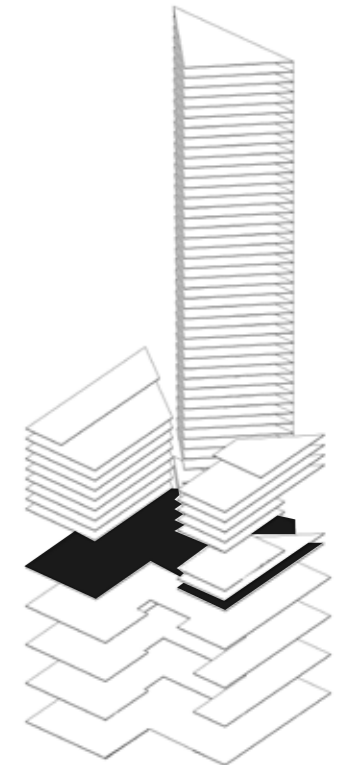
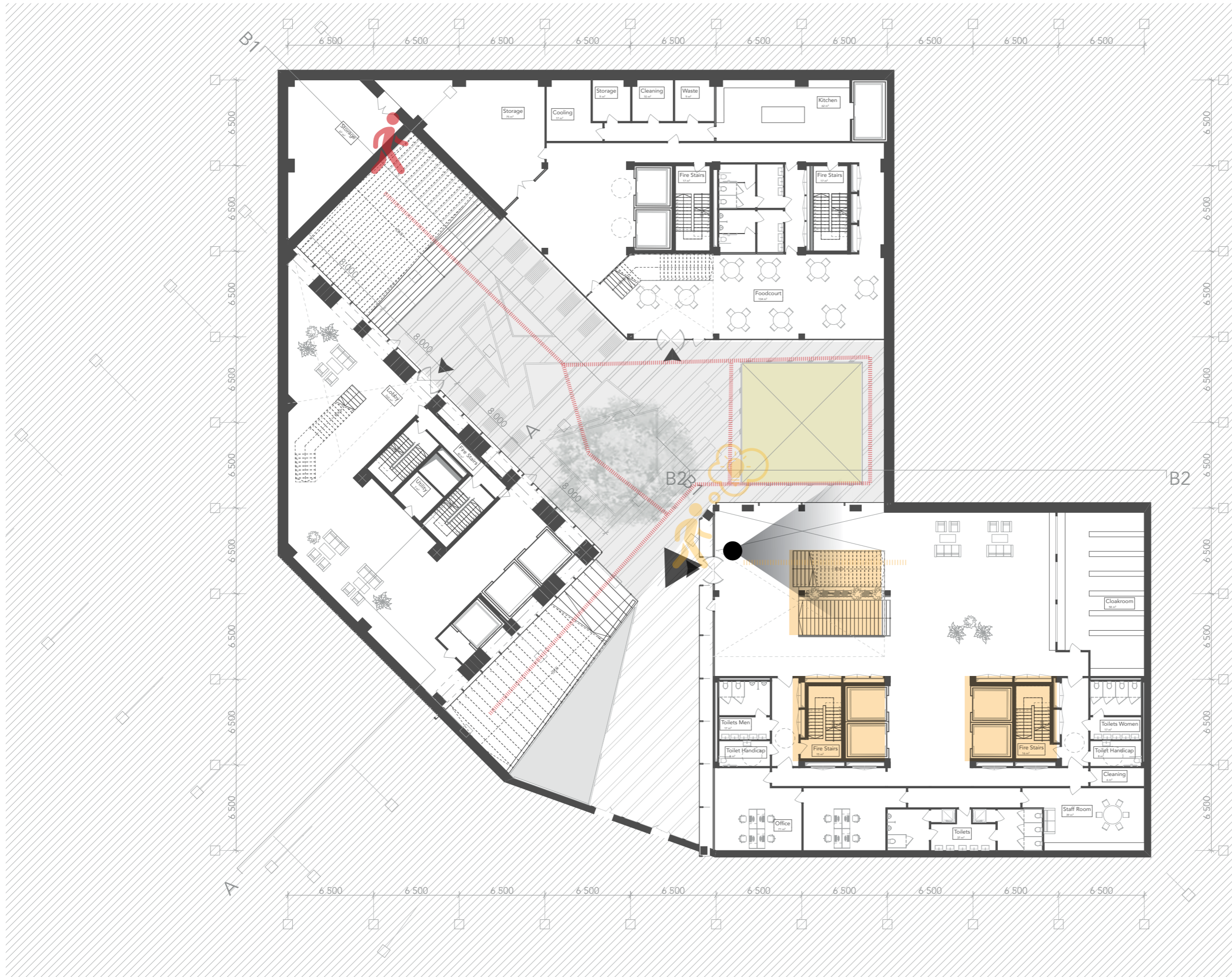

# FLOOR PLAN LEVEL -1



**LEVEL -1**  
 -4,00

- Short-stay**
- Foodcourt
- Kitchen
- Waste
- Cleaning
- Storage
- Cooling
- Storage
- Toilets
- Tower**
- Lobby
- Innovation Center**
- Lobby
- Cloakroom
- Toilets
- Offices
- Staff room



# INNOVATION CENTER





# FLOOR PLAN LEVEL -1

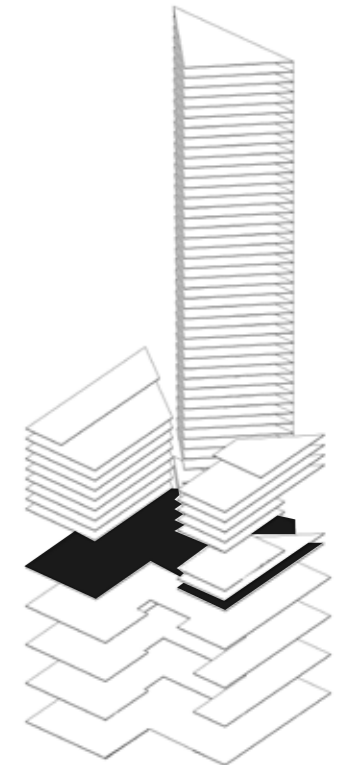

**LEVEL -1**  
-4,00

- Short-stay**
- Foodcourt
- Kitchen
- Waste
- Cleaning
- Storage
- Cooling
- Storage
- Toilets
- Tower**
- Lobby
- Innovation Center**
- Lobby
- Cloakroom
- Toilets
- Offices
- Staff room



# FLOOR PLAN LEVEL -1





# FLOOR PLAN

## LEVEL -2

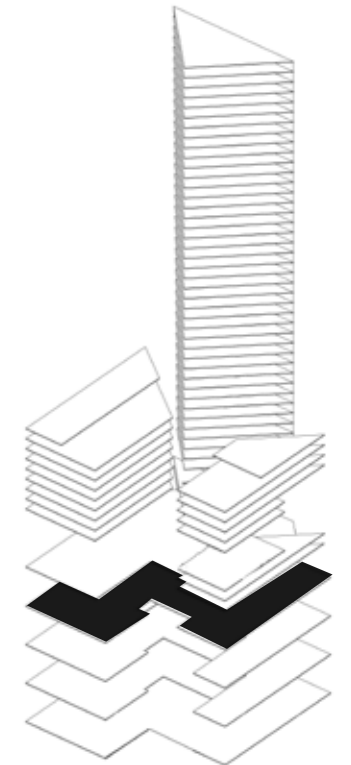

 **LEVEL -2**  
-8,00

**Short-stay**  
Mechanical  
Storage  
Toilets

**Tower**  
Storage

**Innovation Center**  
Mechanical  
Storage  
Toilets

Top balcony  
Circulation



# FLOOR PLAN

LEVEL -2

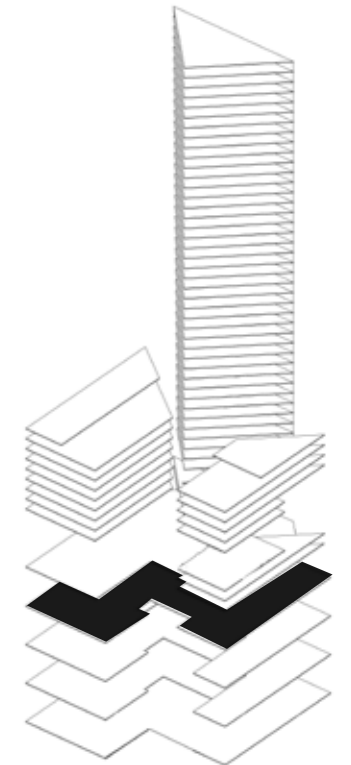

**LEVEL -2**  
-8,00

**Short-stay**  
Mechanical  
Storage  
Toilets

**Tower**  
Storage

**Innovation Center**  
Mechanical  
Storage  
Toilets

Top balcony  
Circulation



# FLOOR PLAN

## LEVEL -3

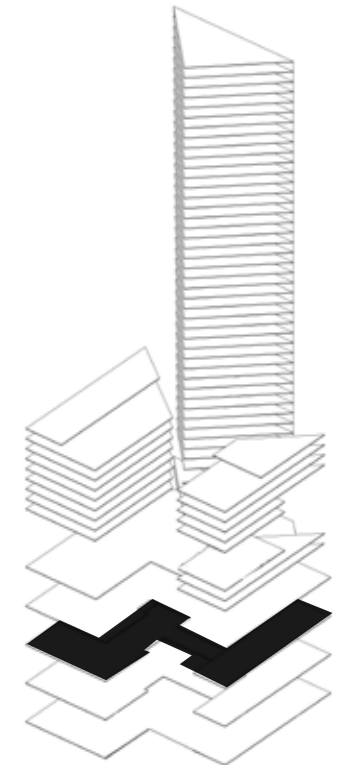

 **LEVEL -3**  
-12,00

**Short-stay**  
Mechanical  
Storage  
Toilets

**Tower**  
Storage

**Innovation Center**  
Classrooms  
Mechanical  
Storage  
Toilets

Lower balcony  
Circulation



# FLOOR PLAN

LEVEL -3

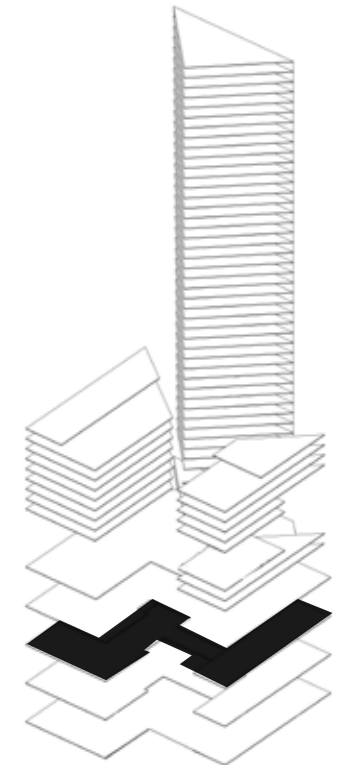
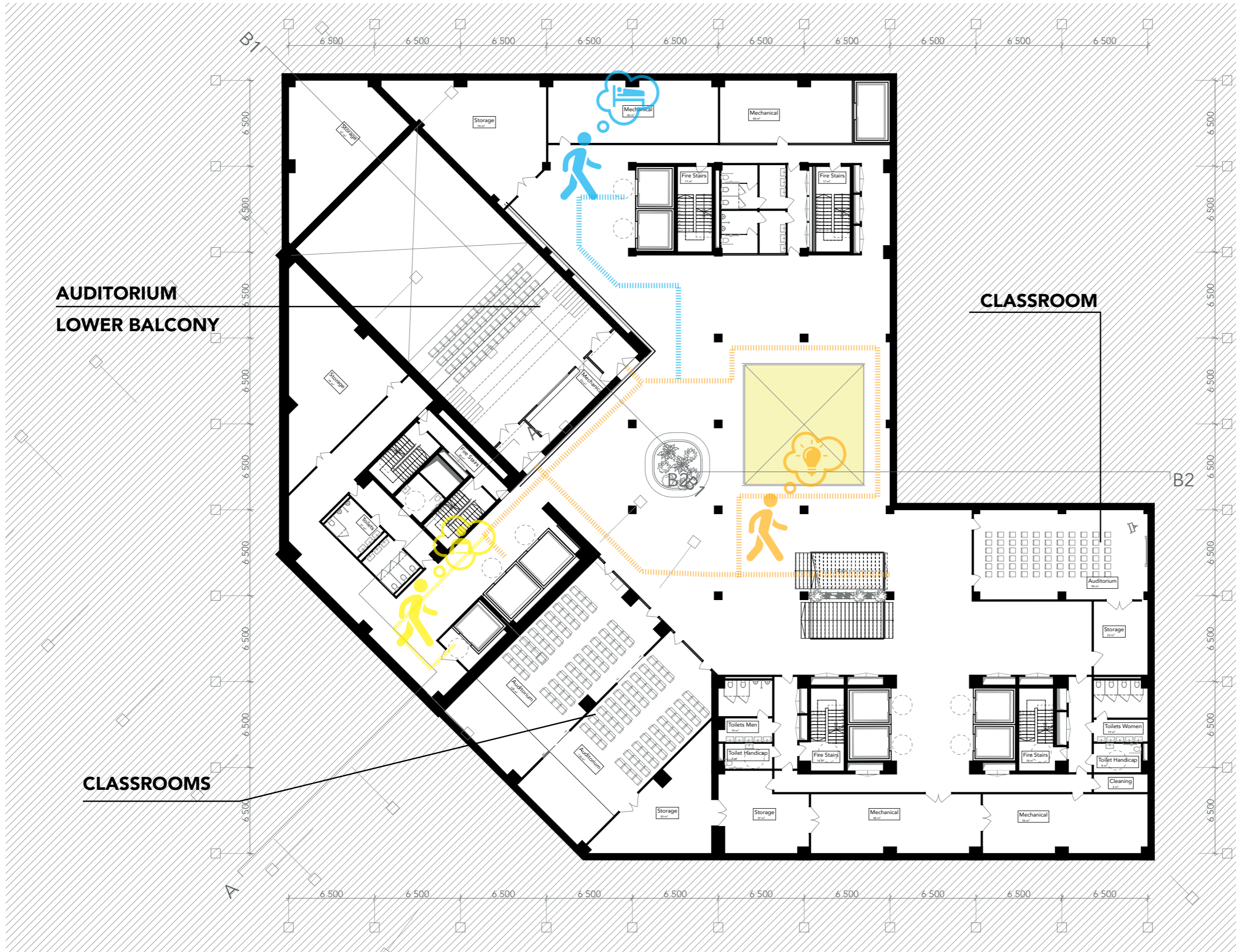

**LEVEL -3**  
-12,00

**Short-stay**  
Mechanical  
Storage  
Toilets

**Tower**  
Storage

**Innovation Center**  
Classrooms  
Mechanical  
Storage  
Toilets

**Lower balcony**  
Circulation



# FLOOR PLAN

## LEVEL -4

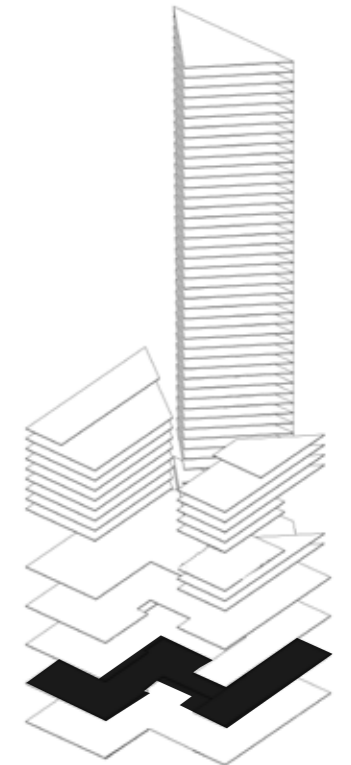

 **LEVEL -4**  
-16,00

**Short-stay**  
Mechanical  
Storage  
Toilets

**Tower**

**Innovation Center**  
Mechanical  
Storage  
Toilets

Main seating  
Circulation



# FLOOR PLAN

LEVEL -4





# FLOOR PLAN

LEVEL -5

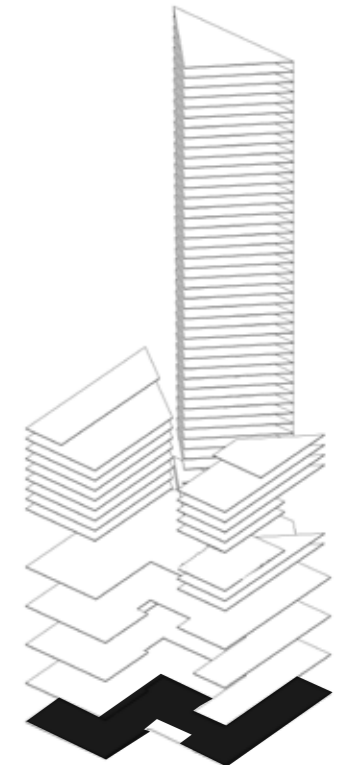

**LEVEL -5**  
-20,00

- Short-stay Kitchen**
- Cleaning
- Cooling
- Waste
- Toilets**
- Dressing room
- Bar
- Waste
- Cooling
- Storage
- Backstage
- Innovation Center**
- Classrooms
- Mechanical
- Storage
- Toilets
- Main seating
- Circulation



# FLOOR PLAN

LEVEL -5

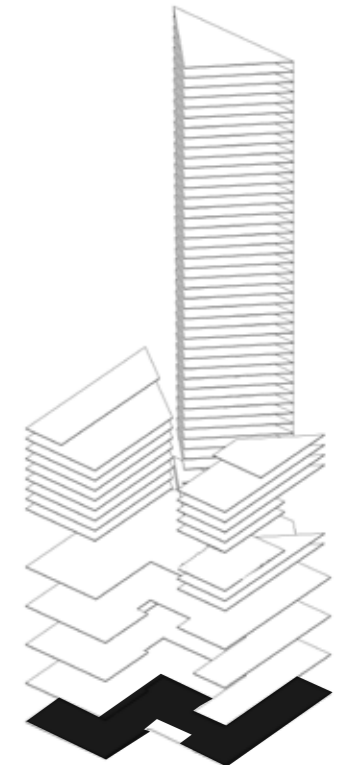

**LEVEL -5**  
-20,00

- Short-stay Kitchen**
  - Cleaning
  - Cooling
  - Waste
- Toilets**
  - Dressing room
  - Bar
- Innovation Center**
  - Classrooms
  - Mechanical
  - Storage
  - Toilets
- Main seating**
  - Circulation



# FLOOR PLAN

LEVEL -5

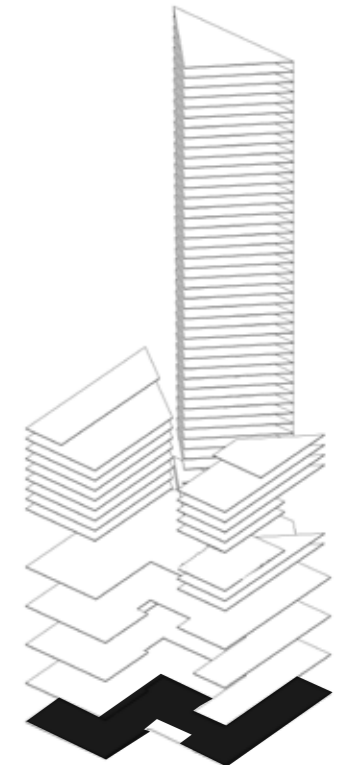

**LEVEL -5**  
-20,00

- Short-stay**
- Kitchen
  - Cleaning
  - Cooling
  - Waste
- Toilets
- Dressing room
- Bar
  - Waste
  - Cooling
  - Storage
- Backstage
- Innovation Center**
- Classrooms
- Mechanical
- Storage
- Toilets
- Main seating
- Circulation



# AUDITORIUM ENTRANCE













# START-UP TOWER ENTRANCE





# FLOOR PLAN LEVEL 1

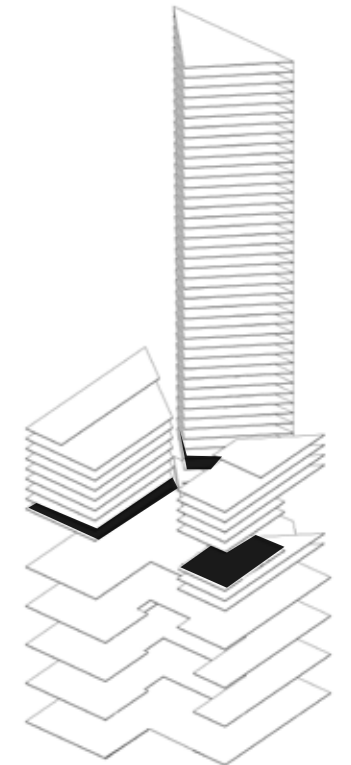
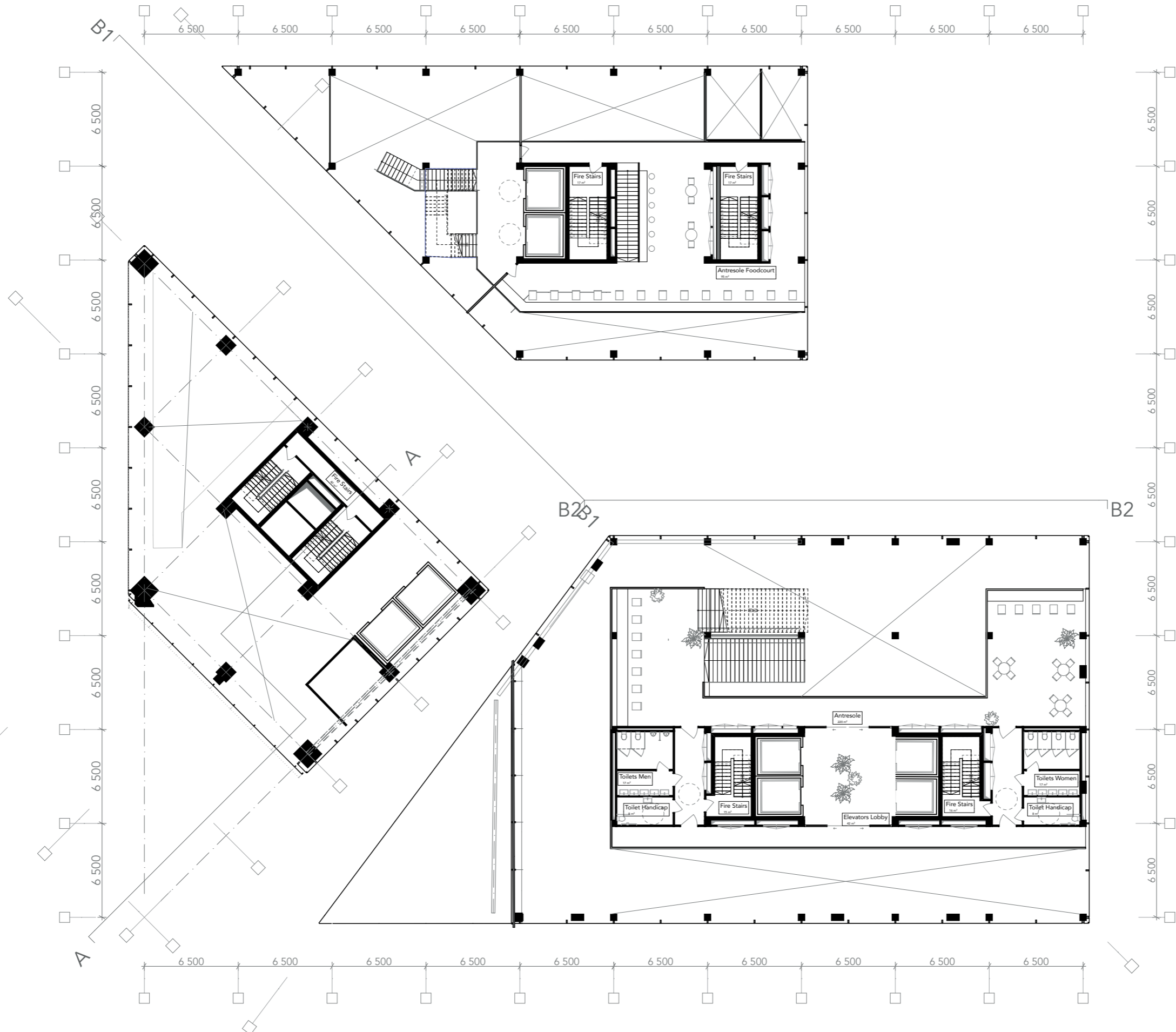

**LEVEL 1**  
+ 4,00

**Short-stay**  
Food Entresol

**Innovation Center**  
Open space



# FLOOR PLAN LEVEL 1

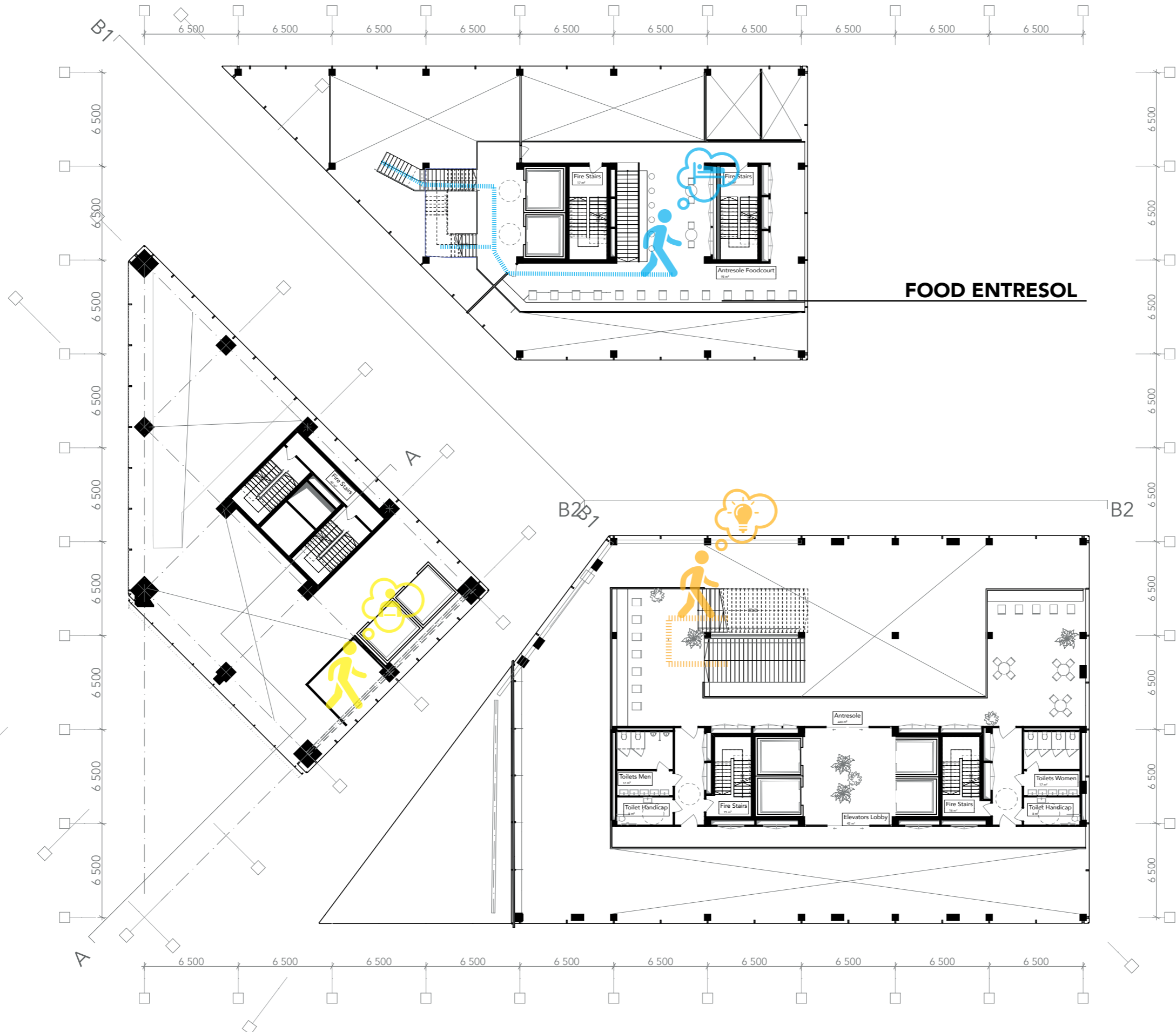

**FOOD ENTRESOL**

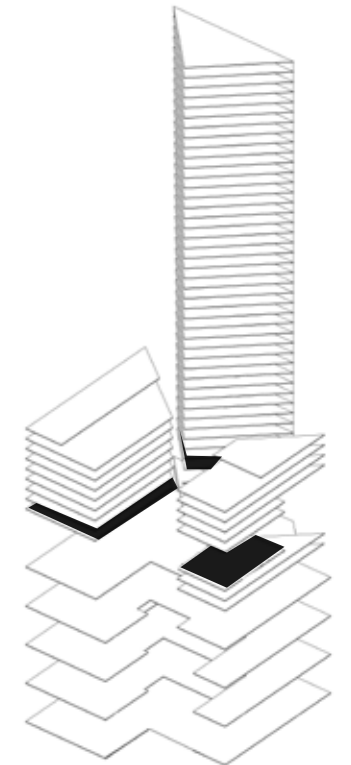

**LEVEL 1**  
+ 4,00

**Short-stay**  
Food Entresol

**Innovation Center**  
Open space



# FLOOR PLAN

## LEVEL 2 - TYPICAL FLOOR

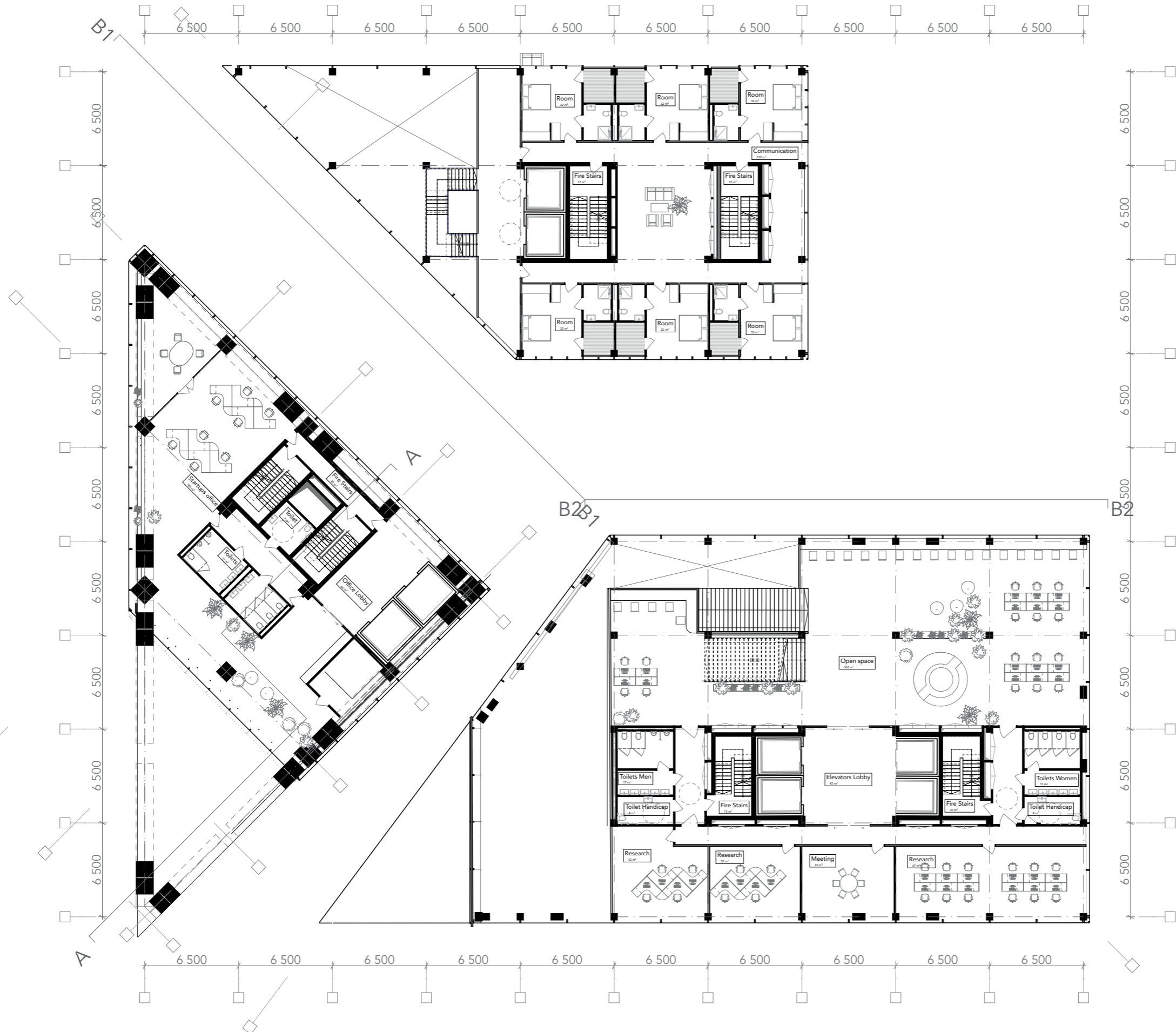

**LEVEL 2**  
+ 8,00

**Short-stay**  
Rooms  
Circulation

**Tower**  
Start-up office  
Toilets

**Innovation Center**  
Co-work space  
Research  
Meeting  
Study  
Toilets



# FLOOR PLAN

## LEVEL 2 - TYPICAL FLOOR

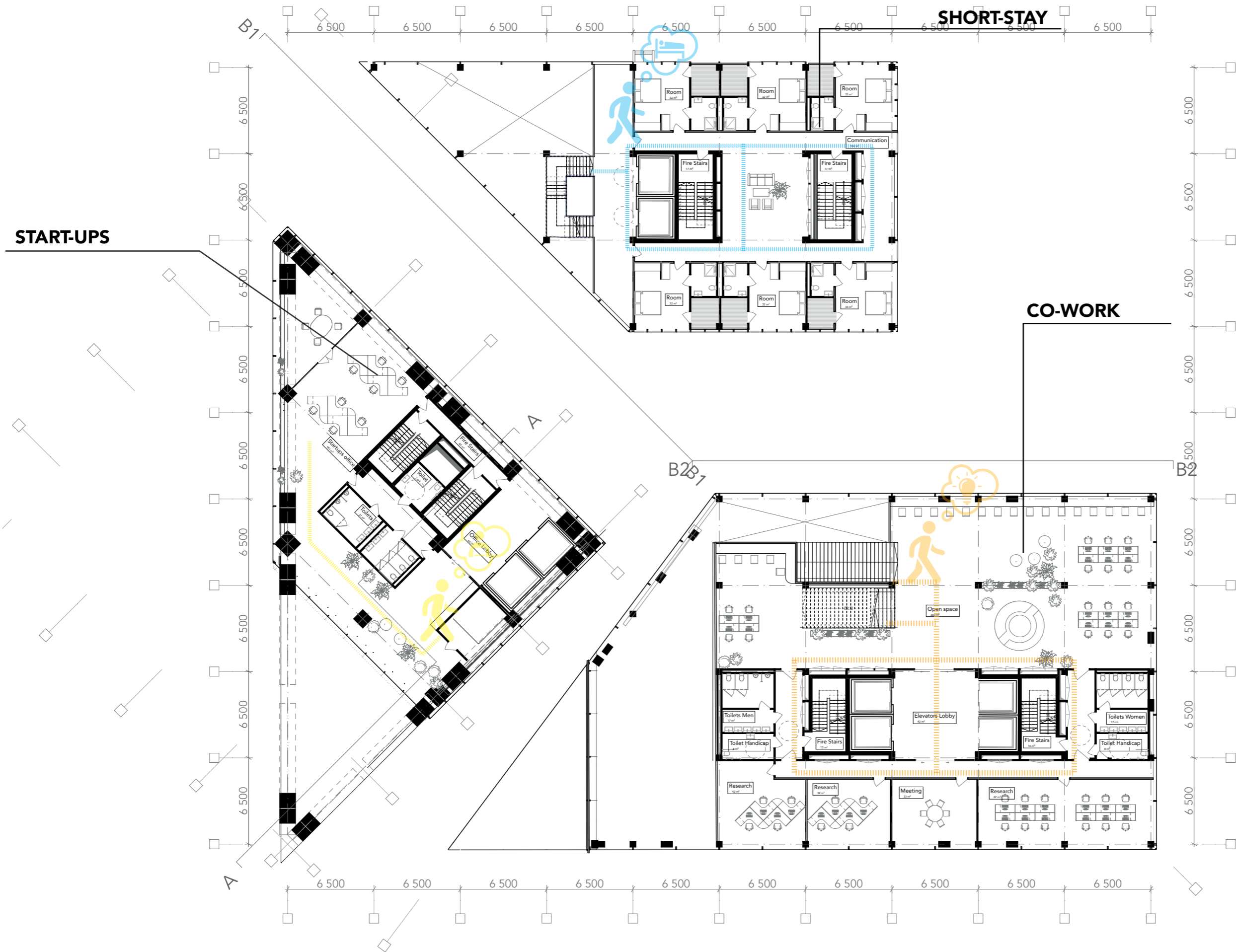

**LEVEL 2**  
+ 8,00

- Short-stay**  
Rooms  
Circulation
- Tower**  
Start-up office  
Toilets
- Innovation Center**  
Co-work space  
Research  
Meeting  
Study  
Toilets



# FLOOR PLAN

## LEVEL 2 - TYPICAL FLOOR

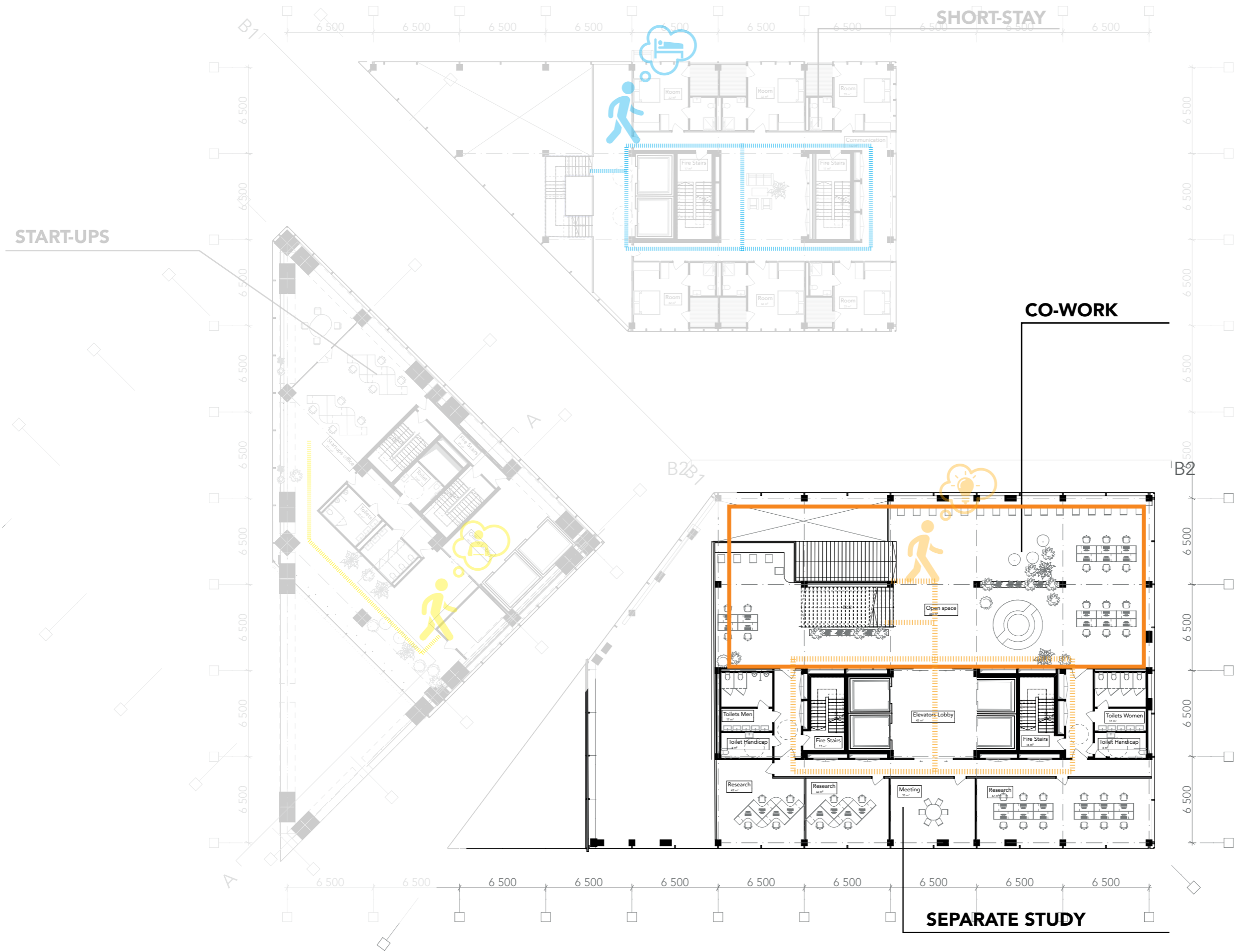

**LEVEL 2**  
+ 8,00

- Short-stay**  
Rooms  
Circulation
- Tower**  
Start-up office  
Toilets
- Innovation Center**  
Co-work space  
Research  
Meeting  
Study  
Toilets



# FLOOR PLAN

## LEVEL 2 - TYPICAL FLOOR

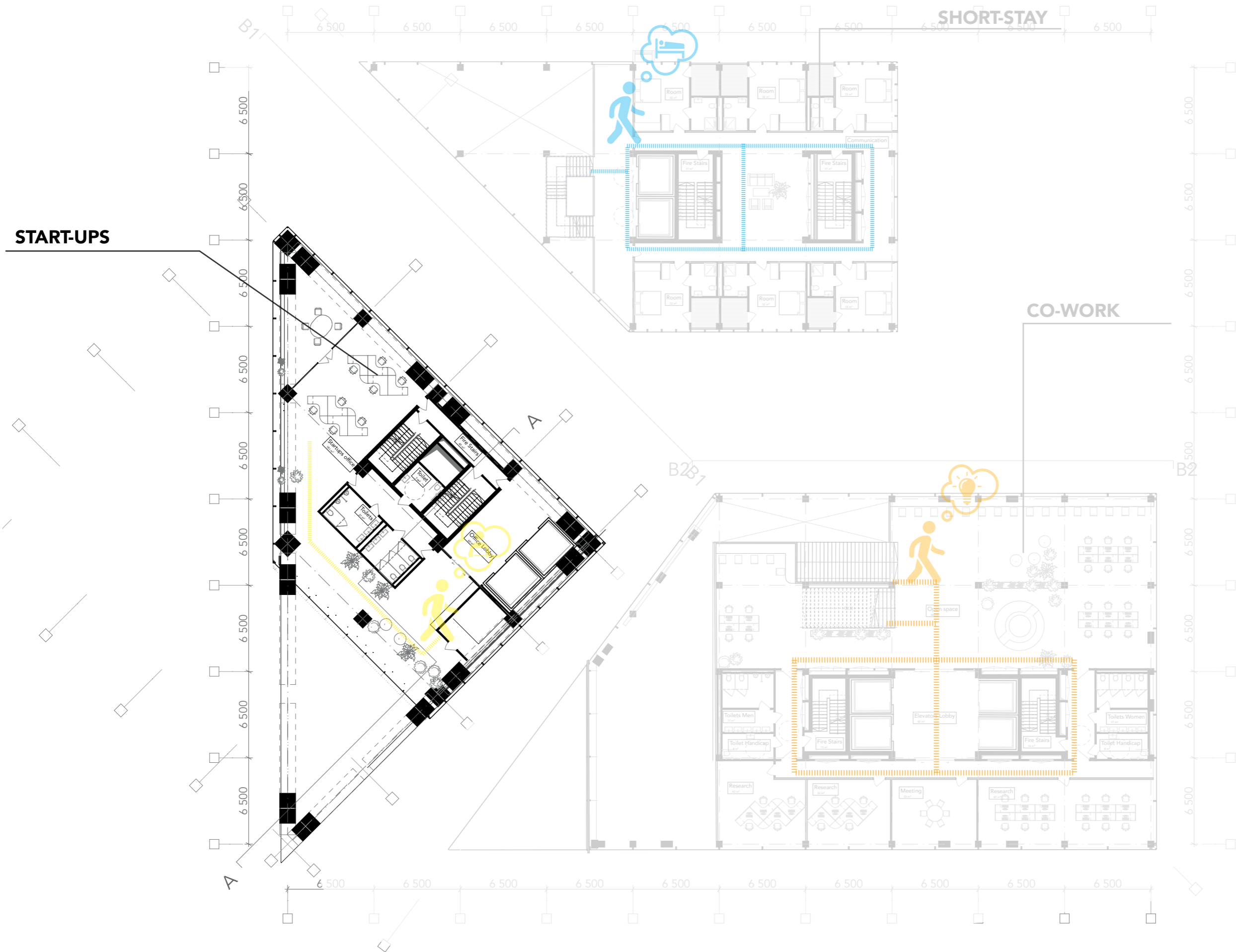

 **LEVEL 2**  
+ 8,00

**Short-stay**  
Rooms  
Circulation

**Tower**  
Start-up office  
Toilets

**Innovation Center**  
Co-work space  
Research  
Meeting  
Study  
Toilets



# FLOOR PLAN

## LEVEL 4 - TYPICAL FLOOR

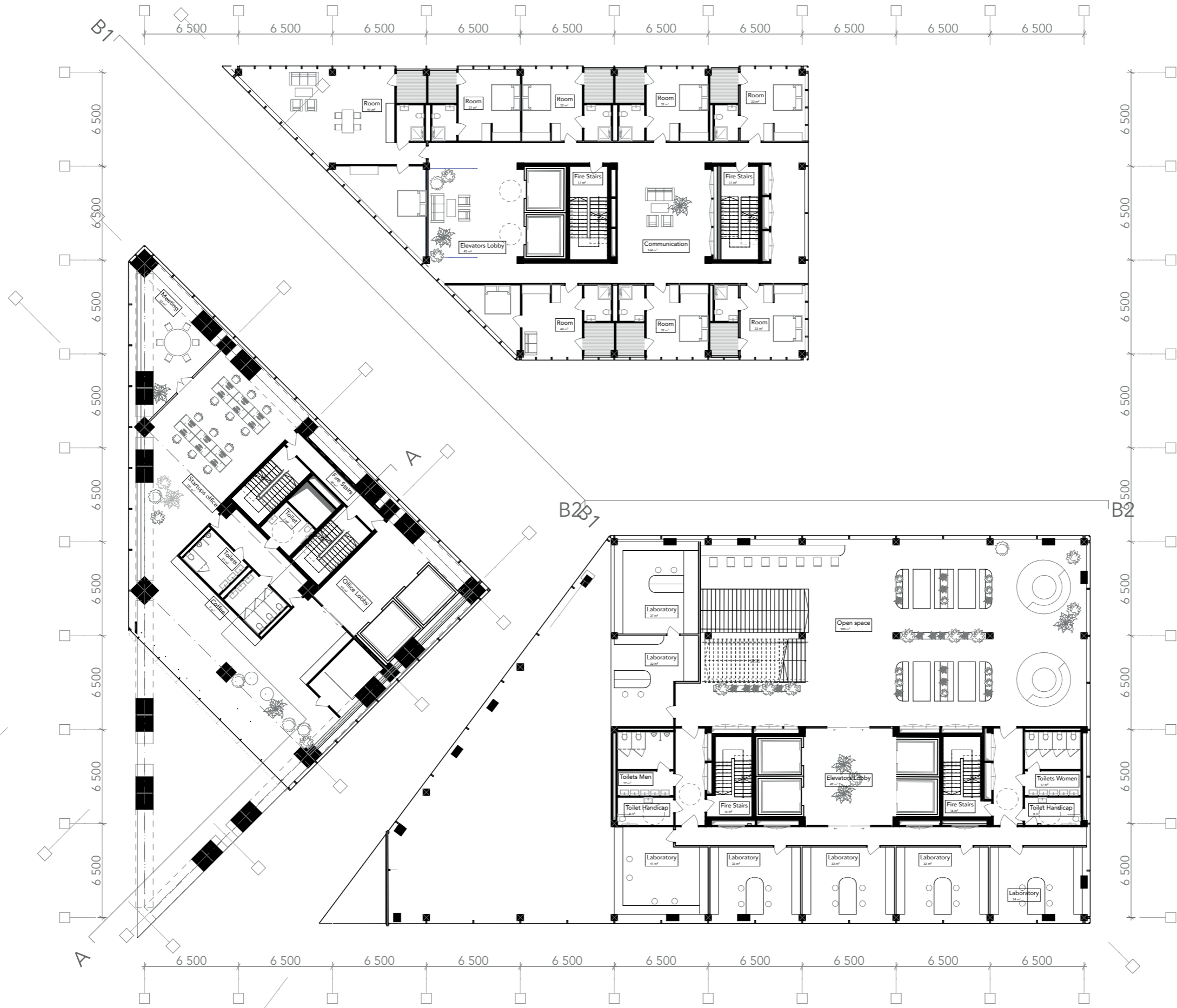

**LEVEL 4**  
+ 16,00

- Short-stay**  
Rooms  
Circulation
- Tower**  
Start-up office  
Toilets
- Innovation Center**  
Co-work space  
Laboratories  
Toilets



# FLOOR PLAN

## LEVEL 4 - TYPICAL FLOOR



**LEVEL 4**  
+ 16,00

- Short-stay**  
Rooms  
Circulation
- Tower**  
Start-up office  
Toilets
- Innovation Center**  
Co-work space  
Laboratories  
Toilets



# FLOOR PLAN

## LEVEL 4 - TYPICAL FLOOR



**LEVEL 4**  
+ 16,00

- Short-stay**  
Rooms  
Circulation
- Tower**  
Start-up office  
Toilets
- Innovation Center**  
Co-work space  
Laboratories  
Toilets



# START-UP OFFICE





# FLOOR PLANS AXONOMETRY

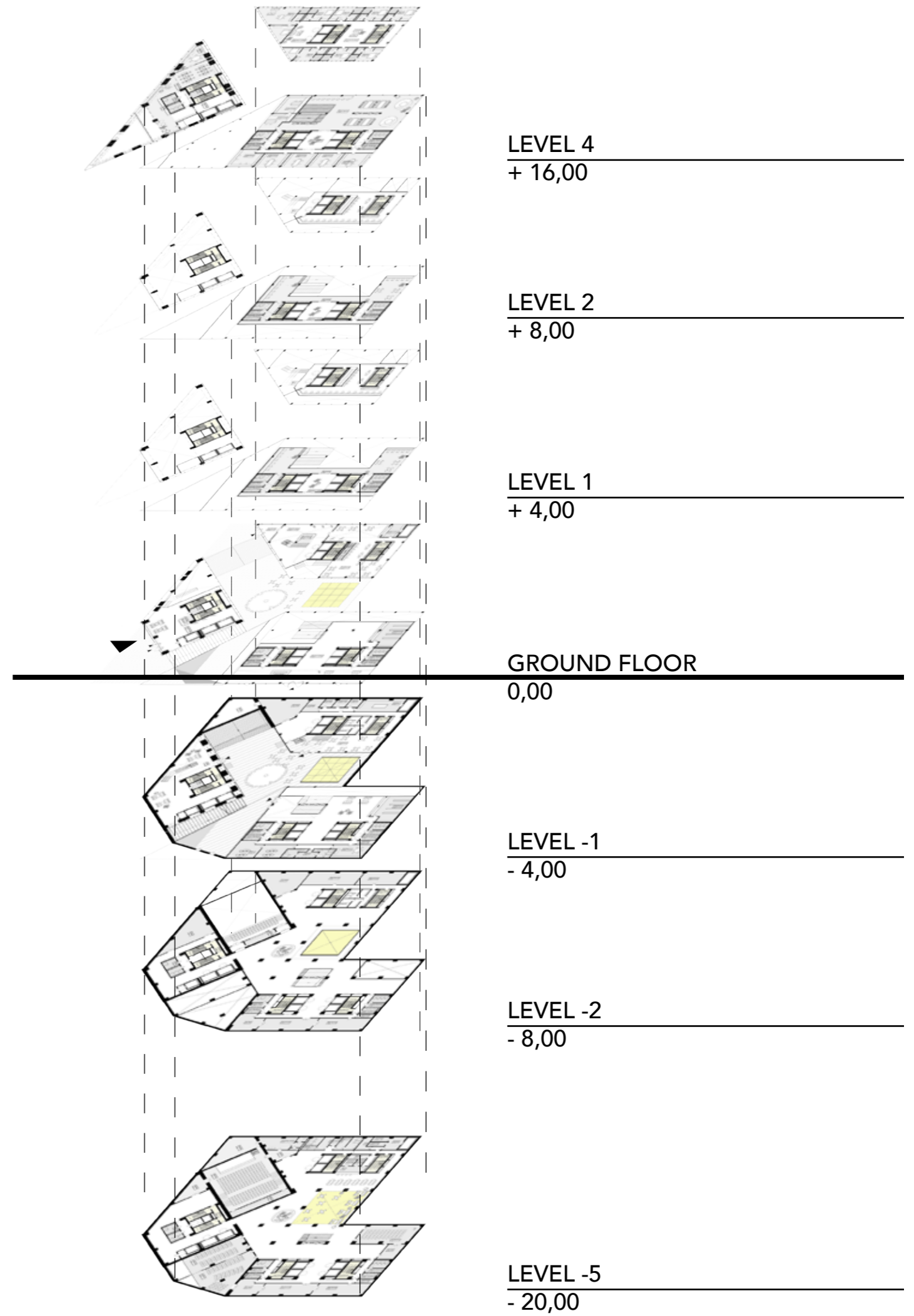



# FLOOR PLANS AXONOMETRY

# PATHS



PASSER-BY

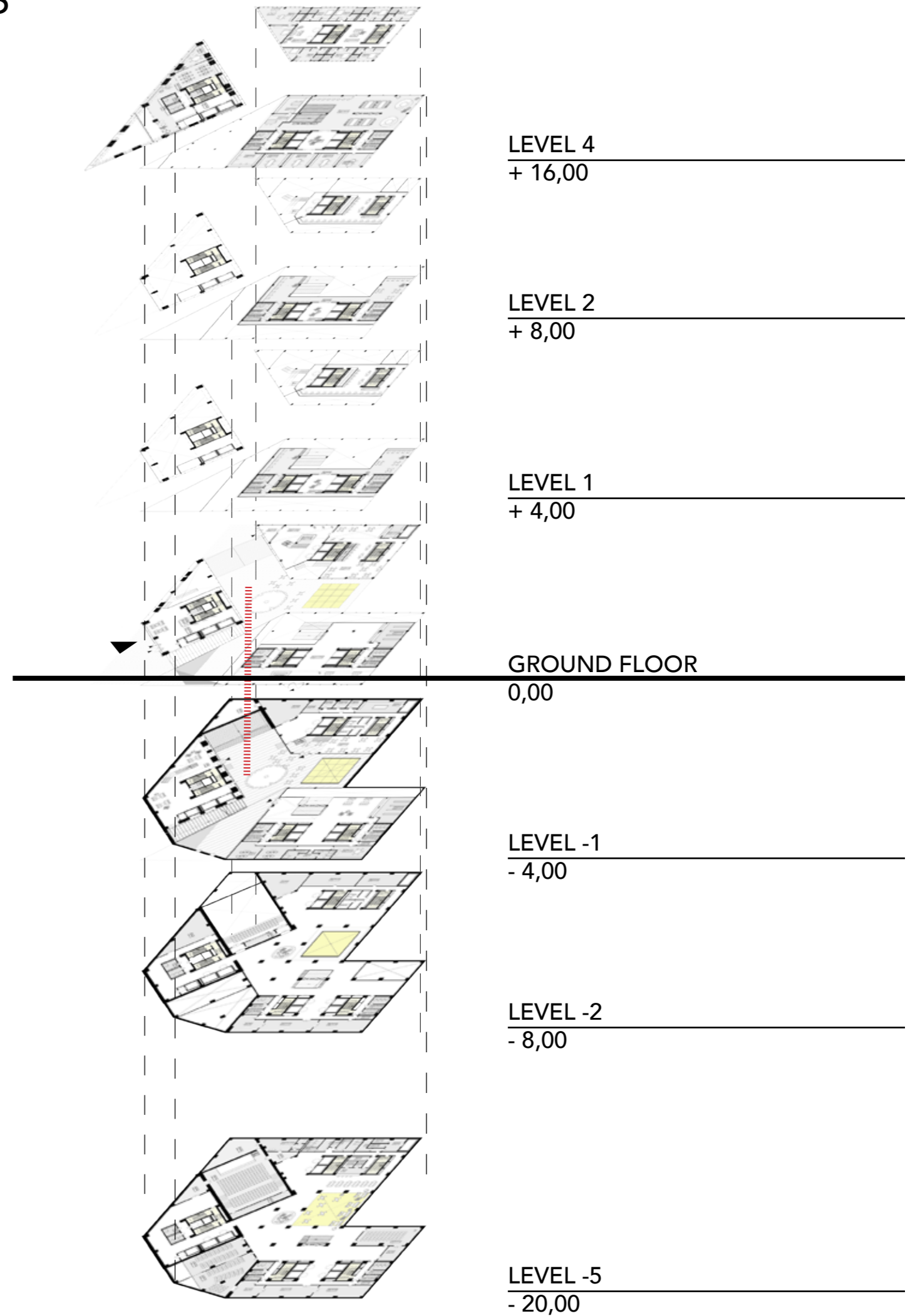



# FLOOR PLANS AXONOMETRY

# PATHS



PASSER-BY

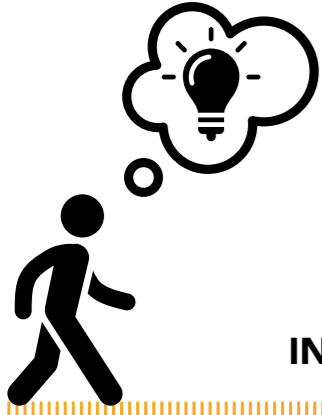

INNOVATION CENTER VISITOR

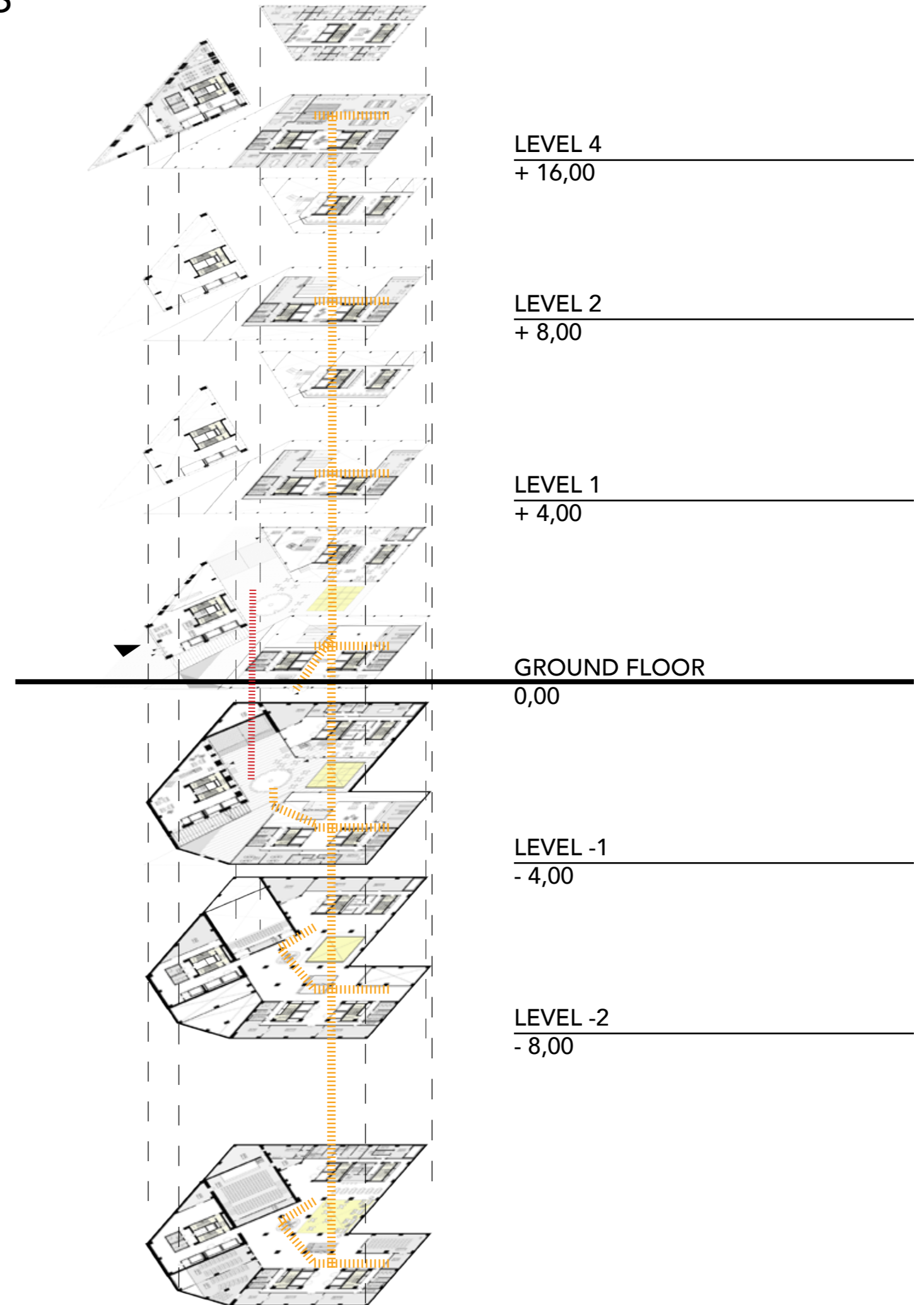



# FLOOR PLANS AXONOMETRY

# PATHS



PASSER-BY



INNOVATION CENTER VISITOR



SHORT-STAY HOTEL GUEST

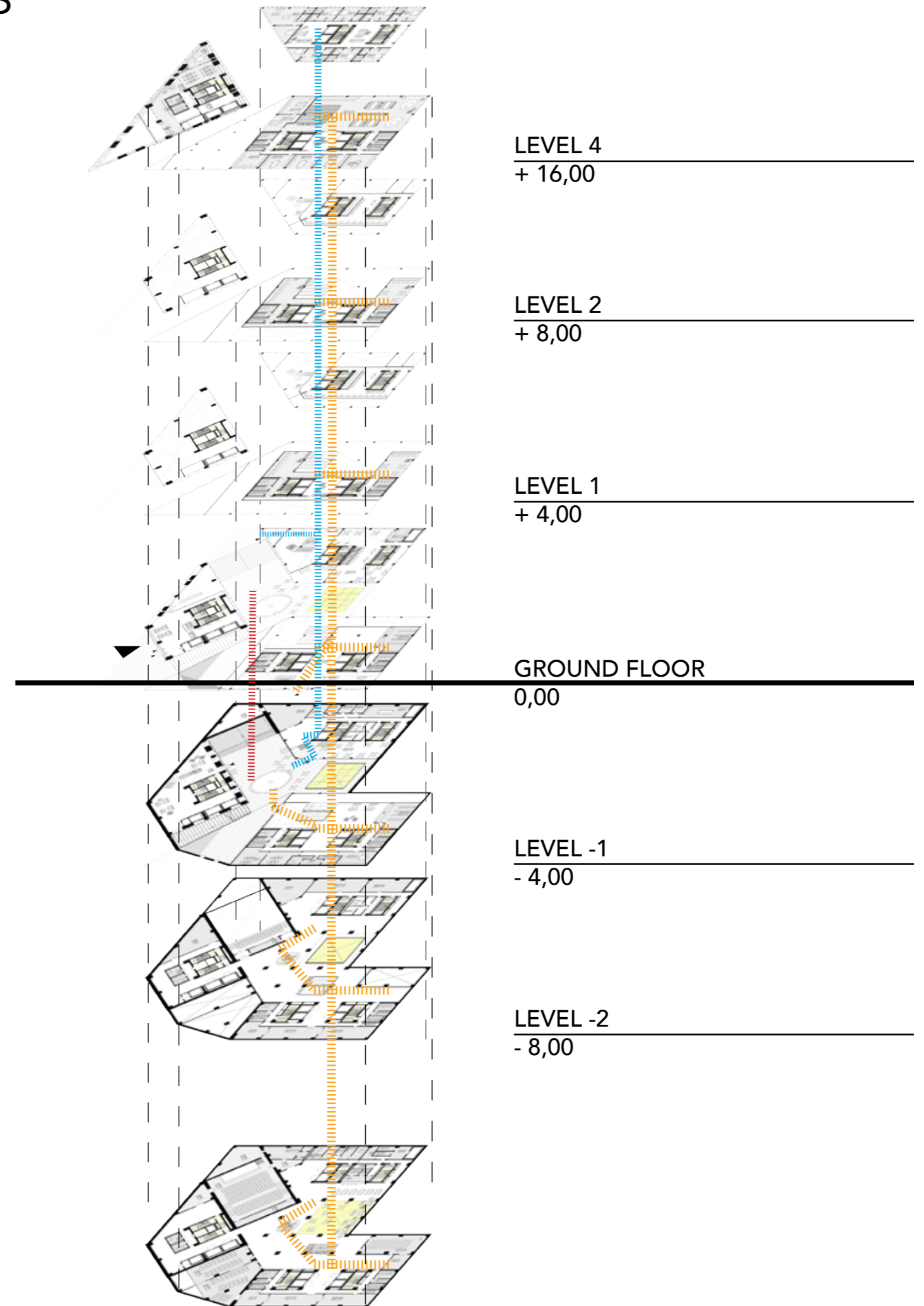



# FLOOR PLANS AXONOMETRY

# PATHS



PASSER-BY

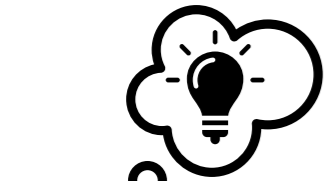

INNOVATION CENTER VISITOR



SHORT-STAY HOTEL GUEST



START-UP OFFICE WORKER

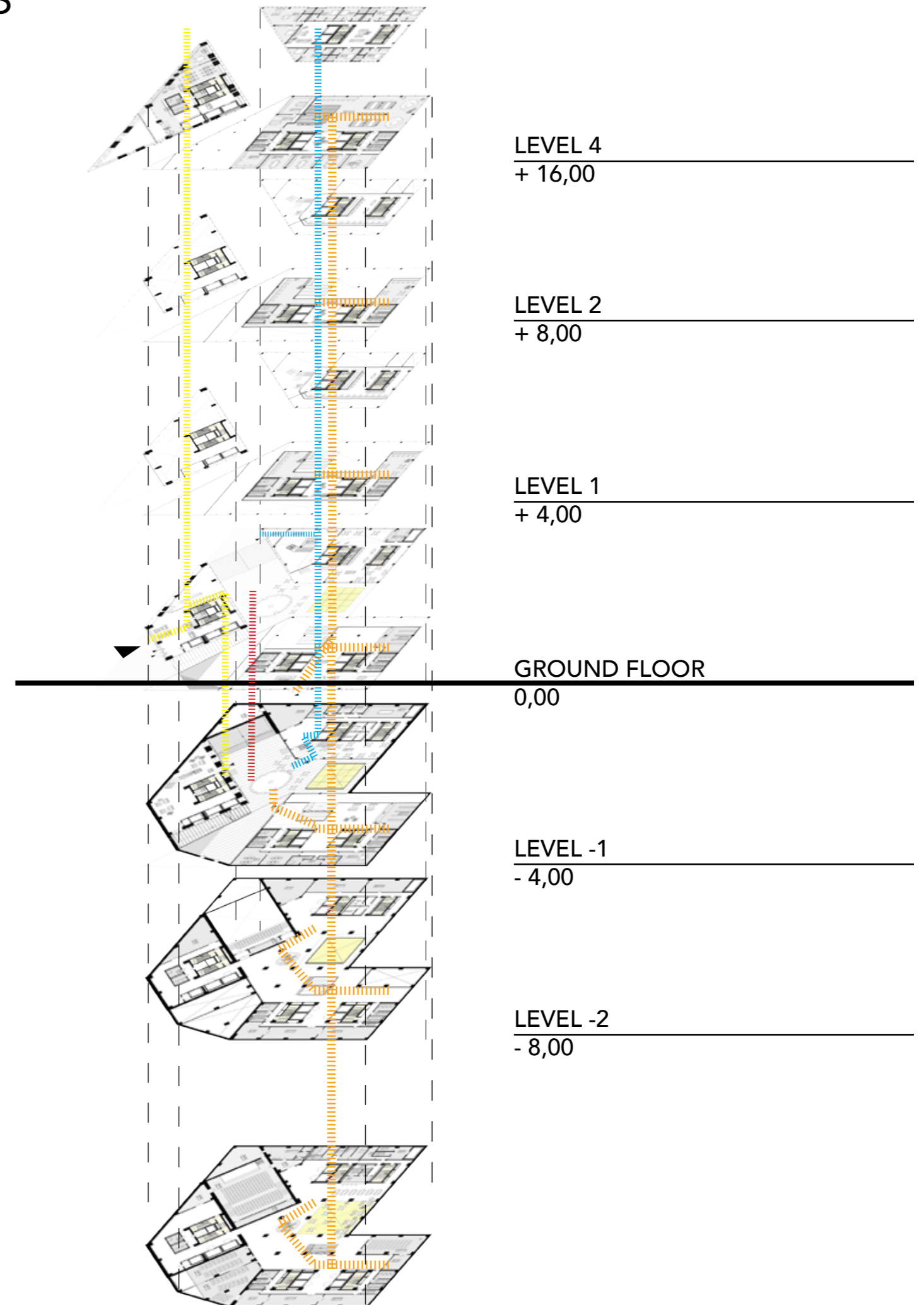



# **SECTIONS**



# SECTIONS

+150 m

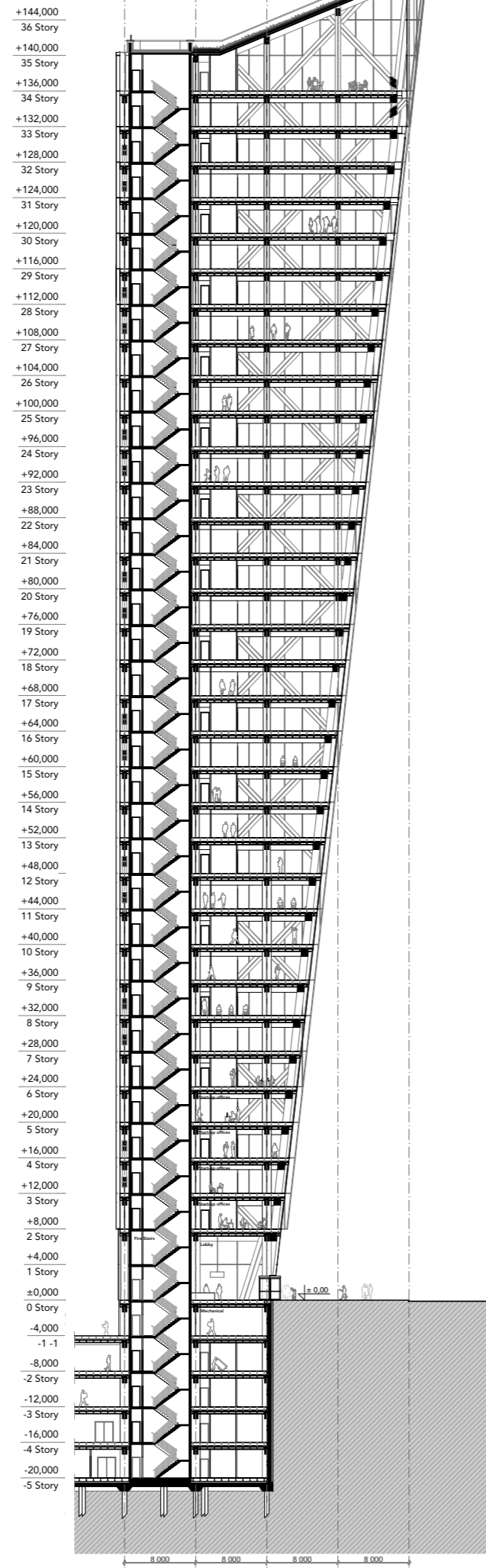

SECTION A

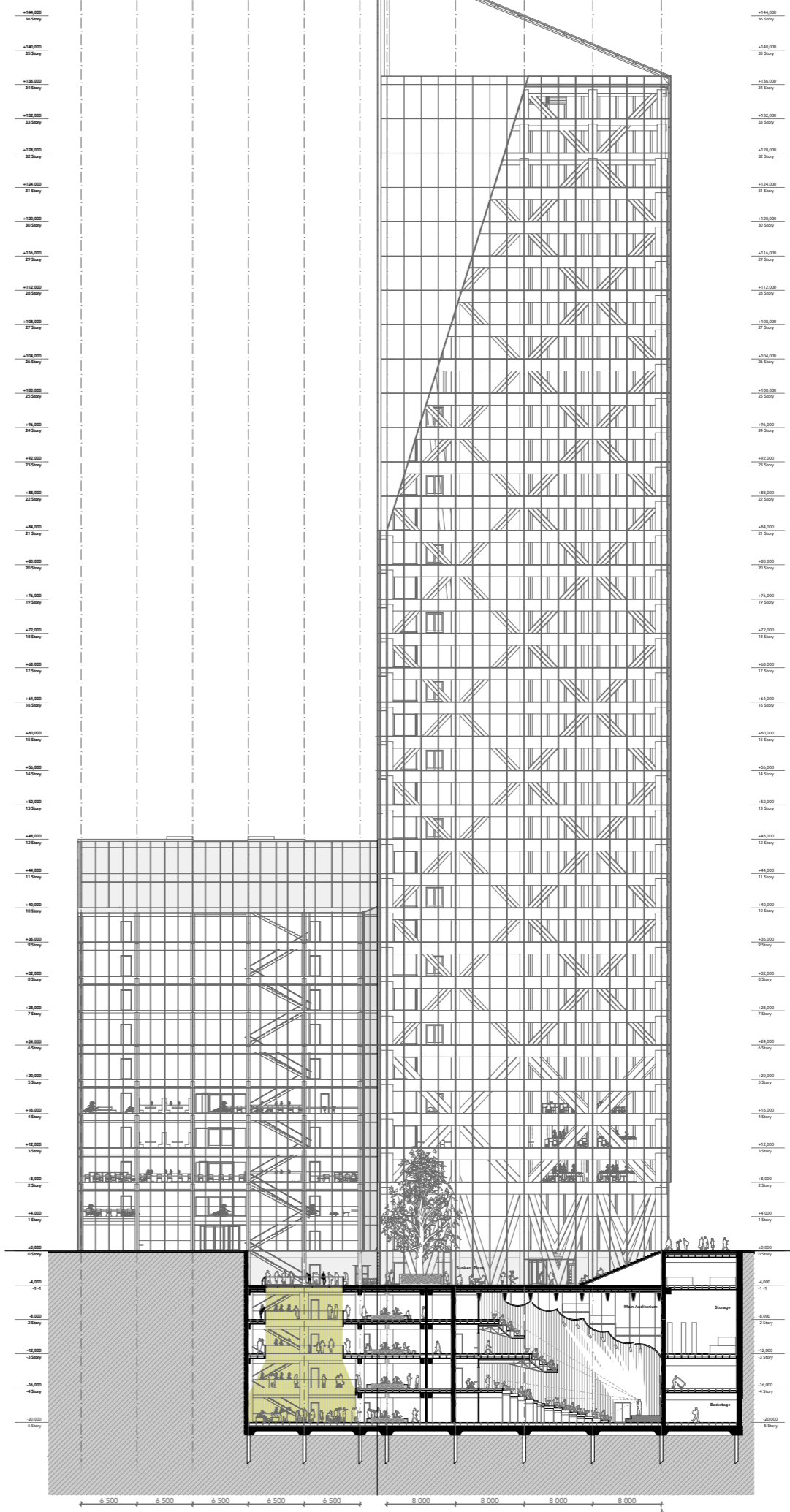

SECTION B



# SECTION 1:200

## SECTION B

+150 m

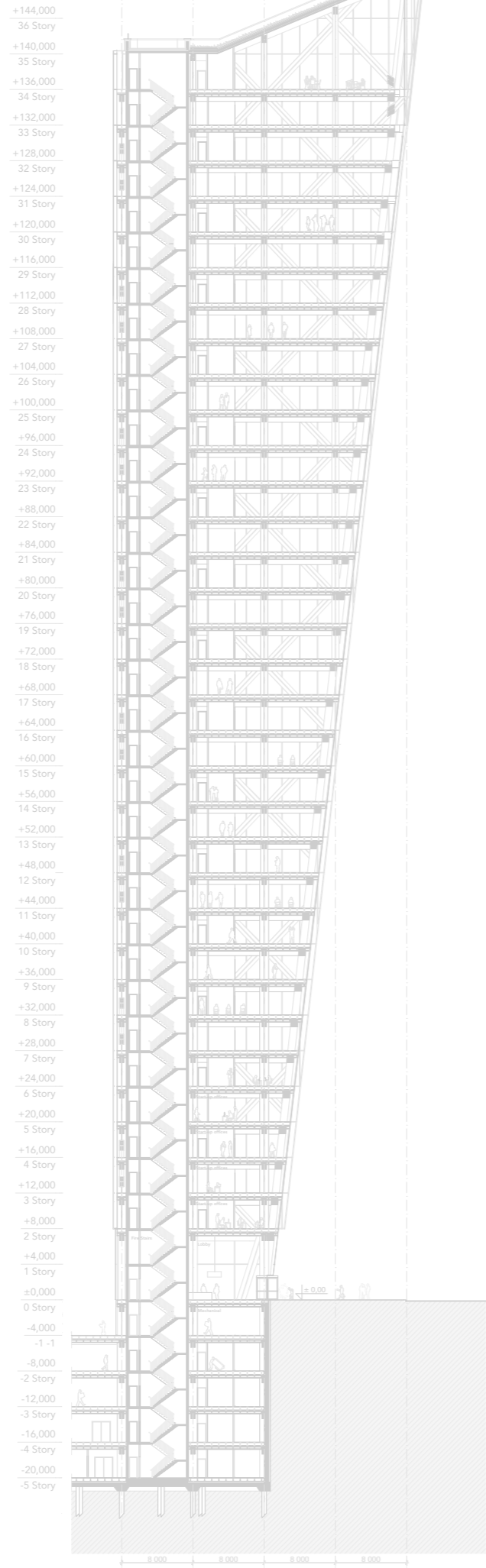

SECTION A

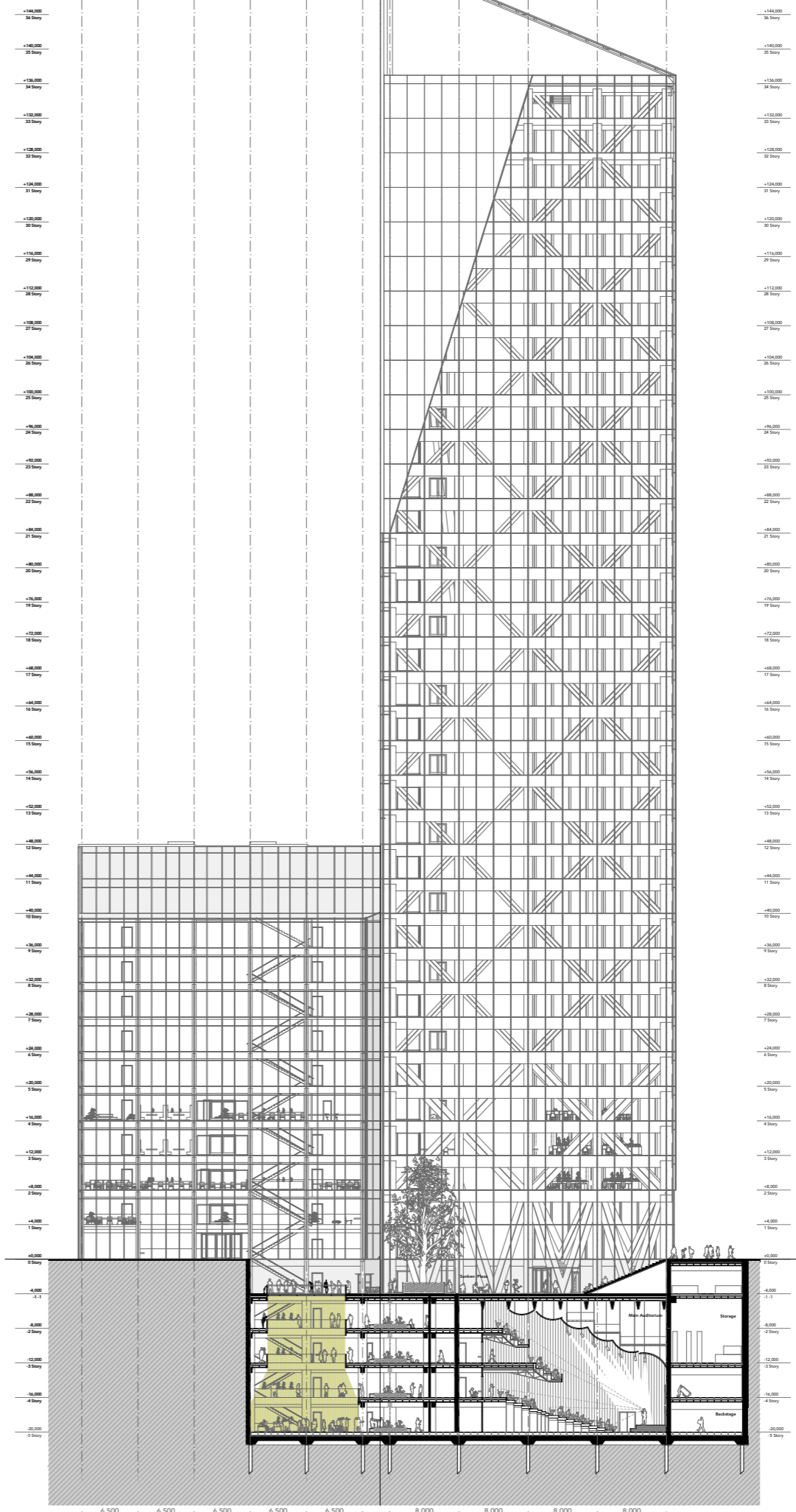

SECTION B



# SECTION 1:200

## SECTION B

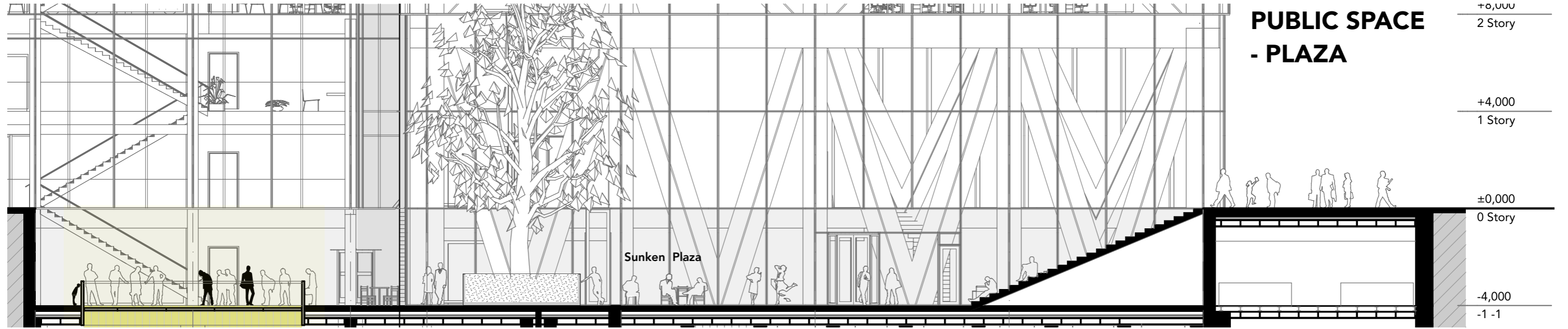



# SECTION 1:200

## SECTION B

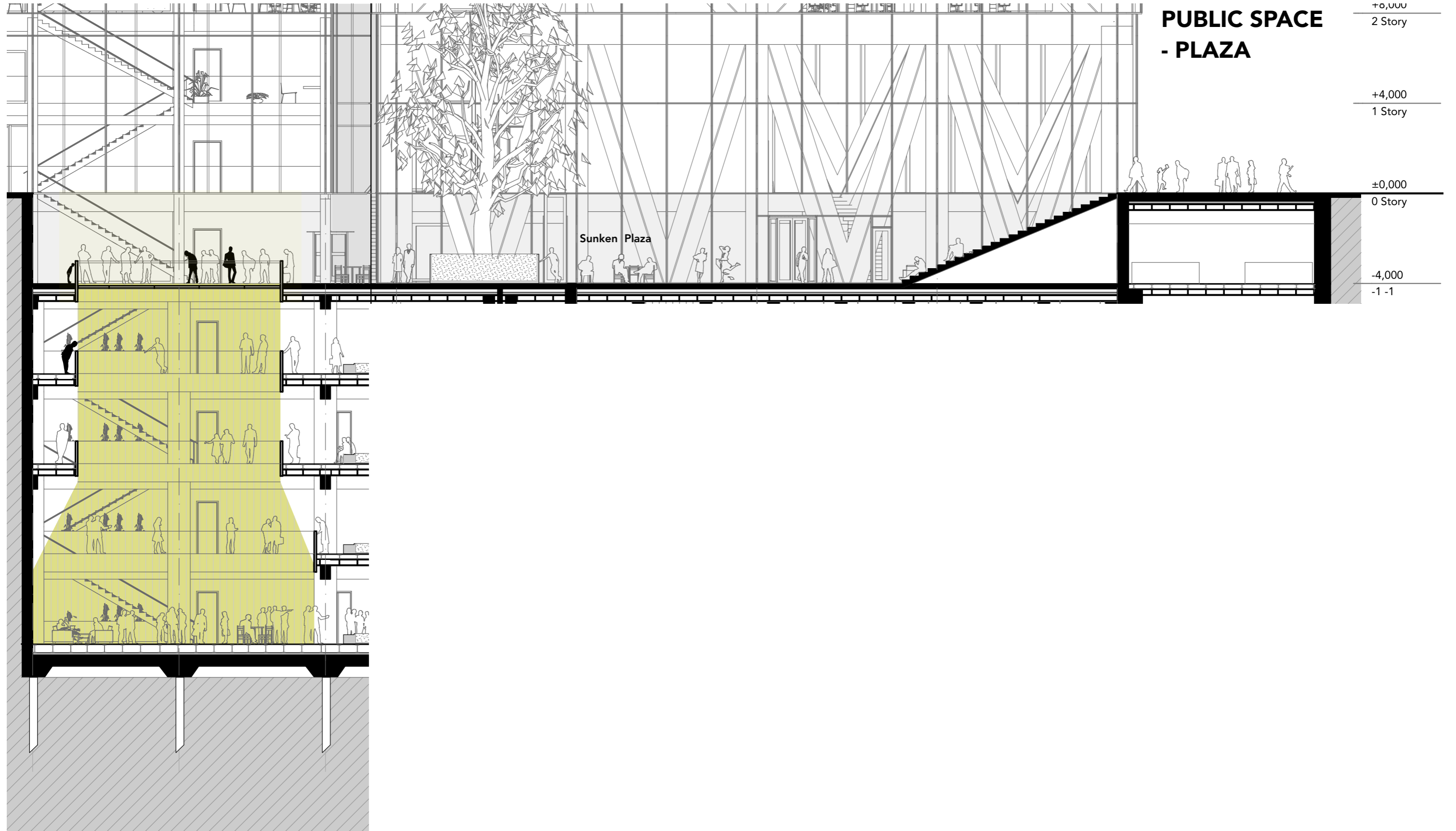

**PUBLIC SPACE  
- PLAZA**

+8,000  
2 Story

+4,000  
1 Story

±0,000  
0 Story

-4,000  
-1 -1

Sunken Plaza

**LIGHT SHAFT**



# SECTION 1:200

## SECTION B

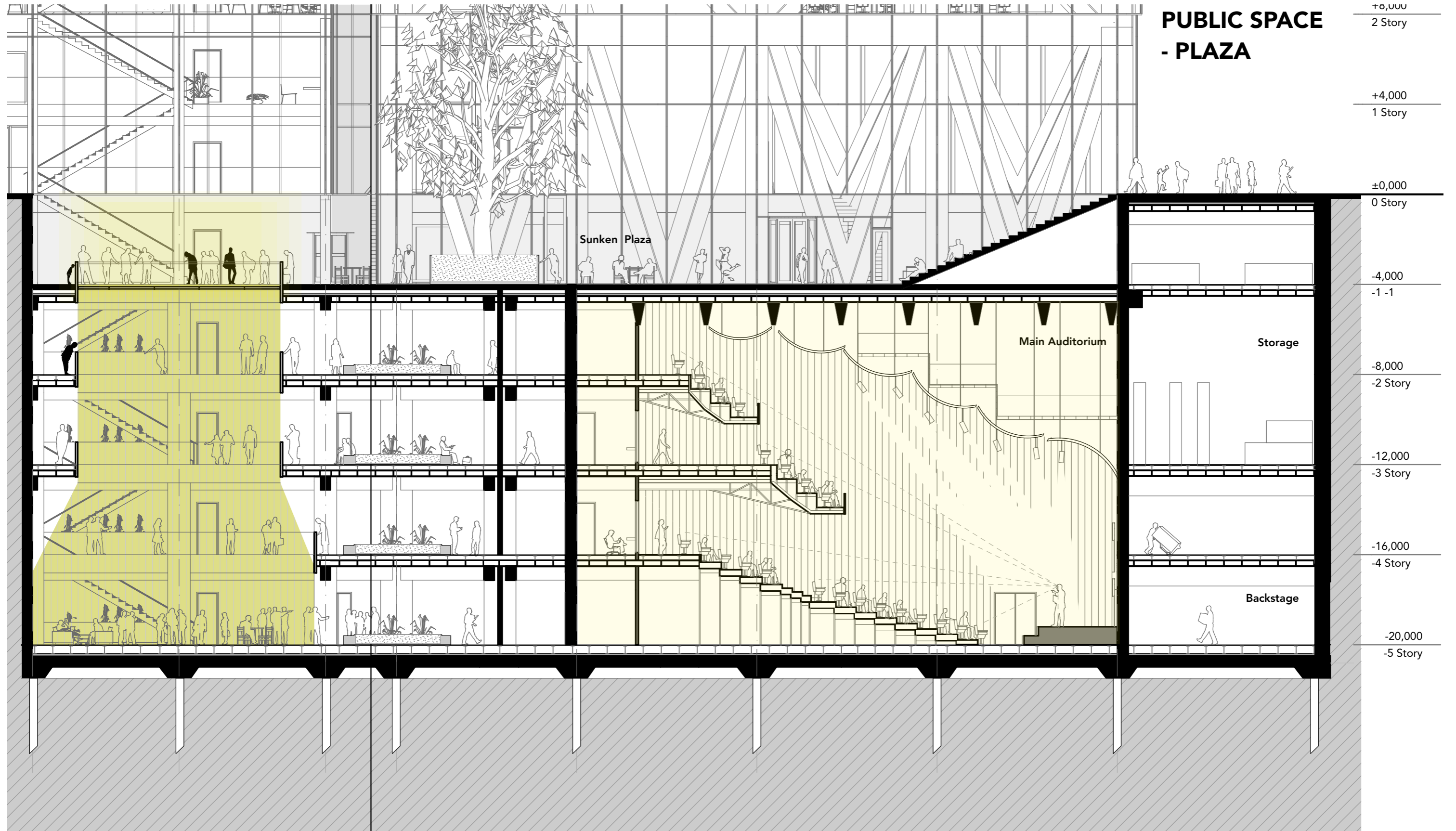

**LIGHT SHAFT**

**MAIN AUDITORIUM**



# SECTION 1:200

## SECTION A

+150 m

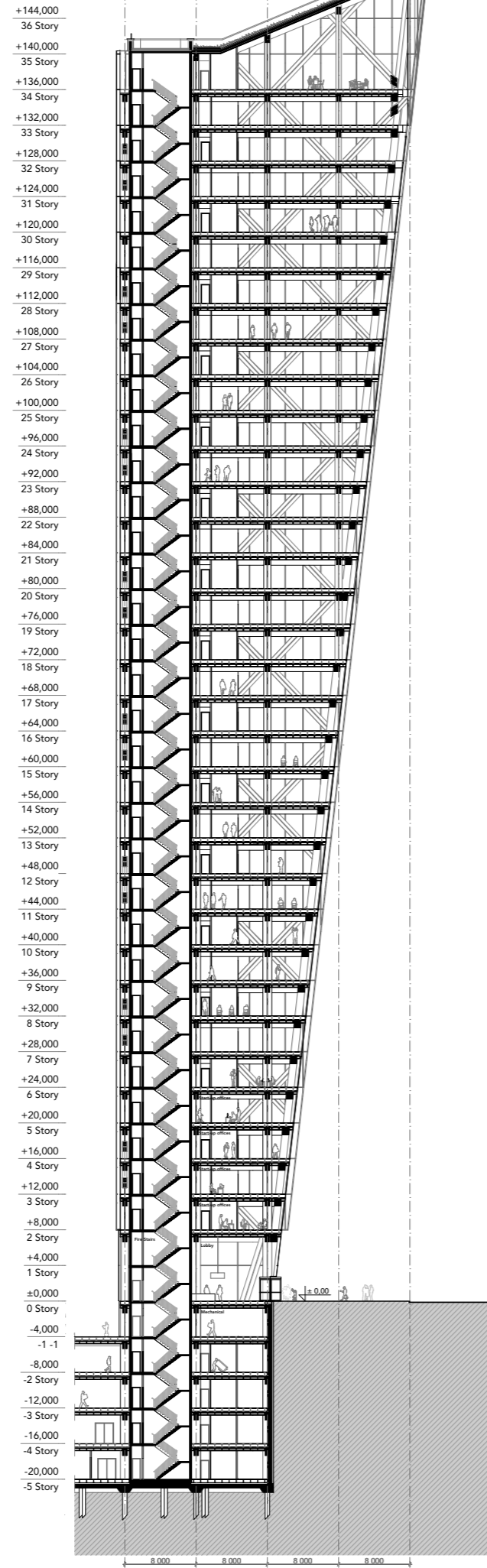



# SECTION 1:200

## SECTION A

+150 m

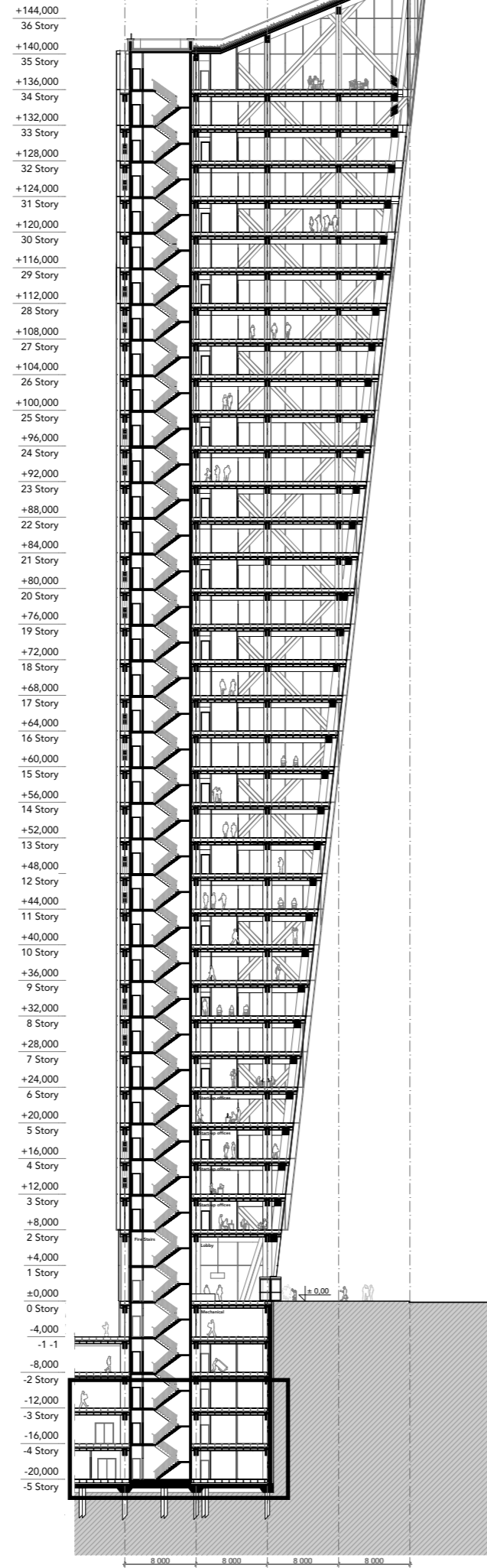

### BASEMENT - STORAGE / MECHANICAL

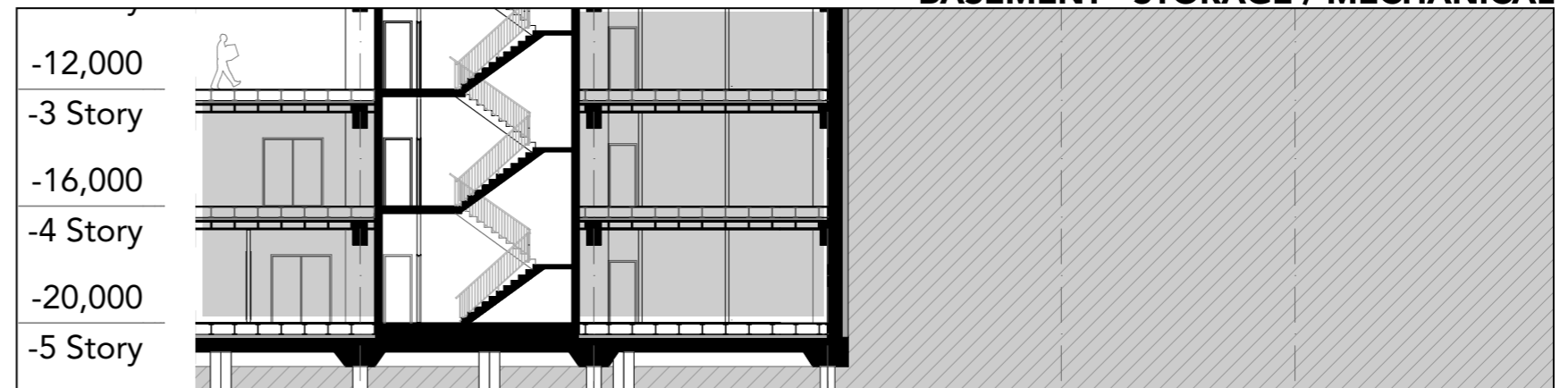



# SECTION 1:200

## SECTION A

+150 m

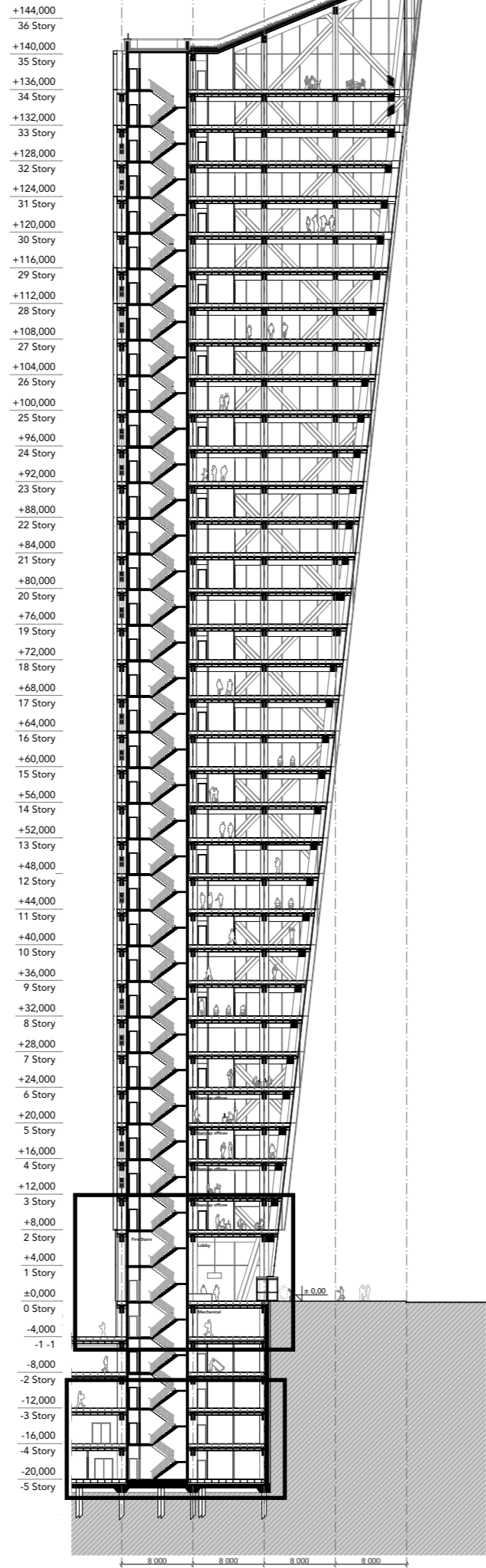

### TOWER ENTRANCE & LOBBY

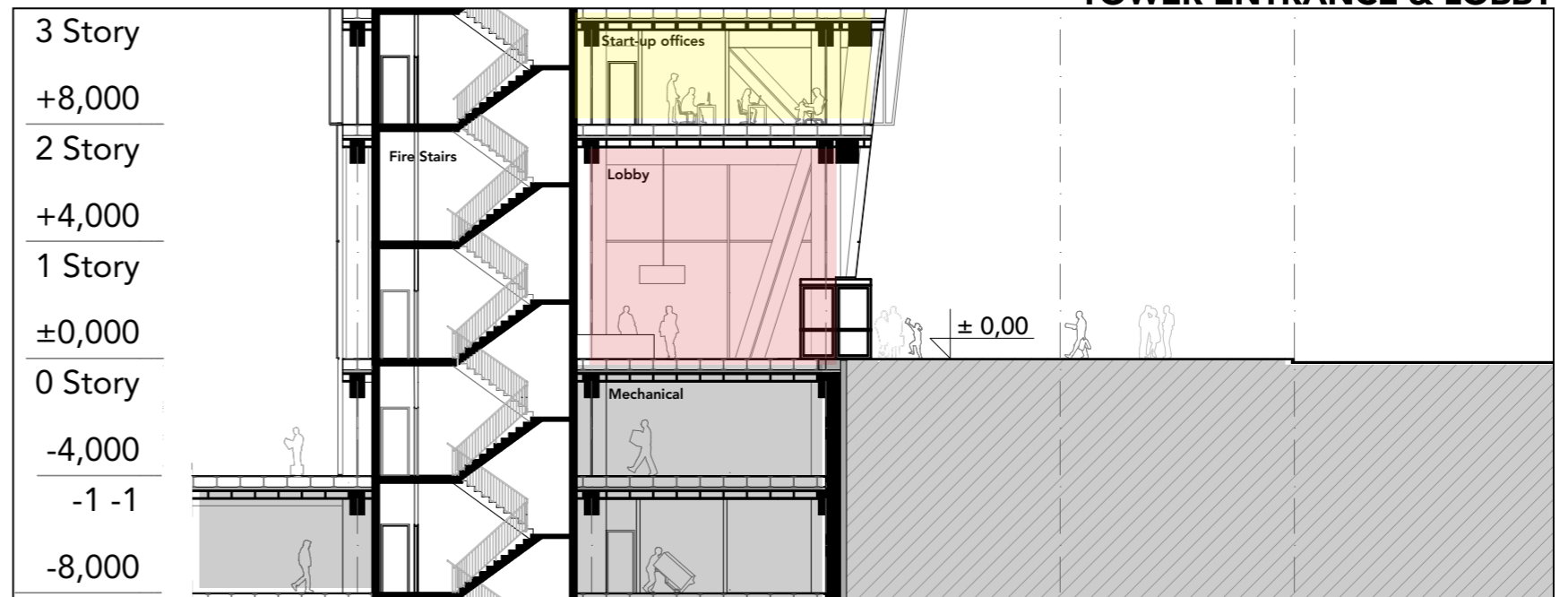

### BASEMENT - STORAGE / MECHANICAL

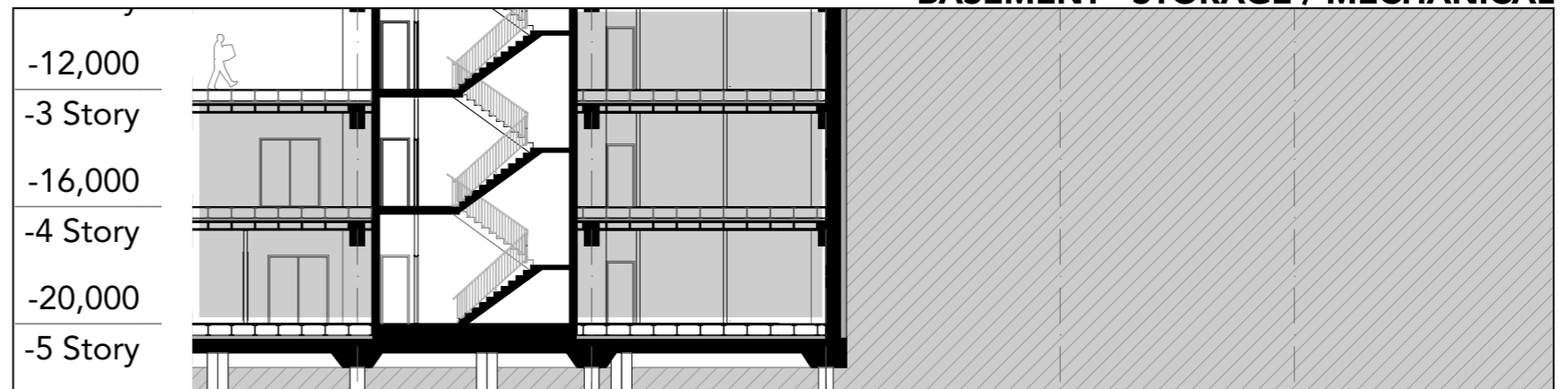



# SECTION 1:200

## SECTION A

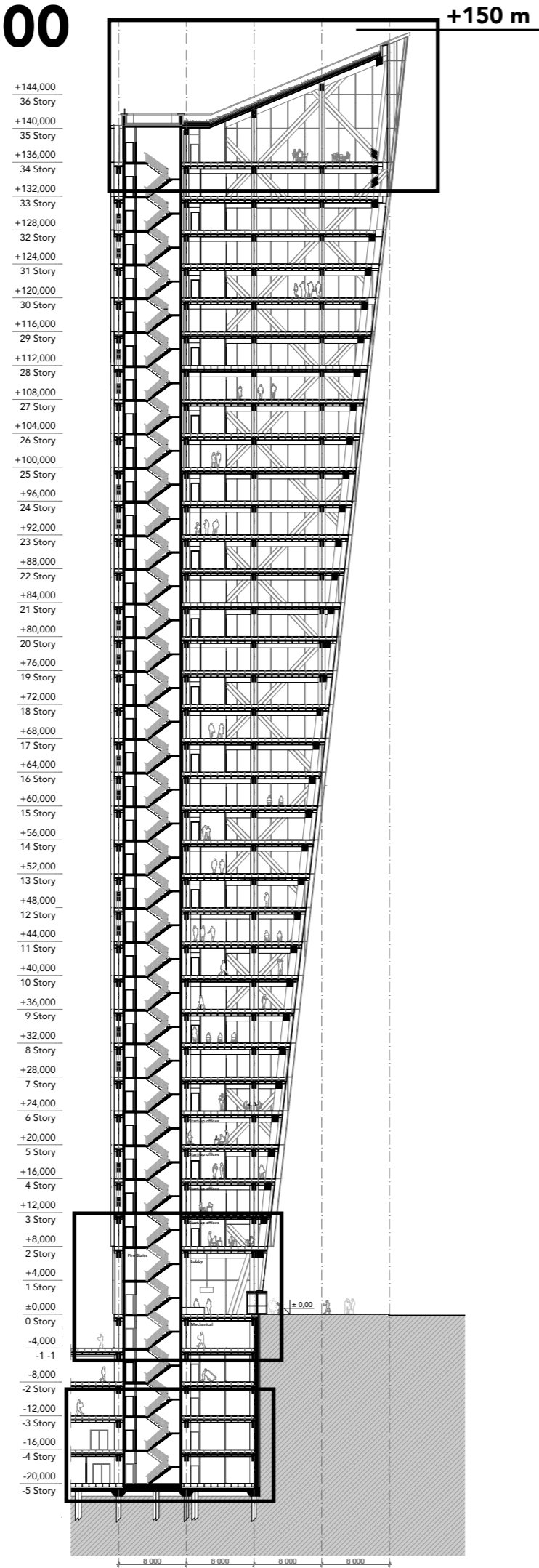

VIEW TOP FLOOR

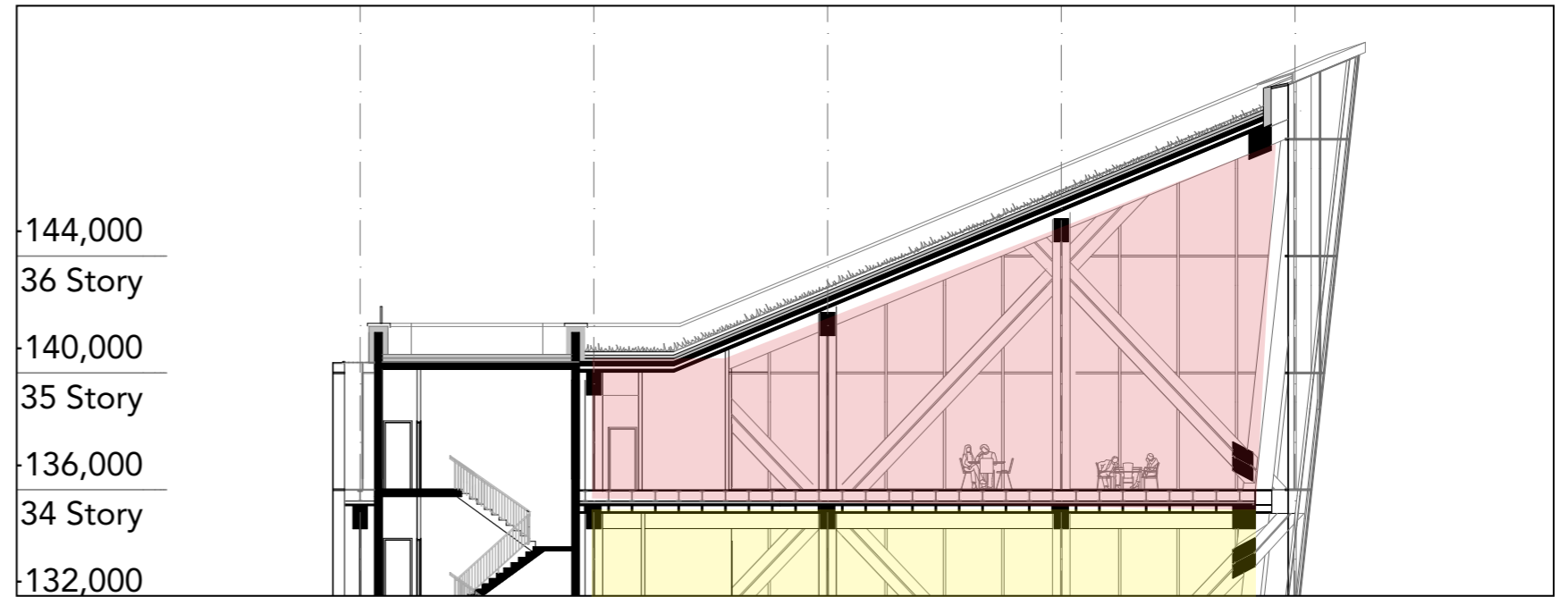

TOWER ENTRANCE & LOBBY

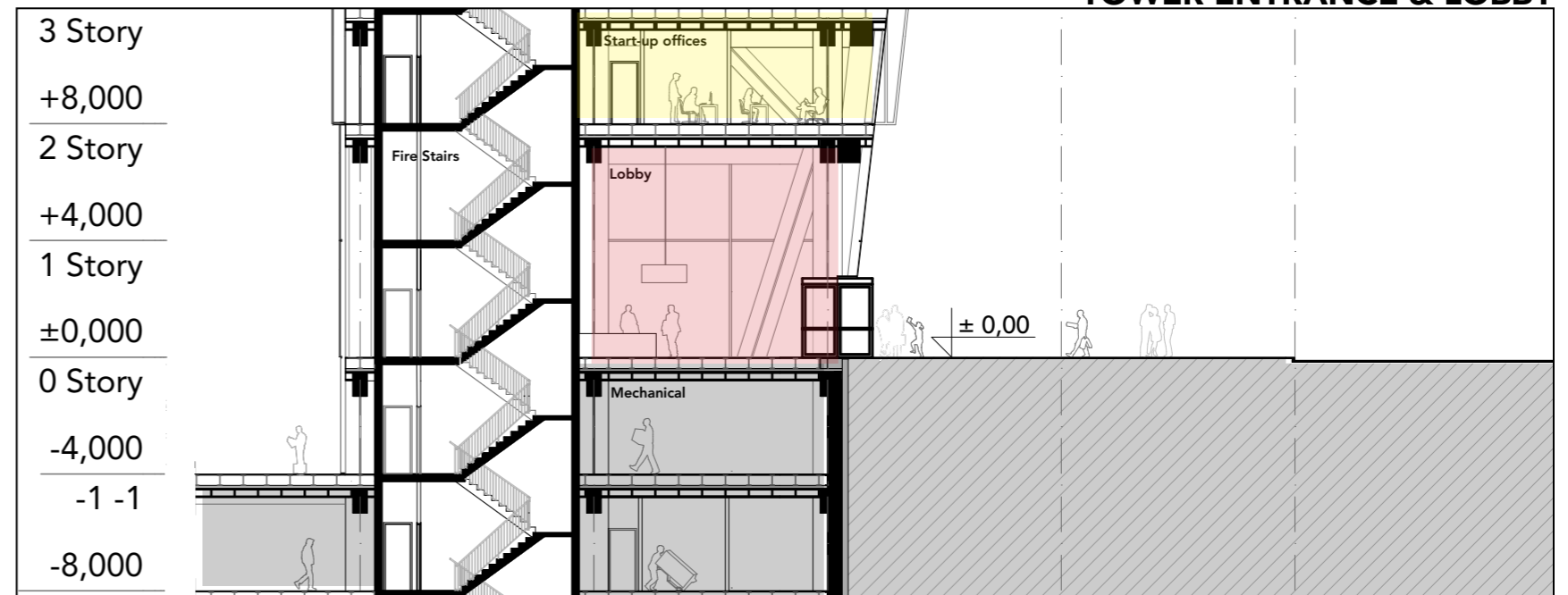

BASEMENT - STORAGE / MECHANICAL

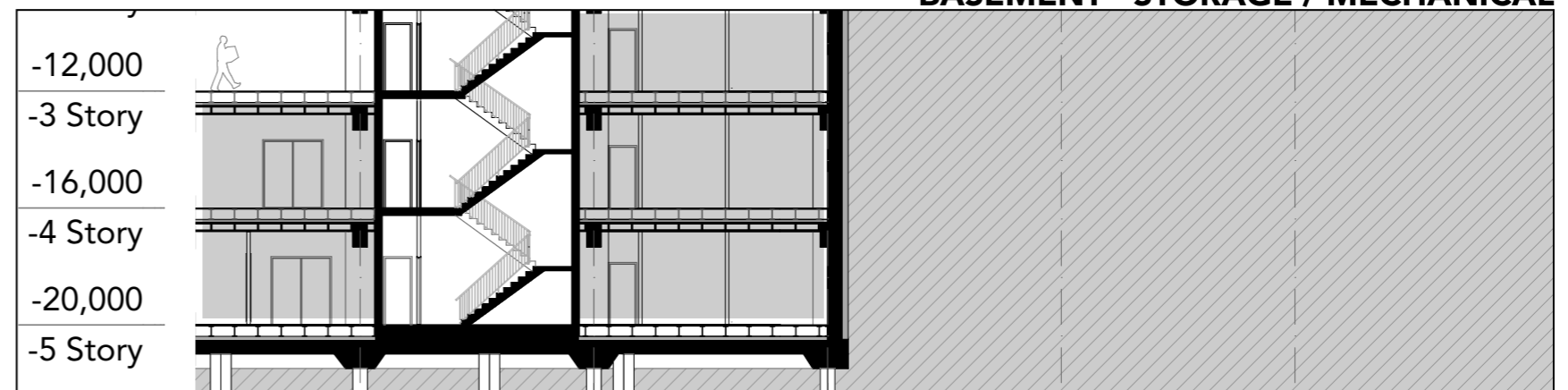



# SECTION 1:200

## SECTION A

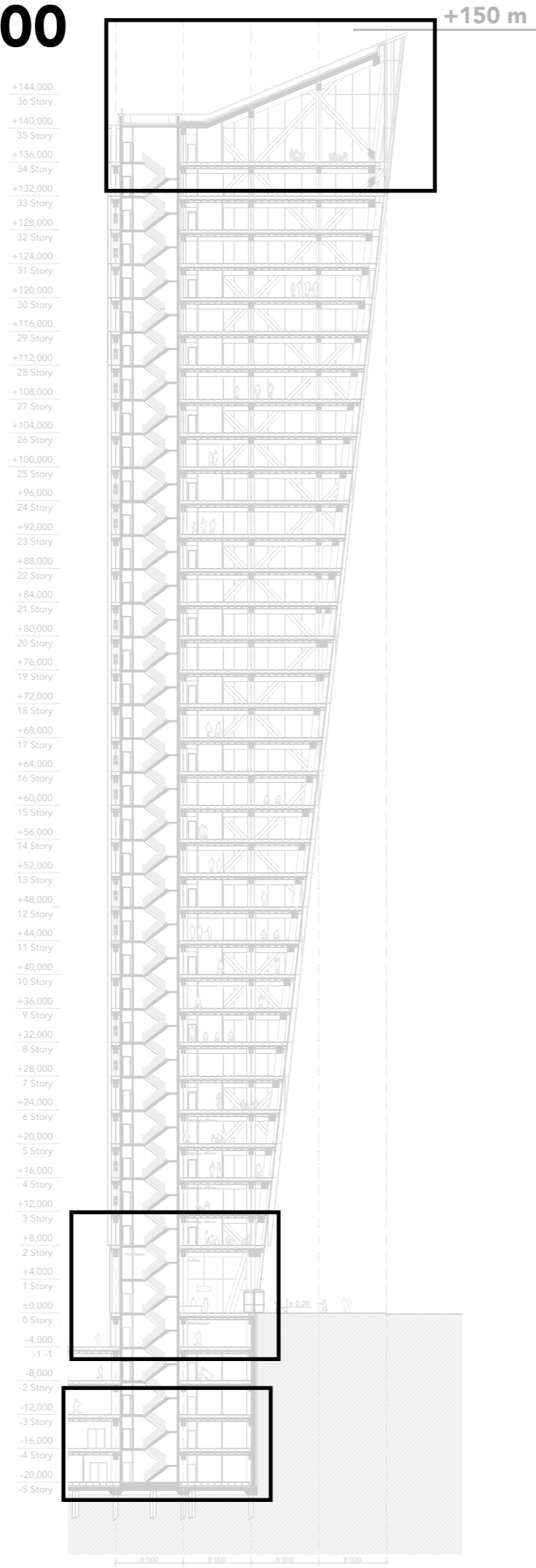

VIEW TOP FLOOR

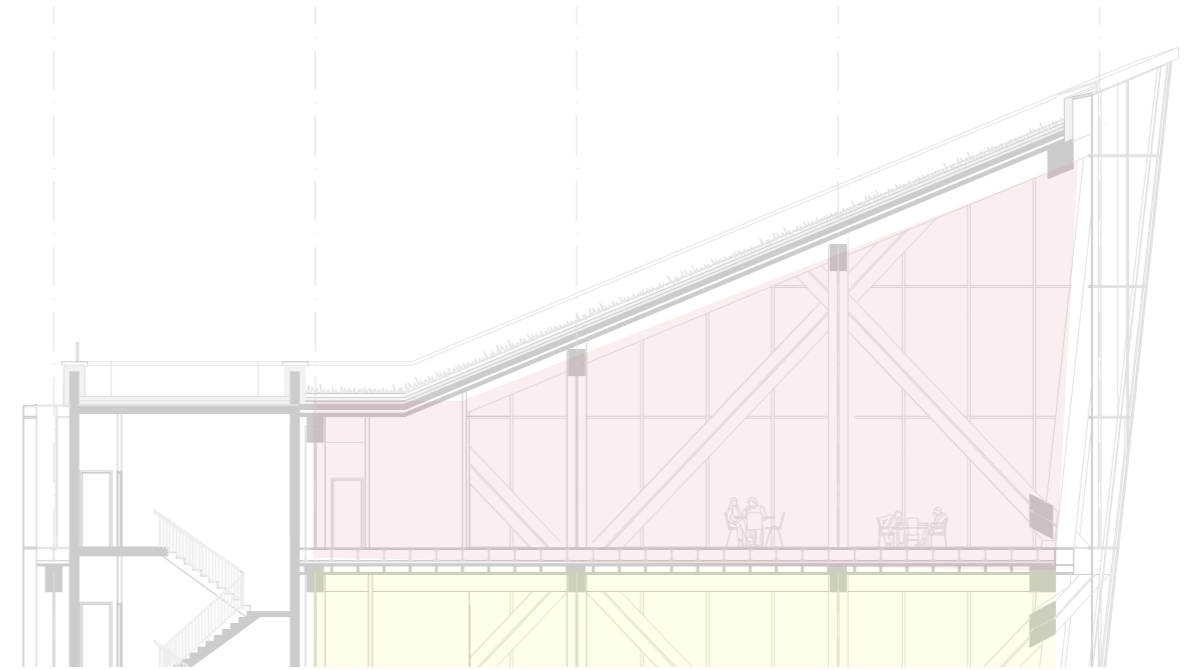

TOWER ENTRANCE & LOBBY

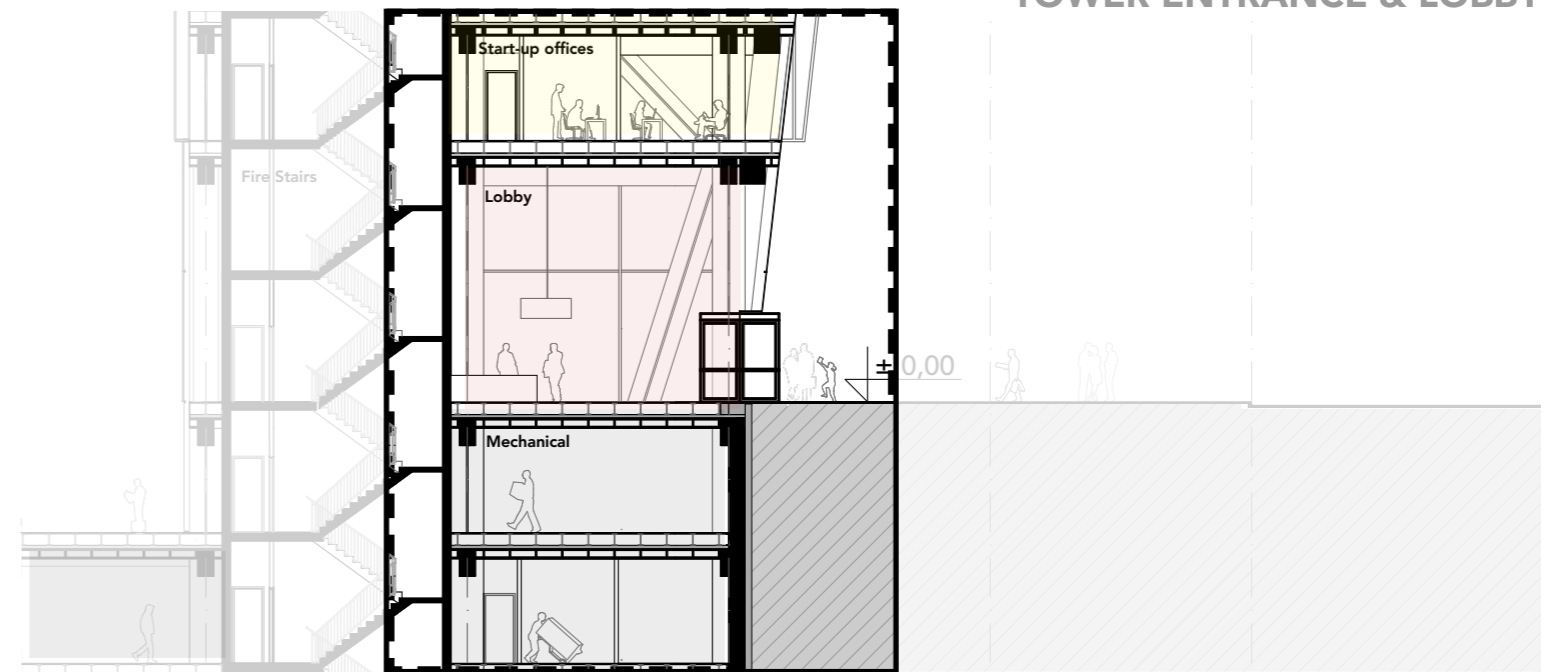

BASEMENT - STORAGE / MECHANICAL

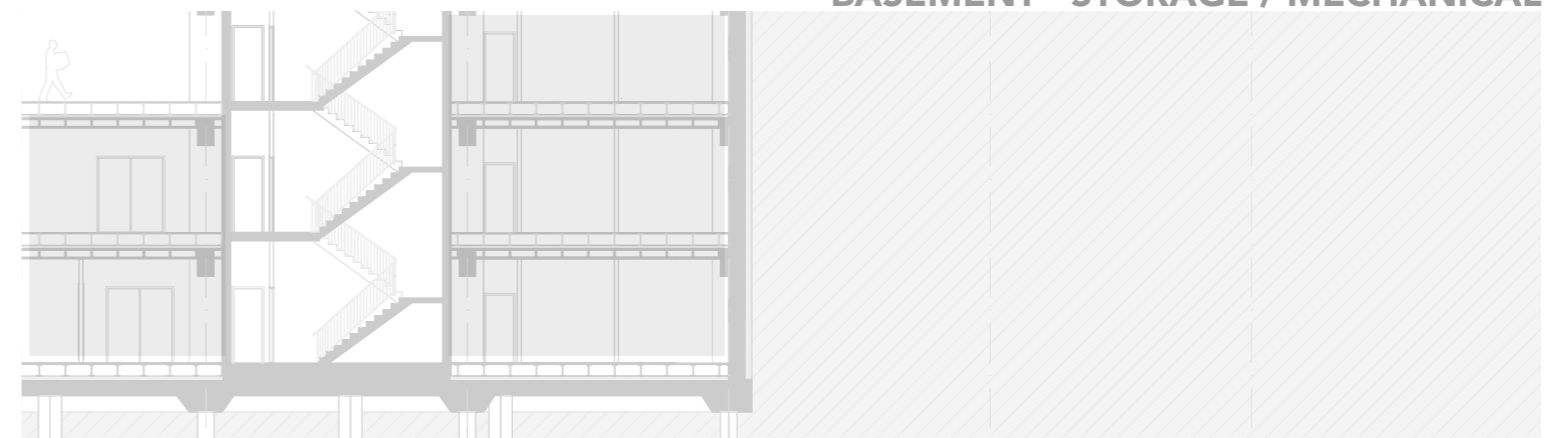



# SECTION 1:50

# FRAGMENT

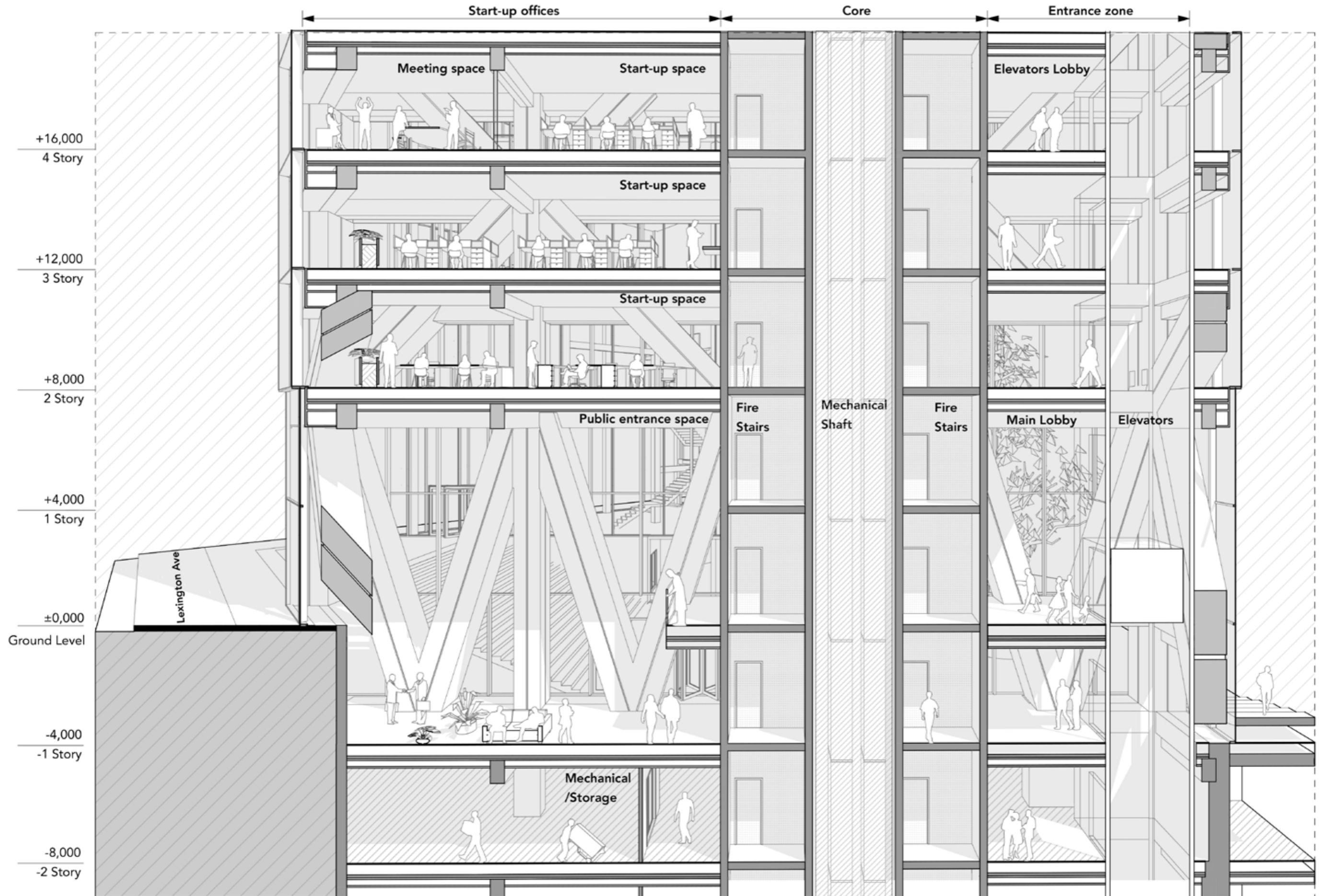



# SECTION 1:50

# FRAGMENT

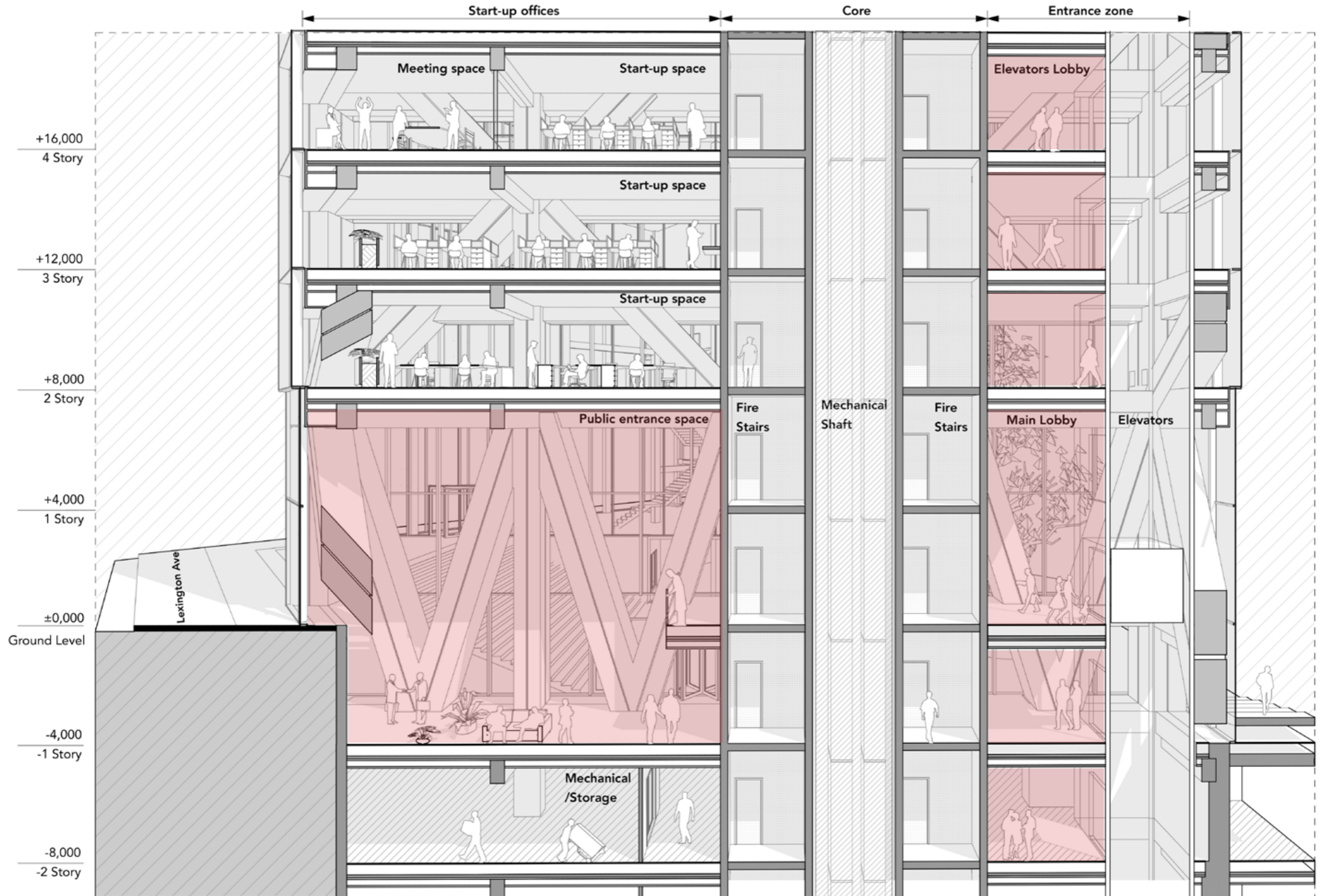



# SECTION 1:50

# FRAGMENT

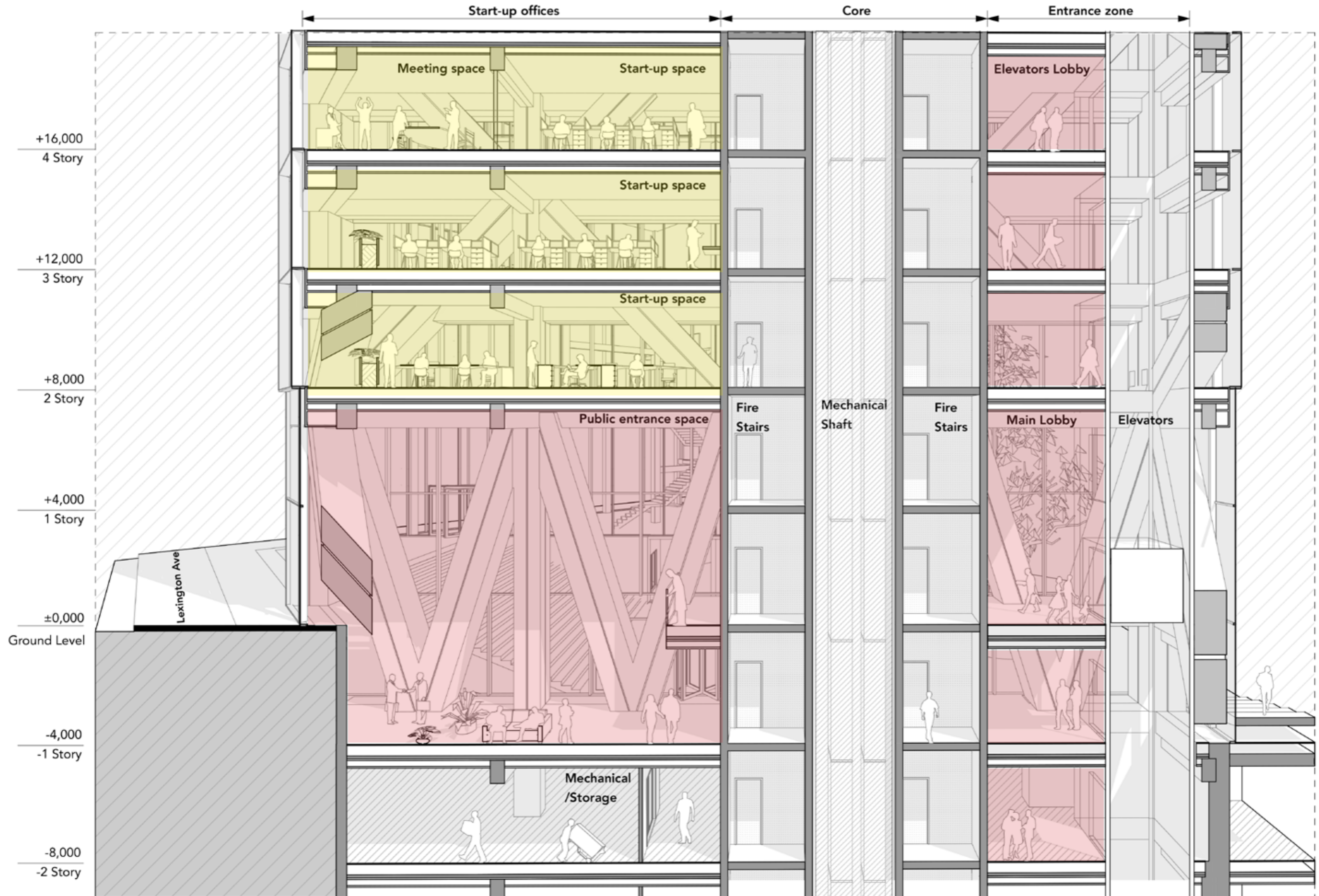



# SECTION 1:50

# FRAGMENT

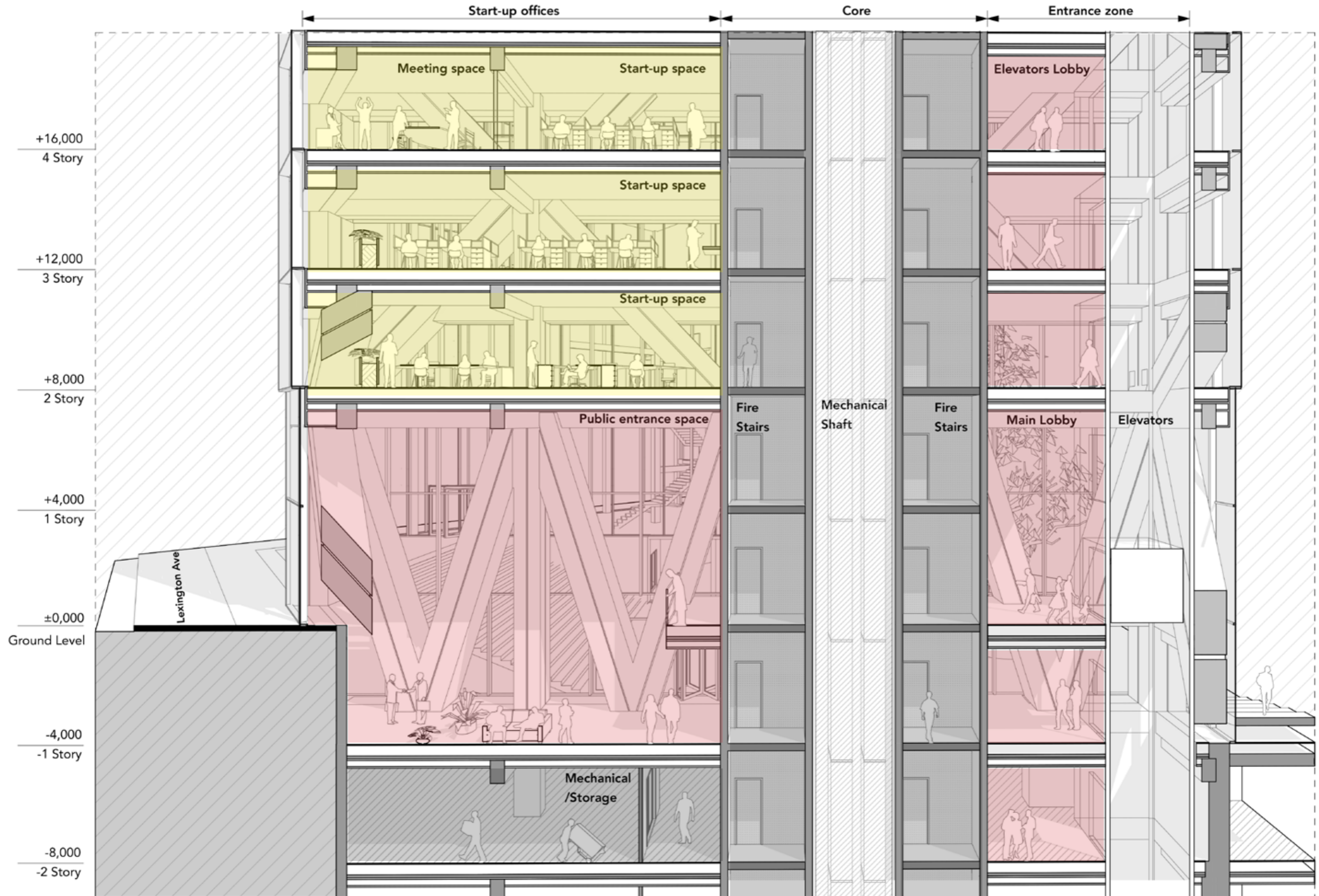



# SECTION 1:50

# FRAGMENT





# **STRUCTURAL SCHEME**



# STRUCTURAL SCHEME

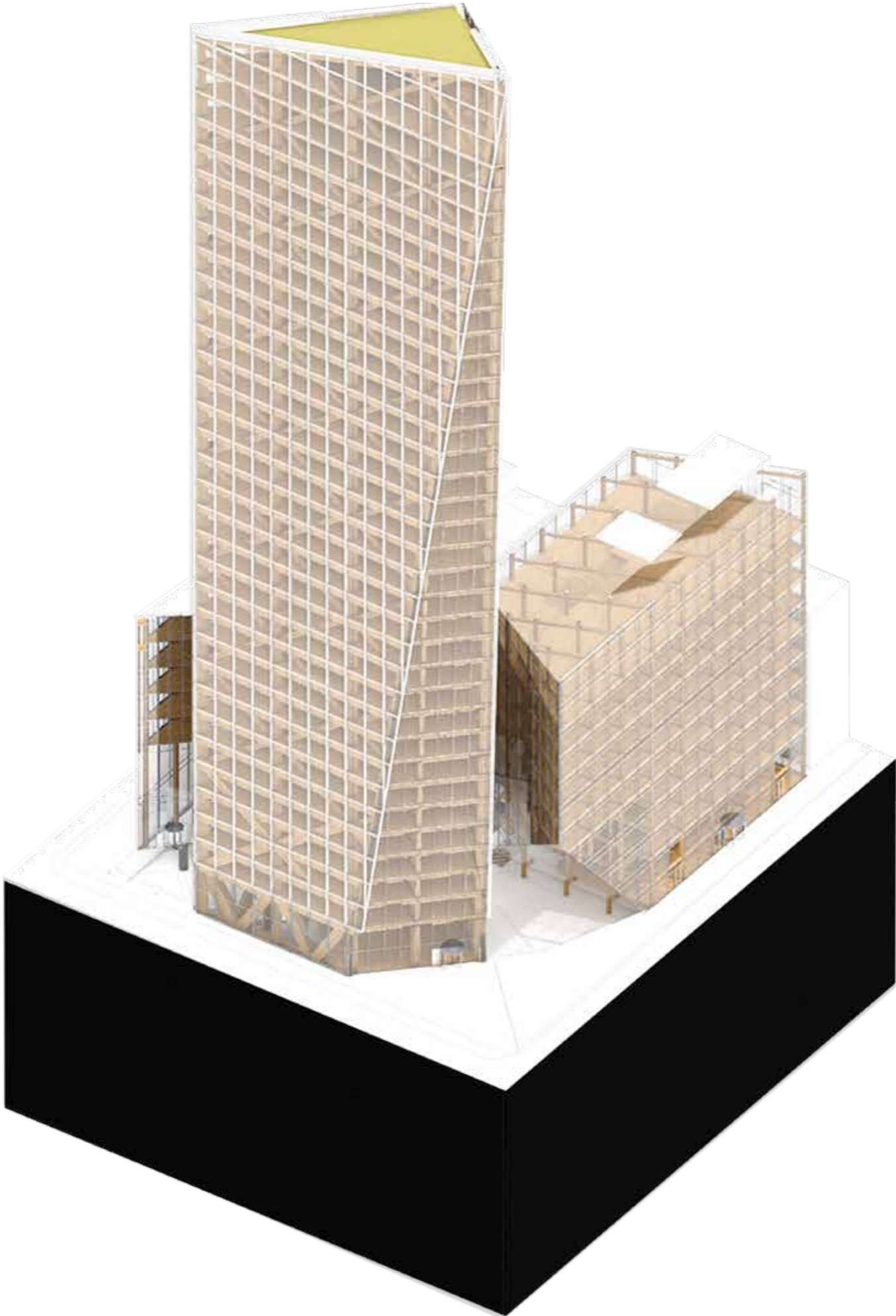

**GLULAMINATED TIMBER  
STRUCTURE**

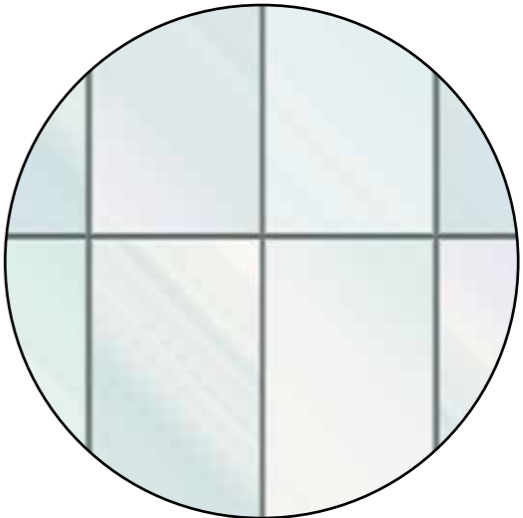

**GLASS  
CURTAIN WALL**



**REINFORCED CONCRETE  
BASEMENT STRUCTURE  
TOWER CORE**



# STRUCTURAL SCHEME

# FOUNDATIONS

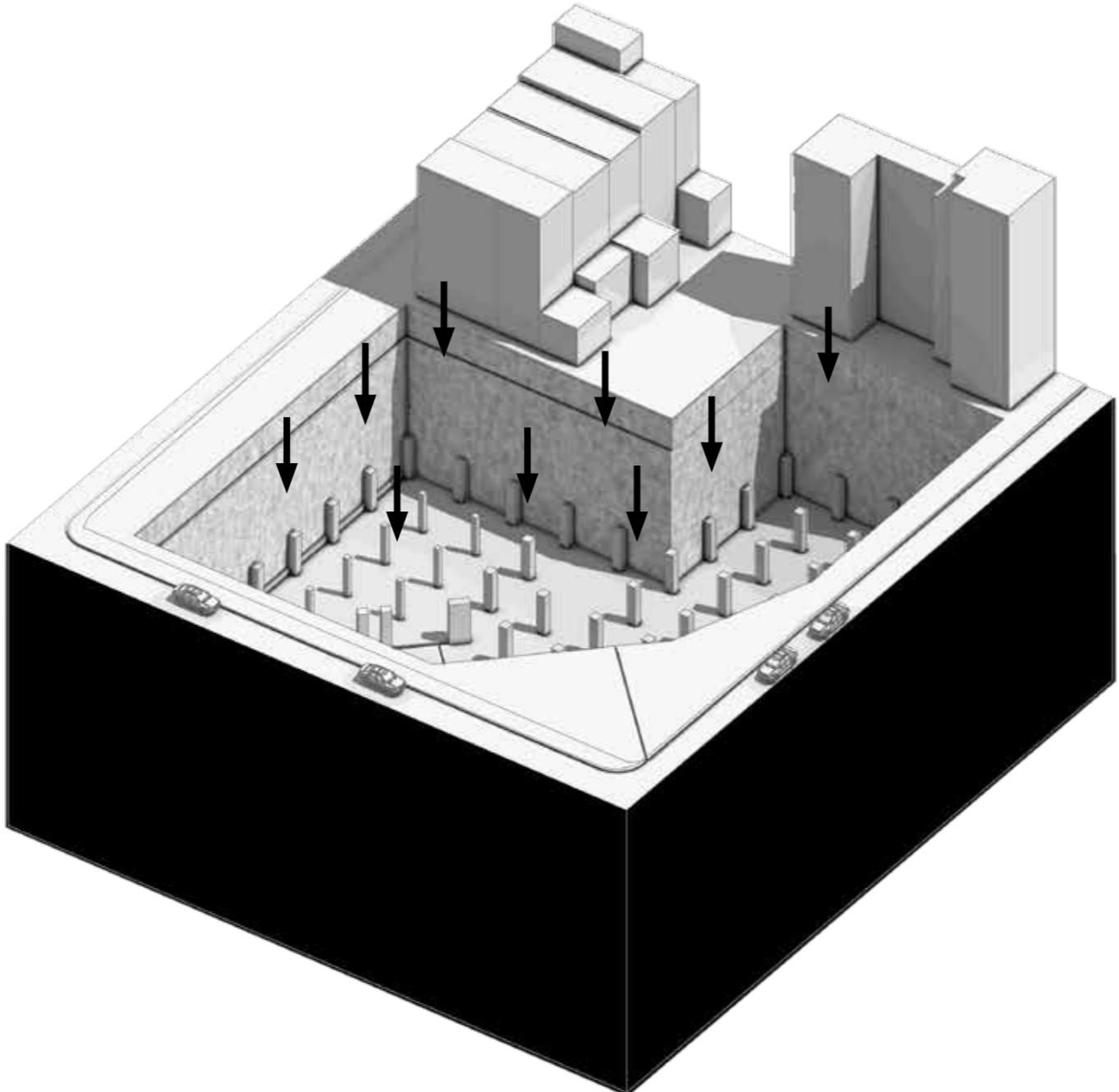

**POLES**  
**BASEMENT**



# STRUCTURAL SCHEME

# BASEMENT

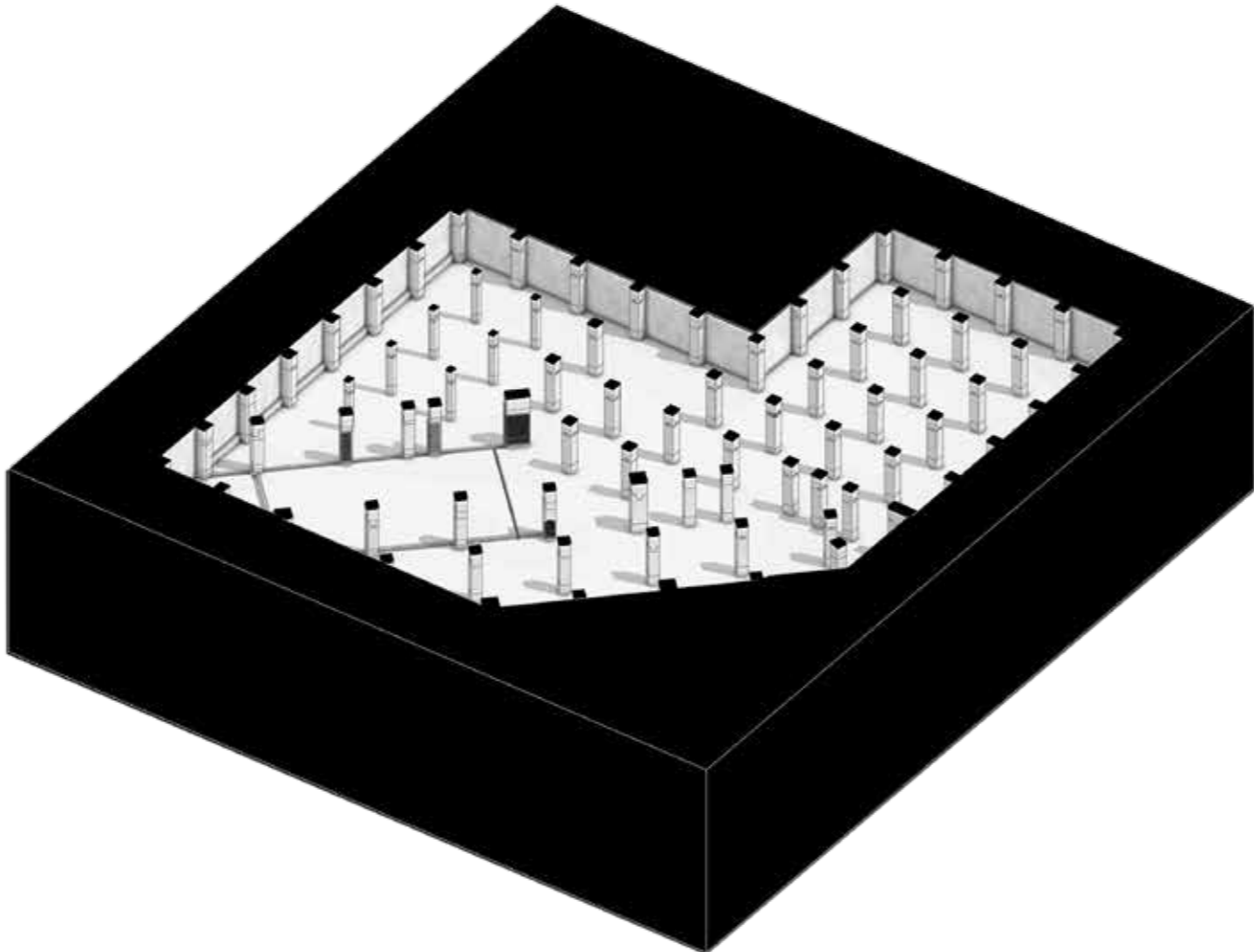

**CONCRETE COLUMNS**  
BASEMENT



# STRUCTURAL SCHEME

# BASEMENT

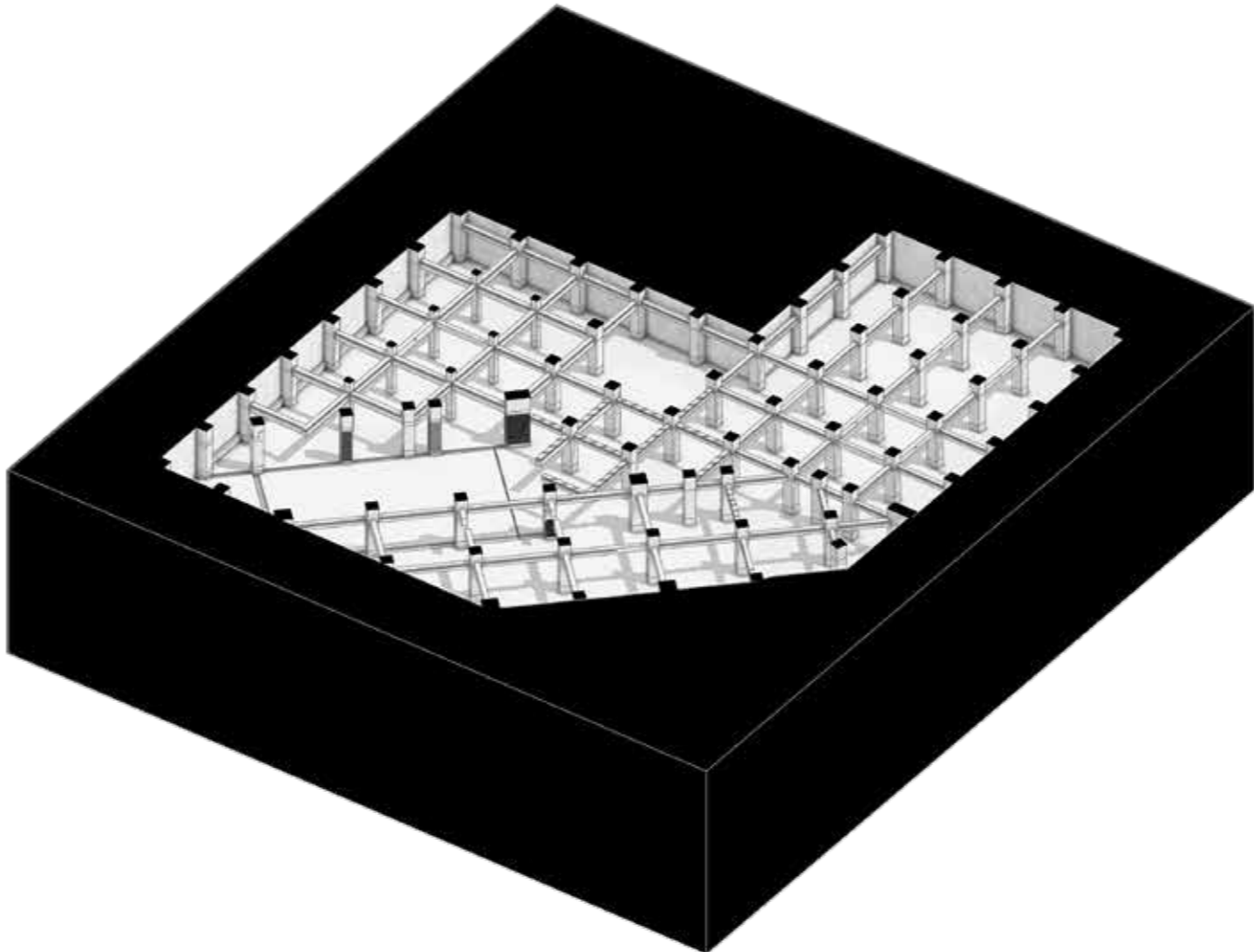

**CONCRETE BEAMS**  
BASEMENT



# STRUCTURAL SCHEME

# BASEMENT

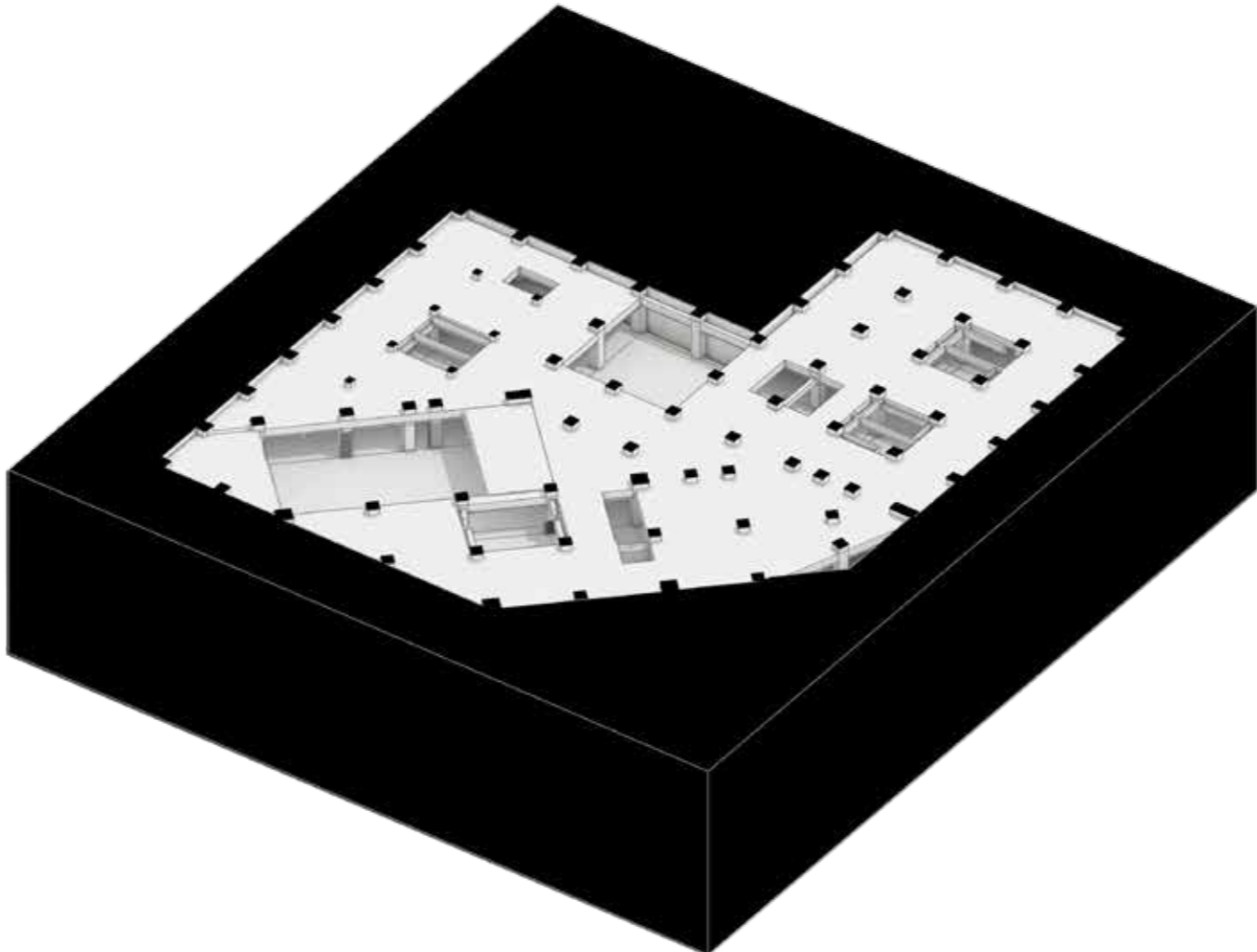

**SLABS**  
**BASEMENT**



# STRUCTURAL SCHEME

# BASEMENT

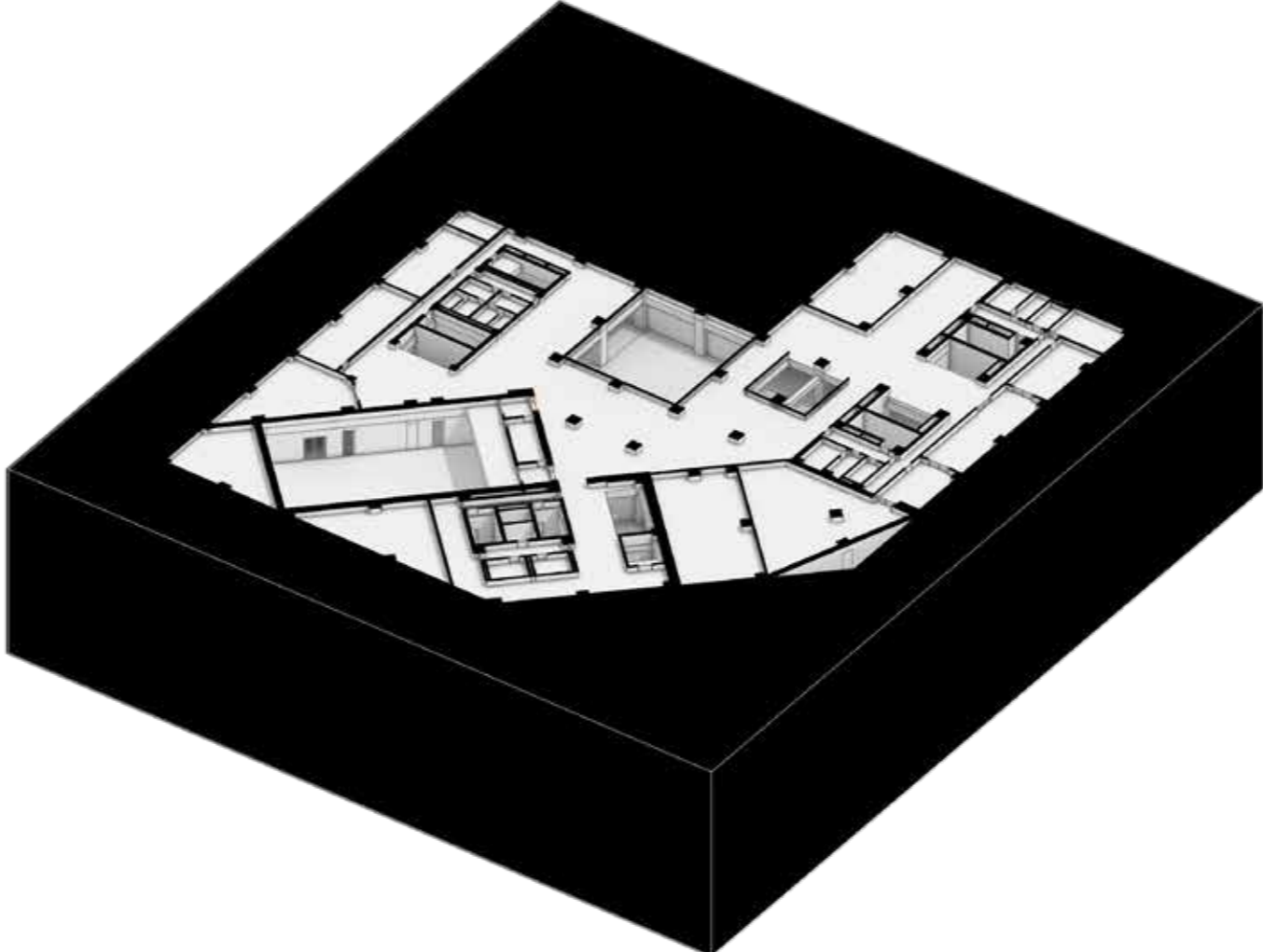

WALLS  
BASEMENT



# STRUCTURAL SCHEME

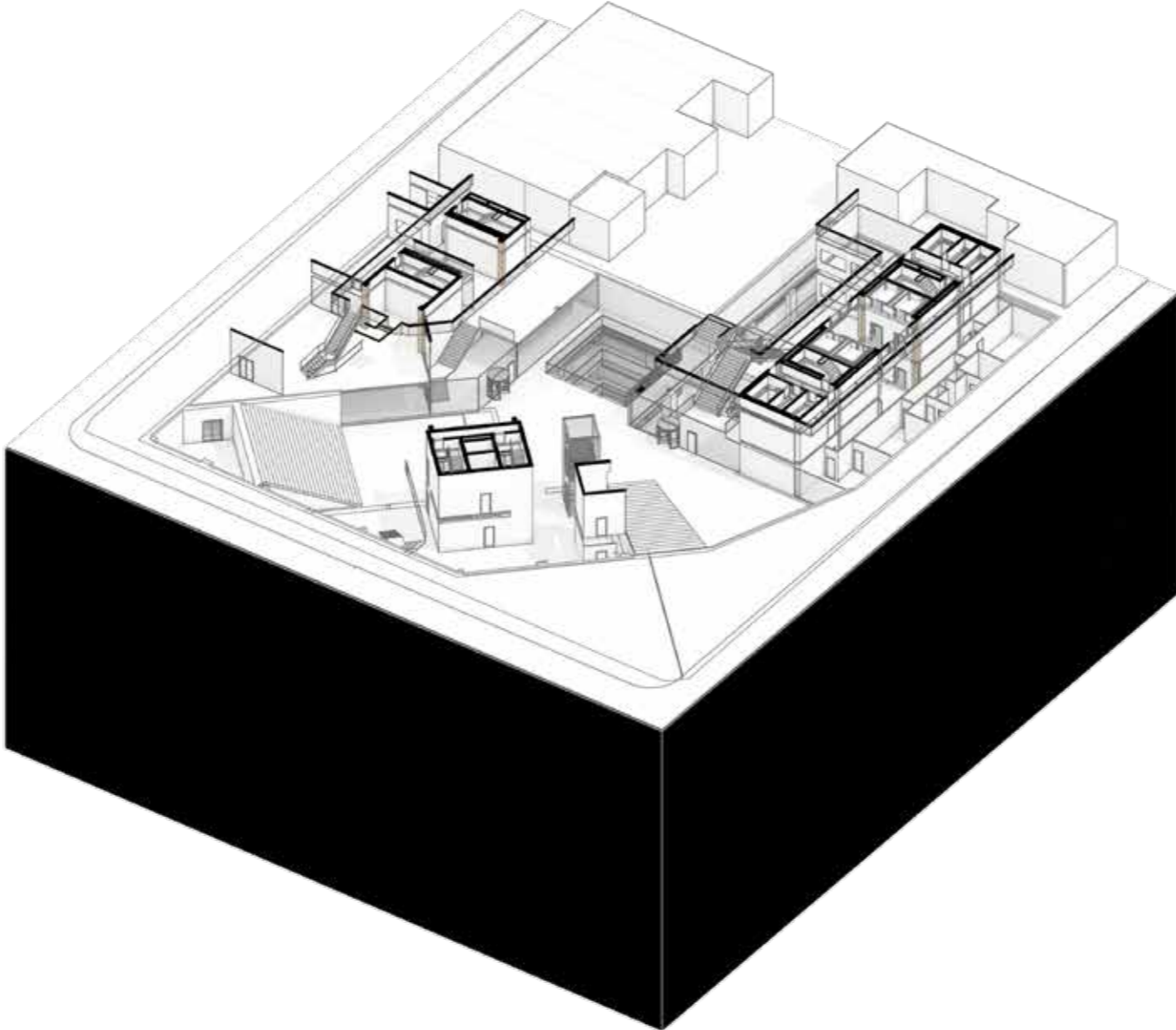



# STRUCTURAL SCHEME

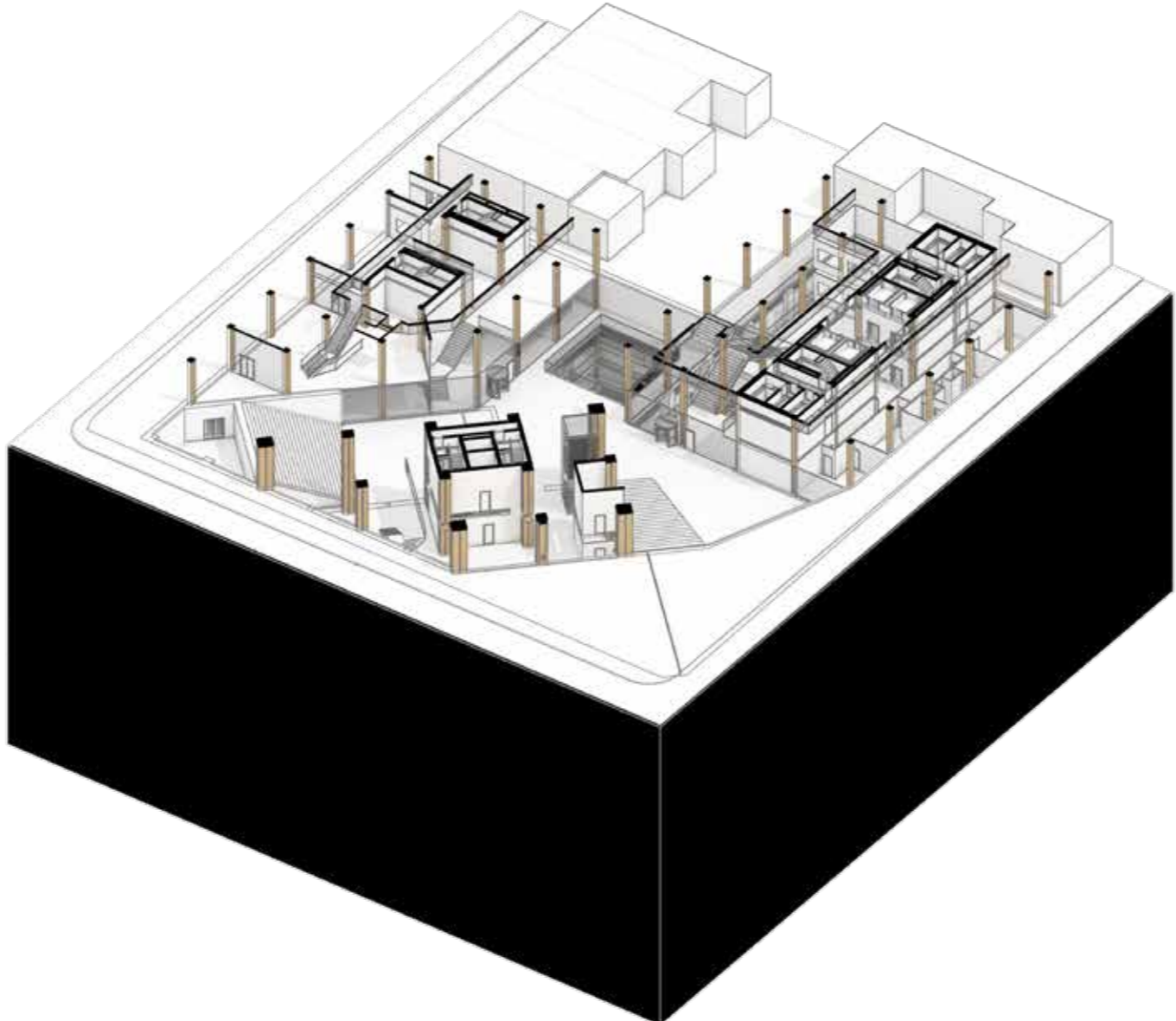



# STRUCTURAL SCHEME

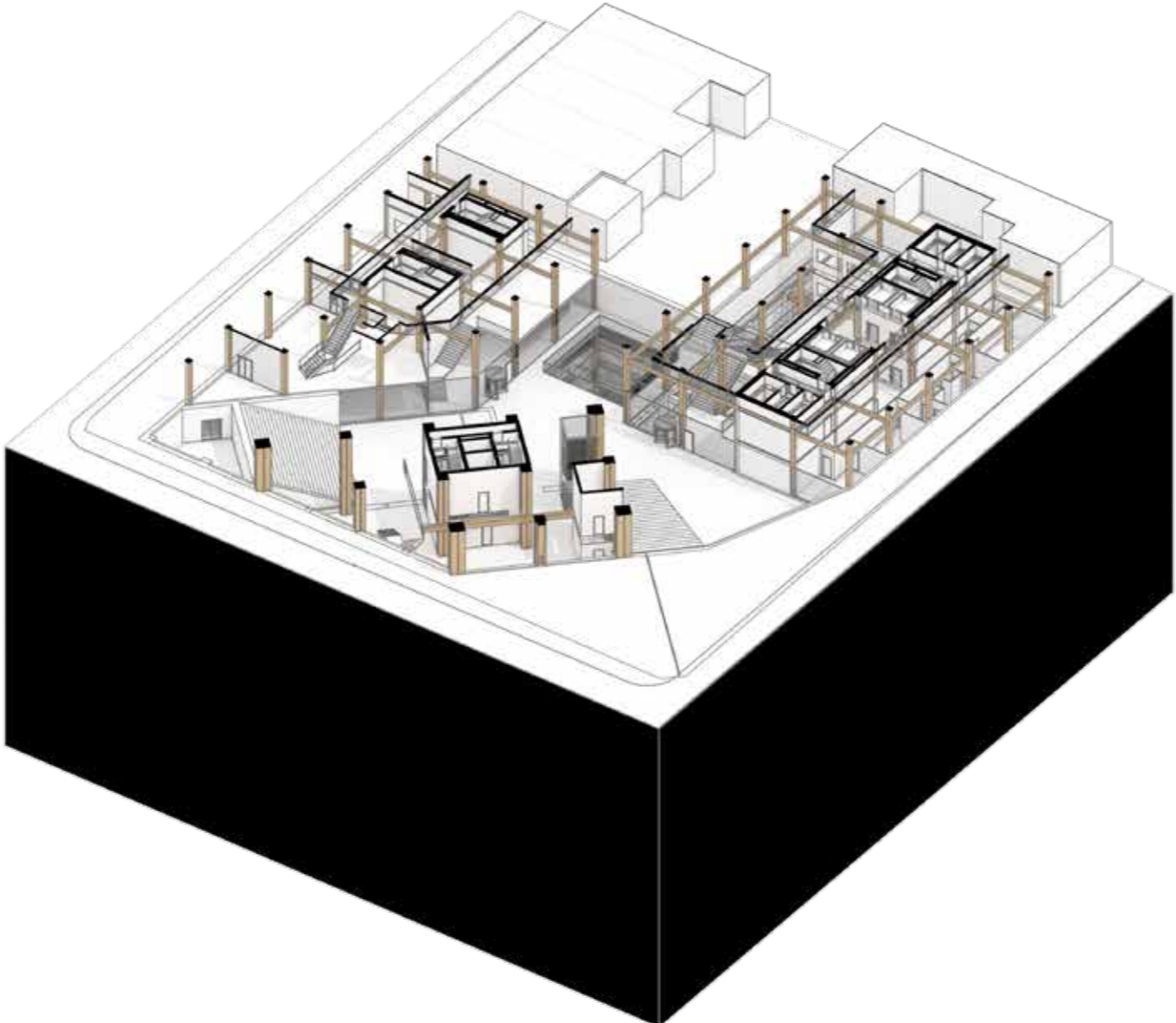



# STRUCTURAL SCHEME

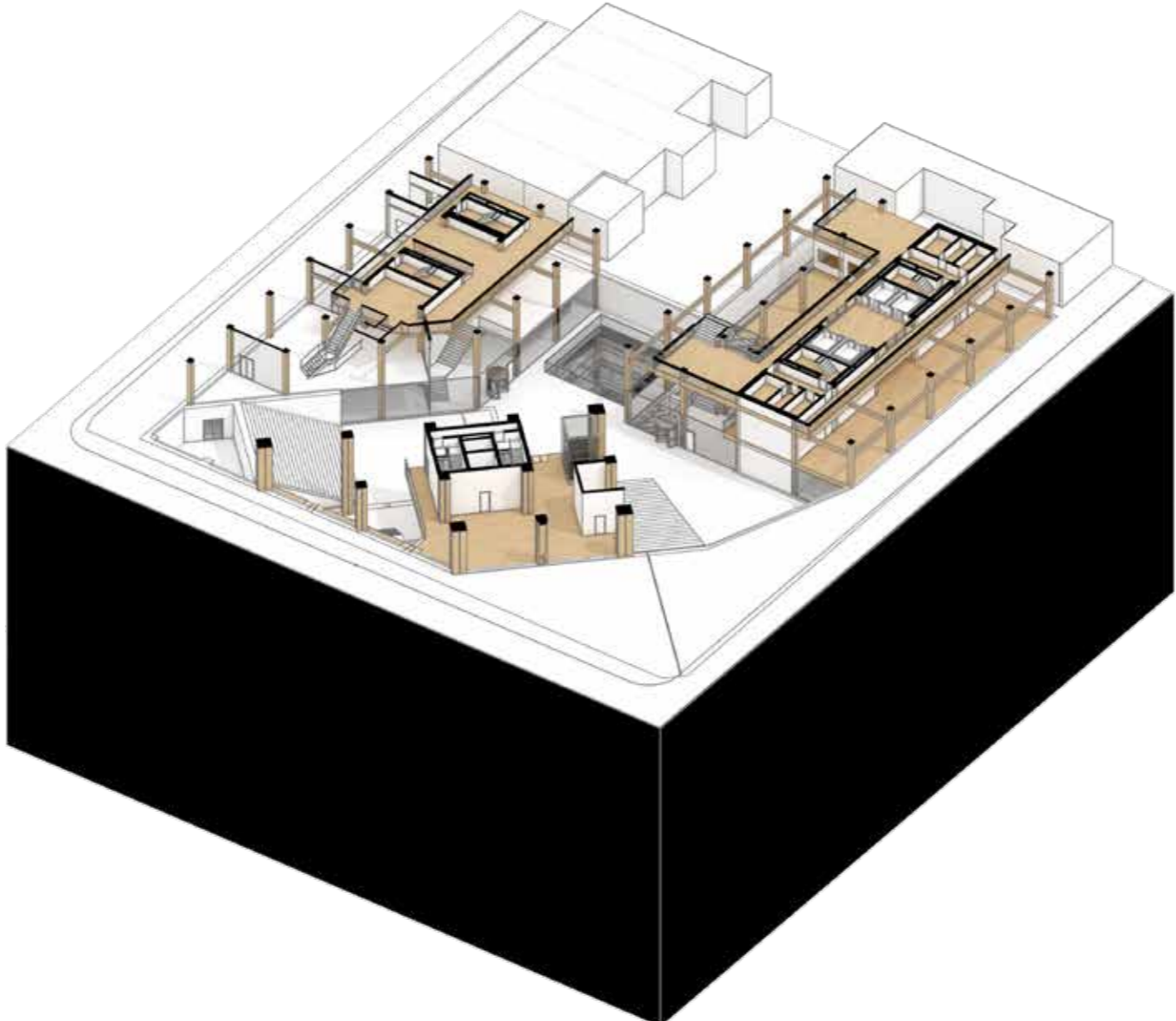



# STRUCTURAL SCHEME

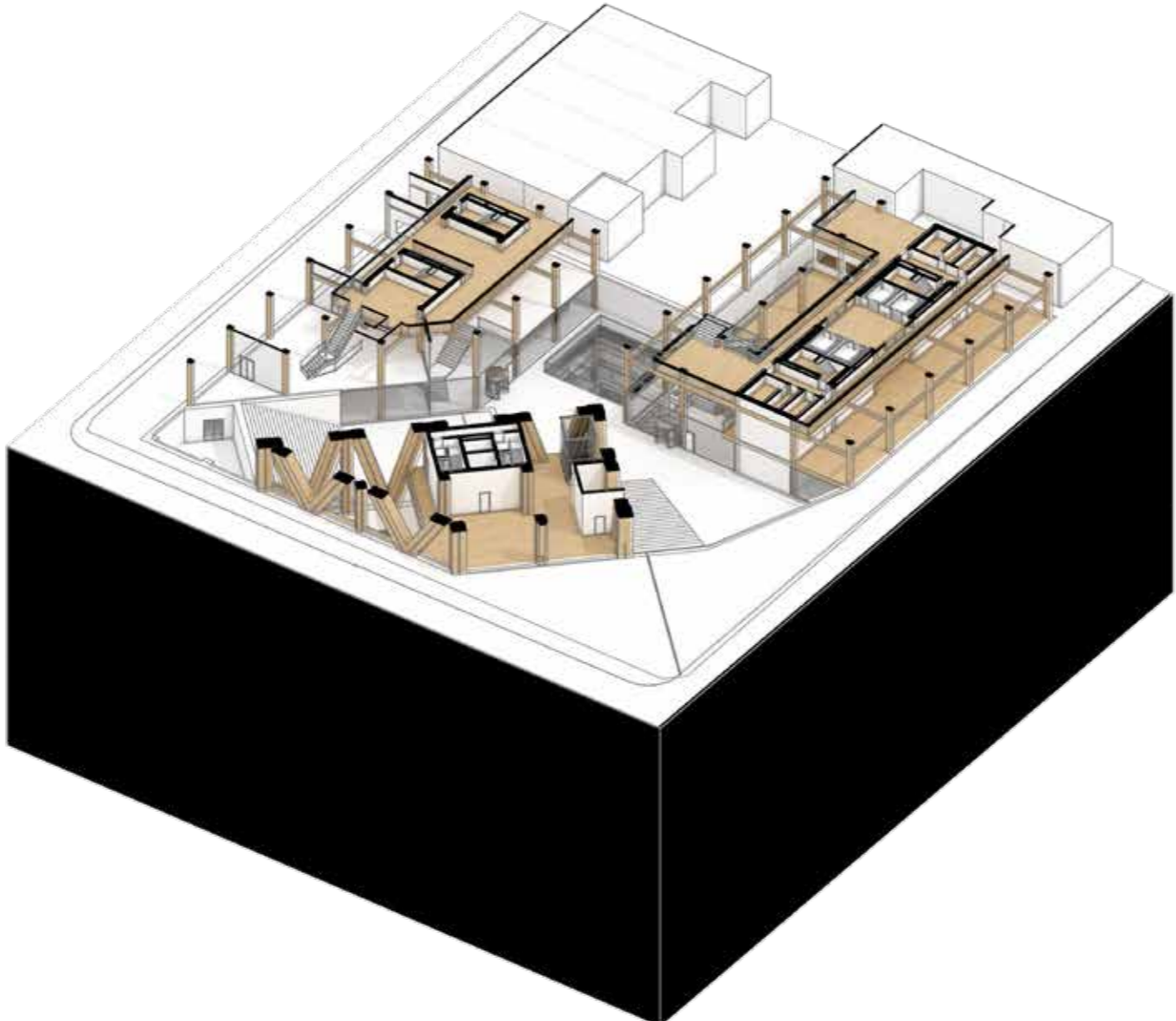



# STRUCTURAL SCHEME

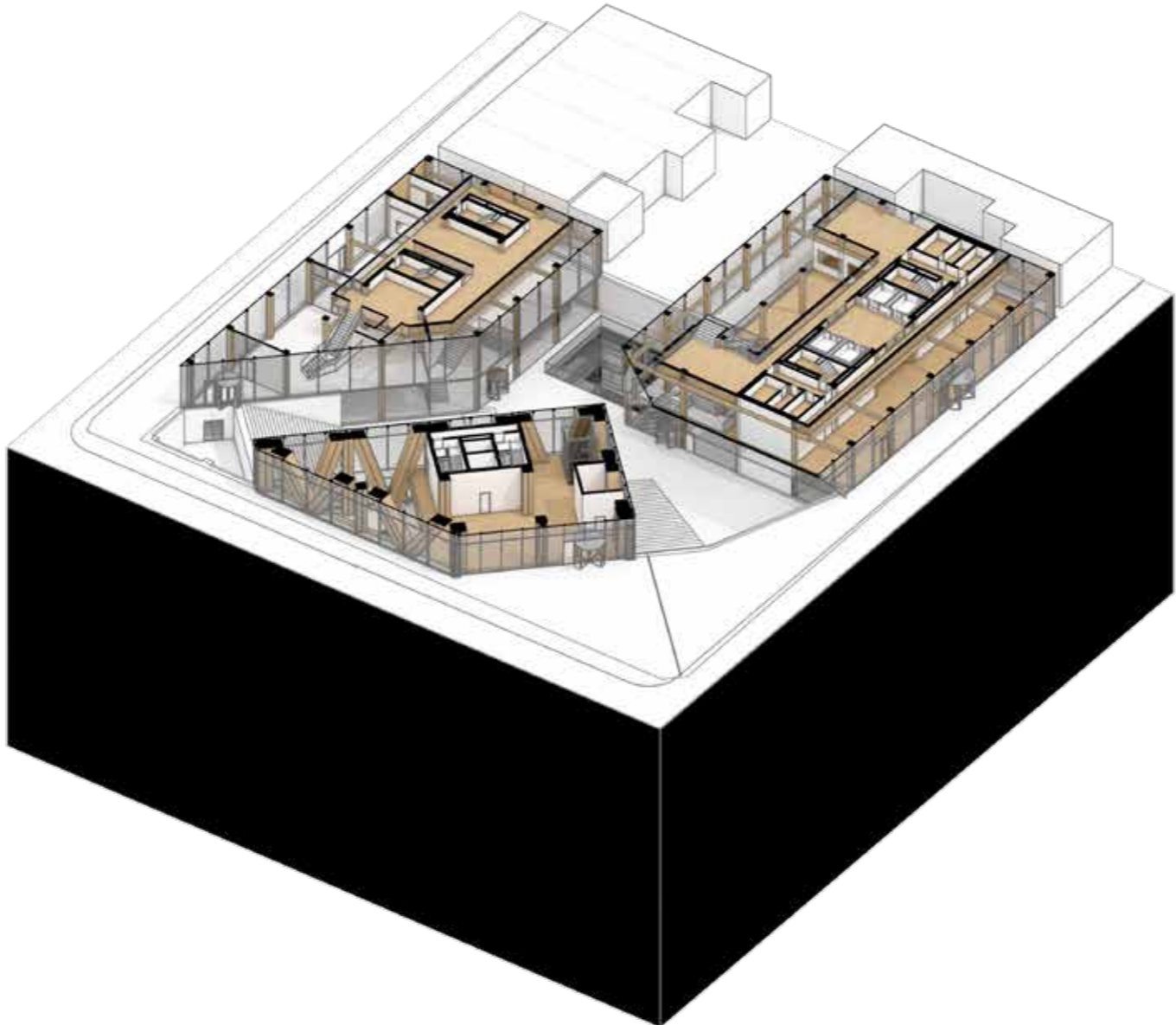



# STRUCTURAL SCHEME

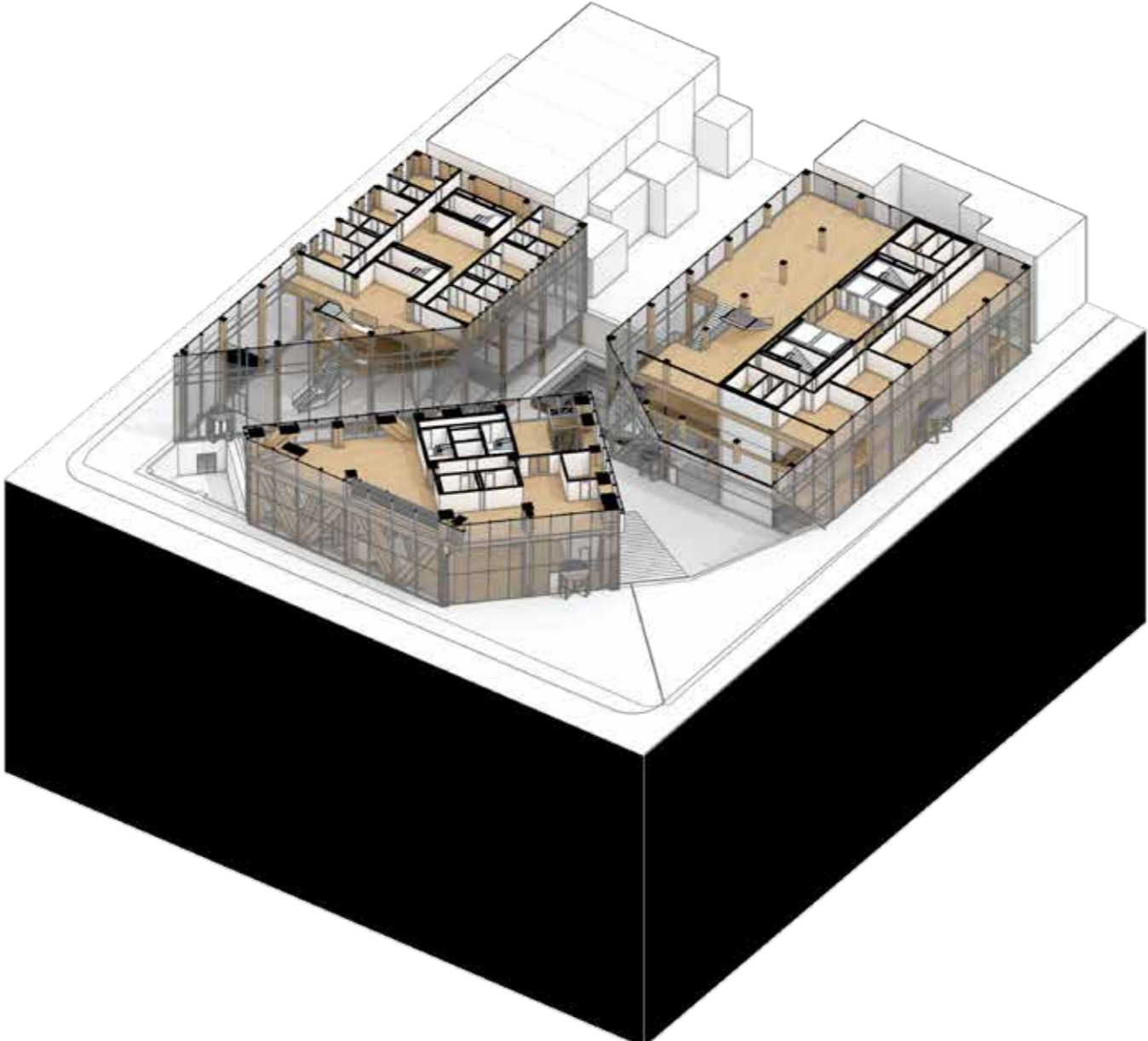



# STRUCTURAL SCHEME

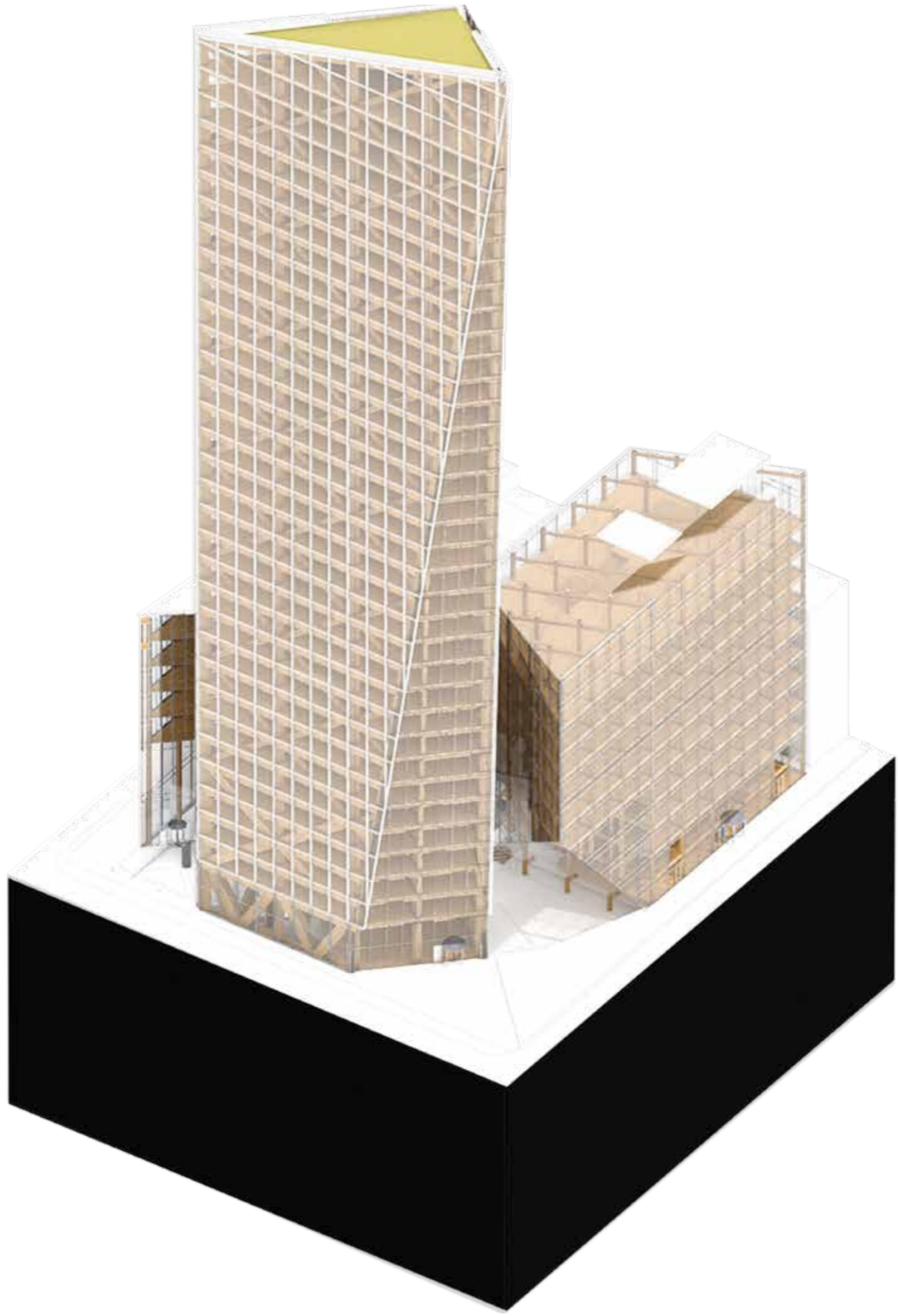

**ELEVATIONS 1:200**



# ELEVATION

EAST

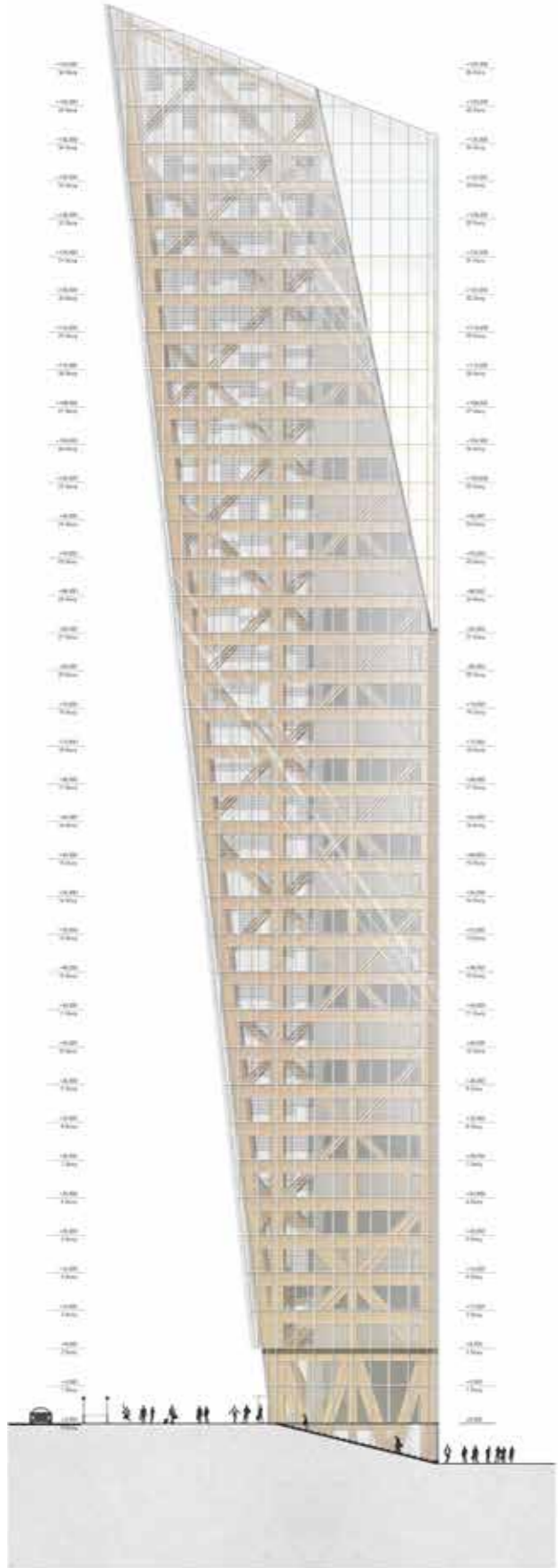

# ELEVATION

# SOUTH

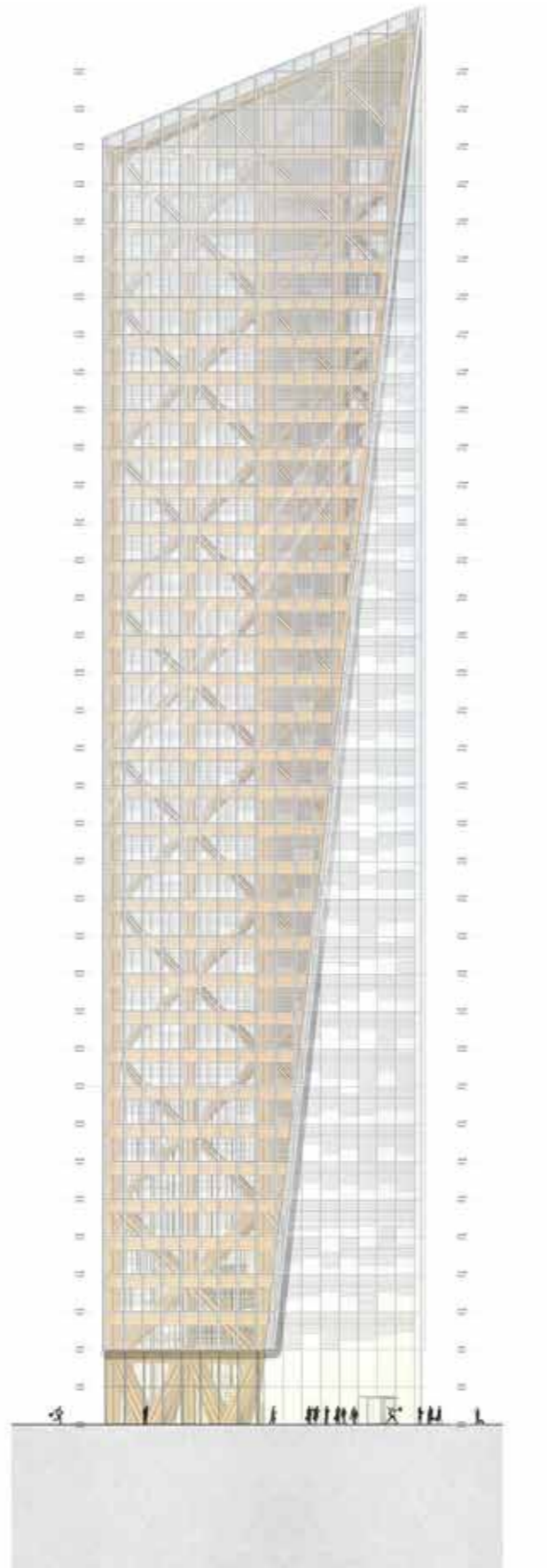
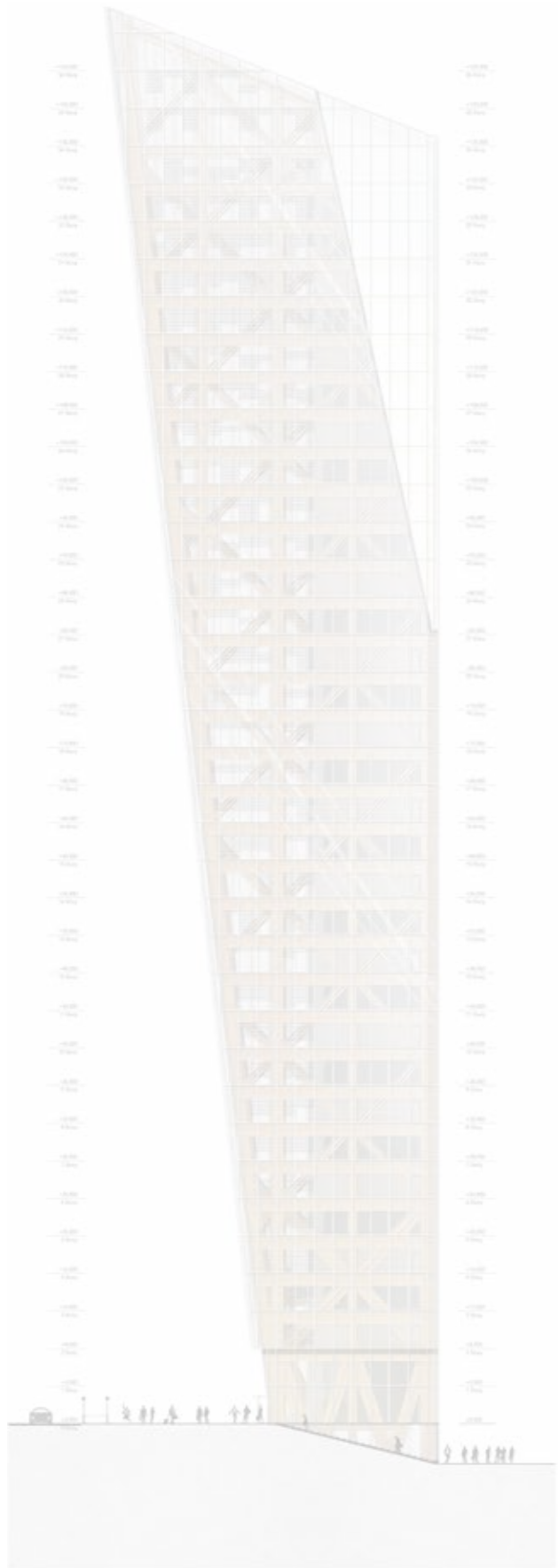



# ELEVATION

WEST



# ELEVATIONS

NORTH

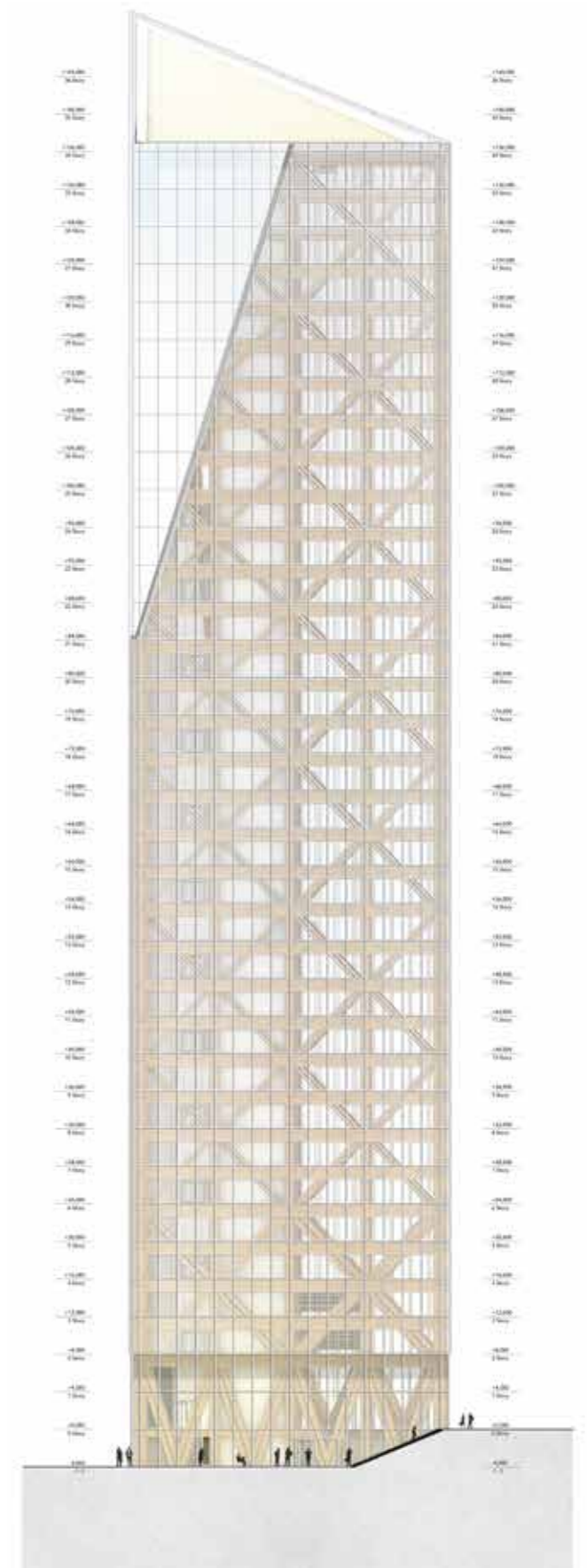
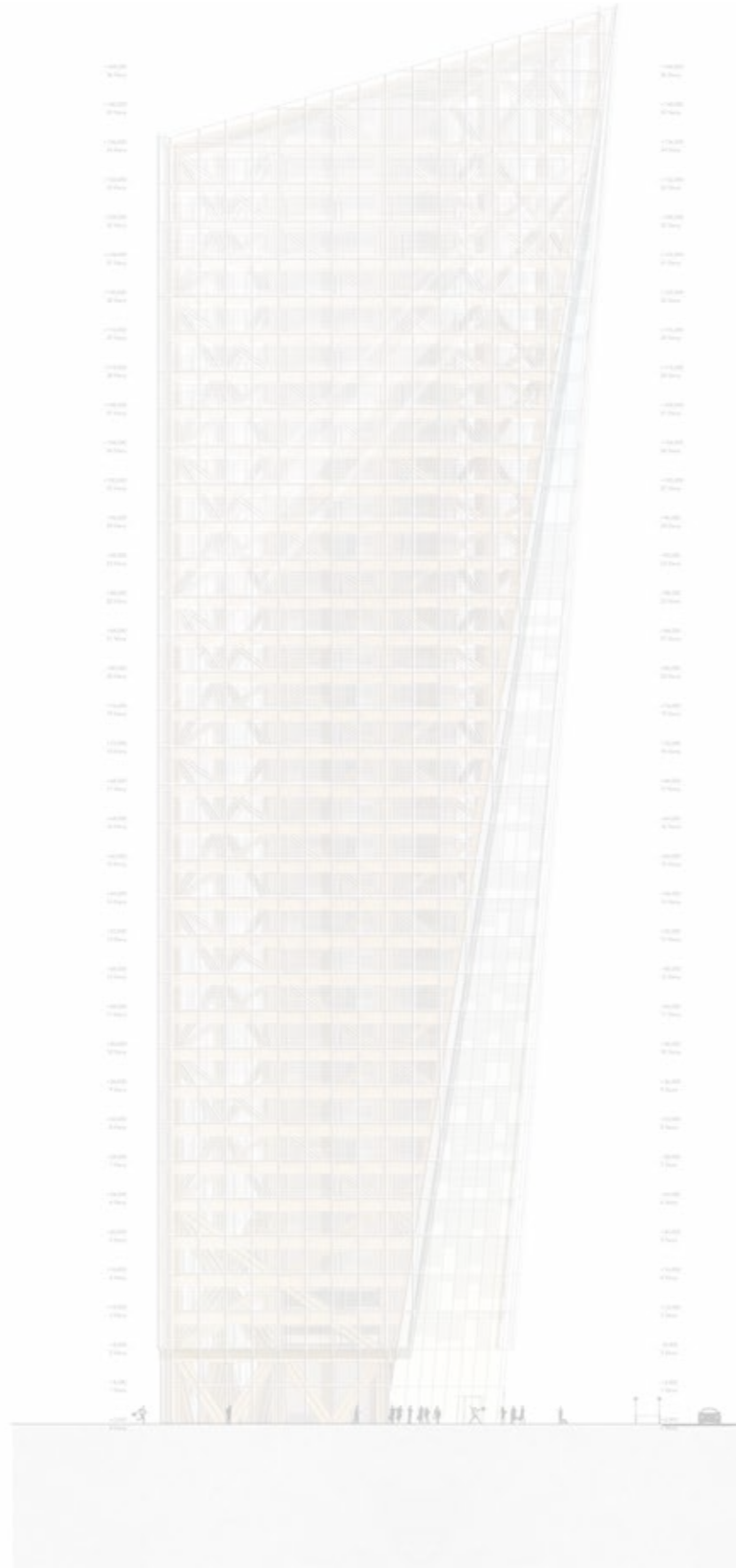
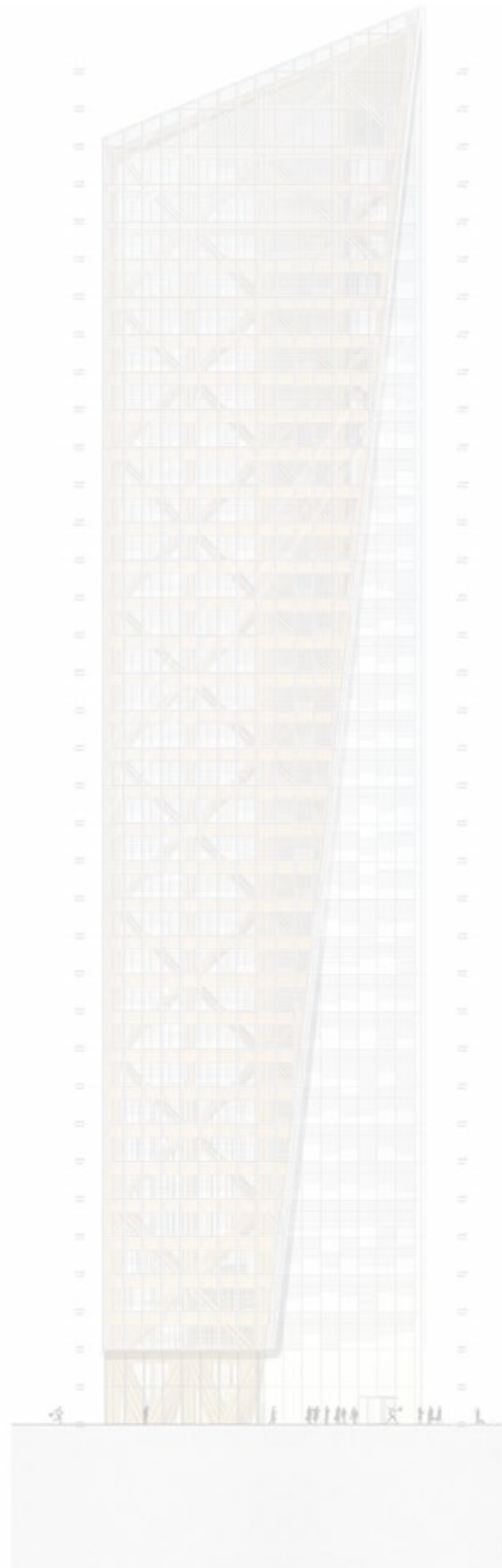
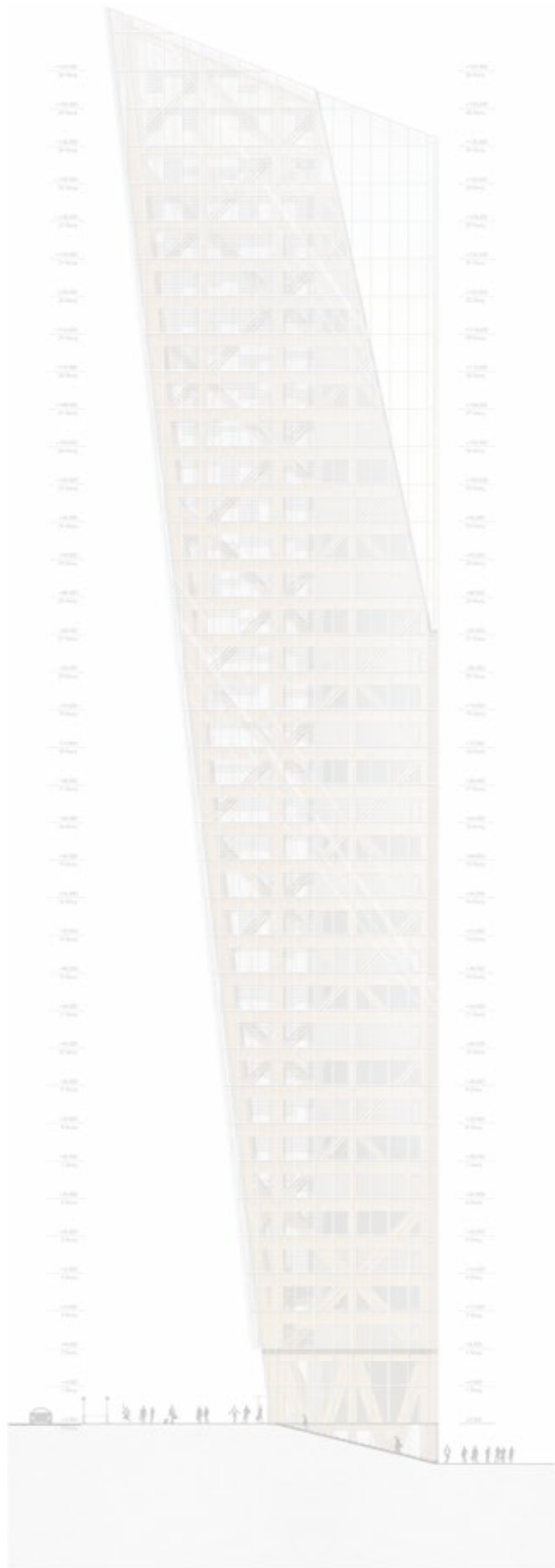



# ELEVATIONS

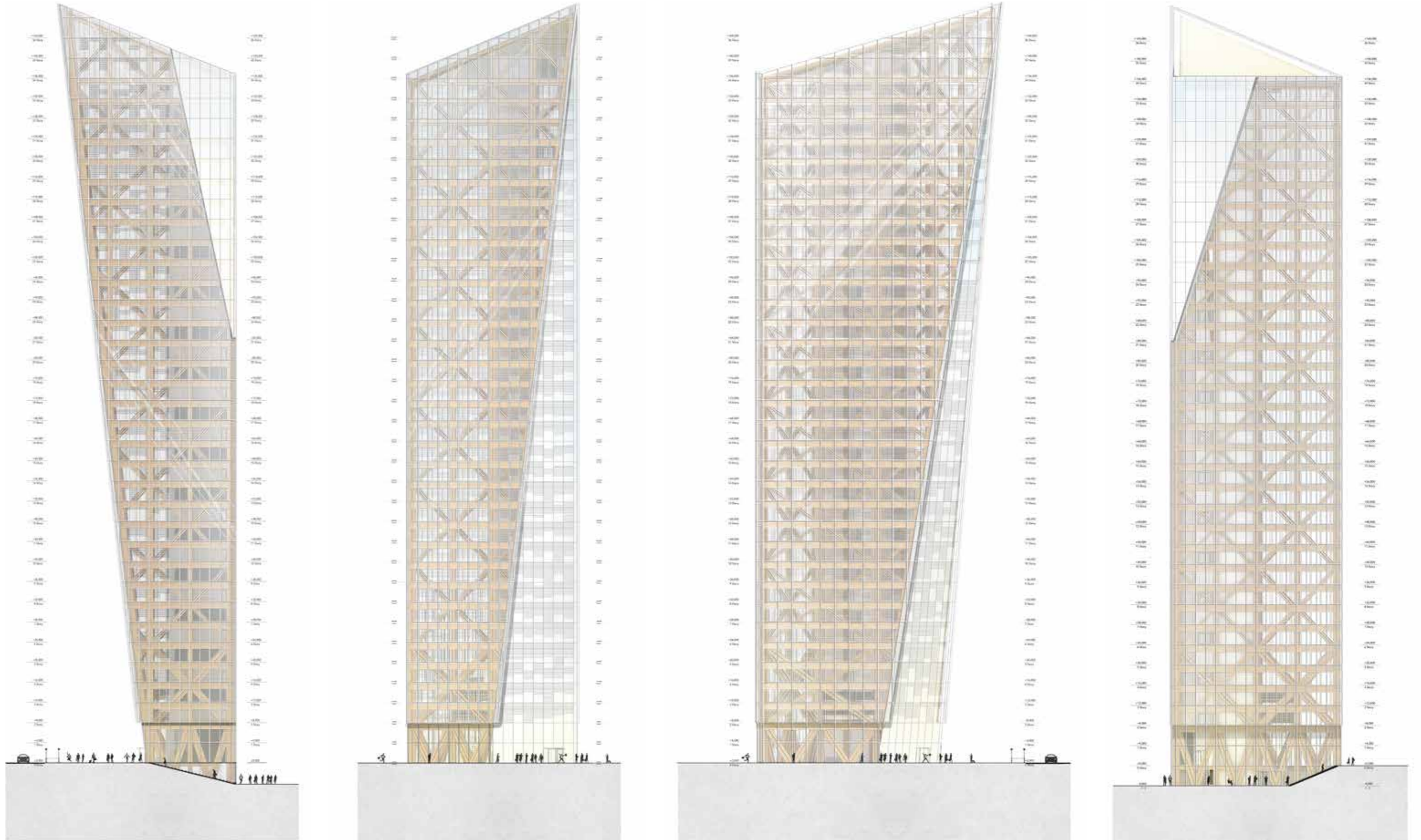

# ELEVATIONS

# GROUND LEVEL RELATIONS

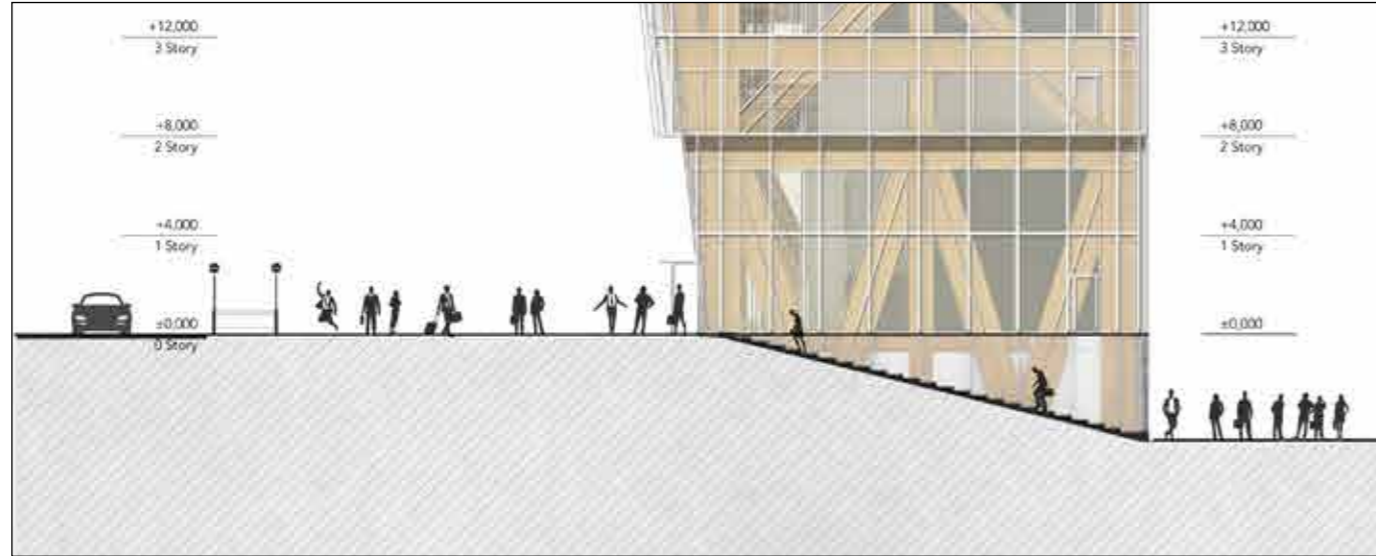

**SUBWAY ENTRANCE**

**EAST**



# ELEVATIONS

# GROUND LEVEL RELATIONS

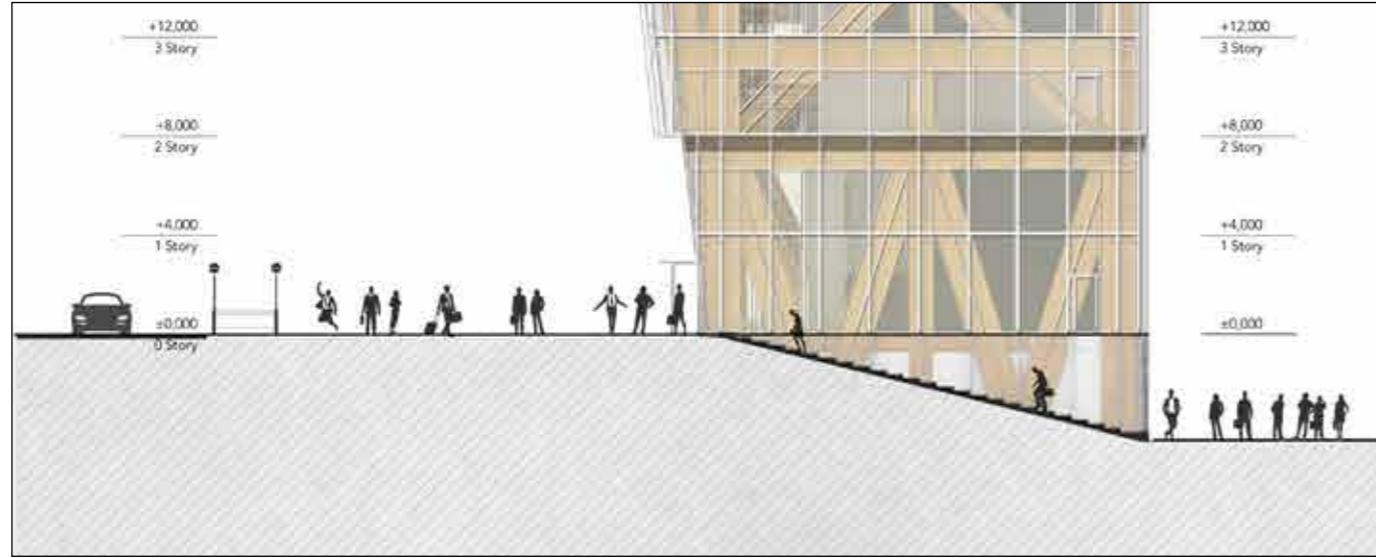

**SUBWAY ENTRANCE**

**EAST**

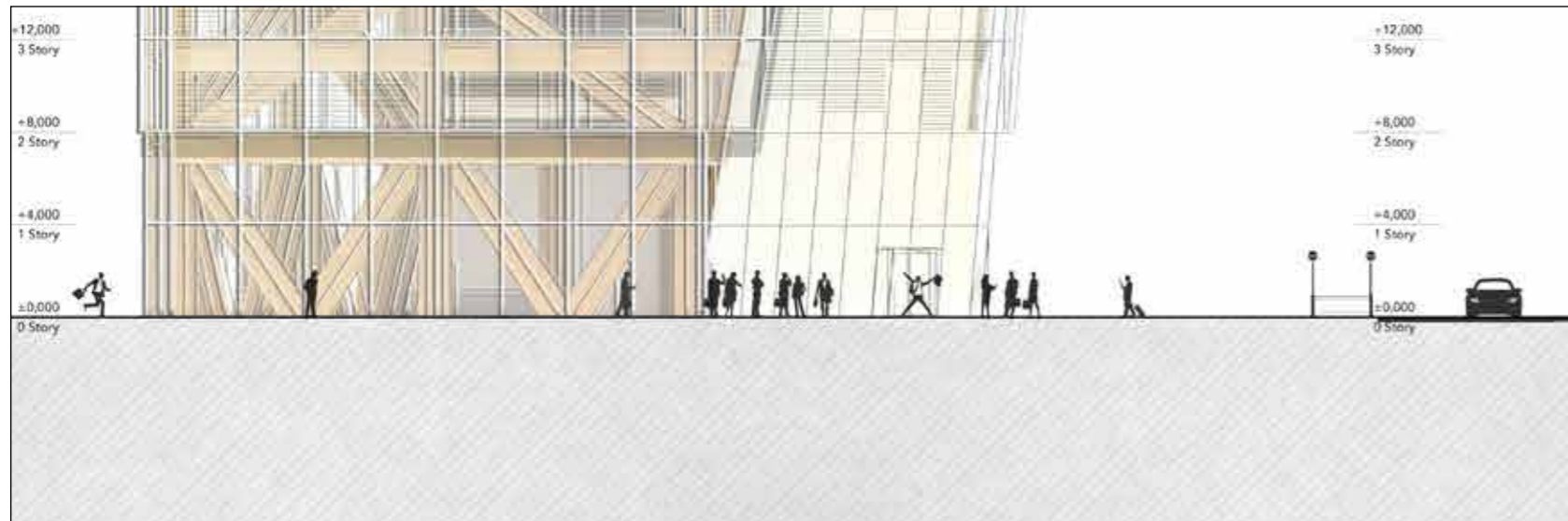

**LEXINGTON AVENUE**

**WEST**

# ELEVATIONS

# GROUND LEVEL RELATIONS

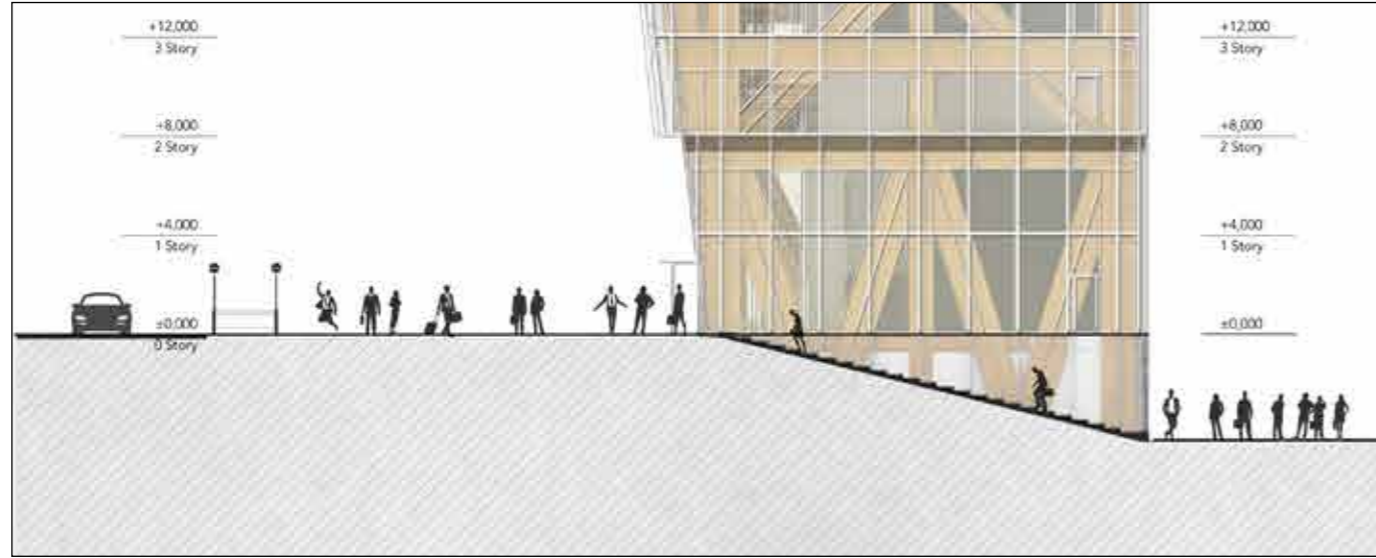

**SUBWAY ENTRANCE**

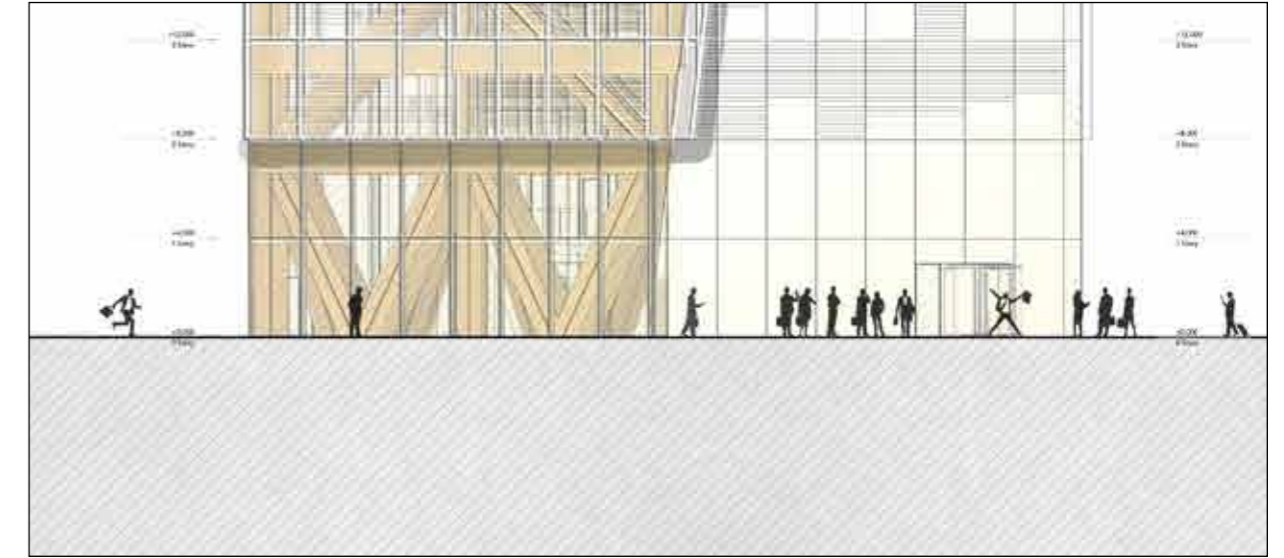

**SOUTH**

**TOWER ENTRANCE**

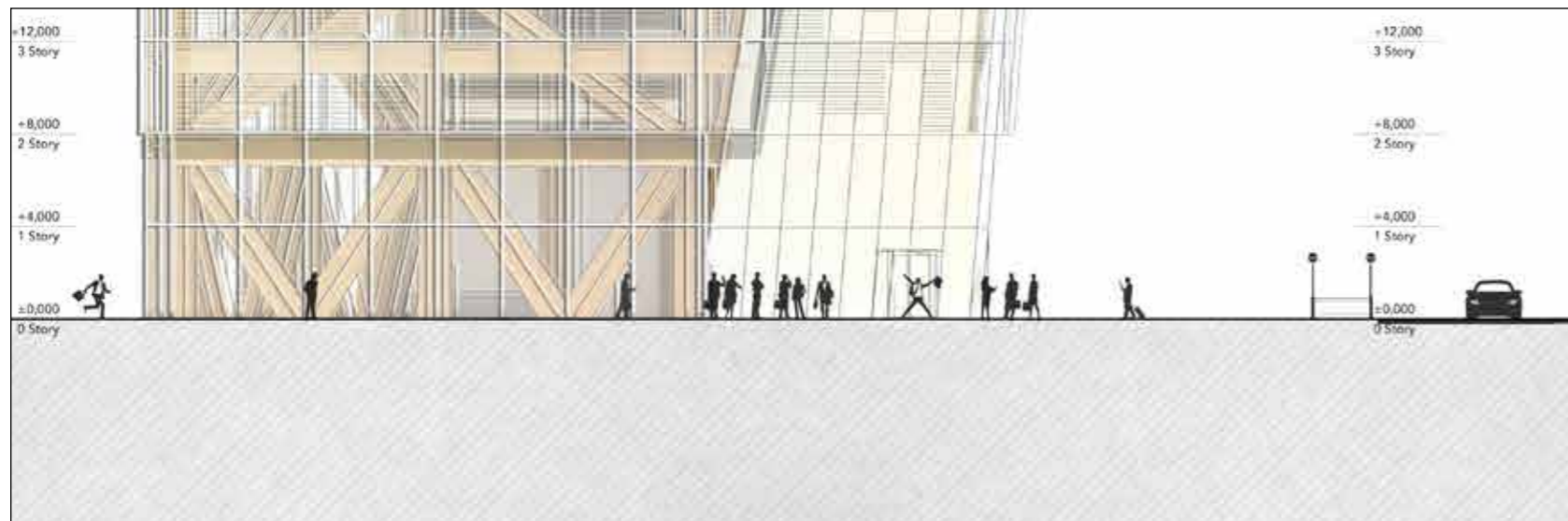

**LEXINGTON AVENUE**

**WEST**



# ELEVATIONS

# GROUND LEVEL RELATIONS

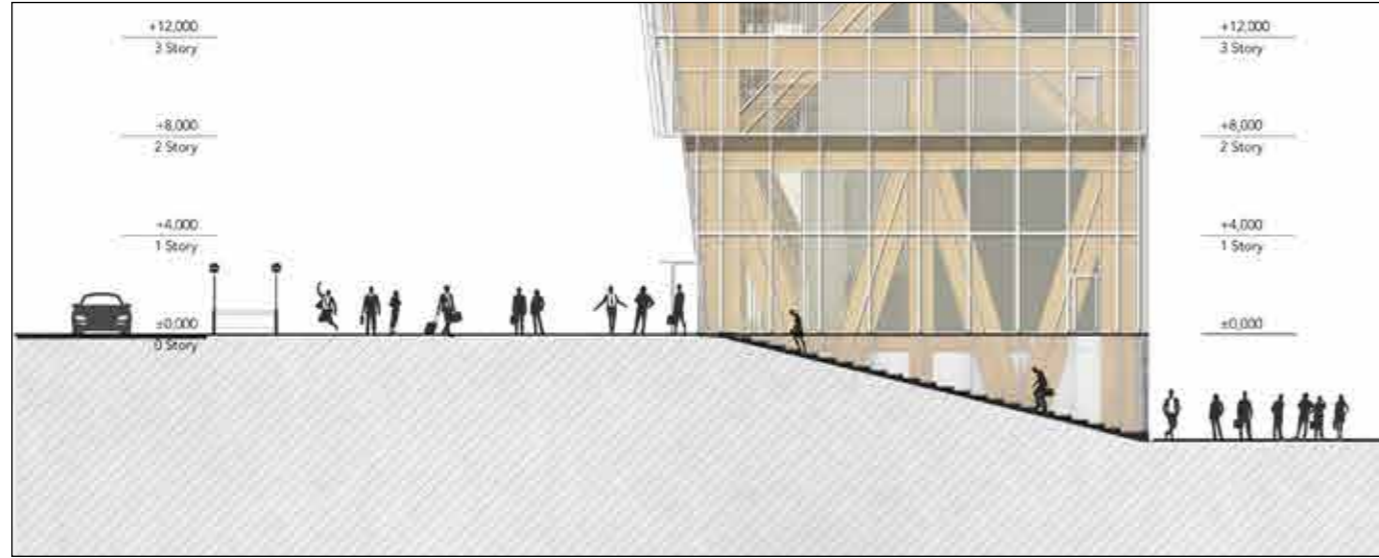

**SUBWAY ENTRANCE**

**EAST**

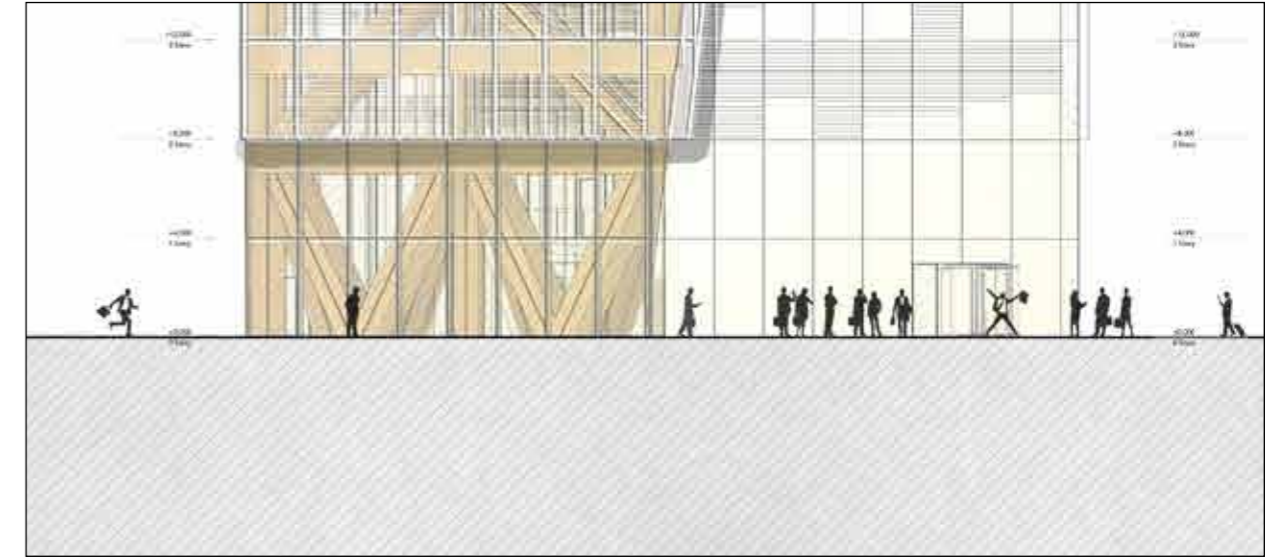

**SOUTH**

**TOWER ENTRANCE**

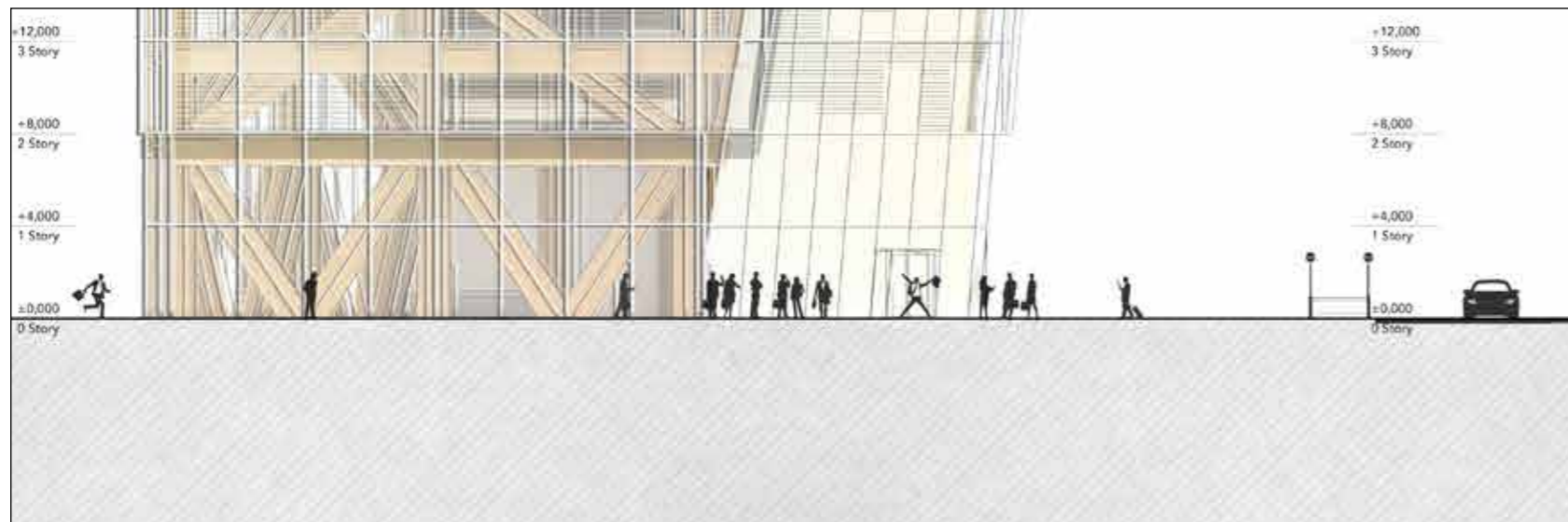

**LEXINGTON AVENUE**

**WEST**

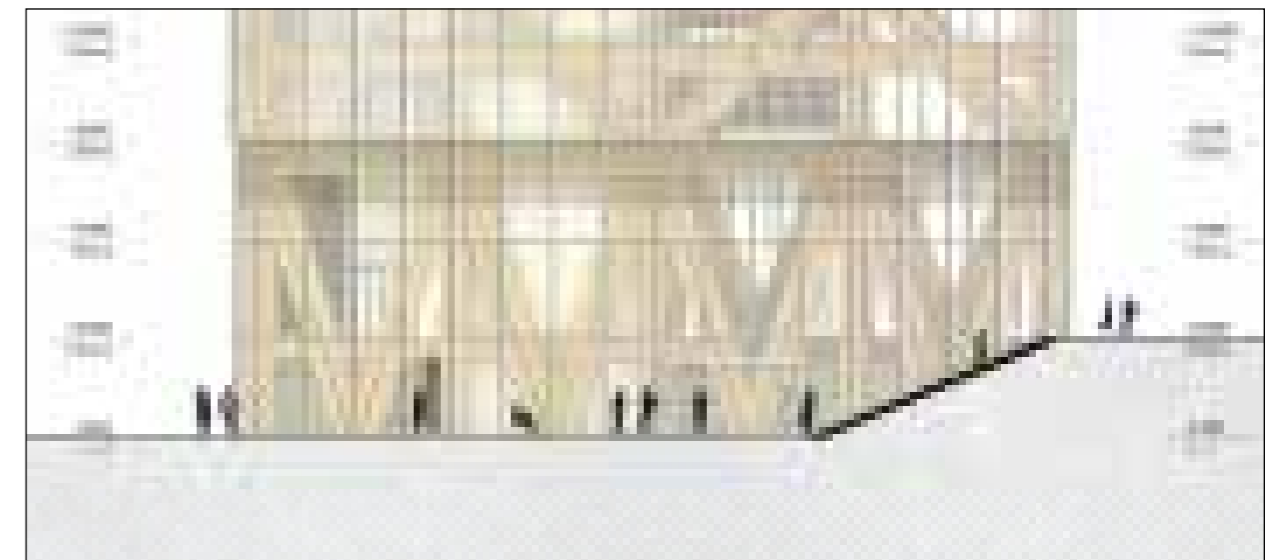

**NORTH**

**SUNKEN PLAZA**

# ELEVATIONS

## GROUND LEVEL RELATIONS

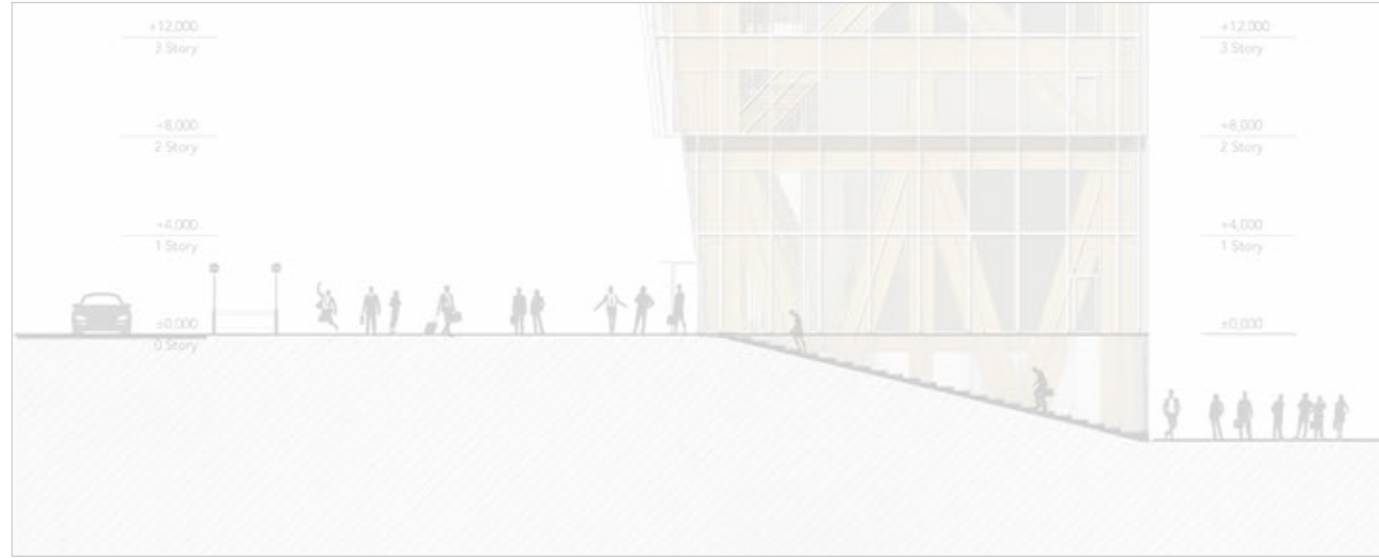

SUBWAY ENTRANCE



EAST SOUTH

TOWER ENTRANCE

## FACADE FRAGMENT 1:20



LEXINGTON AVENUE

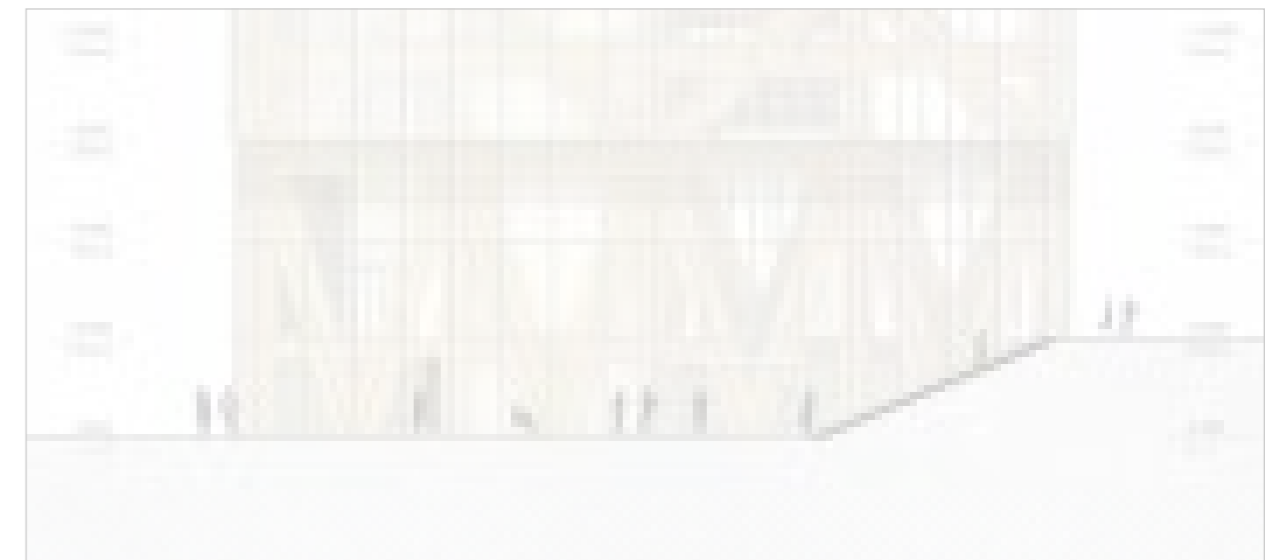

WEST NORTH

SUNKEN PLAZA





# ENVELOPE FRAGMENT 1:20

# GROUND LEVEL

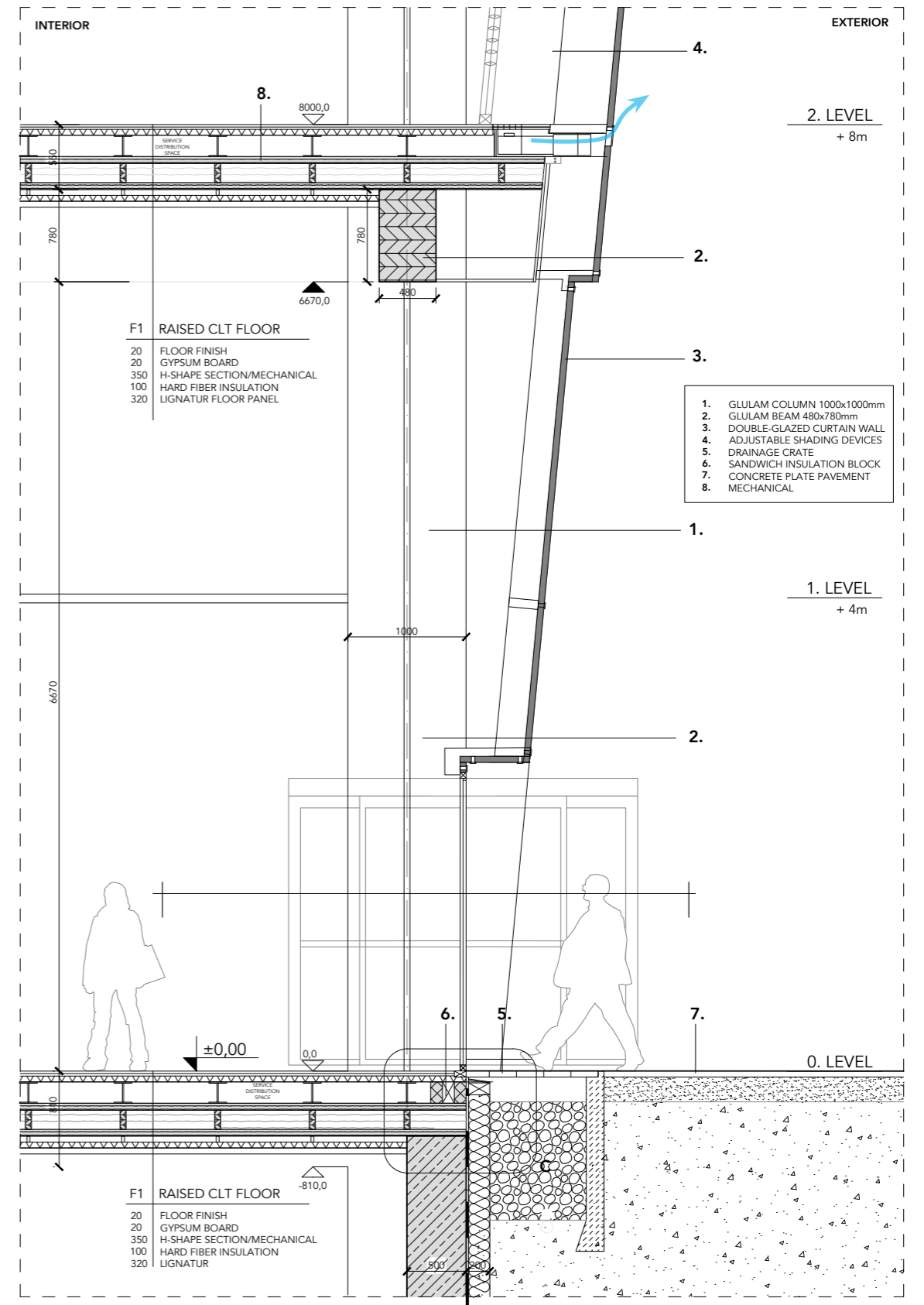

INTERIOR

SECTION



# ENVELOPE FRAGMENT 1:20

# FLOORS CONNECTION

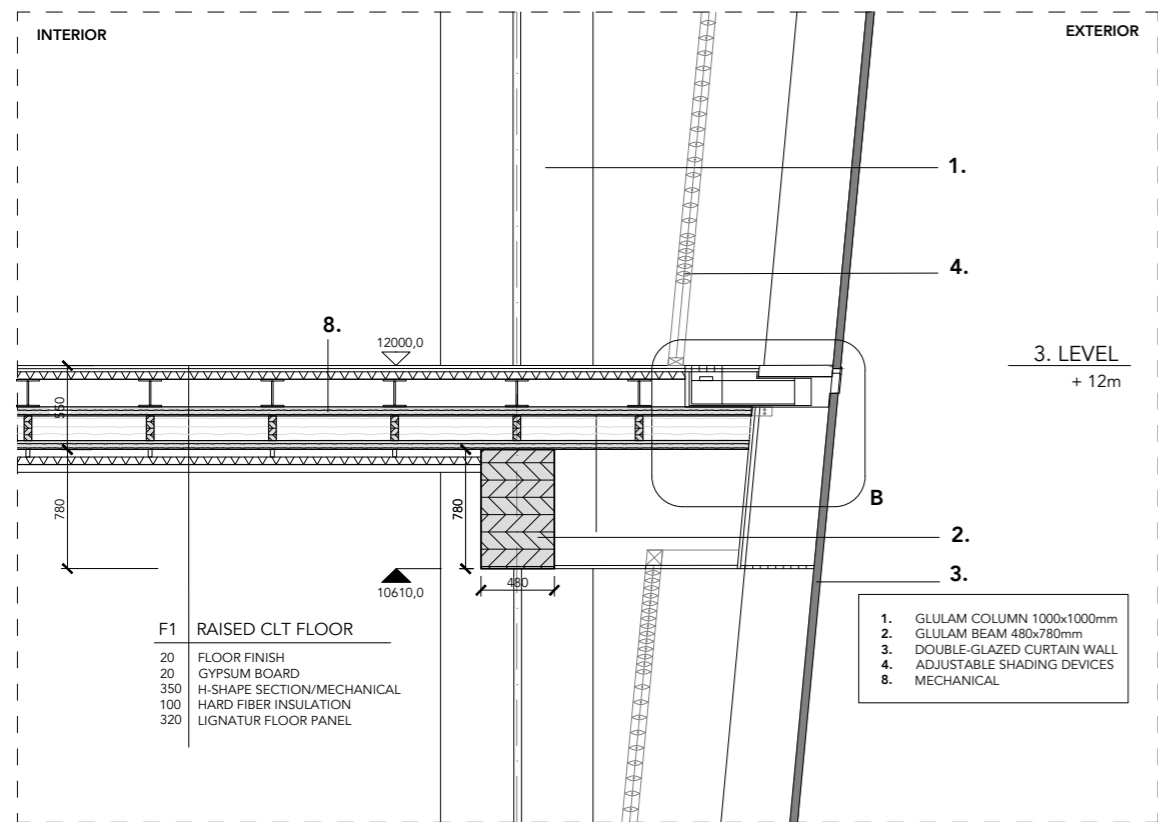

# ENVELOPE FRAGMENT 1:20

# FLOORS CONNECTION



INTERIOR

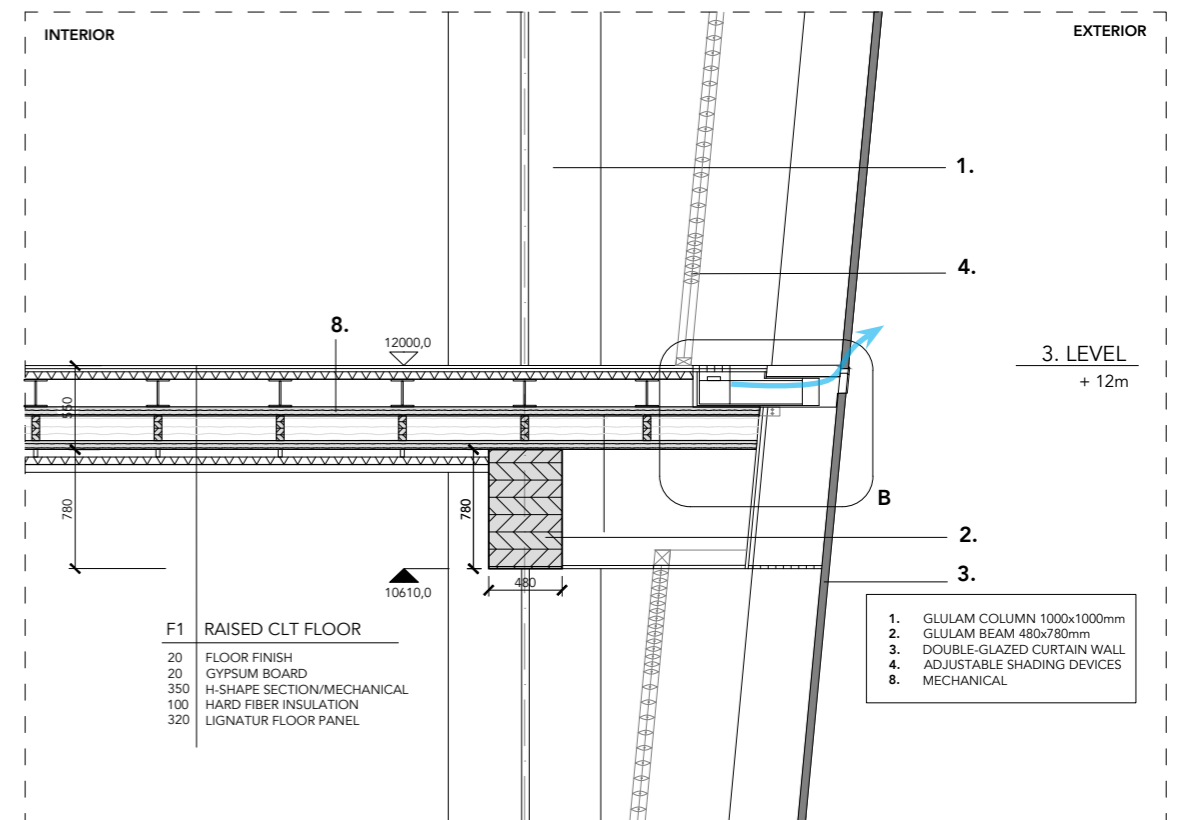

SECTION



# ENVELOPE FRAGMENT 1:20

# ROOF TOP

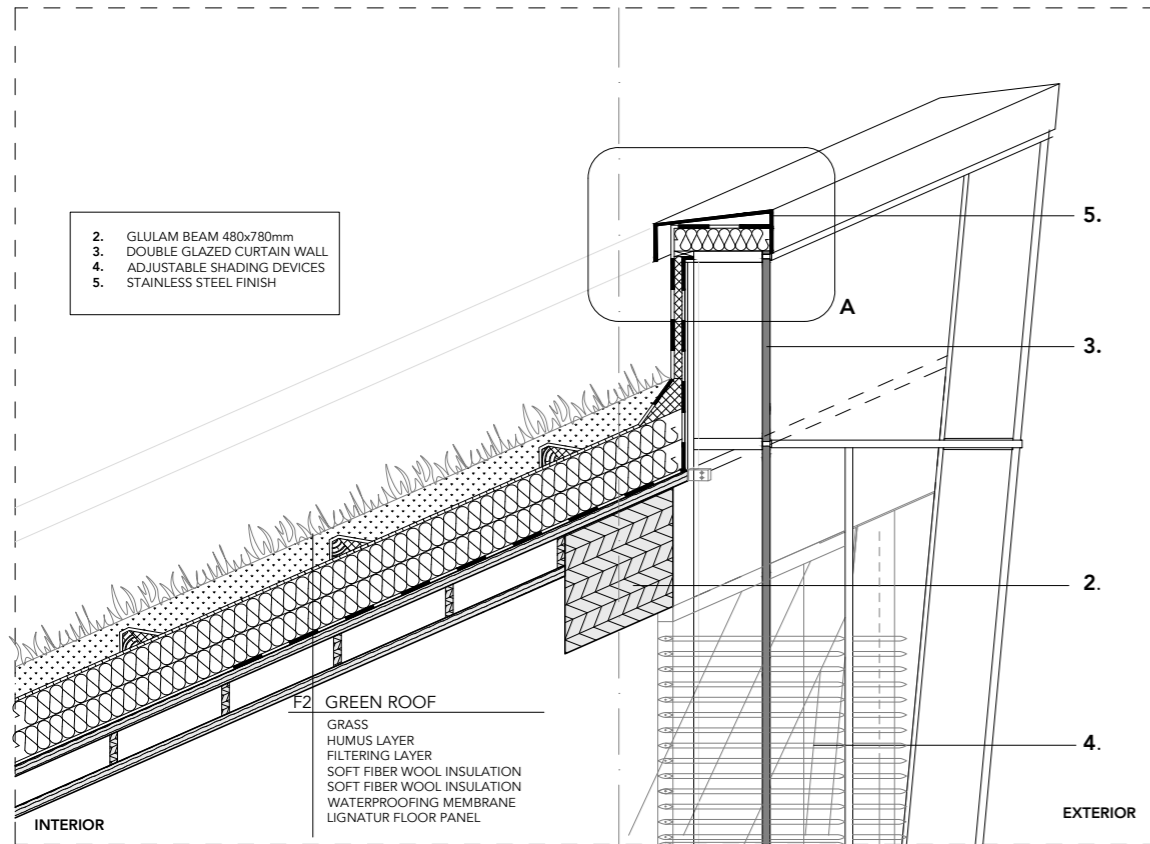

SECTION



EXTERIOR

# ENVELOPE FRAGMENT 1:20

# ROOF TOP

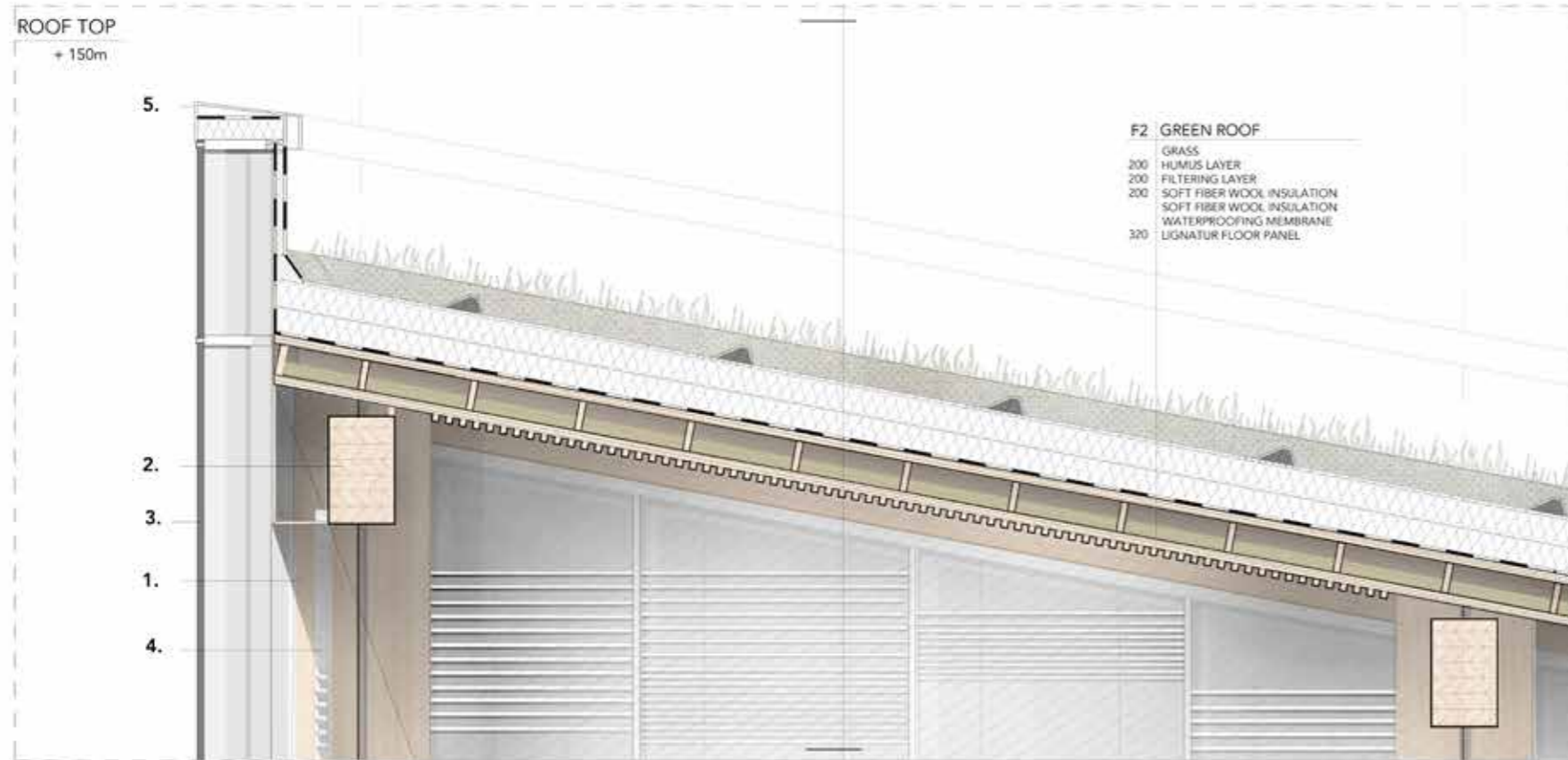

INTERIOR

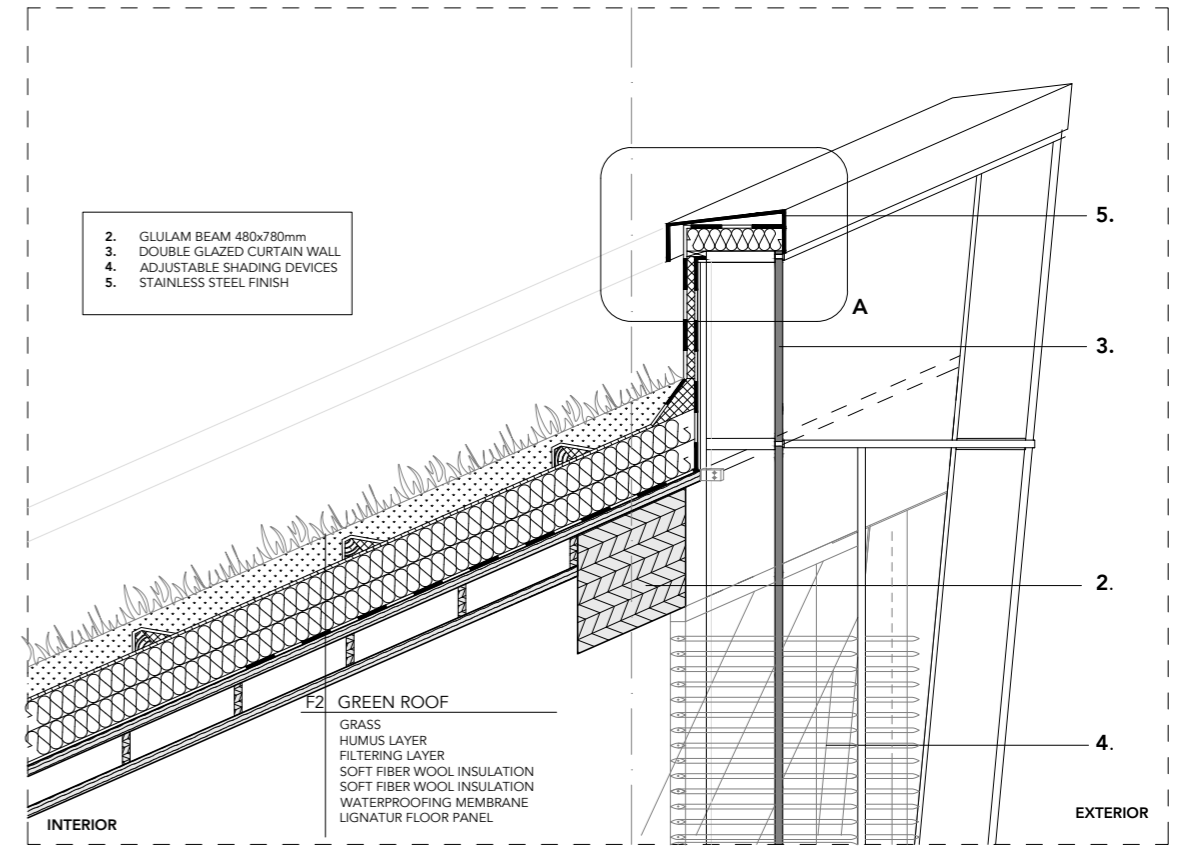

SECTION



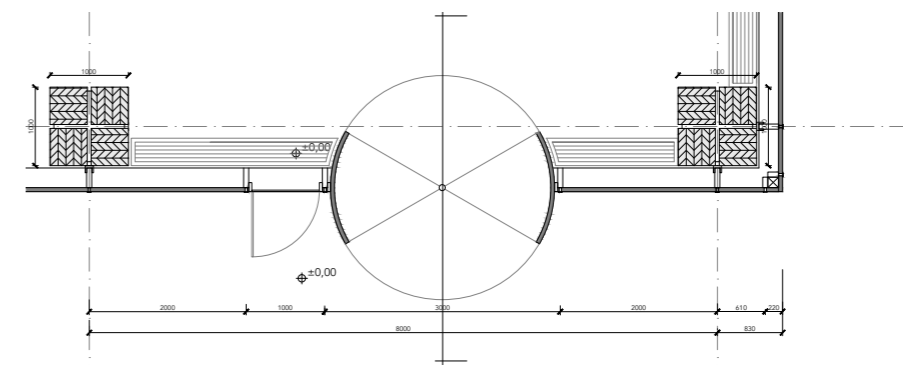
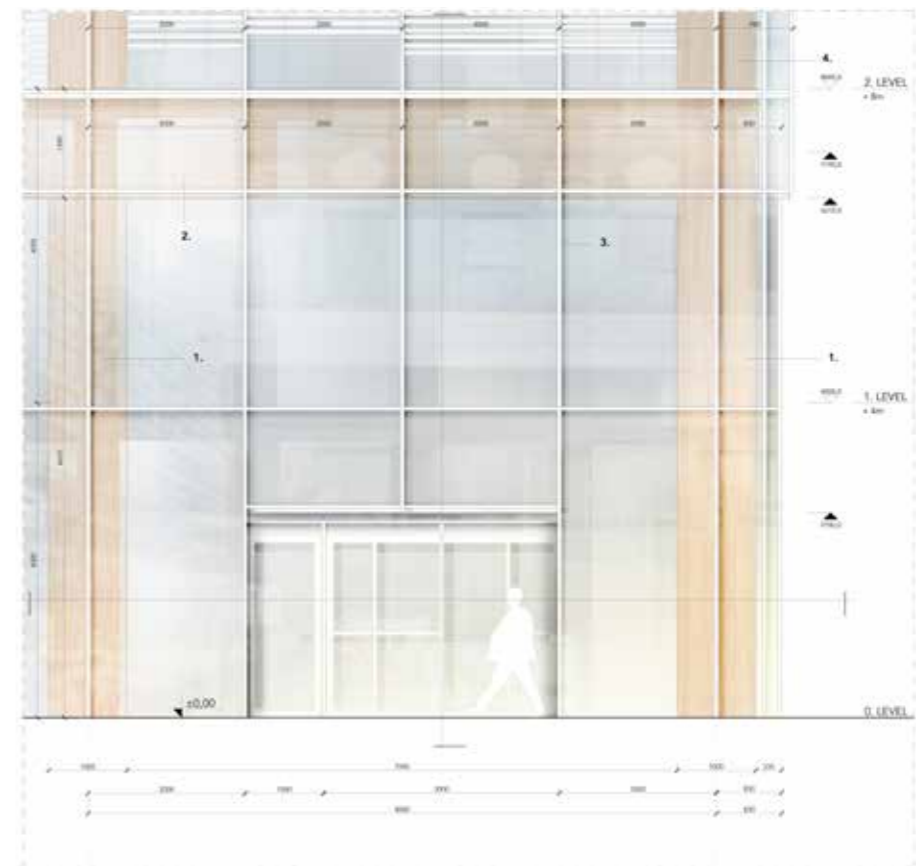
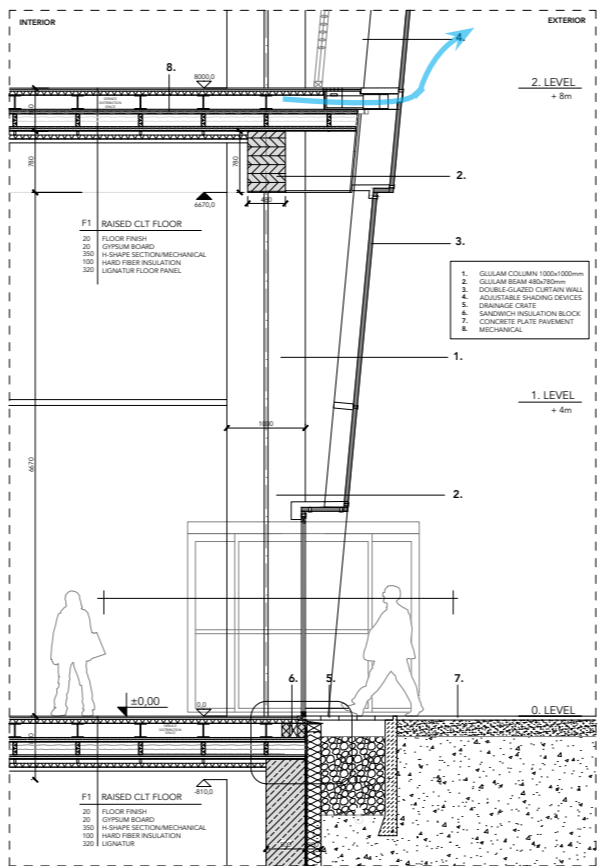
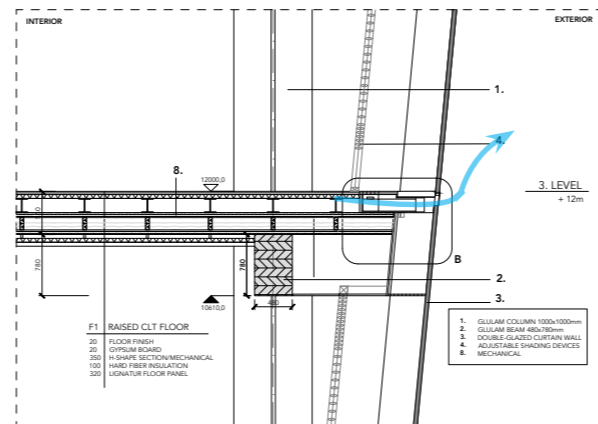
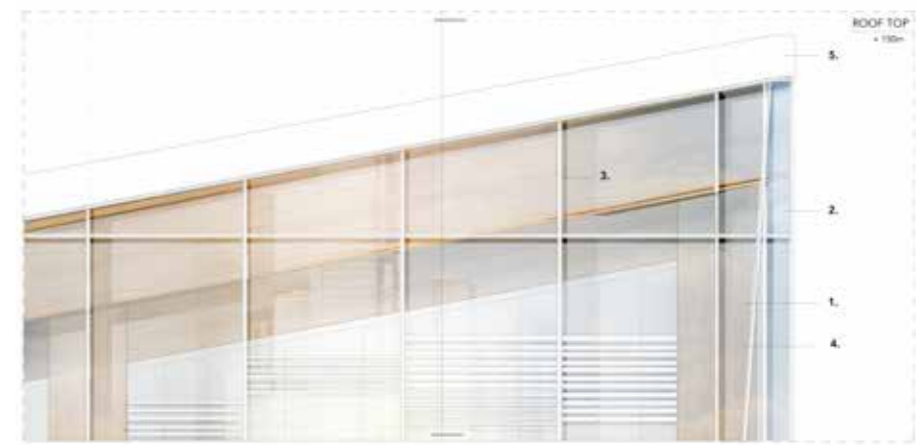
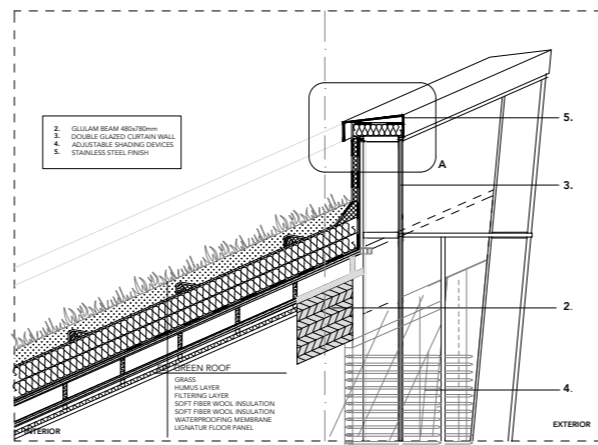
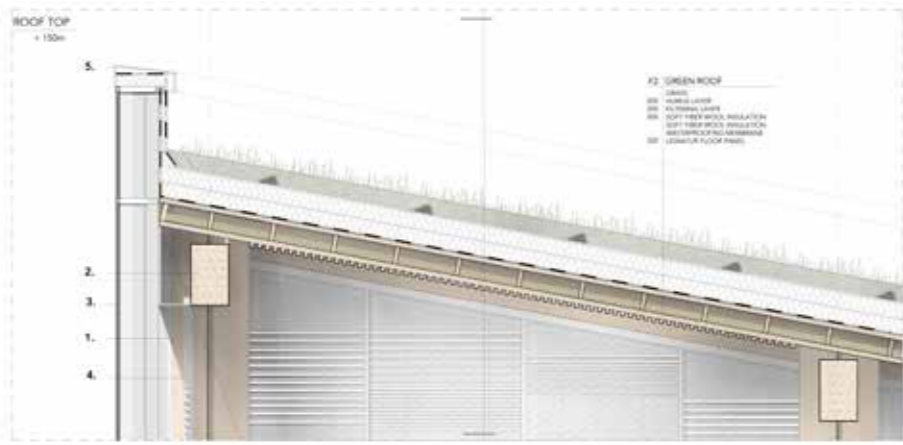

**ENVELOPE FRAGMENT 1:20**

# DETAILS 1:5

## SLAB CONNECTION

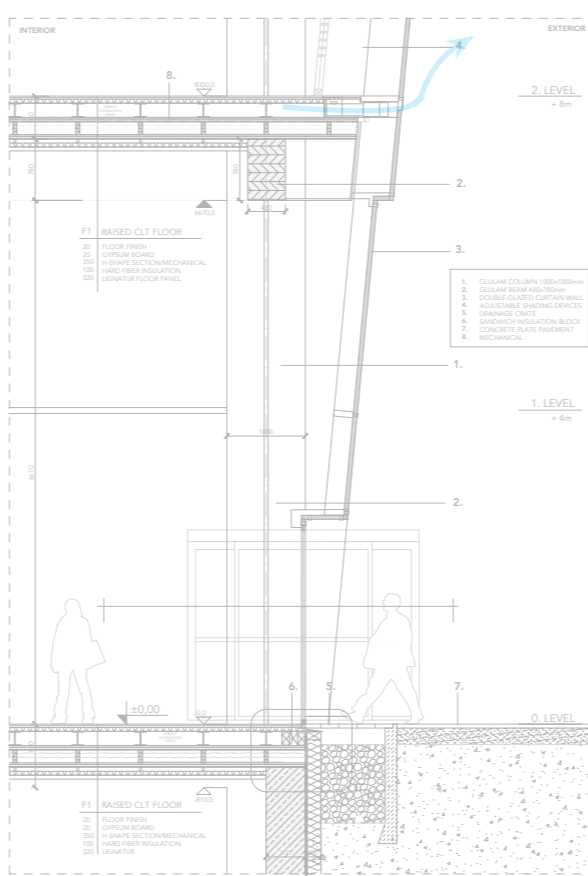
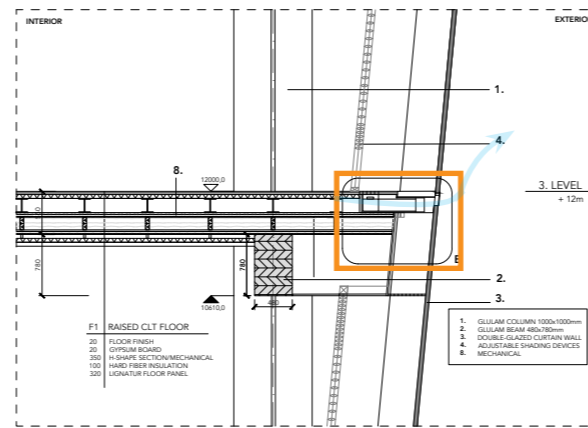
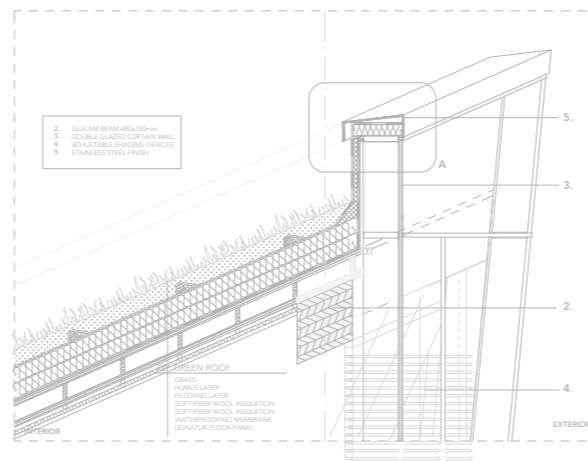
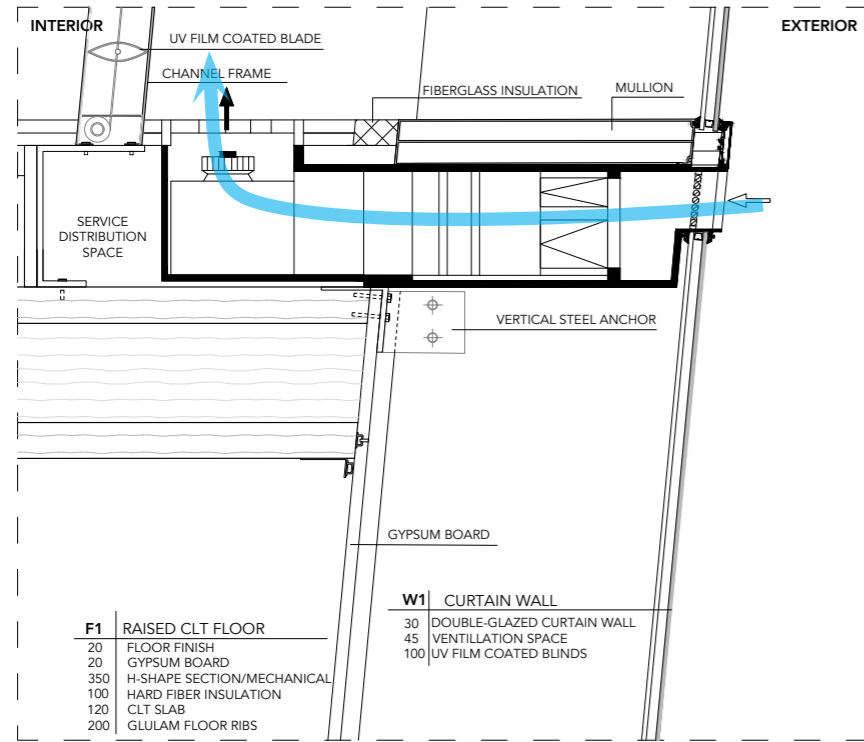

## ROOF TOP

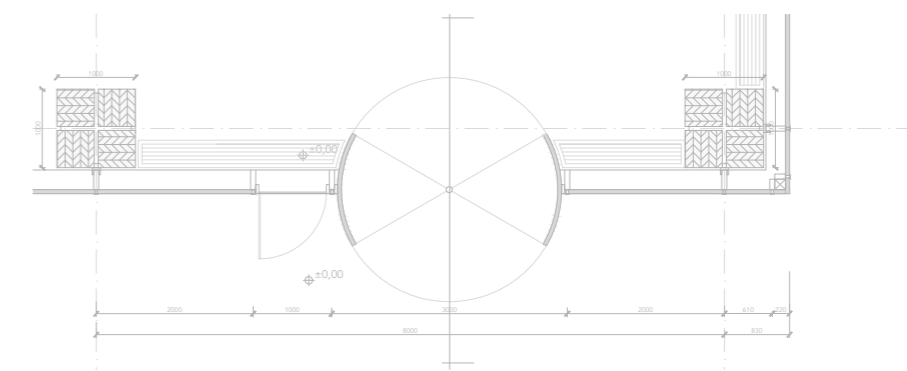



# DETAILS 1:5

## SLAB CONNECTION

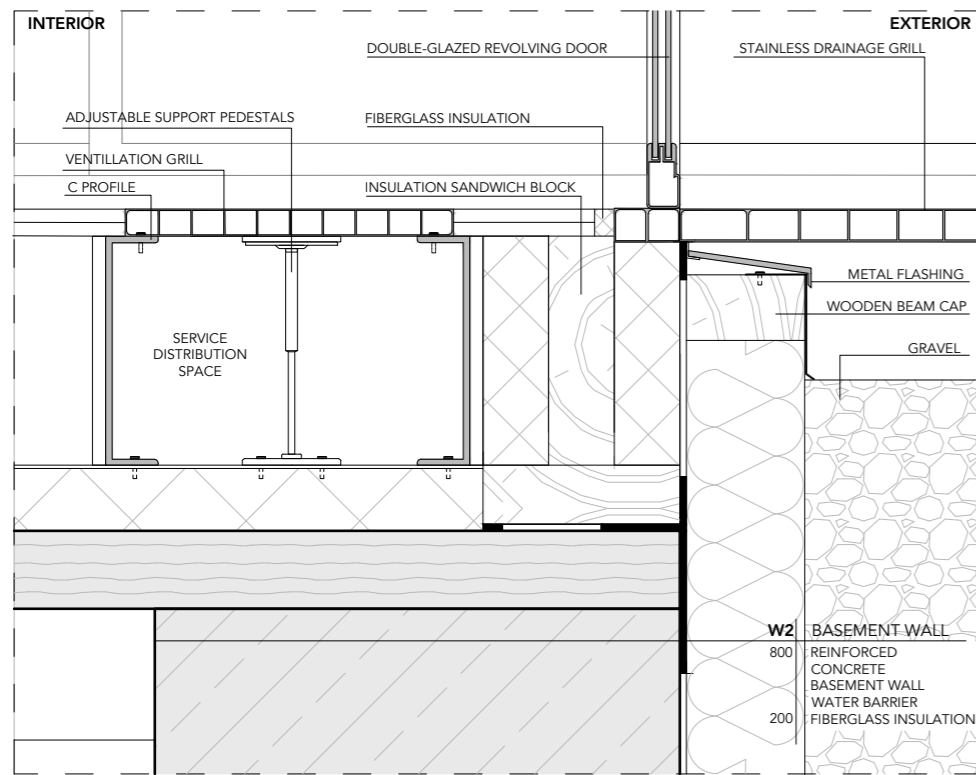
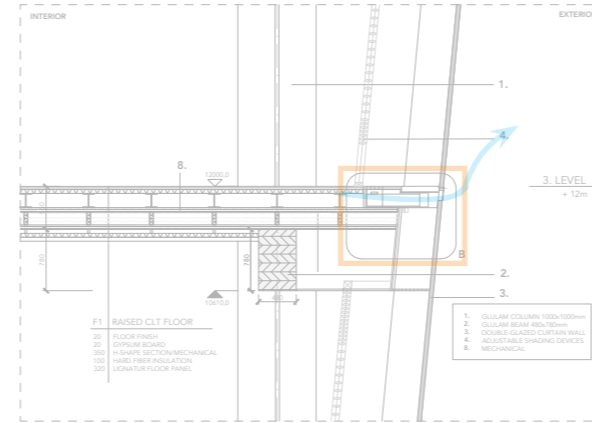
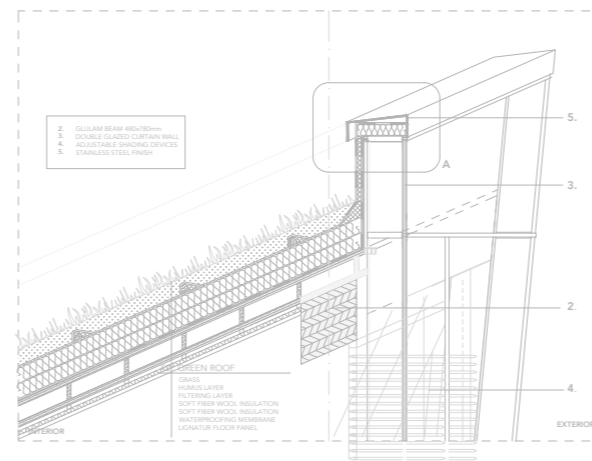
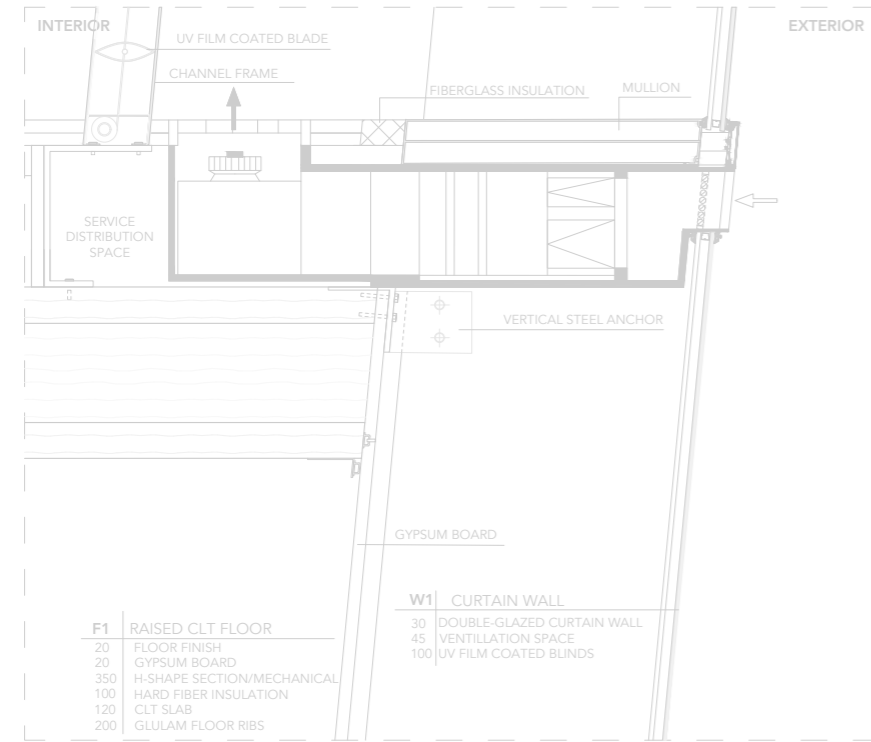

DOOR BOTTOM

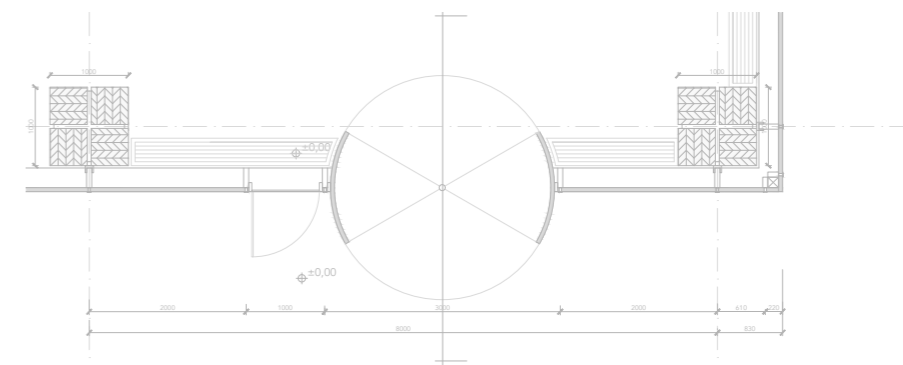
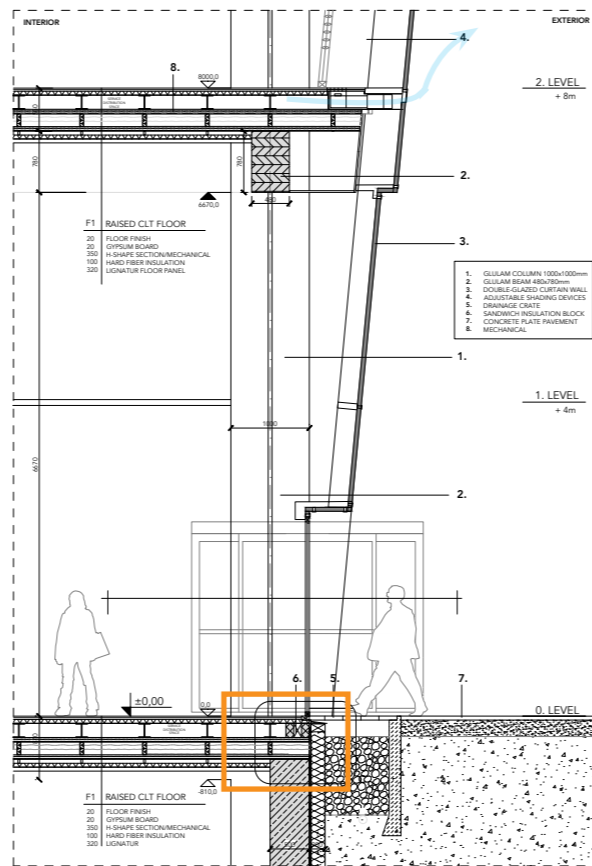

# DETAILS 1:5

## SLAB CONNECTION

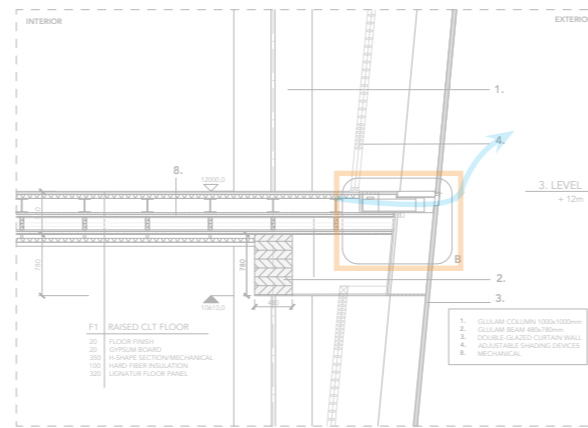
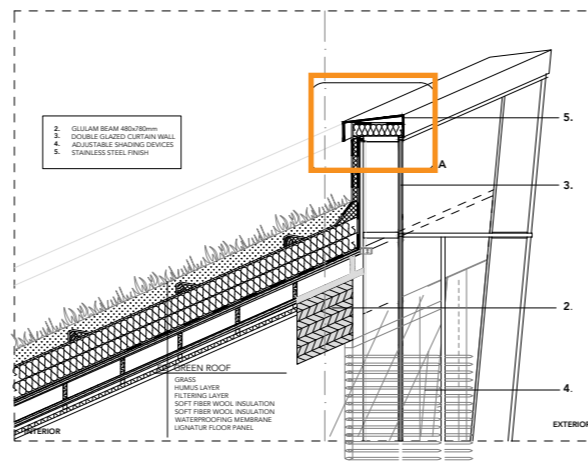
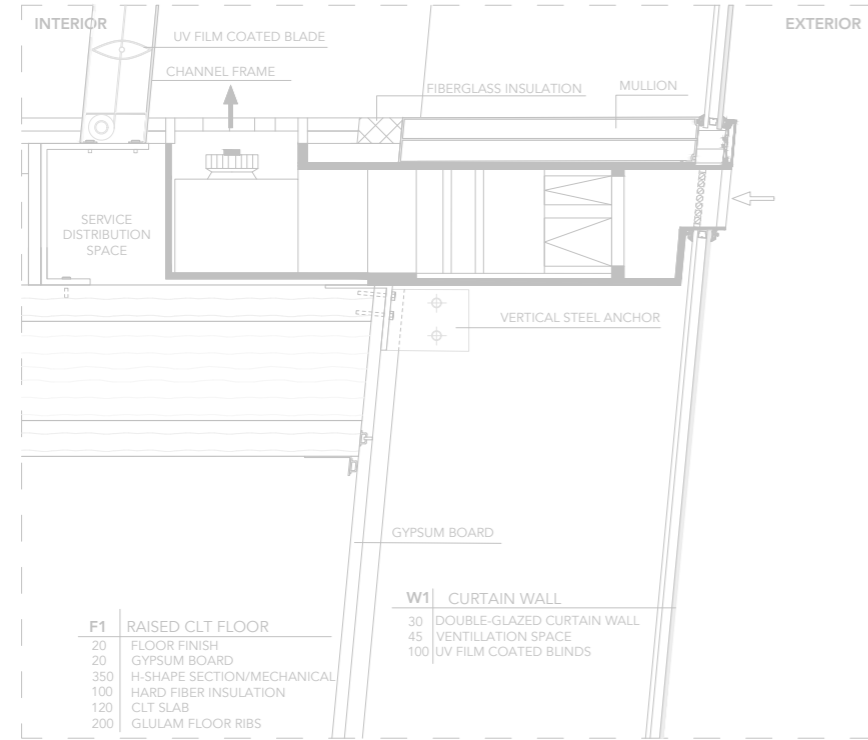

## ROOF TOP

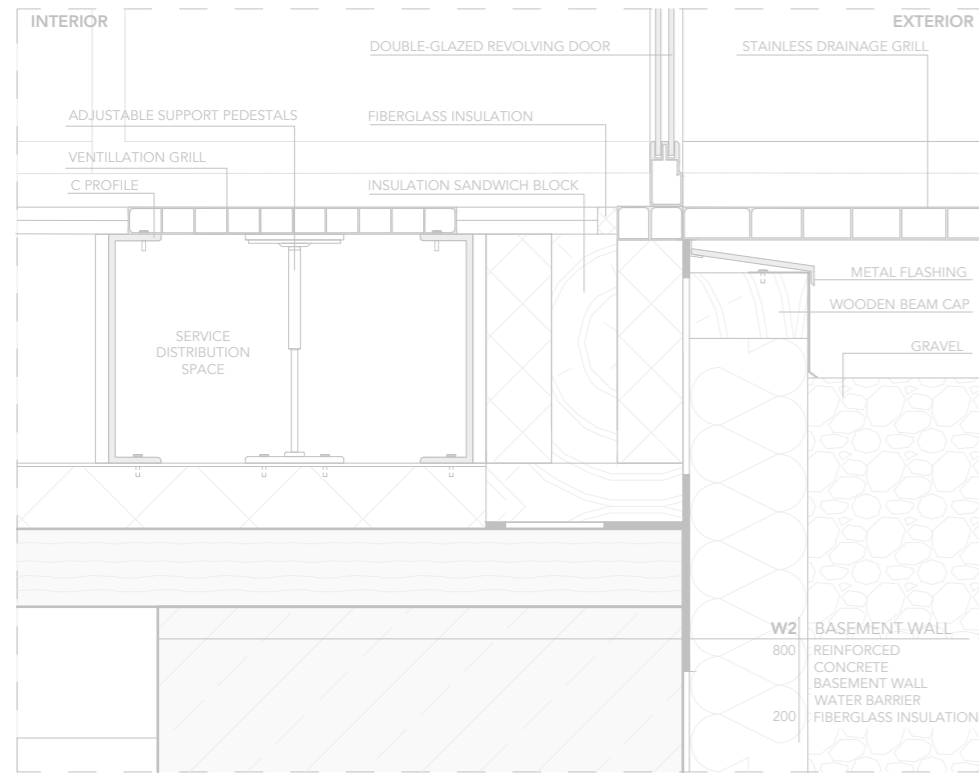
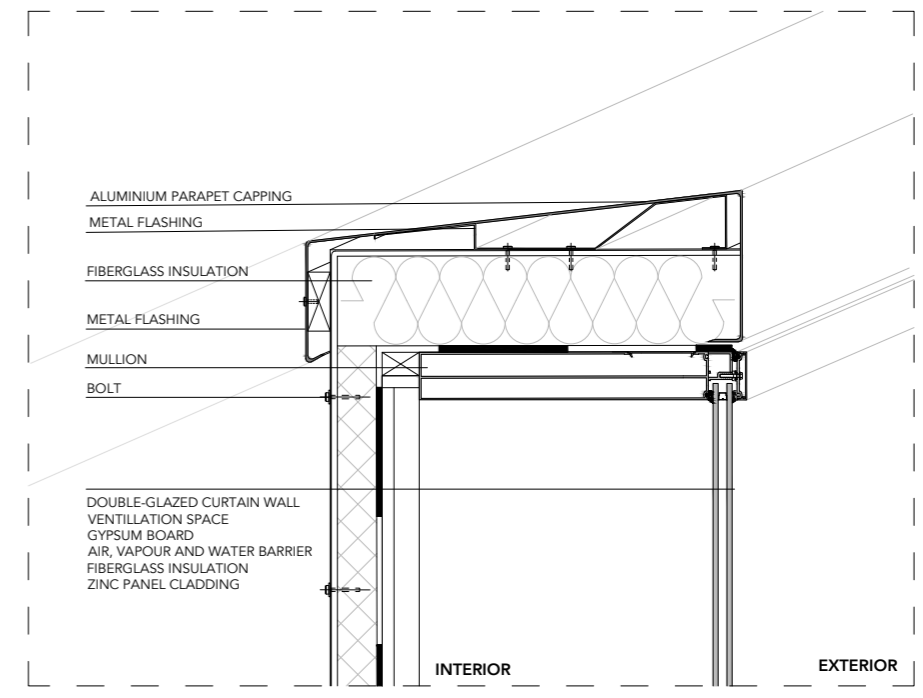

## DOOR BOTTOM

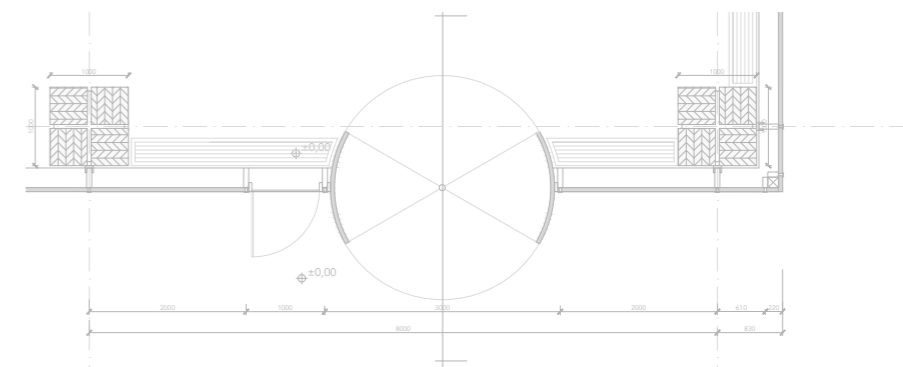
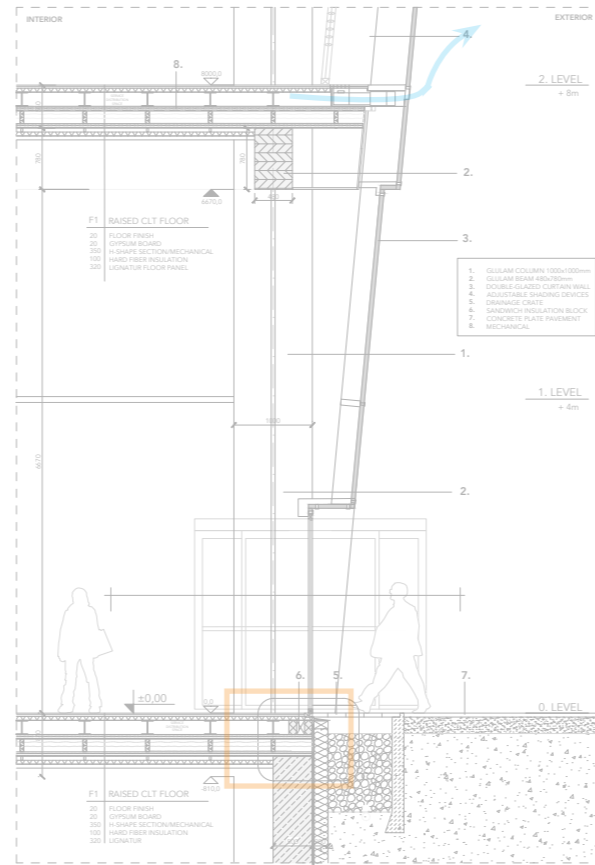



# DETAILS 1:5

## SLAB CONNECTION

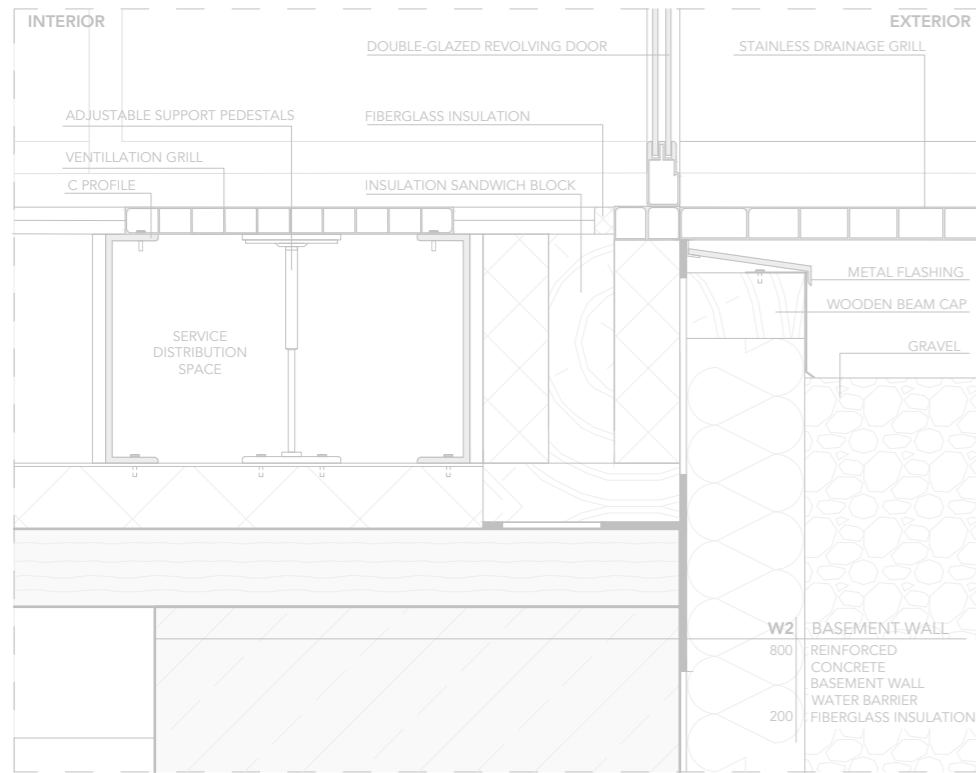
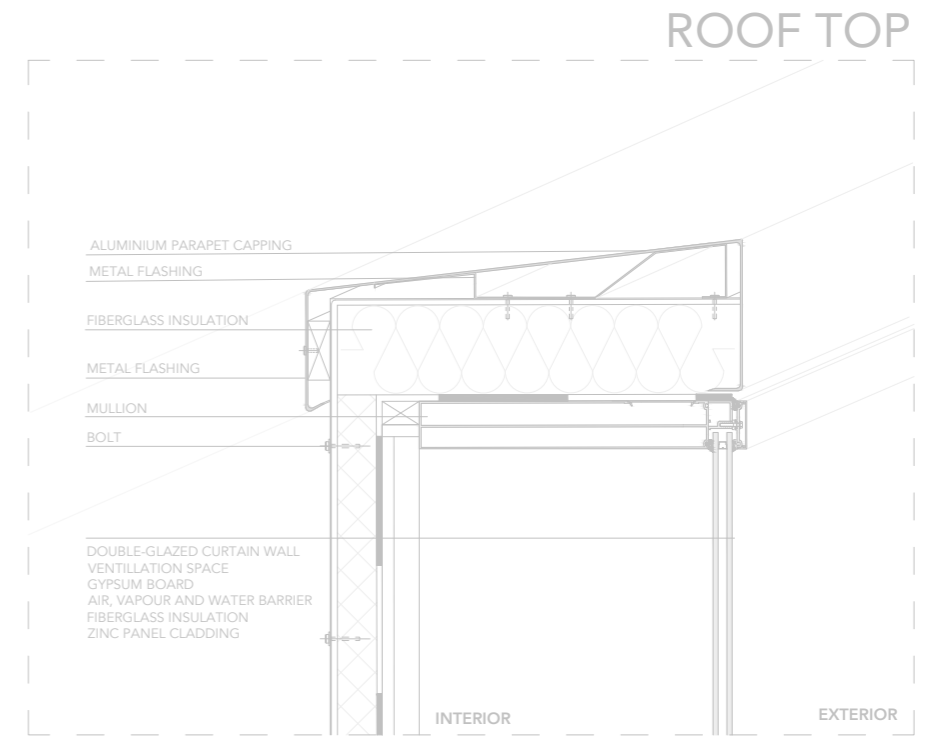
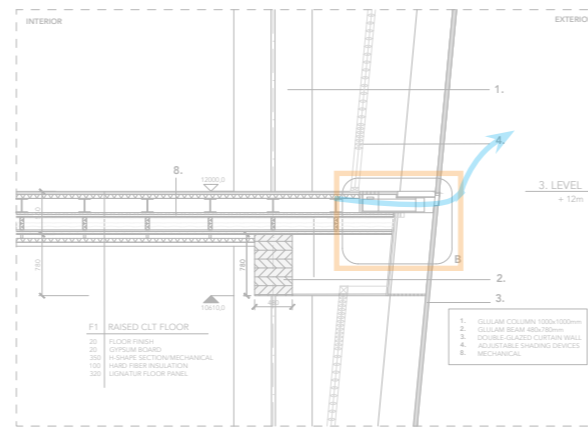
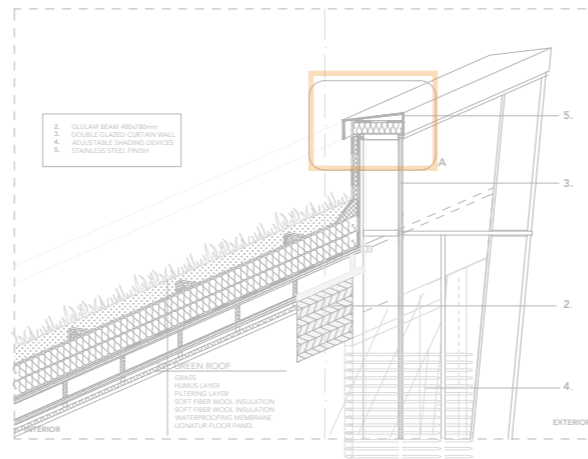
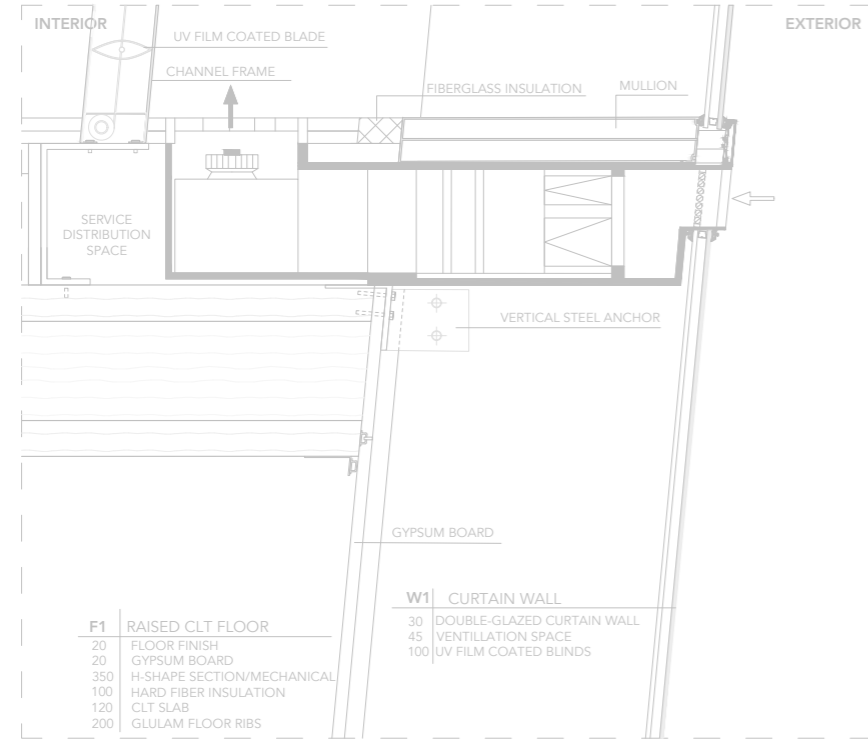

DOOR BOTTOM

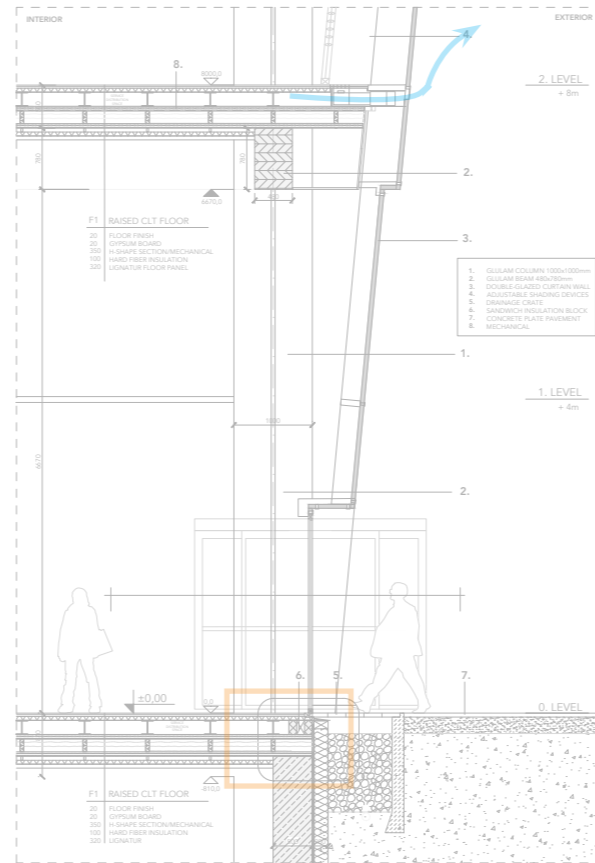

## COLUMN & CURTAIN WALL CORNER

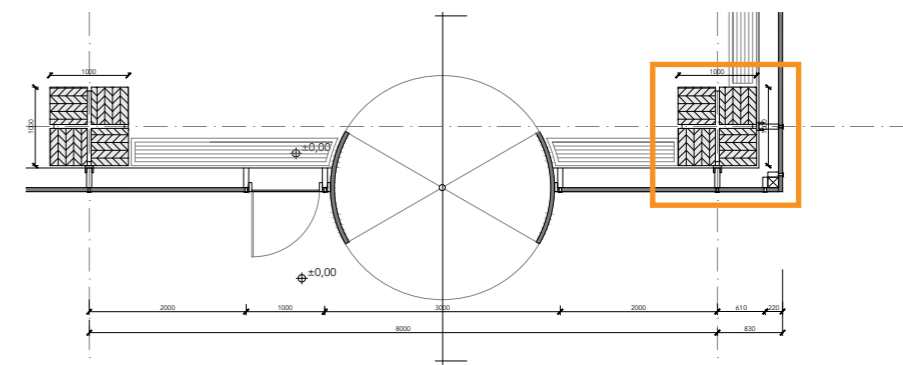
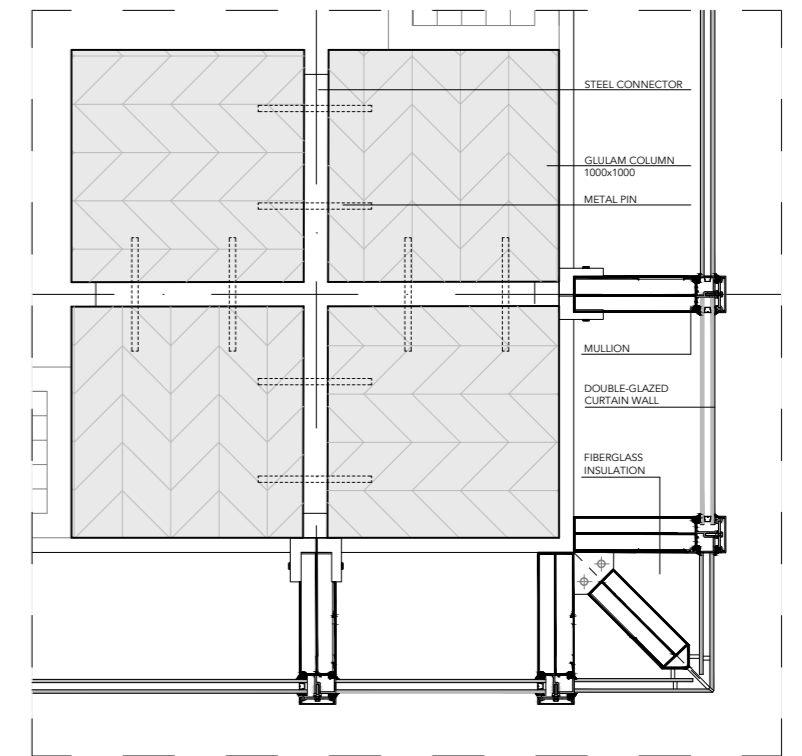

# DETAILS 1:5

## SLAB CONNECTION

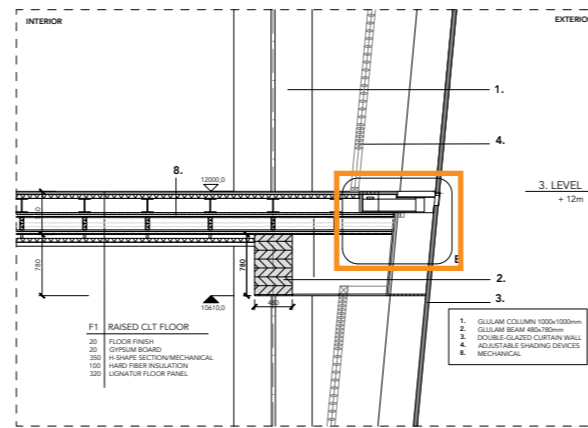
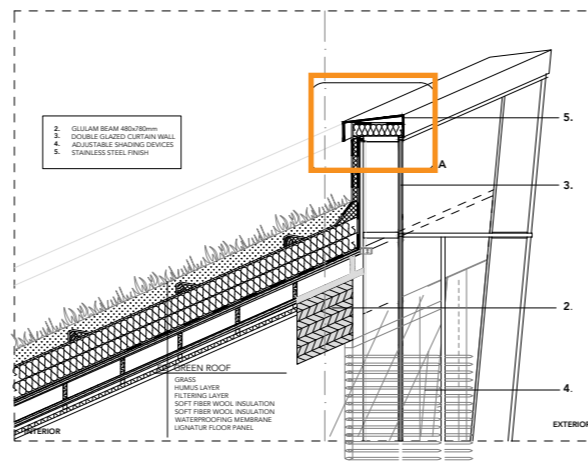
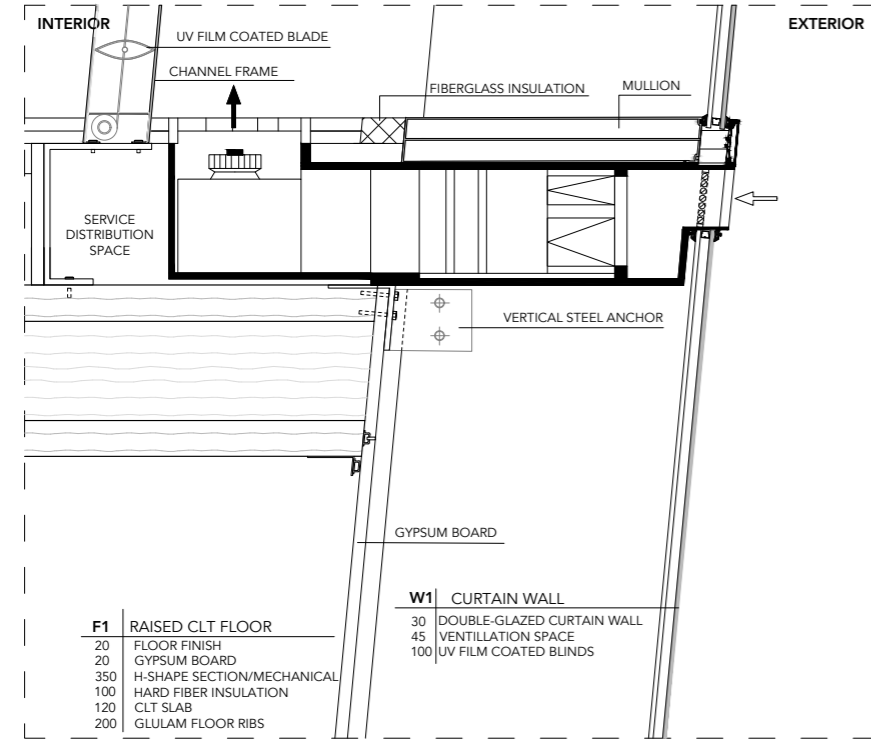

## ROOF TOP

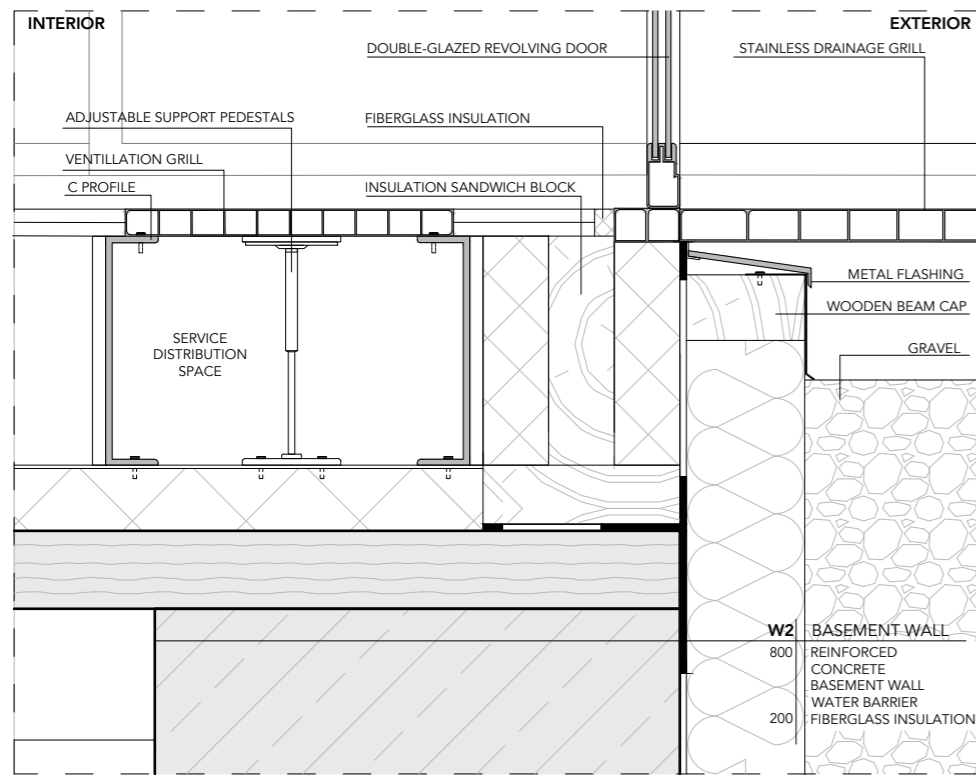
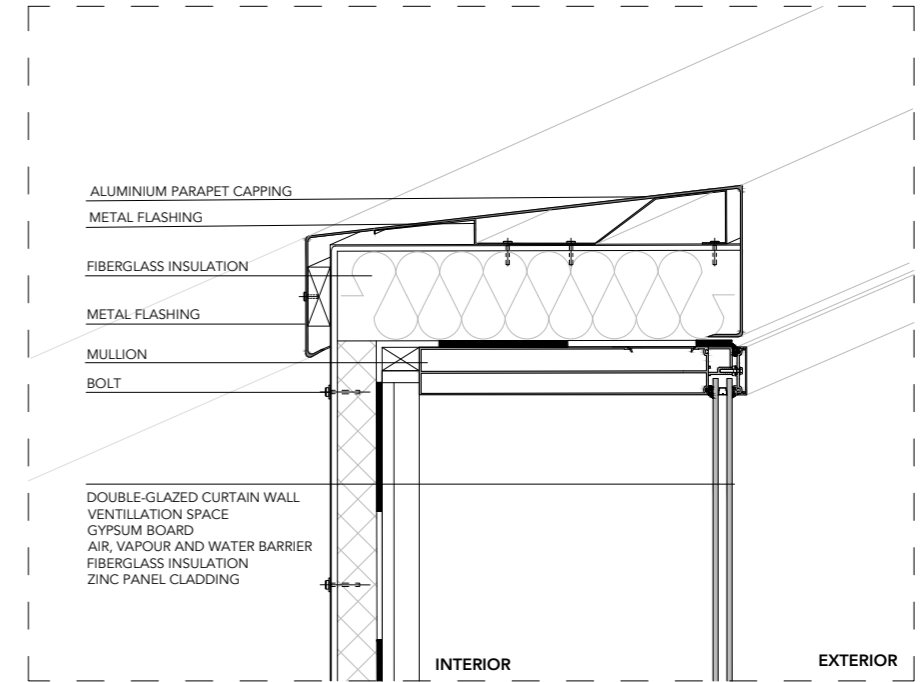

## DOOR BOTTOM

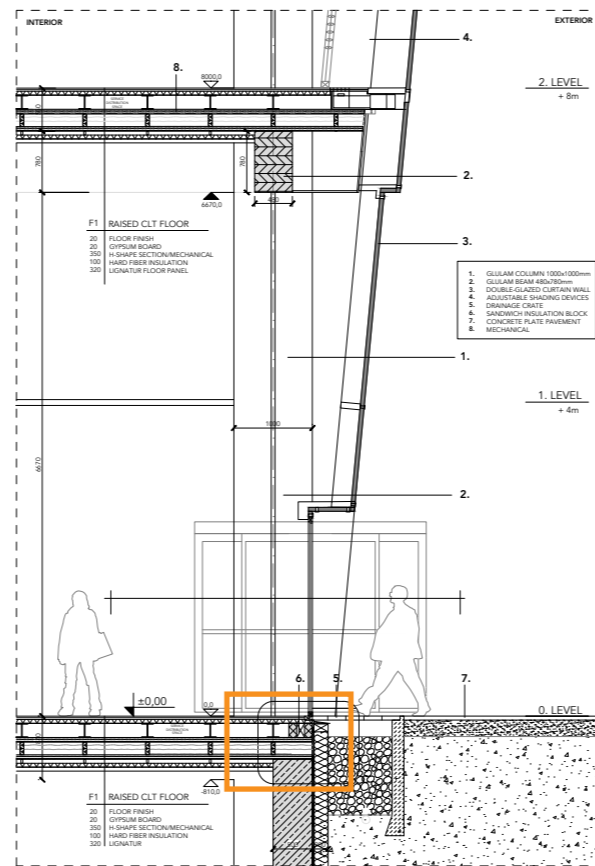

## COLUMN & CURTAIN WALL CORNER

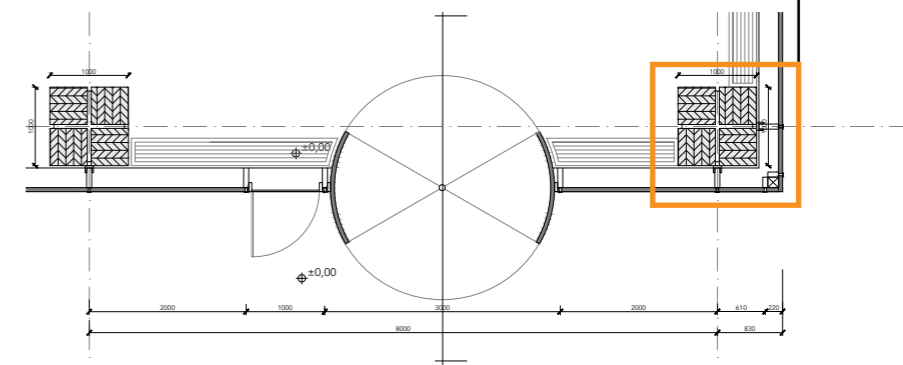
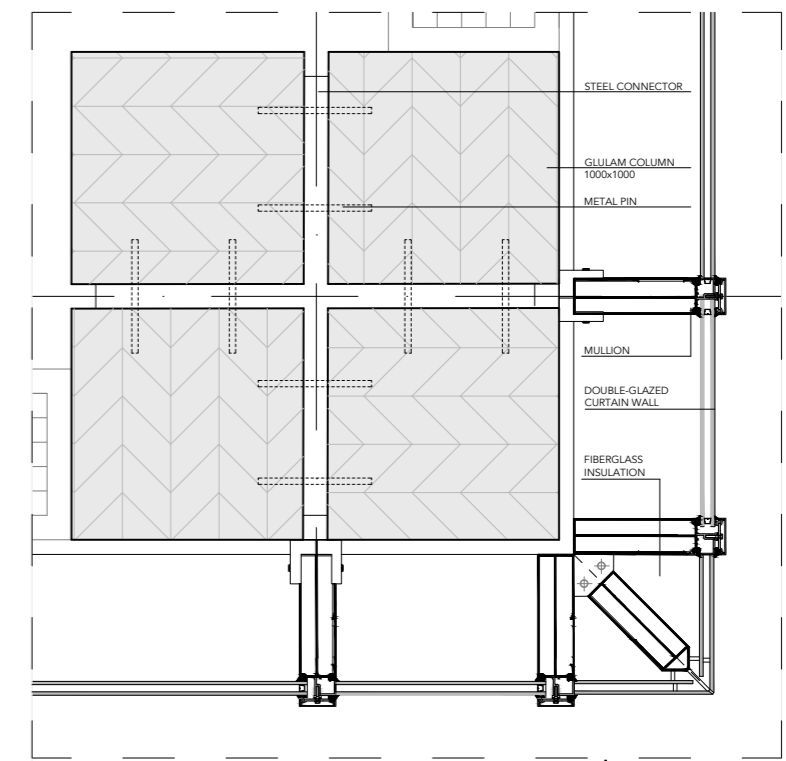



# **CLIMATE DESIGN**

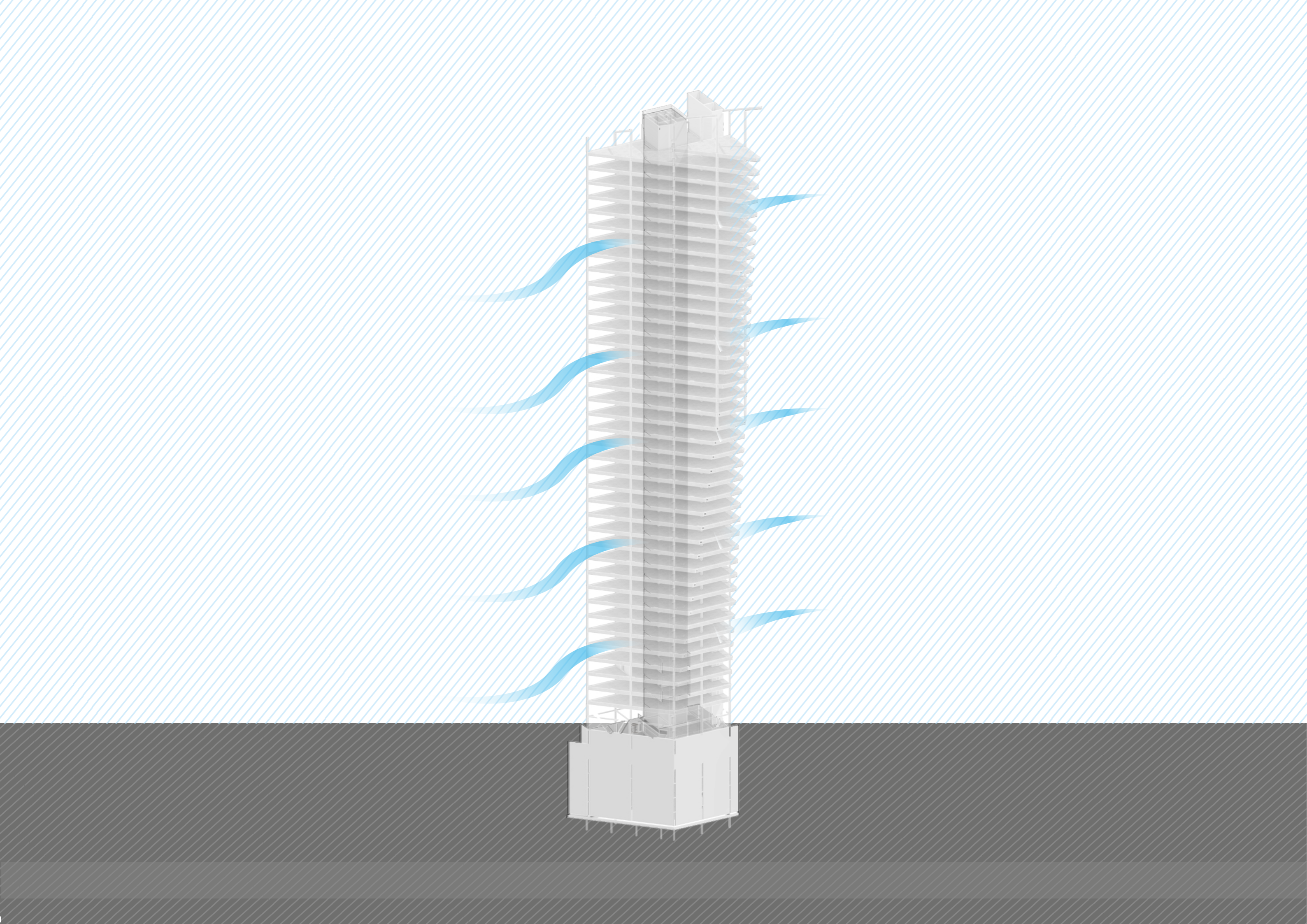



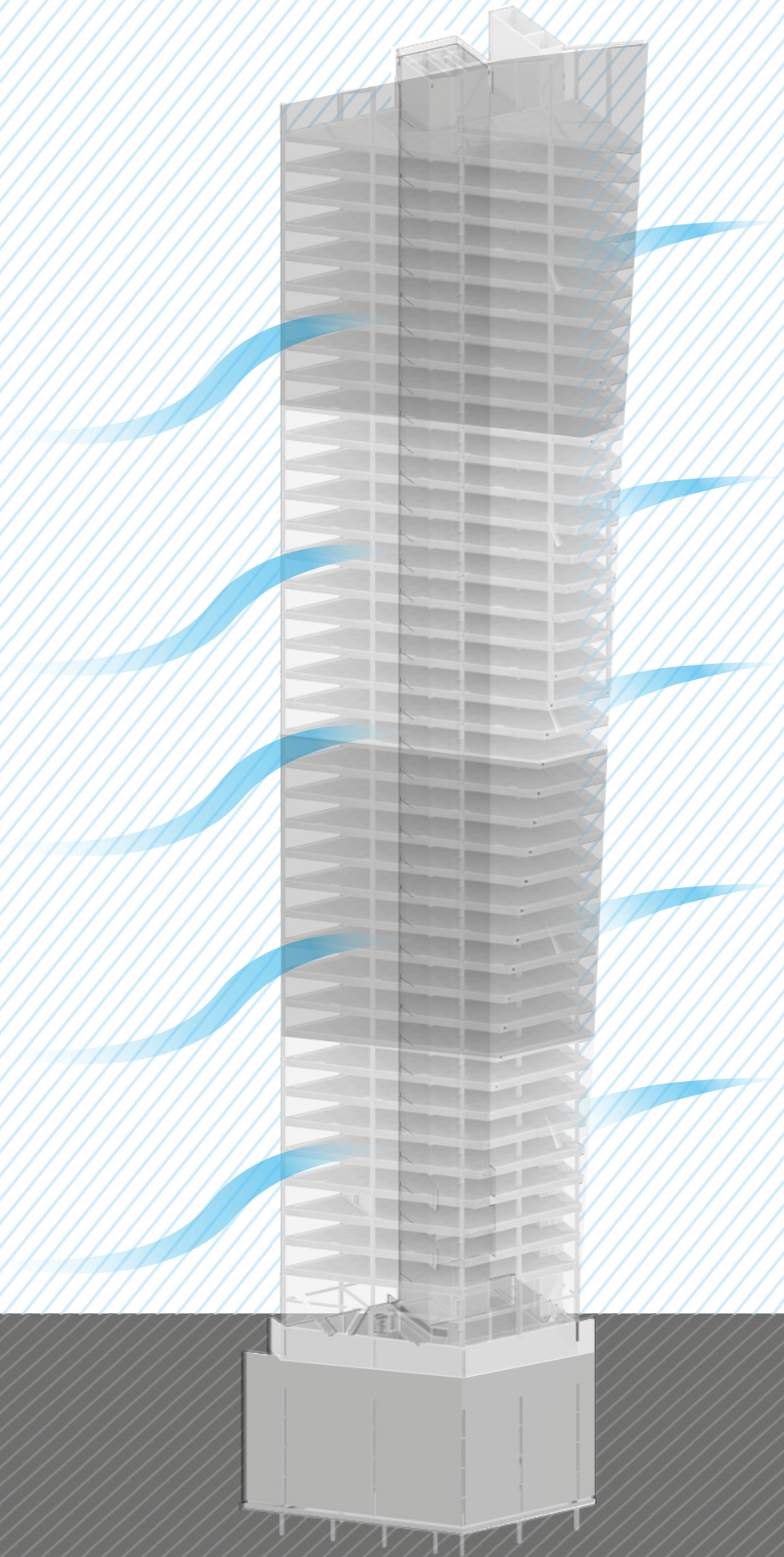

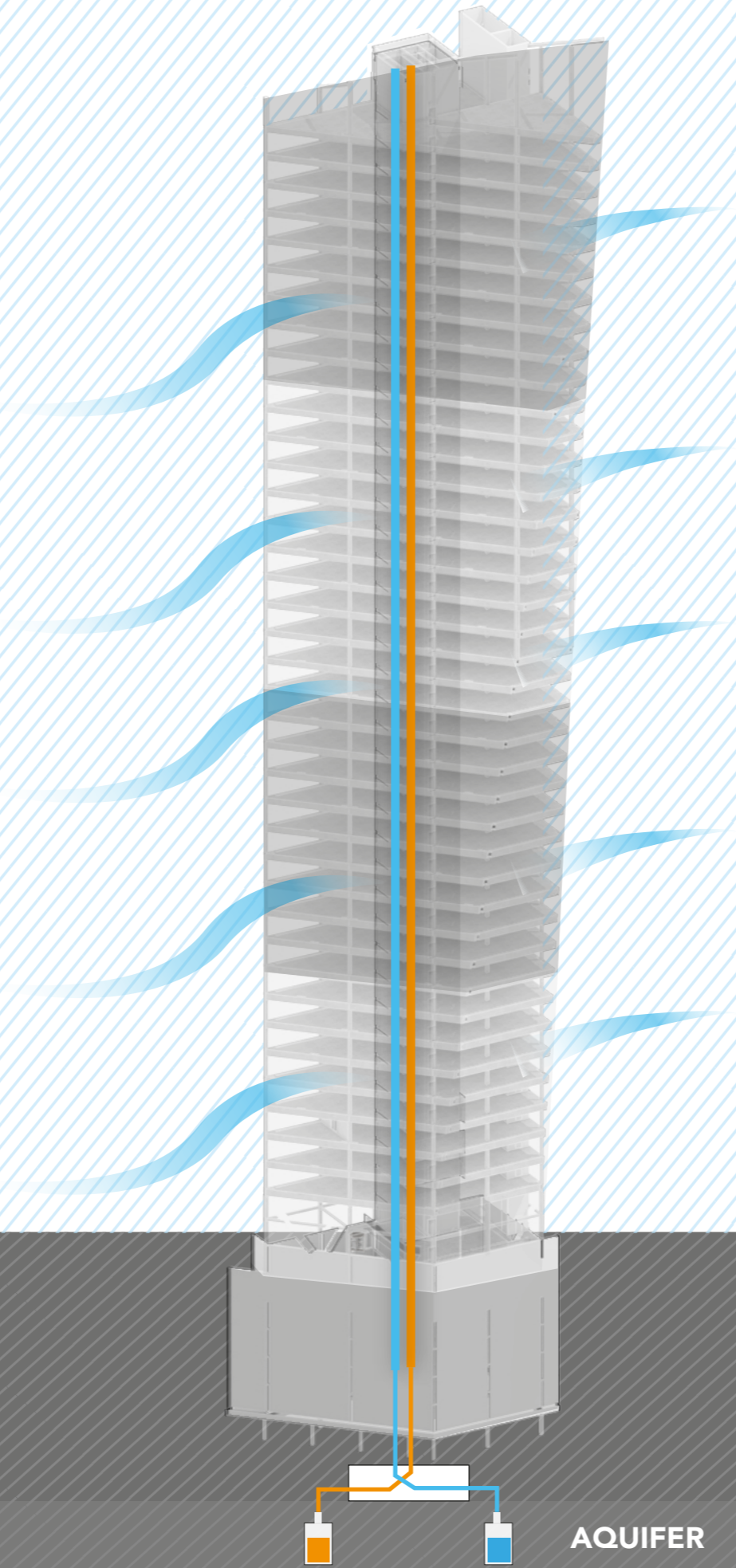

AQUIFER



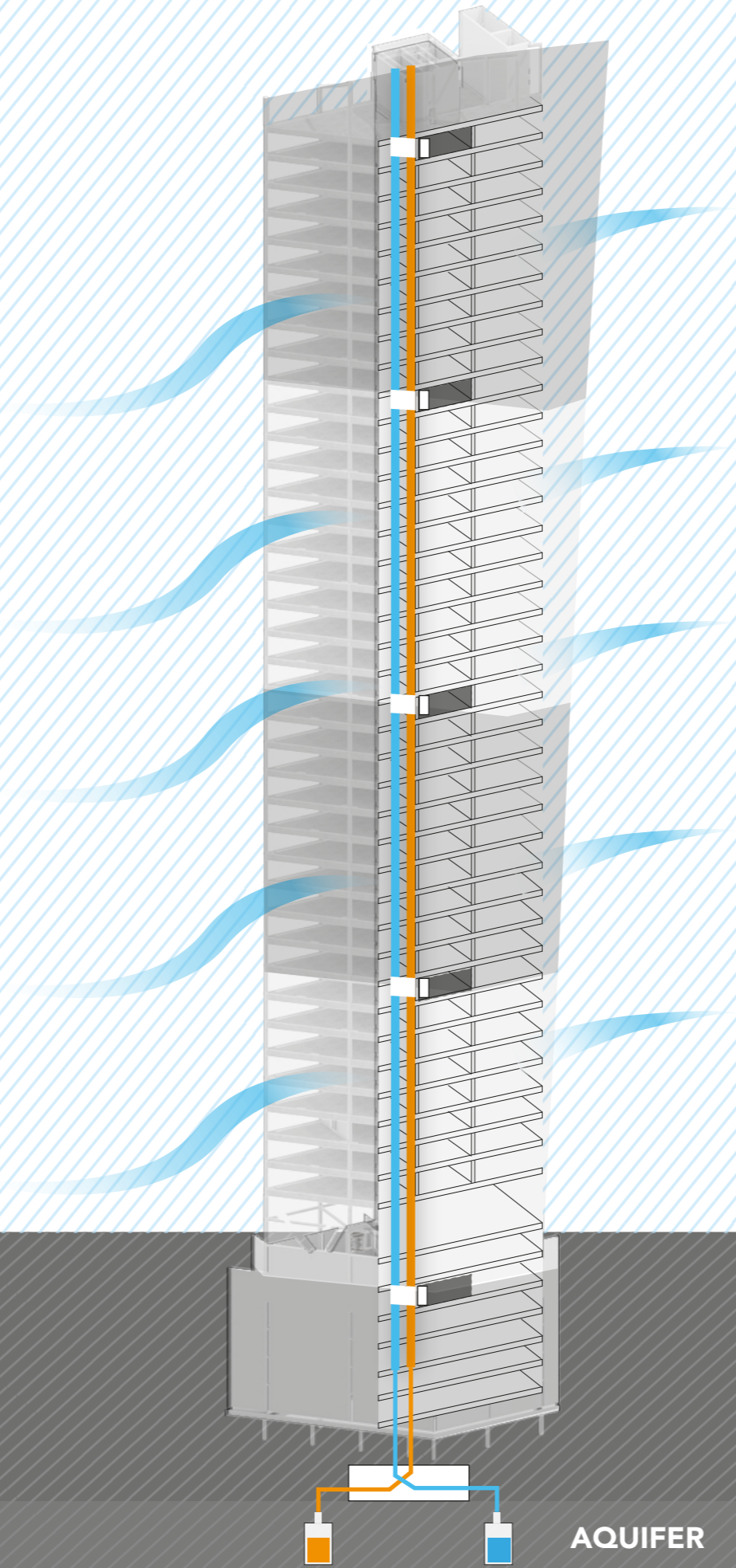

**AQUIFER**

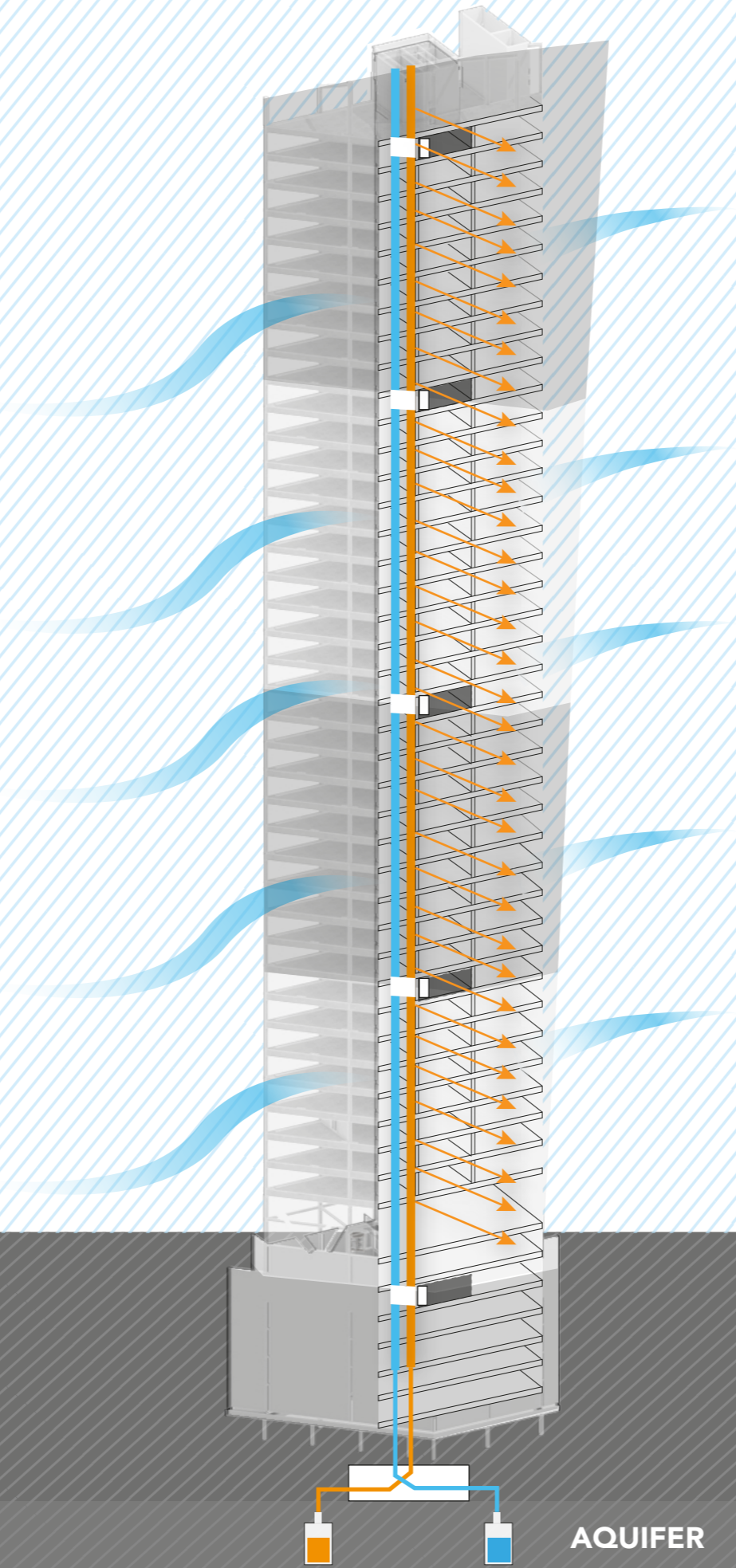



AQUIFER

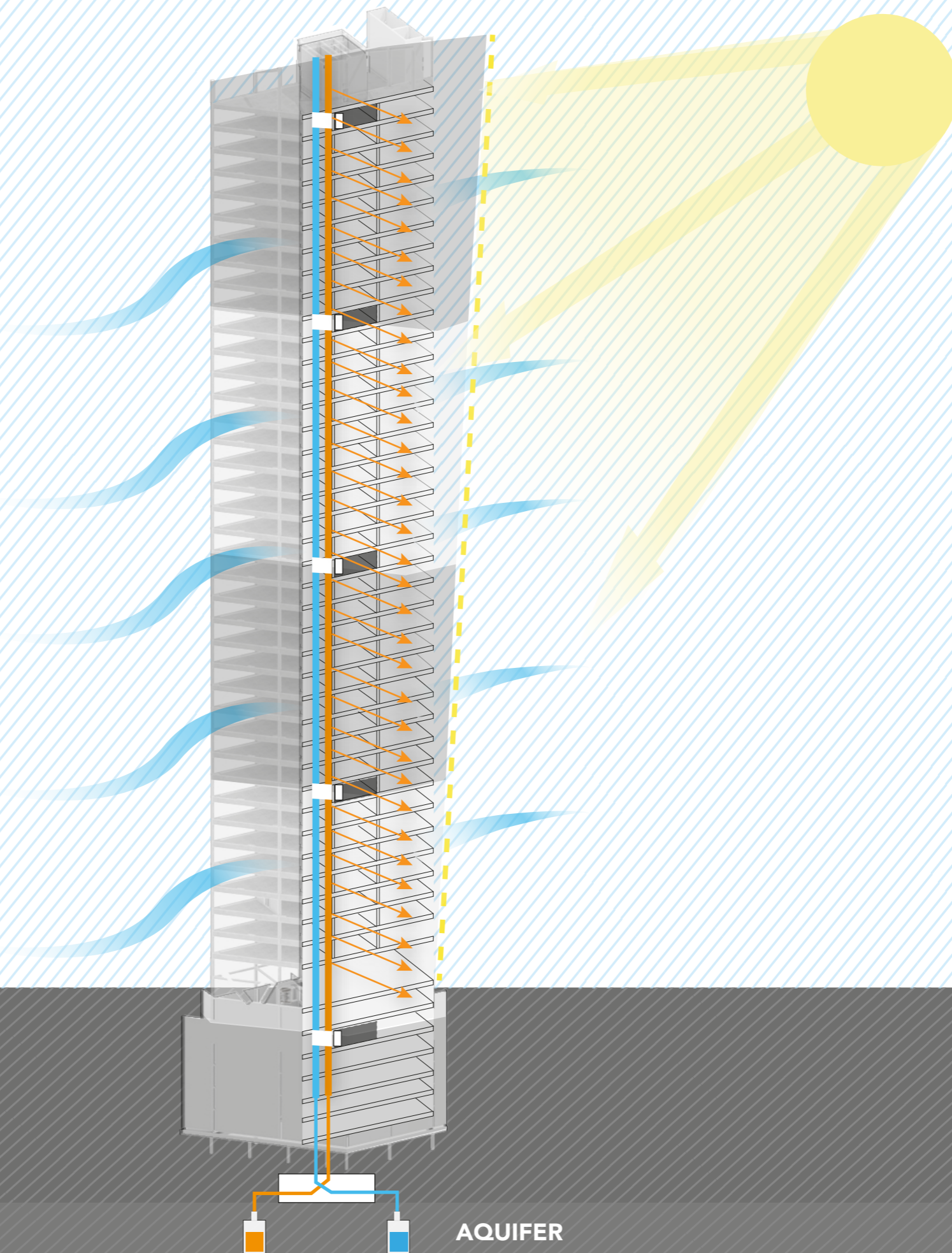

 **SUPPLY**  
 **EXHAUST**



**AQUIFER**

 **SUPPLY**  
 **EXHAUST**

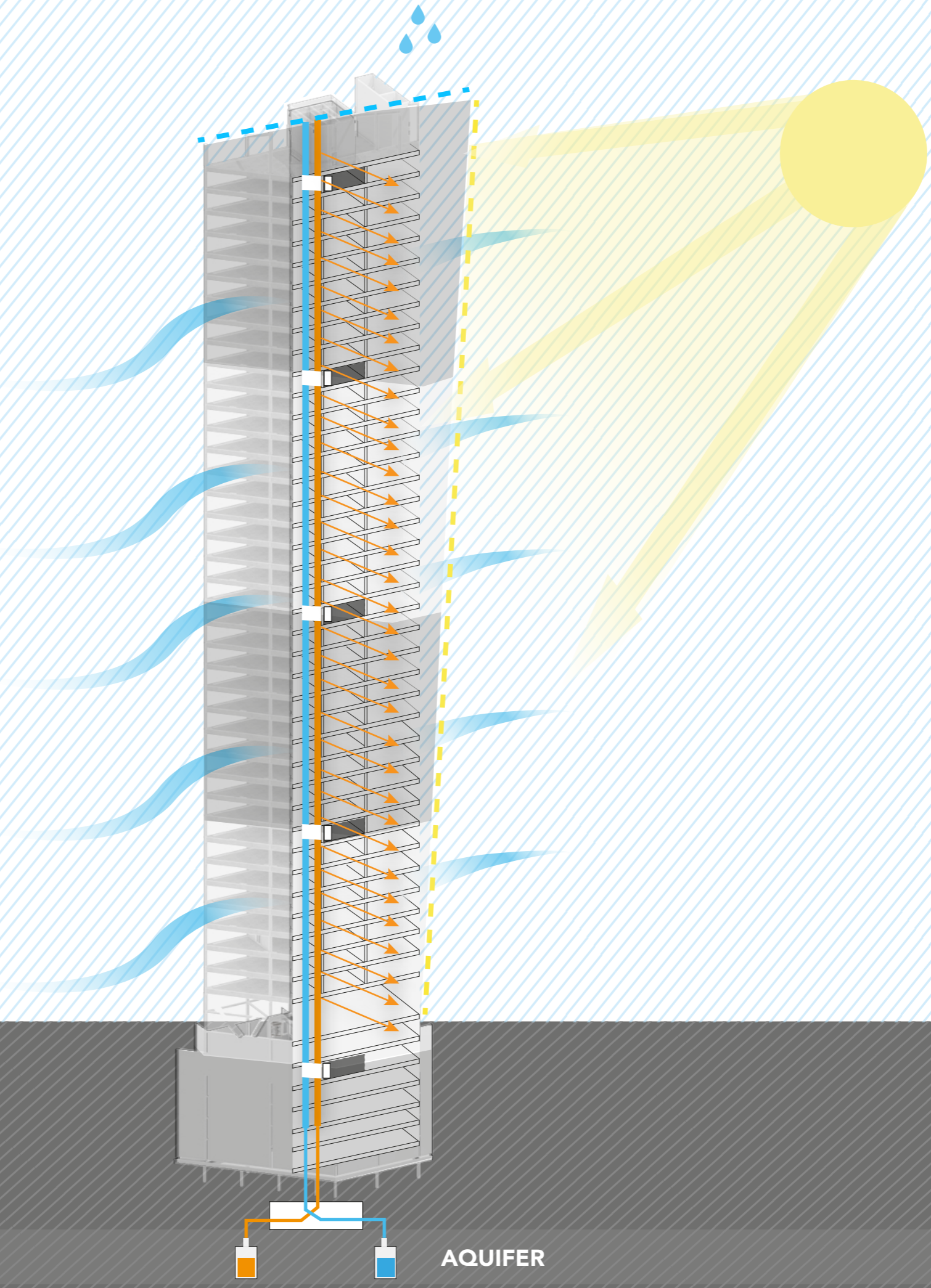

**AQUIFER**



# CLIMATE DESIGN

## START-UP OFFICE

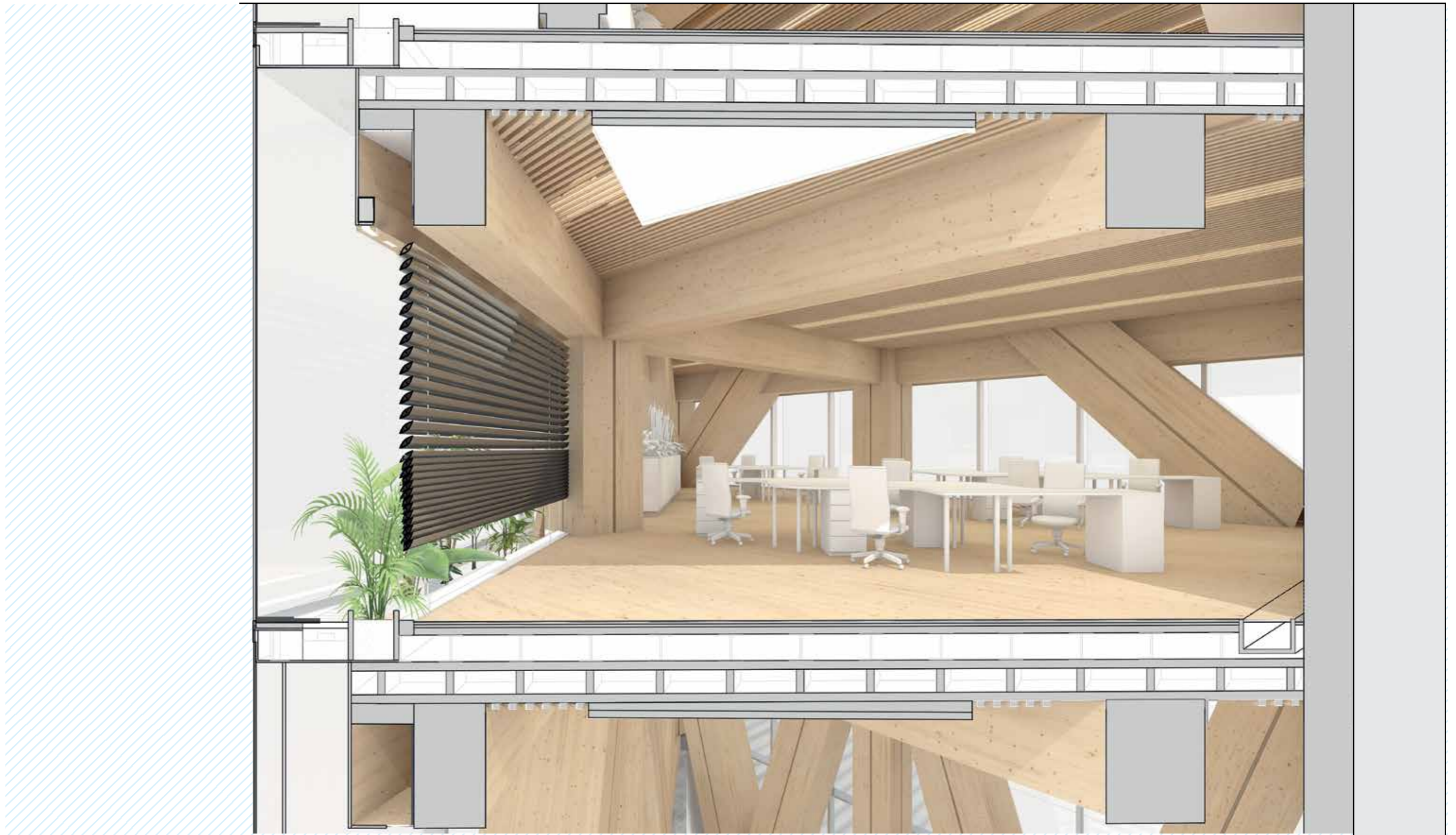

# CLIMATE DESIGN

## START-UP OFFICE

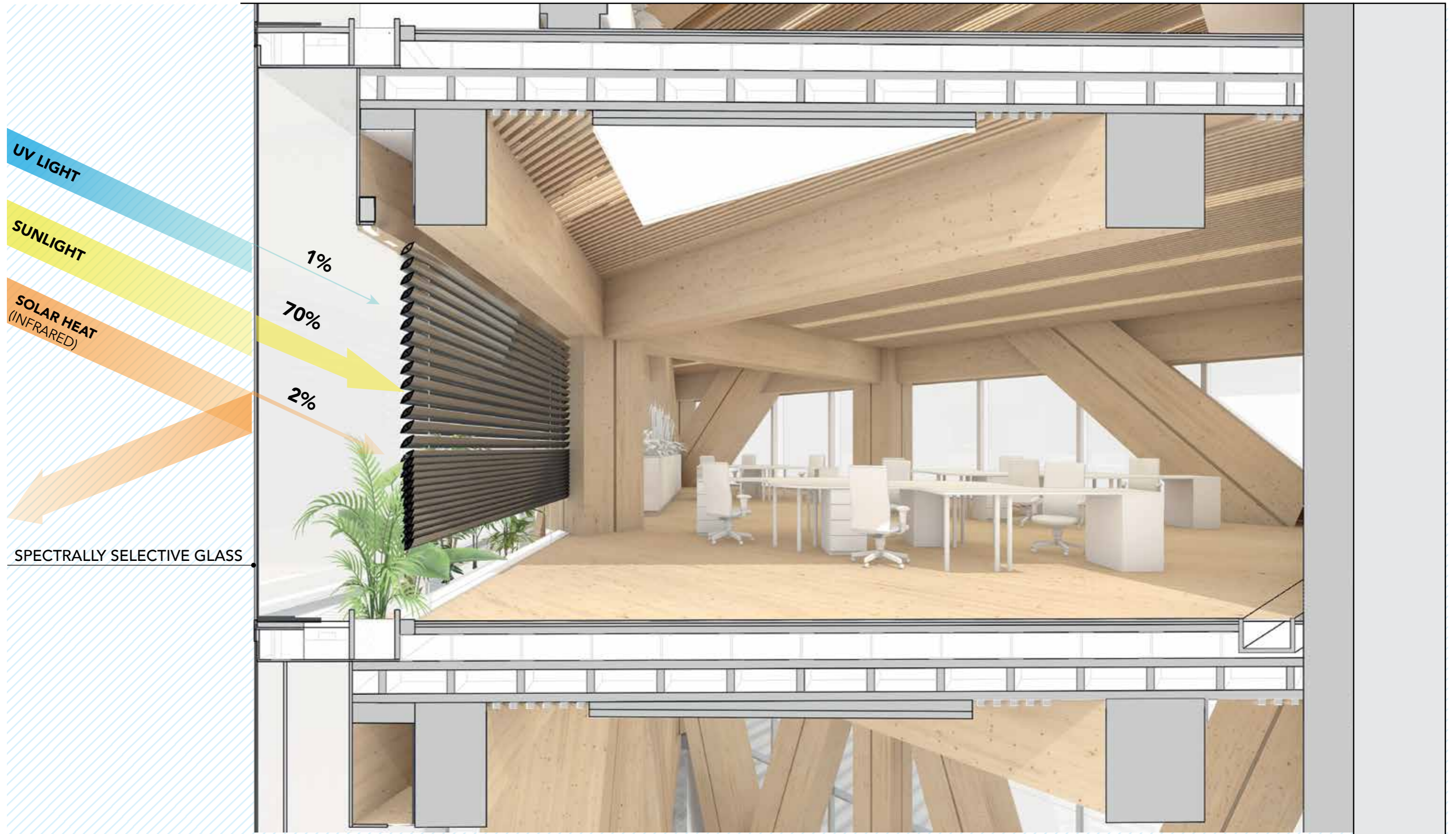



# CLIMATE DESIGN

## START-UP OFFICE

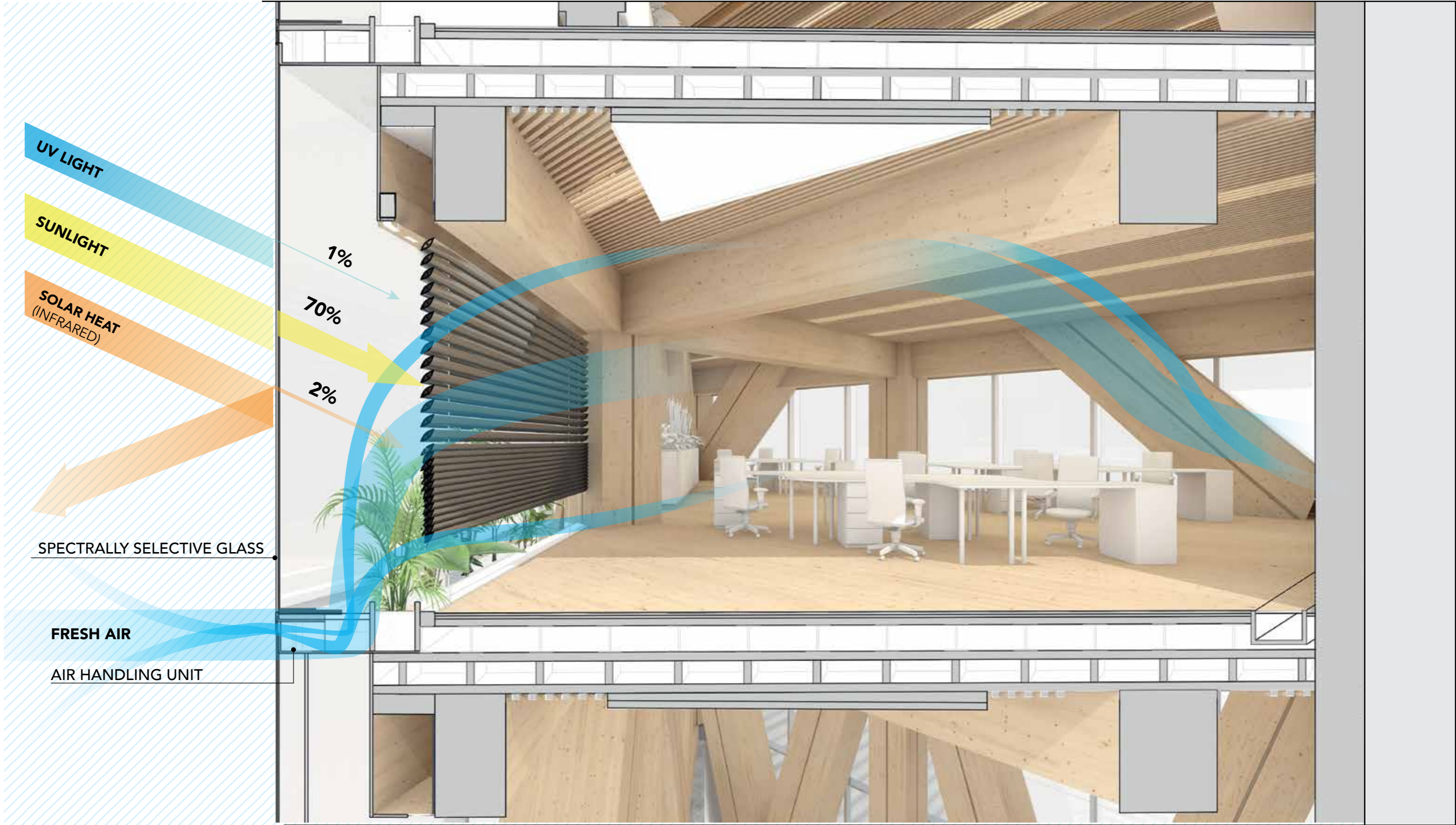



# CLIMATE DESIGN

## START-UP OFFICE

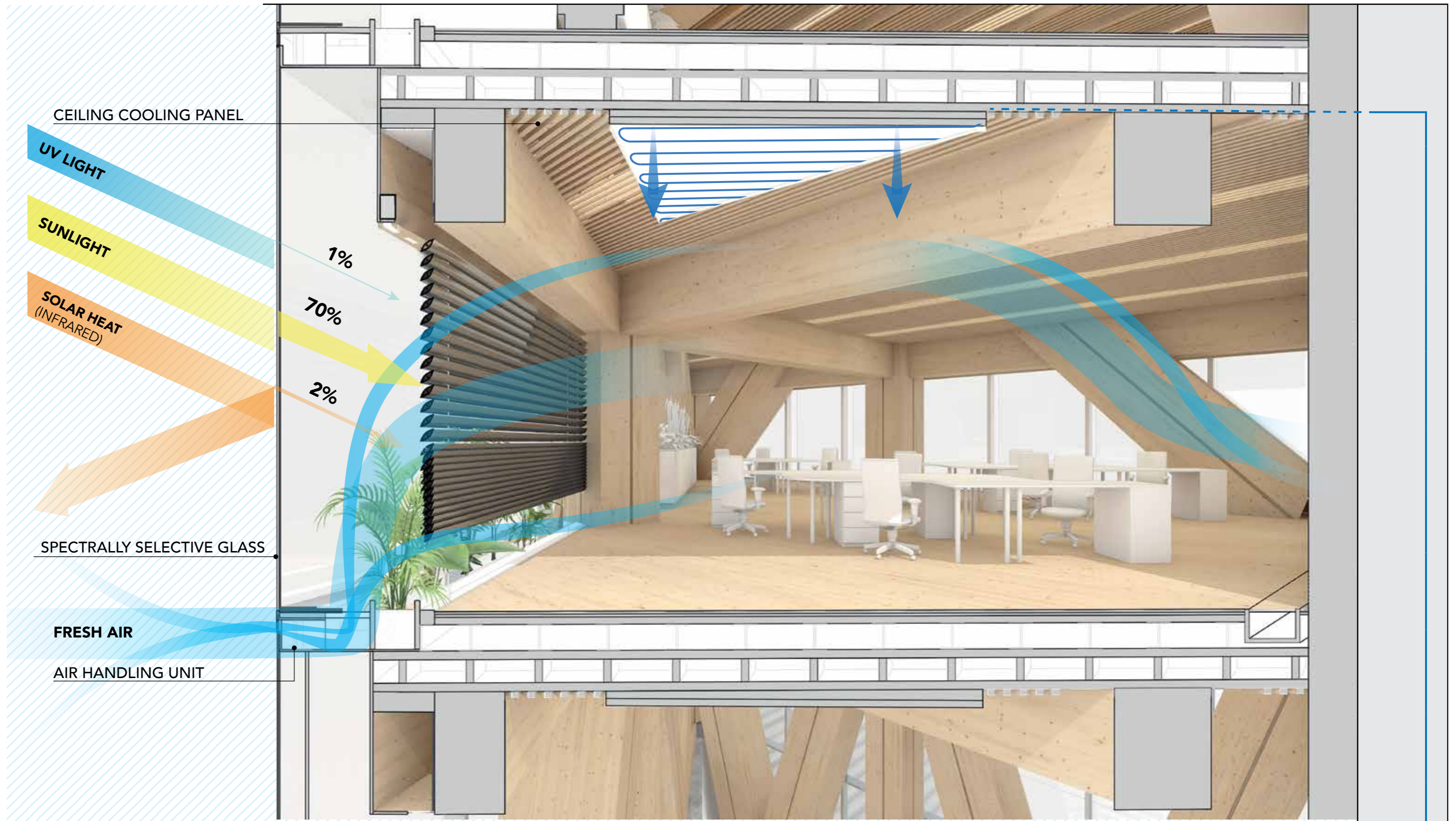



# CLIMATE DESIGN

## START-UP OFFICE

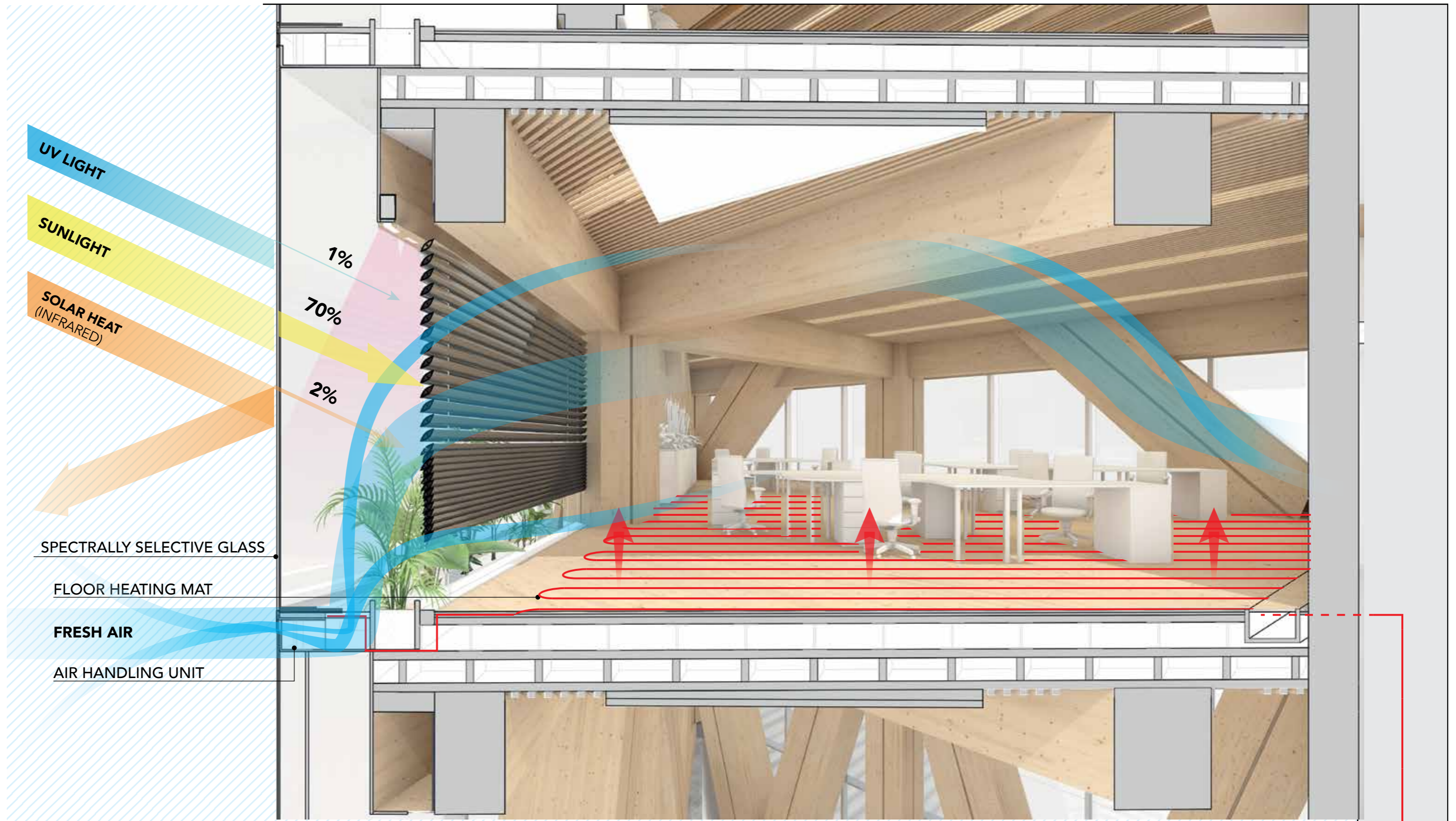

# **CONCLUSIONS**





**bottom-up  
initiative**

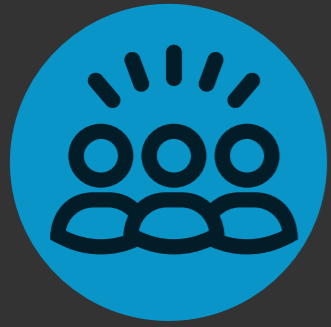

**cooperation**

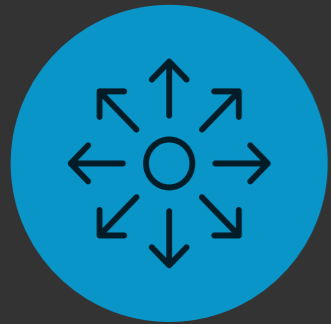

**sharing**



**activation**

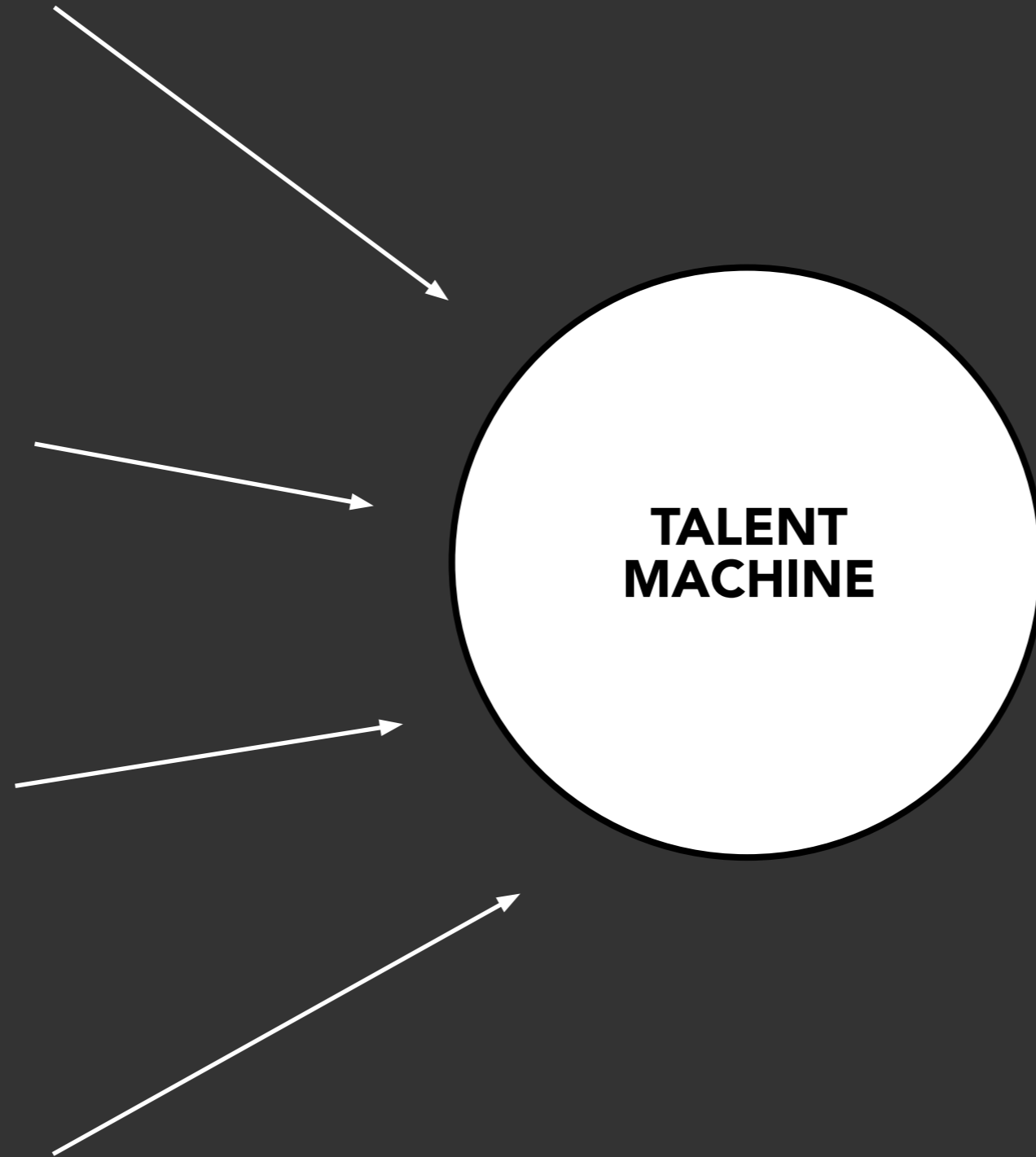

**TALENT  
MACHINE**



**bottom-up  
initiative**

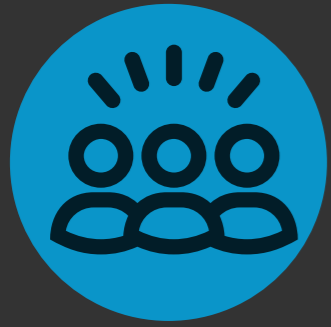

**cooperation**

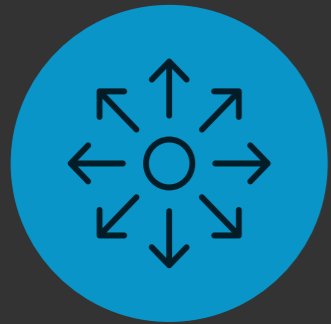

**sharing**



**activation**

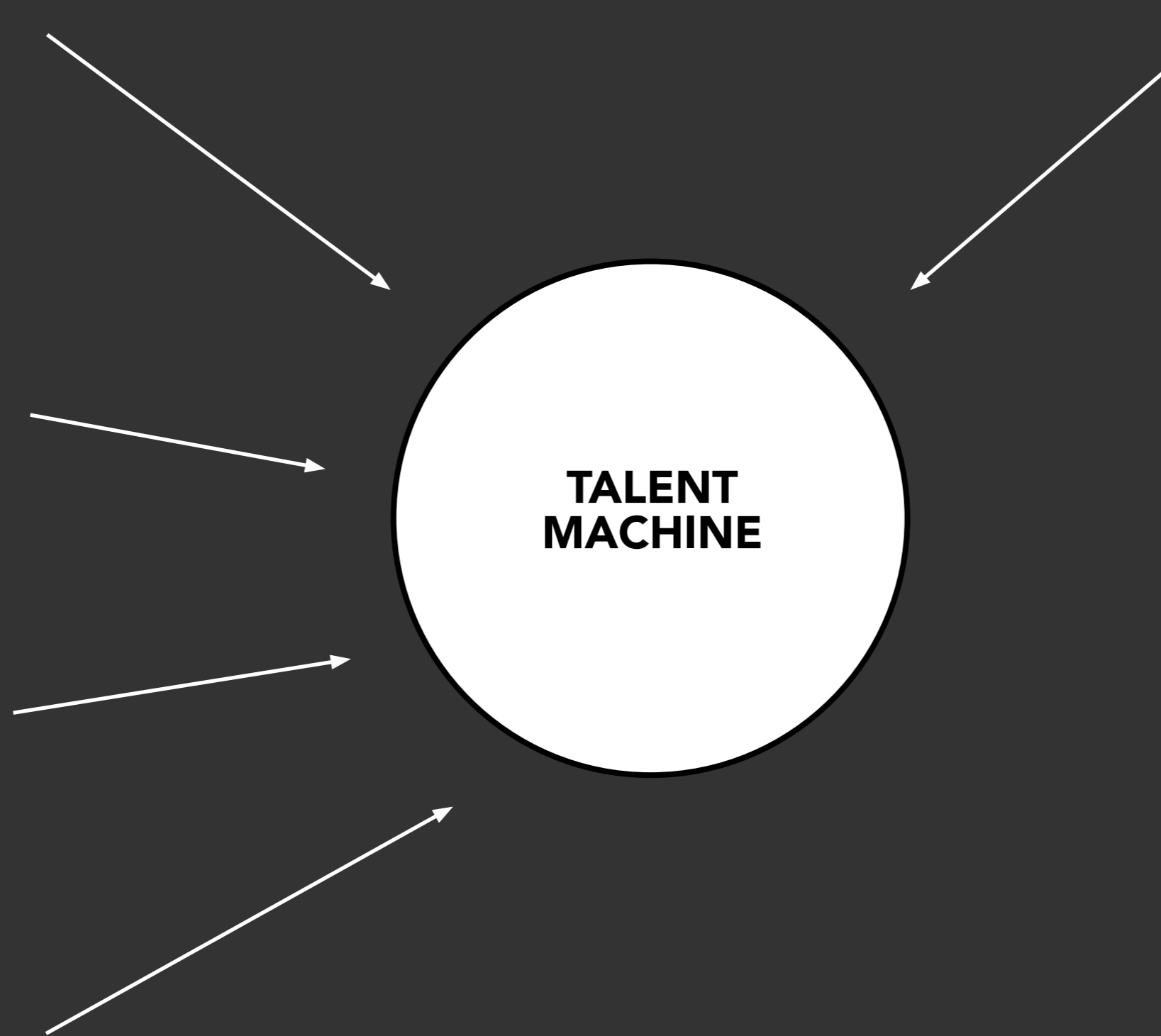

**CHANCE FOR  
PARTICIPATION**





**bottom-up  
initiative**

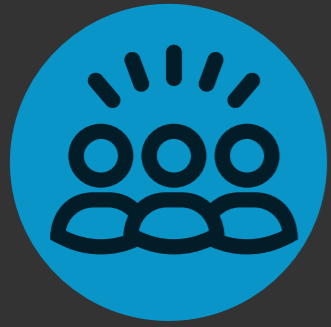

**cooperation**

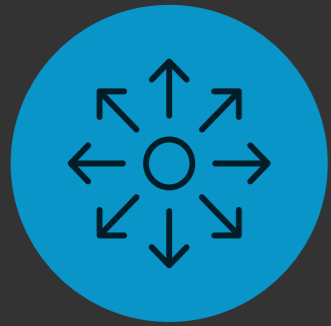

**sharing**



**activation**

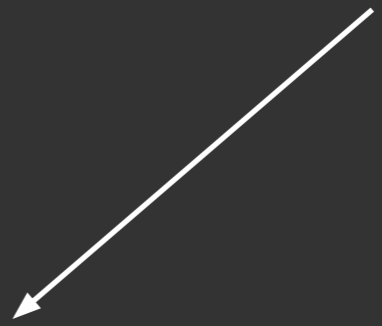
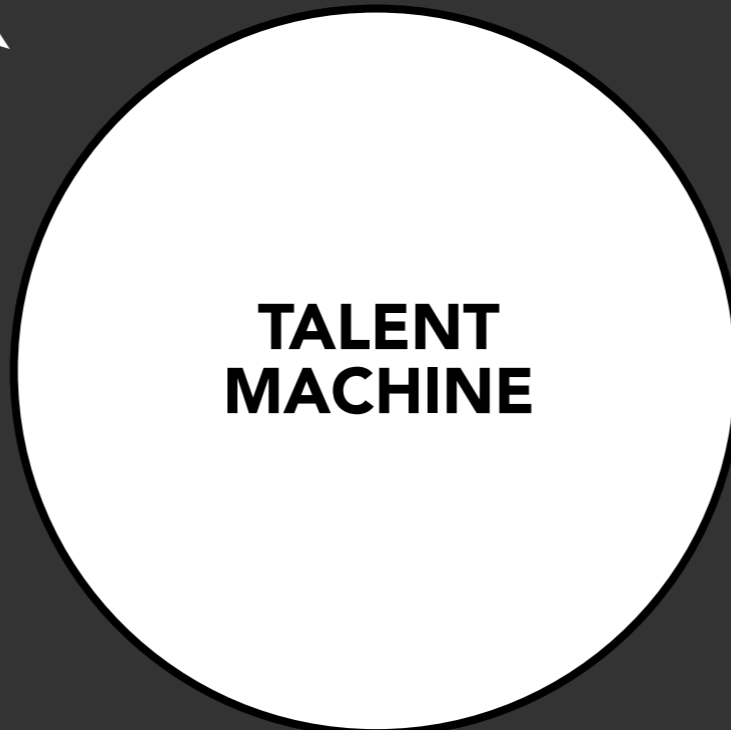

**CHANCE FOR  
PARTICIPATION**

**SPACE FOR  
INITIATIVES**



**bottom-up  
initiative**

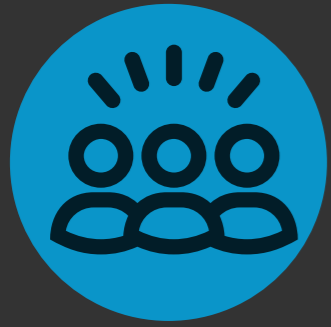

**cooperation**

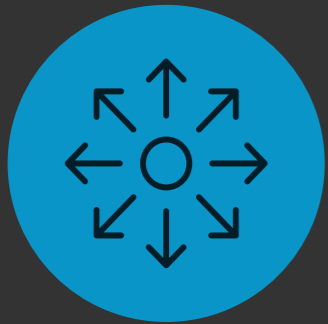

**sharing**



**activation**

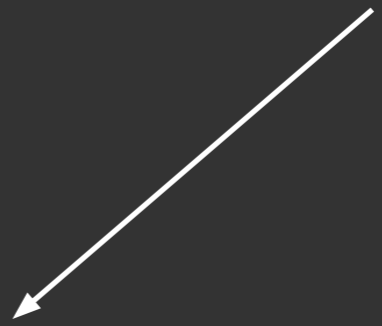
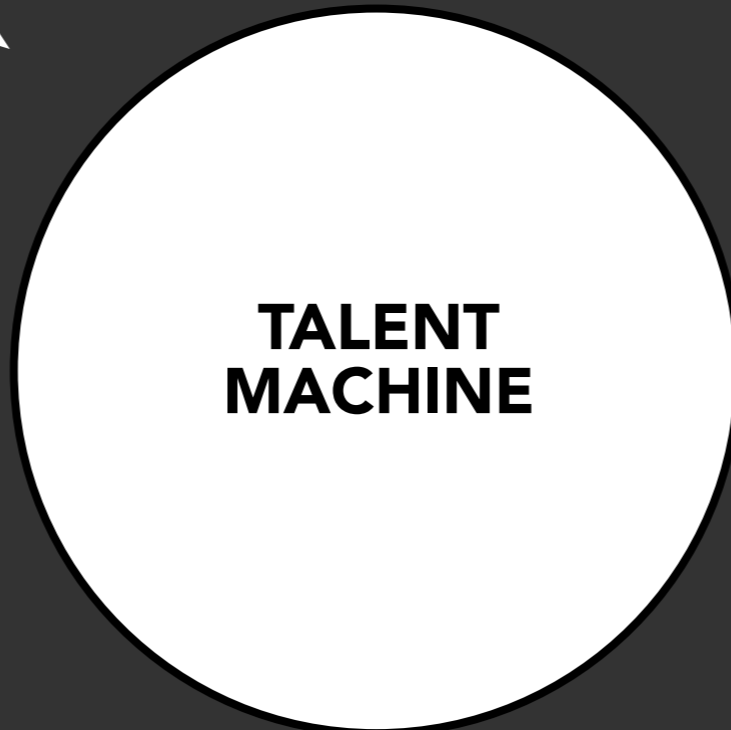

**CHANCE FOR  
PARTICIPATION**

**SPACE FOR  
INITIATIVES**

**CONNECTING  
PROFESSIONALS**





**bottom-up  
initiative**

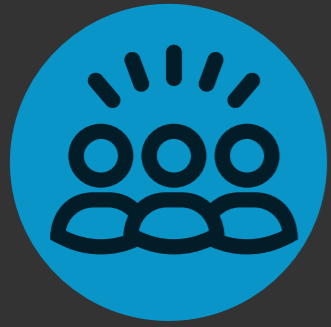

**cooperation**

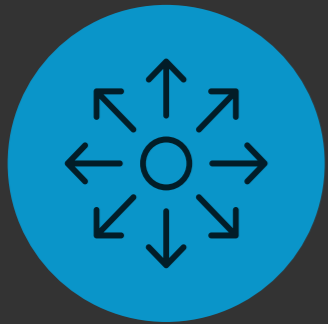

**sharing**



**activation**

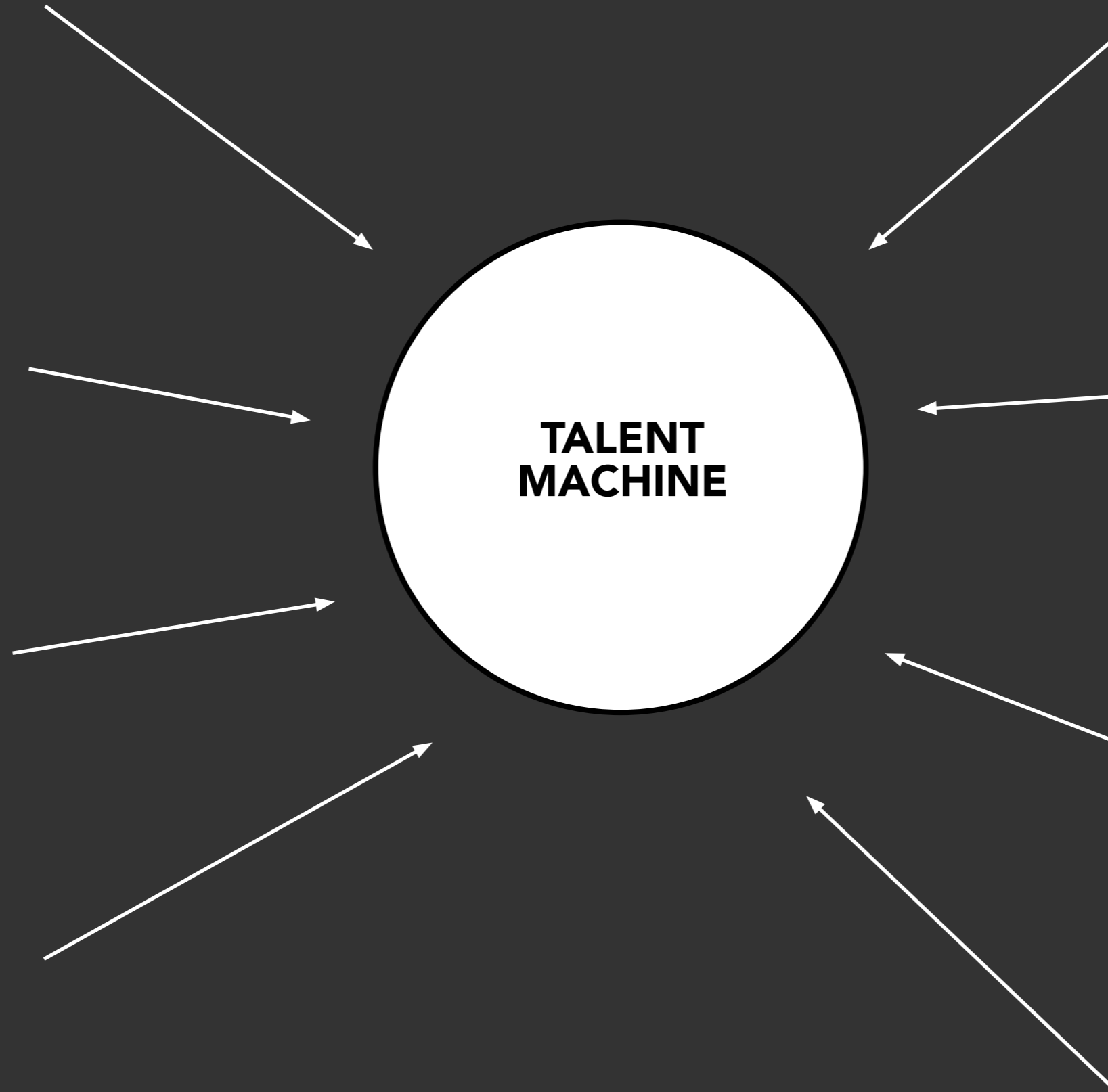

**CHANCE FOR  
PARTICIPATION**

**SPACE FOR  
INITIATIVES**

**CONNECTING  
PROFESSIONALS**

**SUSTAINABLE &  
INSPIRING**



**Thank you**



