

SITE ANALYSIS

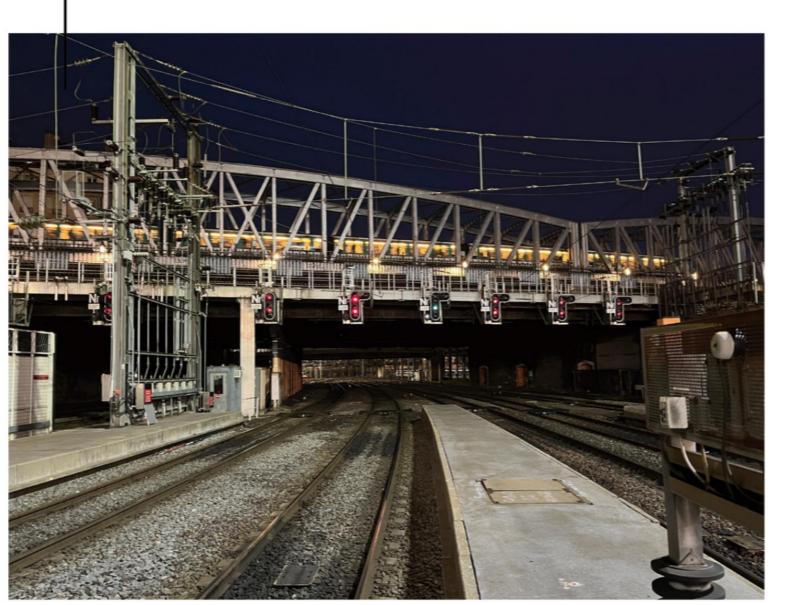

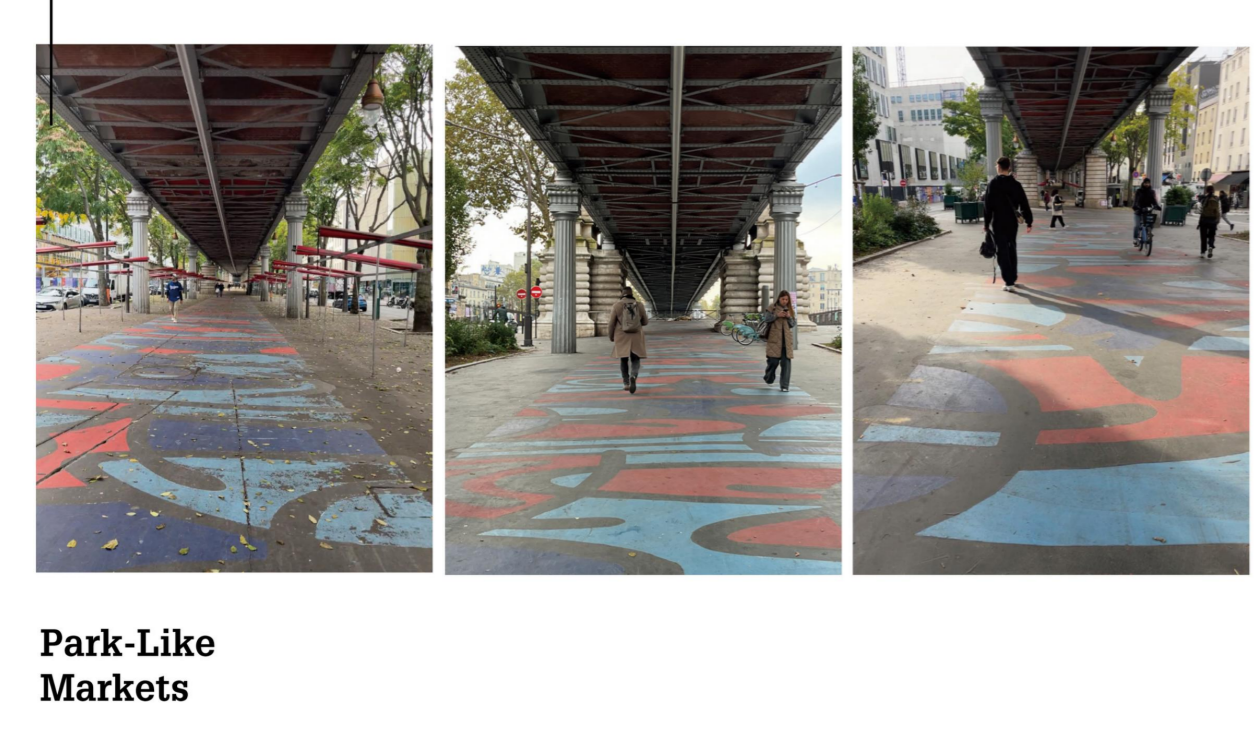

1 Graves 2 Curtains 3 Benches 4 Lounge Area 5 Farewell Hall 6 Viewing Room 7 Memorial Hall 8 Skatepark 9 Contemplation Garden 10 Meditation

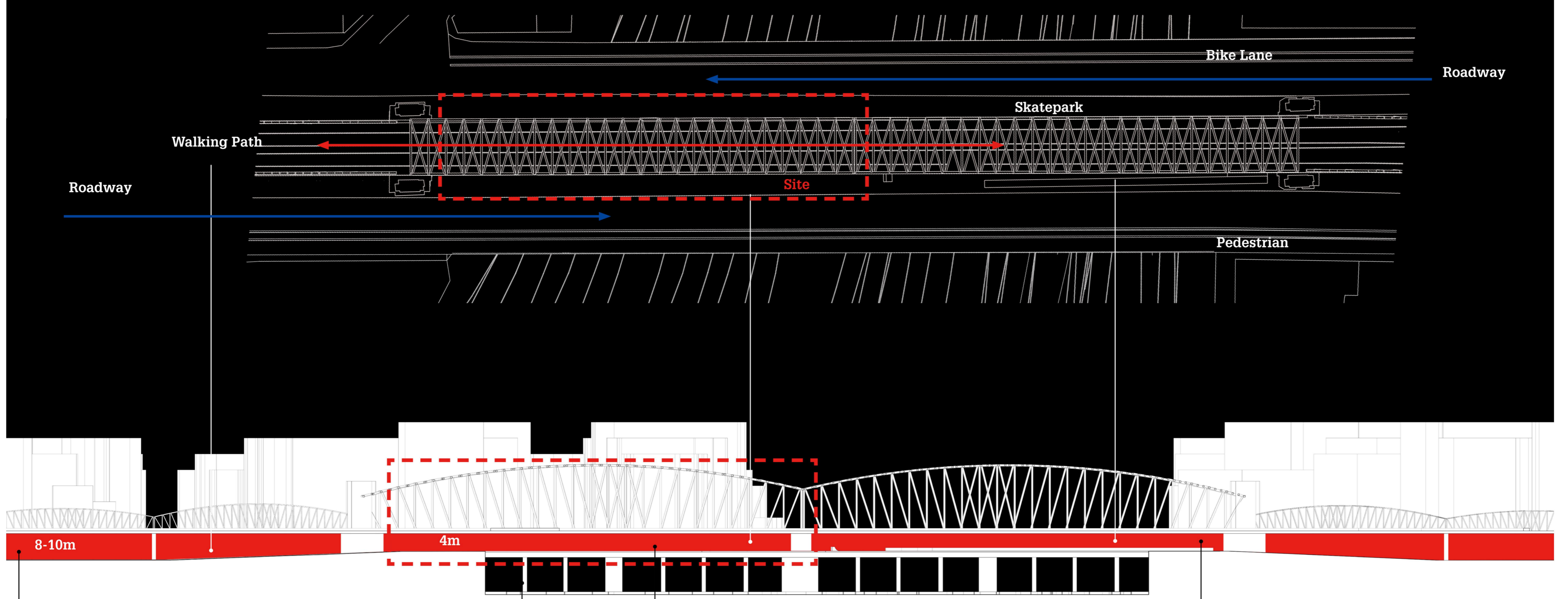
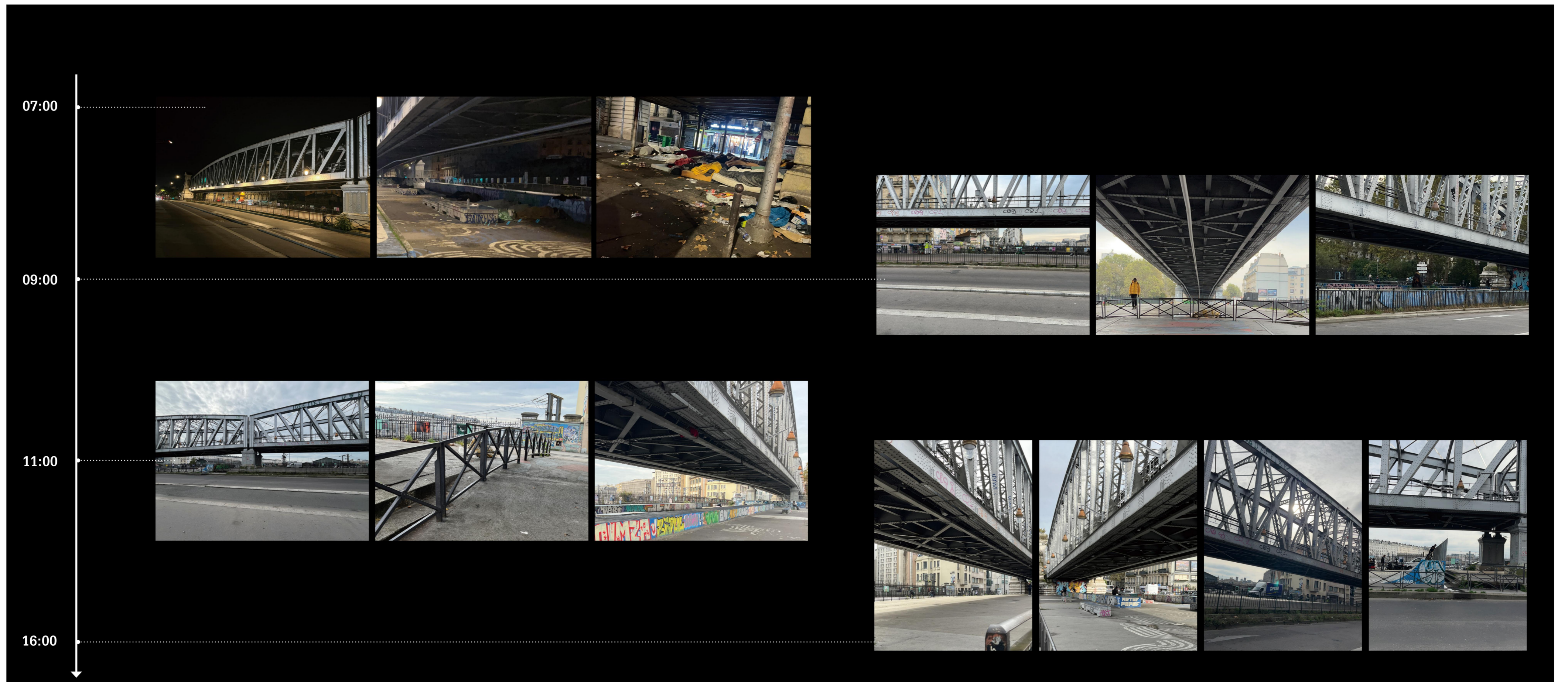
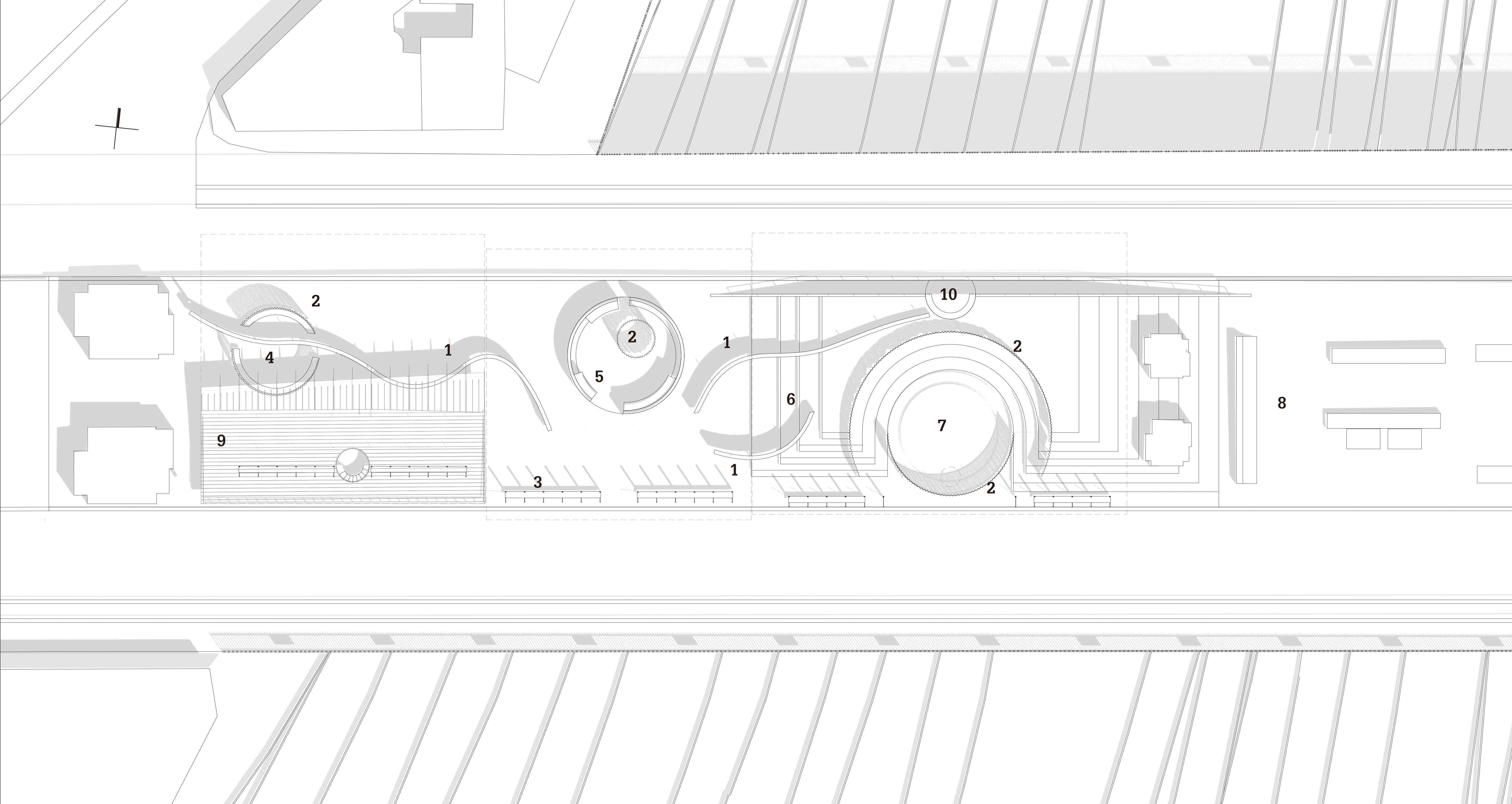
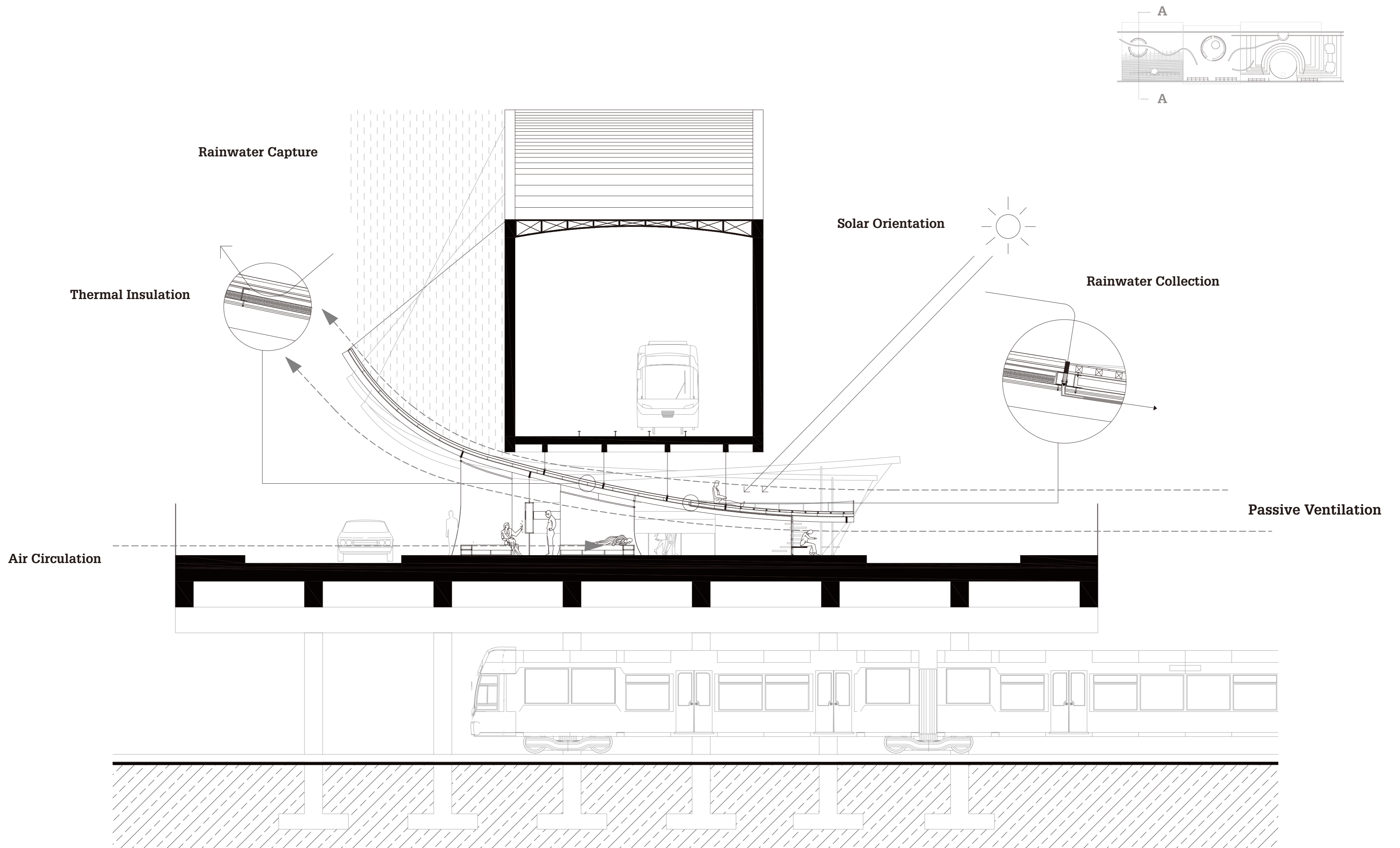

SECTION A-A 1:100

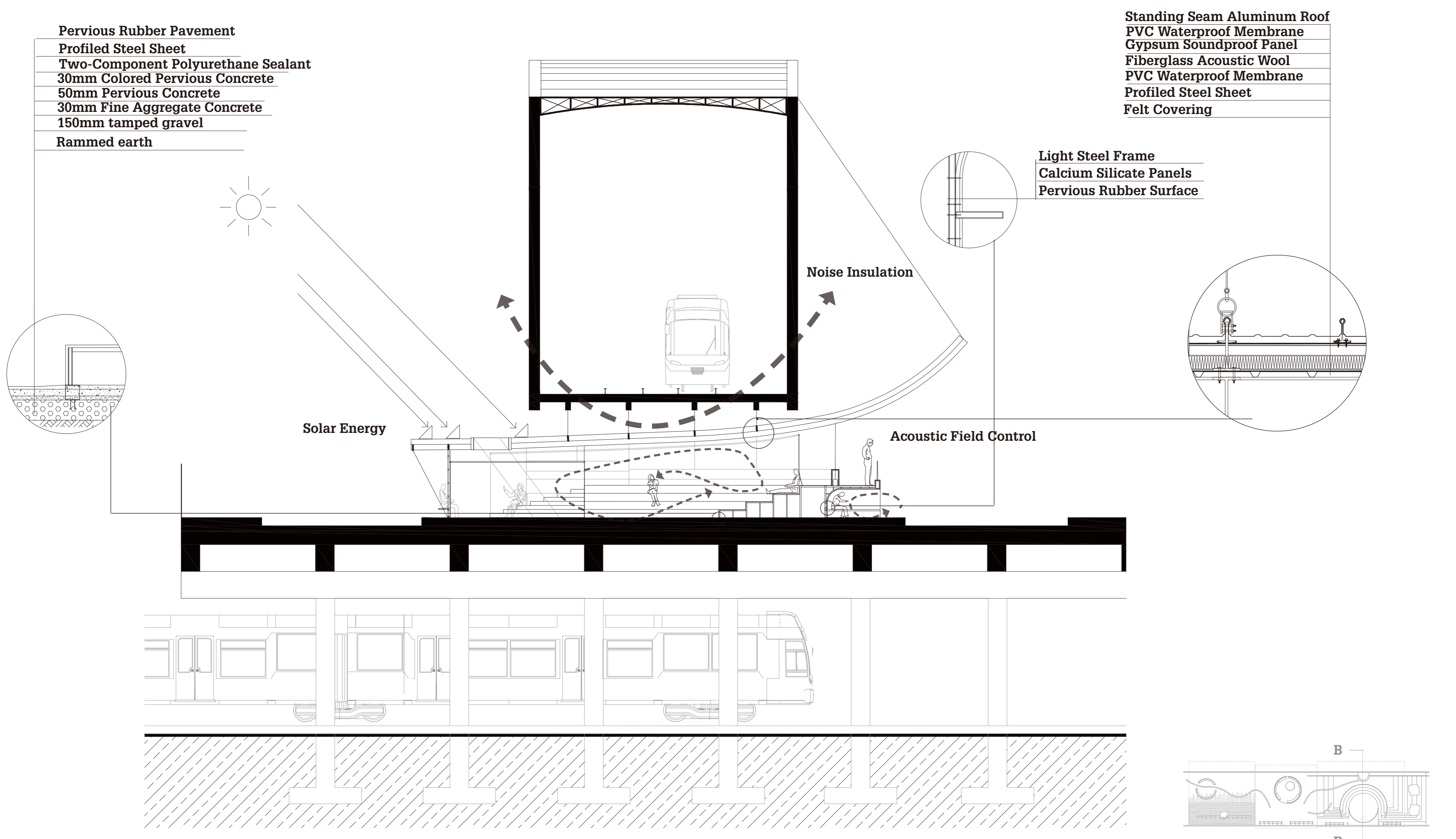

SECTION B-B 1:100

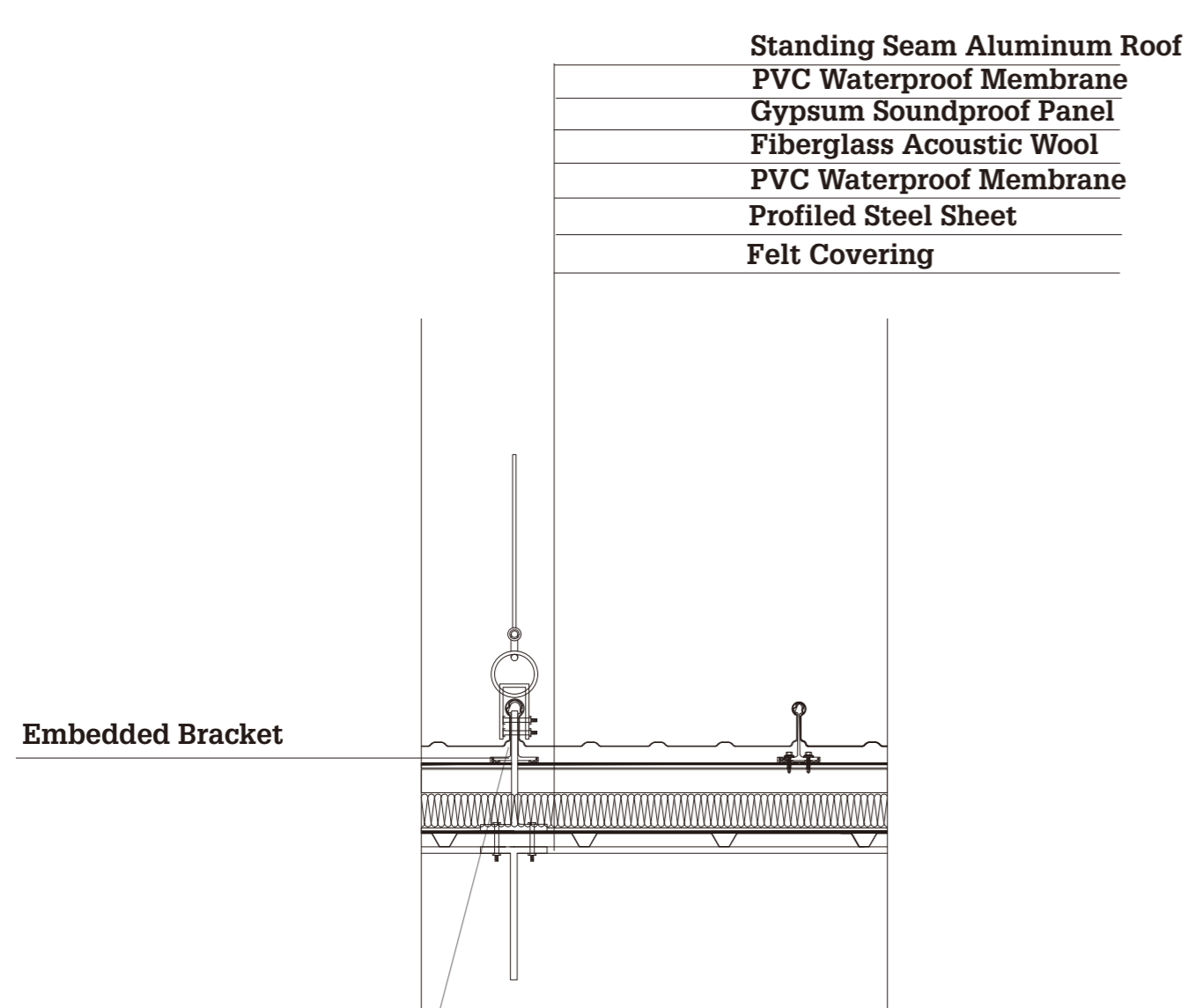
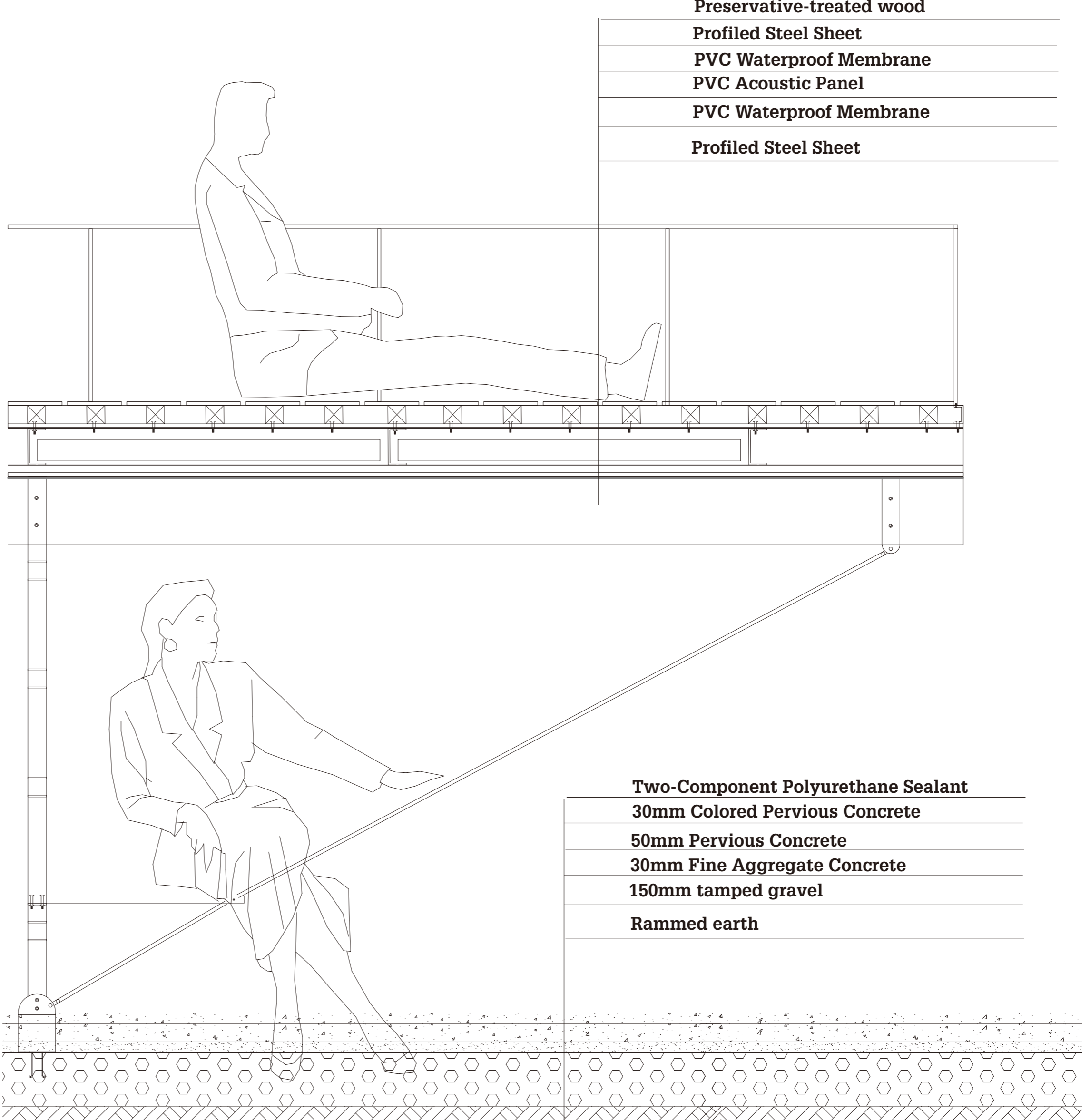
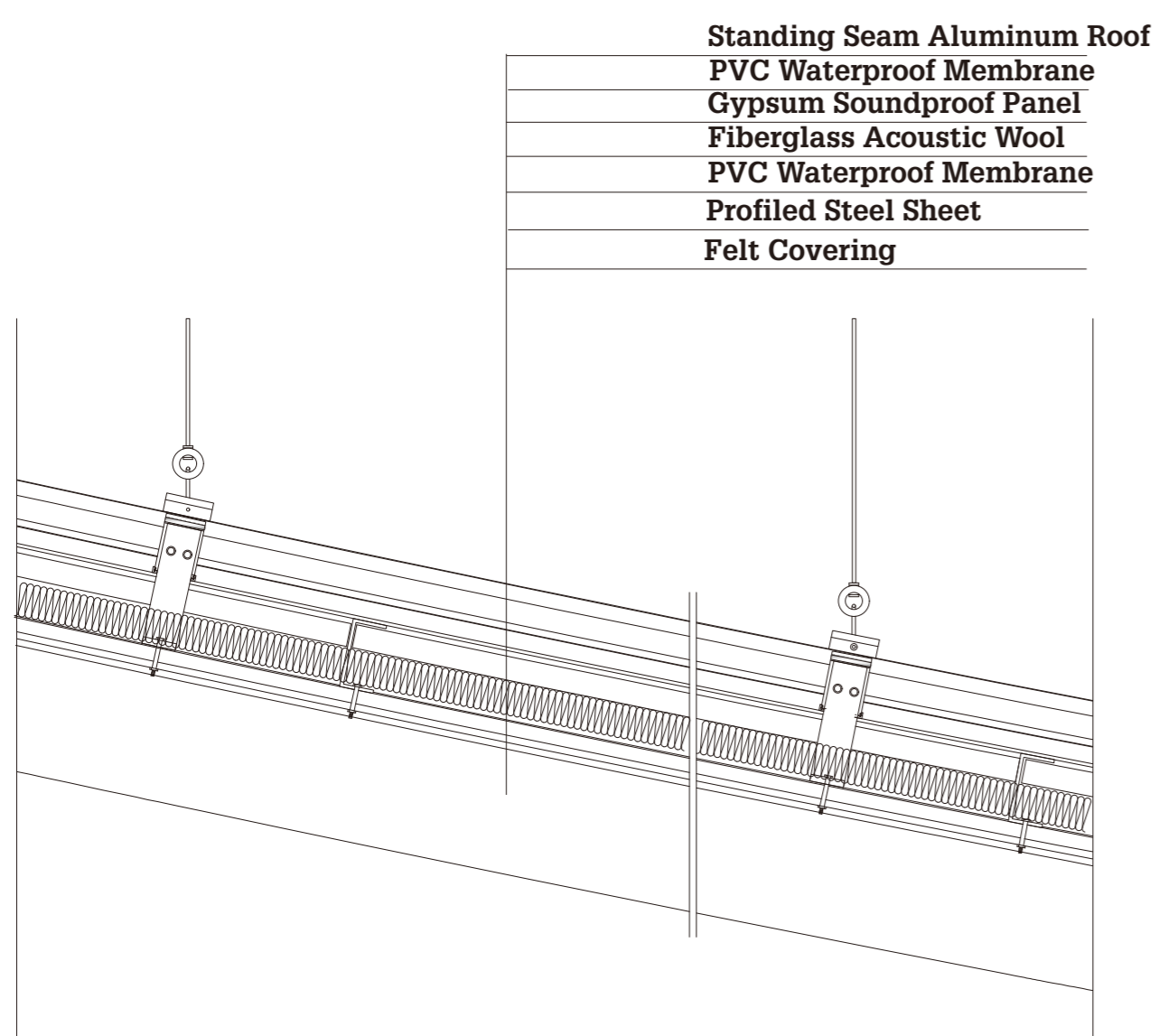

DETAIL A 1:10

DETAIL B 1:10

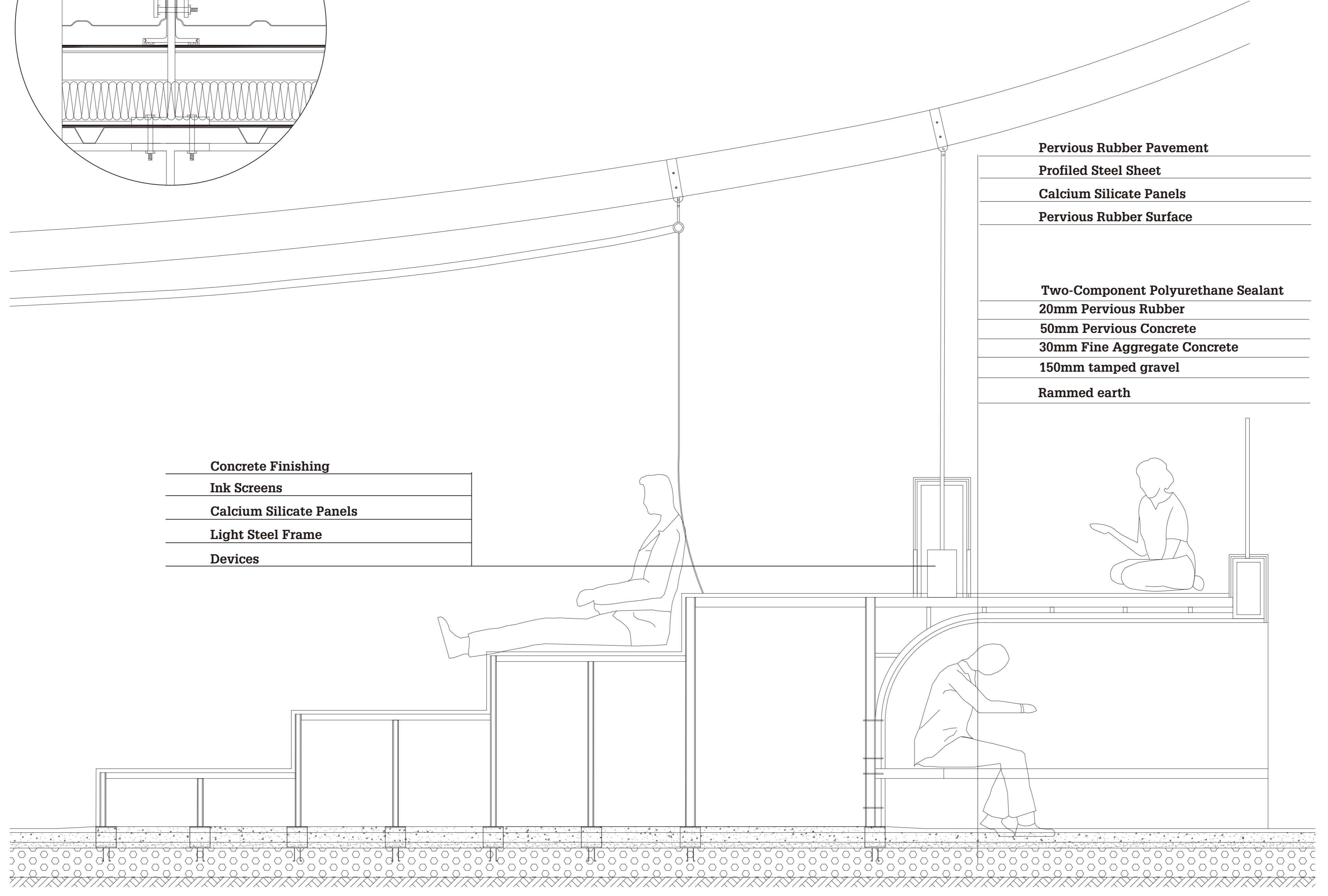
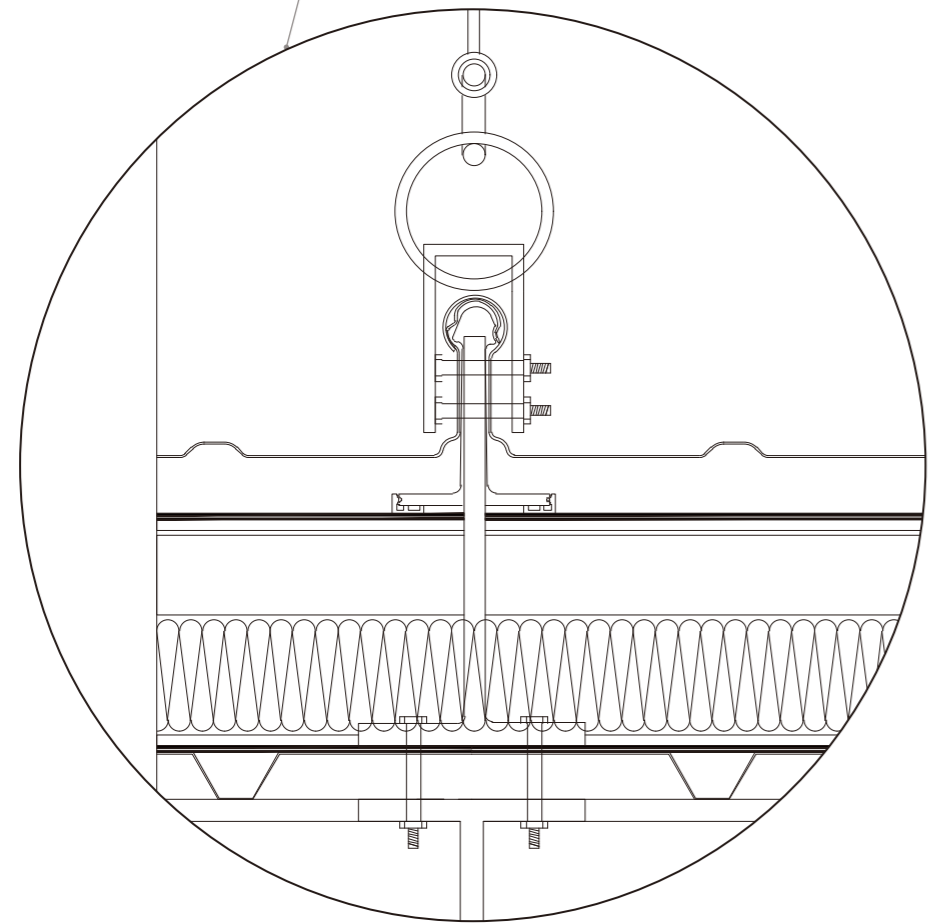

DETAIL C 1:15

EXPLODED ISOMETRIC

STRUCTURES

Viaduct

Ceilings

Cables

Frame

Graves

Curtains

Farewell Room

Theater

Columns

Bridge

Railways



MATERIALS

Steel



Naturally Antiseptic Wood



Aluminum

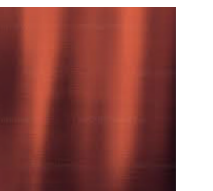

Light Steel



Concrete



Seamless Metal Mesh



Pervious Rubber



Pervious Concrete



FRAGMENT I:50

Standing Seam Aluminum Roof
PVC Waterproof Membrane
Gypsum Soundproof Panel
Fiberglass Acoustic Wool
PVC Waterproof Membrane
Profiled Steel Sheet
Felt Covering

Seamless Metal Mesh
Pervious Rubber
Concrete Finishing

Ink Screen
Calcium Silicate Board
Pressure Sensitive Fiber

Two-Component Polyurethane Sealant
30mm Colored Pervious Concrete
50mm Pervious Concrete
30mm Fine Aggregate Concrete
150mm tamped gravel
Rammed earth

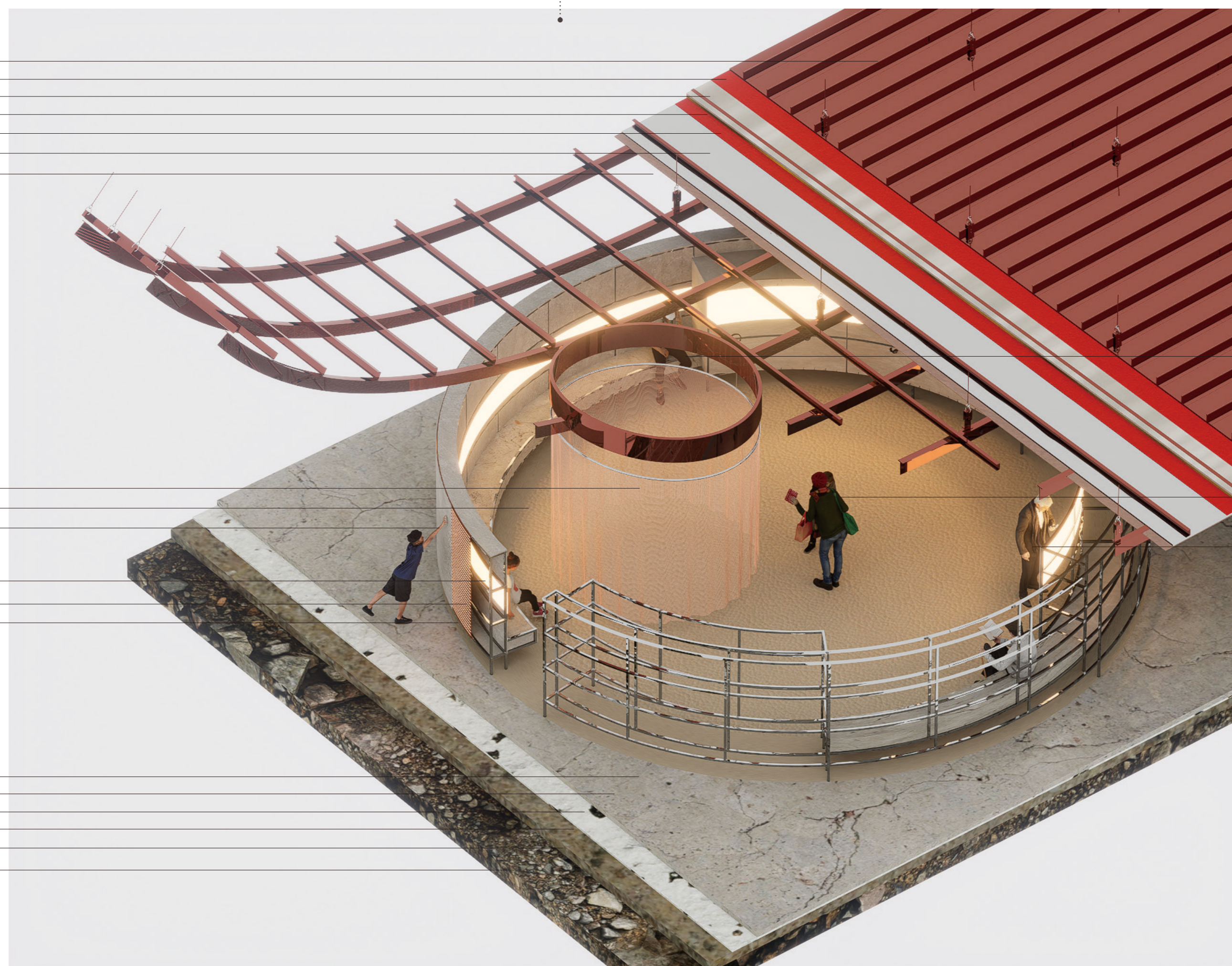

Listening to the Decreased

Meeting people

Facing to the Decreased

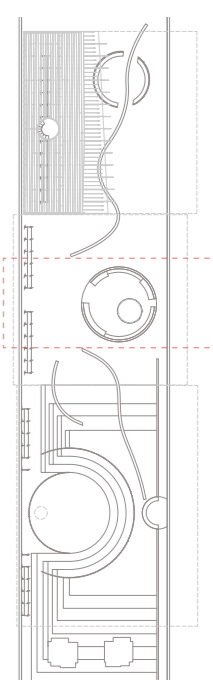

CEREMONIES

Digital Epitaphs

Disappearing Palm Prints

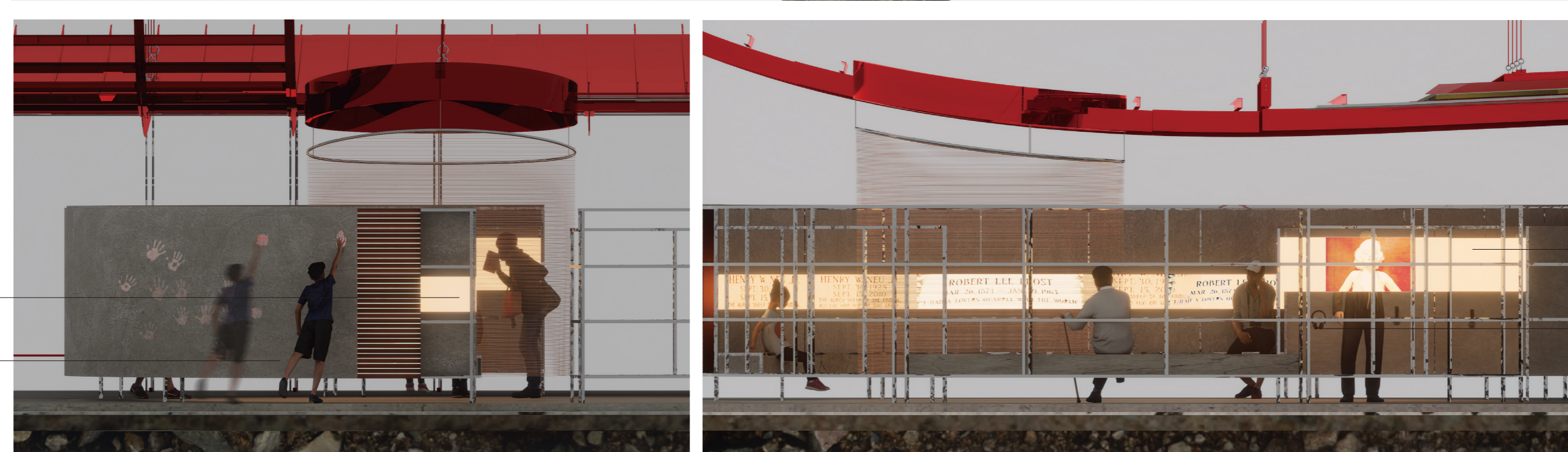

Headsets

Video Equipments

Touching

Meeting

Staying

Looking

Hearing

Seeing

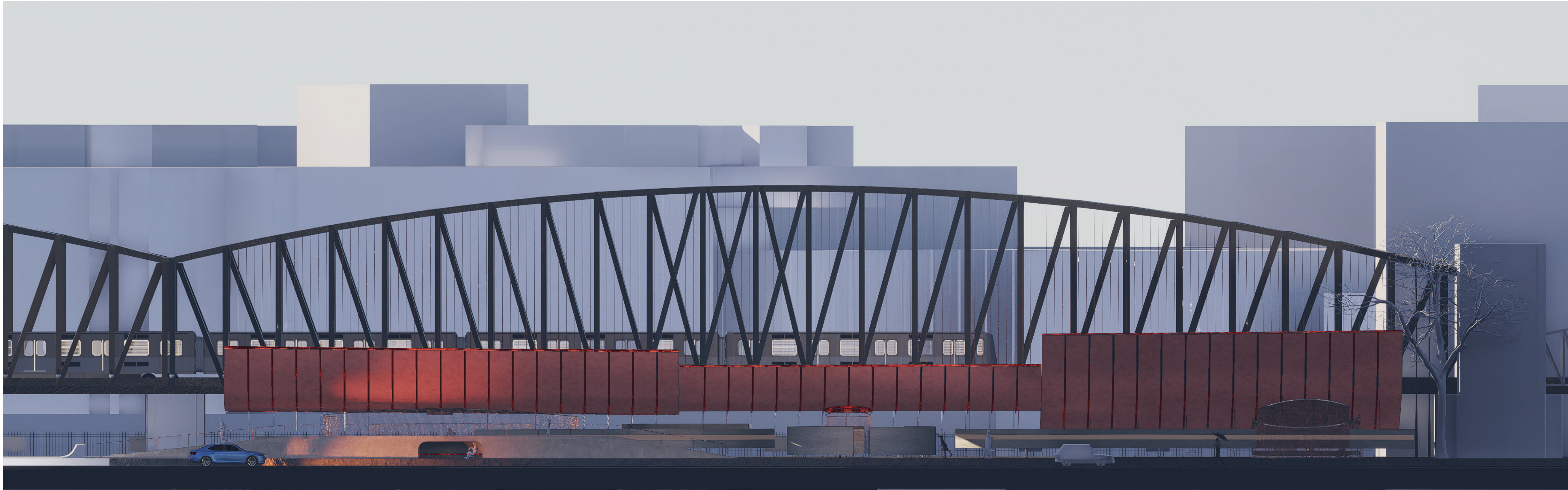
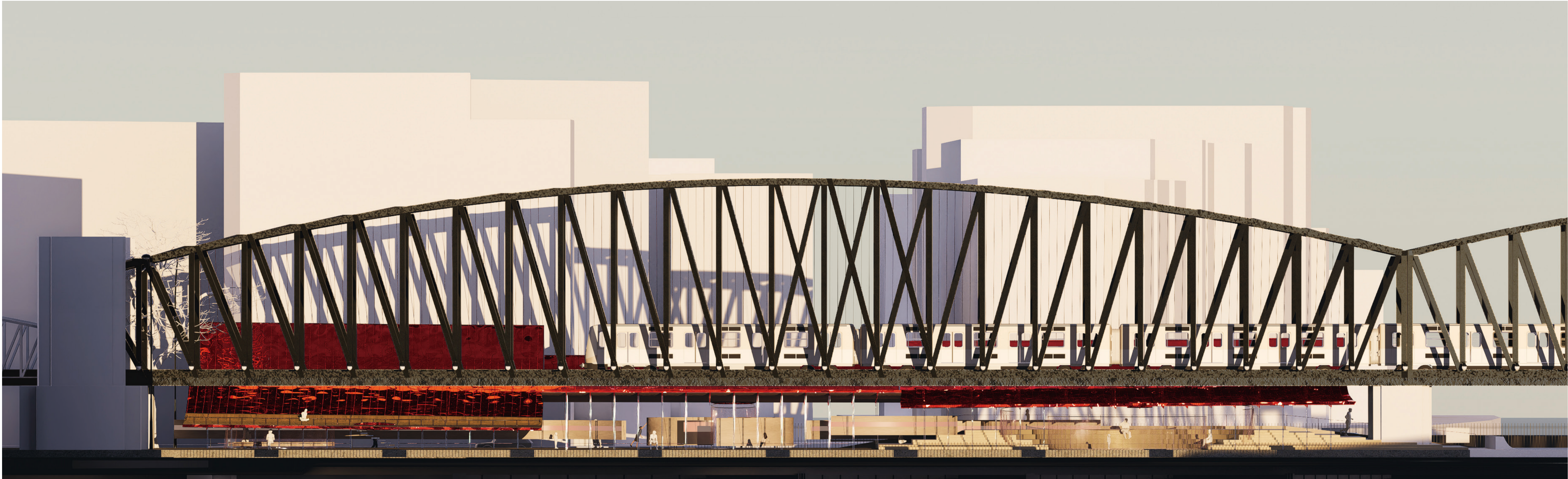

ZOOM-IN DRAWINGS



ZOOM-IN DRAWINGS

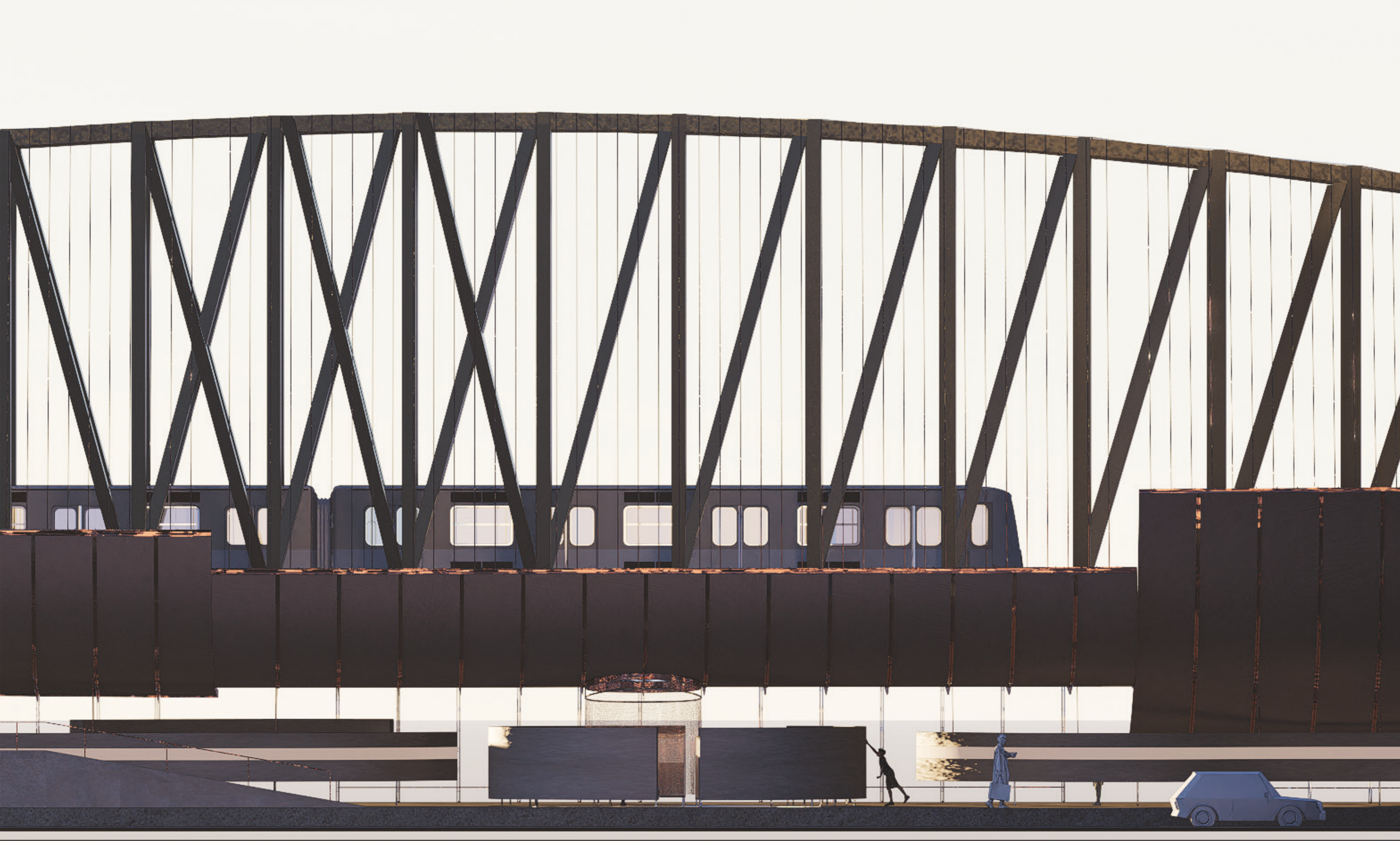
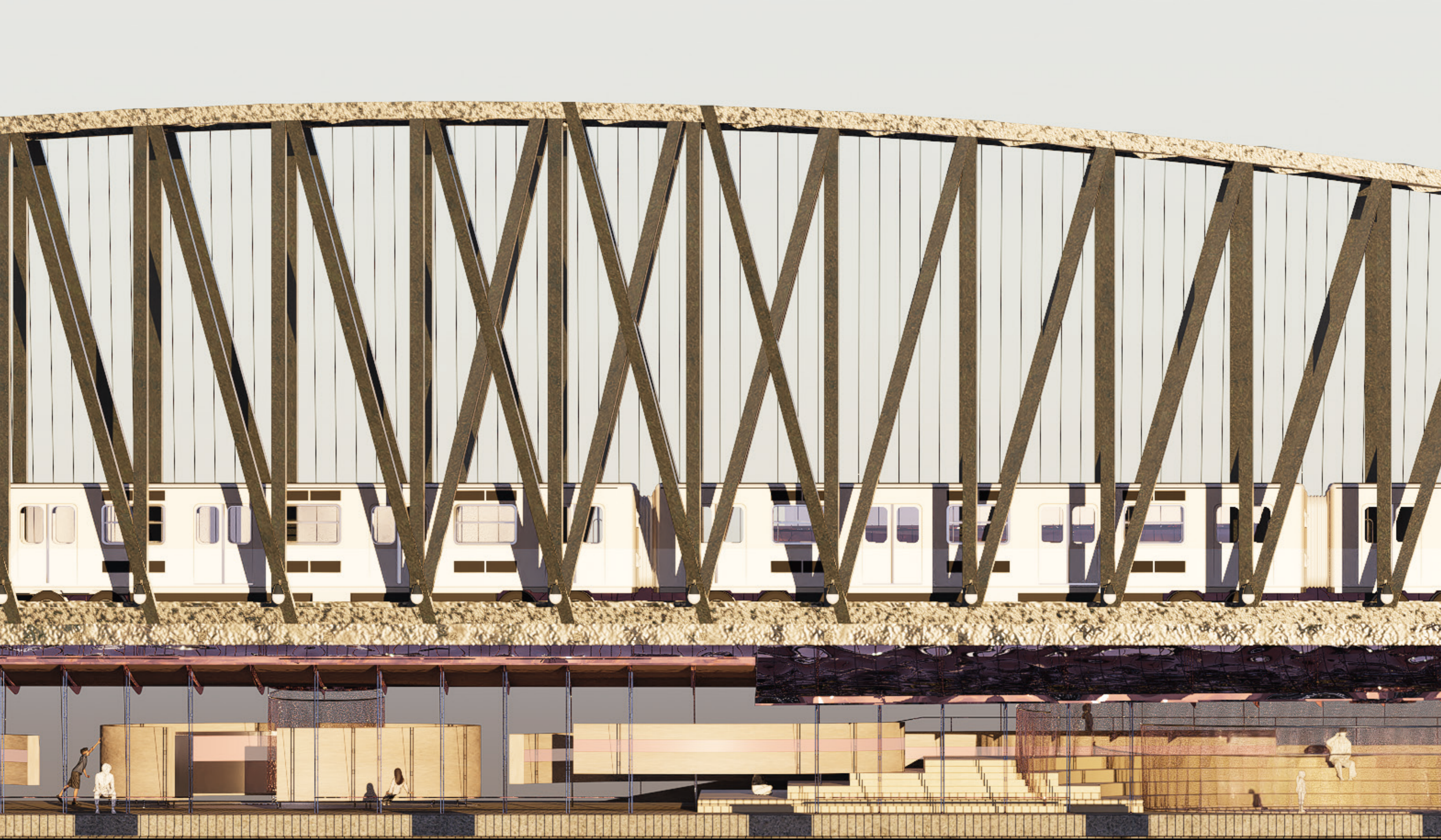

ZOOM-IN DRAWINGS

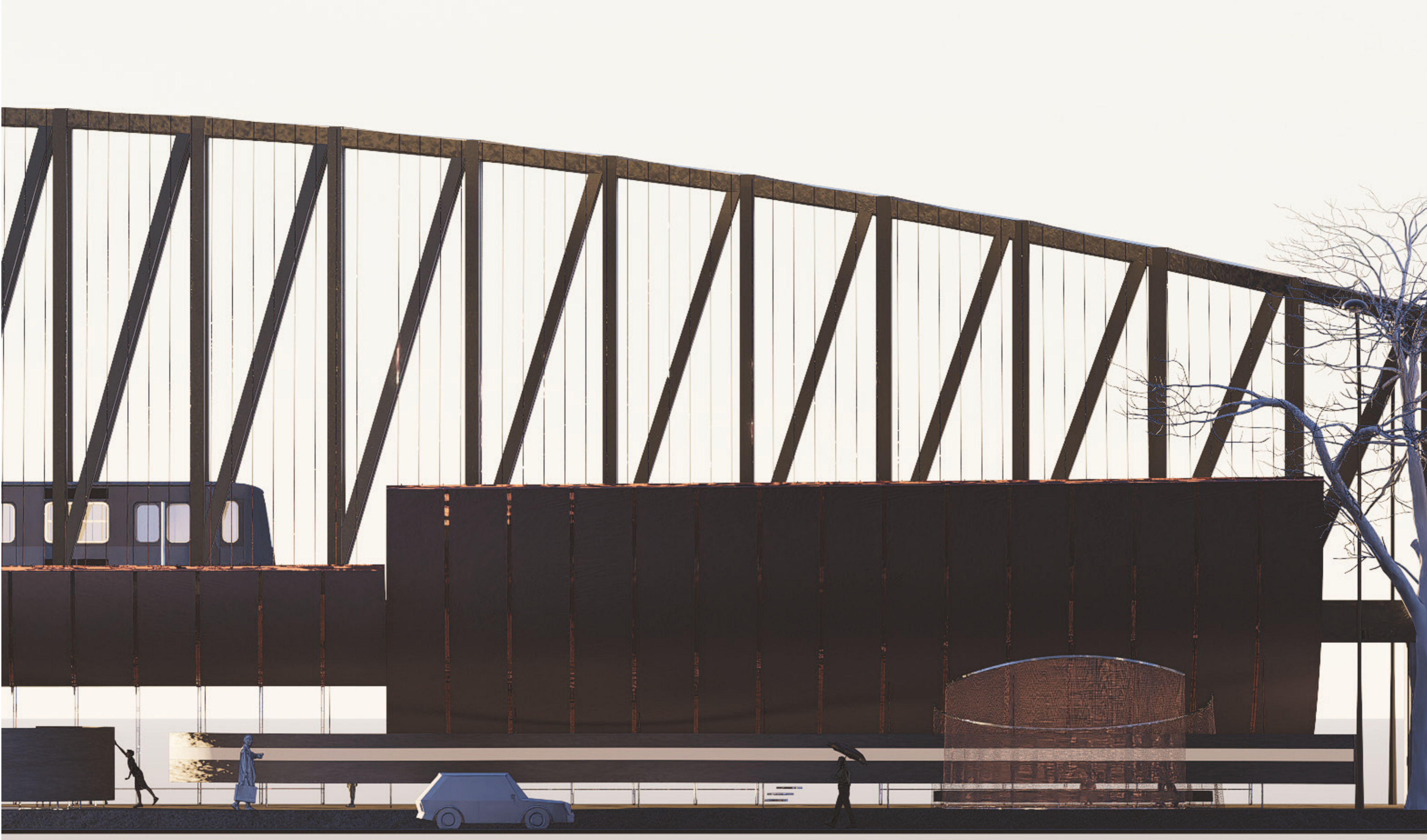
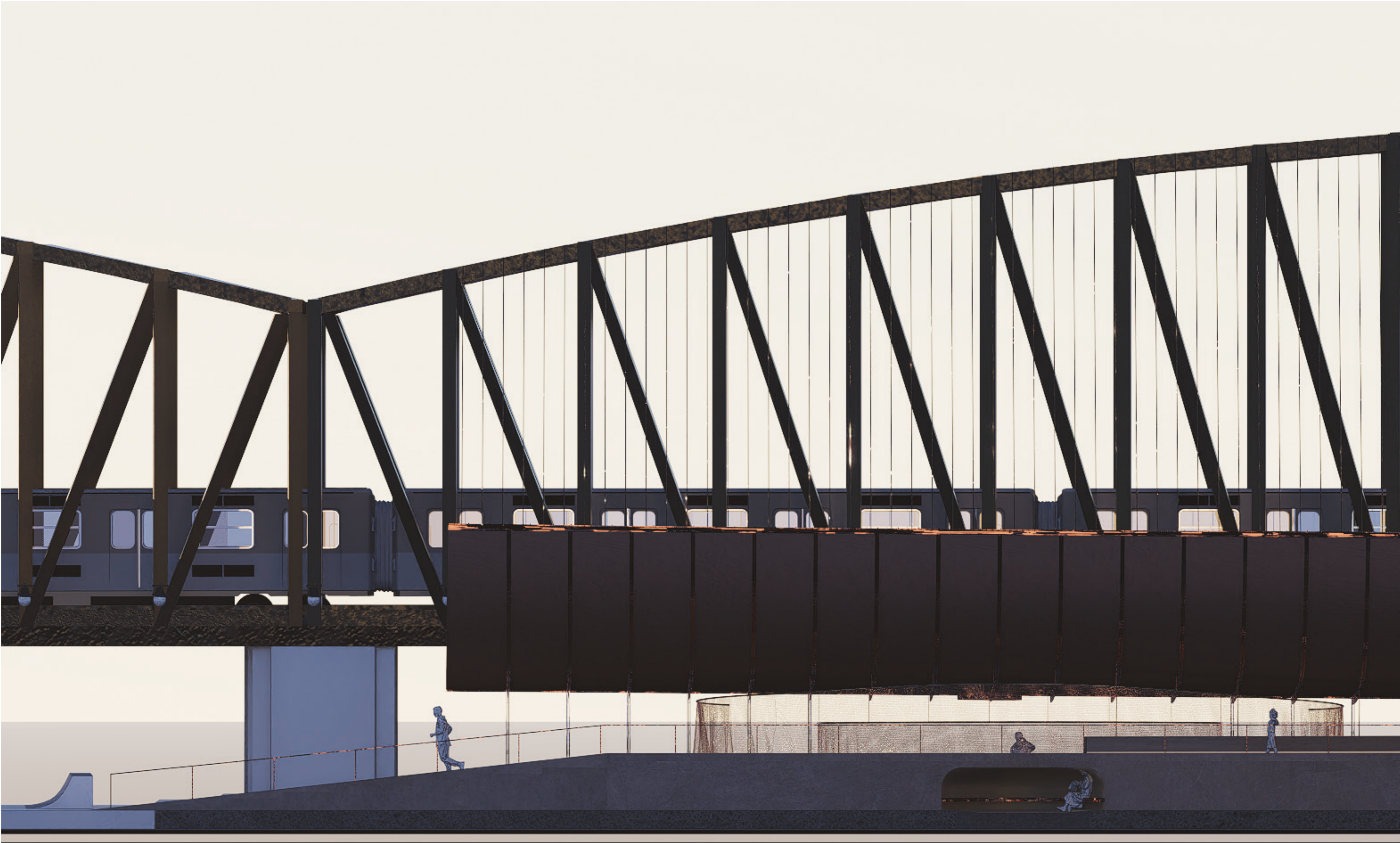

NARRATIVES

HEIGHTS

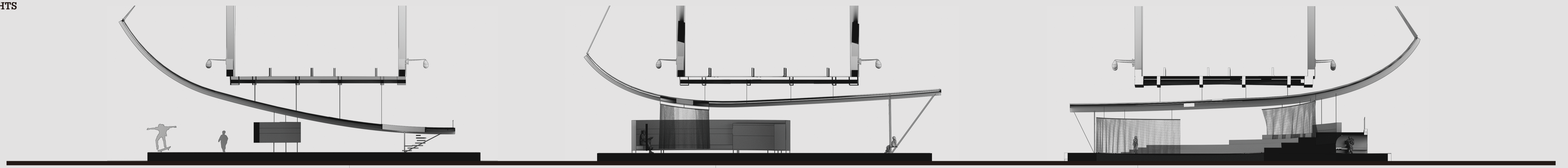

SPACES



EXPERIENCES

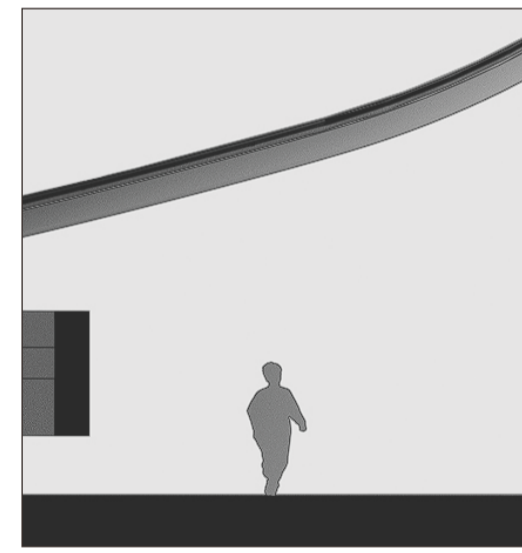

Respecting

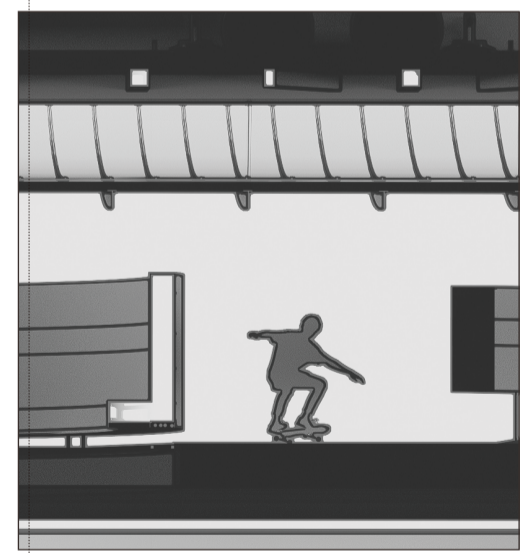

Acting

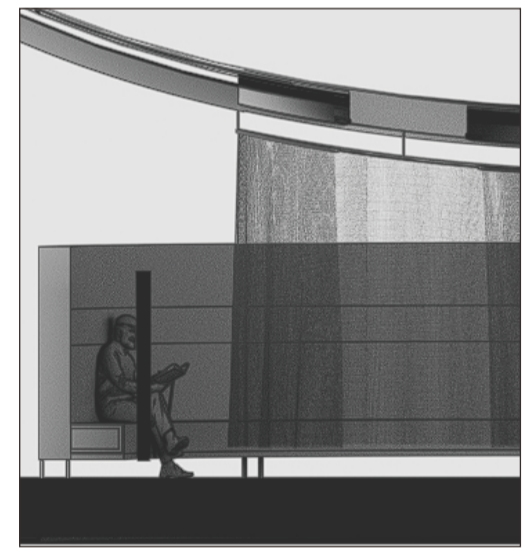

Mourning

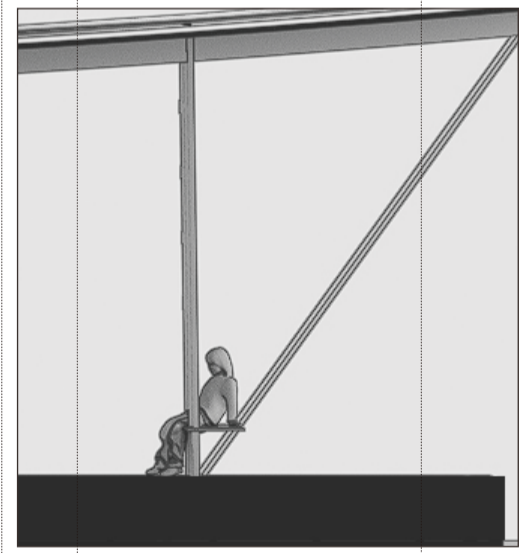

Sitting

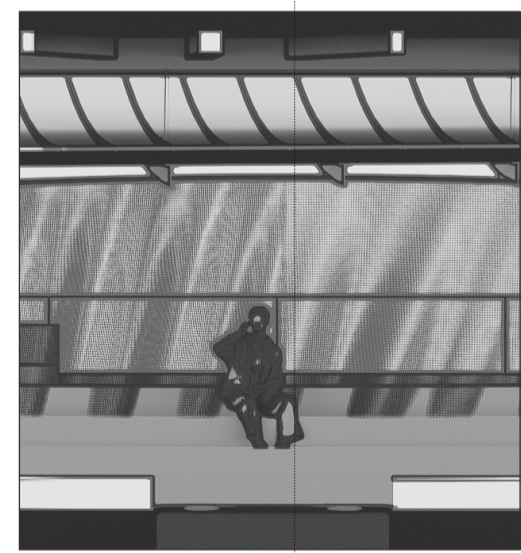

Staying



Toughing



Meditating

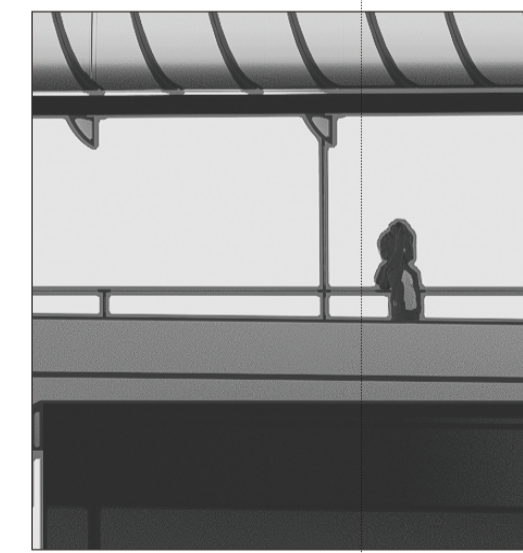

Looking



Climbing

MOODS

Openness

Immersion

undefined

defined

Volume

