

# Professional neck massage device in everyday surroundings

Jiming Bai | September 2019

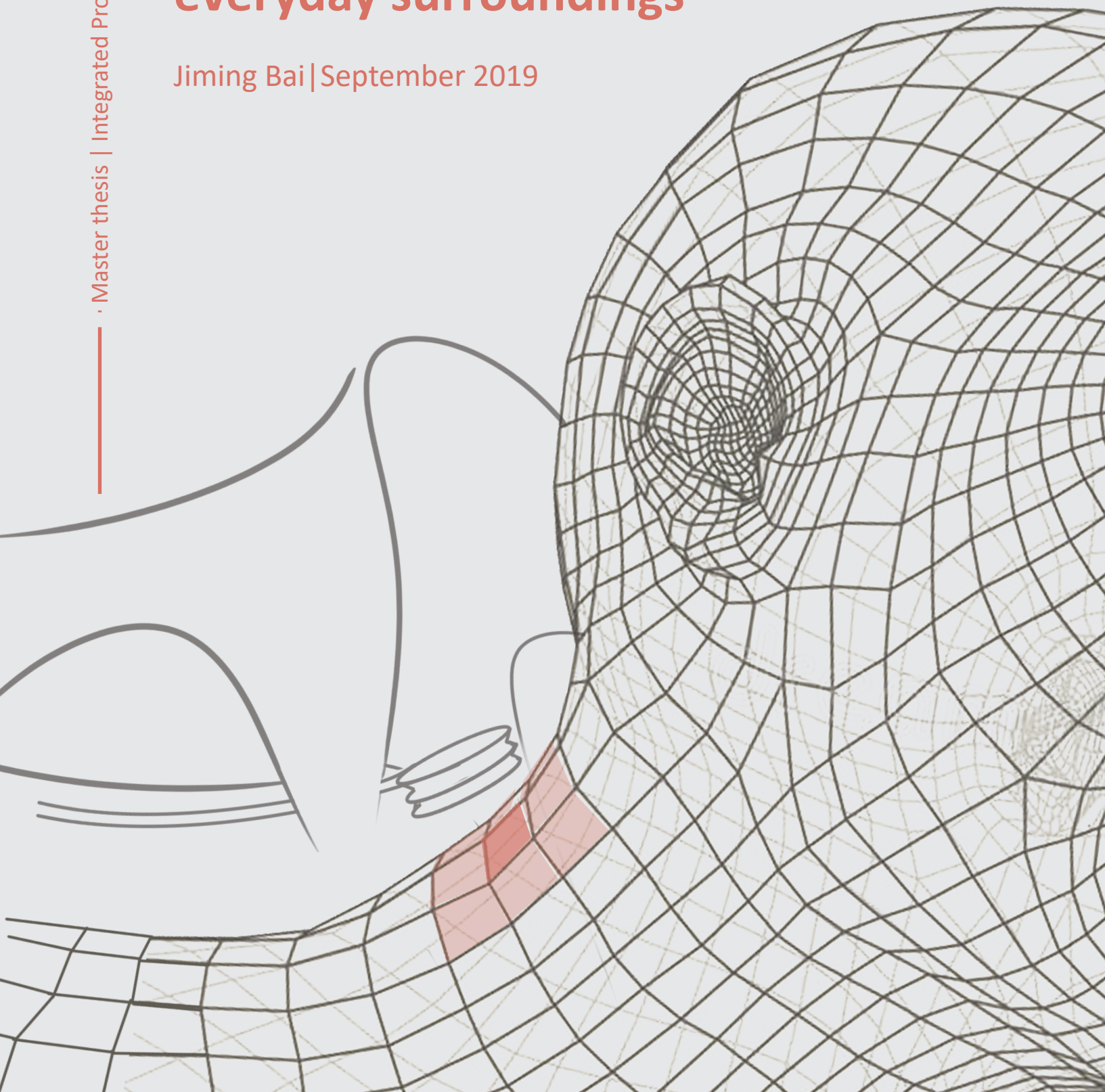

## Acknowledgment

This project was a complex design project with many unfamiliar fields for me, such as Cyber-Physical Systems and Clinical Massage. Without the support from my families, supervisors, friends, experts, and participants, I would not accomplish this proud journey. First of all, I would like to thank my chair and mentor, Imre and Adrie, who have walked me through all the stages of the project. Whenever I felt struggled during the process, they were always there supporting me with their expertise and sweet encouragement. Secondly, thanks to doctor Alexandru, who accepted my interview and gave me professional advice during the design process. Moreover, I would like to express my gratitude to all those participants who were willing to share their experiences and opinions. Last, I appreciate all the practical and emotional support from my family and friends. Without your support, I can't go through all the difficulties.

---

## Topic

"Developing a professional neck massage device in everyday surroundings with the principles of Cyber-Physical Systems and clinical massage"

---

## Graduate student

Jiming Bai  
Jiming.d.bai@gmail.com  
student number: 4730895

---

## Graduation date

16-09-2019

---

## Institute

Delft University of Technology  
Faculty of Industrial Design  
Engineering  
Master Integrated Product Design

---

## Supervisory team

**Chair**  
Prof. Dr. I. Horvath  
I.Horvath@tudelft.nl

**Mentor**  
Ir. A. Kooijman  
A.Kooijman@tudelft.nl

## Executive summary

Office workers who hold a static posture during prolonged computer work have the highest incidence of neck disorders at 34--49% a year (42% in Thailand, 34% in Finland, 36% in Sweden, and 49% in Australia) (Fejer, 2016). It is not a life-critical problem, but it is affecting people's life quality. Treating neck pain is a burden for both the neck pain patients and the public resource. Taking the Netherlands as an example, the total costs of neck pain in the Netherlands are estimated at €540m a year (Ingeborg, 2003). So, a convenient, cheap yet professional way of helping the patients manage their neck pain is urgently needed.

People with neck pain are highly recommended to correct their sitting postures and to more exercise. However, sitting postures and exercises are not the only reason leading to neck pain. Even with the same lifestyle and habits, some people are more likely to have neck pain than others. Moreover, it is not easy for patients to stick to the strict habits. Especially for the target group, their neck pain is strongly related to their work which requires working with computers for a long time. Therefore, a way of treatment is always needed.

Clinical massage, as one of the main treatment methods, has been proved to be effective by many studies. There are some massage devices on the market, but they cannot be used to treat neck pain. Most of them do the same to every user while people vary in body size and symptoms. There is one professional clinical massage device, but it is designed for clinics. It is a robot arm controlled by therapists so patients cannot use it on their own. Moreover, it is too expensive for personal use.

In this project, a smart device was designed by applying principles of clinical massage and Cyber-Physical Systems. Since it is hard to give a reliable assessment by a device, a new way of achieving professional massage was proposed. The idea is to record what the therapist did in the massage treatment and recreate that with the device. With a pressure sensor matrix, the device can record where the force was exerted, how hard the pressure was, and how long it lasted. With this information, the device will be able to figure out what technique the therapist used and then control the actuator to perform the same technique at the same position with the same force intensity.

The device aims to mimic the two most commonly

used massage techniques, "still compression" and "gliding compression". "still compression" means pressing at one point while kneading. It is used to treat trigger points. The device performs this task by adding pressure with an air pump while vibrating. "Gliding compression" means pressing at the muscle while moving a finger along or across the muscle. It is used to treat stiff muscles. The device performs this task by arranging several actuators in line. They inflate one by one to simulate the movement of fingers. The inflatable massage element is attached to a collar. While wearing the collar, users lie on a pillow that fit with their body. In this way, users are relaxed when they are using the device, and the reactive force is provided.

The device can locate massage elements at the right spot. This is done by using two collars with the same shape and size. One of them is embedded with pressure sensor matrix. Users get massaged by therapists while wearing this collar. Then, the recorded positional information is translated to coordinates on the other collar. In this way, the system instructs users to place the massage element at the right spot.

A prototype, including the massage element, the pillow, and the collar was made to test the function described above. In general, the functional requirements are fulfilled. Only the accuracy needs to be improved. There are many insights collected during the evaluation. In reaction to these new insights, an updated structure of the product is proposed in the form of a CAD model and renderings. Basically, the collar is fixed to the pillow at the centerline. Users lie on the pillow first and then tighten the collar. In this way, the process of using the product becomes more intuitive. Moreover, the design of a chair integrated with the neck massage device is proposed. The design fits the working environment. Organizations such as school and companies can buy the chair and put it in the rest area. Then the employees or students can share it. If people want to buy one for personal use, they can only buy the massage device and use it on a bed.

The concept is feasible and fits the target group's needs for convenient professional neck pain treatment. There is great potential for further developing it.

## Content

<b>Introduction</b>	<b>1</b>
Background	2
Problem	2
Objective	2
Approach	2
Deliverables	3
<b>Analysis</b>	<b>4</b>
Neck pain	5
Clinical Massage	7
User study	11
Cyber-Physical Systems	15
Current products	21
Analysis	25
<b>Conceptualization</b>	<b>29</b>
Functional model	30
Ideation	30
Concepts	32
Evaluation	35
Final concept	38
<b>Detailing</b>	<b>43</b>
Overview of the system	44
Detailing of the massage element	45
Selection of air pumps	47
Control of the air pump	50
Selection of power source	51
Detailing of the casing of the control unit	51
<b>Prototyping</b>	<b>53</b>
Prototyping the inner collar	54
Prototyping the outside collar	54
Prototyping the massage element	56
Pilot evaluation	59
Update the design	60
<b>Evaluation</b>	<b>63</b>
Recruitment of participants	64
Approaches	64
Results	67
Conclusion	73
<b>Conclusion</b>	<b>74</b>
Summary of the project	75
Discussion of the result	76
Recommendations	77
Reflection	79
<b>Reference</b>	<b>84</b>

# Chapter 1 - Introduction

This chapter introduces the background and objective of this project. Moreover, it gives an overview of the approaches and the aimed deliverables of this project.

## 1.1 Background

The project is a graduation assignment of the master program Integrated Product Design. The student saw the opportunity of applying principles of CPSs and clinical massage to deal with neck pain problems.

Neck pain has a high prevalence in the adult population. Its prevalence in the world ranges from 16.7% to 75.1%. Within the industry, office workers who hold a static posture during prolonged computer work have the highest incidence of neck disorders at 34--49% a year (42% in Thailand, 34% in Finland, 36% in Sweden, and 49% in Australia) (Fejer, 2016). It is not a life-critical problem, but it is affecting people's life quality.

Clinical massage, as one of the main treatment methods, has been proved to be effective by many studies. However, it is both costly and time-consuming to visit therapists frequently. It is also a massive burden for public resource. The total costs of neck pain in the Netherlands are estimated at €540m a year (Ingeborg, 2003). There are many massage devices on the market. However, current massage devices only have a relaxation effect which does not help for treatment. There is an opportunity to overcome this challenge with the implementation of a massage device as a partial Cyber-physical system (CPS). It is a system that can interact with real-life processes based on its sensing, computing, and actuating capabilities. With the help of CPS, patients' situation and feedback would be detected and analyzed. Thus the most suitable treatment is applied at the right spot.

## 1.2 Problem

Many office workers and people with similar working conditions are suffering from neck pain. They do not have time nor money to visit therapists to treat the pain frequently (Figure 1).

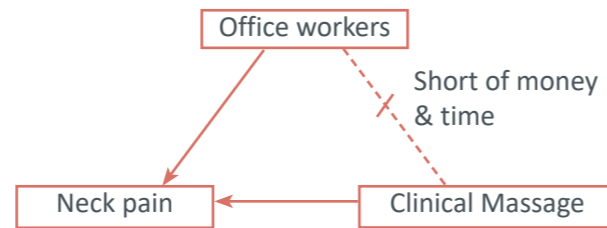

Figure 1: Demonstration of the problem

## 1.3 Objective

The objective is to develop a massage device that helps people treat their neck pain on their own conveniently and effectively by incorporating principles of Clinical massage and Cyber-Physical Systems. A possible architecture of the solution is shown in Figure 2.

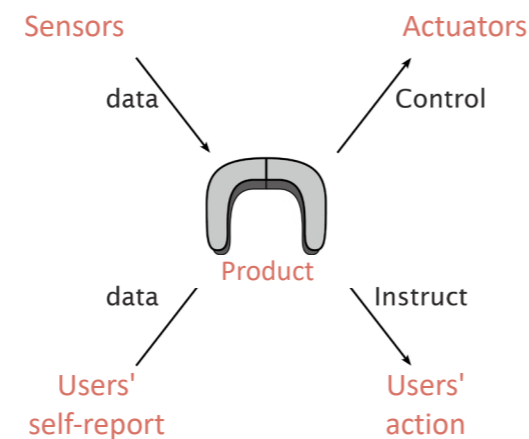

Figure 2: Hypothetical solution

## 1.4 approaches

The project mainly consists of two parts, research part and design part. The research part of the project includes investigation of the neck pain pathologies, clinical massage principles, available technologies, user needs, and existing products. The research will be done in forms of reading literature, interviewing therapists, focus group sessions with users, and searching the Internet. By analyzing the insights from research, a list of requirements is generated. The design part starts with a functional model created on the basis of the list of requirements. The design part includes the process of ideation, developing a feasible concept

with desirable function, investigating technical details, prototyping a partially working prototype, and evaluating the concept with the prototype. The structure of the design process is shown in Figure 3.

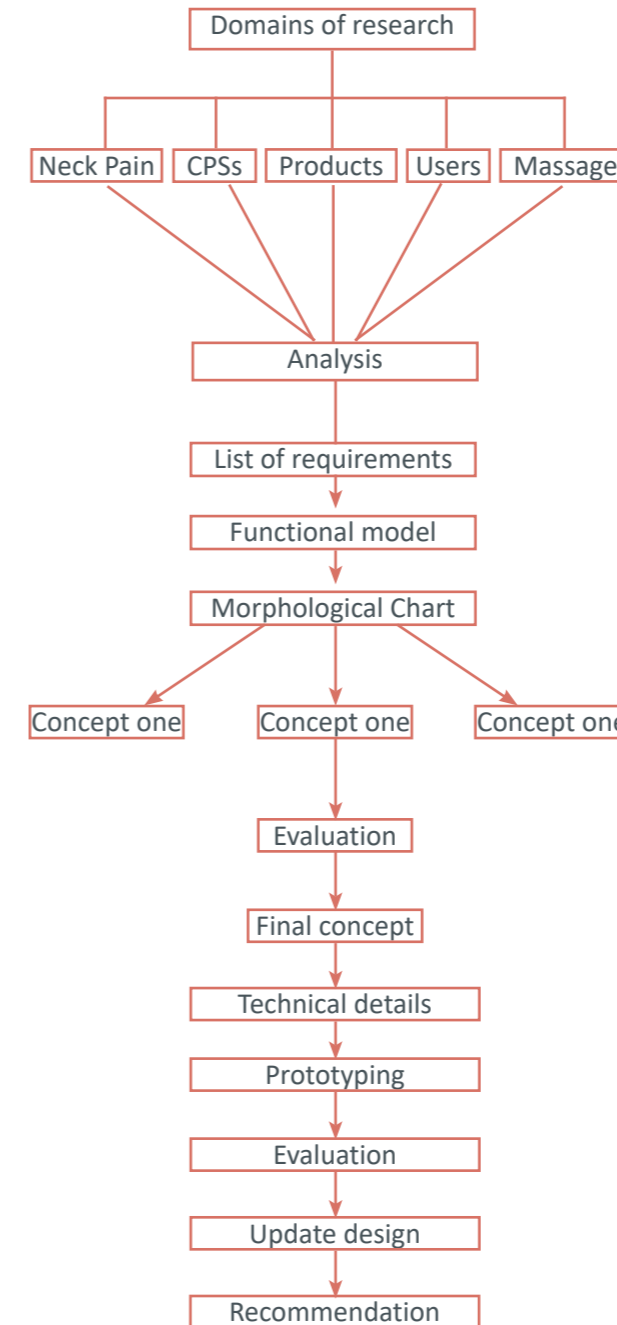

Figure 3: Structure of the process

## 1.5 Deliverables

The deliverable for this project includes a report recording the detailed results of the project, a poster that gives an overview of the main achievements of the project and a testable prototype.

## Acronyms

CPSs: (Cyber-Physical Systems)

NSNP: (nonspecific neck pain)

CM: (Clinical Massage)

TxQx: (Refers to the transcript of the interviews in appendix one. Tx means therapist number, Qx means question number. The answer from the supplementary questions are referred in form of SQx. For example, the answer of the first quest from the first therapist is wrote as T1Q1.)

# Chapter 2 - Analysis

The aim of the analysis chapter is to collect insights for developing a product. There are five domains of interest which are: neck pain, clinical massage, users, Cyber-Physical Systems, and current products. The research was in forms of reviewing literature, interviewing therapists, focus group session with target users, and searching websites. The main insights for the project are listed at the end of each section. As a conclusion, all the insights are put together for analysis to give an orientation for conceptualization. Then a list of requirements and a list of wishes were generated basing on the design goal and insights from research.

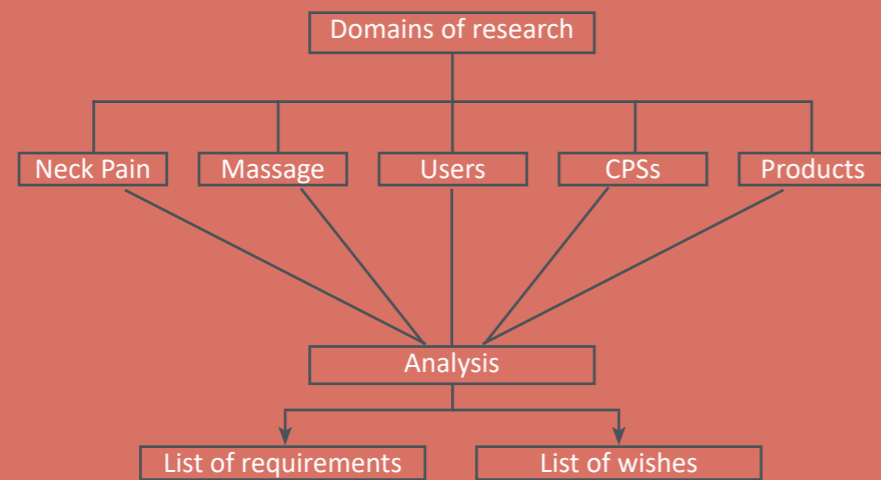

## 2.1 Neck pain

### 2.1.1 Objective

First, the symptoms and pathology of neck pain were investigated to understand what type of neck pain is concerned in this project. Then, the research looked at risk factors that affecting the neck to understand how to affect users' behavior positively. Lastly, current treatment methods were studied to see the limitation of clinical massage and possibilities of involving other techniques.

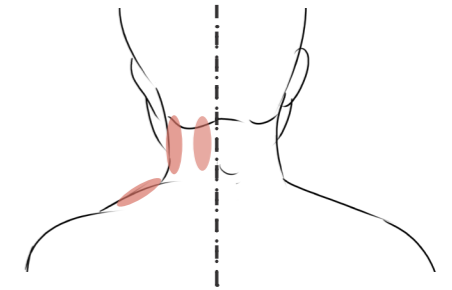

Figure 4: Frequently complained painful areas

### 2.1.2 Methods

The knowledge about neck pain was from literature study and interview with therapists.

Two therapists who work at two different Dutch physiotherapy clinics were interviewed with a questionnaire. The selecting criteria includes:

- Have experience of treating neck pain.
  - Use massage techniques in their treatment.
- (The transcript of the interviews are in appendix one. Question number and therapist number are referred in form of TxQx; The answer from the supplementary questions are referred in form of SQx. For example, the answer of the first quest from the first therapist is wrote as T1Q1.)

### 2.1.3 Symptoms

In the studies assessing neck pain (Margareta, 2009), the complaints about neck pain include a variety of nociception, decreased range of motion, weakness in the muscle, and numbness feeling. The pain is described in different ways such as plausible, burning, shooting, sharp, aching, electric-shock-like. According to one of the interviewed therapist, three most frequently complained painful areas are shown in Figure 4. The neck pain experienced by office workers is mostly chronic diseases. Machado (2016) stated in his study that 86% of the patients reported neck pain had the pain back within half a year.

### 2.1.4 Pathology

Among all types of neck pain disorders, nonspecific neck pain (NSNP) has the most interest among the target group, office workers, and people with similar working manners. NSNP refers to neck pains without any specific systematic disease being detected as the underlying cause such as infections, myelopathy; rheumatoid arthritis, tumors, fractures, dislocations, and other inflammatory joint diseases. Vincent Dewitt (2018), concluded five pain mechanisms underlying NSNP:

- Articular structure dysfunction.  
(For office workers, their articular structure might be distorted due to being in poor postures in a long time.)
- Muscle and tendon structure dysfunction  
(Serkan (2018) believes that muscle stiffness is one of the leading reasons for neck pain. The result of his research showed a clear relationship between neck pain intensity and the degree of neck muscle stiffness.)
- Neural dysfunction  
(The cause of nociception/pain refers to a neural structure dysfunction)
- Central sensitization DP  
(The underlying cause is not related to a structural cause, but refers to a pain processing dysfunction.)
- Referred from a source in adjacent areas such as head and arm  
(The muscle and nerve systems are all connected. The interviewed therapist stated that office workers might have a muscular disorder at the arm, which induces neck pain. (SQ6)

2.1.5 Risk factors

In the book “Neck pain” (Alexandra, 2017), risk factors are concluded as:

- Work with exposure to unusual postures
- Drug abuse
- Increasing age
- High job demands
- History of headaches
- Over-work situation
- Depression
- Obesity
- Smoking (and frequent coughing)
- Low exercise level

Among these risk factors, “work with unusual postures”, “over-work”, “depression”, and “low exercise level” are the most related to office workers. In the paper studying neck pain among office workers (Xiaoqi Chen, 2017), the results showed that there was a significantly higher proportion of females with neck pain than males. Moreover, office workers with neck pain generally have higher psychological distress, more fear-avoidance beliefs for work, long time working with computers, and low exercise self-efficacy. This study confirms the statement in the last paragraph.

2.1.6 Treatment methods for NSNP

Alexandra (2017), concluded a list of existing treatment methods. The methods that proved to be useful for treating neck pain are shown in table 1 and table 2. Apart from the treatment methods mentioned in the tables, there are some other methods that are used to treat neck pain. They do not have sufficient evidence proving the effectiveness though they are commonly used to treat neck pain, such as Guasha, injection, acupuncture, electroacupuncture (Alexandra, 2017). Jessica (2016) stated that relaxation massage and some passive physical modalities (heat, cold, diathermy, hydrotherapy, and ultrasound) are not valid for managing neck pain. Diederik (2015) stated that massage therapy showed a short term

effect, but the effect is not apparent in the long term. An interviewed therapist think continuous clinical massage can help people away from neck pain. However, in that way, people are dependent on treatment. Once the treatment stops, neck pain will come back again (SQ3). Both therapists believe the best way of managing neck pain is to change habits. They teach patients to do some exercise after the treatment. (T1Q4 & T2Q16)

According to the interview, therapists know different techniques, including physical therapy, clinical massage, and Osteopathy. They first do an assessment and then decide which technique to apply. Sometimes they do one type of treatment; sometimes, they do a combination of various techniques (T1Q3 & T2Q3).

2.1.7 List of findings

1. The concerned neck pain problem is called Nonspecific Neck Pain (NSNP) which does not have serious underlying causes. Users must be aware of whether their neck pain is NSNP or not before using the self-treatment device.
2. Neck pain causes are mostly chronic diseases. So that long-time continuous management is needed. Thus, the device should be used regularly.
3. Patients who report neck pain are mostly accompanied by other painful areas. It would be good if the device can treat other body parts as well.
4. Most frequently complained painful areas are the back of the neck (longissimus, splenius), the side of the neck (scalenes) and the top of the shoulder (trapezius) where connects to the neck. These three areas should be the focus of the treatment.
5. There are five possible pathologies of neck pain. The most common one of them is high muscle stiffness. The intended treatment method in this project, the clinical massage, is effective for dealing

Table 1: Neck pain management methods that performed by therapists

Physical therapy	Active strength and stretch muscle by letting the patient do certain neck exercise according to their symptoms.
Clinical massage	Work on soft tissue to recover their balance and elasticity.
Osteopathy	Focuses on treatment of the joints, particularly those of the vertebrae. There are many different techniques such as Lymphatic techniques. Strain-counterstrain, Still techniques and so on.
Mind-Body Therapy	Emotional well-being plays an important role in whether pain arises. Possible therapies on mind includes Interactive Guided Imagery, Journaling, Hypnosis.

Table 2: Neck pain management methods that patients can do themselves

Nutrition	Increase intake of omega-3 fatty acids; Reduce consumption of omega-6 fatty acids; Lower the levels of prostaglandins and leukotrienes.
Cervical support	Semi-hard cervical collars and cervical pillows give extra support and correct the curvature of neck.
Changing life style	Quit smoking, avoiding obesity, doing more exercise, avoid overwork and avoid awkward postures.

with muscle stiffness. So the project will focus on the stiff muscle problem.

6. It is believed that avoiding neck pain by changing habits is better than treating neck pain. It would be good if the massage device can both treat neck pain and help them change their habits.

7. There are four risk factors for neck pain highly related to the target group: work with unusual postures, over-work, depression, and low exercise level. If there are habit change features, these are the bad habits to be changed.

8. When the neck pain is severe, patients should go to therapists or doctors because they can do more techniques than clinical massage. So, the product should be positioned to be used for mild neck

pains.

2.2 Clinical massage

2.2.1 Objective

This part of the research will investigate clinical massage for three reasons:

- To see the essence of clinical massage, which acts as a guide when simplifying the techniques.
- To see the principles of clinical massage to improve the effectiveness of the massage.
- To see the process of clinical massage treatment, which acts as a reference for the smart massage device.

### 2.2.2 Definition

Clinical massage has been proved to be effective for treating neck pain in many studies (Jessica J. Wong, 2016). A definition of massage given by Amanda is: "Mas-sage is the manipulation of the soft tissues (muscles, tendons, and ligaments) of the body." (Kennedy, 2016). The main difference between clinical massage (CM) and wellness (relaxation) massage is that CM is designed according to anatomy to achieve treatment effect rather than enjoyable experience (Margareta, 2008). Another term that often is mixed up with clinical massage is manual therapy (MT). CM is part of MT. Other techniques of MT include chiropractic and traction.

### 2.2.3 How does it work

Clinical massage takes the form of ischemic compression, passive stretching, passive shortening, or any simultaneous or sequential combination of these (Kennedy, 2016). It treats neck pain problem in three ways. First, it is believed that massage interventions can induce local biochemical changes that modulate local blood flow and regulate oxygenation. Then, massage therapy increases the pain threshold at the central nervous system (CNS) level by stimulating the release of neurotransmitters such as endorphins and serotonin. Thirdly, the body, mind, and emotions all interact with the nervous system. Touching the skin sends messages, including reflex actions, to reduce the number of stress hormones and generate a sense of wellbeing (Clay, J, 2008).

### 2.2.4 Working principles

There are six principles concluded in the book "Basic clinical massage therapy" (Clay, J, 2008)

1. The part must also be seen in the context of the whole. For example, a client with a sprained ankle will favor the injured leg, causing muscles in the hip and low back to tighten.

"It happens that if people use a mouse with a bent wrist, the tension is throughout a series of muscles, but it's possible that they only feel pain at neck. I can diagnose by palpation and letting them perform certain tasks. It requires a lot of experience." (SQ6)

2. The direction of the fibers in a section of a muscle determines the direction and type of the work to be done.

3. Find two kinds of points on the body and use techniques to release them. The first one is called a tender point. It feels tender when pressed. It can be treated by placing the muscle into a passively shortened position until it relaxes. The second one is called a trigger point which is a nodule in a taut band of skeletal muscle tissue that is extremely tender or radiates pain in a characteristic pattern. Trigger points are produced by muscle stress, such as overwork, repetitive motion, or sudden excessive stretch.

The way to treat trigger points is to press at it with thumbs 30-50 times. (T1Q10)

4. The therapist must gauge the willingness of the tissue to respond and adjust the pressure accordingly. Negotiates with the tissue the pressure needed to accomplish release. This dialogue is the essence of the art of direct tissue manipulation.

5. Notice that there are antagonist muscles and antagonist's muscles. The antagonist is the muscle that is carrying out motion in question and the antagonist being the muscle that opposes this action. When muscles are weakened, excessively strengthened, or injured, the balance between the two types of muscles is upset. When we find a problem of any kind in a muscle, we are very likely to find a problem in its antagonist. One way to treat the antagonist's muscle is to let users do the exercise using that muscle. "If one muscle has high tension, it is good to exercise the counteractive muscle to achieve a balance." (T1Q4)

6. The treatment of fascia is helpful for treating

muscles as it warms and stimulates the tissue, and gives the muscle added freedom to expand into its fascial sheath. Fascia is the most pervasive type of tissue in the body: it is everywhere, like ivy on old buildings. It is the infrastructure of the body.

Apart from the principle mentioned in the book, one interview therapist points out another principle, which is "Each muscle has a certain area to work on to release the tension but those areas are not always the painful spots." (T2Q8).

### 2.2.5 Massage techniques

There is a large variety of massage techniques mentioned in the book "Basic clinical massage therapy" (Clay, J, 2008). The interviewed therapist rated top 3 most frequently used techniques for treating neck pain. The three techniques include pressing with fingers, gliding with fingers, and holding the neck with two hands together. (SQ1) In the book, these three techniques are named as "still compression", "gliding compression" and "holding". These three techniques are introduced below separately.

#### 2.2.5.1 "Still compression"

Exert pressure perpendicularly to the surface of the muscle. The fingers may do circular movements or hold still for 3-5 seconds and repeat. However, the fingers are always attached to the skin. This technique is often applied to sensitive tissues and on trigger points (Figure 5).

There are two rules when doing still compression. First, Intermittently Move into, and out of the muscle slowly. The slow movement is less jarring the client's tissues and consciousness. Moreover, the sudden release of pressure can be painful. Another rule is, where underlying bone is present, the muscle tissue is compressed against the bone. Otherwise, the pressure is exerted against the resistance of the deeper structures of the body. The compression may be firm or light which depends on the patient's pain

threshold. However, there is maximum pressure, according to a therapist, "Normally, the maximum pressure applied to muscles approximately equals to the pressure when you support the head with one finger." The weight of humans' head is around 5 Kg (Hansraj, 2014). So the maximum force of massage is around 50N.



Figure 5: still compression

#### 2.2.5.2 "Gliding compression"

Slide against the skin while exerting pressures. This technique is often applied to muscles with large areas. The two rules for still compression also apply to the "gliding compression". The in and out of the force exertion should be slow. Then, the compression should be against bones. Other than that, a lubricant may be helpful to avoid painful pulling of body hair. There are two types of gliding compression depending on the direction of fingers movement. If fingers move along a muscle, it is called Stripping (Figure 6). If fingers move across the muscle, it is called Cross-Fiber Friction (Figure 7).

#### Holding

Hold an area of the body with both hands. Several intentions and effects are possible with this approach:

- Give a warm feeling and suggest relaxation to the client.
- Hold the body part with a gentle pressure.
- The direction of the desired change to stretch the muscle.
- Hold while combining compressions techniques.





Figure 6: Gliding compression (stripping)



Figure 7: Gliding compression (Cross-Fiber Friction)



Figure 8: Holding

## 2.2.6 Process of clinical massage

### 1. Assessment

The assessment can be very complicated. There are many questionnaires designed for assessing the status of the patient. There are also many tests, such as X-ray screening are available. However, the interviewed therapists felt that assessment should not take a significant amount of time. For everyday situations, simple assessment appears to have four specific components: complaints of discomfort, health-history, client goals, and palpation. During the assessment, the therapist discovers if there are contraindications for a massage treatment and

considers referral to other treatment.

### 2. Plan

The plan of care should be evidence-based, and client centered. To make the plan, doctors should discuss with the client about what they know about the evidence and what are the patient's preferences and what is their expertise.

### 3. Treatment

Many therapists emphasized the constant assessing during the treatment, which is also known as palpation. Apart from that, constant observation and communication with the client are also important.

### 4. Reassessment

The purpose of reassessment is to help monitor treatment, guide health messages, and potentially change plans of care or refer to other practitioners.

### 5. Health suggestions

The suggestions given to clients include information on body awareness, exercise, and stress management, which can potentially improve outcomes from treatment. These messages may come before, during, or after the treatment.

### 6. Documentation

The participants felt that documentation and charting is the best practice to track change with a client over time. The recorded information helps in making better decisions for the next treatment. Moreover, therapists can also learn from previous cases to improve their skills.

## 2.2.7 List of findings

1. The essence of clinical massage is ischemic compression and passive movements on shortened muscles. This can be a reference for simplifying massage techniques.

2. Massage has intrinsic comforting effect by touching skin. This feature can be used to stimulate positive emotions.

3. Neck pain may be caused by disorders from other parts of body such as limbs and teeth. However, these are not the major causes and it is not realistic

to deal with all the other problems. This project will focus on the problems within the neck area.

4. The following principles of massage can be the reference for the reasoning of the smart device:

- Different muscle need different way of treatment.
- The treatment differs from types of techniques, position of treatment, direction of massage and force level.
- Examine with touch is needed before and during the massage.
- Therapists keeps adjusting the treatment according to the reaction of muscles.
- The work on fascia is needed to warm and stimulate the tissue.
- If a muscle has problem, it is very likely that its antagonist muscles also have problem.
- Each muscle has a certain area to work on to release the tension but those areas are not always the painful spots.

5. A massage treatment contains six steps: Assessment, plan, treatment, reassessment, health suggestion, documentation. A smart massage device can also cover these steps to be professional.

6. The assessment can be simplified to four parts: complains of discomfort, health-history, client goals, and palpation.

7. Discussion with patients is needed when planning for the treatment.

8. The most frequently used techniques for treating neck pain are still compression, gliding compression and holding.

9. The compression should be against bone with a force lower than 50N.

10. Avoid sudden pressing and releasing the force.

## 2.3 User study

### 2.3.1 Objectives

The aim of this part of research is to understand users' attitude and habits about treating neck pain so as to define the context and formulating design requirements and evaluation criteria.

### 2.3.2 Method

The used method of user study is Focus Group. Focus Group is a method used to dive into users opinion by gathering them together in a group session to discuss a topic. Since people do not have much to say when directly asked with the question about neck pain. A booklet (in appendix two) was designed to sensitize them about the topic. The participants are asked to fill in the booklet before coming to the group session. To understand their real thoughts and feeling, in the session, they are asked to explain and discuss what they filled in. There were 8 participants involved in the study. They were selected with three requirements:

- Students or office workers.
- Have NSNP (non-specific neck pain, defined in the literature study about neck pain)
- Have received professional treatment for neck pain before.

Two sessions were held in this study, each with four participants. In the sessions, the researcher reacts to the participants' answer to understand their thoughts underlying their answer. However, there are some prepared questions to guarantee covering expected aspects. (The plan of the session including the trigger questions, can be found in appendix three. )

### 2.3.3 Users' current situation

#### 2.3.3.1 Painful points

Participants were asked to indicate where they have neck pain. The result is shown in Figure 9. The saturation indicates the frequency of being reported. The deeper the color is, the more frequent it was complained by participants.

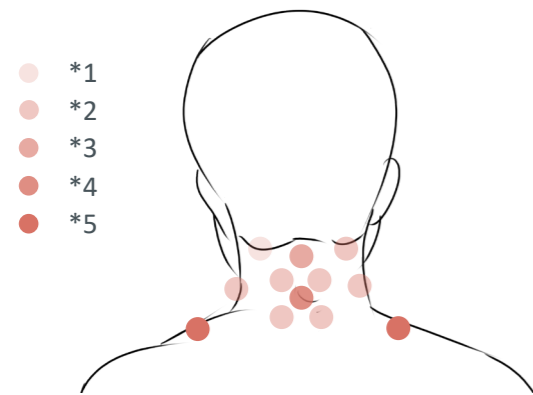

Figure 9: painful points

#### 2.3.3.2 Perceived pain mechanism

Participants were asked to speculate on their pain mechanism. Although it might be different from the real situation, it tells how they perceive the soreness of their neck pain. Their speculations may influence the methods they chose to manage neck pain. The result is shown in Figure 10.

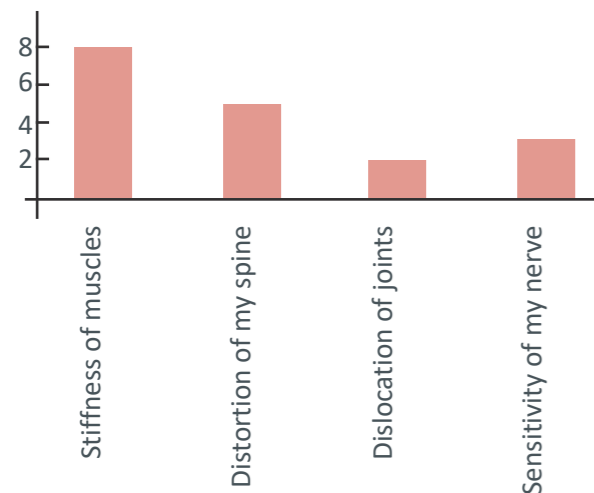

Figure 10: Perceived pain mechanism

#### 2.3.3.3 Journey they go through

Participants were asked to fill in a journey of an experience of neck pain occurrence. The journey includes:

- When, where, why the neck pain occurred,
- How they react when they notice the pain.
- In what way neck pain affects them
- Methods they may take to treat neck pain.
- The effect of those methods.
- The pattern of neck pain occurrence.

The result is shown in Figure 11.

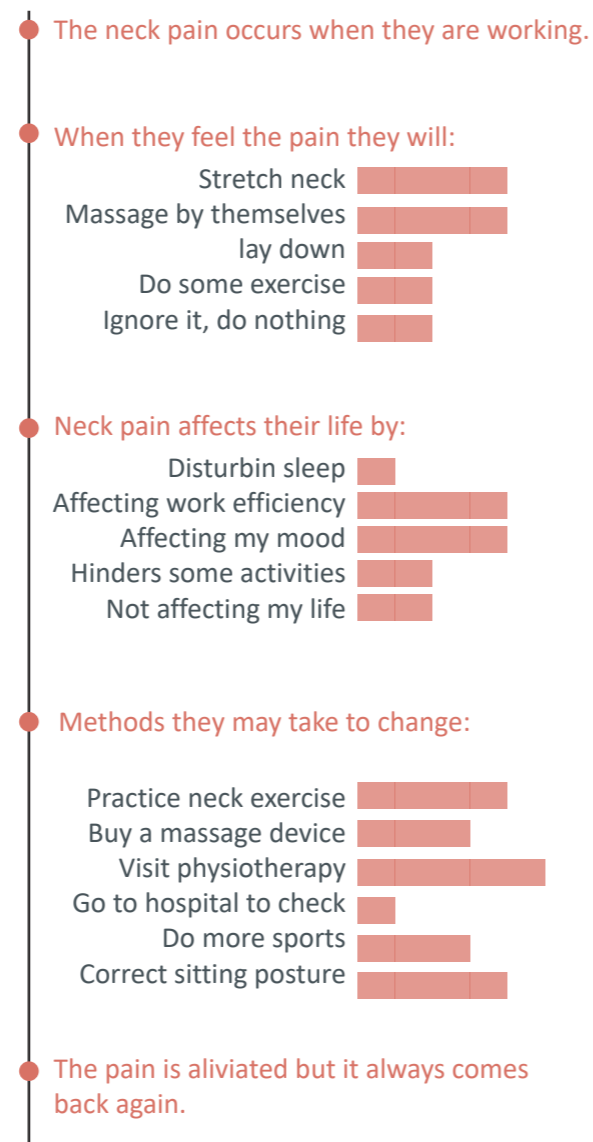

Figure 11: Users' Journey of neck pain

### 2.3.4 Users' comments

During the session, participants expressed their opinions. What they said were recorded and highlighted. The transcript of the two sessions can be found in appendix four. The expressions with similar meaning were grouped together and concluded with one simple statement. The groups of quotes can be found in appendix five. In this section the concluded statements are listed and grouped according to their topics.



Figure 12: Participants massage for each other

#### 2.3.4.1 Users' opinions about massage

In the session, participants were asked to massage for each other according to their symptoms, as shown in Fig 12. After that, they discussed the following topics:

- What they did,
- Why they did that,
- The difference between their massage and therapists' massage,
- Their opinions about clinical massage.

Their comments are concluded into the following statements:

- Massage always help even though it's not professional.
- Therapists search for trigger points and they can feel that's the right point when being massaged.
- Therapists can explain about the treatment and show them the effect which makes them feel confident.
- Massage is associated with something

enjoyable.

- Massage doesn't work on distorted spine.
- Their neck pain can't be cured by massage. But it can be alleviated for a while.
- Continuous professional massage is too expensive for them.

#### 2.3.4.2 Users' wants about massage device

In the booklet, there is a collection of typical neck pain related products. Participants were asked to select one that they think is the most effective and another one that they think is the least effective. The result of their selection is shown in Figure 13. Then, another task in the booklet was to let them draw an ideal massage device in their mind and select four features they value the most. Their selection and drawing can be found in appendix seven.

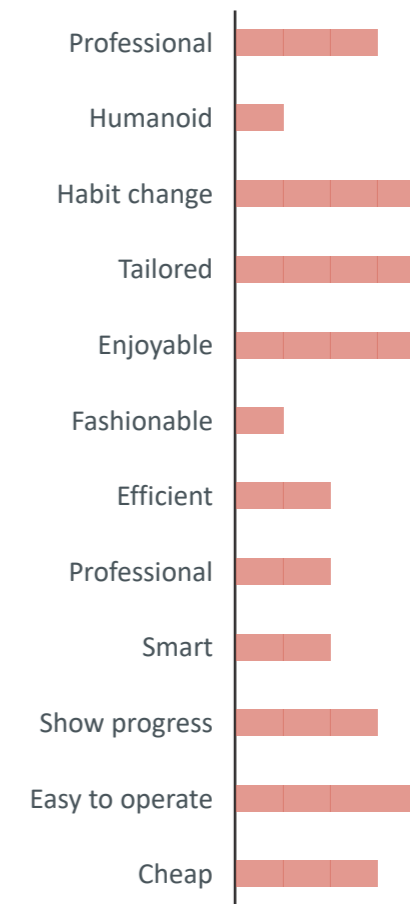

Figure 13: Ranking of wanted features

In the sessions, the participants further explained their selection and ideas from which the following statements were concluded:

- Users don't want extra APP on their mobile phones for treating neck pain.
- Users want adjustable force level.
- Users want the treatment adapt to how much time the users have.
- Users want to get massage at multiple points.
- Users want to control the position of the massaged points.
- Users want to be fully relaxed when using the device.
- Users want to feel safe when having massage.
- Users want to see evidence of treatment effect.
- Users want to see the progress of treating this chronic disease.
- Users want positive feedback after each treatment.
- Users want professional and tailored massage.
- Users want their body be supported during massage.
- Users want the device be cool to show others.
- Users think the appearance of a neck pain treatment devices should: A. looks fit the shape of neck. B. convey the working principle. C. fashionable but not too simple. D. not looks too rigid. E. not looks too vulnerable
- Users want the device to be close to their work place.
- Users want cheaper solution. The acceptance depend on how powerful the product is, but no more than 400 Euro.

#### 2.3.4.3 Users' opinions about neck pain

- The participants' comments about neck pain were throughout the session:
- It is almost impossible to cure neck pain, they are supposed to live with it.
- Their neck pain disappear automatically during holiday when they don't have to work.
- Treating neck pain is in lower priority than work.

- Neck pain treatment doesn't worth spending much will power or effort.
- It's tiring to be in a straight posture.
- They are stressed when working so they can't pay attention to the posture.
- They lack will power to keep the good habits.
- Users want to spend the least time on treating neck pain.
- Users want to do the least operation when using the device.
- Users think keeping good habits is the best way to manage neck pain in long term.
- Users think it's very hard to cure neck pain completely.
- Users think heat radiation helps the treatment.
- Users think they will turn to doctors when the pain is severe.
- Users think their emotion can be affected by their neck pain but not a lot. They get used to it.
- Their perception of neck pain can be affected by emotion.

#### 2.3.4.4 Opinions about smart technologies

- Users think doctors are more trust worthy then AI at current stage.
- Users think it's okay to share their data about neck pain.
- Users want to be involved in decision making process of a smart systems.

#### 2.3.5 List of findings

- Neck pain is highly related to working. Users need a way of instant pain relief during work. So, preferably, the product can be used in the working environment.
- Users with mild neck pain are not willing to pay too much efforts to deal with neck pain. So the product can't be too expensive or require complex operation.
- All the participant perceive stiff muscle as one

of the reasons for their neck pain which mains the intended massage treatment is beneficial for most of the people with neck pain.

- The reported neck pain areas are coincident with what therapists said. The areas include the back of the neck, the sides of the neck and the top of shoulder.
- Users prefer professional and tailor treatment than a random relaxation massage, but what current massage devices are doing is simply relaxation.
- The top-rated features for massage device are professional, tailored, habit change, enjoyable, and easy to operate.
- Users have a gut feeling about where the massage should be applied to. They feel good if the device understands and obey this feeling.
- People have a different pain threshold so the force level should be adjustable.
- People want to feel safe, relaxed while using the device.
- Users want the device adapts to how much time they have.

## 2.4 Principles of CPSs

### 2.4.1 Objectives

Since the starting point of this project was to apply part of principles of Cyber-Physical Systems (CPSs) to help people manage their neck pain, it is necessary to understand what CPSs is, what new opportunities it can bring to neck pain treatment field, and what are the underlying challenges.

### 2.4.2 Introduction of CPSs

There are many different interpretations of Cyber-Physical Systems (I.Horvath, 2017). To make it clear, the definition brought by N.Dey (2018) is taken in this study which is "Cyber-Physical Systems (CPSs) can be considered as physical engineered systems whose processes are monitored, controlled, coordinated and securely integrated by a communication and computing core at all levels and scales." The aim of CPSs is to link the cyber space and physical space to integrate intelligence to execute tasks. The concept of CPSs can be easily mixed up with IOT (Internet of Thing). However, IOT is used to monitor and control devices which don't necessarily have to be in common network. While CPSs aim to monitor and control physical systems using cyber space (N.Dey, 2018).

I.Horvath et al (2012) proposed a structural model representing CPSs as shown in Figure 14. Basically, the system contains three parts of technologies, namely physical, cyber and synergic technologies. They are interconnected and each of them interacts with human and the environment.

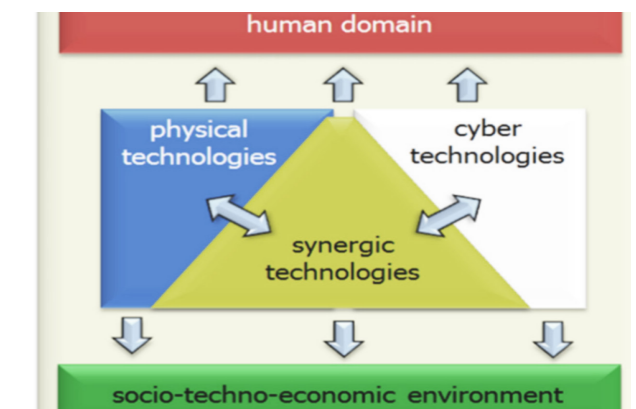

Figure 14: CPSs structural model

### 2.4.3 Characteristics of CPSs

There are 16 most import characteristics identified in a study (I.Horvath, 2012). The keywords of these characteristics are listed here:

- Distributed cooperative systems.
- Distributed decision making over a large number of components.

- Blurred system boundaries.
- Synergy of cyber-part and physical part.
- Diverse set of components.
- Components have either predefined or ad-hoc connection or both.
- Vary in special scale.
- Real-time information processing.
- Can reorganized and reconfigure internal structure.
- Knowledge-intensive, handling built in knowledge, knowledge from sensors, knowledge from reasoning.
- Can operate according to different problem-solving strategies.
- Strive for automatic decision making.
- Can memorize and learn from history.
- Response to unpredictable system state to execute non-planned actions.
- Sophisticated strategies.

With these characteristics CPSs have five paradigmatic features (I.Horvath et al, 2017):

- Penetration into real-life processes.
- Diverse functional semantics.
- Aggregate complexity.
- Cognitive capabilities.
- Run-time variation.

General CPSs possess the features mentioned above. However, due to time and financial constraints, this project will focus on the entry-level of CPSs. I.Horvath et al (2017) proposed a conceptual advancement model showing different stages of progression of CPSs (as shown in Fig 15). There is also a model describing levels of automation corresponding to the level of reasoning capabilities (Figure 16). The cost of the system depends on the development difficulty and the cost of components. The term “entry-level” can be interpreted as the first generation of CPSs and level 1 of automation.

According to I. Horvath’s study (2017), “1G-CPSs include sensors, actuators, bedded algorithms and software components. Thus, the system can collect data, analyze the data, and react to them by controlling actuators. There are two significant

paradigmatic features of 1G-CPSs, self-regulation, and self-tuning. Self-regulation refers to the capability of improving the system performance by various forms of supervised, unsupervised, and reinforcement learning strategies or traditional feedback type of control. Self-tuning capability refers to the potential for restricted functional and architectural adjustments according to different operational conditions. In another word, 1G-CPSs can adjust the way of conducting tasks according to different conditions. However, the adjustment shall not include any serious change in architecture/operation. Moreover, CPSs have no capability for predictive behavior which means they cannot execute non-planned actions in response to unpredictable changes. For 1G-CPSs, Level 1 of automation can be expected. Level 1 of automation refers to a condition that the tasks are mainly executed by a machine, with human control and assistance.

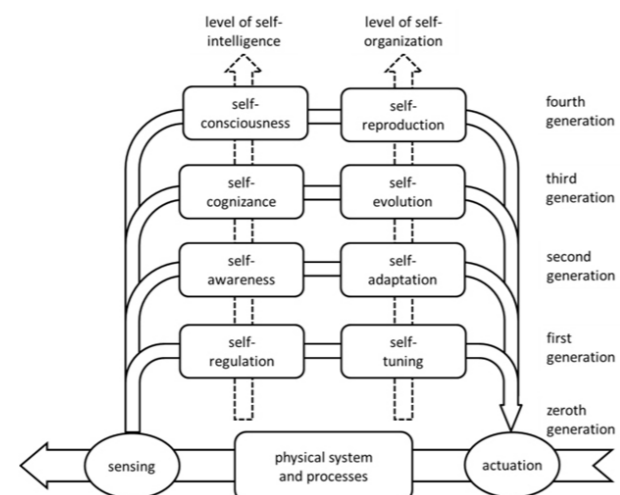

Figure 15: Generation of CPSs

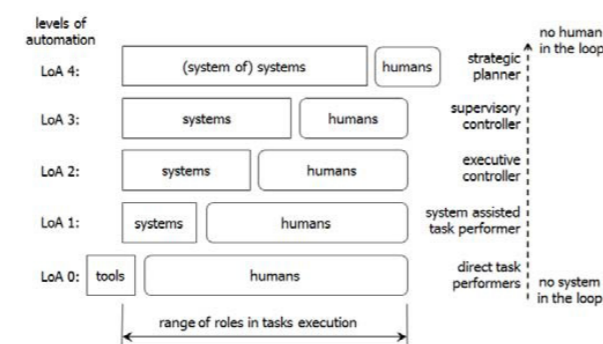

Figure 16: Level of automation

## 2.4.4 Limitations of CPSs

Although the features mentioned in the last section leads to promising applications, the performance of CPSs depends on the technologies. Nilanjan indicated some challenges leading to some limitations of current CPSs. First, traditional analysis techniques are inadequate for real-time performance for the spatially CPSs, especially when there is a massive amount of data. Then, since the CPSs integrates many components which are interdependent to each other, any error will be amplified by the system. So, it is a challenge to guarantee the dependability of CPSs, especially for medical devices. Moreover, the cyber space has the risk of being tempered. As a consequence, system security and data privacy are concerned factors. However, since the principles aimed to be applied in this project are in entry-level, the limitations mentioned above should not have a significant influence on the design.

## 2.4.5 Sensors

CPSs are integration of technologies form many fields, including programming, networking, material, energy, robotics, microchip, sensors, electromechanical and etc.

“A sensor is any device which detects or measures a physical property and records, indicates or otherwise respond to it” (Sinclair, I, 2000). There passive sensors and active sensors. Passive sensors, such as a ruler, requires people’s initiative operation. Although they may appear to be less technical, the implementation of passive sensors can result in a cheaper and often more reliable solution. Active sensors work by converting the signal-carrying form into another form. According to the forms of energy, active sensors are clustered into 5 categories namely radiation sensors, mechanical sensors, thermal sensors, magnetic sensors and chemical sensors. The selection of sensor should base on the aimed information to be detected. Then, their performance are commonly evaluated on five criteria: accuracy, precision,

resolution range and hysteresis.

From the research about neck pain and clinical massage, it was learned that through palpation therapists search for stiff muscles and trigger points. Muscle stiffness is the main information collected by therapist through palpation. Research was done to investigate what types of sensors are able to measure muscle stiffness.

### 2.4.5.1 Muscle stiffness sensors

The first type of sensor that can be used to detect muscle stiffness is called piezoelectric probe. The stiffness of a piece of tissue influences its resonance frequency. By attaching an oscillating probe tightly to the muscle, their combined resonance frequency and the corresponding stiffness can be measured. The way of attaching the probe to muscles is shown in Figure 17. It is attached to the muscle by wrapping the device around the arm tightly. However, for the muscles on the neck, it is not appropriate to wrap something tight to neck in case of choking.

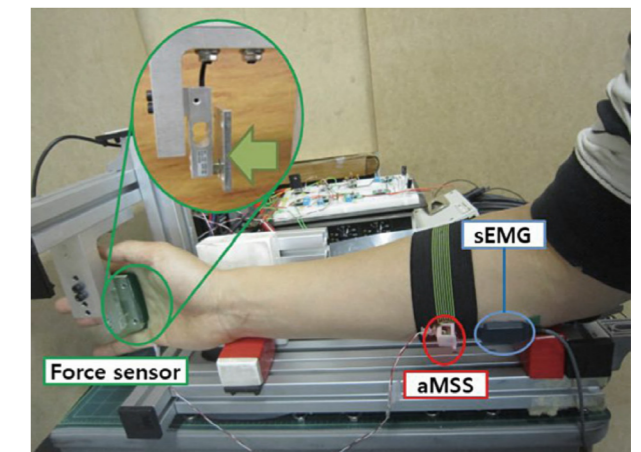

Figure 17: Muscle stiffness sensor one

Rutkove (2009) described muscle tissue as a simplified “three-element circuit”. The three elements are extracellular resistance, the intracellular resistance among the muscle membrane, and the capacitance in lipid bilayers of muscles. The changes of muscles, including the change of stiffness, bring in changes to the

circuit. Son (2018) proposed a way of detecting the changes of multiple muscles by attaching eight electrodes to the skin. Four of the electrodes act as a reference while the other four are sensing electrodes.

Compared with the first types of sensor, this one is more feasible. However, this solution only senses the change in muscle stiffness. It is not sure whether it can measure the value of muscle stiffness. Moreover, the use of eight electrodes makes it obstructive.

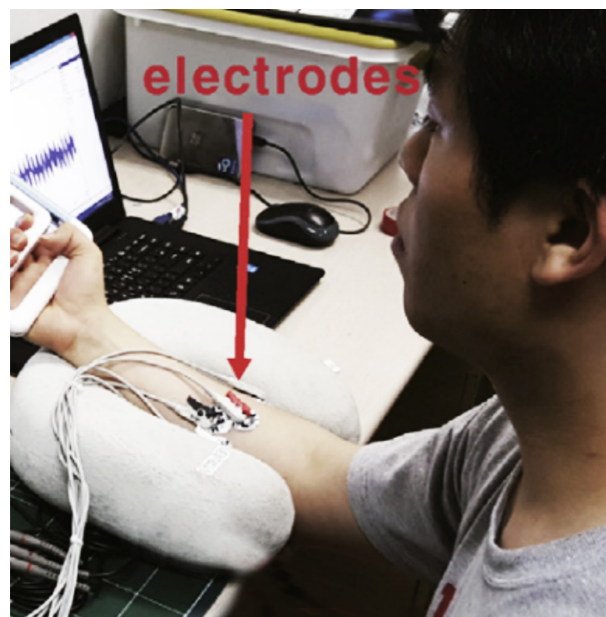

Figure 17: Muscle stiffness sensor two

#### 2.4.5.2 Sense the trigger point

Searching for trigger points is one of the essential tasks for palpation. Trigger points need special attention because once these trigger points are “released,” the whole muscle is relaxed. However, according to the interviewed therapist: “the difference between trigger points and other areas of muscles is inconspicuous. Some of them are hard; some of them are soft; some of them have a different texture. Only therapists with great experience can precisely locate trigger points”. Moreover, sometimes, there is a multilayer of muscles. So, therapists need to search trigger

points while kneading. In consideration of all these challenges, there is no existing sensor that can be used to locate trigger points as far as being learned from the research.

#### 2.4.5.3 Capture therapists' movement

Since it is not promising to do the palpation task with a sensor, It was proposed to learn from therapists and then recreated that with a device. As learned from the research about clinical massage, the essence of massage is to apply ischemic compression. So, the information about the pressure exertion reflects the massage movements. A type of flexible pressure sensor matrix is used for similar intension. Cheng (2016) put a soft pressure matrix on a mat and let people do different activities on the mat. Then, by analyzing the data collected by the sensor, he could figure out the pattern of the people’s activity. His success proves the feasibility of capturing therapists’ movement with a flexible sensor matrix.

The working principle is shown in Figure 18 (Cheng, 2016). When compressed by force, the resistance of the fabric tends to drop. This information can be converted to a voltage by a resistive voltage divider. Then, the voltage signal can then be digitized by an analog-to-digital converter (ADC). When multiple pressure sensors are arranged into a matrix, the pressure exerted on the sensor matrix can be measured in terms of magnitude, location. By adding time serials, the motion and duration of the pressure exertion can also be measured.

#### 2.4.6 Actuators

The output of devices manufactured by a human is often in the form of physical motion or a force, and this is achieved with actuators. Since the desired outputs in this project are basically mimicking the massager’s movements such as pressing and kneading, the research of actuators focused on bio-mechatronic actuators. There are three types of

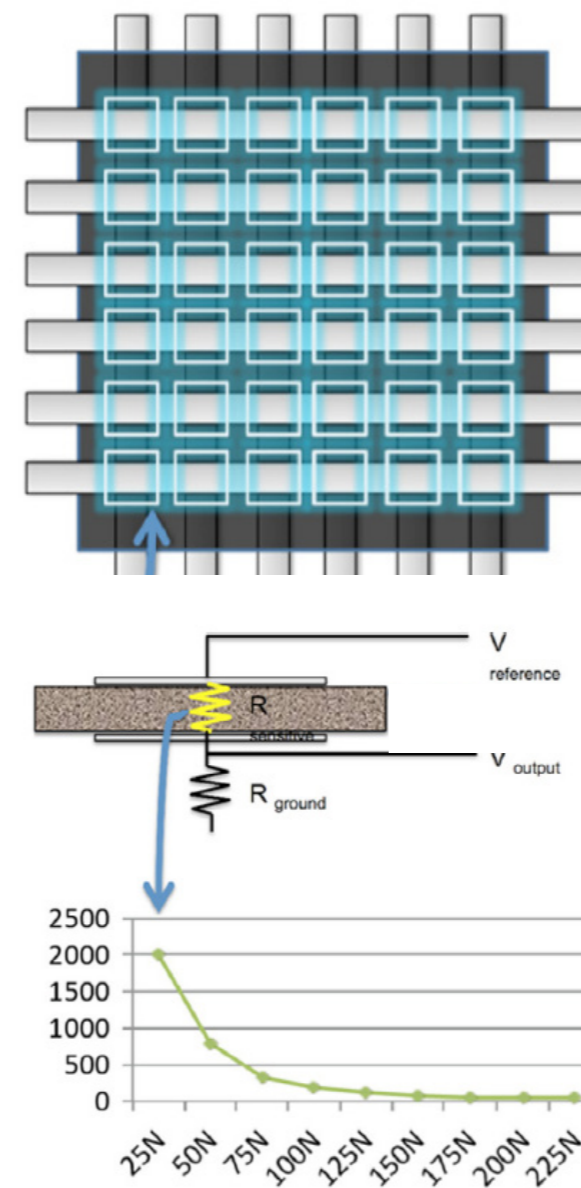

Figure 17: flexible pressure sensor matrix

bio-mechatronic actuators, categorized according to the input energy:

##### a. Electromagnetic Actuators.

Electromagnetic actuators take advantage of Lorentz’s force law, transforming electric power to mechanical movements, mostly rotational movements. The rotational movements can be further transmitted to other forms of movements through mechanical structures such as gear systems or bar systems. The most common example is a step motor, as shown in Figure 18.

##### b. Fluidic Actuators.

Fluidic actuators convert fluidic energy (pressurized gas or li) to mechanical motion and force. One example is pneumatic artificial muscles, called McKibben muscles, which are composed of tubes surrounded by woven threads. When inflated with pressurized air, the tubes expand radially and contract axially, generating tensile forces.

##### c. Shape Memory Alloys

Shape memory alloys earned their name from their ability to “remember” an original shape. When in a deformed state, they respond to thermal or magnetic stimuli by returning to their original shape. The phase transformation occurs even in the presence of heavy loading, which makes SMAs good candidates for actuators.

The aiming movement of the massage actuator includes adding pressure, circular movement, and linear movement. All three types of actuators have the potential to achieve the aimed function. In the ideation phase, consider all of them.

#### 2.4.6.1 Actuators used in current massage devices.

Due to the limitation of time, preferably we can use the actuators that are already being used in massage devices. There are three typical massage actuators used in current massage product.

The first massage actuator uses rotational plates with patterns. It simulates the “gliding compression at the back part of neck. This type if actuator is driven by electronic step motors (Figure 18).

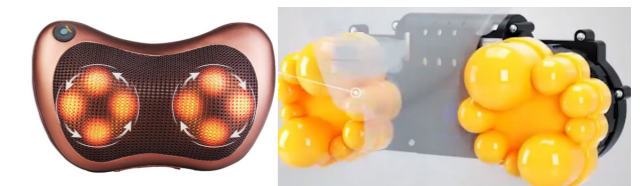

Figure 18: Product using rotational actuator [1]

The second type of actuator has a linear shaft driven by the electromagnet. The tip of the shaft is covered with a cushion. By knocking at muscles a high frequency, it relaxes the muscle. However, it is not simulating any of the clinical massage treatment techniques. However, the product claims to be a massage device (Figure 19).

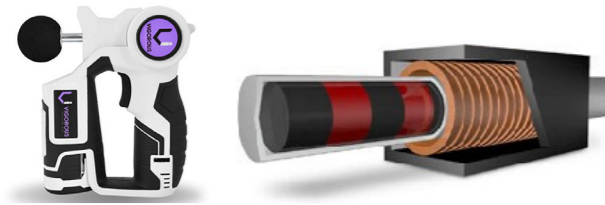

Figure 19: Linear vibration [3]

The third type of massage actuator is a pneumatic actuator. It is most applicable for limbs where the device can be tightly wrapped around the muscle. By sequentially inflate different cavity, it simulates the “gliding compression” technique (Figure 20).



Figure 20: Level of automation [4]

#### 2.4.7 Bridging CPSs to clinical massage

In clinical massage (CM) treatment, therapists assess patients first, then plan the treatment and perform the massage. This process generally fits the sensing, reasoning, and actuating principles of CPSs. Then, during the massage treatment, therapists feel the reaction of muscles and adjust their message accordingly. Fortunately, one of CPSs characteristics is real-time information processing, and the first generation of CPSs already has this ability. So, CPSs have the potential to enable a smart massage device to perform according to clinical massage principles.

The capability of a smart massage device is limited by sensing and actuating technologies.

As indicated by therapists, palpation is an essential part of the assessment. Palpation means assessing by touch the skin and feel the muscle’s elasticity, stiffness, and shape. However, no sensor found in the research is capable of performing this task. Therefore, a professional assessment is not expected to be done by the device. However, the technology of flexible pressure sensor matrix enables recording therapists movements during massage treatment sessions. Then the device can recreate what therapists did.

Other than palpation, therapists also ask questions and let patients perform specific tasks to evaluate their symptoms. This information can also be collected by the product system. By analyzing the symptoms and the corresponding treatment is done by therapists, the system learns how to deal with specific symptoms. At first, therapists may need to correct the decision made by the system. Then, the systems can gradually assess without relying on therapists. This process is regarded as supervised learning. Since the information from palpation is missing, It is not sure whether it is feasible to achieve this machine learning feature.

To recreate the massage done by therapists, the massage actuator needs to perform complex tasks. Although massage techniques are composed of simple actions such as adding pressure, linear movement, and circular movement, it is challenging to combine them in one actuator.

#### 2.4.8 List of findings

1. IG-CPSs can adapt to different operational conditions (Self-tuning ). This capability enables the customization of massage.
2. IG-CPSs can improve its performance by learning from feedback. (Self-regulation)
3. There are available sensors that can sense users’ emotion, posture, muscle stiffness, and body

profile.

4. Currently, available sensors are not capable of doing accurate palpation. Thus, the device cannot perform a professional assessment.

5. There are existing actuators that can simulate the two conventional massage techniques “still compression”, and “gliding compression”. However, none of them can do both at the same time.

6. CPSs enables the device to learn from therapists.

7. CPSs enables the device to optimize its function according to users’ feedback.

#### Links used in this section

[1] [https://www.alibaba.com/product-detail/Head-Shoulder-Back-Neck-shiatsu-Massage\\_60636325105.html](https://www.alibaba.com/product-detail/Head-Shoulder-Back-Neck-shiatsu-Massage_60636325105.html)

[2] [https://www.amazon.com/Jigsaw-Massage-Gun-Athletes-Percussion/dp/B07Q332M-WG/ref=sr\\_1\\_7?keywords=message+gun&qid=1558200758&s=hpc&sr=1-7](https://www.amazon.com/Jigsaw-Massage-Gun-Athletes-Percussion/dp/B07Q332M-WG/ref=sr_1_7?keywords=message+gun&qid=1558200758&s=hpc&sr=1-7)

[3] [https://www.alibaba.com/product-detail/Micro-linear-actuator-for-Vibration-Microscope\\_60773352527.html](https://www.alibaba.com/product-detail/Micro-linear-actuator-for-Vibration-Microscope_60773352527.html)

[4] <https://www.indiamart.com/proddetail/pneumatic-air-pressure-health-massage-system-18169069497.html>

## 2.5 Current products

### 2.5.1 Objectives

The aims of this part of the research are positioning the product and learning from other products.

### 2.5.2 Methods

First, by searching on the Internet about neck massage devices, many products were collected. However, some of the claimed massage devices do not comply with basic massage principles. For example, some of them simulate massage by EMS/TENS/ultrasound, which does not work by compressing muscles. These kinds of products were not taken to account. Six representative neck massage devices were selected for analysis. Each of them was introduced in terms of their working principles, pros, and cons. Then, these six products were mapped in two axes to see the opportunity of new products. After that, more products related to neck pain (not only massage devices) were collected and mapped according to their function and price. This map tells in general how much customers are willing to pay for a neck pain related product. Lastly, in the interviews, therapists were asked to comment on current massage devices. Their answers are shown in a separate section.

### 2.5.3 Neck massage products on the market

#### 2.5.3.1 Breo one (189.9 Euro)



Figure 21: Breo one [1]

#### How does it work

It relaxes neck by rotating knobs which simulates gliding massage on the back-side of the neck. The pressure is from the elastic structure and users pulling the rubber handle.

Pros

- Users can adjust the location and force of massage by manipulating the rubber handle.

Cons

- It only works on one area.
- It is too tight for some users.
- Users need to apply relatively large force when pulling the strip.

**2.5.3.2 Breo INECK (249.9 Euro)**

Figure 22: Breo INECK [2]

How does it work

It relaxes neck through two small rotating knobs which simulates still compression massage technique. The pressure is from the user's gravity. Users lean to a sofa or a bed while using the device.

Pros

- It can massage on both the back and the sides of neck by rotating around the neck.
- A appearance is slim and elegant.

Cons

- The shape is rigid, hard to put the two actuators work at the right point at the same time.
- Gripping ropes is not comfortable.

**2.5.3.3 Maxcare (31.9 Euros)**

Figure 23: Maxcare [3]

How does it work

It relaxes neck by rotating knobs which simulates gliding massage. The pressure is from users' body weight.

Pros

- Users are fully relaxed when using it

Cons

- The flexibility is low.
- It only work on the back side of neck.

**2.5.3.4 Wahl (27.9 Euro)**

Figure 24: Wahl [4]

How does it work

It simulates still compression by adding pressure to muscles while vibrating.

Pros

- Users can use the product on wherever they want.

Cons

- Users need to hold up their arm all the time.

**2.5.3.5 VOYOR (19.9 Euro)**

Figure 25: VOYOR [5]

How does it work

It simulates gliding compression technique by clamping the sides of neck.

Pros

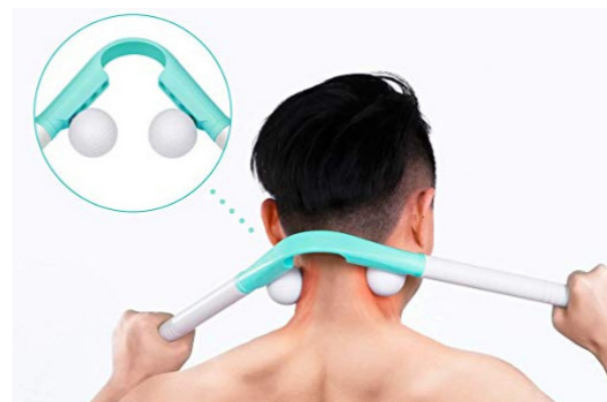
- It is cheap without any electronic components.

- Users can easily adjust where to apply the force and how much force to apply.

Cons

- Users need to hold up and move their arms all the time.
- - It only work on the side of neck.

**2.5.3.6 Mwellem (16.9 Euro)**

Figure 26: Mwellem [6]

How does it work

It has several sticking out balls which supports users' neck when they are lying on this product. The small touching area gives pressure to muscles which simulates still compression technique.

Pros

- Users are fully relaxed when using this

Cons

- The compression is constant while ideally it should have intervals.
- It is rigid but people want the compression at different places.

**2.5.3.7 Summary of current products**

The products mentioned above simulates either "still compression" or "gliding compression". Most of the products that simulate the "still compression" are hand-held devices. For these products, the pressure is exerted either by hand or by making use of gravity. Some of them Only one of them, the Breo Ineck simulates "still compression" in the combination of the use of gravity and two small rotating motors.

Among these products, there are two ways to simulated the "gliding" movement. One of them

requires manually clamping the handles while others use large rotating motors to press at the side muscles. In the research about massage actuators in the last section, there was one pneumatic actuator which simulates the "gliding" movement by inflating sequentially arranged cavities. However, none of the current neck massage devices used this type of actuator. This is because it is not suitable to wrap it tightly to the neck. However, if it can be fastened to the neck without pressing at the throat, this type of actuator would be able to be used.

It was found that those manually controlled devices are easier to adapt to different users and massage on different positions. However, these devices are not suitable for long time use. If a device enables users manually locate massage position and then massage automatically, it would be a good combination.

**2.5.4 Market scan**

The neck pain related products attribute to five categories according to their function, and they were mapped in Figure 27. These five categories include traction, exercise, massage, comforting, and posture correction. Among these categories, "massage" has the widest variety of products. The price of most of the products is lower than 100 Euro. The most expensive product is a massage device which costs 250 Euro.

**2.5.5 Comments from therapists**

In the interview with therapists, they were asked to comment on current neck massage devices on the market and give suggestion for developing a new massage device. Their comments are shown below:

1. "I use a simple massage device to assist the treatment. (T1Q15)
2. "I would like a device that can be used on the whole body, suitable for both large areas and small



Figure 27: Market scan of neck pain related products

areas." (T1Q17)

3. "While using some of the massage devices, users need to hold up their arms to operate it, which builds up extra tension on the muscle." (T2Q16)

4. "Maybe you can do something about their emotion. Some patients tend to overemphasize their neck pain. Even though their pain is gone or very light, they still think there is something wrong with their neck and always want to have a treatment."

### 2.5.6 List of findings

1. Current massage devices simulate either still compression or gliding compression.

2. The actuators used in current neck pain devices are vibration actuator and rotational electromechanics actuators.

3. Those devices that can adapt to different users and massage on different positions are mostly manually controlled. It would be good to develop a product that can adapt to different users and different position while users don't need to do many operations or use awkward postures to hold the device.

4. The prices of current neck pain related personal devices are below 250 Euros which indicates how much money people are willing to invest for a personal neck pain treatment device.

5. Therapists have the need to use some device to assist their treatment. It would be good if the product to be developed can also be used by therapists in their treatment.

6. If it can be fastened to the neck without pressing at the throat, pneumatic actuators would be able to be used for neck-massage.

### Links used in this section

- [1] <https://breousa.com/collections/ineck-neck-massager>  
 [2] <https://breousa.com/collections/ineck-neck-massager>  
 [3] [https://www.amazon.com/MaxKare-Massager-Kneading-Cervical-Relaxation/dp/B06XWDQJCV/ref=sr\\_1\\_28?keywords=neck+massager&qid=1558282165&s=gateway&sr=8-28](https://www.amazon.com/MaxKare-Massager-Kneading-Cervical-Relaxation/dp/B06XWDQJCV/ref=sr_1_28?keywords=neck+massager&qid=1558282165&s=gateway&sr=8-28)  
 [4] [https://www.amazon.com/dp/B00BTYCKK/ref=psdc\\_3767521\\_t2\\_B07G84P94Q?th=1](https://www.amazon.com/dp/B00BTYCKK/ref=psdc_3767521_t2_B07G84P94Q?th=1)  
 [5] [https://www.amazon.com/Neck-Massager-Manual-Pressure-DeepTissue/dp/B07KT6STZP/ref=sr\\_1\\_50?keywords=neck+massager&qid=1558282749&s=gateway&sr=8-50](https://www.amazon.com/Neck-Massager-Manual-Pressure-DeepTissue/dp/B07KT6STZP/ref=sr_1_50?keywords=neck+massager&qid=1558282749&s=gateway&sr=8-50)  
 [6] [https://www.amazon.com/mwellewm-Cervical-Traction-Headache-Hands-Free/dp/B07KM-WX395/ref=sr\\_1\\_52?keywords=neck+massager&qid=1558282749&s=gateway&sr=8-52](https://www.amazon.com/mwellewm-Cervical-Traction-Headache-Hands-Free/dp/B07KM-WX395/ref=sr_1_52?keywords=neck+massager&qid=1558282749&s=gateway&sr=8-52)

## 2.6 Analysis

The findings from each domain are listed at the end of each section accordingly. In the process of analysis, all the findings were collected and clustered as shown in appendix six. Some of those findings are filtered out because they are less relevant to the objective of this project. Those findings that can help further narrow down the design scope and formulate design requirements are listed below. The findings are put into groups if they either conflict or reinforce each other (presented with a vertical line in front).

### 2.6.1 Key findings

Muscle stiffness is the main issue to be solved in this project.

Clinical massage reduce muscle stiffness by ischemic compression and passive movements on shortened muscles.

If people with mild neck pain frequently come to the therapy, it is a waste of resource.

People with severe neck pain prefer to going to doctors instead of using a device.

Users with mild neck pain are not willing to pay too much efforts to deal with neck pain.

The prices of current neck pain related personal devices are below 250 Euro.

Massage has intrinsic comforting effect by touching skin with softness and warmth.

Warm and relax the skin before massage to improve the effectiveness of massage treatment.

Users believe "heating pad" can help managing neck pain.



Palpation can't be achieved by a smart device in current stage.

Doctors are willing to help patients manage their neck pain by themselves

Each muscle has a certain area to work on to release the tension but those areas are not always the painful spots.

It is promising to let therapists finish the assessment task and learn from what they did by using flexible sensor matrix

The compression should be against bone with a force lower than 10 kg.

The press should be perpendicular to muscles.

Avoid sudden pressing and releasing the force.

Users have a gut feeling about where on their neck massage is needed.

Users want the massage customized for their symptoms and body shape.

People have different pain thresholds so the force level should be adjustable.

IG-CPSs can adapt to different operation situations.

Most frequently complained painful areas are the back of neck, the side of neck and the top of shoulder where connects to neck.

The most frequently used techniques for treating neck pain are "still compression", "gliding compression" and "holding".

The treatment on the focused three areas need the combination of all the three techniques.

Current products simulate either "still compression" by add pressure and vibration, or simulate "gliding compression" by the rotational actuators together with pressure.

People want to feel relaxed while using the device.

Those devices that can adapt to different users and massage on different positions are mostly manually controlled.

When using some of the current products, users need to lift their arms to hold the device, this adds to muscle stiffness.

Therapists have the need to use some device to assist their treatment. It would be good if the product to be developed can also be used by therapists in their treatment.

All the participants reported neck pain while working, the product should be able to be used in the working environment.

### 2.6.2 Synthesis

Clinical massage (CM) can deal with stiff muscles which are the most common issue underlying neck pain for the target group. The objective of designing a smart massage device is to simulate CM techniques to help people with mild neck pain reduce muscle stiffness. People with mild neck pain are not willing to pay too much efforts to deal with neck pain. To be effective, patients need to receive continuous massage treatment which requires great effort. So they usually do not visit therapists until the pain becomes severe. It would be valuable if the device reduces the required frequency of visiting therapists.

Assessment is not expected to be done by the device because there is no reliable technology found that can do that. However, there are

technologies that can record the therapist's movement. With this information, the device is expected to recreate the massage done by therapists. There are two main challenges in conducting the massage. The first one is to place actuators precisely at the right place. The other one is to perform the proper combination of massage techniques. Since there is a limited time in this project, it is better to focus on one of these two challenges.

The challenge about how to locate massage actuators on the aim position is proposed as the focus in this project for several reasons. First, it is verifiable without the need of confirming treatment effect. Then, CPSs principles have the potential to help to achieve this goal. Lastly and most importantly, this also fits users demand of the tailored device. Many users complain that those massage devices are not massaging on where they want to get massaged because they have different symptoms and body size. The solution will be already appealing for users if it can massage on the wanted positions.

Since it is decided that the simulation of various techniques is not the focus in this project, it is needed to select one technique to integrate into the device. As introduced in the research about clinical massage techniques, there are three most frequently used techniques for treating neck pain, which is "still compression", "gliding compression" and "holding". However, none of the actuators used in current neck massage devices can do all the three techniques. Since the focus of this project is not to develop a new complex actuator system which can perform different techniques, it is wise to choose one of the three. Since "still compression" techniques have the highest requirement for the preciseness of location, it is proposed as the technique to be provided by the aimed product. Current products doing this type of massage used vibration actuators together with a certain way of applying pressure to muscles.

Users have a gut feeling about where they want to get massaged, and when those places get a massage they do feel better. It was learned from research that there are some trigger points that are more effective to be massaged to relax muscles. "Still compression" techniques are used to treat these trigger points. However, users have no idea where those trigger points are. It would good if the device can provide information to help users find out those trigger points. At the same time, users can also inquire their therapists about the position of trigger points on their neck. At least the interviewed therapists are willing to help patients manage neck pain on their own.

According to the interview with therapists and the user study, neck pain occurs mainly on three areas, the back of the neck, the sides of the neck and the top of the shoulder (close to the neck). Since this product aims to give massage on wherever users want, it is necessary that these three areas be covered by the massage device (Orange areas in Figure 28)

It is learned from a user study that neck pain is highly related to working. When asked to describe an experience when they felt neck pain, all the eight participants indicated their neck pain occurs when they are working, and they think the pain is disturbing can be designed as a shared device in the office. Moreover, if the device is used by multiple users, more data can be collected for self-tuning. The learning capability can be used to improve the preciseness (at the right point and towards the right direction) and comfortableness of the massage.

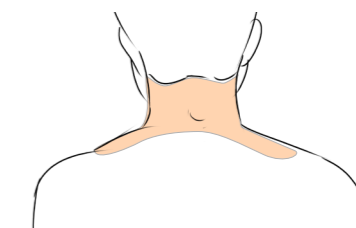

Fig 28: area to be covered

### 2.6.3 Conclusion

The aimed product would be a sharable massage device which can recreate what therapists did in a massage treatment. Given that the information of therapists' movement can be provided with flexible pressure sensor matrix, this project with a focus on developing the actuating part of the system. More specifically, in this project, two main challenges to be solved is how to locate actuators at the right position and how to simulate the "still compression" technique. With this clear goal, a list of the requirement will be generated. From the research, there are many desirable features, such as developing an actuator that can perform all the three massage techniques. These features will be put into a list of wishes.

### 2.6.4 List of fundamental requirements

#### Functional requirements

- The massage should cover three areas, the back of neck (longissimus, splenius), the side of neck (scalenes) and the top of shoulder (trapezius).
- The massage actuator should be located freely in the three areas.
- The massage actuator should be located accurately at the right position as learnt from the therapist's movement.
- Users should be able to overwrite the force level of the massage device.
- The device has to be sharable within the office with more than three people.
- The device should be able to remember users settings.
- The device should be able to recognize different users.
- Users should be able to use the product when they are dressed.

#### Kinematics requirements:

- The pressure should be perpendicular to muscles and be against to a bone.
- The pressing movement should be sequential on different points.

- There should be intervals between massage movements, the pressing lasts 3-5 second each time, the interval is about 1 second.
- The exertion and withdraw of force should be gradual.

#### Geometry requirements:

- The touching area between the focused point and the actuator is around two square centimeters (approximately the area of thumb).

#### Ergonomics requirements:

- The size of device should fit most of the adults' neck size 5% percentile to 95% percentile.

#### Material requirements:

- The contact between users and the device should be warm and smooth.
- The material in contact with users should be replaceable and washable.

#### Safety requirements:

- Users should be able to stop the massage easily.
- The device must stop increasing the force automatically when it reaches 50N.

#### Structural requirements:

- Power source is needed to perform massage.
- Control units are needed to control the change of force.
- Pressure sensor is needed to sense the pressure between the massage unit and muscles.

### 2.6.5 List of wishes

- Vibration function.
- Heating pad.
- Can be used to assist therapists' work.
- Show users the progress of treatment.
- Try to achieve the function without using app on mobile phone.
- Tailor the massage according to how much time the users have each time.

## Chapter 3 - Conceptualization

Based on the analysis, a functional model was drawn to demonstrate the primary function of the product. The model contains several sub-functions. Ideation was done for each of the sub-functions, and all the ideas were organized in a Morphological chart. By combining the solutions for the sub-functions, three concepts were generated. The three concepts were evaluated by using Harris Profile and analyzing the embodiment challenges. After evaluation, one of the three concepts were selected for further development. When developing the final concept, the insights from the evaluation phase and the list of wishes were taken into consideration.

### 3.1 Functional model

Based on the analysis, a functional model was drawn to demonstrate the primary function of the product. The model contains several sub-functions. Ideation was done for each of the sub-functions, and all the ideas were organized in a Morphological chart. By combining the solutions for the sub-functions, three concepts were generated. The three concepts were evaluated by using Harris Profile and analyzing the embodiment challenges. After evaluation, one of the three concepts were selected for further development. When developing the final concept, the insights from the evaluation phase and the list of wishes were taken into consideration.

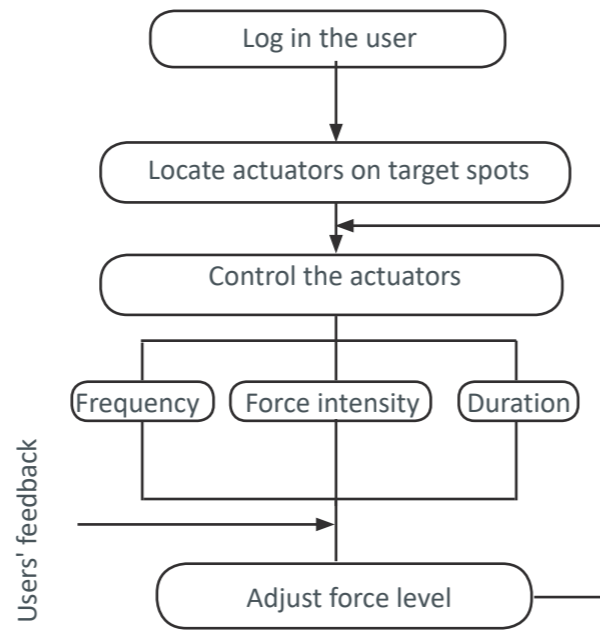

Figure 29: Overall functional model







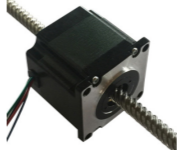

### 3.2 Ideation

Ideation was done in forms of a Morphological chart. According to the functional model, there are seven features for ideation:

- How to match the information of users.
- How to read the positional information on people's neck.
- How to locate actuators to the right position.
- How to exert force.
- How to give reactive force.
- How to control the actuators.
- How do users change the settings.

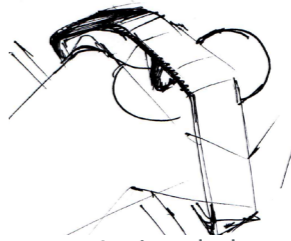
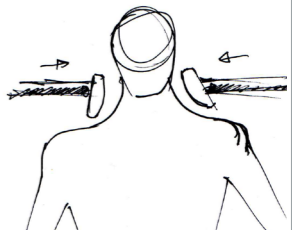
Table 3: Morphological chart

	Option 1	Option 2	Option 3
F1: Log in method	Blue-tooth pairing	Face recognition	Finger print recognition
	Option 1	Option 2	Option 3
F2: Read the positional information	Printed coordinates on the device	Grid based computer vision	Embedded RFID chips
	Option 1	Option 2	Option 3
F3: Control the actuators	Printed coordinates on the device	Grid based computer vision	Embedded NFC chips
	Option 1	Option 2	Option 3
F4: Ways of changing settings	Voice control	Gestural control	Touch screen

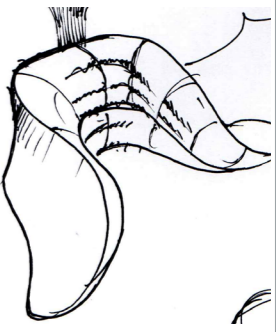
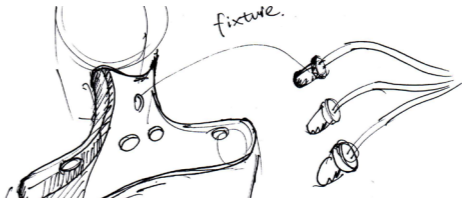
	Option 1	Option 2	Option 3
F4: Exert force	 Step motor	 Electromagnet actuator with linear movement	 Pneumatic actuator
	Option 1	Option 2	Option 3
F5: Reaction force	 Fixed with strip	 Against desk	 Force on both sides
	Option 4	Option 5	
	 Body weight	 Arm pulling	
	Option 1	Option 2	Option 3
F3: locate actuator to the points	 Move body	 Manually move actuators	 Distributed actuator
	Option 4		
	 Multiple removable actuators		

### 3.3 Generate concepts

By combining the ideas for each feature, three concepts were generated. The combination was not random. The idea of one feature determines which ideas for the other feature match together. The generated three concepts are introduced one by one in this section.

#### 3.3.1 Concept 1: Manual massage "scanner"

The device is put on top of the users' shoulders. By pulling strips, users control the position of the actuator inside the device. The actuator can rotate around the rail and linearly stick out a probe to a

massage at the user. In this way, the massage can be applied to any point covered by the device.

On the surface of this device, it is embedded with RFID chips telling the positional information. In the massage unit, there is an RFID sensor. The sensor read current positional information. Then the system instructs users to move the massage element by pulling the straps. After the element is located in the right position, the inside actuators automatically move to the remembered position. Users can adjust the direction and force intensity of the device by voice since their hands are occupied (Figure 30).

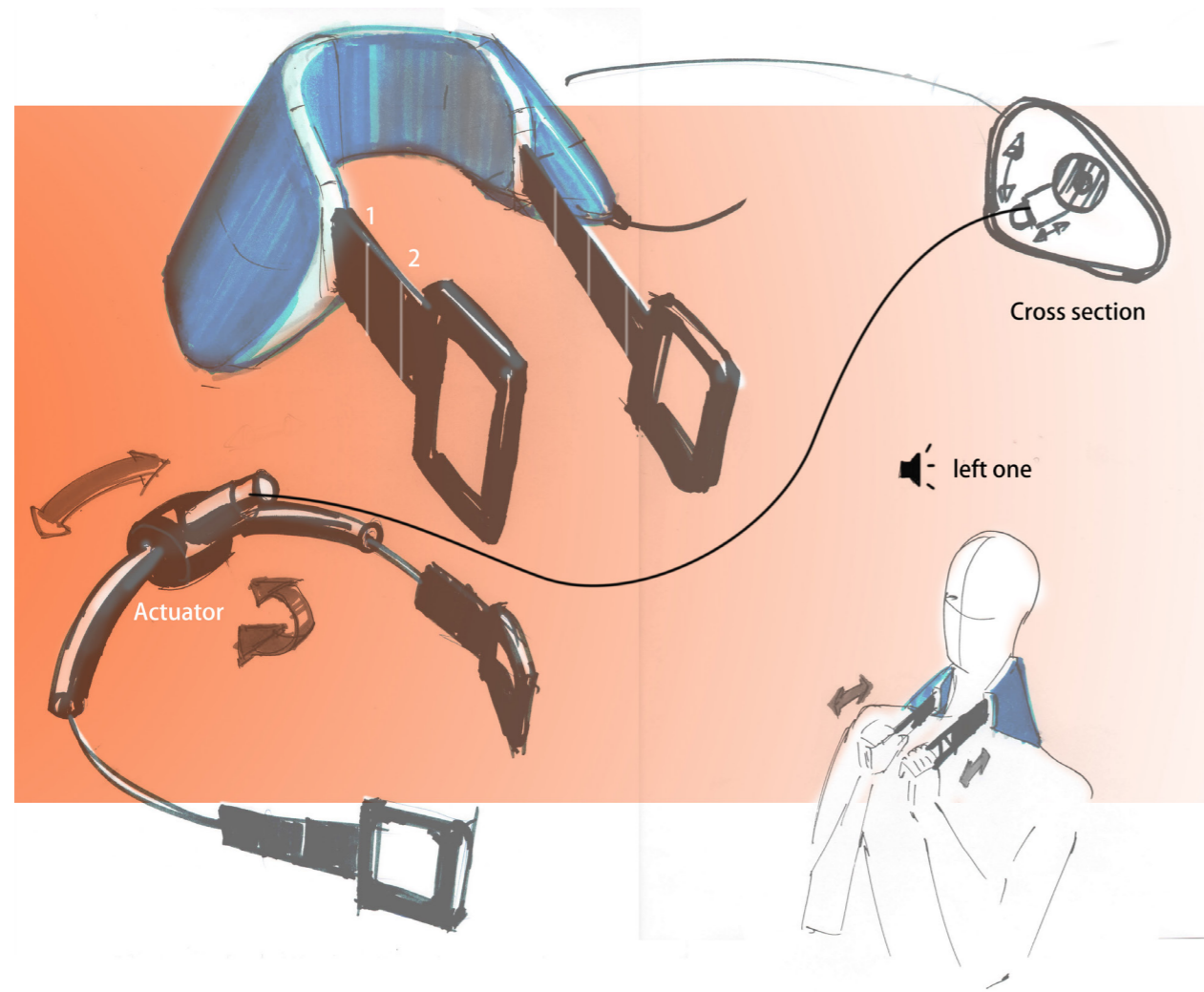

Figure 30: Concept 1

#### 3.3.2 Concept 2: Body position instructor

The device is hung on the wall. Users lean their body to the wall with their waists and heads supported by the equipment. The massage actuator is below the head support, which can rotate and stick out an inner tube. Users wear a collar with a grid pattern. On the collar, users can attach marks which is recognizable by the camera. There is a camera below the head support. By seeing the position of those marks, the system controls the

massage actuator to rotate and instruct users to move their body at the same time. In this way, the actuator is positioned at the points with marks (Figure 31). A gestural control can be used since this is a camera used in this concept.

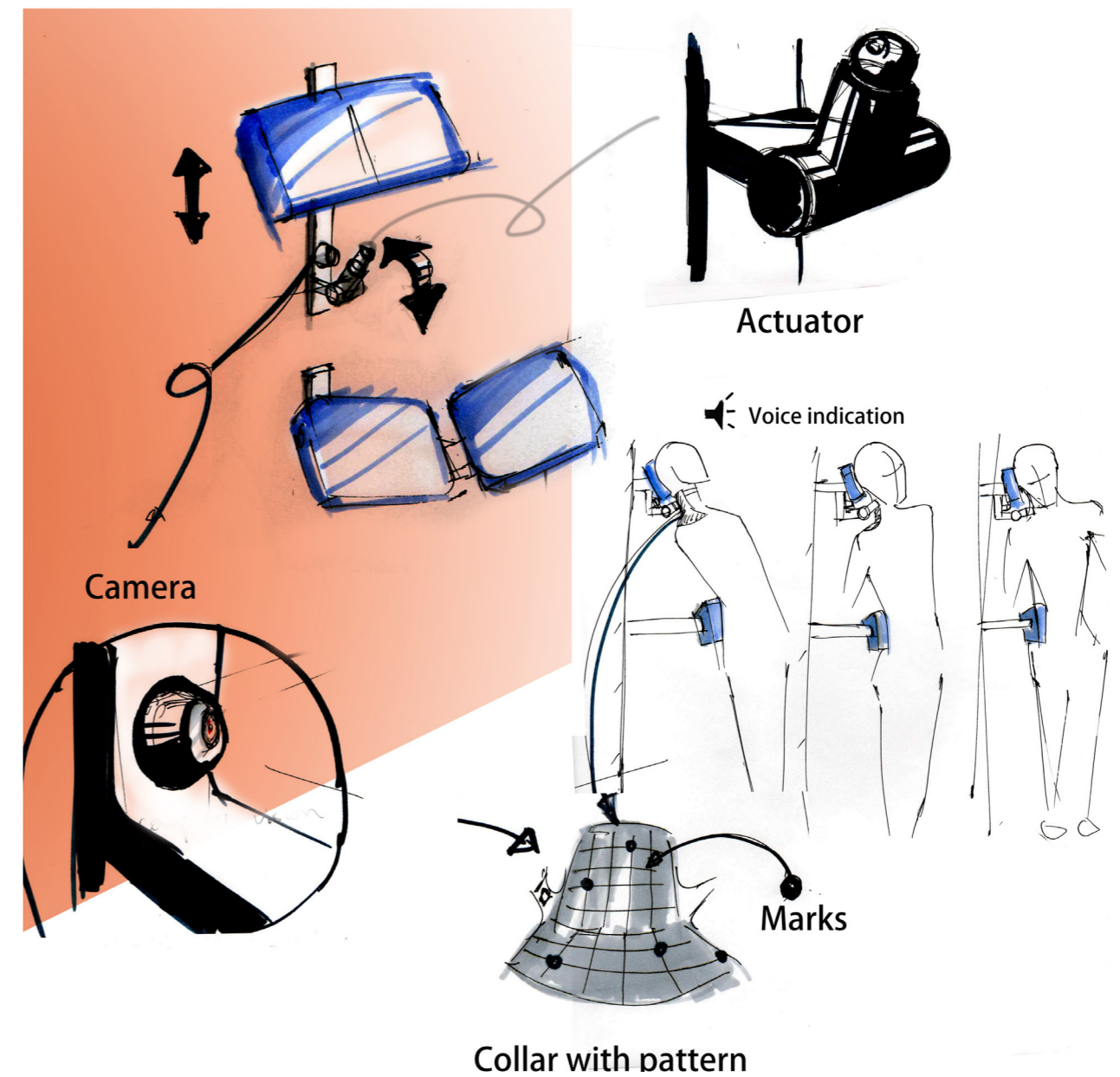

Figure 31: Concept 2

### 3.3.3 Concept 3: Hands-free pneumatic massager

Same as concept 2, users also wear a collar. In this concept, users attach balls to the trigger points according to the instruction from the system according to what was done by therapists. After setting up the collar, on top of the collar, users wear an inflatable device which is tightly fixed to the body. When it is inflated, the pressure is added to the points attached with balls. To control

the direction of the force, there are six separate airbags. The inner surface of the inflatable part has a pressure sensor which tells when the balls are located and thus tells which airbag need be activated (Figure 32). Users can overwrite the force intensity and direction of the massage by using a touch screen because their hands are free in this concept.

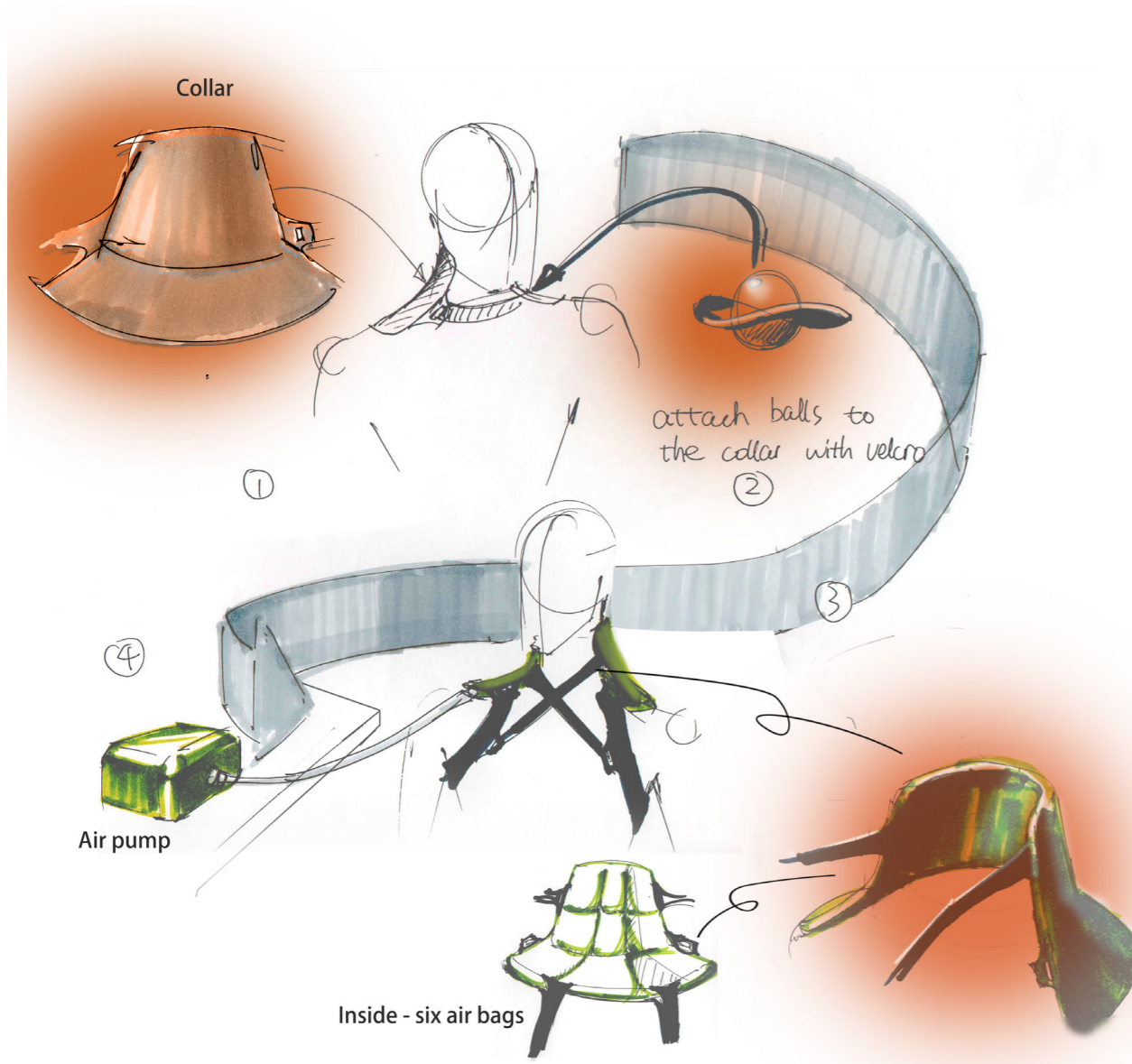

Figure 32: Concept 3

## 3.4 Evaluation

### 3.4.1 Objectives

The aim is to select from the three concepts and get insights for further improving the selected concept.

### 3.4.2 Methods

First, five participants evaluated the three concepts using Harris Profile (a tool for evaluating design alternatives) (Harris, 1961). The evaluation criteria in this phase are perceived comfortableness, perceived ease of use, perceived usefulness, perceived innovativeness, and willingness of use. The scale was coded as -2, -1, 1, +2. The mean value of the five participants was taken for analysis.

The five participants also participated in the focus group session for user study, so they knew the background information of this project already. The evaluation was done individually to avoid influence from others' opinion. The researcher explained the three concepts to participants with drawings. To help participants imagine the effect of using this product, some images of products were provided for them to imagine the feeling. Apart from filling in the Harris Profile, the participants also gave some comments on the concepts. After the user's evaluation, the required technologies for each concept was investigated to estimate the feasibility and cost of the concepts. After all this information is put into together, a final concept was proposed for further development.

### 3.4.3 Harris Profile

Table 4: Harris Profile

	Concept 1	Concept 2	Concept 3
	-2 -1 1 2	-2 -1 1 2	-2 -1 1 2
Perceived usefulness			
Perceived level of comfortable			
Perceived ease of use			
Willingness of use			
Perceived innovation			
Total mark	4	1	5

### 3.4.4 Users comments

The comments are summarized as "likes" and "dislikes" about the concept. They are shown in table 6.

Table 5: Users comments

	Likes	Dislikes
C1	<ul style="list-style-type: none"> <li>One part, simple</li> <li>Easy to learn how to use.</li> </ul>	<ul style="list-style-type: none"> <li>Arms may get tired.</li> <li>Doesn't look fit every one.</li> </ul>
C2	<ul style="list-style-type: none"> <li>The leaning posture activates body.</li> </ul>	<ul style="list-style-type: none"> <li>Worry about preciseness.</li> <li>Difficult to install on wall.</li> </ul>
C3	<ul style="list-style-type: none"> <li>Can be relaxed during massage.</li> <li>Warm feeling when wrapped.</li> <li>Can work with it.</li> </ul>	<ul style="list-style-type: none"> <li>No vibration function.</li> <li>May lose components or get messy.</li> </ul>

### 3.4.5 Evaluation of feasibility

In this section, the foreseen challenges and costly components of the three concepts are presented for elaborative comparison.

#### 3.4.5.1 Concept one: Manual massage "scanner"

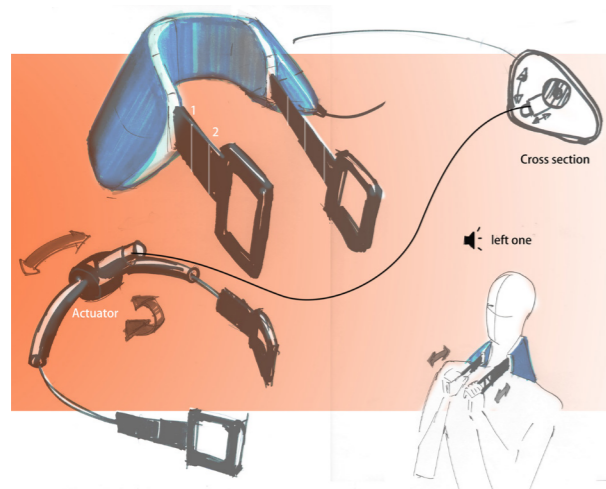

Figure 30: Concept 1

#### Main challenges:

- The movable actuator contains a rotational actuator and a linear actuator which may lead to a bulky solution.
- The location of the actuator is controllable by pulling the strips while it should be locked after the adjustment.
- When vibrating, the connection between components might be damaged.

#### Components:

##### Actuators:

Rotational actuator \*1, linear movement actuator \*1, vibration actuator \*1.

##### Sensors

1\*RFID sensor to sense the position of strips.  
1\*pressure sensor to control the pressure exerted to the skin.

##### Others

Touch screen\*1, speaker\*1, rail structure, locking system, shell, voice control unit.

#### 3.4.5.2 Concept two: Body position instructor

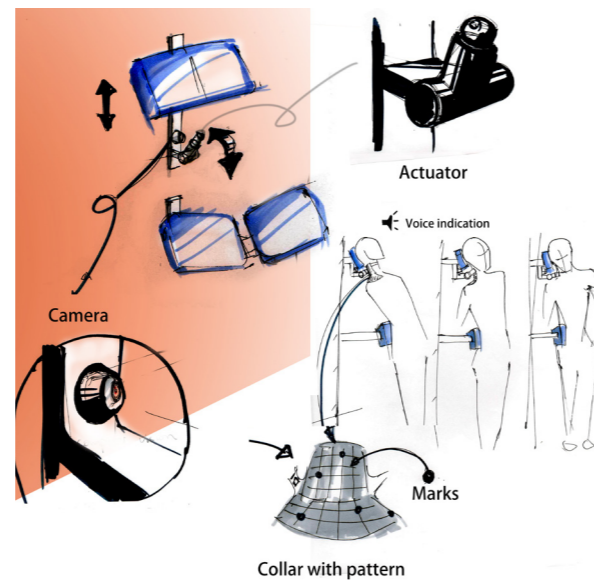

Figure 31: Concept 2

#### Main challenges:

- The recognition of massage points is achieved by grid based computer vision while the collar with grid is distorted since necks are 3D and have different shape and size.
- The adjustable body support adds to cost and complexity.

#### Components:

##### Actuators

Rotational actuator \*1, linear movement actuator \*1, vibrator \*1.

##### Sensors

Camera \*1, pressure sensor \*1.

##### Others

Speaker \*1, frame of head support and waist support, height adjustment and lock mechanism.

#### 3.4.5.3 Concept three: Hands free pneumatic massager

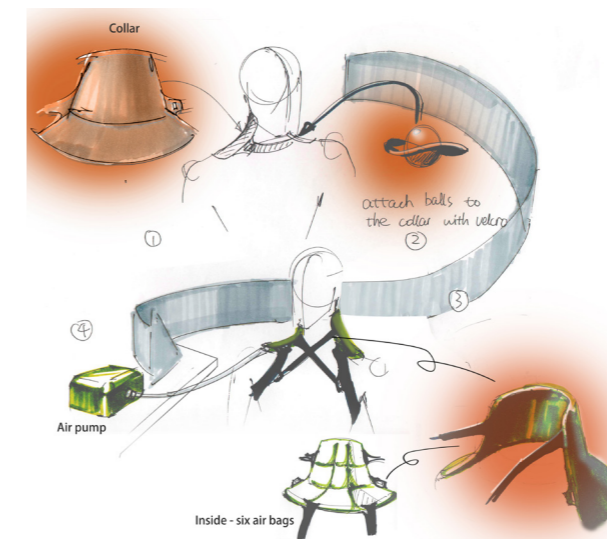

Figure 32: Concept 3

#### Main challenges:

- The idea is to control the direction of force by manipulating the inflating volume of air bags. However, the preciseness and effectiveness of changing direction in this way needs validation.
- The control of six air bags requires six air pumps which makes it bulky.
- The reaction time of pneumatic actuators is relatively slow.

#### Components

##### Actuators

Mini air pumps \*6

##### Sensors

Pressure sensor matrix \*1,

##### Others

Soft collar \*1, Rubber balls with Velcro surface \*6, touch screen \*1, strips \*6

#### 3.4.6 Synthetic

Concept three, the "Automatic pneumatic massager" was rated the highest by users, especially in terms of perceived comfortableness and perceived innovativeness. There are many

features. However, it is perceived as less effective because it simply adds pressure without vibration. Concept one got a close rate to that of concept three for Harris Profile. It is liked mainly because of its simplicity. However, simplicity requires a complicated mechanical structure inside the device, which induces many challenges. Concept three appears to be the most promising direction to be developed when these factors are considered.

To improve concept three, there are some features from the other two concepts can be integrated. First, users showed an obvious preference for pressing with vibration so it should be integrated into the final solution. Then what users like about the second concept is the posture of leaning to the wall (with support). They think it is a good chance to take a break from sitting. It would be good if there is infrastructure enabling users to use the massage device with active postures. Thirdly, participants complained about the number of separated components of concept three, and they liked the simplicity of concept one. Measures should be taken to improve the integration of the final concept. Moreover, some features from the list of wished, such as integrating heating pad and tailoring massage plan according to how much time users have and etc, also have the possibility to be integrated.

#### 3.4.7 Conclusion

Concept three, "Automatic pneumatic massager" is selected to be further developed. The concept needs to combine the vibrating function and improve the level of integration. Moreover, some features in the list of wishes, such as the heating function and showing progress of treatment, can be integrated to the final concept.

### 3.5 Optimized concept

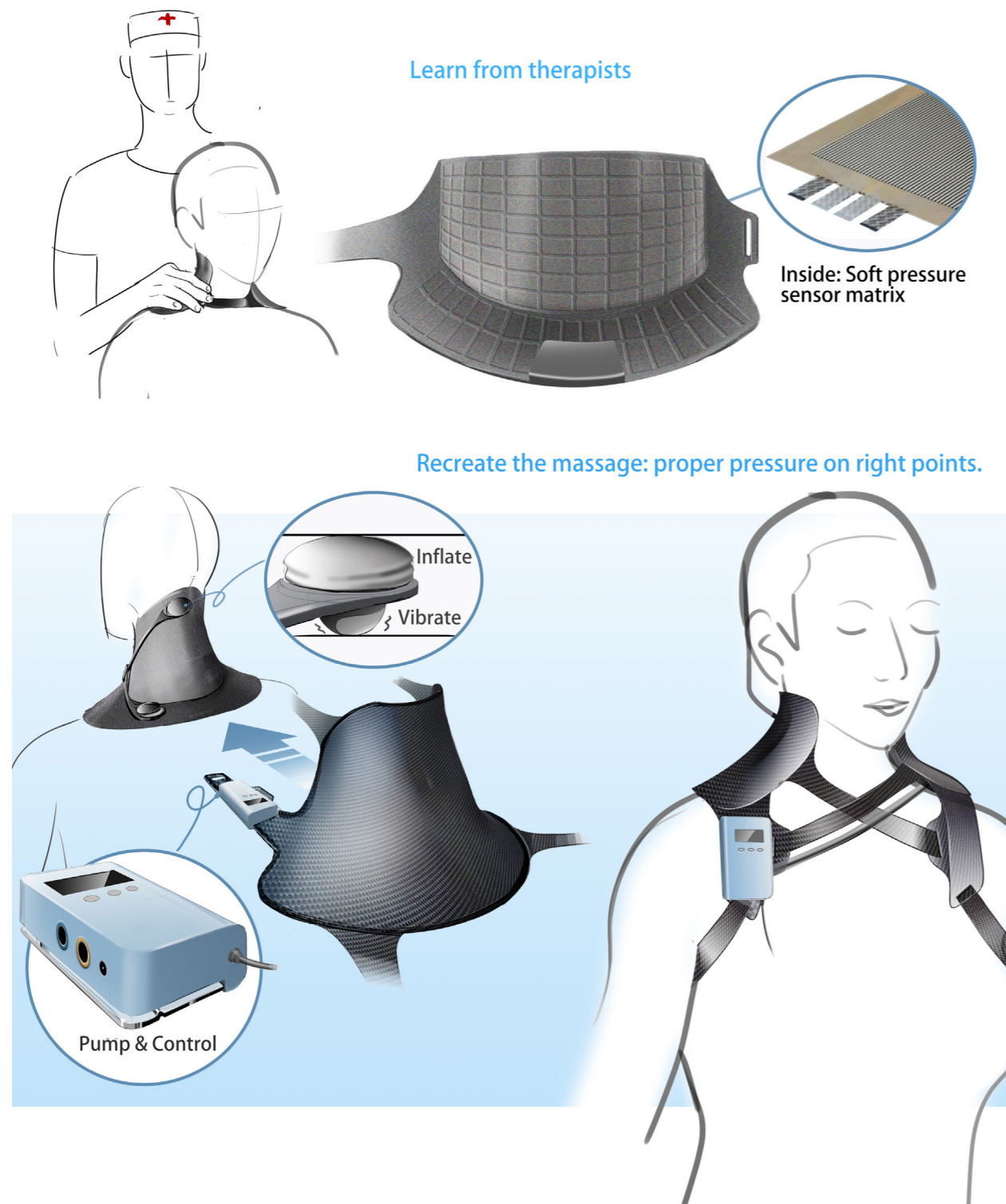

Figure 33: Final concept

#### 3.5.1 Description

##### 3.5.1.1 How does it work

The concept is a massage device that can recreate the customized massage treatment done by therapists. The device consists of two parts. One is used to learn from therapists about what they did during the massage treatment. This part is shown in Figure 34. It is a collar with an embedded pressure sensor matrix which can record the position, magnitude, and duration of the force exertion. These data are transformed into a soft-ware where the pattern of massage is speculated and simplified. All the therapist's movements are classified as gliding compression and still compression.

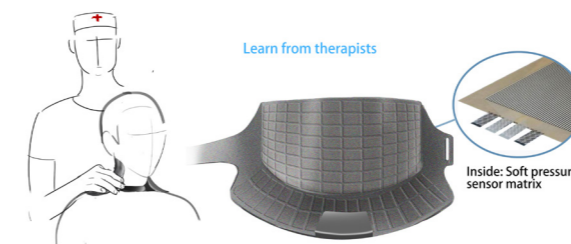

Figure 34: Product part one - the learning unit

The second part of the device also contains a collar that takes the same form as the first part but without the pressure sensor matrix. On this collar, massage actuators can be attached freely. Through an application on users' smart-phone, it tells users how to located the actuators according to the analysis of the recorded data. Then the actuators are controlled to perform either still compression or gliding compression in the right position. There is printed coordinate in the collar to assist users to define the position precisely. An example of an actuator arrangement is shown in Figure 35. However, limited by the number and size of actuators, it is not expected to complete the whole massage treatment with one arrangement. As observed, therapists normally treat four to six positions in one session. With four actuators, it can recreate two to three of them. The system plans for the users about which positions to treat that day.

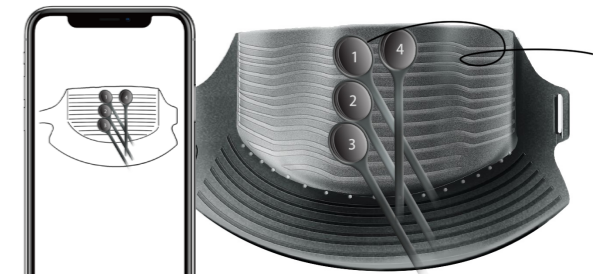

Figure 35: Example of massage pattern

The massage actuators work by inflating to add pressure and vibrate to enhance the massage effect. Since a counterforce must be present to give pressure, there is another component which is used to hold the actuators tight to users' body. This is shown in Figure 36.

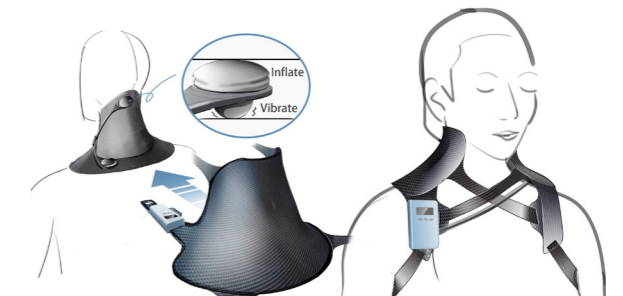

Figure 36: Product part one - the massage unit

By controlling the actuators, "still compression" and "gliding compression" techniques can be mimicked. The way of mimicking these techniques is explained below.

##### Still compression

"Still compression" means exerting pressure perpendicularly to the surface of the muscle. The fingers may do circular movements or simply hold still for 3-5 seconds respectively. This technique is mostly used to deal with trigger points. It can be simulated with a single actuator. The pressure goes up gradually by inflating air. When the pressure reaches the required level, the vibrator starts to vibrate to create a movement of the actuator to simulate the circular movement of thumbs in the "still compression" technique.



Figure 33: Mimic still compression

Gliding compression-Stripping

"Gliding compression" means glide against the skin while exerting pressures. One type of gliding compression is called stripping, which means fingers move along a muscle. This technique is often applied to large muscles. It will be simulated by activating three actuators sequentially. However, the effect is uncertain. The control details will be determined during the prototyping phase.

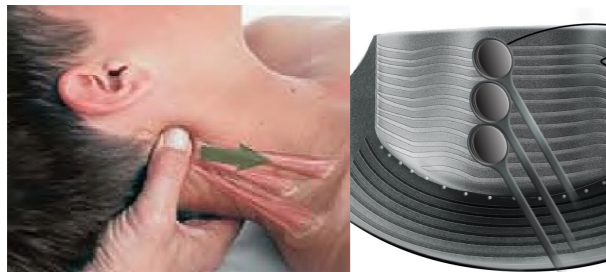

Figure 34: Mimic stripping

Gliding compression-cross finger

Another type of gliding compression is called Cross-Fiber Friction which means fingers move across the muscle. The movement of fingers is relative short in this technique. So, two actuators are enough to simulate this technique.



Figure 35: Mimic cross finger

3.5.1.2 Learning features

Before users get massaged by therapists, they first indicate where they feel uncomfortable by pressing on the collar and answering some questions. Then therapists massage on patients while they still wear the collar. In this way, the device learns how to deal with certain symptoms from therapists. When users do not encounter a new problem, they do not need to turn to therapists for help again. However, therapists may perform the massage differently for the same symptom. In that case, the user can give feedback to the system about the effect of different treatments. This is also valuable information for therapists.

Since the massage recreated by the device is different from what is done by a human, if the device exerts the same pressure as what therapists do, users may feel uncomfortable. So, users can overwrite the force level through the application in their mobile phone. The system remembers the adjustment and will exert this level of force the next time.

3.5.2 Possible using scenarios

The collar with embedded sensor and the related software can be possessed by a company or a clinic. Individual users don't have to buy it themselves. There should be new service systems, but the detailed service design is beyond the scope of this IPD project. However, there are three immediate ideas about using scenarios.

Possessed by companies

Commonly, a company regularly hire massagers to come to the office and massage for the employees. However, the frequency is quite low, and they mostly do relaxation massage. It is also common that companies buy massage chairs and put it in resting areas. However, the number of massage chairs is limited because they are expensive. Moreover, those massage chairs are only used for relaxation. In this scenario, companies can buy

one learning unit and multiple massage unit. They can invite massagers or therapists to come to a massage for their employees at low frequency. Then people can use the massage unit to get a relatively professional massage when therapists do not come.

Possessed by clinics

Normally, patients visit physiotherapy clinics once a week. Since neck pain is a chronic disease which is hard to be cured, it is a burden to get treatment continuously. So, many people chose only to visit therapists when their neck pain becomes heavy. With this product, there can be a rental service held by the clinic. Patients rent the massage unit and get massaged at home. In this way, patients still need to visit therapists but less frequently. The clinics also earn more because, without this service, patients even do not come. Nevertheless, the rental service also brings in extra profit. Moreover,

the data collected by the device also help therapists improve their treatment.

Non-professional use

Some users are less concerned about whether the message is professional or not. They can buy the massage unit themselves because it already serves the need that users want to massage on where they want. Moreover, by collecting data from the devices used in clinics, the system can give a general suggestion about how to deal with certain problems. The suggestion will not be as precise as a customized service but should also be helpful.

3.5.3 Blueprint of the service

To demonstrate the process of users using the device, a simplified service blueprint is shown in table 6.

Table 6: Service blueprint

Phase	The device learn massage from therapists	Get massaged by the device		After using the device
	Report symptoms on device	Select mode		Take off the device
Customer Journey	Get massaged by doctors	Treatment Instruction on App	Relaxation Adjust setting on App	Give Feedback on app
	Transmit data	Attach actuators on inside collar		Organize the device
		Wear the inside collar		
		Wear the outside collar		
		Tighten the collar and turn on		
Touch-points	The collar with a pressure sensor	App		App
	App	Physical part of device		Physical part
	Therapists			



### 3.5.4 Reflect on requirements and wishes

The requirements and wishes that are full filled with the final concept are marked as blue. Those are not full filled are marked as red.

#### Functional requirements

- Users should be able to locate the actuator at where they want to get massaged.
- The actuator should be able to mimic still compression.
- The massage should cover three areas, the back of neck (longissimus, splenius), the side of neck (scalenes) and the top of shoulder (trapezius).
- The the massage should be adjustable in terms of force level, position and direction.
- Users should be able to use the product when they are dressed.
- Perform customized massage for different users.

#### List of wishes

- Vibration function.
- Heating pad.
- Can be used to assist therapists' work.
- Show users the progress of treatment.
- Try to achieve the function without using app on mobile phone.
- Tailor the massage according to how much time the users have each time.
- Users want to be fully relaxed during the massage.

### 3.5.5 Relate to CPSs principles

#### Collect data and analysis

It collects data during therapists' massage treatment. Then the data is analyzed to formulated a simplified massage pattern.

#### Real-time Pressure control

Since the pressure level depends on many factors such as the tightness of the belts, the place of the actuator. To achieve a certain pressure level, the air needed is not always the same. In this case, a pressure sensor is needed to make sure the force exerted is proper.

#### Plan and show progress

Users will be more motivated to use the device if they are informed with the progress. The device can remember how long they have been massaging on one point and tell them how long is still needed to finish that point.

#### Learn from history data

The device learns from doctors' reaction to certain symptoms of the patient. It can also improve its performance according to the user's feedback. The data of different users will be gathered and analyzed to give general suggestions.

## Chapter 4 - Detailing

The conceptualization phase ends up with a description of functions. In the detailing chapter, the concept is further developed to address technical issues. To begin with, all the components within the concept is mapped out to give an overview. Then, the physical components are further explained in details.

### 4.1 Overview of the system

The concept contains three subsystems, as shown in Figure 36. The learning system includes the components used to collect data, store data, and analyze data. The Control system conveys the information from the learning system to the actuating system and users. Moreover, it interacts with users and collects data during this process. The actuating system refers to all components that perform massage operations. In these systems, doctors and users play important roles as information providers and task conductors.

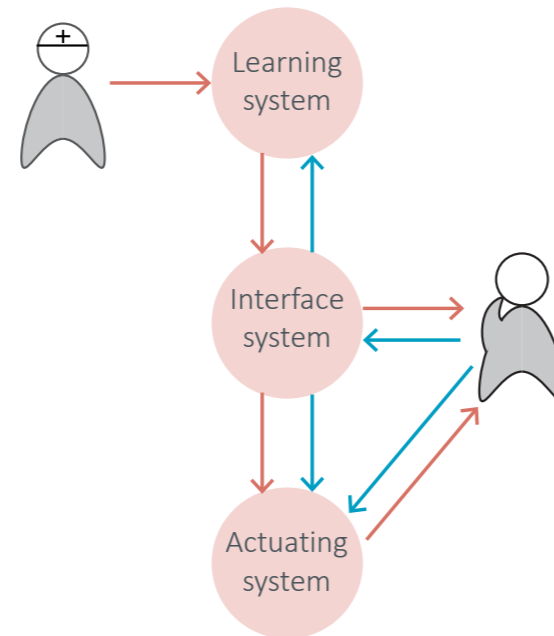

Figure 36: Structure of the system

There are two paths for information transfer between the three systems. First, the information of the doctor’s massage is input to the learning system and analyzed. The result of the analysis is transmitted to the control system. The control system uses this information to control the massaging elements and present information to the patient. Then, the actuating system performs the corresponding operation.

The other path begins with the patient. The patient inputs his or her symptoms and feedback to the control system. Then, the control system adjusts the control of the actuation system according to the feedback. At the same time, the controls system send the patient’s feedback to the doctor so that the doctor can adjust the treatment plan. Besides, the information entered by patients is transmitted to the learning system. The data from patients and doctors can be used for developing an algorithm for intelligent diagnoses. Ideally, In this way, the device can assess without relying on doctors anymore. Although it is uncertain whether the algorithm would be reliable enough or not, the data is collected to prepare for that.

The components within the system are mapped out in a layered model as shown in Figure 37. The model consists of three layers, namely, cyber layer, software layer, and hardware layer. The meaning of software layer and hardware layer

is straightforward. They consist of software and hardware in the system. According to I.Horvath et al. (2017) (2018), cyberware is usable knowledge, information which are converted from data using sets of inferences and reasoning strategies. There are three types of information needed in this system:

- The information about therapists massage treatment.
- The information of users’ feedback to the action of the device.
- The information about users’ symptoms and background information.

Apart from all the components, this model also indicates how the components connect with each other. The software used for analyzing data is installed on a computer; the application used for controlling actuators and interacting with patients is installed in a mobile device. The transmission of data and control signals is achieved with wireless communication technologies for the sake of convenience. Common wireless transmission technologies include Blue tooth, Wi-fi, and Zig Bee. However, the selection between those technologies needs further study.



Figure 37: Layered model of the system

### 4.2 Detailing of learning component

#### 4.2.1 Requirements

The term “Learning components” refers to the components that are used to record what therapists did in the massage treatment. The basis of this unit is a pressure sensor matrix embedded in a collar. There are some requirements for achieving the goal. First, to enable therapists to massage on patients through the collar, the pressure sensor must be flexible. Then, to precisely record the position where doctors exerted pressure, the sensor matrix has to be positionally accurate. Since the contact area between the therapist’s thump and the patient’s body is about 1 cm<sup>2</sup>, theoretically, the accuracy of the sensor matrix must be less than 1mm. Moreover, since the pressure in clinical

massage can be up to 25N/cm<sup>2</sup>(2.5\*10<sup>5</sup> Pa), the range of pressure sensors should be larger than 0 - 2.5\*10<sup>5</sup> Pa.

#### 4.2.2 Structure of the learning unit

##### 4.2.2.1 structure related to accuracy

The fabric pressure sensor matrix can be purchased from the company SEFAR AG [1]. They can customize the sensor matrix according to clients’ needs. The matrix consists of n\*m rows of metal strips. Each cross-section acts as a pressure sensor and forms up one pixel in the pressure distribution image. The closer the rows of metal strips are, the more accurate it can achieve. In the referential case, which detects people’s movement on a mat, the accuracy of the matrix is 1cm. However, It is

speculated that the accuracy can be improved if the sensing elements are placed closer to each other.

#### 4.2.2.2 Connection to the computing system

The way of controlling the matrix and connecting it to a computer is shown in Figure xx. Basically, by switching on and off the power supply of each row one by one in a quite short time, the data at each pixel is acquired and plotted in an image. This data stream is then stored and sent to a computer. After the data stream is collected, the computing system analyzes the data and figure out what activity were conducted. The activity recolonization method includes the following steps(J. Cheng et al, 2016):

1. Ruling out abnormal values.
2. Extracting pressure distribution features.
3. Analyze the time series of the pressure distribution images.
4. Classify the motion features.

#### 4.2.2.3 protective layers

There are two layers of common fabrics attached to the surfaces of the sensor matrix to protect it. The protective fabrics have to be thin, strong, and non-elastic. Moreover, the surface in contact with patients' neck needs to be silky for the sake of comfort. Then, the surface towards the therapist needs to be smooth for ease of them sliding fingers on the fabric.

To cover the three most commonly complained areas and fit for people's body, the wearable "learning component" can't be made with one single piece of fabric. Instead, it will be made by sewing several pieces of fabric together. For this reason, several small pieces of pressure sensor matrix is needed in this design.

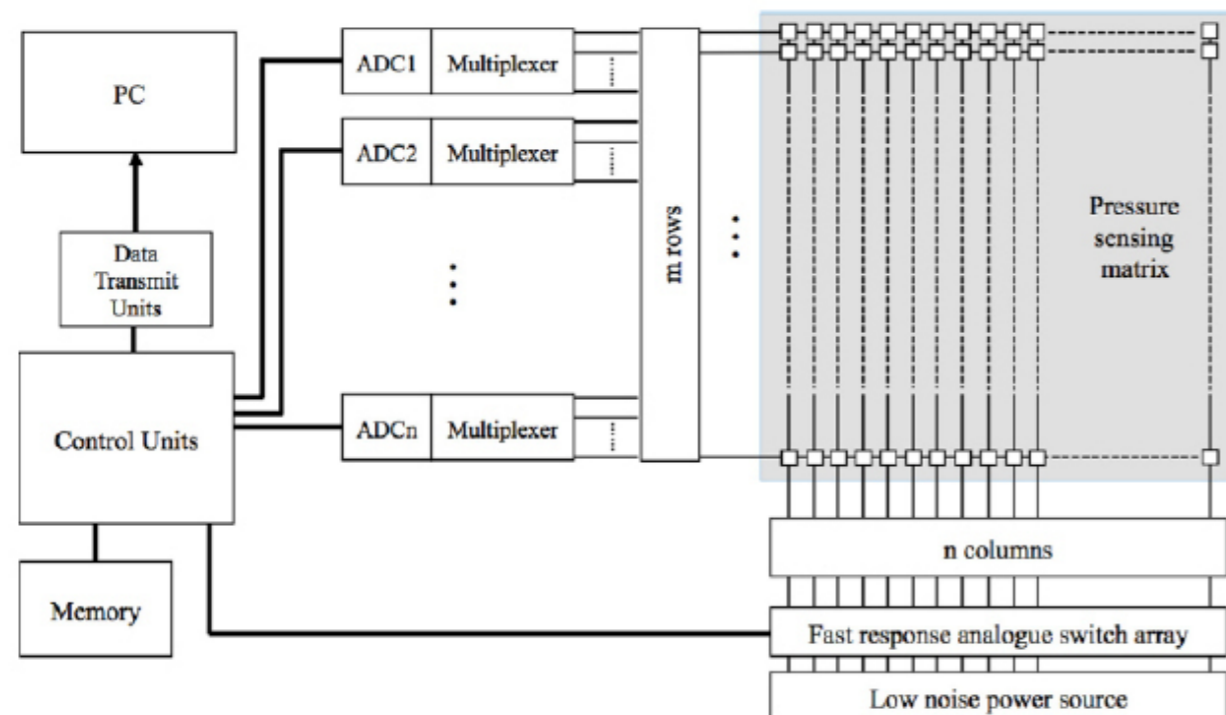

Figure 38: Pressure sensor connection

### 4.3 Detailing of the massage actuator

The massage actuator has the function of inflating to add pressure and vibrating. It consists of one airbag, one vibrator and one plastic shell holding these components. On the bottom of the shell, Velcro fabric is attached, enabling the fixture of the actuator to the inside collar (Figure 39).

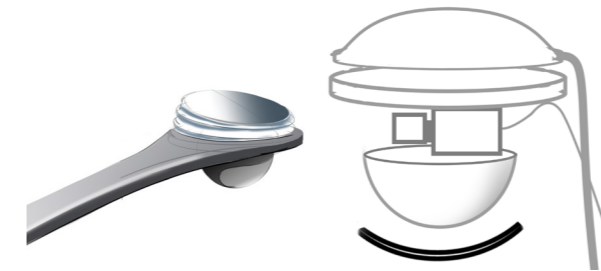

Figure 39: Overview of massage actuator

#### 4.3.4 Selection of vibrators

As described in the conceptualization chapter, when the massage device exerts pressure on users' bodies, it also vibrates. The function of the resonant vibrator is to create a movement of the massage actuator which simulates the rubbing movement in the "still compression technique". Moreover, the vibration function is highly appreciated by users because it adds to the comfortableness.

The main concerns for the selecting vibrators are size and amplitude. The smaller the vibrator is, the more flexible it would be to locate the actuator. Ideally, it is should fit in a cylindrical shell with a diameter of 30 mm and a height of 15 mm. Then, the travel distance of the thumb in the "still compression" technique is about 10 mm. Therefore, the amplitude of the vibration motor should be large enough to bring in a displacement of 10 mm for the massage actuator. However, the amplitude of a vibrator is highly related to its size. A balance needs to be achieved when selecting vibrators.

There are two basic types of vibration motors, eccentric rotating mass vibration motors (ERM) and linear resonant actuators (LRA). ERM vibrates

through a small unbalanced mass doing a high-frequency rotational movement. LRA vibrates through a small mass attached to a spring doing a high-frequency linear movement. From the website of a supplier, the following vibration motors were found [1]. They are listed in Table 7.

Table 7: Vibrators

	Type: ERM Size: 8 *18.5mm Rated voltage: DC 3v Current: 220mA Rotational speed: 8,250 rpm amplitude:10G Price: 6.69 £
	Type: LRA Diameter: 10 * 3.4 mm Rated voltage: DC 3v Current: 55mA Rotational speed: 14,000 rpm amplitude:1.9 G Price: 2.96 £
	Type: ERM Size: 12 * 21.1mm Rated voltage: DC 3v Current: 250mA Rotational speed: 6400 rpm Amplitude:14.3G Price: 2.84 £
	Type: ERM Size: 24 * 12.5 mm Rated voltage: DC 12v Current: 148 mA Rotational speed: 5500 rpm Amplitude:13G Price: 3.78 £

The listed motors meet the requirement of size and have a relatively large amplitude. The unit of amplitude is G (9.8 m/s<sup>2</sup>) which represents the acceleration it provides. The displacement is influenced by the amplitude of the vibrator and by the weight and state of the object. Since the wanted movement is only lateral movement, and the listed vibrators have different shapes and types. They will be attached to the massage actuator in different orientations. To calculate the displacement, the system can be simplified as a spring with one fixed end and one end attached with the vibrator, as shown in Figure 40. However, the elastic coefficient and resistant force is not clear. Thus, it is hard to be calculated. A further test is needed to see whether these vibrators can create enough displacement to simulate the movement of thumbs in the “still compression” technique. There is another goal of using vibrators that users like the vibration feature. However, the pneumatic actuator already vibrates when working because of the random phenomenon. Then, if the goal of creating displacement is not achieved, the vibrator is not needed in this device.

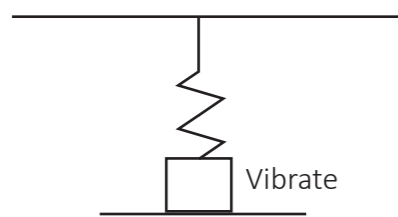

Figure 40: Simplified model of the system

#### 4.3.1 Structure of the inflatable airbag

As learned from research, the load exerted to muscles in clinical massage is around 50N. The contact area between the thump and the patient's body is approximate to 2 cm<sup>2</sup>. Then, the pressure needed in clinical massage is around 25N/cm<sup>2</sup> which equals to 2.5 bar. Then, since the outside collar may deform to a certain level when bearing stress, the airbag should expand largely in length as compensation.

There are two structures found in research that meet the requirements mentioned above. One is the corrugated membrane as shown in Figure 41. The elasticity of the membrane, together with the corrugated shape, enables it to expand linearly. (Benjamin, 2017). Another option is called a multi-chambered inflatable structure as shown in Figure 42. It is made of single-side coated textiles that are impermeable to air. Different layers are bonded together by melting the TPU coating. The textile is not elastic. It expands because different layers are bonded at the boundary. They are detached when being inflated (Yang, 2018). Both structures meet the requirement but considering the availability of the material in this project, the multi-chambered structure is selected.

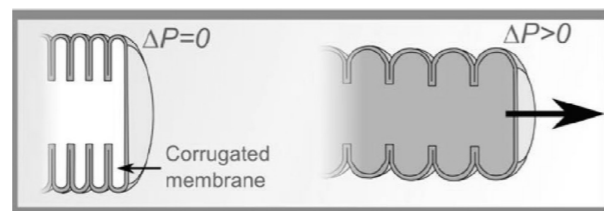

Figure 41: Corrugated membrane

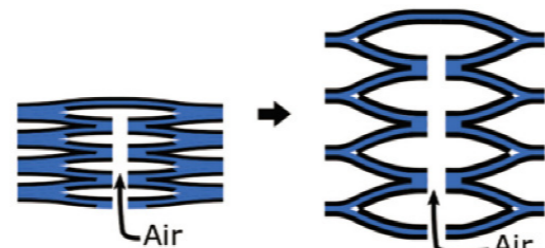

Figure 42: multi-chambered inflatable structure

The way of bonding different layers together is shown in Figure 43. By placing layers with different sizes, there is always an area with TPU coating exposed between two layers. The top and bottom are closed with hard TPU component to ensure a flat surface. Moreover, the bottom component is molded with an air inlet and outlet port. For mass production, large pieces of the coated textile can be purchased from suppliers and then cut with laser cutting machines. After the layers are arranged in order, they are pressed together and put into a special Owen (Yang, 2018).

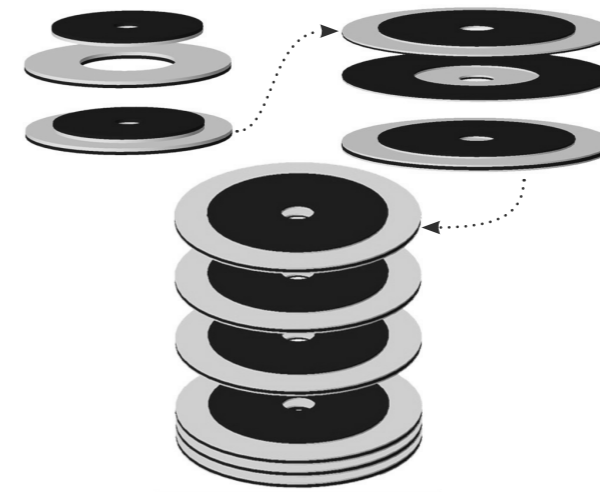

Figure 43: steps of making the structure

The designed dimension of this component is shown in Figure 44. The maximum expansion depends on the distance between the inner bonding circle and the outer bonding circle. That value in this design is 0.4cm. Since there are eight layers in this design, this structure will be able to extend for 3.2 cm in length. The strength of this structure is related to the bonding area and bonding strength. Since there are many unknown factors, it is hard to calculate the maximum pressure precisely it can take. Further testing is needed to determine the final dimensions.

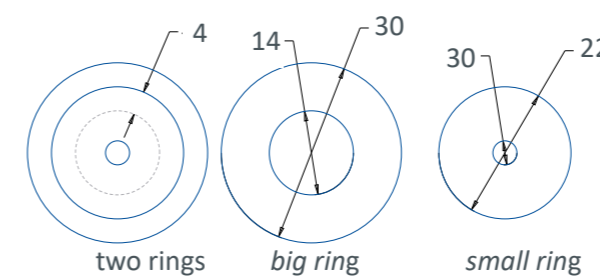

Figure 44: Dimensions

#### 4.3.4 Plastic shell of the massage element

In the massage element, a plastic shell is used to hold the vibrator and the airbag. The shape and structure of the plastic shell are shown in Figure 45. Its material is TPU. As mentioned above, the airbag contains a layer of TPU coating. By heating the contact surface between the shell and the airbag,

they will be firmly bonded together. Moreover, there is an air outlet on the shell which connects to the air pump through a tube. Then, there is an opening left on the bottom shell for the cables of the vibrator. The surface of the bottom is made flat for attaching a piece of Velcro to it. The assembled massage element is shown in Figure 46. The dimensions of the designed plastic shell is shown in Figure 47.

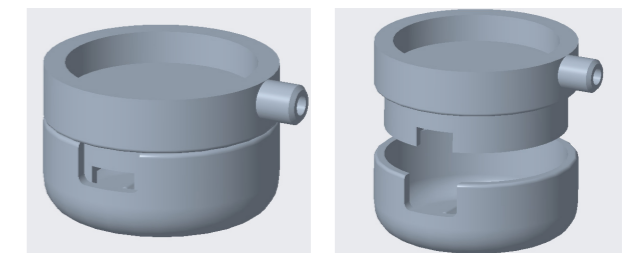

Figure 45: Plastic shell of the massage actuator

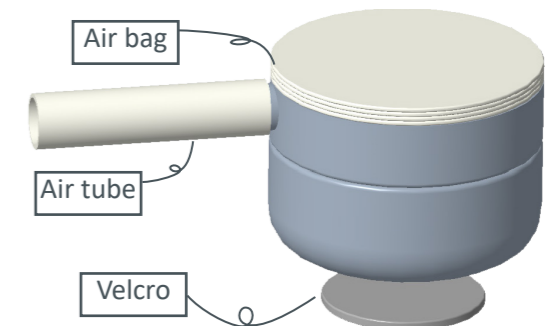

Figure 46: massage actuator

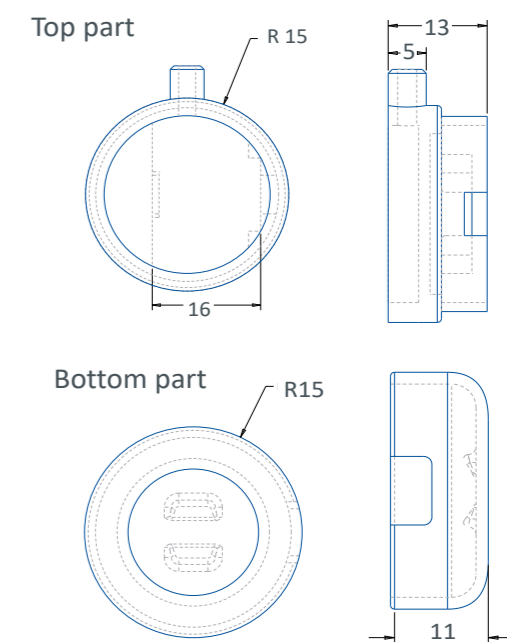

Figure 47: Dimensions of the massage actuator shell

### 4.3.5 Strength of Velcro fixture

According to the parameters shown in a supplier's website [2], the shear strength (the force needed for separating the pieces laterally) of a used ordinary Velcro (after peeling for 1000 times) is 6.6 N/cm<sup>2</sup>, that parameter for reinforced Velcro is 9 6.6 N/cm<sup>2</sup>. If maximum massage force is applied with an angle, the shear force created is  $50 \cdot \cos\theta$  (Figure 48). Taking the value of ordinary Velcro for calculation,  $\theta$  equals to  $82^\circ$  when the shear force reaches the limitation. However, it doesn't mean the actuator will move when the angle is smaller than  $82^\circ$  because there is friction between the actuator and the Velcro surface. But what can be concluded is that the force angle between  $82^\circ$  and  $90^\circ$  is safe.



Figure 48 force angle calculation.

## 4.4 Control of the actuator

### 4.4.1 Air pump

There are three main concerns when selecting an air pump, the maximum pressure, size, and cost. The maximum pressure of the pump must be above 2.5 bar since the pressure in clinical massage ranges from 0 - 2.5 bar. For the sake of convenience, the size of the pumper should be as cheap as possible. Moreover, the cost is also an essential factor in the selection of air pumps.

Two typical products are shown in Table 8 [3]. One of them is cheaper and smaller but can only provide a pressure of 2 bar. The other one can provide 5.8 Bar. Since 1.2 Bar is far less than the needed pressure, the relatively expensive one is selected.

Table 8: Comparison of air pumps

	Max pressure: 120kPa Price: 2.4 \$ Size: 24*24*58 mm <sup>3</sup> Rated voltage: DC12v Power: 4w
	Max pressure: 580kPa Price: 27 \$ Size: 42*87*112 mm <sup>3</sup> Rated voltage: DC12v Power: 45w

### 4.4.2 Valves

To recreate the massage pattern, the pneumatic actuators should be controlled to inflate and deflate. This can be done with a magnet valve. The valve has two states as shown in Figure 49. Port A connects to the actuator; port C connects to the air pump; port B is an air outlet. When the cylinder moves to the right, B is closed, and it is inflating. When the cylinder moves to the left, the air in actuator can be released from B.

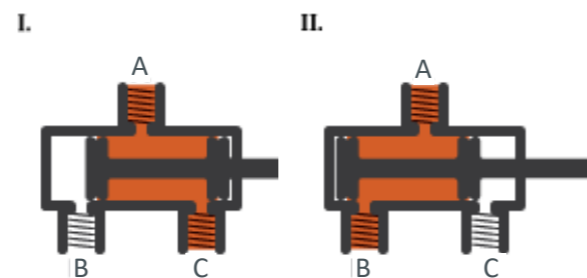

Figure 49 magnetic valve

Since there are four massage actuators in the concept, all of them need to be controlled. However, there is no need to have four air-pumps and four separate valves. A serial valve system was found which can combine multiple valves [3]. Then, only one air pump is needed to drive four actuators. The product is shown in Figure 50. Its price is 80.9\$ which is relatively expensive. Another option is to have four air pumps and control them

separately. However, let alone the four separate values needed, the three extra pumps already cost more than 80.9 \$. Moreover, it also saves space with the serial valve. So the one air pump one serial valve system is selected in the design.



Figure 50: Magnetic valve

### 4.4.3 pressure sensor

A gauge pressure sensor can be used to control the pressure exertion as shown in Figure 51. With a tree-port connector, an air tube is connected on the top of this sensor. In this way, the air pressure in the airbag can be measured.

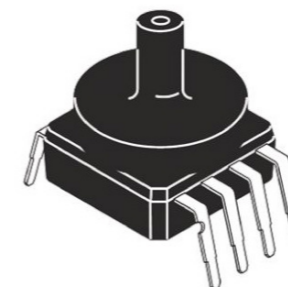

Figure 51: Gauge Pressure Sensor

## 4.5 Power source

The power consumption of the massage device is mainly from the air pump and the four vibrators. The control system also consumes the power of around 0.5W/h which is neglectable compared to the actuators. The rated voltage of the air pump is 12v. So, the voltage of the power source should be at least 12v. The total power of the actuator is about 50w.

It is favorable to use batteries rather than a power cord because then there are fewer constraints in using environments. Assume the duration of using the massage device is 0.5h every time and users use the device five times per week and charge it once a week. The capacity of the rechargeable battery needs to be larger than 2.5Wh. An option is shown in Figure 52. It is a NI-MH type of battery with a capacity of 4500mA and a voltage of 12V. Its price is 23 Euro per piece from Aliexpress [1].

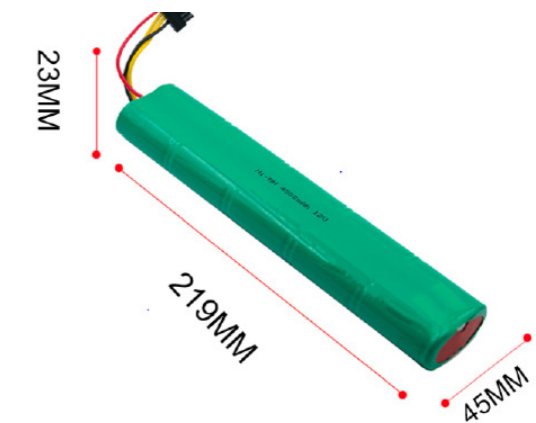

Figure 52: Rechargeable battery

## 4.6 Detailing of the casing

In the conceptualization phase, it was assumed that the air pump and control unit is small. So, the casing of them was designed to be wearable, as shown in Figure 53. However, after further investigation, it was realized that these components are much larger than the assumption. By putting the pump, valve, and battery together, the approximate size of the casing is determined, as shown in Figure 54. Considering the size limitation, the position of air outlet, the position of charging socket, and the ease for carrying. The new casing is designed as shown in Figure 55. An exploded-view is shown in Figure 56 to demonstrate how it is assembled.

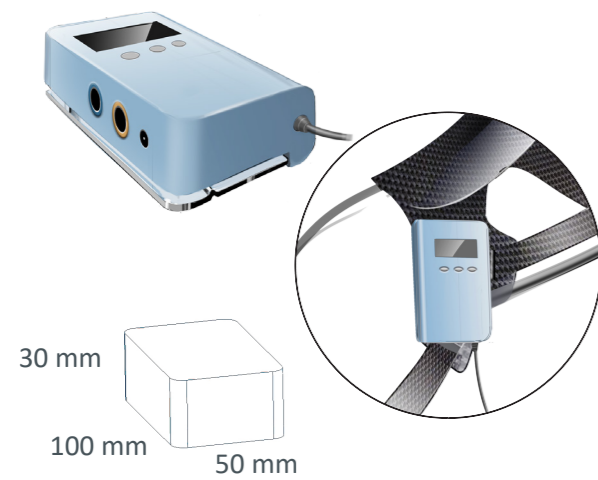

Figure 53: Original casing design

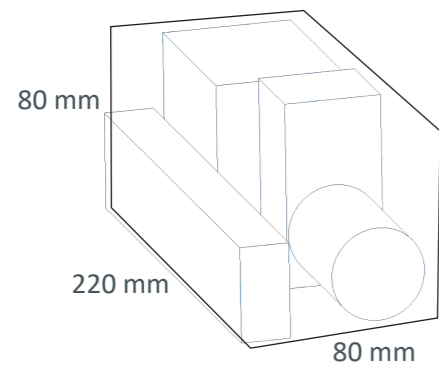

Figure 54: Size of inner components

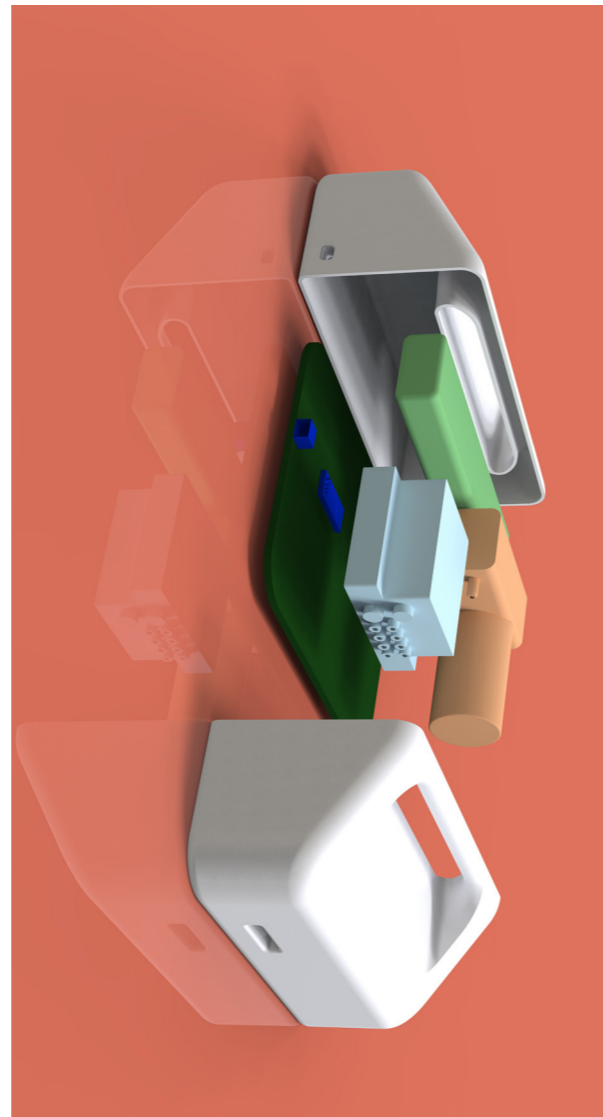

Figure 56: exploded view of casing



Figure 55: new casing design

Links used in this section

- [1] <https://www.sefar.com/en/609/Product-Finder/Smart-Fabrics/Sensing/Sensing.htm?Folder=6919337>
- [2] <https://www.precisionmicrodrives.com/product-catalogue>
- [3] <http://www.czsgddkj.com/news/1309.html>
- [4] <https://www.smc pneumatics.com/SS0755-05M5C.html>
- [5] [https://nl.aliexpress.com/item/32830093582.html?ws\\_ab\\_test=searchweb0\\_0%2Csearchw](https://nl.aliexpress.com/item/32830093582.html?ws_ab_test=searchweb0_0%2Csearchw)

# Chapter 5 - Prototyping

Limited by time and resource, only part of the designed features will be implemented in the prototype. The learning function and the control of the actuator need more time to develop. Thus they are not expected in this prototype. Apart from the proof of the working principle, the prototype is also made to determine some details of the collars and to collect feedback from users.

## 5.1 Expected prototype

One of the main features of the concept is that every point of the aimed areas can be massaged and the massage point is customized. Users can attach actuators on the collar with the guidance of application. Although in the prototype the actuators are not able to create a pattern, the basic element, adding pressure with pneumatic actuator, can be achieved. The requirements for the aimed prototype are listed below.

- The prototype should include the inside and outside collars and one pneumatic actuator .
- The collars should fit the human body (20% percentile to 90% percentile.)
- The actuators should be able to be firmly attached to the inner collar.
- The outside collar should force the actuator tightly to users' bodies without bringing in uncomfortable feelings especially at the throat.

## 5.2 Prototyping of the inside collar

The inside collar refers to the component shown in Figure 57. It is used to attach actuators.



Figure 57: inside collar

### 5.2.1 Design requirements

- It is fixed on neck without causing uncomfortable feeling on throat.
- Actuators can be attached to this collar firmly (Withstand lateral force of 5N)
- Actuators can be attached to this collar precisely (the error is smaller than (1cm).
- Users can wear it at the same position every time with error smaller than 1 cm.

- The surface in contact with users should be soft and smooth.
- It should fit with human body (5% percentile to 95% percentile of adults), at least on the three massage areas (back and side of neck, the top of shoulders)

### 5.2.2 Approach

The major challenge of designing this part is to make it fit with the human body. One way of doing that is the free draping technique used for tailoring clothes. The main idea of free draping technique is to design the cloth on a 3D manikin rather than on 2D paper. In free draping technique, first, a piece of thin white fabric was wrapped on a manikin. By folding and cutting the fabric, make it tightly fit the manikin. Mark on the folded lines and on the counter lines. By spreading the thin fabric, a 3D design is transformed into 2D. With this reference cut the real material to be used in the product. The process of designing the inside collar with free draping technique is shown in figure 58 - 60.



Figure 58: Design the collar on a manikin



Figure 59: Design the collar on a manikin

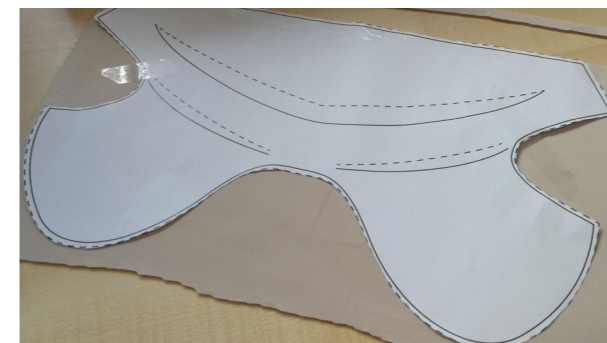

Figure 60: Transfer 3D to 2D

### 5.2.3 Ergonomics study

Free draping technique helps to design the general shape of the collar. To make it fit with the majority of adults, anthropometric data is needed. From the database DINED, the data of Dutch adults' neck was found (shown in table 9). For this product, the circumference is essential data. The value of 95% percentile was taken as a reference since it's less adverse if it is longer than needed. If necks are approximately regarded as cylinders, to cover the back and side of the neck the length of the area able to be attached with actuators should be larger than 75% of neck circumference. In this case, it should be larger than 393mm. The design drawing from free draping is shown in figure 61. It is longer than needed, so only the gray area needs to be covered with Velcro fabric.

Table 9- Neck circumference data

populations	Dutch adults 20–30, mixed		
measures	P5	P95	P50
Neck base circumference (mm)	382	524	453

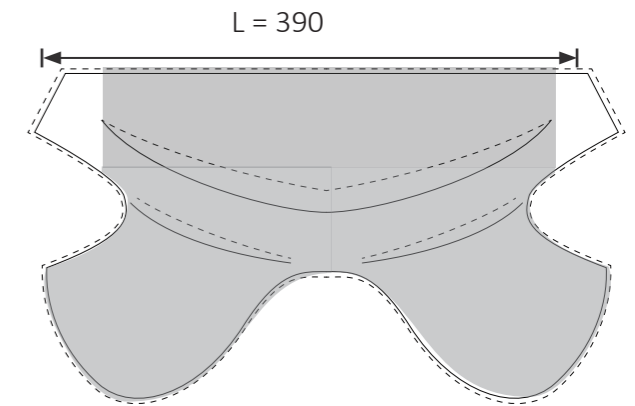

Figure 61: Design the collar on a manikin

### 5.2.4 Result

Cut the selected material according to the drawing and attach functional elements to it. Then the prototype is made as shown in figure 62.



Figure 62: Prototype of the inside collar

### 5.2.5 Material selection

The material selected for making the inside collar is shown in Figure 63. It is selected for two reasons. First, its surface is soft and smooth, so the contact with skin is comfortable. Then, it is elastic in one direction while not elastic in the other direction. Some part of the collar, such as the belt needs to be elastic while others do not. So this fabric is an ideal choice.

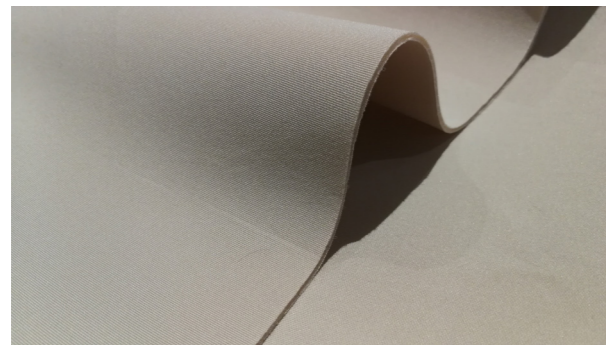

Figure 63: selected material

### 5.2.6 Other considerations in design

#### 4.2.6.1 Wearing position consistency

To recreate the massage done by therapists, it is important to locate actuators at the right position. This is achieved by marking coordinate on the collar. However, it doesn't make sense if people wear the collar differently every time. To avoid this from happening, two black marks were added at the middle of the collar as shown in figure 64. Users can feel the marks by touching it. Since, there are also clear features at the middle of users' neck, this can be a reference for users to check whether the collar is at the right position or not.

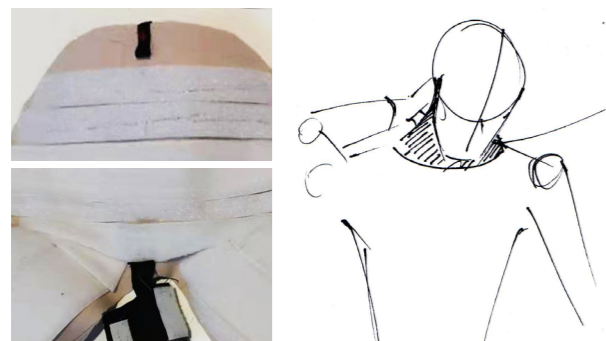

Figure 64: Features for position consistency

#### 5.2.6.2 Cable management

When there are four actuators attached on the collar, the cables and air tubes will become messy. The black loop at the bottom of the collar is used to tidy up the cables (shown in figure 65).

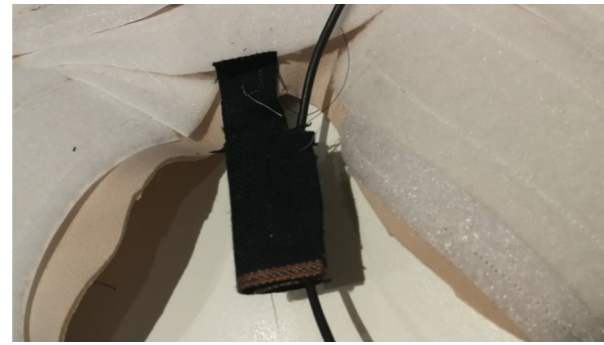

Figure 65: Cable management feature

#### 5.2.6.3 Flexibility

The Velcro fabric has a hard surface which makes the collar become rigid. However, it has to be flexible to fit with different body sizes. To maintain the flexibility, the Velcro fabric was cut to thinner strips on the top part of the collar as shown in figure 66.

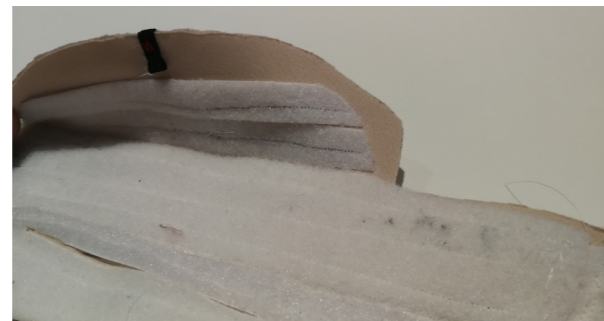

Figure 66: flexible edge

## 5.3 Prototyping the outside collar

The outside collar refers to the component shown in Figure 67. It is used to force actuators tight to users' body and provide reactive force when the actuators exert force to users' neck.

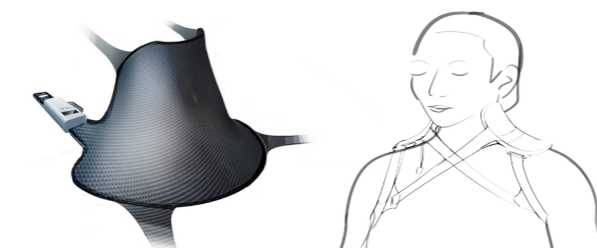

Figure 67: Expected prototype

### 5.3.1 Design requirements

- It must be fastened tightly to users' body.
- When it is fastened, the deformation should be less than 1 cm when being pulled or stretched the massage areas.
- Easy to be put on and fastened by users themselves.
- It shouldn't cause any uncomfortable feelings to users when being fastened especially at the throat.

### 5.3.2 Design approach

Since the fastening effect and the feeling of wearing it are affected by a little change. The design of this component is done by iteratively making, testing and adapting. Some milestone iterations are shown below.

#### 5.3.2.1 Iteration one

A low fidelity model of the outside collar (Figure 61) was made to test if the designed structure can fix the device tight to the users' body. The first version tried to copy the designed structure. Basically, the fabric is tight to the body, but the participant complained that it was compressing the throat (Figure 68). To fix this problem, the connection point between the upper straps and the shoulder straps was moved downward. (as shown in Figure 69). Then, the uncomfortable feeling at throat disappeared. They did not report uncomfortable feeling either. Although some places become loose for people with smaller body size, the three main areas for massage were still tight. However, some other problems were observed through testing:

- It was too warm to wear it.
- It is loosened when people move.
- It is not easy to put it on.
- It is tight to body but doesn't fit.
- It is uncomfortable on shoulders.



Figure 68: Test the first model



Figure 69: Adjust to avoid pressure on throat

#### 5.3.2.2 Iteration two

Several measures were taken to fix the problems observed in the last iteration. First, to make it fit the human body, free draping technique was used. The result is shown in Figure 65. To put on the previous model, people need to go through the shoulder straps first and then connect the upper strip to the loop underneath the shoulder straps, which is too complicated. To ease this process, a new fastening structure was proposed applied to the new model. The main idea of the new structure was to use the "Y" shaped belt to connect both the neck part and the shoulder part. In this way, after users put on the collar, the only thing they need to do is to pull the two straps to fasten it.

The new structure worked well in the front part. However, the back was distorted when pulling the straps. It is shown in figure 66. To fix the deformation problem, the two belts at the back were moved to the center (Figure 67). However, the shoulder part became too free, thus cannot provide enough reactive force. This is illustrated in Figure 68.



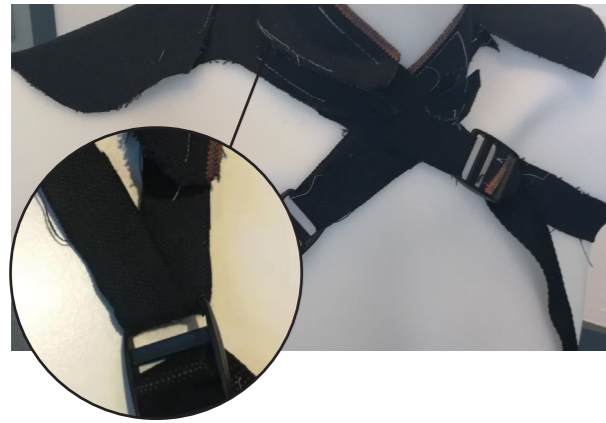

Figure 70: Iteration two



Figure 71: Distorted back



Figure 72: updated model



Figure 73: Lose edges

### 5.3.2.3 Iteration three

To have better force distribution, the location of belts were adjusted for both the front and back. At the same time, some patches were added to the collar. The result is shown in figure 70- 72. The new version worked well on the manikin. However, when it was tested on human, it was found that the neck part was too short and tended to move downward.

To stop the neck area of the collar from sliding down. A paper cardboard covered with fabric was attached to the collar. When tested again on the same person, the above-mentioned problems were solved. The test is shown in figure 73. To see whether the collar fit the majority people, it is tested on another person. (Figure 75).

The final design of the outside collar for prototyping is shown below. It can be made by cutting the fabric and sewing them up in the way shown in Figure 75. The material used in the prototype was thick denim, which is strong and not elastic.



Figure 69: iteration three front



Figure 70: iteration three back

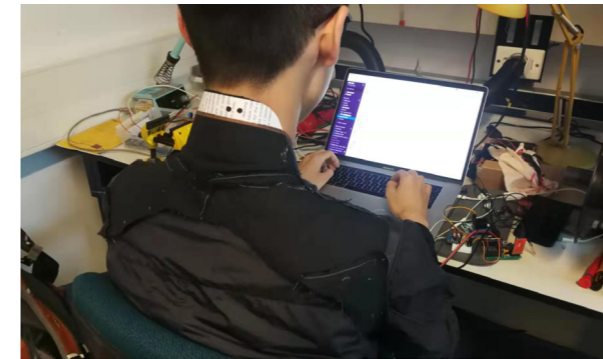

Figure 73: test the updated version

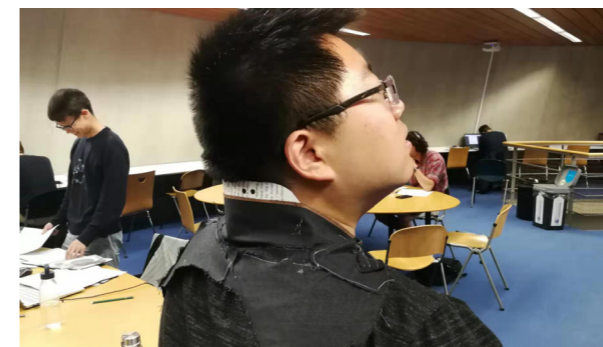

Figure 74: test the updated version

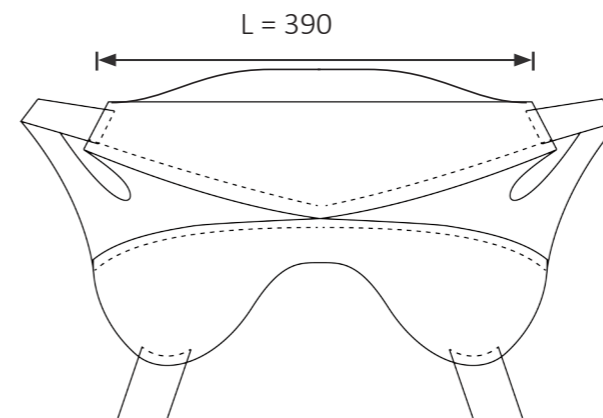



Figure 75: test the updated version

	Type: ERM
	Diameter: 8 mm
	Length: 18.5 mm
	Rated voltage: DC 3v
	Current: 220mA
	Rotational speed: 8,250 rpm
	Amplitude: 10G
Price: 6.69 £	

### 5.4.2 The plastic shell

The vibrator is fixed in a plastic shell. The shell was designed according to the size of the selected vibrator (Figure 74). It contains two components. Their dimensions are shown in Figure 75.

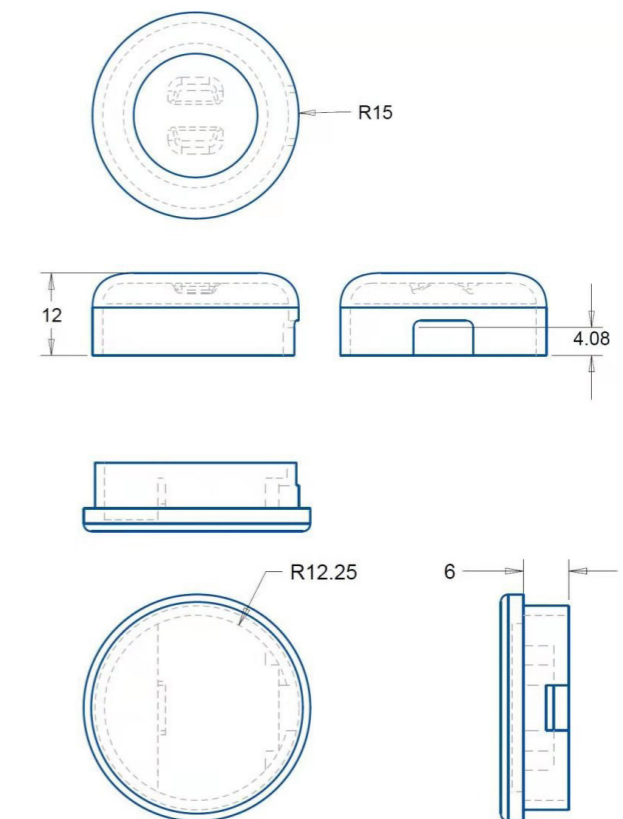

Figure 74: Drawing of the plastic shell

## 5.4 Massage actuator

### 5.4.1 The vibrator

One of the three types of vibrators mentioned in the detailing part was purchased for testing. Its parameters are as follows.

For mass production, this component is made by injection molding. The material should be TPU so that the inflatable air bag can be attached to it tightly. For prototyping, it was 3d printed with PLA (Figure 75)

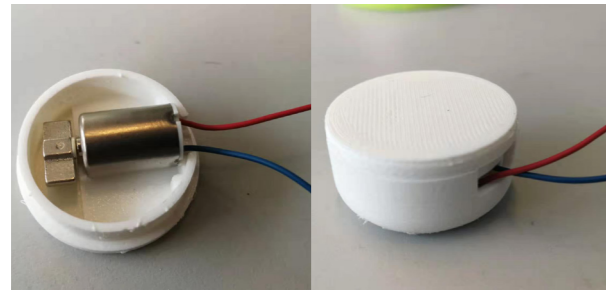

Figure 75: prototype of the plastic shell

#### 5.4.1 Inflatable airbag

The structure of the inflatable airbag is introduced in the last chapter of detailing. The process of making it with hand includes:

1. Prepare the Fabric with TPU coating.
2. Cut out the rings with wanted size. In this case they are (34mm,18mm), (26mm,6mm).
3. Connect the big rings and small rings alternately by heating iron.
4. Close the top and bottom with circles.
5. Insert the tube to the bottom and seal it with glue.

Two pictures taken during the process is shown in Figure 76.



Figure 76: making airbags

The finished airbag is attached to the 3D printed plastic shell as shown in Figure 77. The strength of the airbag was tested with a powerful air pump as shown in Figure 78. When being compressed, the airbag can take pressure up to 1.8 bar before leaking. It doesn't meet the requirement of withstanding 5 bar air pressure. However, it can be used for the testing as long as the air pressure is lower than 1.8 bar.



Figure 78: Prototype of massage actuator

#### 5.5 Pilot evaluation

Before the formal evaluation, a pilot test was performed with the three parts of prototype (inside collar, outside collar, massage element) an air pump (Figure 79). When testing the prototype, two problems were identified. First, the inside collar was too thick, so the force from the massage element was distributed. Then, the outside collar couldn't provide enough reactive force. When force is exerted, the collar moves back.



Figure 79: Prototype of massage actuator

#### 5.6 Updated design

To solve the problem that the force couldn't go through, the inside collar is eliminated. Velcro fabric is attached to the inner surface of the outside collar so that the massage actuator can be fixed to the outside collar (Figure 80). In this way, there is nothing between the massage element and the users' body.

Since outside collar couldn't provide sufficient reactive force, it is considered to have a solid frame around the outside collar. Two solutions were proposed, as shown in Figure 81 and Figure 82. The first solution is a pillow with adjustable side plates. By making use of the gravity of the head, the pillow provides the reactive force. Another solution is a frame around the neck. It is fixed to users' body at chest. The length of the frame is adjustable to fit different body size.

The model of the two solutions was built and printed with a 3D printer. They were tested to compare which one works better (Figure 83). As observed, the second solution couldn't be fixed to the users' body tightly. It moves when force is exerted. The first solution, the pillow fitted the user's body, and it feels good to lie on it. So the "pillow" solution was selected for further development.



Figure 80: updated outside collar

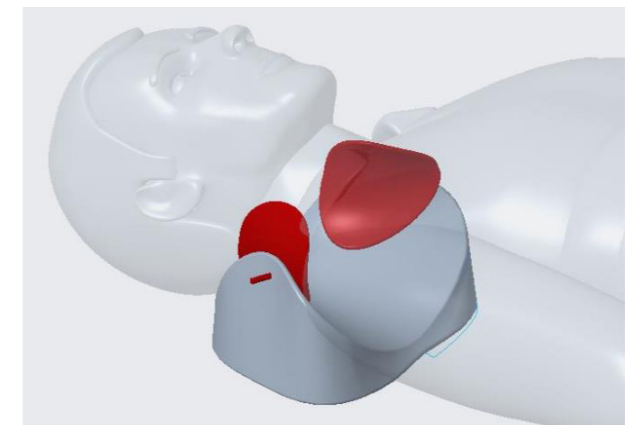

Figure 81: solution one - a pillow

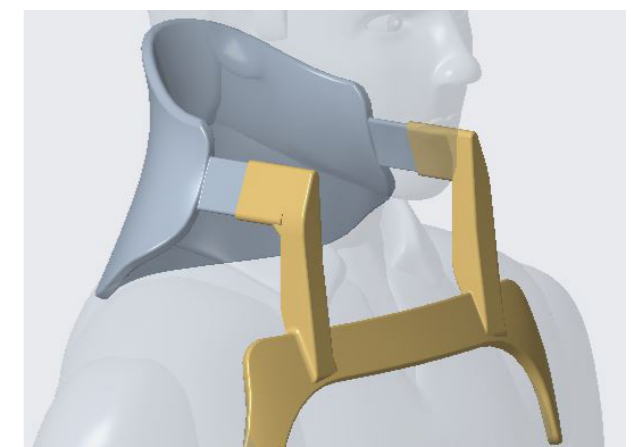

Figure 82: solution two - a solid frame

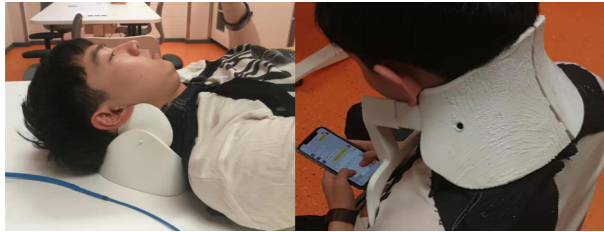

Figure 82: Prototype of massage actuator

### 5.7 Details of the pillow prototype

The prototype of the pillow is shown in Figure 83. The model of this pillow was constructed with a referential manikin. So, it approximately fit people's neck shape. There are two plastic plates at the side of the pillow. They are used to support the sides of the neck and the top of shoulders. Two metal handles were used for ease of adjustment. During the testing, the side plates are fixed by people holding the metal handles. The dimensions of the prototype are shown in Figure(85)



Figure 84: Proposed fastening mechanism

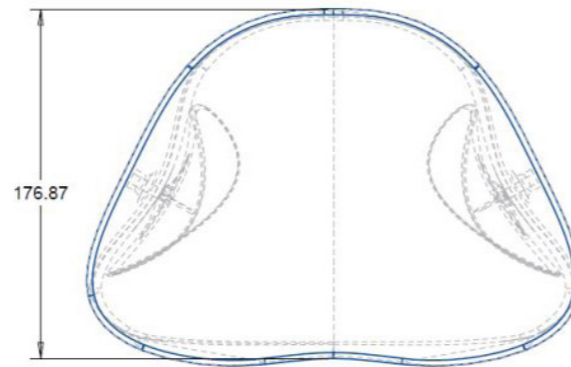
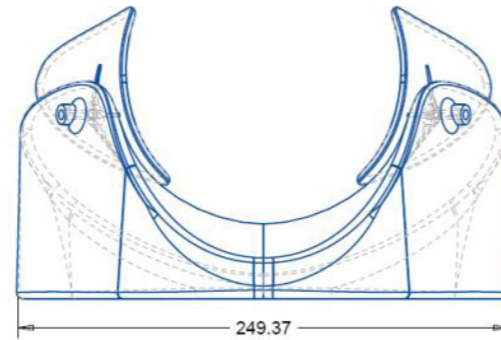

Figure 85: Drawing of the pillow

## Chapter 6 - Evaluation

Due to the limitation of time, the prototype made in this project was not fully functional. So, the performance and massage-treatment effect can't be evaluated. The objective of this evaluation was to validate the fulfillment of some design requirements and to generate insights for improving the concept. Through assessment, the following questions need to be answered:

- What is the accuracy of positioning actuators?
- What is the accuracy of the intensity of force exertion?
- Whether the intended three areas can be covered by the massage device for people with different body sizes?
- Whether the force is exerted in the right direction?
- How good can the vibrator simulate the circular movement in massage?
- Which operation is not smooth?
- Which part of the concept brings an an uncomfortable feeling?

## 6.1 Recruitment of participants

The participants were selected based on the following requirements:

- They ave NSNP (non-specific neck pain, defined in the literature study about neck pain)
- Have received professional massage treatment for neck pain before.
- They should have proper distribution in genders. .
- They should have proper distribution in body size.

Six university students were recruited in this evaluation. Three of them were females, and the other three were males. Their photos and neck size are shown in Table 10. In other paragraphs in this chapter, they are referred to as Px (x indicated the order they took the test.).

Table 10 - Participants

		
P1: X. Yang 34.5 cm	P2: G. Chen 29 cm	P3: Z. Duan 41 cm
		
P4: T. Jia 33 cm	P5: Y. Lin 36.5 cm	P6: Y. Fu 39 cm

## 6.2 Approach

To answer the research questions above, participants were asked to perform a series of tasks while the data were recorded in an evaluation form. In between the procedures, participants were asked to give comments for the operation and comfortableness. Some tasks were performed for multiple purposes. To make it clear, the procedures are introduced based on their purpose rather than the sequence in the test.

### 6.2.1 Evaluate positional accuracy

One of the most important rules in the clinical massage is to massage in the write position. Especially in the treatment of trigger points. Since in the massage treatment, the finger makes a circular movement, the positioning of massage actuators is not necessary to be perfectly accurate. However, more accurate positioning benefits treatment performance. As discussed with a therapist, an ideal accuracy is within 5mm from the point. One of the goals of this users test is to evaluate the accuracy of the current prototype and analyze how can its accuracy be improved.

The way of evaluating the positional accuracy is to add marks on the points that users wanted to get massaged and the points they got massaged by the device. The distance between these two marks was recorded as a positional deviation. Moreover, before measuring the range, participants were asked to evaluate their perceived positional accuracy. Each participant tested three points, one for each of the three target areas. The procedure of this evaluation is introduced in Table 11.

Table 11 - Process of testing positional accuracy



1. Massage on the participant and let them chose one point that they want to get massaged. Repeat for all the three areas.



2. Attach a sticker on the points selected by participants.



3. Attach a piece of metal on the stickers so that they can be found after the participant put on the collar.

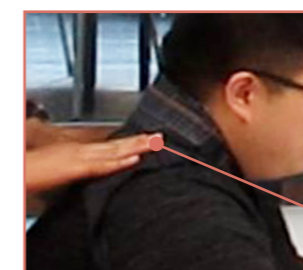

4. Let the participant put on the collar. Touch the collar to find the three points and read the coordinates. (x, y)

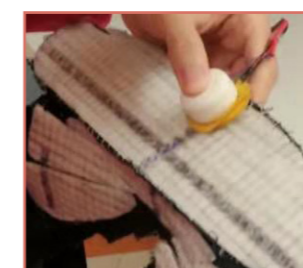

5. Let the participant attach the actuator on the collar according to the coordinate and then put on the collar.

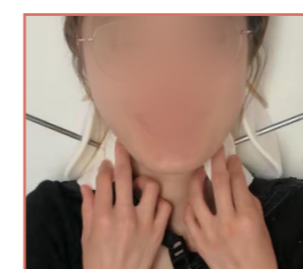

5. Use the device and let the participant evaluate whether the force is applied on the same point they indicated.



6. Put a sticker on the point massaged by the device and measure the distance between that sticker and the original stickers.

### 6.2.2 Evaluate the accuracy of force intensity

During the massage treatment, the intensity of the force exerted by therapists is not constant. Therapists know when to massage lightly and when to massage heavily. The system tries to capture the magnitude of the pressure applied by the therapist and recreate it with an air pump. To control the pressure from pump, there is a gauge pressure sensor measuring the air pressure in the massage element. For further developing the control system, it is important to know how accurate the system can recreate the force intensity. The way of evaluating the accuracy is introduced below.

After users had defined the three points to be massaged, the researcher massaged on one of the three points with his thumb. Gradually increase force level until the participant says stop. In this procedure, put a piece of two-layered fabric and a piece of piezoelectric pressure sensor between the massager's finger and the participant's neck, as shown in Figure 86. When applied with pressure, the resistance of the pressure sensor changes, and it was measured with an ohmmeter.

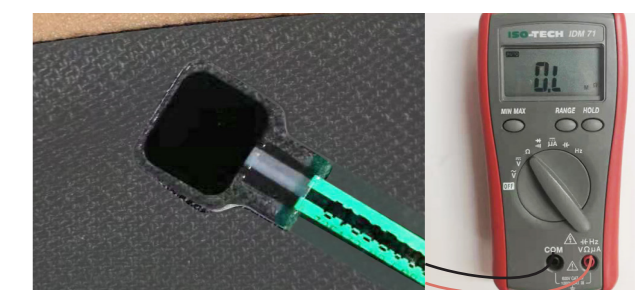

Figure 86: pressure sensor

Then, a digital force gauge was used to transform the resistance value to pressure value. Attach the

pressure sensor at a force gauge while connected to an ohmmeter. Press at the pressure sensor until the resistance reached the same value as measured before. Then, read force value on the force gauge (Figure 87).



Figure 87: transfer to pressure

According to the equation, 1 bar equals to 10N/cm<sup>2</sup>. The force is transformed into air pressure needed for the actuator. The surface area of the force gauge is 1.5 cm<sup>2</sup>. The required area pressure equals to the value on force gauge divided by 15. After the magnitude of pressure is determined, a vacuum air bottle was used to control the force level of massage. First, the bottle is inflated to the determined air pressure with an air pump, as shown in Figure 88.



Figure 88: inflate pressure bottle

Then, connect the bottle to the massage actuate. In this way, the actuator exerts the same pressure as the participant wanted. However, the pressure

received by the participant is different and it is measured by the same pressure sensor as used at the beginning. By comparing the results from the two measurements, the force-level accuracy is evaluated (Figure 89). Moreover, during the test participants were also asked to evaluate their perceived difference between the force-level of the device and that of the human fingers.

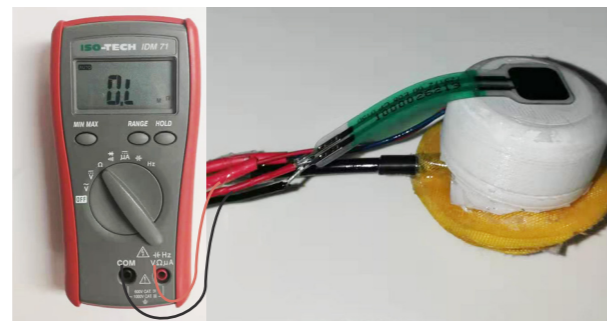

Figure 89: attach pressure sensor to actuator

### 6.2.3 Evaluate force directional accuracy

According to the principle of massage, to penetrate the force to muscles, the pressure should be against to the bone underlying the muscles. To evaluate the accuracy of the force direction of the device, participants were asked with two questions after they got massaged by the device:

1. Do you think the force direction was the same as what was done with a finger at the beginning?
2. Do you think the force was applied against the underlying bone?

The two questions are two different ways of asking the same thing. The reason for asking both of them was to double-check the answer.

### 6.2.4 Evaluate the coverage of the three areas

According to the research, there are three areas that must be able to get massaged, the back of neck (longissimus, splenius), the side of neck (scalenes) and the top of shoulder (trapezius). After participant put on the collar, the researcher checked whether these area are covered by the

collar effectively. The effective coverage means the areas on the collar that can be attached with massage actuators. Then, beside the collar, the pillow also need to provide support for the three areas. This was checked when participants lay down on the pillow. The result is marked one the diagrams shown in Figure 90.

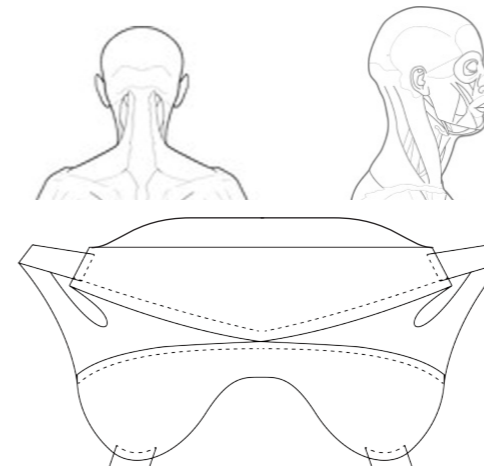

Figure 90: diagram for recording coverage

### 6.2.5 Evaluate the effect of the vibrator

As introduced in the "Prototyping" chapter, a vibrator was embedded in the massage actuator. In the test, the vibrator was powered with a controllable power supply. There are two tasks conducted in this part of evaluation, The first task was to test whether the vibrator can Simulate the circular movement in the "still compression "technique". In this task, the airbag was connected to an air pump. The pump and the power supply of vibrator were controlled simultaneously by the researcher. They were switched on and off every 4 seconds because the force exertion in massage is intermittent. After that, participants were asked with the following questions:

- Did you feel the displacement of the massage actuator when it vibrates?
- How large is it compared with the circular movement of human fingers?
- What is the main difference between what was done by the device and this real massage technique? (massage on the participant again to let him/her compare)

The second task was to evaluate the comforts of using a vibrator. Right after the last task, disconnect the power supply of the vibrator but control the air pump in the same way as mentioned above. Then, let the participant evaluate which way they like better, with a vibrator or without in a scale from 1 to 5. 1 represents definitely without vibrator while 7 means definitely with a vibrator (Figure 91).



Figure 91: Evaluation form for the vibrator

### 6.2.6 Evaluate the comfortableness and operational smoothness

To start with, the researcher helped the participant set up the collar and pillow and explain the operation. Then in the rest part of the test, users perform the tasks by themselves with the help of printed text explanation. The researcher observed the mistakes they made and wrote down on the evaluation form. After the participant finished one task, they were asked with the following questions:

- Did you feel confused or struggle in the last operation?
- Why did you do (the observed mistake)?
- Did you encounter any uncomfortable moment during the last operation?

## 6.3 Result

### 6.3.1 Positional accuracy evaluate result

In most cases, 14 out of 18 times, participants thought the device was massaging on the same point as they indicated. For the rest two cases, they think the position is slightly different for about 1 cm. However, the actual accuracy was not as high as they perceived. The measured positional deviation of each point is shown in table 12. The average deviation is 14.4mm and it ranges from 4mm to 27.5mm. As discussed with a therapist, to guarantee

the treatment effect, the deviation should be within 5mm.

Table 12 - actuator positional deviation (mm)

	P1	P2	P3	P4	P5	P6
Back	6	9.5	4	18	7.5	13.5
Side	17	14	8.5	18.5	12	23.5
Top	27.5	2.5	21	13	21	22.5

The data is plotted in a line chart (Figure 92). It shows that it is more accurate when the point is in the back area of the neck. As observed in the user test, when people move their neck and when they lay down to the pillow, there is relative displacement between the collar and their body. However, this has less influence on the back area.

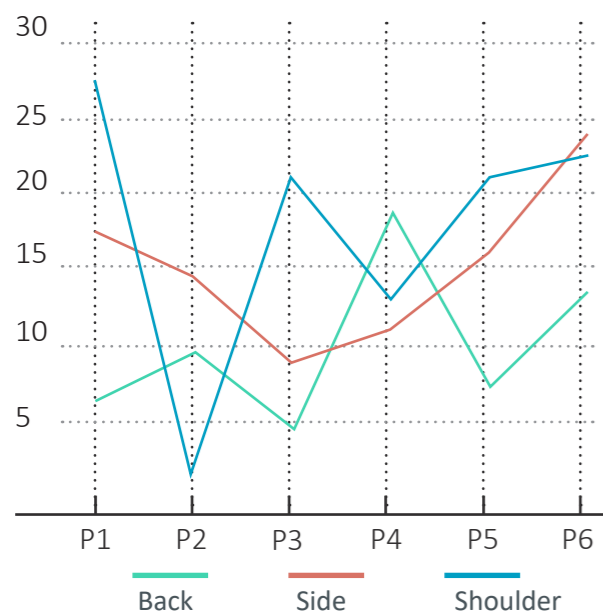

Figure 92: Line chart of the positional accuracy

There are many factors observed in the test that are affecting the positional accuracy:

- The surface area of the massage element was too large to be accurately located.
- There is relative movement between the collar and the user when the users moves.
- The massage element was too thick, so the collar distorts when attached with a massage element.
- People's hair and cloth affect the position of the collar.

- The shape and position of users muscle changes a little bit when people lie down.

### 6.3.2 Force-intensity accuracy evaluate result

The result shows that the pressure transmitted to a muscle is smaller than the applied air pressure. Unlike the positional deviation, The pressure difference was more noticeable for the participants. They were asked to evaluate the difference between the pressure from the device and that from the manual massage at the beginning. The result of their evaluation is shown in a bar chart (Figure 93). In 16 times out of 18, they think the pressure was above 80% of the original pressure.

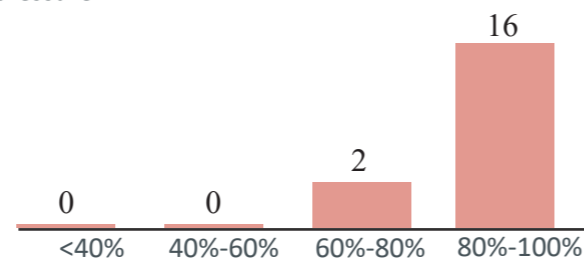

Figure 93 - perceived force level accuracy

The measurement result was different from what was perceived by the participants. The recorded data during the process is shown in Table 13. The meaning of the titles are as follows:

- S1** - Resistance of the pressure sensor when measuring the manual massage force.
- Force1** - Force of the manual massage (Transmitted from the pressure sensor)
- Pressure** - air pressure applied to massage actuator.
- S2** - Resistance of the pressure sensor when measuring the device force.
- Force 2** - Force on muscles applied by the device (Transmitted from the pressure sensor)
- Percentage** - ratio of the force from massage device and the force from real human.

Table 13 - actuator positional deviation (mm)

	P1a	P1b	P1c	P2a	P2b	P2c
S1(kΩ)	8.5	13.1	6.9	14.6	19.8	15.6
Force1(N)	23.0	20.8	26.1	17.2	12.5	13.5
P (bar)	1.53	1.38	1.84	1.14	0.83	0.75
S2(kΩ)	14.1	15.8	8.8	20.2	15.1	15.6
Force 2	18.1	14.0	21.3	12.5	10.0	10.5
Percentage	78%	67%	81%	72%	80%	74%
	P1a	P1b	P1c	P2a	P2b	P2c
S1(kΩ)	32.8	34.1	42.3	11.7	12.7	10.3
Force1(N)	0.36	0.36	0.56	1.64	1.42	1.8
P (bar)	5.5	5.5	8.5	24.7	21.3	27
S2(kΩ)	39.6	54.4	36.4	15.2	14.1	13.3
Force 2	5.2	4.5	7.9	18.6	17.6	21
Percentage	94%	81%	92%	74%	82%	77%
	P1a	P1b	P1c	P2a	P2b	P2c
S1(kΩ)	12.6	17.2	13.1	9.8	8.4	9.1
Force1(N)	1.18	14	19.4	29	32	30
P (bar)	1.18	0.93	1.29	1.93	2.1	2
S2(kΩ)	18.4	20.5	13.3	11.7	12.7	12.0
Force 2	12.5	11	15.5	20.4	25.6	24.5
Percentage	70%	78%	79%	70%	80%	81%

Next to the table, there is a bar chart (Figure 94) showing the measured force intensity on all the three points of each participant. The green bars represent the force intensity of the manual massage done the researcher while the red bars represent that value of the massage done by the device.

As observed from the data, for all the tested points, the force applied by the device was lower than the intended force level. In another word, the actual pressure received by the person is less than the applied air pressure. The accuracy of force intensity is expressed as the ratio between the measured force and the intended force. This may be because the surface area of the massage element is larger than that of human fingers. The average force-intensity accuracy of the device was 78%. However, the accuracy was not consistent for all the tested points. It ranged from 67% to 94%. One explanation for the inconsistency is the error in reading the measurement device. Since the value shown on the device is dynamic, the researcher had

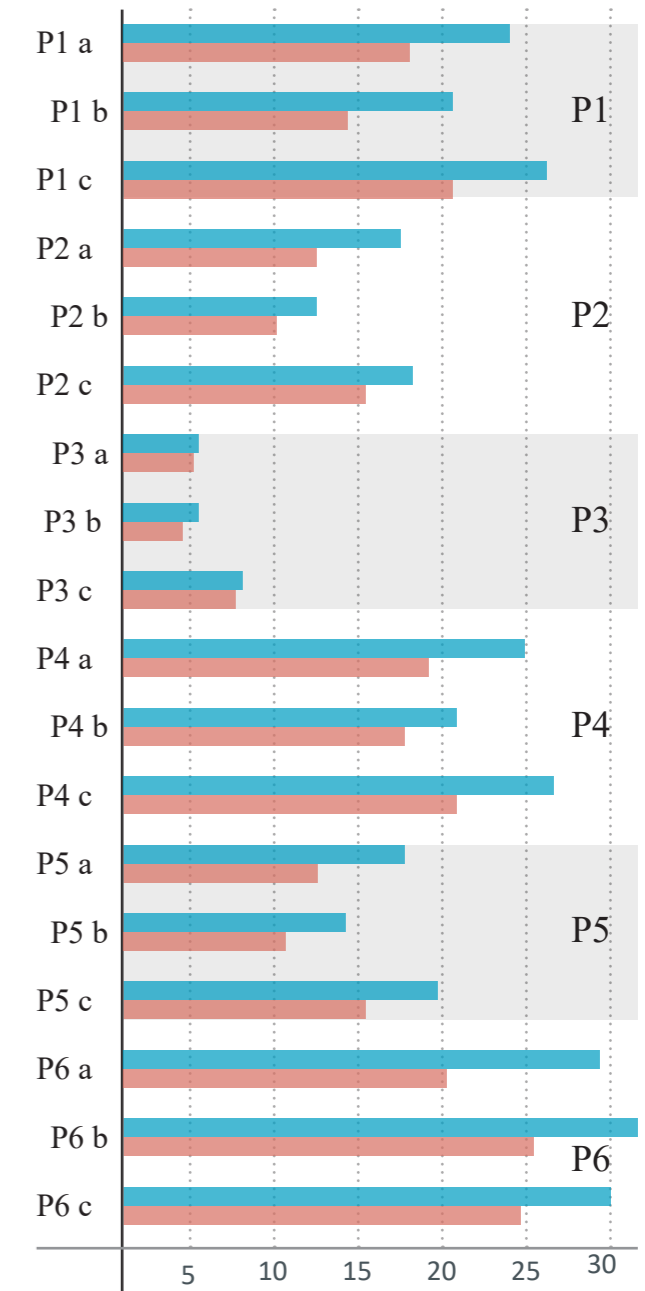

Figure 94: Measured accuracy

to choose a neutral value subjectively. This brings in the randomness to the result of the evaluation. However, associated with this problem, in the development of the control system, the system should think of a way to deal with dynamic values.

There are two phenomena that can also be seen from this set of data. They are less relevant to accuracy but may be helpful for the design. According to the research, the maximum pressure in the massage will probably reach 25N/cm2. In the

test, the amount of pressure applied is determined according to the pain threshold of the participant. The participant with the highest pain threshold received the pressure of 20N/cm<sup>2</sup>, which was close to the data obtained from the research. Another phenomenon observed in this group of data is that the pain threshold in different areas is similar to the same person.

### 6.3.3 Directional accuracy

The assessment of directional accuracy is based on the subject's response to the two questions mentioned above. The two questions are:  
 1. Do you think the force direction was the same as what was done with a finger at the beginning?  
 2. Do you think the force was applied against the underlying bone?

If both answers are positive, then the direction of the force is judged as accurate. If either one of the two answers is negative or both of them are negative, it is judged that the direction of the force at that point is inaccurate. Among the 18 times of evaluation, 14 were identified as accurate. Figure 95 demonstrates the approximate position of the evaluated points and the directional accuracy at those points, red dots meaning inaccuracies and green dots meaning accurate. 75% of the "inaccurate" results occurred at the "shoulder" area while all the results of the back area were identified as accurate in direction.

Figure xx shows the force analysis of a neck and shoulder area separately. At the neck area, the active forces are from gravity and the massage element (shown as the red circle). The reactive forces are provided by the support of the pillow. Since the neck can be seen as a cylinder and the pillow surface is tangent to the neck, the force applied at the neck exerted to the neck is towards the bone inside. As for the shoulder area, the gravity does affect the force exertion here. The only active force is from the massage element. Then, the force direction depends on how well the device

fits the shape of the user's body. If they do not fit perfectly, there will be a gap between the device and the user's body. The airbag expands to fill the gap, but the direction will be possibly deviate from the bone.

To improve the directional accuracy at the shoulder area. The shape of the plate covering this area need to be tuned to fit most users. Alternatively, the plate can be made of shape adaptive material so that it can fit different users.

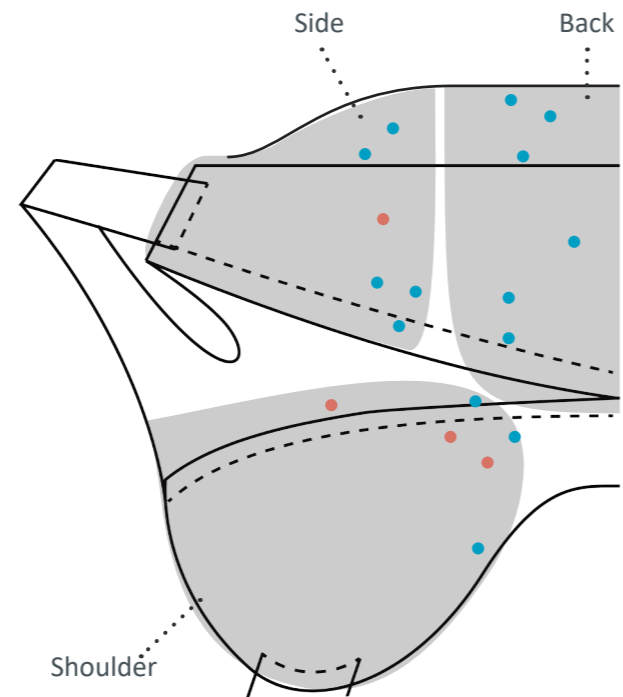

Figure 95: directional accuracy

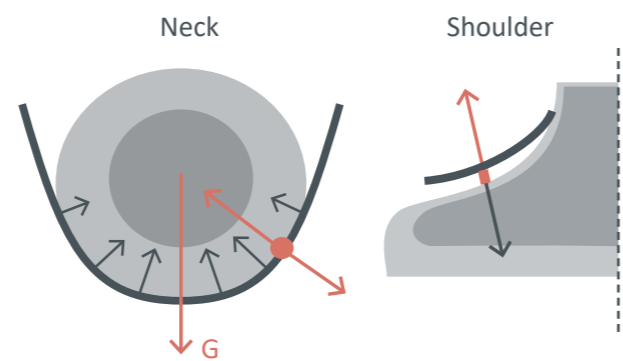

Figure 95: directional accuracy

### 6.3.4 Coverage of the intended areas

Among all the participants, only the participant number 2, who has the thinnest neck, didn't get well covered by the collar at the area indicated in Figure 96. For the rest five participants, all the intended areas were covered effectively by the collar.



Figure 96: uncovered area

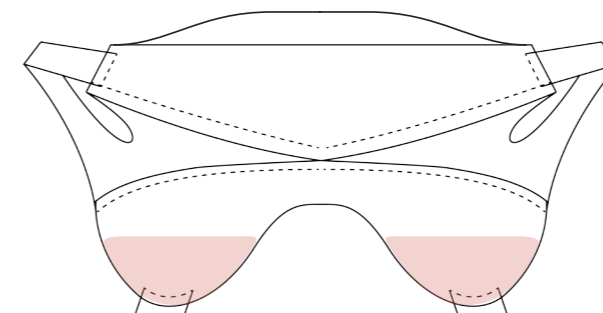

Figure 97: uncovered area-pillow

### 6.3.5 The effect of the vibrator

Regarding the displacement of the massager caused by the vibration, the participants reported that there was no displacement or minor displacement was perceived. One of the significant features of the still compression was the circular movement of fingers. If the use of a vibrator couldn't create enough displacement, it can be concluded that the use of a vibrator doesn't help to mimic the circular movement in the "still compression" technique.

Another task was to determine whether the use of

vibrator has the effect of improving the comfort level of the product. After being massaged in both ways, the subjects were asked to answer which one they prefer. Moreover, they also needed to answer whether the one they chose was definitely better or slightly better. Each answer corresponds to a score. The test result is shown in Figure 98. The average score was -0.5. One of the comments about the vibration stated that "When a vibrator was used, it felt like a pile driver" (P2). If the rotator of the vibrator rotates in low frequency, users could not feel it. While when it rotates in high frequency, it becomes different from massage movement because the circular movement in massage is much slower.

As a conclusion, the use of a vibrator cannot simulate the circular movement of the "still compression," and it had a limited effect on the comfort level of the product. So, the vibrator should be eliminated from the concept, and a new solution is needed to mimic the circular movement.

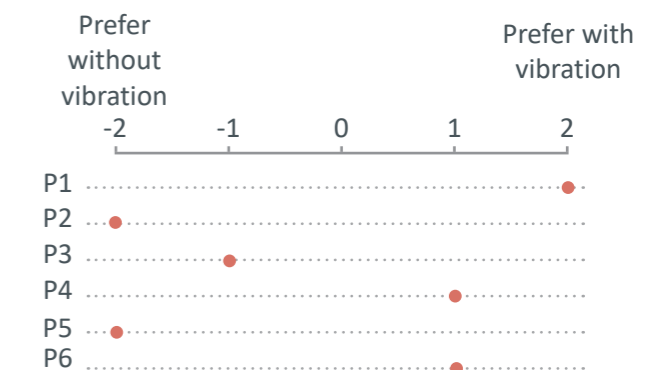

Figure 98: Preference for vibrator

### 6.3.6 Comments about comfortableness and operational smoothness

The result of this part of the evaluation is shown in the forms of a list of quotes from the participants. It happens that many subjects had similar quotes, in that case, only one of them is shown here. These quotes are grouped according to their topics. Then, they are summarized into insight

### 6.3.6.1 About the massage actuator

*"The contact between you finger and my neck was soft, but the massage unit was hard."*

*"The plastic part of the massage element was too thick and it would be very painful when placed at back."*

*"When I put the massage element on the collar, I were not sure that I place it on the correct place. If there is a feedback telling me that I was doing correctly, I would feel safer."*

*"The tubes and cables were too long, and when you lie down, you are afraid to break it or change the position of the massage element."*

*"The surface area of the massage element was large, and it was difficult for me to see whether its center located on the right point."*

Concluded from the quotes above, the complains about the actuator includes:

- It's surface is too hard.
- It is too thick.
- Users don't feel secure about the positioning of the massage element.
- The long cables and tubes are annoying.

### 6.3.6.2 About the collar

*"The text description was hard to understand, a diagram illustration would be helpful."*

*"The way to wear this collar was not usual, so it was not very intuitive."*

*"After the collar is fastened to my body, it fitted me well when I stay still. But once I move my body, such as bowing, I would feel the gap between the collar and my body."*

*"The back of the collar was somehow straight while there is curvature at the back of people's neck. It*

*will fit my body better if the collar is also curved."*

*"The straps on the collar looks very vulnerable."*

*"The number of coordinates was too dense. So it takes time to find the point"*

*"I tend to ignore the step of checking the center line of the collar. It will be more convenient if it aligns automatically."*

Concluded from the quotes above, the complains about the collar includes:

- The way of putting on the collar is not intuitive.
- The collar doesn't stay tight to users' body when users move their neck.
- The back of the collar doesn't follow the curve of users neck.
- The straps looks vulnerable.
- The coordinates are printed too dense.
- Users tend to forget to check the center line of the collar.

### 6.3.6.3 About the pillow

*"The process of manually adjusting the side plates is too cumbersome. I hope it can be automated."*

*When lying down, it is hard to put my neck exactly at the center of the pillow. Especially that the side plates are relatively thin. I was afraid of crushing them.*

*"The bottom of the pillow was not stable enough. The pillow tend to move when you lie down."*

*"The surface of the pillow was a bit hard. I think it would be more comfortable if covered with a layer of sponge or leather, especially on the side plates."*

*"The metal handle used to adjust the plates made the device look like a torture device."*

Concluded from the quotes above, the complains about the pillow includes:

- They hope the process of adjusting the side plates can be done automatically.
- The are scared of the sharp and hard edges of the pillow when they are lying down.
- The bottom of the pillow is slippery.
- The surface of the pillow is too hard.
- The metal handle of the pillow looks scary.

### 6.4.6.4 Evaluate the comments

Among the insights obtained from the users' quotes, some of them are not considered to be integrated into the concept because some of them were caused by the low fidelity of the prototype and some were too futuristic to be implemented.

These comments includes:

- The text description was hard to understand.
- They hope process of manually adjusting the side plates can be automated.
- The metal handle of the pillow looks scary.
- The bottom of the pillow is slippery.
- The straps looks vulnerable.

## 6.4 Conclusion

Through the user test, the positional accuracy, force-intensity accuracy, and directional accuracy of the prototype were evaluated. The positional accuracy is expressed as the distance between the massaged point and the intended points. The measured average positional accuracy was 14.4mm while the aimed accuracy was 5mm. The reasons for the inaccuracy include: There is relative movement between the collar and the user when the users move. The massage element was too thick, so the collar distorts when attached with a massage element. People's hair and cloth affect the position of the collar.

The force-intensity accuracy is expressed as the ratio between the measured pressure on the neck and the air pressure applied to the massage element. The result showed that the actual

pressure applied to the neck is lower than the intended pressure. This may because the surface of the massage element was too large. Moreover, reading of the measuring device was not very accurate because the value was dynamic. It can be speculated that the processing of data would also be an issue because the measured value is dynamic.

The directional accuracy of the massage device was acceptable at the back and side area. However, about half of the test on the top area of the shoulder were not accurate in massage direction. One possible reason can be related to the surface profile of the pillow in that area.

The collar fits the participants well except for P2, who has the thinnest neck. The collar was fastened in front of the users' body in a cross way. For participants with think neck, the collar is pulled downward. For this reason, the side areas could not be covered well.

For all the participants, they did not get sufficient support at the bottom corner area of the collar, as shown in Figure XX. During the test, none of the participants suggested massage in that area. So it did not affect the evaluation process. However, For normal use, that area should also be supported by the pillow. So, the pillow should be extended to that area.

The evaluation of integrating a vibration motor indicates that the use of a vibration motor does not have the effect of mimicking the movement of fingers. Moreover, it does not help to improve the comfort level of the massage device either. So, it is suggested that the vibrator can be eliminated from the concept. Another way of creating a circular movement is needed.

During the evaluation, many insightful comments were received for improving the concept. The solutions are proposed in the next chapter.



# Chapter 7 - Conclusion

This chapter summarizes the main results of the project and discusses the shortcomings of the outcome. After that, the recommendations section suggests what to do next to develop this product according to the evaluation result. At the end, in the reflection section, the student reflects on the goal of this project and what he learnt from this project.

## 7.1 Summary of the project

The project started with an idea of designing a household device to treat neck pain by applying principles of the clinical massage and Cyber-Physical Systems. The target users are office worker, students, and people with similar working environments and suffer from neck pain.

To understand the context, the research was done in five domains, which are neck pain, massage, CPSs, users, and current product. Through reading literature and interviewing therapists. It was learned that the neck pain that target users suffer from is non-specific neck pain that is not caused by serious underlying problems such as cancers. The most common pathological mechanism is stiff muscle. There are three areas on the neck that are most frequently complained about pain and they are defined as the target region to be treated with massage. Clinical massage treats neck pain by applying ischemic compression and passive movements on shortened muscles. For treating neck pain, there are three most commonly used techniques in clinical massage which are called “still compression”, “gliding compression” and “holding”. Doctors decide where to apply which technology according to their assessment. The assessment is done by asking questions, letting patient perform specific tasks, and doing palpation. Palpation means touching the skin with hand and feel the abnormality of muscles. Typical Cyber-Physical Systems contain a sensing part to collect data, a reasoning part to analyzed data and make decisions, a controlling part to control the actuators and an actuating part of performing the task. The structure of Cyber-Physical Systems is coincident with the process of clinical massage.

The realization of the massage function requires more specific technologies. The most challenging issue was how to use sensors to replace the palpation done by therapists. One of the most important information to be obtained is muscle stiffness. There are two types of sensors that can

sense the muscle stiffness. However, they are not suitable for the house-held neck pain treatment device because they are too obstructive. Another aim of palpation is to search for trigger points but no suitable technology could be found to do this task. To overcome this challenge, instead of diagnosing with the device, it was decided to detect what the therapist does on the patient and then recreate their action with the device. This can be done with a soft pressure sensor matrix. By studying a case of using this technology, it was proved that it is promising to achieve this goal.

To understand users’ current situation and their opinion towards clinical massage and their demands for the neck pain treatment, two focus group sessions were held. Before the session, the participants filled in a booklet to be sensitized to the topic. During the sessions, participants discussed what they filled in and explained why they think so. Many insights were concluded from the booklet and the participants’ quotes. Among these insights, two of them had a significant influence on design. First, it was learned that neck pain is highly related to people’s work. All the participants reported that their neck pain occurs when they are working. During the holiday, their neck pain disappears itself. So, it is highly recommended that the device should be suitable for a working environment. Preferably, the device can be sharable among colleagues so that it becomes more affordable. Then, when asked to rate their most desirable features of a massage device, two of the most highly rated features are professional and enjoyable. So “professional” and “enjoyable” were determined as the keywords to be reflected on both functions and aesthetics of the product.

After analyzing the results of the research, a list of requirements and a list of wished were generated. Then, according to the requirements, a functional model was created to conclude all the functions to be achieved by the device. In-general, With the pressure sensor matrix, the device records where

the force was exerted, how hard the pressure was, how long it lasted. With this information, the device can figure out what technique the therapist used, “still compression” or “gliding compression”. Then, the device will be controlled to recreate these two massage techniques in a proper way. Due to the time limitation of this project, the conceptualization phase will focus on developing the actuating system. Ideation was done in the form of a Morphological chart with three topics which are:

How to exert active force on the neck?

How to provide reactive force?

How to locate massage element at the right position.

Three concepts were generated by combining the ideas in the Morphological chart. After evaluating the desirability and feasibility of the three concepts, the final concept was determined. In the concept, the massage techniques will be simulated with a combination of four pneumatic actuators. There are two collars with the same shape and size. One of them is embedded with pressure sensor matrix. Users get massaged by therapists while wearing this collar. Then, the recorded positional information is translated to coordinates. Users locate the actuators on a collar according to the coordinate information to make sure they get massaged at the right place. The reactive force is from the gravity of users’ neck. Users lie on a pillow while using the massage device. The pillow was designed according to the profile of the human body. On the pillow, there are two adjustable plates. Users can adjust the plates to fit their body.

About the massage principle, when one of massage elements are placed on a trigger point, it is controlled to simulate “still compression”. When the massage elements are arranged in a row, they are inflated sequentially to simulate “gliding compression”. The massage actuator consists of an inflatable airbag and a vibrator. The airbag is made by bonding TPU coated fabrics. To inflate multiple airbags a serial magnetic valve is used. The vibrator

was selected according to the size and magnitude. A prototype, including the massage element, the pillow, and the collar was made to test the accuracy of the recreated massage treatment. In general, the accuracy need to be improved, and the vibrator does not have much added-value. At the same time, there are many insights collected during the evaluation about how to improve the accuracy and usability of concept.

## 7.2 Discussion

The concept generated in this project was to record therapists’ movements and then recreated them with a device. This concept fits the objective of this project: “To develop a massage device that helps people treat their neck pain on their own conveniently and effectively by incorporating principles of Clinical massage and Cyber-Physical Systems.” However, this concept is too complicated for a graduation project. So, during the detailing and prototyping phase, the scope was narrowed down to focusing on the actuating system. At the end of conceptualization chapter it is discussed whether the final concept fulfills all the requirements. It fulfills most of the functional requirements except for the “adjustable force direction”. However, this discussion was based on the assumption of the ideal situation. To validate the real performance a testable prototype was made. The evaluation showed a promising result but in general, the accuracy still needs improvement. Due to the low fidelity of the prototype, the performance were not evaluated.

## 7.3 Recommendations

### 7.3.1 Recommendations for next iteration

To continue the project, the first thing is to implement the evaluation of the insights into the concept. This includes:

- Eliminate the vibrator from the massage element.
- Add a layer of fabric on the massage element at where it contacts with users' body.
- Reduce the size of the massage element.
- Create a pattern at the intersection of the coordinates to make users feel secure that they put the element at the right place.
- Create curvature at the back area of the collar.
- Don't print all the numbers of the coordinate but every three numbers.
- Hide the side plates of the pillow inside the pillow and make the edges of the pillow thicker and softer. In this way users won't crush the thin side plates.
- Attach two pieces of rubber at the bottom to avoid slippery.
- Add a layer of fabric on the surface of the pillow.
- Fix the tubes and wire at one end of the side area of the collar so that users won't crush the tubes when they lie down.
- Make the straps elastic. Then collar may stay close to users when they move their necks.
- Connect the straps with elastic fabric and leave two holes for arms to go through. In this way the collar looks more like a small shirt and it will be more intuitive to put it on.

In reaction to these new insights, an updated structure of the product is proposed in the form of a CAD model and renderings (Figure xx). Basically, in the updated concept, the collar is fixed to the pillow at the centerline. Users lie on the pillow first and then tighten the collar. In this way, the process of using the product becomes more intuitive. Then, the device can be mounted on a chair to fit the working environment. Organizations such as school and companies can buy the chair and put it in the rest area. Then the employees or students can

share it. The pump and control units are hidden at the back of the chair. If people want to buy one for personal use, they can only buy the massage device and use it on a bed.

Besides, one of the most important things is to find ways to improve the accuracy of the device. This requires first analyzing which factors affect accuracy. Then, adjust the details and evaluate the accuracy continually until it becomes accurate enough.

### 7.3.2 Future development

After the accuracy of the product is secured, the control system can be developed so that the massage element can be controlled by the intelligent system. Thereafter, the idea that multiple massage elements are pressed in a row to simulate “gliding compression” can be verified. At the same time, the collar embedded with a flexible pressure sensor matrix needs to be developed. There are two challenges in developing the collar. The first one is to guarantee data accuracy. Another one is to reduce the influence of the device to therapists’ performance.

After the learning function and the simulation of the two massage techniques are developed well enough, the device will be evaluated on its treatment effect.



Figure 99: Rendering in context



Figure 100: Rendering of back

## 7.4 Reflection

### 7.4.1 Reflect on the design process

Lead by an experienced and responsible supervisory team, the project was conducted in a very structured way. However, if I had the chance to do the project again, there are several things that I would do differently.

First, in the analysis phase, I tended to collect all the insights from each domain of interest and then analyze all of them together by clustering. I learnt this way of analysis from the course “Vision in Product Design”. Later on, I realized that this method is not suitable the phase of this graduation project. Clustering all the insights gives an overview of all the background information and shows a direction to go. It should have been done in earlier phase. As for the analysis phase in this project, a detailed list of requirements is needed for developing a product. It would be better if the research is done with a “story line”, so that there can be a focus in the research to give more detailed information.

Then, I think I paid too much effort in users study while limited effort in the research about technology. The users study did give valuable insights but technology plays a more important role in this project. In the next project, I should be able to be aware which domain of interest weights more. Anyway, I’m content with the user study I did in this project. I applied what I learnt from the elective “Contextmapping”. I find the sensitized booklet the group session help a lot to dig users insights.

Thirdly, in the conceptualization and detailing part, I developed the concept largely based on my assumption. For example, I thought by tightly fastening the collar to the body, it can provide enough reactive force. However, after I built a prototype, the collar couldn’t provide sufficient reactive force. Most of the force generated by the massage element is distributed due to the

belt effect, although I came up a solution to solve this problem, it would be better if I had realized this problem earlier. It is possible that if I knew this earlier I may not select this concept in the conceptualization phase. So, I should have done some calculation and build simple models to test in earlier stage.

I was too ambitious at the beginning of this project. I wanted to build a fully working prototype of the concept. However, I realized that to develop a complex product system like this requires expertise from many areas. As a product design engineer I should play a role of bridge in the team rather than doing everything myself.

### 7.4.1 Reflect on the learning objectives

My learning objective for the graduation project was also the learning objective for my master study. I hoped I could be able to handle the whole product development process. It is different from the AED (advanced embodiment design) project. Because in AED, we are given a concept which is already defined by the company. But my objective was to figure out a feasible and desirable concept myself and develop it to embodiment level. It is challenging but I think I’m close to my objective now. Before this project I had no idea how to develop such a complex system from nothing. Although the prototype is not developed as complete as I expected, I learned a lot during the process. One of the most important things I learnt from the project is the importance of the list of requirements. I was told to generate a list of requirements in previous projects as well but only from this project I learnt why it needs to be detailed. It reflects the result from analysis and gives a guideline for all the following steps such as ideation and detailing.

Another objective for this project was to apply what I learnt in the last one and half year of master study. I tried to use some methods and design tools such as creative session, Contextmapping, Vision

in Product design, Harris Profile and . They partly worked in this project and partly were misused as discussed in the reflection of design process. It was time consuming to try these techniques. But for learning purpose, I think it worths the time.

Then, I also aimed to earn new skill such as programming and data analysis. Due to the time limitation, I couldn't finish this part of work. However, I learned some expected knowledge such as 3D cutting of fabrics, controlling of air pumps and force analysis. Since I had many experiences of designing the aesthetic and structure of a physical product, I didn't pay much attention to these aspects.

## Chapter 8 - Reference

Alexandra Ilkevitch, MD • Taryn Lawler, DO • J. Adam Rindfleisch, MPhil, MD, "Neck Pain" CHAPTER 68, <https://kundoc.com/pdf-neck-pain-2d191472c15f2ca5009a077cc83973935265.html>

Andrea D.Furlan, Trish, Dryden, Emma L.Irvin, (2012), *Massage Therapy, Journal "Evidence-Based Management of Low Back Pain"* CHAPTER 16, Pages 216-228, Available online 2 March 2011. <https://www.sciencedirect.com/science/article/pii/B9780323072939000167>

Jeff Christenson, (2014), *Sensors and Transducers. Research and Development, Motion Control*, Salt Lake City, UT, United States.

Büscher, G. H., Köiva, R., Schürmann, C., Haschke, R., & Ritter, H. J. (2015). Flexible and stretchable fabric-based tactile sensor. *Robotics and Autonomous Systems*, 63, 244-252.

Cheng, J., Sundholm, M., Zhou, B., Hirsch, M., & Lukowicz, P. (2016). Smart-surface: Large scale textile pressure sensors arrays for activity recognition. *Pervasive and Mobile Computing*, 30, 97-112.

Cen, S. Y., Loy, S. F., Sletten, E. G., & McLaine, A. (2003). The effect of traditional Chinese Therapeutic Massage on individuals with neck pain. *Clinical Acupuncture and Oriental Medicine*, 4(2-3), 88-93.

Carragee, E. J., Hurwitz, E. L., & Pierre Côté, D. C. (2008). Course and prognostic factors for neck pain in the general population. *Spine*, 33(4S), S75-S82.

Clay, J. H. (2008). *Basic clinical massage therapy: integrating anatomy and treatment*. Lippincott Williams & Wilkins.

Chen, X., O'Leary, S., & Johnston, V. (2018). Modifiable individual and work-related factors associated with neck pain in 740 office workers: a cross-sectional study. *Brazilian journal of physical therapy*, 22(4), 318-327.

Dewitte, V., De Pauw, R., Danneels, L., Bouche, K., Roets, A., & Cagnie, B. (2018). The interrater reliability of a pain mechanisms-based classification for patients with nonspecific neck pain. *Brazilian journal of physical therapy*.

Fejer, R., Kyvik, K. O., & Hartvigsen, J. (2006). The prevalence of neck pain in the world population: a systematic critical review of the literature. *European spine journal*, 15(6), 834-848.

Gorissen, B., Reynaerts, D., Konishi, S., Yoshida, K., Kim, J. W., & De Volder, M. (2017). Elastic inflatable actuators for soft robotic applications. *Advanced Materials*, 29(43), 1604977.

Ghaderi, F., Javanshir, K., Jafarabadi, M. A., Moghadam, A. N., & Arab, A. M. (2019). CHRONIC NECK PAIN AND MUSCLE ACTIVATION CHARACTERISTIC OF SHOULDER COMPLEX. *Journal of Bodywork and Movement Therapies*.

Genebra, C. V. D. S., Maciel, N. M., Bento, T. P. F., Simeão, S. F. A. P., & De Vitta, A. (2017). Prevalence and factors associated with neck pain: a population-based study. *Brazilian journal of physical therapy*, 21(4), 274-280.

Ingeborg, B., Korthals-de Bos, C., Hoving, J. L., Van Tulder, M. W., Rutten-van, M., Maureen, P. M. H., ... & Vondeling, H. L. M. B. (2003). Cost effectiveness of physiotherapy, manual therapy, and general practitioner care for neck pain: economic evaluation alongside a randomised controlled trial. *British Medical Journal*, 326, 1-6.

Han, H., & Kim, J. (2013). Active muscle stiffness sensor based on piezoelectric resonance for muscle contraction estimation. *Sensors and Actuators A: Physical*, 194, 212-219.

Kennedy, A. B., Cambron, J. A., Sharpe, P. A., Travillian, R. S., & Saunders, R. P. (2016). Process for

massage therapy practice and essential assessment. *Journal of bodywork and movement therapies*, 20(3), 484-496.

Margareta Nordin, P. T., Carragee, E. J., Peloso, P. M., Jaime Guzman, M. D., & Scott Haldeman, D. C. (2008). Assessment of Neck Pain and Its Associated Disorders. *European Spine Journal*, 17, 101.

Paksaichol, A., Janwantanakul, P., & Lawsirirat, C. (2014). Development of a neck pain risk score for predicting nonspecific neck pain with disability in office workers: a 1-year prospective cohort study. *Journal of manipulative and physiological therapeutics*, 37(7), 468-475.

Rutkove, S. B. (2009). Electrical impedance myography: background, current state, and future directions. *Muscle & Nerve: Official Journal of the American Association of Electrodiagnostic Medicine*, 40(6), 936-946.

Son, C., Kim, S., Kim, S. J., Choi, J., & Kim, D. (2018). Detection of muscle activation through multi-electrode sensing using electrical stimulation. *Sensors and Actuators A: Physical*, 275, 19-28.

Sundholm, M., Cheng, J., Zhou, B., Sethi, A., & Lukowicz, P. (2014, September). Smart-mat: Recognizing and counting gym exercises with low-cost resistive pressure sensing matrix. In *Proceedings of the 2014 ACM international joint conference on pervasive and ubiquitous computing* (pp. 373-382). ACM.

Taş, S., Korkusuz, F., & Erden, Z. (2018). Neck Muscle Stiffness in Participants With and Without Chronic Neck Pain: A Shear-Wave Elastography Study. *Journal of manipulative and physiological therapeutics*, 41(7), 580-588.

Wong, J. J., Shearer, H. M., Mior, S., Jacobs, C., Côté, P., Randhawa, K., ... & van der Velde, G. (2016). Are manual therapies, passive physical modalities, or acupuncture effective for the management of

patients with whiplash-associated disorders or neck pain and associated disorders? An update of the Bone and Joint Decade Task Force on Neck Pain and Its Associated Disorders by the OPTIMA collaboration. *The Spine Journal*, 16(12), 1598-1630.

Yang, H. D., & Asbeck, A. T. (2018, October). A New Manufacturing Process for Soft Robots and Soft/Rigid Hybrid Robots. In *2018 IEEE/RSJ International Conference on Intelligent Robots and Systems (IROS)* (pp. 8039-8046). IEEE.

Zhou, J., Gu, Y., Fei, P., Mai, W., Gao, Y., Yang, R., ... & Wang, Z. L. (2008). Flexible piezotronic strain sensor. *Nano letters*, 8(9), 3035-3040.

Zhao, Z., Ding, D., Fu, Y., & Xu, J. (2019). Measured data-driven shape-adaptive machining via spatial deformation of tool cutter positions. *Measurement*, 135, 244-251.