

Alternative Energy Carriers in Naval Vessels

Streng, J.E.; Kana, A.A.; Verbaan, J.H.; Barendregt, I.P.; Hopman, J.J.

DOI

[10.24868/10701](https://doi.org/10.24868/10701)

Publication date

2022

Document Version

Final published version

Published in

Proceedings of the International Naval Engineering Conference

Citation (APA)

Streng, J. E., Kana, A. A., Verbaan, J. H., Barendregt, I. P., & Hopman, J. J. (2022). Alternative Energy Carriers in Naval Vessels. *Proceedings of the International Naval Engineering Conference*, 16, Article 69. <https://doi.org/10.24868/10701>

Important note

To cite this publication, please use the final published version (if applicable). Please check the document version above.

Copyright

Other than for strictly personal use, it is not permitted to download, forward or distribute the text or part of it, without the consent of the author(s) and/or copyright holder(s), unless the work is under an open content license such as Creative Commons.

Takedown policy

Please contact us and provide details if you believe this document breaches copyrights. We will remove access to the work immediately and investigate your claim.

Alternative Energy Carriers in Naval Vessels

Ir. J. E. Streng^{a*}, Dr. A. A. Kana^b, Ir. J. H. Verbaan^a, Ir. I. P. Barendregt^a, Prof. ir. J. J. Hopman^b

^aDefence Materiel Organisation, The Netherlands ^bDelft University of Technology, The Netherlands;

*Corresponding author. Email: JE.Streng@mindef.nl

Synopsis

In order to reduce fossil fuel consumption of the Royal Netherlands Navy (RNLN) by 70% in 2050, the use of alternative fuels on the large naval surface vessels is examined. This paper examines the implications for the design and operational effectiveness of these vessels by performing two case studies of the Zeven Provinciën air defence and command frigate (LCF) and the Johan de Witt landing platform dock (LPD). In the case studies an operational analysis, a parametric design study, and an effectiveness assessment are performed on multiple proposed designs. Results showed that it is possible to reduce the fossil fuel consumption of the RNLN by almost 70%. This does affect the design of the vessels, however. It was also concluded that the LPD is more suitable for the application of low-energy-density fuels than the LCF, due to its missions requirements. Both the LPD and the LCF show a significant increase in displacement and fuel cost, but it is possible to reduce effects on the operational effectiveness to a minimum.

Keywords: Naval vessels design; alternative fuels; energy carriers; marine engineering; ship design

1 Introduction

The Dutch Ministry of Defence has expressed the ambition to reduce the fossil fuel consumption for operational use by 70% in 2050 (Bijleveld-Schouten and Visser, 2019). To achieve this, multiple projects have already been started such as the design of methanol fuelled support vessels and the use of HVO as an additive to F-76 fuel (Astley et al., 2020; Geertsma and Visser, 2017; Geertma and Krijgsman, 2019). The challenge at hand is so severe however that it is necessary to consider more substantial measures. In this paper the application of alternative energy carriers and energy converters onboard Royal Netherlands Navy (RNLN) large surface vessels will be considered. The paper attempts to answer the following question: How is the design of RNLN vessels affected by the application of alternative energy carriers and energy conversion technologies that is needed to reduce the fossil fuel consumption of the Netherlands armed forces? In the second section, the method that is used in the paper will be discussed. The selection of the case study subjects will also be examined here. In section 3 an operational analysis is performed for both vessels to decide which of the measures of effectiveness are most important in the design process. In the fourth section, a parametric design tool is used in a systematic design variation of the case study subjects to assess the first effects on the main dimensions of the vessels. In section five, two concept designs are selected. For each of these concepts, the consequences for fuel consumption, operational effectiveness, and greenhouse gas (GHG) emission will be assessed. In section 6 the results of the proposed changes are assessed on a fleet level, before presenting the conclusions in section 7. The paper finishes with a short discussion and recommendations.

2 Method

The effects that the application of alternative energy carriers will have on the design of large surface naval vessels have been assessed through a design study. Two case study subjects have been selected for this design study so that potential differences between vessel types may be observed. In this section, the different steps of the design study and the selection of the vessel on which the study has been performed are explained. The design study follows several distinct steps of a systems engineering approach and focuses mainly on concept exploration and the first phase of concept definition (NATO Maritime Capability Group 6 on Ship Design and Maritime Mobility, 2011; van Oers et al., 2018).

Authors' Biographies

Ir. Jurjen Streng is a Naval Architect architect at the Maritime Systems Division of the Dutch Defence Materiel Organisation. He works primarily on the concept design of future surface combatants and the development of design tools.

Ir. Huibert Jan Verbaan holds the position of marine engineer at the Defence Materiel Organisation where he is responsible for the mechanical systems on board existing vessels and new-build projects for the Royal Netherlands Navy.

Ir. Isaac Barendregt graduated in 1989 as a mechanical engineer at Delft University of Technology in the field of transportation technology. In 1991 he joined the Royal Netherlands Navy in the bureau for research and development on propulsion and energy systems for navy ships. Since 2005 he is employed by the Netherlands Defence Materiel Organisation as a senior marine engineer and is involved in several new ship building projects for the Navy. Currently he is head of the Marine Engineering Office.

Dr. Austin Kana is an Assistant Professor in the Maritime Transport Technology Department at Delft University of Technology. his research is on developing techniques to aid early stage ship design activities. He received his PhD from the University of Michigan in 2016 in Naval Architecture and Marine Engineering

Prof. ir. Hans Hopman is retired professor of ship design, production, and operations at the Department of Maritime and Transport Technology, Delft University of Technology, The Netherlands. His research interests include design, engineering, production, repair, and operation of ships and other floating marine objects, including their machinery and electric equipment.

2.1 Case study selection

Considering the replacement schedule (Ministry of Defense, 2020) and the prognosis of the fossil fuel consumption of the RNLN fleet it is apparent that significant action has to be taken sooner rather than later should the reduction goals of fossil fuel consumption be achieved. For several future designs (the Combat Support Ship, Anti Submarine Warfare Frigates, Support vessels, Mine Countermeasure Vessel) the design or construction process has already progressed to a stage where it is no longer possible, or too costly, to consider such actions. Therefore the vessels planned to be delivered before 2030 are not considered. The most suitable subjects for a case study thus are the LPD and the LCF. The design study consists of three separate design steps. In each step more detail is added to the design whilst the number of alternative designs is reduced. The first is an operational analysis, followed by a parametric design and finally a concept design.

2.2 Operational analysis

Since the operational effectiveness is an important constraint in the Defence Energy and Environment Strategy (DEOS) (Bijleveld-Schouten and Visser, 2019), the first design step is an operational analysis. For a finished design, it is possible to run extensive simulations of different scenarios and operational environments to obtain an effectiveness for certain missions (Michalchuk and Bucknall, 2014). In the early design phases it may be more suitable to define measures of effectiveness and judge these measures qualitatively for different designs. This method is simpler and allows for comparison between different designs in the design exploration phase. Since the design variables in this paper all pertain to the ship power generation a simple set of measures of effectiveness related to the power generation will be constructed.

2.3 Parametric design study

The second step in the design process is a systematic design variation. Using a design tool adapted from the Ship Power & Energy Concept (SPEC) tool by the Marine Research institute of the Netherlands (MARIN) (MARIN, 2020), various design parameters can easily be changed to examine the influence on the design of the vessels. In this parameter study, the independent variables will mainly be the power plant configuration and the energy carrier. The aim of this study is to obtain an estimate of the main dimensions of the vessels and to uncover the relations between the selected energy carriers and the other design parameters.

2.4 Concept design

In the final design step, some examples of concepts from the systematic design variation are selected for further analysis. Using these concepts, the feasibility of all the different objectives mentioned in the introduction (fossil fuel consumption, greenhouse gas emission, operational effectiveness) are assessed. A prognosis is made for the fossil fuel consumption, GHG emissions and fuel cost for the entire RNLN fleet until 2050. For the final effectiveness assessment, the influence of the design changes on the MoE's is examined for each MoE, before making a judgement on the overall effectiveness.

3 Operational analysis

The systems which are installed on a vessel influence the capabilities of the vessel and thus operational effectiveness has to be considered during the design phase. This relation is schematically shown in figure 1.

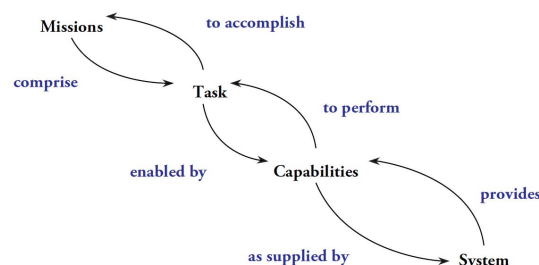

Figure 1: Relations between systems and mission capabilities (Brown, 2013)

3.1 Measures of effectiveness

From the analysis of the missions, tasks, and capabilities which the vessels must fulfil, a list of systems that provide those capabilities can be made. Each of these systems will influence the effectiveness in a multitude of

ways. To gain insight into these interactions they may be divided into different categories. Each change of the design will affect one or more of these categories, and these categories collectively make up the total effectiveness of the vessel. One such list of categories is based on efforts made by (Brown and Andrews, 1980):

- Speed
- Stability
- Strength
- Seakeeping
- Style
 - Stealth
 - Protection
 - Human factors
 - Sustainability
 - Margins
 - Design Issues

This list is primarily used to explain how naval vessel design differs from the design of commercial vessels and is also relatively old (1980). From some of the items in the list, it is not directly clear how they influence the operational effectiveness of a vessel. A more extensive attempt at listing all factors which influence the effectiveness of a vessel is made at the national level in the fundamentals of maritime operations (Middendorp, 2014) and on the international level in the NATO Capability Codes & Capability Statements (North Atlantic Treaty Organization, 2020). In both these documents, an extensive list of missions and an exhaustive overview of the necessary capabilities for each possible mission is given. The complete list of capabilities is very detailed. When considering the capabilities that apply to the platform, however, these can be simplified and categorised in a similar manner to Brown's and Andrews' list (Brown and Andrews, 1980). The list of technical characteristics that are constructed from the capability statements is shown in the list below.

- Offensive capabilities
- Survivability
 - Susceptibility
 - Vulnerability
 - Recoverability
- Mobility
 - Top speed
 - Acceleration and deceleration
 - Mobility
- Range
- Endurance/autonomy

Besides the NATO Capability Codes and the fundamentals of maritime operations, this list is based mainly on conversations with subject matter experts at the DMO (Verbaan, 2020). This list is not necessarily mutually exclusive with the list proposed by Browns and Andrews (Brown and Andrews, 1980). In fact, most of the items that are part of the Brown and Andrews' list can also be categorised according to these specifications. Speed falls under the denominator of mobility, stealth and protection are included in survivability. Seakeeping is a requirement for mobility in heavier weather or at higher speeds. Sustainability is a synonym for endurance in this context. Only stability has been given a less prominent role, as this is a requirement for any vessel, and not unique to naval vessels. It is more readily apparent how these categories influence the success in missions.

3.2 Operational analysis results

In this paper a relatively simple combination of requirements and measures of effectiveness has been used. Since the choice for different energy carriers mainly influences the ships powerplant, the requirements and MoE's related to the powerplant has been selected for the case studies. The power generated onboard is used both for the propulsive power and to supply electric power to onboard systems. As an input for the parametric design tool the sailing profile and e-load of the vessels will remain constant. Furthermore, a range and top speed requirement as stated in table 1 will be used. Since a high acceleration can be of use in tactical situations this will also be assessed. Finally the susceptibility, vulnerability and payload capacity of the platforms are assessed since these may be influenced by the selected energy carriers, but may have an influence on operational effectiveness.

Table 1: Requirements and MoE's for the case studies

	LCF	LPD
Top speed [kts]	30	22
Acceleration	+	-
Range [nm]	5000	5000
Susceptibility	+	-
Vulnerability	++	+
Payload	-	++
Sailing profile	constant	constant

4 Parametric design

In this section, a systematic design variation has been performed. A parametric design tool has been developed based on the SPEC tool by MARIN. In this design tool, it is possible to select different energy carriers and power plant configurations for a vessel and obtain a first indication of vessel dimensions.

4.1 Design tool

The design tool is developed to be used as a preliminary design tool. With a relatively small quantity of design data, it is possible to assess the influences of, and relations between, different parameters. The application of energy carriers with different power densities may affect the vessel dimensions significantly. If the range, payload, and operational profile remain constant, an energy carrier with a lower energy density will lead to a larger fuel mass. This increases the displacement and leads to an increased resistance, a higher required power and higher fuel consumption. This mechanism, shown in figure 2, makes it difficult to estimate the vessel dimensions without an iterative process. The design tool aims to automate this process. To achieve this, a number of simplifications

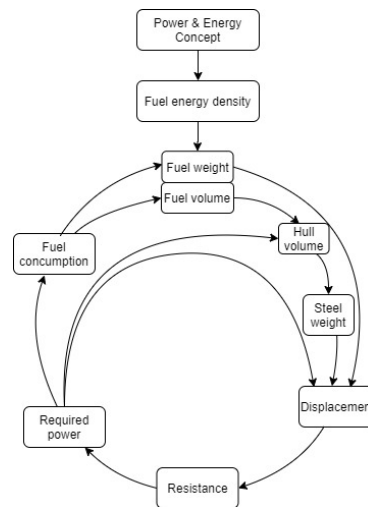

Figure 2: A reduction in energy density leads to a larger increase in the ships displacement

and assumptions are used within the mathematical model. The complete mathematical model of the adapted design tool used in this paper is presented in (Streng, 2021). The most important of the simplifications are the following:

- The entire displacement is divided into four weight groups.
 - Construction and outfitting weight of the hull
 - Weight of the propulsion and power generation system
 - Fuel weight
 - All other weight including operational systems, weapons, accommodation etc..
- A constant admiralty coefficient based on the brake power at the maximum velocity.
- A constant hull shape.
- Efficiencies are taken as constants.
- Energy converter volume and weight are linearly dependent on the required power.

The algorithm evaluates two different functions that both estimate the total displacement of the vessel. The first is derived from the main dimensions of the vessel whilst the second formula is a simple addition of the four different weight groups.

$$\Delta_1 = L_{wl} \cdot B \cdot T \cdot C_b \quad (1)$$

$$\Delta_2 = W_{struct} + W_{fuel} + W_{system} + W_{rest} \quad (2)$$

Three of the four weight categories in the second displacement estimate (4.1) are in their turn a function of the vessel size, operational profile, and the technical properties of the energy carriers and converters. The algorithm is implemented in Matlab and uses a solver to bring the error in the displacement down to zero.

$$\varepsilon_{\Delta} = \Delta_1 - \Delta_2 \quad (3)$$

Using this procedure, the main dimensions and weights of the weight groups are determined. Given the simplifications and assumptions that are used it is not realistic to expect a 100% accurate calculation. There is still a large design margin, irrespective of the results of this calculation. Furthermore, the design tool has not been developed to obtain a final design, but to assess the relations and influences between parameters, and to find a starting point for the next phases in the design process.

4.2 Verification

A verification of the design tool has been performed using reference models. To obtain this reference model the design parameters of the actual vessels have been used as input for the design tool. The difference between the output of the design tool and the dimensions and weights of the real vessels reveal the accuracy of the design tool. In table 2 the dimensions and weight of the real vessels and the reference design are presented side by side where all parameters of the reference design fall within a 10% margin of the real design. This means that within a certain range, the design tool is sufficiently accurate for the purpose which it serves.

Table 2: Verification of reference designs with SPEC and the new adapted design tool

	LCF		LPD	
	DMO design	Reference	DMO design	Reference
W_{struct}	1	1.01	1	0.90
W_{sys}	1	0.98	1	1.01
W_{fuel}	1	1.00	1	1.08
W_{rest}	1	1	1	1
Δ	1	1.03	1	0.98

4.3 Experiment selection

The experiments related to early stage design serve two purposes. The first is the selection of a suitable design with which the design process can continue. The second is to understand more about the relation between the design choice in energy carrier and converter, and the effect they have on the vessel dimensions. Table 3 provides an overview of the different experiments. In each experiment, the power plant configuration is treated as the independent variable, while the operational profile, range, and rest weight are kept constant so that the operational effectiveness also remains (mostly) constant.

The first experiment is equal for both vessels. The current power plant configuration is used for a selection of different fuels: F-76, FAME, HVO, ethanol, methanol, butanol, ammonia, DME and liquid hydrogen. In the second experiment, other power plant configurations are also tested. A fully integrated electric plant (IFEP) is used, powered by an ICE, SOFC, and PEMFC. The original configuration of the LPD is already diesel-electric, so this configuration is not added. The third experiment considers a hybrid electric plant in which both ICEs and SOFCs are used to deliver the electric power. Different power ratios are also used ranging from 100% of the power delivered by the ICE ($r_{P,fc} = 0$) to 100% of the power delivered by the fuel cell ($r_{P,fc} = 1$). The fuels used in this experiment are butanol and methanol. For the LCF a fourth experiment is conducted. Given the high-speed requirement of the LCF, a configuration using a geared drive gas turbine and electric motor, combined with a SOFC ICE electric power plant is tested. This concept is tested using methanol, butanol, and F-76.

Table 3: Selected experiments

	LCF	LPD
Experiment 1	Conventional configuration, different fuels	Conventional configuration, different fuels
Experiment 2	IFEP: ICE, SOFC, PEMFC	IFEP: SOFC, PEMFC
Experiment 3	Hybrid electric: ICE & SOFC	Hybrid electric: ICE & SOFC
Experiment 4	Hybrid SOFC & ICE and direct gas	

4.4 Parametric design results

Experiment 1

In figures 3 and 4 it is clear that the contained energy densities have a drastic impact on the total displacement of the vessel. The two biofuels HVO and FAME have an energy density closer to that of F-76 and similarly sized vessels are thus expected. It is also apparent that the gaseous fuels ammonia and liquid hydrogen will result in a considerably larger vessel. The effects of the alcohol fuels are more moderate and fall in between the two extremes. The most remarkable however is the difference between the two vessels. The increase in displacement of the LPD is much smaller than that of the LCF. This can likely be attributed to two things. The relatively small contribution of the fuel weight to the total displacement of the LPD results in a smaller increase of displacement for the same increase in fuel weight. The high relative fuel weight of the LCF means that the mechanism explained in figure 2 leads to an increase in the total displacement of the vessel more quickly.

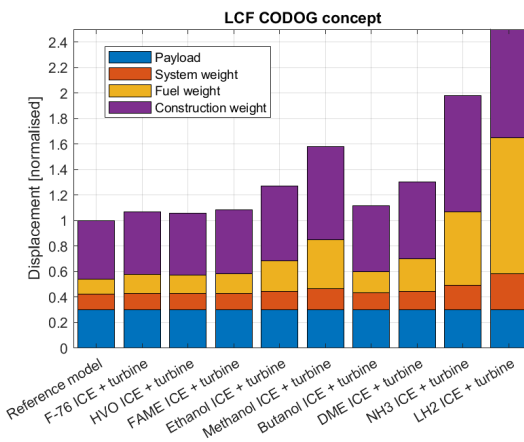
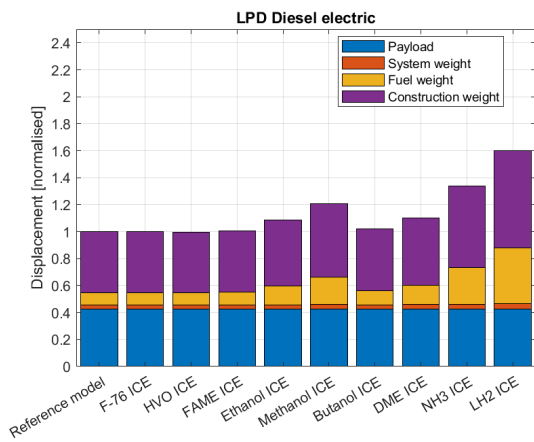

Figure 3: LPD: current configuration with different fuels Figure 4: LCF: current configuration with different fuels

Experiment 2

In figures 5 and 6 it can be observed that the application of fuel cells increases the vessel displacement further. Especially the LCF, which has a high installed power relative to its size grows uncontrollably due to the lower power density of the fuel cells. The pre-formers which are needed for the LT-PEMFC also negate the efficiency gain which is achieved by using fuel cells. The total system efficiency of the LT-PEMFC concept is thus similar to that of an ICE. The lower power density however results in a heavier vessel.

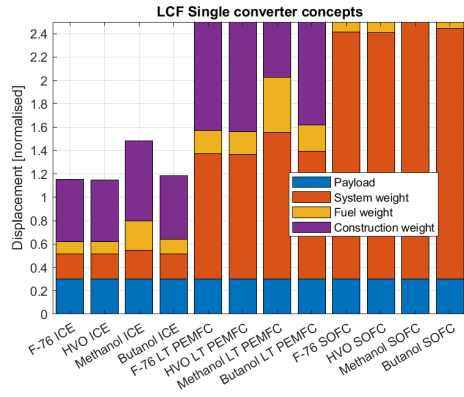

Figure 5: LCF fuel cell configurations

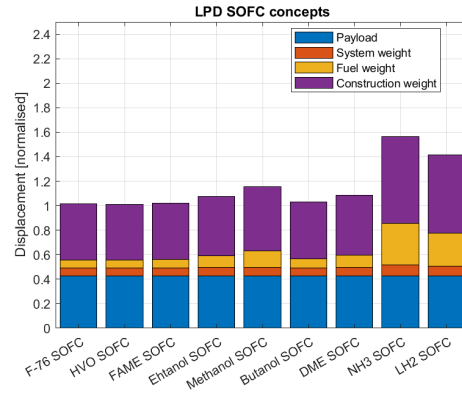

Figure 6: LPD: SOFC

Experiment 3

From the previous experiments, it resulted that a system powered by only fuel cells would likely be very heavy. A hybrid system in which a SOFC and ICE are combined may prove to benefit from the advantages of the efficient fuel cell without an excessive increase in the system weight. With increments of 5%, the power ratio of the fuel cell is increased from 0% to 100% for both methanol and butanol. In figure 7, it can be seen that as the fuel cell power fraction increases, the fuel weight decreases due to the greater system efficiency. Around $r_{P,fc} = 35\%$ there appears to be an optimum. As the average efficiency approaches a maximum the reduction of fuel weight becomes smaller. However, the system weight continues to increase almost linearly.

For the LCF the picture is quite different. Although the efficiency increases, the fuel weight does not decrease as much. This can again be attributed to the relatively high installed power. An increase in the system weight also has a significant effect on the resistance and thus the fuel consumption. The optimum is thus at the beginning, where no fuel cells are used. Additionally, it can be noted that for the LPD, there is an important difference between the use of butanol and methanol. Although both show the same trend with a minimum in the displacement around $r_{P,fc} = 35\%$, the difference between the minimum displacement and the maximum displacement is almost negligible with the use of butanol and much more pronounced with the use of methanol.

Experiment 4

The three experiments so far considered are not sufficient for the LCF. For a comparison with the current design, it is also necessary to assess a design that also uses a gas turbine. In figure 9 the results from this experiment are

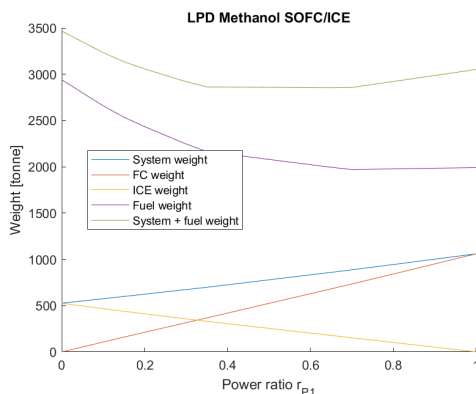

Figure 7: LPD: Hybrid methanol configuration

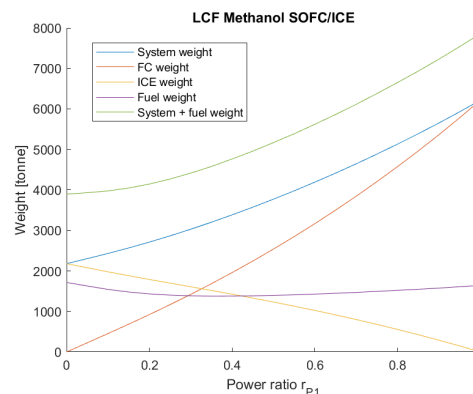

Figure 8: LCF: Hybrid methanol configuration

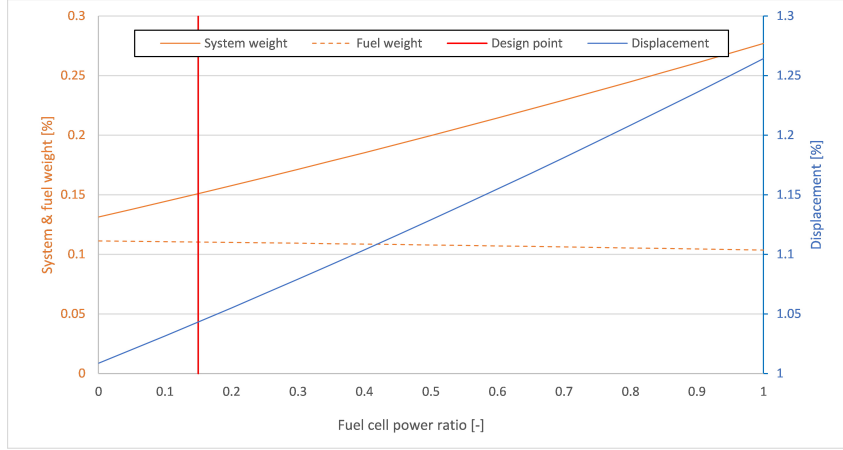

Figure 9: Displacement, system & fuel weight as percentage of reference design displacement

presented. In this experiment, the fuel cell power ratio depicts only the power ratio between the generator set and the fuel cell. The gas turbine is considered to be used only for propulsion and is directly driven. In this experiment, it can be seen that although the total system efficiency does increase, the increased weight of the fuel cell is much higher. An optimum comparable to the LPD is not found.

5 Concept design

The previous sections resulted in a clear indication of the expected results with regards to the main dimensions of the two case study subjects. Other than the main dimensions no detailed consequences have been examined so far. This section will delve deeper into the specific, technical functioning of the vessels and how the adaptation to different power generation concepts affects the operational effectiveness. Consequences that may not have been directly clear from the result of the parametric study will be examined in this section. One configuration from the previous design step is selected for continuation into the concept design phase. From the previous section it appeared that several energy carriers are not deemed feasible. NH₃ and liquid hydrogen simply result in a excessive increase in displacement. When using HVO or FAME, the design does not change much so these are also not as interesting. Therefore, butanol and methanol are chosen for the concept designs. Specifically: for the LPD this is the hybrid SOFC ICE methanol concept depicted in figure 10. For the LCF it is the hybrid electric design with an SOFC, ICE, and gas turbine fuelled by butanol, that is depicted in figure 14. For both vessels, several design points are selected which will be evaluated further. After the evaluation and final design iteration an effectiveness assessment is performed.

5.1 LPD power plant configuration

The selected configuration for the LPD is a combined fuel cell and ICE system. In the previous section it was determined that there is no singular optimum for the ratio $r_{P,1}$ when solely considering displacement as there are multiple minima. In figure 11 this is shown again. The trade-off between these options primarily seems to be between OPEX and CAPEX. Similar to the paper by Saprà (Saprà, 2020), the optimum with the smallest total displacement will be selected. In table 4 the two optimal points are shown together with the reference design.

The power plant configuration will resemble the schematic illustrated in figure 10. As the installed power has increased by 4% compared to the reference design the installed power is now roughly 15.400 kW of which the fuel cells supply 5400 to 10800 kW and the ice the rest. Since the vessels displacement has increased, the resistance and thus the necessary delivered power to the pods also increases as can also be observed in table 4.

It is also possible to determine the maximum achievable speed while sailing solely on fuel cell power by rewriting the equation of the admiralty coefficient into equation (4) and (5)

$$V_{fc,max,1} = \sqrt[3]{\frac{(P_{fc} - P_{aux}) \cdot C_{adm}}{\Delta^{\frac{2}{3}}}} \approx 12kts \quad (4)$$

$$V_{fc,max,2} = \sqrt[3]{\frac{(P_{fc} - P_{aux}) \cdot C_{adm}}{\Delta^{\frac{2}{3}}}} \approx 16kts \quad (5)$$

which leads to maximum speeds of roughly 12 and 16 knots for the two proposed configurations.

Table 4: Changes in weight and installed power of three concepts compared to the reference model (weight relative to reference model)

$r_{P,fc}$ [-]	Reference	ICE	Design 1	Design 2
$r_{P,fc}$ [-]	0	0	0.35	0.7
Displacement [-]	1	1.21	1.13	1.13
System weight [-]	1	1.10	1.46	1.85
Fuel weight [-]	1	2.20	1.62	1.48
Construction weight [-]	1	1.21	1.13	1.13
Installed power [-]	1	1.10	1.06	1.06
Installed power [kW]	14800	15942	15430	15426
Fuel cells [kW]	0	0	5400	10798
ICE's [kW]	14800	15942	10029	4628
Pods [kW]	11000	12142	11630	11626
Speed on fuel cells [kts]	0	0	12	16

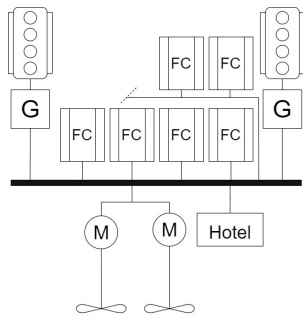

Figure 10: LPD power plant configuration

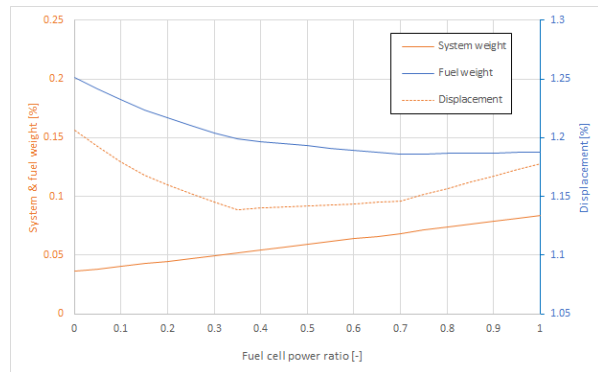

Figure 11: LPD power plant configuration

5.2 Air Defence and Command Frigate power plant configuration

The configuration for the LCF is somewhat more complicated. Due to the large negative effect of low power density energy carriers and energy converters, it was established that in order to maintain the required top speed of 29 knots without an excessive increase of displacement, the gas turbines in the installation must be preserved in the proposed design. Although there was no clear optimum load sharing ratio $r_{P,1}$ from a displacement point of view, a combined configuration using fuel cells, ICE and gas turbines are proposed. In this way, a design with a higher fuel economy can still be explored. One of the problems of the parametric design tool was that it is difficult to consider all the different possibilities there are with regards to the configuration of a more complex power plant. In figures 12 through 15 the current and the different proposed configurations are shown. In all the proposed configurations a fraction of the power otherwise generated by an ice is now generated using fuel cells. Configuration 1 in figure 13 would stay the closest to the current configuration. The main difference between the four configurations is the implementation of electric propulsion. The higher transmission efficiency of a geared transmission increases the total efficiency at high speeds when the engines are operating in design conditions.

In off-design conditions however an electric transmission may be more efficient. Engine efficiency quickly decreases in part-load conditions, but the generator set in an electrical propulsion system can always operate at nominal speed. The current and the first proposed configuration show a combined diesel or gas propulsion configuration.

Due to the fact that the ICE in proposed configuration 2 is replaced by a generator set and electric motors this also means that both the reciprocating engine and the turbines can deliver propulsive power at the same time without the need for more intricate and complex gearboxes. This means that the gas turbine can be smaller in size and that the total system efficiency at top speed increases since the inefficient gas turbines have a lower energy ratio r_E .

Both configuration 2 and 3 also allow the vessel to sail while operating only the fuel cells and electric motors which dramatically reduces the acoustic signature.

Depending on the actual power ratio $r_{P,fc}$ that is selected, configuration one is of limited use as the maximum output power of the fuel cell is lower than the installed auxiliary power in this configuration. It also does not offer the benefit of silent operation, and a higher fuel economy would be its only benefit.

The second configuration benefits from the fact that it can sail on the electric power of the fuel cells and ICE.

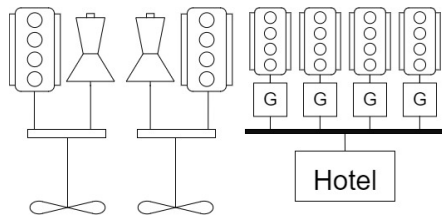

Figure 12: LCF current CODOG configuration

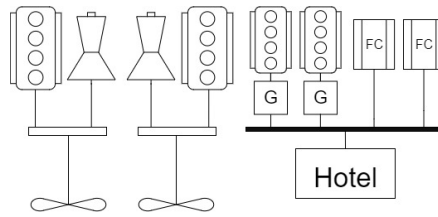

Figure 13: LCF proposed Configuration 1: CODOG + FC

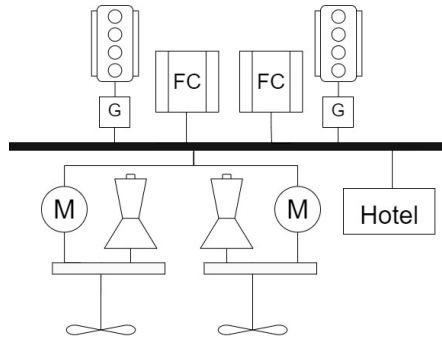

Figure 14: LCF proposed Configuration 2 COD-LAG + FC

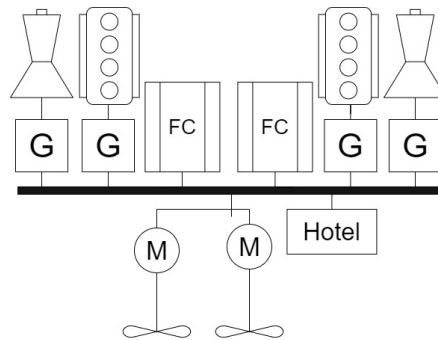

Figure 15: LCF proposed Configuration 3: IFCFEP

The geared gas turbines subsequently provide propulsive power for higher speeds.

The final proposed configuration is configuration three, which is an IFEP configuration where all energy converters supply electric power and the propulsion is supplied by electric motors. One of the benefits of such a system is that no complex shaft or gearbox arrangements are required and there is a high freedom with regard to the placement of individual components. The total system efficiency will be lower than that of the second system however, as the gas turbines are not directly delivering their power to the propellers.

It is apparent that for the same power split, many different design possibilities still remain. Although these choices influence many different properties of the vessel this project is not about the best possible configuration, but the influence of the application of different energy carriers and converters*. To be able to use the full potential benefits of a fuel cell configuration concept 3 and 4 as proposed will be used for the remainder of this section. Of the two, the configuration in figure 14 is more optimised towards high vessel speeds whilst the configuration in figure 15 may be better suited to a highly varying on board energy demand.

Although these configurations were not extensively tested in the parametric variation due to limitations in the model it may still be interesting to consider their implications for the operational effectiveness of the vessel. In figure 4 it was shown already that the use of any but the most energy dense fuel would result in dramatic increase in the displacement. This is without even considering the application of the three configurations discussed above. Given these facts the energy carrier considered for this application will be butanol. Configuration 2 in figure 14 will be used for this analysis.

In figure 16 the development of the weight of different components is presented. As mentioned earlier there is a considerable margin with the exact system weight as the parametric design tool is not suited for the complex configurations which are necessary for the frigate. The figure nonetheless shows the development of the weight when a larger portion of the power is delivered by a fuel cell. For this configuration, three different design points are selected for further assessment. These design points are at $r_{p,fc} = 0.15$, $r_{p,fc} = 0.3$ and $r_{p,fc} = 0.45$ respectively. It must be noted that in this case the power ratio does not include the gas turbine and thus denotes the power split between the reciprocal engine and the fuel cell (and thus not the gas turbine). Since large fuel cell power ratios were found to have an unfavourable influence on the vessels displacement only lower power ratios are selected here. This will allow for assessment of the influence on operational effectiveness whilst limiting the negative influence on the displacement.

6 Overall results

Given the proposed design alterations to the LPD and the LCF it can now be calculated what the consequences will be for the fuel consumption of the RNLN. To do this, the consequences for the two vessels, which are shown

* possibly for the use of direct energy weapons or charging of batteries and super capacitors.

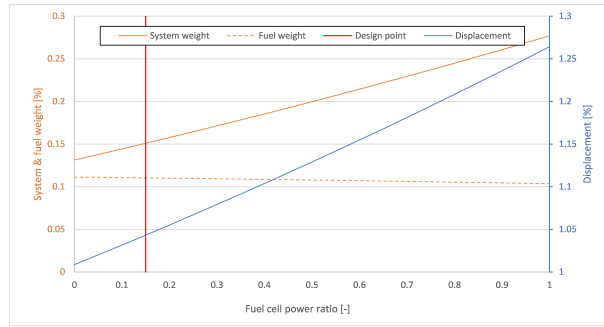

Figure 16: Displacement, system & fuel weight as percentage of reference design displacement

Table 5: proposed designs for the LCF

	Reference	Design 1	Design 2	Design 3
$r_{P,fc}$ [-]	0	0.15	0.3	0.45
Displacement [-]	1	1.03	1.08	1.12
System weight [-]	1	1.19	1.41	1.58
Fuel weight [-]	1	0.95	0.94	0.93
Construction weight [-]	1	1.03	1.08	1.12
Installed power	1	0.87	0.89	0.91
Installed power [kW]	53000	46680	47922	48879
Fuel cells [kW]	0	1497	4611	7055
ICE [kW]	17000	13476	10760	8623
GT [kW]	36000	31707	32551	33201
EM [kW]	0	10973	11371	11678
Speed on fuel cells [kts]		0	10	14

in table 6, have been extrapolated to the rest of the fleet. All new frigates and other fast vessels delivered after 2030 are calculated using the approach for the LCF. For all other vessels, the design alterations for the LPD are used. A prognosis for the fuel consumption can be seen in figure 17. Derived from this, the GHG emissions and the fuel cost expectations are also shown in figure 18 and figure ?? respectively. It is clear that with only the proposed design changes, the goal of the fossil fuel consumption and GHG emissions are almost achieved. Further mixing of HVO with the F-76, or other measures to conserve energy will likely result in the achievement of the DEOS goals. A similar result is found for the GHG emissions. With the proposed design alterations it is almost possible to reduce the GHG emissions by 50%. With other additional measures it is feasible to comply with IMO 2050 goals. It is found however, that the absolute fuel consumption in m^3 significantly increases. This is partially due to the lower energy density of the selected energy carriers, but also due to the increase in displacement and thus required energy. The increase of the total fuel consumption and the use of alternative energy carriers also lead to a significant increase in fuel cost.

Table 6: Proposed design changes for the LDP and LCF

	Design 1	LCF			LPD	
		Design 1	Design 2	Design 3	Design 1	Design 2
Fuel cell power ratio	0.15	0.3	0.45	0.35	0.7	
Displacement	+3%	+8%	+16%	+14%	+20% [t]	
Operational effectiveness	Slight negative effect	Equal	Small positive effect	Equal	Equal	
GHG emissions	-75%*	-75%*	-75%*	-92%*	-93%*	
IMO Tier III compliant	Yes	Yes	Yes	Yes	Yes	
Fossil fuel consumption	-100%*	-100%*	-100%*	-100%*	-100%*	
Total fuel consumption	-5%	-4%	-3%	+62%	+48%	
Investment cost	+	++	+++	++	+++	

7 Conclusions

In this paper, the potential of alternative energy carriers onboard naval vessels were examined. By answering the question: "How are the design and the operational effectiveness of RNLN vessels affected using alternative

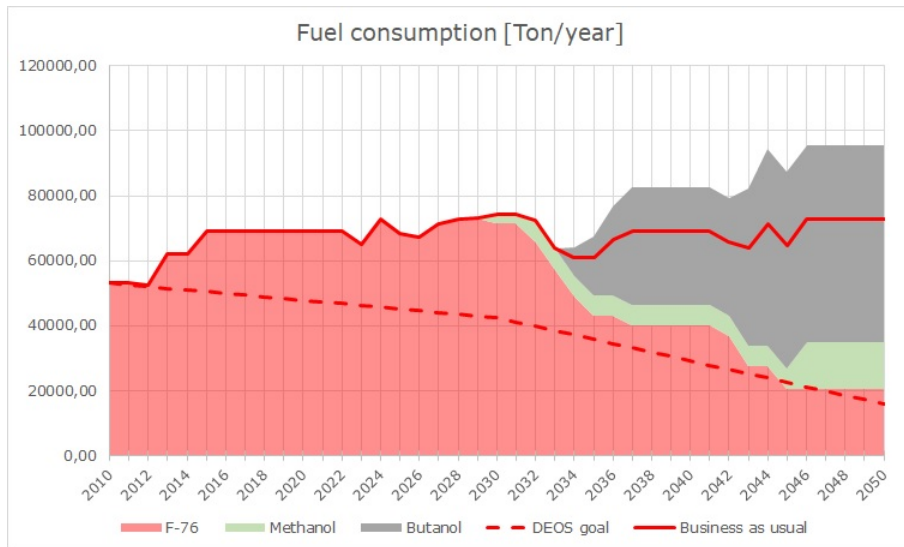

Figure 17: Prognosis of absolute fuel consumption

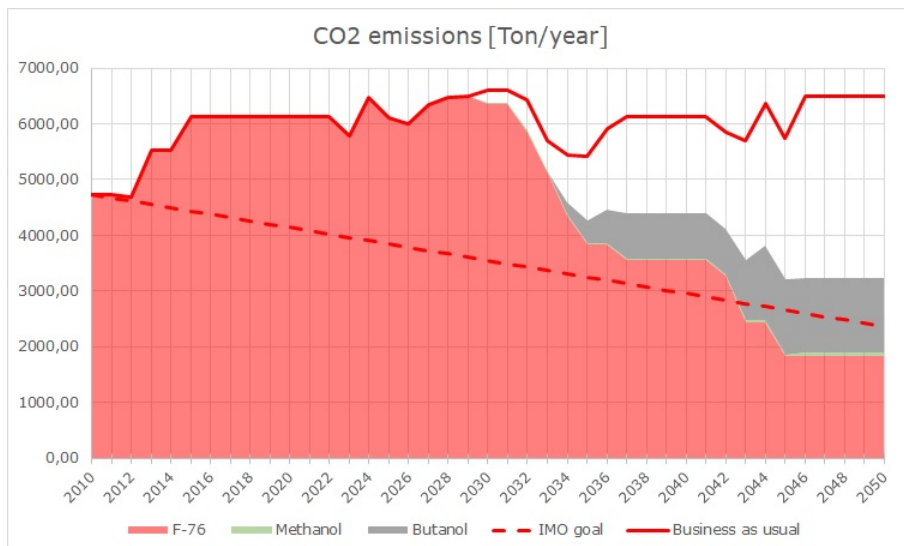

Figure 18: Prognosis of GHG emissions

energy carriers and energy conversion technologies that are needed to reduce the fossil fuel consumption of the Netherlands armed forces?" it may be possible to optimise a design strategy for the future naval vessels of the RNLN. It was shown that by adapting the design of future naval vessels, it is possible to reduce the fossil fuel consumption by almost 70%. If other vessels are adapted during their midlife update, or if HVO is mixed with the F-76, it is possible to achieve a reduction of 70%. Additionally, this would ensure compliance with the IMO goals regarding GHG and NO_x emissions. Achieving these goals, without reducing the operational effectiveness comes at a cost. The designs of the LCF and LPD both have an increased displacement. The mechanism behind this increased displacement is similar, but there are differences between the vessels as well. The conclusion can be summarised in the following points:

1. **Different vessel types require different solutions.** Depending on the operational requirements and the subsequent design priorities, the cost of reducing the fossil fuel consumption will be higher for certain vessels than for others.
2. **Vessels with a high-speed requirement and a relatively high system weight incur a high weight penalty when low energy/power density technologies are applied.** Vessels that have a high top speed and a long-range generally have a relatively high fuel and system weight. The same increase in the fuel weight will thus induce a larger increase in the displacement than for a vessel with a low fuel weight. This increase in the displacement further necessitates a higher installed power.

3. **Vessels with a lower top speed and system weight have the potential to decrease the fuel consumption and displacement significantly through the use of fuel cells.** Vessels with a low top speed and fuel weight have the potential to reduce their fuel consumption (compared to a vessel with the same fuel but no fuel cell) through the application of a relatively large fuel cell power ratio. Although the fuel cells increase the system weight, the increased energy efficiency of the system reduces the fuel weight by a larger amount.
4. **For some vessels, an optimum load share between conventional combustion engines and an SOFC is observed. Energy carriers with a lower energy density have a more pronounced optimum.** The reduction of the displacement is not seen in every vessel type or for every operational profile. When fuels with a higher energy density (e.g. butanol) are used, the difference between the minimum and maximum displacement is lower. A high fuel cell power ratio is thus best suited for vessels using a fuel with a lower energy density.
5. **The effect of the application of the considered technologies on the operational effectiveness is heavily dependent on the mission profile of the vessel.** A net negative effect on the operational effectiveness can be prevented in most situations. In some situations, the application of fuel cells may provide a slight improvement to the susceptibility.

7.1 Recommendations

In this paper multiple simplifications and assumptions have been made that may affect the accuracy and applicability of the results and a short discussion is therefore in order. A number of recommendations for future research can also be provided.

The operational analysis was performed using measures of effectiveness which have been selected specifically to assess the implications concerning alternative energy carriers and energy converters during operations. This list is by no means a complete representation of the design priorities of a naval vessel and only served to highlight the main differences. Such a list is a feasible tool in this approach since it was mainly used to highlight the differences between the original design, and the adapted designs. The subjective nature of the operational analysis is also a point of improvement. With a higher level of detail, a more comprehensive effectiveness assessment may be performed.

Another area for which the results must be discussed is the parametric design tool. The tool is developed on the basis of an earlier tool developed by MARIN and although much improvement has been made, the tool does lack in accuracy in some areas. Given the constant hull form, the assumption is made that the admiralty coefficient is also constant. This assumption is only valid for constant Froude numbers however. This means that as vessels get much larger than the reference design, the estimation of the required power is higher than it would be in reality. This means that as displacement increases, accuracy decreases. Also, when considering more complex power plant configurations with three or more different energy converters that do not distribute their power in the same manner, the results lack in accuracy. The results can still be used to observe trends and examine relations between different design parameters, but the indication as to the main dimensions of the vessels may not be representative. Since the model is not developed for naval vessels, but with any vessel type in mind, further improvement of this model may prove valuable for future design studies.

Acknowledgements

This work was performed as part of an MSc thesis for the main author (Streng, 2021) at Delft University of Technology in Marine Technology. The authors would like to thank the Netherlands Defense Materiel Organisation and Delft University of Technology for their support of this research.

References

- Astley, W., Grasman, A., Stroeve, D., 2020. The impact of alternative fuels on short sea shipping and inland shipping, in: International Naval Engineering Conference and Exhibition.
- Bijleveld-Schouten, D.A.T.B., Visser, D.B., 2019. Defensie Energie en Omgevingsstrategie. Technical Report. Ministry of Defence.
- Brown, A.J., 2013. Application of operational effectiveness models in naval ship concept exploration and design. Ship Science & Technology 7.
- Brown, D., Andrews, D., 1980. The design of cheap warships, in: Proceedings of International Naval Technology Expo, Rotterdam.
- Geerstma, R., Krijgsman, M., 2019. Alternative fuels and power systems to reduce environmental impact of support vessels. Technical Report. Defence Materiel organisation.
- Geertsma, R., Visser, K., 2017. Energy as a weapon, part ii, in: EAAW VII Symposium Proceedings.
- MARIN, 2020. Sustainable Power Marin. Technical Report. Maritime Research Institute Netherlands.

Michalchuk, B.W., Bucknall, R.W.G., 2014. Co2 reduction design strategies for naval ships, in: Proceeding of the 12th International Naval Engineering Conference.

Middendorp, T., 2014. Fundamentals of Maritime Operations: Netherlands maritime military doctrine. Technical Report. Ministry of Defence.

Ministry of Defense, 2020. 2019: balanceren tussen investeren, moderniseren en herstellen. URL: <https://www.defensie.nl/actueel/nieuws/2020/05/20/jaarverslag-2019>.

NATO Maritime Capability Group 6 on Ship Design and Maritime Mobility, 2011. Specialist Team on Ship Systems Engineering. Technical Report. North Atlantic Treaty Organisation.

North Atlantic Treaty Organization, 2020. Bi-SC Capability Codes and Capability Statements. Technical Report.

van Oers, B., Takken, E., Ducheteau, E., Zandstra, R., Cieraad, S., van den Broek de Bruijn, W., Janssen, M., 2018. Warship concept exploration and definition at the netherlands defence materiel organisation. Naval Engineers Journal 130, 61–82.

Sapra, H., 2020. Potential of combined drive of fuel cell and internal combustion engine (cofaice) for naval ships, in: 15th International Naval Engineering Conference & Exhibition.

Streng, J., 2021. Alternative Energy Carriers in Naval Vessels. Master's thesis. Delft University of Technology. 21-04-2021.

Verbaan, H.J., 2020. Marine engineer, DMO. Consulted: 24-06-2020.