

Bioreceptive Urban Facades:

Integration of Bryophytes Into Facades and Their Impact on External Building Temperatures

Diego Valencia - 4742699

First Mentor: Alejandro Prieto

Second Mentor: Marc Ottele

Delft University of Technology

Track: Building Technology

Table of Contents:

1 Introduction (4)

- 1.1 Urban Environments
- 1.2 Urban Facades
- 1.3 Urban Greening
- 1.4 Bioreceptivity
- 1.5 Facade Integration
- 1.6 Research Question
 - 1.6.1 Sub questions
- 1.7 Methodology
- 1.8 Timeline
- 1.9 Framework Organization

2 Literature Review (14)

- 2.1 Urban Heat Island
- 2.2 Bioreceptivity Research
- 2.3 Bioreceptive Properties
- 2.4 Bryophytes
- 2.5 Bryophytes & Evapotranspiration
- 2.6 Research Reflection
- 2.7 Literature Matrix

3 Facade Guidelines (22)

- 3.1 Key Factors

4 Building Conditions (30)

- 4.1 Building Boundary Conditions
- 4.2 Regional conditions
- 4.3 CFD Wind Analysis

5 Bryophytes (40)

- 5.1 Moss Selection
- 5.2 Biofilm

6 Bioreceptive Material (44)

- 6.1 Material
- 6.2 MPC Mixture

7 Facade Design (48)

- 7.1 Facade Design
- 7.2 Wind and Geometry
- 7.3 Facade Pattern
- 7.4 Panel Production

8 Facade Elements (60)

- 8.1 Facade Assembly
- 8.2 Irrigation System
- 8.3 Maintenance

9 Evaluation (72)

- 9.1 Nomenclature
- 9.2 Calculation Methods
- 9.3 Heat Transfer Results and Discussion

10 Transient Evaluation (80)

- 10.1 Building Transient CFD Analysis
- 10.2 CFD Results

11 Conclusions (86)

- 11.1 Conclusions
- 11.2 Reflection
- 11.3 Further Exploration

Appendix

Abstract:

Rapidly expanding urban developments are having an inverse relationship on the surrounding urban environment. Facades and the materials that they are composed of can have a large impact on the warming of urban microclimates. By reducing or cooling the external surfaces of a facade a building maybe able to offset its contribution to the urban heat island effect. The thesis will help quantify the theoretical impact that this new living facade system can have on external surface temperatures. However, because this is a new facade technique, developing the facade design will also generate the guidelines needed to achieve a bioreceptive urban facade. The resulting facade design will reveal insights and discover the limitations of such an application into urban environments.



Diego Valencia - 4742699

First Mentor: Alejandro Prieto

Second Mentor: Marc Ottele

Delft University of Technology

Track: Building Technology 2019

www.bioreceptive.com

INTRODUCTION

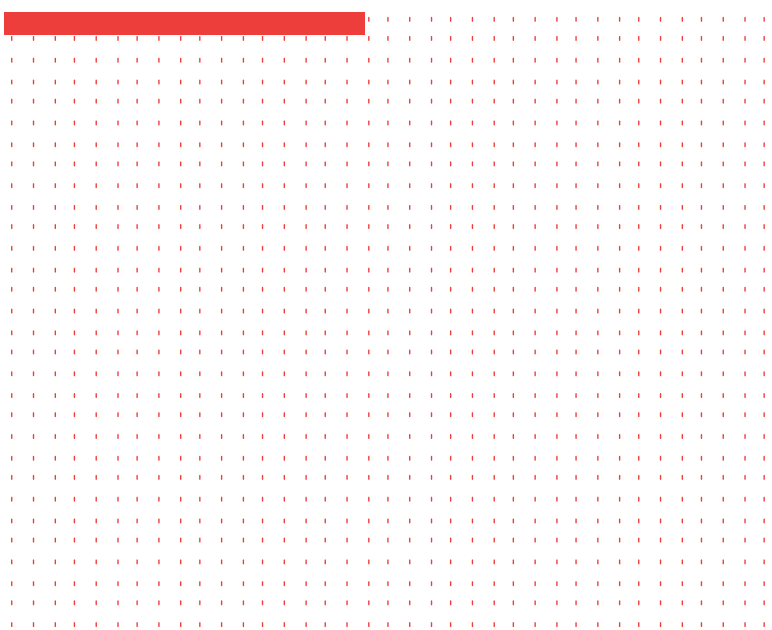

1.1 Urban Environments

In the last few decades urban areas have been rapidly expanding and are projected to continue to grow, with an estimated 80% of the population living in urban areas by 2050. This expansion has created a series of urban environmental problems that poses concerns for the future of our urban environments. Some of these urban environmental problems include poor air quality, lack of urban green, lack of biodiversity, poor stormwater management, Urban Heat Island effect among others. Some of these problems are related directly to the materials that are select for the facade and the way we design with them. Urban Heat Island effect (UHI) is one such problem that has become commonplace in dense cities throughout the world. This has become a growing concern for the built environment, with ambient temperatures in urban areas steadily rising increasing the energy demand for cooling at a city wide scale. Meanwhile, cities who traditionally have had low cooling requirements (such as those in mid/northern europe) now face more intense heat stresses and higher cooling demands to climitize the same space (Ward, Lauf, Kleinschmit, Endlicher 2016). Lastly, UHI has caused a ripple effect and is linked to poor air quality, poor health, poor productivity, higher energy use, among other environmental factors (Klok, Kluck 2018).

1.2 Urban Facades

Currently efforts are being made to tackle the problems of the surrounding urban environment. Some buildings have approached these problems by using advanced materials such as that of Titanium dioxide (TiO₂) coating being used to clean nitrous oxides from the air. Other approaches have used Living Wall Systems (LWS) to provided urban greenery and clean the air while adding thermal insulation to the facade. LWS are just one category of a wide range of green facades types have been developed in the past few decades and have been researched for their potential application into the built environment. Existing research has already quantified the impact such systems have and brought to light some of the benefits and limitations that such a facades may encounter (Safikhani, Abdullah, Ossen, Baharvand, 2014) (Ottelé, 2011).

1.3 Urban Greening

Greening our urban environment has become a priority in densely built areas. Several studies have proven the need for a more biophilic approach in urban design, which can have a wide range of benefits ranging from cleaner air, to psychological benefits and higher worker productivity. However, may of these areas are already built

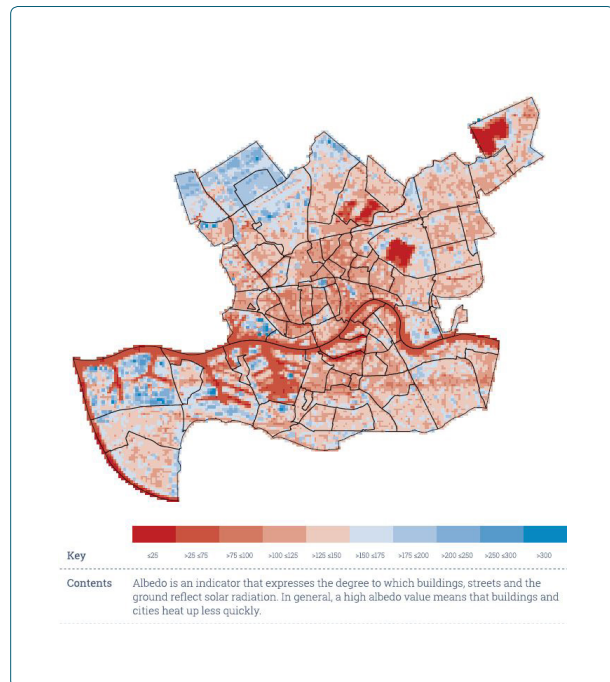

Figure 1 Heat map of Rotterdam Netherlands (Hoeven, Wandl)

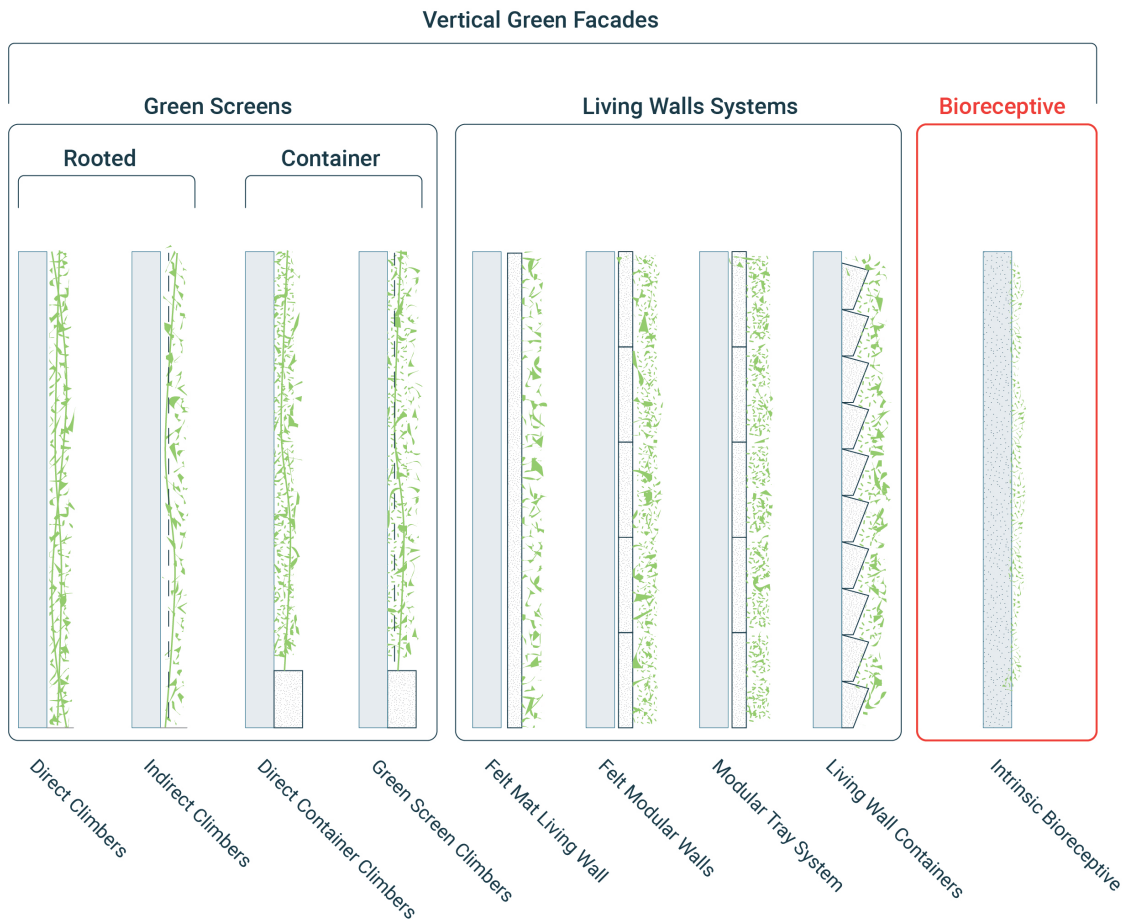

Figure 2 Typologies of current and new vertical green facades.

out and the amount of space is limited, giving rise to vertical applications of greenery. LWS and other types of green facade applications have become a common practice for vertical urban greening and are recommended as a potential way to mitigate UHI heat stress. Yet some issues have prevented these to be implemented on a large scale, including the cost of installations (including additional structural requirements) and the cost of maintaining such as system. In order to have a larger impact on the surrounding urban microclimate these issues need to be overcome.

1.4 Bioreceptivity

In the past few years a new, novel approach to urban green integration has emerged. This new method takes advantage of a set of material properties to promote biological development, known as bioreceptivity (Figure 2). Bioreceptivity has been defined as: *“the aptitude of a material to be colonised by one or several groups of living organisms without necessarily undergoing any biodeterioration”* (Guillitte 1995).

This term encompasses all of the material properties needed to be present to allow the targeted flora to establish and develop on the surface of the material. There are three types of bioreceptivity: extrinsic, semi-extrinsic and intrinsic, illustrated in Figure 3. The ideal type being intrinsic bioreceptivity, characterized when coloniza-

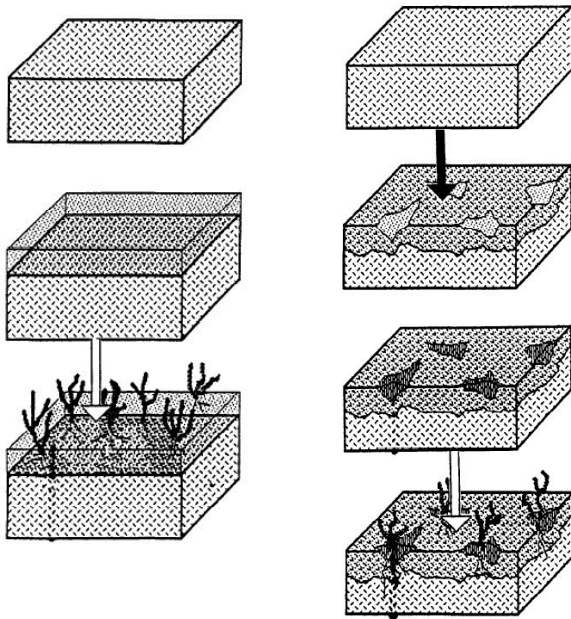

tion depends on the properties of the material, irrespective of exogenous contributions (Guillitte 1995). This level of bioreceptivity does not require external processes or conditions to achieve growth and should thus be the goal when pursuing bioreceptive building materials.

Currently research is being conducted on the application of bioreceptive materials for the built environment and understanding how to successfully colonize such a material with bryophytes (mosses, lichens, hornworts and liverworts). Only in the past few years has the topic been researched at an academic and science level. Based on the available research, the main characteristics that have been investigated are the material properties needed for biological colonization. Initial results have revealed some key insights for the material properties needed, this includes: pH level, porosity, permeability, water absorption and surface roughness. It is important to note that after a literature review on the topic much more needs to be understood about the characteristics needed for successful colonization and which materials are suitable for long term applications.

Recent research and experiments being conducted focuses primarily on Bryophytes as the targeted flora to be established on the material. The reason being is that Bryophytes, such as mosses, lichens, hornworts and liverworts, are nonvascular plant specimens and as

Figure 3 Types of bioreceptive materials (Guillitte 1995).

such do not develop complex root systems and other complex cellular structure like xylem (wood). Having a smaller profile and no root systems makes this the ideal specimen to grow on the exterior of the facade and removes the requirement of having soils as a growing medium. This reduces the weight of the soil and the need for active irrigation systems. However, current estimates place the number of bryophyte species at 16,000 of which about 10,000 are mosses, allowing for a wide variety of options between species that needs to be selected with regards to the growing medium.

1.5 Facade Integration

Given the current level of research, enough knowledge can be gathered on the topic to support the feasibility of bioreceptive materials in urban environments. Therefore it should be possible to design a facade based on the criteria defined by the current research. By adhering to the predetermined characteristics, biocolonization can occur on the skin of the building. Marcos Cruz and Richard Beckett

Figure 4 3D printed bioreceptive prototype panels (Cruz, Beckett)

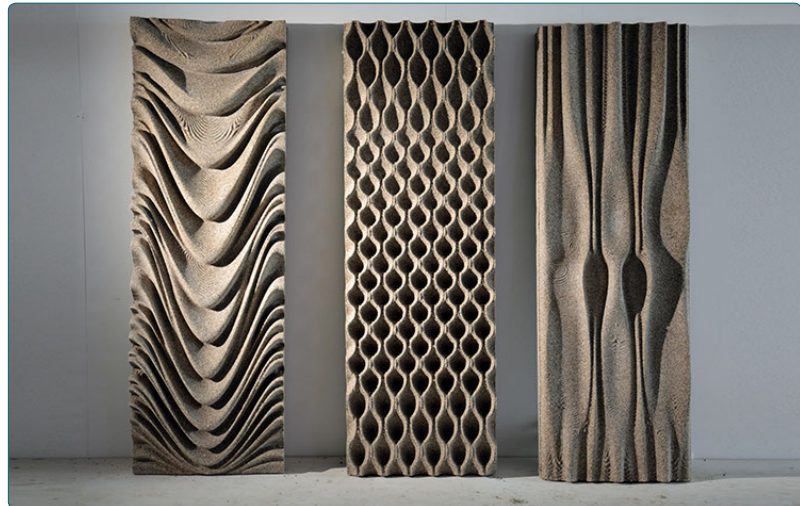

are currently researching this application at Bartlett, UCL and describe the idea as: “Where the metaphor for green walls might be seen as that of the ‘garden’ bolted onto a vertical surface, a more biologically intelligent idea might be that of tree bark, whereby the building material or façade itself acts as a host to propagate living microorganisms, cryptogams, and other more complex plants.” Cruz and Beckett refer to this as ‘Architectural Bark’; a new notion of an extensively used metaphor of building envelopes as a ‘skin’ that has become common in contemporary architectural design. Their current research explores the use of 3D printed cement mixtures to assist in biointegration (Figure 4).

Integrating bioreceptive materials into urban facade raises questions beyond that of the material being used. Although it would be possible to achieve in theory, another question to be asked is what is the benefit of making such an effort? Based on existing moss research it would be possible to deduce that this would have an

impact on air purification and improve urban greenery. Yet there is a much larger potential for such an application. As defined previously, the overheating of urban surfaces poses many problems for urban environments and given the physiology of mosses, it would be relevant to investigate what impact this type of facade might have on the surrounding urban microclimate.

1.6 Research Question

The resulting research question is as follows: How can bioreceptive materials be integrated into urban facades to reduce external facade surface temperatures?

1.6.1 Sub questions

In addition to the main research question, additional questions are needed to investigate and adequately answer the primary question. The sub questions are as follows:

What materials can be used that meet the requirements of a building facade as well as meeting the required properties of a bioreceptive material?

Which bryophytes (mosses, liverworts and hornworts) are suitable for vertical urban facades in the given site conditions?

What are the additional required systems to be integrated into the facade in order to successfully maintain facade growth (i.e. irrigation, sensors)?

What influence will this facade have on the external temperature of a building?

1.7 Methodology

The framework for this thesis is primarily divided into three sections each of which is based on the results of the previous phase in a linear fashion. In this way it can become clearer to understand the complexities of the integration of the materials into the facade.

Literature Review:

It is important to gather and absorb the different research that is at the forefront of this newly developing material technique and understand the many factors involved. The first goal of the review is to generate the materials properties that are suitable for the production of materials needed for the bioreceptive facade. The second goal is to understand the problems of the Urban Heat Island effect and understanding how urban microclimates work. This will focus on researching bioreceptive materials, bryophyte (mosses, liverworts and lichens) habitats and species, biofilms, materials composition, UHI effect and urban microclimates. This will be used to develop the design criteria needed to create and produce the facade

elements. Another result of this stage is to define the boundary conditions for the location and size of the facade.

Facade Design:

Based on the information gathered from the literature review, the design criteria will be generated to act as a set of guidelines for the facade design. Some stages of the facade design are inline with the current methods of facade design and fabrication. This includes developing the design of the facade elements and detailing the required components and systems. However, an integral part of this thesis is determining the production processes necessary to develop biocolonization on the material being used for the facade. This will involve designing a facade system for a building scale but also the material at a micro scale. Additionally the design needs to take into account how such a facade will be produced, monitored and maintained. With adequate time, material samples can be analyzed and observed to provide further insights.

Evaluation:

Based on the developed facade design, the elements and facade as a whole will be analyzed and simulated. This will involve measuring the facade at a component level but also at an urban level to measure how this facade may impact its surrounding microclimate. This will be accomplished through hand calculations with the aid of heat balance equations and simulations using CFD software. Some simulation and analysis softwares to be used are as follows: Grasshopper/Ladybug/Butterfly, Autodesk CFD, among others. After which the facade would be redesigned and analyzed once again to determine what factors are more likely to have an impact on the surface temperatures and the surrounding microclimate.

After these stages, the thesis will conclude by reflecting on the potential application of the facade, the feasibility of integration and the limitations discovered throughout the process. As a part of the conclusions the thesis will discuss future improvements and explorations that can be further investigated.

1.8 Timeline

Following the framework of the methodology the timeline of the thesis will be as outlined in Table 1. The approach is fairly linear with some repetition to allow for redesigning elements and reevaluation. Other sections will be revisited to add any supplemental insights that are gathered throughout the research and design process.

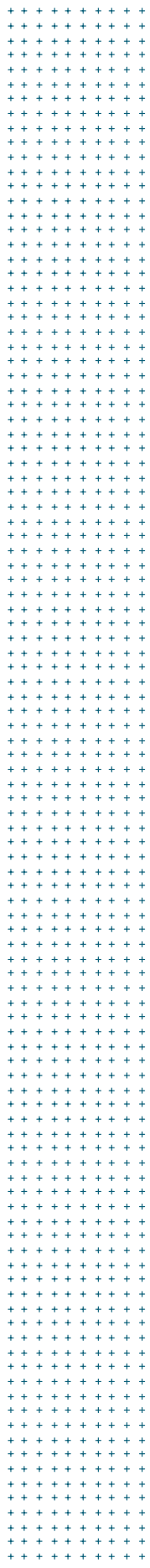
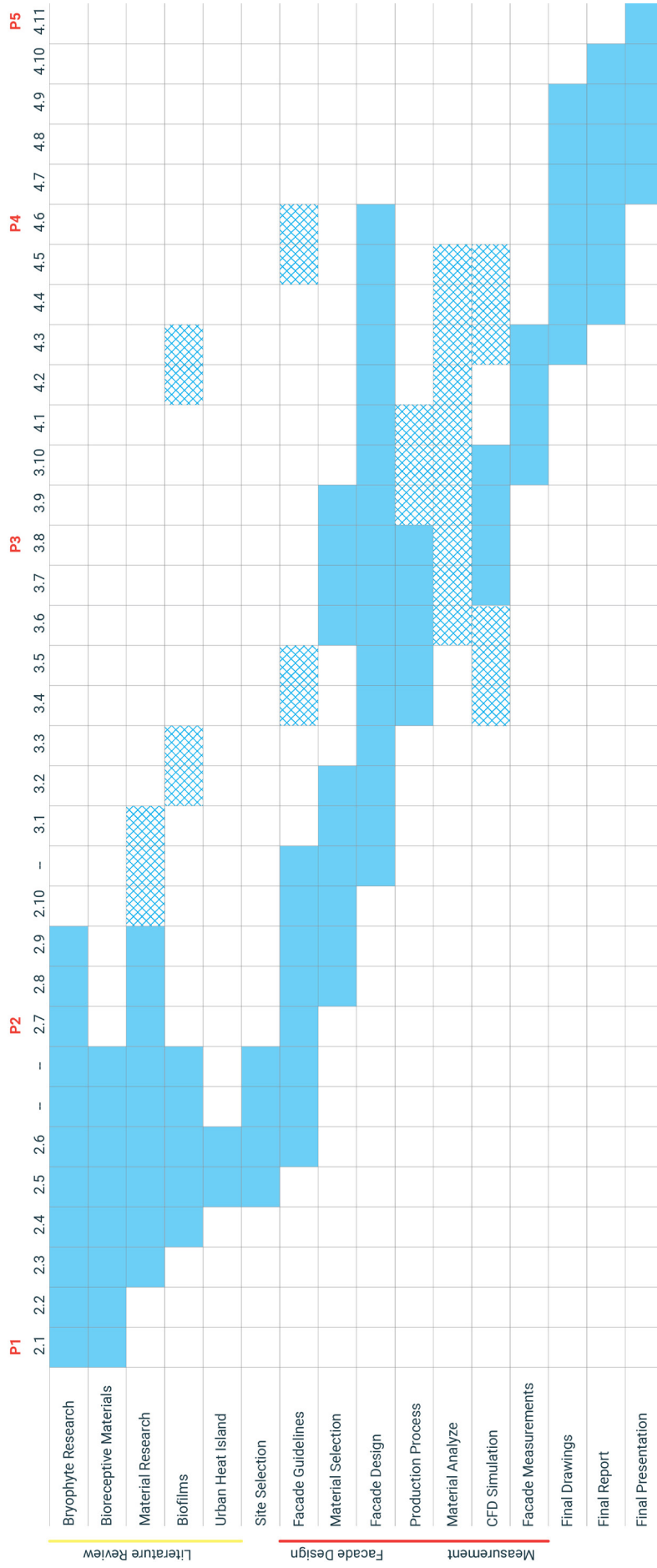

Table 1 Thesis timeline for TU Delft 2018-2019 academic year, Hatched areas are indicative of a deviation.



1.9 Framework Organization

The diagram below describes the organization of the research framework, outlining the sequence and the relationship between different stages in the design (Figure 5). Three key factors of the research phase will be the foundation for the rest of the thesis. These are interlinked; a decision made for one aspect of the bioreceptive material can influence the result of another. This can lead to multiple possibilities that can be further refined or optimized.

Figure 5 Thesis framework

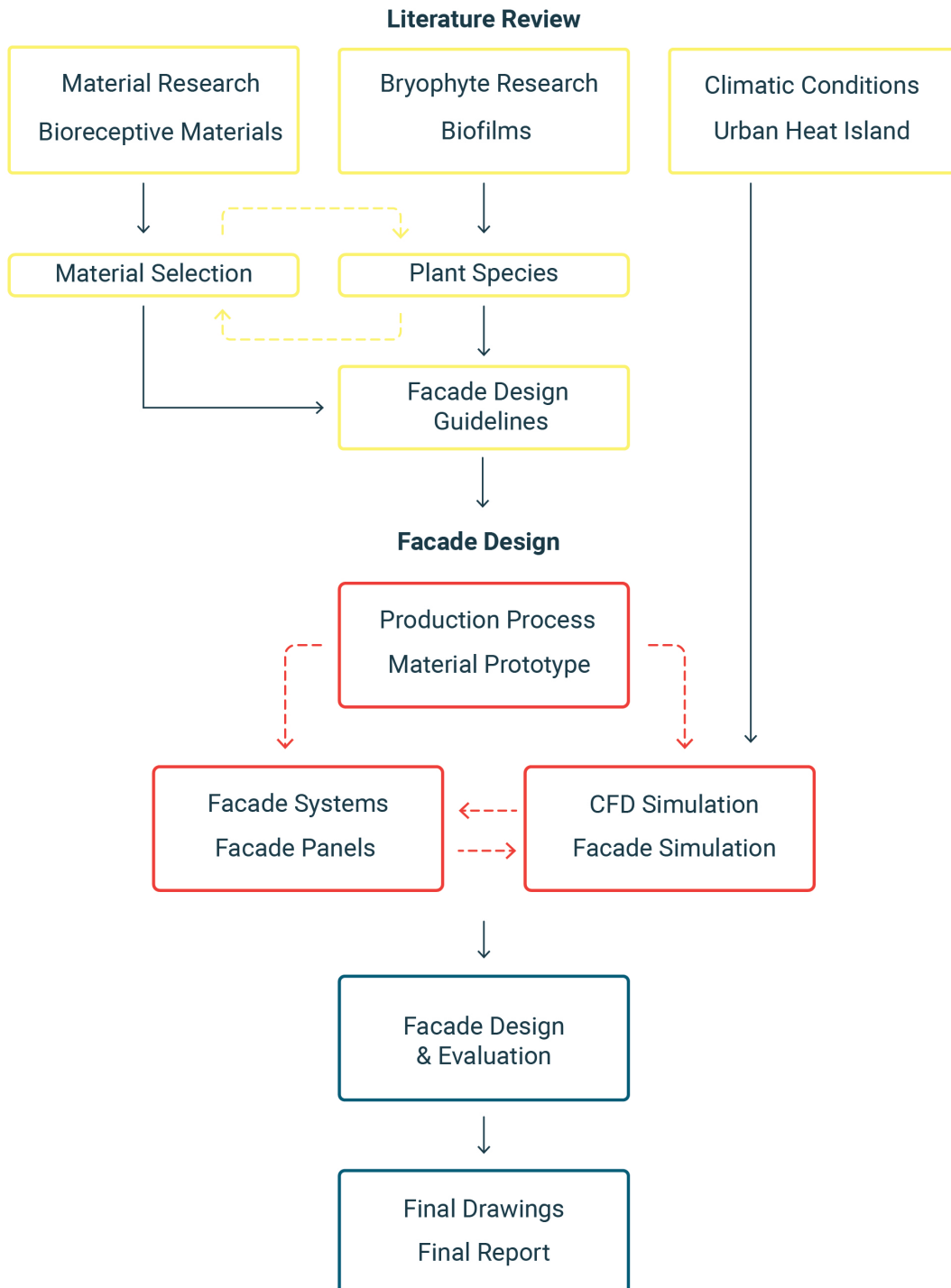

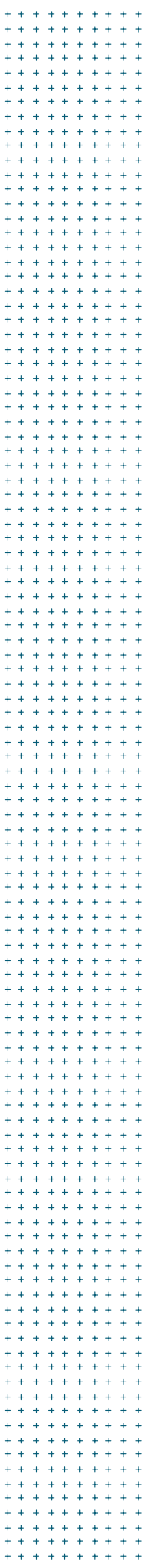

LITERATURE REVIEW

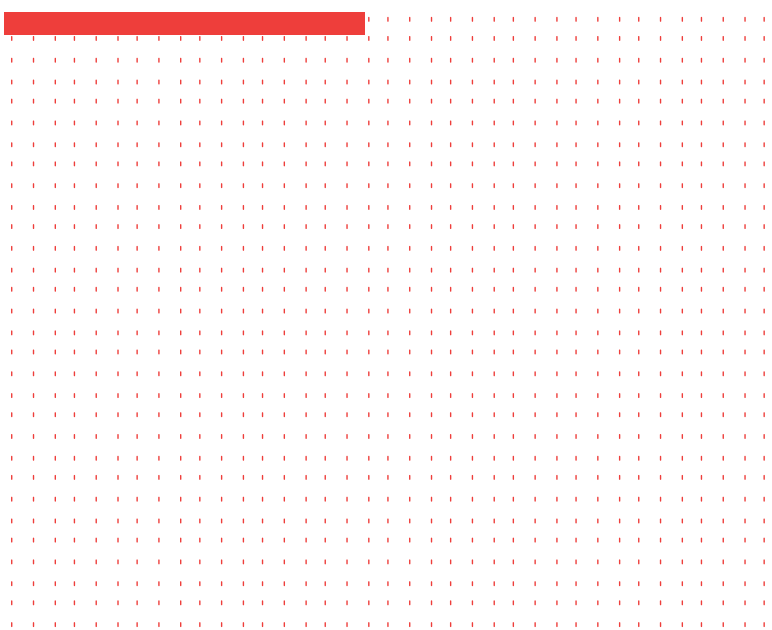

2 Literature Review

To address the urban heat island effect and application of bioreceptive materials a review of current research is necessary. The aim of this research is to building up a baseline of knowledge that can be utilized during the facade designing stages of the thesis. The literature review begins by investigating the urban heat island effect and how facade materials impact the surrounding environment. In particular, this will focus primarily on Rotterdam and Europe. After understanding the problems at hand the literature review will continue on with the primary research focus, bioreceptivity. In conjunction with this research the colonization species will be investigated. Lastly, based on the information gathered material research will commence. Based on the outcomes of the bioreceptivity research, materials that meet the conditions for bioreceptivity and the built environment will be investigated for the desired properties.

2.1 Urban Heat Island

The approach of this thesis is that of an urban facade which influences the surrounding environment in a positive way. Of the many urban environmental problems present in our urban areas, urban heat island effect was chosen as the primary problem to be addressed. This research will have primary focus on European cities and takes the city of Rotterdam, The Netherlands as a primary case study.

The urban heat island effect can be generally described as an urban phenomenon where a combination of factors influence the surrounding microclimate causing an increase in the ambient temperature (Figure 6). Some of the key factors that create this phenomenon are street canyon geometry and the amount of artificial surfaces with increased emissivity (Ward, Lauf, Kleinschmit, Endlicher 2016). This phenomenon has been extensively researched in the past decades and has been well documented however strategies to mitigate this problem have been limited. One factor which has been commonly proposed is the integration of urban greenery which can absorb solar radiation rather than retaining heat (Delta Programme 2015).

Current research on the topic reveals the how growing heat stress impacts our built environment in multiple ways. The Dutch Delta Programme (2015) outlines some of the urban issues the Netherlands faces, some of which includes:

- A decrease in interior comfort in houses, offices and other buildings
- An increase in energy demand for cooling
- An increase in water demand



Figure 6 Urban Heat Island, aerial heat map of an urban downtown center, NASA

- Changing patterns in flora and fauna (mosquitoes, ticks and blue algae)

The report released by the Delta Programme (2015) outlines the impact that heat stress has had in The Netherlands and the link to many heat wave related deaths in the past. In 2006, a heatwave in Rotterdam led to over 600 heat related incidents at medical general practitioners (Klok, Kluck 2018). A study of 70 European cities with urban heat islands revealed how global climate change will exacerbate the problems caused by the urban heat island effect and prolong the effect of heat waves (Ward, Lauf, Kleinschmit, Endlicher 2016). The same study also relieved how colder climate cities experience more extreme heat waves than those of more temperate regions, Rotterdam being one such city.

Rotterdam in particular has an urban heat island which can be characterized by a combination of several factors. An analysis of Rotterdam conducted by researchers at TU Delft observed the following physical UHI factors: Surface water, surface albedo, vegetation indexes, shadow, sky view factor, building volume and building envelope (Hoeven Wandl 2015). Of these factors the ones directly related to this research are surface albedo, vegetation index (relevant for latent heat and heat absorption) and building envelope. The building envelope material is an important factor in this regard, due to the degree of solar exposure and the heat given off at night.

2.2 Bioreceptivity Research

Bioreceptivity has been defined as: “the aptitude of a material to be colonised by one or several groups of living organisms without necessarily undergoing any biodeterioration”(Guillitte 1995). This term encompasses all of the material properties needed to be present to allow the targeted flora to establish and develop on the surface of the material. This phenomenon occurs naturally both in the natural world and in urban environments without the need for human intervention. In our built environment biological films/crusts have developed on the facades of building over several years and it is often seen as a sign of deterioration with substantial efforts made to remove them. However, this is often a misconception and often are not the primary factor for building damage (Gulotta, Villa, Cappitelli, Toniolo 2018).

It has been a well observed over the centuries how living organisms have sporadically integrated themselves into manmade environments. This colonization of algae, lichens, fungi, moss and other living organisms onto the surface of materials is often referred to as a biofilm or a cryptogamic crust (Miller, Sanmartín, Pereira-Pardo, Dionísio, Saiz-Jimenez, Macedo, Prieto 2012). Although it can appear to occur effortlessly, there are many urban and bioreceptive factors can contribute to the success or failure of the development of biofilms. A handful of research groups have been investigating the topics of biofilms and biocolonization with regards to biorecep-

tive materials attempting to recreate the phenomenon.

2.3 Bioreceptive Properties

The aim of the bioreceptivity research was to discover what materials properties are necessary to develop and sustain a biofilm as well as which materials have shown promising results. It is important to note that there is not a clear consensus as to all the factors that influence bioreceptivity but it is clear that both physical and chemical properties have a role (Miller, Sanmartín, Pereira-Pardo, Dionísio, Saiz-Jimenez, Macedo, Prieto 2012). Researchers at the Universitat Politècnica de Catalunya, UPC have proposed that pH is a key factor for cementitious materials and a more pH neutral binder is needed to increase bioreceptivity; see Figure 7 (Manso, Mestres, Ginebra, De Belie, Segura, Aguado 2014). Other researches in more tropical conditions have concluded that capillary water absorption along with pH value are the main factors for moss colonization (Udawattha, Gal-kanda, Ariyaratne, Jayasinghe, Halwatura 2018). Other research conducted, revealed that capillary water functions and open porosity have a greater influence on natural stones, such as granite and limestone (Miller et al. 2012).

From the research mentioned above a list of material properties was generated based on the potential effect on bioreceptivity.

- pH value
- Water absorption
- Porosity
- Surface roughness
- Mineralogical nature

Beyond the material properties there are other factors that can influence the successful application of a biofilm. Climatic conditions can affect the attachment of a biofilm. A recent study has shown how microgrooves on the substrate material can influence colonization. Wind movement along the surface of a material can create tension and remove the cells from the surface, by providing microgrooves the microalgae cells could anchor themselves to the surface (Huang, Zheng, Li, Liao, Fu, Xia 2018). In doing so, tiny vortex was created providing some protection to developing cells. This enhancement was able to increase the concentration of the biofilm and shows how surface texture can factor into the material design.

Of the three types of bioreceptivity (extrinsic, semi-extrinsic and intrinsic) outlined by Guillitte, the ideal type for a building material would be of intrinsic bioreceptivity which is characterized “when colonization depends on the properties of the material, irrespective of exogenous contributions” (Guillitte 1995). Currently some materials

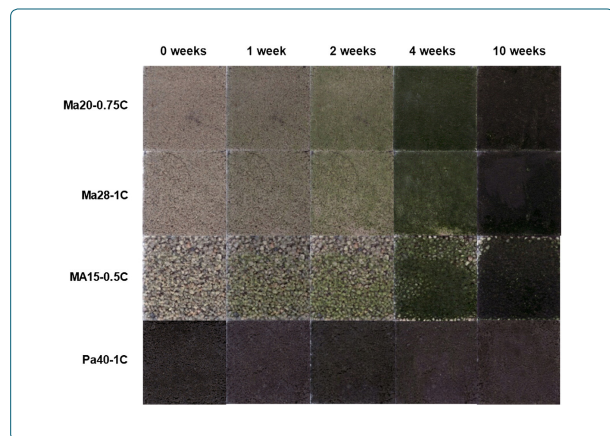

Figure 7 Material testing for bioreceptivity (Manso, Mestres, Ginebra, De Belie, Segura, Aguado 2014)

are being developed to achieve intrinsic bioreceptivity. One of the more promising investigations is the development of cementitious materials at Universitat Politècnica de Catalunya for this purpose. Their research involves replacing traditional portland cement with magnesium phosphate cement (MPC) to bring the pH of the material down to a more neutral level and allow for better bioreceptivity (Manso, De Muynck, Segura, Aguado, Steppe, Boon, De Belie 2014). Their initial results have been promising showcasing a potential bioreceptive material that can be utilized in the built environment. Manso's is currently developing the material in partnership with a cement company in Spain and as of this writing, little has been published about the material.

2.4 Bryophytes

In order to successfully develop a bioreceptive material, the material and the living organisms have to be understood. The previous mainly focused on the key material properties to look for but it is just as important to understand the desired species that will colonize that surface. An ideal candidate for this integrated green facade are

bryophytes. Bryophytes are comprised of mosses, liverworts and hornworts, a group of nonvascular plants which have only simple cell tissues which do not develop complex cellular structure such as root systems or woody tissues (Glime 2017). This is a significant distinction that makes them the ideal candidate for this application, they require no soil and receive their nutrition from air and water (Glime 2017). Additionally, the compact structure of flora adds only a thin layer of dense green on the surface, adding a small amount of weight to the surface (Figure 8).

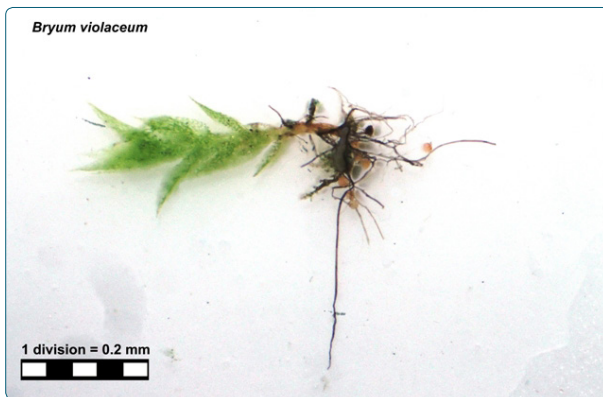

Figure 8 Magnification of a moss structure (Glime 2017).

Also, unlike conventional plants, they reproduce via spores or can grow from cloning and do not require replanting to maintain themselves over time (Reski 2018). These factors among other makes them an ideal candidate for this new green facade, however bryophytes are a large collection of different species and only a handful need to be selected for this purpose.

The natural habitats for these species are also very diverse and can be found in some of the most extreme climates on Earth. They are capable of withstanding long periods of drought while others can withstand the frigid cold temperatures of antarctica (Glime 2017). The resilience of the species makes them diverse enough to survive our harsh urban microenvironments which are particularly contaminated. Current research places moss a plant with a high potential to collect particulate matter for air purification and are now being commonly used as a biomonitor within cities (Goryainova, Vuković, Urošević, Vergel, Ostrovnya, Frontasyeva, Zechmeister 2016). However successful they may be at air purification, the physiolo-

gy of the moss can also be impacted negatively, damaging the cell membrane when there is a high concentration of metallic elements (Sujetovienė, Galinytė 2016). It is therefore important to note that there are limitations.

2.5 Bryophytes & Evapotranspiration

Beyond air purification via photosynthesis, mosses also have the advantage of cooling the surrounding area through evapotranspiration. Bryophytes perform this process by transferring water from the lower sections to the upper tips of the plant where it then evaporates and cools the surrounding air (Glime 2017). This occurs on a very small scale but in essence this acts as a tiny evaporative cooler. This cooling is beneficial both for the moss (helping prevent moisture loss) and the building. A recent laboratory analysis of moss green roofs tested the cooling potential of mosses in a simulated urban application. The study determined that moss moisture and wind velocity were some of the key determining factors for cooling (Katoh, Katsurayama, Koganei, Mizunuma, 2018). The latent heat driven by the evaporation of the moss moisture was the dominating factor and when wind velocity increased so did the rate of evaporation. So long as the moss retains water this process can become an effective way of cooling. The laboratory investigation had resulted with a Bowen ratio (proportion of convection heat to latent heat) of .42 as a baseline, and with latent heat and wind, that ratio dropped as low as .02, see Figure 9 (Katoh, Katsurayama, Koganei, Mizunuma, 2018). Taking this into account, during drier and hotter periods it would be important maintain some moisture on the moss to keep the species from going dormant and while still maintaining evaporation.

Based on the given location of The Netherlands, regionally available mosses will be the preferred species. The Dutch Bryological and Lichenological Society provide a resource for different native species commonly found in the region and will be utilized in the selection of the species. Other important considerations for species selection are as follows:

- Drought tolerance and humidity requirements
- pH requirements of substrate
- Natural Biomes
- Moss character (compact, clustering)
- Solar exposure
- Growth rate
- Frost tolerance (hardiness)

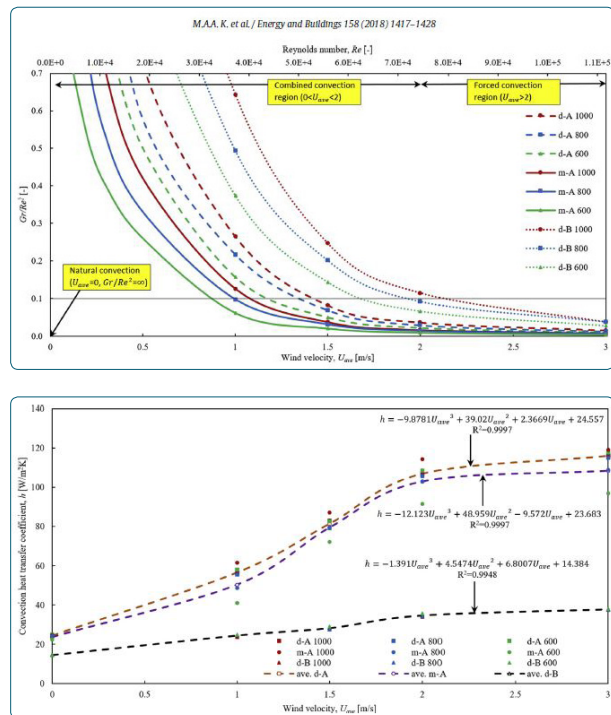

Figure 9 Moss Bowen ratio (above) and convection coefficients (below), observed by Katoh, Katsurayama, Koganei, Mizunuma (2018).

2.6 Research Reflection

Given the research that is available at the time of this thesis it is important to note that the concept of using bioreceptive building materials is still in development. There are still many factors that need to be further investigated in order to understand the complex conditions necessary for a successful material. Additionally, the application of a bryophyte biofilm is dependent on a successful match between material and species which requires a high understanding of materials and biological processes. Initial research showcases the method as a proof of concept with only a select few materials being actively investigated. However, there is a potential to investigate other materials that meet the same material requirements.

This research should be further categorized and translated into key parameters that can be used as inputs for the facade design. Some of the sources cover multiple topics and share similarities between each other. However, the concept covers a broad range of fields and only a few research journals touch upon these. Thus, categorizing them would simplify the process of translating the research into a facade cladding system.

2.7 Literature Matrix

Table 2 shows the relationship between the different sources utilized in the bibliography. The matrix shows the overlap between the underlying research and the different categories being investigated in the thesis. The table shows how different sources cover multiple research topics, however there is no adequate source that covers the full spectrum of the concept of bioreceptive materials as a building material. The thesis will condense all of these subjects into one all encompassing report.

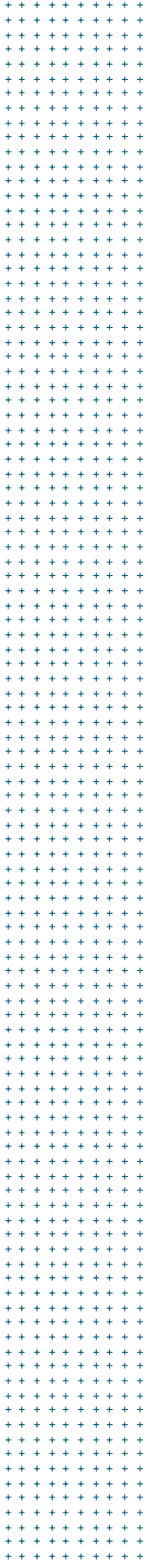
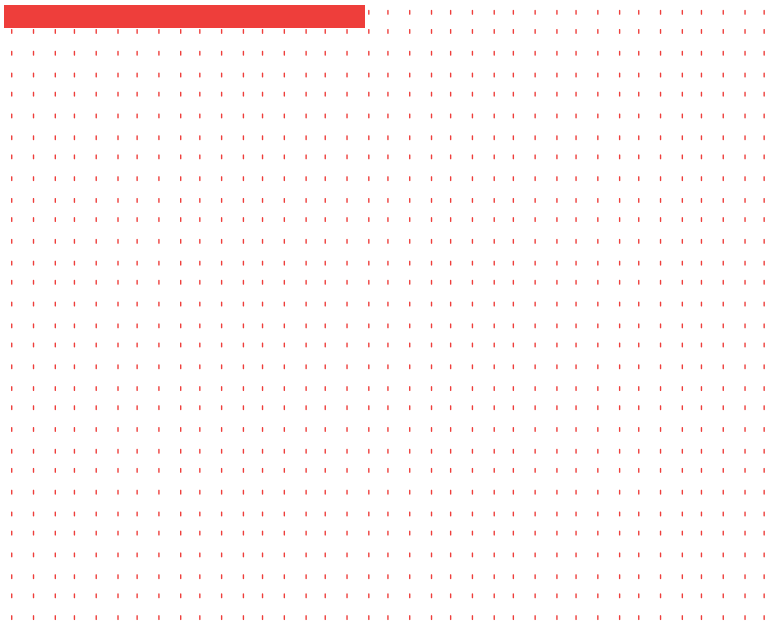

Table 2 Literature matrix

Theme / Source	Bioreceptivity	Materials	MPC	Biofilm	Bryophytes Biology	Moss Selection	Moss Habitat	Urban Green Facades	Urban Environment	Urban Heat Island (UHI)	UHI Netherlands
Working on the Delta. The Decisions to Keep the Netherlands Safe and Liveable									X	X	X
Assessment of vertical element distribution in street canyons using the moss <i>Sphagnum girgensohnii</i>							X		X		
Bioreceptivity: a new concept for building ecology studies	X	X		X							
Biofilm colonization of metamorphic lithotypes of a renaissance cathedral exposed to urban atmosphere	X			X					X		
Enhancing microalgae biofilm formation and growth by fabricating microgrooves onto the substrate surface.	X	X		X							
Reasons to adapt to urban heat (in the Netherlands)									X	X	X
Bioreceptivity evaluation of cementitious materials designed to stimulate biological growth.	X	X	X	X							
Development of a low pH cementitious material to enlarge bioreceptivity.	X	X	X	X							
Bioreceptivity of building stones: A review.	X			X							
The Green Building Envelope								X	X		
Quantitative moss cell biology.					X	X	X				
A review of energy characteristic of vertical greenery systems.								X			
Effects of the urban environmental conditions on the physiology of lichen and moss.					X		X		X		
Mold growth and moss growth on tropical walls.					X						
Heat waves and urban heat islands in Europe: A review of relevant drivers	X	X									
Bioreceptive design: a novel approach to biodigital materiality.	X	X		X	X	X		X			
Preparation and properties of magnesium phosphate cement foam concrete with H2O2 as foaming agent		X	X								
Dutch Bryological and Lichenological Society					X	X					
Effects of convection heat transfer on Sunagoke moss green roof: A laboratory study.					X				X	X	
Hotterdam. How space is making Rotterdam warmer, how this affects the health of its inhabitants, and what can be done about it								X	X	X	X
Bryophyte Ecology				X	X	X	X				

FACADE GUIDELINES





**Environmental
Conditions**

+



Bryophytes

+



**Bioreceptive
Material**

Key Factors:

Based on the results of the literature review it is clear that certain conditions need to be met to achieve a successful bioreceptive facade. A series of guidelines were created to translate the research into a design criteria. These can then be utilized as a series of inputs that can be used to influence the facade design and the systems needed. This helps to facilitate a physical form generated from the supporting research.

From the guidelines, it is clear that there are three key aspects that need to be addressed in order to create a successful bioreceptive facade. The first factor are the environmental conditions present in the location where the facade is to be implemented. This includes but is not limited to the humidity, rainfall, solar irradiation, wind speed, wind direction and surrounding urban conditions. These are all external conditions that are imposed upon the facade.

The second aspect is the ecology of the bryophytes. This includes the ecological conditions needed for successful growth and survival of mosses and other bryophytes. This also includes the awareness of what materials or chemicals can be detrimental to bryophytes. Additionally, the development of a biofilm is also observed to establish the bryophytes.

The last key factor is the material properties of the cladding. Not only does the material have to function as a proper envelope for the building, but as a host to the species being applied to the panel. This aspect covers the material properties needed for a bioreceptive material and the ability to shape the geometry to improve the chances of successful bioreceptive facade.

Source:

Enhancing microalgae biofilm formation and growth by fabricating microgrooves onto the substrate surface.

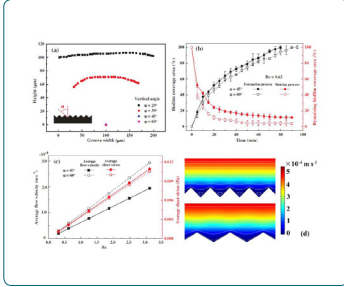

Huang, Y., Zheng, Y., Li, J., Liao, Q., Fu, Q., & Xia, A. et al. (2018)

Surface Grooves and Wind:

Grooves on the surface of a material can create turbulence along the surface, forming pockets of air with lower wind speeds that would otherwise not exist. A tiny vortex can be created providing some protection to developing cells. This increases the concentration of the biofilm and shapes the geometry of the material. This factor can be further adjusted to find an optimal geometry.

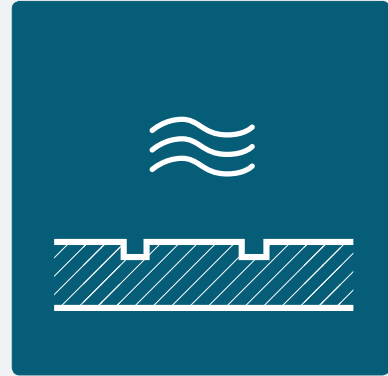

Source:

Bryophyte Ecology [Ebook]. Michigan Technological University and the International Association of Bryologists.

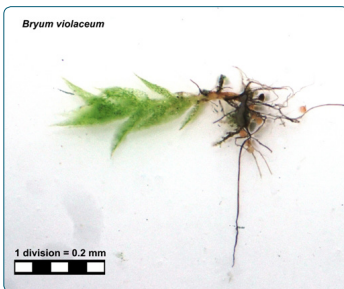

Glime, J. (2017)

Rooting Surface:

Bryophyte spores are often carried by the wind; higher wind speeds can simply push the spores away from the surface. As a result, mosses usually spread into areas where spores can settle, like crevasse in stone or bark. These spaces can allow for a protected space for the establishment of the bryophyte. Because the rhizoids are only a few micromillimeters wide the substrate needs only a poresize that can provide enough space for the specimen to anchor itself.

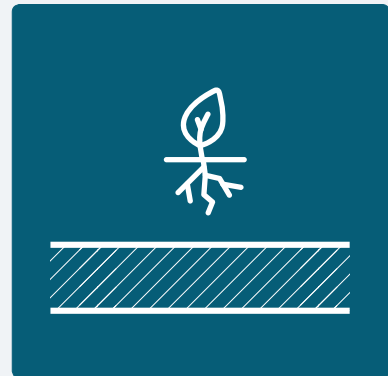

Porosity:

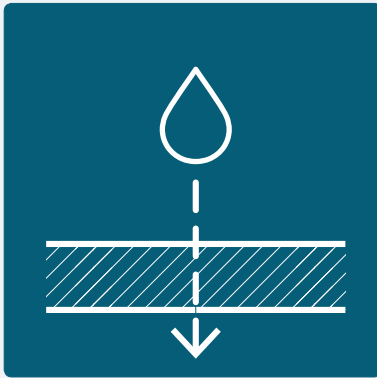

Most natural materials where bryophytes naturally grow have predefined porosities that change over a period of time until it reaches a suitable level for growth. Porosity is one of the key determining factors for bioreceptivity. However, most of the underlying research does not quantify this property with a value, instead it is typically described as: the higher the porosity is better.

Source:

Bioreceptivity of building stones: A review.

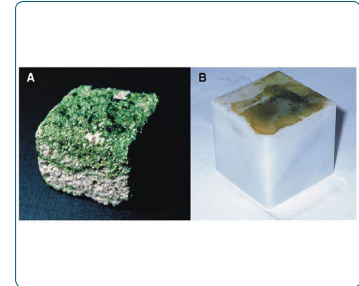

Miller, A., Sanmartín, P., Pereira-Pardo, L., Dionísio, A., Saiz-Jimenez, C., Macedo, M., & Prieto, B. (2012)

pH Level:



The material acting as a substrate should have a pH level that is as neutral as possible. In fact, most bryophyte species prefer slightly acidic substrates rather than alkali ones. However, most cementitious materials are highly alkali reaching levels above 12 pH and require carbonation to occur to naturally reduce the pH of the surface. Alternative materials can be investigated to reduce the pH level.

Source:

Development of a low pH cementitious material to enlarge bioreceptivity.

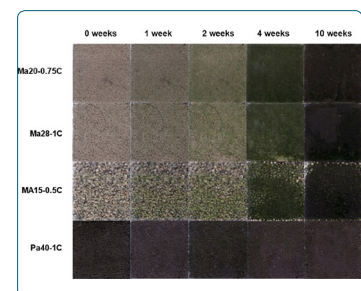

Manso, S., Mestres, G., Ginebra, M., De Belie, N., Segura, I., & Aguado, A. (2014).

Source:

Mold growth and moss growth on tropical walls.

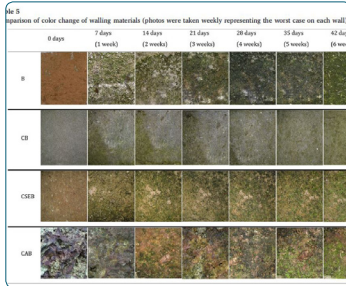

Udawattha, C., Galkanda, H., Ariyaratne, I., Jayasinghe, G., & Halwatura, R. (2018).

Surface Moisture:

Increasing porosity and creating an open cell pore structure creates a more permeable material that is capable of retaining water for longer periods of time. By retaining water from rain events, the water can then be released afterwards to provide a supplemental source of water for the bryophytes. This can further reduce the need for irrigation.

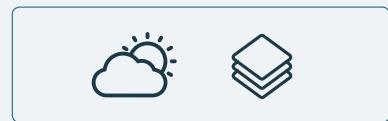
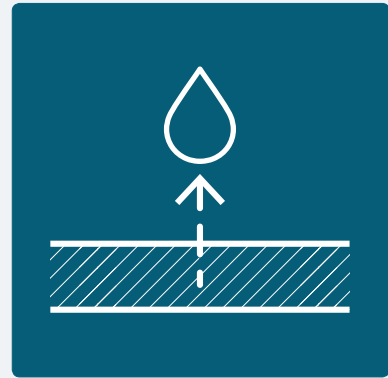

Source:

Preparation and properties of magnesium phosphate cement foam concrete with H2O2 as foaming agent.



Li, T., Wang, Z., Zhou, T., He, Y., & Huang, F. (2019)

Material Dimensions:

The disadvantages of having a material with a higher porosity and pore size creates weaker and more brittle materials. To counter this, a thicker material should be created to prevent cracking. Alternatively reinforcement can be added to the material to prevent cracks from developing.



Irrigation:

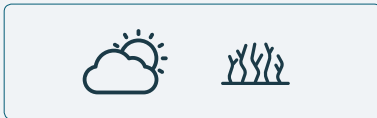
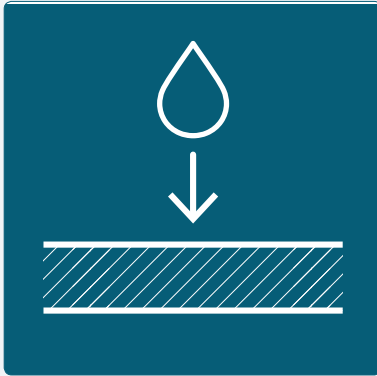

Extreme wind are present at higher elevation which increases the evaporation rate, causing some areas to dry out faster than others. Active irrigation can prevent this from occurring. Although it may not be actively used, an irrigation system may be needed during periods of low rainfall to prevent dormancy and die off. Bryophyte desiccation can damage the cells of the bryophytes.

Source:

Irrigation of 'Green walls' is necessary to avoid drought stress of vegetation

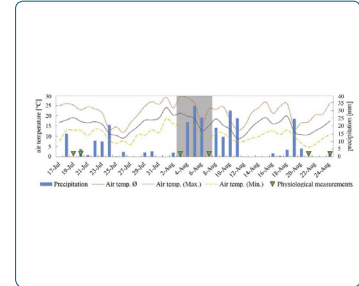

Medl, A., Florineth, F., Kikuta, S., & Mayr, S. (2018)

Facade Metals:



Some metals are toxic to bryophytes, this includes zinc, copper, lead and mercury. Zinc and copper are commonly used for facade systems and should be avoided or covered. Alternatively, aluminum, stainless steel and coated steel are good alternative building materials.

Source:

Bryophyte Ecology [Ebook]. Michigan Technological University and the International Association of Bryologists.

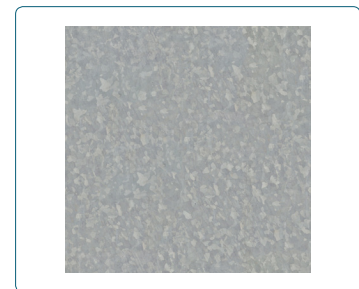

Glime, J. (2017)

Source:

Bryophyte Ecology [Ebook]. Michigan Technological University and the International Association of Bryologists.



Glime, J. (2017)

Water Source:

Rainwater runoff should be properly filtered for metals and contaminants before being used as an irrigation source. Other chemicals such as Chloride should also be avoided. This can be achieved with sand and charcoal filtration systems. This will also improve the lifespan of the irrigation system.

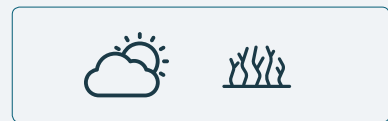

Source:

Bryophyte Ecology [Ebook]. Michigan Technological University and the International Association of Bryologists.



Glime, J. (2017)

Nutrition:

Bryophytes gain their nutrients from air and water, not soil; as is common in vascular plants. Given no natural organic matter is present in high urban conditions such as a building facade other methods need to be used to fertilize the specimens. One way to achieve this is by using liquid NPK solutions as a supplement to the irrigation system.



Solar Exposure:

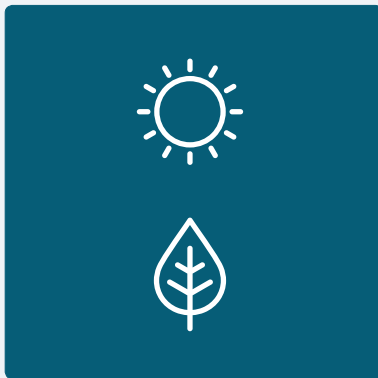

Solar orientation of the facade panel can be a determining factor for the species selection. Different sun exposures can be suitable for different specimens and the ideal conditions for the species should be selected. Additionally, a sudden change in solar orientation can cause the bryophyte to go into shock and stunt growth.



Source:

Bryophyte Ecology [Ebook]. Michigan Technological University and the International Association of Bryologists.



Glime, J. (2017)

Facade Inputs:

These key factors for a bioreceptive facade will provide the foundation for the development of the facade design. They are important for the implementation of the research into a physical design. These can be utilized as a series of inputs and conditions for the design and the function of the system. However, it is important to note that some of these factors are more significant than others and should be looked at with more consideration.

Surface grooves and material porosity are two important drivers to the design. While all others remain important factors, these emphasized factors can be taken as an adjustable variable that can be altered and evaluated. For example: Material pH is a material property that has to approach a neutral pH level that can satisfy the requirements for moss growth, but surface geometry can be altered a variety of ways to achieve turbulence along the surface. This can create a changing variable that can be investigated further in the facade design.

Building upon the information presented in this chapter, the following sections of this thesis explores the three main categories environmental conditions, bryophytes and material. Using the previous research as a series of inputs, each category will be investigated to a higher degree of detail to discover the influences that these guidelines will have on the facade design system.

BUILDING CONDITIONS

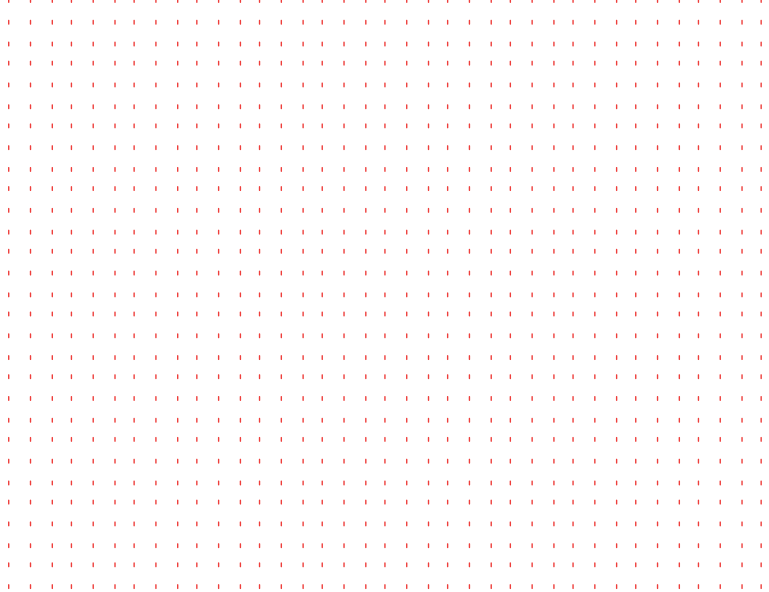

4.1 Building Boundary Conditions

The facade cladding system being developed in this thesis is meant to further the integration of bioreceptive materials into the built environment. The goal of the cladding system is to be able to implement it in urban areas across a variety of urban landscapes. However a case study environment needs to be taken as a potential location to implement the facade. The building conditions under the scope of this thesis take Rotterdam, Netherlands as test case. This was selected as a suitable location for implementation due to a series of criteria, which are outlined below.

4.2 Regional conditions:

Based on the research conducted earlier, bryophytes can be found across many regions of the world yet, some regions are more widely populated than others. Rather than relying on general environmental terms such as Temperate or Tropical, more specific climatic conditions were observed based on suitable habitats for bryophytes. As outlined earlier, mosses gain their nutrients through water and air, so when moist environments are more common so is the spread of mosses. These plants thrive in regions of high humidity and regular rain events. Taking an average relative humidity of 60 percent was the first regional parameter for Europe (see Figure 10).

The next parameter observed hardiness zones across Europe. Hardiness maps are commonly used for agriculture and horticulture purposes to determine viable regions for plant growth based on

Figure 10 Relative humidity map of Europe (Climate Research Unit, Univ. of East Anglia.)

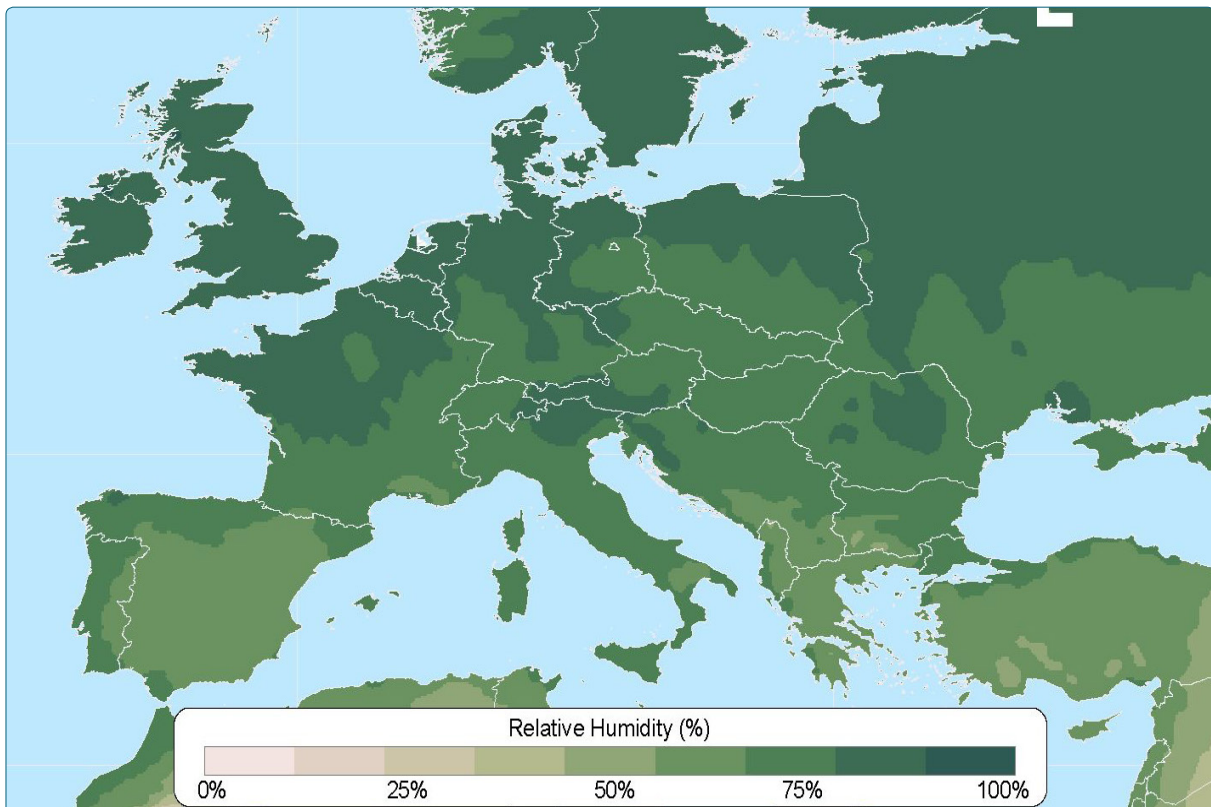

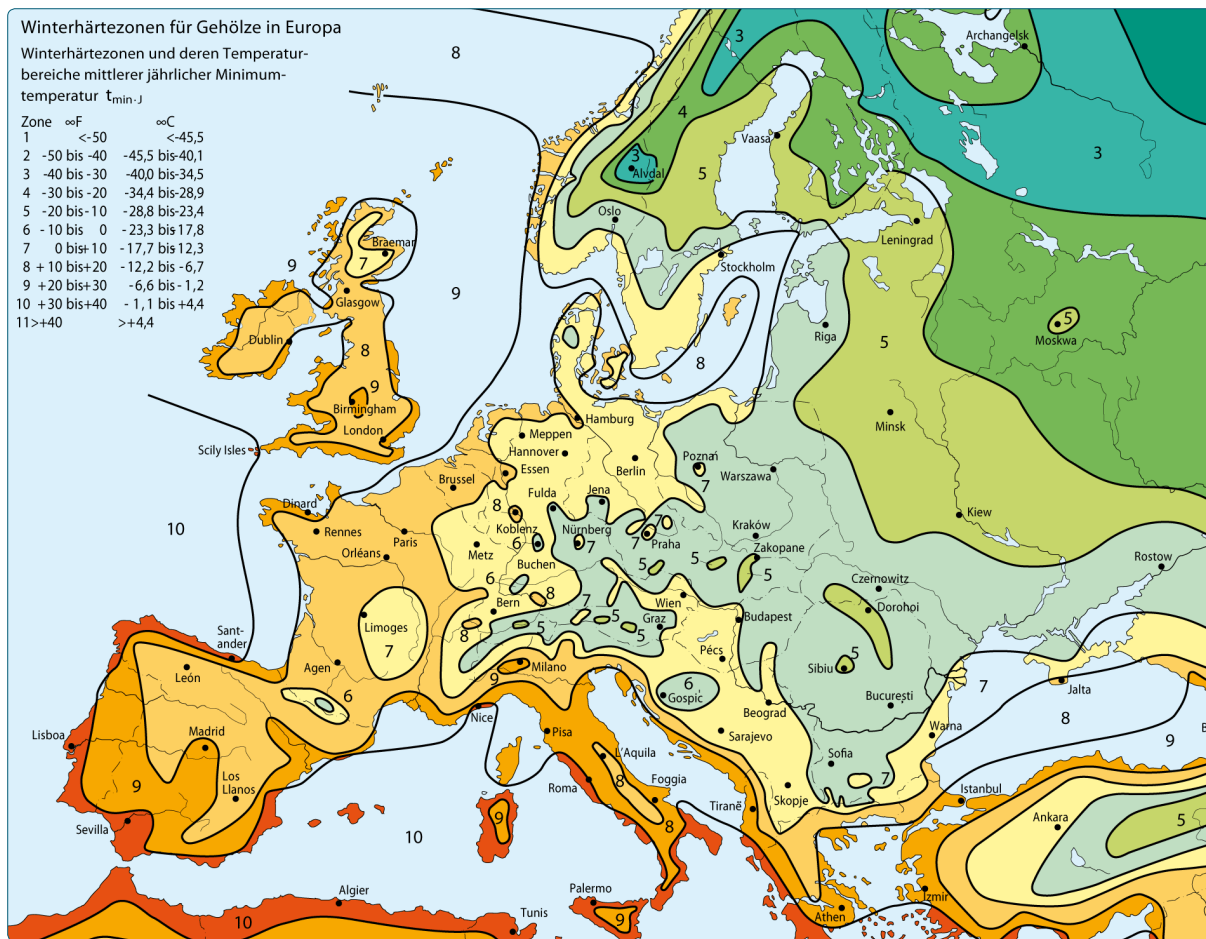

Figure 11 Hardiness zone map of Europe (D.Schreiber, USDA [Wikicommons](#))

climatic conditions. The maps use a primary range of 13 zones to define geographic regions based on the average minimum temperature that the region may experience (shown in Figure 11). This gives a general idea of which locations may encounter below freezing temperatures. Based on the ideal conditions for bryophytes as outlined by research J. Glime, below freezing temperatures are not ideal for the growth of mosses (2017). This is not to say that moss can not endure freezing temperature, they indeed can but, they typically go dormant often appearing more brown (Glime 2017). Due to this, less prolonged periods of sub zero temperature are more suitable for this application.

Based on these conditions, The Netherlands is a suitable candidate for this concept. This can also be supported with field observation, given that mosses are a common plant in the regional ecology. Mosses among other bryophytes are also found scattered throughout most urban areas, proving to be a strong justification of the region and the concept.

Urban Conditions:

Other factors that are necessary to understand are the urban environmental conditions. Although most cities have a unique set of variables specific to them, there are a few conditions that are common

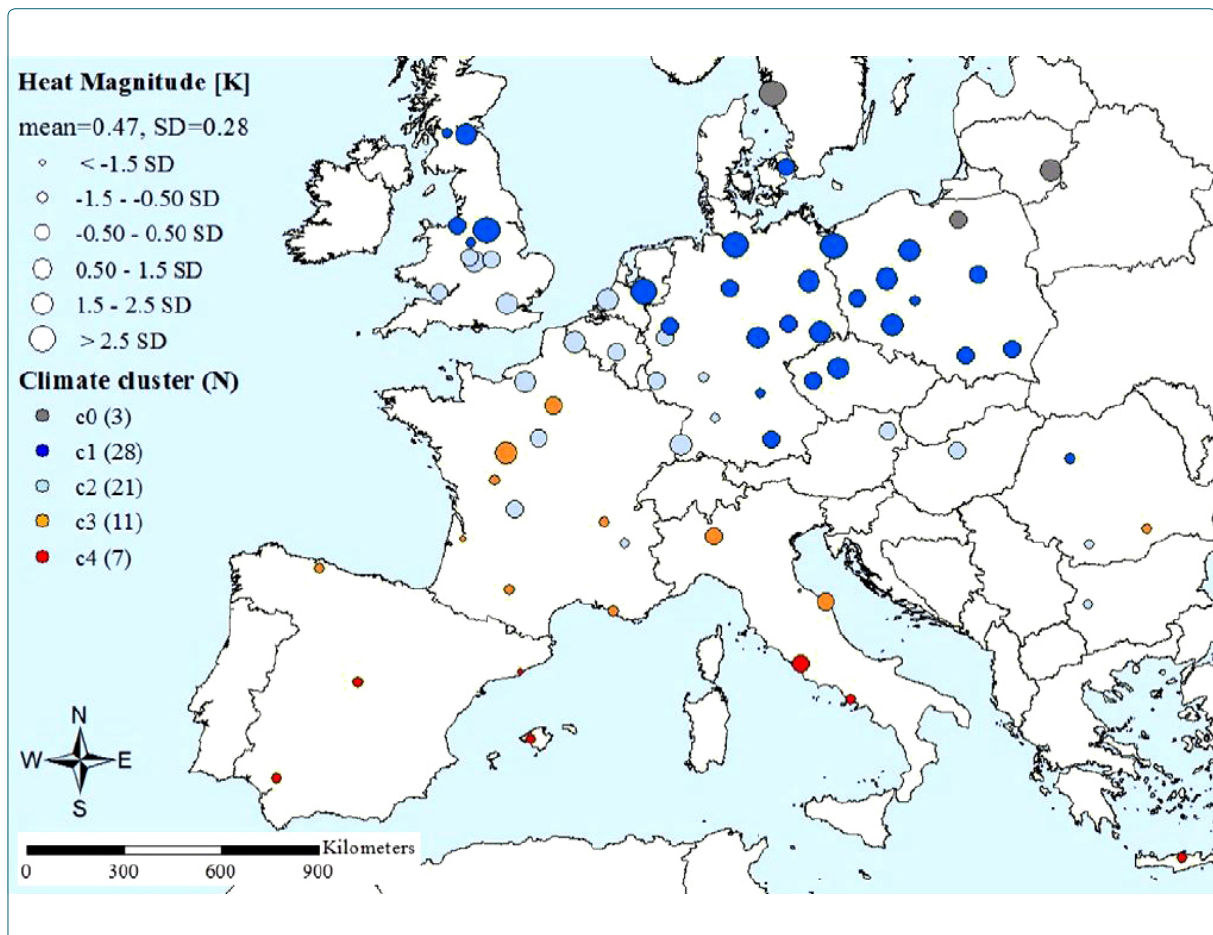

most dense urban areas. Two of these factors are wind conditions and air quality. Beginning with the latter, the quality of air can have an impact on the health of some mosses. It is important to consider that some pollutants in the air can be absorbed by the moss (cleaning the air) but at the same time damaging the cell wall of the plant, slowly killing it. It is therefore important to analyze the urban air pollutants to see if any present toxins can be damaging to the specimens.

Due to the focus of this thesis, an additional parameter can be applied to the selection of suitable candidates for the concept. The impact of urban heat stress is a main cause of UHI and should be considered as one of the defining parameters. Because UHI is a result of urban design decisions, mitigation of the phenomenon should be a design objective. By observing the magnitude of urban heat stress in European cities a potential candidate for UHI mitigation can be selected to be further evaluated (Figure 12).

Urban wind conditions:

Another factor common for dense urban areas are high wind speeds on the surface of the facades. Illustrated by the wind profile shown in Figure 13, as the elevation increases so do wind speeds. This is a typical occurrence in building physics, creating extreme con-

Figure 12 Urban Heat Island, magnitude of heat stress in European cities. Color: climate-cluster type. Size: Magnitude of change. (Ward, K., Lauf, S., Kleinschmit, B., & Endlicher, W. 2016)

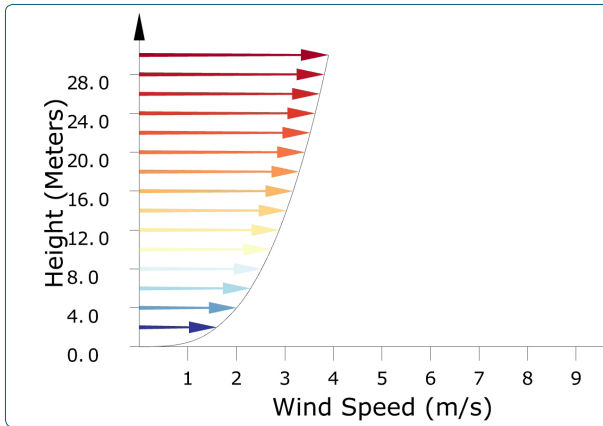

Figure 13 Urban wind profile in The Netherlands

ditions on the facade as the elevation increases. Typical in areas of high density, surrounding high rise buildings can influence the wind flow creating turbulent wind making the flow pattern unique to the building site. This often helps disrupt the high winds creating drag on the leeward side of the buildings, reducing the wind velocities that reach the facade. However, a worse case scenario should be taken as the situation to explore a scenario where no surrounding buildings exist. This can occur with buildings on the perimeter of dense urban areas or along a waterfront. This scenario removes any potential advantage that surrounding buildings may give to the building in question.

Beyond the incoming wind velocity, turbulence in the air flow should also be taken into account. This is dependent on the shape of the building but a typical rectangular form can be taken as a baseline. Large flat surfaces, common in high-rise buildings can create pockets of turbulence where wind velocities are reduced or increased. Commonly observed for these buildings, zones of high velocities can form at the edges of the building, see Figure 14.

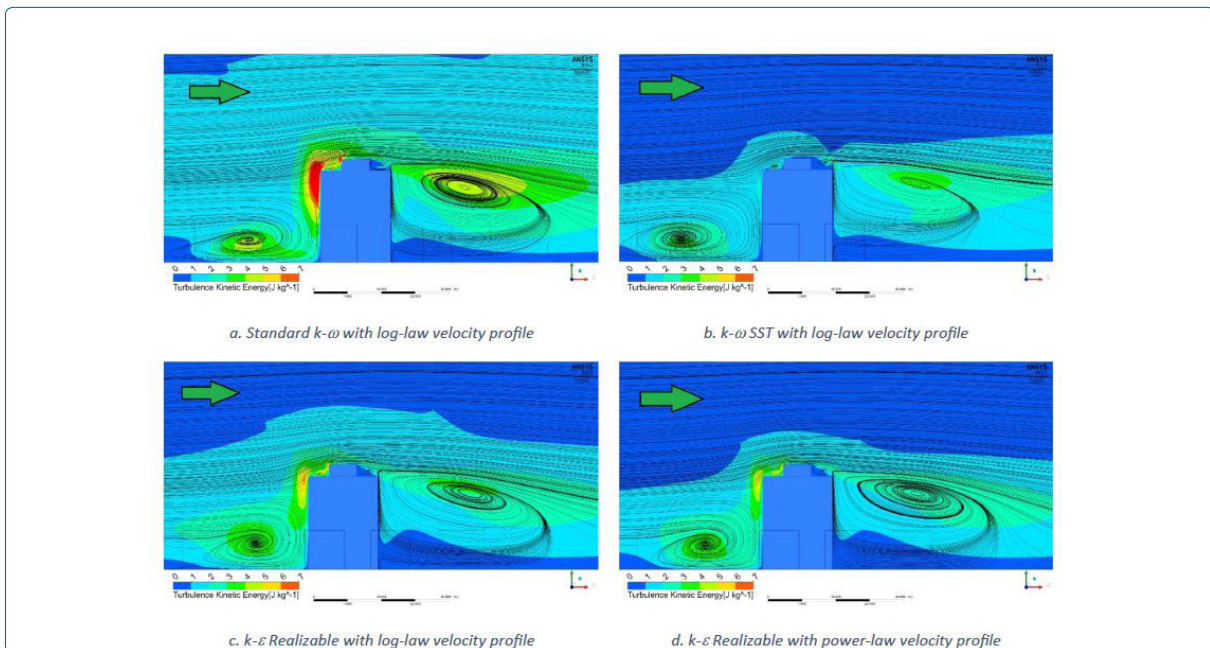

Figure 14 CFD urban wind simulations (Khalilzadeh, Ge & Ng, 2019)

Building:

Given how new the technique is, it is unknown how applicable the material will be for retrofit or reuse situations. That said, it would be safer to assume a new built scenario to better accommodate any new systems needed to create such a facade. A simple massing of a building was created to simulated the basic dimensions of an average mid to high rise building ranging from 10 to 30 stories high.

The building's footprint also takes a typical rectangular shape, measuring 50 meters by 30 meters.

The focus of this thesis is to create a facade system product that can be used for multiple buildings. Therefore, for the window to wall ratio, it is assumed that it will be a changing variable. On most typical buildings in the region, the window to wall ratio is .5 for high-rise buildings. This could have an influence on the final results given that the thermal impacts will not be occurring where a glass window is present. This variable can be adjusted to identify if the impact can be improved when the ratio is changed.

By approaching the design as a product, the facade system has to be able to accommodate different building shapes and achieve the aesthetic vision of the architect. Due to this, the ultimate shape of the facade is an unknown variable in the study. It should therefore be simplified to the most standardized form for high-rises. This mean taking an average rectangular shape that is representative of a generic building that is common in gridded dense urban developments around the world.

Figure 15 Rotterdam Climate data. Top left: Radiation rose. Top Right: Windrose. Mid: Max average wind speeds. Bottom: Average weekly relative humidity.

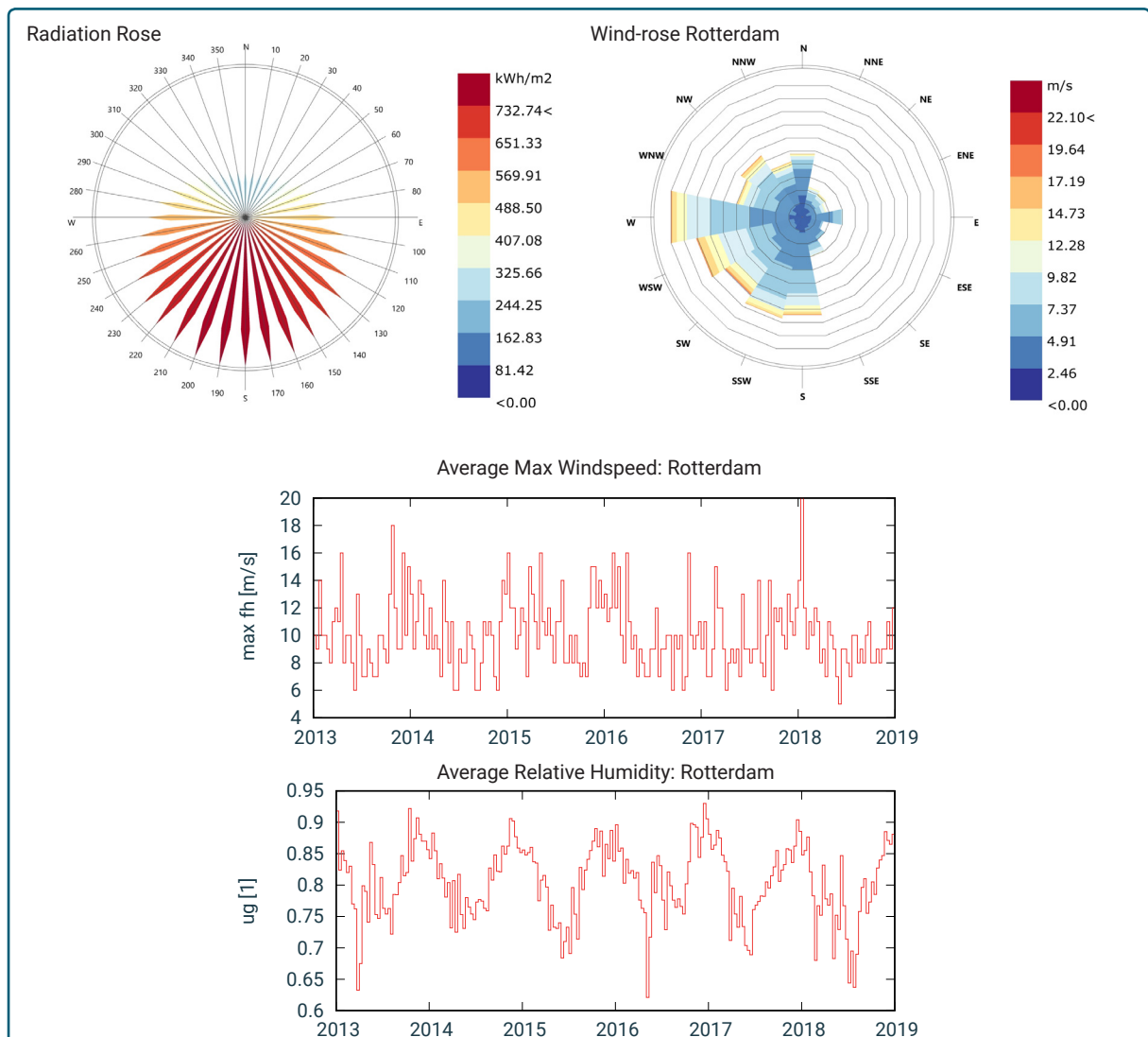

4.3 CFD Wind Analysis

Given the Urban and regional conditions it is important to understand the different conditions present at different elevations of the facade. Simple estimations show that the wind speeds increase significantly the higher up you go. However different building shapes can result in different wind velocities as well as wind directions. For the purposes of this thesis wind velocity and wind direction on the surface of the panel is important for establishment of bryophytes. These factors could then be used to inform the facade panel geometry in order to protect the bryophytes while they grow. For these reasons a CFD simulation was conducted to better understand the wind velocities, pressures and directions that may occur on a conventional facade.

CFD setup:

For the parameters of the CFD simulations a worse case scenario was assumed. For a high-rise building facade this would be a perpendicular wind direction from the surface of the facade as shown in Figure 14. In addition to the direction, an average wind velocity is

Figure 16 CFD building setup. Using a simplified form in the place of higher resolution model.

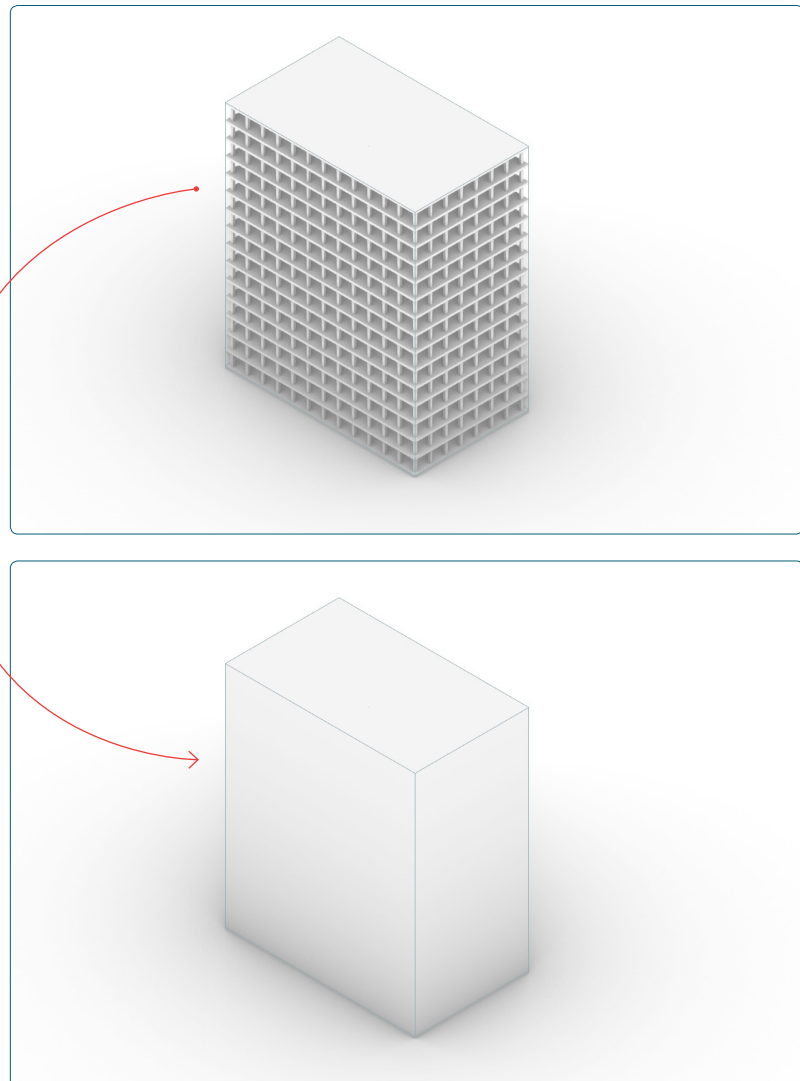

applied to the building based on climate data for the location. The building placed within the wind tunnel used the same dimensions as described in the building boundaries section with a footprint of 30m x 50m and a height of 60m. A simplified solid mass was used to represent this volume to speed up the simulation processing time (Figure 16).

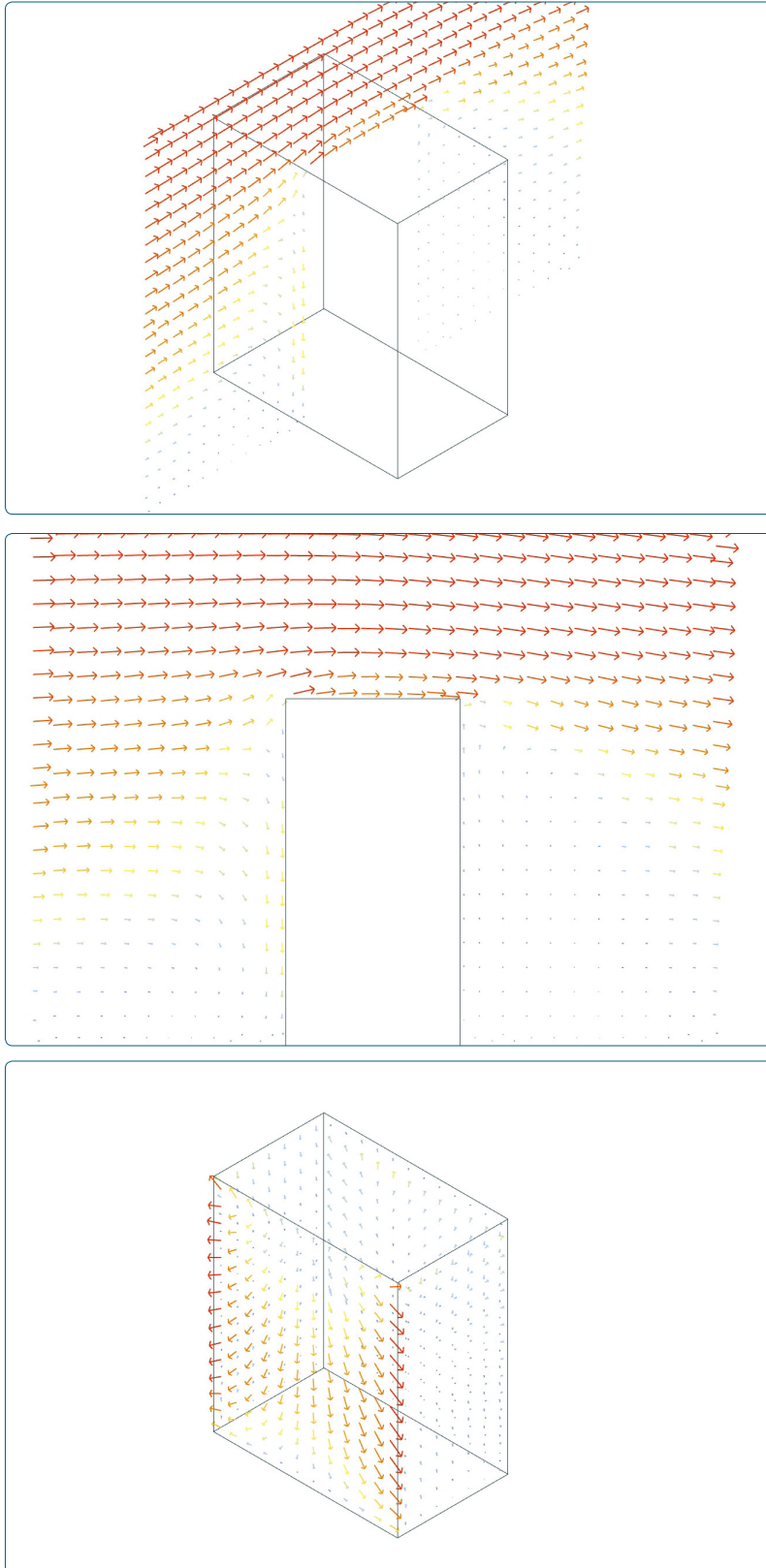

Figure 17 Surface wind velocities and vectors. Top: Isometric wind flow. Mid: Side elevation. Bottom: Isometric of building surface.

Figure 18 Wind vectors and magnitude on a building surface.

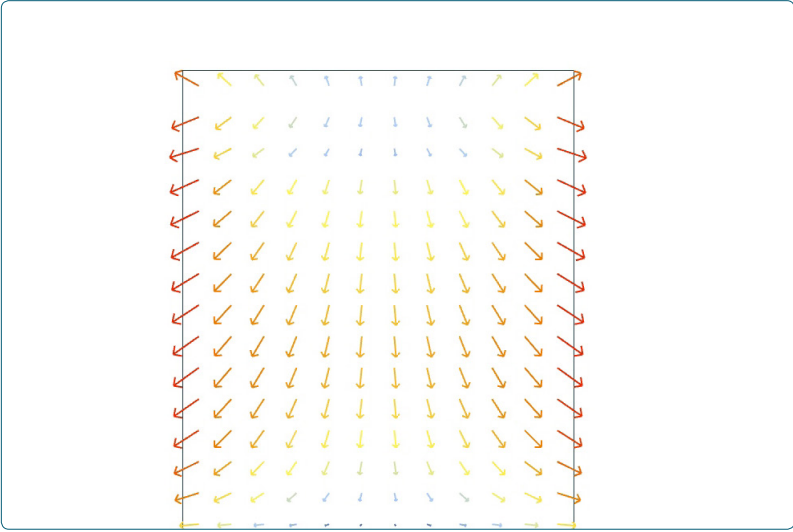

Figure 19 Contour map and heat map of velocities.

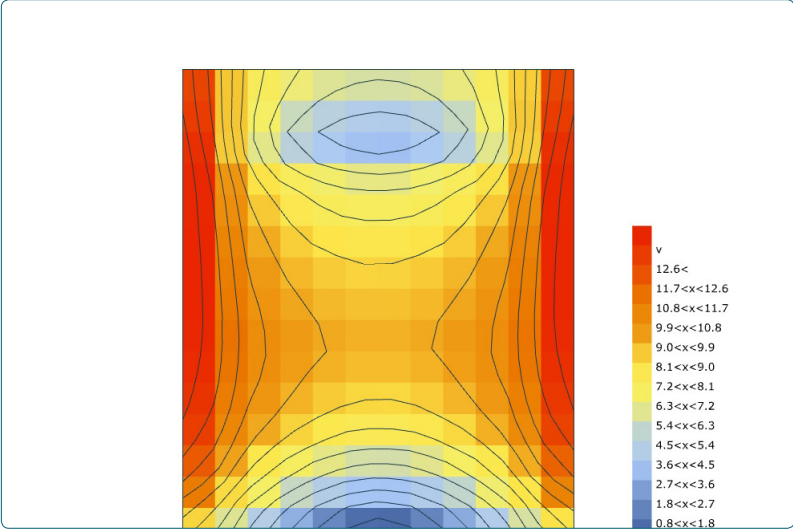
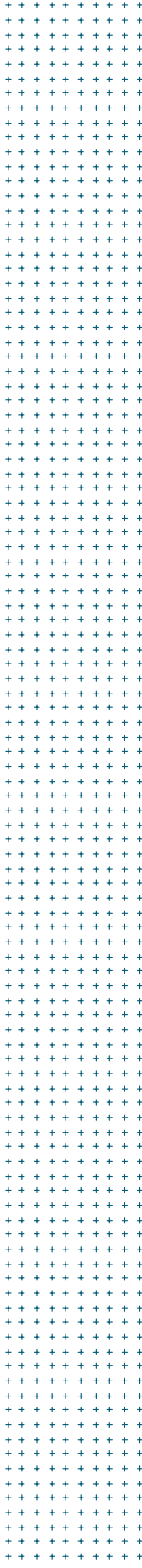
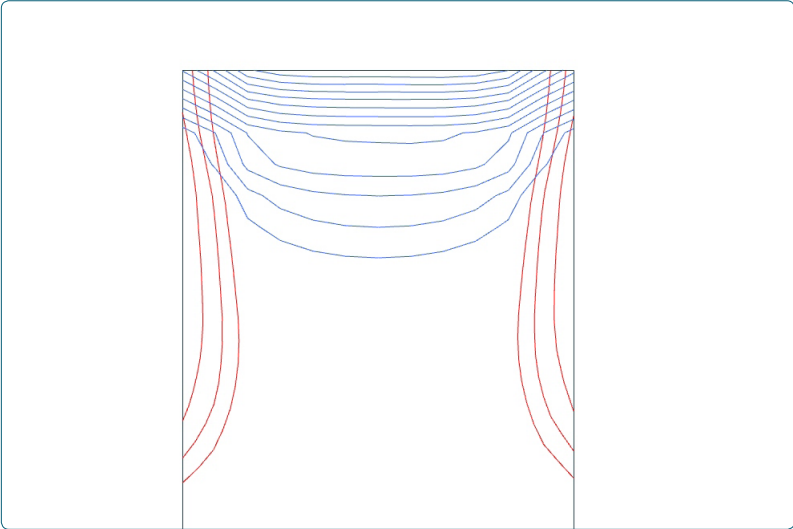

Figure 20 Contour map of zones with the highest pressures (in blue) and highest wind velocities (in red).



Results:

The results of the analysis are shown in figures 17-20 and illustrate the wind velocities on the surface of the face. It can clearly be seen that the side edges of the facade experience higher wind velocities while the center of the building does not. This is due to the compounding wind forces coming from deflected wind of the center of the facade. A contour map of the wind velocities was created to highlight the zone that experience velocities in the upper ten percentile (Figure 20). This concentration of wind at the edges can create an extreme scenario for the growth of mosses and other bryophytes and should be addressed in the facade design.

Another useful result of the CFD analysis are the wind vectors on the surface of the panel, shown in figure (Figure 18). This information can be proven useful in generating geometry that counters the direction of the wind vector for the purposes of creating turbulence. By disrupting the wind direction pockets of low velocity wind can be created. The next section will further explore how the wind vector can be used in the facade design.

BRYOPHYTES

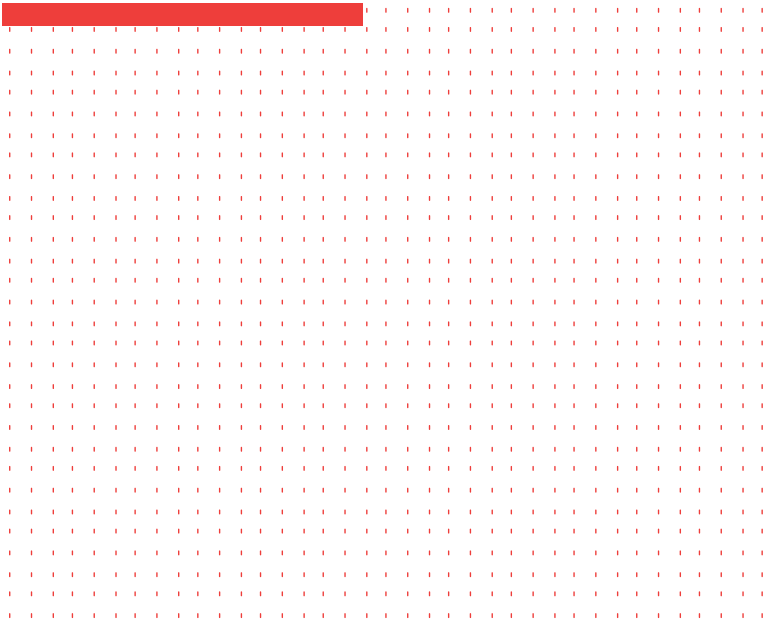

5.1 Moss Selection

Base on the supporting research in the literature review, a list of potential mosses was generated. Both local (The Netherlands) and regional data was used to populate the list of potential species. The parameters for bryophytes outlined in the research dictated which mosses were adequate for this application. The parameters included: pH, Orientation and solar exposure (see Table 3).

It is important to note that these are just a few potential species of the thousands of bryophytes in existence and should be selected based on the regional ecology. It is also important to use bryophytes that are found in the region. Introducing foreign species can impact the local ecology and cause the spread of invasive species creating an imbalance in the ecosystem. However small these bryophytes may be, the presence of a foreign moss may favor some insects over others eventually impacting the habitat. With this understanding, only regionally native species of mosses were considered for this thesis, with the help of research previously conducted by the Dutch Bryological and Lichenological Society (2019).

Although there are many mosses to choose from based on the parameters given, the ultimate determinant for this application is the biocolonization of the material. This would require comparative testing of different species of moss over an extended period of time. The goal is to determine which species can establish themselves quickly and observe the longevity of the specimen. This however, is beyond the scope of this thesis and should be considered a next step in the development of the concept.

5.2 Biofilm

Once the panel has been prepared, the biofilm can then be applied to cultivate bryophyte growth. Given that this process lies more in the realm of horticulture than facade fabrication, it is recommended that the biofilm be applied by someone who is knowledgeable and trained to perform the task. Also, due to the long time period necessary for proper establishment of bryophytes the panels should be kept in a controlled environment to speed up the process. Some species can germinate in as little as 3-7 days while others can take up to 21 days after which it can take several weeks to establish enough of a visual coverage on the substrate (Glime 2017). Under these criteria it is recommended that the panels be transported to a dedicated greenhouse where the biofilm can be applied, monitored and maintained during the establishment period. Doing so will provide the ideal conditions for rapid growth, reducing the production time.

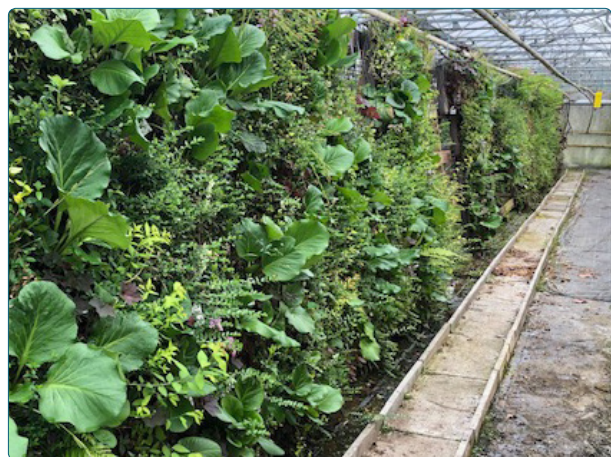

Figure 21 LWS Semper Green greenhouse

Moss	pH	Type	Region	Potential Moss
<i>Aloina ambigua</i>	8	Vertical	Northern Europe and UK	<input checked="" type="checkbox"/>
<i>Anomodon viticulosus</i>	8	Vertical	Northern Europe and UK	<input checked="" type="checkbox"/>
<i>Barbula unguiculata</i> ,	7	Urban Roof	Northern Europe and UK	<input checked="" type="checkbox"/>
<i>Brachythecium laetum</i>	-	Urban Roof	UK	<input type="checkbox"/>
<i>Brachythecium rutabulum</i>	8	Vertical	Northern Europe and UK	<input checked="" type="checkbox"/>
<i>Bryum argenteum</i>	7	Urban Pavement	Northern Europe and UK	<input checked="" type="checkbox"/>
<i>Bryum capillare</i>	7	Vertical	Northern Europe and UK	<input checked="" type="checkbox"/>
<i>Ctenidium molluscum</i>	8	Vertical	Northern Europe and UK	<input checked="" type="checkbox"/>
<i>Didymodon tophaceus</i>	8	Vertical	Northern Europe and UK	<input checked="" type="checkbox"/>
<i>Encalypta streptocarpa</i>	9	Vertical	Northern Europe and UK	<input checked="" type="checkbox"/>
<i>Entodon seductrix</i>	-	Urban Roof	UK	<input type="checkbox"/>
<i>Funaria hygrometrica</i>	6	Urban Roof	Northern Europe and UK	<input type="checkbox"/>
<i>Grimmia decipiens</i>	-	Urban Roof	UK	<input type="checkbox"/>
<i>Grimmia ovalis</i>	5	Urban Roof	Northern Europe and UK	<input type="checkbox"/>
<i>Grimmia pulvinata</i>	8	Urban Pavement	Northern Europe and UK	<input checked="" type="checkbox"/>
<i>Grimmia trichophylla</i>	3	Urban Roof	Northern Europe and UK	<input type="checkbox"/>
<i>Hedwigia ciliata</i>	3	Urban Roof	Northern Europe and UK	<input type="checkbox"/>
<i>Hypnum cupressiforme</i>	-	Vertical	UK	<input type="checkbox"/>
<i>Mnium hornum</i>	3	Vertical	Northern Europe and UK	<input type="checkbox"/>
<i>Plagiomnium cuspidatum</i>	7	Urban Roof	Northern Europe and UK	<input checked="" type="checkbox"/>
<i>Platygyrium repens</i>	6	Urban Roof	Northern Europe and UK	<input type="checkbox"/>
<i>Polytrichastrum formosum</i>	-	Vertical	Northern Europe and UK	<input type="checkbox"/>
<i>Racomitrium fasciculare</i>	2	Urban Roof	Northern Europe and UK	<input type="checkbox"/>
<i>Racomitrium heterostichum</i>	2	Urban Roof	Northern Europe and UK	<input type="checkbox"/>
<i>Rhytiadelphus squarrosus</i>	5	Vertical	Northern Europe and UK	<input type="checkbox"/>
<i>Thamnobryum alopecurum</i>	7	Vertical	Northern Europe and UK	<input checked="" type="checkbox"/>
<i>Zygodon viridissimus</i>	7	Vertical	Northern Europe and UK	<input checked="" type="checkbox"/>

Table 3 Table of Potential Mosses suitable for vertical surfaces in urban areas.

This next step in the process may seem strange in the conventional facade fabrication process, but it is not so strange in the field of green facades. For traditional green facades, partnerships with local nurseries are arranged to pot and grow plants specifically for LWS facades (Figure 21). This is fairly common for most living wall systems and it is often done so in order to achieve a green facade instantly on site. Containers or modules (usually made of plastic) are delivered to a nursery or greenhouse where they are potted and pregrown until it has reached the desired density of foliage. For that process, it may take weeks or months before it is suitable for mounting to a structure.

As for the biofilm itself, a gel mixture can be created to bind and

hydrate the bryophytes. Currently there is little research outlining which mixtures are the most suitable for the establishment of bryophytes but similar steps are utilized for tissue culture propagation of plants (Udawattha, C., Galkanda, H., Ariyaratne, I., Jayasinghe, G., & Halwatura, R. 2018). Using this existing process for cloning plants under controlled environments as a base, a gel mixture was developed as a potential biofilm. The mixture consists of the following materials:

- Agar powder or other horticulture gelling agents
- Distilled water
- NPK nutrient solution (to promote rapid growth)
- Blended moss or moss spores

The gelling agent agar, was used to make the gel like binder. Agar is commonly used in in-vitro tissue culture and has been used to propagate bryophytes in the past (Udawattha, C., Galkanda, H., Ariyaratne, I., Jayasinghe, G., & Halwatura, R. 2018). The gel is made by mixing a percentage of agar with water and supplemented with a nutrient solution (Figure 22). NPK nutrient solutions are common with living wall systems often used as an amendment to the water supply to help fertilize the soils. These nutrients can be decomposed organic matter, such as that found in compost or can be a synthetic formula. The later would be the nutrient of choice, given that it is a sterile solution no mold, fungus or bacteria would risk contaminating the gel. After incorporation, the liquid is heated to solidify the liquid to a gel. Then the moss can be blended into the gel. The gel mixture can then be applied to the surface of the panel in a thin layer of about 1-2 mm thick. The gel binder will keep the living organisms attached to the surface and prevent it from drying out. Over time, the gel will dissolve away leaving behind the moss and remaining nutrients.

Once the biofilm is applied to the foamed MPC the panel will be rotated to a vertical orientation and mounted to a support rail using the existing panel bracket. Additionally, the panel needs to be rotated to match the same solar orientation that it will be experiencing on site. This can be done by tracking the panel number to the final location in the facade design. This process can be generalized to basic solar orientations of North, South, East and West and does not need to exactly mimic the final location. This step is necessary in order to establish the bryophytes with the correct solar exposure. If the solar exposure from the greenhouse is far more different from the final placement on the building, the mosses may go into shock and stunt the growth of the specimens. This extra care is just one more way to ensure establishment and proper installation on site.

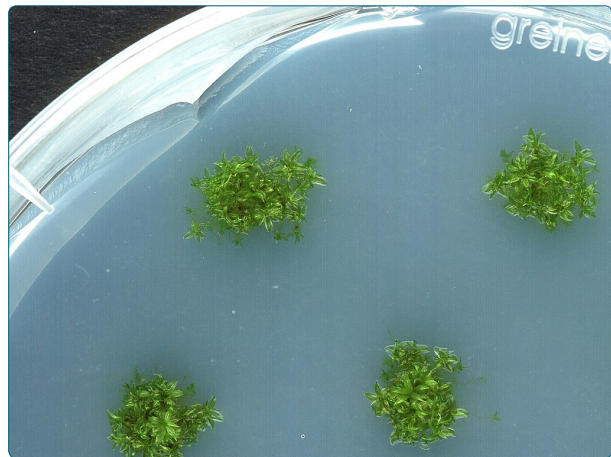

Figure 22 Agar gel with moss (Ralf Reski lab, CC BY-SA 1.0, <https://commons.wikimedia.org/w/index.php?curid=29181222>)

BIORECEPTIVE MATERIAL



6.1 Material

The material properties required as outlined in the literature review where used to further explore potential materials. Although it can be generally understood which properties are necessary to create the bioreceptive material, it is difficult to surmise how much of that property is sufficient. For example, it is recommended that the material be permeable, allowing water to be absorbed by the material, yet a definitive measurement of porosity is not given. However, one study that measures the growth of moss on tropical walls provided the porosity of the materials being tested seen in Figure 23 (Udawattha, Galkanda, Ariyaratne, Jayasinghe, Halwatura 2018). Using this as baseline data, we can assume that a porosity above 28% would be a good starting point. It is therefore important to have a range of properties to test, to better control the percentage of permeability and pore size.

One potential bioreceptive material that has shown some promise in previous reach being conducted by Manso et al. (2014) is Magnesium Phosphate Cement or MPC. As outlined in the literature review, virgin OPC is not an ideal candidate for bioreceptivity given its high pH level but Magnesium Phosphate Cement has a much lower pH. This cementitious material has only recently become a viable alternative to OPC building materials. Just like traditional OPC cements, MPC can be aerated into a less dense more porous material with the use of foaming agents. By using this production method the foaming agent can be a controllable parameter that can influence the pore size and permeability of the concrete. In doing so the material can be further refined to generate a more optimal bioreceptive material.

However, it is important to note that Increasing the pore size and porosity of the material also makes the material more brittle. An increase in porosity for the purpose of bioreceptivity would also require a thicker panel to prevent the material from cracking under load. Thus, based on the underlying research on compressive strength for the materials being used a thicker panel is recommended (Li, Wang, Zhou, He & Huang, 2019). The dimensions taken for this panel ranges from 30mm to 40mm thick. This is significantly thicker than traditional GFRC facades with thickness of about 12 to 15 mm or ceramic facades which are typically 20 to 25 mm thick. However, the increased factors of porosity and pore size make the material more vulnerable to cracking as the material becomes thinner thus, a thickness of 30mm was taken to prevent the material from cracking.

Table 4
Intrinsic properties of walling materials.

	Porosity (f) (%)	Surface Roughness (R _a) (μm)	Capillary Action (I) (mms ^{-1/2})	Water Absorption (gcm ⁻³)	Organic Matter Content (%)	pH Value
B	28.9 ^a	133.03 ^b	1.578 ^a	0.29 ^a	0.51 ^b	9.42 ^f
CB	17.8 ^b	1149.17 ^b	0.814 ^d	0.18 ^b	0.82 ^g	11.49 ^c
CSEB	28.8 ^a	292.1 ^c	0.832 ^c	0.29 ^a	4.02 ^e	8.6 ^g
CAB	15.1 ^b	2575.65 ^a	0.568 ^f	0.15 ^b	10.36 ^a	7.81 ^h
MCB	34.5 ^a	1147.67 ^c	1.196 ^b	0.35 ^a	4.76 ^d	10.95 ^e
FSEB	13.7 ^b	197.46 ^g	0.672 ^e	0.14 ^b	6.22 ^c	11.4 ^d
CP	14.9 ^b	208.71 ^f	0.082 ^h	0.15 ^b	8.45 ^b	12.28 ^a
RCP	15.3 ^b	890.62 ^d	0.352 ^g	0.15 ^b	2.23 ^f	11.63 ^b

(B = Brick, CB = Cement Block, CSEB = Cement Stabilized Earth Block, CAB = Cabook Block, MCB = Mud Concrete Block, FSEB = Fly-ash Stabilized Earth Block, CP = Cement Plaster, RCP = Rough Cement Plaster) ((n = 3), Means that do not share a same letter; along each column, are significantly different according to DMRT).

Figure 23 Mold growth and moss growth on tropical walls (Udawattha, Galkanda, Ariyaratne, Jayasinghe, Halwatura 2018)

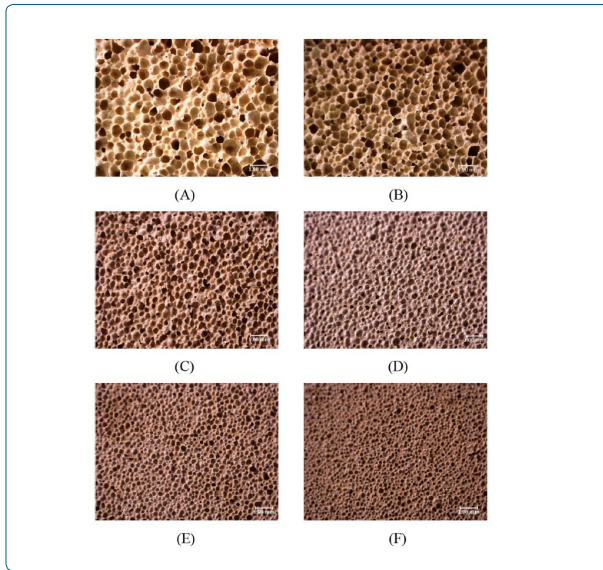

Figure 24 Foamed MPC concretes with ranging porosities.

6.2 MPC Mixture

There are a variety of different ways to produce foamed and aerated concretes but the process of foaming MPC concrete is a fairly new technique. As of this writing, there are only a few research papers that document the process of foamed MPC cements. Some of these papers have explored different foaming agents to achieve the foamed concrete, this includes the use of zinc powder, sodium bicarbonate, protein and hydrogen peroxide (Li, Wang, Zhou, He & Huang, 2019). Of these different foaming agents it was important to consider how some of these chemicals would affect the biological growth of bryophytes.

Comparing these foaming agents to each other, along with the research conducted in the literature review, a foaming agent was selected. As shown in Table 4, foaming agents were compared to each other based on a series of criteria. Zinc powder would not be suitable for this application due to the toxic effect that it has on bryophytes (as discussed in the literature review) and any residual zinc compounds in the concrete could potentially act as a herbicide. It then became obvious that the ideal foaming agent for this application is hydrogen peroxide given it's by-products from the chemical reaction produce only water and oxygen. Not only would this be a much more suitable material for the biocolonization but also allow for a safer and more sustainable production process.

	Foaming Agent	Type	Low Cost	Tested with MPC	Harmful to Bryophytes	Open cell Structure	Harmful biproducts	Beneficial to Bryophytes
1	Zinc Powder	Fine metal powder		X	X	X	X	
2	Sodium bicarbonate	fine chemical powder	X	X	X	-		
3	hydrogen peroxide	Concentrated Liquid	X	X		X		X
4	protein	powder	X		-	-	-	

Table 4 Table of foaming agents.

The chemicals required for a MPC foamed with hydrogen peroxide were outlined in the research review and are as follows:

- dead-burnt magnesia (MgO)
- ammonium dihydrogen phosphate (ADP)
- borax (B)
- calcium stearate (CS)
- manganese dioxide (MnO2)
- water (H2O)
- hydrogen peroxide (H2O2)

The next criteria for bioreceptivity to investigate is the level of porosity of the material can obtain. By adjusting the foaming agent and the foaming stabilizers the desired density and porosity can be achieved. Outlined in the research of Li, Wang, Zhou, He & Huang, different concentrations of the foaming agents produced a range of porosities and densities of MPC (Figure 24). It also detailed the pore structure within the material, and described it as an open cell network (Li, Wang, Zhou, He & Huang, 2019). Using this research as a foundation, three different mixture were selected based on the density and porosity of the material and outlined in Table 5.

Mix	Material	dead-burnt magnesia (MgO)	ammonium dihydrogen phosphate (ADP)	borax (B)	calcium stearate (CS)	manganese dioxide (MnO2)	water (H2O)	hydrogen peroxide (H2O2)	Sandstone or granite
Percentage of Total Mixture									
1	MPC - Foamed - Low	61.1%	15.3%	7.3%	0.2%	1.5%	11.8%	2.8%	
2	MPC - Foamed - Mid	62.6%	15.7%	7.5%	0.2%	1.6%	10.7%	1.8%	
3	MPC - Foamed - High	62.7%	15.7%	7.5%	0.2%	1.9%	10.8%	1.2%	
kg for sample specimens (3)									
1	MPC - Foamed - Low	0.43992	0.11016	0.05256	0.00144	0.0108	0.08496	0.02016	
2	MPC - Foamed - Mid	0.67608	0.16956	0.081	0.00216	0.01728	0.11556	0.01944	
3	MPC - Foamed - High	0.90288	0.22608	0.108	0.00288	0.02736	0.15552	0.01728	
	kg	2.019	0.506	0.242	0.006	0.055	0.356	0.057	
	(+15%) kg	2.322	0.582	0.278	0.007	0.064	0.409	0.065	
Control Sample									
		.35	.085			.015	.1		.45
		0.756	0.1836	0	0	0.0324	0.216	0	0.972
	Total kg	3.078	0.765	0.278	0.007	0.096	0.625	0.065	0.972
Specimen Dimensions									
	Flat Panel	12	20	2.5	0.0006	3	0.0018		
Material									
	Dry Density kg/m³	kg							
1	MPC - Foamed - Low	400	0.72						
2	MPC - Foamed - Mid	600	1.08						
3	MPC - Foamed - High	800	1.44						
	control	1200	2.16						

Table 5 Table of MPC mixtures with a hydrogen peroxide foaming agent.

FACADE DESIGN

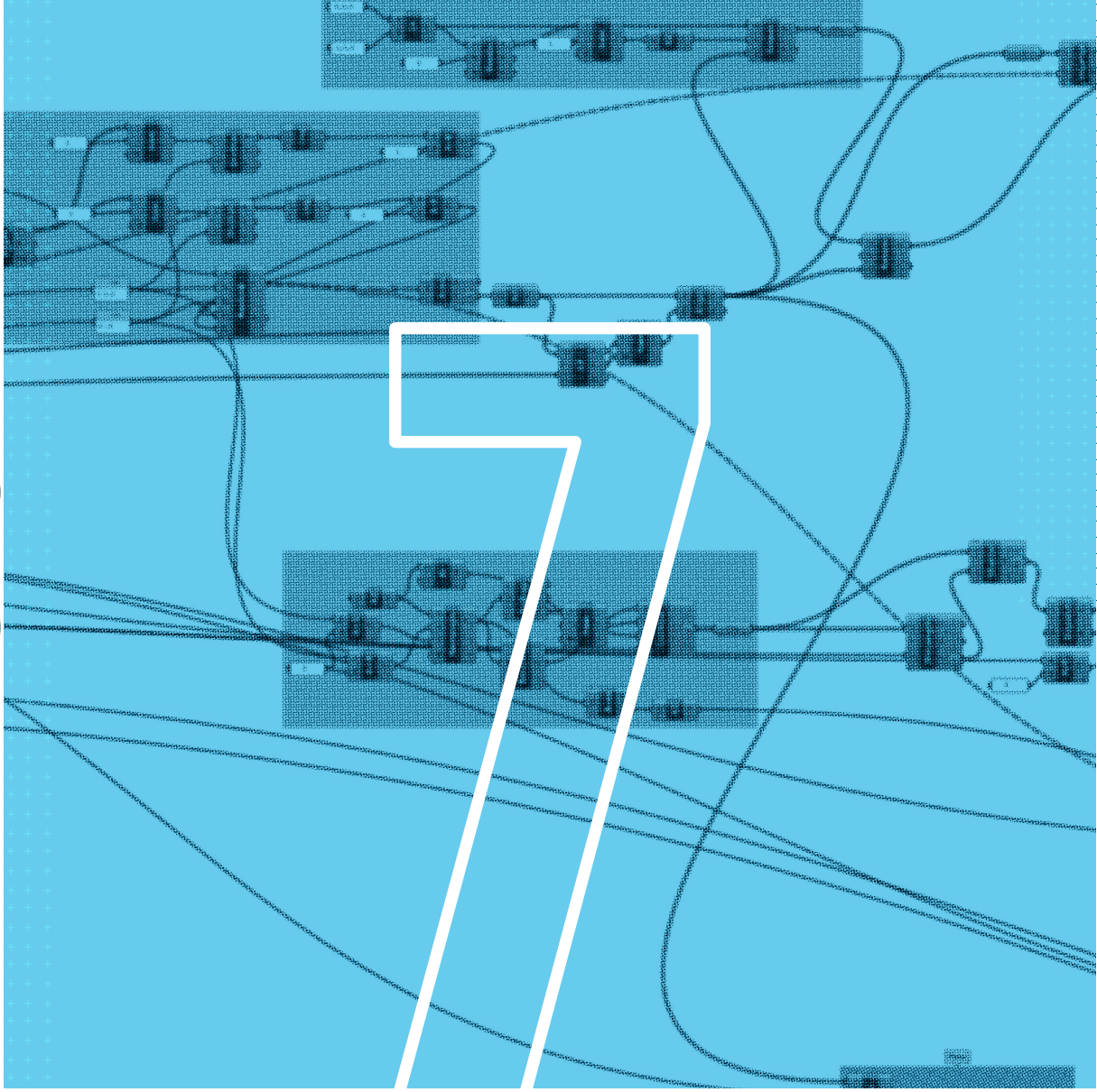

7 Facade Design

The application of green facades and green roofs has become a part of the architectural tool kit as a way to integrate more greenery into dense urban spaces. Since the turn of the century, green facades have grown in popularity in the world architecture and more research has been conducted on this topic as a result. Currently there are many studies that have highlighted the potential benefits of implementation, one reason to do so is to mitigate the urban heat island. As mentioned in the literature review, green facades are an ideal solution to increase urban green regions and thus, reduce the surrounding ambient temperatures. However, as of the time of this thesis, bioreceptive materials are not well understood as to what impact they could have as an urban facade.

The aim of the facade design is to create a facade system that can utilize the bioreceptive material as a cladding material. This applies the concepts of bioreceptive materials to the exterior of the building in order to explore a potential application of the research. The facade system must also go beyond the requirements of the material but include any additional systems needed to maintain the cladding. Also, given that the material has to support living organisms it is important to find locations on the facade where it might not be suitable and try to find a way to overcome it. Once a design has been generated that can meet the technical and bioreceptive requirements, the facade can then be tested for its impact on the surrounding environment.

7.1 Wind and Geometry

As a result of the literature review and the CFD analysis, it is clear that wind plays a key role on two important factors for this thesis. First, the wind velocity is important for the establishment and survival for the bryophytes outlined in the previous sections. Second, the wind velocity is important for the cooling effect of moss as forced convection. This section explores how the CFD results can influence the geometry of the facade to create more habitat zones on the surface.

Based on the research conducted on biofilms and bryophytes in the literature review, biofilm growth will be more successful if air velocities can be slowed down. Although the research does not quantify slow velocity with a measurement, it does outline how biofilm establishment many benefit from the reduction of the flow rate. Research conducted by Huang et al. (2018), shows how creating grooves on the surface of a material can promote biofilm growth. Using this concept, a series of grooves were created to increase surface turbulence and create pockets with low wind speeds within the grooves. As series of parameters were further investigated to determine suitable dimensions for the grooves.

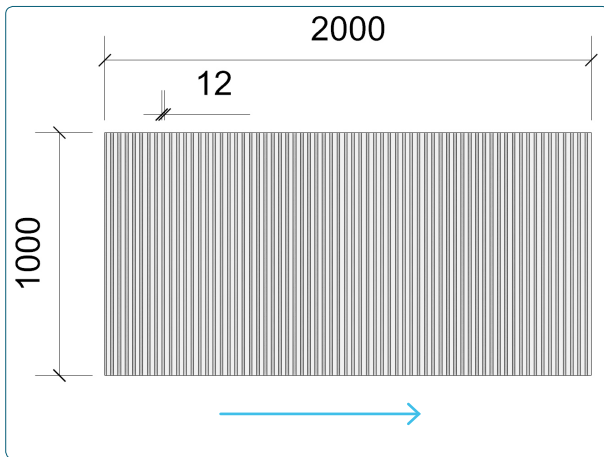

Figure 25 Dimensions of panel and channels with wind direction perpendicular to channels.

Depth of grooves:

These grooves are created by milling channels into the surface of the material at specified depths. The depths of the channels were simulated using Autodesk CFD and compared at 5mm and 10mm to determine the impact that a deeper cavity may have. For a 30mm panel, 10mm would be the maximum depth to be considered, beyond a third of the panel thickness the material may become more prone to cracking. The lower limit of 5mm was taken because most mosses are in their adolescence below this height and this dimension should provide enough protection to maintain growth.

The conditions of the simulation took the angle of approach perpendicular to the direction of the channel, as denoted in Figure 25. This situation can be found in the extreme wind scenarios located at the edges of a building, where wind velocities compound (as discussed previously in the building analysis). The simulation also took 10m/s as a constant wind speed in a compressible wind tunnel setup. Turbulence model SST k-omega SAS was used to simulate the air flow with 300 iterations used.

Figure 26 Middle cross-section of CFD results of scenario A, 5mm and scenario B 10mm.

Once the CFD flow simulation was completed the results were then analyzed using a section plane. Both section planes were compared at the same location. As shown in Figure 26 and Figure 27, the results clearly shows the impact that grooves can have on the first few millimeters of the surface. Seen in the results, a pocket of low wind veloc-

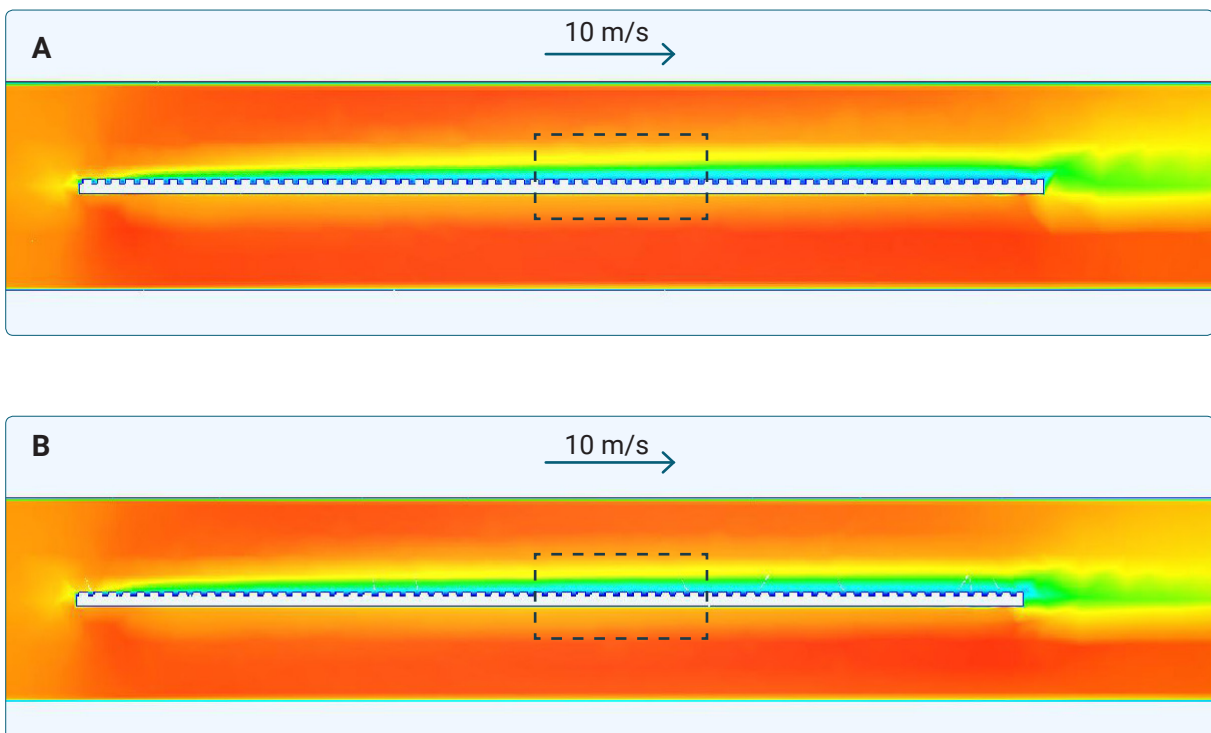

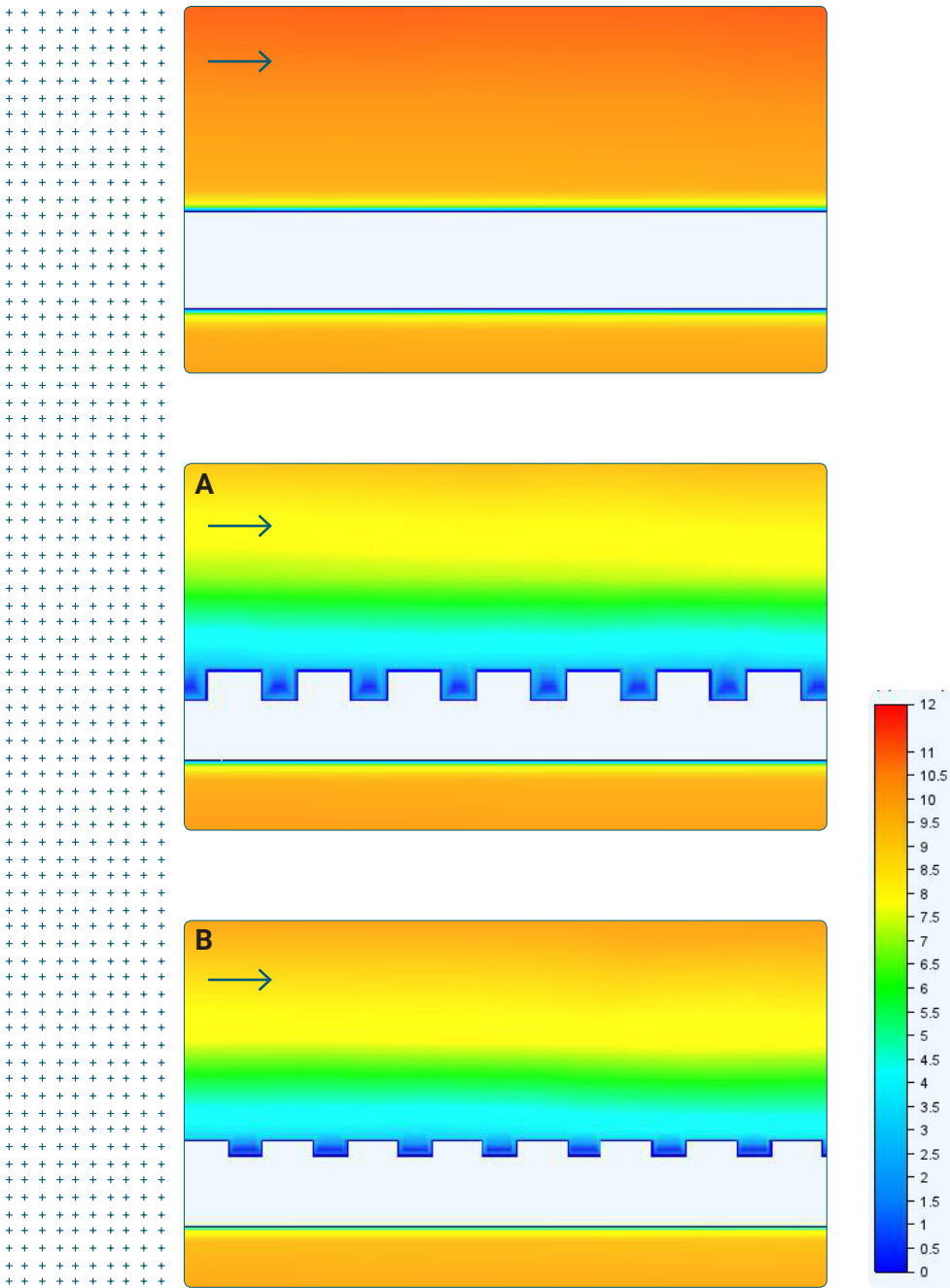

Figure 27 CFD wind tunnel of panel with no grooves. Mid: CFD results of scenario A, 10mm
Bottom: Scenario B, 5mm

ities is created within the channel yet, the differences between the two depths is hard discern. With the channel wind speeds of 1-4 m/s can be observed. Also due to the turbulence caused by the channels, the 10mm zone just above the panel can experience speeds ranging from 4-6 m/s. Ultimately the effect is equally present in both scenarios and it can be assumed that any channel deeper than 5 mm would not have a significant benefit. Based on this simulation conducted, 5 mm would become the minimum required depth for the channels used for the next steps in the facade design.

7.2 Facade Pattern

A pattern was then generated that follows the results and research outlined earlier. The pattern was generated using a parametric design approach with the aid of Rhino and Grasshopper (with Butterfly and Ladybug). EPW climatic data was used as the primary inputs and can be adjusted should the geographical location of the building change. For the volume of the building a generic shape was taken (as described in the building boundary conditions). Using these inputs, a grasshopper script was assembled (Figure 28). The steps taken to generate the geometry in grasshopper can be summarized in a sequence of steps and are as follows:

Building Mass Simulation Vectors:

As a result of the Grasshopper-Butterfly CFD simulation, a series of values are taken as outputs than can be used to generate geometries directly influenced by the simulation. The outputs given includes the following data sets: Velocity X, Velocity Y, Velocity Z, prob reference points, prob reference plane, pressure.

Panel Generation:

Based on the dimensions of the building surface that underwent the simulation, a series of panels need to be generated that can fill the area of the surface. These panels need to follow the previous dimensions given in the material section. This next section of the grass-

Figure 28 Summary of grasshopper script for panel pattern creation.

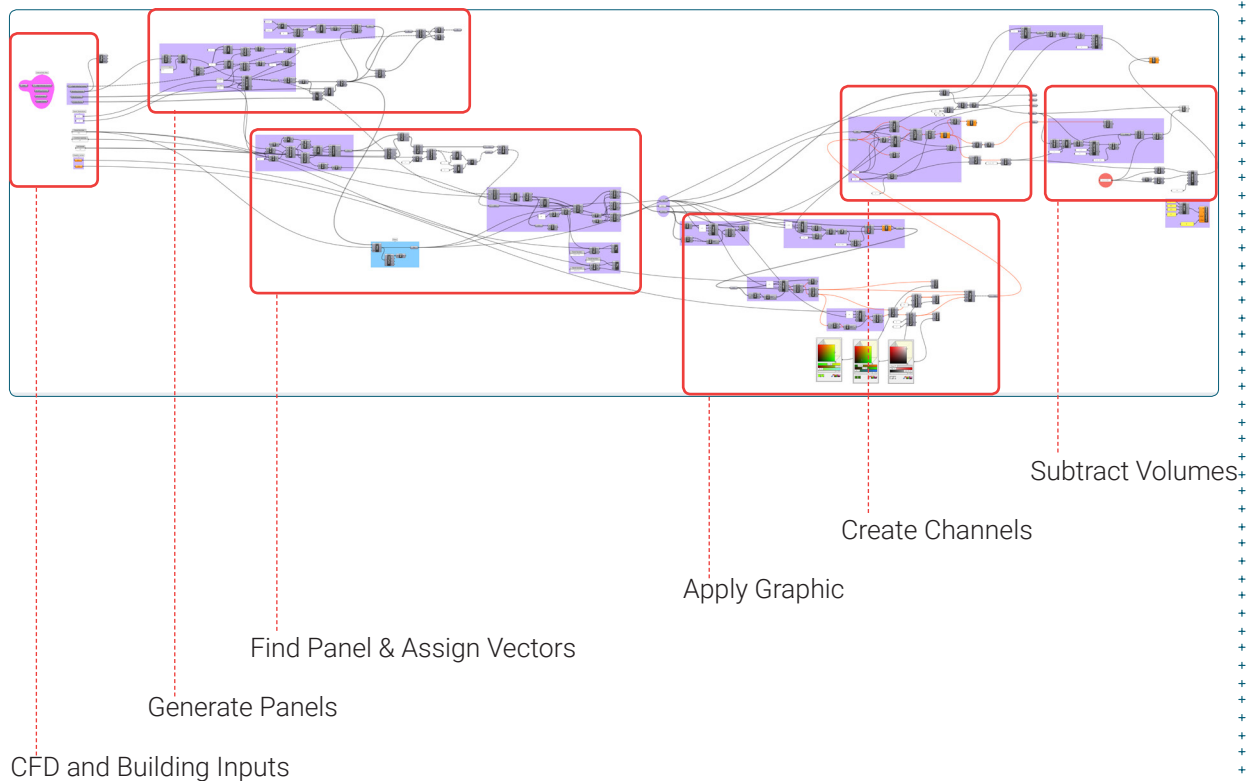

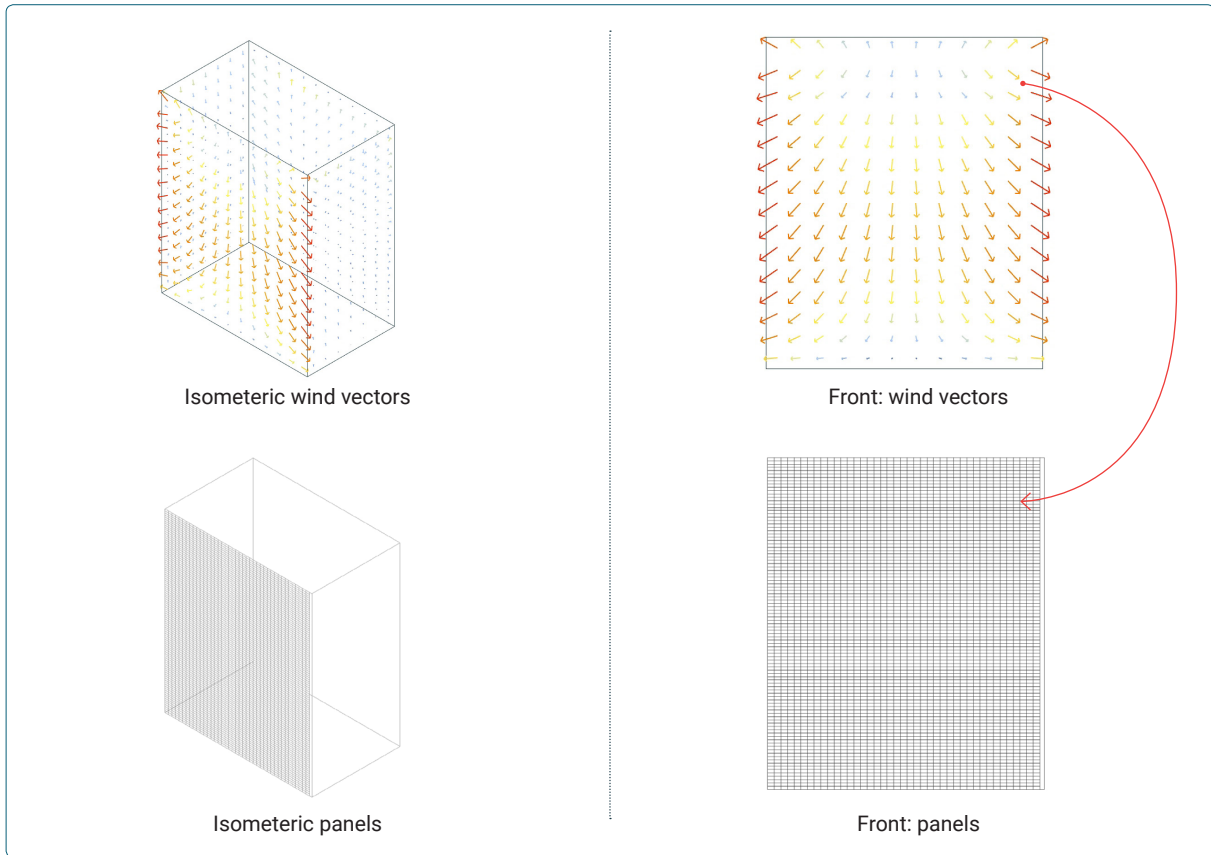

hopper script subdivides the surface into a panelized geometry.

Figure 29 Panel Generation

Vectors to Panels:

Next the prob points in the simulation are recalled and matched with its corresponding velocity vector. Once itemized into a list, the panel centroid is used to find the closest prob point on the surface. The point found is then recalled in the list of vectors and reassociated to the panel. Each panel now has a wind vector assigned to it (Figure 30).

Figure 30 Assign vector to panel

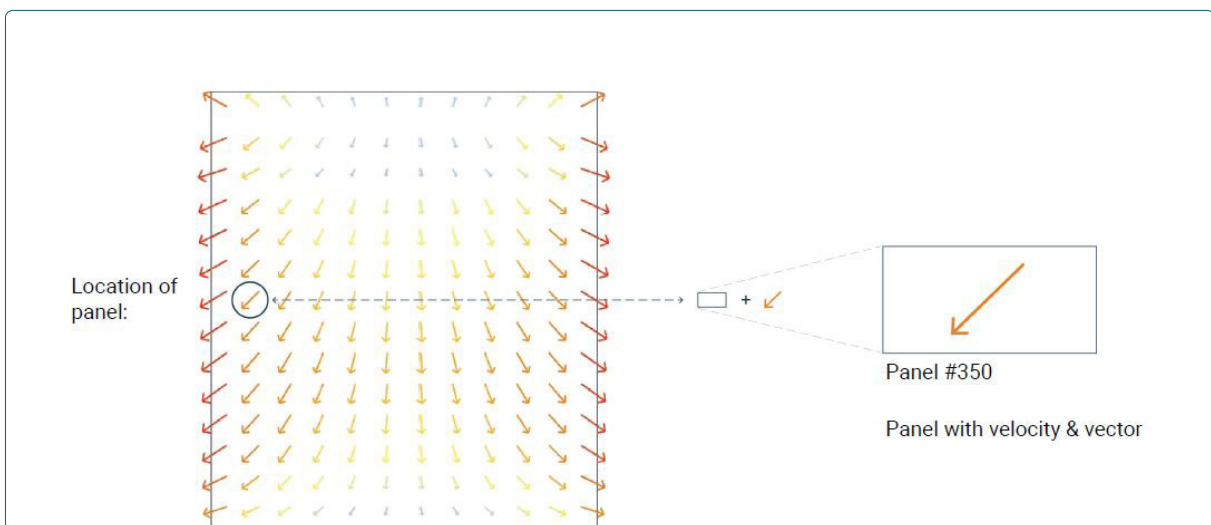

1.

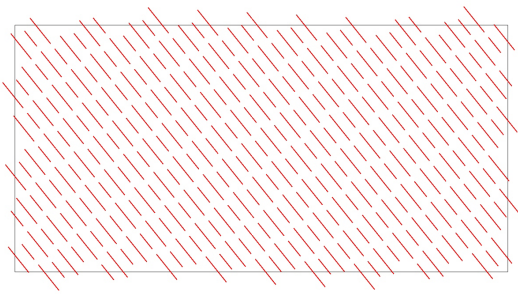

2.

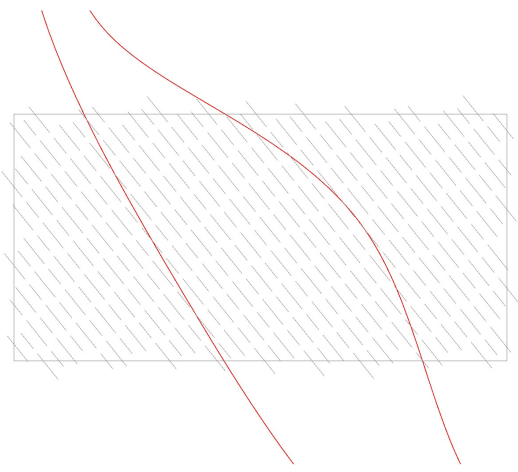

3.

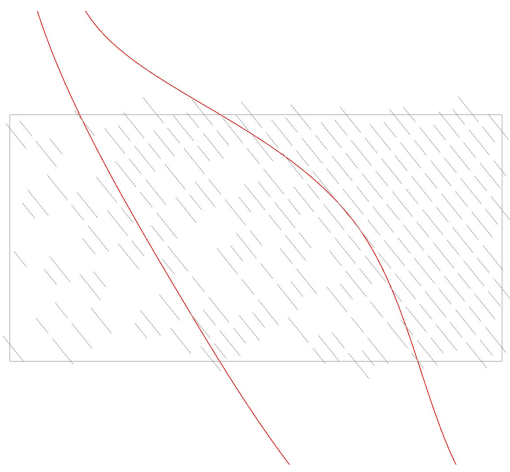

4.

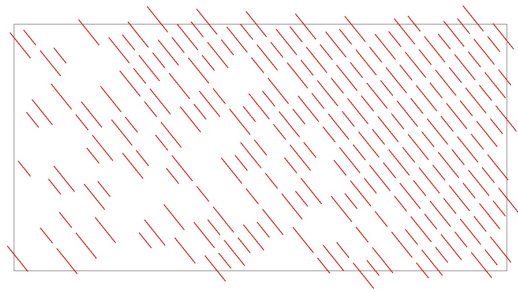

5.

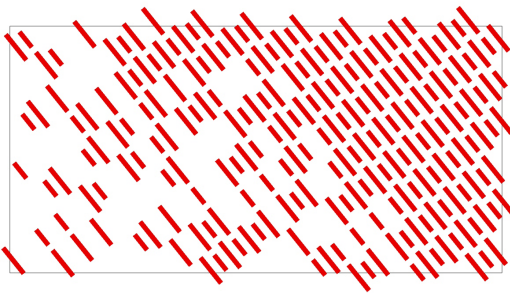

6.

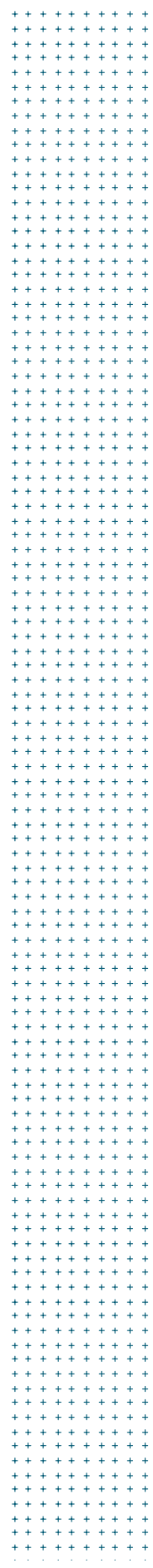

Figure 31 Sequence for panel pattern generation.

Parametric Grooves:

To generate a series of grooves on the surface that corresponds to the parameters outlined earlier in the report, a series of equally spaced lines were created. The spacing of these contours can be controlled by an input parameter that can be adjusted to reduce or increase the number of grooves.

Pattern Generation:

To allow more customization to the design an additional parameter was given to the contours. The lines were subdivided to 150mm segments, then dashed with 50mm intermittent segments. Breaking up the line serves two purposes, the first being that by interrupting the channel it prevents any velocities from accumulating when parallel flows occur. The second, is that it allows more design control by reducing the density of the pattern.

Reorient to primary wind direction:

The pattern is then aligned to the facade panel using the wind vector assigned to it. This is done by aligning the plane of the pattern to the vector direction and rotating the pattern until perpendicular to the flow direction.

Design parameters:

Once the pattern is applied, the pattern can be modified to achieve a desired aesthetic. This is achieved through closed curve boundaries that can be used to generate large scale graphics on the facade. These curves can be assigned a value or density allow the pattern to be controlled by culling away segments from the pattern, shown in Figure 31. In doing so gradients or divisions can be created allowing for graphics to be applied on the facade. This process can then be repeated for the remaining facade panels.

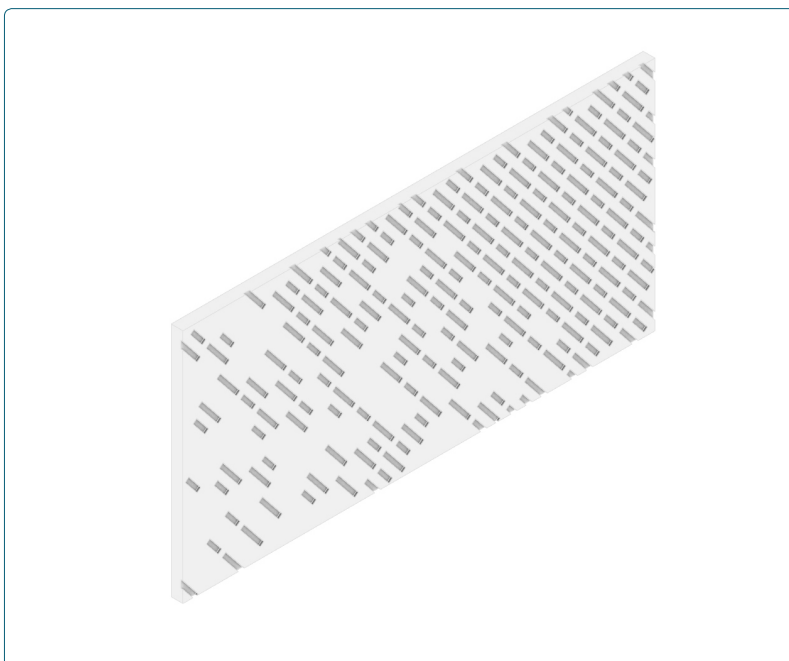

Figure 32 Isometric of final facade panel geometry generated for panel #350.

7.3 Panel Production

To create the panels that will be cladding the building a series of steps need to be taken to ensure that the panels are established with biological growth before being placed on the facade. This section outlines the material production process, the forming processes, the integration of facade components, the application of the biofilm and the establishment period. The first steps outline the steps are more 'conventional' in facade production, while the latter two steps are unique to this thesis. The production sequence is illustrated in Figure 34.

Material casting:

The cladding consists of a foamed MPC concrete in rectangular shapes making it suitable for casting. This process requires a series of standardized molds for the concrete to be poured into. Which can be adjusted to different lengths to create different sized elements on the facade i.e. for window and corner elements. Once the mold is prepared the mixture can be prepared. The foamed MPC concrete must be prepared in particular order as outlined by Li, Wang, Zhou, He & Huang (2019) to ensure the proper foaming reaction. Based on that research the following steps were developed and illustrated in Figure 33.

Once the material has been cast into the molds, it is recommend that the it should remain for at least 3 hours. Typically, for tradition-

Figure 33 Mixture steps, based on research of Li, Wang, Zhou, He & Huang (2019)

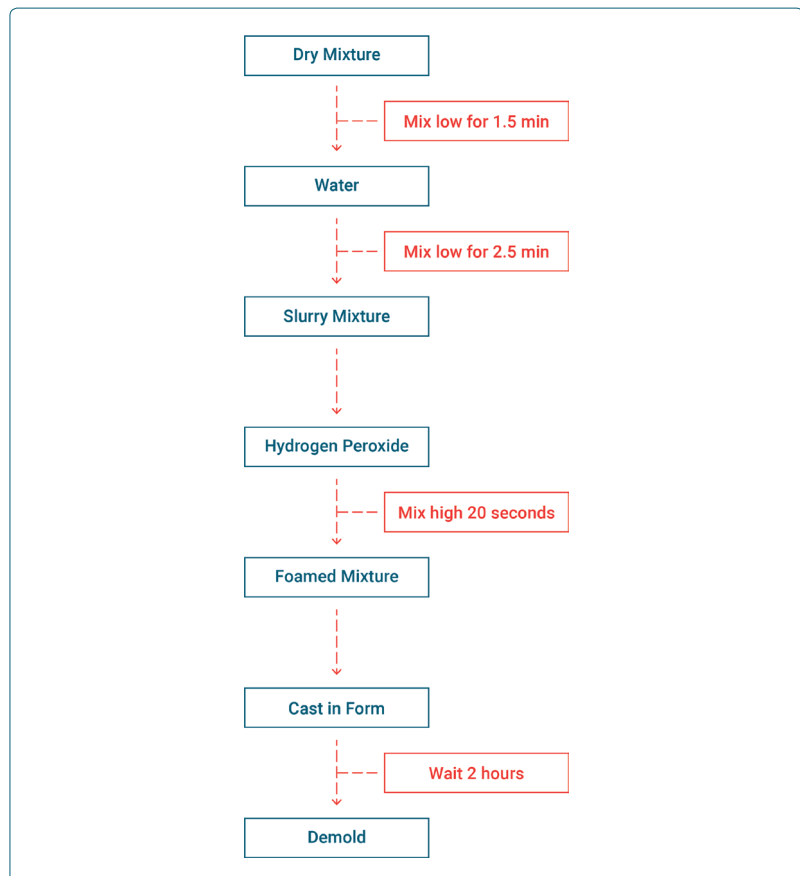

al concrete casting the OPC concrete remains in the mold for at least one day before removing the molds however, MPC has a much faster setting time and can achieve 70% of its strength in less than 3 days (Li, Wang, Zhou, He & Huang, 2019). This characteristic of MPC allows a faster hardening of the cement mixture, faster removal of the formwork and thus, a faster production process. Another advantage for the production of the foamed MPC is eliminating the need of an autoclave oven. Foamed OPC cement or AAC (autoclaved aerated concrete) require an autoclave in the production process to harden the cement before the pockets of air in the cement collapse. However there is a contradiction in the environmental impact of AAC, on the one hand the process uses far less portland cement to make, reducing the mining of resources. On the other, the process uses a large amount of energy (CO₂) to heat the autoclave for hours at a time (Li, Wang, Zhou, He & Huang, 2019). By using foamed MPC the need for an energy intensive autoclave is no longer required, reducing the environmental impact of the production process.

Material forming:

After the material is demolded, the material is then moved to a 3 axis CNC mill where the final surface geometry can be produced using subtractive manufacturing (Figure 35). In the production process, each panel should be assigned a number based on the final location of the panel on the facade. Given the design of the facade produces multiple unique patterns on the surface of the cladding, each panel would require a unique file for the CNC to apply the pattern the

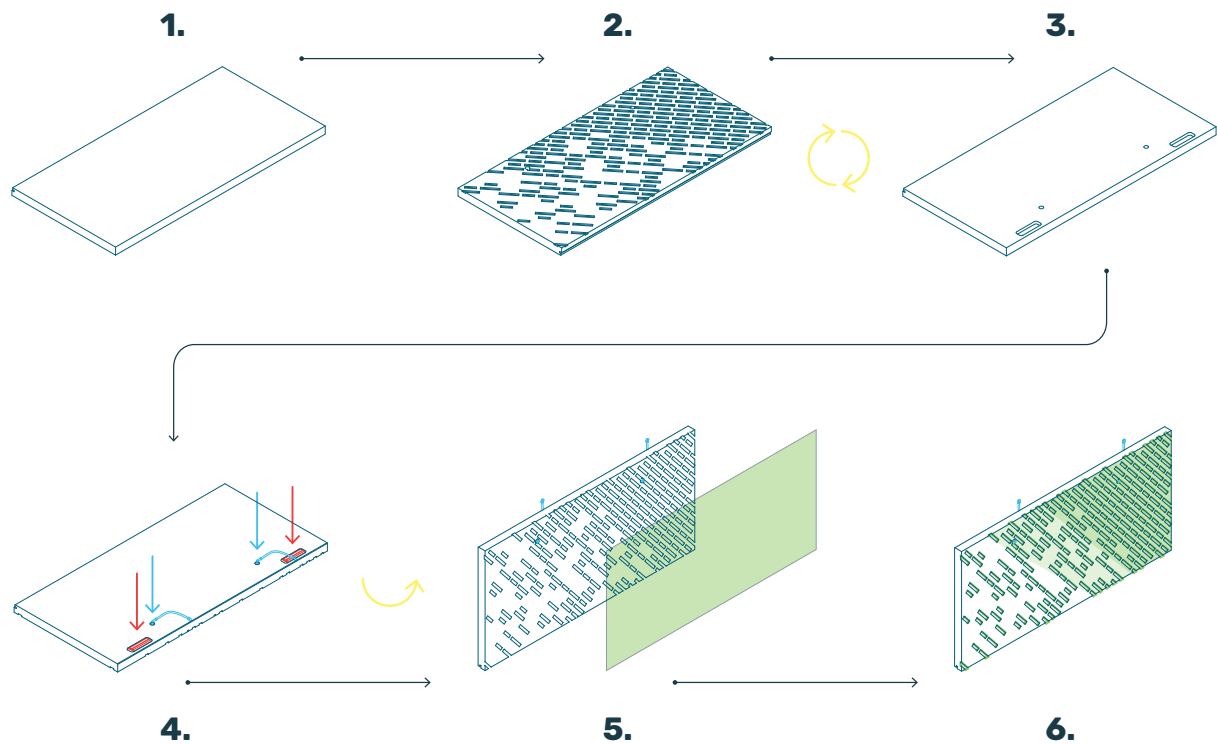

Figure 34 Panel production sequence

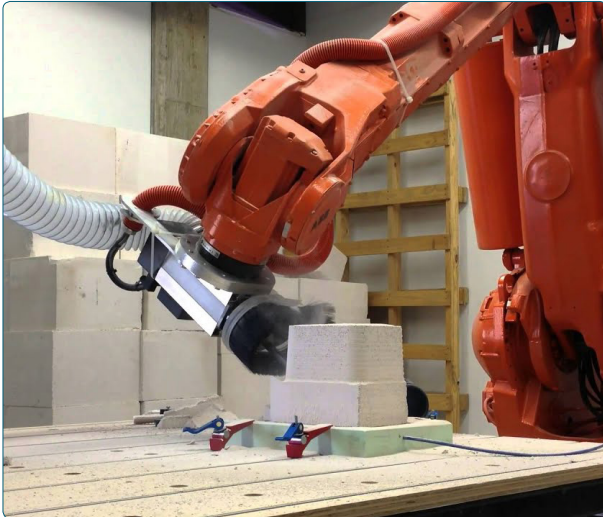

Figure 35 6-axis milling of AAC blocks- Pratt School of Architecture

surface. Once the input file is loaded the CNC can mill away the pattern, this would require the use of masonry bits at standardized dimensions such as the one shown in Figure 36. The process of drilling and routing AAC concrete is not a new technique, it is actually a standard way of integrating electrical and plumbing systems. This makes the masonry bits needed for this process widely available, without the need for custom tooling.

After the pattern is milled, a series of holes are bored into the material; once again using a 3 axis CNC mill. These holes will allow irrigation systems to be placed into the material as well as other sensors that may be required (i.e. humidity sensors). Once all the milling has been completed, the material must be cleaned of all dust and residue to ensure a clean surface for the attachment of other systems and biofilm application.

Mounting bracket and irrigation system:

Once the concrete material takes its final form, other systems and materials can be added to the facade panel. An irrigation system will be attached to the panel using rubber gaskets to seal and hold the misting nozzle in place. The use of a rubber gasket will also make it easier to remove, replace and reuse. Additionally, a UV-resistant silicone sealant can be used to hold the mister in place to improve the lifespan of the rubber gasket.



Figure 36 Masonry bits for CNC milling of foamed MPC concrete

Next, the panel mounting bracket is placed into the appropriate slots that were milled earlier. The anodized aluminum bracket will be cast into the panel with the use of MPC mortar. This mortar is not foamed like the rest of the panel but is rather made using conventional MPC cement mixture. The mortar cement with its higher density will bind the mounting bracket to the foamed cement by integrating into the porous foamed concrete. This should provide an adequate bond that distributes the weight of the panel through the mortar and to the bracket. Once dry, the bracket can be used to move the panel from place to place, as needed.

Once the panel has been prepared, the biofilm can then be applied to cultivate bryophyte growth. Given that this process lies more in the realm of horticulture than facade fabrication, it is recommended that the biofilm be applied by someone who is knowledgeable and trained to perform the task. Also, due to the long time period necessary for proper establishment of bryophytes, the panels should be kept in a controlled environment to speed up the process. Biofilm application should follow the recommendations given in chapter 5 of this report.

Figure 37 Sequence for facade graphic application

1. Panels with channels



2. Boundary Regions- Graphic Design

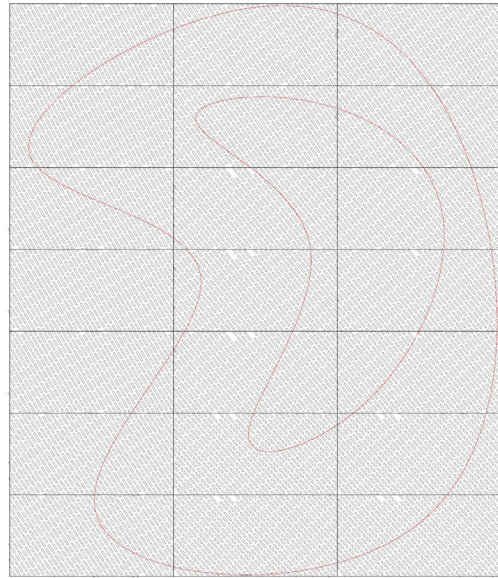

3. Apply densities to regions

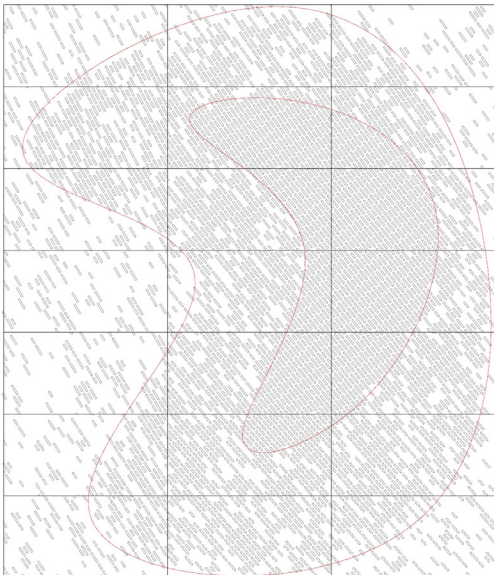

4. Regions-Graphic reassigned

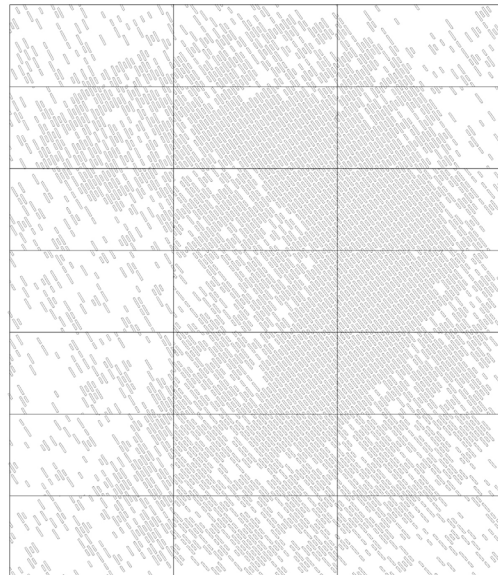

FACADE ELEMENTS

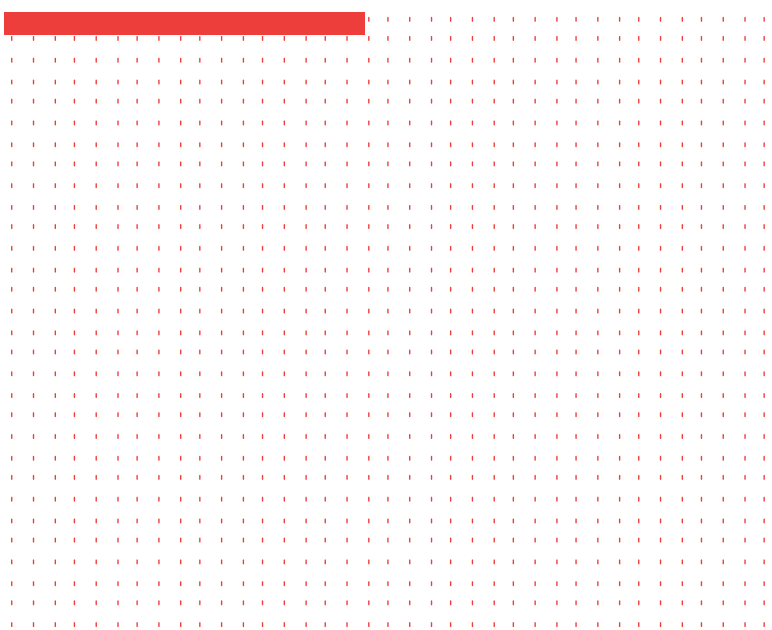
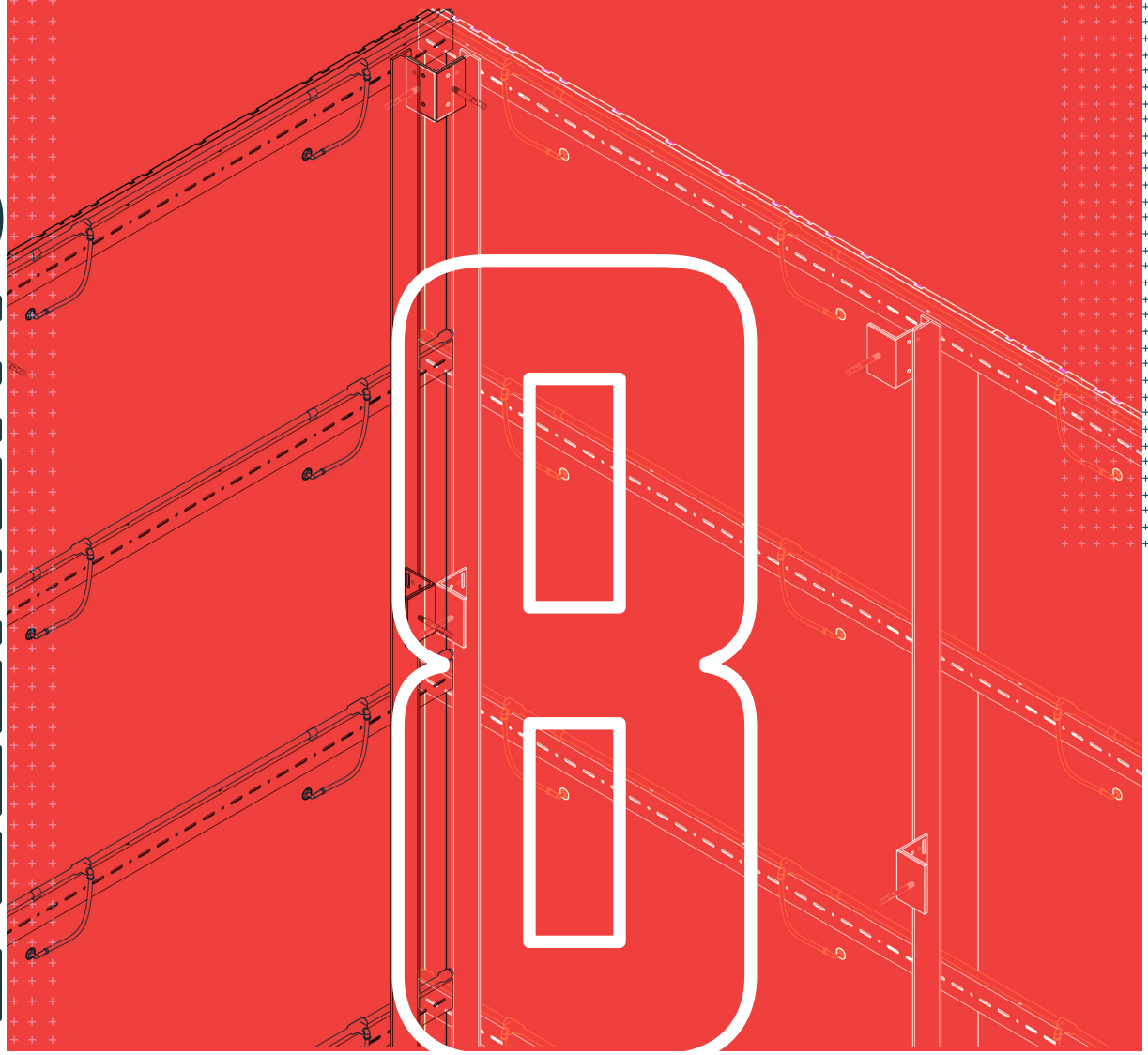

8.1 Facade Assembly

Main structure:

Due to the building conditions previously outlined in this thesis, there are a few typical structural scenarios for a ventilated facade system such as this. For mid to high rise building cladding, the main structural elements are usually either steel frame, concrete reinforced or mass wall (figure xxxx). Although the spacing of the structure varies from material to material, not much else has to change in order for this system to be installed. For large surfaces, smaller structural elements may need to be placed to support the facade.

Mounting Bracket:

Attached to the main structural elements are the mounting brackets with polyimide thermal breaking pads (figure xxx). This bracket is to be mounted to the structure using a bolt compatible with structural material, i.e. a concrete structure needs an expansion masonry anchor bolt. Attached to the mounting bracket is a vertical angle profile. This aluminum profile requires a fixed hole and a slotted hole to allow thermal expansion of the profile.

Insulation:

Once the structure of the facade has been assembled vapor barrier and insulation can be inserted. The insulation can be attached using anchoring plastic ties. This is again to prevent thermal bridges through the insulation material. An air cavity should be maintained in front of the insulation material to allow for ventilation.

Rails and substructure:

After, the aluminium horizontal profiles can be mounted to the vertical profiles. Just like the vertical profiles, the openings for the bolt require one fixed hole and the rest slotted holes for thermal expansion. The horizontal profiles must be leveled and spaced accurately, tolerances between the cladding panels are determined by the accuracy of these elements.

Irrigation system:

Once it is leveled, the irrigation system can be placed. The horizontal profile also has incremental holes running along the top of the profile. Into these holes, the plastic clips are to be placed. These clips hold the irrigation line into place to prevent deformation and movements due to changes in water pressure. The irrigation lines can then be placed. These lines are installed horizontally and in corners there are larger vertical lines that distribute the water throughout the facade. The irrigation lines also have integrated fixtures at increments of 600mm, these act at the connection point between the panel and the main system. Unused openings in the fittings can be capped if they are not needed.

Transport to site:

To ensure the safety of the mosses, the bio colonized panels should be transported to site oriented vertically. This should be done using the integrated mounting brackets. The panels should also be handled using the brackets as much as possible and not the edges of the material.

Facade panel placement

Using the integrated panel brackets to move the panels, the cladding can be placed using a crane or cherry picker to get them to the final location. The panel number needs to correspond to the panel layout drawings to ensure that the panel is the proper location. This is key to achieve the performance of the moss and any graphic that was designed on the facade.

Attaching systems:

Once the panel has been mounted to the rail. The panel has to be connected to the water systems and sensors have to be connected. To connect to the irrigation system, hoses that are pre-installed to the panel have to be pulled up from the cavity. It can then be connected to the irrigation lines at the fitting locations. The humidity sensors have to be connected to a wire that also runs inside the cavity. These sensor only occurs in a few locations and are not found on each panel.

Additional details of the facade can be found in the appendix of this report.

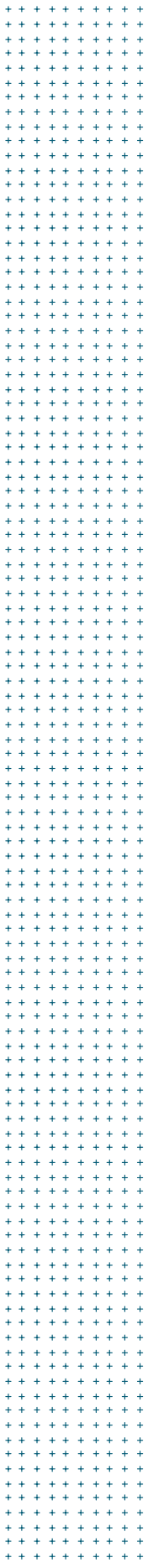

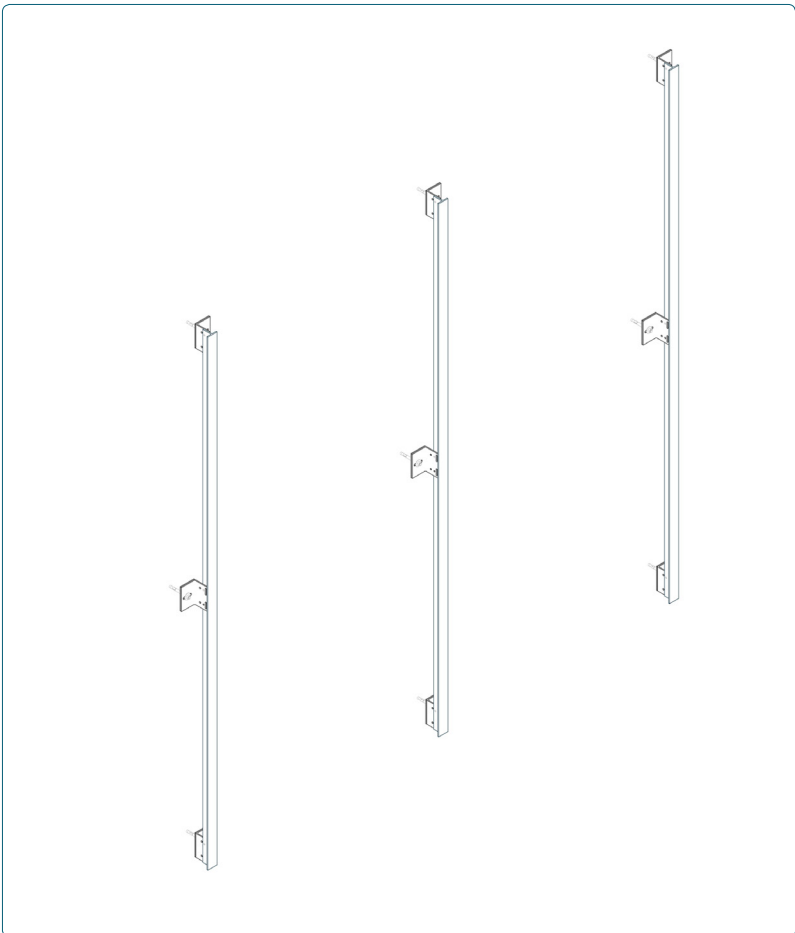
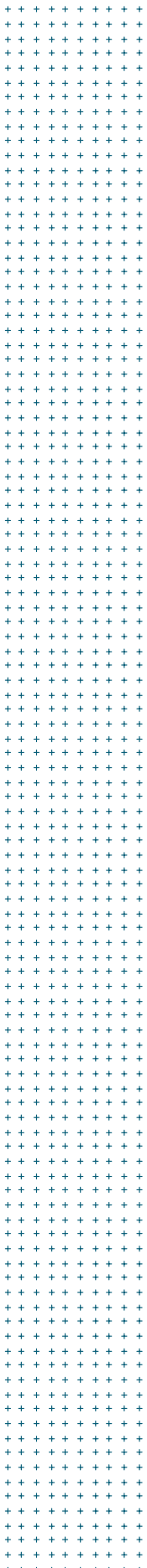

1. Vertical profiles and structural mounting brackets.

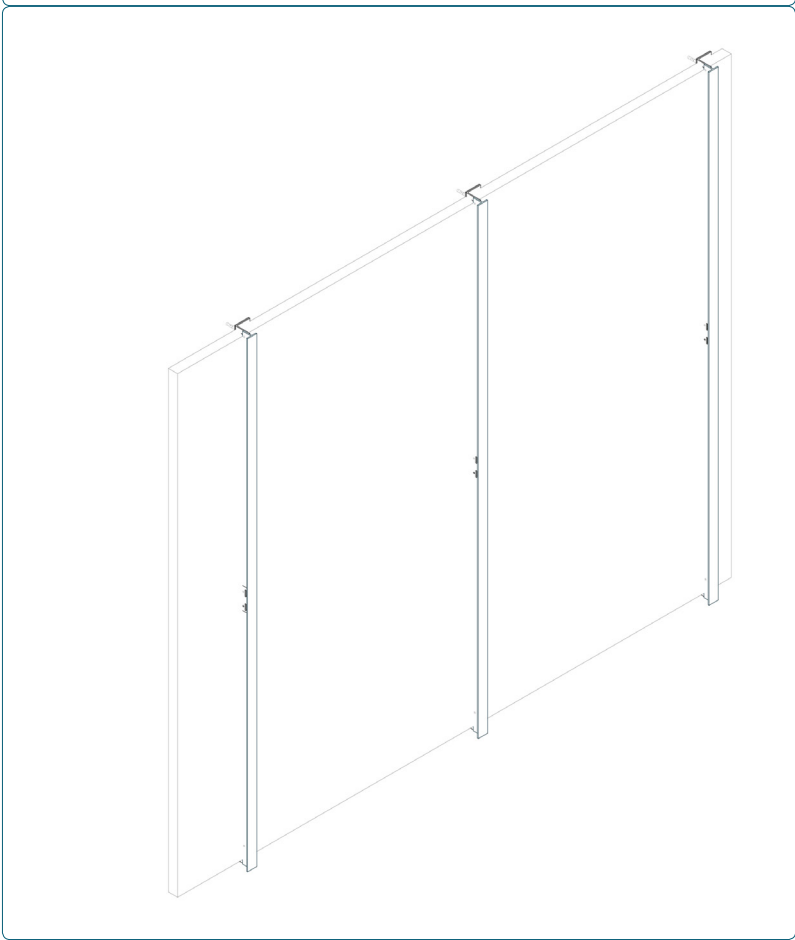

2. Waterproofing membrane and insulation layers.

3. Horizontal profiles and rubber gaskets

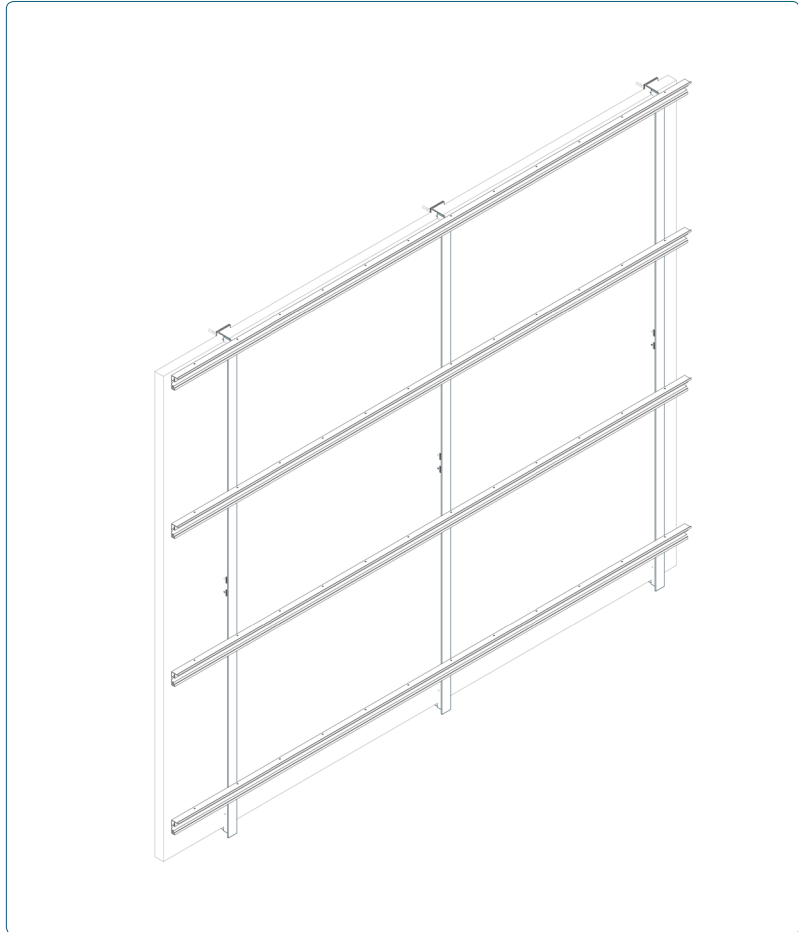

4. Irrigation system and sensors.

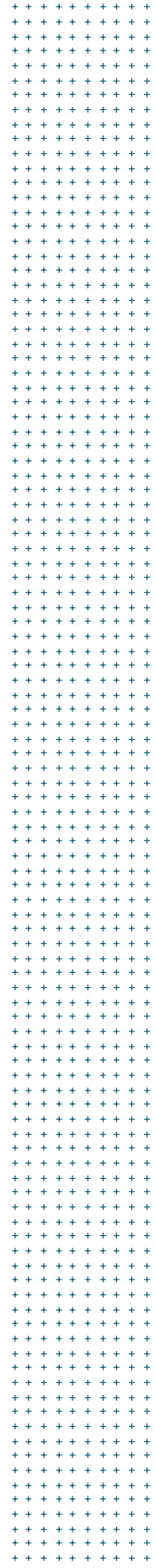
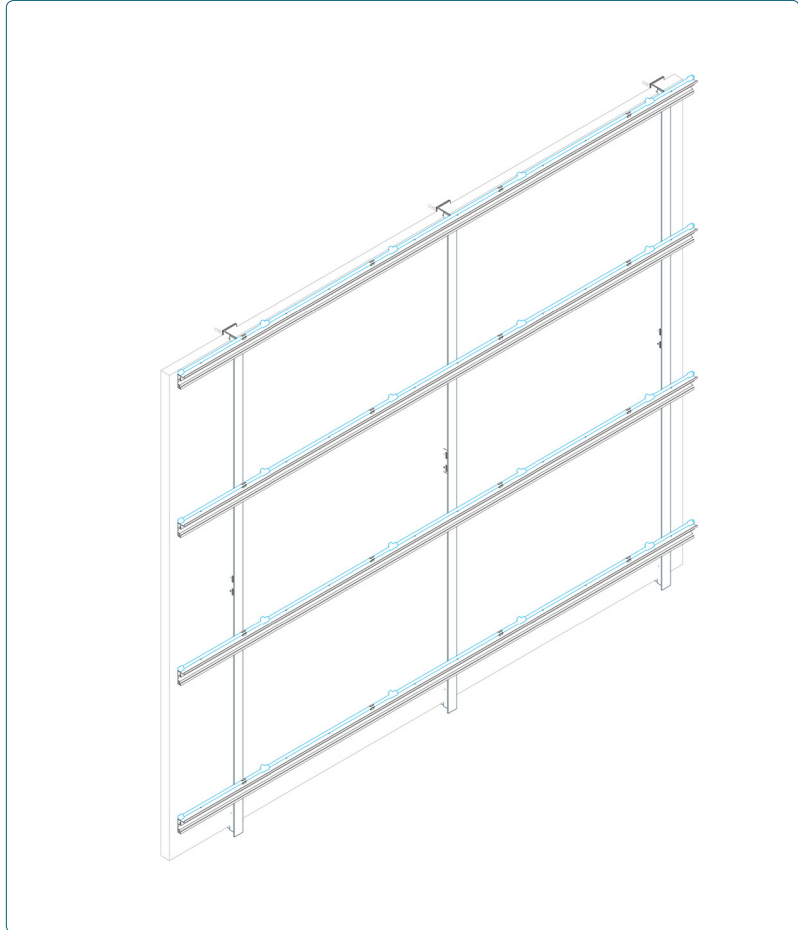

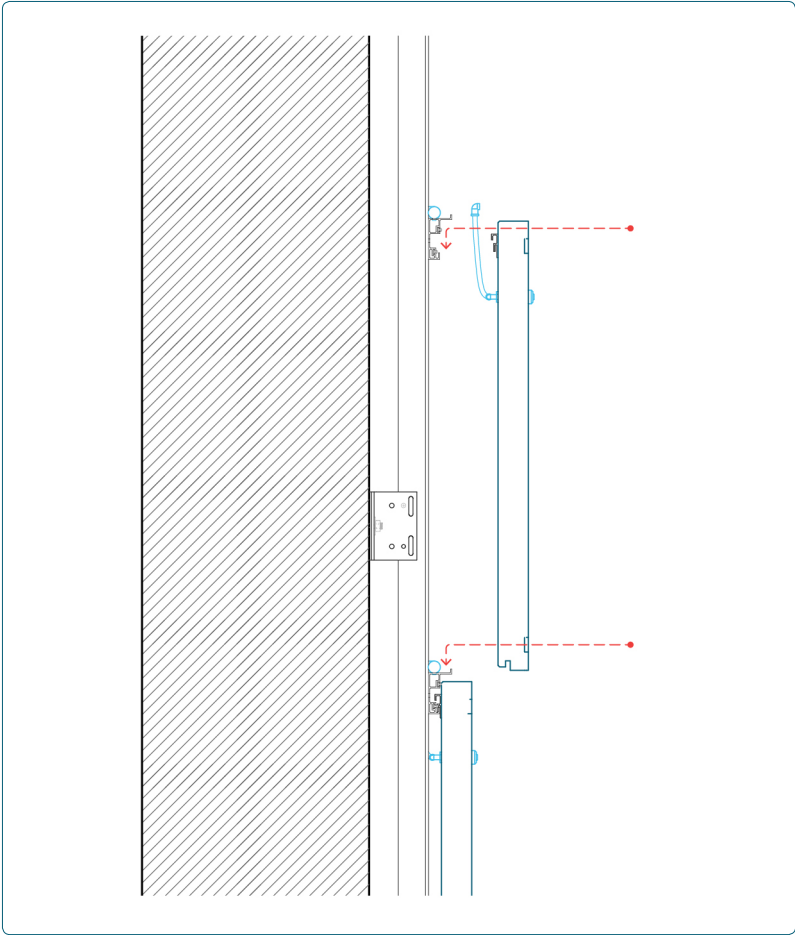

5. Panel mounting to horizontal profile, attach mister to main irrigation lines.

8.2 Irrigation System

Traditional LWS and direct green facades require substrates and irrigation systems that maintain a certain amount of moisture and nutrients within the substrate. When saturated with water these substrates can become heavy, increasing the load on the facade structure. Additionally, they use large amounts of water depending on the climate and water uptake from the plants being used. By using bryophytes the need for heavy soils are no longer required. Instead only incremental moisture needs to be maintained on the surface of the material.

Maintaining moisture on the surface can be achieved through different methods. One method is through external active irrigation to the bryophyte. Water can be applied with the use of misters or sprinklers that evenly spread water across the surface. Given that the facade only requires small amounts of moisture these external applications of water need only be activated for small periods of time. Also for the same reasons, smaller droplets would be more suitable, using a misting nozzle would produce finer droplets. Comparing the different irrigation products, the spray angle coverage of the mister can be further refined. Shown in Figure 38 the misting nozzle selected was the 1/8" ultimist misting nozzle which can produce a mist with droplets about 60 microns. Additional information on the misting nozzle used can be found in the appendix of this document.

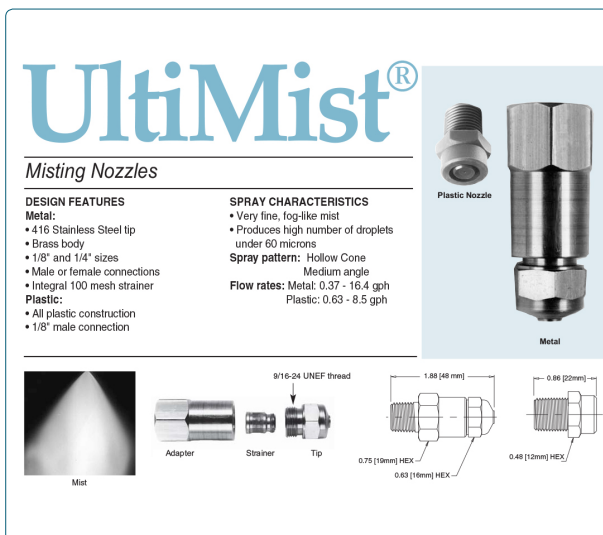

Figure 38 UltiMist® (UM) Misting Nozzle.

To maintain a network of mister across the facade, irrigation lines need to be linked to the nozzles. To achieve this network an irrigation scheme was created to illustrate how the system needs to function (Figure 39). As shown in the schematic, the main water supply is to be located at the top of the building. This is to maintain adequate pressure in the irrigation system. The water supply can be sourced from rainwater harvesting or from a municipal supply. Whatever the source, the water should be filtered through a carbon or sand filtration system before entering the irrigation lines. This is to ensure that no metal contaminants such as zinc or copper oxides enter the supply. This could be harmful to the bryophytes accord to Glime (2017).

Another purpose that the irrigation system serves is to supply the bryophytes with periodic fertilization. One disadvantage to the growth of bryophytes is the lack of organic matter which is readily available natural environments. This organic matter serves as a natural form of fertilization as it decomposes. However, for higher elevations in urban environments this form of natural fertilizer is not accessible. Other methods of fertilization can be employed instead.

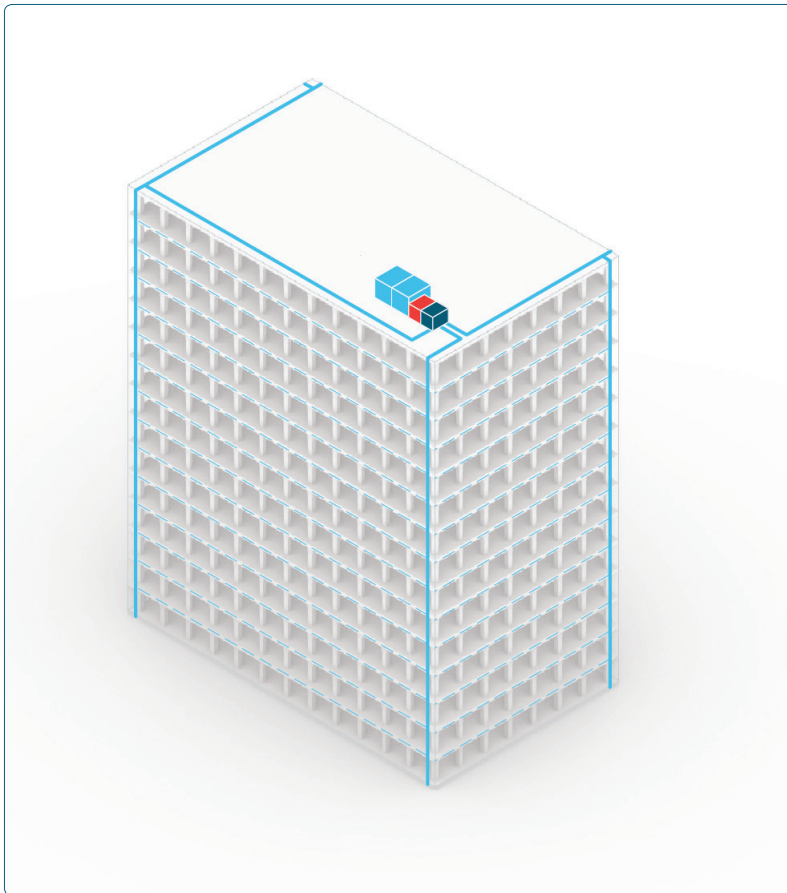

Figure 39 Irrigation building schematic: storage tank with filtered water source, pump/ weather monitoring station and nutrient module

Common in some LWS, aquaponic and hydroponic systems, liquid fertilizers are often employed to promote plant growth. Similar to these systems, liquid fertilizers can be added to the water supply periodically to improve bryophyte growth. Further research needs to be conducted on how much and how often the fertilizer needs to be applied. This can be as little as two times a year to maintain plant health.

To evaluate how often the irrigation system may be needed existing research on mosses was investigated to determine how long they can undergo dry periods. A 1996 journal named "Tolerance of Sphagnum to desiccation" by Clotilde Sagot studied the effects of prolonged heat and desiccation have on mosses. Her results show that Sphagnum mosses can survive up to 14 days without water at temperatures above 20 °C with a relative humidity of 60%, however this decreases significantly when the temperatures reach or exceed 30°C. The study also observes that temperature and moisture are closely related to the survival of the moss. In periods of high temperatures the moss can survive so long as there is moisture present. The inverse is also true; when temperatures are below 20°C the moss can survive longer periods of time without moisture.

It is also important to note that once the moss undergoes full desiccation it becomes harder for the moss to regenerate. To reduce the amount of time the mosses undergo desiccation the period

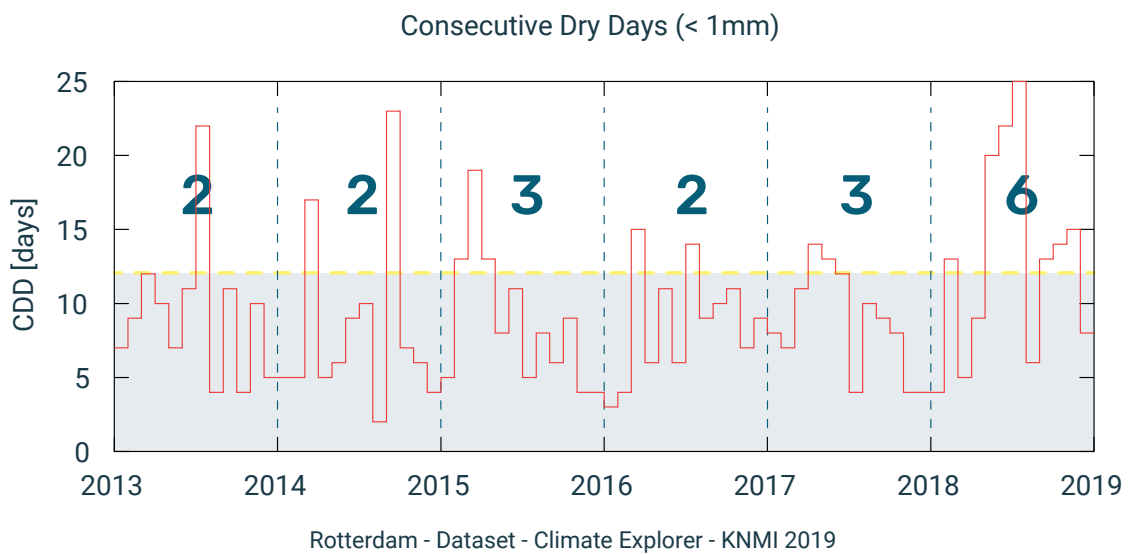
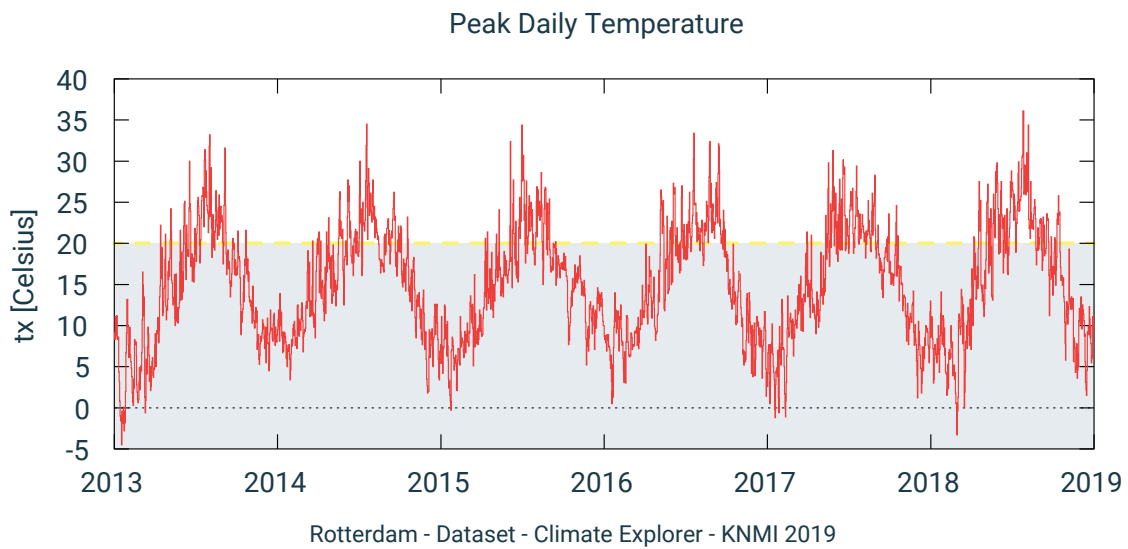

Figure 40 Rotterdam Climatic data from KNMI. Above: Maximum Daily Temperature. Below: Consecutive Dry Days and number of occurrences a year exceeding 12 consecutive days.

of 14 days should be reduced by 2 days to ensure the mosses do not surpass this limit. There is also a key distinction between the study and this thesis, which is the orientation of the moss. The study observed moss at ground level on a horizontal plane, whereas this thesis uses moss on a vertical plane. This could have an effect on the moisture levels and the drainage of the surface, causing the moss to dry out more rapidly than what the study observes.

In climates with regular rain and high humidity such as The Netherlands the irrigation system may not need to be frequently used. However, under extreme conditions and with more frequent heat waves occurring in Europe, the need for an irrigation system may prove necessary. During the summer period when temperatures reach +20°C, if there is no rain within the span of 12 days irrigation needs to be provided to prevent desiccation of the moss. This may occur on average 2-3 times a year based on climatic data from KNMI (The Royal Netherlands Meteorological Institute) as shown in Figure 40. Yet climatic irregularities may require the irrigation system to be used more frequently, as was the case in 2018 when a summer drought created a series of prolonged consecutive dry days.

As mentioned previously in the literature review, heat can cause mosses to dry out or go dormant but if prolonged growth can be halted. During days of unusually high temperatures above 30°C the rate of desiccation is increased and activation of the irrigation system is recommended. Additionally, in order to keep the cooling potential of the facade, if there is no moisture present the evaporative cooling effect is lost. Therefore, having an irrigation system is necessary to protect the investment made to achieve the green facade and benefit from the cooling potential.

Lastly, this system can be automated to reduce maintenance and optimize water usage. When combined with a rooftop weather station and humidity sensors on the facade surface, the irrigation system can only be active when needed. By further optimizing the system, the irrigation system does not need to follow a regular schedule. Rather, it uses the conditions of the day to activate if needed for the amount of moisture needed. Digital irrigation systems like the one described above are already implemented in horticulture and can be modified to work for a concept such as this.

It is important to note that this irrigation system is assuming the building conditions outlined earlier in the report. For buildings that are much smaller (one to five stories high) it may be possible to eliminate the need of such an active irrigation system. For these smaller heights, manual spray irrigation can be used to apply water during droughts or extreme weather scenarios. This is a possibility that can be further investigated in future research yet, for the boundary conditions outlined in the report it is necessary to integrate an irrigation system into the facade.

8.3 Maintenance

As mentioned in the previous sections of this report maintenance can be relatively small for a facade such as this. Within the category of green facades, this concept does not require seasonal pruning of plants, weeding or plant replacement. Also given that bryophytes are not deciduous plants, they do not litter the surroundings with leaves, petals or branches. Pruning and weeding maintenance is required with existing LWS a minimum of two times a year, often with cherry pickers or BMUs (Ottelé 2011). This leads to long term costs requiring specialized labor to maintain the green facade (Figure 41). This has become a limiting factor for the use of traditional LWS systems on highrise buildings. The higher the LWS the more complicated and costly the system is to maintain.

With this new type of green facade, so long as the conditions of bioreceptivity are met and the bryophytes remain active, the bryophytes should be able to grow and maintain themselves. The system should only need to be visually monitored a few times a year to observe growth and ensure irrigation systems are functional. This can be performed form just a quick visual inspection. Should there be any issues with growth the facade can be repropagated with a new biofilm application or by replacing the facade panel itself. Although, at times it may require more maintenance than a typical cladding system the facade the benefits of such a system can outweigh the effort required.

Figure 41 LWS facade maintenance



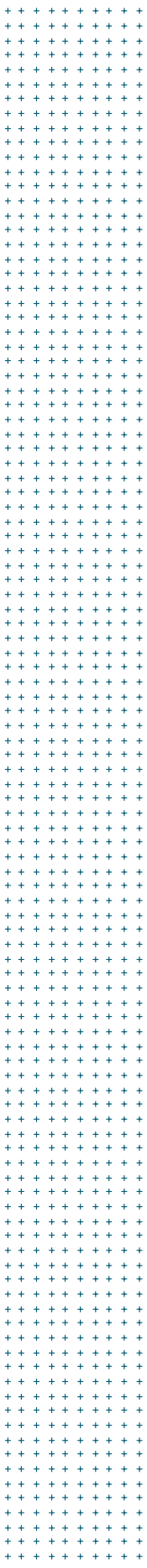

EVALUATION

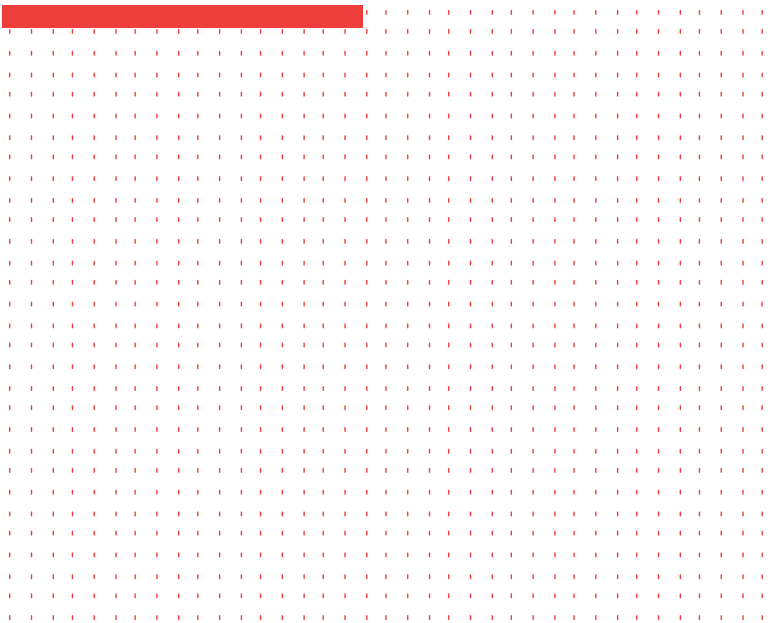

9 Evaluation

Evaluation Setup:

To derive the thermal effects of bryophytes on a vertical surface, a facade panel of one meter by one meter was used as a case study. Under average climatic conditions, the performance of the panel was calculated using heat transfer equations. In order to theoretically calculate the difference that moss makes in this scenario two cases were taken. The first is a foamed MPC panel 30mm thick with a generic moss covering the first 5 mm of the surface. The second takes the same scenario but applies forced convection, with wind speeds of 5 m/s. The moss being evaluated is assumed to be saturated with water. Figure xxx illustrates the heat balance diagram of the facade panel.

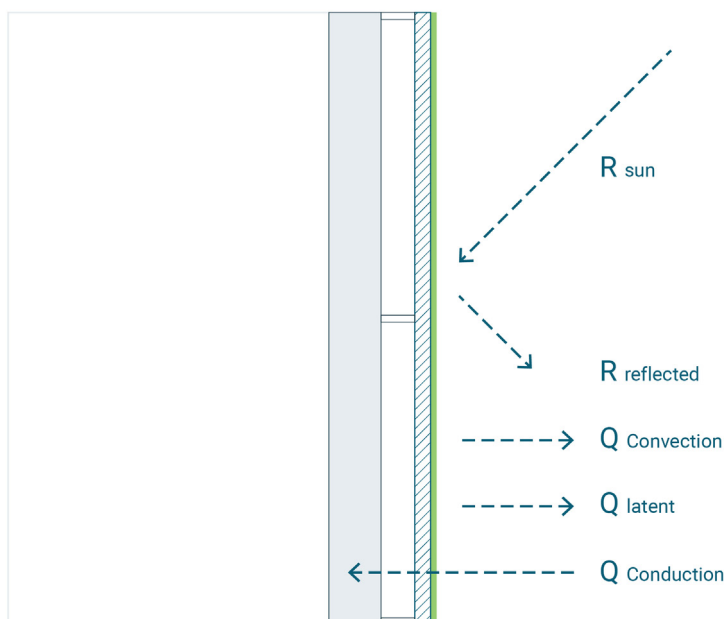
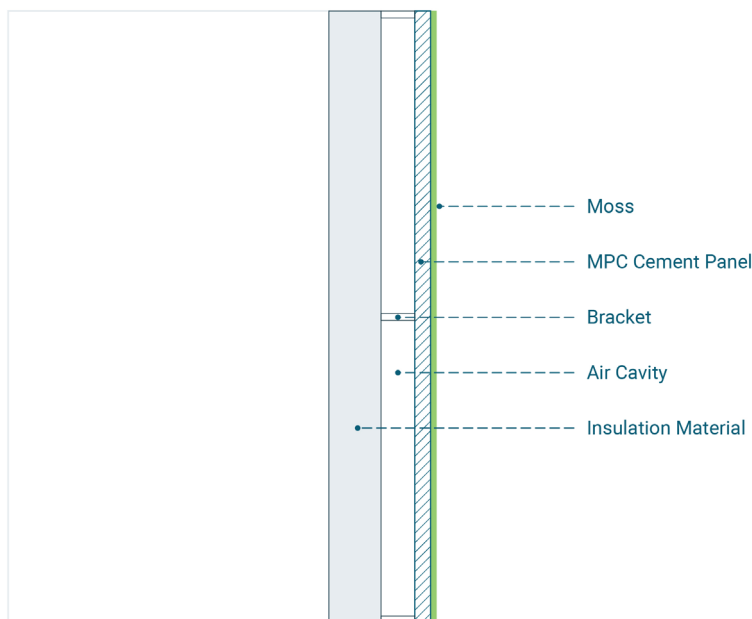

9.1 Nomenclature

A	External Surface Area
B	Bowen ratio
e	Evaporation
Gr	Grashof Number
g	Gravity
h	Convection Heat Transfer
k_n	Thermal Conductivity
L	Thickness
l	Latent Heat of water
$Q_{conduction}$	Conduction Heat
$Q_{convection}$	Convection Heat
Q_{latent}	Latent Heat
Q_{sun}	Total solar radiation
R_I	Irradiance
R_R	Reflected radiation flux
Re	Reynolds Number
r_T	Total thermal resistance
r_n	Thermal resistance
T_∞	Ambient temperature
T_s	Surface temperature
$U_{average}$	Average wind velocity
ν	Kinematic viscosity of fluid
ΔT	Difference in Temperature
β	Coefficient of expansion of fluid

9.2 Calculation Methods

Through the heat balance equations, the total solar radiation Q_{sun} heat balance of the surface needs to be equal to the sum of conduction $Q_{conduction}$, convection $Q_{convection}$, and latent heat Q_{latent} . The total radiation can also be used to solve for unknown or missing variables in the equation and can help determine the impact that moss can have under different conditions. This method can be used to evaluate a facade panel from the design under theoretical conditions.

In addition, Grashof number can be used to determine the buoyancy to a viscous force for heat transfer. This can be used in situations of natural convection to estimate the opposing forces when an increase in temperature can cause the fluid air to rise. Equation 1 shows the formula for Grashof number for vertical flat plates.

Reynolds number is another number that can define the flow patterns in fluid air, in this particular case the wind turbulence. A low Reynolds number can mean the flow is laminar, with little turbulence and little change in the fluid's direction. A higher number means there are changes in speed and direction creating turbulence in the flow. These changes in the flow can create cavitations in the fluid forming eddy currents. Equation 2 shows the formula need to derive the Reynolds number. Together with the Grashof number a ratio can be generated that can specify if forced convection is dominating the heat transfer. This ratio is made from taking the Grashof number and dividing it by Reynolds number squared $[Gr/Re^2]$. A value that is below 0.1 can mean that forced convection is a dominant factor.

Equation 1: Grashof Number

$$Gr = \frac{g\beta(T_s - T_\infty)L^3}{\nu^2}$$

Equation 2: Reynolds number

$$Re = \frac{U_{average} L}{\nu}$$

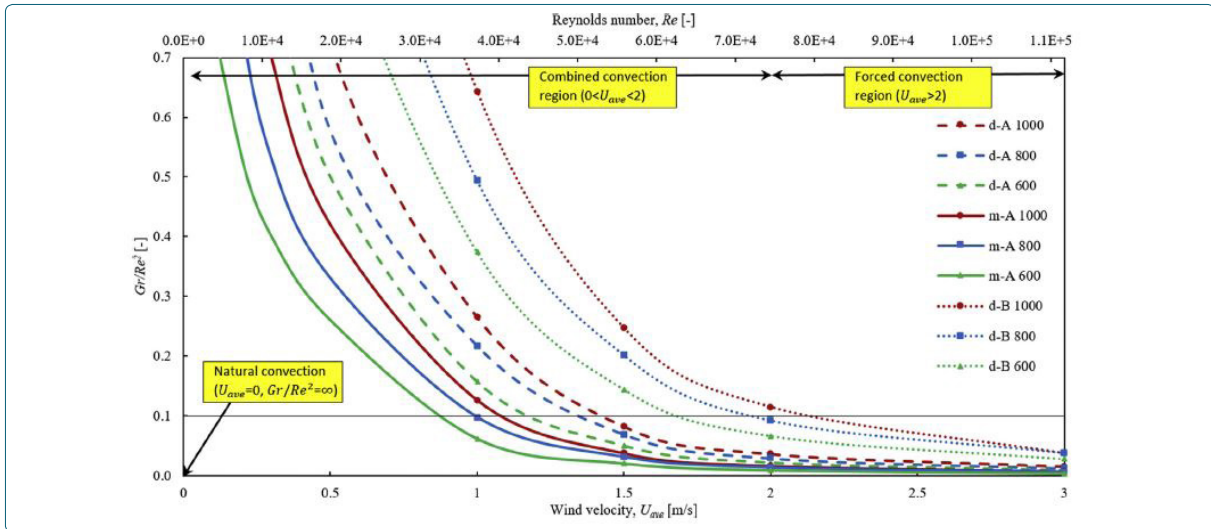

Figure 42 Ratio of Reynolds number and Grashof number to determine convection of moss. Katoh, Katsurayama, Koganei and Mizunuma (2018).

Based on previous research of Katoh, Katsurayama, Koganei and Mizunuma (2018) it can be determined that the ratios given using these formulas produce a results above .1 when the velocity is below 1 m/s. At speed between 1 m/s and 2 m/s there is a significant drop in the ratio (see figure xxx). However, after reaching speeds above 2 m/s forced convection is occurring with a ratio below .04. For speeds higher than this, the ratio is not significantly different.

An important factor in the cooling potential of moss is the evaporation of water from the surface. The latent heat flux Q_{latent} can be calculated using equation 3. The latent heat coefficient of water is taken as 2257 kJ/kg for the equation. In areas where moist moss is not present, the benefits of evaporative cooling in this equation are lost.

Equation 3: Latent Heat flux

$$Q_{latent} = \frac{el}{tA}$$

Convection heat can be calculated by taking the difference in temperature and multiplying by the convection heat transfer coefficient h , as shown in equation 5. However, the convection heat transfer coefficient h for moss is a changing variable dependent on the conditions of convection (forced or natural). As wind speeds change so can the heat transfer coefficient. Due to this, existing research on convection heat transfer of moss was referenced to generate the missing variables. The laboratory research conducted by Katoh, Katsurayama, Koganei and Mizunuma in Japan outline the coefficients at different wind speeds and where used to complete this calculation (2018). A coefficient of 24.5 W/m² K was taken for natural con-

vection and 116 W/m² K for wind speeds above 2 m/s under forced convection.

Equation 4: Convection Heat

$$Q_{convection} = h(T_s - T_\infty)$$

Next the conduction heat flux $Q_{conduction}$ needs to be calculated to complete the heat balance equation. However the total thermal resistance rT still needs to be calculated. A conduction heat flux equation can be used for thermal resistance r_n , then summed with other materials to get the total thermal resistance for the formula. The thermal conductivity k_n for moss was assumed to be 1.13 W/mK and .22 W/mK for foam MPC with a density of 600 kg/m³ as described earlier in the report.

9.3 Heat Transfer Results and Discussion

Assuming a stationary scenario all heat flows must be equal. Some additional values are used based on the climatic conditions, solar irradiation was taken at 800W with an ambient temperature of 25 degrees celsius (an average ambient temperature for summer in Rotterdam). Additionally, a surface coverage of 70% was used, to assume that the panel is not densely covered with moss. This can become a variable that changes based on the desired coverage. Using these as the base inputs, heat balance equations during natural convection the results are as follows:

$$Q_{sun} = 0.7(800W) = 560$$

$$Q_{conduction} = \frac{\Delta T}{.141}$$

$$Q_{convection} = 24.5(T_s - 25)$$

$$Q_{latent} = \frac{e(2257)}{t(1)}$$

The latent heat equation however still needs to be completed. It is therefore assumed that 50% of the volume of moss is saturated with water. In real life this can be up to 90% of the mosses weight. For the missing variable of time, a one hour period is taken. With these

inputs, the latent heat equation is as follows:

Before solving the equations for the facade panel populated with moss the panel should be evaluated without the moss to establish a baseline. This can be calculated by negating evaporative cooling and the convection coefficient of moss (which would potentially provide a benefit to the cooling of the surface). Solving the heat balance equation as mentioned above, a surface temperature of 44.8°C was determined for a surface of sterile, uncolonized MPC.

Completing the equations for the surface colonized with moss and solving for T_{sa} result of 40.1 °C is given. It is important to note that this is assuming that the sun is stationary which would not be the real situation for a vertical urban facade. However this gives a reference point to compare as variables change. Comparing this result with the previous moss-less calculation a difference of 4.7°C can be observed. This can be attributed to the benefits of latent heat from the moisture of the moss.

Adjusting the formula by increasing the wind speed above 2 m/s (in the realm of forced convection) the result given is 33.5 °C.

The difference between the two calculations with moss shows a reduction the external surface temperatures by up to 6.6 °C when under forced convection (wind speeds above 2m/s). This is mainly due to the convection heat transfer coefficient for moss which can increase as wind speeds change.

Based on the heat balance calculations for these three different scenarios it is clear that the addition of moss provides a cooling benefit which can be further enhanced when the surface is under forced convection. This is however a theoretical situation, in a real world scenario this effect would not be as consistent. Wind speeds and directions are variable on large surfaces such as buildings and can impact the heat transfer coefficient. To better estimate the cooling potential of the moss a transient simulation is needed.

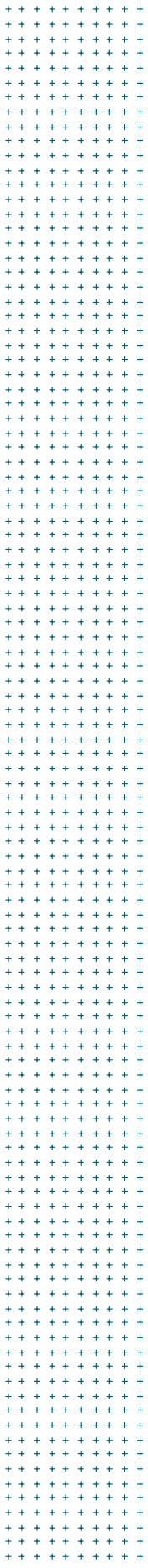

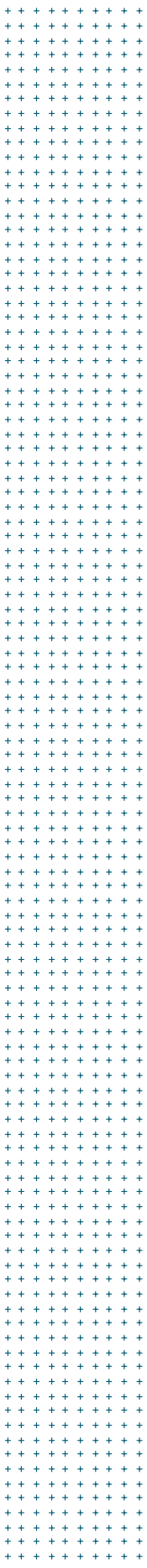

TRANSIENT EVALUATION

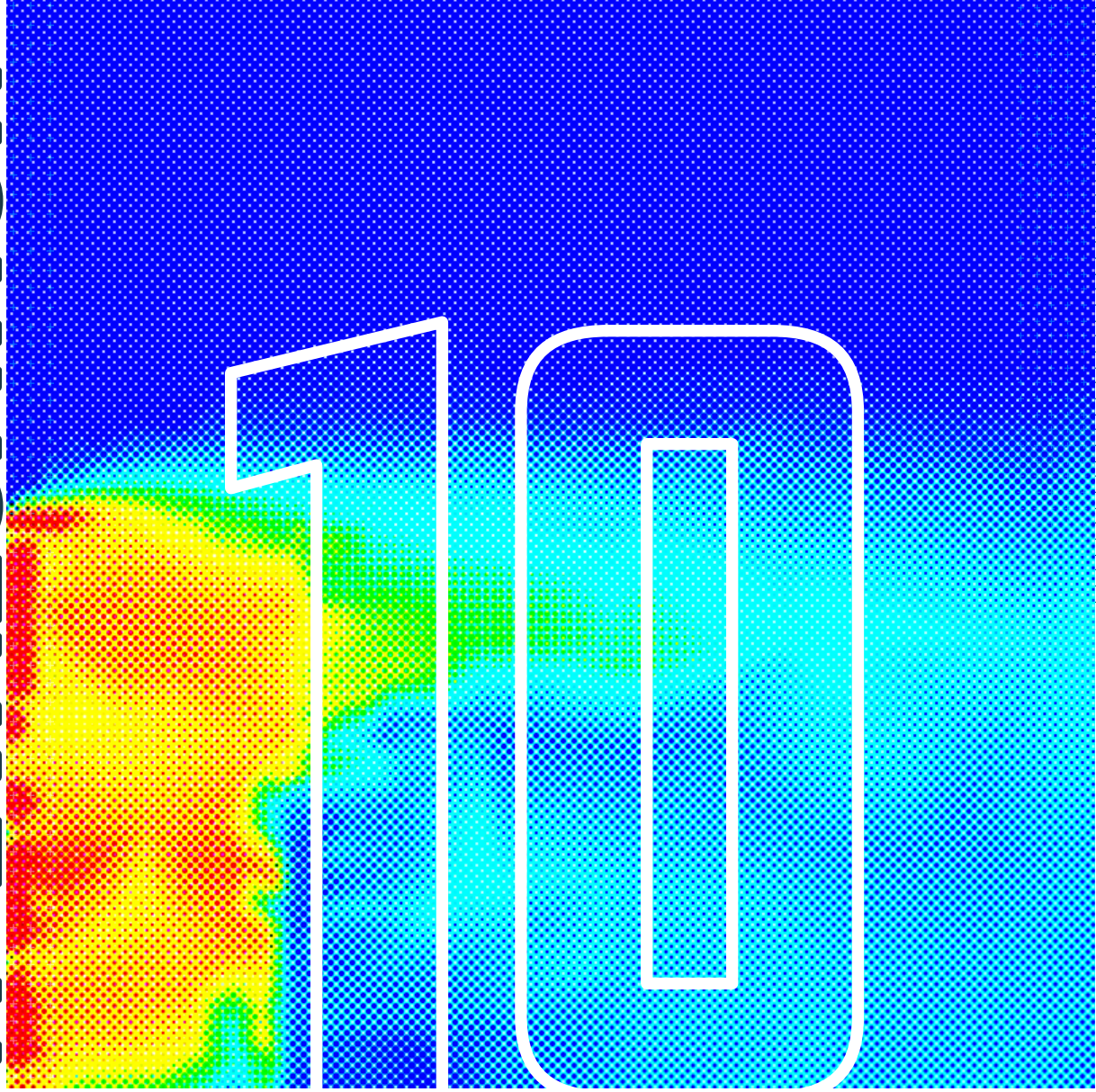

10.1 Building Transient CFD Analysis

To better understand the impact that wind can have on a building surface a transient wind analysis was conducted. The purpose of the analysis is to highlight where on a building the effects of forced convection can positively impact the results. In order to achieve this Autodesk CFD was used to set up two simulations then combine them to one result.

Steady State Setup:

The analysis was setup in two parts, the first is a steady state air flow analysis and the second is a transient heat transfer analysis. For the steady state simulations a wind speed of 10m/s was used as an average high wind speed of the region. The flow simulation used a SST k-omega SAS Turbulent model with 200 iterations (menus can be found in the appendix of this report). The angle of incident was taken perpendicular to the facade this will produce extreme and turbulent wind on the facade (Figure 43). Once the air flow was simulated (see Figure 44) the results were then applied to a heat transfer simulation.

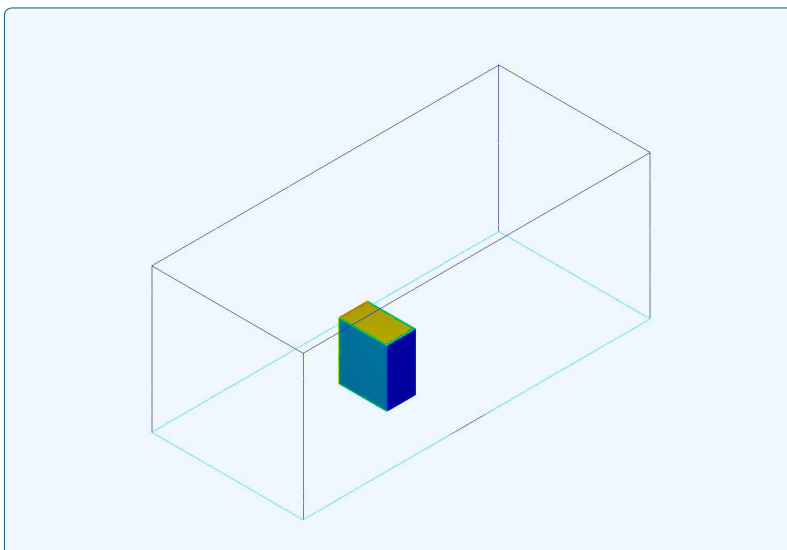
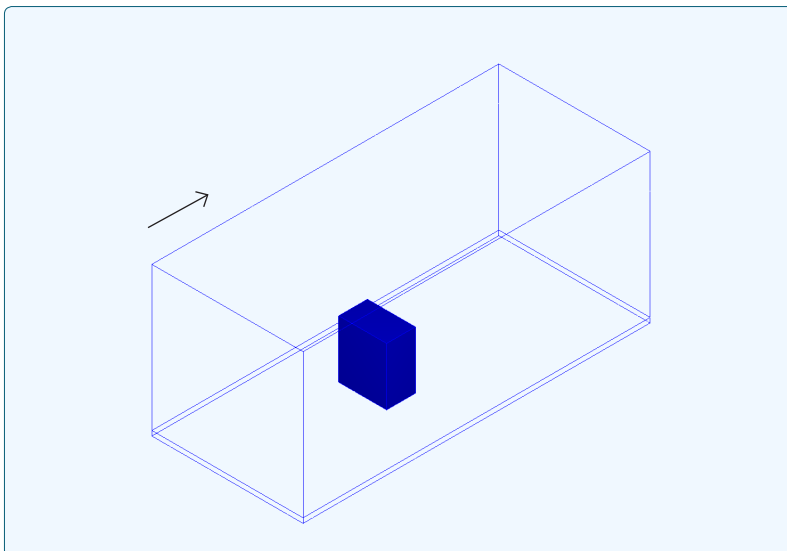

Figure 43 CFD analysis setup. Above: Massing and wind tunnel. Below: solar heat flux applied

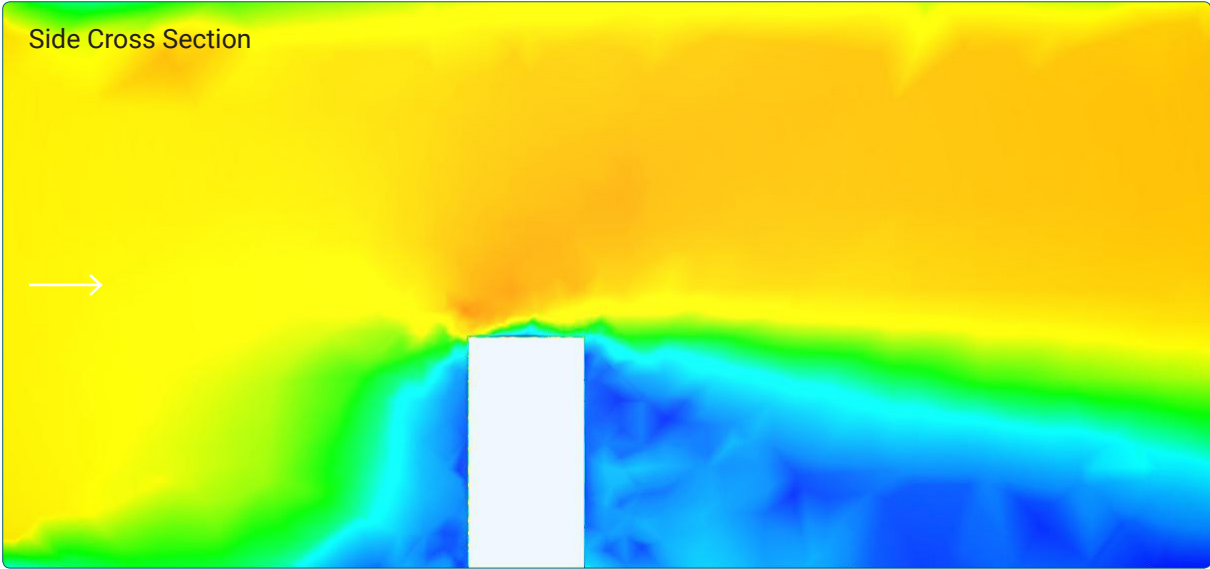
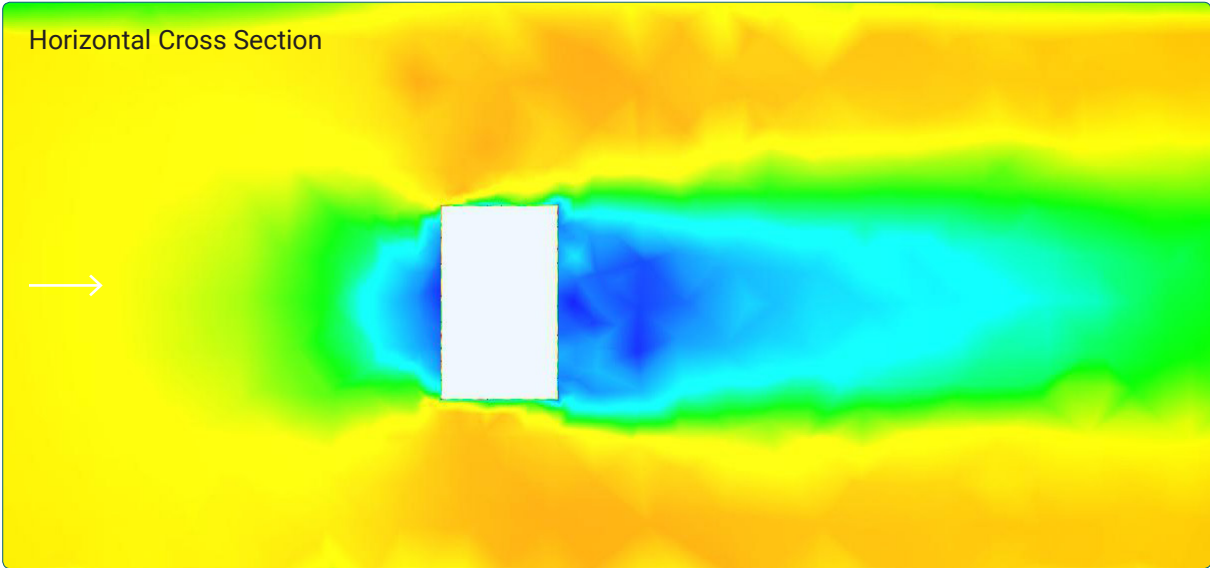
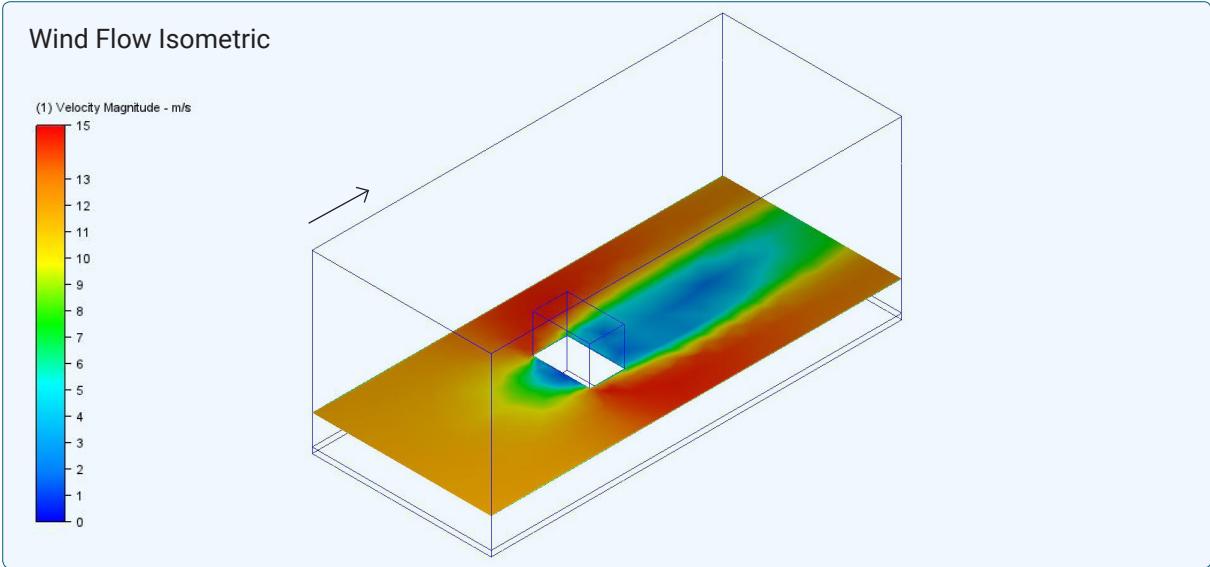
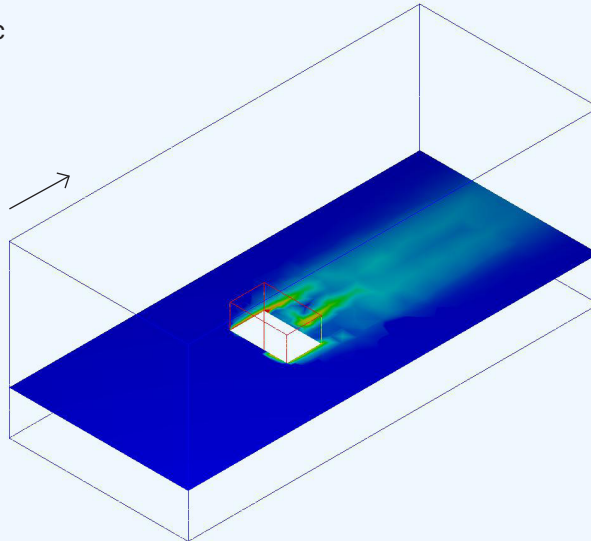
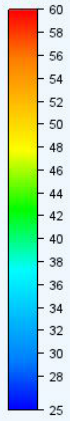

Figure 44 Steady state- wind flow analysis results

Heat Transfer Isometric

(6) Temperature - Celsius



Horizontal Cross Section

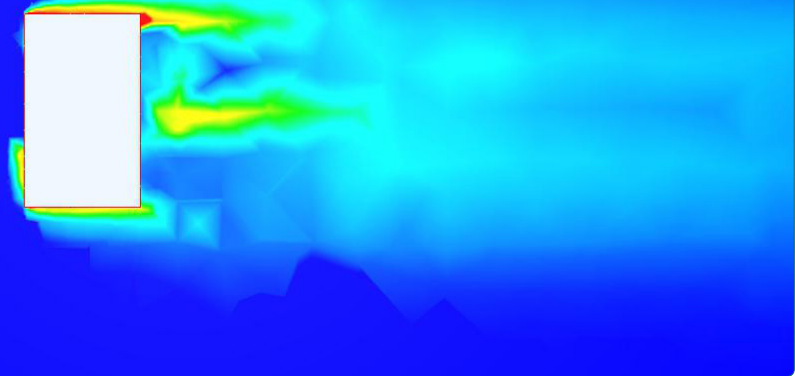
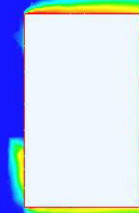

Side Cross Section

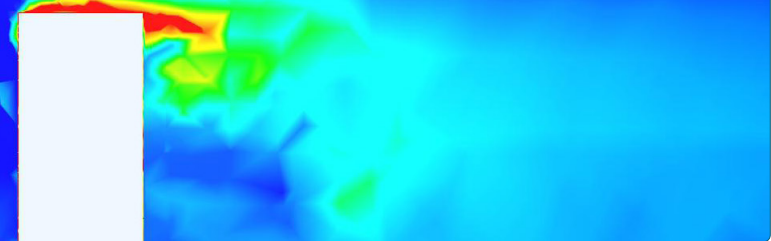
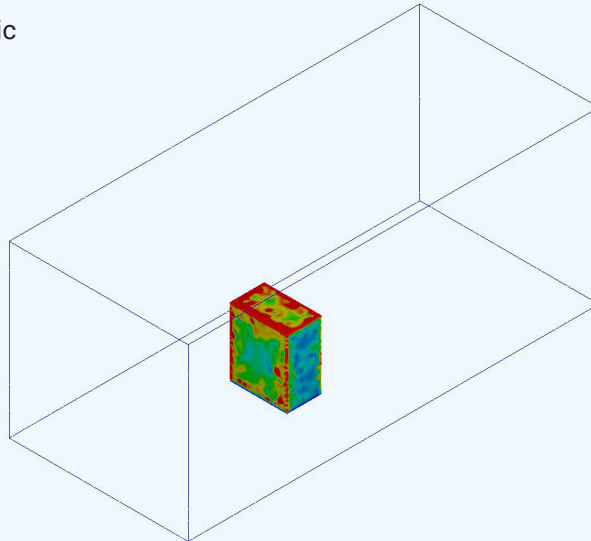

Figure 45 Steady state- wind flow analysis combined with solar heat flux and transient heat transfer analysis. Results of surface heat being transferred to surrounding air.

Surface Temp. Isometric



Front Elevation

(6) Temperature - Celsius

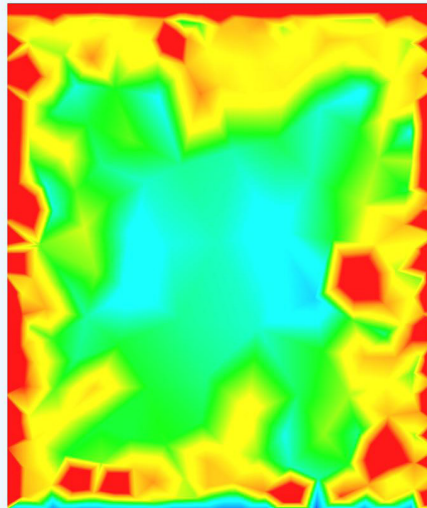
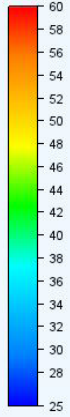

Side Elevation

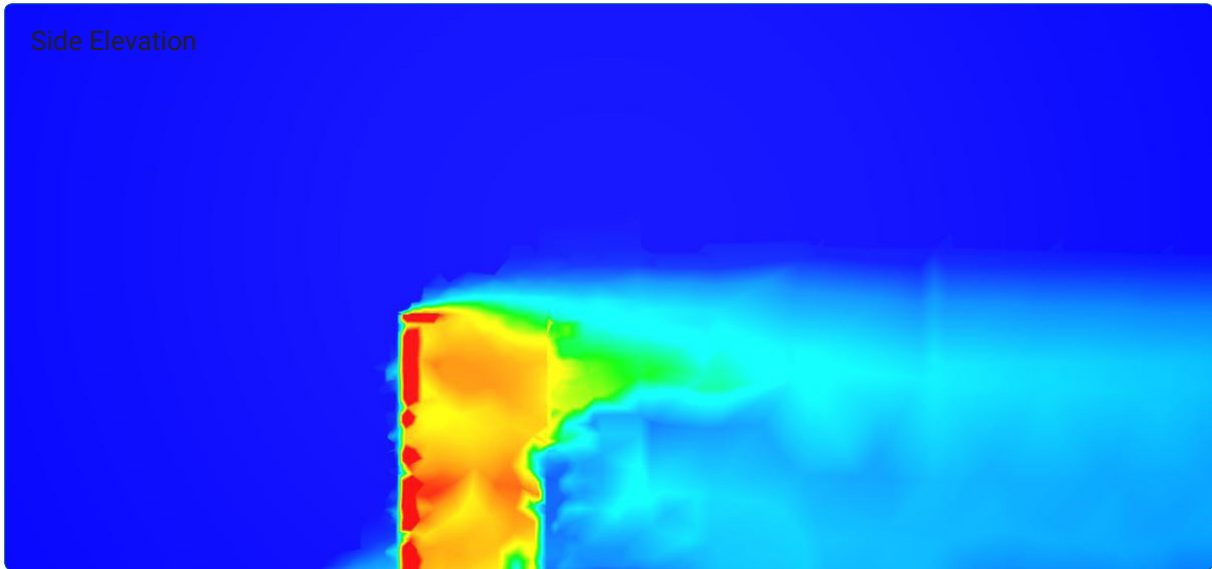

Figure 46 Surface temperature readings of the building

The second part of the analysis takes the steady state fluid flow and applies a heat transfer analysis. Because the building is experiencing solar heating on the surface, solar irradiation was applied to the surface using 13:00 on an average summer day as a baseline condition for the purposes of solar loading. Other common factors such as gravity, forced convection and transient steps were enabled to setup the parameters (menus can be found in the appendix of this report). Once the simulation was complete the results were as shown in figures Figure 45 and Figure 46.

10.2 CFD Results

Based on the results of the CFD analysis it is clear that solar irradiation combined high winds can lead to a wide range of wind velocities and temperatures on the surface of the facade. The pockets of low wind caused by turbulence can reduce the effects of forced convection. These changes in velocity reduce or increase the heat transfer coefficient in the heat transfer equations and produce different results than what the theoretical formula predicts.

Likewise, the turbulence can also distribute hot air across the surface creating zones of higher temperatures (Figure 46). This can also have an effect on the results by influencing the ambient air T variable in the heat balance equations. This can impact the resulting values for conduction heat flux and the convection heat flux. However, due to the wide range of temperatures and wind speeds were found on the surface of the facade it will be difficult to predict and simulate the overall impact a facade as a whole can have.

Further research is needed into more advanced simulation methods to achieve an accurate representation of a moss facade under solar loading and forced convection. Transient CFD analysis can be optimized to predict what potential this can have on the surrounding environment but would require an advanced CFD model and computing power. Hand calculations can produce a theoretical result that show the potential such a material can have, however this is limited to theoretical scenario and not representative of real world situation.

CONCLUSIONS

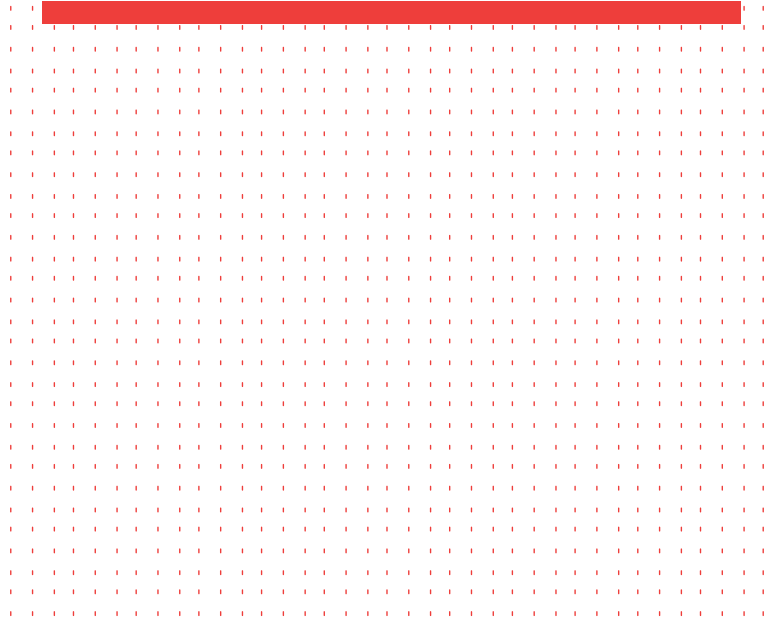
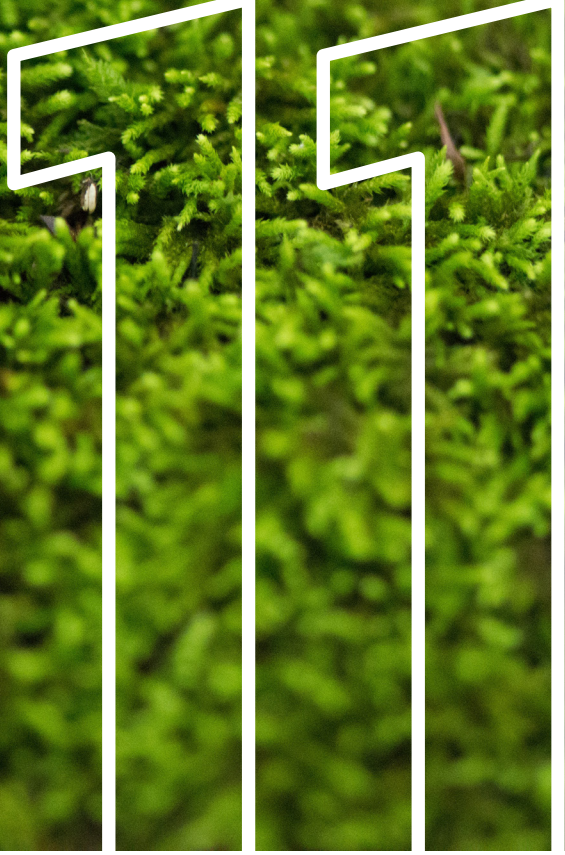

11.1 Conclusions

Throughout the report series of steps were taken to explore how bioreceptive materials be integrated into urban facades. The present state of bioreceptive research focuses on the development of the material and small prototypes and have yet to be implemented on a building scale. Due to this, literature relevant to the topics were distilled to a series of factors that can be implemented towards the generation of a bioreceptive facade. These guiding principles were used to drive the design and generate one which is focused on the successful implementation of a bioreceptive facade. Once created, the facade can be evaluated to determine what influence this new facade can have on external surface temperatures.

Answering the main research question of this report; the evaluation analyzes the potential to reduce external facade surface temperatures. Based on the calculations conducted in the report the use of bryophytes on the exterior of the facade can reduce surface temperatures by up to 3.7 °C and an additional 6.6 °C when under forced convection (theoretically). The largest contributor to the result is forced convection and the conductive heat transfer of moss. However, this effect is highly connected to wind velocity (forced convection) and the evaporation of water via latent heat. Given the transient nature of wind and the variable amounts of moisture the potential cooling effect will also be a constantly changing variable in a real world application. Building size and form is also an influential factor given the turbulence that can be created along the surface of the building.

Sub Questions:

What materials can be used that meet the requirements of a building facade as well as meeting the required properties of a bioreceptive material?

Currently only a few materials have been observed for their potential inherent bioreceptive properties, of these materials MPC has been documented to achieve the necessary material properties to achieve bioreceptivity. The report outlines how this material can be further improved to achieve the desired level of porosity and water retention to increase the bioreceptivity. However, this is only one potential material. Due to the fact that bioreceptivity is a material property and not a material type, there are many more potential materials that can be researched and developed in the future.

Which bryophytes (mosses, liverworts and hornworts) are suitable for vertical urban facades in the given site conditions?

The selection of the bryophytes are highly dependent on the material acting as the substrate and the environmental conditions present on site. The pH level of the material is a key determinant for the selection and the moss should be within the range of acidity of the

material. In the instance of the foamed MPC, the pH range is about 8 (although some modifications may be able to reduce this even further). Based on these conditions, a series of potential specimens were selected to be further refined (shown in table: xxxx).

What are the additional required systems to be integrated into the facade in order to successfully maintain facade growth (i.e. irrigation, sensors)?

Based on the development of the facade design and the existing research on bryophytes an irrigation system is strongly recommended. However, this may change depending on the environmental conditions and the height of the building. As discussed in the irrigation section of this thesis, the irrigation system provides many more benefits than just maintaining the health of the moss; such as maintaining the cooling potential of the surface through latent heat and as delivery method for nutrients.

Other systems that should be added to the facade can also include humidity sensors and a micro weather station. These are also necessary for optimizing the activation of the irrigation system. As discussed in the thesis, these are important for the longevity of the bryophytes and monitoring the moisture on the surface to improve upon the cooling potential of the surface.

What influence will this facade have on the external temperature of a building?

The performance of this bioreceptive facade is highly dependent on the speed of wind making contact with the facade. This is an unpredictable variable that can change in direction or velocity at a moments notice. Evaluating the facade with both a static and transient scenarios shows how the cooling effect can either be more prominent or reduced at different points on the facade. This makes the result much more unpredictable. However, by taking some averages for the environmental conditions that are present on site a generalized reduction of about 2 - 4 °C can be estimated. Additionally, the result is dependent on how much of this material is being used in the design and the window to wall ratio can influence the overall impact of the building.

11.2 Reflection

As stated previously, this concept of integrating bioreceptive materials still needs to be expanded upon and further evaluated. It is also important to note that there is a considerable amount of overlap between different fields. Some of these are obvious fields within the realm of construction such as Architecture, Engineering, Building Physics and Facade fabrication. However, other fields uncommon in the realm of Architecture or building construction such as, Bryology, Horticulture and Irrigation systems that make the thesis

concept unique. Merging these different fields together is necessary to create a successful bioreceptive facade. However, this also requires a wide ranging body of knowledge to support the development of the concept.

The concept of bioreceptive materials are still in their infancy but further exploration into this up and coming material can help push the concept of bioreceptivity into reality. The aim of the thesis was to improve upon the material research and further develop it into a facade system for urban environments. Only then can the facade be evaluated for the thermal impact that this could have on building surface temperatures. There are promising results to support the idea that integrating these bioreceptive materials into urban areas will have an impact on the surface of the facade. Based on calculations conducted in the report the use of bryophytes on the exterior of the facade can reduce surface temperatures by up to 3.7 °C and an additional 6.6 °C when under forced convection (theoretically). The largest contributor to the result is forced convection and the conductive heat transfer of moss. However, this effect is highly connected to wind velocity (forced convection) and the evaporation of water via latent heat.

The thermal performance results of this paper falls into line with similar research conducted on moss green roofs in Japan (Katoh, Katsurayama, Koganei & Mizunuma, 2018). Similar to their findings, the thermal performance was affected by the wind velocity in combination with the moisture of the moss. However, these variables change throughout the facade as shown by the CFD building wind analysis. By sampling different locations of the facade for different velocities it can be observed where the effect of forced convection changes. Unlike solar irradiation which can be calculated with a degree of accuracy, wind is a transient, and wind velocities can fluctuate causing the result to fluctuate as well. However based on the research outlined in the report, speeds above 2 m/s differ only slightly. So long as the minimum speeds of 2 m/s are met there should be an adequate amount of forced convection.

Additionally, given the highly unpredictable nature of urban environments, there are many more factors that can impact the actual result. Thus, further validation is needed to support the initial claims of this report. More intensive CFD transient simulations can be used to optimize the effects of forced convection on moss at a micro and macro scale. It is also recommended that material prototypes be developed and monitored over time in both laboratory and real world environments to further validate the result.

Just as important as understanding the benefits it is also important to investigate the limitations of bioreceptive facades. This paper outlines some of those limitations based on the environmental conditions of the species of bryophytes being used for the mate-

rial. These limitations are set based on the regional conditions of Europe and assumes the solar conditions, relative humidity, ambient temperature and wind speeds of The Netherlands for the purposes of simulations. The results of this paper may vary based on the climatic conditions of a different geographical location. Additionally, bryophytes and the concept as a whole may not be suitable in other regions of the world. Thus, climatic conditions and existing flora should therefore be carefully investigated before implementing any bioreceptive materials. Additionally, there are no guidelines for the climatic and regional limits of the concept and further development of these limitations are needed in order to better define its application.

The underlying literature research conducted in this thesis and the current development of the concept by research groups are still in their early stages. The limited body of work has created some issues when it comes to sourcing the correct supporting research. This can impact the success of the concept, with many aspects still being investigated (at the time of this writing) and needs to be reevaluated once a large body of work has been developed. The field of bioreceptive materials for construction remains in uncharted territory and allows plenty of room for the development of ideas around the concept. Bioreceptive facades are a challenging feat to accomplish, however the potential to pave the way for a new green facade typology makes this a worthwhile endeavor.

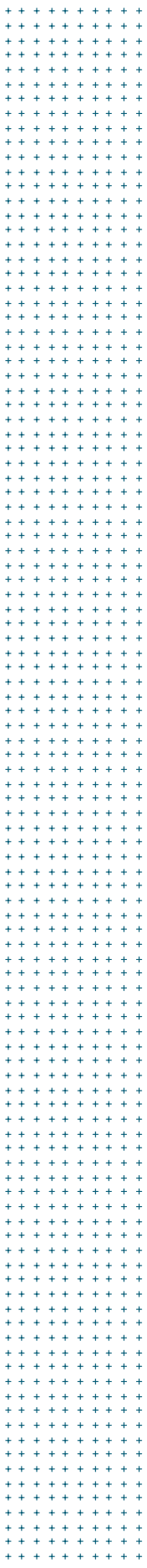

11.3 Further Exploration:

This report highlights the impact that bioreceptive materials can have on the surface temperature of the building however, yet this is only one potential benefits of this material. It is important to note that there are many more aspects to be explored and tested when it comes to bioreceptive materials. Some potential aspects to be further explored include but are not limited to: CO2 sequestration, particulate matter & air purification, rainwater absorption, urban biodiversity, moss as an insulator, among others.

This new category of green facades still has room for further development and exploration. Building upon the research generated in this report there are opportunities to further expand the body of work. The report outlines a series of principals that should be followed however, some aspects are open ended and leave room to develop different design variants. In the case of wind and geometry, different forms can be investigated for their influence on wind along the facade's surface. Another aspect to be further investigated is the application of the irrigation system. This report developed a misting system as a way to provide supplemental water and nutrients to the surface, however this should be properly investigated to determine how a misting system may function on an urban facade and how moisture can be evenly distributed on the surface.

In order to properly measure the impact, a prototype should be developed that can meet the requirements of bioreceptive materials. This requires developing a system dimensioned to the appropriate sizes, selecting suitable materials and integrating the correct systems. The thesis provides the proper foundation for the development of the concept however, based on the underlying research, further steps can be taken to improve the facade to increase the chances of success. The steps explored in the report include wind optimization and creating geometric grooves on the surface, both of which can increase the colonization of the surface with bryophytes. A prototype of these techniques can be further developed and evaluated for their performance over time.

Furthermore, the thesis is not set up to be a comparative study of green facades systems or living wall products. The existing green systems were taken into account when designing the facade components and with the intention of simplifying the systems. However, it was not intended to make definitive comparisons between the bioreceptive facade and other vertical green systems. Further LCA, product cost, production cost and maintenance costs are needed in order to compare this green facade with others. This will ultimately determine the economic incentives to implement this new green facade typology.

Literature

Cruz, M., & Beckett, R. (2016). *Bioreceptive design: a novel approach to biodigital materiality*. Cambridge University Press.

Delta Programme (2015). *Working on the Delta. The Decisions to Keep the Netherlands Safe and Liveable*. Publication of the Ministry of Infrastructure and the Environment and the Ministry of Economic Affairs (<https://english.deltacommissaris.nl/documents/publications/2014/09/16/delta-programme-2015>).

Dutch Bryological and Lichenological Society. (2019). Retrieved from <https://www.blwg.nl/mossen/mossen/mossen.aspx>

Glime, J. (2017). *Bryophyte Ecology [Ebook]*. Michigan Technological University and the International Association of Bryologists.

Goryainova, Z., Vuković, G., Urošević, M., Vergel, K., Ostrovnaya, T., Frontasyeva, M., & Zechmeister, H. (2016). Assessment of vertical element distribution in street canyons using the moss *Sphagnum girgensohnii*: A case study in Belgrade and Moscow cities. *Atmospheric Pollution Research*, 7(4), 690-697. doi: 10.1016/j.apr.2016.02.013

Guillitte, O. (1995). Bioreceptivity: a new concept for building ecology studies. *Science Of The Total Environment*, 167(1-3), 215-220. doi: 10.1016/0048-9697(95)04582-1

Gulotta, D., Villa, F., Cappitelli, F., & Toniolo, L. (2018). Biofilm colonization of metamorphic lithotypes of a renaissance cathedral exposed to urban atmosphere. *Science Of The Total Environment*, 639, 1480-1490. doi: 10.1016/j.scitotenv.2018.05.277

Hoeven, F. D., van der & Wandl, A. (2015) *Hotterdam. How space is making Rotterdam warmer, how this affects the health of its inhabitants, and what can be done about it*. Delft, the Netherlands: TU Delft.

Huang, Y., Zheng, Y., Li, J., Liao, Q., Fu, Q., & Xia, A. et al. (2018). Enhancing microalgae biofilm formation and growth by fabricating microgrooves onto the substrate surface. *Bioresource Technology*, 261, 36-43. doi: 10.1016/j.biortech.2018.03.139

K., M., Kato, Y., Katsurayama, H., Koganei, M., & Mizunuma, M. (2018). Effects of convection heat transfer on Sunagoke moss green roof: A laboratory study. *Energy And Buildings*, 158, 1417-1428. doi: 10.1016/j.enbuild.2017.11.043

Khalilzadeh, A., Ge, H., & Ng, H. (2019). Effect of turbulence modeling schemes on wind-driven rain deposition on a mid-rise building: CFD modeling and validation. *Journal Of Wind Engineering And Industrial Aerodynamics*, 184, 362-377. doi: 10.1016/j.jweia.2018.11.012

Klok, E., & Kluck, J. (2018). Reasons to adapt to urban heat (in the Netherlands). *Urban Climate*, 23, 342-351. doi: 10.1016/j.uclim.2016.10.005

Li, T., Wang, Z., Zhou, T., He, Y., & Huang, F. (2019). Preparation and properties of magnesium phosphate cement foam concrete with H₂O₂ as foaming agent. *Construction And Building Materials*, 205, 566-573. doi: 10.1016/j.conbuildmat.2019.02.022

Manso, S., De Muynck, W., Segura, I., Aguado, A., Steppe, K., Boon, N., & De Belie, N. (2014). Bioreceptivity evaluation of cementitious materials designed to stimulate biological growth. *Science Of The Total Environment*, 481, 232-241. doi: 10.1016/j.scitotenv.2014.02.059

Manso, S., Mestres, G., Ginebra, M., De Belie, N., Segura, I., & Aguado, A. (2014). Development of a low pH cementitious material to enlarge bioreceptivity. *Construction And Building Materials*, 54, 485-495. doi: 10.1016/j.conbuildmat.2014.01.001

Medl, A., Florineth, F., Kikuta, S., & Mayr, S. (2018). Irrigation of 'Green walls' is necessary to avoid drought stress of grass vegetation (*Phleum pratense* L.). *Ecological Engineering*, 113, 21-26. doi: 10.1016/j.ecoleng.2018.01.007

Miller, A., Sanmartín, P., Pereira-Pardo, L., Dionísio, A., Saiz-Jimenez, C., Macedo, M., & Prieto, B. (2012). Bioreceptivity of building stones: A review. *Science Of The Total Environment*, 426, 1-12. doi: 10.1016/j.scitotenv.2012.03.026

Ottelé, M. (2011). *The Green Building Envelope*. TU Delft: Technische Universiteit Delft.

Reski, R. (2018). Quantitative moss cell biology. *Current Opinion In Plant Biology*, 46, 39-47. doi: 10.1016/j.pbi.2018.07.005

Safikhani, T., Abdullah, A., Ossen, D., & Baharvand, M. (2014). A review of energy characteristic of vertical greenery systems. *Renewable And Sustainable Energy Reviews*, 40, 450-462. doi: 10.1016/j.rser.2014.07.166

Sujetovienė, G., & Galinytė, V. (2016). Effects of the urban environmental conditions on the physiology of lichen and moss. *Atmospheric Pollution Research*, 7(4), 611-618. doi: 10.1016/j.apr.2016.02.009

Udawattha, C., Galkanda, H., Ariyaratne, I., Jayasinghe, G., & Halwatura, R. (2018). Mold growth and moss growth on tropical walls. *Building And Environment*, 137, 268-279. doi: 10.1016/j.buildenv.2018.04.018

Ward, K., Lauf, S., Kleinschmit, B., & Endlicher, W. (2016). Heat waves and urban heat islands in Europe: A review of relevant drivers. *Science Of The Total Environment*, 569-570, 527-539. doi: 10.1016/j.scitotenv.2016.06.119

Appendix

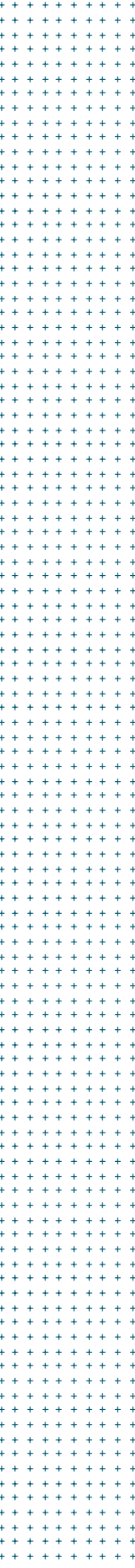

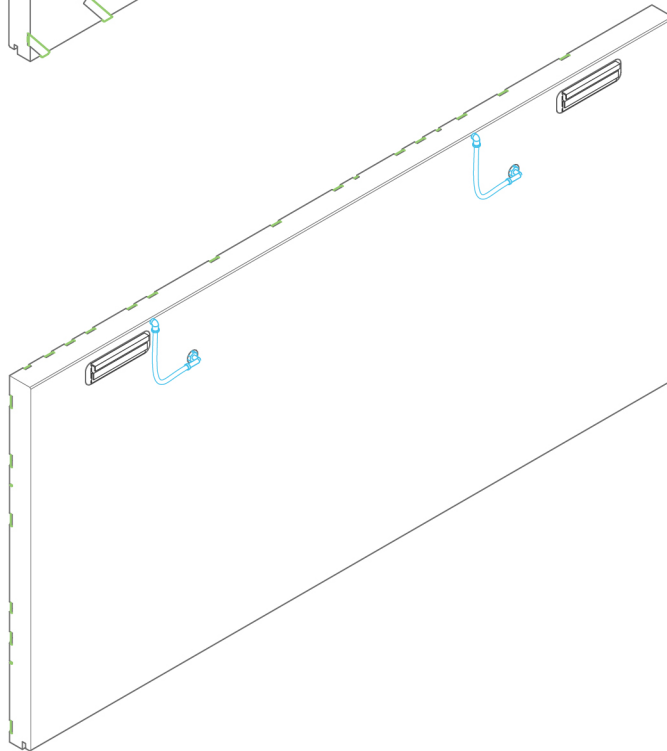
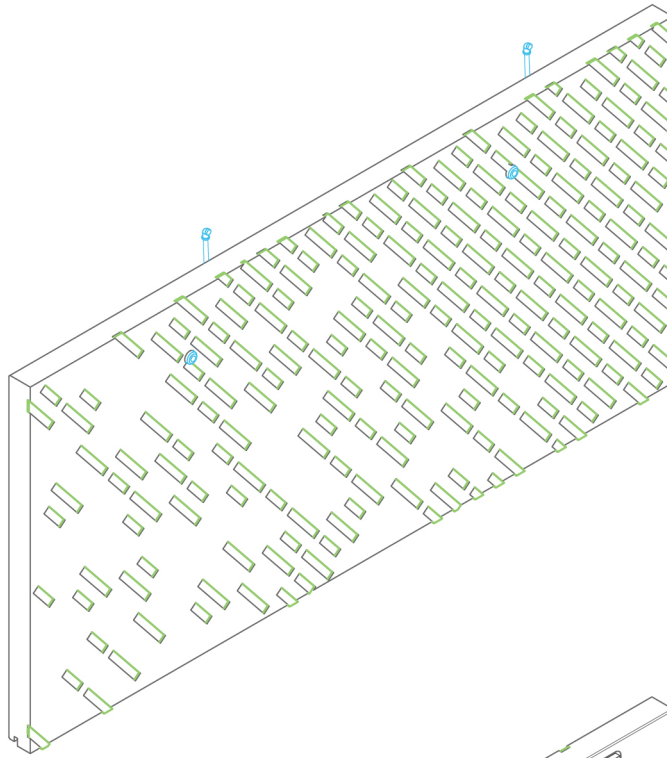

FACADE PANEL - FRONT AND BACK

SCALE: 1-10

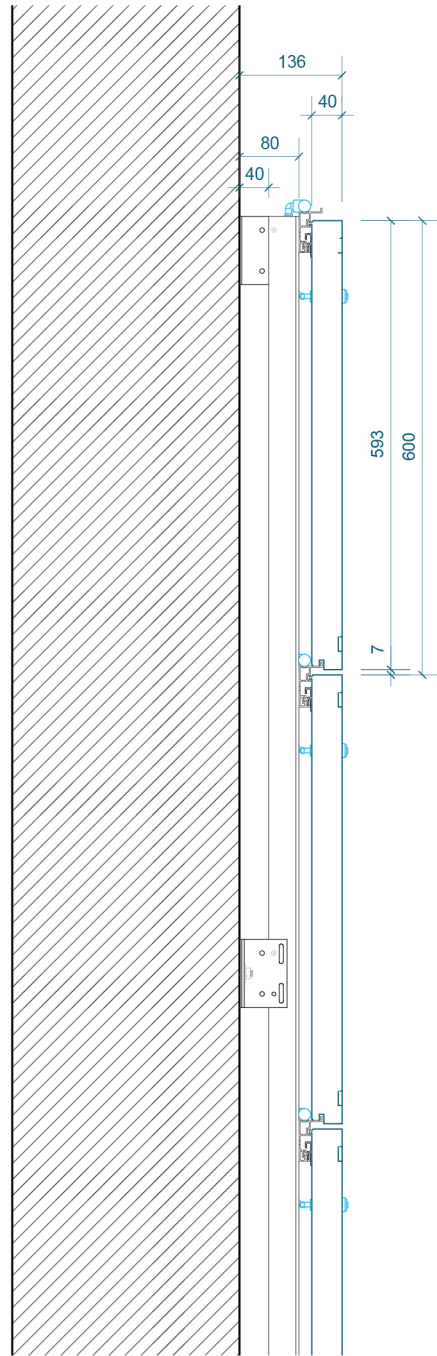

SECTION- FACADE

SCALE: 1-10

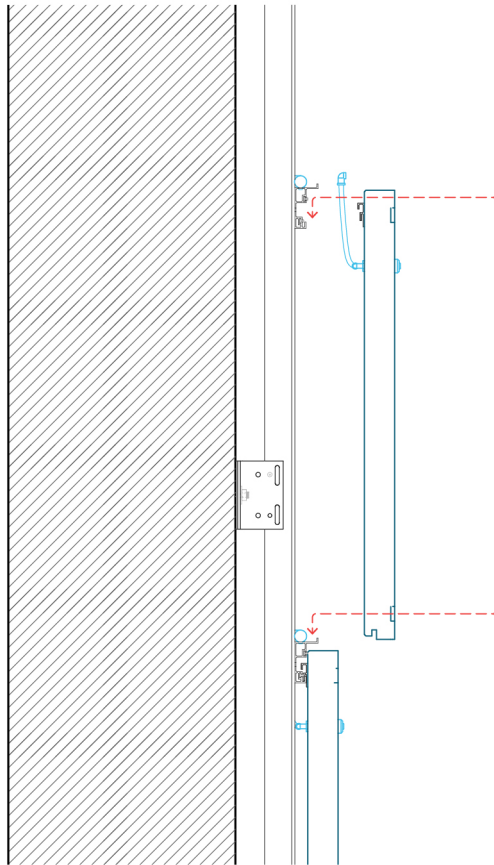

MOUNTING PANEL TO SUBSTRUCTURE

SCALE: 1-10

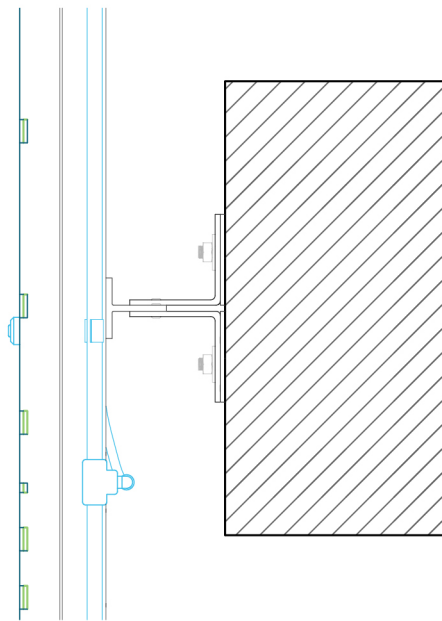

MOUNTING TO STRUCTURE - TOP

SCALE: 1-5

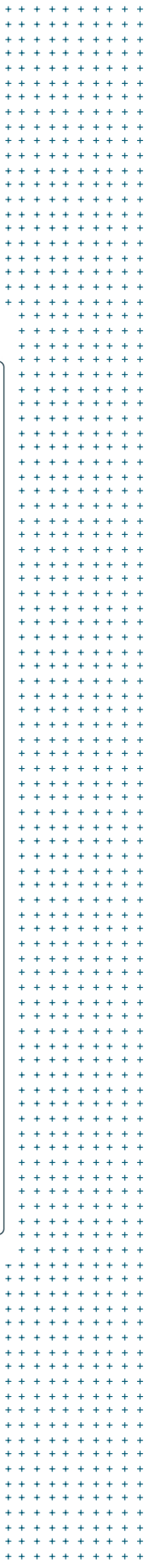

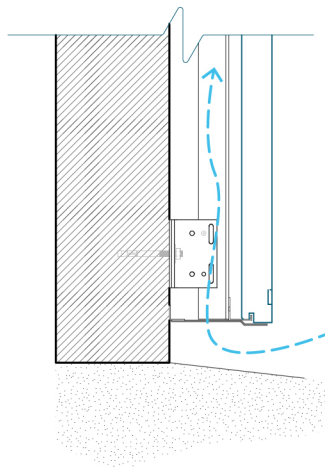
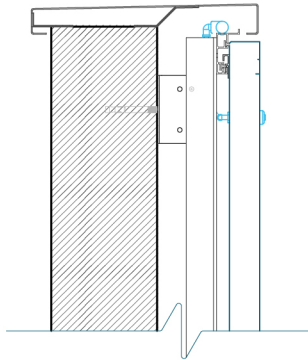

TOP COPING AND BOTTOM VENT

SCALE: 1-10

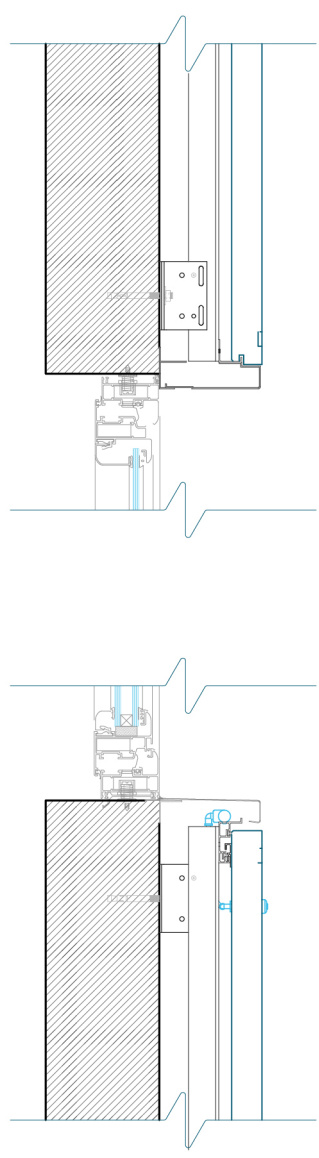
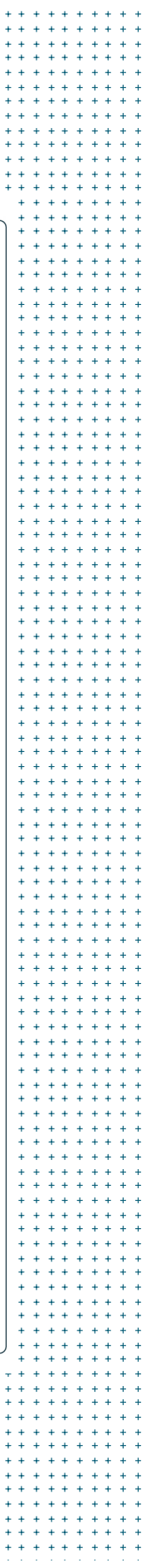

CLADDING AT WINDOW

SCALE: 1-10

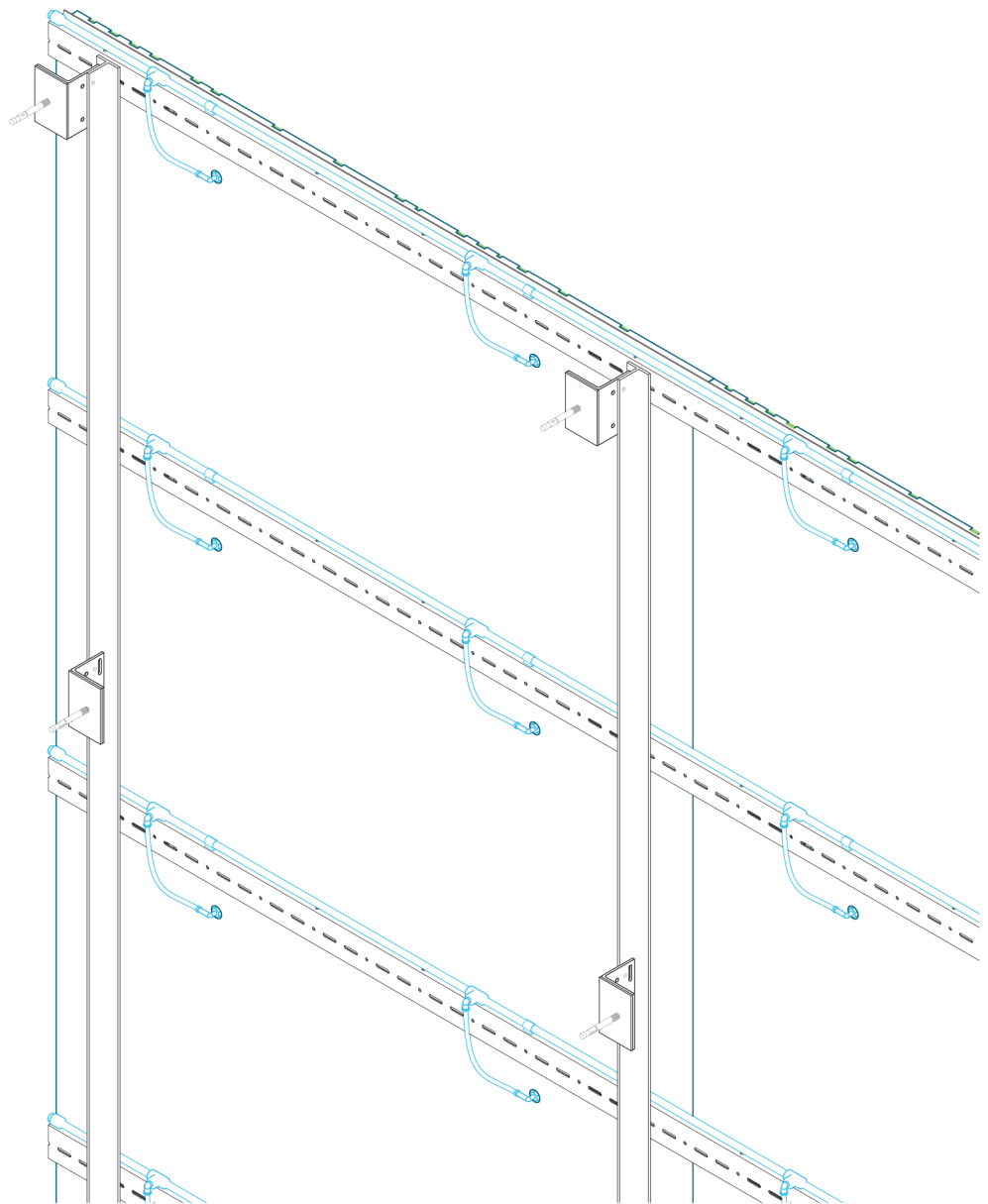

IRRIGATION CONNECTIONS - BACK

SCALE: 1-10

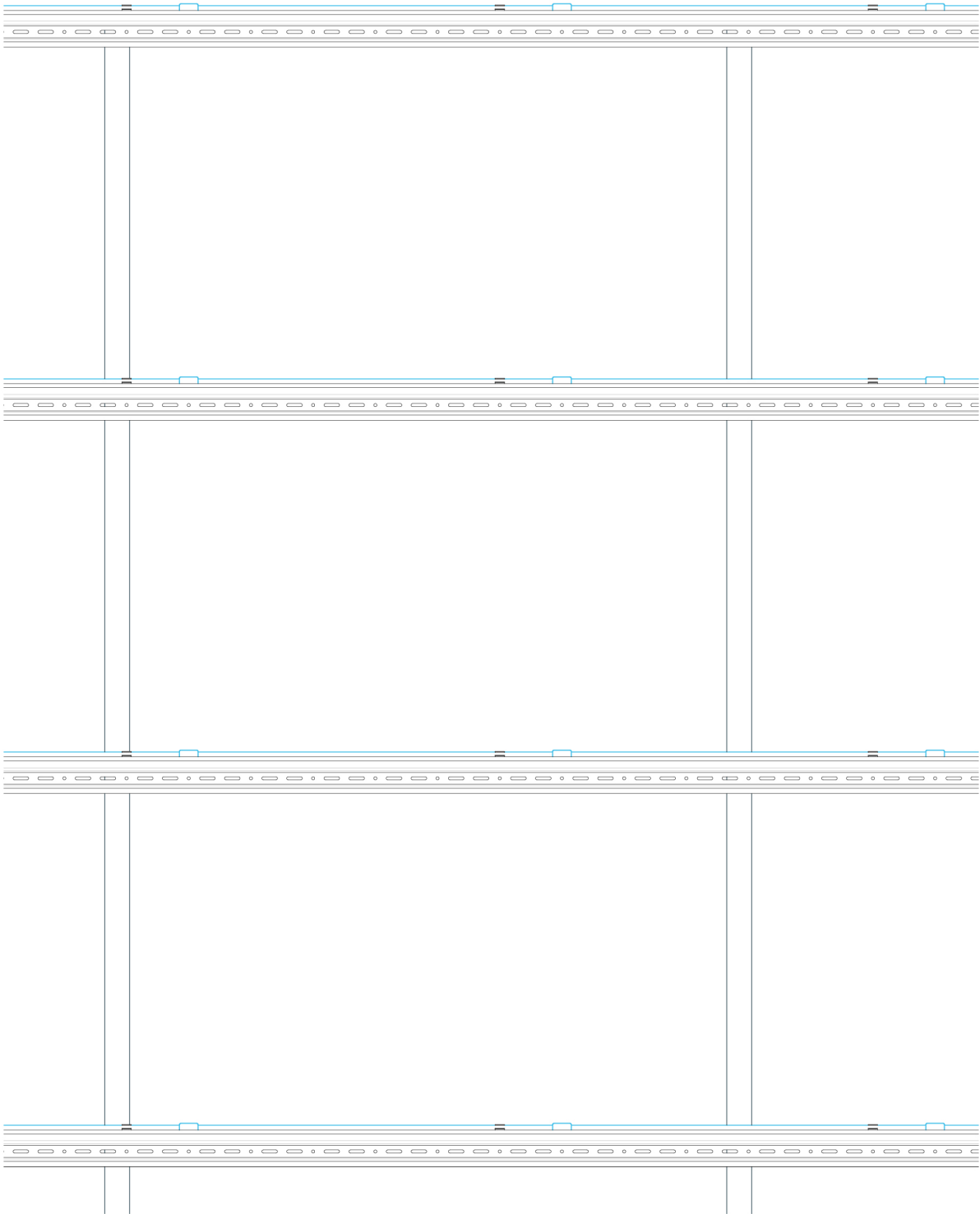

FACADE STRUCTURE - FRONT

SCALE: 1-10



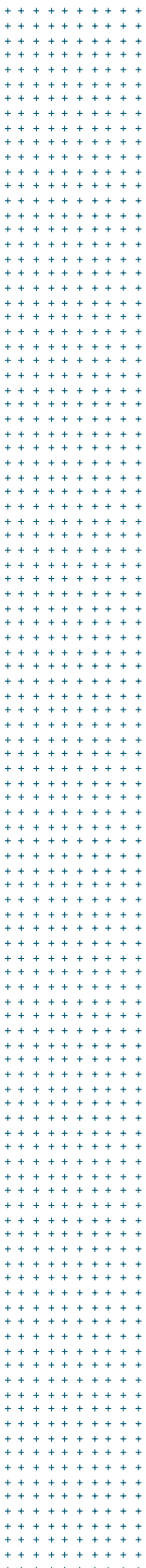

Equations List:

$$Q_{sun} = Q_{convection} + Q_{conduction} + Q_{latent}$$

$$Gr = \frac{g\beta(T_s - T_\infty)L^3}{\nu^2}$$

$$Re = \frac{U_{average}L}{\nu}$$

$$Q_{latent} = \frac{el}{tA}$$

$$Q_{convection} = h(T_s - T_\infty)$$

$$Q_{conduction} = \frac{\Delta T}{r_T}$$

Supplemental Calculations:

$$Q_{sun} = Q_{convection} + Q_{conduction} + Q_{latent}$$

$$Q_{sun} = 0.7(800W) = 560$$

$$Q_{conduction} = \frac{\Delta T}{.141}$$

$$Q_{convection} = 24.5(T_s - 25)$$

$$Q_{latent} = \frac{e(2257)}{t(1)}$$

$$\frac{(560 - 7)}{36} + 25 - .251 = 15.3 + 25 - .251 = 40.1^\circ C$$

$$\frac{(560 - 7)}{66} + 25 - .251 = 8.3 + 25 - .251 = 33.5^\circ C$$

Properties for Autodesk CFD: Air

Properties	
Density	Equation of State
Viscosity	1.817e-05 Pa-s
Conductivity	0.02563 W/m-K
Specific heat	1004 J/kg-K
Compressibility	Cp/Cv 1.4
Emissivity	0.3
Wall roughness	0 meter
Phase	0 Pa

Properties for Autodesk CFD: Air Velocity

Boundary Conditions	
Property settings	
Type	Velocity
Unit	m/s
Time	Steady State
Method	Normal
Direction	Reverse Normal
Spatial Variations	Constant
Velocity Magnitude	10

Apply Remove Cancel

Solver for Autodesk CFD: Heat Transfer

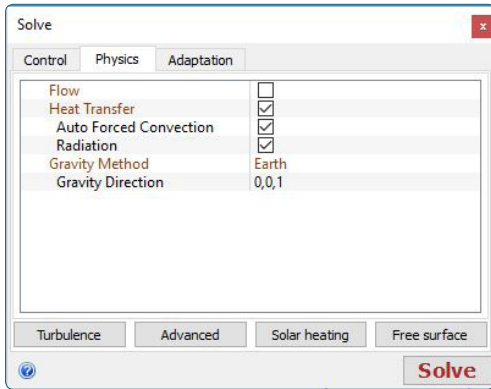

Solver for Autodesk CFD: Steady State - Flow

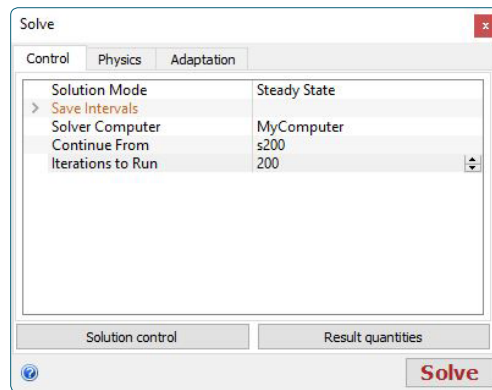
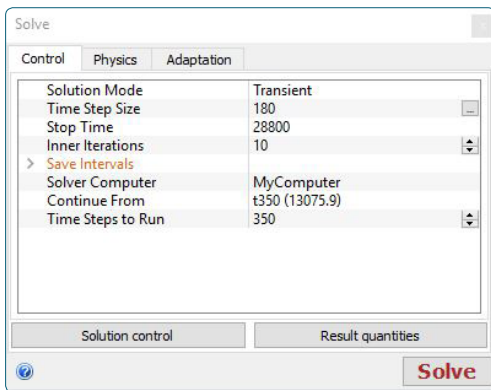
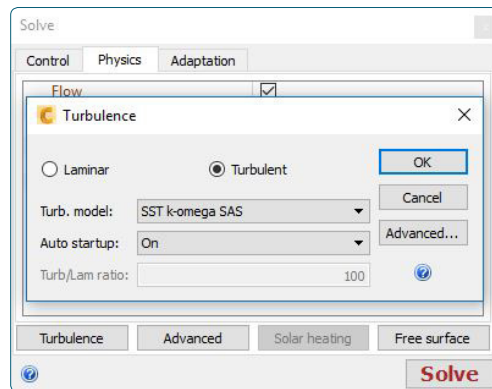
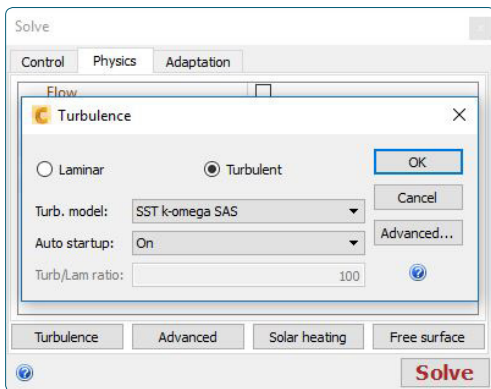
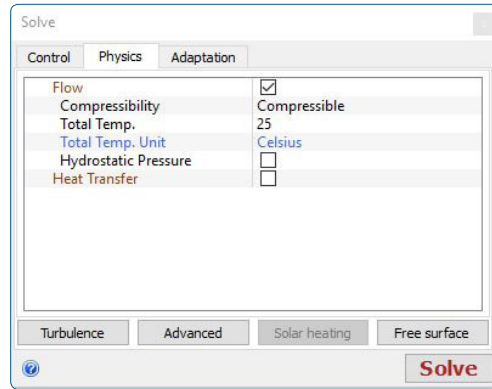



Diego Valencia - 4742699

First Mentor: Alejandro Prieto

Second Mentor: Marc Otte 

Delft University of Technology

Track: Building Technology

www.bioreceptive.com